



HAL
open science

Routing, Protection and Traffic Engineering in WDM All-Optical Networks

Mohamed Koubàa

► **To cite this version:**

Mohamed Koubàa. Routing, Protection and Traffic Engineering in WDM All-Optical Networks. domain_other. Télécom ParisTech, 2005. English. NNT: . pastel-00001947

HAL Id: pastel-00001947

<https://pastel.hal.science/pastel-00001947>

Submitted on 12 Oct 2006

HAL is a multi-disciplinary open access archive for the deposit and dissemination of scientific research documents, whether they are published or not. The documents may come from teaching and research institutions in France or abroad, or from public or private research centers.

L'archive ouverte pluridisciplinaire **HAL**, est destinée au dépôt et à la diffusion de documents scientifiques de niveau recherche, publiés ou non, émanant des établissements d'enseignement et de recherche français ou étrangers, des laboratoires publics ou privés.

THÈSE

présentée à

l'École Nationale Supérieure des Télécommunications

pour obtenir le grade de

Docteur de l'École Nationale Supérieure des Télécommunications
Spécialité : Informatique et Réseaux

par

Mohamed Koubàa

Routage, protection et ingénierie de trafic dans les réseaux WDM tout-optiques

Soutenue à l'ENST Paris le 2 décembre 2005 devant le jury composé de:

Président

Professeur Dominique Seret

Université René Descartes de Paris V, France

Rapporteurs

Professeur Piet Demeester

Université de Gent, Belgique

Professeur Gérard Hébuterne

Institut National des Télécommunications, France

Examineurs

Professeur Marco Ajmone Marsan

École Polytechnique de Turin, Italie

Professeur Samir Thomé

Université de Versailles Saint-Quentin, France

Directeurs de thèse

Professeur Maurice Gagnaire

École Nationale Supérieure des Télécommunications, France

Docteur Nicolas Puech

École Nationale Supérieure des Télécommunications, France

Routing, Protection and Traffic Engineering in WDM All-Optical Networks

by

Mohamed Koubàa

A thesis submitted to the

École Nationale Supérieure des Télécommunications

in partial fulfillment of the requirements for the degree of

Doctor of Philosophy

Examining committee:

Professeur Dominique Seret	Université René Descartes de Paris V, France
Professeur Piet Demeester	Ghent University - IBBT - IMEC, Belgium
Professeur Gérard Hébuterne	Institut National des Télécommunications, France
Professeur Marco Ajmone Marsan	Politecnico di Torino, Italy
Professeur Samir Tohmé	Université de Versailles Saint-Quentin, France
Professeur Maurice Gagnaire	École Nationale Supérieure des Télécommunications, France
Docteur Nicolas Puech	École Nationale Supérieure des Télécommunications, France

École Nationale Supérieure des Télécommunications, Paris, France

December 2, 2005.

Dedicated to
to my family and friends.

Remerciements

Mes premiers remerciements iront à mon directeur de thèse, Maurice Gagnaire, Professeur au département Informatique et Réseaux de l'ENST, pour avoir encadré mon travail depuis mon projet de fin d'études d'Ingénieur en Télécommunications de l'École Supérieure des Communications de Tunis, en passant par le DEA et pendant les trois années de thèse. Il m'a permis de toucher à plusieurs sujets de recherche tous passionnants. Outre ses conseils avisés, j'ai apprécié sa sympathie, sa rigueur, son esprit critique et sa grande pédagogie, dont, j'espère, j'ai su profiter.

Ma profonde reconnaissance va aussi à Nicolas Puech, Docteur au département Informatique et Réseaux de l'ENST, pour avoir co-encadré cette thèse. J'ai pu apprécier ses qualités techniques et humaines pendant ces trois années et profiter de ses remarques et conseils. Je le remercie également pour la relecture du présent document.

Je désire exprimer ma profonde gratitude au gouvernement français qui, à travers le Centre National de Recherche Scientifique (CNRS), a financé mes travaux de recherche en thèse grâce à une bourse de docteur ingénieur (BDI).

Je souhaite également exprimer ma profonde gratitude au gouvernement tunisien qui, à travers le Ministère de l'Enseignement Supérieur, a financé mes études de troisième cycle en France.

Je tiens à remercier très sincèrement Madame Dominique Seret, Professeur à l'Université René Descartes et Vice-présidente de l'Université de Paris V, Monsieur Piet Demeester, Professeur à l'Université de Gent (Belgique), Monsieur Gérard Hébuterne, Professeur à l'Institut National des Télécommunications, Monsieur Marco Ajmone Marsan, Professeur au Politecnico di Torino (Italie), et Monsieur Samir Tohmé, Professeur à l'Université de Versailles Saint-Quentin, pour m'avoir fait l'honneur de participer au jury de thèse et pour les questions très constructives qu'ils m'ont posées. J'ai été particulièrement touché par l'honneur que Madame Dominique Seret m'a fait de présider le jury de cette thèse.

Je tiens aussi à remercier chaleureusement Messieurs Piet Demeester et Gérard Hébuterne pour la lecture très attentive de mon rapport de thèse. Je leur suis particulièrement reconnaissant pour les remarques et suggestions qu'ils m'ont faites.

Je voudrais également remercier Madame Isabelle Demeure puis Monsieur Michel Riguidel pour m'avoir accepté dans le département Informatique et Réseaux de l'ENST. Ils m'ont permis de mener mes travaux de thèse dans d'excellentes conditions et de participer à plusieurs congrès internationaux. J'ai une pensée toute particulière pour toute l'équipe du département, les doctorants et stagiaires avec qui j'ai partagé ces trois années avec beaucoup de bonheur et parmi lesquels je compte à présent certains de mes meilleurs amis.

Un grand merci à Monsieur Bernard Robinet, Directeur de l'École Doctorale, pour sa générosité et ses conseils avisés.

Enfin, j'ai une pensée émue à mes parents et toute ma famille, sans qui je n'aurais jamais pu arriver ici. Je suis heureux de leur avoir apporté ce résultat.

Résumé

Introduction

La croissance du trafic, la complexité des systèmes et l'arrivée de nouveaux acteurs dans le domaine des télécommunications donnent à la planification des grands réseaux de transport une importance toute particulière. L'introduction du multiplexage en longueurs d'onde dans le but d'augmenter les capacités de transmission et d'acheminement mais également la flexibilité et la rentabilité des systèmes, conduit de plus en plus à une optimisation des systèmes existants et à une meilleure intégration des systèmes de nouvelle génération. Nous nous intéressons essentiellement à la partie longue distance des réseaux d'opérateurs. Dans cette thèse nous traitons de la planification de réseaux WDM complètement transparents. Nous avons recours à l'optimisation pour résoudre les modèles mathématiques décrivant ces problèmes. Pour des réseaux comportant un nombre limité de nœuds et pour des matrices de trafic avec un nombre réduit de demandes, il est possible d'obtenir des solutions exactes à l'aide de solveurs. Pour des situations plus complexes, la combinatoire ne permet pas d'obtenir des solutions exactes, on est contraint de recourir à des méthodes approchées utilisant des méta-heuristiques ou simplement des heuristiques.

Les résultats obtenus dans le cadre de la thèse portent principalement sur l'étude des communications transparentes par multiplexage en longueur d'onde. Ils s'inscrivent dans une thématique d'allocation des ressources en vue de réaliser des communications dans un réseau. La problématique générale que nous avons considérée peut se résumer de la manière suivante. Il s'agit de satisfaire dans un réseau tout-optique dont la capacité est finie (le nombre de longueur d'onde disponibles sur chaque lien du réseau étant limité) un ensemble de demandes de trafic, appelé instance de communication, l'objectif étant de minimiser le nombre de demandes de trafic rejetées. La satisfaction d'une requête passe par l'attribution d'un ou plusieurs chemins dans le réseau et d'une ou plusieurs longueurs d'onde pour chaque chemin en fonction du nombre de circuits optiques requis par la demande.

Un circuit optique (lightpath) est supposé utiliser la même longueur d'onde sur tous les liens qu'il traverse pour relier la source à la destination du circuit considéré. Cette contrainte est connue sous le

nom de contrainte de continuité en longueur d'onde. On supposera aussi que deux circuits optiques partageant un ou plusieurs liens en commun ne peuvent en aucun cas utiliser la même longueur d'onde.

Le modèle de trafic considéré est constitué pas la combinaison de trois types de demandes de trafic à savoir les demandes de trafic permanentes (Permanent Lightpath Demands, (PLDs)), les demandes de trafic pré-planifiées (Scheduled Lightpath Demands, (SLDs)) et les demandes de trafic aléatoires (Random Lightpath Demands, (RLDs)).

Une PLD est une demande de trafic connue à l'avance caractérisée par un triplet (s, d, π) , où s et d sont respectivement les nœuds source et destination de la demande de trafic. π est un nombre entier représentant le nombre de circuits optiques à établir entre s et d ($\pi \geq 1$). Une fois acceptée, une PLD demeure dans le réseau indéfiniment. Une SLD est une demande de connexion représentée par un quintuplet $(s, d, \pi, \alpha, \beta)$ où s et d représentent les nœuds source et destination de la demande, π représente le nombre de connexions requises et α et β les dates d'établissement (set-up) et de fin (tear-down) des connexions demandées. Le modèle de trafic SLD est déterministe car les demandes de trafic SLD sont connues à l'avance et est dynamique puisqu'il prend en compte l'évolution de la charge de trafic au cours du temps. Contrairement à une SLD, une RLD est une demande de trafic aléatoire (dynamique) caractérisée par un temps de début aléatoire et une durée elle aussi aléatoire. Une RLD est représentée de la même manière qu'une SLD.

La thèse est organisée en trois parties. La première partie traite du problème de routage et affectation de longueurs d'onde dans les réseaux WDM tout-optiques. La deuxième partie s'intéresse au problème de routage et affectation de longueurs d'onde avec protection. Dans la troisième partie on étudie les moyens d'améliorer le taux de rejet dans les réseaux WDM tout-optiques affecté par la contrainte de continuité en longueur d'onde.

Routage et affectation de longueurs d'onde

Le problème de routage et affectation de longueurs d'onde peut être défini comme suit:

étant donné une topologie physique du réseau, un nombre de longueurs d'onde disponibles sur chaque lien du réseau et un ensemble de demandes de trafic à satisfaire, il s'agit de calculer pour chaque demande de trafic le ou les chemins et la ou les longueurs d'onde nécessaires pour établir la demande, l'objectif étant de minimiser le nombre de demandes de trafic rejetées. Nous supposons ici qu'une demande de trafic est rejetée lorsqu'il est impossible de satisfaire tous les circuits optiques requis par la demande.

Nous traitons d'abord du problème de routage et affectation de longueurs d'onde pour des demandes de trafic de type PLD. Nous étudions ensuite le problème de routage et affectation de longueurs d'onde en considérant simultanément des demandes de trafic SLD et RLD. Les demandes de trafic PLD n'ayant

pas été considérées pour la simple raison qu'une PLD, lorsqu'elle est acceptée, séjourne dans le réseau indéfiniment, ce qui se traduit simplement par une diminution du nombre de longueurs d'onde disponibles sur certains liens du réseau.

Routage et affectation de longueurs d'onde pour les demandes PLD

Dans cette partie, nous proposons des approches à la fois exactes et approchées pour résoudre le problème. Nous commençons par établir des modèles linéaires à nombre entiers multi-objectifs. Nous résolvons les problèmes de routage et d'allocation de longueurs d'onde simultanément. Le premier modèle impose à tous les circuits optiques requis par une demande de trafic PLD le passage par la même route physique connectant la source à la destination. Le routage est dans ce cas dit atomique. Le deuxième modèle permet éventuellement à une demande de trafic d'emprunter plusieurs chemins entre sa source et sa destination. On parle dans ce cas de routage non atomique. Chaque modèle opère en trois étapes. La première étape cherche à minimiser le nombre de demandes de trafic PLD rejetées étant donné une topologie physique du réseau, un nombre fixe de longueurs d'onde par fibre et un ensemble fini de demandes PLD à satisfaire. La deuxième étape cherche à déterminer dans l'ensemble des solutions possibles calculées par la première étape, celles qui minimisent en plus le nombre de circuits optiques rejetés étant donné le nombre minimal de demandes de trafic PLD rejeté calculé par la première étape. La troisième étape sélectionne parmi les solutions obtenues celle qui minimise le coût total des chemins physiques empruntés.

Les modèles linéaires à nombre entiers proposés sont NP-difficiles et leur résolution reste limitée à des tailles de réseaux réduites (réseaux de moins de 30 nœuds) et des matrices de trafic de quelques dizaines de demandes. Pour résoudre des problèmes de tailles réalistes, on a eu recours à des heuristiques pour calculer le routage et l'allocation des longueurs d'onde. Nous proposons une heuristique (recherche aléatoire, (random search)) qui établit un ordre de calcul du routage et des longueurs d'onde pour les demandes de trafic PLD et sélectionne la solution qui minimise le nombre de demandes de trafic PLD rejetées. Deux heuristiques ont été proposées selon que l'on autorise le routage non atomique ou non.

Les résultats expérimentaux obtenus en considérant différentes topologies de réseaux et différentes matrices de trafic montrent que les heuristiques proposées calculent dans la majorité des cas le même taux de rejet que celui calculé par les modèles exacts.

Routage et affectation de longueurs d'onde pour les demandes SLD et RLD

Dans cette partie seules des approches heuristiques ont été adoptées. Nous proposons deux heuristiques. La première calcule à la volée le routage et l'affectation des longueurs d'onde des demandes de trafic SLD et RLD indistinctement en fonction des dates d'arrivée de ces demandes de trafic au réseau.

La deuxième heuristique calcule le routage et l'affectation des longueurs d'onde pour les demandes de trafic SLD et RLD séparément en deux étapes. La première étape calcule le routage et l'affectation des longueurs pour les demandes de trafic SLD *a priori* cherchant à minimiser le nombre de demandes SLD rejetées. Les demandes de trafic SLD sont connues à l'avance, on utilise une heuristique à base de recherche aléatoire pour calculer le routage et l'affectation des longueurs d'onde pour les SLDs. La deuxième étape calcule à la volée le routage et l'affectation des longueurs d'onde pour les demandes de trafic RLD séquentiellement en fonction de leurs dates d'arrivée au réseau et en tenant compte du routage des demandes de trafic SLD déjà calculé par le biais de la première étape.

L'apport du routage non atomique par rapport au routage atomique a été aussi étudié dans cette partie.

Les résultats expérimentaux menés dans le cadre de cette étude montrent qu'à faible charge, la deuxième heuristique calcule le meilleur taux de rejet global (SLD et RLD confondues). On montre également qu'à forte charge la première heuristique calcule le meilleur taux de rejet global cependant le nombre de SLDs rejetées dans ce cas est beaucoup plus important que dans le cas de la deuxième heuristique. On montre également que la deuxième heuristique requiert des temps de calcul plus importants que ceux de la première heuristique principalement à cause du temps nécessaire au calcul du routage et de l'affectation des longueurs pour les demandes de trafic SLD.

Routage et affectation de longueurs d'onde avec protection

Dans cette partie de la thèse nous nous intéressons à la protection des circuits optiques. Il s'agit de définir pour chaque demande de trafic autant de circuits optiques primaires que de circuits de protection. Les circuits optiques primaires sont utilisés au cours du fonctionnement normal du réseau, les circuits optiques de protection (backups) sont empruntés en cas de panne de conduit. Les circuits optiques primaires et de backups doivent être disjoints (c-à-d ne partagent aucun conduit commun) afin d'assurer le rétablissement du fonctionnement du réseau en cas de panne. On s'intéresse aux pannes simples de conduit et on suppose qu'en cas de panne, tous les circuits optiques qui traversent le conduit défaillant dans les deux directions, sont affectés et doivent ainsi être reroutés sur leurs chemins de protection respectifs. Cette approche bi-directionnelle du problème est à notre connaissance originale.

Les ressources dédiées à la protection sont calculées et réservées au moment du calcul du routage des canaux optiques primaires et ne peuvent ainsi être réutilisées par aucune demande de trafic. Ces ressources étant rarement sollicitées, nous cherchons à en minimiser le nombre grâce au multiplexage des circuits optiques de protection (backup multiplexing). Le backup multiplexing autorise deux ou plusieurs canaux optiques de protection à utiliser la même longueur d'onde sur un ou plusieurs liens

communs à la condition que les canaux optiques primaires ne partageant aucun conduit en commun. Le problème peut être décrit comme suit:

étant donné une topologie physique du réseau, un nombre de longueurs d'onde disponibles sur chaque lien du réseau et un ensemble de demandes de trafic à satisfaire, il s'agit de définir pour chaque demande de trafic le ou les chemins et la ou les longueurs d'onde nécessaires pour établir les circuits optiques primaires et de protection, l'objectif étant de minimiser le nombre de demandes de trafic rejetées. Nous supposons ici qu'une demande de trafic est rejetée lorsqu'il est impossible de satisfaire tous les circuits optiques requis par la demande. La minimisation du nombre de demandes de trafic rejetées passe par la minimisation des ressources nécessaires pour assurer la protection des circuits optiques primaires.

L'étude menée se décompose en deux parties. La première partie traite du problème de routage et affectation de longueurs d'onde avec protection considérant des demandes de trafic de type PLD. La seconde partie étudie le problème de routage et affectation de longueurs d'onde avec protection en considérant simultanément les demandes de trafic SLD et RLD.

Routage et affectation de longueurs d'onde avec protection pour les demandes PLD

Dans cette première partie des approches exactes et approchées ont été proposées. En ce qui concerne les approches exactes, nous proposons de résoudre les problèmes de routage et d'affectation de longueurs d'onde séparément afin de réduire la complexité des modèles proposés. Deux modèles linéaires multi-objectifs à nombre entiers ont été développés. Le premier modèle calcule les routes pour les circuits primaires et de protection séparément, le deuxième calcule les routes simultanément. L'objectif est de minimiser le nombre de routes primaires passant par un lien donné du réseau (il s'agit de distribuer le trafic sur tous les liens du réseau) afin de minimiser l'impact d'une panne de conduit sur le nombre de circuits optiques primaires devant être reroutés. Nous nous intéressons ensuite à la minimisation du nombre de liens du réseau traversés par les routes de protection afin d'attribuer la même longueur d'onde à plusieurs routes de backups lorsque les routes primaires correspondantes ne partagent aucun conduit en commun. Nous cherchons également à minimiser le coût total des routes primaires et de protection lorsque plusieurs solutions sont possibles.

Une fois les routes calculées, on propose d'utiliser un modèle linéaire à nombre entiers pour affecter les longueurs d'ondes aux routes ou bien une heuristique qui attribue selon un algorithme de coloration de graphe (degré de saturation, (DSATUR)) un nombre minimal de couleurs aux nœuds d'un graphe de conflit généralisé constitué de nœuds primaires (correspondant aux chemins primaires) et de nœuds de protection (correspondant aux chemins de protection).

Les modèles linéaires à nombre entiers proposés sont NP-difficiles, nous proposons de développer une heuristique pour résoudre le problème de routage et affectation de longueurs d'onde avec protection

pour des problèmes de tailles réalistes. L'heuristique établit un ordre de routage des demandes et calcule les circuits primaires et de protection en trois étapes:

- La première étape calcule les circuits optiques primaires. Les étapes 2 et 3 sont abandonnées s'il n'est pas possible de satisfaire les circuits optiques primaires requis par la demande de trafic.
- La deuxième étape construit autant de graphes auxiliaires que de longueurs d'ondes disponibles sur chaque lien du réseau et affecte un coût à chaque arc du graphe auxiliaire en fonction de l'état de la longueur d'onde sur le lien considéré.
- La troisième étape sélectionne les canaux optiques de protection les moins coûteux (ceux qui partagent un maximum de liens avec les canaux de protection déjà établis). Si la troisième étape échoue, la demande de trafic est rejetée et les circuits optiques primaires établis sont libérés.

Les résultats expérimentaux montrent que bien que le premier modèle linéaire calcule les routes primaires et de protection séparément, il fournit de meilleures performances en termes de nombre de longueurs d'onde requises. On montre aussi que le deuxième modèle présente de meilleures performances en termes de congestion des routes primaires et des routes de protection. Cependant le fait de concentrer le passage des routes de protection par un nombre minimal de liens dans le réseau ne contribue pas à une utilisation minimale des ressources, essentiellement parce que les routes primaires correspondantes partagent de nombreux conduits en commun et qu'il est ainsi impossible d'attribuer la même longueur d'onde aux backups.

Nous montrons aussi que l'heuristique proposée pour calculer le routage et l'affectation des longueurs d'onde avec protection pour les demandes PLD calcule des taux de rejet égaux à ceux calculés par approches exactes.

Routage et affectation de longueurs d'onde avec protection pour les demandes SLD et RLD

Dans cette partie nous nous intéressons au routage et affectation de longueurs d'onde avec protection en considérant conjointement les SLDs et les RLDs. Nous proposons deux heuristiques analogues à celles proposées dans la partie routage et affectation de longueurs d'onde et nous étudions l'apport du routage non atomique par rapport au routage atomique.

Les résultats expérimentaux obtenus confortent les résultats obtenus dans la partie routage et affectation de longueurs d'onde.

Reroutage

Dans cette partie nous proposons un algorithme de reroutage de canaux optiques afin d'améliorer le taux de rejet lorsque la contrainte de continuité en longueur d'onde est imposée. Nous considérons deux classes de trafic correspondant aux demandes de trafic SLD et aux demandes de trafic RLD. Nous supposons ici que le trafic SLD est un trafic de haute priorité et qu'il est impossible de rerouter une demande de trafic SLD.

L'idée consiste en cas de rejet d'une nouvelle demande de trafic arrivant au réseau de rerouter un nombre minimal de demandes de trafic RLD déjà établies afin de libérer les ressources nécessaires à l'établissement de la nouvelle demande de trafic. Si le reroutage est possible, la demande de trafic est satisfaite, dans le cas contraire, la demande de trafic est définitivement rejetée.

Deux algorithmes ont été proposés. Le premier calcule à la volée séquentiellement le routage et l'affectation des longueurs d'onde pour les demandes de trafic à leurs instants d'arrivée au réseau. Le deuxième calcule le routage et l'affectation de longueurs d'onde pour les demandes de trafic SLD *a priori* (l'objectif étant de minimiser le nombre de SLDs rejetées) avant de considérer le routage et l'affectation de longueurs d'onde des RLDs à la volée en tenant compte du routage des demandes SLD. L'objectif des deux algorithmes est de minimiser le nombre de demandes de trafic rejetées étant donné un nombre limité de longueurs d'onde par fibre.

Deux métriques ont été considérées lors de l'étape de reroutage. La première cherche à minimiser le nombre de canaux WDM à rerouter au moment de l'établissement d'une nouvelle demande de trafic. La deuxième métrique cherche à minimiser le nombre de demandes de trafic RLD à rerouter.

Grâce aux résultats de simulations nous observons que les résultats obtenus montrent un gain non négligeable en terme de taux de rejet. Nous montrons aussi que l'algorithme proposé requiert un temps de calcul inférieur comparé aux études déjà présentées dans la littérature.

Mots clés

fibre optique, longueur d'onde, multiplexage en longueurs d'onde, 'Time Division Multiplexing, TDM', 'Wavelength Division Multiplexing, WDM', canal optique ('lightpath'), circuit, commutation de circuits, réseaux optiques, réseaux tout-optiques, transparence, réseaux opaques, conversion de longueur d'onde, réseaux hybrides, planification, dimensionnement, routage et affectation de longueurs d'onde, protection, protection de chemin ('path protection'), protection de lien ('link protection'), panne de lien ('link failure'), panne de conduit ('span failure'), multiplexage de chemins de protection ('backup multiplexing'), reroutage, optimisation, modèles linéaires à nombres entiers, coloration de graphe, meta-heuristique, heuristique, ingénierie de trafic, différenciation de service, 'Quality of Service, QoS', 'Synchronous Dig-

ital Hierarchy, SDH', 'Asynchronous Transfer Mode, ATM', 'Multiprotocol Label Switching, MPLS', 'Generalized Multiprotocol Label Switching, GMPLS', 'Optical Virtual Private Network, OVPN', 'Permanent Lightpath Demands, PLDs', 'Scheduled Lightpath Demands, SLDs', 'Random Lightpath Demands, RLDs', routage atomique, routage non atomique, congestion, 'Optical Add/Drop Multiplexer, OADM', 'Optical Cross-Connect, OXC'.

Abstract

As traffic on telecommunication networks continues to grow driven by increasing demand for voice and data communication services, the optical layer needs to provide functionalities such as lightpaths set-up and tear-down, protection and rerouting.

This thesis mainly focuses on all-optical lightpaths establishment. We consider all along the thesis single fiber optical networks with finite resources, that is with a given amount of wavelengths per fiber-links. We present a suite of methods for optimizing design and for analyzing rejection ratios in all-optical WDM networks. Both exact and approximate optimization techniques are considered. The methods are assessed through various experiments and are shown to produce good results and to be able to scale up to networks of realistic sizes.

In a first step, we investigate the problem of Routing and Wavelength Assignment (RWA) for Permanent Lightpath Demands (PLDs). PLDs are pre-known connection requests which remain indefinitely in the network once accepted. We first develop multi-objective integer linear programming (MOILP) models. The models being intractable for realistic RWA problems, we then propose heuristic methods based on combinatorial optimization models to compute approximate solutions for the considered problem. This work is then extended to consider a realistic traffic model obtained by the combination of three types of traffic demands referred to as Permanent Lightpath Demands, Scheduled Lightpath Demands (SLDs) and Random Lightpath Demands (RLDs). SLDs are characterized by pre-known dates of arrival and life durations. They may correspond for instance to a set of long term lightpath establishments in order to provide Optical Virtual Private Network services. Conversely RLDs are characterized by random arrival and life duration processes. The benefits of load balancing through traffic bifurcation are studied.

In a second step, we deal with the Routing and Spare Capacity Assignment (RSCA) problem. We first consider PLDs and develop integer linear programming models and heuristic methods for both the routing and the wavelength assignment sub-problems. This work is then extended to deal with the RSCA of SLDs and RLDs.

Due to the wavelength continuity constraint, a new lightpath demand may be rejected. In a third

step, we focus on the improvement of the lightpath demand rejection ratio by means of lightpath rerouting strategies. We have developed such strategies in order to minimize traffic disruption on already routed demands. As SLDs correspond to high priority traffic, we assume that they cannot be rerouted. At the opposite, a new lightpath establishment may require the rerouting of one or several RLDs.

For each of these steps, we have developed multiple optimization tools which have been applied to a wide range of network sizes, topologies and traffic scenarios. Our conclusions are then drawn based on these results.

Declaration

The work in this thesis is based on research carried out at the "Accès et Mobilité Group", the Department of Computer Science and Networks, Telecom Paris, France. No part of this thesis has been submitted elsewhere for any other degree or qualification and it is all my own work unless referenced to the contrary in the text.

Copyright © 2005 by Mohamed Koubàa.

All right reserved. No part of this thesis may be reproduced, in any form or by any means, without the author's prior written consent and information.

Table of Contents

Declaration	xix
1 Introduction	1
1.1 Research motivation	1
1.2 Contribution of this thesis	5
1.3 Organization of the dissertation	7
2 Optical Fiber Communication: From Transmission to Networking	9
2.1 Introduction	9
2.2 Optical network drivers	9
2.2.1 Fiber capacity	10
2.2.2 Traffic growth	10
2.2.3 Reduced cost	10
2.2.4 Traffic type change	11
2.2.5 Restoration capability	11
2.3 Optical transmission: technology and devices	11
2.3.1 Multiplexing techniques	11
2.3.2 Fiber types	12
2.3.2.1 Multi-mode fiber	12
2.3.2.2 Single-mode fiber	13
2.3.3 Light sources	14
2.3.4 Line rates	15
2.3.5 LH and ULH transmission	15
2.3.5.1 Long haul (LH)	15
2.3.5.2 Ultra long haul (ULH)	16
2.4 From optical transmission to optical networking	16
2.4.1 Optical network elements	17
2.4.1.1 Optical amplifiers	17

2.4.1.1.1	Semiconductor optical amplifiers	17
2.4.1.1.2	Optical doped fiber amplifiers	18
2.4.1.1.3	Raman optical amplifiers	18
2.4.1.2	Optical line terminals	18
2.4.1.3	Optical add/drop multiplexers	19
2.4.1.4	Optical cross-connects	20
2.4.2	Optical switching techniques	23
2.4.3	Evolution of optical networks: challenges and requirements	24
2.4.4	Taxonomy used in this thesis	27
3	Literature Survey	29
3.1	Introduction	29
3.2	Routing and wavelength assignment	29
3.2.1	Separate wavelength-route selection	31
3.2.1.1	Path selection algorithms	31
3.2.1.1.1	Fixed routing	31
3.2.1.1.2	Fixed alternate routing	31
3.2.1.1.3	Adaptive routing	32
3.2.1.1.4	Least congested path routing	33
3.2.1.2	Wavelength selection algorithms	33
3.2.2	Simultaneous wavelength-path selection	34
3.3	Routing and spare capacity assignment	34
3.4	Lightpath rerouting	38
3.5	Thesis overview	39
4	Routing and Wavelength Assignment for Permanent Lightpath Demands	43
4.1	Introduction	43
4.2	Description of the problem	44
4.3	The linear programming approach	46
4.3.1	Notations	46
4.3.2	Model 1: Atomic RWA for PLDs model formulation	48
4.3.3	Model 2: Non Atomic RWA for PLDs model formulation	54
4.3.4	Problem size reduction	59
4.4	The heuristic approach	59
4.4.1	Mathematical formulation	59
4.4.2	The sequential Permanent Atomic RWA algorithm	61

4.4.3	The sequential Permanent non atomic RWA algorithm	61
4.4.4	Description of the Random Search algorithm	63
4.4.5	Illustrative example	64
4.5	Experimental results	66
5	Routing and Wavelength Assignment for Scheduled and Random Lightpath Demands	73
5.1	Introduction	73
5.2	Description of the problem	74
5.3	Notations	75
5.4	Atomic routing algorithms	77
5.4.1	Sequential RWA for scheduled and random lightpath demands: sequential Atomic RWA algorithm	77
5.4.2	Separate RWA for scheduled and random lightpath demands: separate Atomic RWA algorithm	80
5.4.2.1	PHASE1: RWA for scheduled lightpath demands	80
5.4.2.1.1	Mathematical formulation	80
5.4.2.1.2	The Random Search algorithm	81
5.4.2.2	PHASE2: RWA for random lightpath demands	83
5.5	Non atomic routing algorithms	84
5.5.1	Sequential RWA for scheduled and random lightpath demands: sequential non atomic RWA algorithm	85
5.5.2	Separate RWA for scheduled and random lightpath demands: separate non atomic RWA algorithm	86
5.5.2.1	PHASE1: RWA for scheduled lightpath demands	86
5.5.2.1.1	Mathematical formulation	86
5.5.2.1.2	The Random Search algorithm	87
5.5.2.2	PHASE2: RWA for random lightpath demands	88
5.6	Experimental results	90
6	Routing and Spare Capacity Assignment for Permanent Lightpath Demands	99
6.1	Introduction	99
6.2	Description of the problem	100
6.3	The linear programming approach	102
6.3.1	Notations	102
6.3.2	Lightpath routing	104
6.3.2.1	Model 1: Separate computation of primary and backup routes	104

6.3.2.1.1	PHASE 1: primary paths computation	105
6.3.2.1.2	PHASE 2: backup paths computation	106
6.3.2.2	Model 2: Simultaneous computation of primary and backup routes	109
6.3.2.3	Problem size reduction	114
6.3.3	Wavelength assignment	114
6.3.3.1	The linear programming approach	115
6.3.3.1.1	Notations	115
6.3.3.1.2	Mathematical model	116
6.3.3.2	The heuristic approach	118
6.3.3.2.1	The graph coloring problem	118
6.3.3.2.2	The heuristic	119
6.4	The heuristic approach	119
6.4.1	Mathematical formulation	119
6.4.2	Description of the RS algorithm	120
6.4.2.1	STAGE 1: primary lightpath computation	120
6.4.2.2	STAGE 2: auxiliary graphs (AG) construction	121
6.4.2.3	STAGE 3: backup lightpath computation	122
6.4.3	Illustrative example	122
6.5	Experimental results	127
7	Routing and Spare Capacity Assignment for Scheduled and Random Lightpath Demands	133
7.1	Introduction	133
7.2	Description of the problem	134
7.3	Notations	134
7.4	Sequential RSCA for scheduled and random lightpath demands	137
7.4.1	STAGE 1: primary lightpath computation	137
7.4.2	STAGE 2: auxiliary graphs construction	138
7.4.3	STAGE 3: backup lightpath computation	138
7.4.4	Illustrative example	138
7.5	Separate RSCA for scheduled and random lightpath demands	142
7.5.1	PHASE 1: RSCA of scheduled lightpath demands	142
7.5.2	PHASE 2: RSCA for random lightpath demands	144
7.5.3	Illustrative example	144
7.6	Experimental results	147

8	Lightpath Rerouting for Scheduled and Random Lightpath Demands for Traffic Engineering in WDM Networks	150
8.1	Introduction	150
8.1.1	Traffic model	151
8.1.2	Rerouting dynamics	151
8.1.3	Type of lightpaths	151
8.2	Description of the problem	152
8.3	Notations	153
8.4	The routing and rerouting algorithms	155
8.4.1	Sequential RWA with rerouting for scheduled and random lightpath demands	155
8.4.1.1	PHASE 1: routing phase	155
8.4.1.2	PHASE 2: rerouting phase	157
8.4.1.3	Illustrative example	158
8.4.2	Separate RWA with rerouting for scheduled and random lightpath demands	163
8.4.2.1	RWA for scheduled lightpath demands	163
8.4.2.2	RWA with rerouting for random lightpath demands	163
8.4.2.3	Illustrative example	163
8.5	Experimental results	166
9	Conclusions and Future Work	173
9.1	Conclusions	173
9.2	Future tracks	175
	Glossary	195

List of Figures

2.1	A three-node network example to illustrate the role of OADMs	20
2.2	Three OXC architectures	22
2.3	Evolution of optical networks	25
3.1	Classification of proactive methods	36
3.2	Traffic on the New York - Washington link of the Abilene backbone network in a typical week.	40
4.1	Routing and wavelength assignment for permanent lightpath demands	45
4.2	The three steps required for the RWA for PLDs	46
4.3	The 14-node network topology	67
4.4	The 29-node network topology	67
4.5	Average PLDs' rejection ration w.r.t. D	68
4.6	Average number of rejected PLDs w.r.t. D	69
4.7	Average permanent lightpath rejection ratio w.r.t. D	69
4.8	Average number of rejected permanent lightpaths w.r.t. D	70
4.9	Average number of required WDM channels w.r.t. D	70
4.10	Average number of required variables w.r.t. D	71
4.11	Average number of required constraints w.r.t. D	71
4.12	Average required CPU execution time w.r.t. D	72
5.1	RWA for scheduled and random lightpath demands	75
5.2	average rejection ratio	91
5.3	average number of rejected LDs	91
5.4	average SLDs' rejection ratio	92
5.5	average RLDs' rejection ratio	92
5.6	average lightpath rejection ratio	92
5.7	average SLPs' rejection ratio	92
5.8	average RLPs' rejection ratio	93

5.9	average CPU execution time	93
5.10	average lightpath overall length	94
5.11	average number of required WDM channels	94
5.12	average rejection ratio w.r.t. W	95
5.13	average number of rejected LDs	96
5.14	average number of rejected lightpaths	96
5.15	average rejection ratio w.r.t. γ	97
5.16	average number of rejected LDs	97
5.17	average number of rejected lightpaths	97
5.18	average rejection ratio w.r.t. μ	98
6.1	Routing and spare capacity assignment for permanent lightpath demands	101
6.2	Model 1 schematic representation	104
6.3	Model 2 schematic representation	110
6.4	average number of variables	127
6.5	average number of constraints	127
6.6	average number of required wavelengths	128
6.7	average number of required WDM channels	128
6.8	average primary lightpath congestion	129
6.9	average backup lightpath congestion	129
6.10	average length of primary paths	129
6.11	average length of backup paths	129
6.12	average lightpath overall length	130
6.13	average CPU execution time	130
6.14	average number of required wavelengths (dedicated protection)	130
6.15	average number of required WDM channels (dedicated protection)	130
7.1	Routing and spare capacity assignment for Scheduled and Random Lightpath Demands	135
7.2	average rejection ratio	148
7.3	average number of rejected LDs	148
7.4	average rejected lightpaths	148
7.5	average number of rejected lightpaths	148
7.6	average lightpath overall length	149
7.7	average CPU execution time	149
8.1	Schematic representation of the LRR problem	153

8.2	Schematic representation of the seqRWAwR algorithm	156
8.3	National Science Foundation Network (NSFNet)	158
8.4	Schematic representation of the sepRWAwR algorithm	164
8.5	Average rejection ratio gain.	169
8.6	Average rejection ratio.	169
8.7	Average number of rerouted RLDs.	170
8.8	Average number of rerouted WDM channels.	170
8.9	average lightpath overall length	170
8.10	Average CPU execution time.	170

List of Tables

2.1	Taxonomy used in this thesis	28
4.1	Pseudo-code of the sequential Permanent Atomic RWA algorithm	62
4.2	The 14-node NSFNet network topology and the set of PLDs to be set up	63
4.3	Pseudo-code of the sequential Permanent non atomic RWA algorithm	64
4.4	Pseudo-code of the Random Search (RS) algorithm	65
4.5	The 14-node NSFNet network topology and the PLDs to be set up	66
4.6	RWA according to the RS algorithm for the PLDs shown in Table 4.5	66
4.7	Results for Model 1 and Model 2 under different simulation scenarios	68
5.1	Pseudo code for the sequential Atomic RWA algorithm	78
5.2	The set of SLDs to be set up	79
5.3	The RLDs to be set up	79
5.4	RS algorithm for the atomic RWA of SLDs	82
5.5	Non bifurcated RWA for the SLDs	83
5.6	The RLDs to be set up	84
5.7	Pseudo code for the sequential non atomic RWA algorithm	86
5.8	The set of SLDs to be set up	88
5.9	RWA for the SLDs	88
5.10	RS algorithm for the (non atomic) RWA of SLDs	89
5.11	The RLDs to be set up	90
6.1	Pseudo-code for primary lightpath selection	121
6.2	Pseudo-code of the Random Search (RS) algorithm	123
6.3	The 14-node NSFNet network topology and the PLDs to be set up	124
6.4	Weight of the arcs for each AG at the date of computing the backup for PLD p_3	125
6.5	Weight of the arcs for each AG at the date of computing the backup for PLD p_1	126
7.1	The set of SLDs to be set up	139

7.2	The RLDs to be set up	139
7.3	Weight of the arcs for each AG, G^ω , once the primaries of SLD δ_1 are set up	140
7.4	Weight of the arcs for each AG, G^ω , once the primary of SLD δ_2 is set up	140
7.5	Weight of the arcs for each AG, G^ω , once the primaries of SLD δ_3 are set up	141
7.6	Weight of the arcs for each AG, G^ω , once the primaries of RLD τ_2 are set up	141
7.7	RS algorithm for the atomic RSCA for SLDs	143
7.8	The set of SLDs to be set up	144
7.9	The RLDs to be set up	145
7.10	RSCA for the SLDs: description of \mathcal{A}^{406} at the arrival time of τ_1	146
8.1	Comparison of the rerouting algorithms.	152
8.2	Path computation and wavelength selection for LD i with starting time t	157
8.3	Rerouting algorithm used for PHASE 2	159
8.4	The set of LDs to be set up	160
8.5	The network state at the starting time of SLD δ_5 ($t = 309$)	161
8.6	The network state at the starting time of SLD δ_8 ($t = 506$)	161
8.7	The number of RLDs and RLDs to reroute in order to set up SLD δ_8 ($t = 506$)	162
8.8	The network state according to the seqRWAwR algorithm once SLD δ_8 is set up	162
8.9	The set of LDs to be set up	165
8.10	RWA for the SLDs	165
8.11	The network state according to the sepRWAwR algorithm once SLD δ_8 is set up	166
8.12	Average rejection ratio ($N = 14$, $W = 32$, $K = 5$, $\mu^{-1} = 500$, $\nu^{-1} = 1$, $\pi = 1$).	168
8.13	Average number of rejected SLDs ($N = 14$, $W = 32$, $K = 5$, $\mu^{-1} = 500$, $\nu^{-1} = 1$, $\pi = 1$).	168
8.14	Average number of rejected RLDs ($N = 14$, $W = 32$, $K = 5$, $\mu^{-1} = 500$, $\nu^{-1} = 1$, $\pi = 1$).	168

Chapter 1

Introduction

1.1 Research motivation

The rapid evolution of telecommunications networks is always driven by the ever-increasing demands of the Internet as well as continuous advances in communications systems. Over the last years, we have witnessed the explosive growth of the Internet due in part to the proliferation of applications such as data and call centers, as well as by the bootstrapping effect of increased consumption resulting from lower rates. Furthermore, the emergence of time critical applications such as Internet telephony, video conferencing, television channel distribution, and multimedia graphics heightened the need for increasing bandwidth capacity on the underlying telecommunications infrastructure. This unprecedented demand for bandwidth capacity has witnessed a wide deployment of point-to-point Wavelength Division Multiplexing (WDM) transmission systems which have emerged as a viable and future-proof solution, in the Internet infrastructure.

At the same time, there has been increasing effort to enhance routing schemes to support higher data rates, traffic engineering functions and Quality of Service issues. Relevant efforts have been spent on the Internet Protocol (IP) to support the high data rates provided by the optical fiber as well as traffic engineering functions [1] [2] [3] and different Quality of Service (QoS) levels [4]. Multi-Protocol Label Switching (MPLS) [5] [6] allows, on one hand, faster switching at the Label Switching Routers (LSRs) as well as QoS and traffic engineering support. MPLS, on the other hand, makes the Internet architecture, built upon the connectionless paradigm, connection-oriented.

WDM technology has first been deployed mainly for point-to-point transmission. Routing and switching functions are hence performed electronically at each network node. Optical signals must go through opto-electronic (O/E) and electro-optical (E/O) conversions at each intermediate node. Consequently, a network node may not be able to process all the traffic carried by all its input signals,

including the traffic intended for the node as well as the traffic that is just passing through the node to other destinations, causing an electronic bottleneck. To overcome these electronic bottlenecks and thanks to recent advances in optical technologies, WDM systems are moving beyond point-to-point transmission systems to all-optical systems incorporating optical routing and switching, circuit set-up and tear-down, protection and rerouting functions at the optical layer.

This thesis mainly focuses on all-optical lightpath establishment. A lightpath is an optical communication channel established between a node pair in the network. In the absence of any wavelength-conversion device, a lightpath is required to be on the same wavelength throughout the path it uses to connect the node pair in the network. A lightpath may hence span multiple fiber links, e.g., to provide a circuit-switched interconnection between two nodes which may have a heavy traffic flow between them and which may be located far from each other in the physical fiber network topology. Each intermediate node on the lightpath essentially provides an all-optical bypass facility to support the lightpath. In an N -node optical network, if each node is equipped with $N - 1$ transceivers (transmitters (lasers) and receivers (filters)) and if there are enough wavelengths on all fiber-links, then every node pair could be connected by an all-optical lightpath, and there is no networking problem to solve. However, it should be noted that the network size (N) should be scalable, transceivers are expensive devices so that each node may be equipped with only a few of them, and technological constraints dictate that the number of WDM channels that can be supported in a fiber be limited to W (whose value is a few tens today, but is expected to improve with time and technological breakthroughs). Thus, only a limited number of lightpaths should be set up on the network. Under such a network setting, a challenging networking problem is, given a set of lightpath demands each requesting an integral number of lightpaths that need to be established on the network, and given a constraint on the number of wavelengths, to select the physical paths and assign the wavelengths over which these lightpaths should be set up so that the number of established lightpath demands is maximized. While shortest-path routes may be most preferable from the individual point of view of each lightpath, note that this choice may have to be sometimes sacrificed, in order to allow more lightpaths to be set up. Thus, one may allow several alternate paths for lightpaths to be established. Lightpaths that cannot be set up due to constraints on paths and wavelengths are said to be rejected (blocked), so that the corresponding lightpath demands are rejected. The network optimization problem that must be addressed is to minimize the rejection ratio in all-optical WDM networks defined as the ratio of the number of rejected lightpaths demands to the total number of lightpaths demands arriving at the network. This particular problem, referred to as the Routing and Wavelength Assignment (RWA) problem, has been examined in detail in Chapters 4 and 5.

In Chapter 4, we investigate the RWA problem considering Permanent Lightpath Demands (PLDs).

PLDs (known as static lightpath demands in literature) are pre-known connection requests. A PLD is represented by a tri-triple (s_i, d_i, π_i) where s_i , d_i are respectively the source node and destination node of the demand, π_i is the number of requested lightpaths to be established from s_i to d_i . Two methods are proposed to deal with the RWA problem for PLDs referred to as the Permanent Routing and Wavelength Assignment (PRWA) problem. The former formulates the PRWA problem as multi-objective path-based integer linear programming (MOILPs) models which, when solved, compute optimal solutions. We solve the models exactly for small size networks (few nodes and a limited number of PLDs). For moderately large PRWA problem instances (tens of nodes and tens of PLDs) the models turn out to have an extremely large number of variables and constraints, and hence become intractable. This motivated a second method based on heuristic algorithms which compute approximate sub-optimal solutions hopefully close to the optimal solutions. The proposed methods are studied and compared through rejection ratios. The benefits of using non atomic (bifurcated) routing w.r.t. atomic (non bifurcated) routing are also studied.

In Chapter 5, we extend the work presented in Chapter 4 to consider a realistic traffic model made of three types of lightpath demands namely Permanent Lightpath Demands, Scheduled Lightpath Demands (SLDs), and Random Lightpath Demands (RLDs). SLDs are characterized by pre-known dates of arrival and life spans. An SLD is a connection demand represented by a tuple $(s_i, d_i, \pi_i, \alpha_i, \beta_i)$ where s_i , d_i are the source and the destination nodes of the demand, π_i is the number of requested lightpaths to be set up between s_i and d_i , and α_i and β_i are respectively the set-up and tear-down dates of the demand. The SLD model is deterministic because it is known in advance and is dynamic because it takes into account the evolution of the traffic load in the network over time. SLDs may correspond for instance to a set of long term lightpath establishments in order to provide Optical Virtual Private Network (OVPN) services. Conversely, an RLD corresponds to a connection request that arrives randomly and is dealt with on the fly. RLDs (known as dynamic lightpath demands in literature) are characterized by random arrivals and unknown life spans. The aim of this study is to model a realistic situation where an operator wishes to employ its optical network initially designed for PLDs and SLDs to offer on the fly lightpath provisioning service. As we are going to explain later, in such a scenario RLDs have to use resources that are sparse in the network. This is much different from the typical situation considered so far. Indeed, in most of the papers on dynamic traffic, RLDs occupy an initially empty network with the same number of available wavelengths on all the fiber-links. Here, available capacity varies from fiber-link to another because PLDs and SLDs are already set up.

In a wavelength-routed WDM network (as well as in other networks), the failure of a network element (e.g., fiber link, cross-connect, etc.) may cause the failure of several lightpaths, thereby leading to large data (and revenue) losses. Within the framework of this thesis we focus on the Routing and

Spare Capacity Assignment (RSCA) problem in all-optical WDM transparent networks. A shared path protection scheme to protect from single span failures is adopted. Resources sharing should minimize the spare resources required to ensure protection and hence allows more lightpaths to be set up (see Chapters 6 and 7).

In Chapter 6 we study the RSCA for PLDs. The RSCA problem for PLDs referred to as the Permanent Routing and Spare Capacity Assignment (PRSCA) problem consists in choosing two diverse span-disjoint routes between the source node and the destination node of any PLD. One route is used for the primary path elected to be the working path for the PLD under normal working conditions, and the other route for the backup path which is activated when a failure related to the physical route of the primary path occurs. We study single span failures instead of single link failures as considered so far in most of the papers dealing with path protection in all-optical networks. Indeed, here we assume that a span is bidirectional and that when a span failure occurs, all disrupted primary lightpaths traversing the failed span in any direction have to be rerouted on their backup paths. The number of available wavelengths per fiber-link being limited, the objective is to maximize the number of PLDs that are successfully routed (i.e. to minimize the number of blocked PLDs due to lack of resources). For this purpose, we propose to use shared path protection by allowing several backup paths to use the same network resources for protection when their respective primary paths may not fail at the same time. We expect that extra resources required to ensure protection are minimized and hence more PLDs are accepted.

Two methods are proposed to deal with the RSCA problem for PLDs. The first method proposes, to deal with the routing and the Wavelength Assignment (WA) subproblems separately on account of their complexity. We formulate the routing subproblem as multi-objective path-based integer linear programming models. For the WA subproblem, two approaches are considered. The first approach formulates the WA subproblem as an integer linear programming model. The second relies on the construction of an auxiliary graph referred to as the Generalized Conflict Graph and makes use of a graph coloring heuristic to assign wavelengths for primary and backup paths.

The multi-objective integer linear programming models turn out to be intractable for realistic size optimization problems. A second method based on heuristic algorithms is proposed. The proposed heuristics are studied and compared through rejection ratios.

In Chapter 7 we extend the protection methods presented in Chapter 6 to deal with the RSCA of PLDs, SLDs and RLDs. Several RSCA methods are proposed, studied and compared through rejection ratios. The benefits of using non atomic routing w.r.t. atomic routing are once again demonstrated.

The characteristics of IP based traffic require the network infrastructure to be able to utilize its resources in a more flexible and dynamic way. So, a key issue for new generation optical networks is

to achieve traffic engineering strategies so as to better support traffic loads. Criteria and strategies for rerouting data flows in the network, because of a network change or due to a variation of the traffic demand, is another important topic we address in Chapter 8.

Due to the wavelength continuity constraint, an incoming lightpath demand may be rejected due to the non availability of a path-free wavelength. In Chapter 8, we focus on how to improve the lightpath demand rejection ratio by means of lightpath rerouting strategies. We develop such strategies with the aim of minimizing traffic disruption on already routed demands. As SLDs correspond to high priority traffic, we assume that they cannot be rerouted. As the opposed to that, the establishment of an incoming lightpath demand (be it an SLD or an RLD) may require the rerouting of one or several RLDs. PLDs have not been considered as, once established, PLDs hold the network resources for long times which can be seen as a reduction of the number of available wavelengths in the network.

1.2 Contribution of this thesis

The specific contributions of this thesis are the following:

- Multi-Objective Integer Linear Programming (MOILPs) models to tackle the RWA and the RSCA problems for PLDs (see Chapters 4 and 6).
- Approximate heuristics formulated as combinatorial optimization problems of the following network optimization problems:
 - RWA for PLDs in a wavelength routed network (Chapter 4).
 - RWA for SLDs in a wavelength routed network (Chapter 5).
 - RSCA for PLDs in a wavelength routed network (Chapter 6).
 - RSCA for SLDs in a wavelength routed network (Chapter 7).
- A realistic traffic model obtained by the combination of permanent lightpath demands, scheduled lightpath demands and random lightpath demands.
- Lightpath rerouting methods are proposed to improve the network throughput in all-optical WDM networks affected by the wavelength continuity constraint (Chapter 8).

The proposed models and algorithms have potential applications for both network operators and equipment manufacturers. They may be used by the former as a part of their dimensioning and engineering tools and by the latter for the design of flexible network equipment architectures of equipment manufacturers. Furthermore, the models and algorithms are, to some extent, technology independent in the

sense that they may be used in other connection oriented networks such as SDH/SONET, ATM, and MPLS.

The following have been published during the course of this research:

1. M. Koubàa, N. Puech, and M. Gagnaire, "Lightpath Rerouting for Differentiated Services in WDM All-Optical Networks", Proceedings, IEEE International Workshop on Design of Reliable Communication Networks (DRCN), Naples, pp. 15-22, Oct. 16-19, 2005.
2. M. Koubàa, N. Puech, and M. Gagnaire, "Traffic Engineering for Differentiated Services in Transparent Networks", Proceedings, 19th International Teletraffic Congress (ITC), Beijing, pp. 375-384, Aug. 29-2, 2005.
3. M. Koubàa, N. Puech, and M. Gagnaire, "Routing, Protection and Wavelength Assignment for Scheduled and Random Lightpath Demands in WDM All-Optical Networks", invited paper, Inter-networking, Paris, Jul. 28-29, 2005.
4. E.A. Doumith, M. Koubàa, N. Puech, and M. Gagnaire, "Gain and Cost brought in by Wavelength Conversion for the Routing and Wavelength Assignment for Scheduled and Random Lightpath Demands in WDM All-Optical Networks", Proceedings, 10th European Conference on Networks & Optical Communications (NOC), London, pp. 147-154, Jul. 5-7, 2005.
5. M. Koubàa, N. Puech, and M. Gagnaire, "Routing and Spare Capacity Assignment for Scheduled and Random Lightpath Demands in All Optical Transport Networks", Proceedings, IEEE Next Generation Internet Networks Conference (NGI), pp. 39-46, Rome, Apr. 18-20, 2005.
6. M. Koubàa, N. Puech, and M. Gagnaire, "Bifurcated versus Non-bifurcated Routing and Wavelength Assignment for Scheduled and Random Lightpath Demands in WDM Networks", Proceedings, First IFIP Optical Networks & Technologies Conference (OpNeTec), pp. 137-144, Pisa, Oct. 18-20, 2004.
7. M. Koubàa, N. Puech, and M. Gagnaire, "Strategies for the Routing and Wavelength Assignment of Scheduled and Random Lightpath Demands", Proceedings, 3rd IEEE European Conference on Universal Multiservice Networks (ECUMN), pp. 91-103, Porto, Oct. 25-27, 2004.
8. M. Koubàa, N. Puech, and M. Gagnaire, "Routing and Wavelength Assignment of Scheduled and Random Lightpath Demands", Proceedings, IEEE and IFIP International Conference on Wireless and Optical Communications Networks (WOCN), pp. 16-19, Oman, Jun. 7-9, 2004.

9. N. Puech, M. Koubàa, M. Gagnaire, and J. Kuri, "Models for Path Protection in WDM Optical Mesh Networks", Proceedings, International Network Optimization Conference (INOC), pp. 472-477, Paris, Oct. 2003.
10. M. Koubàa, N. Puech, M. Gagnaire, and J. Kuri, "Shared Path Protection Routing for Single Span Failures in WDM Optical Mesh Networks", Proceedings, Photonics In Switching (PS), pp. 177-179, Paris, Sep. 2003.

1.3 Organization of the dissertation

This thesis is organized as follows. Chapter 2 gives a brief introduction to optical WDM networks. In Chapter 3 we describe some of the important issues in all-optical WDM networks including routing and wavelength assignment, survivability, and bandwidth loss due to the wavelength continuity constraint. In Chapter 4 we investigate the RWA problem for PLDs. Chapter 5 focuses on the RWA problem considering SLDs and RLDs. In Chapter 6 we deal with the RSCA problem for PLDs. Chapter 7 studies the RSCA problem considering PLDs, SLDs and RLDs simultaneously. In Chapter 8 we present the methods we proposed to improve rejection ratios in all-optical WDM networks using lightpath rerouting. Chapter 9 present the conclusions of the thesis and some future tracks.

Chapter 2

Optical Fiber Communication: From Transmission to Networking

2.1 Introduction

As telecommunication networks face increasing bandwidth demand and diminishing fiber availability, network providers are moving towards a crucial milestone in the network evolution: the optical layer. Optical networks provide higher capacity than existing networks and reduced costs for new applications such as the Internet, video and multimedia interaction, and advanced digital services [7] [8] [9]. Optical networks based on optical technologies and components provide routing, grooming, and restoration mechanisms.

This chapter aims at introducing the essential concepts related to optical networking. In Section 2.2 we first discuss the factors that have driven the deployment of optical networks. Optical transmission technologies history and advances are then presented in Section 2.3. A brief description of the key transmission systems and elements that build up optical networks follows in Subsection 2.4.1. The main switching techniques in optical networks are described in Subsection 2.4.2. Finally, Subsection 2.4.3 presents the issues and requirements that must be addressed to fully exploit the potential benefits of next generation optical networks.

2.2 Optical network drivers

Several factors are driving the need for optical networks. The most important reasons for migrating to the optical layer are described below.

2.2.1 Fiber capacity

The first implementation of what has emerged as the optical network began on routes that were fiber limited. Providers needed more capacity between two sites, but higher bit rates or fibers were not available. The only options in these kind of situations were to install more fiber, which is an expensive and labor-intensive chore, or place more Time Division Multiplexed (TDM) signals on the same fiber. Wavelength Division Multiplexing (WDM) provided many virtual fibers on a single physical fiber. By transmitting each signal at a different frequency (wavelength), network providers could send many signals on one fiber just as through they were each traveling on their own fiber.

2.2.2 Traffic growth

With the rapid growth of the Internet and the World-Wide-Web, we are seeing a relentless demand for higher capacities networks [10] [11] [12]. Corporate intranets and Virtual Private Networks (VPN), consumer home PCs with modems, and the rise of the World-Wide-Web has pushed aggregate bandwidth demand to the terabit level. This trend seems to continue for a while by the ongoing deployment of new broadband access technologies such as Digital Subscriber Lines (DSL) and cable modems. The global voice traffic continue increasing significantly by approximately 10 to 20% per year [13]. Moreover many new applications are foreseen and expected that will increase demands from both business and private customers for scalable, flexible, transparent, terabit speed, customized bandwidth services.

2.2.3 Reduced cost

In WDM systems, each location that demultiplexes signals will need an electrical network element for each channel, even if no traffic is dropping at that site. By implementing an optical network, only those wavelengths that add or drop traffic at a site need corresponding electrical nodes. Other channels can simply pass through optically, which provides tremendous cost saving in equipment and network management.

Despite the network cost saving in equipment and management thanks to the penetration of optical networks, deregulation, privatization and intense competition have forced down the per-bit price of bandwidth. Deregulation and privatization have had a huge impact on the structure of the telecommunication industry, resulting in a process of business transformation for network providers. The liberalization of the market led to the entrance of new network operators and therefore competition between them [14].

In addition, technological advances have succeeded in continuously reducing the cost of bandwidth. This reduced cost of bandwidth in turn spurs the development of a new set of applications that make use of more bandwidth and affects behavioral patterns. These applications are placing increasing

demands from both business and private customers for ultra-scalable, flexible, transparent, terabit speed, customized bandwidth services.

2.2.4 Traffic type change

There is also a significant change in the type of traffic that is increasingly dominating the network. Much of the new demand is being spurred by data, as opposed to traditional voice traffic. However, much of the network today is architected to efficiently support voice traffic, not data traffic. This change in traffic mix is causing service providers to reexamine the way they build their networks, the type of services they deliver, and even their entire business model.

2.2.5 Restoration capability

In optical networks, a fiber provides a number of wavelengths to carry data traffic, each operating at a very high rate of several gigabits per second, a fiber cut can have massive implications. In current electrical architecture, each network element performs its own restoration. For a WDM system with many channels on a single fiber, a fiber cut would initiate multiple failures, causing many independent systems to fail. By performing restoration in the optical layer, rather than the electrical layer, optical networks can perform protection switching faster and more economically. Additionally, the optical layer can provide restoration in networks that currently do not have a protection scheme. By implementing optical networks, provides can add restoration capabilities to embedded asynchronous systems without upgrading to an electrical-protection scheme.

These factors have driven the development and deployment of high capacity optical networks. Optical fiber communication is now firmly established as the preferred means of communication from a network core technology towards the metropolitan and access networks areas. Compared to transmission over electrical cables, optical fiber offers an almost perfect transmission medium: low loss over a very high bandwidth, low levels of undesirable transmission impairments, immunity to electromagnetic interference, and long life-spans. Measurements of fiber plants over 20 years have indicated little degradation.

2.3 Optical transmission: technology and devices

2.3.1 Multiplexing techniques

The need for multiplexing is driven by the fact that it is much more economical to transmit data at higher rates over a single fiber than it is to transmit at lower rates over multiple fibers, in most

applications. There are fundamentally two ways of increasing the transmission capacity on a fiber. The first is to increase the bit rate. This requires higher-speed electronics. Many lower-speed data streams are multiplexed into a higher-speed stream at the transmission bit rate by means of electronic time division multiplexing (TDM). The multiplexer typically interleaves the lower-speed streams to obtain the higher-speed stream. Today, the highest transmission rate in commercially available systems is around 10 Gbps; 40 Gbps TDM technology will be available soon. To push TDM technology beyond these rates, researchers are working on methods to perform the multiplexing and demultiplexing functions optically. This approach is called Optical Time Division Multiplexing (OTDM). Laboratory experiments have demonstrated the multiplexing/demultiplexing of several 10 Gbps streams into/from a 250 Gbps stream, although commercial implementation of OTDM is still several years away [15] [16] [17] [18].

Another way to increase the capacity is by using wavelength division multiplexing. WDM is essentially the same as Frequency Division Multiplexing (FDM). For some reason, the term FDM is used widely in radio communication, but WDM is used in the context of optical communication, perhaps because FDM was studied first by communications engineers and WDM by physicists. The idea is to transmit data simultaneously at multiple carrier wavelengths (or, equivalently, frequencies or colors) over a fiber. To first order, these wavelengths do not interfere with each other provided they are kept sufficiently far apart. Thus WDM provides virtual fibers, in that it makes a single fiber look like multiple "virtual" fibers, with each virtual fiber carrying a single data stream. WDM systems are widely deployed today in long-haul and undersea networks and are being deployed in metro networks as well. The key advantage of using WDM for long-haul transmission (see Subsection 2.3.5.1) is the reduced fiber and amplifier requirement. Only one fiber needs to be installed and lit, and all installed channels can be amplified simultaneously using optical amplifiers (see Subsection 2.4.1.1).

WDM and TDM both provide ways to increase the transmission capacity and are complementary to each other. Therefore networks today use a combination of TDM and WDM. Indeed, with WDM multiple TDM channels can be sent simultaneously along a fiber. Each TDM channel occupies a wavelength on the ITU-specified grid, separated at a channel spacing of 100 GHz [19]. Some commercial systems propose 50 GHz or even 25 GHz spacing [20]. With these narrow spacings the transmission is termed Dense WDM (DWDM). DWDM systems allow a limited number of channels (to around 4 to 6 channels) to be transmitted simultaneously and are well suited to shorter reach applications.

2.3.2 Fiber types

2.3.2.1 Multi-mode fiber

Early experiments in the mid 1960s by Kao and Hockham [21] demonstrated that information encoded in light signals could be transmitted over a glass fiber waveguide. These early experiments proved that

optical transmission over fiber was feasible. However, it was not until the development of processes to fabricate low-loss optical fiber in the early 1970s by researchers at Corning [22] and Bell Labs [23] that optical fiber transmission systems really took off. This silica-based optical fiber has three low-loss windows in the 800, 1300, and 1550 nm infrared wavelength bands [24] [25]. The lowest loss is around 0.25 dB/km in the 1550 nm band, and about 0.5 dB/km in the 1300 nm band. These fibers enabled transmission of light signals over distances of several tens of kilometers before they needed to be regenerated. A regenerator converts the light signal into an electrical signal and retransmits a fresh copy of the data as a new light signal. Regenerators were expensive devices and are still expensive today, so it is highly desirable to maximize the distance between regenerators.

The early fibers were the so-called Multi-Mode Fibers (MMF). Multi-mode fibers have core diameters of about 50 to 85 μm . This diameter is large compared to the operating wavelength of the light signal and therefore multi-mode fibers support multiple propagation modes, each mode traveling at a slightly different speed through the fiber. At the end of the fiber, the different modes arrive at slightly different times, resulting in a smearing of the pulse. This smearing is called dispersion, and this specific form is called inter-modal dispersion. Inter-modal dispersion restricts the transmission distances on multi-mode fibers [26]. Typically, the early transmission systems operated at bit rates ranging from 32 to 140 Mbps with regenerators every 10 km. Multi-mode fiber systems are still in use for low-cost computer interconnection at a few hundred megabits per second over a few kilometers.

2.3.2.2 Single-mode fiber

The next generation of systems deployed around 1984 used standard Single-Mode Fiber (SMF) [27] in the 1300 nm wavelength band to cope with inter-modal dispersion. Single-mode fibers have a relatively small core diameter of about 8 to 10 μm , which is a small multiple of the operating wavelength range of the light signal. This forces all the energy in a light signal to travel in the form of a single mode.

Using single-mode fiber effectively eliminates inter-modal dispersion and enables a dramatic increase in the bit rates and distances possible between regenerators. These systems typically have regenerator spacing of about 40 km and operate at bit rates of a few hundred megabits per second. References [28] [29] [30] [31] describe some of the early terrestrial optical fiber transmission systems.

The next step in this evolution, in the late 1980s, was to deploy systems in the 1550 nm wavelength window to take advantage of the lower loss in this window, with respect to the 1300 nm window. This enabled longer spans between regenerators.

At this point another impairment, namely chromatic dispersion, becomes a limiting factor as far as increasing the bit rates is concerned. Chromatic dispersion is another form of dispersion in optical fiber. The energy in a light signal or pulse has a finite bandwidth. Even in a single-mode fiber, the different

frequency components of a pulse propagate with different speeds. This is due to the fundamental physical properties of the glass. This effect again causes a smearing of the pulse at the output, just as with inter-modal dispersion. The wider the spectrum of the pulse, the more the smearing due to chromatic dispersion.

The chromatic dispersion in an optical fiber depends on the wavelength of the signal. It turns out that without any special effort, the standard silica-based optical fiber has almost no chromatic dispersion in the 1300 nm band, but has a significant dispersion in the 1550 nm band. Thus chromatic dispersion was not an issue in the earlier systems at 1300 nm.

The high chromatic dispersion at 1550 nm motivated the development of Dispersion-Shifted Fibers (DSF) [32]. Dispersion-shifted fibers are carefully designed to have zero dispersion in the 1550 nm wavelength window.

A nice description of different fiber types can be found in [26], which reviews the major physical transmission impairments such as attenuation and chromatic dispersion. Non-linear fiber effects are discussed in [33]. One of them is called Four-Wave Mixing (FWM). In FWM, three light signals at different wavelengths interact in the fiber to create a fourth light signal at a wavelength that may overlap with one of the light signals. As we can imagine, this signal interferes with the actual data that is being transmitted on that wavelength.

Some equipment vendors employ bi-directional transmission on a single fiber, using filters and circulators to separate the two directions at the network nodes [34]. Other vendors use two separate fibers for each direction of transmission.

Optical fiber cables are usually installed in underground fiber ducts connecting cities. The ducts often run parallel to or underneath existing infrastructure networks, e.g. roads, railways, or gas pipelines.

2.3.3 Light sources

The other key devices needed for optical fiber transmission are light sources and receivers. Compact semiconductor lasers and Light-Emitting Diodes (LEDs) provided practical light sources. These lasers and LEDs were simply turned on and off rapidly to transmit digital (binary) data. The transmitter was turned on for the duration of a bit period to send a binary "1" and turned off for the duration of the bit period to signal a binary "0". This is called binary Non Return to Zero (NRZ) modulation. Semiconductor photo-detectors enabled the conversion of the light signal back into the electrical domain. The early telecommunication systems (late 1970s through the early 1980s) used multi-mode fibers along with LEDs or laser transmitters in the 800 and 1300 nm wavelength bands.

LEDs are relatively low-power devices that emit light over a fairly wide spectrum of several nanometers to tens of nanometers. A laser provides higher output power than a LED and therefore allows

transmission over greater distances before regeneration. The early lasers were Multi-Longitudinal Mode (MLM) Fabry-Perot lasers. Later Distributed Feed Back (DFB) lasers have been developed. A DFB laser is an example of a Single Longitudinal Mode (SLM) laser. An SLM laser emits a narrow single wavelength signal in a single spectral line, in contrast to MLM lasers whose spectrum consists of many spectral lines. This technological breakthrough spurred further increases in the bit rate to more than 1 Gbps.

2.3.4 Line rates

The individual channels in a WDM system are TDM signals at rates of typically 2.5 Gbps or 10 Gbps. These transmission speeds, or line rates, correspond to the Synchronous Digital Hierarchy (SDH) data units of STM-16, STM-64, and STM-256. All channels are bidirectional.

Traditionally, each rise in equipment transmission rate by a factor of 4 is accompanied by a cost increase of 250% [35] [36], giving a financial incentive to groom traffic up to the highest transmission rate. It is therefore desirable that a WDM system can mix channels of different speed wavelengths, so that a seamless migration to higher line rates can be achieved on the same WDM equipment [37] [38]. This can allow significant operational cost savings [39], though not all vendors provide this functionality.

In effect, switching a wavelength to a higher rate increases the overall spectral efficiency of the WDM transmission system, since the ITU specified wavelength grid is fixed. Recent advances have achieved 0.8 bits/s/Hz efficiency with 40 Gbps line rates at a 50 GHz channel spacing [40]; the theoretical maximum being 1 bit/s/Hz without using more complicated modulation and coding schemes.

2.3.5 LH and ULH transmission

There are generally two currently available platforms for optical core network transmission, based on the following prevailing industry segmentation:

2.3.5.1 Long haul (LH)

Long Haul (LH) transmission systems that are currently available have a capacity of typically up to 1.6 Tbps per fiber, via upgradeable stages. This is generally arranged as 160 wavelengths of 10 Gbps channels, spaced over several transmission bands that can be turned on separately. Therefore, a possible upgrade route is to deploy a 40-channel LH transmission system, and then upgrade to 80 and 160 channels when necessary by adding extra components to utilize further bands of transmission capacity.

The reach for LH line systems is in the range of 400 to 600 km, depending on vendor and fiber type. A Non Return to Zero modulation scheme is common for LH line systems, and amplifiers are required about every 100 km [24].

2.3.5.2 Ultra long haul (ULH)

The newer Ultra Long Haul (ULH) transmission systems have a reach of over 2000 km, with 4000 km reported in some commercially available systems [41] on the ideal fiber type.

A Return to Zero modulation scheme is employed to achieve longer distance transparent transmission [24]. Raman amplification [36] is needed about every 100 km. Dispersion slope compensation [42] and dynamic gain equalization [43] is also required to achieve such long distances. Forward Error Correction (FEC) is also used to boost system reach by enhancing the Bit Error Rate (BER) performance [44].

ULH technology has the potential to increase the level of optical transparency in core networks; however, since ULH involves more sophisticated technologies, it is significantly more expensive than LH.

The past of optical communication has been mostly about transmission and how to provide higher bandwidths while simultaneously reducing the cost per bit transmitted. The future is likely to be about optical networking. Transmission will continue to play a key role, but the new game is to reduce the cost per connected bit transmitted. The implication of this statement is that the optical layer will move from providing simple transmission pipes to a managed optical network. This allows service providers to deliver a range of new services using the optical network. In order to be successful at accomplishing this objective, service providers and equipment manufacturers will need to figure out how to get the best network efficiencies by combining the optical layer with higher layers such as Synchronous Optical Network (SONET) (for Static TDM services) and IP (for statistical multiplexed services).

2.4 From optical transmission to optical networking

In the SDH and SONET based optical transport networks deployed today, WDM is used primarily in point-to-point transmission systems. In recent years, people have realized that optical networks are capable of providing more functions than just point-to-point transmission. Major advantages are to be gained by incorporating some of the switching and routing functions that were performed by electronics into the optical part of the network. In the SDH and SONET based optical transport networks, the electronics at a node must handle not only all the data intended for that node but also all the data that is being passed through that node on to other nodes in the network. If the latter data could be routed through in the optical domain, the burden on the underlying electronics at the node would be significantly reduced. The ultimate goal of this trend is the realization of *transparent* or *all-optical networks* wherein data is carried from its source to its destination in optical form, without any optical-to-electrical conversions along the path.

2.4.1 Optical network elements

The key network elements that enable optical networking are described below.

2.4.1.1 Optical amplifiers

In an optical communication system, the optical signals from the transmitter are attenuated by the optical fiber as they propagate through it. Other optical components also add loss. Beyond a certain distance, the signal become too weak to be detected due to the accumulation of loss. Before this happens, the signal strength has to be restored. Prior to the advent of optical amplifiers, the only option to strength the transmitted signal was to regenerate the signal, that is, receive the signal, and retransmit it. This process is accomplished by *regenerators*. A regenerator converts the optical signal to an electrical signal, cleans it up, and converts it up to an optical signal before retransmission.

Optical Amplifiers (OA) offer several advantages over regenerators. Optical amplifiers are insensitive to the bit rate or signal format unlike regenerators which are specific to the bit rate and modulation format used by the communication system. Thus a system using optical amplifiers can be easily upgraded, for example, to a higher bit rate, without replacing any amplifier. In contrast, in a system using regenerator, such an upgrade would require the replacement of all the regenerator. Furthermore, optical amplifiers have fairly large gain bandwidths, and as a consequence, a single amplifier can simultaneously amplify several WDM signals. In contrast, a regenerator is specific for each wavelength. Thus, optical amplifiers have become an essential component in LH and ULH fiber optic systems [36]. We will consider three types of amplifiers: Semiconductor optical amplifiers, erbium doped fiber amplifiers, and [24], and Raman optical amplifiers.

An optical amplifier works on the same principle as that of a laser. In short, incident light is amplified by sustained stimulated emission. The amplification is achieved by a pumping process whereby either electrical or optical pumping boosts the incident signal power in a gain medium or just in a fiber. A pump is a local power source that couples its power to an incident optical signal, thereby amplifying the incident signal by transferring its power either directly or through doped impurities to the optical signal.

2.4.1.1.1 Semiconductor optical amplifiers Semiconductor Optical Amplifiers (SOAs) are essentially laser diodes, without end mirrors, which have fiber attached to both ends. They amplify any optical signal that comes from either fiber and transmit an amplified version of the signal out of the second fiber. SOAs are typically constructed in a small package, and they work for 1310 nm and 1550 nm systems. SOAs are small size devices but have high-coupling loss, and a higher noise figure.

2.4.1.1.2 Optical doped fiber amplifiers Optical Doped Fiber Amplifiers (ODFA) are lengths of fiber doped with an element (rare earth) that can amplify light. The most common doping element is erbium, which provides gain for wavelengths of 1525-1560 nm. At the end of the length of fiber, a laser transmits a strong signal at a lower wavelength (called the pump wavelength) back up the fiber. This pump signal excites the dopant atoms into a higher energy level. This allows the data signal to stimulate the excited atoms to release photons. Most Erbium-Doped Fiber Amplifiers (EDFA's) are pumped by lasers with a wavelength of either 980 or 1480 nm. The 980 nm pump wavelength has shown gain efficiencies of around 10 dBpmW, while the 1480 nm pump wavelength provides efficiencies of around 5 dBpmW. Typical gains are on the order of 25 dB.

2.4.1.1.3 Raman optical amplifiers Raman Optical Amplifiers (ROA) differ in principle from EDFAs or conventional lasers in that they utilize Stimulated Raman Scattering (SRS) to create optical gain. SRS is a type of inelastic scattering that results in broadband amplification of optical channels [26] [45]. Known as one of the fiber impairments that affects signals propagation, SRS can be exploited to provide amplification. The Raman gain spectrum [26] is fairly broad and the peak of the gain is centered about 13 THz below the frequency of the pump signal used. In the near-infrared region of interest, this corresponds to a wavelength separation of about 100 nm. Therefore by pumping a fiber using a high-power pump laser, we can provide gain to other signals, with a peak gain obtained 13 THz below the pump frequency. For instance, using pumps around 1460-1480 nm provides Raman gain in the 1550-1600 nm window.

Raman amplifiers have lower noise and nonlinear effects, and they handle wider bands than EDFAs. Today, Raman amplifiers are used to complement EDFAs by providing additional gain in ULH and LH transmission systems. The biggest challenge in realizing Raman amplifiers lies in the pump source itself. These amplifiers require high-power pump sources of the order of 1 W or more at the right wavelength.

2.4.1.2 Optical line terminals

An Optical Line Terminal (OLT) multiplexes multiple wavelengths into a single fiber and demultiplexes a set of wavelengths on a single fiber into separate fibers. OLTs are used at the ends of a point-to-point WDM link. Three functional elements compose an OLT: transponders, wavelength multiplexers, and optional optical amplifiers. A transponder adapts the signal coming in from a client of the optical network into a signal suitable for use inside the optical network. Likewise, in the reverse direction, it adapts the signal from the optical network into a signal suitable for the client. The adaptation includes several functions. The signal may for instance need to be converted into a wavelength that is suited for use inside the optical network. The transponder may add additional overhead for network management purposes. It may also add forward error correction, particularly for signals at 10 Gbps and

higher rates. The transponder also monitors the bit error rate at the ingress and egress points in the networks. Transponders typically constitute the bulk of the cost, footprint, and power consumption in an OLT. Therefore reducing the number of transponders helps minimizing both the cost and the size of the equipment deployed.

The signal coming out from a transponder is multiplexed with other signals at different wavelengths using a wavelength multiplexer onto a fiber. Moreover, an optical amplifier may be used to boost the signal power if needed. In the other direction, the signal is amplified again, if needed, before it is sent through a demultiplexer that extracts the individual wavelengths. The wavelengths are again terminated at a transponder (if present) or directly at the client equipment.

2.4.1.3 Optical add/drop multiplexers

Optical Add/Drop Multiplexers (OADMs) provide a cost effective means for handling pass through traffic in both metro and long-haul networks. An OADM takes in signals at multiple wavelengths and selectively drops some of these wavelengths locally while letting others pass through. It also selectively adds wavelengths to the composite outbound signal. An OADM has two line ports where the composite WDM signals are present, and a number of local ports where individual wavelengths are dropped and added.

To understand the benefits of OADMs, we consider the three-node network shown in Figure 2.1(a). We assume that we have to set up one traffic connection between nodes A and B, one traffic connection between nodes B and C and three traffic connections between nodes A and C. Now suppose we deploy point-to-point WDM systems to support this traffic demand. Two point-to-point systems are required, one between nodes A and B and the other between nodes B and C. As we saw earlier, each point-to-point system uses an OLT at each end of the link.

Consider what is needed at node B. Node B has two OLTs. Each OLT terminates four wavelengths and therefore requires four transponders. However, only one out of those four wavelength is destined for node B. The remaining transponders are used to support the pass through traffic between nodes A and C. These transponders are hooked back to back to provide this function. Therefore, six out of the eight transponders available at node B are used to handle the pass-through traffic (see Figure 2.1(a)).

Consider the OADM solution shown in Figure 2.1(b). We now deploy a wavelength routed network instead of deploying point-to-point WDM systems. One OADM is required at node B and two OLTs are still required at nodes A and C. The OADM drops one of the four wavelengths, the remaining three wavelengths are passed through in the optical domain without requiring transponders. Only two transponders are needed at node B, instead of the eight transponders required for the solution shown in Figure 2.1(a).

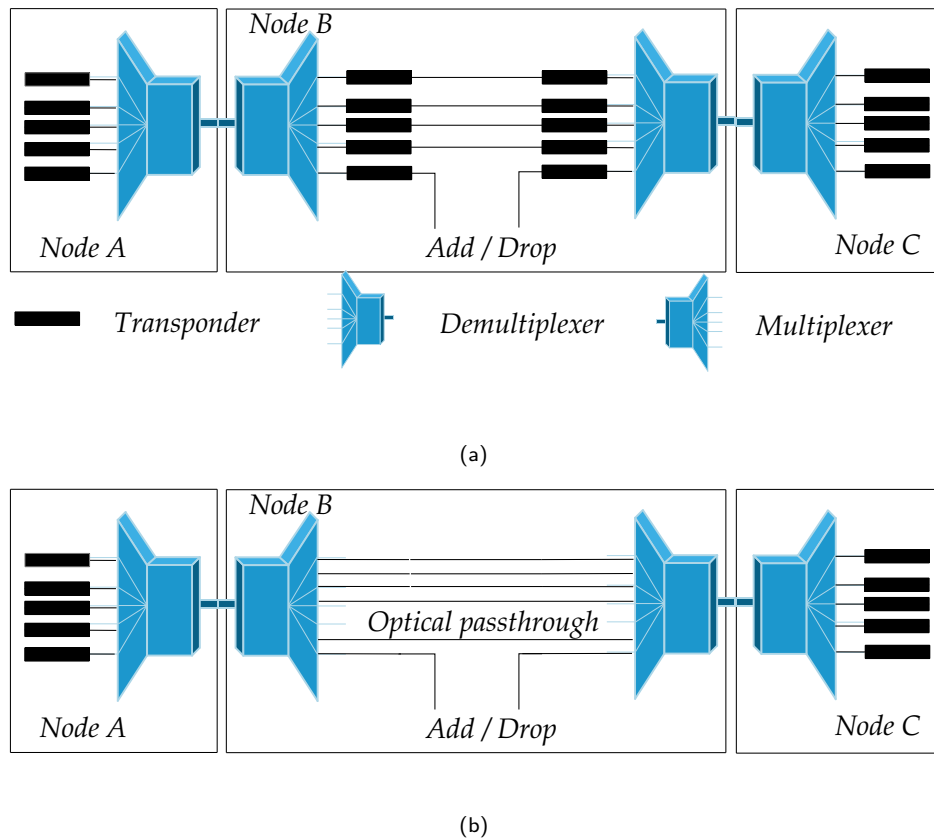
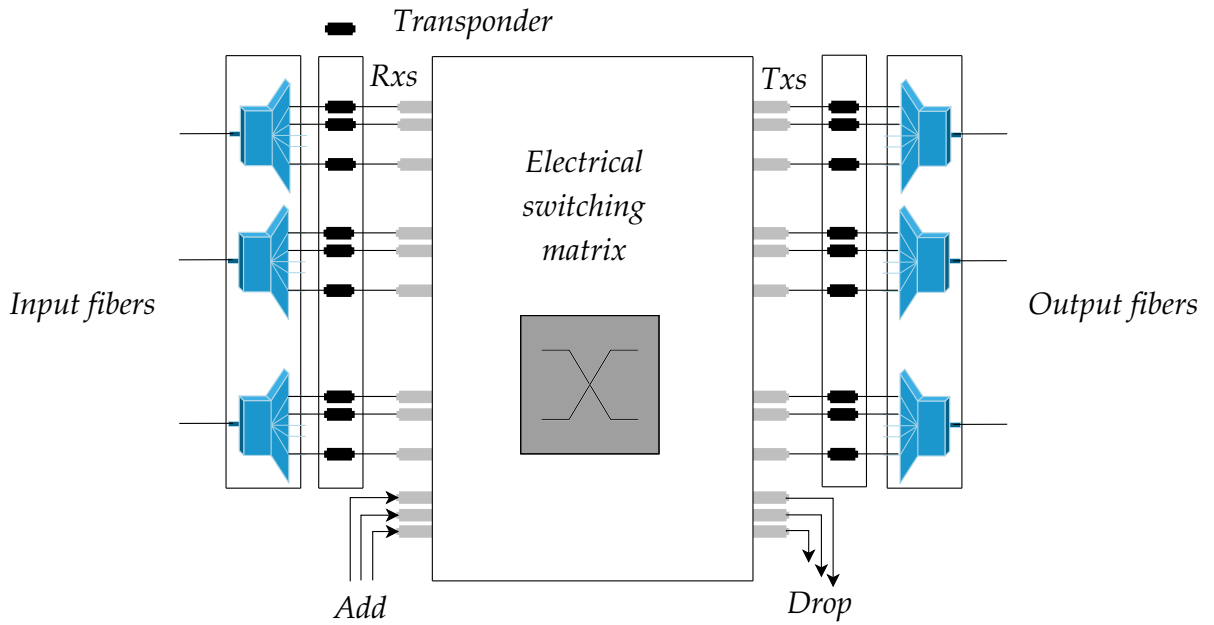

Figure 2.1 : A three-node network example to illustrate the role of OADM

2.4.1.4 Optical cross-connects

An Optical Cross-connect (OXC) basically performs a similar function as OADM but at much larger sizes. OXCs have a large number of ports (ranging from a few tens to thousands) and are able to switch wavelengths from one input port to another. Both OADM and OXCs may incorporate wavelength conversion capabilities. Figure 2.2 shows two different types of OXCs. The architectures differ in terms of whether the switching matrix is done electrically or optically, in the use of optical to electrical (O/E) and optical to electrical to optical (O/E/O) conversions.

Looking at Figures 2.2(a) and 2.2(b), observe that in the opaque configurations the switch core can be either in the electrical or optical; that is signals may be switched either in the electrical domain or in optical domain. An electrical switch core can groom traffic at fine granularities and typically includes time division multiplexing of lower-speed circuits into the line rate at the input and output ports. Today electrical core OXCs have capabilities to switch signal at granularities of STM-1 (51 Mbps) or STM-48 (2,5 Gbps). In contrast, an optical switching matrix does not offer any grooming possibility. It simply



(a) Opaque OXC

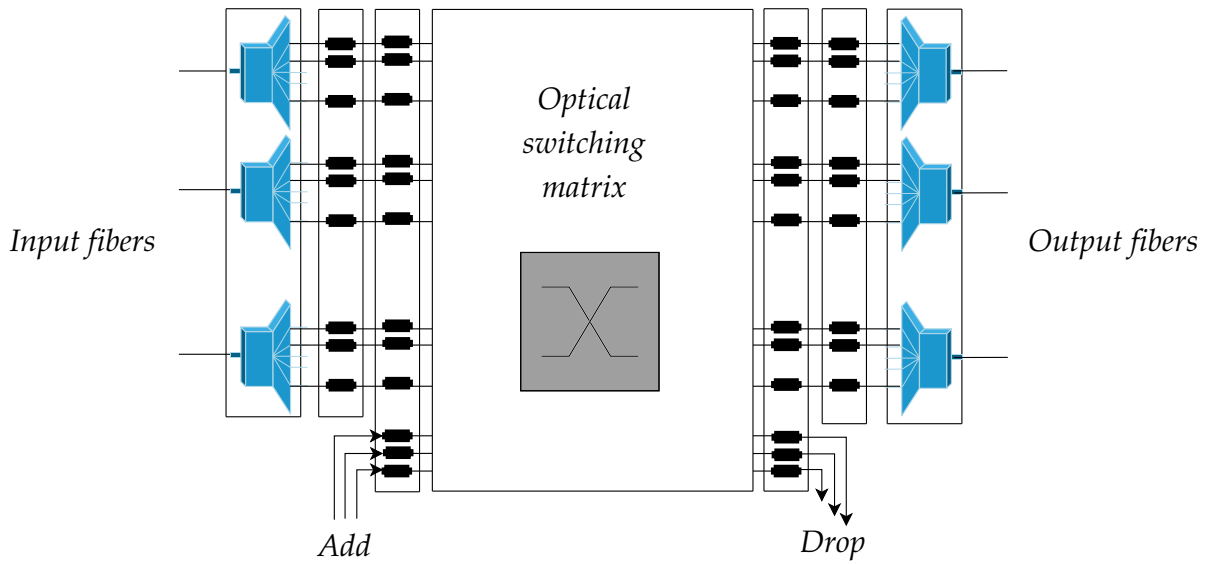

(b) Transparent-core OXC

switch an arriving signal on an input port to an output port.

An electrical switching matrix is designed to have a total switch capacity, for instance, 1.28 Tbps. This capacity can be utilized to switch up to 512 OC-48 (2,5 Gbps) signals or 128 OC-192 (10 Gbps) signals. The optical switching matrix is typically bit rate independent. Therefore a 1000 port optical switching matrix can switch up to 1000 OC-48 streams, 1000 OC-192 streams, or even 1000 OC-768

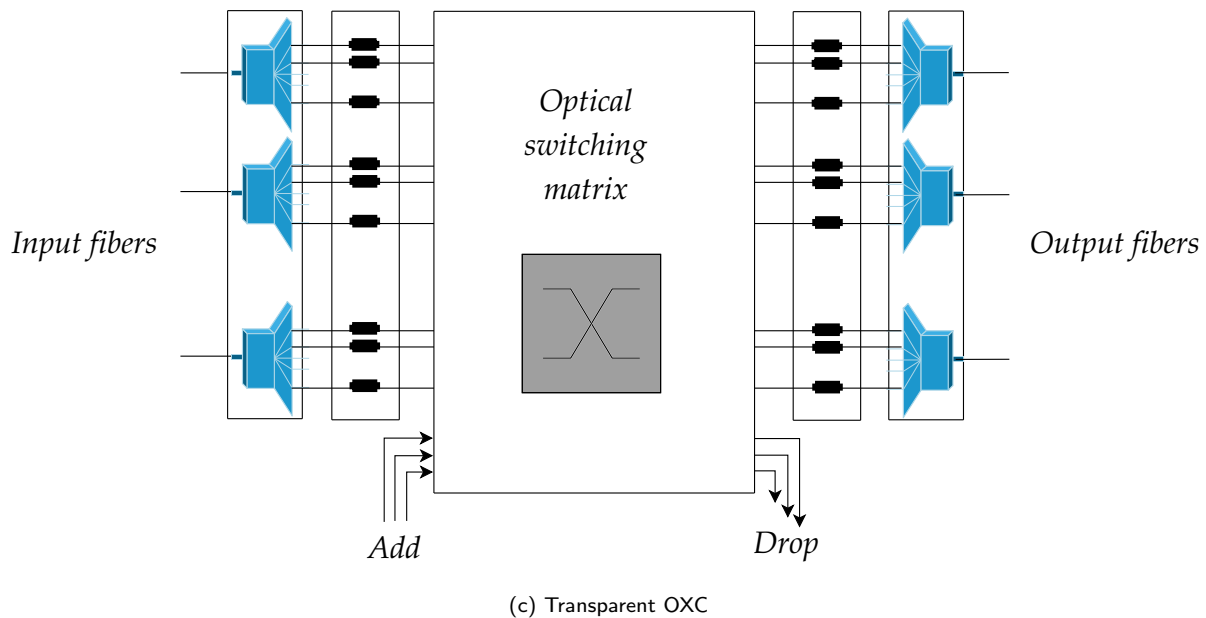

Figure 2.2 : Three OXC architectures

(40 Gbps) streams, all at the same cost per port. The optical switching matrix is thus more scalable in capacity, comparing to an electrical switching matrix, making it more future proof as bit rates continue increasing.

Moreover, the cost of an electrical port increases with bit rates. For instance, an OC-192 port might cost twice as much as an OC-48 port. The cost of a port on an optical switching matrix is the same regardless of the bit rate. Therefore at higher bit rates, it will be more cost-effective to switch signals through an optical switching matrix than an electrical switching matrix.

An optical switching matrix is also transparent; it does not care whether it is switching a 10 Gbps Ethernet signals or a 10 Gbps SONET signal. Conversely, electrical switching matrices require separate port cards for each interface type, which has to convert the input signal into a format suitable for the switch fabric.

Figure 2.2(a) shows an opaque switch architecture with an electrical switching matrix. The interfaces to the electrical switching matrix are opaque interfaces with transceivers (receivers and transmitters) which subsequently enable O/E and E/O conversions. The switching matrix is opaque to the signal's characteristics, that is, it switches the specific bit rate and format of the signal. Though the technology required to implement this type of architecture is mature and available today, the opaque switch architecture faces a number of challenges when confronted with traffic growth. It would eventually reach scalability limitations in signal bit rate, switch matrix port count and network element cost. These

are key motivations behind the attempt to develop large port-count transparent switches. The OXC architecture shown in Figure 2.2(b) consists of transponders connected to the input/output ports of an optical switching matrix. The transponders in the OXC are necessary in this type of architecture, particularly in the case of optical matrices with significant loss of optical power, which will be the case in the short and probably the mid term. On the other hand, the transparency of the matrix allows the switching function to be decorrelated from the signal's characteristics, which makes this architecture more adaptable to changes of these characteristics. Figure 2.2(c) shows a transparent switch architecture. This switch architecture has transparent interface cards and no opaque transceiver cards on its add/drop ports. The optical switching matrix is bit rate independent and accommodates any data rates available. The switching matrix can scale more easily, than the electrical switching matrix, to accommodate up to 40 Gbps per port. Transparent switches are expected to be cheaper in terms of switching matrix and interface card cost than opaque switches. This would result in significant cost reduction because a large amount of the traffic that passes through an office would be able to bypass the opaque switch (typically approximately 75% through-to-total ratio). This would in turn eliminate about 75% of the network O/E element's interfaces, and thus about 75% of the network cost, power, and footprint.

2.4.2 Optical switching techniques

The three main approaches that seem promising for the gradual migration of the switching functions from electronics to optics are Optical Circuit Switching (OCS), Optical Packet Switching (OPS), and Optical Burst Switching (OBS). While OCS provides bandwidth at a granularity of a wavelength, OPS can offer an almost arbitrarily fine granularity, comparable to currently applied electrical packet switching, and OBS lies between them.

In optical circuit-switched network, data is transmitted between any source-destination pair using connections (e.g., lightpaths in WDM networks, Label Switching Paths (LSPs) in MPLS networks, VCs in ATM networks, ...). A connection has a life-cycle of three phases: set-up, operation, and tear-down. In the set up phase, the connection is instantiated by assigning resources on the links and switches traversed by the connection (time slots in TDM links, frequency bands in FDM or WDM links and input/output ports in switches). In the operation phase, the data is transmitted on the reserved resources. The resources remain reserved for the connection lasting. Finally, in the tear-down phase, the resources are released.

In optical packet switching, a data stream is broken up into packets of small size before being transmitted. Routing information is added in the overhead of each packet. Packet streams can be multiplexed together statistically, making more efficient use of capacity and providing increased flexibility

over WDM [46]. Packet switches analyze the information contained in the packet headers and thus determine where to forward the packets. Optical packet-switching technologies enable the fast allocation of WDM channels on-demand with fine granularities (microsecond time scales). An optical packet switch can cheaply support incremental increases of the transmission bit rate so that frequent upgrades of the transmission layer capacity can be envisaged to match increasing bandwidth demand with minor impact on switching nodes [47]. In addition, OPS offers high speed, data rate/format transparency, and configurability, which are some of the important characteristics needed in future networks supporting different forms of data [48]. However, for several reasons the implementation of OPS is particularly difficult. First, due to factors such as fiber length, temperature variation and chromatic dispersion, the packets traveling on a fiber experience different delays. The packet propagation speed is also affected by temperature variations. Moreover the delays that packets experience in switching nodes are not also fixed which lead to potential electronic bottlenecks. Second, a very small switching matrix reconfiguration time for very high bit rates is required which is hardly achievable with current optical switching technologies. Finally, no technology is known today to implement an optical Random Access Memory (RAM) to deal with packet contention at the output ports. Though several optical packet-switching network prototypes have been developed [46] [49] [50], this type of networks are unlikely to be deployed in the short future, in particular, due to technological limitations.

Optical burst switching was proposed as another way of implementing optical packet switching whereas circumventing the implementation difficulties of OPS. The basic unit of data to be transmitted is a burst, which consists of multiple packets. The data burst is sent after a control packet reserves necessary resources on the intermediate nodes without waiting for acknowledgment from the destination node (as done in the virtual circuit setup process in ATM). OBS could achieve high bandwidth utilization with lower average processing and synchronization overhead than packet switching since it does not require packet-by-packet operation. The problem of packet contention that rises with OPS is solved thanks to the resource reservation mechanism implemented with the control packet. It is also possible to implement Quality of Service (QoS) by managing the offset time between the control packet and the data burst [48] [51]. Despite these advantages with respect to OPS, OBS mainly remains a subject of academic study.

Optical circuit switching is the switching mode that will most likely be implemented in optical transparent networks in the near future.

2.4.3 Evolution of optical networks: challenges and requirements

Figure 2.3 shows the evolution of the optical layer. The initial use for optical fiber communication is to provide high-bandwidth point-to-point pipes. At the end of these pipes, data is converted from the

optical to the electrical domain, and all the switching, routing, and intelligent control functions are handled by higher-layers such as SONET or IP. This is the static, opaque optical layer shown towards the bottom left of Figure 2.3. From this point, the optical layer is seeing an evolution through two different dimensions.

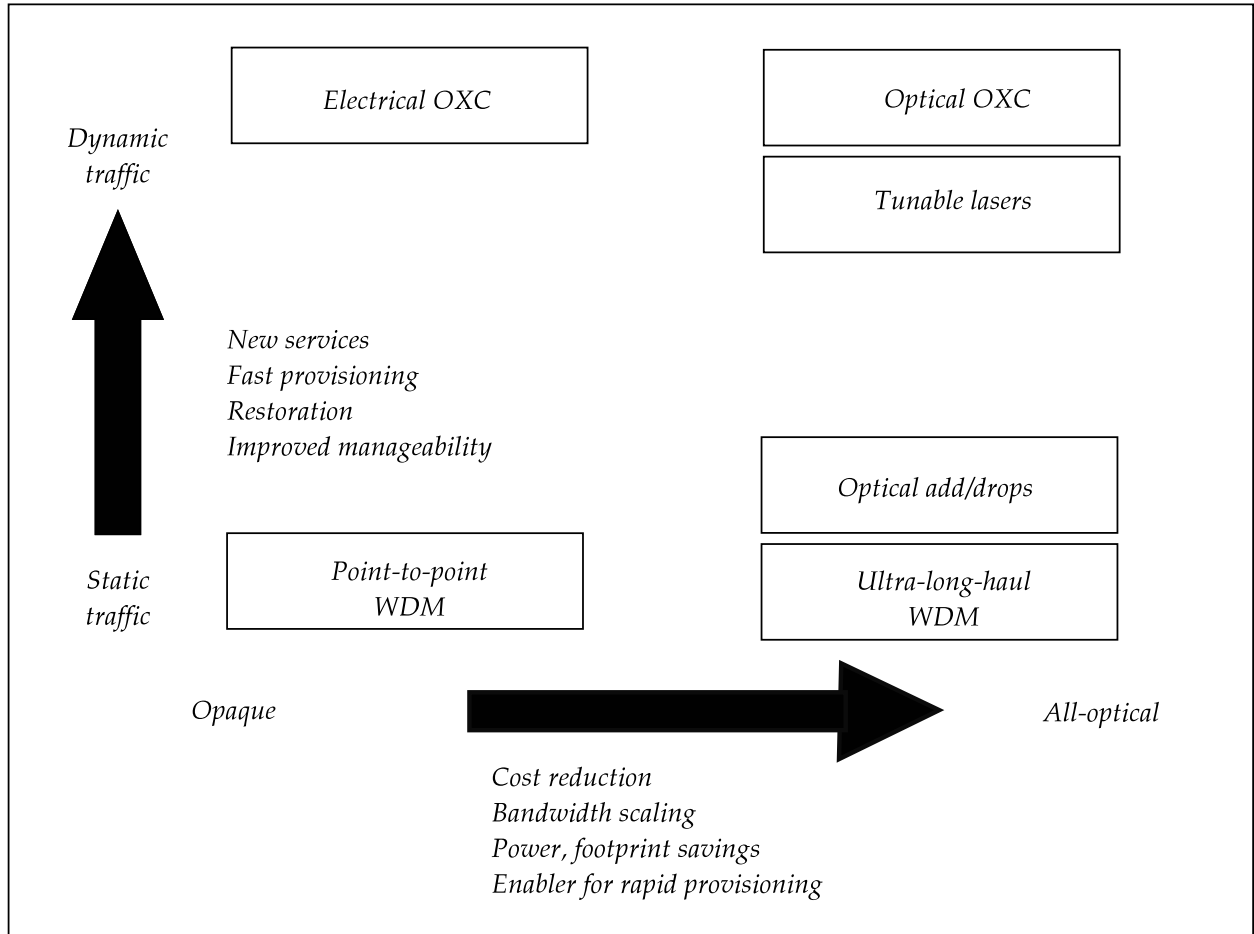

Figure 2.3 : Evolution of optical networks

The first trend is to handle more functions in the optical layer by moving toward a network that is more all-optical (transparent). Optical transparency has long been considered as a strong advantage of any type of WDM networking technology, be it long-haul, metro, or access. Given the diverse mix of data signaling formats at the access side, this capability is crucial in isolating service providers from the constant evolution of newer data format standards. The benefits of optical transparency allow service providers to address many issues and translate them into competitive advantages. It reduces channel latency and does not require expensive transponders (for O/E/O conversions), offering significant scalability improvements and cost-reduction. Furthermore, optical transparency can yield

large cost savings since it eliminates the need for maintaining separate electronic sub-rate grooming and tributary multiplexing network elements. Optical transparency is just not a requirement, but it is clearly one of the factors that will make WDM networks simple and efficient.

The trend toward all-optical network is being fueled by the recent introduction of ultra-long-haul WDM systems and optical add/drop multiplexers. The ultra-long-haul systems allow optical signals to be transmitted over a few thousands of kilometers before requiring any regeneration. OADM's provide a low cost option for adding and dropping some wavelengths while allowing other wavelengths to pass through in the optical domain.

Along the other dimension shown in Figure 2.3, optical networks are evolving from static networks to dynamic, intelligent, smart networks. Indeed, the optical layer is evolving to provide additional functionalities, including the ability to set up and tear down connection demands across the network in a dynamic fashion, and the ability to reroute them rapidly in case of a failure. This helps services providers propose new services allowing them to generate new revenues. Intelligent wavelength channel provisioning schemes are hence required. These software algorithms must yield very fast connection set-up times. Such *on-demand* provisioning mandates automated end-point address identification, fast route computation, and low set-up latencies. Furthermore, to provide more generalized and farther-reaching service definitions, different optical QoS levels must also be implemented. For example, the QoS levels on an optical connection can reflect its delay, priority, protection, and channel quality features, etc.

In order to enable such services, service providers have to address both network survivability and management issues. Several survivability mechanisms are necessary to provide better service definitions to their customers. Indeed, customer Service Level Agreements (SLAs) for critical traffic such as real-time voice or financial transactions will specify recovery time scales in tens of milliseconds range. Conversely, it is well known that a large part of the Internet traffic is relatively delay insensitive, such as e-mail, fax, telnet, ftp, web caching, etc. Many of these customers will be pleased with low-cost service providing with longer recovery timescales or possibly even lower recovery probabilities. Survivability schemes can be classified into two forms, protection and restoration. The former refers to pre-provisioned recovery whereas the latter refers to dynamic (i.e., active, post-fault) signal recovery.

Network management is one of the most important and difficult issues involved with the optical network. Despite the wide range of protocols and services supported, network administrators will ask for standards based, bit-rate independent management solutions that allow performance monitoring, fault localization, and accounting activities. The quality of the network management solution and its ability to offer unified management may indeed be the primary factor in choosing the system to deploy.

2.4.4 Taxonomy used in this thesis

In this thesis, we used the taxonomy presented in Table 2.1. The taxonomy is widely adopted in the literature about optical networking.

span	is the physical pipe connecting two adjacent nodes i and j in the network. Fibers laid down in a span may have opposite directions. We assume all along this thesis that a span (i, j) is made of two opposite unidirectional fibers.
wavelength	is a particular carrier frequency.
link	also called <i>fiber-link</i> refers to a single unidirectional fiber connecting two adjacent nodes. We assume that the bandwidth of each optical fiber is wavelength-division demultiplexed into a set of W wavelengths.
path	also called physical route or simply route is a succession of fiber links and intermediate nodes to go from a source node s to a destination node d in the network.
lightpath	also called <i>optical channel</i> , connecting a source node s to a destination node d is defined by a physical route in the network connecting s to d and a set of wavelengths, one for each link on the route. The wavelengths used on each fiber-link may be different. This assumes the use of wavelength converters at intermediate nodes when necessary to shift one wavelength on an input port to another output port. In the context of all-optical networks, wavelength conversion, at intermediate node, is forbidden. The same wavelength is used on all the links all along the path. This is known as the Wavelength Continuity Constraint (WCC). In this thesis, we consider all-optical transport networks.
path-free wavelength	is a wavelength which is not used by any lightpath on any fiber-link of the considered path.
WDM channel	also called <i>wavelength-link</i> , is a wavelength used on a link.
Working path (WP)	also called primary path or simply primary is a route and a wavelength assigned to that route in the optical network, using which data is carried from source node s to destination node d , during normal operation of the network, when there are no failures.

Protection path (PP) also called backup path or simply backup denote a route and a wavelength assigned to that route in the optical network using which data is carried from the source node s to destination node d , during a failure situation in the network.

Table 2.1: Taxonomy used in this thesis

Chapter 3

Literature Survey

3.1 Introduction

Some of the important issues in all-optical WDM networks include routing and wavelength assignment, survivability, bandwidth loss due to the wavelength continuity constraint, control and management and traffic grooming. Within the framework of this thesis, we study the first three issues and propose new routing methods and techniques to enhance the network throughput w.r.t. to the already proposed methods in the literature.

In the following we briefly describe each of these issues and discuss the advantages and drawbacks of the solutions proposed in the literature to deal with these problems.

3.2 Routing and wavelength assignment

The Routing and Wavelength Assignment (RWA) problem is defined as follows. Given a network topology and a set set of lightpath demands to be set up and given a constraint on the number of wavelengths, we need to determine the paths and the wavelengths that should be assigned to the lightpath demands so that a certain optimality criterion (performance metric) is achieved.

The RWA algorithms available in the literature differ in their performance metrics and traffic assumption: the performance metrics used generally fall under one of the following three categories:

- Number of wavelengths required to set up the arrived or given set of lightpath demands (see among others [52] [26]).

- Lightpath demands blocking probability also called throughput which is defined as the ratio between the number of blocked lightpath requests and the total number of lightpath demands arrived or given [53].
- Number of fiber resources handled at the routing nodes (fiber cost).

Traffic assumptions generally fall into one of the following three categories: static, incremental, and dynamic [54] [55].

- Static traffic assumes that the entire set of static (permanent) lightpath demands is known in advance, and the problem is then to set up lightpaths for these requests in a global fashion while minimizing network resources such as the number of wavelengths or the number of fibers in the network. Alternatively, one may attempt to set up as many of these permanent connections as possible for a given fixed number of wavelengths per fiber-link. The RWA problem for static traffic is known as the Static Lightpath Establishment (SLE) problem [56] [57] [58] [59].
- In the incremental-traffic case, connection requests arrive sequentially, a (the) lightpath(s) is (are) established for each connection, and the lightpath(s) remains in the network indefinitely.
- For the case of dynamic traffic, a (the) lightpath(s) is (are) set up for each connection request as it (they) arrive(s), and the lightpath(s) is (are) released after some finite amount of time. The objective in the incremental and dynamic traffic cases is to set up lightpaths and assign wavelengths in a manner which minimizes the amount of connection blocking (or maximizes the number of connections that are established), or the total (weighted) number of blocked connections over a given period of time. This problem is known as the Dynamic Lightpath Establishment (DLE) problem [56] [57] [58] [59]. Hereafter, we briefly survey the different approaches to solve both the SLE and the DLE problems.

A number of studies have investigated the RWA problem for setting up a static set of lightpaths [60] [61] [57]. These studies often formulate the SLE problem as an integer linear program (ILP) (see among others [24] [62]), or rely on heuristic approaches in an attempt to minimize the number of wavelengths required to establish a given set of lightpaths. The ILP formulations turn out to be NP difficult ILPs [60] and therefore may only be solved for very small systems. For larger systems, heuristic methods must be used. To make the problem more tractable, the SLE problem can be partitioned into two subproblems namely the routing subproblem and the Wavelength Assignment (WA) subproblem. The two subproblems are solved separately [57] [63].

The DLE problem is more difficult to solve, and therefore, heuristics methods are generally employed. As lightpaths are established and torn down dynamically, routing and wavelength assignment decisions must be made as lightpath requests arrive to the network. It is possible that, for a given connection

request, there may be insufficient network resources to set up a lightpath, in which case the connection request will be blocked. The connection may also be blocked if there is no common wavelength available on all of the links along the chosen path. Thus, the objective in the dynamic situation is to choose a path and a wavelength(s) which maximizes the probability of setting up a given connection, while at the same time attempting to minimize the blocking for future connections. Similar to the case of static lightpaths, the dynamic RWA problem can also be decomposed into a routing subproblem and a corresponding wavelength assignment subproblem.

Approaches to solve the routing subproblem can be broadly classified into four types: Fixed Routing (FR), Fixed Alternate Routing (FAR), Adaptive Routing (AR) and Least Congested Path Routing (LCR) [64] [65] [66] [67] [68]. Among these approaches, fixed routing is the simplest while adaptive routing yields the best performance. Alternate routing offers a trade-off between complexity and performance. These approaches will briefly be discussed in the following Subsection 3.2.1.1.

For the WA subproblem, a number of heuristics have been proposed [69] [70] [71] [72] [73] [74] [75]. Some of the more significant heuristics are described in Subsection 3.2.1.2.

3.2.1 Separate wavelength-route selection

3.2.1.1 Path selection algorithms

In this section, a brief description of the main path selection algorithms proposed in the literature is given. Four path selection algorithms are here described namely Fixed Routing, Fixed-Alternate Routing, Adaptive Routing and Least Congested Path Routing.

3.2.1.1.1 Fixed routing Fixed routing is the simplest algorithm. A single fixed path is predetermined for each source-destination pair. When a Lightpath Demand (LD) is to be set up, the network will attempt to establish a lightpath along the fixed path. It checks whether some wavelength is free on all the links on the path. If none is free on this fixed route, then the LD is blocked. If more than one wavelength is available, a wavelength selection algorithm can be used to select the best wavelength.

A fixed routing approach is simple to implement and has a short set up time; however, it is very limited in terms of routing options and may lead to a high level of blocking. In order to minimize the blocking in fixed routing networks, the predetermined paths need to be selected in a manner which balances the load evenly across the network links.

3.2.1.1.2 Fixed alternate routing Fixed alternate routing [76] [71] [65] [67] is an extension of the FR algorithm. For every node pair in the network, a set of K -alternate shortest paths ($K > 1$) is provided. These paths are computed off-line. When a lightpath request is to be set up, its candidate K -alternate

shortest paths are searched in a fixed order and the first path with as many path-free wavelengths as the number of requested wavelengths is selected. The order according to which the K-alternate candidate paths are considered is typically based on either path length or path congestion or path delay or any other cost function. In no path can be found with as many path-free wavelengths as the requested number of wavelengths, then the LD is blocked. If more than one wavelength is free on the selected shortest path, a wavelength assignment algorithm can be used to choose the best wavelengths.

Although this algorithm is slightly more complex than the FR algorithm, it has also the advantage of simplicity and shorter connection set-up time. It also has better performance than the FR algorithm as a choice among multiple shortest paths has to be done. However, the candidate paths for a node pair may not include all the possible paths. As a result, the performance of the algorithm is not the best achievable.

3.2.1.1.3 Adaptive routing Adaptive routing algorithm also called unconstrained routing algorithm [77] [78] [79] [80] [76] [71] [65] [67] is expected to achieve better performance than the FR and FAR algorithms. Adaptive routing does not predetermine the candidate paths for any node pair. Instead it keeps up to date the network state information. This state information is dynamic and is updated whenever a connection is established or torn down. When a new LD is to be set up for a source destination pair, it chooses the best path (based on some cost criterion) among all the possible paths. Thus, by exploring all possible paths, it attempts to increase the acceptance rate of connection requests. In order to choose the optimal path, a cost is assigned to each link in the network based on current network state information, such as wavelength availability on links. A least-cost routing algorithm is then executed to find the least cost path.

Since the AR algorithm considers all possible paths, it results in better performance than the FR and FAR algorithms. In spite of this merit, the algorithm has longer setup times than the FR and FAR algorithms. Moreover, this algorithm is more suitable for centralized implementation and less amenable to distributed implementation.

While near-term emerging systems will be fairly static, with lightpaths being established for long periods of time, it is expected that, as network traffic continues to scale up and become more bursty in nature, a higher degree of multiplexing and flexibility will be required at the optical layer. Thus, lightpath establishment will become more dynamic in nature, with connection requests arriving at higher rates, and lightpaths being established for shorter time durations. In such situations, maintaining distributed global information may become infeasible. The alternative is to implement routing schemes which rely only on local information.

A number of adaptive routing schemes exist which rely on local information rather than global information. The advantage of using local information is that the nodes do not have to maintain a

large amount of state information; however, routing decisions tend to be less optimal than in the case of global information. One of the main local information based adaptive routing schemes is the least congested path routing algorithm.

3.2.1.1.4 Least congested path routing Least congested path routing [66] chooses the path with least congestion among the possible paths connecting a source node and a destination node in the network. The congestion of a path is determined from the number of free wavelengths available on the entire path. The greater the number of free wavelengths, the less congested is the path.

For every node pair in the network, a set of K alternate shortest paths are computed off-line. When a LD between a source node and a destination node in the network is to be set up, the cost of each of the K alternate shortest paths is computed. The cost of a path is determined by the wavelength availability (congestion) along the path. If more than one path has the same cost, then the path with shorter hop count is preferred. Once the path is selected, a wavelength assignment algorithm is then used to select the wavelength(s). By selecting the least congested path, the algorithm tries to keep as many path-free wavelengths as possible in order to help satisfying many of future LDs. This algorithm is expected to perform better than the FR and FAR algorithms. Since this algorithm is based on alternate routing, its performance is expected to be poorer than the that of the AR algorithm.

3.2.1.2 Wavelength selection algorithms

In general, if there are multiple feasible wavelengths between a source node and a destination node, then a wavelength assignment (selection) algorithm is required to select a wavelength for a given lightpath. The wavelength selection may be performed either after a path has been determined, or in parallel when finding a path. Since the same wavelength must be used on all links in a lightpath, it is important that wavelengths are chosen in a way which attempts to reduce blocking for subsequent connections. A review of wavelength assignment approaches can be found in [56] [81].

One example of a simple, but effective, wavelength assignment heuristic is First-Fit (FF) [73] [77] [82] [65]. In First-Fit, the wavelengths are indexed, and a lightpath will attempt to select the wavelength with the lowest index before attempting to select a wavelength with a higher index. By selecting wavelengths in this manner, existing connections will be packed into a smaller number of total wavelengths, leaving a larger number of wavelengths available for longer lightpaths.

Another approach for choosing between different wavelengths is to simply select randomly one of the wavelengths. In general, First-Fit will outperform random wavelength assignment when full knowledge of the network state is available [71]. However, if the wavelength selection is done in a distributed manner, with only limited or outdated information, then random wavelength assignment may outperform First-Fit assignment. The reason for this behavior is that, in a First-Fit approach, if multiple connections are

attempting to set up a lightpath simultaneously, then it may be more likely that they will choose the same wavelength, leading to one or more connections being blocked.

Other simple wavelength assignment heuristics include the Most Used Wavelength (MUW) heuristic and the Least Used Wavelength (LUW) heuristic [64]. In most used wavelength assignment, the wavelength which is the most used in the rest of the network is selected. This approach attempts to provide maximum wavelength reuse in the network. The least used approach attempts to spread the load evenly across all wavelengths by selecting the wavelength which is the least used throughout the network. Both most used and least used approaches require global knowledge.

A number of more advanced wavelength assignment heuristics which rely on complete network state information have been proposed [74] [75]. It is assumed in these heuristics that the set of possible future lightpath connections is known in advance. For a given connection, the heuristics attempt to choose a wavelength which minimizes the number of lightpaths in the set of future lightpaths that will be blocked by this connection. It is shown that these heuristics offer better performance than First-Fit and random wavelength assignment.

3.2.2 Simultaneous wavelength-path selection

All the algorithm discussed so far select the path and wavelength(s) independently in two separate steps. The joint wavelength-path selection algorithms consider the cost of selecting every wavelength-path pair and choose the least cost pair. The cost functions that may be used for wavelength-path pair selection take into account factors such as the wavelength availability in the network, the hop length of the path, and the congestion (or, equivalently, the number of path-free wavelengths) on the path. Simultaneous wavelength-path selection algorithms use alternate routing approach: The path for a LD is selected among K candidate alternate shortest paths computed off-line. A detailed description of Simultaneous wavelength-path selection algorithms can be found in [83].

3.3 Routing and spare capacity assignment

Another important issue in WDM optical networks is survivability (also called Routing and Spare Capacity Assignment (RSCA) here) because of the inherent vulnerability of wire-based transmission systems and because of the increasing reliance of society on telecommunications services. Survivability refers to the ability of a network to maintain an acceptable level of service during a network or equipment failure. Failures in the optical network come from link failures, node failures, or other optical layer hardware, among which the link failure is the most common one [84]. Customers expect to see uninterrupted service, even in the event of failures, that is why survivability methods must be very fast so

that the recovery time be of the order of milliseconds. Survivability methods can be done either at the optical layer or at the client layers. SONET and ATM systems may employ their own failure recovery techniques. However, handling failures at the optical layer has some advantages. First, failures can be recovered at the lightpath level faster than at the client layer. Second, when a network component fails, the number of affected lightpaths (and thus need to be recovered) is much smaller when compared to the number of failed connections at the client layer. This will not only help restore service quickly but will also result in lesser traffic and control overhead.

Network survivability methods can broadly be classified into two categories [85]: *reactive methods* and *protection methods*. The former refer to dynamic (i.e., active, post-fault) recovery whereas the latter refer to pre-provisioned recovery. Reactive methods include methods that compute the protection path (backup) and allocate spare resources a posteriori upon occurrence of a failure. The backup lightpath is established based on the availability of resources at the time of component failure. These methods are potentially efficient in terms of network resources utilization since spare resources are allocated only in case of a failure. However, it is usually difficult to guarantee bounded restoration times with them. To overcome the shortcomings of restoration methods, proactive methods can be employed. Proactive methods compute the primary and the backup paths and reserve resources for backups a priori at the the connection setup time. Upon occurrence of a failure the backup lightpath is established and traffic is immediately routed on the backup. A protection method avoids long delays in setting up backup paths upon a failure. The shorter delays help to provide transparency to higher layers. The protection methods also provide guarantee that a connection can be restored in the event of a failure. Hence, the restoration time of a proactive technique is much lower and may match SONET/SDH recovery timescales (50 milliseconds), leading to fast recovery. It is noteworthy that the two techniques can coexist in the same network.

This thesis is primarily concerned with survivability in optical transport networks at the optical layer. Restoration is out of the scope of this thesis. We present several protection strategies, algorithms, performance issues, and research results available in the literature. Most of the discussion pertains to the single link and span failure models. These models assume that at any instant of time at most one and only one failure occurs. The key ideas and approaches used for link and span failures can be extended to handle node failures and multiple component failures.

A proactive method is either span-based or path-based (see Figure 3.1). The span based method reroutes traffic around the failed component. When a span fails, a new path is selected between the end-nodes of the failed span. This path, along with the working segment of the primary path, will be used as the backup path. This method is unattractive for several reasons. The choice of backup paths is limited. Few paths exist between the end-nodes of the failed span, and backup paths are usually longer as the computed new path uses the working segment of the primary path, and

reroutes the working traffic around the end-nodes of the failed span. Moreover, in all-optical networks, the backup path must necessarily use the same wavelength as the primary path since its working segment is retained. Furthermore, handling node failures this way is very difficult. In the path-based method, a backup lightpath is selected between the end-nodes of the failed primary lightpath. Unlike the span-based method, in the path-based method a backup lightpath need not retain the working segment of the primary lightpath. This method shows better resource utilization than the span-based protection method [86]. The backup path can use any wavelength independently of the one used by the corresponding primary lightpath.

A proactive method may use a dedicated protection or shared protection. Inherent in the restoration methods of SONET self-healing rings, dedicated protection (i.e., 1 + 1 or 1 : 1) provides a very fast restoration service. However, this comes at a cost, since the ratio of redundancy (i.e., the ratio of capacity taken by protection and working paths in the network) usually reaches 100%. In the 1 + 1 protection architecture, a protection entity is dedicated to each working entity. The dual-feed mechanism is used whereby the working entity is permanently bridged onto the protection entity at the source of the protected domain. In normal operation mode, identical traffic is transmitted simultaneously on both the working and protection entities. At the other end (sink) of the protected domain, both feeds are monitored for alarms and maintenance signals. A selection between the working and protection entity is made based on some predetermined criteria, such as the transmission performance requirements or defect indication.

In the 1 : 1 protection architecture, a protection entity is also dedicated to each working entity. The protected traffic is normally transmitted by the working entity. When the working entity fails, the protected traffic is switched to the protection entity. The two ends of the protected domain must signal detection of the fault and initiate the switchover.

For better resource utilization, shared protection (i.e., 1 : n or m : n, typically $m \leq n$) can be employed. If two or several primary paths do not fail simultaneously, their backup lightpaths can share

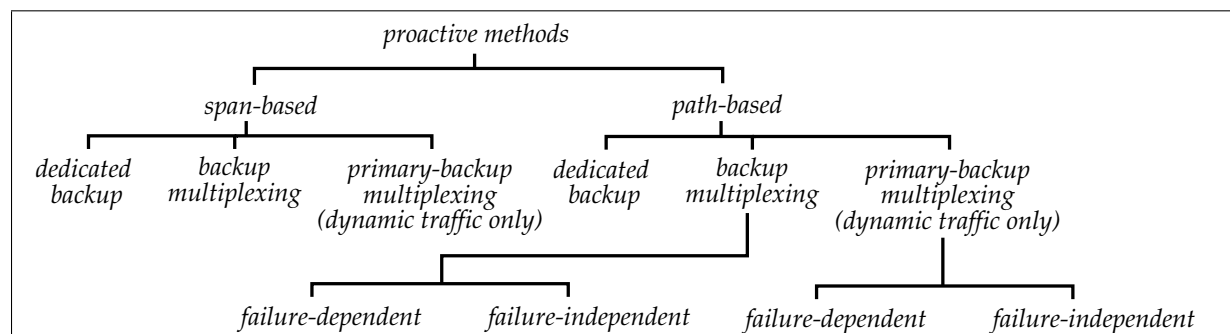

Figure 3.1 : Classification of proactive methods

common WDM channels. This technique is known as *backup multiplexing*.

A proactive method may use primary backup multiplexing [87]. The primary-backup multiplexing technique allows a primary lightpath and one or several backup lightpaths to share the same resources. By using this technique, an increased number of lightpaths can be established at the expense of reduced restoration guarantee. This technique is useful for dynamic traffic where the lightpaths are short-lived.

A path-based proactive method is either failure-dependent or failure-independent. In failure-dependent method, a backup lightpath is associated with the failure of every fiber-link used by the primary path. When a primary lightpath fails, the backup that corresponds to the failed link is used. The backup lightpath can use any link, including those used by the failed primary lightpath, except, obviously, the failed link. Different backup lightpaths corresponding to a primary lightpath may share the same WDM channels as they will not be used simultaneously in case of a single link-failure model. In a failure-independent method, a backup path, which is link-disjoint with the primary path is chosen. The backup is used upon occurrence of a link-failure, regardless of which link (used by the primary path) is failed.

The RSCA algorithms available in the literature differ in their performance metrics and traffic assumption: the performance metrics used generally fall under one of the following three categories:

- Number of wavelengths required to set up the arrived or given set of lightpath demands.
- Number of wavelengths required to set up backup lightpaths.
- Lightpath demands blocking probability.
- Number of fiber resources handled at the routing nodes (fiber cost).
- Impact of failures on traffic.

whilst traffic assumptions generally fall into one of the following three categories: static, incremental, and dynamic.

Several studies and research work have been reported on protection in WDM networks considering either static lightpath demands [88] [89] [90] [91] [92] [93] [94] [95] [96] or dynamic lightpath demands [87] [97] [98] [99] [100] [101] [102] [103]. In [89], ILP formulations for the routing and wavelength assignment problem are developed for a static traffic demand for both path and link protection schemes. In [104], the primary path is divided into several overlapped segments. The calculation of the backup path for each sub-domain is done individually. Redundant trees are used to provide rapid recovery in [105]. The proposed algorithm constructs two trees in such a fashion that each destination vertex is connected to the source by at least one of the directed trees when any vertex (edge) in the graph is eliminated. In [106], the performance of sub-path protection scheme is studied in terms of capacity utilization and recovery time, compared with path and link protection schemes. The authors in [107]

develop an on-line network control mechanism to manage the connections in WDM mesh networks using path-protection schemes. They use the two-step approach to route the connections. The authors in [108] propose to use the link-disjoint path pair, whose longer path is shortest among all such pairs of paths, for path protection so that the delay on the backup path is minimized. They prove that the problem of finding such a pair of paths is NP-complete. In [103], the authors attempt to optimize the network resource utilization of each call by minimizing the overall cost of the primary and backup path. The paths are selected from K precomputed candidate route pairs.

3.4 Lightpath rerouting

Apart from wavelength conversion and space division multiplexing, there is yet another way, called rerouting, to improve network throughput affected by the wavelength continuity constraint in all-optical WDM networks. Rerouting (or repacking) is a concept originally introduced in the design of circuit-switched telephone networks [109] [110]. It has also been applied to optical WDM networks recently [111] [112] [113] [114]. Rerouting occurs when an incoming LD is about to be rejected. It aims at rearranging a certain number of existing lightpaths to free one or several wavelengths for the incoming LD. There are two ways to rearrange an existing lightpath [115]. One is *partially rearranging*, which keeps the original path of the lightpath to be rerouted but reassigns a different wavelength to the fiber-links along the path. This is also referred to as *wavelength rerouting*. Another is *fully rearranging*, which consists in finding a new path with another wavelength to replace the old path. This latter one is referred to as *lightpath rerouting*. A comprehensive survey of rerouting techniques can be found in [116]. We focus on Lightpath ReRouting (LRR) strategies in this thesis.

Two types of LRR may be distinguished: partial and global. The former aims at rerouting a minimum number of already established LDs in order to set up the incoming LD. The latter runs a RWA algorithm, every time a new LD arrives at the network, considering the set of LDs formed by the current LD and the set of LDs already established in the network. Partial LRR is more attractive than global LRR. Global LRR could be very expensive in terms of service disruption and network signalling overhead since all the established lightpaths (carrying a large volume of traffic) have to be torn down before being set up again on their new computed paths and wavelengths. We focus on partial LRR simply called LRR in subsequent sections. Global LRR is out of the scope of this study.

A LRR scheme runs in two phases [111] [113]. The first phase, known as the rerouting algorithm in the literature, aims at determining existing lightpaths or connection demands to be rerouted in order to accommodate an incoming LD. The second phase, also called the rerouting procedure, defines the sequence of steps executed in the network to migrate the rerouted lightpaths or connections to their new paths. The first phase should be simple (*i.e.*, run in polynomial time) and should minimize the

number of existing lightpaths that must be rerouted. The second phase is a key function of the control plane and largely determines the rerouting disruption time which should be minimal [117]. Rerouting procedures are out of the scope of this thesis.

Rerouting has been widely investigated previously [109] [110] [118] [119] [112] [113] [111] in the framework of network survivability [120] [121], or network resource utilization efficiency. We only consider LRR techniques developed in order to reduce the number of blocked demands.

Lee and Li [111] first introduced the wavelength rerouting concept by studying the rerouting problem with the objective to minimize the disruption incurred due to wavelength rearranging. For an undirected WDM network of N nodes, L physical fiber-links and W wavelengths on each fiber-link, they proposed a wavelength rerouting scheme called *Parallel Move-To-Vacant Wavelength-Retuning (MTV-WR)*, which has the following advantages. First, it facilitates control because the old and new paths of rerouted traffic share the same switching nodes. Second, it reduces the calculation because only the wavelengths on the links of existing paths need to be changed. Third, it significantly reduces the disruption period. An algorithm for implementing the MTV-WR scheme, referred to as *RRA1*, has also been proposed. *RRA1* takes $O(N^3W + N^2W^2)$ time per rejected LD to identify the LDs to be rerouted and select a path and a wavelength pair for the considered LD. Mohan and Murthy [113] later provided an $O(N^2W)$ time improved algorithm for the problem. This second algorithm is referred to as *RRA2*.

3.5 Thesis overview

This thesis is organized into three parts. The first part deals with the RWA problem, the second part addresses the RSCA problem and the third part proposes traffic engineering strategies to improve the rejection ratios in all-optical WDM networks affected by the WCC.

Three classes of traffic have been considered referred to as Permanent Lightpath Demands (PLDs), Scheduled Lightpath Demands (SLDs) and Random Lightpath Demands (PLDs). A permanent lightpath demand (PLD) is defined by a tri-tuple (s_i, d_i, π_i) . s_i , d_i are respectively the source node and destination node of the demand, π_i is the number of requested lightpaths to be established from s_i to d_i . PLDs if accepted remain in the network indefinitely. PLDs represent long term traffic forecasts.

In recent years, the uncertainty of demands has made the accurate long term forecasting of traffic a particularly difficult problem. The uncertainty is due to factors such as the massive adoption of data applications and the development of competition in the telecommunications market. Paradoxically, the day-to-day traffic is fairly predictable because of its periodic nature. Figure 3.2 shows the traffic on the New York - Washington link of the Abilene backbone network [122] from 4/03/03 to 4/10/03. The periodicity of traffic is explained by human activity: office hours and evening hours are peak periods for communication services. The volume of traffic decreases during the night, when only computing

processes such as the backup of large databases communicate, usually without human participation. The pattern repeats on a day to day basis with minor changes on weekends and special days like holidays. The predictability of the day-to-day traffic demands suggests that they can be modeled

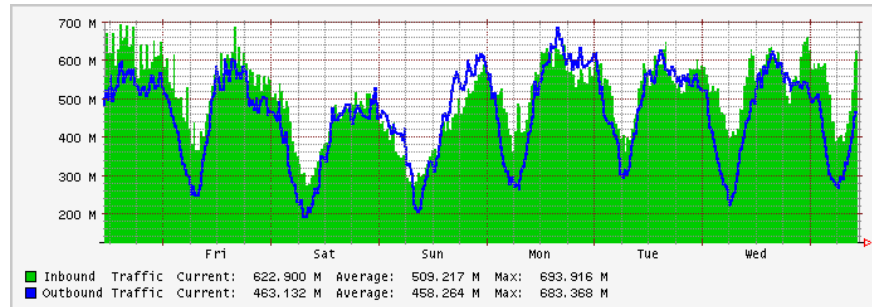

Figure 3.2 : Traffic on the New York - Washington link of the Abilene backbone network in a typical week.

deterministically. A deterministic traffic model called Scheduled Lightpath Demands has been proposed by Kuri et al. [123] [124] [125] that deterministically captures the time and space distribution of traffic demands in a network. An SLD is characterized by a set up time and a tear down time. An SLD is defined by a 5-tuple $(s_i, d_i, \pi_i, \alpha_i, \beta_i)$ where s_i , d_i are the source and the destination nodes of the demand, π_i is the number of requested lightpaths to be set up between s_i and d_i , and α_i and β_i are respectively the set-up and tear-down times of the demand. The SLD traffic model is both *dynamic* and *deterministic* in that it deterministically captures the time and space distribution of traffic demands in a network.

As one moves from the long and mid term to short term network optimization problems, the dynamics and the randomness of traffic become important factors that must be taken into account. RLDs are unknown lightpath demands that are characterized by random arrivals and life spans. We use the same 5-tuple notation to characterize an RLD.

The first part of this thesis focuses on the RWA problem in all-optical networks [126] [127] [128] [129]:

- First, we considered the RWA problem for PLDs. We developed new arc-path MOILP models. Our models solve the RWA for PLDs' sets with multiple entries for the same source destination pairs; each pair requesting an integral number of lightpaths. The models aim at minimizing the number of blocked PLDs given the amount of resources available in the network. Two models are presented; one model for the atomic case and the other for the non atomic case.

The MOILPs being intractable for large size RWA problems, we propose heuristic methods to compute near-optimal RWA solutions. The heuristics we propose take into account the ranking according to which the PLDs are routed in the network.

- Then, the RWA for SLDs and RLDs is investigated. We present heuristic methods that compute simultaneously the RWA for the SLDs and the RLDs. The objective is to minimize the number of rejected lightpaths demands given a limited number of available wavelengths on each fiber-link in the network. This is much different from the scenarios already considered in literature where only one class of traffic is considered.

The second part of the thesis study the RSCA problem in all-optical networks [130] [131] [132] [133]:

- We first consider the RSCA problem for PLDs. We addressed the routing and wavelength assignment subproblems in two separate phases. We developed MOILP models for the routing subproblem. The objective is to minimize the number of affected primary lightpaths in case of a span failure. We also proposed an ILP model for the wavelength assignment subproblem as well as a heuristic approach. The heuristic approach define the so called generalized conflict graph and uses the DSATUR graph coloring heuristic to select the wavelengths for the primary and backup paths computed by the MOILPs. We used a shared path protection scheme in order to minimize the spare resources required to ensure protection. We require our models to survive single span failure instead of single link failure as considered in most of the studies presented in literature. Indeed, we here assume that a span is bidirectional and require, in case of a span failure, that all the lightpaths that go through the failed span to be rerouted on their protection paths.

We then proposed a heuristic approach to deal with the RSCA for PLDs. We used original methods based on the construction of auxiliary graphs to select the less costly path-wavelength pair for each PLD. The objective is to minimize the number of blocked PLDs given the number of available wavelengths in the network. For this purpose a shared path protection scheme is used.

- The RSCA problem for SLDs and PLDs is then considered. We extend the methods used for the RSCA of the PLDs to deal with the SLDs and the RLDs simultaneously. The objective is to minimize the spare resources required to ensure protection and hence maximize the number of lightpath demands successfully routed.

The last part of the thesis defines traffic engineering methods to improve the rejection ratios in all-optical WDM networks while considering simultaneously the SLDs and RLDs [134] [135]. Our methods try to reroute a minimum number of existing lightpaths to accommodate a new lightpath demand if the latter gets blocked in normal assignment process. The objective is to minimize the rejection ratio by means of lightpath rerouting while minimizing traffic disruption during the rerouting process. We show that our rerouting algorithms are less time consuming than the rerouting algorithms previously presented in literature.

The optimization tools developed for each of the aforementioned parts have been applied to a wide range of network sizes, topologies and traffic scenarios. Our conclusions are then drawn based on these results.

Chapter 4

Routing and Wavelength Assignment for Permanent Lightpath Demands

4.1 Introduction

This chapter focuses on the Routing and Wavelength Assignment (RWA) problem for Permanent Lightpath Demands (PLDs) in all-optical WDM networks operating under the wavelength continuity constraint. This problem is known as the static lightpath establishment problem in the literature (see Chapter 3 for details). The lightpath demands (here called PLDs) are known in advance, the RWA problem for PLDs (referred to as the *Permanent Routing and Wavelength Assignment problem (PRWA)*) consists in choosing a route and a wavelength for each requested permanent lightpath so that no two lightpaths are assigned the same wavelength on a common link.

The number of available wavelengths per fiber-link in the network being limited, the objective is to maximize the number of PLDs that are successfully routed (i.e. to minimize the number of blocked PLDs due to lack of resources). In other words, we have to map onto the physical topology an arbitrary maximum number of PLDs. A PLD is rejected (blocked) if at least one of its requested lightpath(s) cannot be set up.

We consider single fiber all-optical networks (one fiber in each direction - see Section 2.4.4) without wavelength conversion capabilities at intermediate nodes. Hence while establishing the maximum possible permanent lightpaths, we are subject to the following constraints:

- *A lightpath should have wavelength continuity:* A lightpath must be assigned the same wavelength along the route (path) it uses from its source node to its destination node.

- *The routing should be done so that routes are on the shortest path(s):* This constraint ensures that the throughput of the network is maximized. Non-shortest paths use more WDM channels that other lightpaths would normally use.
- *Wavelengths should be assigned to reduce blocking of additional PLDs:* Appropriate wavelength assignment algorithms should be used in order to maximize the network throughput and wavelength reuse.

Two approaches are here proposed to deal with the PRWA problem. We first propose new *Multi-Objective path-based Integer Linear Programming (MOILP) models* which, when solved, compute optimal solutions. We considered PLDs requesting an integral number of lightpaths ($\pi \geq 1$) which is much different from the typical cases considered so far in literature where usually binary traffic matrices are to be set up. Two models are proposed depending on whether bifurcated routing is allowed or not. To the best of our knowledge this is the first time that such models are proposed.

Even for small size problem instances with a few number of nodes and demands, the proposed models turn out to be difficult integer linear programming models. It has been proven in [60] that the RWA for PLDs is NP-complete. Therefore we propose *heuristics* to find near-optimal solutions hopefully close to the optimal ones. The heuristics we propose take into account the ranking according to which the paths and wavelengths are selected for PLDs. Two heuristics are proposed for the non atomic and atomic cases.

It is shown that our heuristics compute rejection ratios close to the rejection ratios computed by the MOILPs. We also show that our heuristics scale well when the number of nodes of the considered networks and the number of demands arriving at these networks increases.

The chapter is organized as follows. Section 4.2 describes the PRWA problem. Section 4.3 presents the MOILP formulations. In Section 4.4, we describe the heuristic approach. In Section 4.5, simulation experiments are carried out considering different network topologies and different traffic matrices. Simulation results obtained for both the exact approach (MOILPs) and the approximate approach (heuristics) are compared. The aim is to validate the experimental results obtained with the heuristic algorithms that will be used in the subsequent chapters.

4.2 Description of the problem

The PRWA problem can be stated as follows.

For a given:

- physical network topology $G = (V, E)$, where V represents vertices (network nodes) and E represents the links joining these vertices (fiber links),
- set of Permanent Lightpath Demands,
- W , the number of wavelengths available on each fiber-link in the network,

determine a feasible RWA whilst minimizing the number of rejected PLDs (maximize the network throughput).

Two MOILP models are proposed to compute optimal RWA solutions for either the atomic routing case and the non atomic routing case as shown in Figure 4.1. These models are referred to as *Model 1* and *Model 2* respectively. We then developed approximate approaches to compute near-optimal solutions. Two heuristics are described. The first heuristic called the *Permanent Atomic Routing and Wavelength Assignment (PARWA) heuristic* assumes atomic (non bifurcated) routing (all the requested lightpaths have to be routed on the same shortest path joining the source node and the destination node of any PLD) whereas the second one referred to as the *Permanent non atomic Routing and Wavelength Assignment (PRWA) heuristic* allows non atomic (bifurcated) routing (the requested lightpaths may follow several paths between the source node and the destination node of any PLD). The performance of the proposed approaches are studied and compared through rejection ratios. The benefits of traffic splitting are demonstrated.

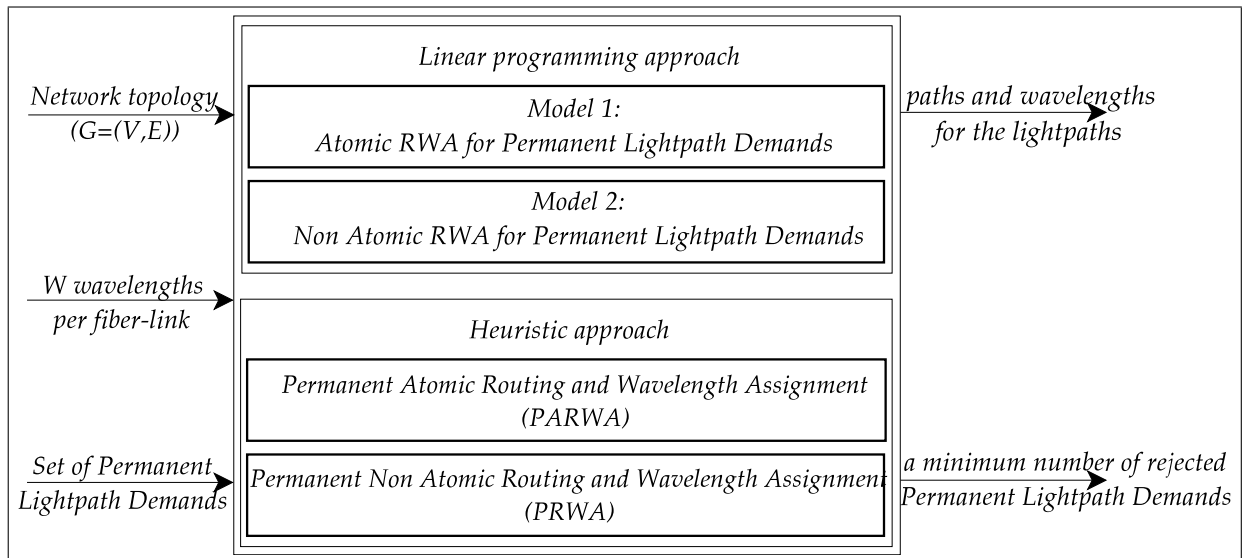

Figure 4.1 : Routing and wavelength assignment for permanent lightpath demands

4.3 The linear programming approach

Due to complexity reasons, the RWA problem is often decomposed into two separate subproblems (see Chapter 3): the routing subproblem and the wavelength assignment subproblem. The subproblems are solved separately. We here propose to address the routing and wavelength assignment problems jointly for better performance. We present two ILP models for the PRWA problem. The first model (Model 1) imposes atomic (non bifurcated) routing whereas the second model (Model 2) allows bifurcated traffic. Both models rely on three steps to compute the RWA for PLDs as shown in Figure 4.2: Given a network topology, a fixed number of available wavelengths (W) on each fiber-link, the K -alternate shortest paths between each possible source-destination pair in the network, and a set of PLDs to be set up, Step 1 computes the RWA for PLDs with the objective of minimizing the number of rejected PLDs. It may happen that multiple RWA solutions exist for the same number of rejected PLDs. The second step (Step 2) selects a solution that additionally minimizes the number of rejected *permanent lightpaths* given the number of rejected PLDs computed by Step 1. The last step (Step 3) selects, among the possible solutions, the one that, in addition, minimizes the total cost of used physical paths.

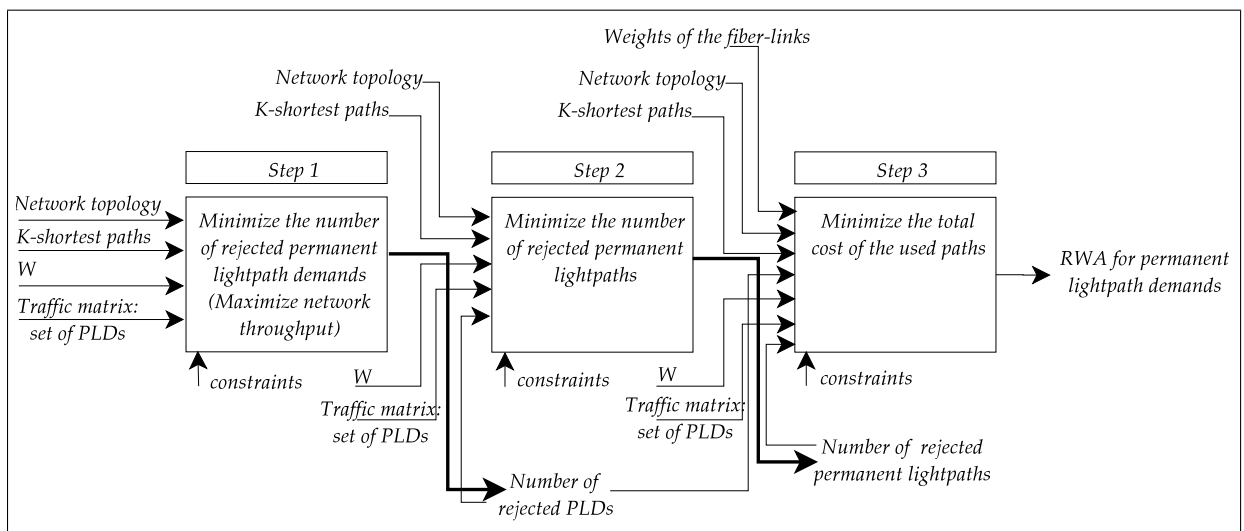

Figure 4.2 : The three steps required for the RWA for PLDs

4.3.1 Notations

We use the following notations and typographical conventions.

Index conventions

- i , j , and p as subscripts usually denote a *demand index*, a *link index*, and a *route index* respectively.

- r, λ as superscripts usually denote a *lightpath index* and a *wavelength index* respectively.

The parameters

- $G = (V, E, \xi)$ is an arc-weighted symmetrical directed graph representing the network topology with vertex set V (representing the network nodes), arc set E (representing the network fiber-links) and weight function $\xi : E \rightarrow \mathbb{R}_+$ mapping the physical length of the links (or any other cost of the links set by the network operator).
- $N = |V|$ denotes the number of vertices (network nodes) of the directed graph representing the network topology.
- $L = |E|$ denotes the number of arcs (network links) of the directed graph representing the network topology.
- W denotes the number of available wavelengths (i.e., WDM channels) per fiber-link. We assume that all the network links have the same number of available wavelengths.
- D denotes the number of PLDs to be set up. The PLD numbered i , denoted p_i , $1 \leq i \leq D$ corresponds to a connection demand between a node-pair in the telecommunication network.
- PLD numbered i , $1 \leq i \leq D$, (to be set up) is defined by a tri-tuple (s_i, d_i, π_i) . $s_i \in V$, $d_i \in V$ are respectively the source node and destination node of the demand, π_i is the number of requested lightpaths to be established from s_i to d_i .
- $\eta = \max_{1 \leq i \leq D} \pi_i$ is the maximum number of lightpaths requested by a PLD p_i , $1 \leq i \leq D$.
- R_i denotes the set of available routes connecting the source node and destination node of PLD p_i . For each PLD p_i , $1 \leq i \leq D$, we compute beforehand K -alternate shortest paths connecting the source node to the destination node of the PLD according to the algorithm described in [136] (if as many paths exist, otherwise we consider the available ones).
- $P = \cup_{1 \leq i \leq D} R_i$ is the set of all the available routes considering all the K -alternate shortest paths computed between all the PLDs to be set up.
- P_j is the set of routes in P traversing the (directed) link (arc) $j \in E$.
- C_p denotes the cost of path $p \in P$. C_p is the cumulative weight of all the physical links forming the path p , (for example the total length of the path). Note that in the case when all the links' weights are equal to 1, C_p represents the number of links (spans) (number of hops) that the path traverses from source to destination.

- H is the set of physical route pairs that share at least one common link in the network. H is computed off-line. $H = \{(p, q) \in P \times P : \exists j \in E, p \in P_j \text{ and } q \in P_j\}$.

The variables

- The binary variable $\phi_{i,r}^{p,\lambda}$.
 $\forall 1 \leq i \leq D, \forall 1 \leq r \leq \pi_i, \forall p \in R_i, \forall 1 \leq \lambda \leq W, \phi_{i,r}^{p,\lambda} = 1$, if the physical route p and the wavelength λ are selected to carry the traffic of the r^{th} lightpath requested by PLD p_i . $\phi_{i,r}^{p,\lambda} = 0$, otherwise.
- The binary variable $\tau_{i,r}$.
 $\forall 1 \leq i \leq D, \forall 1 \leq r \leq \pi_i, \tau_{i,r} = 1$ if the r^{th} lightpath requested by PLD p_i is set up. $\tau_{i,r} = 0$, otherwise.
- The binary variable v_i .
 $\forall 1 \leq i \leq D; v_i = 1$, if PLD p_i is established, i.e., if all the lightpaths requested by PLD i are established. $v_i = 0$, otherwise.
- The binary variable χ^p .
 $\forall p \in R_i; \chi^p = 1$ if path p carries all the lightpaths requested by p_i to carry all the requested lightpaths, otherwise $\chi^p = 0$. The variables χ^p are useful for the atomic case.

4.3.2 Model 1: Atomic RWA for PLDs model formulation

Using the previous notations, Model 1 states as follows:

Step 1

Given N, E, W, D, R_i, P , and P_j ,

Maximize the number of established PLDs,

$$\vartheta = \sum_{i=1}^D v_i \quad (1)$$

Subject to:

- For a given p_i , the number of established lightpaths must be at most equal to the number of requested lightpaths π_i ,

$$\sum_{r=1}^{\pi_i} \sum_{p \in R_i} \sum_{\lambda=1}^W \phi_{i,r}^{p,\lambda} \leq \pi_i, \quad \forall 1 \leq i \leq D \quad (2)$$

- No more than W wavelengths are available on a link j ,

$$\sum_{i=1}^D \sum_{r=1}^{\pi_i} \sum_{p \in R_i \cap P_j} \sum_{\lambda=1}^W \phi_{i,r}^{p,\lambda} \leq W, \quad \forall j \in E \quad (3)$$

- Two lightpaths sharing at least one physical link cannot be assigned the same wavelength λ ,

$$\phi_{i,r}^{p,\lambda} + \phi_{i',r'}^{q,\lambda} \leq 1, \quad (4)$$

$$\forall 1 \leq i, i' \leq D, \forall 1 \leq r \leq \pi_i, \forall 1 \leq r' \leq \pi_{i'}, \forall (p, q) \in R_i \times R_{i'} \times H, \forall \lambda \in W$$

- Either all or none of the lightpaths requested by a PLD p_i have to be set-up,

$$\tau_{i,1} = \tau_{i,r}, \quad \forall 1 \leq i \leq D, \forall 2 \leq r \leq \pi_i \quad (5)$$

- Define $\tau_{i,r}$ variables,

$$\tau_{i,r} \leq \sum_{p \in R_i} \sum_{\lambda=1}^W \phi_{i,r}^{p,\lambda}, \quad \forall 1 \leq i \leq D, \forall 1 \leq r \leq \pi_i \quad (6)$$

$$\phi_{i,r}^{p,\lambda} \leq \tau_{i,r}, \quad \forall 1 \leq i \leq D, \forall 1 \leq r \leq \pi_i, \forall p \in R_i, \forall 1 \leq \lambda \leq W \quad (7)$$

- All of the lightpaths requested by p_i have to follow the same path between the source and the destination nodes,

$$\sum_{p \in R_i} \chi^p \leq 1, \quad \forall 1 \leq i \leq D \quad (8)$$

$$\phi_{i,r}^{p,\lambda} \leq \chi^p, \quad \forall 1 \leq i \leq D, \forall p \in R_i, \forall 1 \leq r \leq \pi_i, \forall 1 \leq \lambda \leq W \quad (9)$$

$$\chi^p \leq \sum_{r=1}^{\pi_i} \sum_{\lambda=1}^W \phi_{i,r}^{p,\lambda}, \quad \forall 1 \leq i \leq D, \forall p \in R_i \quad (10)$$

- Domain constraints,

$$\phi_{i,r}^{p,\lambda} \in \{0, 1\}, \quad \forall 1 \leq i \leq D, \forall p \in R_i, \forall 1 \leq r \leq \pi_i, \forall 1 \leq \lambda \leq W \quad (11)$$

$$\chi^p \in \{0, 1\}, \quad \forall 1 \leq i \leq D, \forall p \in R_i \quad (12)$$

$$\tau_{i,r} \in \{0, 1\}, \quad \forall 1 \leq i \leq D, \forall 1 \leq r \leq \pi_i \quad (13)$$

$$v_i \in \{0, 1\}, \quad \forall 1 \leq i \leq D \quad (14)$$

From the above formulation, one can deduce that $\forall 1 \leq i \leq D, v_i = \tau_{i,1}$ variables. Hence the objective function can be turned to:

$$\text{Maximize } \vartheta = \sum_{i=1}^D \tau_{i,1} \quad (15)$$

We use v_i variables for the sake of clarity of the model formulation.

The number of variables computed within *Step 1* grows as $O(DWK\eta)$ and the number of constraints grows as $O(K^2\eta^2D^4W)$.

Step 1 aims at maximizing ϑ , the number of PLDs to be established. Equations (2) ensure that the number of established lightpaths for a PLD p_i is at most equal to the number of requested lightpaths π_i . Equations (3) state that the number of wavelengths to be used on any fiber-link cannot exceed W . Equations (4) ensure that two lightpaths sharing at least one common physical link cannot use the same wavelength λ . Equations (5) ensure that either all or none of the lightpaths requested by a PLD p_i are set up. $\tau_{i,r}$ variables are defined in equations (6) and (7). Equations (8), (9), and (10) correspond to the non bifurcated routing constraints. Equations (11), (12), (13), and (14) ensure that all the variables are binary.

It may happen that multiple solutions maximize the number of established PLDs for the given problem instance. Thus once the maximum number of established demands ϑ_{\max} has been found, one can look within the set of feasible solutions for one that optimizes a second criterion. For example, we may prefer a solution that maximizes the number of established lightpaths.

Using the same notations, the second step goes as follows:

Step 2

Given N, E, W, D, R_i, P, P_j , and ϑ_{\max} ,

Maximize the number of established lightpaths,

$$\phi = \sum_{i=1}^D \sum_{r=1}^{\pi_i} \sum_{p \in R_i} \sum_{\lambda=1}^W \phi_{i,r}^{p,\lambda} \quad (16)$$

Subject to:

- The number of established PLDs must be at least ϑ_{\max} ,

$$\vartheta_{\max} \leq \sum_{1 \leq i \leq D} \nu_i \quad (17)$$

- For a given p_i , the number of established lightpaths must be at most equal to the number of requested lightpaths π_i ,

$$\sum_{r=1}^{\pi_i} \sum_{p \in R_i} \sum_{\lambda=1}^W \phi_{i,r}^{p,\lambda} \leq \pi_i, \quad \forall 1 \leq i \leq D \quad (18)$$

- No more than W wavelengths are available on a link j ,

$$\sum_{i=1}^D \sum_{r=1}^{\pi_i} \sum_{p \in R_i \cap P_j} \sum_{\lambda=1}^W \phi_{i,r}^{p,\lambda} \leq W, \quad \forall j \in E \quad (19)$$

- Two lightpaths sharing at least one physical link cannot be assigned the same wavelength λ ,

$$\phi_{i,r}^{p,\lambda} + \phi_{i',r'}^{q,\lambda} \leq 1, \quad (20)$$

$$\forall 1 \leq i, i' \leq D, \forall 1 \leq r \leq \pi_i, \forall 1 \leq r' \leq \pi_{i'}, \forall (p, q) \in R_i \times R_{i'} \times H, \forall \lambda \in W$$

- Either all or none of the lightpaths requested by a PLD p_i have to be set-up,

$$\tau_{i,1} = \tau_{i,r}, \quad \forall 1 \leq i \leq D, \forall 2 \leq r \leq \pi_i \quad (21)$$

- Define $\tau_{i,r}$ variables,

$$\tau_{i,r} \leq \sum_{p \in R_i} \sum_{\lambda=1}^W \phi_{i,r}^{p,\lambda}, \quad \forall 1 \leq i \leq D, \forall 1 \leq r \leq \pi_i \quad (22)$$

$$\phi_{i,r}^{p,\lambda} \leq \tau_{i,r}, \quad \forall 1 \leq i \leq D, \forall 1 \leq r \leq \pi_i, \forall p \in R_i, \forall 1 \leq \lambda \leq W \quad (23)$$

- All of the lightpaths requested by p_i have to follow the same path between the source and the destination nodes,

$$\sum_{p \in R_i} \chi^p \leq 1, \quad \forall 1 \leq i \leq D \quad (24)$$

$$\phi_{i,r}^{p,\lambda} \leq \chi^p, \quad \forall 1 \leq i \leq D, \forall p \in R_i, \forall 1 \leq r \leq \pi_i, \forall 1 \leq \lambda \leq W \quad (25)$$

$$\chi^p \leq \sum_{r=1}^{\pi_i} \sum_{\lambda=1}^W \phi_{i,r}^{p,\lambda}, \quad \forall 1 \leq i \leq D, \forall p \in R_i \quad (26)$$

- Domain constraints,

$$\phi_{i,r}^{p,\lambda} \in \{0, 1\}, \quad \forall 1 \leq i \leq D, \forall p \in R_i, \forall 1 \leq r \leq \pi_i, \forall 1 \leq \lambda \leq W \quad (27)$$

$$\chi^p \in \{0, 1\}, \quad \forall 1 \leq i \leq D, \forall p \in R_i \quad (28)$$

$$\tau_{i,r} \in \{0, 1\}, \quad \forall 1 \leq i \leq D, \forall 1 \leq r \leq \pi_i \quad (29)$$

$$v_i \in \{0, 1\}, \quad \forall 1 \leq i \leq D \quad (30)$$

The number of variables computed within *Step 2* grows as $O(DWK\eta)$ and the number of constraints grows as $O(K^2\eta^2D^4W)$.

The model aims at maximizing the number ϕ of lightpaths to be set up for a given value of the maximum number of demands to be established, ϑ_{\max} , computed within *Step 1*. Again, it may happen that several solutions maximize the number of lightpaths to be set up for a given value ϑ_{\max} . One may for example prefer the solution that minimizes the total cost of the used physical paths and turn the problem into:

Step 3

Given $N, E, W, D, R_i, P, P_j, \vartheta_{\max}, \phi_{\max}$, and $C_p, \forall p \in P$,

Minimize the cost of the used physical paths,

$$\sum_{i=1}^D \sum_{r=1}^{\pi_i} \sum_{p \in R_i} \sum_{\lambda=1}^W C_p \phi_{i,r}^{p,\lambda} \quad (31)$$

Subject to:

- The number of established lightpaths must be at least ϕ_{\max} ,

$$\phi_{\max} \leq \sum_{i=1}^D \sum_{r=1}^{\pi_i} \sum_{p \in R_i} \sum_{\lambda=1}^W \phi_{i,r}^{p,\lambda} \quad (32)$$

- The number of established PLDs must be at least ϑ_{\max} ,

$$\vartheta_{\max} \leq \sum_{i=1}^D \nu_i \quad (33)$$

- For a given p_i , the number of established lightpaths must be at most equal to the number of requested lightpaths π_i ,

$$\sum_{r=1}^{\pi_i} \sum_{p \in R_i} \sum_{\lambda=1}^W \phi_{i,r}^{p,\lambda} \leq \pi_i, \quad \forall 1 \leq i \leq D \quad (34)$$

- No more than W wavelengths are available on a link j ,

$$\sum_{i=1}^D \sum_{r=1}^{\pi_i} \sum_{p \in R_i \cap P_j} \sum_{\lambda=1}^W \phi_{i,r}^{p,\lambda} \leq W, \quad \forall j \in E \quad (35)$$

- Two lightpaths sharing at least one physical link cannot be assigned the same wavelength λ ,

$$\phi_{i,r}^{p,\lambda} + \phi_{i',r'}^{q,\lambda} \leq 1, \quad (36)$$

$$\forall 1 \leq i, i' \leq D, \forall 1 \leq r \leq \pi_i, \forall 1 \leq r' \leq \pi_{i'}, \forall (p, q) \in R_i \times R_{i'} \times H, \forall \lambda \in W$$

- Either all or none of the lightpaths requested by a PLD p_i have to be set-up,

$$\tau_{i,1} = \tau_{i,r}, \quad \forall 1 \leq i \leq D, \forall 2 \leq r \leq \pi_i \quad (37)$$

- Define $\tau_{i,r}$ variables,

$$\tau_{i,r} \leq \sum_{p \in R_i} \sum_{\lambda=1}^W \phi_{i,r}^{p,\lambda}, \quad \forall 1 \leq i \leq D, \forall 1 \leq r \leq \pi_i \quad (38)$$

$$\phi_{i,r}^{p,\lambda} \leq \tau_{i,r}, \quad \forall 1 \leq i \leq D, \forall 1 \leq r \leq \pi_i, \forall p \in R_i, \forall 1 \leq \lambda \leq W \quad (39)$$

- All of the lightpaths requested by PLD p_i have to follow the same path between the source and the destination nodes,

$$\sum_{p \in R_i} \chi^p \leq 1, \quad \forall 1 \leq i \leq D \quad (40)$$

$$\phi_{i,r}^{p,\lambda} \leq \chi^p, \quad \forall 1 \leq i \leq D, \forall p \in R_i, \forall 1 \leq r \leq \pi_i, \forall 1 \leq \lambda \leq W \quad (41)$$

$$\chi^p \leq \sum_{r=1}^{\pi_i} \sum_{\lambda=1}^W \phi_{i,r}^{p,\lambda}, \quad \forall 1 \leq i \leq D, \forall p \in R_i \quad (42)$$

- Domain constraints,

$$\phi_{i,r}^{p,\lambda} \in \{0, 1\}, \quad \forall 1 \leq i \leq D, \forall p \in R_i, \forall 1 \leq r \leq \pi_i, \forall 1 \leq \lambda \leq W \quad (43)$$

$$\chi^p \in \{0, 1\}, \quad \forall 1 \leq i \leq D, \forall p \in R_i \quad (44)$$

$$\tau_{i,r} \in \{0, 1\}, \quad \forall 1 \leq i \leq D, \forall 1 \leq r \leq \pi_i \quad (45)$$

$$v_i \in \{0, 1\}, \quad \forall 1 \leq i \leq D \quad (46)$$

The number of variables computed within *Step 3* grows as $O(DWK\eta)$ and the number of constraints grows as $O(K^2\eta^2D^4W)$.

4.3.3 Model 2: Non Atomic RWA for PLDs model formulation

The Permanent Atomic RWA model (Model 1) leads to poor rejection ratios (see Section 4.5) as all the requested lightpaths of any PLD have to follow the same path connecting the source to the destination of the PLD. Indeed, a PLD may be rejected even though bandwidth is available. This is due to the non availability of enough path-free wavelengths on any of the shortest paths associated to the PLD. With non atomic (bifurcated) routing, the lightpaths requested by a PLD may use several paths between the source node and the destination node of the considered demand. Still using the preceding notations, the ILP formulation of Model 2 goes as follows:

Step 1

Given $N, E, W, D, R_i, P,$ and $P_j,$

Maximize the number of established PLDs,

$$\vartheta = \sum_{i=1}^D v_i \quad (47)$$

Subject to:

- For a given p_i , the number of established lightpaths must be at most equal to the number of requested lightpaths π_i ,

$$\sum_{r=1}^{\pi_i} \sum_{p \in R_i} \sum_{\lambda=1}^W \phi_{i,r}^{p,\lambda} \leq \pi_i, \quad \forall 1 \leq i \leq D \quad (48)$$

- No more than W wavelengths are available on a link j ,

$$\sum_{1 \leq i \leq D} \sum_{r=1}^{\pi_i} \sum_{p \in R_i \cap P_j} \sum_{\lambda=1}^W \phi_{i,r}^{p,\lambda} \leq W, \quad \forall j \in E \quad (49)$$

- Two lightpaths sharing at least one physical link cannot be assigned the same wavelength λ ,

$$\phi_{i,r}^{p,\lambda} + \phi_{i',r'}^{q,\lambda} \leq 1, \quad (50)$$

$$\forall 1 \leq i, i' \leq D, \forall 1 \leq r \leq \pi_i, \forall 1 \leq r' \leq \pi_{i'}, \forall (p, q) \in R_i \times R_{i'} \times H, \forall \lambda \in W$$

- Either all or none of the lightpaths requested by p_i have to be set-up,

$$\tau_{i,1} = \tau_{i,r}, \quad \forall 1 \leq i \leq D, \forall 2 \leq r \leq \pi_i \quad (51)$$

- Define $\tau_{i,r}$ variables,

$$\tau_{i,r} \leq \sum_{p \in R_i} \sum_{\lambda=1}^W \phi_{i,r}^{p,\lambda}, \quad \forall 1 \leq i \leq D, \forall 1 \leq r \leq \pi_i \quad (52)$$

$$\phi_{i,r}^{p,\lambda} \leq \tau_{i,r}, \quad \forall 1 \leq i \leq D, \forall 1 \leq r \leq \pi_i, \forall p \in R_i, \forall 1 \leq \lambda \leq W \quad (53)$$

- Domain constraints,

$$\phi_{i,r}^{p,\lambda} \in \{0, 1\}, \quad \forall 1 \leq i \leq D, \forall p \in R_i, \forall 1 \leq r \leq \pi_i, \forall 1 \leq \lambda \leq W \quad (54)$$

$$\tau_{i,r} \in \{0, 1\}, \quad \forall 1 \leq i \leq D, \forall 1 \leq r \leq \pi_i \quad (55)$$

$$v_i \in \{0, 1\}, \quad \forall 1 \leq i \leq D \quad (56)$$

The number of variables computed within *Step 1* of the Permanent non atomic RWA model (Model 2) grows as $O(DWK\eta)$ and the number of constraints grows as $O(K^2\eta^2D^4W)$.

Step 1 aims at maximizing ϑ , the number of PLDs to be established. Equations (48) ensure that the number of established lightpaths for a PLD p_i is at most equal to the number of requested lightpaths π_i . Equations (49) state that the number of wavelengths to be used on any fiber-link cannot exceed W . Equations (50) ensure that lightpaths sharing common physical links cannot use the same wavelength λ . Equations (51) ensure that either all or none of the lightpaths requested by a PLD p_i have to be set up. $\tau_{i,r}$ variables are defined in equations (52) and (53). Equations (54), (55), and (56) ensure that all the variables are binary.

It may happen that multiple solutions maximize the number of established PLDs for a same problem instance. Thus once the maximum number of established demands ϑ_{\max} has been found, one can look within the set of solutions for one that optimizes a second criterion. For example, we may prefer a solution that maximizes the number of established lightpaths.

The second step goes as follows:

Step 2

Given N, E, W, D, R_i, P, P_j , and ϑ_{\max} ,

Maximize maximize the number of established lightpaths,

$$\phi = \sum_{i=1}^D \sum_{r=1}^{\pi_i} \sum_{p \in R_i} \sum_{\lambda=1}^W \phi_{i,r}^{p,\lambda} \quad (57)$$

Subject to:

- The number of established PLDs must be at least ϑ_{\max} ,

$$\vartheta_{\max} \leq \sum_{i=1}^D v_i \quad (58)$$

- For a given p_i , the number of established lightpaths must be at most equal to the number of requested lightpaths π_i ,

$$\sum_{r=1}^{\pi_i} \sum_{p \in R_i} \sum_{\lambda=1}^W \phi_{i,r}^{p,\lambda} \leq \pi_i, \quad \forall 1 \leq i \leq D \quad (59)$$

- No more than W wavelengths are available on a link j ,

$$\sum_{1 \leq i \leq D} \sum_{r=1}^{\pi_i} \sum_{p \in R_i \cap P_j} \sum_{\lambda=1}^W \phi_{i,r}^{p,\lambda} \leq W, \quad \forall j \in E \quad (60)$$

- Two lightpaths sharing at least one physical link cannot be assigned the same wavelength λ ,

$$\phi_{i,r}^{p,\lambda} + \phi_{i',r'}^{q,\lambda} \leq 1, \quad (61)$$

$$\forall 1 \leq i, i' \leq D, \forall 1 \leq r \leq \pi_i, \forall 1 \leq r' \leq \pi_{i'}, \forall (p, q) \in R_i \times R_{i'} \times H, \forall \lambda \in W$$

- Either all or none of the lightpaths requested by p_i have to be set-up,

$$\tau_{i,1} = \tau_{i,r}, \quad \forall 1 \leq i \leq D, \forall 2 \leq r \leq \pi_i \quad (62)$$

- Define $\tau_{i,r}$ variables,

$$\tau_{i,r} \leq \sum_{p \in R_i} \sum_{\lambda=1}^W \phi_{i,r}^{p,\lambda}, \quad \forall 1 \leq i \leq D, \forall 1 \leq r \leq \pi_i \quad (63)$$

$$\phi_{i,r}^{p,\lambda} \leq \tau_{i,r}, \quad \forall 1 \leq i \leq D, \forall 1 \leq r \leq \pi_i, \forall p \in R_i, \forall 1 \leq \lambda \leq W \quad (64)$$

- Domain constraints,

$$\phi_{i,r}^{p,\lambda} \in \{0, 1\}, \quad \forall 1 \leq i \leq D, \forall p \in R_i, \forall 1 \leq r \leq \pi_i, \forall 1 \leq \lambda \leq W \quad (65)$$

$$\tau_{i,r} \in \{0, 1\}, \quad \forall 1 \leq i \leq D, \forall 1 \leq r \leq \pi_i \quad (66)$$

$$v_i \in \{0, 1\}, \quad \forall 1 \leq i \leq D \quad (67)$$

The number of variables computed within *Step 2* grows as $O(DWK\eta)$ and the number of constraints grows as $O(K^2\eta^2D^4W)$.

Step 2 aims at maximizing the number ϕ of permanent lightpaths to be set up for a given value of the maximum number of PLDs to be established, ϑ_{\max} , computed within *step 1*.

Again, it may happen that several solutions maximize the number of lightpaths to be set up for a given value ϑ_{\max} . One may for example prefer a solution among the possible ones that minimizes the total cost of the used physical paths and turn the problem into:

Step 3

Given $N, E, W, D, R_i, P, P_j, \vartheta_{\max}, \phi_{\max}$, and $C_p, \forall p \in P$,

Minimize the cost of the used physical paths,

$$\sum_{i=1}^D \sum_{r=1}^{\pi_i} \sum_{p \in R_i} \sum_{\lambda=1}^W C_p \phi_{i,r}^{p,\lambda} \quad (68)$$

Subject to:

- The number of established lightpaths must be at least ϕ_{\max} ,

$$\phi_{\max} \leq \sum_{i=1}^D \sum_{r=1}^{\pi_i} \sum_{p \in R_i} \sum_{\lambda=1}^W \phi_{i,r}^{p,\lambda} \quad (69)$$

- The number of established PLDs must be at least ϑ_{\max} ,

$$\vartheta_{\max} \leq \sum_{i=1}^D v_i \quad (70)$$

- For a given p_i , the number of established lightpaths must be at most equal to the number of requested lightpaths π_i ,

$$\sum_{r=1}^{\pi_i} \sum_{p \in R_i} \sum_{\lambda=1}^W \phi_{i,r}^{p,\lambda} \leq \pi_i, \quad \forall 1 \leq i \leq D \quad (71)$$

- No more than W wavelengths are available on a link j ,

$$\sum_{i=1}^D \sum_{r=1}^{\pi_i} \sum_{p \in R_i \cap P_j} \sum_{\lambda=1}^W \phi_{i,r}^{p,\lambda} \leq W, \quad \forall j \in E \quad (72)$$

- Two lightpaths sharing at least one physical link cannot be assigned the same wavelength λ ,

$$\phi_{i,r}^{p,\lambda} + \phi_{i',r'}^{q,\lambda} \leq 1, \quad (73)$$

$$\forall 1 \leq i, i' \leq D, \forall 1 \leq r \leq \pi_i, \forall 1 \leq r' \leq \pi_{i'}, \forall (p, q) \in R_i \times R_{i'} \times H, \forall \lambda \in W$$

- Either all or none of the lightpaths requested by p_i have to be set-up,

$$\tau_{i,1} = \tau_{i,r}, \quad \forall 1 \leq i \leq D, \forall 2 \leq r \leq \pi_i \quad (74)$$

- Define $\tau_{i,r}$ variables,

$$\tau_{i,r} \leq \sum_{p \in R_i} \sum_{\lambda=1}^W \phi_{i,r}^{p,\lambda}, \quad \forall 1 \leq i \leq D, \forall 1 \leq r \leq \pi_i \quad (75)$$

$$\phi_{i,r}^{p,\lambda} \leq \tau_{i,r}, \quad \forall 1 \leq i \leq D, \forall 1 \leq r \leq \pi_i, \forall p \in R_i, \forall 1 \leq \lambda \leq W \quad (76)$$

- Domain constraints,

$$\phi_{i,r}^{p,\lambda} \in \{0, 1\}, \quad \forall 1 \leq i \leq D, \forall p \in R_i, \forall 1 \leq r \leq \pi_i, \forall 1 \leq \lambda \leq W \quad (77)$$

$$\tau_{i,r} \in \{0, 1\}, \quad \forall 1 \leq i \leq D, \forall 1 \leq r \leq \pi_i \quad (78)$$

$$v_i \in \{0, 1\}, \quad \forall 1 \leq i \leq D \quad (79)$$

The number of variables computed within *Step 3* grows as $O(DWK\eta)$ and the number of constraints grows as $O(K^2\eta^2D^4W)$.

4.3.4 Problem size reduction

In order to reduce the number of variables necessary to define the problem, we use the pruning method suggested before by [137] [138]. For each PLD p_i , the variables (ϕ and τ) that do not belong to the K -alternate shortest paths computed before routing for each PLD are pruned.

4.4 The heuristic approach

Given a set of PLDs and a physical network topology with a fixed number of wavelengths per fiber-link, we want to determine a RWA that minimizes the number of rejected PLDs.

4.4.1 Mathematical formulation

We define the following additional notations:

- $P_{i,k}$, $1 \leq i \leq D$, $1 \leq k \leq K$, represents the k^{th} alternate shortest path in R_i from source node (s_i) to destination node (d_i) of p_i .
- $\mathcal{B}_{i,k}$ is the set of shortest paths in P which have at least one common link with shortest path $P_{i,k}$.
- $\Lambda = \{\lambda_1, \lambda_2, \dots, \lambda_W\}$ is the set of the available wavelengths on each fiber-link of the network.
- $c_j^\omega \in \{1, +\infty\}$ is the cost of using wavelength λ_ω on link $j \in E$. $c_j^\omega = 1$ if wavelength λ_ω is free on link j ; $c_j^\omega = +\infty$ if a lightpath has already been set up and uses λ_ω on link j .
- $C_{i,k}^\omega = \sum_{j \in P_{i,k}} c_j^\omega$ is the cost of using wavelength λ_ω on $P_{i,k}$, the k^{th} alternate shortest path in R_i connecting the source node to the destination node of PLD p_i . $C_{i,k}^\omega < +\infty$ if λ_ω is a path-free wavelength on $P_{i,k}$; $C_{i,k}^\omega = +\infty$ otherwise.
- $\gamma_{i,k}^\omega = 1$, $1 \leq i \leq D$, $1 \leq k \leq K$, $1 \leq \omega \leq W$, if wavelength λ_ω is a path-free wavelength along the k^{th} alternate path, $P_{i,k}$, connecting the source to the destination node of PLD p_i ($C_{i,k}^\omega < +\infty$). $\gamma_{i,k}^\omega = 0$ otherwise ($C_{i,k}^\omega = +\infty$).
- $\kappa_{i,k} = (\gamma_{i,k}^1, \gamma_{i,k}^2, \dots, \gamma_{i,k}^W)$, $1 \leq i \leq D$, $1 \leq k \leq K$, is a W -dimensional binary vector.
- $\sigma_{i,k} = \sum_{\omega=1}^W \gamma_{i,k}^\omega$, $1 \leq i \leq D$, $1 \leq k \leq K$, computed the total number of path-free wavelengths along $P_{i,k}$.
- \mathcal{A}_i is the set of accepted and active PLDs at time of computing the RWA for PLD p_i .
- ρ_D is a D -dimensional vector. ρ_D is a permutation of $\{1, 2, \dots, D\}$. Vector ρ_D is generated randomly. It indicates the ranking according to which the PLDs are to be routed. The PLDs are routed sequentially. (e.g., in the case when $D = 3$, three PLDs, p_1 , p_2 , and p_3 , are to be set up. $\rho_D = (2, 3, 1)$ means that PLD p_2 is routed first, p_3 is routed second and p_1 is routed third).
- Π_D is the set of all possible ranking vectors ρ_D . $\Pi_D = S_D$ the symmetric group of degree D (the group of all permutations on $\{1, 2, \dots, D\}$).
- $C : \Pi_D \rightarrow \mathbb{N}$ is the function that counts the number of blocked PLDs for a given ranking vector ρ_D . The combinatorial optimization problem to solve is:

$$\text{Minimize } C(\rho_D)$$

$$\text{subject to: } \rho_D \in \Pi_D$$

We used a Random Search (RS) algorithm to compute the RWA for PLDs. Before explaining the principles of the RS algorithm, we first describe the *sequential Permanent Atomic RWA algorithm* and the *sequential Permanent non atomic RWA algorithm*. We assume that for each p_i , $1 \leq i \leq D$, K -alternate shortest paths (if as many paths exist) are computed off-line (before any routing).

4.4.2 The sequential Permanent Atomic RWA algorithm

The sequential Permanent Atomic RWA algorithm (seqPARWA) computes the RWA for a given set of PLDs sequentially according to a given ranking. When a PLD is to be set up, the seqPARWA algorithm considers the K -alternate shortest paths associated to the PLD in turn and looks for as many path-free wavelengths as the number of requested lightpaths on each shortest path. Two cases arise: No paths with as many path-free wavelengths as the number of requested lightpaths exist and the PLD is, in this case, blocked. In the other case the PLD is set up. It may happen that the number of available wavelengths on a shortest path is higher than the number of requested lightpaths. In that case the wavelengths are assigned according to a First-Fit (FF) scheme [60] [77] [82]. Table 4.1 shows the pseudo-code of the seqPARWA algorithm.

The following example explains how we compute the RWA for the PLDs according to the seqPARWA algorithm described above. We consider the 14-node network topology and the set of three PLDs described in Table 4.2. We assume 4 available wavelengths per fiber-link ($W = 4$) and we compute 3 alternate shortest paths between the source node and destination node of each PLD ($K = 3$). We also assume that the considered PLDs are routed sequentially according to the ranking given in Table 4.2.

The first demand to be routed is p_1 . p_1 requires two lightpaths. We assume that no PLD has already been set up and hence all the wavelengths are available. $\kappa_{1,1} = (1, 1, 1, 1)$ shows that all the wavelengths are available on $P_{1,1}$. p_1 is hence set up using λ_1 and λ_2 on $P_{1,1}$. Costs $C_{1,1}^1$ and $C_{1,1}^2$ of using wavelengths λ_1 and λ_2 on $P_{1,1}$ are updated to $+\infty$ as well as the cost of all the paths that share at least one fiber-link with $P_{1,1}$ on λ_1 and λ_2 . The next PLD to be routed is PLD p_2 . p_2 requires 3 lightpaths. $C_{2,1}^1 = +\infty$ and $C_{2,1}^2 = +\infty$. $\kappa_{2,1} = (0, 0, 1, 1)$ indicates that only wavelengths λ_3 and λ_4 are still available on $P_{2,1}$ (Wavelengths λ_1 and λ_2 are used by PLD p_1 on fiber-link 1-3). p_2 cannot hence be established on $P_{2,1}$. $\kappa_{2,2} = (1, 1, 1, 1)$. PLD p_2 is set up using wavelengths λ_1 , λ_2 and λ_3 on $P_{2,2}$. The cost of using wavelengths λ_1 , λ_2 and λ_3 on $P_{2,2}$ is updated to $+\infty$. The cost of paths belonging to $\mathcal{B}_{2,2}$ on λ_1 , λ_2 and λ_3 is also updated to $+\infty$. The last PLD to be considered is p_3 . $\kappa_{3,1} = (0, 0, 1, 1)$, $\kappa_{3,2} = (0, 0, 0, 1)$, and $\kappa_{3,3} = (0, 0, 1, 1)$. There are no as many path-free wavelengths as the number of requested lightpaths by PLD p_3 on any of its associated shortest paths. p_3 is hence rejected. The number of rejected PLDs according to the seqPARWA algorithm is equal to 1.

4.4.3 The sequential Permanent non atomic RWA algorithm

In the case when bifurcated routing is allowed, the sequential Permanent non atomic RWA algorithm (seqPRWA) looks for the requested number of path-free wavelengths considering all the K -alternate shortest paths associated to any PLD. Again two cases arise. The number of path-wavelengths considering all the shortest paths associated to the considered PLD is lower than the number of requested

lightpaths. In this case, the PLD is blocked; otherwise, the requested lightpaths are set up. It may happen that the number of available path-free wavelengths computed considering all the shortest paths in R_i is higher than the number of requested lightpaths. In this case, shorter paths are preferred to the longer ones as they consume fewer WDM channels. A First-Fit scheme is used for wavelengths selection. The pseudo-code of the seqPRWA algorithm is shown in Table 4.3.

Let us again consider the example described in Table 4.2. When p_1 is considered, all the wavelengths are available. $\kappa_{1,1} = (1, 1, 1, 1)$ and p_1 is set up using wavelengths λ_1 and λ_2 on $P_{1,1}$. Then p_2 is to

```

ALGORITHM The sequential Permanent Atomic RWA algorithm
Input:  $\rho, D, R_i, W$ 
Output: computes the number of rejected PLDs as well as the number of rejected lightpaths
  (* According to  $\rho$ , compute the number of rejected PLDs when routed sequentially *)
1 rejectedPLDs:=0
2 rejectedLPs:=0
3 for each item in  $\rho$  do
3.1 Find the corresponding PLD  $p_i, 1 \leq i \leq D$ 
  (* Consider in turn the K-alternate shortest paths associated to PLD  $p_i$  and compute the number of path-free
  wavelengths on each path until the PLD is set up or rejected *)
3.2  $k:=1$ 
3.3 FLAG:=0
3.4 while ( $k \leq K$ ) and (FLAG = 0) do
3.5   for  $\omega := 1$  to  $W$  do
3.6     Compute  $\gamma_{i,k}^\omega$ 
     endfor
     if  $\sigma_{i,k} \geq \pi_i$  then
3.7       FLAG:=1
     endif
3.8      $k:=k+1$ 
   endwhile
3.9 if (FLAG=0) then
  (* The PLD cannot be set up. There are not enough path-free wavelengths on any of the considered shortest
  paths associated to PLD  $p_i$  *)
3.10 rejectedPLDs:=rejectedPLDs+1
3.11 rejectedLPs:=rejectedLPs+ $\pi_i$ 
   else
  (* The PLD is set up. Instantiate the lightpaths. Update paths' cost. In the case when  $\sigma_{i,k} > \pi_i$ , the
  wavelengths are selected according to a First-Fit scheme *)
3.12  $\omega := 1$ 
3.13  $p := 1$ 
3.14 while ( $\omega \leq W$ ) and ( $p \leq \pi_i$ ) do
3.15   if  $C_{i,k}^\omega \leq +\infty$  then
3.16      $C_{i,k-1}^\omega := +\infty$ 
3.17      $p := p + 1$ 
   endif
3.18    $\omega := \omega + 1$ 
   endwhile
   endif
   endfor
end. The sequential Permanent Atomic RWA algorithm

```

Table 4.1 : Pseudo-code of the sequential Permanent Atomic RWA algorithm

National Science Foundation Network (NSFNet)	PLD	s	d	π	the shortest paths
	1	1	6	2	$P_{1,1}=1-3-6$ $P_{1,2}=1-2-3-6$ $P_{1,3}=1-4-5-6$
	2	9	3	3	$P_{2,1}=9-4-1-3$ $P_{2,2}=9-12-13-6-3$ $P_{2,3}=9-4-5-6-3$
	3	3	12	4	$P_{3,1}=3-6-13-12$ $P_{3,2}=3-1-4-9-12$ $P_{3,3}=3-6-11-10-12$

Table 4.2 : The 14-node NSFNet network topology and the set of PLDs to be set up

be set up. $\kappa_{2,1} = (0, 0, 1, 1)$ and $\kappa_{2,2} = (1, 1, 1, 1)$. $\sum_{k=1}^3 \sigma_{2,k} \geq 3$. PLD p_2 is hence set up using wavelengths λ_3 and λ_4 on $P_{2,1}$ and wavelength λ_1 on $P_{2,2}$. p_3 is now considered. $\kappa_{3,1} = (0, 0, 1, 1)$, $\kappa_{3,2} = (0, 1, 1, 1)$, and $\kappa_{3,3} = (0, 0, 0, 0)$. p_3 is set up using wavelengths λ_2 and λ_3 on $P_{3,1}$ and $P_{3,2}$ respectively. All the PLDs have been set up according to the seqPRWA algorithm.

4.4.4 Description of the Random Search algorithm

The pseudo-code used for the RS (Random Search) algorithm is shown in Table 4.4. Three problem-specific functions are required to implement the RS algorithm:

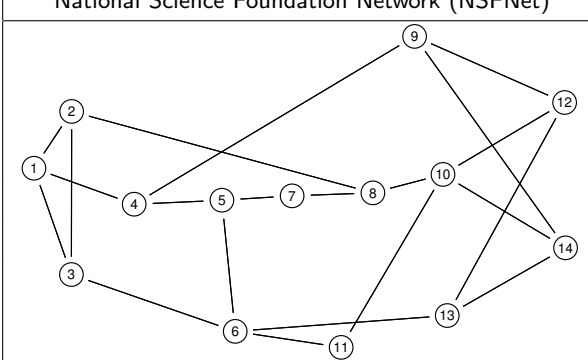
1. An initial solution is created by a function that defines the components of the vector ρ_D .
2. A random function generates random values for ranking vectors ρ_D . Note that one has to verify that the cost of the generated vector ρ_D (number of rejected PLDs) has not already been evaluated. In that case, another ranking vector is generated randomly using the random function. For this purpose we keep trace of a certain number of already visited ρ_D vectors by updating a list we called the *BLACK LIST*.
3. The objective function computes for a given value of vector ρ_D the number of rejected PLDs, C . The PLDs are considered sequentially according to the ranking given by ρ_D . The ranking vector which reject a minimum number of PLDs is retained.

It may happen that several vectors ρ_D reject the same number of demands. In that case, one may prefer a solution that minimizes the number of rejected permanent lightpaths (maximize the number of established lightpaths).

Two RWA algorithms are proposed depending on whether bifurcated routing is allowed or not. The first algorithm called the Permanent Atomic RWA algorithm (PARWA) uses the seqPARWA algorithm

to compute the RWA for PLDs. The second algorithm called the Permanent non atomic RWA algorithm or simply PRWA computes the RWA for PLDs based on the seqPRWA algorithm.

4.4.5 Illustrative example

To illustrate the way the RS computes the RWA for the PLDs, let us consider the set of PLDs shown in Table 4.5. We consider the 14-network topology shown in Table 4.5 with 2 wavelengths on each fiber-link ($W = 2$). We computed 2 alternate shortest paths for each PLD ($K = 2$). The computed shortest paths are shown in Table 4.5. We also assume non atomic routing.

Let us assume that the PLDs are to be processed according to the ranking shown in Table 4.5 ($\rho_D = (1, 2, 3, 4, 5)$). PLD p_1 arrives when all the wavelengths are available. p_1 requires 2 lightpaths. $\kappa_{1,1} = (1, 1)$ and p_1 is hence set up using wavelengths λ_1 and λ_2 on $P_{1,1}$. p_2 is now considered. We

```

ALGORITHM The sequential Permanent non atomic RWA algorithm
Input:  $\rho, D, R_i, W$ 
Output: computes the number of rejected PLDs as well as the number of rejected lightpaths
  (* According to  $\rho$ , compute the number of rejected PLDs when routed sequentially *)
1 rejectedPLDs:=0
2 rejectedLPs:=0
3 for each item in  $\rho$  do
3.1 Find the corresponding PLD  $p_i, 1 \leq i \leq D$ 
  (* compute the total number of path-free wavelengths considering all the alternate shortest paths associated to
  PLD  $p_i$  *)
3.2 for  $k:=1$  to  $K$  do
3.3   for  $\omega:=1$  to  $W$  do
3.4     Compute  $\gamma_{i,k}^\omega$ 
     endfor
   endfor
3.5 if  $\sum_{k=1}^K \sigma_{i,k} \geq \pi_i$  then
  (* Instantiate the lightpaths. Update paths' cost and the PLD is set up. In the case when  $\sigma_{i,k} > \pi_i$ , the
  wavelengths are selected according to a First-Fit scheme *)
3.6    $\omega := 1$ 
3.7    $p := 1$ 
3.8   while ( $\omega \leq W$ ) and ( $p \leq \pi_i$ ) do
3.9     if  $C_{i,k}^\omega \leq +\infty$  then
3.10       $C_{i,k-1}^\omega := +\infty$ 
3.11       $p := p + 1$ 
     endif
3.12       $\omega := \omega + 1$ 
   endwhile
   else
  (* The PLD cannot be set up. There are not enough path-free wavelengths on any of the considered shortest
  paths associated to PLD  $p_i$  *)
3.13   rejectedPLDs:=rejectedPLDs+1
3.14   rejectedLPs:=rejectedLPs+ $\pi_i$ 
   endif
endfor
end. The sequential Permanent non atomic RWA algorithm

```

Table 4.3 : Pseudo-code of the sequential Permanent non atomic RWA algorithm

compute $\kappa_{2,1} = (1, 1)$ and λ_1 is selected to service p_2 on $P_{2,1}$. Then p_3 is to be set up. p_3 requires one lightpath. We compute $\kappa_{3,1} = (0, 0)$ and $\kappa_{3,2} = (0, 0)$. PLD p_3 cannot be set up as no longer path-free wavelengths are available to service the PLD. PLD p_3 is hence rejected. PLD p_4 is to be set up. $\kappa_{4,1} = (1, 1)$ and p_4 is established using wavelength λ_1 on $P_{4,1}$. p_5 is now considered. $\kappa_{5,1} = (1, 1)$ and p_5 is set up using wavelength λ_1 on $P_{5,1}$. According to $\rho_D = (1, 2, 3, 4, 5)$, PLD p_3 is rejected. The number of rejected PLDs is $C(\rho_D) = 1$.

Let us now assume that $\rho_D = (3, 2, 1, 4, 5)$. PLD p_3 is to be set up first. All the wavelengths are available. $\kappa_{3,1} = (1, 1)$ and λ_1 is selected to service the PLD on $P_{3,1}$. Then p_2 is serviced using λ_1 on $P_{2,1}$ as $\kappa_{2,1} = (1, 1)$. p_1 is now to be set up. $\kappa_{1,1} = (0, 1)$ and $\kappa_{1,2} = (1, 1)$. $\sum_{k=1}^2 \sigma_{1,k} = 3$ and p_1 is

ALGORITHM *Routing and Wavelength Assignment for Permanent Lightpath Demands*

Input: D, R_i, W

Output: A RWA solution for the PRWA problem

(* This pseudo code illustrate the way we compute the routing and Wavelength Assignment given a graph G representing the network topology, a set of Permanent LDs to be set up and a number of wavelengths available on each fiber-link in the network. We compute a RWA solution for the PRWA problem that minimizes the number of rejected PLDs. The wavelengths are assigned to the lightpaths according to a First-Fit scheme. In case of a tie (several RWA solutions reject the same number of PLDs), one may prefer one that minimizes the number of rejected lightpaths. *)

(* Generate an initial routing vector ρ according to a random function then compute its cost in terms of number of rejected PLDs *)

1 Generate a random initial order vector ρ

(* Route the PLDs sequentially according to the order in ρ and compute the number of rejected PLDs as well as the number of rejected lightpaths using one of the algorithms described below depending on whether one uses bifurcated or non bifurcated routing. *)

2 Call the seqPARWA algorithm (see Table 4.1) or the seqPRWA algorithm (see Table 4.3) depending on whether one uses bifurcated or non bifurcated routing in order to compute the number of blocked PLDs (rejectedPLDs) and the number of rejected lightpaths (rejectedLPs)

3 Copy ρ to best ρ

4 bestrejectedPLDs:=rejectedPLDs

5 bestrejectedLPs:=rejectedLPs

6 Put ρ in a BLACK LIST

7 for $i := 1$ to n do

7.1 Generate a new random order vector ρ

7.2 Call the seqPARWA algorithm (see Table 4.1) or the seqPRWA algorithm (see Table 4.3) depending on whether one uses bifurcated or non bifurcated routing in order to compute the number of blocked PLDs (rejectedPLDs) and the number of rejected lightpaths (rejectedLPs)

7.3 if (rejectedPLDs < bestrejectedPLDs) then

7.4 update bestrejectedPLDs, bestrejectedPLDs:=rejectedPLDs

7.5 Copy ρ to best ρ

elseif (rejectedPLDs = bestrejectedPLDs) then

7.6 if (rejectedLPs < bestrejectedLPs) then

7.7 update bestrejectedLPs, bestrejectedLPs:=rejectedLPs

7.8 Copy ρ to best ρ

endif

endif

8 Put ρ in a BLACK LIST

endfor

end. *Routing and Wavelength Assignment for Permanent Lightpath Demands*

Table 4.4 : Pseudo-code of the Random Search (RS) algorithm

National Science Foundation Network (NSFNet)		i	s_i	d_i	π_i	the shortest paths
	1	9	2	2	$P_{1,1}=9-4-1-2$ $P_{1,2}=9-12-10-8-2$	
	2	13	1	1	$P_{2,1}=13-6-3-1$ $P_{2,2}=13-14-9-4-1$	
	3	12	4	1	$P_{3,1}=12-9-4$ $P_{3,2}=12-13-14-9-4$	
	4	11	8	1	$P_{4,1}=11-10-8$ $P_{4,2}=11-6-5-7-8$	
	5	2	12	1	$P_{5,1}=2-8-10-12$ $P_{5,2}=2-3-6-13-12$	

Table 4.5 : The 14-node NSFNet network topology and the PLDs to be set up

serviced using λ_2 on $P_{1,1}$ and λ_1 on $P_{1,2}$ as bifurcated routing is allowed. PLD p_4 is then considered. $\kappa_{4,1} = (0, 1)$ and λ_2 is selected on $P_{4,1}$ to service the PLD. Next p_5 is to be serviced. $\kappa_{5,1} = (1, 1)$ and p_5 is set up using wavelength λ_1 on $P_{5,1}$. The number of rejected PLDs computed for the considered ranking vector $\rho_D = (3, 2, 1, 4, 5)$ is $C(\rho_D) = 0$.

The RWA for the PLDs according to the non atomic RS algorithm is given in Table 4.6.

i	s_i	d_i	π_i	lightpath	
				$P_{i,k}$	λ
3	12	4	1	$P_{3,1}=12-9-4$	λ_1
2	13	1	1	$P_{2,1}=13-6-3-1$	λ_1
1	9	2	2	$P_{1,1}=9-4-1-2$	λ_2
				$P_{1,2}=9-12-10-8-2$	λ_1
4	11	8	1	$P_{4,1}=11-10-8$	λ_2
5	2	12	1	$P_{5,1}=2-8-10-12$	λ_1

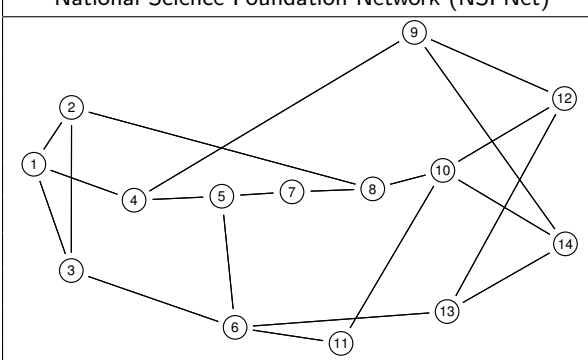
Table 4.6 : RWA according to the RS algorithm for the PLDs shown in Table 4.5

4.5 Experimental results

In this section, we present numerical results to evaluate the performance of the Random Search algorithm w.r.t. to the ILP models described in the previous sections. We first describe the parameters common to all the experiments. We considered two network topologies: the 14-node NSFNet network (Figure 4.3) and a hypothetical US backbone network of 29 nodes (Figure 4.4). We used AMPL 9.010 with

CPLEX¹ 9.020 to solve the MOILP models described above. The CPLEX solver was run on a Sun Sparc machine with 2 GB RAM running Solaris 9 (SunOS 5.9).

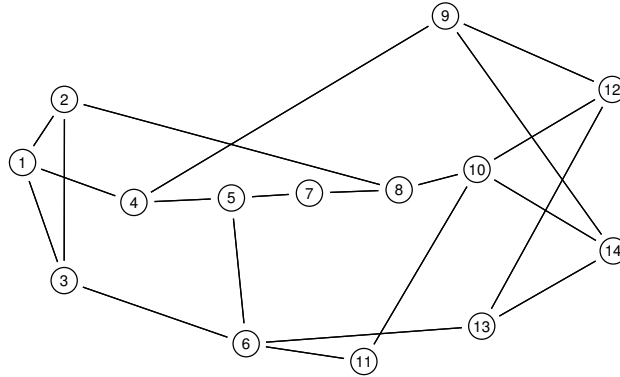

Figure 4.3 : The 14-node network topology

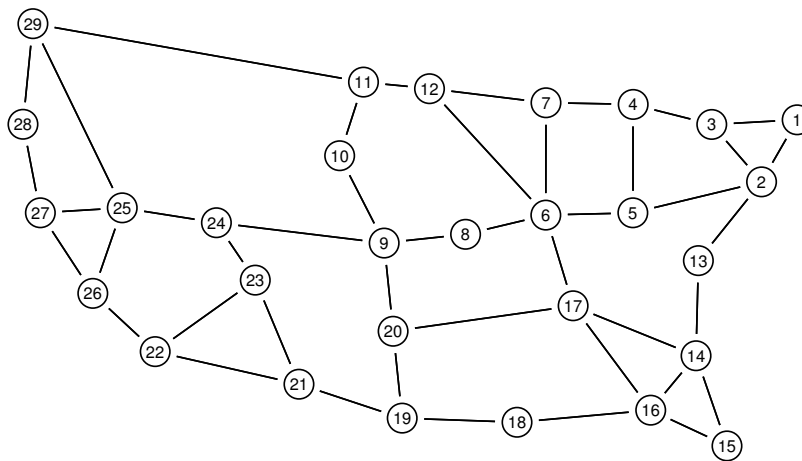

Figure 4.4 : The 29-node network topology

The source and destination nodes of the PLDs are drawn according to a random uniform distribution in the interval $[1, 14]$ for the 14-node network and $[1, 29]$ for the 29-node network. We also used uniform random distributions over the intervals $[1, 3]$ for the number of lightpaths to be set up between the source node and destination node of each PLD. We assume that we compute $K = 3$ alternate shortest paths between each source destination pair and that there are $W = 4$ available wavelengths on each fiber-link in the network. We generated 25 test scenarios (25 traffic matrices), ran the algorithms on them and computed rejection ratio averages for each algorithm.

We want to assess the gain obtained using bifurcated routing compared to non bifurcated routing.

¹CPLEX, ILOG CPLEX, <http://www.cplex.com>

Table 4.7 shows the average number of required variables and constraints for different values of D considering the 14-node network and the 29-node network.

N	D	Model 1						Model 2					
		Number of variables			Number of constraints			Number of variables			Number of constraints		
		Step 1	Step 2	Step 3	Step 1	Step 2	Step 3	Step 1	Step 2	Step 3	Step 1	Step 2	Step 3
14	8	2352	2352	2352	2873.44	2874.44	2875.44	2328	2328	2328	2652.8	2653.8	2654.8
14	12	5256	5256	5256	5936.4	5937.4	5938.4	5220	5220	5220	5586	5587	5588
14	14	7140	7140	7140	7893.68	7894.68	7895.68	7098	7098	7098	7515.6	7516.6	7517.6
29	4	930	930	930	1565.16	1566.16	1567.16	915	915	915	1424.2	1425.2	1426.2
29	11	4422	4422	4422	5291.8	5292.8	5293.8	4389	4389	4389	4979	4980	4981
29	18	11772	11772	11772	12913.2	12914.2	12915.2	11718	11718	11718	12414	12415	12416

Table 4.7 : Results for Model 1 and Model 2 under different simulation scenarios

In the following each couple of figures shows the same simulation results obtained for the 14-node network (left side) and the 29-node network (right side) respectively.

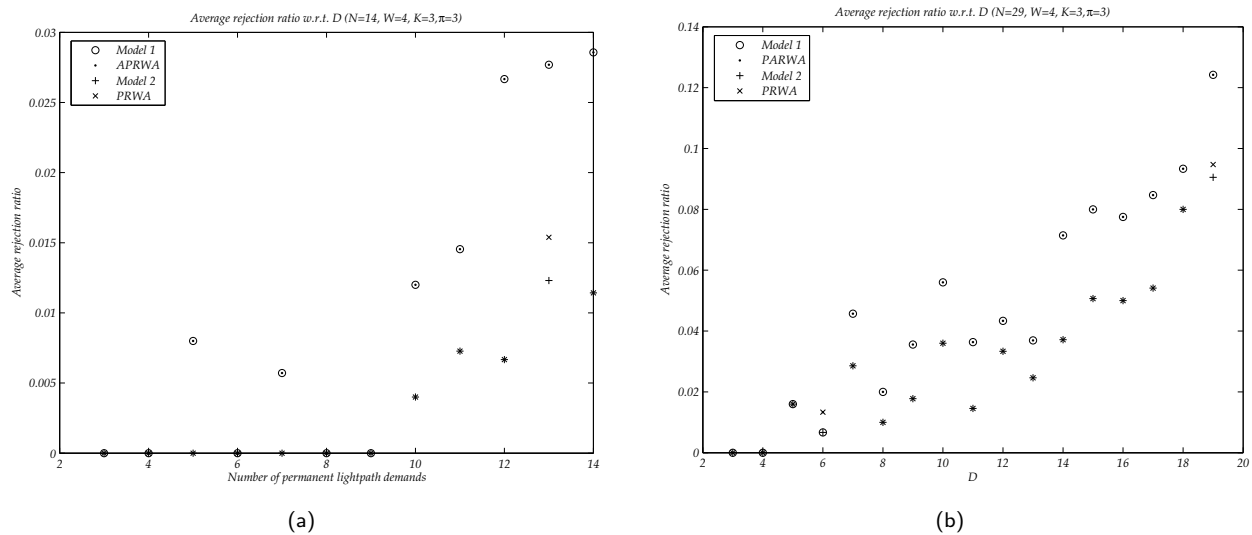

Figure 4.5 : Average PLDs' rejection ratio w.r.t. D

Figure 4.5 shows the average rejection ratio w.r.t. D , the number of PLDs arriving at the network, for the proposed MOILPs and heuristics. We notice that non atomic routing sets up more PLDs than atomic routing. The rejection ratio gain (thanks to traffic splitting) increases with D . Figure 4.5 also shows that both the PARWA and PRWA algorithms based on the proposed Random Search algorithm compute rejection ratios almost the same as the rejection ratios computed by Model 1 and Model 2.

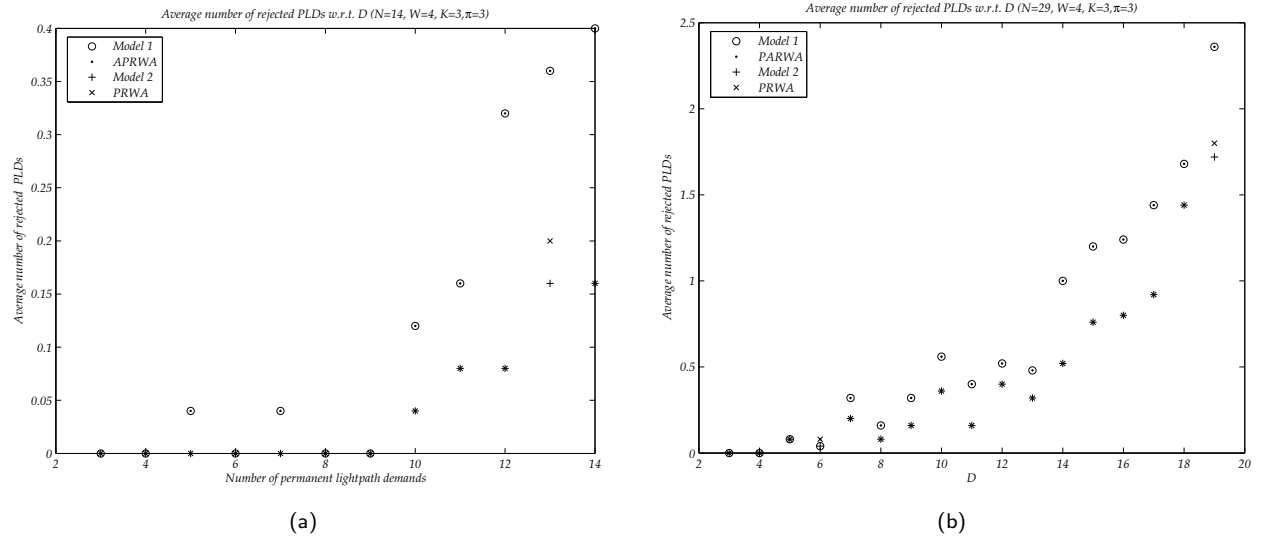

Figure 4.6 : Average number of rejected PLDs w.r.t. D

Figure 4.6 shows the average number of rejected PLDs w.r.t. D. The number of rejected PLDs increases with D as the number of available wavelengths per fiber-link is limited. Let us remind ourselves that PLDs, once accepted, remain in the network indefinitely.

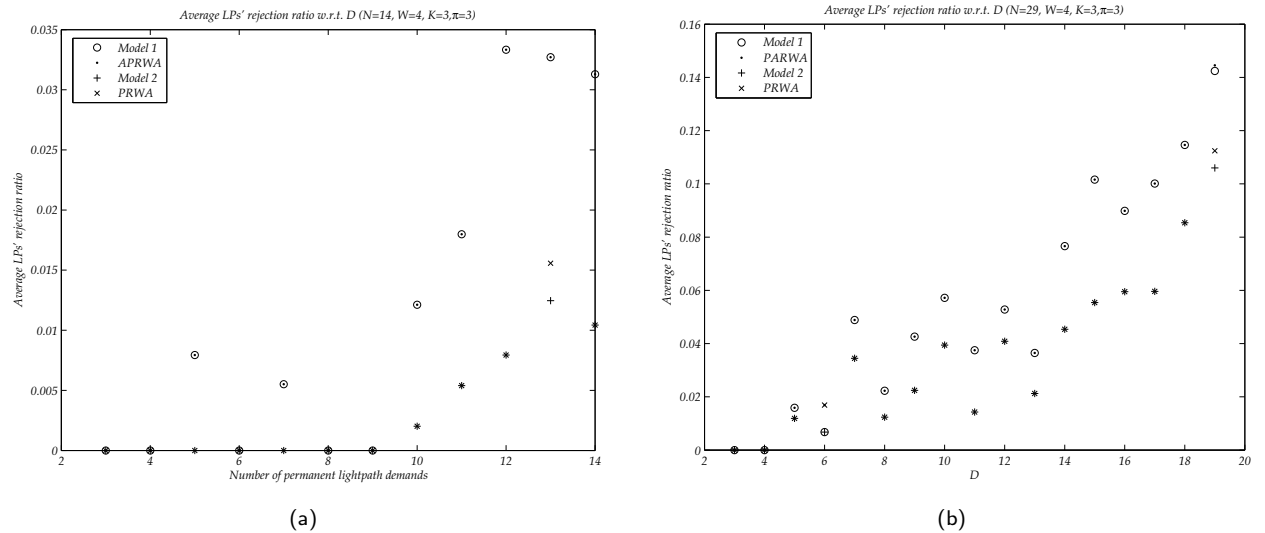

Figure 4.7 : Average permanent lightpath rejection ratio w.r.t. D

Figure 4.7 draws permanent lightpath (PLP) average rejection ratio w.r.t. D and Figure 4.8 shows the average number of rejected permanent lightpaths w.r.t. D. The PLP rejection ratio is computed as the ratio of the total number of rejected lightpaths to the total number of requested lightpaths. Once

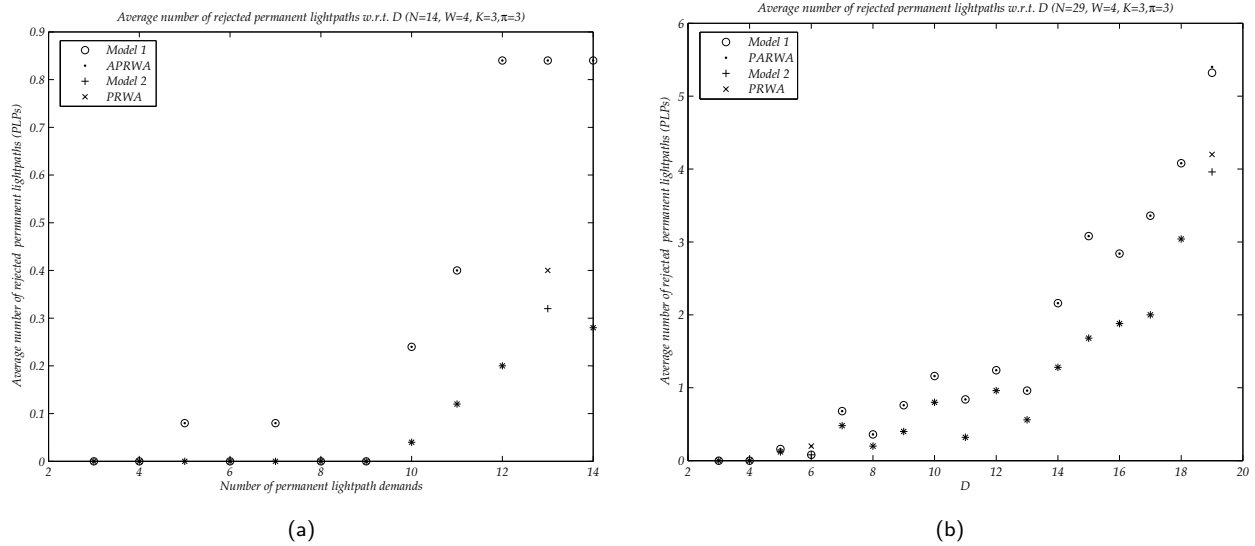

Figure 4.8 : Average number of rejected permanent lightpaths w.r.t. D

again we notice that the PLP rejection ratio (and hence the number of rejected PLPs) increases with D . More PLPs are blocked when bifurcated routing is forbidden.

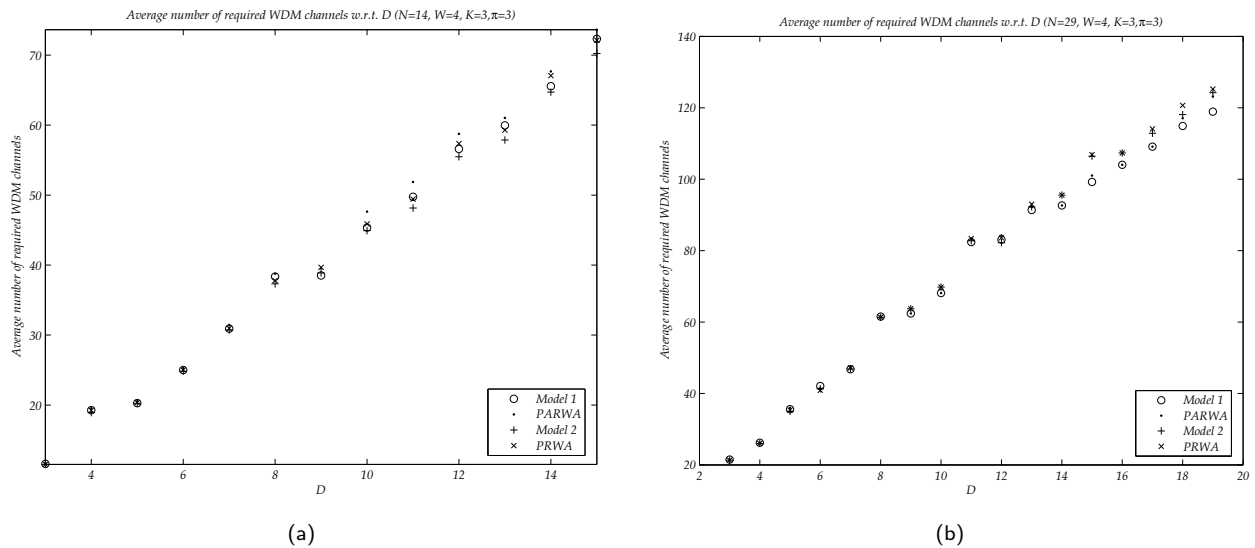

Figure 4.9 : Average number of required WDM channels w.r.t. D

Figure 4.9 plots the average number of required WDM channels w.r.t. D . The average number of required WDM channels increases with D . More WDM channels are consumed when traffic bifurcation is allowed. Indeed, by allowing bifurcated routing, additional PLDs are accepted and hence more WDM channels are consumed.

In the following two figures, each pair of bars shows the average number of required variables (4.10) and constraints (4.11). The results with Model 1 are on the left and with Model 2 on the right. Each bar is divided into three segments. The height of the black segment indicates the average number of variables (respectively constraints) requested by Step 1. The height of the white bar shows the average number of variables (respectively constraints) requested by Step 2, and finally the height of the gray bar shows the average number of variables (respectively constraints) requested by Step 3.

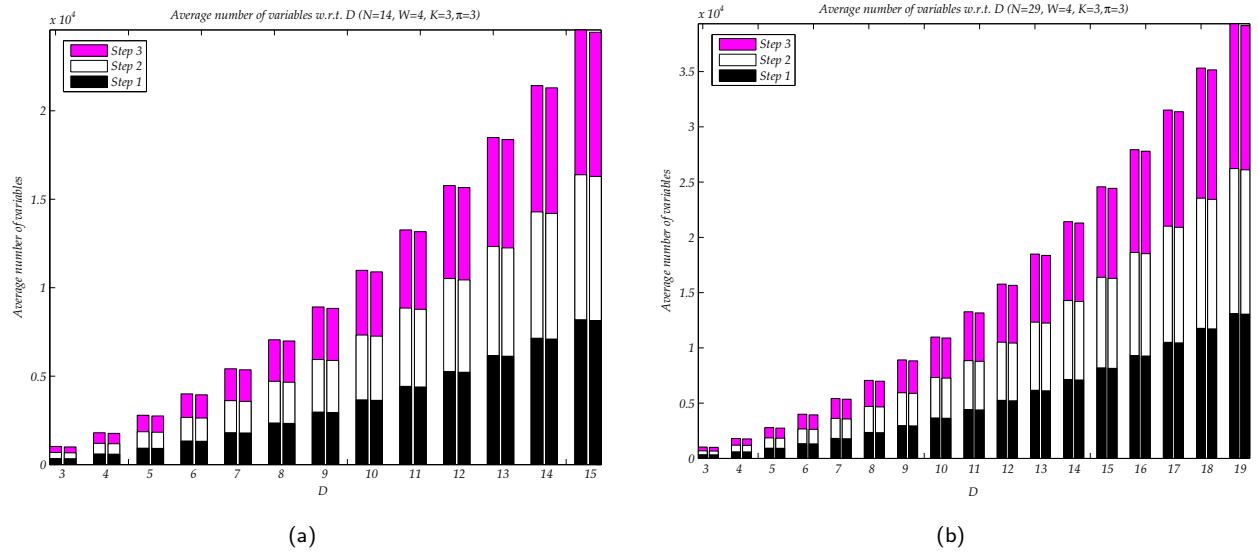

Figure 4.10 : Average number of required variables w.r.t. D

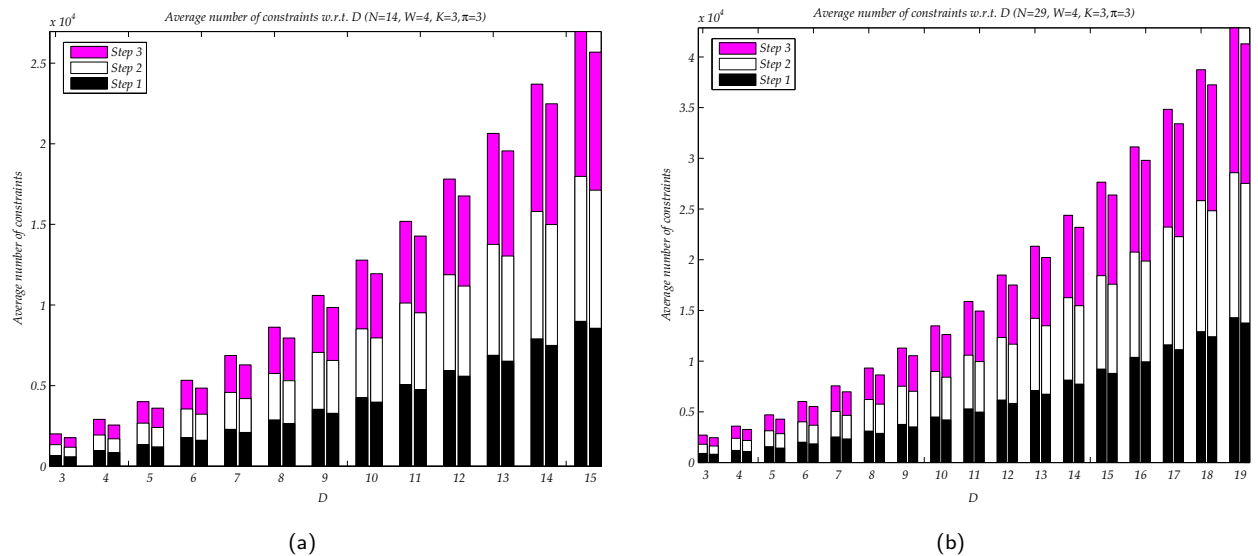

Figure 4.11 : Average number of required constraints w.r.t. D

Figure 4.10 shows the average number of variables requested by each model w.r.t. D . Both models require almost the same number of variables. The number of variables increases with D .

Figure 4.11 shows the average number of constraints requested by each model w.r.t. D . Model 2 requires fewer constraints than Model 1. Model 2 uses fewer variables and constraints and provides better results in terms of rejection ratios than Model 1. The number of variables also increases with D .

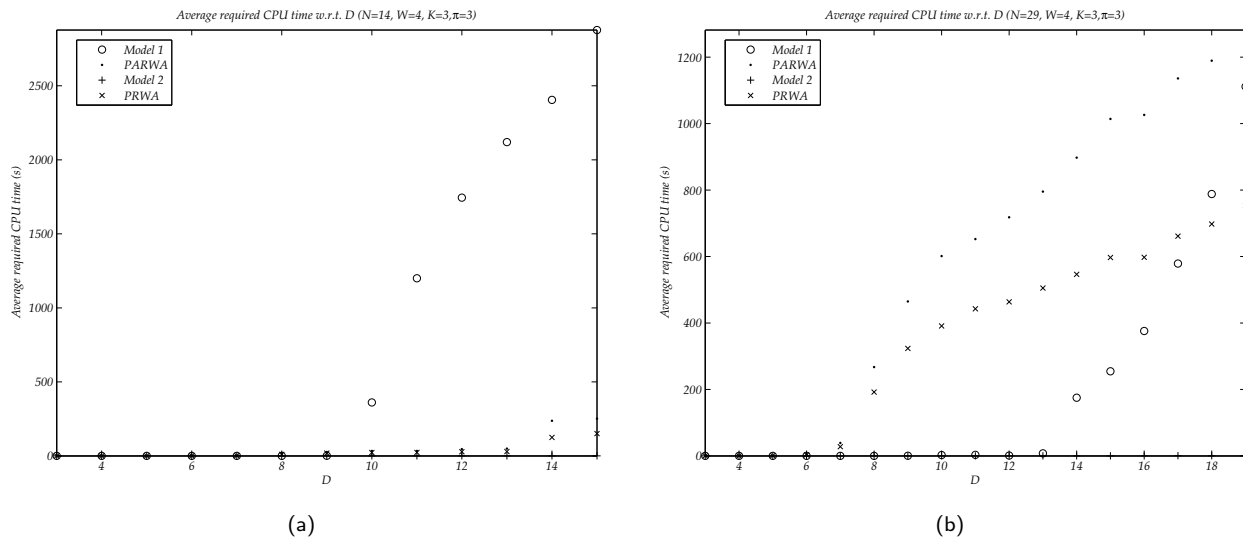

Figure 4.12 : Average required CPU execution time w.r.t. D

In Figure 4.12, the average CPU execution times required by Model 1, Model 2, the PARWA algorithm and the PRWA algorithm are illustrated. Model 1 requires long time to compute the RWA for PLDs even for small problem sizes. The PARWA and the PRWA algorithms also need long times to compute the RWA. This is mainly due to the time required by the random search algorithm to compute the best ranking vector.

Chapter 5

Routing and Wavelength Assignment for Scheduled and Random Lightpath Demands

5.1 Introduction

Optical Virtual Private Networks (OVPNs) are the key service networks provided by an optical transport network [139]. In OVPNs, connection requests can be classified into three different types: permanent (or static), scheduled, and random (or dynamic). A set of Permanent Lightpath Demands (PLDs) is required by OVPN clients in order to satisfy their minimal connectivity and capacity requirements. Scheduled Lightpath Demands (SLDs) may be required to increase the capacity of a network at specific times and/or on certain links. For example, suppose that periodical backups of database are required between the headquarter and production centers during office hours or between data centers during nights. Then, the lightpath demands for the backups of database are called SLDs. Random Lightpath Demands (RLDs) are connection requests that are dynamically established and released in time.

In this chapter we investigate the RWA problem in all-optical WDM networks for SLDs and RLDs. PLDs are not considered here since, once established, these LDs hold the network resources indefinitely which can be seen as a reduction of the number of available wavelengths on some network links. One may, for instance, assume that PLDs are routed off-line during the network planning phase. A fixed amount of resources required to establish the PLDs is computed. We then apply a certain over-dimensioning factor to this amount of resources which gives us the amount of available resources to set up SLDs and RLDs. To the best of our knowledge, this is the first time that a mix of two types

of traffic demands is considered while dealing with the RWA problem in all-optical WDM networks operating under the wavelength continuity constraint.

We still consider single fiber all-optical networks without wavelength conversion capabilities at intermediate nodes. A lightpath should hence use the same wavelength on all of the fiber-links it traverses from its source to its destination.

We propose two RWA strategies applied to different sets of SLDs and RLDs. Assuming a given network topology and capacity (number of available wavelengths per fiber-link), the metric used to compare these strategies is based on the lightpath demand rejection ratio. The first RWA strategy indiscriminately computes the RWA for the SLDs and the RLDs at their arrival times at the network. No distinction is made between an SLD and an RLD. A LD (be it an SLD or an RLD) is rejected when at least one of the lightpaths requested by the LD cannot be set up. The second RWA strategy processes in two separate phases. The first phase computes off-line the RWA for SLDs. SLDs are known in advance. The second phase computes the RWA for RLDs taking into consideration the RWA for SLDs already calculated by the first phase. RLDs are hence routed on the remaining network sparse resources. Two versions of each RWA strategy is presented depending on whether non atomic routing is allowed or not. The benefits of using non atomic routing w.r.t. atomic routing is investigated.

It is shown that non atomic routing maximizes network throughput. The second strategy performs better than the first one under network weak load at the price of higher CPU time consumption.

The remainder of the chapter is organized as follows. Subsection 5.2 describes the RWA problem for scheduled and random lightpath demands. Subsections 5.4 and 5.5 give the description of the mathematical formalization and the proposed RWA algorithms under atomic and non atomic routing strategies respectively. In Subsection 5.6, simulation experiments are carried out considering different network topologies and different traffic matrices. Simulation results obtained for the proposed algorithms are discussed.

5.2 Description of the problem

The RWA problem for SLDs and RLDs can be defined as follows: given a set of SLDs to be set up; the RLD being unknown *a priori*, and given a network topology with a limited number of wavelengths per fiber-link, find a RWA for SLDs and RLDs which meet an optimality criterion. Different optimality criteria may be considered for the routing problem. We are here interested in minimizing the number of rejected LDs while satisfying the wavelength continuity constraint. For this purpose, two RWA strategies have been proposed. The first RWA strategy uses a Dijkstra based routing algorithm to select path(s) for incoming LDs (be they SLDs or RLDs) on the fly at their arrival times while the wavelengths are assigned according to First-Fit scheme in case of a tie. The second RWA strategy aims at establishing

the RLDs dynamically, provided that the RWA for SLDs has already been computed off-line by means of a global optimization tool.

Two algorithms are proposed for each RWA strategy as shown in Figure 5.1 depending on whether non atomic routing is allowed or not. By comparing the obtained rejection ratios, we discuss the advantages and drawbacks of each routing algorithm.

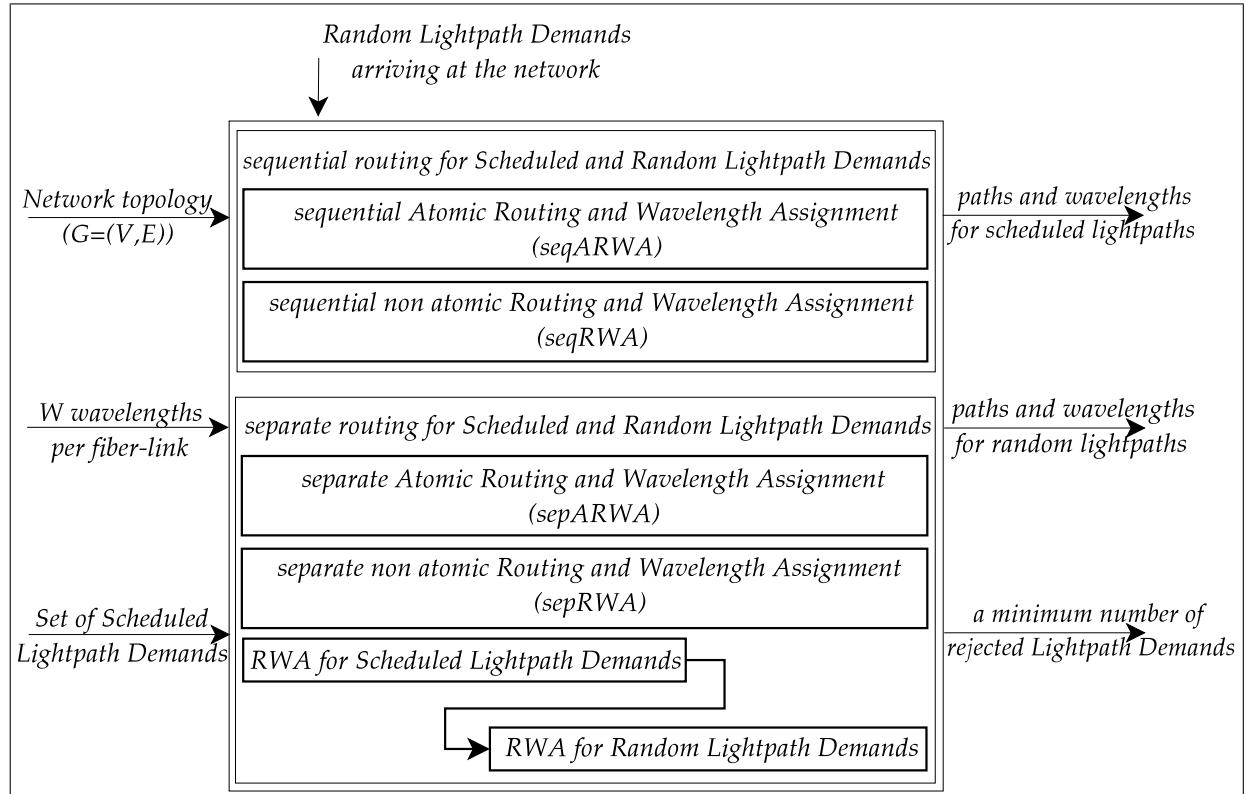

Figure 5.1 : RWA for scheduled and random lightpath demands

5.3 Notations

The notations used to describe a lightpath demand, be it scheduled or random, are the following ones.

- $G = (V, E, \xi)$ is an arc-weighted symmetrical directed graph representing the network topology with vertex set V , arc set E and weight function $\xi : E \rightarrow \mathbb{R}_+$ mapping the physical length (or any other cost of the links set by the network operator) of each arc of E .
- $N = |V|$ denotes the number of vertices (network nodes) of the directed graph representing the network topology.

- $L = |E|$ denotes the number of arcs (network links) of the directed graph representing the network topology.
- W denotes the number of available wavelengths (i.e., WDM channels) per fiber-link. We assume that all the network links have the same number of available wavelengths,
- $\Lambda = \{\lambda_1, \lambda_2, \dots, \lambda_W\}$ is the set of the available wavelengths on each fiber-link of the network.
- D denotes the total number of SLDs and RLDs to be set up.
- The LD numbered i , $1 \leq i \leq D$, to be established is defined by a 5-tuple $(s_i, d_i, \pi_i, \alpha_i, \beta_i)$ where $s_i \in V$, $d_i \in V$ are the source and the destination nodes of the demand, π_i is the number of requested lightpaths to be set up between s_i and d_i , and α_i and β_i are respectively the set-up and tear-down dates of the demand.
- $P_{i,k}$, $1 \leq i \leq D$, $1 \leq k \leq K$, represents the k^{th} alternate shortest path in G connecting node s_i to node d_i (source and destination of the i^{th} demand). We compute K -alternate shortest paths for each source-destination pair (LD) according to the algorithm described in [136] (if as many paths exist, otherwise we only consider the available ones).
- R_i is the set of the shortest paths computed for LD number i .
- $P = \cup_{1 \leq i \leq D} R_i$ is the set of all the available paths considering all the K -alternate shortest paths computed between all possible source destination pairs in the network.
- $B_{i,k}$ is the set of shortest paths in P which have at least one common link with shortest path $P_{i,k}$.
- $c_j^{\omega,t} \in \{1, +\infty\}$ is the cost of using wavelength λ_ω , on link $j \in E$ at time t . $c_j^{\omega,t} = 1$ if wavelength λ_ω is free on link j at time t ; $c_j^{\omega,t} = +\infty$ if there is a lightpath using λ_ω on link j .
- $C_{i,k}^{\omega,t} = \sum_{j \text{ on } P_{i,k}} c_j^{\omega,t}$ is the cost of using wavelength λ_ω on $P_{i,k}$, the k^{th} alternate shortest path in R_i connecting source node s_i to destination node d_i of LD i at time t . $C_{i,k}^{\omega,t}$ denotes the cumulative weight of all the fiber-links along $P_{i,k}$. $C_{i,k}^{\omega,t} < +\infty$ if λ_ω is a path-free wavelength on $P_{i,k}$ at time t ; $C_{i,k}^{\omega,t} = +\infty$ otherwise.
- $\gamma_{i,k}^{\omega,t} = 1$ ($C_{i,k}^{\omega,t} < +\infty$), $1 \leq i \leq D$, $1 \leq k \leq K$, $1 \leq \omega \leq W$, if wavelength λ_ω is a path-free wavelength along the k^{th} alternate path $P_{i,k}$, connecting the source node to the destination node of LD i , at time t . $\gamma_{i,k}^{\omega,t} = 0$ ($C_{i,k}^{\omega,t} = +\infty$) otherwise.
- $\kappa_{i,k}^t = (\gamma_{i,k}^{1,t}, \gamma_{i,k}^{2,t}, \dots, \gamma_{i,k}^{W,t})$, $1 \leq i \leq D$, $1 \leq k \leq K$, is a W -dimensional binary vector showing the available path-free wavelengths on $P_{i,k}$ at time t .

- $\sigma_{i,k}^t = \sum_{\omega=1}^W \gamma_{i,k}^{\omega,t}$, $1 \leq i \leq D$, $1 \leq k \leq K$, is the number of path-free wavelengths on $P_{i,k}$ at time t .

δ will denote an SLD whereas τ will denote an RLD. We also use π_i^δ , $P_{i,k}^\delta$, R_i^δ , $\gamma_{i,k}^{\omega,t,\delta}$, $\kappa_{i,k}^{t,\delta}$, and $\sigma_{i,k}^{t,\delta}$ (respectively π_i^τ , $P_{i,k}^\tau$, R_i^τ , $\gamma_{i,k}^{\omega,t,\tau}$, $\kappa_{i,k}^{t,\tau}$, and $\sigma_{i,k}^{t,\tau}$) for the parameters representing an SLD (respectively an RLD) when it is necessary to make a clear distinction between scheduled and random demands.

5.4 Atomic routing algorithms

We here assume atomic routing also called non bifurcated routing: all the lightpaths requested by a LD have to be routed on the same path joining the source node to the destination node of the LD. Two heuristic algorithms are proposed as described below.

5.4.1 Sequential RWA for scheduled and random lightpath demands: sequential Atomic RWA algorithm

The *sequential Atomic RWA algorithm (seqARWA)* aims at minimizing the number of rejected LDs (SLDs and RLDs). The LDs are processed sequentially at their arrival dates. All the lightpaths requested by a LD are routed through the same path. At the incoming date of a LD, the associated K -alternate shortest paths (computed off-line) are considered in turn according to their lengths (number of hops) and we look (on each path) for the number of path-free wavelengths. The LD numbered i is set up whenever there is at least one shortest path in R_i on which there are as many available path-free wavelengths as the number of requested lightpaths π_i . The wavelengths are assigned according to a First-Fit scheme in the case when the number of available path-free wavelengths is higher than the number of requested lightpaths. If it does not exist enough wavelengths to satisfy the demand on any of its K -alternate shortest paths, the LD is rejected.

Note that whenever there are enough available path-free wavelengths on two or several distinct paths, the shortest one is preferred as it will use fewer WDM channels. In Table 5.1, we draw the pseudo-code used for the seqARWA algorithm.

To illustrate how the seqARWA algorithm computes the RWA for SLDs and RLDs, let us consider the 14-node network topology and the set of three SLDs and two RLDs to be set up shown in Table 5.2 and Table 5.3 respectively. We assume 3 available wavelengths per fiber-link ($W = 3$). Let note λ_1 , λ_2 , and λ_3 these wavelengths. We also assume that we computed 3 alternate shortest paths between the source and destination nodes of each LD ($K = 3$).

Let us remind that after every successful lightpath establishment or release, the cost, $C_{i,k}^{\omega,t}$, of using a wavelength λ_ω on a path $P_{i,k}$ has to be updated to $+\infty$ (respectively a finite positive value equal to the number of hops on the path (or any other cost value)) in case of a lightpath establishment (respectively a lightpath release). We have also to update to $+\infty$ (respectively a finite positive value) the cost of the wavelength(s) used by the considered LD on the paths in $\mathcal{B}_{i,k}$ that share common links

ALGORITHM *The sequential Atomic RWA algorithm*

Input: R_i , $1 \leq i \leq N(N-1)$, W ,

Output: computes a RWA for a maximum number of accepted LDs (SLDs and RLDs)

(* The algorithm looks, every time a new LD arrives at the network, for as many path-free wavelengths as the number of requested lightpaths considering each of the K -alternate shortest paths connecting the source to the destination node of the LD. The LD is set up when it exist at least one shortest path among the considered ones on which there are enough path-free wavelengths; otherwise, the LD is rejected. The algorithm returns the minimum number of rejected LDs as well as the number of rejected lightpaths (LPs). *)

```

1  rejectedLDs:=0
2  rejectedLPs:=0
3  for each new arrived LD at time t do
3.1  setup:=0
3.2  k:=1
3.3  while (k ≤ K) and (setup = 0) do
      (* Compute the number of available path-free wavelengths on each shortest path in  $R_i$  *)
3.4      for  $\omega := 1$  to  $W$  do
3.5          Compute  $\gamma_{i,k}^{\omega,t}$ 
      endfor
3.6      if  $\sigma_{i,k}^t \geq \pi_i$  then
      (* set up the LD. In the case when  $\sigma_{i,k}^t > \pi_i$ , the wavelengths are selected according to a First-Fit
      scheme. Update the cost of  $P_{i,k}$  on the used wavelengths *)
3.7          setup:=1
3.8           $\omega := 1$ 
3.9           $p := 1$ 
3.10         while ( $\omega \leq W$ ) and ( $p \leq \pi_i$ ) do
3.11             if  $C_{i,k}^{\omega,t} \leq +\infty$  then
3.12                  $C_{i,k}^{\omega,t} := +\infty$ 
3.13                  $p := p + 1$ 
             endif
3.14              $\omega := \omega + 1$ 
         endwhile
3.15         k := k + 1
      else
      (* The LD cannot be set up on  $P_{i,k}$ . There are not enough path-free wavelengths on  $P_{i,k}$ . *)
3.16         k := k + 1
      endif
    endwhile
3.17  if (k = K + 1) and (setup = 0) then
      (* The LD cannot be set up. The LD is rejected. Update the number of rejected LDs and the number of
      rejected LPs *)
3.18      rejectedLDs:=rejectedLDs +1
3.19      rejectedLPs:=rejectedLPs + $\pi_i$ 
    endif
  endfor
end. The sequential Atomic RWA algorithm

```

Table 5.1 : Pseudo code for the sequential Atomic RWA algorithm

National Science Foundation Network (NSFNet)	SLD (δ)	s	d	π	α	β	the shortest paths
	1	1	6	3	106	407	$P_{1,1}=1-3-6$ $P_{1,2}=1-2-3-6$ $P_{1,3}=1-4-5-6$
	2	9	5	2	307	807	$P_{2,1}=9-4-5$ $P_{2,2}=9-12-13-6-5$ $P_{2,3}=9-14-13-6-5$
	3	10	4	2	605	904	$P_{3,1}=10-14-9-4$ $P_{3,2}=10-12-9-4$ $P_{3,3}=10-11-6-5-4$

Table 5.2 : The set of SLDs to be set up

RLD (τ)	s	d	π	α	β	the shortest paths
1	11	1	3	406	807	$P_{1,1} = 11-6-3-1$ $P_{1,2} = 11-10-8-2-1$ $P_{1,3} = 11-6-5-4-1$
2	8	2	2	609	1007	$P_{2,1} = 8-2-1$ $P_{2,1} = 8-2-3-1$ $P_{2,1} = 8-7-5-4-1$

Table 5.3 : The RLDs to be set up

with the path(s) assigned to the LD in case of a lightpath establishment (respectively a lightpath release whenever none of the links of these paths are still used by active LDs).

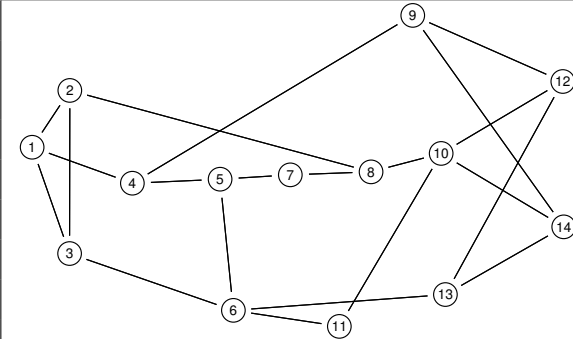
At time $t = 106$ SLD δ_1 is to be set up. We compute $\kappa_{1,1}^{106,\delta} = (1, 1, 1)$ and δ_1 is set up using λ_1 , λ_2 , and λ_3 on $P_{1,1}^\delta$. Then SLD δ_2 is to be considered at time $t = 307$. We compute $\kappa_{2,1}^{307,\delta} = (1, 1, 1)$ and wavelengths λ_1 , and λ_2 are selected on $P_{2,1}^\delta$. RLD τ_1 is to be routed at time $t = 406$. $\kappa_{1,1}^{406,\tau} = (1, 1, 1)$. All the wavelengths are available on $P_{1,1}^\tau$. RLD τ_1 is hence serviced on $P_{1,1}^\tau$ using λ_1 , λ_2 , and λ_3 . The next LD to be set up is SLD δ_3 . SLD δ_2 and RLD τ_1 are active whilst the lightpaths of δ_1 are released. $\kappa_{3,1}^{605,\delta} = (0, 0, 1)$; δ_3 cannot be set up on $P_{1,1}^\delta$. $\kappa_{3,2}^{605,\delta} = (0, 0, 1)$ and $\kappa_{3,3}^{605,\delta} = (0, 0, 0)$. SLD δ_3 cannot be set up on any of its associated shortest paths; δ_3 is rejected. The last LD to be set up is τ_2 . δ_2 and τ_1 are still active. We compute $\kappa_{2,1}^{609,\tau} = (1, 1, 1)$ and τ_2 is set up using λ_1 and λ_2 on $P_{2,1}^\tau$.

5.4.2 Separate RWA for scheduled and random lightpath demands: separate Atomic RWA algorithm

The *separate Atomic RWA algorithm (sepARWA)* relies on two separate phases to compute the RWA for SLDs and RLDs. The first phase (PHASE 1) computes, given a set of SLDs, a network topology and a fixed number of wavelengths per fiber-link, a RWA solution for SLDs that minimizes the number of rejected demands. The second phase (PHASE 2) computes sequentially according to the algorithm described in Subsection 5.4.1 the RWA for RLDs, taking into account the RWA for SLDs which has already been computed by PHASE 1.

5.4.2.1 PHASE1: RWA for scheduled lightpath demands

5.4.2.1.1 Mathematical formulation Given a set of SLDs, we want to set up for each SLD δ_i , if possible, as many lightpaths as the number π_i of requested lightpaths while satisfying the wavelength continuity constraint. We assume that there are at most W available wavelengths per fiber-link and that for each SLD, the requested lightpaths have to follow the same shortest path connecting the source to the destination of the SLD. The objective is to minimize the number of rejected SLDs. Hereafter the description of the mathematical formulation of the RWA problem for SLDs formulated as a combinatorial optimization problem. We need the following additional notations:

- M denotes the number of SLDs and $\Delta = \{\delta_1, \delta_2, \dots, \delta_M\}$ is the set of SLDs to be set up. The SLDs are numbered from 1 to M according to their dates of arrival at the network (δ_1 is the first SLD arriving at the network, δ_M is the last one).
- (G, Δ) is a pair representing an instance of the SLD routing problem.
- a vector $(\rho_{i,1}, \rho_{i,2}, \dots, \rho_{i,K})$ is associated to the SLD δ_i . $\rho_{i,k} = 1$ if the lightpaths requested by SLD δ_i are to be routed along $P_{i,k}^\delta$, the k^{th} alternate shortest path for SLD δ_i .
- $\rho_\Delta = ((\rho_{1,1}, \rho_{1,2}, \dots, \rho_{1,K}), (\rho_{2,1}, \rho_{2,2}, \dots, \rho_{2,K}), \dots, (\rho_{M,1}, \rho_{M,2}, \dots, \rho_{M,K}))$ is called an admissible routing solution for Δ if for each SLD δ_i ($1 \leq i \leq M$), there exists a unique ℓ , $1 \leq \ell \leq K$, such that $\rho_{i,\ell} = 1$ and $\rho_{i,k} = 0$ for each path k , ($1 \leq k \leq K$), k different from ℓ .
- Π_Δ is the set of all admissible routing solutions for Δ .
- $C : \Pi_\Delta \rightarrow \mathbb{N}$ is the function that counts the number of blocked SLDs for an admissible solution. The combinatorial optimization problem to solve is:

$$\begin{aligned} &\text{Minimize} && C(\rho_\Delta) \\ &\text{subject to:} && \rho_\Delta \in \Pi_\Delta \end{aligned}$$

5.4.2.1.2 The Random Search algorithm We used a Random Search (RS) algorithm to find an approximate minimum of the function C . Once again the wavelengths are assigned according to a First-Fit scheme. Three problem-specific functions are required to implement the RS algorithm: an initial solution is created by a function that defines the components of the vector ρ . One may, for instance, choose the shortest path $P_{i,1}$ ($1 \leq i \leq M$) as the route for the lightpaths requested by each SLD in Δ ($\rho = ((1,0,\dots,0), (1,0,\dots,0), (1,0,\dots,0))$). A random function generates random values for vector ρ according to the following steps:

- For each SLD δ_i , $1 \leq i \leq M$, generate a pseudo-random number \mathcal{X} uniformly distributed in the interval $[1, K]$. The shortest path $P_{i,\mathcal{X}}$ is selected as the route for the lightpaths requested by SLD δ_i .
- Once vector ρ is generated, one has to verify, before computing its cost (measured in terms of number of rejected SLDs), that the cost of the generated vector ρ has not already been evaluated. In that case, another ρ vector is generated randomly according to the preceding phase. In order to verify that the cost of the new generated random vector ρ has not been already evaluated, we keep trace of a certain number of already generated ρ vectors by updating a list we called the *BLACK LIST*.

Finally, an objective function computes for a given value of vector ρ the number of rejected SLDs, C . The SLDs are considered one by one sequentially according to their dates of arrival at the network. Each SLD is routed according to the route selected in ρ . The wavelengths are assigned according to a First-Fit scheme whenever the number of available path-free wavelengths on the selected path for the considered SLD is higher than the number of requested lightpaths. The SLD is rejected whenever the number of path-free wavelengths on the selected path for the considered SLD is lower than the number of requested lightpaths.

The detailed pseudo-code of the RS algorithm is drawn in Table 5.4.

For illustration purposes, let us, again, consider the network topology and the set of three SLDs to be set up shown in Table 5.2. Once again we assume that $W = 3$ and that $K = 3$.

One admissible solution (among others) is $\rho = ((1,0,0), (1,0,0), (1,0,0))$ (the requested lightpaths for each SLD have to follow the first shortest path $P_{i,1}$, $1 \leq i \leq 3$). Let us evaluate the cost of this solution by computing the number of rejected SLDs. We assume that initially no SLD has already been routed and hence all available wavelengths are free. SLD δ_1 requires 3 lightpaths. These lightpaths have to be routed on $P_{1,1}$. One has first to verify that three available wavelengths are path-free on $P_{1,1}$. Vector $\kappa_{1,1}^{106,\delta} = (1,1,1)$ indicates that all the wavelengths are free. SLD δ_1 is hence set up using wavelengths λ_1 , λ_2 , and λ_3 on $P_{1,1}$. When SLD δ_2 arrives at time $t = 307$, δ_1 is still active. We

compute $\kappa_{2,1}^{307,\delta} = (1, 1, 1)$ and λ_1 and λ_2 are selected on $P_{2,1}$. Then SLD δ_3 is to be set up, δ_1 and δ_2 are still active. $\kappa_{3,1}^{605,\delta} = (0, 0, 1)$ shows that λ_1 and λ_2 are already used (δ_2 is using λ_1 and λ_2 on link 9-4). Only one path-free wavelength remains on $P_{3,1}$. SLD δ_3 is thus rejected. The cost of the

ALGORITHM *The separate Atomic RWA for the SLDs*
Input: $\Delta, R_i^\delta, W, n,$
Output: computes a RWA solution for the SLDs that minimizes the number of rejected SLDs.
 (* compute an initial vector ρ_0 and compute its cost (number of rejected SLDs). One may for instance choose the first shortest path for all of the SLDs *)
 1 Generate an initial vector ρ_0
 2 Copy ρ_0 to $\text{best}\rho$ and append it in the BLACK LIST
 3 Call the objective function to compute the number of rejected SLDs (bestrejectedSLDs) as well as the number of rejected lightpaths ($\text{bestrejectedSLPs} = \sum_{i \in \text{set of rejected SLDs}} \pi_i$ (see pseudo-code from STEP 5.1 to STEP 5.14 for the details)
 (* repeat n times *)
 4 for $i := 1$ to n do
 4.1 Call the random function to generate a new random vector ρ
 5 Verify that the cost of ρ has not already been evaluated. Check if ρ is already in the BLACK LIST. If yes, another random ρ is generated, otherwise put ρ in the BLACK LIST and its cost is evaluated according to the following.
 (* Call the objective function to compute the number of rejected SLDs (rejectedSLDs) as well as the number of rejected lightpaths ($\text{rejectedSLPs} = \sum_{i \in \text{set of rejected SLDs}} \pi_i$. We assume that it exist $\ell_i, 1 \leq \ell_i \leq K, 1 \leq i \leq M$ that $\rho_{i,\ell_i} = \pi_i^\delta$ ($\ell_i = 1, 1 \leq i \leq M$, if the shortest path $P_{i,1}$ is used). *)
 5.1 $\text{rejectedSLDs} := 0, \text{rejectedSLPs} := 0$
 5.2 for $i := 1$ to M do
 5.3 Compute $\gamma_{i,\ell_i}^{\omega,t,\delta}, \forall 1 \leq \omega \leq W$
 5.4 if $\sigma_{i,\ell_i}^{t,\delta} \geq \pi_i^\delta$ then
 (* set up the SLD. In the case when $\sigma_{i,\ell_i} > \pi_i^\delta$, the wavelengths are selected according to a First-Fit scheme. Update the cost of the P_{i,ℓ_i}^δ on the used wavelengths *)
 5.5 $\omega := 1, p := 1$
 5.6 while $(\omega \leq W)$ and $(p \leq \pi_i^\delta)$ do
 5.7 if $C_{i,\ell_i}^{\omega,t} \leq +\infty$ then
 5.8 $C_{i,\ell_i}^{\omega,t} := +\infty, p := p + 1$
 endif
 5.9 $\omega := \omega + 1$
 endwhile
 else
 (* The SLD cannot be set up. There are not enough path-free wavelengths on P_{i,ℓ_i} . Update the number of rejected SLDs and the number of rejected LPs *)
 5.10 $\text{rejectedSLDs} := \text{rejectedSLDs} + 1, \text{rejectedSLPs} := \text{rejectedSLPs} + \pi_i^\delta$
 endif
 endifor
 5.11 if $\text{rejectedSLDs} < \text{bestrejectedSLDs}$ then
 5.12 $\text{bestrejectedSLDs} := \text{rejectedSLDs}, \text{bestrejectedSLPs} := \text{rejectedSLPs}$, copy ρ to $\text{best}\rho$
 elseif $\text{rejectedSLDs} = \text{bestrejectedSLDs}$ then
 5.13 if $\text{rejectedSLPs} < \text{bestrejectedSLPs}$ then
 5.14 $\text{bestrejectedSLPs} := \text{rejectedSLPs}$, copy ρ to $\text{best}\rho$
 endif
 endifor
 end. *The separate Atomic RWA for the SLDs*

Table 5.4 : RS algorithm for the atomic RWA of SLDs

SLD	s	d	π	α	β	the lightpath used by the SLDs	
						the shortest paths	wavelengths
1	1	6	3	106	407	$P_{1,1} = 1-3-6$	λ_1
						$P_{1,1} = 1-3-6$	λ_2
						$P_{1,1} = 1-3-6$	λ_3
2	9	5	2	307	807	$P_{2,1} = 9-4-5$	λ_1
						$P_{2,1} = 9-4-5$	λ_2
3	10	4	2	605	904	$P_{3,3} = 10-11-6-5-4$	λ_1
						$P_{3,3} = 10-11-6-5-4$	λ_2

Table 5.5 : Non bifurcated RWA for the SLDs

considered solution (in terms of number of rejected SLDs) is $C(\Pi_{\rho,\Delta}) = 1$.

It is easy to check that when vector ρ is equal to $((1, 0, 0), (1, 0, 0), (0, 0, 1))$, all SLDs are accepted. It may happen that several admissible solutions (ρ) compute the same number of rejected demands. In that case we prefer a solution that minimizes the number of rejected scheduled lightpaths (SLPs).

5.4.2.2 PHASE2: RWA for random lightpath demands

In this section, we briefly describe the algorithm proposed to compute the RWA for RLDs. The objective of the algorithm is to minimize the number of rejected RLDs given the RWA for SLDs (which has already been computed according to the atomic Random Search algorithm described above). The RLDs are processed sequentially at arrival dates. All the lightpaths of an RLD are routed through the same path. We used the same algorithm as in Subsection 5.4.1 to compute the RWA for a new arriving RLD τ_i : the associated K -alternate shortest paths are considered in turn according to their lengths and we look for the number of path-free wavelengths on each path. The RLD is set up whenever there is at least one shortest path in R_i^{τ} on which there are as many available path-free wavelengths as the number of requested lightpaths π_i^{τ} . The wavelengths are assigned according to a First-Fit scheme in the case when the number of available path-free wavelengths is higher than the number of requested lightpaths. If it does not exist enough wavelengths to satisfy the demand, the RLD is rejected. Note that whenever there are enough available path-free wavelengths on two or several distinct paths, the shortest one is preferred as it will use fewer WDM channels.

Consider again the network represented in Table 5.2 with three available wavelengths on each fiber-link ($W = 3$). We assume that we computed the RWA for the SLDs according to the RS algorithm described in Paragraph 5.4.2.1.2. The characteristics of the *Scheduled LightPaths* (SLPs) to be set up are given in Table 5.5. We then assume that we have to compute the RWA for the set of RLDs described in Table 5.6. We computed 3 alternate shortest paths for each RLD ($K = 3$).

At time $t = 406$ RLD τ_1 is to be set up requesting 3 lightpaths. SLDs δ_1 and δ_2 are already routed whereas SLD δ_3 is to be set up at time $t = 605$. We compute $\kappa_{1,1}^{406,\tau}$. $\kappa_{1,1}^{406,\tau} = (0, 0, 1)$ shows that

RLD	s	d	π	α	β	the shortest paths
1	11	1	3	406	807	$P_{1,1} = 11-6-3-1$ $P_{1,2} = 11-10-8-2-1$ $P_{1,3} = 11-6-5-4-1$
2	8	2	2	609	1007	$P_{2,1} = 8-2-1$ $P_{2,1} = 8-2-3-1$ $P_{2,1} = 8-7-5-4-1$

Table 5.6 : The RLDs to be set up

wavelengths λ_1 and λ_2 are no longer available. These wavelengths will be taken by SLD δ_3 at time $t = 605$. We then compute $\kappa_{1,2}^{406,\tau}$. $\kappa_{1,2}^{406,\tau} = (1, 1, 1)$ and τ_1 is set up on $P_{1,2}^\tau$ using λ_1 , λ_2 , and λ_3 . It should be noted that if RLD τ_1 finished before the start time of SLD δ_3 , it could have used the resources to be taken by SLD δ_3 at its arrival date.

When RLD τ_2 arrives SLD δ_2 and RLD τ_1 are still active. The lightpaths of SLD δ_1 are released at time $t = 407$. We first compute $\kappa_{2,1}^{609,\tau}$. $\kappa_{2,1}^{609,\tau} = (0, 0, 0)$. All the wavelengths are used by τ_1 on link 8-2. RLD τ_2 cannot be set up on $P_{2,1}^\tau$. We then compute $\kappa_{2,1}^{609,\tau} = (0, 0, 0)$; τ_2 cannot be set up on $P_{2,1}^\tau$ for the same reason. Finally we compute $\kappa_{2,3}^{609,\tau} = (0, 0, 1)$ as wavelengths λ_1 and λ_2 are already assigned to δ_3 on link 5-4. RLD τ_2 cannot be set up on any of its associated shortest paths, τ_2 is rejected.

We notice that the sepARWA and seqARWA algorithms have the same rejection ratio ($Rr = 1/5$). The sepARWA rejects RLD τ_2 while the seqARWA rejects SLD δ_3 .

5.5 Non atomic routing algorithms

Two RWA algorithms have also been proposed for the non atomic case. The first RWA algorithm called *sequential non atomic RWA algorithm (seqRWA)* computes, in the same way the seqARWA do, the RWA for SLDs and RLDs sequentially at the arrival date of each LD. The second RWA algorithm called *separate non atomic RWA (sepRWA) algorithm* deals, as the sepARWA algorithm do, with SLDs and RLDs in two separate phases.

Unlike the seqARWA and the sepARWA algorithms, the seqRWA and sepRWA algorithms allow non atomic routing. When the number of path-free wavelengths on the shortest path is lower than the number of requested lightpaths by an LD, the traffic may be split on several alternate shortest paths connecting the source node to the destination node of the LD. This assumes that the cumulated number of available path-free wavelengths along the considered shortest paths is at least equal to the number of requested lightpaths; otherwise, the demand is rejected. It may happen that the cumulated number of available path-free wavelengths along the K-alternate shortest paths considered for each LD

(if so many paths exist) is higher than the number of requested lightpaths. In that case, available path-free wavelengths along the shortest paths are preferred to those on the longest ones as shortest paths consume fewer WDM channels. Again we use a First-Fit scheme for wavelength selection.

5.5.1 Sequential RWA for scheduled and random lightpath demands: sequential non atomic RWA algorithm

This section presents the sequential non atomic RWA algorithm. We deal with SLDs and RLDs sequentially at their arrival dates. The lightpaths requested by a LD may follow several distinct paths connecting the source to the destination of the LD. The traffic of any LD is split if and only if the number of available path-free wavelengths on the shortest path $P_{i,1}$ is lower than the number of requested lightpaths π_i .

When a new LD, i , arrives at the network, we look for as many path-free wavelengths as the number of requested lightpaths along the K -alternate shortest paths in R_i connecting the source node to the destination node of the LD. First, one tries to route all the requested lightpaths on the shortest one, if it is possible (i.e. if there are as many available path-free wavelengths along the shortest path as the requested number of lightpaths), otherwise, several paths in R_i are used. As they require fewer WDM channels, path-free wavelengths with shorter paths are preferred to those with longer ones. Again, the wavelengths are assigned according to a First-Fit scheme. The pseudo-code of the seqRWA algorithm is shown in Table 5.7.

Let us take the example of the preceding paragraphs to describe the process of the seqRWA. Again we assume that there are 3 available wavelengths per fiber-link ($W = 3$). We compute 3 alternate shortest paths for each LD ($K = 3$).

At time $t = 106$ SLD δ_1 is to be considered. We compute $\kappa_{1,1}^{106,\delta} = (1, 1, 1)$ and δ_1 is set up using wavelengths λ_1 , λ_2 , and λ_3 on $P_{1,1}^\delta$. Then SLD δ_2 is to be set up. We compute $\kappa_{2,1}^{307,\delta} = (1, 1, 1)$; λ_1 and λ_2 are used on $P_{2,1}^\delta$. At time $t = 406$ RLD τ_1 is to be set up. $\kappa_{1,1}^{406,\tau} = (1, 1, 1)$ and τ_1 is hence serviced on $P_{1,1}^\tau$ using λ_1 , λ_2 , and λ_3 . Next SLD δ_3 is considered. SLD δ_2 and RLD τ_1 are still active whilst the lightpaths of SLD δ_1 are released. $\kappa_{3,1}^{605,\delta} = (0, 0, 1)$, $\kappa_{3,2}^{605,\delta} = (0, 0, 0)$, and $\kappa_{3,3}^{605,\delta} = (0, 0, 0)$. Only one wavelength is available on all the shortest paths associated to SLD δ_3 . $\sum_{k=1}^3 \sigma_{i,k}^{605} = 1 < 2$. SLD δ_3 is thus rejected. RLD τ_2 is the last LD to be routed. SLD δ_2 and RLD τ_1 are still active. We compute $\kappa_{2,1}^{609,\tau} = (1, 1, 1)$ and RLD τ_2 is set up using λ_1 and λ_2 on $P_{2,1}^\tau$.

5.5.2 Separate RWA for scheduled and random lightpath demands: separate non atomic RWA algorithm

5.5.2.1 PHASE1: RWA for scheduled lightpath demands

This section describes the non atomic Random Search algorithm used to compute the RWA for SLDs.

5.5.2.1.1 Mathematical formulation Still using the notations of Subsection 5.3 and Subparagraph 5.4.2.1.1, we redefine the following notations:

```

ALGORITHM The sequential (non atomic) RWA algorithm
Input:  $R_i$ ,  $1 \leq i \leq N(N-1)$ ,  $W$ ,
Output: computes a RWA for a maximum number of LDs (SLDs and RLDs)
(* The algorithm looks, every time a new LD arrives at the network, for as many path-free wavelengths as the number
of requested lightpaths considering all the  $K$ -alternate shortest paths connecting the source to the destination node
of the LD. The LD is set up if the cumulative number of path-free wavelengths along the considered shortest paths
is at least equal to the number of requested lightpaths; otherwise, the LD is rejected. The algorithm returns the
minimum number of rejected LDs as well as the number of rejected lightpaths (LPs). *)
1 rejectedLDs:=0
2 rejectedLPs:=0
3 for each new arrived LD at time  $t$  do
3.1 for  $k:=1$  to  $K$  do
3.2 for  $\omega:=1$  to  $W$  do
3.3 Compute  $\gamma_{i,k}^{\omega,t}$ 
endfor
endfor
3.4 if  $\sum_{k=1}^K \sigma_{i,k}^t \geq \pi_i$  then
(* set up the LD. In the case when  $\sum_{k=1}^K \sigma_{i,k}^t > \pi_i$ , the wavelengths are selected according to a First-Fit
scheme. Update the cost of  $P_{i,k}$ ,  $1 \leq k \leq K$ , on the used wavelengths. *)
3.5  $k:=1$ ,  $p:=1$ 
3.6 while ( $k \leq K$ ) and ( $p \leq \pi_i$ ) do
3.7  $\omega:=1$ 
3.8 while ( $\omega \leq W$ ) and ( $p \leq \pi_i$ ) do
3.9 if  $C_{i,k}^{\omega,t} \leq +\infty$  then
3.10  $C_{i,\ell_i}^{\omega,t} := +\infty$ ,  $p := p + 1$ 
endif
3.11  $\omega := \omega + 1$ 
endwhile
endwhile
else
(* The RLD cannot be set up. There are not enough path-free wavelengths on the  $P_{i,k}$ ,  $1 \leq k \leq K$ . *)
3.12 rejectedLDs:=rejectedLDs+1,
3.13 rejectedLPs:=rejectedLPs+ $\pi_i$ 
endif
endfor
end. The sequential (non atomic) RWA algorithm

```

Table 5.7 : Pseudo code for the sequential non atomic RWA algorithm

- a vector $(\rho_{i,1}, \rho_{i,2}, \dots, \rho_{i,K})$ is associated to the SLD δ_i . The element $\rho_{i,k}$ indicates the number of lightpaths to be routed along $P_{i,k}^\delta$, the k^{th} alternate shortest path for SLD δ_i ,
- $\rho_\Delta = ((\rho_{1,1}, \rho_{1,2}, \dots, \rho_{1,K}), (\rho_{2,1}, \rho_{2,2}, \dots, \rho_{2,K}), \dots, (\rho_{1,M}, \rho_{2,M}, \dots, \rho_{K,M}))$ is called an admissible routing solution for Δ if $\sum_{k=1}^K \rho_{i,k} = \pi_i^\delta, 1 \leq i \leq M$.
- Π_Δ is the set of all admissible routing solutions for Δ .
- $C : \Pi_\Delta \rightarrow \mathbb{N}$ is the function that counts the number of blocked SLDs for an admissible solution. The combinatorial optimization problem to solve is:

$$\text{Minimize } C(\rho_\Delta)$$

$$\text{subject to: } \rho_\Delta \in \Pi_\Delta$$

5.5.2.1.2 The Random Search algorithm We used the same RS algorithm defined in Subparagraph 5.4.2.1.2. It must be noted that the traffic requested by an SLD δ_i may be split on two or several paths among the shortest paths in R_i . Once again the wavelengths are assigned according to a First-Fit scheme. The pseudo-code used for the non atomic RS algorithm is shown in Table 5.10.

In order to describe the process of the non atomic RS algorithm, let us still consider the same example as before with three SLDs to establish. The set of SLDs to be set up is shown in Table 5.8. An admissible solution (among others) $\rho = ((1, 1, 1), (2, 0, 0), (0, 1, 1))$ is generated arbitrarily. Again we assume that there are 3 available wavelengths per fiber-link ($W = 3$) and that 3 alternate shortest paths are computed for each SLD ($K = 3$).

When SLD δ_1 arrives at time $t = 106$, we assume that no LDs have already been routed (all the wavelengths are available on all of the fiber-links). According to ρ , three lightpaths are requested and each lightpath has to follow a shortest path. One has to check that there is at least one available path-free wavelength on each shortest path. $\kappa_{1,1}^{106,\delta} = (1, 1, 1)$ and λ_1 is selected on $P_{1,1}^\delta$ for the first lightpath. $\kappa_{1,2}^{106,\delta} = (0, 1, 1)$. λ_1 is no more available and wavelength λ_2 is selected on $P_{1,2}^\delta$ for the second lightpath. We then compute $\kappa_{1,3}^{106,\delta} = (1, 1, 1)$. None of the available wavelengths is used on $P_{1,3}^\delta$ and λ_1 is selected for the third lightpath. SLD δ_1 is hence set up. SLD δ_2 is to be set up at time $t = 307$. Two lightpaths have to be established upon $P_{2,1}^\delta$. One has to check that there are at least two available path-free wavelengths on $P_{2,1}^\delta$. We compute $\kappa_{2,1}^{307,\delta} = (0, 1, 1)$. Only λ_1 is no more available whereas λ_2 and λ_3 are still free on $P_{2,1}^\delta$. SLD δ_2 is hence set up using wavelengths λ_2 and λ_3 on $P_{2,1}^\delta$. When SLD δ_3 arrives, the lightpaths associated to δ_1 are already released. Two lightpaths are requested by δ_3 . According to ρ , one lightpath is to be routed on $P_{3,2}^\delta$ while the second lightpath is to be routed on $P_{3,3}^\delta$. $\kappa_{3,2}^{605,\delta} = (1, 0, 0)$ and $\kappa_{3,3}^{605,\delta} = (1, 1, 1)$. Wavelengths λ_2 and λ_3 are still used

by SLD δ_2 on fiber-link 4-5 whereas all the wavelengths are available on $P_{3,3}^\delta$. SLD δ_3 is set up using wavelength λ_1 on $P_{3,2}^\delta$ and $P_{3,3}^\delta$. All the SLDs could be accepted according to ρ .

The above solution consumes 19 WDM channels. One may prefer a solution that minimize, in addition to the number of rejected SLDs, the number of used WDM channels. One may check that the following solution $\rho = ((3, 0, 0), (2, 0, 0), (1, 0, 1))$ accommodate all the SLDs and uses only 11 WDM channels. The set up lightpaths are shown in Table 5.9.

National Science Foundation Network (NSFNet)	SLD (δ)	s	d	π	α	β	the shortest paths
	1	1	6	3	106	407	$P_{1,1}=1-3-6$ $P_{1,2}=1-2-3-6$ $P_{1,3}=1-4-5-6$
	2	9	5	2	307	807	$P_{2,1}=9-4-5$ $P_{2,2}=9-12-13-6-5$ $P_{2,3}=9-14-13-6-5$
	3	10	4	2	605	904	$P_{3,1}=10-14-9-4$ $P_{3,2}=10-12-9-4$ $P_{3,3}=10-11-6-5-4$

Table 5.8 : The set of SLDs to be set up

SLD (δ)	s	d	π	α	β	the lightpath used by the SLDs	
						the shortest paths	wavelengths
1	1	6	3	106	407	$P_{1,1} = 1-3-6$ $P_{1,1} = 1-3-6$ $P_{1,1} = 1-3-6$	λ_1 λ_2 λ_3
2	9	5	2	307	807	$P_{2,1} = 9-4-5$ $P_{2,1} = 9-4-5$	λ_1 λ_2
3	10	4	2	605	904	$P_{3,1} = 10-14-9-4$ $P_{3,3} = 10-11-6-5-4$	λ_3 λ_1

Table 5.9 : RWA for the SLDs

5.5.2.2 PHASE2: RWA for random lightpath demands

Once the RWA for SLDs has been established, we deal with RLDs sequentially, that is demand by demand at their arrival dates. When a new RLD τ_i arrives, we look for as many path-free wavelengths as the number of requested lightpaths along the K -alternate shortest paths in R_i^τ . First, one tries to route all the requested lightpaths on the shortest path, if possible (i.e. if there are as many available path-free wavelengths along the shortest path as the requested number of lightpaths), otherwise, several paths in R_i^τ are used. As mentioned before, path-free wavelengths with shorter paths are preferred to those

ALGORITHM *Non atomic (bifurcated) RWA for SLDs*

Input: $\Delta, R_i^\delta, W, n,$

Output: compute a RWA for a maximum number of accepted SLDs
 (* compute an initial vector ρ_0 and compute its cost (number of rejected SLDs). One may for instance choose the first shortest path for all of the SLDs *)

- 1 Generate an initial vector ρ_0
- 2 Copy ρ_0 to $\text{best}\rho$ and append it in the BLACK LIST
- 3 Call the objective function to compute the number of rejected SLDs (bestrejectedSLDs) as well as the number of rejected lightpaths ($\text{bestrejectedSLPs} = \sum_{i \in \text{set of rejected SLDs}} \pi_i$ (see pseudo-code from STEP 5.1 to STEP 5.20 for the details)
- 4 **for** $i := 1$ **to** n **do**
 - 4.1 Generate a random vector ρ . ρ must verify that for each SLD $\sum_{k=1}^K \rho_{i,k} = \pi_i$
 - 5 Verify that the cost of ρ has not already been evaluated. Check if ρ is already in the BLACK LIST. If yes, another random ρ is generated, otherwise put ρ in the BLACK LIST and its cost is evaluated according to the following.
 (* Call the objective function to compute the number of rejected SLDs (rejectedSLDs) as well as the number of rejected lightpaths ($\text{rejectedSLPs} = \sum_{i \in \text{set of rejected SLDs}} \pi_i$. *)
 - 5.1 $\text{rejectedSLDs} := 0, \text{rejectedSLPs} := 0$
 - 5.2 **for** $i := 1$ **to** M **do**
 - 5.3 FLAG:=0, $k := 1$
 - 5.4 **while** ($k \leq K$) and (FLAG = 0;) **do**
 - 5.5 **if** $\rho_{i,k} \neq 0$ **then**
 - 5.6 Compute $\gamma_{i,k}^{\omega,t,\delta}, \forall 1 \leq \omega \leq W$
 - 5.7 **if** $\sigma_{i,k}^{t,\delta} < \rho_{i,k}$ **then** FLAG:=1 **endif**
 - endif**
 - 5.8 $k := k + 1$
 - endwhile**
 - 5.9 **if** FLAG=0 **then**
 (* set up the SLD. *)
 - 5.10 $k := 1, p := 1$
 - 5.11 **while** ($k \leq K$) and ($p \leq \rho_{i,k}$) **do**
 - 5.12 $\omega := 1$
 - 5.13 **while** ($\omega \leq W$) and ($p \leq \pi_i^\delta$) **do**
 - 5.14 **if** $C_{i,k}^{\omega,t} \leq +\infty$ **then** $C_{i,\ell_i}^{\omega,t} := +\infty, p := p + 1$ **endif**
 - 5.15 $\omega := \omega + 1$
 - endwhile**
 - endwhile**
 - 5.16 **else**
 (* The SLD cannot be set up *)
 - 5.16 $\text{rejectedSLDs} := \text{rejectedSLDs} + 1, \text{rejectedSLPs} := \text{rejectedSLPs} + \pi_i^\delta$
 - endif**
 - endfor**
 - 5.17 **if** $\text{rejectedSLDs} < \text{bestrejectedSLDs}$ **then**
 - 5.18 $\text{bestrejectedSLDs} := \text{rejectedSLDs}, \text{bestrejectedSLPs} := \text{rejectedSLPs}$, copy ρ to $\text{best}\rho$
 - elseif** $\text{rejectedSLDs} = \text{bestrejectedSLDs}$ **then**
 - 5.19 **if** $\text{rejectedSLPs} < \text{bestrejectedSLPs}$ **then**
 - 5.20 $\text{bestrejectedSLPs} := \text{rejectedSLPs}$, copy ρ to $\text{best}\rho$
 - endif**
 - endif**
 - endfor**
- end.** *Non atomic (bifurcated) RWA for SLDs*

Table 5.10 : RS algorithm for the (non atomic) RWA of SLDs

with longer ones as they consume fewer WDM channels. Once again, a First-Fit scheme is adopted for wavelength selection. The same algorithm described in Subsection 5.5.1 is used to compute the non atomic RWA for RLDs.

We consider the set of RLDs shown in Table 5.11. We assume that the RWA for SLDs has already been computed according to the RS algorithm. The routes and wavelengths for the requested SLPs, as computed by the RS algorithm, are shown in Table 5.9.

RLD (τ)	s	d	π	α	β	the shortest paths
1	11	1	2	406	807	$P_{1,1} = 11-6-3-1$ $P_{1,2} = 11-10-8-2-1$ $P_{1,3} = 11-6-5-4-1$
2	8	2	2	609	1007	$P_{2,1} = 8-2-1$ $P_{2,1} = 8-2-3-1$ $P_{2,1} = 8-7-5-4-1$

Table 5.11 : The RLDs to be set up

RLD τ_1 arrives at time $t = 406$ requesting 3 lightpaths. We compute $\kappa_{1,1}^{406,\tau}$. $\kappa_{1,1}^{406,\tau} = (0, 1, 1)$ shows that λ_1 is no longer available on $P_{1,1}^\tau$ (λ_1 will be used at time $t = 605$ by SLD δ_3 on $P_{3,3}^\delta$). Only two wavelengths are available. One has then to look for at least one additional available path-free wavelength on $P_{1,2}$ and $P_{1,3}$. We then compute $\kappa_{1,2}^{406,\tau}$. $\kappa_{1,2}^{406,\tau} = (1, 1, 1)$. RLD τ_1 is hence set up using wavelengths λ_2 and λ_3 on $P_{1,1}^\tau$ and wavelength λ_1 on $P_{1,2}$. Then RLD τ_2 is to be considered at time $t = 609$. $\kappa_{2,1}^{609,\tau} = (0, 1, 1)$. λ_1 is still used by RLD τ_1 at the arrival date of τ_2 and hence λ_2 and λ_3 are used on $P_{2,1}^\tau$ by τ_2 .

5.6 Experimental results

In this section we experimentally evaluate the algorithms presented in the previous sections.

We used the network topologies shown in Figure 4.3 and Figure 4.4 with 14 and 29 nodes respectively. The source and destination nodes for both the SLDs and the RLDs are drawn according to a random uniform distribution in the interval $[1, 14]$ for the 14-node network and in $[1, 29]$ for the 29-node network. We also used a uniform random distribution over the intervals $[1, 5]$ for the number of requested lightpaths. The set-up/tear-down dates of the SLDs are also drawn according to a random uniform distribution in the intervals $[1, 1440]$. We assume observation periods of about a day (1440 is the number of minutes in a day). The RLDs arrive according to a Poisson process with an arrival rate $\nu = 5$ and if accepted, will hold the circuit for exponentially distributed times with mean $\mu = 500$ much larger than the cumulated round-trip time and the connection set-up delay.

We call a scenario the set of demands be they scheduled or random that occur from start to finish of a day. We assume that we compute 5 alternate shortest paths ($K = 5$) between each source/destination pair and that there are 64 available wavelengths on each fiber-link in the network ($W = 64$). We want to discuss the advantages and the drawbacks of each of the presented RWA algorithms.

We generated 25 test scenarios, ran the algorithms on them and computed rejection ratio averages for each algorithm. In the following, since the results obtained for the 29-node network are characterized by the same shapes, we only provide the curves obtained in the case of the 14-node network.

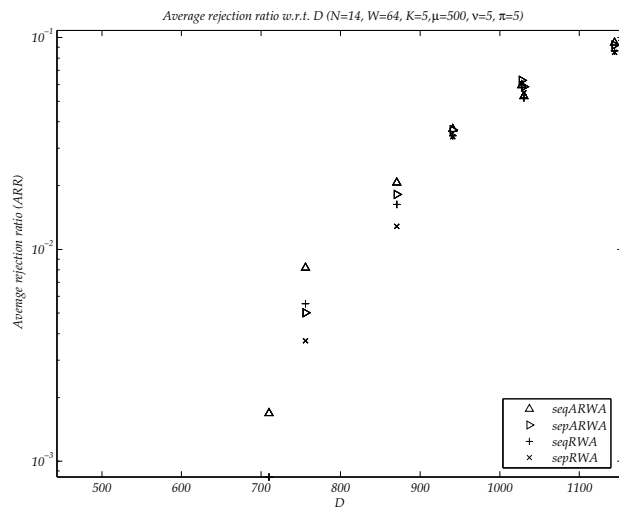

Figure 5.2 : average rejection ratio

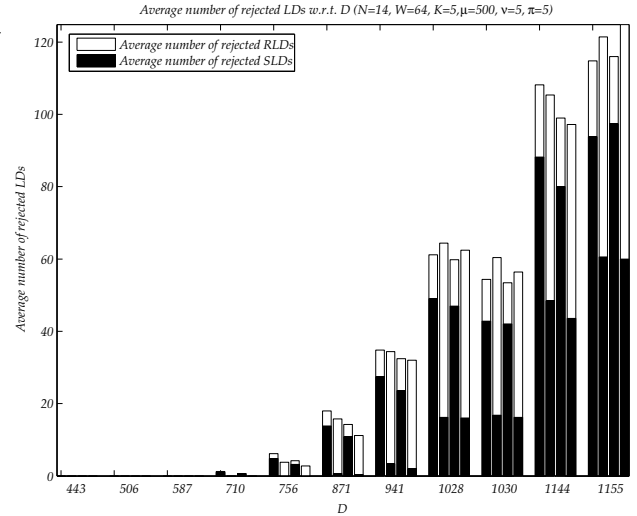

Figure 5.3 : average number of rejected LDs

Figure 5.2 shows the average rejection ratio computed for different values of D , the number of lightpath demands arriving at the network. Figure 5.3 plots the average number of rejected SLDs and RLDs w.r.t. D for each of the proposed RWA algorithms. Each quadruplet of bars shows the average number of blocked LDs computed using the seqARWA (first bar from the left-hand side), the sepARWA algorithm (second bar), the seqRWA algorithm (third bar), and the sepRWA algorithm (fourth bar) respectively. Each bar is divided into two segments. The height of the black segment indicates the average number of rejected SLDs whereas the height of the white one shows the average number of rejected RLDs.

We notice that the rejection ratio increases with D . For small values of D ($D \leq 941$), the sepRWA algorithm computes the smallest rejection ratio. We also notice that non atomic routing improves the network throughput as non atomic RWA algorithms have better rejection ratios than atomic RWA algorithms. When D increases ($D > 941$), the sequential RWA algorithms may have better performance than the separate RWA algorithms. This is mainly due to the fact that SLDs have long life times compared to RLDs and once SLDs are accepted few amount of resources remain to service RLDs.

Separate RWA algorithms reject fewer SLDs than the sequential RWA algorithms as the RWA for SLDs is computed off-line in a separate phase before considering the RLDs. However, the seqARWA algorithm and the seqRWA algorithm reject fewer RLDs than the sepARWA as no distinction is made between SLDs and RLDs when computing the RWA.

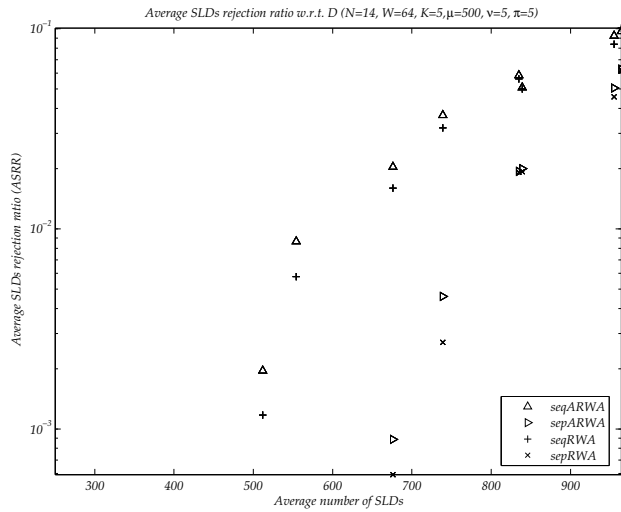

Figure 5.4 : average SLDs' rejection ratio

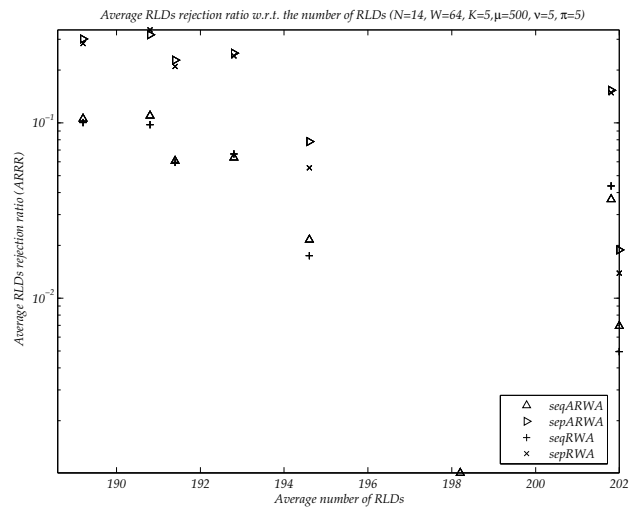

Figure 5.5 : average RLDs' rejection ratio

Figure 5.4 shows the average rejection ratio for SLDs w.r.t. M , the number of SLDs arriving at the network. Figure 5.5 draws the RLDs' rejection ratio w.r.t. the number of RLDs arriving at the network. We notice that the rejection ratio of SLDs increases with M while the rejection ratio of RLDs remains almost the same.

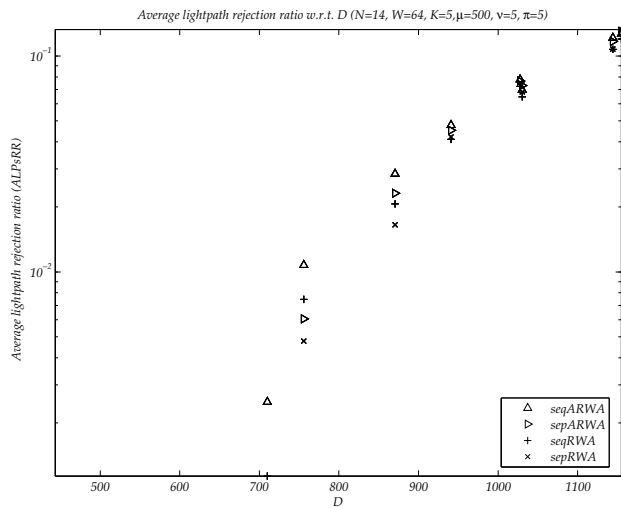

Figure 5.6 : average lightpath rejection ratio

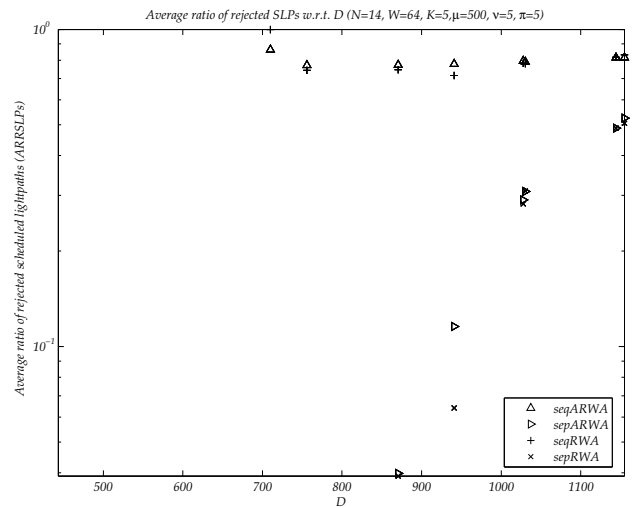

Figure 5.7 : average SLPs' rejection ratio

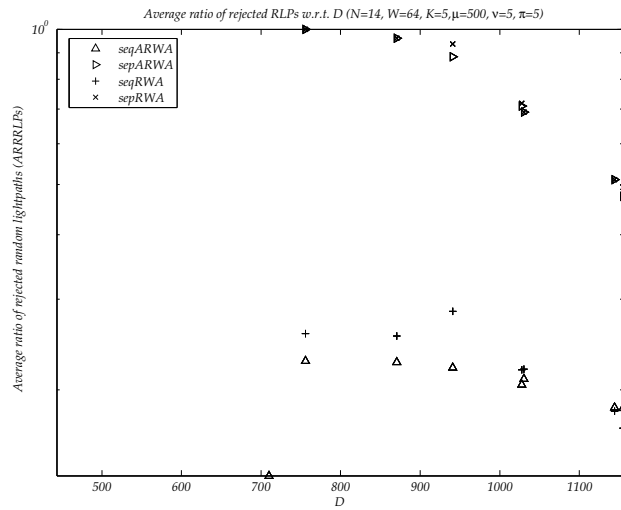

Figure 5.8 : average RLPs' rejection ratio

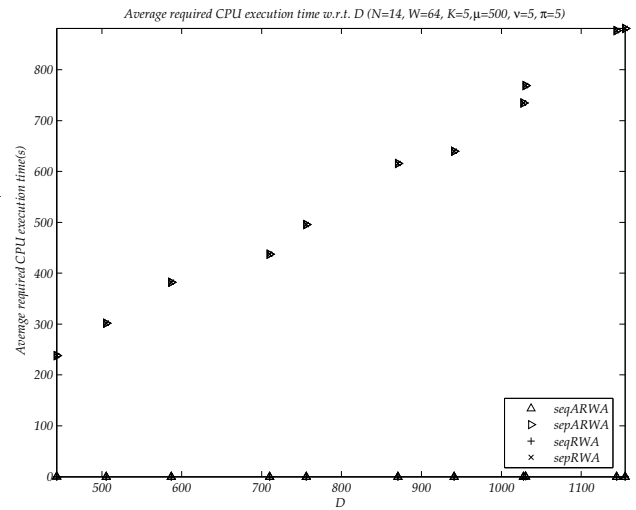

Figure 5.9 : average CPU execution time

Figure 5.6 shows the lightpath rejection ratio w.r.t. D . The sepARWA and the sepRWA algorithms reject fewer lightpaths (LPs) than the sequential routing algorithms for small values of D ($D \leq 941$). The lightpath rejection ratio becomes roughly the same when D increases as there are no longer wavelengths still free to serve arriving LDs. Figures 5.7 and 5.8 show the SLPs' (scheduled lightpaths) and RLPs' (random lightpaths) rejection ratio w.r.t. D respectively. The average number of rejected SLPs computed by the sequential RWA algorithms remain roughly constant whereas the average number of blocked SLPs computed by the sepARWA and the sepRWA algorithms increases with D . This is mainly due to the fact that the seqARWA and the seqRWA algorithms compute indiscriminately the RWA for the SLDs and the RLDs on the fly at the arrival date of each LD whilst the sepARWA and the sepRWA algorithms compute the RWA for the SLDs off-line before they consider the RLDs. The RLPs rejection ratio remain roughly constant for the seqARWA and the seqARWA algorithms. Better performance is observed when bifurcated routing is allowed. The RLPs' rejection ratio computed by the sepARWA and the sepRWA algorithms remain higher than the the RLPs' rejection ratio computed by the seqARWA and the seqARWA algorithms when D increases.

Figure 5.9 plots the average CPU execution time required by each of the proposed RWA algorithms. The sequential RWA algorithms are particularly noted for their small CPU times compared to the separate routing algorithms. This is mainly due to the time required by the Random Search algorithm to compute the RWA for SLDs.

Figure 5.10 shows the average lightpath overall length w.r.t. D . We notice that the average lightpath overall length increases with D . Each quadruplet of bars shows the average lightpath overall length computed using the seqARWA (first bar from the left-hand side), the sepARWA algorithm (second

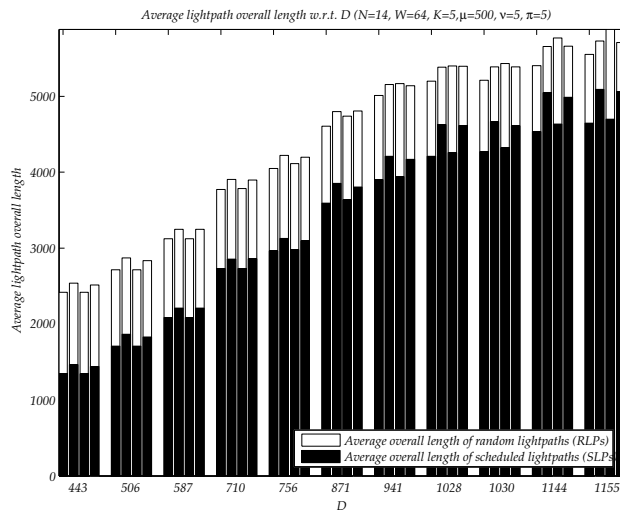

Figure 5.10 : average lightpath overall length

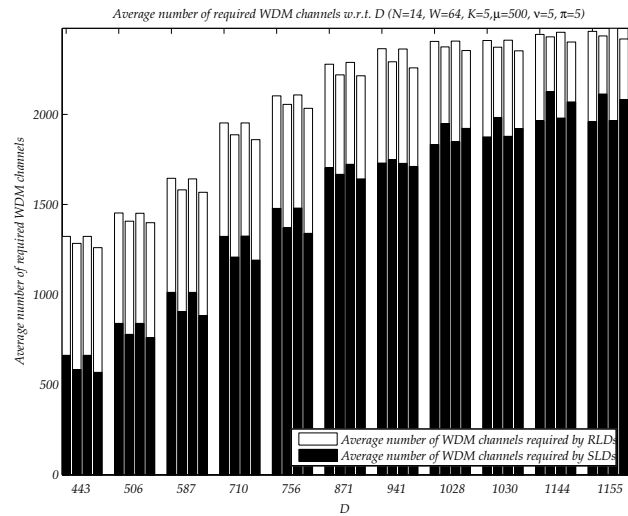

Figure 5.11 : average number of required WDM channels

bar), the seqRWA algorithm (third bar), and the sepRWA algorithm (fourth bar) respectively. Each bar is divided into two segments. The height of the black segment indicates the average overall length of SLPs whereas the height of the white one shows the average overall length of RLPs. We notice that the sepARWA and the sepRWA algorithms compute longer lightpaths than the seqARWA and the seqRWA algorithms. This is due to the fact that the separate RWA algorithms reject fewer LDs than the sequential RWA algorithms. Longer paths are selected in order to set up more LDs when no more free wavelengths are available on shortest paths.

In Figure 5.11, we plot the number of WDM channels required by each of the proposed RWA algorithms w.r.t. D . The number of required WDM channels increases with D and become roughly constant when the network capacity ($42 = 2688$, where 42 is the number of fiber links of the 14-node network and 64 is the number of wavelengths available on each fiber-link) is reached. Once again we notice that more WDM channels are consumed by SLDs. The separate RWA algorithms requires more WDM channels for SLDs than the sequential RWA algorithms.

Figure 5.12 shows the average rejection ratio computed by each of the proposed RWA algorithms w.r.t. W , the number of wavelengths available on each network fiber-link for different values of D . Figure 5.12(a) shows the rejection ratio computed by the seqARWA algorithm and Figure 5.12(b) shows the rejection ratio computed by the sepARWA algorithm. In Figure 5.12(c) we plot the rejection ratio of the seqRWA algorithm and in Figure 5.12(d), the rejection ratio of the sepRWA algorithm has been drawn. We notice that the rejection ratio decreases with W .

In Figure 5.13, we draw the average number of rejected SLDs and RLDs when W increases and in

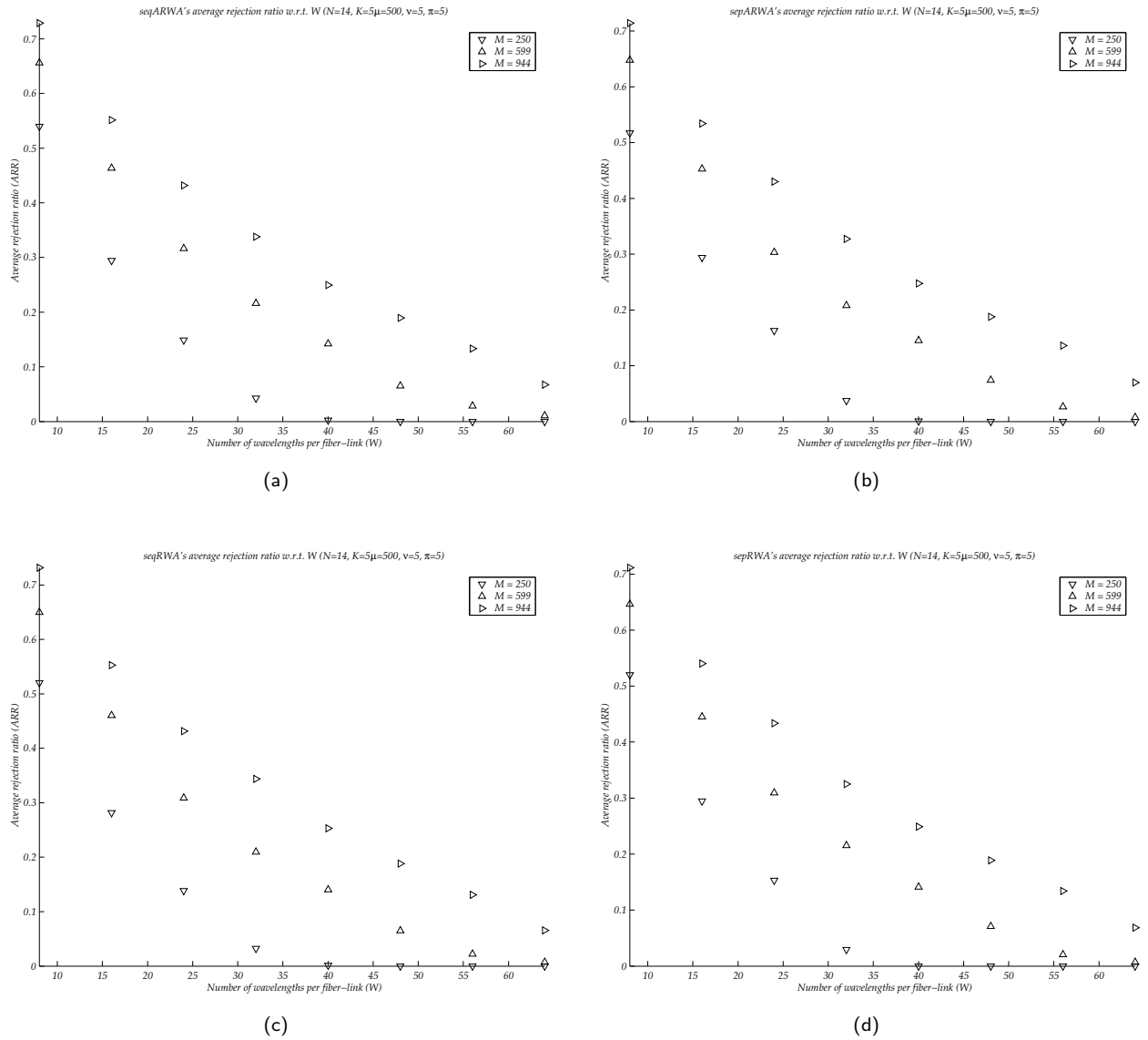

Figure 5.12 : average rejection ratio w.r.t. W

Figure 5.14 we draw the average number of rejected SLPs and RLPs w.r.t. W for each of the proposed RWA algorithms. Once again the number of rejected LDs and LPs fall down when the number of available wavelengths on each fiber-link increases.

Figure 5.15 shows the average rejection ratio for the seqARWA, the sepARWA, the seqRWA, and the sepRWA algorithms respectively w.r.t. D for different values of the RLDs arrival rate ν . The average rejection ratio decreases when the arrival rate for the RLDs increases.

Figure 5.16 and Figure 5.17 show the average number of rejected LDs (respectively LPs) w.r.t. D for two different values of ν ($\nu = 1$ and $\nu = 5$). Each group of 8 bars shows the number of rejected

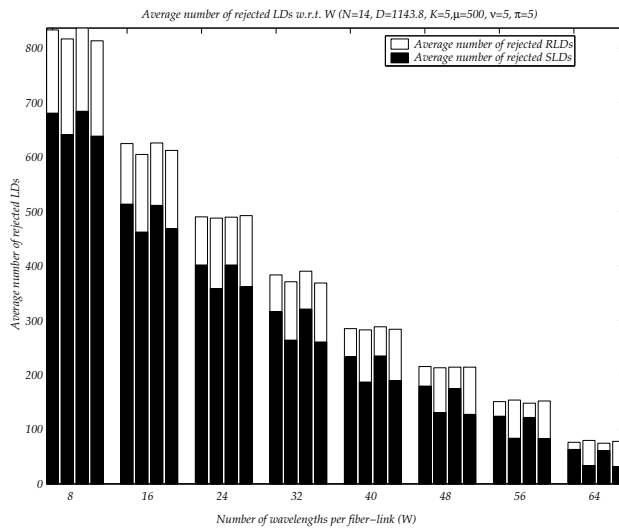

Figure 5.13 : average number of rejected LDs

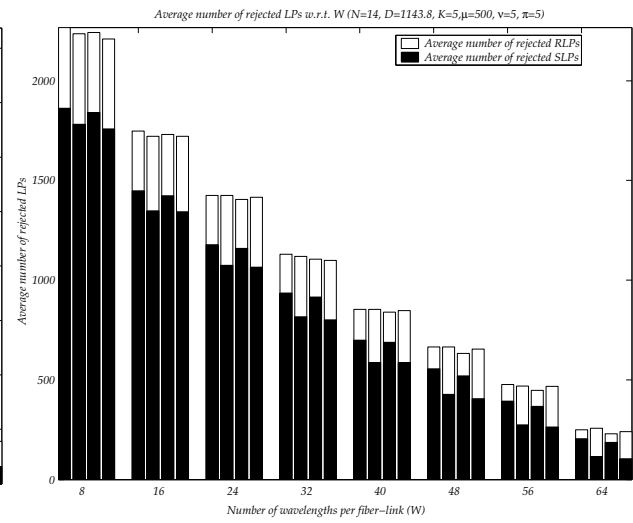
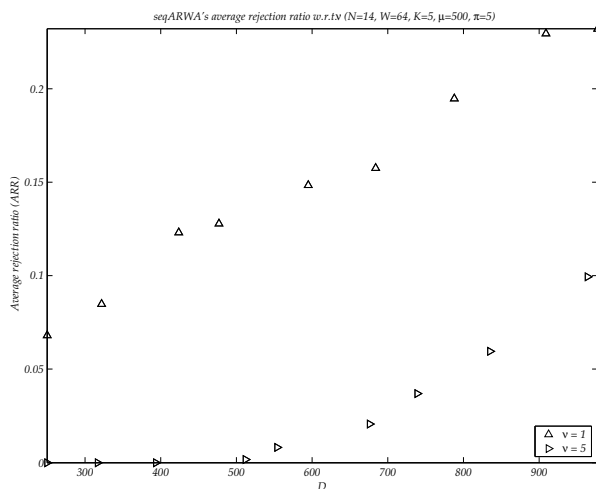
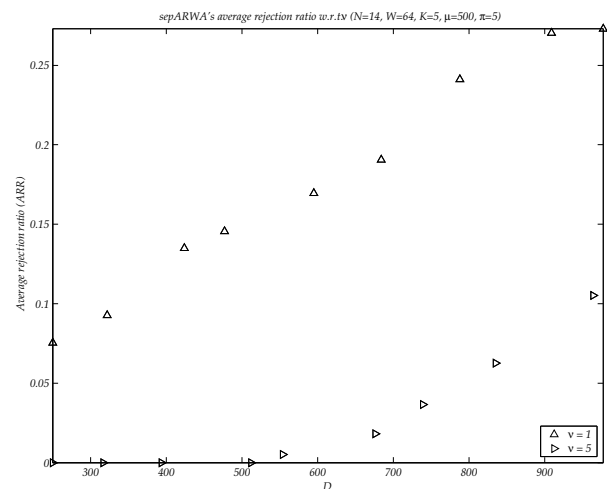

Figure 5.14 : average number of rejected lightpaths



(a)



(b)

LDs (respectively LPs) for a given value of D and ν for each of the proposed RWA algorithms. The first bar from the left-hand side shows the average number of rejected LDs (respectively LPs) for the seqARWA algorithm when $\nu = 5$. The second bar from the left-hand side shows the average number of rejected LDs (respectively LPs) for the seqARWA algorithm when $\nu = 1$. The third bar shows the average number of rejected LDs (respectively LPs) for the sepARWA algorithm when $\nu = 5$. The fourth bar shows the average number of rejected LDs (respectively LPs) for the sepARWA algorithm when $\nu = 1$. The fifth bar shows the average number of rejected LDs (respectively LPs) for the seqRWA algorithm when $\nu = 5$. The sixth bar shows the average number of rejected LDs (respectively LPs) for the seqRWA algorithm when $\nu = 1$. Finally the the seventh bar shows the average number of

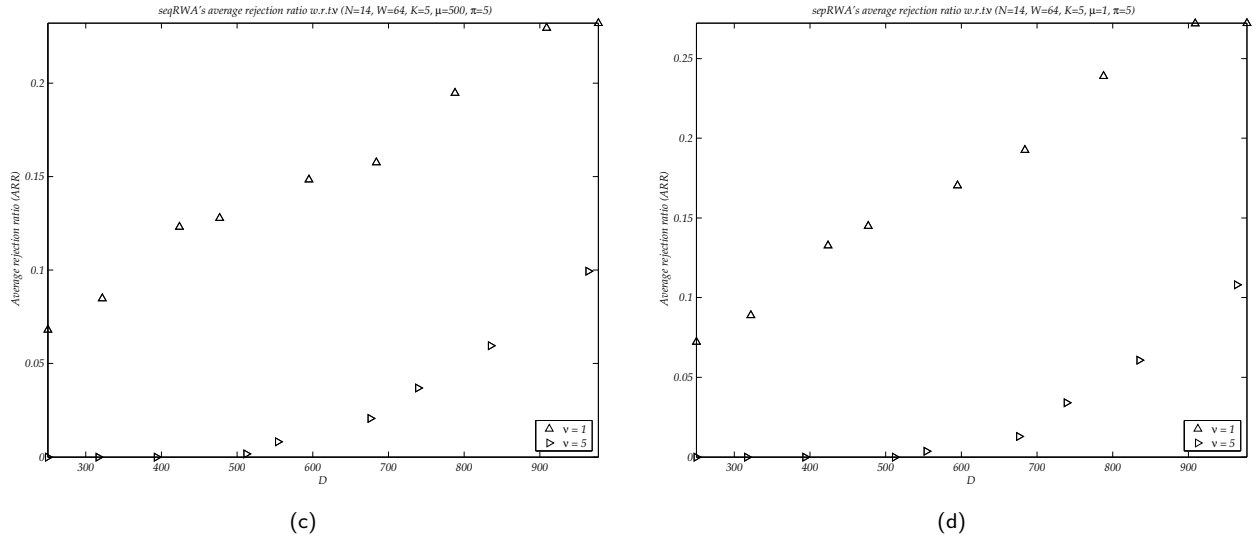

Figure 5.15 : average rejection ratio w.r.t. ν

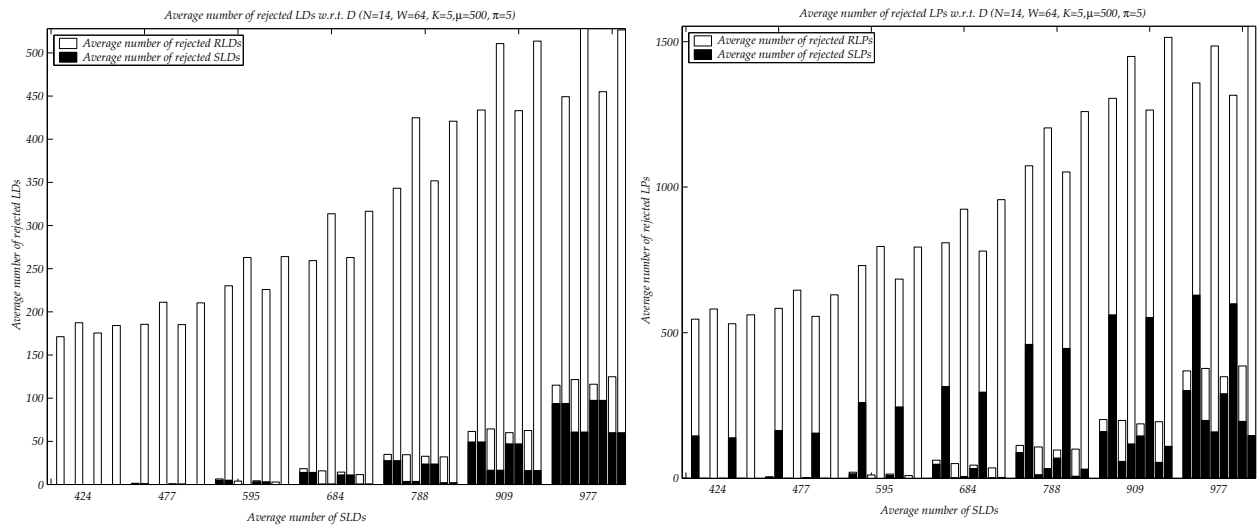

Figure 5.16 : average number of rejected LDs Figure 5.17 : average number of rejected lightpaths

rejected LDs (respectively LPs) for the sepRWA algorithm when $\nu = 5$. The eighth bar shows the average number of rejected LDs (respectively LPs) for the sepRWA algorithm when $\nu = 1$. Each bar is divided into two segments, the height of the black segment shows the average number of rejected SLDs (respectively SLPs) whereas the height of the white segment represents the number of rejected RLDs (respectively RLPs).

We notice that the number of rejected LDs (respectively LPs) increases when the arrival rate of the RLDs decreases.

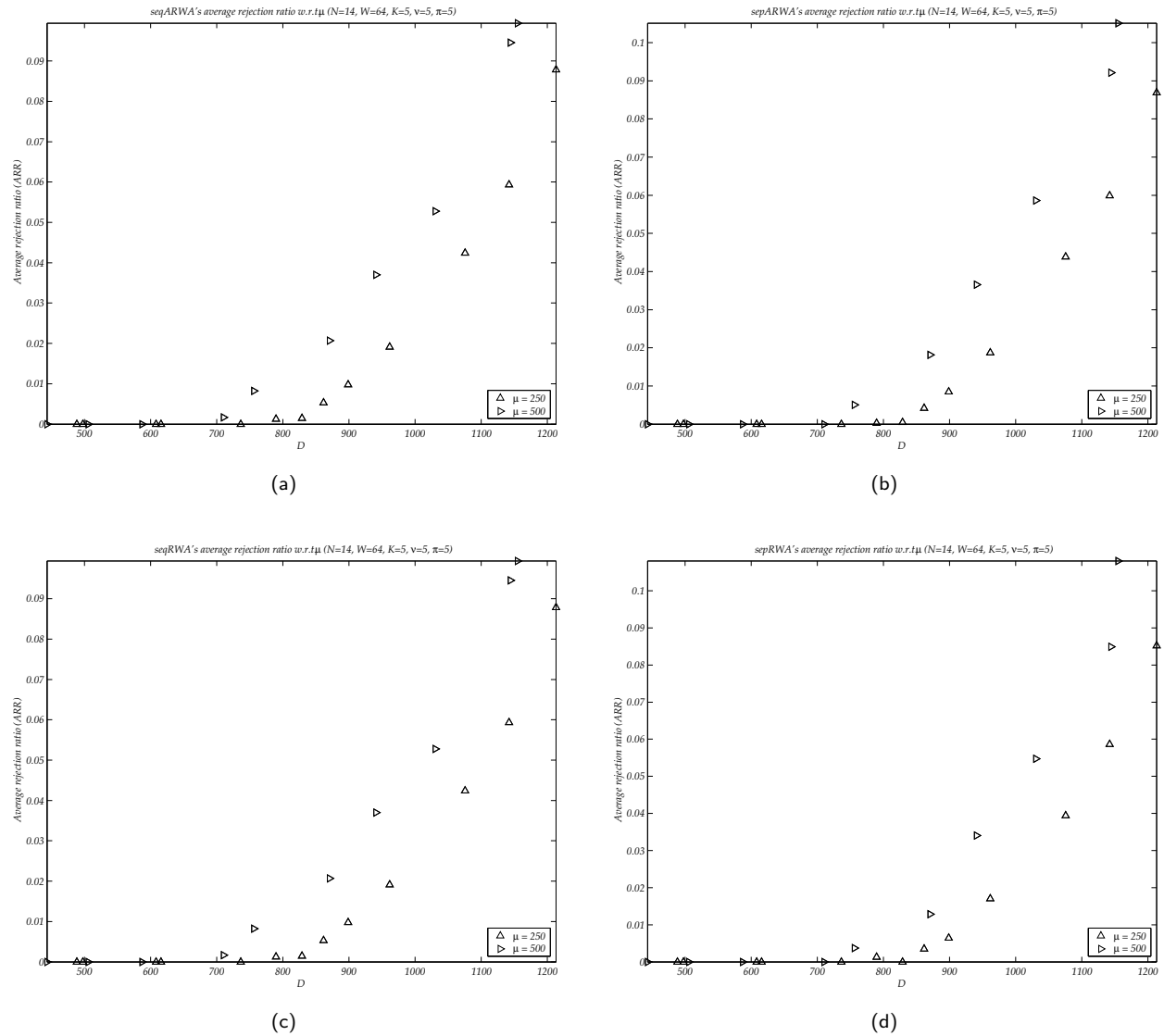

Figure 5.18 : average rejection ratio w.r.t. μ

In Figure 5.18, we draw the average rejection ratio for each RWA algorithm w.r.t. D for two different values of μ , the exponential mean duration of the RLDs. We notice that the rejection ratio increases when μ increases. This is only to be expected as an RLD, once accepted, will hold the assigned path-wavelength pair(s) for longer times. Consequently SLDs (when routed sequentially) and RLDs may be rejected due to a lack of resources.

Chapter 6

Routing and Spare Capacity Assignment for Permanent Lightpath Demands

6.1 Introduction

In this chapter, we propose end-to-end shared path protection methods to survive single span failures in WDM all-optical networks considering PLDs. In path protection, in order to recover from any single span failure, two diverse span-disjoint routes are needed between the source node and the destination node of any PLD. One route is used for the primary path (or simply the primary) elected to be the working path for the PLD under normal working conditions, and the other route for the backup path (also called the protection path or simply the backup) which is activated when a failure related to the physical route of the primary path occurs (see Chapter 3). We here propose *Routing and Spare capacity Assignment (RSCA)* algorithms to survive single span failures instead of single link failures. Indeed, since we assume that a span is bidirectional, when a span failure occurs, we require our algorithms to provide recovery of all disrupted primary lightpaths traversing the failed span in any direction. This is quite different from what has been considered so far in the literature where methods are proposed to deal with disrupted lightpaths traversing the failed single fiber-link.

As network resources dedicated to ensure protection account for a large part of the cost of a network, one has to minimize these resources. We here propose to use shared protection methods (also called backup multiplexing methods) by allowing two or several protection paths to use the same network resources for protection when their respective primary paths may not fail at the same time. We expect, according to the methods proposed below, that extra resources required to ensure protection (required WDM channels and required wavelengths) are minimized.

We consider single fiber all-optical networks without wavelength conversion capabilities at intermediate nodes. First, a linear programming approach has been adopted to address the RSCA problem for PLDs referred to as the *Permanent Routing and Spare Capacity Assignment (PRSCA)* problem. The routing and wavelength assignment subproblems are considered separately due to complexity reasons. We propose MOILP models for the routing subproblem. The main objective is to minimize the impact of a single span failure on the number of disrupted permanent lightpaths. Then an ILP model is described to deal with the wavelength assignment subproblem. The ILP model being intractable for large size RSCA problem instances, we then propose a heuristic approach that makes use of an approximate graph coloring algorithm.

The proposed MOILPs turn out to be difficult ILP models even for small size problem instances, we then propose heuristic methods to find near-optimal solutions. The routing and wavelength assignment subproblems are no longer addressed separately.

We study and compare the proposed approaches through simulation experiments. We show that the heuristic method we propose computes RSCA solutions close to the solutions provided by the optimal methods and scales well when large RSCA problems are considered.

The rest of this chapter is organized as follows. In Section 6.2 we describe the RSCA problem for PLDs and present the methods we propose to tackle the problem. Exact methods based on integer linear programming models are described in Subsection 6.3 and heuristic methods are described in Subsection 6.4. Finally, in Section 6.5, simulation experiments are carried out considering different network topologies and different traffic matrices. Simulation results obtained for both the exact approach (MOILPs) and the approximate approach (heuristic) are compared.

6.2 Description of the problem

The RSCA problem for PLDs in WDM all-optical transport networks can be defined as follows:

For a given:

- physical network topology $G = (V, E)$, where V represents vertices (network nodes) and E represents the links joining these vertices (fiber-links),
- set of PLDs,

determine a feasible RSCA for the PLDs that minimizes the number of required wavelengths. Here we assume no constraints on the number of wavelengths available on each fiber-link in the network and aim at minimizing this number when all the given PLDs are set up.

We propose shared path protection methods to survive single span failures. We aim at minimizing the spare resource required to ensure protection as they account for a large part of the network total cost.

Two approaches are here adopted to deal with the PRSCA problem as illustrated in Figure 6.1. The first approach uses exact methods which, when solved, provide optimal solutions. We here propose, due to complexity reasons, to deal with the routing and wavelength assignment subproblems separately. The routing subproblem aims at computing the routes for the primaries and the backups whereas the wavelength assignment subproblem aims at assigning the wavelengths for these paths while minimizing the number of required wavelengths. Two MOILP models are proposed for path selection. The first model referred to as *Model 1* computes the routes for the primaries and the backups separately whereas the second model also called *Model 2* jointly computes the routes for the primary paths and the backup paths. For wavelength selection, two methods are proposed. The first method uses an Integer Linear programming (ILP) model to assign the wavelengths for a given set of primary and backup paths. The ILP model turn out to be intractable for large size problem instances, a second method, based on a graph coloring heuristic, is proposed.

We hope to solve the exact methods for small size networks (few nodes and few numbers of PLDs). For moderately large RSCA problem instances (tens of nodes and tens of PLDs) the MOILP formulations turn out to have an extremely large number of variables and constraints, and hence become nondeterministic polynomial time hard (intractable). Therefore heuristic algorithms are proposed as an alternative approach to compute approximate solutions for the PRSCA problem.

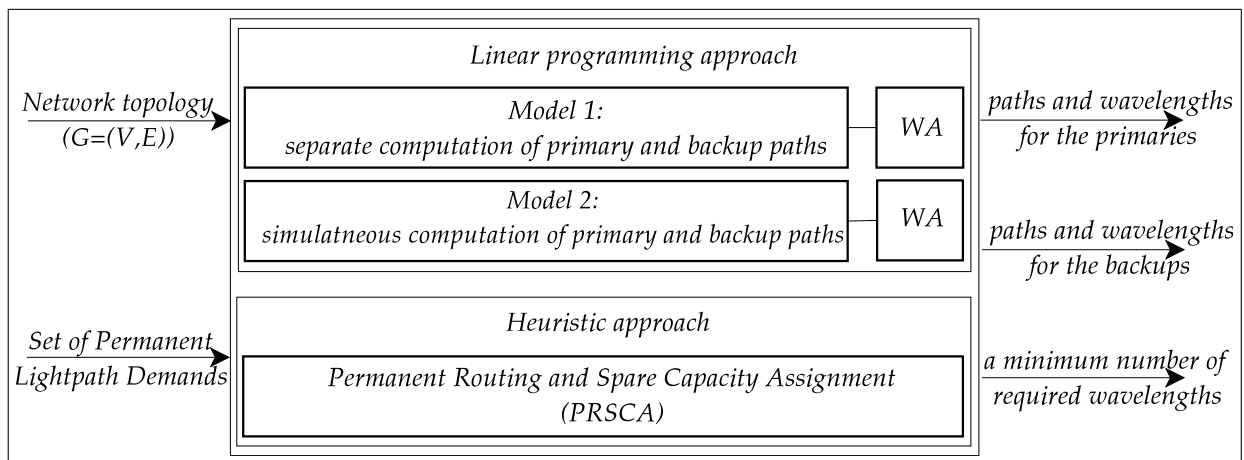

Figure 6.1 : Routing and spare capacity assignment for permanent lightpath demands

6.3 The linear programming approach

The PRSCA problem can be solved either in one phase, where both the routing and wavelength assignment are determined at the same time, or alternatively in two phases, where first the routes are fixed and then a feasible wavelength assignment is determined for the given routing. We here, due to complexity reasons, adopt the decomposition approach proposed in [140] [138] [130] [131] and separately consider the two following subproblems:

- Lightpath Routing (LR): given a set of PLDs, compute working routes and their associated backups.
- Wavelength Assignment (WA): assign a wavelength to each route computed in the preceding step.

6.3.1 Notations

We use the following notations and typographical conventions.

Index conventions

- i, j , and p as subscripts usually denote a *demand index*, a *link index*, and a *route index* respectively.
- ω as superscript usually denotes a *wavelength index*.

The parameters

- $G = (V, E, \xi)$ is an arc-weighted symmetrical directed graph representing the network topology with vertex set V (representing the network nodes), arc set E (representing the network fiber-links) and weight function $\xi : E \rightarrow \mathbb{R}_+$ mapping the physical length of the links (or any other cost of the links set by the network operator).
- $N = |V|$ denotes the number of vertices (network nodes) of the directed graph representing the network topology.
- $L = |E|$ denotes the number of arcs (network links) of the directed graph representing the network topology.
- W denotes the number of available wavelengths (i.e., WDM channels) per fiber-link. We assume that all the network links have the same number of available wavelengths.
- D denotes the number of permanent lightpath demands to be set up. The PLD numbered i , denoted p_i , $1 \leq i \leq D$, corresponds to a connection demand between a node-pair in the telecommunication network.

- PLD numbered i , $1 \leq i \leq D$, (to be set up) is defined by a tri-tuple (s_i, d_i, π_i) . $s_i \in V$, $d_i \in V$ are respectively the source node and destination node of the demand, π_i is the number of requested lightpaths to be established from s_i to d_i . For the sake of simplicity, we assume that for each PLD, only one lightpath is required between the source and the destination nodes of the demand ($\pi_i = 1$). This scheme can be generalized to consider traffic requests with a required number of lightpaths π ($\pi \geq 1$) by considering π simultaneous traffic requests between the same source and the same destination nodes with one required lightpath each.
- R_i denotes the set of available routes connecting the source node and destination node of PLD p_i . For each PLD p_i , $1 \leq i \leq D$, we compute beforehand K -alternate shortest paths connecting the source node to the destination node of the PLD according to the algorithm described in [136] (if as many paths exist, otherwise we consider the available ones).
- $P = \cup_{1 \leq i \leq D} R_i$ is the set of all the available routes considering all the K -alternate shortest paths computed between all the PLDs to be set up.
- P_j is the set of routes in P traversing the (directed) link (arc) $j \in E$.
- C_p denotes the cost of path $p \in P$. C_p is the cumulative weight of all the physical links forming the path p , (for example the total length of the path). Note that in the case when all the links' weights are equal to 1, C_p represents the number of links (spans) (number of hops) that the path traverses from source to destination.
- H is the set of physical route pairs that share at least one common link in the network. H is computed off-line. $H = \{(p, q) \in P \times P : \exists j \in E, p \in P_j \text{ and } q \in P_j\}$.

The variables

The models described in the following sections aim at determining routes for the primary and the backup paths for a given set of PLDs. These routes are defined for Model 1 and Model 2 by the following variables:

- The binary variable ϕ_i^p .
 $\forall 1 \leq i \leq D, \forall p \in P, \phi_i^p = 1$, if the path p is selected to carry any working traffic. $\phi_i^p = 0$, otherwise.
- The binary variable ψ_i^p .
 $\forall 1 \leq i \leq D, \forall p \in P, \psi_i^p = 1$, if the path p is selected to carry a backup traffic. $\psi_i^p = 0$, otherwise.

- The binary variable ℓ_j .

$\forall j \in E, \ell_j = 1$, if at least one protection path p traverses (directed) link j . $\ell_j = 0$, otherwise.

6.3.2 Lightpath routing

6.3.2.1 Model 1: Separate computation of primary and backup routes

The first model called *Model 1* computes separately primary and backup paths in two phases (see Figure 6.2). PHASE 1 computes primary paths with the objective of minimizing primary lightpath congestion, that is the maximum number of primary lightpaths traversing any (directed) fiber-link in the network. Minimizing the number of primary lightpaths traversing a fiber-link in the network should lead to a minimum number of disrupted PLDs when a span fails. Taking the primaries into account, the second phase (PHASE 2) computes backup paths with the objective of maximizing link sharing among backup lightpaths while ensuring that for each PLD, the primary path is less expensive than its corresponding backup path. Maximizing link sharing among backups, should lead to minimal WDM channel requirements since we assign the same resource to protect several backup paths when their associated primary paths are span disjoint (This last assumption ensures that in case of a single failure, there is no traffic interruption).

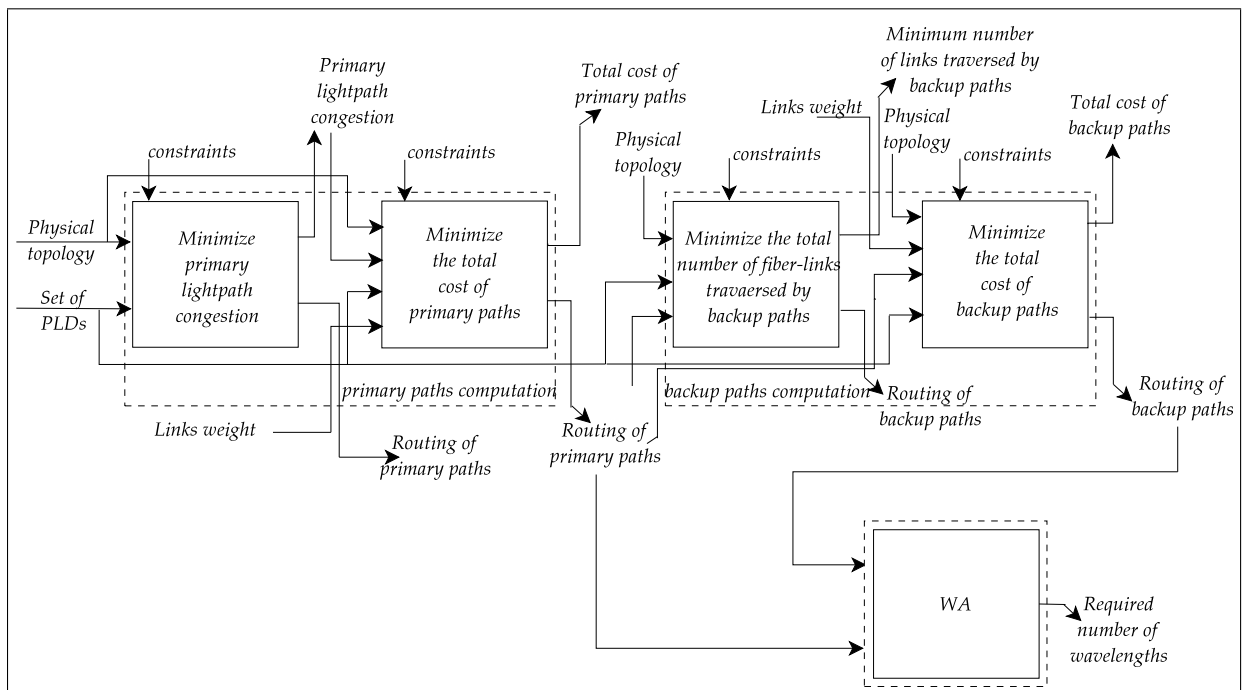

Figure 6.2 : Model 1 schematic representation

6.3.2.1.1 PHASE 1: primary paths computation Choosing the primary routes consists of computing the values for the binary variables ϕ_i^p , in order to minimize the primary lightpath congestion.

Step 1

Given $N, E, D, R_i, \forall 1 \leq i \leq D, P$, and $P_j, \forall j \in E$,

Minimize primary lightpath congestion,

$$\phi \quad (1)$$

Subject to:

- Select exactly one primary path for each p_i ,

$$\sum_{p \in R_i} \phi_i^p = 1, \quad \forall 1 \leq i \leq D \quad (2)$$

- Definition of the lightpath congestion,

$$\sum_{i=1}^D \sum_{p \in R_i \cap P_j} \phi_i^p \leq \phi, \quad \forall j \in E \quad (3)$$

- Domain constraints,

$$\phi_i^p \in \{0, 1\}, \quad \forall 1 \leq i \leq D, \forall p \in P \quad (4)$$

The number of variables computed within *Step 1* grows as $O(D^2K)$ and the number of constraints grows as $O(KD + L)$.

Step 1 aims at maximizing ϕ , the (primary) lightpath congestion in the network. Equations (2) express that exactly one primary path has to be selected for each PLD. Equations (3) define ϕ . Finally, Equations (4) ensure that ϕ_i^p variables are binary.

It may happen that multiple solutions minimize the lightpath congestion for a same problem instance. Thus, once the minimum possible congestion value ϕ_{\max} has been found, one can look within the set of possible solutions for one that optimizes a second criterion. For example, we may prefer a solution that minimizes the total cost of primary paths, while lightpath congestion is maintained equal to ϕ_{\max} . We define the new optimization problem:

Step 2

Given $N, E, D, R_i, \forall 1 \leq i \leq D, P, P_j, \forall j \in E, \phi_{\max},$ and $C_p, \forall p \in P,$

Minimize the total cost of primary paths,

$$\Phi = \sum_{p \in P} C_p \phi_i^p \quad (5)$$

Subject to:

- Select exactly one primary path for each $p_i,$

$$\sum_{p \in R_i} \phi_i^p = 1, \quad \forall 1 \leq i \leq D \quad (6)$$

- Definition of the lightpath congestion,

$$\sum_{i=1}^D \sum_{p \in R_i \cap P_j} \phi_i^p \leq \phi_{\max}, \quad \forall j \in E \quad (7)$$

- Domain constraints,

$$\phi_i^p \in \{0, 1\}, \quad \forall 1 \leq i \leq D, \forall p \in P \quad (8)$$

Note that in the case when all the links' weights are equal to 1, C_p represents the number of physical links (spans) (number of hops) that the path traverses to go from source to destination. In that case, one chooses within the set of solutions the one that minimizes the average hop count.

The number of variables computed within *Step 2* grows as $O(D^2K)$ and the number of constraints grows as $O(KD + L)$.

6.3.2.1.2 PHASE 2: backup paths computation Once the primary paths are determined according to the preceding phase, we must choose a backup path for each requested lightpath. Choosing the backup paths consists of computing values for the binary variables $\psi_i^p,$ in order to minimize the total number of network links traversed by backup paths ($\ell_{\max},$ see below). Minimizing the number of fiber-links traversed by backup paths may hopefully lead to a minimal consumption of WDM channels (and hence wavelengths) when using backup multiplexing. Note that the ϕ_i^p are parameters and no longer variables in the following model.

Step 1

Given $N, E, D, R_i, \forall 1 \leq i \leq D, P, P_j, C_p, \forall p \in P$, and $\phi_i^p, \forall 1 \leq i \leq D, \forall p \in P$,

Minimize the number of links traversed by a small number of protection paths,

$$\ell = \sum_{j \in E} \ell_j \quad (9)$$

Subject to:

- Select exactly one backup path for each p_i ,

$$\sum_{p \in R_i} \psi_i^p = 1, \quad \forall 1 \leq i \leq D \quad (10)$$

- Primary and backup paths must be span disjoint,

$$\phi_i^p + \psi_i^q \leq 1, \quad \forall 1 \leq i \leq D, \forall (p, q) \in R_i \times R_i \cap H \quad (11)$$

- Primaries must be less expensive than their corresponding backups,

$$\sum_{p \in R_i} C_p(\phi_i^p - \psi_i^p) \leq 0, \quad \forall 1 \leq i \leq D \quad (12)$$

- Consistent relationships between ℓ et ψ variables,

$$\psi_i^p \leq \ell_j, \quad \forall p \in P_j \quad (13)$$

$$\ell_j \leq \sum_{p \in P_j} \psi_i^p, \quad (14)$$

- Domain constraints,

$$\psi_i^p \in \{0, 1\}, \quad \forall 1 \leq i \leq D, \forall p \in P \quad (15)$$

$$\ell_j \in \{0, 1\}, \quad \forall j \in E \quad (16)$$

The number of variables computed within *Step 1* grows as $O(D^2K+L)$ and the number of constraints grows as $O(K^3D^2)$.

The objective function (9) aims at minimizing the number of links traversed by backup paths. Equations (10) ensure that a protection path has to be selected for each PLD. Equations (11) ensure

that primary and backup paths have to be span disjoint. Equations (12) stress that for every PLD, the cost of the primary path must be lower than the cost of its associated backup path. Equations (13), and (14) express consistent relationships between ℓ and ψ variables. Finally, Equations (15) and (16) set domain constraints.

Again, it may happen that multiple solutions minimize the number of physical links traversed by backup paths for a same problem instance. Thus, once the minimum possible value ℓ_{\max} has been found, one can look within the set of solutions for one that optimizes a second criterion. For example, we may prefer the solution that minimizes the total cost of backup paths. The new optimization problem states as follows:

Step 2

Given $N, E, D, R_i, \forall 1 \leq i \leq D, P, P_j, \forall j \in E, \phi_i^p, \forall 1 \leq i \leq D, \forall p \in P, \forall p \in P$, and ℓ_{\max} ,

Minimize the total cost of protection paths,

$$\Psi = \sum_{p \in P} C_p \psi_i^p \quad (17)$$

Subject to:

- Select exactly one backup path for each p_i ,

$$\sum_{p \in R_i} \psi_i^p = 1, \quad \forall 1 \leq i \leq D \quad (18)$$

- Primary and backup paths must be span disjoint,

$$\phi_i^p + \psi_i^q \leq 1, \quad \forall 1 \leq i \leq D, \forall (p, q) \in R_i \times R_i \cap H \quad (19)$$

- Primaries must be less expensive than their corresponding backups,

$$\sum_{p \in R_i} C_p (\phi_i^p - \psi_i^p) \leq 0, \quad \forall 1 \leq i \leq D \quad (20)$$

- Consistent relationships between ℓ et ψ variables,

$$\psi_i^p \leq \ell_j, \quad \forall p \in P_j \quad (21)$$

$$\ell_j \leq \sum_{p \in P_j} \psi_i^p, \quad (22)$$

- At most ℓ_{\max} links are to be traversed by backup paths,

$$\sum_{j \in E} \ell_j \leq \ell_{\max}, \quad (23)$$

- Domain constraints,

$$\psi_i^p \in \{0, 1\}, \quad \forall 1 \leq i \leq D, \forall p \in P \quad (24)$$

$$\ell_j \in \{0, 1\}, \quad \forall j \in E \quad (25)$$

The number of variables computed within *Step 2* grows as $O(D^2K+L)$ and the number of constraints grows as $O(K^3D^2)$.

6.3.2.2 Model 2: Simultaneous computation of primary and backup routes

The second model, called *Model 2*, jointly computes primary and backup paths as shown in Figure 6.3. The description is based on the notations given in Section 6.3.1. Model 2 should provide better results in terms of resource consumption compared to the preceding model since it simultaneously computes values for ϕ and ψ variables.

Step 1

Given $N, E, D, R_i, \forall 1 \leq i \leq D, P,$ and $P_j, \forall j \in E,$

Minimize primary lightpath congestion,

$$\phi \quad (26)$$

Subject to:

- Select exactly one primary path for each p_i ,

$$\sum_{p \in R_i} \phi_i^p = 1, \quad \forall 1 \leq i \leq D \quad (27)$$

- Select exactly one backup path for each p_i ,

$$\sum_{p \in R_i} \psi_i^p = 1, \quad \forall 1 \leq i \leq D \quad (28)$$

- Primary and backup paths must be span disjoint,

$$\phi_i^p + \psi_i^q \leq 1, \quad \forall 1 \leq i \leq D, \forall (p, q) \in R_i \times R_i \cap H \quad (29)$$

- Primaries must be less expensive than their corresponding backups,

$$\sum_{p \in R_i} C_p(\phi_i^p - \psi_i^p) \leq 0, \quad \forall 1 \leq i \leq D \quad (30)$$

- Definition of the lightpath congestion,

$$\sum_{i=1}^D \sum_{p \in R_i \cap P_j} \phi_i^p \leq \phi, \quad \forall j \in E \quad (31)$$

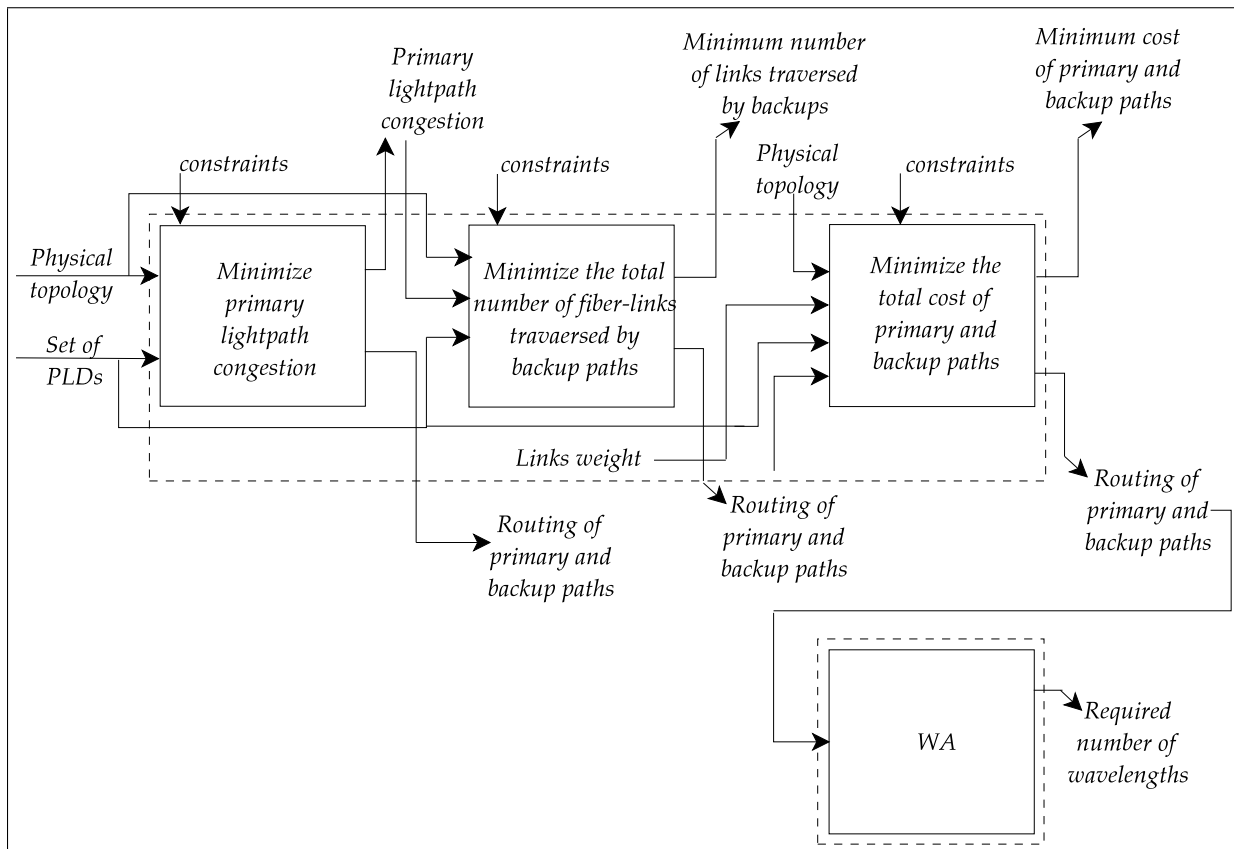

Figure 6.3 : Model 2 schematic representation

- Domain constraints,

$$\phi_i^p \in \{0, 1\}, \quad \forall 1 \leq i \leq D, \forall p \in P \quad (32)$$

$$\psi_i^p \in \{0, 1\}, \quad \forall 1 \leq i \leq D, \forall p \in P \quad (33)$$

The model aims at minimizing primary lightpath congestion ϕ . Constraints (27), (28), and (29) express that exactly one primary path and one protection path have to be selected for each PLD. These paths must be span disjoint. Equations (30) express that the cost of a primary route must be lower than the cost of its associated protection route. This condition prevents the computation of long primary paths, in terms of number of physical links, which account for a large part in the function cost. Equations (31) define ϕ . Finally, Equations (32) and (33) ensure that ϕ_i^p and ψ_i^p variables are binary.

The number of variables computed within *Step 1* grows as $O(D^2K)$ and the number of constraints grows as $O(K^3D^2)$.

Once the minimum value ϕ_{\max} has been found, one can look within the set of possible solutions for one that optimizes a second criterion. For example, we may prefer a solution that minimizes the total number of physical links traversed by backup paths while the primary lightpath congestion is maintained equal to ϕ_{\max} . For that purpose we consider a second optimization problem:

Step 2

Given $N, E, D, R_i, \forall 1 \leq i \leq D, P, P_j, \forall j \in E$, and ϕ_{\max} ,

Minimize the number of links traversed by backup paths,

$$l = \sum_{j \in E} l_j \quad (34)$$

Subject to:

- Select exactly one primary path for each p_i ,

$$\sum_{p \in R_i} \phi_i^p = 1, \quad \forall 1 \leq i \leq D \quad (35)$$

- Select exactly one backup path for each p_i ,

$$\sum_{p \in R_i} \psi_i^p = 1, \quad \forall 1 \leq i \leq D \quad (36)$$

- Primary and backup paths must be span disjoint,

$$\phi_i^p + \psi_i^q \leq 1, \quad \forall 1 \leq i \leq D, \forall (p, q) \in R_i \times R_i \cap H \quad (37)$$

- Primaries must be less expensive than their corresponding backups,

$$\sum_{p \in R_i} C_p (\phi_i^p - \psi_i^p) \leq 0, \quad \forall 1 \leq i \leq D \quad (38)$$

- Definition of the lightpath congestion,

$$\sum_{i=1}^D \sum_{p \in R_i \cap P_j} \phi_i^p \leq \phi_{\max}, \quad \forall j \in E \quad (39)$$

- Consistent relationships between ℓ et ψ variables,

$$\psi_i^p \leq \ell_j, \quad \forall p \in P_j \quad (40)$$

$$\ell_j \leq \sum_{p \in P_j} \psi_i^p, \quad (41)$$

- Domain constraints,

$$\phi_i^p \in \{0, 1\}, \quad \forall 1 \leq i \leq D, \forall p \in P \quad (42)$$

$$\psi_i^p \in \{0, 1\}, \quad \forall 1 \leq i \leq D, \forall p \in P \quad (43)$$

$$\ell_j \in \{0, 1\}, \quad \forall j \in E \quad (44)$$

The number of variables computed within *Step 2* grows as $O(D^2K)$ and the number of constraints grows as $O(K^3D^2)$.

The model aims at minimizing ℓ , the number of physical links traversed by backup paths. Equations (39) ensure that primary lightpath congestion will not exceed ϕ_{\max} . Equations (40) and (41) express consistent relationships between ℓ and ψ variables and Equations (44) set domain constraints for ℓ variables.

Again, it may happen that multiple solutions minimize the number of physical links traversed by backup paths for a same problem instance. Thus, once the minimum possible value ℓ_{\max} has been

found, one can look within the set of solutions for one that optimizes a second criterion. For example, we may prefer the solution that minimizes the total cost of primary and backup paths. The new optimization problem becomes:

Step 3

Given $N, E, D, R_i, \forall 1 \leq i \leq D, P, P_j, \forall j \in E, \phi_{\max}, \ell_{\max},$ and $C_p, \forall p \in P,$

Minimize the total cost of primary and backup paths,

$$\sum_{p \in P} C_p(\phi_i^p + \psi_i^p) \quad (45)$$

Subject to:

- Select exactly one primary path for each $p_i,$

$$\sum_{p \in R_i} \phi_i^p = 1, \quad \forall 1 \leq i \leq D \quad (46)$$

- Select exactly one backup path for each $p_i,$

$$\sum_{p \in R_i} \psi_i^p = 1, \quad \forall 1 \leq i \leq D \quad (47)$$

- Primary and backup paths must be span disjoint,

$$\phi_i^p + \psi_i^q \leq 1, \quad \forall 1 \leq i \leq D, \forall (p, q) \in R_i \times R_i \cap H \quad (48)$$

- Primaries must be less expensive than their corresponding backups,

$$\sum_{p \in R_i} C_p(\phi_i^p - \psi_i^p) \leq 0, \quad \forall 1 \leq i \leq D \quad (49)$$

- Definition of the lightpath congestion,

$$\sum_{i=1}^D \sum_{p \in R_i \cap P_j} \phi_i^p \leq \phi_{\max}, \quad \forall j \in E \quad (50)$$

- Consistent relationships between ℓ et ψ variables,

$$\psi_i^p \leq \ell_j, \quad \forall p \in P_j \quad (51)$$

$$\ell_j \leq \sum_{p \in P_j} \psi_i^p, \quad (52)$$

- At most ℓ_{\max} links are to be traversed by backup paths,

$$\sum_{j \in E} \ell_j \leq \ell_{\max} \quad (53)$$

- Domain constraints,

$$\phi_i^p \in \{0, 1\}, \quad \forall 1 \leq i \leq D, \forall p \in P \quad (54)$$

$$\psi_i^p \in \{0, 1\}, \quad \forall 1 \leq i \leq D, \forall p \in P \quad (55)$$

$$\ell_j \in \{0, 1\}, \quad \forall j \in E \quad (56)$$

The number of variables computed within *Step 3* grows as $O(D^2K+L)$ and the number of constraints grows as $O(K^3D^2)$.

6.3.2.3 Problem size reduction

In order to reduce the number of variables necessary to define the problem, we use the pruning method suggested before by [137] [138]. For each PLD, between end-nodes s and d of G , we first compute a set of K -alternate shortest routes using the algorithm described in [136]. Once these routes have been computed, we select J pairs of span disjoint routes out of them. For the considered (s, d) couples, one primary-backup pair among the J pairs has to be selected. The variables (ϕ and ψ) that do not correspond to the J candidate route pairs are pruned.

6.3.3 Wavelength assignment

In this section we explain the methods we used to assign wavelengths to both primary and backup paths calculated by solving the models described in the preceding sections. The problem is known as the Wavelength Assignment (WA) problem. Two methods are proposed in the following. The first method formulates the WA problem as an ILP model. The ILP model turn out to have extremely high number of variables and constraints, we then propose a second method that makes use of a graph

coloring heuristic. The second method defines a generalization of the *conflict graph* concept in order to deal with both the primaries and the backups and an extension to a standard approximate efficient graph coloring heuristic: the *degree saturation* algorithm (*DSATUR*) [141]. For better resource utilization, we use shared path protection.

6.3.3.1 The linear programming approach

In this section we describe the ILP model used to assign wavelengths for the paths computed by the preceding models. One has to assign a wavelength to each of the computed paths. We need additional parameters and variables to describe the model:

6.3.3.1.1 Notations

We define the following notations:

The parameters

- W denotes the number of available wavelengths on each fiber-link of the network. We assume that there is no capacity limitation on a fiber, W should be as large.
- The binary parameters $\mathcal{T}_{i,i'}$.
 $\mathcal{T}_{i,i'} = 1$, if the primary paths computed for PLD p_i and PLD $p_{i'}$ share at least one common span.
 $\mathcal{T}_{i,i'} = 0$, otherwise.
- The binary parameters $\mathcal{U}_{i,i'}$.
 $\mathcal{U}_{i,i'} = 1$, if the backup paths computed for PLD p_i and PLD $p_{i'}$ share at least one common link.
 $\mathcal{U}_{i,i'} = 0$, otherwise.

The variables

- The binary variables V^ω .
 $V^\omega = 1$ if a primary or a backup lightpath uses wavelength λ_ω on its path from its originating node to its destination node. $V^\omega = 0$, otherwise.
- The binary variables \mathcal{X}_i^ω and \mathcal{S}_i^ω .
 $\mathcal{X}_i^\omega = 1$ (respectively $\mathcal{S}_i^\omega = 1$) if the primary (respectively backup) lightpath connecting the originating node s to the destination node d of PLD p_i uses wavelength λ_ω . $\mathcal{X}_i^\omega = 0$ (respectively $\mathcal{S}_i^\omega = 0$), otherwise.
- The binary variables $\mathcal{F}_{i,j}^\omega$ and $\mathcal{I}_{i,j}^\omega$.
 $\mathcal{F}_{i,j}^\omega = 1$ (respectively $\mathcal{I}_{i,j}^\omega = 1$) if the primary (respectively backup) lightpath connecting the source node to the destination node of PLD p_i uses wavelength λ_ω on (directed) fiber-link j .
 $\mathcal{F}_{i,j}^\omega = 0$ (respectively $\mathcal{I}_{i,j}^\omega = 0$), otherwise.

- The binary variables \mathcal{Y}_j^ω .

$\mathcal{Y}_j^\omega = 1$, if wavelength λ_ω is used on directed fiber-link j . $\mathcal{Y}_j^\omega = 0$, otherwise.

6.3.3.1.2 Mathematical model The WA optimization problem is defined according to:

Given $N, E, D, R_i, P, P_j, \phi_i^p$, and $\psi_i^p, \forall p \in P$,

Minimize the number of required wavelengths,

$$\sum_{\omega=1}^W V^\omega \quad (57)$$

Subject to:

- Consistent relationship between $\mathcal{F}_{i,j}^\omega, \mathcal{X}_i^\omega$, and ϕ_i^p ,

$$\mathcal{F}_{i,j}^\omega = \mathcal{X}_i^\omega \phi_i^p, \quad \forall 1 \leq i \leq D, \forall p \in P, \forall 1 \leq \omega \leq W \quad (58)$$

- Consistent relationship between $\mathcal{I}_{i,j}^\omega, \mathcal{S}_i^\omega$, and ψ_i^p ,

$$\mathcal{I}_{i,j}^\omega = \mathcal{S}_i^\omega \psi_i^p, \quad \forall 1 \leq i \leq D, \forall p \in P, \forall 1 \leq \omega \leq W \quad (59)$$

- One wavelength is to be selected for each primary path and backup path,

$$\sum_{\omega=1}^W \mathcal{X}_i^\omega = 1, \quad \forall 1 \leq i \leq D \quad (60)$$

$$\sum_{\omega=1}^W \mathcal{S}_i^\omega = 1, \quad \forall 1 \leq i \leq D \quad (61)$$

- Consistent relationship between $\mathcal{I}_{i,j}^\omega$ and \mathcal{Y}_j^ω variables,

$$\mathcal{Y}_j^\omega \leq \sum_{i=1}^D \mathcal{I}_{i,j}^\omega, \quad \forall j \in E, \forall 1 \leq \omega \leq W \quad (62)$$

$$\mathcal{I}_{i,j}^\omega \leq \mathcal{Y}_j^\omega, \quad \forall 1 \leq i \leq D, \forall j \in E, \forall 1 \leq \omega \leq W \quad (63)$$

- Wavelength conflict avoidance,

$$\sum_{i=1}^D \mathcal{F}_{i,j}^\omega + \mathcal{Y}_j^\omega \leq 1, \quad \forall j \in E, \forall 1 \leq \omega \leq W \quad (64)$$

- Constraints indicating if wavelength λ_ω is used by any lightpath,

$$V^\omega \leq \sum_{i=1}^D \mathcal{X}_i^\omega, \quad \forall 1 \leq \omega \leq W \quad (65)$$

$$\mathcal{X}_i^\omega \leq V^\omega, \quad \forall 1 \leq i \leq D, \forall 1 \leq \omega \leq W \quad (66)$$

$$V^\omega \leq \sum_{j \in E} \mathcal{Y}_j^\omega, \quad \forall 1 \leq \omega \leq W \quad (67)$$

$$\mathcal{Y}_j^\omega \leq V^\omega, \quad \forall j \in E, \forall 1 \leq \omega \leq W \quad (68)$$

- Two backup paths can not share the same wavelength if their respective primary paths share one or several common spans,

$$\mathcal{I}_{i,i'}^\omega \mathcal{U}_{i,i'} (\mathcal{S}_i^\omega + \mathcal{S}_{i'}^\omega) \leq \mathcal{I}_{i,i'}^\omega \mathcal{U}_{i,i'}, \quad \forall 1 \leq i \neq i' \leq D, \forall 1 \leq \omega \leq W \quad (69)$$

- Domain constraints,

$$V^\omega \in \{0, 1\}, \quad \forall 1 \leq \omega \leq W \quad (70)$$

$$\mathcal{X}_i^\omega \in \{0, 1\}, \quad \forall 1 \leq i \leq D, \forall 1 \leq \omega \leq W \quad (71)$$

$$\mathcal{S}_i^\omega \in \{0, 1\}, \quad \forall 1 \leq i \leq D, \forall 1 \leq \omega \leq W \quad (72)$$

$$\mathcal{F}_{i,j}^\omega \in \{0, 1\}, \quad \forall 1 \leq i \leq D, \forall j \in E, \forall 1 \leq \omega \leq W \quad (73)$$

$$\mathcal{Y}_j^\omega \in \{0, 1\}, \quad \forall j \in E, \forall 1 \leq \omega \leq W \quad (74)$$

The number of variables computed within the WA model grows as $O(2D^2 + 3DWL)$ and the number of constraints grows as $O(2D^2KW + D^2W + 3DWL)$.

The model aims at minimizing the number of wavelengths required for primary and backup paths computed according to the models described above. Equations (58) (respectively Equations (59)) express the relationship between $\mathcal{F}_{i,j}^\omega$, \mathcal{X}_i^ω variables and ϕ_i^p parameters (respectively $\mathcal{I}_{i,j}^\omega$, \mathcal{S}_i^ω variables and ψ_i^p parameters). Constraints (60) and (61) ensure that each lightpath (be it primary or backup) has to use the same wavelength on all the links it traverses. Equations (62) and (63) show the relationship between $\mathcal{I}_{i,j}^\omega$ and \mathcal{Y}_j^ω variables, Equations (64) ensure that a wavelength has to be used once on each fiber-link. The values for V^ω are determined according to Equations (65), (66), (67), and (68). Equations (69) ensure that backups whose corresponding primaries share one or several spans cannot share the same wavelength.

6.3.3.2 The heuristic approach

Due to the model complexity, the standard solvers were unable to solve the WA model described in the preceding section for the size considered in the hereby described examples. To overcome this shortcoming, we use an approximate heuristic based on a graph coloring algorithm called the *DSATUR* algorithm [141]. We have chosen DSATUR for its high performance. DSATUR uses a heuristic to dynamically change the ordering of the nodes and then applies the greedy method to color these nodes:

- A node with highest saturation degree (number of differently colored neighbors) is chosen and given the smallest color that is still available.
- In case of a tie, the node with highest degree (number of neighbors that are still in the uncolored subgraph) is chosen.
- In case of a tie, a random node is chosen.

In order to deal with both primary and backup lightpaths, we define a generalization of the conflict graph [56] and an extension to the DSATUR algorithm.

6.3.3.2.1 The graph coloring problem The *Graph Coloring Problem* (GCP) can be simply stated as the problem of finding an assignment of colors to the vertices of a graph so that two adjacent vertices are assigned different colors. The objective is to minimize the total number of colors used in the assignment. This problem in general is NP complete [142]. Heuristics have been widely used for the GCP. For instance, I quote the algorithms described in [143] [144] [145] [146]. Other simplest methods have been proposed. Among these, the *Greedy method* takes an ordering of nodes of a graph and colors these nodes with the smallest color satisfying that no adjacent nodes are assigned same colors. However the Greedy method performs poorly in practice. DSATUR uses a heuristic which changes the ordering of nodes and then uses the Greedy method to color these nodes.

In the case when only primary paths are considered, the graph coloring problem can be divided into two steps as stated below:

1. Construct a conflict graph: a conflict graph is an auxiliary graph such that each path in the network (computed by the preceding models) is represented by a node in the conflict graph. An undirected edge joins two nodes in the conflict graph if the corresponding paths share at least one common fiber-link.
2. Color the nodes of the conflict graph such that no two adjacent nodes are assigned same colors. The minimum number of colors needed to color a graph is called *the chromatic number* of the graph.

6.3.3.2.2 The heuristic Considering both the primary and backup paths, in a first step we construct the conflict graph without distinguishing the primaries from the backups. The constructed conflict graph is called the Generalized Conflict Graph (GCG). An undirected edge connects two vertices in the GCG if the corresponding paths share a common fiber-link.

Once the GCG is constructed, we remove edges connecting backup paths whose corresponding primaries are span disjoint. This will allow us to allocate the same wavelength to these two backups since their respective primary paths will not fail simultaneously. The vertices of the GCG are then colored using the DSATUR algorithm in such a way that no two adjacent connected vertices are assigned the same color.

6.4 The heuristic approach

Given a set of PLDs and a physical network topology with a limited number of wavelengths per fiber-link, we want to determine a RSCA that minimizes the number of rejected PLDs.

6.4.1 Mathematical formulation

We need the following additional notations:

- $P_{i,k}$, $1 \leq i \leq D$, $1 \leq k \leq K$, represents the k^{th} alternate shortest path in R_i from source node (s_i) to destination node (d_i) of PLD p_i .
- $\Lambda = \{\lambda_1, \lambda_2, \dots, \lambda_W\}$ is the set of the available wavelengths on each fiber-link of the network.
- $c_j^\omega \in \{1, +\infty\}$ is the cost of using wavelength λ_ω on link $j \in E$. $c_j^\omega = 1$ if wavelength λ_ω is free on link j ; $c_j^\omega = +\infty$ if a lightpath (be it a primary or a backup) has already been set up and uses λ_ω on link j .
- $C_{i,k}^\omega = \sum_{j \in P_{i,k}} c_j^\omega$ is the cost of using wavelength λ_ω on $P_{i,k}$, the k^{th} alternate shortest path in R_i connecting the source node to the destination node of PLD p_i . $C_{i,k}^\omega < +\infty$ if λ_ω is a path-free wavelength on $P_{i,k}$; $C_{i,k}^\omega = +\infty$ otherwise.
- $\gamma_{i,k}^\omega = 1$, $1 \leq i \leq D$, $1 \leq k \leq K$, $1 \leq \omega \leq W$, if wavelength λ_ω is a path-free wavelength along the k^{th} alternate path, $P_{i,k}$, connecting the source to the destination node of PLD p_i ($C_{i,k}^\omega < +\infty$). $\gamma_{i,k}^\omega = 0$ otherwise ($C_{i,k}^\omega = +\infty$).
- $\kappa_{i,k} = (\gamma_{i,k}^1, \gamma_{i,k}^2, \dots, \gamma_{i,k}^W)$, $1 \leq i \leq D$, $1 \leq k \leq K$, is a W -dimensional binary vector.
- $\sigma_{i,k} = \sum_{\omega=1}^W \gamma_{i,k}^\omega$, $1 \leq i \leq D$, $1 \leq k \leq K$, is the number of path-free wavelengths along $P_{i,k}$.

- \mathcal{A}_i is the set of accepted and active PLDs at time of computing the RWA for PLD p_i .
- $\mathcal{B}_{i,k}$ is the set of shortest paths in P which have at least one common link with shortest path $P_{i,k}$.
- $\Omega_{i,k}$ is the set of shortest paths in R_i which are span disjoint from the shortest path $P_{i,k}$.
- ρ_D is a D -dimensional vector. ρ_D is a permutation of $\{1, 2, \dots, D\}$. Vector ρ_D is generated randomly. It indicates the ranking according to which the PLDs are to be routed. The PLDs are routed sequentially. (e.g., in the case when $D = 3$, three PLDs, p_1 , p_2 , and p_3 , are to be set up. $\rho_D = (2, 3, 1)$ means that PLD p_2 is routed first, p_3 is routed second and p_1 routed third).
- Π_D is the set of all possible ranking vectors ρ_D . $\Pi_D = S_D$ the symmetric group of degree D (the group of all permutations on $\{1, 2, \dots, D\}$).
- $C : \Pi_D \rightarrow \mathbb{N}$ is the function that counts the number of blocked PLDs for a given ranking vector ρ_D . The combinatorial optimization problem to solve is:

$$\begin{aligned} & \text{Minimize} && C(\rho_D) \\ & \text{subject to:} && \rho_D \in \Pi_D \end{aligned}$$

Once again, we use a Random Search (RS) algorithm to compute the RSCA for PLDs and an approximate minimum of function C .

6.4.2 Description of the RS algorithm

The same RS algorithm described in Section 4.4 is used to compute the RSCA for a given set of PLDs. The PLDs are considered sequentially according to the ranking given by ρ_D . When a PLD is to be set up, three separate stages are activated to select the paths and the wavelengths for the primaries and the backups.

6.4.2.1 STAGE 1: primary lightpath computation

STAGE 1 aims at computing primary lightpaths for the PLDs. Primaries are computed according to the sequential RWA algorithm described in Section 4.4.3. Given a PLD p_i for which we try to compute a primary and a backup lightpath, we consider the associated K -alternate shortest paths computed off-line (beginning with the shortest one) and look for a path with at least one path-free wavelength. If such a path is found, the wavelength is selected according to a First-Fit scheme whenever the number of path-free wavelengths found is higher than 1. The pseudo-code used to compute the RWA for the primaries is shown in Table 6.1.

```

ALGORITHM Primary lightpath selection
Input:  $p_i, R_i, W, \mathcal{A}_i, C_{i,k}^{\omega,i}, \forall i \in \mathcal{A}_i, 1 \leq k \leq K, 1 \leq \omega \leq W$ 
Output: computes a primary path and select a wavelength for a given PLD  $p_i$ 
1 FLAG=0
2  $k = 1$ 
3 while ( $k \leq K$ ) && (FLAG==0) do
3.1  $\omega = 1$ 
3.2 while ( $\omega \leq W$ ) && (FLAG==0) do
3.3 if  $C_{i,k}^{\omega} \leq +\infty$  then
3.4 FLAG=1
endif
3.5  $\omega = \omega + 1$ 
endwhile
3.6  $k = k + 1$ 
endwhile
4 if (FLAG==1) then
(* A path-free wavelength can be found to set up the primary lightpath *)
4.1  $C_{i,k-1}^{\omega-1,i} = +\infty$ 
else
(* PLD  $p_i$  cannot be set up. PLD  $p_i$  is rejected *)
endif
end. Primary lightpath selection

```

Table 6.1 : Pseudo-code for primary lightpath selection

Let us note by $P_{i,p}$, $1 \leq p \leq K$, the path selected for the primary computed by STAGE 1. Among the remaining K -alternate shortest paths for PLD p_i , we select those which are span disjoint with path $P_{i,p}$ given by $\Omega_{i,p}$. Two cases are possible:

- $\Omega_{i,p} = \emptyset$. All the remaining alternate shortest paths share common links with the primary path $P_{i,p}$. PLD p_i is rejected. The primary lightpath is hence released and STAGE 2 and STAGE 3 are skipped.
- $\Omega_{i,p} \neq \emptyset$ and PLD p_i may be serviced if at least one path-free wavelength remains on at least one of the shortest paths in $\Omega_{i,p}$. STAGE 2 is launched.

6.4.2.2 STAGE 2: auxiliary graphs (AG) construction

Once the primary lightpath has been selected, STAGE 2 constructs the so called *Auxiliary Weighted Graphs* in order to select the less costly backup lightpath. W directed auxiliary weighted graphs, G^ω , one per wavelength are constructed. The vertices in G^ω correspond to routing nodes in the network and the arcs correspond to the wavelength channels on the fiber-links of the network. The cost u_j^ω of the arc j on the Auxiliary Graph (AG) G^ω is determined according to the status of the corresponding WDM channel.

- $u_j^\omega = 1$ if wavelength λ_ω is free on link j at time of setting up PLD p_i .

- $u_j^\omega = +\infty$ if fiber-link j is used on wavelength λ_ω by a primary lightpath or by one or several backup lightpaths with which the backup of the current PLD (p_i) cannot be multiplexed (the associated primaries share a common span) at time of setting up the PLD.
- $u_j^\omega = 0$ if link j is used on wavelength λ_ω by one or several backup lightpaths which can be multiplexed with the backup of PLD p_i at time of setting up PLD p_i .

We define $U_{i,k}^\omega = \sum_{j \in P_{i,k}} u_j^\omega$ as the cost of using wavelength λ_ω on $P_{i,k}$, the k^{th} alternate shortest path in R_i connecting the source node to the destination node of PLD p_i . $U_{i,k}^\omega < +\infty$ if wavelength λ_ω is a path-free wavelength on $P_{i,k}$ or λ_ω is used by one or several backup lightpaths which can be multiplexed with $P_{i,k}$; $U_{i,k}^\omega = +\infty$ otherwise.

6.4.2.3 STAGE 3: backup lightpath computation

The best candidate path in $\Omega_{i,p}$ is then selected according to the following algorithm:

- For each ω , $1 \leq \omega \leq W$, compute the cost $U_{i,k}^\omega$ on G^ω for each path in $\Omega_{i,p}$.
- Reject all the paths that do not have path-free wavelengths ($U_{i,k}^\omega = +\infty$, $\forall 1 \leq \omega \leq W$).
- Among the remaining paths, select the one with minimal cost. Note that whenever no paths with a finite cost on at least $\pi_i = 1$ wavelength remain at this stage of the algorithm, PLD p_i is rejected and the associated primary is released.

The number of rejected PLDs is then computed for each ρ_D . The ranking vector which rejects a minimum number of PLDs is retained. The pseudo-code used for the RS algorithm is shown in Table 6.2.

It may happen that several vectors ρ_D reject the same number of PLDs. In that case, one may prefer a solution (among the possible ones) that minimizes the number of required WDM channels.

6.4.3 Illustrative example

We consider the 14-node network topology shown in Table 6.3. We assume that we have to set up the set of 3 PLDs shown in Table 6.3. We compute 3 alternate shortest paths for each PLD ($K = 3$) and we assume that there are 2 available wavelengths per fiber-link ($W = 2$). We want to compute a RSCA that minimizes the number of rejected PLDs.

Let us assume that the PLDs are to be set up according to the ranking given by Table 6.3 ($\rho_D = (1, 2, 3)$). We first consider PLD p_1 before routing PLD p_2 then PLD p_3 .

PLD p_1 is to be set up when all the wavelengths are still available. We first try to compute a primary path using the algorithm described in Subsection 6.4.2.1. $C_{1,1}^1 = 3$ and $C_{1,1}^2 = 3$, $\kappa_{1,1} = (1, 1)$ and

ALGORITHM *Routing and Spare Capacity for Permanent Lightpath Demands***Input:** $D, R_i, \forall 1 \leq i \leq M, W$ **Output:** An RSCA solution for the PRSCA problem

(* Compute a RSCA for a given set of PLDs, a graph G representing the network topology and a fixed number of wavelengths per fiber-link. The aim is to minimize the number of rejected PLDs. A FF scheme is used for wavelength assignment. In case of a tie (several RSCA solutions reject the same number of PLDs), one may prefer one that minimizes the required number of WDM channels. *)

(* Generate an initial ranking vector ρ according to which the PLDs are set up. The number of rejected PLDs is then determined. *)

```

1 Generate a random initial order vector  $\rho$ 
  (* Compute according to the ranking given by  $\rho$  the primary and backup for each PLD  $p_i$ . *)
2 Call the sequential algorithm in Table 6.1 to compute the primary for PLD  $p_i$ . Let  $P_{i,p}$  the path selected for the
  primary computed within STAGE 1 if the primary can be set up
3 if the primary cannot be set up then
3.1 rejectedPLDs:=rejectedPLDs+1
  else
    Compute  $\Omega_{i,p}$ 
3.2 if  $\Omega_{i,p} = \emptyset$  then
3.3 rejectedPLDs:=rejectedPLDs+1
  else
3.4 Construct the AGs for each wavelength  $\lambda_\omega, 1 \leq \omega \leq W$ 
3.5 mincost= $+\infty$ , pathid $x=0$ 
3.6 for each path  $P_{i,k}$  in  $\Omega_{i,p}$  do
3.7   for  $\omega := 1$  to  $W$  do
3.8     compute  $U_{i,k}^\omega$ , the cost of  $P_{i,k}$  on AG  $G^\omega$ 
3.9     if  $U_{i,k}^\omega \leq +\infty$  then minCost= $C_{i,k}^{\omega,i}$ , pathid $x=k$  endif
  endfor
3.10 if minCost= $+\infty$  then
3.11 rejectedPLDs:=rejectedPLDs+1, release the primary
  else
3.12 the backup is to be set up, compute the required number of WDM channels, requiredWDMCHs
  endif
  endif
4 Copy  $\rho$  to best $\rho$ , bestrejectedPLDs:=rejectedPLDs, bestrequiredWDMCHs:=requiredWDMCHs
5 Put  $\rho$  in a BLACK LIST
6 for  $i := 1$  to  $n$  do
6.1 Generate a new random order vector  $\rho$ 
6.2 switch to Step 2 to compute the number of rejected PLDs. The PLDs are set up according to the ranking given
  by  $\rho$ .
6.3 if (rejectedPLDs < bestrejectedPLDs) then
6.4 Copy  $\rho$  to best $\rho$ , update bestrejectedPLDs, bestrejectedPLDs:=rejectedPLDs
  elseif (rejectedPLDs = bestrejectedPLDs) then
6.5 if (requiredWDMCHs < bestrequiredWDMCHs) then
6.6 Copy  $\rho$  to best $\rho$ , update bestrequiredWDMCHs, bestrequiredWDMCHs:=requiredWDMCHs
  endif
  endif
7 Put  $\rho$  in a BLACK LIST
endfor
end. Routing and Spare Capacity for Permanent Lightpath Demands

```

Table 6.2 : Pseudo-code of the Random Search (RS) algorithm

hence λ_1 is selected for the primary lightpath on $P_{1,1}$. The cost, $C_{1,1}^1$, of path $P_{1,1}$ on λ_1 is updated to $+\infty$ as well as the cost of all the paths that share common links with $P_{1,1}$ on wavelength λ_1 (belonging

National Science Foundation Network (NSFNet)		i	s_i	d_i	π_i	the shortest paths
	1	9	2	1	$P_{1,1}=9-4-1-2$ $P_{1,2}=9-12-10-8-2$ $P_{1,3}=9-4-1-3-2$	
	2	13	1	1	$P_{2,1}=13-6-3-1$ $P_{2,2}=13-14-9-4-1$ $P_{2,3}=13-6-5-4-1$	
	3	12	4	1	$P_{3,1}=12-9-4$ $P_{3,2}=12-13-14-9-4$ $P_{3,3}=12-13-6-5-4$	

Table 6.3 : The 14-node NSFNet network topology and the PLDs to be set up

to $\mathcal{B}_{1,1}$) ($C_{1,1}^1 = +\infty$, $C_{1,3}^1 = +\infty$, $C_{2,2}^1 = +\infty$, $C_{2,3}^1 = +\infty$, $C_{3,1}^1 = +\infty$, and $C_{3,2}^1 = +\infty$). We now have to look for a path-free wavelength to set up the backup. The primary path and the backup path must be span disjoint. $\Omega_{1,1} = P_{1,2}$ point out that the only candidate path for the backup is $P_{1,2}$. We then construct the auxiliary graphs (G^ω) from which the cost $U_{1,2}^\omega$ of $P_{1,2}$ on each available wavelength is determined. The wavelengths for which the cost of $P_{1,2}$ is $+\infty$ are discarded (these wavelengths are used either by primary lightpaths or by backup lightpaths which cannot multiplexed with the backup of PLD p_1). As no PLDs are routed yet (backup multiplexing is impossible at this time), all the arcs on the constructed AG G^ω , $1 \leq \omega \leq 2$, have weight equal to $u_j^\omega = 1$ except arcs 9-4, 4-1, and 1-2 which have weight equal to $+\infty$ on G^1 as they belong to the primary path of p_1 . The cost $U_{1,2}^\omega$ of $P_{1,2}$ on each AG G^ω , $1 \leq \omega \leq 2$, is equal to 4. Again λ_1 is selected for the backup on $P_{1,2}$. The cost $C_{1,2}^1$ of using path $P_{1,2}$ on wavelength λ_1 is updated to $+\infty$ as well as the cost of all the paths that have common links with $P_{1,2}$ on wavelength λ_1 ($C_{1,2}^1 = +\infty$). Then PLD p_2 is to be routed. We compute $C_{2,1}^1 = 3$, $C_{2,1}^2 = 3$, and $\kappa_{2,1} = (1, 1)$. Wavelength λ_1 is thus selected for the primary on $P_{2,1}$. $C_{2,1}^1$ is updated to $+\infty$ as well as costs $C_{2,3}^1$ and $C_{3,3}^1$ of paths $P_{2,3}$ and $P_{3,3}$ respectively on wavelength λ_1 . The primary is selected, a backup has to be found. $\Omega_{1,1} = P_{2,2}$. $P_{2,2}$ is the candidate for the backup. We have to compute its cost for each wavelength by constructing the AGs G^ω , $1 \leq \omega \leq W$. Note that the backups of p_1 and p_2 may be multiplexed as their respective primary paths are span disjoint. $P_{2,2}$ and $P_{1,2}$ are link disjoint. The cost of $P_{2,2}$ on G^1 is $U_{2,2}^1 = +\infty$ as the primary path of p_1 share links 9-4 and 4-1 with $P_{2,2}$ on λ_1 . $U_{2,2}^2 = 4$ and hence wavelength λ_2 is selected for the backup on $P_{2,2}$. The cost $C_{2,2}^2$ is updated to $+\infty$. The costs $C_{1,1}^2$, $C_{1,3}^2$, $C_{2,3}^2$, $C_{3,1}^2$, and $C_{3,2}^2$ of respective paths $P_{1,1}$, $P_{1,3}$, $P_{2,3}$, $P_{3,1}$, and $P_{3,2}$ on λ_2 are also updated to $+\infty$ as they belong to $\mathcal{B}_{2,2}$. The last PLD to be set up is p_3 . $C_{3,1}^1 = +\infty$, $C_{3,1}^2 = +\infty$, and $\kappa_{3,1} = (0, 0)$. No path-free wavelengths remain on $P_{3,1}$. We also notice that $C_{3,2}^1 = +\infty$, $C_{3,2}^2 = +\infty$, and $\kappa_{3,2} = (0, 0)$. Path $P_{3,2}$ cannot be selected for the primary. The

next path to be considered is $P_{3,3}$, $C_{3,3}^1 = +\infty$, $C_{3,3}^2 = 4$, and $\kappa_{3,3} = (0, 1)$. Wavelength λ_2 is hence selected to set up the primary lightpath on $P_{3,3}$. The cost $C_{3,3}^2$ of path $P_{3,3}$ on λ_2 is updated to $+\infty$ as well as the cost of the paths in $\mathcal{B}_{3,3}$ on wavelength λ_2 . We then compute $\Omega_{3,3} = \{P_{3,1}\}$ and $P_{3,1}$ may be selected for the backup if a path-free wavelength remains on $P_{3,1}$. We first begin by constructing the AGs G^1 and G^2 . The arcs' weights on each AG are shown in Table 6.4. For the sake of clarity, the arcs with weight equal to 1 (links with free wavelengths) have not been drawn.

G^1			G^2		
arc	weight	comment	arc	weight	comment
9-4	$+\infty$	used by the primary of p_1	13-14	$+\infty$	used by the backup of p_2
4-1	$+\infty$	used by the primary of p_1	14-9	$+\infty$	used by the backup of p_2
1-2	$+\infty$	used by the primary of p_1	9-4	$+\infty$	used by the backup of p_2
9-12	0	used by the backup of p_1	4-1	$+\infty$	used by the backup of p_2
12-10	0	used by the backup of p_1	12-13	$+\infty$	used by the primary of p_3
10-8	0	used by the backup of p_1	13-6	$+\infty$	used by the primary of p_3
8-2	0	used by the backup of p_1	6-5	$+\infty$	used by the primary of p_3
13-6	$+\infty$	used by the primary of p_2	5-4	$+\infty$	used by the primary of p_3
6-3	$+\infty$	used by the primary of p_2			
3-1	$+\infty$	used by the primary of p_2			

Table 6.4 : Weight of the arcs for each AG at the date of computing the backup for PLD p_3

According to Table 6.4, $U_{3,1}^1 = +\infty$ and $U_{3,1}^2 = +\infty$. Link 9-4 is used on λ_1 by the primaries of PLD p_1 and on λ_2 by the backup of PLD p_2 which cannot multiplexed with the backup of PLD p_3 as their respective primary share a common span ($P_{3,3}$ and $P_{2,1}$ share common link 13-6). The backup for PLD p_3 cannot be set up, the primary is released and the PLD is rejected. According to the ranking $\rho_D = (1, 2, 3)$, PLD p_3 is rejected.

Now assume that $\rho_D = (3, 2, 1)$. PLD p_3 is to be set up first, then PLD p_2 is considered and finally PLD p_1 is routed. p_3 is to be serviced first. $C_{3,1}^1 = 2$, $C_{3,1}^2 = 2$, and $\kappa_{3,1} = (1, 1)$. Wavelength λ_1 is hence selected for the primary on $P_{3,1}$. The cost $C_{3,1}^1$ of path $P_{3,1}$ on λ_1 is updated to $+\infty$. $\mathcal{B}_{3,1} = \{P_{1,1}, P_{1,3}, P_{2,2}, P_{3,2}\}$ and $C_{1,1}^1$, $C_{1,3}^1$, $C_{2,2}^1$, and $C_{3,2}^1$ are updated to $+\infty$. The primary being set up, a backup lightpath has to be selected. We compute $\Omega_{3,1} = P_{3,3}$. The weighted auxiliary graphs G^ω , $1 \leq \omega \leq 2$, are constructed and λ_1 is selected again for the backup on $P_{3,3}$. We update the cost $C_{3,3}^1$ of path $P_{3,3}$ on λ_1 as well as the cost $C_{2,3}^1$ of path $P_{2,3}$ on λ_1 to $+\infty$ as they share common links. The next PLD to set up is p_2 . $C_{2,1}^1 = +\infty$ and $C_{2,1}^2 = 3$, $\kappa_{2,1} = (0, 1)$ and λ_2 is selected for the primary on $P_{2,1}$. Cost $C_{2,1}^2$ is updated to $+\infty$ as well as the cost of the paths that share common links with $P_{2,1}$ that belong to $\mathcal{B}_{2,1}$. A backup has now to be found for the PLD. $\Omega_{2,1} = \{P_{2,2}\}$. The cost of $P_{2,2}$ on each AG has to be evaluated. $U_{2,2}^1 = +\infty$ as link 9-4 is used by the primary of PLD p_3 and

$U_{2,2}^2 = 4$ as no backup multiplexing is possible. λ_2 is hence selected for the backup of PLD p_2 on $P_{2,2}$. The cost of using wavelength λ_2 on path $P_{2,2}$, $C_{2,2}^2$ is updated to $+\infty$ as well as the cost of all the paths in $\mathcal{B}_{2,2}$ on λ_2 ($\mathcal{B}_{2,2} = \{P_{1,1}, P_{1,3}, P_{2,3}, P_{3,1}, P_{3,2}\}$). The last PLD to be set up is p_1 . $C_{1,1}^1 = +\infty$, $C_{1,1}^2 = +\infty$, and $\kappa_{1,1} = (0, 0)$. $P_{1,1}$ cannot be selected to set up the primary for p_1 . $C_{1,2}^1 = 4$, $C_{1,2}^2 = 4$, and $\kappa_{1,2} = (1, 1)$. λ_1 is selected for the primary on $P_{1,2}$ and $C_{1,2}^1$ is updated to $+\infty$ as well as the cost of all the shortest paths that share a common link with $P_{1,2}$ (belonging to $\mathcal{B}_{1,2}$). Let us now compute the backup. $\Omega_{1,2} = \{P_{1,1}, P_{1,3}\}$. Two candidate backup paths exist. The less costly path-wavelength pair is selected for the backup. The AGs G^1 and G^2 are constructed. The arcs' weights on each AG are shown in Table 6.5. Again, for the sake of clarity, the arcs with weight equal to 1 (links with free wavelengths) have not been drawn.

G^1			G^2		
arc	weight	comment	arc	weight	comment
12-9	$+\infty$	used by the primary of p_3	13-6	$+\infty$	used by the primary of p_2
9-4	$+\infty$	used by the primary of p_3	6-3	$+\infty$	used by the primary of p_2
12-13	$+\infty$	used by the backup of p_3	3-1	$+\infty$	used by the primary of p_2
13-6	$+\infty$	used by the backup of p_3	13-14	0	used by the backup of p_2
6-5	$+\infty$	used by the backup of p_3	14-9	0	used by the backup of p_2
5-4	$+\infty$	used by the backup of p_3	9-4	0	used by the backup of p_2
9-12	$+\infty$	used by the primary of p_1	4-1	0	used by the backup of p_2
12-10	$+\infty$	used by the primary of p_1			
10-8	$+\infty$	used by the primary of p_1			
8-2	$+\infty$	used by the primary of p_1			

Table 6.5 : Weight of the arcs for each AG at the date of computing the backup for PLD p_1

From Table 6.5 we compute $U_{1,1}^1 = +\infty$, $U_{1,1}^2 = 1$, $U_{1,3}^1 = +\infty$, and $U_{1,3}^2 = 2$. The weights of links 9-4 and 4-1 are equal to 0 as they belong to a the backup path of PLD p_2 which can be multiplexed with the backup of p_1 since the primary paths of p_2 and p_1 are span disjoint. Wavelength λ_2 is selected to service the backup for PLD p_1 on $P_{1,1}$. Note that the weights of links 12-13, 13-6, 6-5, and 5-4 are equal to $+\infty$ even if they belong to a backup path. This is due to the fact that the primary paths of PLD p_3 and p_1 share common span (9, 12) and hence their respective protection paths cannot be multiplexed. The number of rejected PLDs when routed according to the ranking given by $\rho_D = (3, 2, 1)$ is equal to 0.

6.5 Experimental results

In this section we first compare the results obtained by the models presented previously (referred to as Model 1 and Model 2) in order to characterize the trade-off between the gain provided by computing simultaneously primary and backup paths and the computational cost of the models.

We first describe the parameters common to all the experiments. We considered the 14-node network topology shown in Figure 4.3. The source and destination nodes for the PLDs were drawn from uniform distributions in the interval $[1, 14]$. For each source-destination pair, we computed K alternate shortest paths according to the algorithm described in [136] and selected $J = 5$ pairs of span disjoint paths if so many paths exist; otherwise we considered the available ones. There exists at least $J = 1$ pair of span-disjoint paths because the network is 2-connected. The number of variables is reduced according to the pruning procedure explained in Section 6.3.2.3. We compute average values over 25 scenarios for each experiment. We used AMPL 9.010 with CPLEX to solve the MOILP models described above. The CPLEX solver was run on a Sun Sparc machine with 2 GB RAM running Solaris 9 (SunOS 5.9).

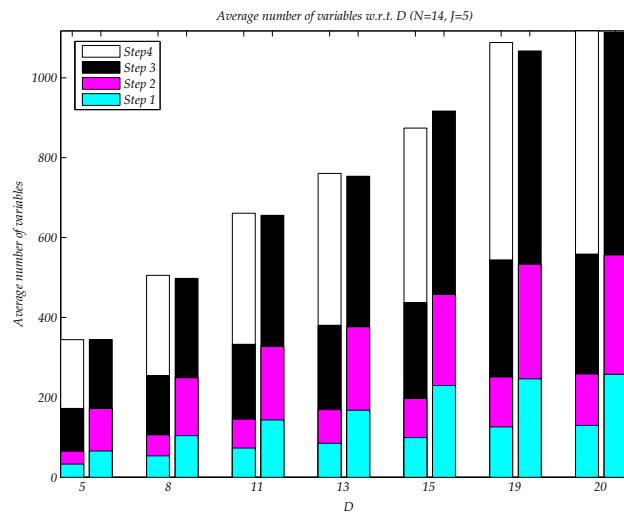

Figure 6.4 : average number of variables

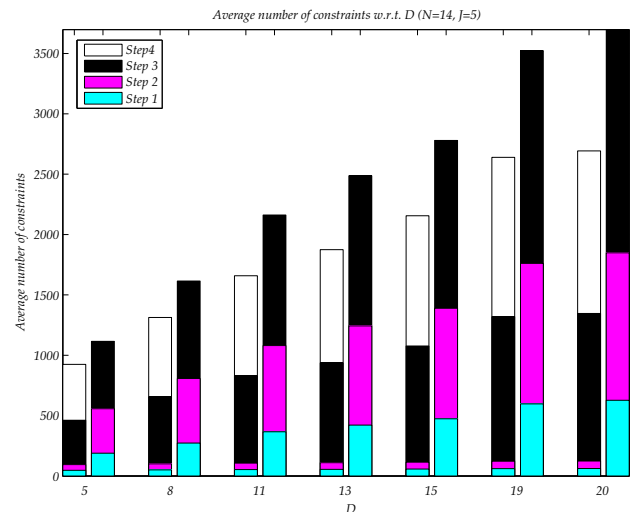

Figure 6.5 : average number of constraints

Figure 6.4 shows the average number of variables required by Model 1 and Model 2. The left bar shows the average number of variables defined by each step of Model 1 and the second bar shows the average number of variables requested by the three steps of Model 2. We notice that both models require almost the same number of variables when considering the sum of the number of variables defined by each step.

In Figure 6.5 we plot the requested number of constraints. The left bar shows the average number of constraints requested by Model 1 and the right bar shows the average number of constraints requested

by Model 2. We observe that the number of constraints defined by Model 1 is much less than those defined by Model 2. Consequently, the solver performs a lot of processing in the case of Model 2 compared to Model 1 and hence, the average run time is much larger in the case of Model 2 (see Figure 6.13).

Let now focus on the number of wavelengths and WDM channels requested by the considered models. We used the ILP model of Section 6.3.3.1 and the heuristic algorithm of Section 6.3.3.2 to compute the minimum number of wavelengths required to set up the primary and backup lightpaths whose paths have been computed by Model 1 and Model 2. The average number of required wavelengths computed by the two methods is almost the same, we choose to present the results obtained with the heuristic algorithm.

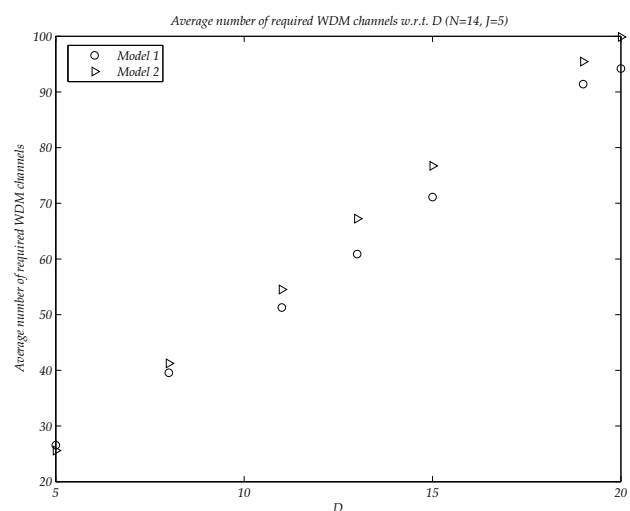
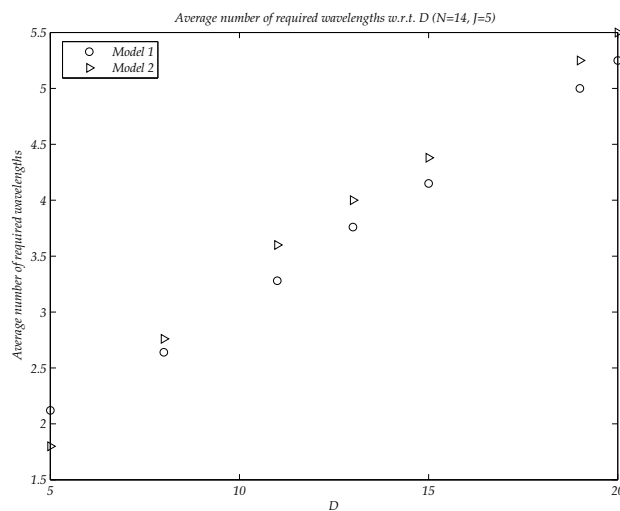

Figure 6.6 : average number of required wave- Figure 6.7 : average number of required WDM lengths channels

Figure 6.6 and Figure 6.7 show the average number of required wavelengths and the average number of required WDM channels respectively. We notice that Model 1 outperforms Model 2 in spite of the fact that Model 1 computes the paths for the primaries and the backups separately. This is much different from what expected. Let us first take a look on primary lightpath congestion and backup lightpath congestion computed by the proposed Models.

Figures 6.8 and 6.9 show the average primary lightpath congestion and the average backup lightpath congestion respectively. We here observe that Model 2 computes better primary lightpath congestions than Model 1. Model 2 also performs better than Model 1 as the backup lightpath congestion computed by Model 2 is higher than the backup lightpath congestion computed by Model 1. This mainly due to the fact that fewer fiber-links are traversed by Model 2 when computing the backup paths. The

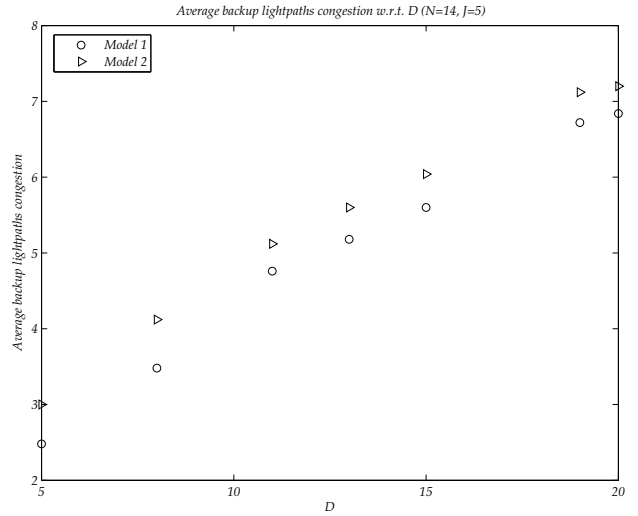
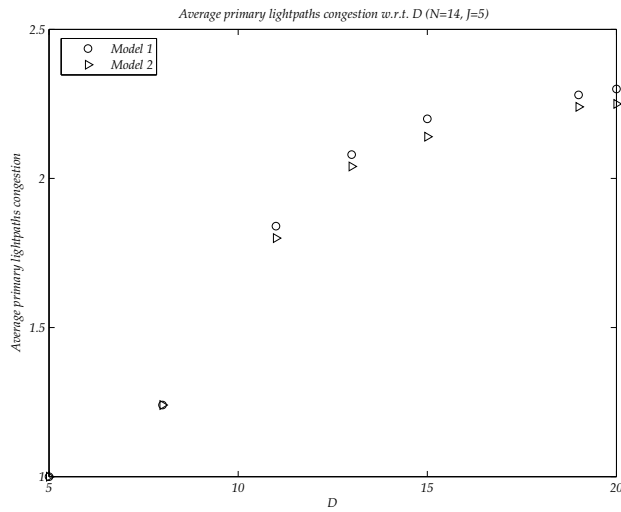

Figure 6.8 : average primary lightpath congestion Figure 6.9 : average backup lightpath congestion

fact that a minimum number of fiber-links are traversed by backup paths may not necessarily lead to a minimal number of required wavelengths as these backup paths cannot share the same wavelengths if their primary paths share common spans.

Model 2, when computing jointly the primary and backup paths, performs better than Model 1 in the sense that Model 2 computes lower primary lightpath congestions and minimizes the number of fiber-links traversed by backup paths. However the number of wavelengths required to set up the primary and backup paths computed upon the paths calculated by Model 1 remains below the number of wavelengths computed upon the paths provided by Model 2.

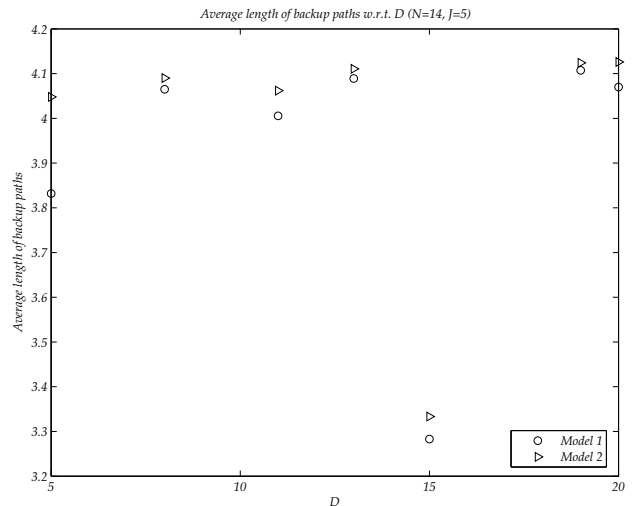
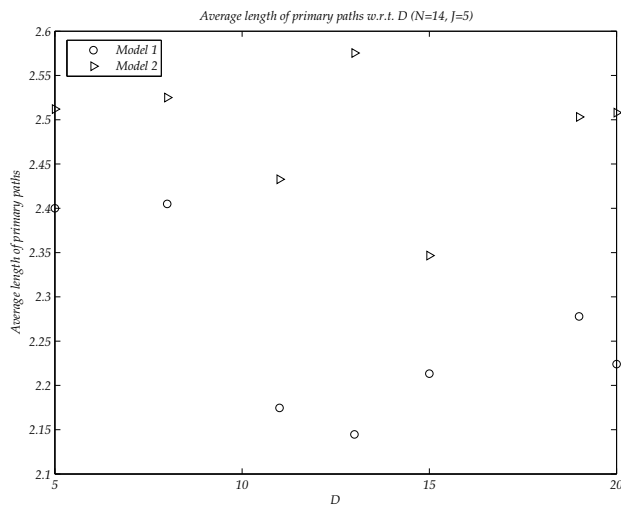

Figure 6.10 : average length of primary paths

Figure 6.11 : average length of backup paths

Figures 6.10 and 6.11 show the average length of the primary and backup paths computed by Model 1 and Model 2 respectively. We observe that the primary and backup paths computed by Model 2 are usually longer than the paths computed by Model 1.

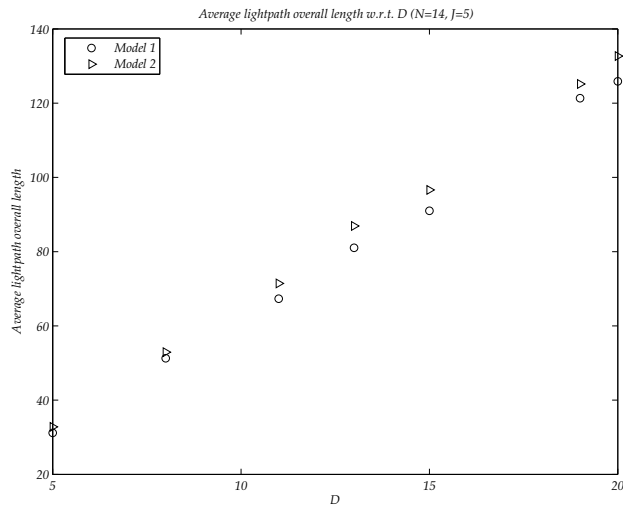

Figure 6.12 : average lightpath overall length

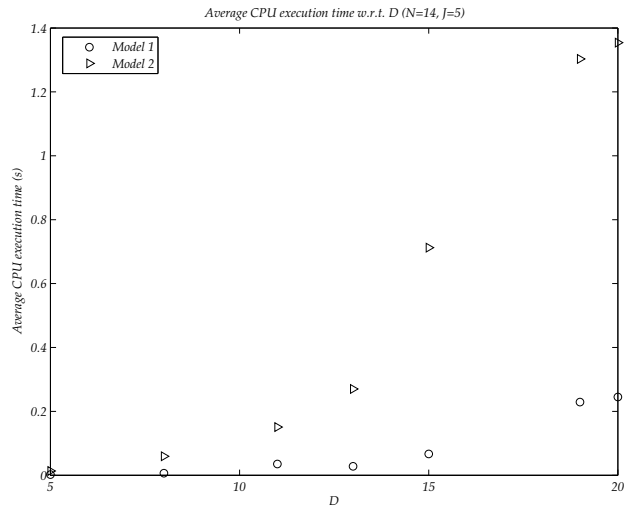

Figure 6.13 : average CPU execution time

In Figure 6.12 we plot the average overall length of the established lightpaths. Once again we notice that Model 2 computes longer lightpaths than the lightpaths set up by Model 1.

Figure 6.13 shows the average CPU execution time required by the proposed models. Model 1 requires less constraints and needs shorter times to compute the primary and backup paths.

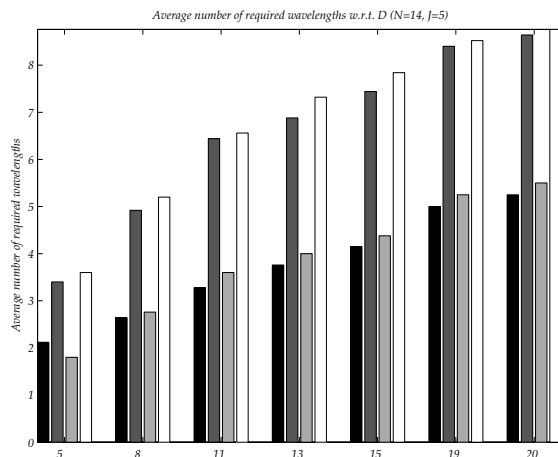

Figure 6.14 : average number of required wave-lengths (dedicated protection)

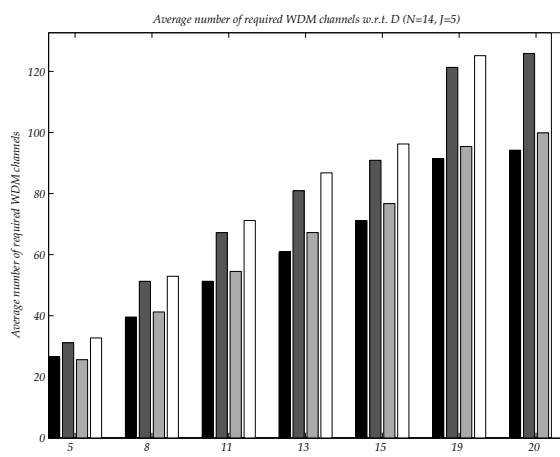

Figure 6.15 : average number of required WDM channels (dedicated protection)

In Figure 6.14 we represented the average number of required wavelengths when dedicated path protection and shared path protection schemes are used. The first two bars show the average number of required wavelengths computed by Model 1 when protection paths are shared (first bar) and dedicated (second bar). The second two bars show the average number of required wavelengths computed by Model 2 when the protection paths are shared and dedicated respectively. Figure 6.15 shows the average number of required WDM channels. We notice that thanks to backup multiplexing, the average number of required wavelengths and WDM channels is decreased. An average gain of 40% is achieved in terms of number of required wavelengths.

To study the performance of the heuristic method described in Section 6.4, we consider the same sets of PLDs and primary and backup paths computed according to Model 1. We then compute the minimum number of required wavelengths according to the wavelength assignment heuristic described in the preceding sections. Once the minimum number of required wavelengths is calculated, we then compute the RSCA for the given PLDs and hence the rejection ratio (number of rejected PLDs) according to our heuristic method. We noticed that the proposed heuristic performs as better as Model 1 as the rejection ratio remains equal to zero.

Chapter 7

Routing and Spare Capacity Assignment for Scheduled and Random Lightpath Demands

7.1 Introduction

In this chapter we consider working and protection paths for scheduled and random lightpath demands in an optical transport network operating under the wavelength continuity constraint. We also assume a limited number of wavelengths per each fiber-link. The objective is to minimize the rejection ratio. To achieve this goal, we use shared path protection techniques to minimize the spare resources required to ensure protection. As mentioned in Chapter 5, we assume that PLDs are routed off-line during a network planning phase. A fixed amount of resources is then computed thanks to an over-dimensioning factor. These resources are to be used to set up SLDs and RLDs. We propose two RSCA strategies to deal with the RSCA for SLDs and RLDs. The first RSCA strategy computes the RSCA for SLDs and RLDs on the fly at their arrival times whereas the second RSCA strategy exploits the *a priori* knowledge of SLDs to compute the RSCA for SLDs before considering RLDs. We present the proposed strategies and study their performance in terms of rejection ratios.

We outline that routing SLDs off-line and RLDs online instead of routing SLDs and RLDs on-line enables lower rejection ratios. We also compare the algorithms in terms of complexity and show that the sequential RSCA algorithm is less CPU time consuming than the the separate RSCA algorithm.

The chapter is organized as follows. In Section 7.2 we describe the RSCA problem for SLDs and RLDs. Subsection 7.3 presents the notations. Subsections 7.4 and 7.5 describe the algorithms we

propose to deal with the RSCA for SLDs and RLDs. Section 7.6 shows the simulation results.

7.2 Description of the problem

The RSCA problem for SLDs and RLDs in all-optical WDM networks is defined as follows: given a network topology with a limited number of wavelengths per fiber-link, define for each LD (be it an SLD or an RLD) a pair of span-disjoint lightpaths to be used as working and protection lightpaths, such that the rejection ratio is minimized. We hope that the rejection ratio is minimized by minimizing the spare resources required to ensure protection. We use shared path protection techniques to allow several LDs sharing the same network resources on their protection paths. Shared protection should lead to minimal WDM channel requirements to ensure the protection of primary lightpaths and hence preserves more network resources to accommodate additional LDs.

As mentioned above, we propose two strategies to compute the RSCA for SLDs and RLDs as shown in Figure 7.1. The first RSCA strategy considers the SLDs and the RLDs sequentially on the fly. Both primary and backup lightpaths are computed at the arrival time of each LD. The second RSCA strategy computes the RSCA for SLDs and RLDs in two separate phases. The first phase computes the RSCA for SLDs and aims at minimizing the number of blocked SLDs. The second phase computes the RSCA for RLDs on the fly and taking into account the RSCA of SLDs which has been already calculated by the first phase. For each strategy, two RSCA algorithms are proposed depending on whether non atomic routing is allowed or not. In the following we only present the atomic RSCA algorithms referred to as the *sequential Atomic RSCA algorithm (sepARSCA)* and the *separate Atomic RSCA algorithm (sepARSCA)* respectively. The non atomic RSCA algorithms can be deduced by dividing a LD (be it an SLD or an RLD) requesting π lightpaths to π simultaneous LDs with one requested lightpath each. Simulation results show the results obtained with both the atomic RSCA and non atomic RSCA algorithms. The benefits of using non atomic routing are demonstrated.

7.3 Notations

We use the following notations and typographical conventions to describe a lightpath demand (LD), be it scheduled or random.

- $G = (V, E, \xi)$ is an arc-weighted symmetrical directed graph representing the network topology with vertex set V , arc set E and weight function $\xi : E \rightarrow \mathbb{R}_+$ mapping the physical length (or any other cost of the links set by the network operator) of each arc of E .

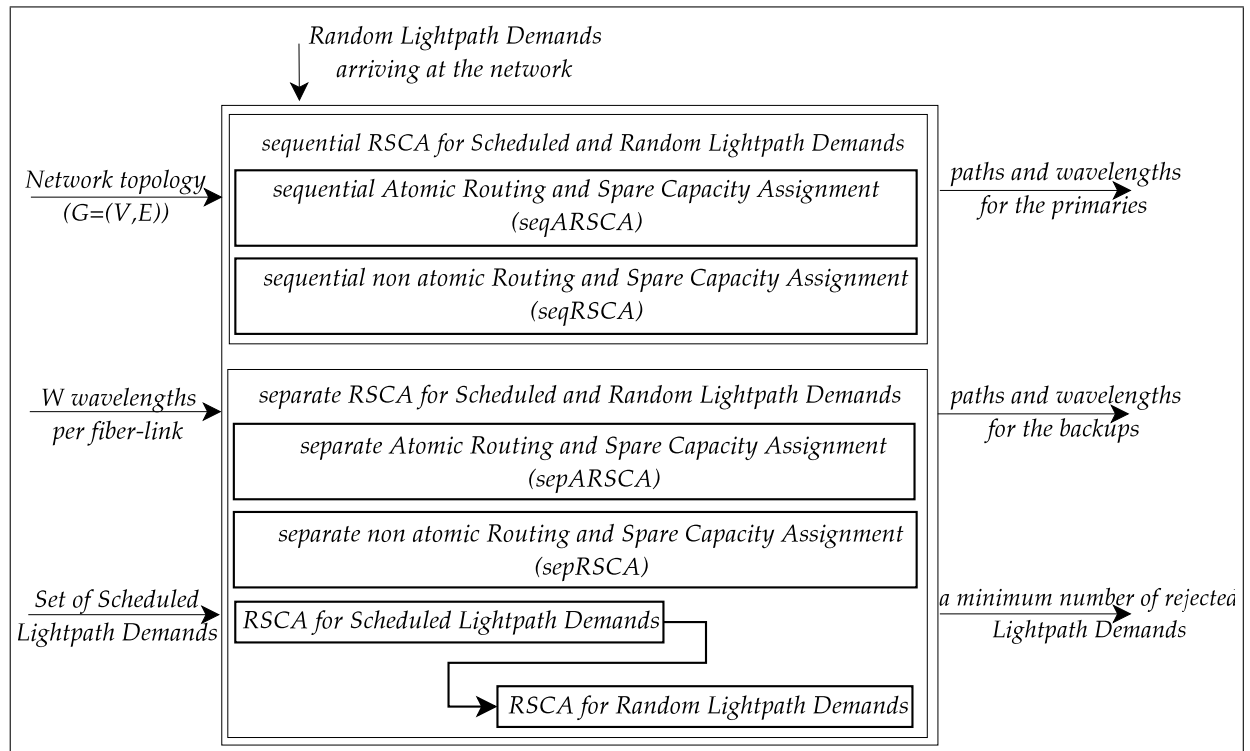

Figure 7.1 : Routing and spare capacity assignment for Scheduled and Random Lightpath Demands

- $N = |V|$ denotes the number of vertices (network nodes) of the directed graph representing the network topology.
- $L = |E|$ denotes the number of arcs (network links) of the directed graph representing the network topology.
- W denotes the number of available wavelengths (i.e., WDM channels) per fiber-link. We assume that all the network links have the same number of available wavelengths,
- $\Lambda = \{\lambda_1, \lambda_2, \dots, \lambda_W\}$ is the set of the available wavelengths on each fiber-link of the network.
- D denotes the total number of SLDs and RLDs to be set up.
- The LD numbered i , $1 \leq i \leq D$, to be established is defined by a 5-tuple $(s_i, d_i, \pi_i, \alpha_i, \beta_i)$ where $s_i \in V$, $d_i \in V$ are the source and the destination nodes of the demand, π_i is the number of requested lightpaths to be set up between s_i and d_i , and α_i and β_i are respectively the set-up and tear-down dates of the demand.
- $P_{i,k}$, $1 \leq i \leq D$, $1 \leq k \leq K$, represents the k^{th} alternate shortest path in G connecting node s_i to node d_i (source and destination of the i^{th} demand). We compute K -alternate shortest paths

for each source-destination pair (LD) according to the algorithm described in [136] (if as many paths exist, otherwise we only consider the available ones).

- R_i is the set of the shortest paths computed for LD number i .
- $P = \cup_{1 \leq i \leq D} R_i$ is the set of all the available paths considering all the K -alternate shortest paths computed between all possible source destination pairs in the network.
- $\mathcal{B}_{i,k}$ is the set of shortest paths in P which have at least one common link with shortest path $P_{i,k}$.
- $c_j^{\omega,t} \in \{1, +\infty\}$ is the cost of using wavelength λ_ω , on link $j \in E$ at time t . $c_j^{\omega,t} = 1$ if wavelength λ_ω is free on link j at time t ; $c_j^{\omega,t} = +\infty$ if there is a lightpath using λ_ω on link j .
- $C_{i,k}^{\omega,t} = \sum_{j \text{ on } P_{i,k}} c_j^{\omega,t}$ is the cost of using wavelength λ_ω on $P_{i,k}$, the k^{th} alternate shortest path in R_i connecting source node s_i to destination node d_i of LD i at time t . $C_{i,k}^{\omega,t}$ denotes the cumulative weight of all the fiber-links along $P_{i,k}$. $C_{i,k}^{\omega,t} < +\infty$ if λ_ω is a path-free wavelength on $P_{i,k}$ at time t ; $C_{i,k}^{\omega,t} = +\infty$ otherwise.

The cost $C_{i,k}^{\omega,t}$ is updated to $+\infty$ after every successful primary or backup lightpath establishment and to a finite cost equal to the number of hops of the path when the lightpath is released. Note that the cost of the paths belonging to $\mathcal{B}_{i,k}$, which share common links with $P_{i,k}$, has also to be updated $+\infty$ when the lightpath is set up and to a finite cost equal to the number of hops of the path when the lightpath is released and these paths or part of these paths are not used by active LDs

- $\gamma_{i,k}^{\omega,t} = 1$ ($C_{i,k}^{\omega,t} < +\infty$), $1 \leq i \leq D$, $1 \leq k \leq K$, $1 \leq \omega \leq W$, if wavelength λ_ω is a path-free wavelength along the k^{th} alternate path $P_{i,k}$, connecting the source node to the destination node of LD i , at time t . $\gamma_{i,k}^{\omega,t} = 0$ ($C_{i,k}^{\omega,t} = +\infty$) otherwise.
- $\kappa_{i,k}^t = (\gamma_{i,k}^{1,t}, \gamma_{i,k}^{2,t}, \dots, \gamma_{i,k}^{W,t})$, $1 \leq i \leq D$, $1 \leq k \leq K$, is a W -dimensional binary vector showing the available path-free wavelengths on $P_{i,k}$ at time t .
- $\sigma_{i,k}^t = \sum_{\omega=1}^W \gamma_{i,k}^{\omega,t}$, $1 \leq i \leq D$, $1 \leq k \leq K$, is the number of path-free wavelengths on $P_{i,k}$ at time t .
- \mathcal{A}^t is the set of accepted and active LDs (SLDs and RLDs) at time t .
- $\Omega_{i,k}$ is the set of shortest paths in R_i which are span disjoint from the shortest path $P_{i,k}$.

δ will denote an SLD whereas τ will denote an RLD. We also use π_i^δ , $P_{i,k}^\delta$, R_i^δ , $\gamma_{i,k}^{\omega,t,\delta}$, $\kappa_{i,k}^{t,\delta}$, and $\sigma_{i,k}^{t,\delta}$ (respectively π_i^τ , $P_{i,k}^\tau$, R_i^τ , $\gamma_{i,k}^{\omega,t,\tau}$, $\kappa_{i,k}^{t,\tau}$, and $\sigma_{i,k}^{t,\tau}$) for the parameters representing an SLD (respectively an RLD) when it is necessary to make a clear distinction between scheduled and random demands.

7.4 Sequential RSCA for scheduled and random lightpath demands

This section describes the *sequential Atomic Routing and Spare Capacity Assignment algorithm (seqARSCA)*. The SLDs and RLDs are routed sequentially at their respective arrival times. The aim of the seqARSCA algorithm is to minimize the number of rejected LDs given a limited number of wavelengths per fiber-link in the network. We use backup multiplexing in order to minimize the network resources required to ensure protection and hence preserve resources to set up additional lightpath demands. When a new LD arrives, three stages are executed to deal with path selection and wavelength assignment. STAGE 1 aims at selecting a path for the primaries with as many path-free wavelengths as the number of requested lightpaths. STAGE 2 and STAGE 3 are executed only if STAGE 1 succeeds in setting up the primaries and if there is at least one shortest path in the set of K-alternate shortest paths computed for the LD, which is span disjoint from the path used by the primaries. STAGE 2 constructs the so called *Weighted Auxiliary Graphs (WAGs)* (or simply AGs) used by STAGE 3 to select if possible the backup path for the backups.

7.4.1 STAGE 1: primary lightpath computation

We use the same sequential atomic RWA algorithm described in Chapter 5 (see Section 5.4.1) to select the primary path and the wavelengths for the primaries: Considering in turn the K-alternate shortest paths (computed off-line between each possible source destination pair in the network), we try to find a path which has as many available path-free wavelengths as the number of lightpaths required by the LD. If such a path is found, the wavelengths are selected according to a First-Fit scheme. The pseudo-code used to compute the primaries is shown in Table 5.1.

Let us note by $P_{i,p}$, $1 \leq i \leq D$, $1 \leq p \leq K$, the path selected for the primaries if such a path exist. Among the remaining K-alternate shortest paths for the LD, we select those which are span disjoint with path $P_{i,p}$ given by $\Omega_{i,p}$. Two cases are possible:

- $\Omega_{i,p} = \emptyset$. All the remaining alternate shortest paths share common links with the primary path $P_{i,p}$. The LD is hence rejected. The primary lightpaths are hence released and STAGE 2 and STAGE 3 are skipped.
- $\Omega_{i,p} \neq \emptyset$ and the LD may be serviced if as many path-free wavelengths remain on at least one of the shortest paths in $\Omega_{i,p}$ as the number of requested lightpaths by the LD. STAGE 2 is launched and the less costly backup lightpaths are selected according to the following:

7.4.2 STAGE 2: auxiliary graphs construction

We consider the following W directed auxiliary weighted graphs, G^ω , one per wavelength. The vertices in G^ω correspond to the routing nodes in the network and the arcs correspond to the wavelength channels on the fiber-links of the network. The cost $u_j^{\omega,t}$ of arc j on the AG G^ω is determined according to the status of the corresponding WDM channel.

- $u_j^{\omega,t} = 1$ if wavelength λ_ω is free on link j at time t .
- $u_j^{\omega,t} = +\infty$ if wavelength λ_ω is used on link j at time t by a primary lightpath or by one or several backup lightpaths which cannot be multiplexed with the backup lightpath of the LD under consideration (the associated primaries share a common span) on wavelength λ_ω at the arrival time t of the LD.
- $u_j^{\omega,t} = 0$ if wavelength λ_ω is used on link j at time t by one or several backups which can be multiplexed with the backup of the current LD.

7.4.3 STAGE 3: backup lightpath computation

Among the remaining K -alternate shortest paths in $\Omega_{i,p}$, we select the best candidate path according to the following algorithm:

- For each ω , $1 \leq \omega \leq W$, compute the cost of each path in $\Omega_{i,p}$ on G^ω .
- Reject all the paths that do not have as many path-free wavelengths as the required number of lightpaths.
- Among the remaining paths, select the one with minimal cost. Note that whenever no paths with a finite cost on at least π_i wavelengths remain at this stage of the algorithm, the LD is rejected and the associated primaries are released.

7.4.4 Illustrative example

For illustration purposes, we consider the 14-node network topology shown in Table 7.1. We want to compute according to the seqARSCA the RSCA for the SLDs and RLDs shown in Tables 7.1 and 7.2 respectively. We assume that there are 3 wavelengths per fiber-link ($W = 3$) and that we computed 3 alternate shortest paths for each LD ($K = 3$).

It must be noted that after every successful lightpath establishment or release, the cost, $C_{i,k}^{\omega,t}$, of using wavelength λ_ω on path $P_{i,k}$ must be updated. We also have to update the cost of all the paths belonging to $\mathcal{B}_{i,k}$ which share at least one common link with path $P_{i,k}$. This allows keeping up to date

the status of each wavelength available in the network on each shortest path in P . The cost $C_{i,k}^{\omega,t}$ is updated to $+\infty$ when a lightpath is established upon $P_{i,k}$ using wavelength λ_ω and updated to a finite value (count hop of the path) when the lightpath is released. Note that when a lightpath is released the cost of the paths sharing at least a common link with the path of the released lightpath are updated to their hop counts only if none of the links used by these paths are still used by active lightpaths.

National Science Foundation Network (NSFNet)	SLD	s	d	π	α	β	the shortest paths
	1	2	9	2	106	407	$P_{1,1}=2-1-4-9$ $P_{1,2}=2-8-10-14-9$ $P_{1,3}=2-3-1-4-9$
	2	5	9	1	205	807	$P_{2,1}=5-4-9$ $P_{2,2}=5-6-13-14-9$ $P_{2,3}=5-6-13-12-9$
	3	13	3	2	307	605	$P_{3,1}=13-6-3$ $P_{3,2}=13-6-5-4-1-3$ $P_{3,3}=13-14-9-4-1-3$

Table 7.1 : The set of SLDs to be set up

RLD	s	d	π	α	β	the shortest paths
1	11	1	2	406	908	$P_{1,1} = 11-6-3-1$ $P_{1,2} = 11-10-8-2-1$ $P_{1,3} = 11-6-5-4-1$
2	8	2	3	409	1007	$P_{2,1} = 14-13-6-3$ $P_{2,2} = 14-9-4-1-3$ $P_{2,3} = 14-10-8-2-3$

Table 7.2 : The RLDs to be set up

SLD δ_1 arrives at time $t = 106$. SLD δ_1 requires 2 lightpaths. All the wavelengths are still available. We first have to select a primary path. We compute $\kappa_{1,1}^{106,\delta} = (1, 1, 1)$. SLD δ_1 is thus set up on $P_{1,1}^\delta$ using wavelengths λ_1 and λ_2 . The primaries have been set up for SLD δ_1 , we then look for the candidate backup paths among the remaining available shortest paths in R_1^δ . Only one candidate path exists as $\Omega_{1,1} = \{P_{1,2}^\delta\}$. The next step consists in computing the 3 weighted auxiliary graphs (AGs) G^ω , $1 \leq \omega \leq 3$, required to evaluate the cost of path $P_{1,2}^\delta$ on each wavelength in order to select the less costly wavelengths. Table 7.3 shows the weight of the arcs corresponding to busy links on each AG when the primaries of SLD δ_1 are set up. $U_{1,2}^{1,106} = 4$, $U_{1,2}^{2,106} = 4$, and $U_{1,2}^{3,106} = 4$. Wavelengths λ_1 and λ_2 are hence selected for the backups on $P_{1,2}^\delta$.

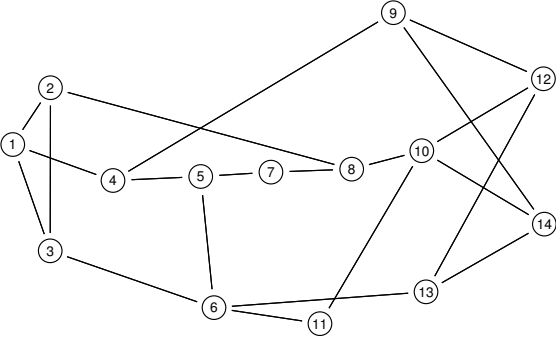
G ¹			G ²		
arc	weight	comment	arc	weight	comment
2-1	$+\infty$	used by the primary of δ_1	2-1	$+\infty$	used by the primary of δ_1
1-4	$+\infty$	used by the primary of δ_1	1-4	$+\infty$	used by the primary of δ_1
4-9	$+\infty$	used by the primary of δ_1	4-9	$+\infty$	used by the primary of δ_1

Table 7.3 : Weight of the arcs for each AG, G^ω , once the primaries of SLD δ_1 are set up

Now SLD δ_2 is considered. A primary path has to be selected. We compute $\kappa_{2,1}^{205,\delta} = (0, 0, 1)$ and hence wavelength λ_3 is selected on $P_{2,1}^\delta$ for the primary. We then compute $\Omega_{2,1}$. $\Omega_{2,1} = \{P_{2,2}^\delta, P_{2,3}^\delta\}$ shows that there are two candidate paths for the backups. Table 7.4 shows the weight of the arcs of each AG when the primary lightpath for SLD δ_2 is set up. Note that links 2-8, 8-10, 10-14, and 14-9 are used by backup paths on wavelengths λ_1 and λ_2 and that their weights on AGs G^1 and G^2 are $+\infty$ because the primary path of SLD δ_1 , $P_{1,1}^\delta$, shares the span (4,9) with the primary path, $P_{2,1}^\delta$, of SLD δ_2 . Their associate backup paths cannot hence be multiplexed. $U_{2,2}^{1,205} = +\infty$, $U_{2,2}^{2,205} = +\infty$, $U_{2,2}^{3,205} = 4$, $U_{2,3}^{1,205} = 4$, $U_{2,3}^{2,205} = 4$, and $U_{2,3}^{3,205} = 4$. Wavelength λ_3 is thus selected for the backup on $P_{2,2}^\delta$.

G ¹			G ²			G ³		
arc	weight	comment	arc	weight	comment	arc	weight	comment
2-1	$+\infty$	used by the primary of δ_1	2-1	$+\infty$	used by the primary of δ_1	5-4	$+\infty$	used by the primary of δ_2
1-4	$+\infty$	used by the primary of δ_1	1-4	$+\infty$	used by the primary of δ_1	4-9	$+\infty$	used by the primary of δ_2
4-9	$+\infty$	used by the primary of δ_1	4-9	$+\infty$	used by the primary of δ_1			
2-8	$+\infty$	used by the backup of δ_1	2-8	$+\infty$	used by the backup of δ_1			
8-10	$+\infty$	used by the backup of δ_1	8-10	$+\infty$	used by the backup of δ_1			
10-14	$+\infty$	used by the backup of δ_1	10-14	$+\infty$	used by the backup of δ_1			
14-9	$+\infty$	used by the backup of δ_1	14-9	$+\infty$	used by the backup of δ_1			

Table 7.4 : Weight of the arcs for each AG, G^ω , once the primary of SLD δ_2 is set up

At time $t = 307$ δ_3 is to be set up. SLD δ_3 requires two lightpaths. $\kappa_{3,1}^{307,\delta} = (1, 1, 1)$ and λ_1 and λ_2 are selected for the primaries on $P_{3,1}^\delta$. We now have to compute the backups. There is only one candidate backup path for δ_3 ($\Omega_{3,1} = \{P_{3,3}^\delta\}$). Table 7.5 shows the weight of the arcs of each AG once the primaries of SLD δ_3 are set up. We then have to evaluate the cost of $P_{3,3}^\delta$ on each weighted AG G^ω , $1 \leq \lambda \leq 3$. $U_{3,3}^{1,307} = 4$, $U_{3,3}^{2,307} = 4$, and $U_{3,3}^{3,307} = 4$. Note that the backup path of SLD δ_3 can be multiplexed with the backup path of SLDs δ_1 and δ_2 as their associated primary paths are span disjoint. Wavelengths λ_1 and λ_2 are selected for the backups.

When RLD τ_1 arrives, all the SLDs are still active. $\kappa_{1,1}^{406,\tau} = (0, 0, 1)$, $\kappa_{1,2}^{406,\tau} = (0, 0, 1)$, and $\kappa_{1,3}^{406,\tau} = (0, 0, 0)$. There are no paths with as many path-free wavelengths as the number of requested

G ¹			G ²			G ³		
arc	weight	comment	arc	weight	comment	arc	weight	comment
2-1	$+\infty$	used by the primary of δ_1	2-1	$+\infty$	used by the primary of δ_1	5-4	$+\infty$	used by the primary of δ_2
1-4	$+\infty$	used by the primary of δ_1	1-4	$+\infty$	used by the primary of δ_1	4-9	$+\infty$	used by the primary of δ_2
4-9	$+\infty$	used by the primary of δ_1	4-9	$+\infty$	used by the primary of δ_1	5-6	0	used by the backup of δ_2
2-8	0	used by the backup of δ_1	2-8	0	used by the backup of δ_1	6-13	0	used by the backup of δ_2
8-10	0	used by the backup of δ_1	8-10	0	used by the backup of δ_1	13-14	0	used by the backup of δ_2
10-14	0	used by the backup of δ_1	10-14	0	used by the backup of δ_1	14-9	0	used by the backup of δ_2
14-9	0	used by the backup of δ_1	14-9	0	used by the backup of δ_1			
13-6	$+\infty$	used by the primary of δ_3	13-6	$+\infty$	used by the primary of δ_3			
6-3	$+\infty$	used by the primary of δ_3	6-3	$+\infty$	used by the primary of δ_3			

Table 7.5 : Weight of the arcs for each AG, G^ω , once the primaries of SLD δ_3 are set up

lightpaths. RLD τ_1 is rejected. RLD τ_2 is now considered. SLDs δ_2 , and δ_3 are still active while the lightpaths of δ_1 have been released. RLD τ_2 requires 3 lightpaths. $\kappa_{2,1}^{409,\tau} = (0, 0, 1)$, $\kappa_{2,2}^{409,\tau} = (0, 0, 0)$, and $\kappa_{2,3}^{409,\tau} = (1, 1, 1)$. There are not enough path-free wavelengths on $P_{2,1}^\tau$ and $P_{2,2}^\tau$ to establish the requested lightpaths whereas all the wavelengths are available on $P_{2,3}^\tau$. RLD τ_2 is thus set up on $P_{2,3}^\tau$ using λ_1 , λ_2 , and λ_3 . The next step consists in computing the backups. $\Omega_{2,3} = \{P_{2,1}^\tau, P_{2,1}^\tau\}$. Table 7.6 shows for each auxiliary graph G^ω , $1 \leq \omega \leq 3$, the weights of arcs corresponding to busy links. According to Table 7.6, we compute $U_{2,1}^{1,409} = +\infty$, $U_{2,1}^{2,409} = +\infty$, $U_{2,1}^{3,409} = 3$, $U_{2,2}^{1,409} = 0$, $U_{2,2}^{2,409} = 0$, and $U_{2,2}^{3,409} = 3$. We notice that there is only one available wavelength on $P_{2,1}^\tau$ and hence $P_{2,1}^\tau$ cannot be used for the backups of τ_2 . Wavelengths λ_1 , λ_2 , and λ_3 are used only by backup paths on $P_{2,2}^\tau$. These backups can be multiplexed with the backup of RLD τ_2 as their associated primary paths are span disjoint (the weight of arcs 14-9, 9-4, 4-1, and 1-3 are equal to zero on auxiliary graphs G^1 and G^2). The backups of RLD τ_2 are hence set up using wavelengths λ_1 , λ_2 , and λ_3 on $P_{2,2}^\tau$.

G ¹			G ²			G ³		
arc	weight	comment	arc	weight	comment	arc	weight	comment
13-6	$+\infty$	used by the primary of δ_3	13-6	$+\infty$	used by the primary of δ_3	5-4	$+\infty$	used by the primary of δ_2
6-3	$+\infty$	used by the primary of δ_3	6-3	$+\infty$	used by the primary of δ_3	4-9	$+\infty$	used by the primary of δ_2
14-10	$+\infty$	used by the primary of τ_2	14-10	$+\infty$	used by the primary of τ_2	14-10	$+\infty$	used by the primary of τ_2
10-8	$+\infty$	used by the primary of τ_2	10-8	$+\infty$	used by the primary of τ_2	10-8	$+\infty$	used by the primary of τ_2
8-2	$+\infty$	used by the primary of τ_2	8-2	$+\infty$	used by the primary of τ_2	8-2	$+\infty$	used by the primary of τ_2
2-3	$+\infty$	used by the primary of τ_2	2-3	$+\infty$	used by the primary of τ_2	2-3	$+\infty$	used by the primary of τ_2
13-14	0	used by the backup of δ_3	13-14	0	used by the backup of δ_3	5-6	0	used by the backup of δ_2
14-9	0	used by the backup of δ_3	14-9	0	used by the backup of δ_3	6-13	0	used by the backup of δ_2
9-4	0	used by the backup of δ_3	9-4	0	used by the backup of δ_3	13-14	0	used by the backup of δ_2
4-1	0	used by the backup of δ_3	4-1	0	used by the backup of δ_3	14-9	0	used by the backup of δ_2
1-3	0	used by the backup of δ_3	1-3	0	used by the backup of δ_3			

Table 7.6 : Weight of the arcs for each AG, G^ω , once the primaries of RLD τ_2 are set up

7.5 Separate RSCA for scheduled and random lightpath demands

Hereafter we describe the *separate Atomic RSCA algorithm (sepARSCA)*. The RSCA for the SLDs and the RLDs is computed in two separate phases according to the following:

7.5.1 PHASE 1: RSCA of scheduled lightpath demands

Given a set of SLDs and a physical network with a fixed number of wavelengths per link W , we want to determine for each SLD a pair of span-disjoint paths to be used as working and protection paths, such that the rejection ratio is minimized. Hereafter the description of the mathematical formulation of the RSCA problem for the SLDs formulated as combinatorial optimization problem.

Mathematical formulation

We need the following additional notations:

- M denotes the number of SLDs and $\Delta = \{\delta_1, \delta_2, \dots, \delta_M\}$ is the set of SLDs to be set up. The SLDs are numbered from 1 to M according to their date of arrival at the network (δ_1 is the first SLD arriving at the network whereas δ_M is the last one).
 - (G, Δ) is a pair representing an instance of the SLD routing problem.
 - a binary vector $(\rho_{i,1}, \rho_{i,2}, \dots, \rho_{i,k}, \dots, \rho_{i,K})$ is associated to the demand δ_i . $\rho_{i,k} = 1$, $1 \leq k \leq K$, if all the primaries defined by SLD δ_i are routed along $P_{i,k}^\delta$ or if all the backups defined by δ_i are routed along $P_{i,k}^\delta$. All the lightpaths (be they working or backup lightpaths) of an SLD are routed through the same path (i.e., bifurcated routing is not allowed).
 - $\rho_\Delta = ((\rho_{1,1}, \rho_{1,2}, \dots, \rho_{1,K}), (\rho_{2,1}, \rho_{2,2}, \dots, \rho_{2,K}), \dots, (\rho_{M,1}, \rho_{M,2}, \dots, \rho_{M,K}))$ is called an admissible routing solution for Δ if $\sum_{k=1}^K \rho_{i,k} = 2$, $1 \leq i \leq M$.
 - Π_Δ is the set of all admissible routing solutions for Δ .
 - $C : \Pi_\Delta \rightarrow \mathbb{N}$ is the function that counts the number of blocked SLDs for an admissible solution.
- The combinatorial optimization problem to solve is:

$$\begin{aligned} &\text{Minimize} && C(\rho_\Delta) \\ &\text{subject to:} && \rho_\Delta \in \Pi_\Delta \end{aligned}$$

We used a Random Search (RS) algorithm to find an approximate minimum of the function C . The wavelengths are selected according to a First-Fit scheme. The pseudo-code for the RSCA Random Search algorithm is shown in Table 7.7.

ALGORITHM *Separate Atomic RSCA for the SLDs*

Input: $\Delta, R_i^\delta, W, n,$

Output: computes a RSCA solution for the SLDs that minimizes the number of rejected SLDs.
 (* compute an initial vector ρ_0 and compute its cost (number of rejected SLDs). One may for instance choose the first shortest path for all of the SLDs *)

- 1 Generate an initial vector ρ_0
- 2 Copy ρ_0 to $\text{best}\rho$ and append it in the BLACK LIST
- 3 Call the objective function to compute the number of rejected SLDs (bestrejectedSLDs) as well as the number of rejected lightpaths ($\text{bestrejectedSLPs} = \sum_{i \in \text{set of rejected SLDs}} \pi_i$ (see pseudo-code from STEP 5.1 to STEP 5.17 for the details)
 (* repeat n times *)
- 4 **for** $i := 1$ **to** n **do**
 - 4.1 Call the random function to generate a new random vector ρ
 - 5 Verify that the cost of ρ has not already been evaluated. Check if ρ is already in the BLACK LIST. If yes, another random ρ is generated, otherwise put ρ in the BLACK LIST and its cost is evaluated according to the following.
 (* Call the objective function to compute the number of rejected SLDs (rejectedSLDs) as well as the number of rejected lightpaths ($\text{rejectedSLPs} = \sum_{i \in \text{set of rejected SLDs}} \pi_i$. We assume that it exists ℓ_i and ℓ'_i , $1 \leq \ell_i \leq K$, $1 \leq \ell'_i \leq K$, $\ell_i < \ell'_i$, $1 \leq i \leq M$ that $\rho_{i, \ell_i} = 1$ and $\rho_{i, \ell'_i} = 1$.) *)
 - 5.1 $\text{rejectedSLDs} := 0$; $\text{rejectedSLPs} := 0$
 - 5.2 **for** $i := 1$ **to** M **do**
 - 5.3 **if** $P_{i, \ell'_i} \in \mathcal{B}_{i, \ell_i}$ **then**
 (* Look for π_i path-free wavelengths on P_{i, ℓ_i} to set up the primaries *)
 - 5.4 Compute $\gamma_{i, \ell_i}^{\omega, t, \delta}, \forall 1 \leq \omega \leq W$
 - 5.5 **if** $\sigma_{i, \ell_i}^{t, \delta} \geq \pi_i^\delta$ **then**
 - 5.6 instantiate the primaries for SLD δ_i
 - 5.7 Look for π_i path-free wavelengths on P_{i, ℓ'_i} to set up the backups
 - 5.8 Compute $\gamma_{i, \ell'_i}^{\omega, t, \delta}, \forall 1 \leq \omega \leq W$
 - 5.9 **if** $\sigma_{i, \ell'_i}^{t, \delta} \geq \pi_i^\delta$ **then**
 - 5.10 instantiate the backups for SLD δ_i
 - 5.11 **else**
 release the established primary lightpaths
 - 5.12 **goto** 5.14
 - 5.13 **else**
goto 5.14
 - 5.14 **endif**
 - 5.15 **else**
 SLD δ_i cannot be set up, $\text{rejectedSLDs} := \text{rejectedSLDs} + 1$, $\text{rejectedSLPs} := \text{rejectedSLPs} + \pi_i^\delta$
 - 5.16 **endif**
 - 5.17 **endif**
- 5.18 **if** $\text{rejectedSLDs} < \text{bestrejectedSLDs}$ **then**
 $\text{bestrejectedSLDs} := \text{rejectedSLDs}$, $\text{bestrejectedSLPs} := \text{rejectedSLPs}$, copy ρ to $\text{best}\rho$
- 5.19 **elseif** $\text{rejectedSLDs} = \text{bestrejectedSLDs}$ **then**
if $\text{rejectedSLPs} < \text{bestrejectedSLPs}$ **then** $\text{bestrejectedSLPs} := \text{rejectedSLPs}$, copy ρ to $\text{best}\rho$ **endif**
- 5.20 **endif**

end. *Separate Atomic RSCA for the SLDs*

Table 7.7 : RS algorithm for the atomic RSCA for SLDs

7.5.2 PHASE 2: RSCA for random lightpath demands

In this section, we describe the algorithm proposed to compute the RSCA for RLDs. The objective of the algorithm is to minimize the number of rejected RLDs given the RSCA for SLDs (which has already been computed according to the Random Search algorithm). Backup multiplexing is used just as for the SLDs by executing the three routing stages described previously. The RLDs are processed sequentially at arrival times the same way the SLDs and RLDs are routed using the seqARSCA algorithm. When a new RLD arrives, a primary path with as many path-free wavelengths as the number of requested lightpaths is selected according to STAGE 1 (see Subsection 7.4.1). If STAGE 1 fails, the RLD is rejected and STAGE 2 and STAGE 3 are skipped. When the primary path is selected, we then look for a backup path with as many path-free wavelengths as the number of requested lightpaths. The weighted auxiliary graphs are constructed for each available wavelength as described in Subsection 7.4.2 and the less costly backups are selected according to STAGE 3 (see Subsection 7.4.3).

7.5.3 Illustrative example

For illustration purposes, we consider the example of the preceding paragraphs to describe the process of the sepARSCA. We assume that we have to set up the SLDs and RLDs shown in Tables 7.8 and 7.9 respectively. We first compute the RSCA for the SLDs before considering the RLDs.

SLD	s	d	π	α	β	the shortest paths
1	2	9	2	106	407	$P_{1,1}=2-1-4-9$ $P_{1,2}=2-8-10-14-9$ $P_{1,3}=2-3-1-4-9$
2	5	9	1	205	807	$P_{2,1}=5-4-9$ $P_{2,2}=5-6-13-14-9$ $P_{2,3}=5-6-13-12-9$
3	13	3	2	307	605	$P_{3,1}=13-6-3$ $P_{3,2}=13-6-5-4-1-3$ $P_{3,3}=13-14-9-4-1-3$

Table 7.8 : The set of SLDs to be set up

An admissible solution (among other possible ones) $\rho = ((1, 1, 0), (0, 1, 1), (1, 0, 1))$ is generated arbitrarily. According to ρ , the primary and backup paths of SLD δ_1 have to follow paths $P_{1,1}^\delta$ and $P_{1,2}^\delta$ respectively. $P_{2,2}^\delta$ and $P_{2,3}^\delta$ are the paths to be used by the primary and backup paths of δ_2 and finally δ_3 has to be set up using path $P_{3,1}^\delta$ for the primaries and path $P_{3,3}^\delta$ for the backups. We assume that the cost of the primaries measured in terms of number of hops between the source and the destination of the

RLD	s	d	π	α	β	the shortest paths
1	11	1	2	406	908	$P_{1,1} = 11-6-3-1$ $P_{1,2} = 11-10-8-2-1$ $P_{1,3} = 11-6-5-4-1$
2	8	2	3	409	1007	$P_{2,1} = 14-13-6-3$ $P_{2,2} = 14-9-4-1-3$ $P_{2,3} = 14-10-8-2-3$

Table 7.9 : The RLDs to be set up

path must be lower than the cost of their associated backups. This condition prevents the computation of long primary paths requiring more WDM channels. Let us now evaluate the cost of the above solution in terms of the number of rejected SLDs. When SLD δ_1 is to be set up at time $t = 106$, we first have to check that the selected primary and backup paths according to vector ρ are span disjoint, otherwise the SLD cannot be established. As $P_{1,1}^\delta$ and $P_{1,2}^\delta$ have no spans in common, we now have to compute the available path-free wavelengths on each path. We assume that no SLD has already been routed, hence all the wavelengths are available. SLD δ_1 requires two lightpaths. $\kappa_{1,1}^{106,\delta} = (1, 1, 1)$ and λ_1 and λ_2 are chosen for the primaries. The primaries being set up, we now have to check if there are at least two path-free wavelengths on $P_{1,2}^\delta$. The AGs described in the preceding sections are constructed. We then compute $U_{1,2}^{1,106} = 4$, $U_{1,2}^{2,106} = 4$, and $U_{1,2}^{3,106} = 4$. Wavelengths λ_1 and λ_2 are selected for the backups of SLD δ_1 . At time $t = 205$, SLD δ_2 is to be set up. SLD δ_1 is still active. $P_{2,2}^\delta$ and $P_{2,3}^\delta$ share two spans, the SLD is hence blocked. SLD δ_3 is now considered. SLD δ_1 is still active. $P_{3,1}^\delta$ and $P_{3,3}^\delta$ are span disjoint. $\kappa_{3,1}^{307,\delta} = (1, 1, 1)$ and wavelengths λ_1 and λ_2 are chosen for the primaries. Then the AGs are constructed and compute $U_{3,3}^{1,307} = 4$, $U_{3,3}^{2,307} = 4$, and $U_{3,3}^{3,307} = 5$. Wavelengths λ_1 and λ_2 are used for the backups. Note that despite the fact that wavelengths λ_1 and λ_2 are used on the backups of SLD δ_1 , these wavelengths are reused by SLD δ_3 since the associated primary paths of δ_1 and δ_2 are span disjoint, so that their backup lightpaths can be multiplexed on link 14-9. The cost of this solution measured in terms of rejected SLDs is $C(\rho_\Delta) = 1$ ($Rr = \frac{1}{3}$). Similarly, one can easily see that when vector ρ equals to $((1, 1, 0), (1, 1, 0), (1, 0, 1))$, we get $C(\rho_\Delta) = 0$ ($Rr = 0$).

The process described above is iterated a fixed number of times, the solution with the minimal cost C is selected. When two solutions have the same cost, the one which maximizes the number of established lightpaths is kept (rejects less requested lightpaths).

The characteristics of the lightpaths used by the SLDs are given in Table 7.10. We now assume that we have to compute the primaries and the backups for the RLDs described in Table 7.9. Note that unlike the SLDs, the primary path of an RLD may have a higher cost (in terms of number of hops)

SLD	s	d	π	α	β	the lightpath used by the SLDs			
						primary paths	wavelengths	backup paths	wavelengths
1	2	9	2	106	407	$P_{1,1} = 2-1-4-9$	λ_1	$P_{1,2} = 2-8-10-14-9$	λ_1
						$P_{1,1} = 2-1-4-9$	λ_2	$P_{1,2} = 2-8-10-14-9$	λ_2
2	5	9	1	205	807	$P_{2,1} = 5-4-9$	λ_3	$P_{2,2} = 5-6-13-14-9$	λ_3
3	13	3	2	307	605	$P_{3,1} = 13-6-3$	λ_1	$P_{3,3} = 13-14-9-4-1-3$	λ_1
						$P_{3,1} = 13-6-3$	λ_2	$P_{3,3} = 13-14-9-4-1-3$	λ_2

Table 7.10 : RSCA for the SLDs: description of \mathcal{A}^{406} at the arrival time of τ_1

than its associated backup since RLDs have shorter life spans compared to SLDs.

When RLD τ_1 arrives at $t = 406$, SLDs δ_1 , δ_2 , and δ_3 are still active. A primary path has to be selected for δ_3 . We first have to select a primary path. We compute $\kappa_{1,1,406}^{406,\tau} = (0, 0, 1)$ and notice that $P_{1,1}^\tau$ cannot be selected for the primaries as only wavelength λ_3 is still available. We then compute $\kappa_{1,2}^{406,\tau} = (0, 0, 1)$. Again only wavelength λ_3 is available and $P_{1,2}^\tau$ cannot be used for the primaries. We then compute $\kappa_{1,3}^{406,\tau} = (0, 0, 0)$. No wavelengths are available on $P_{1,3}^\tau$. RLD τ_1 is rejected. RLD τ_2 is now to be set up, δ_2 , and δ_3 are still active whereas the lightpaths of SLD δ_1 have been released. We first have to find a path with 3 path-free wavelengths to be used as the primary path. $\kappa_{1,1}^{409,\tau} = (0, 0, 1)$, $\kappa_{1,2}^{409,\tau} = (0, 0, 0)$ and $\kappa_{1,3}^{409,\tau} = (1, 1, 1)$. There is not enough path-free wavelengths on $P_{2,1}^\tau$ and $P_{2,2}^\tau$ to establish the requested lightpaths. However, all the wavelengths are available on $P_{2,3}^\tau$ and τ_2 is set up on $P_{2,3}^\tau$ using wavelengths λ_1 , λ_2 , and λ_3 . Then a backup path has to be selected. Two candidate backup paths exist as $\Omega_{2,3} = \{P_{2,1}^\tau, P_{2,2}^\tau\}$. The AGs G^ω , $1 \leq \omega \leq 3$, have to be constructed to determine the cost of paths $P_{2,1}^\tau$ and $P_{2,2}^\tau$ that the path-wavelength pairs with the minimal costs are selected.

Table 7.6 shows for each auxiliary graph G^ω , $1 \leq \omega \leq 3$ the weights of all arcs corresponding to busy links (i.e. all other arcs have weight $u_j^{\omega,409} = 1$, $j \in E$, $1 \leq \omega \leq 3$).

According to Table 7.6, we compute $U_{2,1}^{1,409} = +\infty$, $U_{2,1}^{2,409} = +\infty$, $U_{2,1}^{3,409} = 3$, $U_{2,2}^{1,409} = 0$, $U_{2,2}^{2,409} = 0$, and $U_{2,2}^{3,409} = 3$. We notice that there is only one available wavelength on $P_{2,1}^\tau$ and hence $P_{2,1}^\tau$ cannot be used as the backup path for τ_2 . Wavelengths λ_1 , λ_2 , and λ_3 are used only by backup paths on $P_{2,2}^\tau$. These backups can be multiplexed with the backup of RLD τ_2 as their associated primaries are span disjoint (the weight of arcs 14-9, 9-4, 4-1, and 1-3 are equal to zero on auxiliary graphs G^1 and G^2). The backups of RLD τ_2 are hence set up using wavelengths λ_1 , λ_2 , and λ_3 on $P_{2,2}^\tau$.

7.6 Experimental results

In this section we experimentally evaluate the algorithms presented in the previous sections.

We used the network topologies shown in Figure 4.3 and Figure 4.4 with 14 and 29 nodes respectively. The source and destination nodes for both the SLDs and the RLDs are drawn according to a random uniform distribution in the interval $[1, 14]$ for the 14-node network and in the interval $[1, 29]$ for the 29-node network respectively. We also used a uniform random distribution over the intervals $[1, 3]$ for the number of requested lightpaths. The set-up and tear-down dates of the SLDs are also drawn according to a random uniform distribution in the intervals $[1, 1440]$. We assume observation periods of about a day (1440 is the number of minutes in a day). The RLDs arrive according to a Poisson process with an arrival rate $\nu = 1$ and if accepted, will hold the circuits for exponentially distributed times with mean $\mu = 500$ much larger than the cumulated round-trip time and the connection set-up delay.

Let us remind ourselves the acronyms of the proposed algorithms.

- seqARSCA: the sequential Atomic RSCA algorithm.
- sepARSCA: the separate Atomic RSCA algorithm.
- seqRSCA: the sequential RSCA algorithm.
- sepRSCA: the separate RSCA algorithm.

We assume that we compute 5 alternate shortest paths ($K = 5$) between each source/destination pair and that there are 32 available wavelengths on each fiber-link in the network ($W = 32$). We want to discuss the advantages as well as the drawbacks of each of the presented RSCA algorithms. In the following, we only plot the experimental results obtained for the 29-node network.

Figure 7.2 shows the average rejection ratio w.r.t. D , the number of SLDs and RLDs arriving at the network. We notice that the average rejection ratio increase with D . We also notice that the sequential RSCA algorithms perform better than the separate RSCA algorithms. The seqRSCA algorithm has the smallest rejection ratio w.r.t. other RSCA algorithms.

In Figure 7.3 we draw the average number of rejected SLDs and RLDs w.r.t. D . Each quadruplet of bars shows the average number of blocked LDs computed using the seqARSCA algorithm (first bar from the left-hand side), the sepARSCA algorithm (second bar), the seqRSCA algorithm (third bar), and the sepRSCA algorithm (fourth bar) respectively. Each bar is divided into two segments. The height of the black segment indicates the average number of rejected SLDs whereas the height of the white one shows the average number of rejected RLDs. The average number of rejected SLDs and RLDs increases when the traffic load in the network goes up. The separate RSCA algorithms reject fewer SLDs than the sequential RSCA algorithms as they compute the RSCA for the SLDs off-line in a

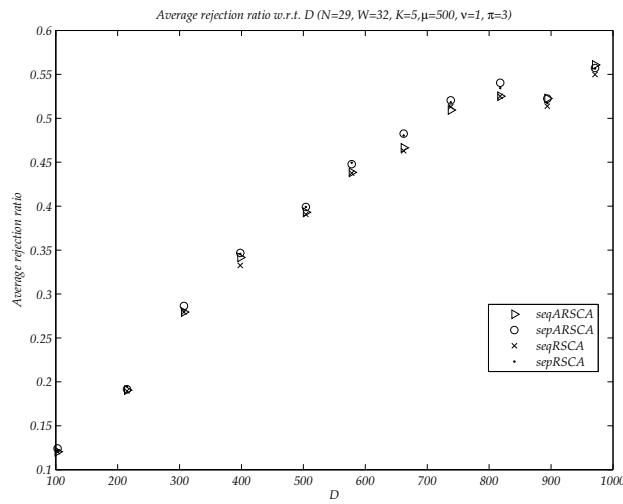

Figure 7.2 : average rejection ratio

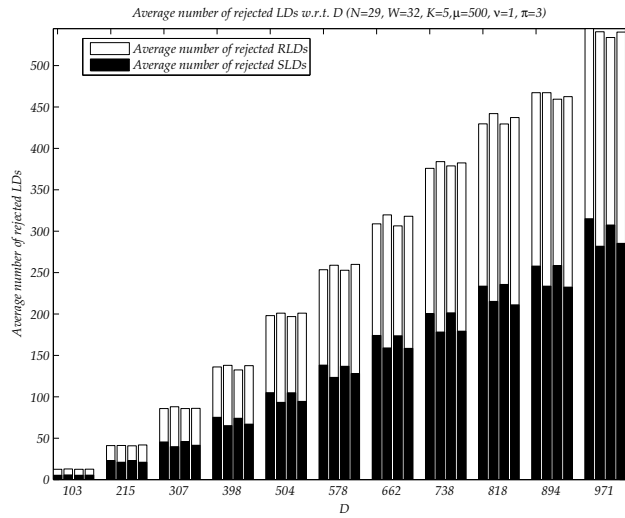

Figure 7.3 : average number of rejected LDs

separate phase before considering the RLDs. However, more RLDs are rejected by the separate RSCA algorithms as once the SLDs are accepted, the SLDs hold the resources for long times and no more available wavelengths remain in the network to set up all the incoming RLDs. The probability that an incoming RLD is rejected at its arrival time becomes significantly high.

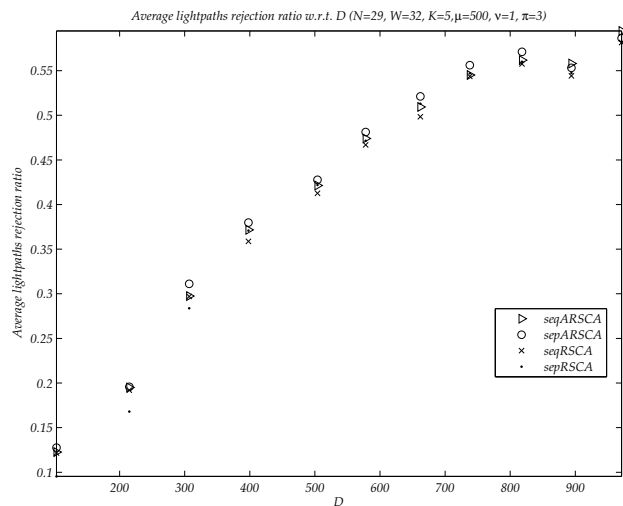

Figure 7.4 : average rejected lightpaths

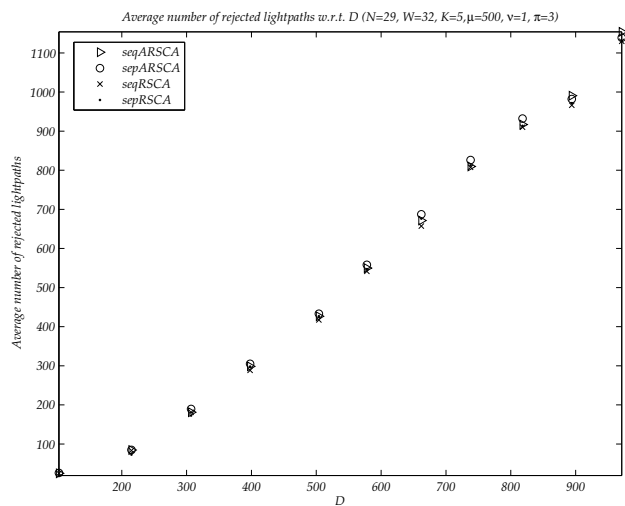

Figure 7.5 : average number of rejected lightpaths

Figures 7.4 and 7.5 show the average lightpath rejection ratio and the average number of rejected lightpaths respectively. The average number of rejected lightpaths increases with D. All algorithms compute almost the same average number of rejected lightpaths for small values of D whilst the seqRSCA algorithm rejects the minimum number of lightpaths when D increases.

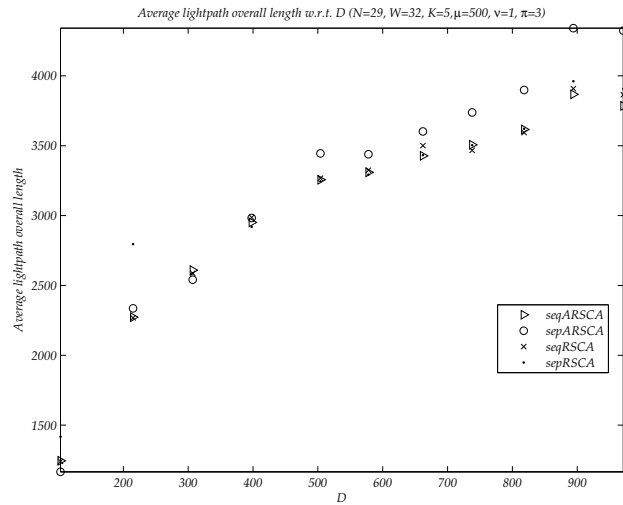

Figure 7.6 : average lightpath overall length

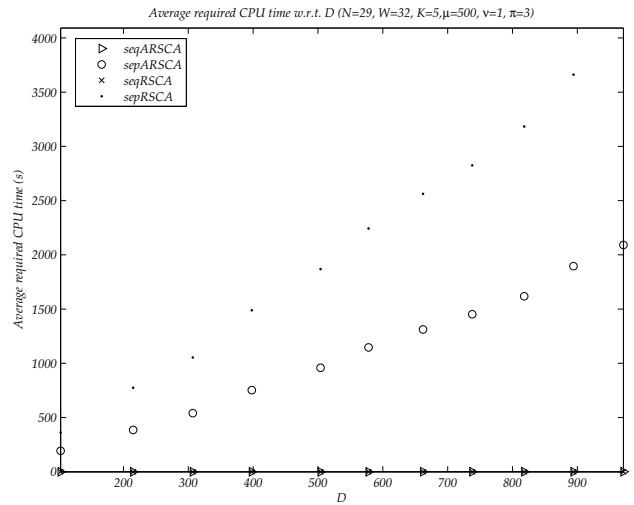

Figure 7.7 : average CPU execution time

In Figure 7.6, the average lightpath overall length is drawn w.r.t. D . The lightpath overall length increases with D . The atomic RSCA algorithms use longer paths than the non atomic RSCA algorithms. This is because all the lightpaths requested by a LD have to follow the same path between the source node and the destination node of the lightpath request even if path-free wavelengths are available on shortest paths (the number of available path-free wavelengths is less than the number of lightpaths requested by the demand). The seqRSCA algorithm still computes one of the smallest lightpath overall lengths.

Figure 7.7 shows the average CPU time required by each of the proposed RSCA algorithms to compute the RSCA for the requested lightpaths. We notice that the sequential RSCA algorithms require small times to compute the RSCA for the considered traffic matrices whereas the separate RSCA algorithms require long times especially to compute the RSCA for the SLDs using the RS algorithms. We also observe that sepRSCA algorithm requires longer times to compute the RSCA for SLDs than the sepARSCA algorithm. This is because the sepRSCA algorithm assumes non atomic routing and hence several paths may be used by an SLD to set up the requested lightpaths. One has thus to check that there are as many path-free wavelengths on each selected path as the number of requested lightpaths to be set up on that path and given by vector ρ . For the the sepARSCA algorithm, only one path has to be used by the SLD. Thus, one only has to check if there are as many path-free wavelengths as the number of lightpaths requested by the SLD on only that path.

Chapter 8

Lightpath Rerouting for Scheduled and Random Lightpath Demands for Traffic Engineering in WDM Networks

8.1 Introduction

In this chapter we propose RWA algorithms applying Lightpath ReRouting (LRR) (see Chapter 3) to alleviate the inefficiency brought by the wavelength continuity constraint in WDM all-optical networks without wavelength converters. When an incoming traffic demand cannot be satisfied due to a lack of network resources, rerouting aims at reassigning the wavelength and/or the path of one or several established connections in order to set up this new demand. Rerouting refers implicitly to dynamic traffic. In most previous studies related to rerouting, only random (dynamic) traffic is considered. In this chapter, we propose a new LRR scheme considering SLDs and RLDs. SLDs correspond to guaranteed services while RLDs correspond to best effort services. Thus SLDs cannot be rerouted. Two phases routing algorithms are proposed. The first phase, also called the *routing phase* computes the RWA for an incoming demand without any rerouting. The second phase, referred to as the *rerouting phase*, is activated whenever the first phase fails in setting up the considered demand. The rerouting phase uses a new rerouting algorithm which differs from RRA1 ([111]) and RRA2 ([113]) in the following aspects (see Table 8.1):

8.1.1 Traffic model

We consider two types of traffic demands namely SLDs and RLDs corresponding to different traffic priorities. Only RLDs have been considered for RRA1 and RRA2.

8.1.2 Rerouting dynamics

As mentioned in Chapter 3, rerouting dynamics have a direct impact on the duration of the disruption period. The shorter this duration the lower the service disruption.

When the rerouting phase is ran, the new algorithm we propose, does not consider any auxiliary graph. Both, RRA1 and RRA2 rely on auxiliary graphs to determine the set of existing lightpaths that should be rerouted and select the resources to be assigned for the LD to be accommodated.

Moreover, our algorithm does not check afresh whether an existing lightpath is retunable or not. Indeed, it dynamically updates the rerouting status of established lightpaths after every successful lightpath establishment or release. RRA1 checks for the retunability status of each established lightpath online when a LD is to be set up. At the opposite, RRA2 checks for the retunability status of a lightpath as our algorithm do.

8.1.3 Type of lightpaths

RRA1 and RRA2 consider bidirectional lightpaths. If a direct lightpath is set up in the network from node u to node v , a reverse lightpath from v to u is also to be set up using the same path and the same wavelength as the one used by the direct lightpath. In WDM networks, routing strategies are subject to a trade-off with respect to the directionality of lightpaths. In existing optical networks, operators adopt bidirectional circuits for signaling and physical layer management purposes. Such an approach is non-optimal in terms of resource utilization efficiency. In MPLS, the direct and reverse circuits use different paths in order to optimize traffic engineering efficiency. This approach is adopted for our case study.

RRA1 and RRA2 fail to select the minimum number of lightpaths to be rerouted in the case when lightpaths are unidirectional. A simple example has been proposed in [111] to illustrate this shortcoming.

Through numerical examples and experimental simulations, we outline that thanks to rerouting, the rejection ratio is decreased and that our LRR algorithm is less CPU consuming than the rerouting algorithms described in [111] and [113].

The rest of the chapter is organized as follows. In Section 8.2 we describe the rerouting problem. Section 8.3 defines the notations necessary to present the proposed algorithms. Two routing and

	RRA1 [111]	RRA2 [113]	New algorithm
Traffic model	RLDs	RLDs	SLDs+RLDs
Auxiliary graphs	yes	yes	no
Lightpath retunability information	checked online	updated	updated
Type of lightpaths	bidirectional	bidirectional	unidirectional
Complexity	$O(N^3W + N^2W^2)$	$O(N^2W)$	$O(KW)$
Wavelength rerouting	yes	yes	yes
Lightpath rerouting	no	no	yes

Table 8.1 : Comparison of the rerouting algorithms.

rerouting algorithms are presented in Sections 8.4.1 and 8.4.2 respectively. Section 8.5 gives some simulation results.

8.2 Description of the problem

In WDM all-optical networks without wavelength conversion, traffic rerouting is motivated either by an optimization of resource utilization or by network survivability. Network survivability is out of the scope of this chapter. We only consider traffic rerouting techniques developed in order to reduce the number of blocked demands. Indeed, when an incoming traffic demand cannot be satisfied due to a lack of network resources we use rerouting to reassign the wavelength and/or the path of one or several established connections in order to set up this new demand. Two Routing and Wavelength Assignment with Rerouting (RWA_wR) algorithms are proposed as shown in Figure 8.1. The first algorithm, called *sequential RWA with Rerouting* (seqRWA_wR), indiscriminately computes the RWA for SLDs and RLDs on the fly at their arrival times at the network. As mentioned above, the seqRWA_wR relies on two separate phases to compute the RWA for an incoming LD (be it an SLD or an RLD). The routing phase tries to route the LD on one of its associated K-alternate shortest paths (computed off-line) without any rerouting. The rerouting phase is activated only when the routing phase fails. It tries to free as many path-free wavelengths as the number of lightpaths requested by the arriving LD by rerouting one or several existing RLDs.

The second RWA_wR algorithm, referred to as *separate RWA with Rerouting* (sepRWA_wR) computes the RWA_wR for SLDs and RLDs separately. It first considers the RWA for SLDs without any rerouting and aims at minimizing the number of rejected SLDs. It then computes the RWA_wR for RLDs on the fly on the sparse resources remaining in the network the same way the seqRWA_wR algorithm do.

Two versions of each algorithm are proposed w.r.t. the objective function considered for the rerouting phase. Mainly two functions have been adopted when rerouting the RLDs. The first function aims at

minimizing the overall length (total number of hops) of the RLDs to be rerouted whereas the second tries to minimize the number of rerouted RLDs.

We study and compare the proposed RWA ω R algorithms in terms of rejection ratios. It is shown that the seqRWA ω R aiming at minimizing the number of RLDs to be rerouted computes the lowest rejection ratio while a significant number of SLDs are rejected compared to the sepRWA ω R.

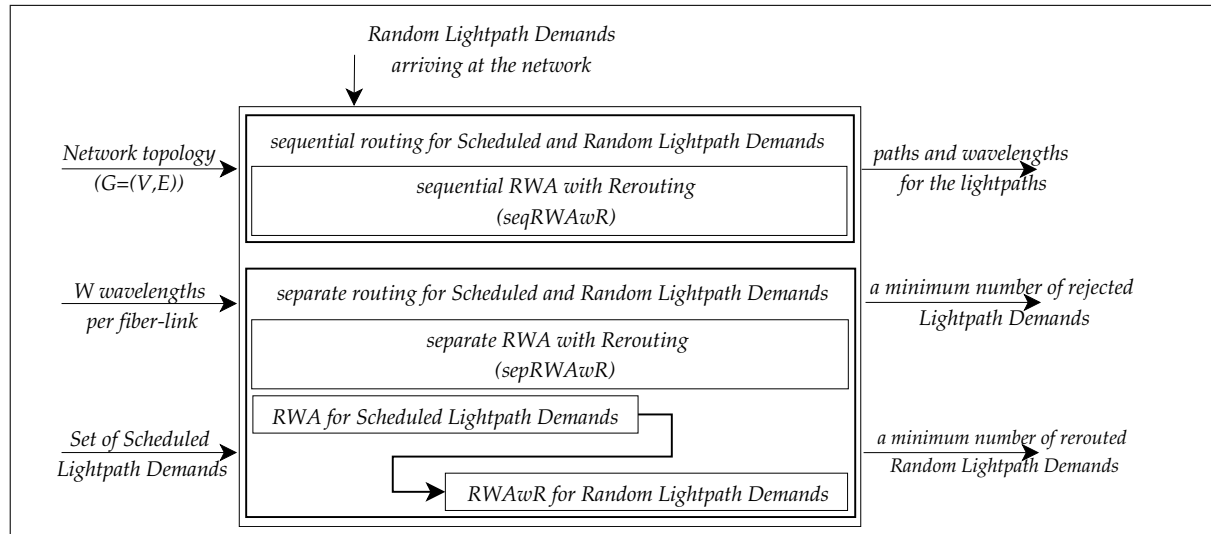

Figure 8.1 : Schematic representation of the LRR problem

8.3 Notations

We use the following notations and typographical conventions.

Index conventions

- $i, j,$ and p as subscripts usually denote respectively a *node pair index* (demand index), a *link index*, and a *route index* respectively.
- ω as superscript usually denotes a *wavelength index*.

The parameters

- $G = (V, E, \xi)$ is an arc-weighted symmetrical directed graph representing the network topology with vertex set V , arc set E and weight function $\xi: E \rightarrow \mathbb{R}_+$ mapping the physical length (or any other cost of the links set by the network operator) of each arc of E .
- $N = |V|$ denotes the number of vertices (network nodes) of the directed graph representing the network topology,

- $L = |E|$ denotes the number of arcs (network links) of the directed graph representing the network topology,
- W denotes the number of available wavelengths (i.e., WDM channels) per fiber-link. We assume that all the network links have the same number of available wavelengths,
- $\Lambda = \{\lambda_1, \lambda_2, \dots, \lambda_\omega, \dots, \lambda_W\}$ is the set of available wavelengths on each fiber-link of the network,
- D denotes the total number of SLDs and RLDs to be set up,
- The LD numbered $1 \leq i \leq D$ (to be established) is defined by a 5-tuple $(s_i, d_i, \pi_i, \alpha_i, \beta_i)$. $s_i \in V$, $d_i \in V$ are the source and the destination nodes of the demand, π_i is the number of requested lightpaths, and α_i and β_i are respectively the set-up and tear-down dates of the demand. For the sake of simplicity, we assume that for each LD, only one lightpath is required between the source and the destination nodes of the demand ($\pi_i = 1$). This scheme can be generalized to consider traffic requests with a required number of lightpaths π ($\pi \geq 1$) by considering π simultaneous traffic requests between the same source and the same destination nodes with one required lightpath each.
- $P_{i,k}$, $1 \leq i \leq D$, $1 \leq k \leq K$, represents the k^{th} alternate shortest path in G connecting node s_i to node d_i (source and destination of the i^{th} demand). We compute K -alternate shortest paths for each source-destination pair (LD) according to the algorithm described in [136] (if as many paths exist, otherwise we only consider the available ones).
- R_i is the set of the shortest paths computed for LD number i ,
- P is the set of alternate shortest paths computed between the source and destination nodes of each possible node pair in the network. Clearly $|P| \leq N(N-1)K$.
- $c_j^{\omega,t} \in \{1, +\infty\}$ is the cost of using wavelength λ_ω , on link $j \in E$ at time t . $c_j^{\omega,t} = 1$ if wavelength λ_ω is a free wavelength on fiber-link j , $c_j^{\omega,t} = +\infty$, otherwise (wavelength λ_ω is used by a lightpath passing through link j).
- $C_{i,k}^{\omega,t} = \sum_{j \in P_{i,k}} c_j^{\omega,t}$ is the cost of using wavelength λ_ω on $P_{i,k}$, the k^{th} alternate shortest path in R_i connecting the source to the destination node of LD i at time t . The cost function is determined as follows:

$$C_{i,k}^{\omega,t} = \begin{cases} \epsilon & \text{if wavelength } \lambda_\omega \text{ is path free on } P_{i,k} \\ +\infty & \text{if } \lambda_\omega \text{ is already used by another LD on at least one fiber-link of } P_{i,k} \end{cases}$$

ϵ is a tiny positive value (number of hops of the path). A lightpath using a wavelength λ_ω on a shortest path $P_{i,k}$ can be rerouted if one of the following cases may happen:

- A path-free wavelength $\lambda_{\omega'} : \omega \neq \omega'$ exist on $P_{i,k}$; $C_{i,k}^{\omega',t} < +\infty$.
- A path-free wavelength λ_{ω} , $1 \leq \omega \leq W$, exist on one of the shortest paths $P_{i,k'} : k \neq k'$, $1 \leq k' \leq K$, connecting the source to the destination of the lightpath; $C_{i,k'}^{\omega,t} < +\infty$.
- $\gamma_{i,k}^{\omega,t} = 1$, $1 \leq i \leq D$, $1 \leq k \leq K$, $1 \leq \omega \leq W$, if wavelength λ_{ω} is a path-free wavelength along the k^{th} alternate path $P_{i,k}$, connecting the source to the destination node of LD i , at time t . $\gamma_{i,k}^{\omega,t} = 0$, otherwise.
- $\kappa_{i,k}^t = (\gamma_{i,k}^{1,t}, \gamma_{i,k}^{2,t}, \dots, \gamma_{i,k}^{W,t})$, $1 \leq i \leq D$, $1 \leq k \leq K$, is a W -dimensional binary vector showing the available path-free wavelengths on $P_{i,k}$ at time t .
- $\sigma_{i,k}^t = \sum_{\omega=1}^W \gamma_{i,k}^{\omega,t}$, $1 \leq i \leq D$, $1 \leq k \leq K$, is the number of path-free wavelengths on $P_{i,k}$ at time t .
- \mathcal{A}^t is the set of accepted and active LDs (SLDs and RLDs) at time t .
- $\mathcal{B}_{i,k}$ is the set of shortest paths in P which have at least one common link with shortest path $P_{i,k}$.

8.4 The routing and rerouting algorithms

We now describe the routing and rerouting algorithms we propose to deal with the RWA for the SLDs and the RLDs. Subsection 8.4.1 gives the principles of the seqRWAwR algorithm whereas Subsection 8.4.2 details the sepRWAwR algorithm.

8.4.1 Sequential RWA with rerouting for scheduled and random lightpath demands

The sequential RWA with Rerouting (seqRWAwR) considers the SLDs and RLDs on the fly at their arrival dates. Two phases are executed to compute the RWA for an arriving LD (be it an SLD or an RLD) as shown in Figure 8.2. The routing phase (PHASE 1) is initiated to compute the RWA for an arriving LD according to the sequential RWA algorithm described in Chapter 5 without rerouting any existing lightpath. If the initial phase fails, the rerouting phase (PHASE 2) is activated. It will determine which lightpaths (associated to already established RLDs) should be rerouted and how they should be rerouted in order to set up the new connection. If rerouting is infeasible, the incoming LD is definitively rejected.

8.4.1.1 PHASE 1: routing phase

When a new LD i arrives at the network at time t , we first try to route the demand without rerouting any active LD according to the sequential Dijkstra based algorithm described in Section 5.4.1: Considering

in turn the shortest paths in R_i starting with the shortest one, we look for a path-free wavelength to set up the incoming connection. When several path-free wavelengths exit on a shortest path, the wavelength is selected according to a First-Fit scheme. Hereafter (Table 8.2) the pseudo-code used to compute the physical route and select a path-free wavelength for the demand.

When there is no available path-free wavelengths on the K alternate shortest paths considered, PHASE 2 is launched to hopefully free one path-free wavelength on one of these paths after rerouting a minimum number of already routed RLDs (a minimum number of WDM channels respectively). The worst case time complexity of PHASE 1 is $O(KW)$.

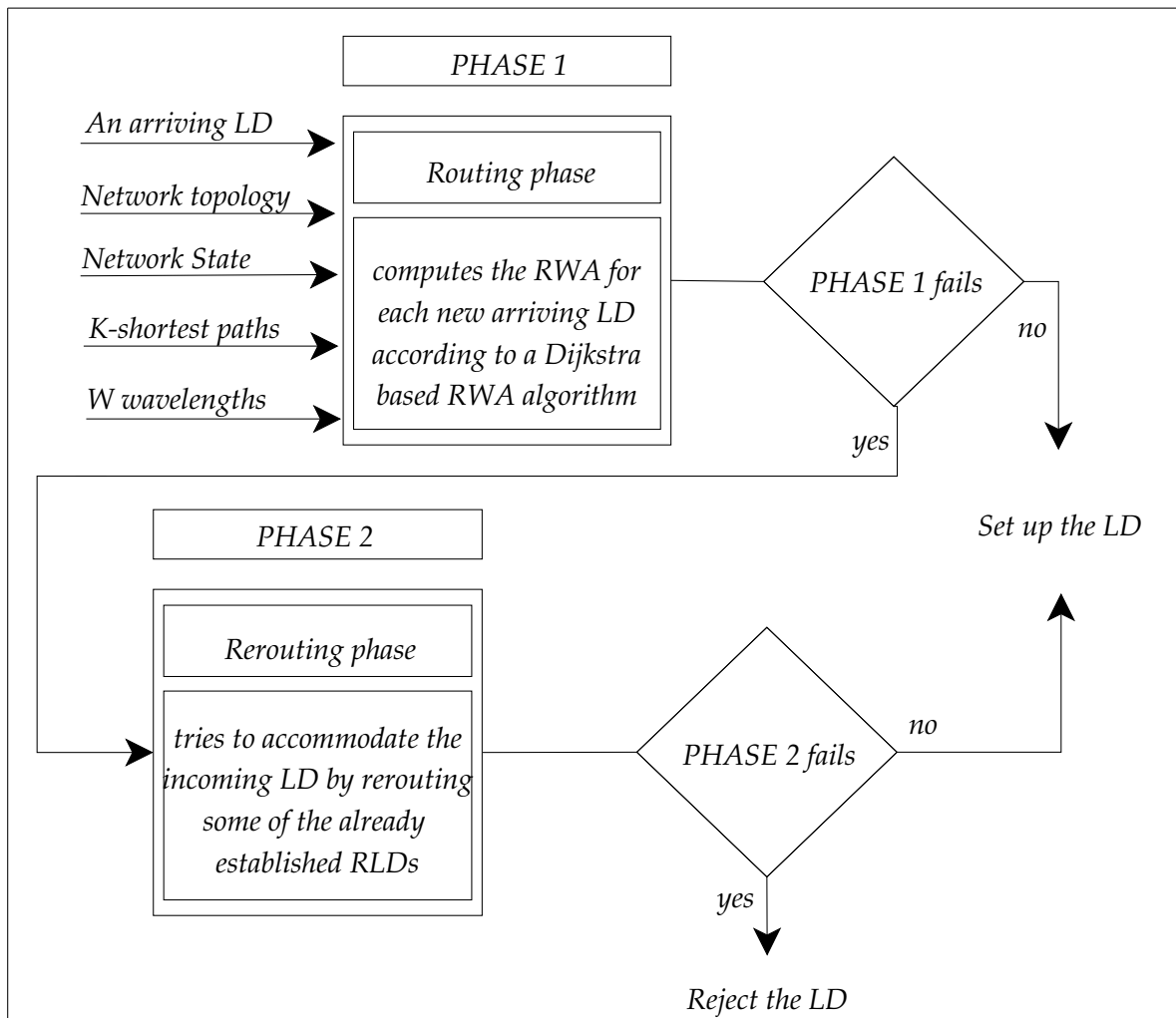

Figure 8.2 : Schematic representation of the seqRWAwR algorithm

```

ALGORITHM Sequential path computation for LD i with starting time t
Input: LD i, K, Ri, W
Output: computes a physical route and selects a path-free wavelength for the new LD
(* We look for, considering in turn the shortest paths in Ri starting with the shortest one, a path-free wavelength to
set up the incoming connection. The wavelength is selected according to a First-Fit scheme when several path-free
wavelengths exit on the same shortest path. *)
1 FLAG:=0
2 k:=1
3 while (k ≤ K) and (FLAG=0) do
3.1 ω:=1
3.2 while (ω ≤ W) and (FLAG=0) do
3.3 if (C(i, k, ω, t) ≤ +∞) then
3.4 (* The LD is set up without requiring any rerouting. *)
3.5 FLAG:=1
endif
endwhile
4 if (FLAG=0) then
4.1 (* No network resource remain in the network to set up the LD. *)
4.2 Switch to PHASE 2.
endif
end. Sequential path computation for LD i with starting time t

```

Table 8.2 : Path computation and wavelength selection for LD i with starting time t

8.4.1.2 PHASE 2: rerouting phase

We need the following additional notations to describe the rerouting phase.

- $Q_{i,k}^{\omega,t}$, $1 \leq k \leq K$, $1 \leq i \leq D$, $1 \leq \omega \leq W$, denotes the set of LDs in \mathcal{A}^t to be rerouted when serving the incoming LD i at time t using wavelength λ_ω on $P_{i,k}$.
- $\mathcal{O}_{i,k}^{\omega,t}$, $1 \leq k \leq K$, $1 \leq i \leq D$, $1 \leq \omega \leq W$, is the number of LDs to be rerouted at time t in order to satisfy the incoming LD i on $P_{i,k}$ using wavelength λ_ω . Clearly $\mathcal{O}_{i,k}^{\omega,t} = \text{card}(Q_{i,k}^{\omega,t})$.
- $\mathcal{O}_{i,k}^{t,\min} = \min_{1 \leq k \leq K} \min_{1 \leq \omega \leq W} \mathcal{O}_{i,k}^{\omega,t}$, is the minimum number of RLDs to be rerouted to satisfy the incoming LD i at time t on $P_{i,k}$.

Once a LD (be it an SLD or an RLD) numbered i, is rejected by PHASE1 at time t. PHASE2 considers in turn the K-alternate shortest paths associated to request i and computes for each wavelength λ_ω , $1 \leq \omega \leq W$, the corresponding $Q_{i,k}^{\omega,t}$, $\mathcal{O}_{i,k}^{\omega,t}$ pair. Let us remark that the absence of a path-free wavelength for demand i implies that for any wavelength λ_ω and any shortest path $P_{i,k}$, $\mathcal{O}_{i,k}^{\omega,t} > 0$. The wavelengths requiring the rerouting of one or several SLDs are discarded. We then compute $\mathcal{O}_{i,k}^{t,\min}$. The wavelength, that requires a minimum number of RLDs to be rerouted whatever the shortest path, is hence selected. Let us assume that path $P_{i,2}$ and wavelength λ_4 , for instance, correspond to $\mathcal{O}_{i,2}^{t,\min}$. $\mathcal{O}_{i,2}^{4,t}$ and $Q_{i,2}^{4,t}$ denote the number and set of RLDs to be rerouted respectively. Two cases may happen: all the RLDs in $Q_{i,2}^{4,t}$ can be rerouted according to PHASE1 either by only changing the used wavelength

when keeping the same physical path (wavelength rerouting (see Chapter 3)) or by changing either the physical path and then possibly the used wavelength (lightpath rerouting (see Chapter 3)). In this case, the incoming LD is serviced using λ_4 on $P_{i,2}$. The cost, $C_{i,2}^{4,t}$, of using wavelength λ_4 on $P_{i,2}$ at time t is updated to $+\infty$, as well as the cost off all the paths in $\mathcal{B}_{i,2}$ that share at least one common link with $P_{i,2}$. We also update to $+\infty$ the cost of the new paths used by the rerouted RLDs as well as the cost of the paths which share common links with these paths. We then update to ϵ the cost of the paths that have been used by the released lightpaths as well as the cost of the paths that share fiber-links with these paths provided that their fiber-links are not still used by any active LD. Hence the rerouting status of each existing lightpath is kept up-to-date after every successful lightpath establishment or release.

The second case to happen is that λ_4 cannot be freed because one or several RLDs cannot be rerouted. In that case, we update $\mathcal{O}_{i,2}^{4,t}$ to $+\infty$. We then compute again $\mathcal{O}_{i,k}^{t,min}$ still considering all the available wavelengths and shortest paths in R_i . This process is reiterated at most KW times.

When all the non-discarded wavelengths on all the shortest paths in R_i are considered and if the LD is not set up yet, the demand is definitively rejected. The pseudo code of the rerouting phase is given in Table 8.3. The worst case time complexity of the seqRWAwR considering the routing and the rerouting phases is $O(KW)$ time.

8.4.1.3 Illustrative example

In the following an example describing how the seqRWAwR algorithm computes the RWA for a given set of LDs. We consider the network topology shown in Figure 8.3 and the set of LDs described in Table 8.4. We compute $K = 2$ shortest paths for each source destination pair as shown in Table 8.4. We assume that there are $W = 2$ wavelengths on each fiber link of the network.

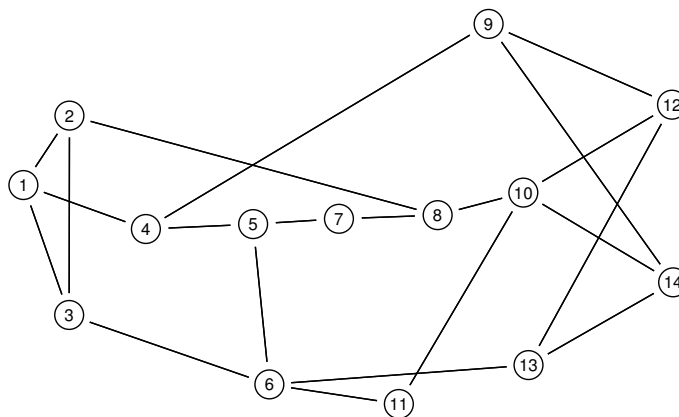

Figure 8.3 : National Science Foundation Network (NSFNet)

ALGORITHM *Rerouting algorithm used for PHASE 2*

Input: LD i , K , R_i , W

Output: Reroutes a minimum number of RLDs (respectively WDM channels) to free a path-free wavelength for a new arriving LD

(* The algorithm tries to free one path-free wavelength on one of the considered K -alternate shortest paths after rerouting a minimum number of already routed RLDs (a minimum number of WDM channels respectively). *)

```

1   $k := 1$ 
2  while ( $k \leq K$ ) and (FLAG=0) do
2.1  for  $\omega := 1$  to  $W$  do
2.2    (* identify the RLDs to reroute *)
2.3    compute  $Q_{i,k}^{\omega,t}$ 
2.4    discard a wavelength if an SLD is to be added to  $Q_{i,k}^{\omega,t}$ 
2.5    (* compute the number of RLDs (respectively WDM channels) to reroute while routing the new arriving LD on  $P_{i,k}$  using wavelength  $\lambda_\omega$  *)
2.6    compute  $O_{i,k}^{\omega,t}$ 
2.7  endfor
2.8  compute  $O_{i,k}^{t,min}$  the minimum number of RLDs (respectively WDM channels) to reroute to accommodate the LD on  $P_{i,k}$  using wavelength  $\lambda_\omega$ 
2.9  while ( $O_{i,k}^{t,min} \leq +\infty$ ) do
2.10    (* try to reroute all the RLDs in  $Q_{i,k}^{\omega,t}$ . If one of the RLDs cannot be rerouted, the following wavelength requiring a minimum number of RLDs (respectively WDM Channels) to reroute is selected. When none of the wavelengths on  $P_{i,k}$  can be freed, the following shortest path in  $R_i$  associated to LD  $i$  is considered. *)
2.11    FLAG:=0
2.12     $p:=1$ 
2.13    while (FLAG=0) do
2.14      reroute all the RLDs in  $Q_{i,k}^{\omega,t}$ 
2.15      if one RLD in  $Q_{i,k}^{\omega,t}$  cannot be rerouted then
2.16        FLAG=1
2.17      endif
2.18    endwhile
2.19    if FLAG=0 then
2.20      (* all the RLDs in  $Q_{i,k}^{\omega,t}$  are rerouted. The new arriving LD  $i$  is to be set up on  $P_{i,k}$  using  $\lambda_\omega$  *)
2.21      free the wavelengths used by the RLDs to be rerouted
2.22      instantiate the lightpath required by LD  $i$ 
2.23      update the cost of path  $P_{i,k}$  on wavelength  $\lambda_\omega$  to  $+\infty$ 
2.24      update the cost of all the paths that share a common link with  $P_{i,k}$  on  $\lambda_\omega$  to  $+\infty$ 
2.25      update the cost of the new lightpaths used by the rerouted RLDs to  $+\infty$ 
2.26      update the cost of the paths that share common links with the new paths of the rerouted RLDs on the used wavelengths
2.27    else
2.28      (* LD  $i$  cannot be set up on  $P_{i,k}$  on  $\lambda_\omega$ . Still considering the  $P_{i,k}$  consider the next wavelength that requires a minimum number of RLDs (respectively WDM channels) to be rerouted. *)
2.29       $Q_{i,k}^{\omega,t} := +\infty$ 
2.30      compute  $O_{i,k}^{t,min}$ 
2.31    endif
2.32  endwhile
2.33   $k = k + 1$ 
2.34 endwhile
end. Rerouting algorithm used for PHASE 2

```

Table 8.3 : Rerouting algorithm used for PHASE 2

When SLD δ_1 arrives at the network, we assume that no LDs have already been routed (all the wavelengths are available on all of the fiber links). $C_{1,1}^{\lambda_1,106} = 2$. λ_1 is hence selected for SLD δ_1 on $P_{1,1}$. The cost of using wavelength λ_1 on $P_{1,1}$ is updated to $+\infty$ ($C_{1,1}^{\lambda_1,106} = +\infty$). We then update

i	LD	s_i	d_i	π_i	α_i	β_i	R_i , the shortest paths	
1	SLD	2	10	1	106	1007	$P_{1,1}=2-8-10$	$P_{1,2}=2-3-6-11-10$
2	RLD	11	6	1	205	607	$P_{2,1}=11-6$	$P_{2,2}=11-10-12-13-6$
3	RLD	12	2	1	206	806	$P_{3,1}=12-10-8-2$	$P_{3,2}=12-13-6-3-2$
4	SLD	2	6	1	307	525	$P_{4,1}=2-3-6$	$P_{4,2}=2-1-3-6$
5	SLD	11	4	1	309	609	$P_{5,1}=11-6-5-4$	$P_{5,2}=11-10-14-9-4$
6	RLD	2	5	1	405	807	$P_{6,1}=2-8-7-5$	$P_{6,2}=2-3-6-5$
7	RLD	7	13	1	407	605	$P_{7,1}=7-5-6-13$	$P_{7,2}=7-8-10-14-13$
8	SLD	10	5	1	506	1009	$P_{8,1}=10-8-7-5$	$P_{8,2}=10-11-6-5$

Table 8.4 : The set of LDs to be set up

the cost of using λ_1 on the paths in $\mathcal{B}_{1,1}$ that have at least one common link with path $P_{1,1}$. We here only consider the shortest paths shown in Table 8.4 between the source and destination nodes of the LDs to be set up. $\mathcal{B}_{1,1} = \{P_{6,1}, P_{7,2}\}$ and $C_{6,1}^{\lambda_1,106} = +\infty$ and $C_{7,2}^{\lambda_1,106} = +\infty$. At time $t = 205$, RLD τ_2 is to be set up. We first have to check the cost of $P_{2,1}$ on λ_1 . $C_{2,1}^{\lambda_1,205} = 1$. λ_1 is still available on $P_{2,1}$. RLD τ_2 is set up using wavelength λ_1 on $P_{2,1}$. $C_{2,1}^{\lambda_1,205}$ is updated to $+\infty$ as well as the cost $C_{5,1}^{\lambda_1,205}$ of path $P_{5,1}$ and $C_{8,2}^{\lambda_1,205}$ of path $P_{8,2}$ on wavelength λ_1 as $P_{5,1}$ and $P_{8,2}$ have common links with path $P_{2,1}$ and belong to $\mathcal{B}_{2,1}$. Later RLD τ_3 arrives. $C_{3,1}^{\lambda_1,206} = 3$ and λ_1 is selected on $P_{3,1}$ for the RLD. $C_{3,1}^{\lambda_1,206}$ and $C_{8,1}^{\lambda_1,206}$ are updated to $+\infty$. At time $t = 307$, SLD δ_4 is to be established. $C_{4,1}^{\lambda_1,307} = 2$ and SLD δ_4 is set up using wavelength λ_1 on $P_{4,1}$. The cost of using wavelength λ_1 on $P_{4,1}$ ($C_{4,1}^{\lambda_1,307}$) is updated to $+\infty$ as well as the cost (rerouting status) of $P_{1,2}$ on λ_1 ($C_{1,2}^{\lambda_1,307} = +\infty$), the cost of $P_{4,2}$ on λ_1 ($C_{4,2}^{\lambda_1,307} = +\infty$), and the cost of $P_{6,2}$ on λ_1 ($C_{6,2}^{\lambda_1,307} = +\infty$). Table 8.5 shows the lightpaths that have already been set up at the arrival date of SLD δ_5 .

When SLD δ_5 is to be set up, $C_{5,1}^{\lambda_1,309} = +\infty$. λ_1 is no more available on $P_{5,1}$. $C_{5,1}^{\lambda_2,309} = 3$ and δ_5 is set up on $P_{5,1}$ using wavelength λ_2 . $C_{2,1}^{\lambda_2,309}$, $C_{5,1}^{\lambda_2,309}$, $C_{6,2}^{\lambda_2,309}$, and $C_{8,2}^{\lambda_2,309}$ are updated to $+\infty$. At time $t = 405$, RLD τ_6 arrives at the network. All the routed LDs are still active. $C_{6,1}^{\lambda_1,405} = +\infty$ and $C_{6,1}^{\lambda_2,405} = 3$. RLD τ_6 is hence routed on $P_{6,1}$ using wavelength λ_2 . $C_{1,1}^{\lambda_2,405}$, $C_{6,1}^{\lambda_2,405}$, $C_{7,1}^{\lambda_2,405}$, and $C_{8,1}^{\lambda_2,405}$, are updated to $+\infty$. RLD τ_7 is to be set up at time $t = 407$. None of the established lightpaths is released yet. $C_{7,1}^{\lambda_1,407} = 3$ and the RLD is set up on $P_{7,1}$ and wavelength λ_1 . $C_{7,1}^{\lambda_1,407}$ is updated to $+\infty$.

SLD δ_8 arrives when all the previous routed lightpath demands are still active. Table 8.6 shows the network state at the arrival date of SLD δ_8 . $C_{8,1}^{\lambda_1,506} = +\infty$, $C_{8,1}^{\lambda_2,506} = +\infty$, $C_{8,2}^{\lambda_1,506} = +\infty$, and $C_{8,2}^{\lambda_2,506} = +\infty$. There is no path-free wavelength to set up the SLD. PHASE 1 (routing phase) fails and PHASE 2 (rerouting phase) is launched to hopefully free at least one path-free wavelength on

i	LD	s_i	d_i	π_i	lightpath		LRR status					
					physical path	λ	shortest path (k = 1)			shortest path (k = 2)		
							$P_{i,1}$	$C_{i,1}^{1,t}$	$C_{i,1}^{2,t}$	$P_{i,1}$	$C_{i,2}^{1,t}$	$C_{i,2}^{2,t}$
1	SLD	2	10	1	2-8-10	λ_1	2-8-10	$+\infty$	2	2-3-6-11-10	$+\infty$	4
2	RLD	11	6	1	11-6	λ_1	11-6	$+\infty$	1	11-10-12-13-6	4	4
3	RLD	12	2	1	12-10-8-2	λ_1	12-10-8-2	$+\infty$	3	12-13-6-3-2	4	4
4	SLD	2	6	1	2-3-6	λ_1	2-3-6	$+\infty$	2	2-1-3-6	$+\infty$	3
5	SLD	11	4	1	not routed yet		11-6-5-4	$+\infty$	3	11-10-14-9-4	4	4
6	RLD	2	5	1	not routed yet		2-8-7-5	$+\infty$	3	2-3-6-5	$+\infty$	3
7	RLD	7	13	1	not routed yet		7-5-6-13	3	3	7-8-10-14-13	$+\infty$	4
8	SLD	10	5	1	not routed yet		10-8-7-5	$+\infty$	3	10-11-6-5	$+\infty$	3

Table 8.5 : The network state at the starting time of SLD δ_5 ($t = 309$)

i	LD	s_i	d_i	π_i	lightpath		LRR status					
					physical path	λ	shortest path (k = 1)			shortest path (k = 2)		
							$P_{i,1}$	$C_{i,1}^{1,t}$	$C_{i,1}^{2,t}$	$P_{i,1}$	$C_{i,2}^{1,t}$	$C_{i,2}^{2,t}$
1	SLD	2	10	1	2-8-10	λ_1	2-8-10	$+\infty$	$+\infty$	2-3-6-11-10	$+\infty$	4
2	RLD	11	6	1	11-6	λ_1	11-6	$+\infty$	$+\infty$	11-10-12-13-6	4	4
3	RLD	12	2	1	12-10-8-2	λ_1	12-10-8-2	$+\infty$	3	12-13-6-3-2	4	4
4	SLD	2	6	1	2-3-6	λ_1	2-3-6	$+\infty$	2	2-1-3-6	$+\infty$	3
5	SLD	11	4	1	11-6-5-4	λ_2	11-6-5-4	$+\infty$	$+\infty$	11-10-14-9-4	4	4
6	RLD	2	5	1	2-8-7-5	λ_2	2-8-7-5	$+\infty$	$+\infty$	2-3-6-5	$+\infty$	$+\infty$
7	RLD	7	13	1	7-5-6-13	λ_1	7-5-6-13	$+\infty$	$+\infty$	7-8-10-14-13	$+\infty$	4
8	SLD	10	5	1	not routed yet		10-8-7-5	$+\infty$	$+\infty$	10-11-6-5	$+\infty$	$+\infty$

Table 8.6 : The network state at the starting time of SLD δ_8 ($t = 506$)

one of the shortest paths associated to SLD δ_8 . For this purpose we first compute for each shortest path $P_{8,k}$, $1 \leq k \leq 2$, and for each wavelength λ_ω , $1 \leq \omega \leq 2$, $\mathcal{O}_{8,k}^{\omega,506}$, the number of RLDs, and $\mathcal{Q}_{8,k}^{\omega,506}$, the set of RLDs, to be rerouted to accommodate SLD δ_8 on $P_{8,k}$ using wavelength λ_ω at time $t = 506$ respectively. For clarity reasons, we here considered minimizing the number of rerouted RLDs (Rerouting is done the same way when the objective is to minimize the number of rerouted WDM channels). The number of RLDs and the set of RLDs to reroute in order to set up SLD δ_8 on one of its shortest paths using one of the available wavelengths in the network are shown in Table 8.7.

Wavelength λ_2 is discarded on path $P_{8,2}$ as it requires the rerouting of SLD δ_5 . We then compute

$P_{8,k}$	λ	$\mathcal{O}_{8,k}^{\omega,506}$	$\mathcal{Q}_{8,k}^{\omega,506}$
$P_{8,1}=10-8-7-5$	λ_1	2	$\{\tau_3, \tau_7\}$
$P_{8,1}=10-8-7-5$	λ_2	1	$\{\tau_6\}$
$P_{8,2}=10-11-6-5$	λ_1	1	$\{\tau_2\}$

Table 8.7 : The number of RLDs and RLDs to reroute in order to set up SLD δ_8 ($t = 506$)

$\mathcal{O}_{8,k}^{506,min}$. $\mathcal{O}_{8,k}^{506,min}$ corresponds to the minimum value in $\{\mathcal{O}_{8,1}^{1,506} = 2, \mathcal{O}_{8,1}^{2,506} = 1, \mathcal{O}_{8,2}^{1,506} = 1\}$. $\mathcal{O}_{8,k}^{506,min} = 1$, RLD τ_6 has to be rerouted to set up SLD δ_8 on $P_{8,1}$ using wavelength λ_2 . From Table 8.6, we deduce that τ_6 cannot be rerouted as $C_{6,1}^{\lambda_1,506} = +\infty$, $C_{6,2}^{\lambda_1,506} = +\infty$, and $C_{6,2}^{\lambda_2,506} = +\infty$. $\mathcal{O}_{8,1}^{2,506}$ is updated to $+\infty$ as τ_6 cannot be rerouted. We then look for the minimum number of RLDs to be rerouted in $\{2, +\infty, 1\}$. $\mathcal{O}_{8,k}^{506,min} = 1$, RLD τ_2 has to be rerouted to set up SLD δ_8 on $P_{8,2}$ using wavelength λ_1 . $C_{2,2}^{\lambda_1,506} = 4$, and $C_{2,2}^{\lambda_2,506} = 4$. $P_{2,2}$ has no common links with $P_{8,2}$. The lightpath associated to RLD τ_2 is released and $C_{2,1}^{\lambda_1,506}$ is updated to 1. $C_{5,1}^{\lambda_1,506}$, the cost of using λ_1 on $P_{5,1}$, and $C_{8,2}^{\lambda_1,506}$, the cost of using λ_1 on $P_{8,2}$ are updated to 3 respectively. SLD δ_8 is hence routed on $P_{8,2}$ using wavelength λ_1 and RLD τ_2 is rerouted on $P_{2,2}$ using wavelength λ_1 . $C_{2,2}^{\lambda_1,506}$, the cost of using λ_1 on $P_{2,2}$ is updated to $+\infty$. $C_{8,2}^{\lambda_1,506}$, the cost of using λ_1 on $P_{8,2}$ is also updated to $+\infty$. $C_{5,2}^{\lambda_1,506}$, $C_{3,2}^{\lambda_1,506}$, $C_{2,1}^{\lambda_1,506}$, $C_{5,1}^{\lambda_1,506}$ are updated to $+\infty$ as the corresponding shortest paths share common links with the paths of the established lightpaths. The network state, once SLD δ_8 is set up, is shown in Table 8.8.

i	LD	s_i	d_i	π_i	lightpath		LRR status					
					physical path	λ	shortest path ($k = 1$)			shortest path ($k = 2$)		
							$P_{i,1}$	$C_{i,1}^{1,t}$	$C_{i,1}^{2,t}$	$P_{i,1}$	$C_{i,2}^{1,t}$	$C_{i,2}^{2,t}$
1	SLD	2	10	1	2-8-10	λ_1	2-8-10	$+\infty$	$+\infty$	2-3-6-11-10	$+\infty$	4
2	RLD	11	6	1	11-10-12-13-6	λ_1	11-6	$+\infty$	$+\infty$	11-10-12-13-6	$+\infty$	4
3	RLD	12	2	1	12-10-8-2	λ_1	12-10-8-2	$+\infty$	3	12-13-6-3-2	$+\infty$	4
4	SLD	2	6	1	2-3-6	λ_1	2-3-6	$+\infty$	2	2-1-3-6	$+\infty$	3
5	SLD	11	4	1	11-6-5-4	λ_2	11-6-5-4	$+\infty$	$+\infty$	11-10-14-9-4	$+\infty$	4
6	RLD	2	5	1	2-8-7-5	λ_2	2-8-7-5	$+\infty$	$+\infty$	2-3-6-5	$+\infty$	$+\infty$
7	RLD	7	13	1	7-5-6-13	λ_1	7-5-6-13	$+\infty$	$+\infty$	7-8-10-14-13	$+\infty$	4
8	SLD	10	5	1	10-11-6-5	λ_1	10-8-7-5	$+\infty$	$+\infty$	10-11-6-5	$+\infty$	$+\infty$

Table 8.8 : The network state according to the seqRWAwR algorithm once SLD δ_8 is set up

8.4.2 Separate RWA with rerouting for scheduled and random lightpath demands

The separate RWA with Rerouting algorithm (sepRWAwR) deals with SLDs and RLDs separately as shown in Figure 8.4. The sepRWAwR first computes the RWA for SLDs (SLDs are known *a priori*) before considering the RLDs. The objective is to minimize the number of rejected SLDs for the given number of available wavelengths W . No rerouting is performed when computing the RWA for SLDs. The sepRWAwR then considers the RLDs on the fly according the seqRWAwR algorithm described previously and taking into account the RWA for SLDs which has already been calculated off-line. Let us remind that an RLD may use the resources that are to be used by an SLD if the lightpath of the considered RLD is to be released before the starting time of the SLD.

8.4.2.1 RWA for scheduled lightpath demands

Once again we use a Random Search (RS) algorithm to compute the RWA for the SLDs. As $\pi_i = 1$, both the atomic and non atomic RS algorithms described in Chapter 5 may be used here. The pseudo-code used to compute the RWA for the SLDs is described in Chapter 5 in Section 5.5.2.1.2 .

8.4.2.2 RWA with rerouting for random lightpath demands

Once the RWA for the SLDs has been calculated, the RLDs are set up sequentially according to the seqRWAwR algorithm described in Section 8.4.1. The routing phase (PHASE 1) tries to set up the new arriving RLD on one of its associated K -alternate shortest paths. If the routing phase fails to find a path-free wavelength for the RLD, the rerouting phase (PHASE 2) is launched to hopefully free one path-free wavelength to accommodate the incoming RLD. As discussed before, SLD rerouting is forbidden.

Again two objective functions have been considered within the rerouting phase. The first function tries to minimize the number of rerouted RLDs when a new one is set up. The second objective function aims at minimizing the number of WDM channels to be rerouted to free a path-free wavelength for the arriving RLD.

The same pseudo-codes described earlier, have been considered for the routing and rerouting phases.

8.4.2.3 Illustrative example

Let us again consider the example described in Section 8.4.1.3. The set of LDs to be set up are shown in Table 8.9. We first consider the RWA for SLDs before considering the RWA for RLDs. Four SLDs are to be set up.

One possible solution for the RWA for the SLDs is $\rho = ((1, 0), (1, 0), (1, 0), (1, 0))$. Indeed, with at the starting time of SLD δ_1 , $\kappa_{1,1}^{106} = (1, 1)$. Both wavelengths λ_1 and λ_2 are still available and λ_1 is

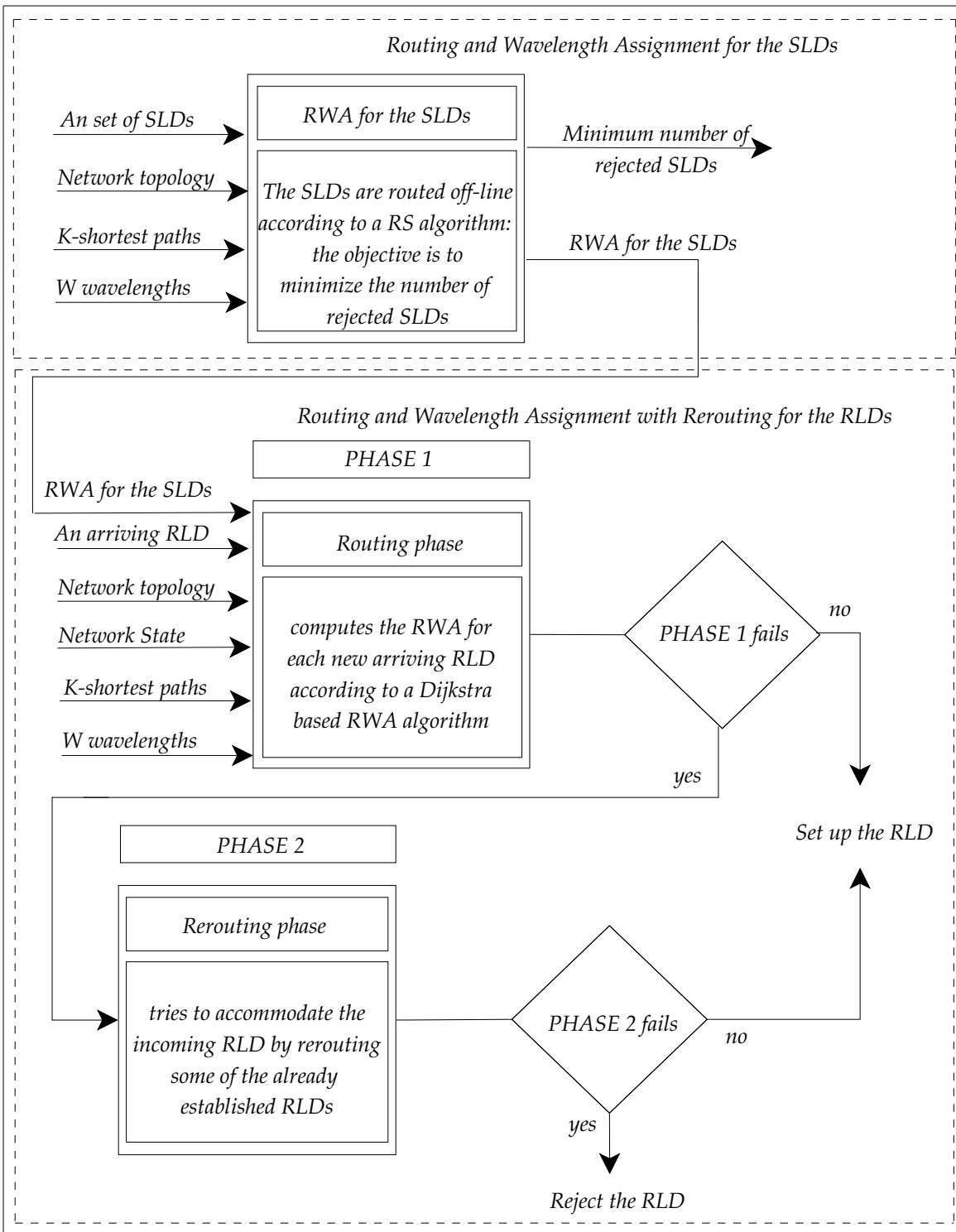

Figure 8.4 : Schematic representation of the *sepRWAwR* algorithm

i	LD	s_i	d_i	π_i	α_i	β_i	R_i , the shortest paths	
1	SLD	2	10	1	106	1007	$P_{1,1}=2-8-10$	$P_{1,2}=2-3-6-11-10$
2	RLD	11	6	1	205	607	$P_{2,1}=11-6$	$P_{2,2}=11-10-12-13-6$
3	RLD	12	2	1	206	806	$P_{3,1}=12-10-8-2$	$P_{3,2}=12-13-6-3-2$
4	SLD	2	6	1	307	525	$P_{4,1}=2-3-6$	$P_{4,2}=2-1-3-6$
5	SLD	11	4	1	309	609	$P_{5,1}=11-6-5-4$	$P_{5,2}=11-10-14-9-4$
6	RLD	2	5	1	405	807	$P_{6,1}=2-8-7-5$	$P_{6,2}=2-3-6-5$
7	RLD	7	13	1	407	605	$P_{7,1}=7-5-6-13$	$P_{7,2}=7-8-10-14-13$
8	SLD	10	5	1	506	1009	$P_{8,1}=10-8-7-5$	$P_{8,2}=10-11-6-5$

Table 8.9 : The set of LDs to be set up

selected on $P_{1,1}$ for δ_1 . At time $t = 307$, SLD δ_4 arrives at the network; $\kappa_{4,1}^{307} = (1, 1)$ so that SLD δ_4 is set up on $P_{4,1}$ using wavelength λ_1 . Later SLD δ_5 is to be set up. We then compute $\kappa_{5,1}^{309} = (1, 1)$ and SLD δ_5 is set up on $P_{5,1}$ using wavelength λ_1 . Finally, SLD δ_8 is to be considered. $\kappa_{8,1}^{506} = (1, 1)$ and SLD δ_8 is set up on $P_{8,1}$ using wavelength λ_1 . The RWA for the SLDs according to ρ is shown in Table 8.10.

i	SLD	s_i	d_i	π_i	α_i	β_i	lightpath	
							path	λ
1	SLD	2	10	1	106	1007	$P_{1,1}=2-8-10$	λ_1
4	SLD	2	6	1	307	525	$P_{4,1}=2-3-6$	λ_1
5	SLD	11	4	1	309	609	$P_{5,1}=11-6-5-4$	λ_1
8	SLD	10	5	1	506	1009	$P_{8,1}=10-8-7-5$	λ_1

Table 8.10 : RWA for the SLDs

Now we have to consider the RLDs taking into account the RWA for the SLDs. SLD δ_1 arrives when all the wavelengths are still free. The RWA for δ_1 has already been computed. δ_1 is set up on $P_{1,1}$ using wavelength λ_1 . $C_{1,1}^{\lambda_1,106}$, the cost of using wavelength λ_1 on $P_{1,1}$ is updated to $+\infty$. We then have to update the cost of the paths in $\mathcal{B}_{1,1}$ that share at least one common link with path $P_{1,1}$ on λ_1 , $C_{6,1}^{\lambda_1,106} = +\infty$ and $C_{7,2}^{\lambda_1,106} = +\infty$. At time $t = 205$, RLD τ_2 is to be set up. τ_2 cannot be set up on $P_{2,1}$ using λ_1 even if $C_{2,1}^{\lambda_1,205} = 1$ as wavelength λ_1 will be used at time $t = 309$ by SLD δ_5 on $P_{5,1}$ (see Table 8.10). $C_{2,1}^{\lambda_2,205} = 1$ and λ_2 is selected for τ_2 on $P_{2,1}$. $C_{2,1}^{\lambda_2,205}$ is updated to $+\infty$ as well as the cost $C_{5,1}^{\lambda_2,205}$ of path $P_{5,1}$ and $C_{8,2}^{\lambda_2,205}$ of path $P_{8,2}$ on wavelength λ_2 as $P_{5,1}$ and $P_{8,2}$ belong to $\mathcal{B}_{2,1}$. When RLD τ_3 arrives, τ_3 cannot use wavelength λ_1 on $P_{3,1}$ even though $C_{3,1}^{\lambda_1,206} = 3$. Indeed, SLD δ_8

will arrive at time $t = 506$ while RLD τ_3 is still active and will use λ_1 on path $P_{8,1}$ which belongs to $\mathcal{B}_{3,1}$. $C_{3,1}^{\lambda_2,206} = 3$ and λ_2 is selected to service RLD τ_3 on $P_{3,1}$. $C_{3,1}^{\lambda_2,206}$ and $C_{8,1}^{\lambda_2,206}$, the cost of paths $P_{3,1}$ and $P_{8,1}$ on λ_2 is updated to $+\infty$ respectively. SLD δ_4 arrives at time $t = 307$. δ_4 has to be set up on $P_{4,1}$ using wavelength λ_1 according to Table 8.10. $C_{4,1}^{\lambda_1,307}$ is updated to $+\infty$ as well as $C_{1,2}^{\lambda_1,307}$, $C_{4,2}^{\lambda_1,307}$, and $C_{6,2}^{\lambda_1,307}$. At time $t = 309$, SLD δ_5 is to be set up. The pair $(P_{5,1}, \lambda_1)$ is selected according to Table 8.10 to accommodate SLD δ_5 . $C_{5,1}^{\lambda_1,309}$, the cost of using wavelength λ_1 on $P_{5,1}$ is updated to $+\infty$ as well as costs $C_{2,1}^{\lambda_1,309}$ and $C_{8,2}^{\lambda_1,309}$ of paths $P_{2,1}$ and $P_{8,2}$ on λ_1 . At time $t = 405$, RLD τ_6 has to be set up. $C_{6,1}^{\lambda_1,405} = +\infty$ and $C_{6,1}^{\lambda_2,405} = 3$. λ_2 is hence selected for τ_6 on $P_{6,1}$. $C_{6,1}^{\lambda_2,405}$, $C_{1,1}^{\lambda_2,405}$, and $C_{7,1}^{\lambda_2,405}$ are updated to $+\infty$ as the corresponding respective paths share common links. When RLD τ_7 arrives, all the LDs are still active. $C_{7,1}^{\lambda_1,407} = 3$ but λ_1 cannot be assigned to the RLD on $P_{7,1}$ as it will be used later by SLD δ_8 whilst τ_7 is still active. $C_{7,1}^{\lambda_2,407} = +\infty$, $C_{7,2}^{\lambda_1,407} = +\infty$, and $C_{7,2}^{\lambda_2,407} = 4$. RLD τ_7 is hence to set up on $P_{7,2}$ using wavelength λ_2 . $C_{7,2}^{\lambda_2,407}$ and $C_{5,2}^{\lambda_2,407}$ are updated to $+\infty$. The last LD to be routed is SLD δ_8 . δ_8 is set up on $P_{8,1}$ using wavelength λ_1 and $C_{8,1}^{\lambda_1,506}$, $C_{3,1}^{\lambda_1,506}$, and $C_{7,1}^{\lambda_1,506}$ are updated to $+\infty$.

The RWA for the considered set of LDs (shown in Table 8.9), as computed by the sepRWAwR algorithm, is drawn in Table 8.11.

i	LD	s_i	d_i	π_i	lightpath		LRR status					
					physical path	λ	shortest path ($k = 1$)			shortest path ($k = 2$)		
							$P_{i,1}$	$C_{i,1}^{1,t}$	$C_{i,1}^{2,t}$	$P_{i,1}$	$C_{i,2}^{1,t}$	$C_{i,2}^{2,t}$
1	SLD	2	10	1	2-8-10	λ_1	2-8-10	$+\infty$	$+\infty$	2-3-6-11-10	$+\infty$	4
2	RLD	11	6	1	11-6	λ_2	11-6	$+\infty$	$+\infty$	11-10-12-13-6	4	4
3	RLD	12	2	1	12-10-8-2	λ_2	12-10-8-2	$+\infty$	$+\infty$	12-13-6-3-2	4	4
4	SLD	2	6	1	2-3-6	λ_1	2-3-6	$+\infty$	2	2-1-3-6	$+\infty$	3
5	SLD	11	4	1	11-6-5-4	λ_1	11-6-5-4	$+\infty$	$+\infty$	11-10-14-9-4	4	$+\infty$
6	RLD	2	5	1	2-8-7-5	λ_2	2-8-7-5	$+\infty$	$+\infty$	2-3-6-5	$+\infty$	3
7	RLD	7	13	1	7-8-10-14-13	λ_2	7-5-6-13	$+\infty$	$+\infty$	7-8-10-14-13	$+\infty$	$+\infty$
8	SLD	10	5	1	10-8-7-5	λ_1	10-8-7-5	$+\infty$	$+\infty$	10-11-6-5	$+\infty$	$+\infty$

Table 8.11 : The network state according to the sepRWAwR algorithm once SLD δ_8 is set up

8.5 Experimental results

The purpose of the experimental evaluation is to compare the performances of the proposed algorithms and assess the gain obtained thanks to rerouting. We use the following acronyms to refer to the

following algorithms.

- *seqRWA*: The sequential RWA algorithm computes sequentially, on the fly, the RWA for LDs without any rerouting (see Chapter 5).
- *sepRWA*: The separate RWA algorithm computes the RWA for SLDs and RLDs in two separate phases according to the *sepRWAwR* algorithm. The *sepRWA* algorithm does not use any rerouting (see Chapter 5).
- *seqRWAwR*: The sequential RWA with Rerouting algorithm computes the *RWAwR* for SLDs and RLDs as described in Section 8.4.1. The LDs are considered on the fly at their arrival times. No real distinction is made between SLDs and RLDs. PLDs are routed off-line. The rerouting phase, when activated, aims at minimizing the number of RLDs to be rerouted in order to set up an incoming LD (be it an SLD or an RLD).
- *sepRWAwR*: The separate RWA with Rerouting algorithm computes the *RWAwR* for SLDs and RLDs as described in Section 8.4.2. The RWA for SLDs and RLDs is computed in two separate phases. The rerouting phase, when activated, aims at minimizing the number of RLDs to be rerouted in order to set up an incoming RLD.

We used the network topologies shown in Figure 4.3 and Figure 4.4 with 14 and 29 nodes respectively. The source and destination nodes for SLDs and RLDs are drawn according to a random uniform distribution in the interval $[1, 14]$ for the 14-node network and in $[1, 29]$ for the 29-node network. The set-up/tear-down dates of the SLDs are also drawn according to a random uniform distribution in the interval $[1, 1440]$. We assume observation periods of about a day (1440 is the number of minutes in a day). The RLDs arrive according to a Poisson process with an arrival rate $\nu^{-1} = 1$ (min) and if accepted, will hold the circuits for exponentially distributed times with mean $\mu^{-1} = 500$ (min) much larger than the cumulated round-trip time and the connection set-up delay. We computed $K = 5$ shortest paths between the source node and destination node of any possible source destination pair in the network. We also assume that there are $W = 32$ wavelengths available on each fiber-link.

We generated 25 test scenarios, ran the algorithms for each scenario and compute rejection ratio averages for each algorithm. In the following, since the results obtained for the 29-node network are characterized by the same shapes, we only provide the curves obtained in the case of the 14-node network.

Table 8.12 shows the average rejection ratio w.r.t. D , the number of SLDs and RLDs arriving at the network. We notice that thanks to rerouting, the number of rejected LDs (SLDs and RLDs) is reduced. We also notice that the *seqRWAwR* algorithm computes the smallest rejection ratio. Unexpectedly, the *sepRWAwR* has a rejection ratio which is higher than the one computed by the *seqRWAwR*. This is

D	1219	1282	1375	1393	1495	1578	1626	1744	1864	1933
seqRWA (10^3)	12.566	21.869	39.771	43.626	68.477	88.949	98.667	124.106	152.918	164.691
sepRWA (10^3)	11.877	21.464	39.131	45.950	73.987	96.576	105.503	138.349	174.270	186.500
seqRWAwR (10^3)	0.755	3.588	11.259	14.465	35.308	57.322	63.975	90.482	122.468	135.680
sepRWAwR (10^3)	1.115	3.900	12.597	16.589	41.380	64.317	72.581	104.748	150.494	164.132

Table 8.12 : Average rejection ratio ($N = 14$, $W = 32$, $K = 5$, $\mu^{-1} = 500$, $\nu^{-1} = 1$, $\pi = 1$).

D	1219	1282	1375	1393	1495	1578	1626	1744	1864	1933
seqRWA	3	6	15	17	32	48	61	86	130	145
sepRWA	0	0	0	0	0	0	0	0	0	1
seqRWAwR	0	1	4	5	15	29	37	61	100	114
sepRWAwR	0	0	0	0	0	0	0	0	0	1

Table 8.13 : Average number of rejected SLDs ($N = 14$, $W = 32$, $K = 5$, $\mu^{-1} = 500$, $\nu^{-1} = 1$, $\pi = 1$).

D	1219	1282	1375	1393	1495	1578	1626	1744	1864	1933
seqRWA	12	22	40	44	70	92	100	131	155	173
sepRWA	14	28	54	64	111	152	172	241	325	359
seqRWAwR	1	4	11	15	37	61	68	97	128	148
sepRWAwR	1	5	17	23	62	102	118	183	280	316

Table 8.14 : Average number of rejected RLDs ($N = 14$, $W = 32$, $K = 5$, $\mu^{-1} = 500$, $\nu^{-1} = 1$, $\pi = 1$).

mainly due to the fact that when the RWA of SLDs is computed off-line, RLDs, when arriving at the network, cannot find enough free wavelengths to be set up. The number of rejected SLDs and RLDs for different values of D are shown in Tables 8.13 and 8.14 respectively. It must be noted that when D increases, the proposed RWA strategies compute almost the same rejection ratio. This can be explained by the fact that in the absence of free wavelengths in the network on which the already established lightpaths can be rerouted, LRR becomes infeasible.

In Figure 8.5, we draw the average rejection ratio gain w.r.t. D . The average rejection ratio gain has been computed as the difference between the average number of rejected LDs without LRR and the average number of rejected LDs with LRR divided by D and multiplied by 100. An average rejection ratio gain of 3.5% (5% for the 29-node network) is observed under the aforementioned simulation parameters. The rejection ratio gain increases with D before it drops under heavy load.

Figure 8.6 shows the average rejection ratio computed for our second objective function considered for the rerouting phase. This function aims at minimizing the number of WDM channels (belonging to RLDs) to be rerouted when accommodating an incoming lightpath demands. Two RWAwR strategies

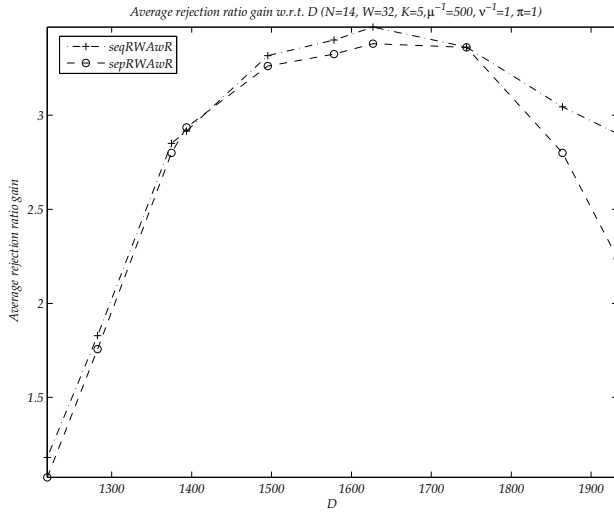

Figure 8.5 : Average rejection ratio gain.

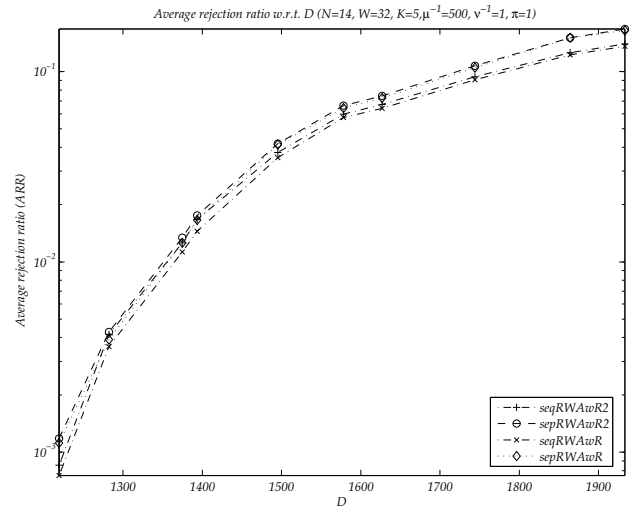

Figure 8.6 : Average rejection ratio.

have been implemented. The first one, called *seqRWAwR2*, computes sequentially the RWAwR for SLDs and RLDs as the *seqRWAwR* algorithm do. The second strategy, referred to as *sepRWAwR2*, computes the RWA for SLDs and RLDs in two separate phases according to the *sepRWAwR*. We notice that the *seqRWAwR* and the *sepRWAwR* algorithms have the smallest rejection ratios. Indeed, minimizing the number of WDM channels to be rerouted may lead to reroute several RLDs. These RLDs to be rerouted may use longer paths and hence may consume more network resources. This may block up the establishment of future arriving LDs.

Figures 8.7 and 8.8 show the average number of rerouted RLDs and WDM channels w.r.t. D . We notice, obviously, that the *seqRWAwR2* and the *sepRWAwR2* algorithms require more RLDs to be rerouted whereas the *seqRWAwR* and the *sepRWAwR* require more WDM channels to be rerouted. We can also notice from Figures 8.7 and 8.8 that the average length in terms of number of hops of rerouted random lightpaths is 2.5 hops. Implicitly, this short length lets assume a rapid rerouting procedure.

Figure 8.9 shows the average overall length for both random and scheduled lightpaths w.r.t. D . Each quadruplet of bars shows the average lightpath overall length of random lightpaths (height of the white bar) and scheduled lightpaths (height of the black bar) for each of the proposed algorithms described previously. The first and second bars (from the left-hand side) refer to the *seqRWA* and the *sepRWA* algorithms respectively whereas the third and fourth bars refer to the *seqRWAwR* and the *sepRWAwR* algorithms respectively. We outline that the lightpath overall length increases with D . We also notice that when rerouting is allowed, longer lightpaths are used by the lightpath requests. This can be explained by the fact that when a LD arrives at the network and when the routing phase fails,

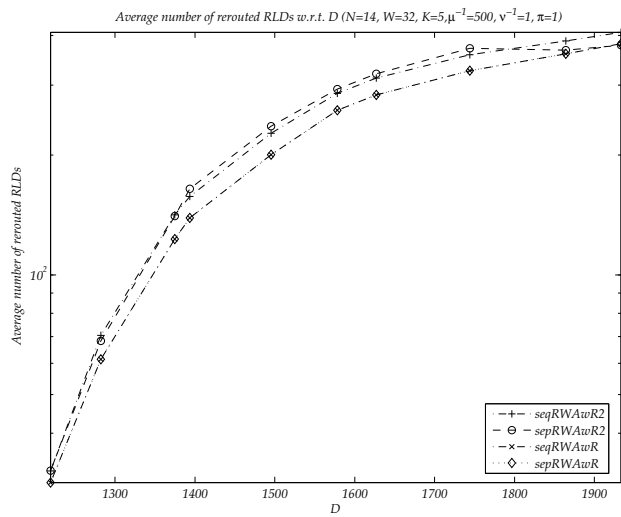

Figure 8.7 : Average number of rerouted RLDs.

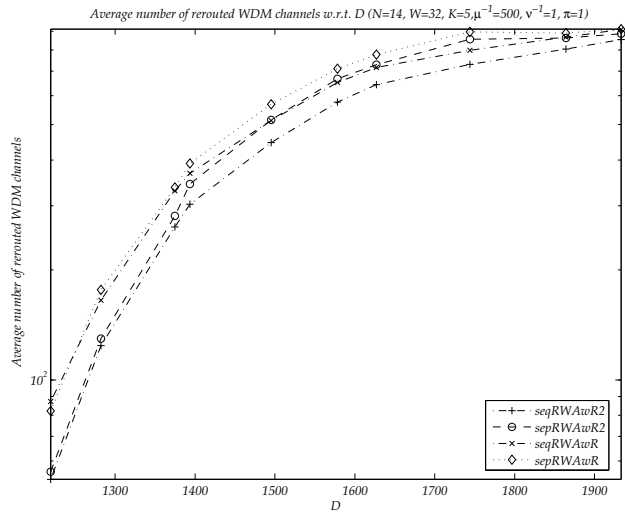

Figure 8.8 : Average number of rerouted WDM channels.

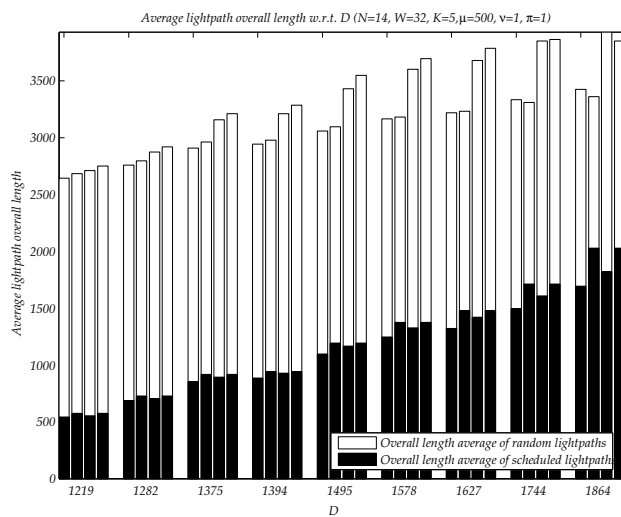

Figure 8.9 : average lightpath overall length

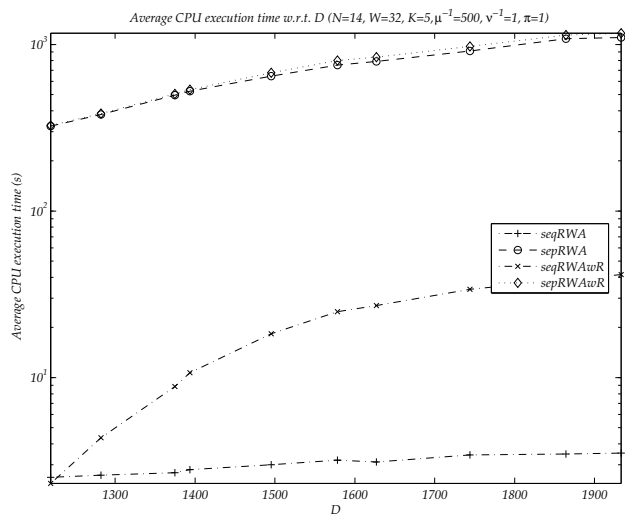

Figure 8.10 : Average CPU execution time.

the rerouting phase tries in a first attempt to reroute the existing RLDs by keeping their physical paths and changing only their wavelengths. If the routing of the incoming LD remains infeasible at this stage, the rerouting phase tries in a second attempt to move existing RLDs into different physical paths and possibly wavelengths. The new used paths are hence longer than the oldest ones.

Figure 8.10 draws the average CPU execution time required by each of the proposed algorithms. Sequential RWA_wR algorithms have smallest CPU execution times w.r.t. separate RWA_wR algorithms. The difference between the time required by the seqRWA algorithm and the time required by the seqRWA_wR algorithm corresponds to the time necessary to the rerouting phase to set up incoming LDs using LRR. The separate RWA algorithms, with and without rerouting, require almost the same CPU time. This time is mainly necessary to compute the RWA for SLDs according to the RS algorithm described previously. The time required for rerouting is short as fewer RLDs are to be satisfied and hence LRR is getting rare. SLDs are not concerned with rerouting as their RWA is computed off-line.

Chapter 9

Conclusions and Future Work

9.1 Conclusions

In this thesis we developed several software tools for solving all-optical networks design problems, as well as tools for analyzing the rejection ratios in circuit-switched WDM networks without wavelength converters. Three classes of traffic have been considered namely permanent lightpath demands (PLDs), scheduled lightpath demands (SLDs) and random lightpath demands (RLDs). We have considered the future scenario of WDM networks designed and optimized to support permanent and scheduled lightpath demands as well as lambda-connection service on demand. Different traffic priority classes may co-exist on the same optical network.

In Chapter 4 we studied the routing and wavelength assignment (RWA) problem for PLDs. We first developed integer linear programming models aiming at minimizing the number of rejected PLDs given a fixed amount of available wavelengths per fiber-link. The RWA for PLDs being NP complete we then proposed a Random Search heuristic to compute the RWA for PLDs. The PLDs are considered in a random manner when computing the paths and wavelengths they have to use. This is much different from the typical situation considered so far in most of the papers dealing with the RWA problem under static traffic assumptions in which the PLDs are routed sequentially according to a fixed order. Two versions of either the integer linear programming model and the Random Search heuristic have been presented depending on whether bifurcated (non atomic) routing is allowed or not. We showed that the approximate solution provided by the Random Search heuristic is close to the optimal one computed by integer linear programming models. We also showed that better performance are achieved when bifurcated routing is allowed (i.e. when the lightpaths requested by a lightpath demand may follow several paths between the source node and the destination node of the lightpath demand).

In Chapter 5 we investigated the RWA problem considering SLDs and RLDs. PLDs have not been considered as PLDs once set up remain in the network indefinitely which can be seen as a reduction in the number of available wavelengths on each fiber-link. Two algorithms have been presented. The former indiscriminately computes the RWA for SLDs and RLDs sequentially at the arrival time of each lightpath demand. The latter processes in two separate phases. It first computes the RWA for SLDs before selecting the paths and the wavelengths for RLDs upon the remained sparse resources in the network. Once again two versions of each algorithm have been presented depending on whether bifurcated routing is allowed or not. We showed that the first algorithm performs better than the second one in terms of rejection ratio while the second algorithm rejects fewer SLDs.

Chapter 6 focuses on the routing and spare capacity assignment (RSCA) problem for PLDs. A failure-independent shared path protection scheme has been adopted to minimize the amount of spare resources required to ensure protection. We decomposed the RSCA problem for PLDs in two separate problems the routing subproblem and the wavelength assignment subproblem. The former computes the paths for the primary and backup lightpaths the latter assigns wavelength for the computed paths. Two integer linear programming models have been presented. The first model computes the primary paths and the backup paths separately while the second one jointly computes the primary and backup paths. We then used an integer linear programming model to select wavelengths for the computed primary and backup paths. The wavelength assignment subproblem being NP complete, we then proposed to use an approximate graph coloring heuristic namely DSATUR to select the wavelengths. We defined a generalization of the conflict graph and an extension of the DSATUR algorithm to deal with both the primary paths and the backup paths. The second part of the chapter presents a Random Search heuristic to deal with the RSCA problem for large problem instances. The routing and wavelength assignment subproblems are addressed jointly. We showed that the first integer linear programming model performs as better as the second when as the number of requested wavelengths computed for both models remain almost the same. The approximate solution computed by the Random Search heuristic remains close to the optimal solution computed by the exact models.

In Chapter 7 we extend the work presented in Chapter 6 to deal with both the SLDs and the RLDs. The routing and wavelength assignment subproblems are addressed simultaneously. We presented two algorithms. The first algorithm computes the RSCA for the SLDs and the RLDs on the fly at their arrival times. The second algorithm computes the RSCA for SLDs off-line and then considers the RLDs on the fly tacking into account the RSCA for SLDs. Two versions of each algorithm have been described depending on whether bifurcated routing is allowed on not. We evaluate the rejection ratio gain thanks to bifurcated routing and studied the trade-off between resource efficiency usage and computational cost of each algorithm.

In Chapter 8 we gave traffic engineering methods in order to improve rejection ratios in all-optical

WDM transport networks affected by the wavelength continuity constraint. We proposed lightpath rerouting methods with different objectives. We showed that the rejection ratio is improved significantly thanks to rerouting at the price of a higher signaling overhead. We also proved that our proposed methods are less time consuming than the methods proposed so far in literature.

9.2 Future tracks

Future work will focus on the following topics:

- In Chapters 4 and 6 we presented new MOILP models to address the RWA and the RSCA problems for PLDs. These MOILPs turn out to be intractable even for small problem instances. In order to process large problems, the set of PLDs may be for instance partitioned on the physical network topology into different subsets so that the number of demands of each subset can be processed with the proposed MOILPs. The solutions of the subsets may then be assembled to form a global solution for the original set of PLDs. We want to define how to virtually cut out the original set of PLDs to form the different subsets and evaluate the gain in terms of computation time obtained by such a solution and study the performance of this approach in terms of network resources requirement or rejection ratios with respect to the global solution obtained without partitioning the set of demands.
- In Chapter 8 we studied lightpath rerouting techniques to improve the rejection ratios in all-optical WDM networks. We demonstrated that thanks to lightpath rerouting we achieve a rejection ratio gain of 5% while few paths join the source to the destination of each lightpath demand. Such a gain may be obtained by allowing sparse wavelength conversion in the network. We want to determine the minimum number of required wavelength converters and their placements to achieve the same gains obtained with lightpath rerouting. We also want to study the performance of such approach in terms of network signaling and network cost in comparison with the proposed lightpath rerouting methods.
- The proposed methods and algorithms must be adapted so that they may be used in a real world all-optical network. Indeed, in such networks without wavelength conversion at intermediate nodes, transmission impairments resulting from the peculiar characteristics of optical communications complicate the process of path selection and wavelengths assignment. These transmission impairments include loss, noise (due primarily to Amplifier Spontaneous Emission - ASE), dispersion (Chromatic Dispersion - CD, and Polarization Mode Dispersion - PMD), cross-talk, and non-linear effects. Thus, the feasibility of a path between a node pair in the network is no longer simply a function of topology and resource availability but will also depend on the accumulation

of impairments along the path. If the impairments accumulation is excessive, the Optical Signal to Noise Ratio (OSNR) and hence the electrical Bit Error Rate (BER) at the destination node may be not acceptable (exceeds a threshold), making the resultant lightpath unusable for data communications.

- In an optical network, a control mechanism is needed to set up and tear down lightpaths [56] [79] [78]. Upon the arrival of a lightpath demand, this mechanism must be able to select a path, assign a wavelength to the selected path, and configure the appropriate optical switches in the network. The mechanism must also be able to provide updates to reflect which wavelengths are currently being used on each fiber-link so that nodes may make informed routing decisions.
- While WDM technology brings huge transmission capacity potential to a single fiber, the capacity requirement of a single lightpath demand might be far less than the capacity of a single wavelength. Traffic grooming tries to address this capacity mismatch problem by packing low-rate lightpath demands into high-rate lightpaths. Throughout this thesis we considered lightpath demands requesting a whole number of lightpaths. Future work need to define cost effective grooming strategies to *groom* the multiple low rates lightpath demands into high-rate optical channels that the network throughput is maximized.

Bibliography

- [1] D. O. Awduche. MPLS and Traffic Engineering in IP Networks. *ieee-cm*, 37(12):42–47, Dec. 1999.
- [2] D. Awduche, J. Malcolm, J. Agogbua, M. O'Dell, J. McManus, W. S. Lai, and D. McDysan. Requirements for Traffic Engineering over MPLS. RFC 2702, Internet Engineering Task Force, Sep. 1999. <http://asg.web.cmu.edu/rfc/rfc2702.html>.
- [3] G. N. Rouskas and H. G. Perros. A Tutorial on Optical Networks. In Lecture Notes in Computer Science, editor, *Networking 2002 Tutorials*, volume 2497, pages 155–193, New York, NY, USA, 2002.
- [4] S. Blake, D. Black, M. Carlson, E. Davies, Z. Wang, and W. Weiss. An Architecture for Differentiated Services. RFC 2475, Internet Engineering Task Force, Dec. 1998. <http://rfc.net/rfc2475.html>.
- [5] E. Rosen, A. Viswanathan, and R. Callon. Multi-protocol Label Switching Architecture. RFC 3031, Internet Engineering Task Force, Jan. 2001. <http://asg.web.cmu.edu/rfc/rfc3031.html>.
- [6] Y. Rekhter B. S. Davie. *MPLS Technology and Applications*. mk-sn, San Francisco, CA, USA, 2000.
- [7] P. E. Green. *Fiber-Optic Networks*. ph, Englewood Cliffs, NJ, 1992.
- [8] R. Ramaswami. MultiWavelength Lightwave Networks for Computer Communication. *ieee-cm*, 31(2):78–88, Feb. 1993.
- [9] N. K. Cheung, K. Nosu, and G. Winzer. Special issue on Dense WDM Networks. *ieee-jsac*, 8(6), Aug. 1990.
- [10] K. Hold. Perception is reality: Internet growth: It ain't what it used to be, but then it never really was. *Broadband World*, 3(2), 2001. <http://www.broadbandpub.com/broadbandworld/v3n2/coverstory.pdf>.

- [11] S. Young, R. Modi, and M. Holland. Global bandwidth: Strategies in an oversupplied market. An Ovum report, Oct. 2002. <http://www.ovum.com>.
- [12] RHK. United States Internet Traffic Experiences Annual Growth of 100% but a 17% Revenue Drop. RHK, Telecommunication Industry Analysis, May 2002. <http://www.rhk.com/pressrelease.asp?id=157>.
- [13] L. Grimaldi. The future of the bandwidth market and the impact of new optical technologies. Business Briefing: Global Optical Communications, 2002.
- [14] A. Solheim. Agile Photonic Networking. World Markets Series: Global Optical Communications World Markets Whitepaper, Jul. 2002.
- [15] J. X. Cai et al. 2.4 Tb/s (120 × 20 Gb/s) Transmission over Transoceanic Distance with Optimum FEC Overhead and 48 Percent Spectral Efficiency. In *Proceedings, Optical Fiber Communication 2001 Technical Digest*, pages PD20/1–3, Anaheim, CA, 2001.
- [16] B. Bakhshi et al. 1 Tbit/s (101 × 10 Gbit/s) Transmission over Transpacific Distance using 28 nm C-band EDFAs. In *Optical Fiber Communication 2001 Technical Digest*, page PD21/1Ü3, Anaheim, CA, 2001.
- [17] G. Varella, F. Pitel, and J. F. Marcero. 3 Tb/s (300 × 11.6 Gb/s) Transmission over 7380 km using 28 nm C+L-Band with 25 Ghz Channel Spacing and NRZ Format. In *Optical Fiber Communication 2001 Technical Digest*, page PD22/1Ü3, Anaheim, CA, 2001.
- [18] B. Zhu et al. 3.08 Tb/s (77 × 42.7 Gb/s) Transmission over 1200 km of Non-Zero Dispersion-Shifted Fiber with 100-km Spans using C-L-Band Distributed Raman Amplification. In *Optical Fiber Communication 2001 Technical Digest*, page PD23/1Ü3, Anaheim, CA, 2001.
- [19] ITU-T. Spectral Grids for WDM Applications: DWDM Frequency Grid. Recommendation G.694.1, International Telecommunication Union, Jun. 2002.
- [20] P. Green. Progress in Optical Networking. *ieee-cm*, 39(1):54–61, Jan. 2001.
- [21] K. C. Kao and G. A. Hockham. Dielectric-Fiber Surface Waveguides for Optical Frequencies. *Institution of Electrical Engineers*, 133(3):1151–1158, Jul. 1996.
- [22] F. P. Kapron, D. B. Keck, and R. D. Maurer. Radiation Losses in Glass Optical Waveguides. *Applied Physics Letters*, 17(10):423–425, Nov. 1970.
- [23] J. B. MacChesney, P. B. O'Connor, F. V. DiMarcello, J. R. Sompson, and P. D. Lazay. Preparation of Low Loss Optical Fibers Using Simultaneous Vapor Phase Deposition and Fusion. In *Proceedings, 10th International Congress on Glass*, volume 6, pages 40–44, Kyoto, Japan, 1974.

- [24] R. Ramaswami. Optical Fiber Communication: From Transmission to Networking. *iee-cm*, 40(5):138–147, May 2002.
- [25] R. Ramaswami. Optical Fiber Communication: From Transmission To Networking. *iee-cm*, 40(5):138–147, May 2002.
- [26] R. Ramaswami and K. Sivarajan. *Optical Networks: A Practical Perspective*. mk-sn, 1998.
- [27] ITU-T. Characteristics of a Single-Mode Optical Fibre Cable. Recommendation G.652, International Telecommunication Union, Apr. 1997.
- [28] J. S. Cook and O. I. Szentesi. North American Field Trials and Early Applications in Telephony. *iee-jsac*, 1(3):393–397, Apr. 1983.
- [29] A. Moncalvo and F. Tosco. European Field Trials and Early Applications in Telephony. *iee-jsac*, 1(3):398–403, Apr. 1983.
- [30] H. Ishio. Japanese Field Trials and Applications in Telephony. *iee-jsac*, 1(3):404–412, Apr. 1983.
- [31] J. R. Stauffer. FT3C - A Lightwave System for Metropolitan and Intercity Applications. *iee-jsac*, 1(3):413–419, Apr. 1983.
- [32] ITU-T. Characteristics of a Dispersion-Shifted Single-Mode Optical Fibre Cable. Recommendation G.653, International Telecommunication Union, Apr. 1997.
- [33] D. Papadimitriou and D. Penninckx. Physical Routing Impairments in wavelength-Switched Optical Networks. *Business Briefing: Global Optical Communications*, 2002.
- [34] Comparing Metro WDM Systems: Unidirectional vs. Bidirectional Implementations. Cisco Systems White Paper, 2001. http://www.cisco.com/warp/public/cc/pd/olpl/metro/on15500/on15540/prodlit/cisim_wp.htm.
- [35] S. Saracino. Which Core Technology for your Network? *BT Technology Journal*, 20(4):19–26, Oct. 2002.
- [36] K. Grobe, M. Donhauser, M. Wiegand, and J. McCall. Optical Metropolitan DWDM Networks: An Overview. *BT Technology Journal*, 20(4):27–44, Oct. 2002.
- [37] A. Kung, A. Agarwal, S. Banerjee, D. Grosz, D. Maywar, M. Movassaghi, and T. Wood. 10 Gb/s and 40 Gb/s Ultra-Long-Haul Transmission on a Common all-Raman Single-Wide-Band Platform. In *Proceedings, European Conference on Optical Communications*, Copenhagen, Denmark, Sep. 2002.

- [38] O. Gerstel, R. Ramaswami, and S. Foster. Merits of Hybrid Optical Networking. In *Proceedings, Optical Fiber Communication*, pages 33–34, Anaheim, California, USA, Mar. 2002.
- [39] J. Nikolopoulos, J. Leung, K. Gardiner, and T. Stephens. Transport Planning Considerations in Next Generation Backbone Optical Networks. In *Proceedings, National Fiber Optic Engineers Conference*, Dallas, Texas, USA, Sep. 2002.
- [40] D. Grosz, A. Agarwal, S. Banerjee, A. Kung, D. Maywar, A. Gurevich, T. Wood, C. Lima, B. Faer, J. Black, and C. Hwu. 5.12 Tb/s (128 × 42.7 Gb/s) Transmission with 0.8 bit/s/Hz Spectral Efficiency over 1280 km of Standard Single-Mode Fiber using All-Raman Amplification and Strong Signal Filtering. In *Proceedings, European Conference on Optical Communications*, Copenhagen, Denmark, Sep. 2002.
- [41] B. Doshi, D. Einstein, R. Nagarajan, S. Prasanna, C. Baatar, N. Blackwood, M. Sharma, S. Jothipragasam, A. Alfakih, and N. Raman. Ever-Higher Bit Rate per Wavelength, Ultra-Long Haul DWDM Systems, Optical Transparency, and Sub-Rate Grooming: A Complex Multi-dimensional Puzzle. In *Proceedings, 10th International Telecommunication Network Strategy and Planning Symposium*, pages 537–546, Munich, Germany, Jun. 2002.
- [42] M. Islam. Raman Amplifiers for Telecommunications. *IEEE Journal of Selected Topics in Quantum Electronics*, 8(3):548–559, May 2002.
- [43] Y. Zhou, A. Lord, and E. Sikora. Ultra-Long-Haul WDM Transmission Systems. *BT Technology Journal*, 20(4):61–70, Oct. 2002.
- [44] G. Jones, J. Nijhof, and W. Forsyiaik. Optimisation of 80 × 10 Gbit/s Ultra-Long-Haul DWDM Systems. In *Proceedings, London Communications Symposium*, London, UK, Sep. 2002.
- [45] A. Gumaste and T. Antony. *DWDM Network Designs and Engineering Solutions*. Cisco Press Networking Technology Series, 2003.
- [46] D. K. Hunter, M. H. M. Nizam, M. C. Chia, I. Andonovic, K. M. Guild, A. Tzanakaki, M. J. O’Mahony, L. D. Bainbridge, M. F. C. Stephens, R. V. Penty, and I. H. White. WASPNET: A Wavelength Switched Packet Network. *ieee-cm*, 37(3):120–129, Mar. 1999.
- [47] I. Chlamtac, V. Elek, A. Fumagalli, and C. Szabo. Scalable WDM Network Architecture Based on Photonic Slot Routing and Switched Delay Lines. In *ieee-infocom*, volume 2, pages 7–11, Kobe, Japan, Apr. 1997.

- [48] M. Yoo and C. Qiao. Just-Enough-Time (JET): A High Speed Protocol for Bursty Traffic in Optical Networks. In *Proceedings, IEEE/LEOS Conference on Technologies for a Global Information Infrastructure*, pages 26–27, Aug. 1997.
- [49] P. Gambini, M. Renaud, C. Guillemot, F. Callegati, I. Andonovic, B. Bostica, D. Chiaroni, G. Corazza, S. L. Danielsen, P. Gravey, P. B. Hansen, M. Henry, C. Janz, A. Kloch, R. Krahenbuhl, C. Raffaelli, M. Schilling, A. Talneau, and L. Zucchelli. Transparent optical packet switching: network architecture and demonstrators in the KEOPS project. *ieee-jsac*, 16(7):1245–1259, Sep. 1998.
- [50] B. B. Mortensen and M. S. Berger. Optical Packet Switched Demonstrator. In *Proceedings, Optical Internet and Photonic Switching Conference*, pages 27–29, Jeju Island, South Korea, Jul. 2002.
- [51] Y. Xiong, M. Vandenhoute, and H. Cankaya. Design and Analysis of Optical Burst-Switched Networks. In *Proceedings, SPIE All-Optical Networking 1999: Architecture, Control, and Management Issues*, volume 3843, pages 112–119, Aug. 1999.
- [52] B. Mukherjee. *Optical Communication Networks*. mh, Jul. 1997.
- [53] T. E. Stern and K. Bala. *Multiwavelength Optical Networks : a Layered Approach*. aw, 1999.
- [54] O. Gerstel and S. Kutten. Dynamic Wavelength Allocation in All-Optical Ring Networks. In *ieee-icc*, volume 1, pages 432–436, Montreal, Quebec, Canada, Jun. 1997.
- [55] J. Y. Yoo and S. Banerjee. Design, Analysis, and Implementation of Wavelength-Routed All-Optical Networks. In *IEEE Communications Surveys, Broadband Networks area*, 1997. <http://home.att.net/~sbanerjee/publications.html>.
- [56] H. Zang, J. P. Jue, and B. Mukherjee. A Review of Routing and Wavelength Assignment Approaches for Wavelength-Routed Optical WDM Networks. *onm*, 1(1):47–60, Jan. 2000.
- [57] D. Banerjee and B. Mukherjee. A Practical Approach for Routing and Wavelength Assignment in Large Wavelength-Routed Optical Networks. *ieee-jsac*, 14(5):903–908, Jun. 1996.
- [58] J. P. Jue. Lightpath Establishment in Wavelength-Routed WDM Optical Networks. *Optical networks: recent advances*, pages 99–122, 2001. <http://www.utdallas.edu/~jjue/cs6v81/articles/dle.pdf>.
- [59] Y. Zhu and R. Lin. Algorithms for Lightpath Establishment in Wavelength-Routed Networks. In C. F. Lam, C. Fan, N. Hanik, and K. Oguchi, editors, *Optical Transmission, Switching, and*

- Subsystems, Proceedings of the SPIE*, volume 5281, pages 334–341, May 2004. http://adsabs.harvard.edu/cgi-bin/nph-bib_query?bibcode=2004SPIE.5281..334Z&db_key=PHY.
- [60] I. Chlamtac, A. Ganz, and G. Karmi. Lightpath Communications: An Approach to High-Bandwidth Optical WANs. *ieee-tr-com*, 40(7):1171–1182, Jul. 1992.
- [61] R. Ramaswami and K. N. Sivarajan. Routing and Wavelength Assignment in All-Optical Networks. *ieee-acm-tn*, 3(5):489–500, Oct. 1995.
- [62] I. Chlamtac, A. Ganz, and G. Karmi. Lightnet: Lightpath Based Solutions for Wide Bandwidth WANs. In *ieee-infocom*, volume 3, pages 1014–1021, San Francisco, CA, Jun. 1990.
- [63] S. Subramaniam and A. B. Richard. Wavelength Assignment in Fixed Routing WDM Networks. In *ieee-icc*, volume 1, pages 406–410, Montreal, Canada, Jun. 1997.
- [64] K. Chan and T. P. Yum. Analysis of Least Congested Path Routing in WDM Lightwave Networks. In *ieee-infocom*, volume 2, pages 962–969, Toronto, Canada, Apr. 1994.
- [65] H. Harai, M. Murata, and H. Miyahara. Performance of Alternate Routing Methods in All-Optical Switching Networks. In *ieee-infocom*, volume 2, pages 516–524, Kobe, Japan, Apr. 1997.
- [66] L. Li and A. K. Somani. Dynamic Wavelength Routing Using Congestion and Neighborhood Information. *ieee-acm-tn*, 7(5):779–786, Oct. 1999.
- [67] S. Ramamurthy and B. Mukherjee. Fixed-Alternate Routing and Wavelength Conversion in Wavelength-Routed Optical Networks. *ieee-acm-tn*, 10(3):351–367, Jun. 2002.
- [68] S. Ramamurthy. *Optical Design of WDM Network Architectures*. Ph.d. dissertation in telecommunications, University of California, Davis, 1998.
- [69] I. Chlamtac, A. Ganz, and G. Karmi. Purely Optical Networks for Terabit Communication. In *ieee-infocom*, volume 3, pages 887–896, Washington, DC, Apr. 1989.
- [70] R. A. Barry and S. Subramaniam. The MAX-SUM Wavelength Assignment Algorithm for WDM Ring Networks. In *Proceedings, Optical Fiber Communication*, pages 121–122, Dallas, USA, Feb. 1997.
- [71] A. Birman and A. Kershenbaum. Routing and Wavelength Assignment Methods in Single-Hop All-Optical Networks with Blocking. In *ieee-infocom*, volume 2, pages 431–438, Boston, MA, Apr. 1995.

- [72] G. Jeong and E. Ayanoglu. Comparison of Wavelength-Interchanging and Wavelength-Selective Cross-Connects in Multiwavelength All-Optical Networks. In *ieee-infocom*, volume 1, pages 156–163, San Francisco, CA, Mar. 1996.
- [73] E. Karasan and E. Ayanoglu. Effects of Wavelength Routing and Selection Algorithms on Wavelength Conversion Gain in WDM Optical Networks. *ieee-acm-tn*, 6(2):186–196, Apr. 1998.
- [74] S. Subramaniam and R. A. Barry. Wavelength Assignment in Fixed Routing WDM Networks. In *ieee-icc*, volume 1, pages 406–410, Jun. 1997.
- [75] X. Zhang and C. Qiao. Wavelength Assignment for Dynamic Traffic in Multi-fiber WDM Networks. In *Proceedings, the 7th International Conference on Computer Communications and Networks*, pages 479–485, Lafayette, LA, Oct. 1998.
- [76] K. Bala, T. E. Stern, and K. Bala. Algorithms for Routing in a Linear Lightwave Network. In *ieee-infocom*, volume 1, pages 1–9, Miami, FL, Apr. 1991.
- [77] A. Mokhtar and M. Azizoglu. Adaptive Wavelength Routing in All-Optical Networks. *ieee-acm-tn*, 6(2):197–206, Apr. 1998.
- [78] R. Ramaswami and A. Segall. Distributed Network Control for Wavelength Routed Optical Networks. In *ieee-infocom*, volume 1, pages 138–147, San Francisco, CA, Mar. 1996.
- [79] H. Zang, L. Sahasrabudhe, J. P. Jue, S. Ramamurthy, and B. Mukherjee. Connection Management for Wavelength-Routed WDM Networks. In *ieee-globecom*, volume 2, pages 1428–1432, Rio de Janeiro, Brazil, Dec. 1999.
- [80] J. P. Jue and G. Xiao. An Adaptive Routing Algorithm with a Distributed Control Scheme for Wavelength-Routed Optical Networks. In *Proceedings, the 9th International Conference on Computer Communications*, pages 192–197, Oct. 2000.
- [81] E. Karasan and E. Ayanoglu. Performance of WDM Transport Networks. *ieee-jsac*, 16(7):1081–1096, Sep. 1998.
- [82] X. Sun, Y. Li, I. Lambadaris, and Y. Q. Zhao. Performance Analysis of First-Fit Wavelength Assignment Algorithm in Optical Networks. In *Proceedings, 7th International Conference on Telecommunications*, volume 2, pages 403–409, Jun. 2003.
- [83] C. S. R. Murthy and M. Gurusamy. *WDM Optical Networks: Concepts, Design, and Algorithms*. ph, 2002.

- [84] O. Gerstel and R. Ramaswami. Optical Layer Survivability: An Implementation Perspective. *ieee-jsac*, 18(10):1885–1899, Oct. 2000.
- [85] W. S. Lai and D. McDysan. Network Hierarchy and Multilayer Survivability. RFC 3386, Internet Engineering Task Force, Nov. 2001. <http://www.faqs.org/rfcs/rfc3386.html>.
- [86] R. R. Iraschko, M. H. MacGregor, and W. D. Grover. Optimal Capacity Placement for Path Restoration in Mesh Survivable Networks. In *ieee-icc*, volume 3, pages 1568–1574, Jun. 1996.
- [87] G. Mohan and A. K. Somani. Routing Dependable Connections with Specified Failure Restoration Guarantees in WDM Networks. In *ieee-infocom*, volume 3, pages 1761–1770, Jerusalem, Mar. 2000.
- [88] B. T. Doshi, S. Dravida, P. Harshavardhana, O. Hauser, and Y. Wang. Optical Network Design and Restoration. *Bell Labs Technical Journal*, pages 58–83, Jan. 1999.
- [89] S. Ramamurthy and B. Mukherjee. Survivable WDM Mesh Networks, Part I - Protection. In *ieee-infocom*, volume 2, pages 744–751, New York, USA, Mar. 1999.
- [90] S. Ramamurthy and B. Mukherjee. Survivable WDM Mesh Networks, Part II - Restoration. In *ieee-icc*, volume 3, pages 2023–2030, Mar. 1999.
- [91] F. Ricciato, S. Salsano, and M. Listanti. Optimal Routing for Protection and Restoration in an Optical Network. *pnc*, 4(3):409–422, Jul. 2002.
- [92] C. P. Larsen, D. Fogaras, T. Cinkler, and D. Marx. Heuristic Algorithms for Joint Configuration of the Optical and Electrical Layer in Multi-Hop Wavelength Routing Networks. In *ieee-infocom*, volume 2, pages 1000–1009, Apr. 2000.
- [93] J. B. Orlin, R. K. Ahuja, and T. L. Magnanti. *Network Flows: Theory, Algorithms and Applications*. ph, 1993.
- [94] C. S. Li and R. Ramaswami. Automatic Fault Detection, Isolation, and Recovery in Transparent All-Optical Networks. *ieee-jlt*, 15(10):1784–1793, Oct. 1997.
- [95] N. Nagatsu, S. Okamoto, and K. Sato. An Optical Path Cross-Connect System Scale Evaluation Using Path Accommodation Design for Restricted Wavelength Multiplexing. *ieee-jsac*, 14(5):893–902, Jun. 1996.
- [96] M. Alanyali and E. Ayanoglu. Provisioning Algorithms for WDM Optical Networks. *ieee-tr-com*, 7(5):767–778, Oct. 1999.

- [97] G. Mohan and C. S. R. Murthy. Routing and Wavelength Assignment for Establishing Dependable Connections in WDM Networks. In *29th Annual International Symposium on Fault-Tolerant Computing*, pages 94–101, Madison, Wisconsin, USA, Jun. 1999.
- [98] Y. Wang, Q. Zeng, and H. Zhao. Dynamic Survivability in WDM Mesh Networks Under Dynamic Traffic. *pnc*, 6(1):5–24, Jul. 2003.
- [99] A. Todimala and B. Ramamurthy. A Dynamic Partitioning Sub-Path Protection Routing Technique in WDM Mesh Networks. In *ieee-icc*, pages 327–340, Washington, DC, USA, Aug. 2002. International Council for Computer Communication.
- [100] G. Mohan, C. S. R. Murthy, and A. K. Somani. Efficient Algorithms for Routing Dependable Connections in WDM Optical Networks. *ieee-acm-tn*, 9(5):553–566, Oct. 2001.
- [101] V. Anand and C. Qiao. Dynamic Establishment of Protection Paths in WDM Networks, Part i. In *Proceedings, 9th IEEE International Conference on Computer Communications and Networks*, pages 198–204, Oct. 2000.
- [102] G. Ellinas, A. G. Hailemariam, and T. E. Stern. Protection Cycles in Mesh WDM Networks. *ieee-jsac*, 18(10):1924–1937, Oct. 2000.
- [103] C. Xin, Y. Ye, S. Dixit, and C. Qiao. A Joint Lightpath Routing Approach in Survivable Optical Networks. *onm*, 3(3):13–20, May 2002.
- [104] P. H. Ho and H. T. Mouftah. SLSP: A New Path Protection Scheme for the Optical Internet. In *Proceedings, Optical Fiber Communication Conference*, volume 2, pages TuO1–1–TuO1–3, Anaheim, California, Mar. 2001.
- [105] M. Medard, S. G. Finn, R. A. Barry, and R. G. Gallager. Redundant Trees for Preplanned Recovery in arbitrary Vertex-Redundant or Edge Redundant Graphs. *ieee-acm-tn*, 7(5):641–652, Oct. 1999.
- [106] V. Anand, S. Chauhan, and C. Qiao. Sub-Path Protection: A New Framework for Optical Layer Survivability and its Quantitative Evaluation. Technical Report 2002-01, Department of Computer Science and Engineering, State University of New York at Buffalo, Feb. 2002. <http://www.cse.buffalo.edu/tech-reports/2002-01.ps>.
- [107] H. Zang and B. Mukherjee. Connection Management for Survivable Wavelength-Routed WDM Mesh Networks. *onm*, 2(4):17–28, Jul. 2001.
- [108] A. Sen, B. H. Shen, and S. Bandyopadhyay. Survivability of Lightwave Networks Path Lengths in WDM Protection Scheme. *Journal of High Speed Networks*, 10(4):303–315, 2001.

- [109] M. Ackroyd. Call Repacking in Connecting Networks. *iee-jsac*, 27(3):589–591, Mar. 1979.
- [110] A. Girard and S. Hurtubise. Dynamic Routing and Call Repacking in Circuit-Switched Networks. *iee-tr-com*, 31(12):1290–1294, Dec. 1983.
- [111] K.-C. Lee and V. O. K. Li. A Wavelength Rerouting Algorithm in Wide-Area All-Optical Networks. *iee-jlt*, 14(6):1218–1229, Jun. 1996.
- [112] K.-C. Lee and V. O. K. Li. A Circuit Rerouting Algorithm in Wide-Area All-Optical Networks. In *iee-infocom*, volume 1, pages 954–961, Toronto, Canada, Jun. 1994.
- [113] G. Mohan and C. S. R. Murthy. A Time Optimal Wavelength Rerouting Algorithm for Dynamic Traffic in WDM Networks. *iee-jlt*, 17(3):406–417, Mar. 1999.
- [114] E. W. M. Wong, A. K. M. Chan, and T.-S. P. Yum. Analysis of Rerouting in Circuit-Switched Networks. *iee-acm-tn*, 8(3):419–427, Jun. 2000.
- [115] Y. Wan and W. Liang. Wavelength Rerouting in Survivable WDM Networks. In *Proceedings, IFIP Networking, Lecture Notes in Computer Science*, volume 3462, pages 431–442, Waterloo, Ontario, Canada, May 2005.
- [116] E. W. M. Wong, A. K. M. Chan, and T.-S. P. Yum. A Taxonomy of Rerouting in Circuit Switched Networks. *iee-cm*, 37(11):116–122, Nov. 1999.
- [117] P. Aukia, M. Kodialam, P. V. N. Koppol, T. V. Lakshman, H. Sarin, and B. Suter. RATES: A Server for MPLS Traffic Engineering. *iee-cm*, 14(2):34–41, Apr. 2000.
- [118] R. Cohen. Smooth Intentional Rerouting and its Applications in ATM Networks. In *iee-infocom*, volume 3, pages 1490–1497, Toronto, Canada, Jun. 1994.
- [119] V. B. Iversen. Traffic Engineering of Cellular Wireless Systems. In *Proceedings of the International Seminar on Teletraffic and Networks*, pages 289–292, Oct. 1997.
- [120] O. Crochat and J. Y. Le Boudee. Design Protection for WDM Optical Networks. *iee-jsac*, 16(7):1158–1165, Sep. 1998.
- [121] F. De Turek B. Van Caenegem, W. Van Parys and P. M. Demeester. Dimensioning of Survivable WDM Networks. *iee-jsac*, 16(7):1146–1157, Sep. 1998.
- [122] Advanced Networking for Research and Education. Abilene Backbone Network. <http://abilene.internet2.edu>.

- [123] J. Kuri. *Optimization Problems in WDM Optical Transport Networks with Scheduled Lightpath Demands*. PhD in Philosophy, École Nationale Supérieure des Télécommunications de Paris, Paris, France, Sep. 2003. <http://www.infres.enst.fr/~kuri>.
- [124] J. Kuri, N. Puech, M. Gagnaire, and E. Dotaro. Routing and Wavelength Assignment of Scheduled Lightpath Demands in a WDM Optical Transport Network. In *Proceedings, International Conference on Optical Communications and Networks*, Singapore, Nov. 2002.
- [125] J. Kuri, N. Puech, M. Gagnaire, E. Dotaro, and R. Douville. Routing and Wavelength Assignment of Scheduled Lightpath Demands. *ieee-jsac*, 21(8):1231–1240, Oct. 2003.
- [126] M. Koubàa, N. Puech, and M. Gagnaire. Strategies for the Routing and Wavelength Assignment of Scheduled and Random Lightpath Demands. In *Proceedings, 3rd European Conference on Universal Multiservice Networks*, pages 91–103, Porto, Portugal, Oct. 2004.
- [127] M. Koubàa, N. Puech, and M. Gagnaire. Routing and Wavelength Assignment of Scheduled and Random Lightpath Demands. In *Proceedings, IEEE and IFIP International Conference on Wireless and Optical Communication Networks*, pages 16–19, Muscat, Oman, Jun. 2004.
- [128] M. Koubàa, N. Puech, and M. Gagnaire. Routing and Wavelength Assignment For Scheduled and Random Lightpath Demands: Bifurcated Routing Versus Non-Bifurcated Routing. In *Proceedings, IFIP Optical Networks & Technologies Conference*, pages 137–144, Pisa, Italy, Oct. 2004.
- [129] E. A. Doumith, M. Koubàa, N. Puech, and M. Gagnaire. Gain and Cost brought in by Wavelength Conversion for the Routing and Wavelength Assignment of two Traffic Classes in WDM Networks. In *Proceedings, 10th European Conference on Networks & Optical Communications*, pages 147–154, London, UK, Jul. 2005.
- [130] N. Puech, M. Koubàa, M. Gagnaire, and J. Kuri. Models for Path Protection in WDM Optical Mesh Networks. In *Proceedings, International Network Optimization Conference*, pages 472–477, Paris, France, Oct. 2003.
- [131] M. Koubàa, N. Puech, M. Gagnaire, and J. Kuri. Shared Path Protection Routing for Single Span Failures in WDM Optical Mesh Networks. In *Proceedings, Photonics in Switching*, pages 472–477, Paris, France, Sep. 2003.
- [132] M. Koubàa, N. Puech, and M. Gagnaire. Routing and Spare Capacity Assignment for Scheduled and Random Lightpath Demands in All-Optical Transport Networks. In *Proceedings, IEEE Next Generation Internet Networks Conference*, pages 39–46, Rome, Italy, Apr. 2005.

- [133] M. Koubàa, N. Puech, and M. Gagnaire. Routing, Protection and Wavelength Assignment for Scheduled and Random Lightpath Demands in WDM All-Optical Networks. In *Proceedings, Internetworking*, Paris, France, Jul. 2005.
- [134] M. Koubàa, N. Puech, and M. Gagnaire. Traffic Engineering for Differentiated Services in WDM All-Optical Networks. In *Proceedings, 19th International Teletraffic Congress*, pages 375–384, Beijing, China, Aug. 2005.
- [135] M. Koubàa, N. Puech, and M. Gagnaire. Lightpath Rerouting for Differentiated Services in WDM All-Optical Networks. In *Proceedings, 5th IEEE International Workshop on Design of Reliable Communication Networks*, pages 15–22, Naples, Italy, Oct. 2005.
- [136] D. Eppstein. Finding the k Shortest Paths. In *IEEE Symposium on Foundations of Computer Science*, pages 154–165, 1994. <http://citeseer.ist.psu.edu/eppstein94finding.html>.
- [137] D. Banerjee and B. Mukherjee. Wavelength-Routed Optical Networks: Linear Formulation, Resource Budgeting Tradeoffs, and a Reconfiguration Study. *ieee-acm-tn*, 8(5):598–607, Oct. 2000.
- [138] N. Puech, J. Kuri, and M. Gagnaire. Topological Design and Lightpath Routing in WDM Mesh Networks: A Combined Approach. *pnc*, 4(3):443–456, Jul. 2002.
- [139] ITU-T. Architecture of Optical Transport Network. Recommendation G.872, International Telecommunication Union, Nov. 2001.
- [140] E. Leonardi, M. Mellia, and M. A. Marsan. Algorithms for the Logical Topology Design in WDM all-optical Networks. *onm*, 1(1):35–46, Jan. 2000.
- [141] D. Brélaz. New Methods to Color Vertices of a Graph. *Communications of the ACM*, 22(4):251–256, Apr. 1979.
- [142] M. R. Garey and D. S. Johnson. *Computers and Intractability: A Guide to the Theory of NP-Completeness*. whf, New York, NY, USA, 1990.
- [143] A. Blum. An $O(n^{0.4})$ -Approximation Algorithm for 3-Coloring (and Improved Approximation Algorithm for k -Coloring). In *Proceedings, Photonics of the 21st ACM Symposium on Theory of Computing*, pages 535–542, New York, USA, May 1989.
- [144] L. Kucera. The Greedy Coloring is a Bad Probabilistic Algorithm. *Journal of Algorithms*, 12(4):674–684, Dec. 1991.
- [145] J. C. Culberson and F. Luo. Exploring the k -Colorable Landscape with Iterated Greedy. In *Cliques, Coloring, and Satisfiability: Second DIMACS Implementation Challenge, David S. Johnson and*

Michael A. Trick (eds.), DIMACS Series in Discrete Mathematics and Theoretical Computer Science, American Mathematical Society, volume 26, pages 75–88, 1996. <http://web.cs.ualberta.ca/~joe/publications.html>.

- [146] D. S. Johnson, C. R. Aragon, L. A. McGeoch, and C. Schevon. Optimization by Simulated Annealing: An Experimental Evaluation; Part I Graph Partitioning. *Operations Research*, 37(6):865–892, Nov. 1989.

Index

- Adaptive Routing, 31
- Amplifier Spontaneous Emission, 175
- AR, 31
- ASE, 175
- atomic routing, 77
- Auxiliary Weighted Graph, 121

- backup multiplexing, 37
- BER, 16, 176
- Bit Error Rate, 16

- CD, 175
- Chromatic Dispersion, 175
- circuits, 2

- Dense WDM, 12
- DFB, 15
- Digital Subscriber Line, 10
- Dispersion-Shifted Fibers, 14
- Distributed Feed Back, 15
- DSF, 14
- DSL, 10
- DWDM, 12

- EDFA, 18
- electro-optical, 1
- electronic bottleneck, 2
- Erbium-Doped Fiber Amplifiers, 18

- failure-dependent, 37
- failure-independent, 37

- FAR, 31
- FDM, 12
- FEC, 16
- FF, 33
- First-Fit, 33
- Fixed Alternate Routing, 31
- Fixed Routing, 31
- Forward Error Correction, 16
- Four-Wave Mixing, 14
- FR, 31
- Frequency Division Multiplexing, 12
- FWM, 14

- GCG, 119
- GCP, 118
- Generalized Conflict Graph, 119
- Graph Coloring Problem, 118

- Internet, 1
- Internet Protocol, 1
- IP, 1

- Label Switching Path, 23
- Label Switching Routers, 1
- LCR, 31
- Least Congested Path Routing, 31
- Least Used Wavelength, 34
- LED, 14
- LH, 15
- Light-Emitting Diodes, 14

- lightpath, 2, 27
- lightpath provisioning, 3
- lightpath rerouting strategies, 5
- Lightpath Routing, 102
- link, 27
- Long Haul, 15
- LSP, 23
- LSR, 1
- LUW, 34

- MLM, 15
- MMF, 13
- MOILP, 44
- MOILPs, 5
- Most Used Wavelength, 34
- MPLS, 1
- Multi-Longitudinal Mode, 15
- Multi-Mode Fiber, 13
- Multi-Objective Integer Linear Programming, 5
- Multi-Protocol Label Switching, 1
- MUW, 34

- non bifurcated routing, 77
- Non Return to Zero, 14
- NRZ, 14

- OA, 17
- OADM, 19
- OBS, 23
- OCS, 23
- ODFA, 18
- OLT, 18
- OPS, 23
- Optical Add/Drop Multiplexer, 19
- Optical Amplifier, 17
- Optical Burst Switching, 23
- Optical Circuit Switching, 23
- Optical Cross-connect, 20
- Optical Doped Fiber Amplifier, 18
- optical layer, 2
- Optical Line Terminal, 18
- Optical Packet Switching, 23
- Optical Signal to Noise Ratio, 176
- Optical Time Division Multiplexing, 12
- Optical Virtual Private Network, 3
- Optical Virtual Private Networks, 73
- opto-electronic, 1
- OSNR, 176
- OTDM, 12
- OVPN, 3, 73
- OXC, 20

- PARWA, 45, 63
- path, 27
- path-free wavelength, 27
- Permanent Atomic RWA algorithm, 63
- Permanent Lightpath Demands, 2
- Permanent Non Atomic RWA, 64
- Permanent Routing and Spare Capacity Assignment, 4, 100
- Permanent Routing and Wavelength Assignment, 43
- PLDs, 2, 39
- PLP, 69
- PMD, 175
- Polarization Mode Dispersion, 175
- PP, 28
- protection, 2
- protection methods, 35
- Protection Path, 28
- PRSCA, 4, 100

- PRWA, 43, 45, 64
- QoS, 1, 24
- Quality of Service, 1, 24
- RAM, 24
- Raman Optical Amplifier, 18
- Random Access Memory, 24
- Random Lightpath Demands, 3
- Random Search, 60
- reactive methods, 35
- regenerators, 17
- rerouting, 2
- RLDs, 3, 39
- ROA, 18
- Routing and Spare Capacity Assignment, 4
- Routing and Wavelength Assignment with Rerouting, 152
- RS, 60
- RSCA, 4, 34
- RWAwR, 152
- Scheduled Lightpath Demands, 3
- SDH, 15
- Semiconductor Optical Amplifier, 17
- separate Atomic RSCA, 142
- separate Atomic RWA, 80
- separate RWA with Rerouting, 152, 163
- sepARSCA, 142
- sepARWA, 80
- sepRSCA, 147
- sepRWA, 84
- sepRWAwR, 152, 163
- seqARSCA, 137
- seqARWA, 77
- seqPARWA, 61
- seqPRWA, 61
- seqRSCA, 147
- seqRWA, 84
- seqRWAwR, 152, 155
- sequential Atomic Routing and Spare Capacity Assignment, 137
- sequential Atomic RWA, 77
- sequential non atomic RWA, 85
- sequential permanent atomic RWA, 61
- sequential permanent non atomic RWA, 61
- sequential RWA with Rerouting, 152, 155
- Service Level Agreement, 26
- set-up, 2
- shared path protection, 4
- Single Longitudinal Mode, 15
- Single-Mode Fiber, 13
- SLA, 26
- SLDs, 3, 39
- SLM, 15
- SMF, 13
- SOA, 17
- SONET, 16
- span, 27
- SRS, 18
- Stimulated Raman Scattering, 18
- survivability, 7
- Synchronous Digital Hierarchy, 15
- Synchronous Optical NETWORK, 16
- TDM, 10, 12
- tear-down, 2
- the separate RSCA algorithm, 147
- the sequential RSCA algorithm, 147
- Time Division Multiplexed, 10
- transponder, 18

ULH, 16

Ultra Long Haul, 16

Virtual Private Network, 10

VPN, 10

WAG, 137

wavelength, 27

Wavelength Continuity Constraint, 27

wavelength continuity constraint, 5

Wavelength Division Multiplexing, 1, 10

WCC, 27

WDM, 1, 10

WDM channel, 27

Weighted Auxiliary Graph, 137

Working Path, 27

WP, 27

Glossary

A

- AG** Auxiliary Graph.
- AR** Adaptive Routing.
- ASE** Amplifier Spontaneous Emission.
- ATM** Asynchronous Transfer Mode.

B

- BER** Bit Error Rate.

C

- CD** Chromatic Dispersion.

D

- DFB** Distributed Feed Back.
- DLE** Dynamic Lightpath Establishment.
- DSF** Dispersion-Shifted Fibers.
- DSL** Digital Subscriber Lines.
- DWDM** Dense Wavelength Division Multiplexing.

E

- EDFA** Erbium-Doped Fiber Amplifier.

F

- FAR** Fixed Alternate Routing.
- FDM** Frequency Division Multiplexing.
- FEC** Forward Error Correction.
- FF** First-Fit.
- FR** Fixed Routing.
- FWM** Four-Wave Mixing.

G

- GCG** Generalized Conflict Graph.
- GCP** Graph Coloring Problem.

L

- LCR** Least Congested Routing.
- LD** Lightpath Demand.
- LED** Light-Emitting Diodes.
- LH** Long Haul.
- LR** Lightpath Routing.
- LSP** Label Switching Path.
- LUW** Least Used Wavelength.

M

- MLM** Multi-Longitudinal Mode.
- MMF** Multi-Mode Fibers.
- MUW** Most Used Wavelength.

N

NRZ Non Return to Zero.

O

OA Optical Amplifier.

OADM Optical Add/Drop Multiplexer.

OBS Optical Burst Switching.

OCS Optical Circuit Switching.

ODFA Optical Doped Fiber Amplifiers.

OLT Optical Line Terminal.

OPS Optical Packet Switching.

OSNR Optical Signal to Noise Ratio.

OTDM Optical Time Division Multiplexing.

OVPN Optical Virtual Private Network.

OXC Optical Cross-connect.

P

PARWA Permanent Atomic Routing and Wavelength Assignment.

PLP Permanent Lightpaths.

PMD Polarization Mode Dispersion.

PP Protection Path.

PRSCA Permanent Routing and Spare Capacity Assignment.

PRWA Permanent Routing and Wavelength Assignment.

Q

QoS Quality of Service.

R

- RAM** Random Access Memory.
- ROA** Raman Optical Amplifiers.
- RS** Random Search.
- RWA** Routing and Wavelength Assignment.
- RWAwR** Routing and Wavelength Assignment with Rerouting.

S

- SDH** Synchronous Digital Hierarchy.
- sepARSCA** separate Atomic Routing and Spare Capacity Assignment.
- sepARWA** separate Atomic Routing and Wavelength Assignment.
- sepRSCA** separate Routing and Spare Capacity Assignment.
- sepRWA** separate Routing and Wavelength Assignment.
- sepRWAwR** separate Routing and Wavelength Assignment with Rerouting.
- seqARSCA** sequential Atomic Routing and Spare Capacity Assignment.
- seqARWA** sequential Atomic Routing and Wavelength Assignment.
- seqPARWA** sequential Permanent Atomic Routing and Wavelength Assignment.
- seqPRWA** sequential Permanent Routing and Wavelength Assignment.
- seqRSCA** sequential Routing and Spare Capacity Assignment.
- seqRWA** sequential Routing and Wavelength Assignment.
- seqRWAwR** sequential Routing and Wavelength Assignment with Rerouting.
- SLA** Service Level Agreement.
- SLE** Static Lightpath Establishment.
- SLM** Single Longitudinal Mode.
- SLPs** Scheduled Lightpaths.

SMF	Single-Mode Fibers.
SOA	Semiconductor Optical Amplifiers.
SONET	Synchronous Optical NETwork.
SRS	Stimulated Raman Scattering.
STM	Synchronous Transport Mode.
T	
TDM	Time Division Multiplexing.
U	
ULH	Ultra Long Haul.
V	
VPN	Virtual Private Networks.
W	
WA	Wavelength Assignment.
WAG	Weighted Auxiliary Graph.
WCC	Wavelength Continuity Constraint.
WDM	Wavelength Division Multiplexing.
WP	Working Path.