



HAL
open science

Non-rational conformal field theories and applications in string theory.

Charles Jegu

► **To cite this version:**

Charles Jegu. Non-rational conformal field theories and applications in string theory.. Physics [physics]. Ecole Polytechnique X, 2007. English. NNT: . pastel-00002591

HAL Id: pastel-00002591

<https://pastel.hal.science/pastel-00002591v1>

Submitted on 28 Jul 2010

HAL is a multi-disciplinary open access archive for the deposit and dissemination of scientific research documents, whether they are published or not. The documents may come from teaching and research institutions in France or abroad, or from public or private research centers.

L'archive ouverte pluridisciplinaire **HAL**, est destinée au dépôt et à la diffusion de documents scientifiques de niveau recherche, publiés ou non, émanant des établissements d'enseignement et de recherche français ou étrangers, des laboratoires publics ou privés.

PhD dissertation
Non-rational conformal field theories
and applications in string theory

Charles JEGO

CPHT, Ecole Polytechnique

June 1st, 2007

Jury:

Costas BACHAS	
Michel BAUER	Referee
Pierre BIELIAVSKY	
Vladimir DOTSENKO	Referee
Elias KIRITSIS	Supervisor
Boris PIOLINE	
Jan TROOST	

Contents

1	Abstract	5
2	Introduction	6
3	Lie group representation theory and orbits	10
3.1	Lie groups and Lie algebras	10
3.2	Representations	14
3.3	Adjoint and co-adjoint representations and orbits	15
4	Conformal field theory	17
4.1	Introduction to conformal field theory	17
4.1.1	Conformal symmetry group and conformal field theory . .	17
4.1.2	Motivations	18
4.2	Conformal field theory basics	20
4.2.1	The Hilbert space and the vertex operators	20
4.2.2	Chiral theories	23
4.2.3	The Virasoro algebra and the primary fields	25
4.2.4	Correlation functions in a chiral conformal field theory . .	28
4.2.5	Representations of the Virasoro algebra	30
4.3	Boundary conformal field theory basics	32
4.4	Advanced conformal field theory	36
4.4.1	Conformal field theory on the torus and higher genus surface	37
4.4.2	Wess-Zumino-Witten models and affine Lie algebras . . .	38
4.4.3	The fusion rules and the Verlinde formula	44
4.4.4	Superconformal algebras	46
4.5	Classical conformal field theory and group theory	46
4.6	Beyond rational conformal field theory.	50
5	Heisenberg algebras and pp-waves	51
5.1	Introduction	51
5.2	\mathcal{H}_{2n+2} Heisenberg algebra	52
5.2.1	Definition	53
5.2.2	Representations	54
5.2.3	Heisenberg algebras and string theory	57
5.3	Heisenberg algebras in string theory	59
5.3.1	One NS5 brane and one F1 string	60
5.3.2	Two NS5 branes and one F1 string	64
5.3.3	Penrose limit of the near-horizon geometry	65
5.4	\mathcal{H}_{2n+2} correlation functions	67
5.4.1	Two-point functions	67
5.4.2	Three-point functions	68
5.4.3	Four-point functions	72
5.5	Conclusion	80

6	A Verlinde formula in non-rational conformal field theories	81
6.1	Introduction	81
6.2	The H_3^+ theory	82
6.2.1	H_3^+ Wess-Zumino-Witten model and Euclidean AdS_3 space	83
6.2.2	Current algebra and primary fields	86
6.2.3	Correlation functions and fusion	90
6.3	The hyperbolic three-plane H_3^+	94
6.3.1	Degenerate representations	97
6.3.2	Degenerate and non-degenerate representations	100
6.3.3	Generalization	102
6.4	Conclusion	102
7	Rigid open strings, Lie algebras and star products	105
7.1	Introduction	105
7.2	Mathematical introduction	106
7.2.1	Different points of view on orbits	106
7.2.2	Quantization	108
7.2.3	Star product and classical limit	109
7.3	Co-adjoint orbit quantization	109
7.3.1	An electric charge in the presence of a magnetic monopole	110
7.3.2	A classical particle on a co-adjoint orbit	113
7.4	Rigid strings	114
7.4.1	Generalization	114
7.4.2	A check from Wess-Zumino-Witten models	116
7.4.3	The rigid open string Hilbert space	118
7.4.4	Interactions of open strings	120
7.5	A compact example: $SU(2)$	121
7.5.1	The kinematical $3j$ symbol	121
7.5.2	The dynamical $6j$ symbol	124
7.5.3	Interaction and associativity	126
7.5.4	Quantum group $U_q(SU(2))$	128
7.5.5	The relation to (rational) boundary conformal field theory	129
7.6	Remarks on $SL(2, \mathbb{R})$ orbits, representations and fusion	130
7.6.1	Orbits and representations	130
7.6.2	The geometry of tensor product decomposition	132
7.6.3	Interactions	134
7.7	A non-compact example: $SL(2, \mathbb{R}) \equiv SU(1, 1)$	134
7.7.1	The kinematical $3j$ symbol	135
7.7.2	The dynamical $6j$ symbol	136
7.7.3	Interaction and associativity	138
7.7.4	Quantum group $U_q(SU(1, 1))$	139
7.8	Associative products based on quantum groups	140
7.9	Conclusions and open problems	142
8	Conclusion of the dissertation and perspectives	144

9 Acknowledgments	145
A Various useful results	146
B ${}_3F_2(1)$ hypergeometric functions and $3j$ symbol transformations	150
B.1 Whipple functions	150
B.2 Another useful notation	151
B.3 Two-term and three-term relations	152
B.4 An integer limit of Whipple's relations	153
B.5 Transformations of $SU(2)$ and $SU(1,1)$ $3j$ symbols	154

1 Abstract

This dissertation is devoted to the study of certain non-rational conformal field theories which arise in the context of string theory. In contrast to rational conformal field theories, which have been extensively studied in the past few decades, non-rational theories are not yet well-understood. A better understanding is crucial in order to get a good grip on string theory in non-compact curved backgrounds, and eventually to address cosmological issues. Since the dissertation relies heavily on Lie group theory and conformal field theory, detailed introductions to these fields are provided for the reader who may not be familiar with them. The dissertation then moves on to a detailed presentation of the work that was done in the course of the PhD. This work dealt with pp-waves with Heisenberg symmetry, a Verlinde-like formula in non-rational conformal field theories (for instance in H_3^+), and rigid open strings whose endpoints live on co-adjoint orbits of Lie algebras. It led to the publication of two papers [1, 2].

Résumé de la thèse

Cette thèse est dédiée à l'étude de quelques théories conformes non rationnelles, qui apparaissent dans le cadre de la théorie des cordes. Contrairement aux théories conformes rationnelles, qui ont bénéficié de très nombreuses études dans les toutes dernières décennies, les théories non rationnelles ne sont pas encore bien comprises. Une meilleure compréhension est pourtant nécessaire pour mieux appréhender la théorie des cordes dans des fonds courbés non compacts, et pour pouvoir à terme s'attaquer à des problèmes cosmologiques. Dans la mesure où la thèse a fréquemment recours à des notions et à des résultats de la théorie des groupes de Lie et de la théorie conforme des champs, des introductions détaillées à ces domaines sont présentées à l'attention des lecteurs qui ne sont pas familiarisés avec eux. La thèse présente ensuite le travail qui a été réalisé au cours du doctorat. Ce travail s'est attaqué à des espaces présentant pour symétrie l'algèbre de Heisenberg, à une extension de la formule de Verlinde pour des théories conformes non rationnelles (comme H_3^+), et aux cordes ouvertes rigides contraintes sur des orbites co-adjointes d'algèbres de Lie. Deux articles ont été publiés [1, 2].

2 Introduction

The beginning of the twentieth century was marked by several major revolutions in physics. In 1915, Einstein came up with a geometric theory of gravity that exceeded the scope of Newton's theory. Some time later, a myriad of physicists, including Planck, Einstein, Bohr, Dirac, Heisenberg, Pauli, Schrödinger and von Neumann, contributed to the birth of quantum mechanics, which describes the world of particles, at small length scales (typically from 10^{-10} to 10^{-18} meters). Thanks to these pioneering works and many others that followed, physicists are now able to accurately describe the four fundamental forces of nature: electromagnetics, the weak and the strong force, and gravity. The first three forces are described by quantum field theories: electromagnetics by quantum electrodynamics (QED), the (electro-)weak force by the Glashow-Salam-Weinberg theory (which contains QED), and the strong force by quantum chromodynamics (QCD). These theories constitute what is known as the standard model of particle physics, while the remaining fourth force, gravity, is described by Einstein's general relativity.

All these theories have been tested to a rather large extent using numerous astronomical, cosmological and particle physics observations, and the degree of agreement between theoretical predictions and experimental measurements is quite impressive¹. It is worth noting that, though they were in their time much disconnected from every-day life, the theory of general relativity and quantum mechanics gave rise to unexpected yet wonderful applications, ranging from the global positioning system (GPS) and satellites to laser technology and superconductors, which are all part of our lives today.

The story is not finished. The fact that scientists have at hand an accurate description of the forces of nature does not mean that they properly understand their fundamental structure. From a theoretic point of view, physicists cannot be content with the above picture. Indeed, while gravity is usually considered to act on long distance (astronomical) scales, it is also of course present at short distance scales – though so weak it is usually negligible compared to other forces. But short length scales are the realm of quantum mechanics, hence physicists expect to be able to describe gravity from a quantum point of view. Moreover some gravitational phenomena in the universe, like black holes, are highly energetic, therefore are also expected to involve quantum mechanics. Another example is provided by the cosmological microwave background which is a signature of quantum fluctuations of gravity after the Big-Bang. Finally, developing a quantum theory of gravity is part of a long and continuous work by physicists in order to unify one after the other the many forces of nature. Electricity and magnetism were unified by Maxwell, while electromagnetism and the weak force were unified thanks to the work of Salam, Weinberg *et al.* This story continues up to this day with grand unification theories that

¹The best example may be the anomalous magnetic moment of the electron, which is related to the fine structure constant α . The QED prediction agrees with the experimentally measured value to more than ten significant figures, making it the most accurately verified prediction in the history of physics.

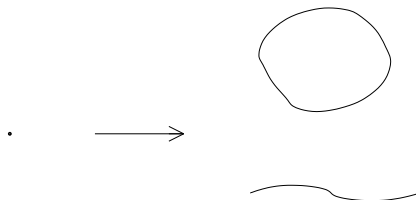

Figure 1: The fundamental idea of string theory is to replace points by (closed or open) strings.

try to unify the electroweak force and the strong force. For all these reasons, theoretical physicists would like to find a unifying theory that would include a quantum description of gravitation. Designing a theory of quantum gravity proves however to be very difficult. For instance the most elementary approach to try, canonical quantization of Einstein's action, leads to infinities (divergences that cannot be renormalized). While no final answer has been given to this problem, a promising theory of quantum gravity has been developed over the past thirty years, starting with a paper by Scherk and Schwarz in 1974 [3]: string theory (for introductory books see [4, 5, 6, 7, 8, 9]).

The basic idea of string theory is to replace points that used to be the fundamental classical objects in quantum field theories by strings *i.e.* one-dimensional objects, as shown in figure 1. Starting from a classical string, it is then possible to use the whole standard machinery of quantum mechanics. Results are surprising and highly interesting. The quantized theory includes gravity, without the divergences that plagued the standard quantum field theory approach and which came from the local nature of the interactions (which are now spread out over the string worldsheet pictured in figure 2, see also figure 3). This is what physicists were looking for. The theory also predicts extra dimensions (believed to be compact and small) and the existence of axions which are potential candidates for dark matter². Moreover, (super)string theory is a supersymmetric theory³ which includes bosons and fermions *i.e.* all presently known forms of matter, and physicists are close to making connection with supersymmetric extensions of the standard model. Indeed, string theory is a natural extension of particle theory: one expects to recover all usual properties of quantum field theories in the low energy (large distance) limit, since a string resembles a point when seen from far away. In this picture, the usual elementary particles should

²According to cosmologists, dark matter is necessary to explain the mass and the structure of the universe. The model-independant axion is a Goldstone boson which appears in every perturbative string theory in four (or less) non-compact dimensions.

³Supersymmetry is a symmetry which relates the masses and couplings of fermions and bosons. It is expected to be discovered rather soon in the Large Hadron Collider (LHC) at the CERN in Geneva (constraints on the scale of supersymmetry breaking come from the expected mass of the Higgs, itself related to the breaking of electroweak symmetry, and imply that all these energy scales cannot be much different from each other. The LHC has been designed to reach energies high enough to find the Higgs boson and supersymmetry, provided they do exist).

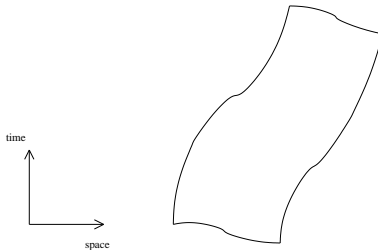

Figure 2: The string worldsheet is the two-dimensional surface in space-time which represents the evolution of the string in the course of time.

correspond to the different vibration modes of the string.

Despite these undeniable successes, several challenges await string theory. Firstly, a clear non-perturbative description of string theory is still missing, despite the appearance of non-perturbative objects like D-branes. This means that at this time the theory must be expanded around a given vacuum (and no clear theoretical argument is known in order to choose a vacuum, though constraints are given by the standard model which string theory must reproduce at low energy). Also, the relation between the various possible string theories beyond the supersymmetric regime is not yet well understood, likewise for the supersymmetry breaking. Finally the quantum theory is not quite well understood in curved space-time, whereas such an understanding is necessary to deal with cosmological issues. It is this last issue that is addressed in the dissertation, through the study of non-rational conformal field theories, which are related to non-trivial (curved, non-compact) backgrounds.

String theory is usually formulated and quantized in textbooks on the (flat) Minkowski space. Quantizing the theory on curved spaces is much more difficult and is currently partially understood in only a few highly-symmetric cases like the anti-de Sitter space AdS_3 with NS-NS flux for instance. There are many ways to gain insight on what string theory is like on (possibly non-compact) curved spaces. An important idea that is generically valid is that symmetry helps, since it provides powerful tools to constrain the theory and is an elegant way to understand it intuitively using algebra and geometry. Group theory and conformal symmetry prove to be useful in this context and were used extensively in this study⁴, which deals with rather mathematical issues. Another idea that was used is that string theory simplifies in the low energy (or semi-classical)

⁴It is worth noting that conformal field theory proves to be useful in other areas of physics as well, like statistical or condensed matter physics. For instance it is related to the Ising model, the 3-state Potts model or also to the stochastic Schramm-Loewner evolution (SLE, which is a one-parameter family of conformally invariant measures on curves in the plane, giving the continuum limit of a number of lattice models on the plane in statistical physics at criticality – in particular, it is conjectured to be the scaling limit of various critical percolation models, see *e.g.* [10, 11, 12, 13]). Conformal field theory has also been used to study quantum Brownian motion, the Kondo problem (which appears in the study of the electrical resistance at low temperature), Toda field theory (an integrable model whose solutions describe solitons), polymers or even the traveling salesman problem (see *e.g.* [14, 15, 16]).

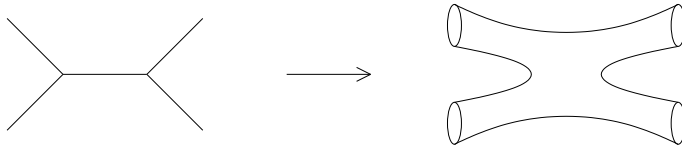

Figure 3: Feynman diagrams of particle physics are replaced by smoother equivalents in string theory. An example is pictured above for four closed strings. The interaction does not happen at any specific point anymore.

limit, and can then be described by an effective field theory.

Finally, a huge challenge that string theory must face is to come up with predictions which would be experimentally verified. The natural scale of string theory as a quantum theory of gravitation may *a priori* be expressed in terms of the only physically relevant constants, which are Planck's constant \hbar , Newton's gravitation constant G and the speed of light c . For instance, the typical length and energy are Planck's length and Planck's energy:

$$L_P = \sqrt{\frac{\hbar G}{c^3}} \approx 1.6 \cdot 10^{-35} \text{ m} , \quad E_P = \sqrt{\frac{\hbar c^5}{G}} \approx 1.2 \cdot 10^{19} \text{ GeV} \quad (1)$$

These numerical values are several orders of magnitude beyond the reach of human experimental devices, which make the theory very difficult to test. As a comparison, protons in the LHC will collide with energies reaching $14 \cdot 10^3$ GeV. Some possible solutions out of this problem have been suggested, using branes and large extra dimensions. See *e.g.* [17, 18].

Overall, string theory is an exciting field of research. Despite the expected difficulty of a phenomenological test and although some of the most remarkable applications of the theory up to this day may have been in the field of mathematics, who knows which surprises await physicists?

The dissertation is organized as follows: sections 3 and 4 provide detailed introductions to Lie group (representation) theory and conformal field theory. This background is necessary to understand the work that is presented afterwards. The goal in these sections is to make the dissertation as self-contained as possible, and understandable by anyone having a graduate level in physics. After this pedagogical starter, more technical parts follow and present in chronological order the work accomplished in the course of the PhD, which led to the publication of two papers [1, 2]. An analysis of pp-wave backgrounds with Heisenberg symmetry is given in section 5. Section 6 presents a Verlinde-like formula for some sectors of non-rational conformal field theories, and section 7 is devoted to the study of open strings in the semi-classical limit, and their relation to star products. Finally, some notes are collected in an appendix: section A collects several useful formulas and section B deals with Whipple hypergeometric functions.

3 Lie group representation theory and orbits

This first introductory section reviews useful definitions and results concerning Lie groups, Lie algebras and their representations as well as orbits. The notions introduced in this section will be used throughout the dissertation. The most important ones are the notion of representation reviewed in section 3.2 (it will be used almost everywhere, starting in the other introductory part in section 4) and the notion of (co-adjoint) orbit introduced in section 3.3 (it will be of use in section 7). For a more extended presentation of Lie group theory, the reader is referred to [19] chapters 1 and 2 or to [20], and to [21] chapters 13 and 14 for (affine) Lie algebras. Geometric quantization and the theory of co-adjoint orbits are thoroughly explained in [22].

3.1 Lie groups and Lie algebras

Before proceeding further, this subsection reviews some basic definitions.

A *Lie group* G is a differentiable manifold with a consistent group structure *i.e.* such that both

$$\begin{aligned} G \times G &\rightarrow G & \text{and} & & G &\rightarrow G \\ (g, h) &\mapsto gh & & & g &\mapsto g^{-1} \end{aligned} \quad (2)$$

are differentiable (analytic) functions. The dissertation will study several Lie groups, including:

$$\begin{aligned} SU(2) &= \{U \in \mathcal{M}(2, \mathbb{C}) \mid UU^\dagger = 1 \text{ and } \det(U) = 1\} & (3) \\ SU(1, 1) &= \left\{ U \in \mathcal{M}(2, \mathbb{C}) \mid UgU^\dagger = g \text{ with } g = \begin{pmatrix} 1 & 0 \\ 0 & -1 \end{pmatrix} \text{ and } \det(U) = 1 \right\} \\ SL(2, \mathbb{R}) &= \{M \in \mathcal{M}(2, \mathbb{R}) \mid \det(M) = 1\} \end{aligned}$$

Note for later use that the groups $SL(2, \mathbb{R})$ and $SU(1, 1)$ are isomorphic since:

$$g \in SL(2, \mathbb{R}) \leftrightarrow h = t^{-1}gt \in SU(1, 1), \quad \text{where} \quad t = \begin{pmatrix} 1 & i \\ i & 1 \end{pmatrix} \quad (4)$$

The *universal covering group* of a group H is the group that discretely covers any group G discretely covering H , *i.e.* any group G such that there is a discrete invariant subgroup N in G verifying $H \sim G/N$. A group H and its universal cover $U(H)$ are locally isomorphic, but their global properties may vary. For instance, $U(H)$ is simply connected while H may not be so. As an example, the universal covering group of $SU(1, 1)$ is topologically equivalent to the product of a disk and a straight line (it cannot be realized in the matrix form)⁵. Another example of a Lie group is:

$$S_p(n, \mathbb{C}) = \{M \in \mathcal{M}(2n, \mathbb{C}) \mid M^\dagger \epsilon_n M = \epsilon_n\} \quad (5)$$

⁵In string theory one must be cautious whether it is the group or the universal cover of the group that is studied. For instance in the case of $SL(2, \mathbb{R})$ it is actually the universal cover that is usually considered (in order to have a non-compact time).

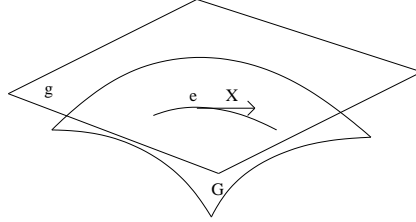

Figure 4: Relation between a Lie group G and its Lie algebra \mathfrak{g} . The point e is a point on the group (say, the identity) and X is the tangent vector at this point of the left-invariant vector field pictured here as a curve on the group manifold G .

where (the matrix s is reproduced n times in the matrix ϵ_n):

$$s = \begin{pmatrix} 0 & 1 \\ -1 & 0 \end{pmatrix}, \quad \epsilon_n = \begin{pmatrix} s & & (0) \\ & \dots & \\ (0) & & s \end{pmatrix} \quad (6)$$

The group $S_p(n, \mathbb{C})$ is the group of *symplectic* matrices⁶ and corresponds to skew-symmetric (*i.e.* anti-symmetric) bilinear forms in \mathbb{C}^{2n} . Related groups are $S_p(n, \mathbb{R}) = S_p(n, \mathbb{C}) \cap GL(2n, \mathbb{R})$ and $S_p(n) = S_p(n, \mathbb{C}) \cap U(2n)$.

A *Lie algebra* \mathfrak{g} is a vector space with an internal differentiable product $(X, Y) \mapsto [X, Y]$ called a Lie bracket, where $X, Y, [X, Y] \in \mathfrak{g}$. The Lie bracket is antisymmetric and satisfies the *Jacobi identity*:

$$[[X, Y], Z] + [[Z, X], Y] + [[Y, Z], X] = 0 \quad (7)$$

For instance, any matrix algebra $\mathcal{M}_n(\mathbb{K})$ is a Lie algebra (where $\mathbb{K} = \mathbb{R}$ or \mathbb{C}), with Lie bracket $[X, Y] = XY - YX$.

An important result is that to every Lie group G one can canonically associate a Lie algebra \mathfrak{g} . The procedure is as follows. Since G is a manifold, it is possible to define its tangent space $\mathfrak{g}(g)$ at any point $g \in G$. Then, the left shift $L(g_0) : g \mapsto g_0 g$ is a diffeomorphism of G , which generates the mapping $dL(g_0) : \mathfrak{g}(e) \rightarrow \mathfrak{g}(g_0)$, where e is the unit element of G . A left-invariant vector field on G is defined by $X(g_0) = dL(g_0)x$, for x a fixed element of $\mathfrak{g}(e)$. This vector field defines a curve on G whose tangent vectors at any point g_0 is $X(g_0)$, see figure 4. This curve is a one-dimensional subgroup of G , and is entirely specified by $x \in \mathfrak{g}(e)$. There is actually a one-to-one correspondence between vectors of $\mathfrak{g} = \mathfrak{g}(e)$ and one-parameter subgroups of G . The Lie algebra \mathfrak{g} of the group G then consists of all left-invariant (or, equivalently, right-invariant) vector fields on G *i.e.* it is isomorphic to $\mathfrak{g}(e)$. The Lie bracket on \mathfrak{g} is defined

⁶This group is related to the notion of symplectic form, considered later in section 7. For instance, the s matrix corresponds to the symplectic form $dq \wedge dp$ in canonical coordinates (see Hamiltonian mechanics).

by the formula:

$$[X, Y] = \lim_{t \rightarrow 0} \frac{Ad_{h(t)} - E}{t} Y \quad (8)$$

where $h(t)$ is the vector field on G such that $h(0) = e$ and X is the tangent vector at this point. Moreover $Ad_{h(t)}Y = hYh^{-1}$ as specified below in section 3.3, and E is the identity operator.

Reciprocally, and assuming the Lie group to be simply connected (*i.e.* such that any closed curve on the group can be contracted into a point), it can be canonically reconstructed from the Lie algebra. More precisely, to every Lie algebra \mathfrak{g} it is possible to associate a simply connected Lie group G such that its canonically associated Lie algebra is \mathfrak{g} . The operation that relates the two structures is the exponentiation:

$$\begin{aligned} \exp : \mathfrak{g} &\rightarrow G \\ X &\mapsto g = \exp(X) = \sum_{n \in \mathbb{N}} \frac{X^n}{n!} \end{aligned} \quad (9)$$

From a geometric point of view, the above results mean that the Lie algebra is the tangent space of the group G at the identity. It is isomorphic to any tangent space of the Lie group. A straightforward consequence is that locally (near any point) a Lie group strongly resembles its Lie algebra, see figure 4.

Some useful isomorphisms of Lie algebras, involving algebras that will be studied in the dissertation, are:

$$\begin{aligned} su(2) &\sim so(3) \sim sp(1, \mathbb{C}) \\ sl(2, \mathbb{R}) &\sim su(1, 1) \sim so(2, 1) \sim sp(1, \mathbb{R}) \end{aligned} \quad (10)$$

In particular, a basis for $su(1, 1)$ in a matrix representation is:

$$\begin{aligned} b_1 &= \frac{1}{2}\sigma_1, & b_2 &= -\frac{1}{2}\sigma_2, & b_3 &= \frac{i}{2}\sigma_3 \\ [b_1, b_2] &= -b_3, & [b_2, b_3] &= b_1, & [b_3, b_1] &= b_2 \end{aligned} \quad (11)$$

while a (real) basis of $sl(2, \mathbb{R})$ is:

$$c_1 = \frac{1}{2}\sigma_1, \quad c_2 = \frac{1}{2}\sigma_3, \quad c_3 = \frac{i}{2}\sigma_2 \quad (12)$$

It has the same structure constants (since $c_i = t^{-1}b_i t$). The matrices σ_i are the Pauli matrices, listed in appendix A.

Two extra definitions will be of use. A *simple* Lie algebra \mathfrak{g} is a non-abelian Lie algebra which does not contain any non-trivial ideal (*i.e.* ideals different from \mathfrak{g} and zero), that is to say which has no invariant Lie subalgebra other than zero and itself. A Lie subalgebra \mathfrak{h} of a Lie algebra \mathfrak{g} is invariant if and only if for any elements $a \in \mathfrak{h}$ and $b \in \mathfrak{g}$, $[a, b]$ is an element of \mathfrak{h} . A group

is simple if and only if it is connected and its Lie algebra is simple. A *semi-simple* Lie algebra is a direct sum of simple Lie algebras or, also, an algebra with no abelian invariant subalgebra. An equivalent definition of semi-simple Lie algebras is that the Killing form is non-degenerate (this is known as Cartan's criterion). The *Killing form* is a symmetric invariant bilinear form defined by:

$$\begin{aligned} K : g \times g &\rightarrow \mathbb{R} \\ (X, Y) &\mapsto \text{Tr}(ad_X ad_Y) \end{aligned} \quad (13)$$

where ad_X is introduced below in subsection 3.3. If K is non-degenerate (*i.e.* $K(X, Y) = 0$ for all $Y \in g$ implies that $X = 0$), then it defines a Casimir on g and a metric on the associated Lie group G . This explains the interest of semi-simple algebras. For instance $su(2)$, $sl(2, \mathbb{R})$ and $sp(n, \mathbb{C})$ are semi-simple algebras. The dissertation mostly deals with such algebras.

Since a Lie algebra g is a vector space, it is convenient to introduce a basis of g , that may be denoted by vectors J^1, \dots, J^n where n is the dimension of the algebra. These vectors (or generators) satisfy the following commutation relations:

$$[J^a, J^b] = \sum_c \iota f^{ab}_c J^c \quad (14)$$

where f^{ab}_c are called the *structure constants* of the algebra. They are real if the generators of the algebra are hermitian. In this basis, the Killing form is the simplest possible 2-tensor that can be formed from the structure constants:

$$K(J^a, J^b) = 2Qg^{ab} = - \sum_{c=1}^n \sum_{d=1}^n f^{bc}_d f^{ad}_c \quad (15)$$

(when the squared length of the longest root is equal to 2), where g^{ab} is the induced metric (it is indeed symmetric) and Q is the dual Coxeter number⁷. The coefficient $f^{abc} = \sum_d f^{ab}_d g^{dc}$ is totally antisymmetric and $\sum_{a,b} g_{ab} J^a J^b$ is a (quadratic) Casimir, where g_{ab} is the inverse of g^{ab} .

Affine Lie algebras, also called affine Kac-Moody algebras, are a generalization of Lie algebra and will often be used in the dissertation. They are constructed in two steps. The first one introduces a new basis of vectors for the algebra $g \otimes \mathbb{C}[t, t^{-1}]$, called *loop algebra*. This loop algebra couples elements of g to Laurent series of a complex parameter t , hence a basis is spanned by $J_n^a = J^a \otimes t^n$ for integer n . The second step extends loop algebras to affine Lie algebras by adding a central element k (hence the name):

$$[J_n^a, J_m^b] = \sum_c \iota f^{ab}_c J_{n+m}^c + kn g^{ab} \delta_{n+m,0} \quad (16)$$

Affine Lie algebras are usually denoted by \hat{g} or \hat{g}_k and will be presented in more detail in subsection 4.4.2.

⁷The dual Coxeter number is determined by the algebra g . It is equal to the value of the quadratic Casimir in the adjoint representation divided by the length squared of the longest root. See *e.g.* [21] for more details.

3.2 Representations

A fundamental notion in group theory is that of representation. The dissertation will deal with many examples of representations, *e.g.* representations of the Virasoro algebra, of the fusion algebra, of the Heisenberg algebra, of $sl(2, \mathbb{R})$ and $\widehat{sl(2, \mathbb{R})}_k$ *etc.* The definition of group and algebra representations with their most important properties are reviewed below.

A representation T of a group G (not necessarily a Lie group) on a topological vector space V is a group homomorphism that sends any element of G to an automorphism of V , *i.e.* $T : G \rightarrow GL(V)$ such that the function $G \times V \rightarrow V$, $(g, v) \mapsto T(g)v$ is continuous. The group G therefore acts on the space V . For instance, the trivial representation is $T(g) = E$, the identity element of $GL(V)$. The *dimension* of the representation is the dimension of the space V .

When V is a prehilbertian vector space with bilinear hermitian form $\langle \cdot, \cdot \rangle$, a representation is *unitary* if and only if for any element g in the Lie group G , $T(g)$ is unitary. That is to say, $\langle T(g)v, T(g)w \rangle = \langle v, w \rangle$ for any $v, w \in V$.

Two representations T_1 and T_2 of a group G , defined on vector spaces V_1 and V_2 , are *equivalent* if and only if there exists an isomorphism $\phi : V_1 \rightarrow V_2$ such that for any $g \in G$, $\phi \circ T_1(g) = T_2(g) \circ \phi$. *Schur's lemma* is a useful result in this context. It states that if T_1 and T_2 are irreducible representations of G on V_1 and V_2 respectively, such that there exists a linear function ϕ satisfying $\phi \circ T_1(g) = T_2(g) \circ \phi$ for any $g \in G$ (it is then said to intertwine T_1 and T_2), then either ϕ is an isomorphism and T_1 and T_2 are equivalent, or $\phi = 0$. Moreover, two unitary representations T_1 and T_2 defined on vector spaces V_1 and V_2 are unitarily equivalent if and only if there exists a unitary isomorphism $\phi : V_1 \rightarrow V_2$ such that for any $g \in G$, $\phi \circ T_1(g) = T_2(g) \circ \phi$. If two unitary representations are equivalent, then they are unitarily equivalent.

A representation is reducible if and only if there exists at least one invariant subspace W of V (such that for any element g in G and w in W , $T(g)w \in W$) that is neither $\{0\}$ nor V . In other words, the matrix representation of T in a certain basis reads:

$$T = \begin{pmatrix} * & * \\ 0 & * \end{pmatrix} \quad (17)$$

A representation that is not reducible is *irreducible*. Irreducible representations are useful since they are the building blocks of any other finite dimensional representation of compact groups. Indeed, in the case of compact groups, any finite dimensional representation is completely reducible *i.e.* is a direct sum of irreducible representations. This remains true for non-compact groups if they are connected and semi-simple. Unitary representations are also completely reducible.

The rest of the dissertation will mostly deal with unitary irreducible representations. Unitarity is usually required for physical reasons (in order to ensure that the norm of any vector is positive); moreover any (continuous) representation of a compact Lie group G on a prehilbertian space is equivalent to a unitary representation. Irreducibility can be assumed in several cases of interest (as

mentioned above) since other (finite dimensional, or unitary) representations follow from the irreducible case.

In subsection 3.1 it was stressed that Lie algebras are canonically associated to Lie groups. The relation extends to representation. A representation of a Lie algebra \mathfrak{g} is a homomorphism that sends elements of \mathfrak{g} to endomorphisms of a vector space V . If \mathfrak{g} is the canonical Lie algebra of the Lie group G , and T is a representation of G on V , then T canonically defines a representation of \mathfrak{g} on V thanks to the exponentiation map:

$$T(X) = \left. \frac{dT(g(t))}{dt} \right|_{t=0} \quad (18)$$

where $X \in \mathfrak{g}$ is the tangent vector at $t = 0$ of the one-dimensional subgroup $g(t)$ of G such that $g(0) = e$, that is to say $g(t) = e^{tX}$ (for infinite dimensional representations, one needs to be a bit more careful because the domain on which the representations of \mathfrak{g} and G act may be different). Properties of representations (unitarity, irreducibility *etc.*) are preserved when going from a group representation to an algebra representation and vice-versa.

Finally, the *character*⁸ of a representation T is defined by:

$$\begin{aligned} \chi : G &\rightarrow \mathbb{R} \\ g &\mapsto \chi_T(g) = \text{Tr}(T(g)) \end{aligned} \quad (19)$$

where the trace is taken over the vector space V , that is supposed here to be finite dimensional. This is a useful quantity, since characters of two equivalent representations are the same. Moreover, characters are constant on conjugacy classes, *i.e.* $\chi_T(hgh^{-1}) = \chi_T(g)$. The character of the direct sum (respectively the tensor product) of two representations is equal to the sum (respectively the product) of their characters.

3.3 Adjoint and co-adjoint representations and orbits

The adjoint and co-adjoint representations are important examples of representations and will be used in section 7. These concepts are reviewed here.

The conjugate action of a Lie group G on itself is defined by:

$$\begin{aligned} G \times G &\rightarrow G \\ (g, h) &\mapsto ghg^{-1} \end{aligned} \quad (20)$$

The set of all points ghg^{-1} where g is any element of the group is called the *conjugacy class* (or orbit) of the element h . The set of elements $g \in G$ such that $ghg^{-1} = h$ is called the *stabilizer* of h . The notion of orbit is naturally extended to elements of the Lie algebra. The conjugate action of G on itself

⁸Characters of group representations appear in the classical limit of conformal field theory, see section 4.5.

induces a representation of G on its canonical Lie algebra \mathfrak{g} , called the *adjoint representation* of G :

$$\begin{aligned} Ad : G \times \mathfrak{g} &\rightarrow \mathfrak{g} \\ (g, X) &\mapsto Ad_g X = gXg^{-1} = \left(\frac{d}{dt} (g \exp(tX) g^{-1}) \right)_{t=0} \end{aligned} \quad (21)$$

This in turn induces the adjoint representation of \mathfrak{g} on \mathfrak{g} :

$$\begin{aligned} ad : \mathfrak{g} \times \mathfrak{g} &\rightarrow \mathfrak{g} \\ (X, Y) &\mapsto ad_X Y = [X, Y] = XY - YX = \left(\frac{d}{dt} (Ad_{\exp(tX)} Y) \right)_{t=0} \end{aligned} \quad (22)$$

Co-adjoint representations can be defined when there exists a bilinear form $\langle \cdot, \cdot \rangle$ on \mathfrak{g} . The bilinear form will always be assumed to be G -invariant and non-degenerate (it may be the Killing form for semi-simple algebras). The dual space \mathfrak{g}^* is then the space of linear forms on \mathfrak{g} , which can be identified with \mathfrak{g} if this algebra is finite dimensional: for $g_1, g_2 \in \mathfrak{g}$, $\langle g_1, \cdot \rangle : \mathfrak{g} \mapsto \langle g_1, g_2 \rangle$ is an element of \mathfrak{g}^* . The *adjoint orbit* of an element $X \in \mathfrak{g}$ is the set of elements gXg^{-1} for all $g \in G$. The *co-adjoint orbit* of an element $\lambda \in \mathfrak{g}^*$ is defined in a similar way. It is the set of elements⁹ $Ad_g^* \lambda = g\lambda g^{-1}$ for any $g \in G$. The *co-adjoint representation*, which is a representation of the group G on the dual \mathfrak{g}^* of the canonically associated Lie algebra \mathfrak{g} , is defined as:

$$\begin{aligned} Ad^* : G \times \mathfrak{g}^* &\rightarrow \mathfrak{g}^* \\ (g, \lambda) &\mapsto Ad_g^* \lambda, \text{ such that for any } Y \in \mathfrak{g}, \\ &\quad \langle Ad_g^* \lambda, Y \rangle = \langle \lambda, Ad_{g^{-1}} Y \rangle \end{aligned} \quad (23)$$

The co-adjoint representation of G induces a representation of the Lie algebra \mathfrak{g} on the dual \mathfrak{g}^* :

$$\begin{aligned} ad^* : \mathfrak{g} \times \mathfrak{g}^* &\rightarrow \mathfrak{g}^* \\ (X, \lambda) &\mapsto ad_X^* \lambda, \text{ such that for any } Y \in \mathfrak{g}, \\ &\quad \langle ad_X^* \lambda, Y \rangle = -\langle \lambda, ad_X Y \rangle \end{aligned} \quad (24)$$

⁹This definition is not the most generic one, but it is enough for a wide range of groups including $SU(2)$ and $SU(1,1)$ that will be considered in section 7. For a more general definition, see [22] which uses a projection on the dual \mathfrak{g}^* .

4 Conformal field theory

This section is the second and last introductory section to the dissertation. It uses some results of the previous section on group theory and provides a pedagogical introduction to unitary rational conformal field theory (CFT). The emphasis is put on the general ideas of the theory and on the major results, which are presented in a hopefully clear and simple way. The following pages may therefore be of some use to people who are not familiar with the field. For those who wish to learn more about conformal field theory, there already exist a number of articles, reviews or books devoted to this subject [7, 21, 23, 24, 25, 26, 27, 28, 29, 30, 31, 32, 33, 34, 35]. These notes are indebted to all these works.

Section 4.1 reviews fundamental definitions and motivations to study conformal field theory, while sections 4.2 and 4.3 present the philosophy of conformal field theory without and with boundary (respectively), along with important general results. Section 4.4 is an introduction to more advanced issues, like conformal field theory on the torus, Wess-Zumino-Witten models and the Verlinde formula. Section 4.5 reviews classical conformal field theory and its relation to group theory and connects to section 3. Finally section 4.6 addresses several issues concerning non-rational conformal field theories, whose study is at the core of the dissertation. Most results reviewed in this section are useful to understand the papers [1, 2] which are reviewed later in sections 6 and 7, as well as section 5.

4.1 Introduction to conformal field theory

4.1.1 Conformal symmetry group and conformal field theory

The conformal symmetry group is defined on the Euclidean¹⁰ space \mathbb{R}^d as the group of locally defined transformations that preserve angles (isogonal mappings), *i.e.* the group of transformations $x^\mu \rightarrow x'^\mu$ that leave the metric invariant up to an overall multiplicative factor:

$$g'_{\mu\nu}(x') = \Lambda(x)g_{\mu\nu}(x) \quad (25)$$

Note that the Poincaré group (consisting of translations and rotations) is a subgroup of the conformal group, as it corresponds to the case $\Lambda(x) = 1$.

If $d > 2$, the conformal group can be shown to be generated by translations, rotations, dilatations $x'^\mu = \lambda x^\mu$ with $\lambda > 0$, and special conformal transformations:

$$x'^\mu = \frac{x^\mu + x^2 a^\mu}{1 + 2(x \cdot a) + x^2 a^2} \quad (26)$$

¹⁰Minkowskian space-time implies some difficulties. Most notably, the time direction must be non-compact in order to avoid closed time-like curves that would break causality. The whole space-time is therefore non-compact, meaning that the associated conformal field theory is non-rational (and this is outside the scope of the present introduction). See later for more details. As a consequence, the whole of section 4 is restricted to Euclidean space *i.e.* space with a metric of strictly positive signature.

where $a^\mu \in \mathbb{R}^d$ and $x.a = x^\mu a^\nu g_{\mu\nu}$. Moreover, the conformal group is then isomorphic to $O(1, d + 1)$.¹¹

If $d = 2$ *i.e.* if one is actually considering conformal transformations on the complex plane \mathbb{C} , the above four kinds of transformations generate what is called the *Möbius group*. This group consists of all the transformations of the form $z \rightarrow z' = \frac{az+b}{cz+d}$ where $a, b, c, d \in \mathbb{C}$ and $ad - bc = 1$, and is therefore the group $SL(2, \mathbb{C})/\mathbb{Z}_2$.

Yet, if $d = 2$, the conformal group is infinite dimensional *i.e.* much larger than the Möbius group. Indeed, for any locally defined holomorphic function f , the transformation $z' = f(z)$ is conformal¹². This result is fundamental as it explains why conformal invariance is so important in two dimensions: the group being infinite dimensional, it provides very strong constraints on any two-dimensional theory which has the conformal group as a symmetry group, meaning that it is a precious tool in order to understand such a theory.

Finally, to make things more precise, a conformal field theory is a Euclidean quantum field theory which symmetry group contains the local conformal transformations. Like any other quantum field theory, a conformal field theory will be determined by its space of states (presumably a Hilbert space) and the collection of its correlation functions (vacuum expectation values). Conformal field theories are highly constrained, as was already stressed above. For instance, scale invariance implies that all particle-like excitations must be massless (however, even if they are massive, conformal invariance is nevertheless a good approximation in either the low or high energy limit).

4.1.2 Motivations

Among the conformal transformations, the scaling symmetry is of particular importance. One reason why is that the most important scale invariant two-dimensional local quantum field theory are actually conformally invariant¹³. The scale invariance (the conformal group) appears in various fields of physics.

In statistical physics, critical points of second-order phase transitions (*i.e.* such that the second derivative of the free energy has a discontinuity) are scale invariant, because the correlation length becomes infinite. For instance, the continuum two-dimensional Ising model at its critical temperature is described by the conformal field theory of a free massless real (Majorana) fermion, and the three-state Potts model is described by a conformal field theory at $c = \frac{4}{5}$ (see relation (39) for the definition of the central charge c). Moreover, as mentioned in the introduction to the dissertation, conformal symmetry has been used to

¹¹Hint: the dimensions of both spaces are equal to $\frac{1}{2}(d+1)(d+2)$ and therefore match. The isomorphism is more easily built by considering the algebras. Assuming that the space is of the more general form $\mathbb{R}^{p,q}$ of signature (p, q) , it can be shown that the conformal group is isomorphic to the group $O(p+1, q+1)$ (recall that the Lorentz or Poincaré group is isomorphic to $O(p, q)$).

¹²The choice $z' = f(\bar{z})$ would also conserve angles, but would reverse the orientation. This possibility will not be considered in these notes.

¹³For a counter-example, see [36]

study quantum Brownian motion, the Kondo problem, Toda field theory, polymers or even the traveling salesman problem.

In particle physics, scale invariance appears at short distances in QCD, when probing protons deeply with inelastically scattered electrons: no characteristic length scale appears because the quarks are asymptotically free and hence appear as point-like constituents.

In string theory, the excitations of the string are described, from the point of view of the worldsheet, by a conformal field theory. This can be seen in *Polyakov's action* for (bosonic) strings moving in flat space-time [37, 38, 39]:

$$S_P = -\frac{T}{2} \int d^2\xi \sqrt{\det g} g^{\alpha\beta} \frac{\partial X^\mu}{\partial \xi^\alpha} \frac{\partial X^\nu}{\partial \xi^\beta} \eta_{\mu\nu} \quad (27)$$

which is conformally invariant¹⁴. The metric of the space-time is the Minkowski metric $\eta_{\mu\nu}$, while $g_{\alpha\beta}$ is the intrinsic metric on the worldsheet. It is standard to denote by $T = \frac{1}{2\pi\alpha'} = \frac{1}{2\pi l_s^2}$ the tension of the string, where α' is the Regge slope and l_s the string length¹⁵. The classical limit of the theory associated to Polyakov's action is obtained by taking $T \rightarrow \infty$, or alternatively $\alpha' \rightarrow 0$ or $l_s \rightarrow 0$. This is consistent with the usual classical limit $\hbar \rightarrow 0$ in quantum mechanics, where the dimensionless action is proportional to $1/\hbar$ (since here, by analogy, $T \sim 1/\hbar$). This limit is also consistent with the idea that the classical limit amounts to considering the string from far away ($l_s \rightarrow 0$), when it resembles a point particle (therefore the limit is rather called point particle limit in string theory). This limit also means that the string becomes very stiff ($T \rightarrow \infty$), so the oscillation modes of the string become very massive and decouple from the low-energy theory. Hence the string is described by the movement of its center of mass only – like a particle. The stress-energy tensor, also called the energy-momentum tensor, is:

$$T_{\alpha\beta} = -\frac{2}{T} \frac{1}{\sqrt{\det g}} \frac{\partial \mathcal{L}_P}{\partial g^{\alpha\beta}} \quad (28)$$

where \mathcal{L}_P is the Lagrangian associated to the Polyakov action. The stress-energy tensor will play a prominent role in conformal field theory. Conformal invariance is a precious tool in string theory for several reasons. The no-ghost theorem, which ensures that the theory is free of ghosts (states that lead to negative probabilities in quantum mechanics), requires the theory to be conformally invariant both at the classical and at the quantum levels. Remark also that perturbation theory in terms of the string coupling¹⁶ is given as a sum over

¹⁴Hint: the Weyl transformation $g^{\alpha\beta} \rightarrow \Omega g^{\alpha\beta}$ is straightforward, since $\det g = \det g_{\alpha\beta}$ and the metric is two-dimensional.

¹⁵A possible order of magnitude for the string length may be given by Planck's length L_P , though it may be larger than that.

¹⁶This dimensionless parameter is $g_s = e^{\Phi/2}$ where Φ is the dilaton. The weight of the contribution of a Riemann surface of Euler characteristic $\chi = 2 - 2g$ is $g_s^{-\chi}$, where g is the genus of the surface (the number of handles). In string theory, the limit $g_s \rightarrow 0$ is called the classical limit.

the genus of the possible worldsheet surfaces and has this rather simple structure because conformal symmetry allows one to identify any genus zero surface to the sphere (tree-amplitude), any genus one surface to the torus (one-loop amplitude) *etc.* Moreover, string amplitudes can be expressed in terms of correlation functions of the associated conformal field theory (when passing from conformal field theory to string theory, one must consider the perturbative expansion and compute it term by term by integrating over the moduli parameters of the surface – for instance τ for the torus – and over the position of the vertex operators of the strings – taking into account the possible gauge freedom, which for instance fixes the position of three vertices on the sphere). Finally, various string models basically differ in the specific content of the worldsheet conformal field theory (including boundary conditions when necessary), therefore a classification of two-dimensional conformal field theories may give a perspective on the variety of consistent string theories that can be constructed (though the consistent string theories may actually correspond to different vacua of a single theory). The relation of conformal field theory to string theory was the main motivation to study this field, since properties concerning the former translate to results for the latter.

Finally, one may say that conformal field theories are easily solvable toy models of genuinely interacting quantum field theories, and therefore are interesting in their own right as a way to get some insight on the physics of the quantum world. Conformal field theories are also interesting from the point of view of mathematics and have given rise to new mathematical fields like vertex operator algebras.

4.2 Conformal field theory basics

As mentioned in the introduction, a two-dimensional conformal field theory is naturally defined on a Riemann surface, *i.e.* a two-(real-)dimensional surface which possesses complex coordinates¹⁷ z and \bar{z} , therefore allowing the local conformal transformations to be well defined. A basic example is the Riemann sphere *i.e.* the sphere identified to the complex plane with the point at infinity added. It is this sole example that will be studied throughout subsection 4.2, which explains all the fundamental ideas of conformal field theory.

4.2.1 The Hilbert space and the vertex operators

For *rational* conformal field theories (*i.e.* theories with a finite number of primary fields, which are defined below), the space of states is a vector space, most of the time a Hilbert space denoted \mathcal{H} . It contains a vacuum state (*i.e.* a stable Poincaré invariant state) $|0\rangle$ from which any other *state* $|\Phi\rangle$ can be generated thanks to a *vertex operator* $\Phi(z, \bar{z})$:

$$|\Phi\rangle = \Phi(0, 0)|0\rangle \tag{29}$$

¹⁷It is useful to consider z and \bar{z} as independent variables, although one should remember that the physics is described by $\bar{z} = z^*$ the complex conjugate of z .

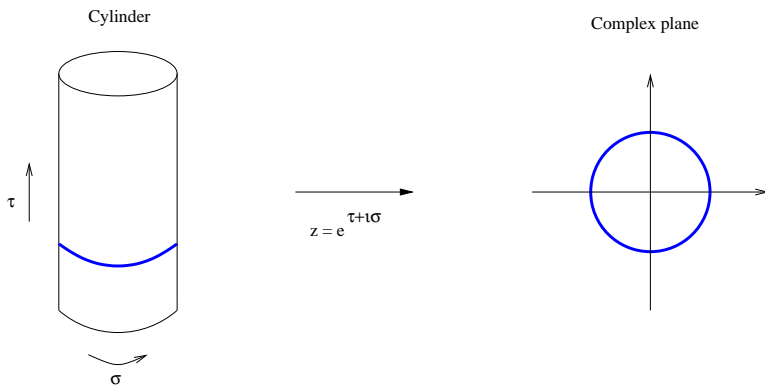

Figure 5: The cylinder is conformally mapped to the complex plane, therefore leading to radial quantization. A constant time line is pictured in thick blue.

For unitary rational theories, the uniqueness theorem ensures that there is a one-to-one correspondence between states in the Hilbert space and vertices (which are also called *fields*) defined on the sphere (function of z, \bar{z}), therefore both terms will be used as synonyms.

Before proceeding further, a question motivated by string theory may arise: why consider a sphere while the worldsheet of a free (closed) string is actually rather like a cylinder? The reason is that the cylinder can be conformally mapped to the complex plane (topologically identified to the Riemann sphere), according to figure 5 (strictly speaking the sphere has two punctures at $z = 0$ and $z = \infty$, corresponding to the two ends of the infinite cylinder). The cylinder is assimilated to the complex plane $w = \tau + i\sigma$, with the identification $\sigma \sim \sigma + 2\pi$. The conformal transformation $z = e^w$ then relates the cylinder to the plane. Note that equal time lines $\tau = \tau_0$ along the cylinder are associated to fixed radius circles $|z| = e^{\tau_0}$ on the complex plane. The infinite past $\tau \rightarrow -\infty$ corresponds to $|z| \rightarrow 0$ while the infinite future $\tau \rightarrow \infty$ corresponds to $|z| \rightarrow \infty$. In the quantum theory, time-ordering, that is needed in order to construct correlation functions, is replaced by a radial ordering that ensures that in an n -point function $\langle \Phi_1(z_1, \bar{z}_1) \dots \Phi_n(z_n, \bar{z}_n) \rangle$ one has $|z_1| > \dots > |z_n|$. This is called *radial quantization*.

A short study of the fields of the theory is presented below. All fields are assumed to be *local*:

$$\Phi(z, \bar{z})\Psi(w, \bar{w}) = (-1)^F \Psi(w, \bar{w})\Phi(z, \bar{z}) \quad (30)$$

where F is the *fermionic number*: it is one if both Φ and Ψ are fermionic and zero otherwise. The locality condition implies that correlation functions do not depend on the order in which fields appear (up to a sign when there are fermions).

A useful and important property of rational conformal field theories is that one does not need to study the whole Hilbert space \mathcal{H} . Instead, one can restrict

to a finite dimensional subspace, here denoted by \mathcal{V} , which has the useful property that it generates \mathcal{H} , meaning that any correlation function in \mathcal{H} can be reconstructed from correlation functions in \mathcal{V} , thanks to a process called factorization or descent (that will be explained later, see subsection 4.2.5). Fields in \mathcal{V} are called *primary fields* and have the property that they transform covariantly under conformal transformations (the transformed field is still denoted by Φ for simplicity):

$$\Phi(f(z), \bar{f}(\bar{z})) = \left(\frac{df(z)}{dz} \right)^{-h} \left(\frac{d\bar{f}(\bar{z})}{d\bar{z}} \right)^{-\bar{h}} \Phi(z, \bar{z}) \quad (31)$$

where $h = (\Delta + s)/2$ and $\bar{h} = (\Delta - s)/2$ are real numbers called the (left and right) *conformal weights*¹⁸ of the primary field Φ , where Δ is the (*anomalous scaling dimension*) and determines the behavior of the field under scalings, and s is the (*planar spin*) and determines the behavior under rotations.

The formula (31) is to be understood as valid in correlation functions (assuming the vacuum to be invariant under the conformal transformation $f(z)$). Note that the metric $g_{z\bar{z}}$ precisely transforms like (31) under conformal transformations, with conformal weights $h = \bar{h} = 1$. Throughout the rest of this introduction to conformal field theory, and unless otherwise mentioned, primary fields are the only fields that will be considered (except for the stress-energy tensor which, as will be seen later, is only quasi-primary *i.e.* transforms like (31) only under conformal transformations which belong to the Möbius group).

A key formula concerning primary fields (or other fields as well) is the *operator product expansion* (OPE):

$$: \Phi_i(z_1, \bar{z}_1) \Phi_j(z_2, \bar{z}_2) : \sim \sum_k C_{ij}^k z_{12}^{h_k - h_i - h_j} \bar{z}_{12}^{\bar{h}_k - \bar{h}_i - \bar{h}_j} \Phi_k(z_2, \bar{z}_2) + \text{finite} \quad (32)$$

where $z_{12} = z_1 - z_2$, $\bar{z}_{12} = \bar{z}_1 - \bar{z}_2$, and $z_{12}, \bar{z}_{12} \rightarrow 0$. The notation $::$ indicates normal ordering¹⁹ and $+ \text{finite}$ indicates regular terms in the asymptotic expansion. The coefficient C_{ij}^k is symmetric in i and j (for bosonic fields – it is anti-symmetric if both fields are fermionic. This complication will not be taken into account anymore below). The operator product expansion should be understood as a formula valid in any correlation function, for which it defines an exact expansion. In the rest of the dissertation the notations $::$ and $+ \text{finite}$ will be conveniently dropped in any operator product expansion (since finite terms are sub-leading terms in the limit and are irrelevant in most cases of interest). Note the remarkable property that the set of primary fields closes under the operator product expansion, *i.e.* only primary fields appear in the first term of the right-hand side of equation (32). Although in general the operator product expansion only defines an asymptotic expansion, for conformal field theories it does converge in some domain of z_{12} . The radius of convergence is equal to the

¹⁸In statistical physics, for instance for the Ising model, the critical exponents are simple linear combinations of these weights.

¹⁹Normal ordering is a prescription for defining products of free fields by specific subtractions of divergent terms. In the case of interacting theories, the normal-ordered product of fields is divergent, and the divergence is given by the operator product expansion.

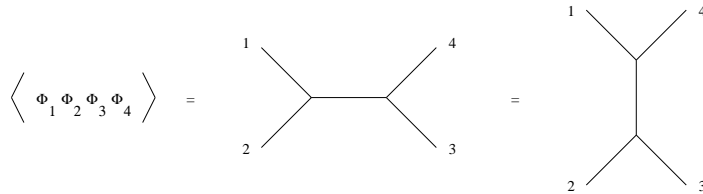

Figure 6: Crossing symmetry.

distance to the nearest other operator in the correlation function. The operator product expansion is highly important because it encodes the dynamics of the theory. Indeed, any correlation function can be reduced to basic two-point functions by applying this expansion as many times as necessary. The operator product expansion defines on the space of fields what is called a *vertex operator algebra* (it is not an algebra because of the z dependence of the coefficients that appear in the product $\Phi_i\Phi_j$), a notion that has been much studied in the mathematical literature.

The conformal bootstrap The *conformal bootstrap* is a powerful program which attempts to determine the constants C_{ij}^k (which, as was said, actually encode all the dynamics of the correlation functions) from two basic symmetry requirements: correlation functions must be local, and the operator product expansion must be associative. This last constraint is the main dynamical principle in this viewpoint and arises from the investigation of the four-point function, which can be decomposed (factorized) in two possible ways, schematically shown in figure 6. This is what is called the *crossing symmetry* condition, which leads to algebraic equations which must be solved by the structure constants C_{ij}^k . Unfortunately, the bootstrap program is in principle very hard to carry out because it involves technical difficulties, and it is mostly tractable for theories with a finite number of primary fields (meaning a finite number of C_{ij}^k constants), like the minimal models²⁰. It also works for logarithmic conformal field theories (the name comes from the fact that some of their correlation functions contain logarithms, see [40]) or, to cite a non-rational theory, the $SL(2, \mathbb{C})/SU(2)$ Wess-Zumino-Witten model [41, 42].

4.2.2 Chiral theories

For rational conformal field theories, the Hilbert space can be decomposed into a left part and a right part, also called *chiral sector* and *anti-chiral sector* (or sometimes holomorphic and anti-holomorphic, or also meromorphic and anti-

²⁰Minimal models are pure Virasoro theories of central charge $c = 1 - 6 \frac{(p-q)^2}{pq}$ where p and q are strictly positive integers with $q \geq p$. The definition of the central charge is given below in equation (39). Minimal models are unitary if and only if $q = p + 1$. They are related to the Landau-Ginzburg model (a scalar field theory), which provides a Lagrangian representation of minimal models.

meromorphic or analytic and anti-analytic), for which vertices only depend on z or \bar{z} respectively. For instance, a chiral primary field transforms like the vacuum under right conformal transformations, *i.e.* has $\bar{h} = 0$ (hence $h = \Delta = s$) and therefore only depends on z . The fact that the theory splits into a right and a left part that are independent from each other can be understood from a string theory point of view since the oscillations of a closed string can be decomposed into two waves moving in opposite directions and independently of each other. Finally, the operator product expansion formula (32) proves that the subspace of (anti-)chiral fields closes under the operator product expansion, therefore defining a consistent sub-theory by itself, with its own dynamics (the closed vertex algebra of chiral fields is called the *chiral ring*). This theory is studied below.

All the simplifications that were assumed concerning the Hilbert space allows to write the following decomposition:

$$\mathcal{H} = \sum_{i, \bar{j}} n_{i, \bar{j}} \mathcal{H}_i \otimes \mathcal{H}_{\bar{j}} \quad (33)$$

where $n_{i, \bar{j}}$ are positive integers²¹. The spaces \mathcal{H}_i describe the chiral part of the theory and $\mathcal{H}_{\bar{j}}$ its anti-chiral part. Moreover in rational conformal field theories every representation i and every representation i^\vee (i^\vee is the conjugate representation of i , see subsection 4.4.3) occur exactly once in the sum, so actually $\mathcal{H} = \sum_i n_{i, \sigma(i)} \mathcal{H}_i \otimes \mathcal{H}_{\sigma(i)}$, where σ defines an automorphism of the fusion rule algebra (see section 4.4.3). The present introduction to conformal field theory is restricted to the simplest case of diagonal theories, for which $\sigma(i) = i^\vee$. Otherwise, the theory is called non-diagonal. It is therefore possible to restrict oneself to the study of the irreducible representations \mathcal{H}_i of the chiral vertex operator algebra (the study of $\mathcal{H}_{\bar{j}}$ would be exactly identical so will not be considered for the sake of conciseness). As explained later in subsection 4.2.5, the subspace \mathcal{H}_i is actually associated to a single (chiral) primary field Φ_i . Decomposition (33) may be valid for some non-rational conformal field theories, however a counter-example is provided by the logarithmic conformal field theories.

The *cluster property*

$$\left\langle \prod_i \Phi_i(z_i) \prod_j \Phi_j(\lambda w_j) \right\rangle_{\lambda \rightarrow 0} \sim \left\langle \prod_i \Phi_i(z_i) \right\rangle \left\langle \prod_j \Phi_j(w_j) \right\rangle_{\lambda^{-\sum_j h_j}} \quad (34)$$

is an essential ingredient for the above picture to be correct, and will always be assumed here. It implies strong and useful constraints on the theory. For instance, it implies that there is only one state with $h = 0$, which is the vacuum state. Another consequence is that the space of states can be completely decomposed into irreducible representations of the Möbius group *i.e.* of the Lie algebra $sl(2, \mathbb{C})$ (these representations precisely correspond to the spaces \mathcal{H}_i).

²¹Usually $n_{i, \bar{j}} = \delta_{i, \bar{j}}$. Cases which mix different representations may however be considered.

The cluster property also implies that the set of conformal weights of the primary fields (*i.e.* the spectrum of L_0 , that plays the role of the Hamiltonian, as explained below) is bounded by zero. This means that the energies of the (irreducible) representations are positive, *i.e.* that they are physically relevant. Indeed, the unitarity of the theory requires that all conformal weights are positive²². Finally, the cluster property ensures that the locality, the property of covariant transformation under Möbius transformations (*i.e.* the property to be a quasi-primary state) and the positivity of any conformal weight, for any state in the whole Hilbert space, follow from these properties for primary states.

The collection of all correlation functions $\langle \prod_i \Phi_i(z_i) \rangle$ of primary fields Φ_i constitutes a representation of the chiral conformal field theory. The representation is called *untwisted* if all these amplitudes (correlators) are single-valued as z_i encircles the origin or the infinity, otherwise it is called *twisted*. An example of twisted representations is provided by the Ramond sector of a fermionic algebra (indeed, fermionic fields pick up a minus sign when z encircles the origin).

Finally, all known conformal field theories have a hermitian inner product, which is positive definite if and only if the theory is unitary. This is related to the fact that there exists an antilinear involution $\Phi \rightarrow \bar{\Phi}$ for any field Φ such that:

$$\left(\left\langle \prod_i \Phi_i(z_i) \right\rangle \right)^* = \left\langle \prod_i \bar{\Phi}_i(\bar{z}_i) \right\rangle \quad (36)$$

The hermitian conjugate of a field Φ of conformal weights h, \bar{h} is defined by:

$$(\Phi(z, \bar{z}))^\dagger = \Phi\left(\frac{1}{\bar{z}}, \frac{1}{z}\right) \bar{z}^{-2h} z^{-2\bar{h}} \quad (37)$$

This definition is justified by the fact that time reversal is implemented on the plane by $z \rightarrow 1/z^*$. The adjoint state is:

$$\langle \bar{\Phi} | = \lim_{z, \bar{z} \rightarrow 0} \langle 0 | (\Phi(z, \bar{z}))^\dagger = (|\Phi\rangle)^\dagger \quad (38)$$

This remark ends the analysis of the structure of the Hilbert space of states. The next subsection is a study of the stress-energy tensor, which is an essential element of the theory since it is the field that generates conformal transformations (in the sense given below in (45)).

4.2.3 The Virasoro algebra and the primary fields

What will be called *stress-energy tensor*, and denoted $T(z)$, is actually one of the two non-zero components of the energy-momentum tensor $T_{\alpha\beta}$. More

²²Proof (see below for the definition and properties of the Virasoro algebra):

$$\begin{aligned} ||L_{-1}|\Phi_h\rangle||^2 &= \langle \Phi_h | L_1 L_{-1} | \Phi_h \rangle = \langle \Phi_h | [L_1, L_{-1}] | \Phi_h \rangle \\ &= 2\langle \Phi_h | L_0 | \Phi_h \rangle = 2h\langle \Phi_h | \Phi_h \rangle \end{aligned} \quad (35)$$

precisely, $T_{zz} = T(z)$ is the left part of the energy-momentum tensor, which appears in the study of the chiral conformal field theory, and $T_{\bar{z}\bar{z}} = \bar{T}(\bar{z})$ is its right part, which would appear in the anti-chiral theory (which will not be studied here for the sake of conciseness – results are essentially the same). The fields T and \bar{T} are therefore in no way conjugate of each other, but this notation is standard in conformal field theory. The other components of $T_{\alpha\beta}$ are $T_{z\bar{z}} = T_{\bar{z}z} = \frac{1}{2}Tr(T_{\alpha\beta}) = 0$ if the theory is conformally invariant both at the classical and at the quantum level. If there exists a *conformal anomaly*, then the conformal invariance is broken at the quantum level and the trace of the energy-momentum tensor is not zero. It is given by $T_{\alpha}^{\alpha} = \frac{c}{96\pi^3} \sqrt{\det g} R^{(2)}$, where c is the central charge (see below) and $R^{(2)}$ is the two-dimensional Riemann scalar curvature associated to the metric $g_{\alpha\beta}$.

The operator product expansion of the stress-energy tensor with itself is:

$$T(z)T(w) \sim \frac{c/2}{(z-w)^4} + \frac{2T(w)}{(z-w)^2} + \frac{\partial T(w)}{z-w} \quad (39)$$

where the *central charge* c appears in the most divergent term. This generic result is a natural extrapolation of formulas obtained for simple cases like the free boson theory. Translated in terms of the modes of the energy-momentum tensor, one obtains the following commutation relations:

$$[L_n, L_m] = (n-m)L_{n+m} + \frac{c}{12}n(n^2-1)\delta_{n+m,0} \quad (40)$$

which define the *Virasoro algebra*. The relation between the field T and its modes L_n is given by a Laurent expansion, which can be inverted:

$$T(z) = \sum_{n \in \mathbb{Z}} L_n z^{-n-2}, \quad L_n = \frac{1}{2i\pi} \oint_0 z^{n+1} T(z) dz \quad (41)$$

where \oint_0 is a notation that will be used elsewhere and will always stand for a positively oriented integral around any contour that encircles zero. The connection is made clear by the following formula (the second contour integral is around w):

$$[A; B] = \oint_0 dw \oint_w dz a(z)b(w) \quad (42)$$

where $A = \int_0 a(z)dz$ and $B = \int_0 b(w)dw$.

The central charge c is very important since it is the parameter of the theory. For a start, it is an extensive measure of the number of degrees of freedom of the theory: when two decoupled systems (of free fields) are put together, the stress-energy tensors simply add up *i.e.* $T_{\text{total}} = T_1 + T_2$ and so does the central charge, $c_{\text{total}} = c_1 + c_2$. For example, one counts 1 for a free boson, 1/2 for a free fermion, -26 for the fermionic reparametrization ghosts and 11 for the bosonic reparametrization ghosts (recall that the ghosts associated to the reparametrization in the bosonic theory are fermionic, and vice-versa). The

central charge is a real number and must be positive in a unitary theory²³. It is a rational number in a rational conformal field theory (the name comes from the rationality of the central charge and of all the conformal weights, though these quantities may be rational as well in non-rational conformal field theories). Note the existence of a central charge \bar{c} for the field \bar{T} . However, the modular invariance of the partition function on the torus, that will be discussed in subsection 4.4.1, implies $c - \bar{c} = 0 \pmod{24}$, and two-dimensional Lorentz invariance actually implies $c = \bar{c}$. Finally, as previously mentioned, a non-zero central charge indicates a conformal anomaly. The central charge therefore describes how the system reacts to macroscopic length scales (*i.e.* breaking of conformal invariance), for instance introduced by boundary conditions (see section 4.3). In order to ensure that the quantum theory is conformally invariant, and unless one considers exceptional cases for which $R^{(2)} = 0$, one must impose that $c = 0$ (yet one often wishes to consider theories with $c \neq 0$, for instance the free boson theory which has $c = 1$, simply because by coupling this theory to other theories one may get $c_{\text{total}} = 0$).

A short digression in order to improve the intuitive understanding of the role of the modes L_n may be of some help. Following [43], a classical analysis of the conformal transformations in two dimensions leads to consider generators $l_n = -z^{n+1}\partial_z$ of the transformations $z \rightarrow z + \epsilon(z)$ with $\epsilon(z) = -\sum_{n \in \mathbb{Z}} c_n z^{n+1} = (\sum_{n \in \mathbb{Z}} c_n l_n) z$. These generators satisfy the Virasoro algebra with $c = 0$ (which makes sense because c appears only in the quantum theory, as a consequence of normal ordering):

$$[l_n, l_m] = (n - m)l_{n+m} \quad (44)$$

This algebra is known as the *Witt algebra*. These remarks are one way to understand why L_0 is associated with scale transformations, since $l_0 = -z\partial_z$. See also (53) below: the conformal weight h , which describes how the field Φ behaves under conformal (scale) transformations, is the eigenvalue of L_0 for the eigenvector $|\Phi\rangle$. Another way to say this is that $H = L_0$ is the generator of time shifts (since radial quantization indeed relates scalings of z and shifts of τ) *i.e.* plays the role of the Hamiltonian in chiral conformal field theory²⁴. Note also that L_{-1} is associated to translations, since $l_{-1} = -\partial_z$. Finally, it can be checked that l_{-1} , l_0 and l_1 generate the Möbius group.

Primary fields of the chiral theory are defined by the property that their operator product expansion with the stress-energy tensor is:

$$T(z)\Phi(w) \sim \frac{h\Phi(w)}{(z-w)^2} + \frac{\partial_w \Phi(w)}{z-w} \quad (45)$$

²³Proof (see also (53)): $L_{-n} = L_n^\dagger$ from hermiticity of the theory (reality condition on T), and:

$$\langle 0|L_n L_{-n}|0\rangle = \langle 0|[L_n, L_{-n}]|0\rangle = \langle 0|2nL_0 + \frac{c}{12}n(n^2 - 1)|0\rangle = \frac{c}{12}n(n^2 - 1)\langle 0|0\rangle \geq 0 \quad (43)$$

²⁴The true Hamiltonian for the complete theory constituted by both chiral and anti-chiral sectors is actually $H = L_0 + \bar{L}_0 - \frac{c}{12}$.

This definition (which is also a possible definition of the conformal weight h , which appears in the most divergent term) is equivalent to the one given in (31). The facts that the eigenvalues of L_0 are the conformal weights and that the generator L_{-1} is associated to translations can be made more precise using relation (41). Indeed, together with the above formula, it implies that:

$$L_0\Phi(z) = h\Phi(z) , \quad L_{-1}\Phi(z) = \partial_z\Phi(z) \quad (46)$$

Comparing equation (45) to equation (39), one can see that the stress-energy tensor has weight 2 but is not a primary field, unless $c = 0$ (yet it is a quasi-primary field, as was already mentioned). Under a generic conformal transformation, the stress-energy tensor transforms as:

$$T(z) = \left(\frac{df(z)}{dz}\right)^2 T(f(z)) + \frac{c}{12} \left[\frac{f'''(z)}{f'(z)} - \frac{3}{2} \left(\frac{f''(z)}{f'(z)}\right)^2 \right] \quad (47)$$

The extra contribution is called the *Schwarzian derivative* and is zero for transformations that belong to the Möbius group.

4.2.4 Correlation functions in a chiral conformal field theory

Conformal symmetry provides strong constraints on conformal field theories. One of the most surprising results of the symmetry is that the group of conformal transformations that are globally defined on the sphere (it is the Möbius group, or also the subgroup of the group of conformal transformations that leave the vacuum invariant) fixes entirely the functional dependence of the one, two and three point functions of (quasi-)primary fields. The one-point function is:

$$\langle\Phi_i(z_1)\rangle = C_i\delta_{h_i,0} \quad (48)$$

i.e. is non zero for the vacuum field $h_i = 0$ only. The two-point function is:

$$\langle\Phi_i(z_1)\Phi_j(z_2)\rangle = \frac{C_{ij}}{z_{12}^{2h}} \quad (49)$$

where $h = h_i = h_j$, $z_{12} = z_1 - z_2$ and C_{ij} is a constant that can be set to one by choosing a proper normalization of the fields²⁵. The requirement $h_i = h_j$ makes sense since the long-distance behaviour of both fields must be the same if they are to have a non-zero correlation function, and since this behaviour is determined by h , see equation (31). Note the appearance of a branch cut under the exchange of Φ_i and Φ_j *i.e.* under $z_{12} \rightarrow e^{2\pi}z_{12}$, unless the conformal weight h is an integer or a half-integer. The locality property of the fields as given in equation (30) therefore means that h must be an integer if the fields are

²⁵This is possible because for any primary field Φ_i in a rational conformal field theory, there is only one primary field $\Phi_{i\vee}$ such that $\langle\Phi_i(z_1)\Phi_{i\vee}(z_2)\rangle \neq 0$. The field $\Phi_{i\vee}$ is the conjugate of the field Φ_i , see subsection 4.4.3.

bosonic and a half-integer in the fields are fermionic²⁶. This may be seen as a spin-statistics theorem. Finally, it is clear from (49) that in a physically suitable theory h must be positive since otherwise the theory would possess correlation functions increasing with the distance. The three-point function is:

$$\langle \Phi_i(z_1)\Phi_j(z_2)\Phi_k(z_3) \rangle = \frac{C_{ijk}}{z_{12}^{h_{ij}} z_{13}^{h_{ik}} z_{23}^{h_{jk}}} \quad (50)$$

where $h_{ij} = h_i + h_j - h_k$, and same expressions for h_{ik} and h_{jk} . The coefficients C_{ijk} is related to the coefficient C_{ij}^k that appeared in the operator product expansion (32). More precisely, one may check that plugging the operator product expansion in the three-point function and using the result for the two-point function, assuming the C_{ij} have been normalized to one, yields $C_{ijk} = C_{ij}^{k\vee}$. The coefficients C_{ijk} are symmetric in i, j, k (for bosonic fields) and may actually be zero. The possible couplings of the theory (*i.e.* the non-zero C_{ijk}) are given by the fusion coefficients discussed later in subsection 4.4.3.

The Möbius group also imposes strong constraints on higher n-point functions, but is not enough to fix the functional dependence entirely anymore. For instance, the four-point function is:

$$\langle \Phi_i(z_1)\Phi_j(z_2)\Phi_k(z_3)\Phi_l(z_4) \rangle = f(z) \prod_{1 \leq m < n \leq 4} z_{mn}^{h/3 - h_m - h_n} \quad (51)$$

where $h = h_i + h_j + h_k + h_l$ (moreover $h_1 = h_i, h_2 = h_j$ etc.), $z_{mn} = z_m - z_n$, and the *anharmonic ratio* $z = \frac{z_{12}z_{34}}{z_{13}z_{24}}$ is the only conformal invariant on the plane (other quantities depending on the coordinates z_i and invariant under the Möbius group may be constructed but they can all be expressed in terms of z). The function f may *a priori* be any meromorphic function. The Möbius group allows one to fix any three vertices (fields) to whichever point one wishes, and it is rather standard to choose $z_1 = \infty, z_2 = 1, z_3 = z$ the anharmonic ratio, and $z_4 = 0$.

It is possible to use other conformal transformations than the Möbius group (*i.e.* generated by L_n with $n \neq 0, \pm 1$) to further constrain the n-point functions with $n \geq 4$. These constraints lead to Ward identities that are not so simple because the vacuum is not invariant under these transformations (typically, one has to deal with complicated differential equations).

Another example of a constraint that may be used to fix n-point functions with $n \geq 4$ is given by the Knizhnik-Zamolodchikov equation and will be discussed in subsection 4.4.2.

Finally, physical correlation functions would involve (primary) fields of the global theory that would not necessarily be chiral or anti-chiral anymore. Analogues of relations (48) to (51) hold in this case as well. A deeper analysis of the four-point function (or of any higher n-point function) leads to the concept

²⁶This is not exactly correct though. Bosons and fermions are only well-defined for the whole theory *i.e.* when considering both chiral and anti-chiral parts of the Hilbert space. The above analysis is focusing on the chiral part only. For the whole theory, it is the spin s , and not the conformal weight h , that is found to be either integer or half-integer.

of *conformal blocks*, which are the building blocks of such correlation functions. They can be computed from the definition of primary fields and the expression of the operator product expansion between the stress-energy tensor and primary fields. More precisely, physical correlation functions decompose into sums of analytic times anti-analytic functions, which are the conformal blocks. For instance, it is possible to write the four-point function in the form:

$$\langle \Phi_i(\infty)\Phi_j(1)\Phi_k(z)\Phi_l(0) \rangle = \sum_m C_{ij}^m C_{klm} \mathcal{F}_m(z) \bar{\mathcal{F}}_m(\bar{z}) \quad (52)$$

where \mathcal{F}_m are the (left) conformal blocks which show propagation of the field Φ_m in the s-channel (see figure 6). This analysis will be used in section 5.

The axiom of duality Physical n-point correlation functions obtained by combining the left-movers and the right-movers are expected to be independent of the sewing procedure (the way one contracts fields together thanks to the operator product expansion, in order to be finally left with three-point functions only). This assumption, that is highly important for consistency of the theory, is however far from obvious, and is known as the *axiom of duality* [25]. Apart from extra conditions arising from considerations on the torus and that will be mentioned below in subsection 4.4.1, this axiom imposes constraints on matrices called the braiding and the fusion (or fusing) matrices, which must satisfy two polynomial equations known as the pentagon and the hexagon identities. Finding solutions to these polynomial equations is one possible path to choose in order to try to catalogue all possible consistent conformal field theories.

4.2.5 Representations of the Virasoro algebra

This subsection explains how representations \mathcal{H}_i (which determine the spectrum of the theory) are constructed. In this context, states provide a more convenient framework than fields (keep in mind though that, for unitary rational theories, states and fields are equivalent descriptions). By definition, a chiral primary state $|\Phi_h\rangle$ of weight h satisfies:

$$L_{n>0}|\Phi_h\rangle = 0, \quad L_0|\Phi_h\rangle = h|\Phi_h\rangle \quad (53)$$

This definition is equivalent to the definition (45) for primary fields. Recall that the state $|\Phi_h\rangle = \Phi_h(0)|0\rangle_{\text{in}}$ is generated from the vacuum $|0\rangle_{\text{in}}$, which must satisfy:

$$L_{n\geq -1}|0\rangle_{\text{in}} = 0 \quad (54)$$

Similarly (upon taking the adjoint):

$$\text{out}\langle 0|L_{n\leq 1} = 0 \quad (55)$$

These relations are necessary for the stress-energy tensor T to be well-behaved when $z \rightarrow 0$ or $z \rightarrow \infty$ respectively, and reflects the conformal invariance of the

vacuum. The only modes that annihilate both $|0\rangle_{\text{in}}$ and ${}_{\text{out}}\langle 0|$ are $L_{\pm 1,0}$, which indicates that the vacuum is invariant under the Möbius group.

Other states in the representation generated by the primary state $|\Phi_h\rangle$ are obtained by applying successively any generator of the kind $L_{n<0}$. They are called *secondary states*. A basis of the set of secondary states is spanned by states of the form $L_{-n_1}L_{-n_2}\dots L_{-n_k}|\Phi_h\rangle$ with n_1, \dots, n_k strictly positive integers, with $n_1 \leq n_2 \leq \dots \leq n_k$. This construction of conformal families shows that the spectrum of conformal dimensions of a conformal field theory consists of the infinite integer spaced series $h_i + n$ (for all indices i) where n is any positive integer and h_i is the conformal weight of the primary field Φ_{h_i} . The conformal behaviour of secondary fields is more complicated than the one of primaries. The secondary fields, together with the primary field Φ_h they descend from, constitute a conformal family $[\Phi_h]$ that is a representation of the Virasoro algebra (denoted previously by \mathcal{H}_h or rather \mathcal{H}_i). The set of states associated to a conformal family is called a *Verma module* and is noted V_{Φ_h} . The complete set of fields in the theory consists of the sum of all conformal families.

Some important remarks are in order. First, since the complete set of fields is constituted of all primary and secondary fields, it is now possible to understand why any correlation function in the conformal field theory is given in terms of the correlators of the primary fields (this is what was called the factorization or descent procedure): one simply has to insert generators L_{-n} in the correlation functions of the primary fields and use the conformal Ward identities²⁷ in order to obtain (descending) correlation functions of secondary fields.

It may happen that a secondary state χ descending from a primary state Φ satisfies equations (53) and can therefore be considered as a primary state as well. Such a state is called a *null state*. It generates its own Verma module. If the original Verma module V_{Φ} has no null state, then it is an irreducible representation of the Virasoro algebra. If it has a null state, the Verma module V_{Φ} is a reducible representation. The irreducible conformal family is obtained by setting all null states to zero, which can be consistently assumed since null states are orthogonal to any state in the Verma module V_{Φ} (including itself)²⁸. A conformal family that contains a null field that needs to be removed is called *degenerate*, and the associated primary field is called a degenerate field. Degenerate fields are characterized by their conformal weight, which must be of

²⁷The conformal Ward identities are obtained by relating L_{-n} to $T(z)$ thanks to (41) and then use the operator product expansion between the stress-energy tensor and primary fields (45) to obtain:

$$\left\langle T(z) \prod_{i=1}^n \Phi_i(z_i) \right\rangle = \sum_{j=1}^n \left(\frac{h_j}{(z-z_j)^2} + \frac{\partial_{z_j}}{z-z_j} \right) \left\langle \prod_{i=1}^n \Phi_i(z_i) \right\rangle \quad (56)$$

²⁸Proof (use the definition of primary fields): $\langle \chi | \prod_i L_{-n_i} | \Phi_h \rangle = (\prod_i L_{n_i} | \chi \rangle)^\dagger | \Phi_h \rangle = 0$

the form [44, 45]:

$$\begin{aligned} h_{n,m} &= \frac{c-1}{24} + \frac{1}{2} (n\alpha_+ + m\alpha_-)^2 \\ \alpha_{\pm} &= \frac{\sqrt{1-c} \pm \sqrt{25-c}}{\sqrt{24}} \end{aligned} \tag{57}$$

where n, m are positive integers²⁹. The conformal weight of the corresponding null field is $h = h_{n,m} + nm$. Finally, since null states are orthogonal to any other state in the Verma module, null fields decouple in any correlation function (*i.e.* any correlation function involving a null field is zero). This property may be used with any null state in order to constrain n -point functions. This leads to differential equations, called the BPZ equations [23] (BPZ stands for Belavin-Polyakov-Zamolodchikov), that must be satisfied by correlation functions and that constrain the possible couplings of the theory (another example of an equation implied by a null state is provided by the Knizhnik-Zamolodchikov equation, see subsection 4.4.2). Solutions are then typically found in terms of special functions, like the hypergeometric functions. Though usually not enough to determine the entire theory completely, null states are sufficient in the case of the minimal models for instance (all the fields of these models are maximally degenerate).

4.3 Boundary conformal field theory basics

Until now this survey was restricted to the case of conformal field theories defined on spaces without a boundary – and, more precisely, on the Riemann sphere. This kind of theory describes closed strings. One may wish to study open strings as well. For that purpose one needs to study conformal field theory on surfaces with a boundary (the boundary represents the brane on which the open string endpoints live³⁰), the simplest example of which being the disc (it is conformally equivalent to the strip *i.e.* the open string worldsheet). The space on which boundary conformal field theory will be studied below will be the upper-half plane $\mathbb{C}_+ = \{z \in \mathbb{C} | \Im z \geq 0\}$, since the unit disc (parametrized by w) can be conformally mapped to the upper-half plane using the transformation $z = i\frac{1-w}{1+w}$. The strip is mapped to the upper-half plane with two punctures at $z = 0$ and $z = \infty$ thanks to the relation $z = e^{\tau+i\sigma}$. The interested reader who wishes to learn more on boundary conformal field theory is referred to [32, 46, 47, 48, 49, 50, 51, 52].

²⁹One may check that for Liouville theory (for which $c = 1 + 6Q^2$ where $Q = b + \frac{1}{b}$ and b is a strictly positive real number, usually non-rational), degenerate fields have conformal weights $h_{n,m} = \frac{Q^2}{4} - \frac{1}{4} (mb + \frac{n}{b})^2$ where m and n are strictly positive integers. This theory was studied in [1].

³⁰Branes are dynamical objects on which open strings can end. A common example is the D-brane, a contraction for Dirichlet brane (the name comes from the fact that the coordinates of the attached string satisfy Dirichlet boundary conditions in the direction normal to the brane, and hence have a fixed value). In classical string theory ($g_s \rightarrow 0$), the back-reaction of the brane on the bulk geometry is suppressed. In general, it should be taken into account, making things more difficult to understand.

Note that from a string theory point of view, asking if a conformal field theory can be extended to a theory that is well-defined on worldsheets with boundary is actually the question of which open strings can be consistently added to a given closed string theory. There are deep connections between the features of conformal field theory in the *bulk (parent theory)* and in the presence of a boundary (*open descendant theory*). Indeed, since the theory is local and since the parent (bulk) theory on the sphere determines already the operator product expansion of any two fields, the descendant field theory in the bulk is locally equivalent to its parent theory. As a consequence, the set of fields in the boundary theory is the same as in the bulk theory. The remaining degrees of freedom of the boundary conformal field theory lie in the coherent boundary conditions that can be imposed (these are the Chan-Paton degrees of freedom). Since the operator product expansion in the bulk allows any correlation function to be reduced to one-point functions, all the remaining information of the boundary theory must be encoded in these one-point functions $\langle \Phi_i \rangle$, or in the related concept of boundary state, reviewed below.

The existence of the boundary implies one constraint that the stress-energy tensor must satisfy for the boundary theory to be conformal:

$$T(z) = \bar{T}(\bar{z}) , \quad \text{for } z = \bar{z} \quad (58)$$

This is a continuity (boundary) condition, which means that there is no energy-momentum flow across the boundary (or, also, that the real boundary is preserved by diffeomorphisms). Because of this relation, the chiral and the anti-chiral parts of the conformal field theory are now entangled and cannot be separated anymore. A single Virasoro algebra therefore organizes the boundary theory, while there were two copies (left and right) of the Virasoro algebra in the absence of a boundary. From a string theory point of view, this is consistent with the fact that oscillations of an open string cannot be decomposed into two independent waves moving in opposite directions (contrarily to closed strings). The boundary condition changes the conformal Ward identities, which become:

$$T(z)\Phi(w, \bar{w}) = \left(\frac{h}{(z-w)^2} + \frac{\partial_w}{z-w} + \frac{\bar{h}}{(z-\bar{w})^2} + \frac{\partial_{\bar{w}}}{z-w} \right) \Phi(w, \bar{w}) \quad (59)$$

Another notable difference from the case without boundary is that amplitudes (n-point correlation functions) are now linear in the conformal blocks rather than bilinear.

Continuity conditions must also be written for all other chiral fields $\Phi(z)$:

$$\Phi(z) = \Omega \bar{\Phi}(\bar{z}) , \quad \text{for } z = \bar{z} \quad (60)$$

where Ω is called a gluing automorphism and may depend on Φ . It is necessary to accommodate the standard Dirichlet ($\Omega = -id$) and Neumann ($\Omega = id$) boundary conditions (*id* is the identity operator). The above equation is only valid when one considers the maximal case in which the whole symmetry algebra is left unbroken.

Boundary states will encode all the information about the boundary. Given a boundary condition labeled by α , the associated boundary state $|\alpha\rangle$ satisfies $\langle \prod_i \Phi_i \rangle_\alpha = \langle \langle \alpha | \prod_i \Phi_i | \alpha \rangle \rangle$ for any correlation function on the boundary. The boundary state has to obey:

$$(L_n - \bar{L}_{-n})|\alpha\rangle = 0 \quad (61)$$

for any integer n . This is implied by relation (58), and other similar relations may be deduced from (60). These equations must be solved by the boundary state, and the solution can be found separately in each part $\mathcal{H}_i \otimes \mathcal{H}_{\bar{j}}$ of the Hilbert space. An important result is that, assuming $\bar{j} = i^\vee$ and up to normalisation, there is only one state that satisfies the above conditions. It is a generalization of coherent states, and is called the *Ishibashi state* [46] (denoted by $||i\rangle\rangle$). The theory is rational when the bulk theory is rational (finite number of bulk primaries) and when there is a finite number of Ishibashi states. It is possible to choose the normalization of Ishibashi states such that:

$$\langle \langle j' | | q^{\frac{1}{2}(L_0 + \bar{L}_0 - \frac{c}{12})} | | j \rangle \rangle = \delta_{j,j'} \chi_j(q) \quad (62)$$

where $q = e^{2i\pi\tau}$, τ is a complex number and $\chi_j(q) = Tr_{\mathcal{H}_i} (q^{L_0 - c/24})$ is the character³¹ of the representation \mathcal{H}_i of the meromorphic vertex operator algebra³².

A remarkable fact that is valid for all rational conformal field theories is that the characters transform into each other under modular transformations (*i.e.* they provide a representation of the modular group $SL(2, \mathbb{Z})$, introduced in subsection 4.4.1):

$$\chi_i(\tau + 1) = \sum_j T_i^j \chi_j(\tau), \quad \chi_i(-1/\tau) = \sum_j S_i^j \chi_j(\tau) \quad (63)$$

where T and S are constant matrices and the sums are over all representations \mathcal{H}_j . In unitary rational conformal field theories, the modular S matrix is unitary and symmetric and the matrix T is diagonal and of finite order. These results will be useful in subsection 4.4.3.

The scalar product for Ishibashi states is:

$$\langle \langle j | | j' \rangle \rangle = \delta_{j,j'} S_0^j \quad (64)$$

³¹The $-c/24$ term comes from radial quantization. Indeed, it is the zero-mode of the stress-energy tensor on the cylinder (the string worldsheet) $L_0^{cyl.}$ that plays the role of the Hamiltonian (recall that, classically, it corresponds to the infinitesimal operator $-z\partial_z = -\partial_w$ where z is the coordinate on the plane and $w = \tau + i\sigma$ the coordinate on the cylinder, τ being the time). L_0 is the zero mode of the stress-energy tensor on the plane. Writing the Fourier expansion of $T^{cyl.}(w)$ and the Laurent expansion of $T(z)$, and relating the two with the conformal transformation of the energy-momentum tensor (47), shows that $L_0^{cyl.} = L_0 - c/24$, where the extra term $-c/24$ comes from the Schwarzian derivative.

³²In general there may be extra variables in the characters in order to keep track of more quantum numbers, in the case where the chiral algebra is extended.

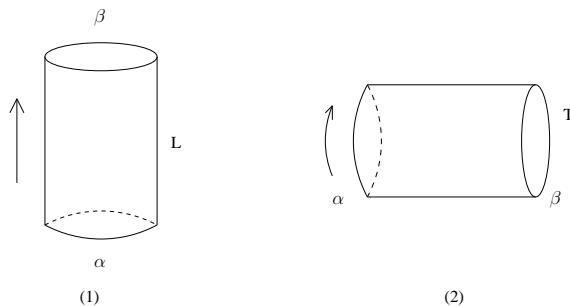

Figure 7: Two ways of calculating the partition function $Z_{\alpha\beta}$: (1) on the cylinder, between the boundary states $|\alpha\rangle$ and $|\beta\rangle$, (2) as a periodic time evolution on the strip, with boundary conditions α and β .

where 0 indicates the identity (trivial) representation. Now, any boundary state is given by a linear combination of Ishibashi states:

$$|\alpha\rangle = \sum_i A_i^\alpha |i\rangle \quad (65)$$

Using this result, one may calculate the non-vanishing one-point functions:

$$\langle \Phi_{i,\omega(i^\vee)}(z, \bar{z}) \rangle_\alpha = \frac{A_{i^\vee}^\alpha}{|z - \bar{z}|^{2h_i}} \quad (66)$$

where $\Phi_{i,\omega(i^\vee)}$ is a primary field in the representation $\mathcal{H}_i \otimes \mathcal{H}_{\omega(i^\vee)}$, and ω is a map on the set of sectors induced by Ω – for simplicity, it may be assumed that it is the identity. Relation (66) shows how, for a diagonal conformal field theory, the admissible types of boundaries are in one-to-one correspondence with the bulk fields [47].

The constants A_i^α determine the boundary conformal field theory. They are constrained by sewing conditions (axiom of duality) that will not be reviewed here and by Cardy’s condition [47]. This condition is derived from considerations on the partition function³³. More precisely, the exchange of time and space on the worldsheet (*i.e.* worldsheet duality), which amounts to an S matrix transformation, relates the one-loop open string diagram to a closed string tree diagram, see figure 7. Considering two boundary conditions α, β corresponding to the two endpoints of an open string, and assuming that at least one of the two branes α, β is compact, one expects to find a discrete open string spectrum. Therefore, the open string partition function is calculated by summing over all open string states linking the two branes :

$$Z_{\alpha\beta}(q') = \text{Tr}_{\mathcal{H}_{\alpha\beta}} (e^{-2\pi T H_o}) = \sum_i n_{\alpha\beta}^i \chi_i(q') \quad (67)$$

³³The name comes from an analogy with statistical physics, in which the partition function is a sum over the spectrum of a quantum system, weighted by $e^{-\beta E}$ where E is the energy of the state and β the inverse temperature.

where T is the time, $H_o = L_0 - \frac{c}{24}$ is the open string Hamiltonian and $n_{\alpha\beta}^i$ are positive integers and counts the multiplicity of the boundary primaries. The boundary conditions α, β manifest themselves only in the nature of the Hilbert space $\mathcal{H}_{\alpha\beta}$ and in its decomposition $\mathcal{H}_{\alpha\beta} = \oplus_i n_{\alpha\beta}^i \mathcal{H}_i$ into representations of a single chiral algebra. The quantity $Z_{\alpha\beta}$ may also be written as a closed string two-point function between the boundary states in the Hilbert space of the bulk theory³⁴:

$$Z_{\alpha\beta}(q) = \langle \langle \alpha || e^{-2\pi L H_{cl}} || \beta \rangle \rangle = \sum_j (A_j^\alpha)^* A_j^\beta \chi_j(q) \quad (68)$$

where L is the length (now playing the role of time) and $H_{cl} = L_0 + \bar{L}_0 - \frac{c}{12}$ the closed string Hamiltonian. Relating both expressions with the help of $q = e^{2i\pi\tau}$, $\tau = iL = i/T$ and $q' = e^{-2i\pi/\tau} = e^{-2\pi T}$ yields:

$$n_{\alpha\beta}^i = \sum_j (A_j^\alpha)^* A_j^\beta S_j^i \quad (69)$$

This relation constrains the quantities A_j^α , since $n_{\alpha\beta}^i$ are integers (this non-linear constraint implies that boundary states are not states in the usual meaning of the word, since they do not belong to a vector space). It is called Cardy's constraint, or Cardy's equation. An important remark is that the numbers $n_{\alpha\beta}^i$ also appear in the Hilbert space decomposition $\mathcal{H}_{\alpha\beta} = \oplus_i n_{\alpha\beta}^i \mathcal{H}_i$, which is very reminiscent of the fusion rules discussed in subsection 4.4.3. The classification of possible boundary conditions is therefore connected to the classification of integer-valued representations of the fusion algebra (see below section 4.4). More precisely, one set of boundary states (called the Cardy states) can be constructed by choosing $A_i^\alpha = \frac{S_{\alpha}^i}{\sqrt{S_0^i}}$. Then (in a unitary rational theory):

$$n_{\alpha\beta}^i = \sum_j \frac{(S^{-1})_j^\alpha S_\beta^j S_i^j}{S_0^j} = N_{i\beta}^\alpha \quad (70)$$

i.e. $n_{\alpha\beta}^i$ is the fusion matrix, thanks to Verlinde's formula (see relation (92) below). Since the whole symmetry algebra is supposed unbroken here, the set of representations α appearing in the possible boundary conditions is the same as the set of representations that classify the bulk fields Φ_i . This (Cardy) construction should be kept in mind when reading section 6.

4.4 Advanced conformal field theory

In the previous sections all the fundamental ideas of conformal field theory were introduced. More advanced topics are reviewed below. They include conformal field theory on the torus, Wess-Zumino-Witten models, the fusion rules, the Verlinde formula, superconformal field theories and the classical limit of conformal field theories.

³⁴Two branes *i.e.* two boundary conditions are considered here. This is a slightly different setting from the one introduced in the beginning of this section, with only one brane.

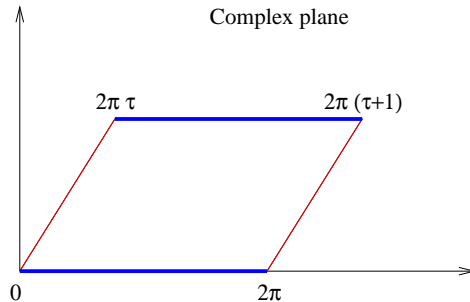

Figure 8: The torus as a Riemann surface. Periodicity conditions on the torus are imposed by identifying (thick) blue lines and (thin) red lines respectively.

4.4.1 Conformal field theory on the torus and higher genus surface

Until now the study was restricted to conformal field theory on the sphere. Other Riemann surfaces are of interest too. They are classified by their genus g which counts the number of handles on the surface. Beside the sphere, the simplest (and most important) example of a Riemann surface is the torus. It is reviewed in this subsection.

The torus has genus one and is described by identifying points on the complex plane as shown in figure 8.

The parameter τ is the *modulus* of the torus, also known as modular parameter or Teichmüller complex parameter. It encodes the geometry of the torus³⁵. The moduli τ , $-\tau$, $\tau + 1$ and $-1/\tau$ all describe the same torus³⁶. It is standard to restrict to $\Im\tau \geq 0$ and moreover identify $\tau \sim \tau + 1 \sim -1/\tau$. These two transformations, respectively denoted by $T : \tau \rightarrow \tau + 1$ and $S : \tau \rightarrow -1/\tau$, generate the *modular group* $SL(2, \mathbb{Z})/\mathbb{Z}_2$ which is the group of modular transformations $\tau \rightarrow \tau' = \frac{a\tau + b}{c\tau + d}$ with $ad - bc = 1$ and $a, b, c, d \in \mathbb{Z}$. This group should not be confused with the Möbius group $SL(2, \mathbb{C})/\mathbb{Z}_2$. Because the geometry of the torus is unchanged under any modular transformation, one expects any physical quantity (like correlation functions on the torus) to be modular invariant. This requirement imposes strong constraints on the theory.

An important quantity on the torus is the *partition function*, also called vacuum amplitude or annulus amplitude:

$$Z(\tau) = \text{Tr}_{\mathcal{H}} \left(q^{L_0 - c/24} \bar{q}^{\bar{L}_0 - \bar{c}/24} \right) = \text{Tr}_{\mathcal{H}} \left(e^{-2\pi\tau_2 H} e^{2i\pi\tau_1 P} \right) \quad (71)$$

where $q = e^{2i\pi\tau}$, $\bar{q} = e^{-2i\pi\bar{\tau}}$, $\tau = \tau_1 + i\tau_2$, $H = L_0 + \bar{L}_0 - c/12$ describes the propagation along the cylinder and $P = L_0 - \bar{L}_0$ implements the rotation around the cylinder (recall that $h + \bar{h} = \Delta$ is the scaling dimension and $h - \bar{h} = s$ is the spin). The above relation shows that the partition function can be obtained by

³⁵More generally, a genus g surface with $g \geq 2$ is characterized by $3(g-1)$ complex numbers called the moduli of the surface.

³⁶It can be seen using figure 8. For $-1/\tau$, use a global rescaling by a factor τ .

propagating a state forward in time by $-2\pi\tau_2$ and spatially by $2i\pi\tau_1$, and then summing over all states in the Hilbert space (hence the trace).

An important statement concerning the axiom of duality discussed in section 4.2 is that (considering a conformal field theory that is well-defined on the sphere) there are three additional requirements arising from considerations on the torus for this axiom to be satisfied. The T and S transformations must verify $S^2 = C$ where C is the charge conjugation (see definition below in subsection 4.4.3) and $(ST)^3 = S^2$, together with one extra equation found by considering the two-point function on the torus. Finally, it is also required that the partition function Z be modular invariant. Under these conditions, the conformal field theory is consistent on the torus and moreover on any higher genus Riemann surface. In particular, any n -point function on any Riemann surface is independent of the sewing procedure.

To understand this fact better one should remember that, since the conformal field theory is local, the operator product expansion is the same irrespective of the surrounding surface and, as the theory on the sphere determines the operator product expansion entirely, it actually determines the theory on a Riemann surface of arbitrary genus³⁷. This however does not ensure that the theory will be consistent on any Riemann surface. For this to be true, the only extra requirements were stated above.

For most conformal field theories³⁸, the partition function can be expressed in terms of the characters χ_i :

$$Z(\tau) = \sum_{i, \bar{j}} n_{i\bar{j}} \chi_i(\tau) \chi_{\bar{j}}(\bar{\tau}) \quad (72)$$

The modular invariance of the partition function imposes very strong constraints on the integers $n_{i\bar{j}}$ which one may try to solve in the conformal bootstrap approach. Relation (72) is related to the decomposition of the Hilbert space given in (33).

4.4.2 Wess-Zumino-Witten models and affine Lie algebras

Wess-Zumino-Witten (WZW) models, sometimes called Wess-Zumino-Novikov-Witten (WZNW) models, are classically defined by the action³⁹:

$$S_{WZW} = \frac{k}{16\pi} \int_{\Sigma} d^2x \operatorname{Tr} (\partial^\mu g^{-1} \partial_\mu g) - \frac{ik}{24\pi} \int_B d^3y \epsilon_{\alpha\beta\gamma} \operatorname{Tr} (\tilde{g}^{-1} \partial^\alpha \tilde{g} \tilde{g}^{-1} \partial^\beta \tilde{g} \tilde{g}^{-1} \partial^\gamma \tilde{g}) \quad (73)$$

³⁷A similar argument has been used when discussing boundary conformal field theory in section 4.3.

³⁸A counter-example is provided by logarithmic conformal field theories.

³⁹The first term in the action is referred to as the σ -model. It is said to be non-linear if the kinetic term has a field-dependent coefficient. The second term, called the Wess-Zumino term, is necessary for the whole theory to be conformally invariant [53, 54, 55].

where Σ is a two-dimensional surface, B is a three-dimensional surface such that its boundary is equal to Σ (*i.e.* $\partial B = \Sigma$), k is a real number called the *level*, $\epsilon_{\alpha\beta\gamma}$ is the completely anti-symmetric tensor and $g(x)$ is a bosonic matrix field living on the (semi-)simple compact Lie group G , which will be associated to the Lie algebra \mathfrak{g} . The field $\tilde{g}(y)$ is an extension of $g(x)$ to the three-dimensional surface B . It satisfies $\tilde{g}(y)|_{y=x \in \Sigma} = g(x)$. The trace Tr is taken over a matrix representation t^a of the group such that⁴⁰ $Tr(t^a t^b) = 2g^{ab}$ and $[t^a, t^b] = \sum_c \iota f^{ab}_c t^c$, where f^{ab}_c are the structure constants of the Lie algebra \mathfrak{g} . Finally, in order for the action to be real, the matrix field g must be valued in a unitary representation.

Two important results are that the quantum theory is well defined if and only if k is an integer⁴¹, and it is unitary if and only if k is positive. Therefore it will always be assumed that $k \in \mathbb{N}$. The classical limit is given by $k \rightarrow \infty$. Note the remarkable property that the effective action for the quantum theory is simply equal to the classical action where the level k has been replaced by $k + Q$ where Q is the dual Coxeter number of the group.

The classical equation of motion for the field g is:

$$\partial_z (g^{-1} \partial_{\bar{z}} g) = 0 \quad (74)$$

where the new coordinates are $z = x^0 + \iota x^1$ and $\bar{z} = x^0 - \iota x^1$. The equation of motion is solved by any $g(z, \bar{z}) = f(z) \bar{f}(\bar{z})$ where f and \bar{f} are holomorphic and anti-holomorphic functions respectively. This result implies the conservation of two currents J and \bar{J} (*i.e.* $\partial_{\bar{z}} J = 0$ and $\partial_z \bar{J} = 0$):

$$J(z) = -k \partial_z g g^{-1}, \quad \bar{J}(\bar{z}) = k g^{-1} \partial_{\bar{z}} g \quad (75)$$

The conservation of these currents implies the invariance of the Wess-Zumino-Witten action under $g(z, \bar{z}) \rightarrow \Omega(z) g(z, \bar{z}) \bar{\Omega}(\bar{z})^{-1}$ where Ω and $\bar{\Omega}$ are arbitrary matrices in G . The action therefore has the local $G \times G$ symmetry.

Because the left (also called chiral, or holomorphic) part of the symmetry generated by J is independent of the right part, the latter one will not be considered here for the sake of simplicity.

It is natural to decompose $J(z) = \sum_a J^a(z) t^a$. At the quantum level, it can be shown that the currents generate a current algebra, *i.e.* that their operator product expansion is of the form:

$$J^a(z) J^b(w) \sim \frac{k g^{ab}}{(z-w)^2} + \sum_c \iota f^{ab}_c \frac{J^c(w)}{z-w} \quad (76)$$

⁴⁰Here g^{ab} plays the role of a metric with respect to the structure constants f^{ab}_c . In the simplest cases, like for $SU(2)$, $g^{ab} = \delta^{ab}$. When $G = SL(2, \mathbb{R})$, a standard choice is $g^{ab} = \text{diag}(1, 1, -1)$. This metric is related to the one induced by the Killing form reviewed in section 3.1. Things are more complicated when the group is not semi-simple, since for instance the Killing metric is then degenerate (see later the case of \mathcal{H}_{2n+2}).

⁴¹This requirement comes from the fact that the path integral in the quantum theory must be well defined, therefore different ways of calculating the three-dimensional term in the action must yield the same result modulo 2π . This condition does not provide any constraints for non-compact groups.

or, equivalently, that their modes satisfy an affine Lie algebra \hat{g} :

$$[J_n^a, J_m^b] = \sum_c \iota f_c^{ab} J_{n+m}^c + kn g^{ab} \delta_{n+m,0} \quad (77)$$

Remark that the zero modes $n = m = 0$ generate the algebra g . Modes and operators are related by a Laurent expansion:

$$J^a(z) = \sum_{n \in \mathbb{Z}} J_n^a z^{-n-1}, \quad J_n^a = \frac{1}{2i\pi} \oint_0 z^n J^a(z) dz \quad (78)$$

These relations are analogous to relations (41) for the stress-energy tensor T (note however that T has conformal weight 2 while J has conformal weight 1, as can be seen from equation (76)).

An important result concerning Wess-Zumino-Witten models is that they are actually conformally invariant. This is shown by constructing explicitly the energy-momentum tensor⁴²:

$$T(z) = \frac{1}{2(k+Q)} \sum_{a,b} g_{ab} : J^a J^b : (z) \quad (79)$$

where $::$ denotes normal ordering. In terms of the modes, relation (79) reads:

$$\begin{aligned} L_n &= \frac{1}{2(k+Q)} \sum_{a,b} \sum_{m \in \mathbb{Z}} g_{ab} : J_m^a J_{n-m}^b : \\ &= \frac{1}{2(k+Q)} \sum_{a,b} g_{ab} \left(\sum_{m=-\infty}^{-1} J_m^a J_{n-m}^b + \sum_{m=0}^{\infty} J_{n-m}^a J_m^b \right) \end{aligned} \quad (80)$$

This construction is called the *Sugawara construction* [56, 57]. The (right) central charge of the theory is then $c = \frac{k \dim g}{k+Q}$ (it is equal to the left central charge \bar{c}), where $\dim g$ is the dimension of the Lie algebra g . Note the inequalities $1 \leq r \leq c \leq \dim g$ where r is the rank of the algebra, *i.e.* the dimension of the Cartan subalgebra (the largest subalgebra whose generators all commute with each other).

Affine Lie algebras are infinite dimensional algebras which constrain strongly any theory which possesses it as a symmetry, just like the Virasoro algebra does. What the Sugawara construction shows (independantly of the theory of Wess-Zumino-Witten models) is that the Virasoro algebra is in the envelopping algebra of any affine Lie algebra.

In this context, an example of a constraint provided by affine Lie algebras is given by the *Knizhnik-Zamolodchikov equation* [55]. It is obtained by first applying equation (79) into a correlation function $\langle \prod_i \Phi_i(z_i) \rangle$, and then by using the operator product expansions $T\Phi$ and $J\Phi$, given below in (83). The

⁴²The overall factor depends on a convention which writes $\sum_{c,d} f^{acd} f^{bcd} = 2Qg^{ab}$, where the squared length of the highest root has been normalized to 2, see [21].

resulting equation yields two independent and non-trivial relations. One of them is obtained by multiplying the equation by $(z - z_i)$ and then by integrating over a closed contour encircling z_i . This yields the conformal weight of the field Φ_i , $h_i = \frac{1}{2(k+Q)} \sum_{a,b} g_{ab} t_i^a t_i^b$. The other relation is obtained by simply integrating over a closed contour encircling z_i . The result is precisely the Knizhnik-Zamolodchikov equation:

$$\left(\partial_{z_i} - \frac{1}{k+Q} \sum_{a,b} \sum_{j \neq i} \frac{1}{z_{ij}} g_{ab} t_i^a t_j^b \right) \left\langle \prod_k \Phi_k(z_k) \right\rangle = 0 \quad (81)$$

This equation may be used to constrain n-point functions, as will be done in section 5.

The currents are Virasoro primary fields of conformal weight $h = 1$. They satisfy the commutation relations:

$$[L_n, J_m^a] = -m J_{n+m}^a \quad (82)$$

which indicates that the mode J_m^a lowers the conformal weight by m .

In the purely conformal case, (Virasoro) primary fields are defined as the fields which behave like the metric under any conformal transformation (*i.e.* which transform covariantly with respect to a scale transformation). It is then natural to define Wess-Zumino-Witten (or affine) primaries as fields which transform like the field $g(z, \bar{z})$ under a $G(z) \times G(\bar{z})$ transformation. This is equivalent to requiring the operator product expansion of chiral Wess-Zumino-Witten primary fields with currents to be:

$$J^a(z) \Phi_\lambda(w) \sim \frac{-t_\lambda^a \Phi_\lambda(w)}{z-w} \quad (83)$$

where the affine primary Φ_λ is associated with the representation λ of the algebra g and t_λ^a is the matrix t^a in the representation λ . This definition is indeed similar to the definition of Virasoro primaries Φ in terms of the operator product expansion of $T\Phi$.

Wess-Zumino-Witten primary fields are in one-to-one correspondence with Wess-Zumino-Witten primary states which satisfy:

$$J_0^a |\Phi_\lambda\rangle = -t_\lambda^a |\Phi_\lambda\rangle, \quad J_{n>0}^a |\Phi_\lambda\rangle = 0 \quad (84)$$

Primary states, which yield a representation of the zero-modes algebra (the Lie algebra g), are the starting point for the construction of representations of the affine Lie algebra, obtained by constructing secondary states with the repeated action of the modes $J_{n_i < 0}^{a_i}$. Although the zero-mode representation may be unitary, the current (affine) algebra representation may not be so, and it is necessary to add the Virasoro constraints $(L_n - \delta_{n,0}) |\Phi_\lambda\rangle = 0$ for any positive integer n . This is a quantum analogue of the classical constraint imposed by conformal invariance, and ensures that a unitary spectrum is obtained. This is very similar to the construction of Verma modules.

There exist an inner product, and the unitarity (or reality) condition writes $(J_n^a)^\dagger = J_{-n}^a$.

Important results are that a Wess-Zumino-Witten primary field is necessary a Virasoro primary field (but the inverse is not true), of conformal weight $h_\lambda = \frac{1}{2(k+Q)} \sum_{a,b} g_{ab} t_\lambda^a t_\lambda^b$. Moreover, the number of affine primary fields is finite. This means that Wess-Zumino-Witten models are rational conformal field theories (yet the number of Virasoro primary fields is infinite). One should therefore always work with the affine Lie algebra representations.

Before concluding this section, remark that the central charge c and all conformal weights h_λ are positive (since $\sum_a t_\lambda^a t_\lambda^a$ is the quadratic Casimir, hence is positive), which is consistent with the statement that Wess-Zumino-Witten models are unitary.

Finally, the compactness of the target space⁴³ in string theory renders the spectrum of the underlying worldsheet model discrete. Wess-Zumino-Witten models associated to compact groups G therefore have a discrete spectrum (see the example of $SU(2)$ given below in subsection 4.4.3).

Wess-Zumino-Witten models, string theory and generalized gravity

Wess-Zumino-Witten models describe strings moving on group manifolds. The connection is established by relating the Wess-Zumino-Witten action to the *modified Polyakov action* for closed bosonic strings with non-trivial fields $G_{\mu\nu}$, $B_{\mu\nu}$ and Φ :

$$S'_P = -\frac{T}{2} \int d^2\xi \left(\sqrt{\det g_{ab}} g^{ab} G_{\mu\nu}(X) + \epsilon^{ab} B_{\mu\nu}(X) \right) \frac{\partial X^\mu}{\partial \xi^a} \frac{\partial X^\nu}{\partial \xi^b} + \frac{1}{8\pi} \int d^2\xi \sqrt{\det g_{ab}} R^{(2)} \Phi(X) \quad (85)$$

where $R^{(2)}$ is the scalar curvature of the intrinsic metric (on the worldsheet) g_{ab} . This action gives back (27) when $G_{\mu\nu} = \eta_{\mu\nu}$, $B_{\mu\nu} = 0$ and $\Phi = 0$.

Considering the modified Polyakov action and requiring that this model is conformally invariant, *i.e.* that the trace of the stress-energy tensor be zero at first order⁴⁴ in $\alpha' = l_s^2$, one obtains the following conditions:

$$\begin{aligned} R_{\mu\nu} - \frac{1}{4} H_{\mu\rho\sigma} H_\nu{}^{\rho\sigma} + \nabla_\mu \nabla_\nu \Phi &= 0 \\ \nabla^\mu (e^{-\Phi} H_{\mu\nu\rho}) &= 0 \\ (\nabla\Phi)^2 - 2\Box\Phi - R + \frac{1}{12} H^2 + \frac{D-26}{3l_s^2} &= 0 \end{aligned} \quad (86)$$

⁴³In general, the target space is the space in which a function takes its values. For Wess-Zumino-Witten models, the target space is the space-time (it is the space G on which the function $x \mapsto g(x)$ takes its values).

⁴⁴However, thanks to the remarkable behaviour of Wess-Zumino-Witten models, which only receive corrections in the level in quantum theory, solutions of equations (86) corresponding to group manifolds remain exact at all orders in α' , upon the replacement $k \rightarrow k + Q$, see (??).

where $R_{\mu\nu}$ is the Ricci tensor and ∇_μ is the covariant derivative, related to the metric $ds^2 = G_{\mu\nu}(x)dx^\mu dx^\nu$, D is the total space-time dimension (the -26 term comes from the bosonic ghosts), Φ is the dilaton (the massless scalar field found in all perturbative string theory, whose expectation value determines the string coupling constant), and $H_{\mu\nu\rho} = \partial_\mu B_{\nu\rho} + \partial_\nu B_{\rho\mu} + \partial_\rho B_{\mu\nu}$. Interestingly, when the background fields $G_{\mu\nu}$, $B_{\mu\nu}$ and Φ are such that the first two equations are satisfied, the model (without the ghosts) describes a conformal field theory with central charge:

$$c = D + 3l_s^2 \left((\nabla\Phi)^2 - 2\Box\Phi - R + \frac{1}{12}H^2 \right) \quad (87)$$

which is indeed a constant. The above relations (86) are called the *generalized gravity equations*. They may also be obtained from the effective action⁴⁵ for the background fields of bosonic string theory (in dimension $D = 26$):

$$S \sim \int d^D x \sqrt{-\det G_{\mu\nu}} e^{-\Phi} \left(R + (\nabla\Phi)^2 - \frac{1}{12}H^2 \right) \quad (88)$$

at first order in α' , where R is the Ricci scalar for the metric $G_{\mu\nu}$.

Cosets and orbifolds What makes Wess-Zumino-Witten models so important is that they provide a classification of rational conformal field theories, in the sense that all known unitary rational conformal field theories have an alternative description obtained from the Wess-Zumino-Witten models by means of two constructions, namely cosets and orbifolds⁴⁶. This paragraph briefly mentions the definitions of cosets and orbifolds.

The *coset* construction is obtained when considering a simple Lie algebra g which has a subalgebra h , with Virasoro modes L_n^g and L_n^h and central charges c^g and c^h respectively. Then the modes $L_n^{g/h} = L_n^g - L_n^h$ satisfy the Virasoro algebra with central charge $c^{g/h} = c^g - c^h$, *i.e.* they define a new conformal field theory, which is the coset theory g/h (recall how a group G with subgroup H may be factorized as $G \cong G/H \times H$). An example of coset will be discussed in section 6: $SL(2, \mathbb{C})/SU(2) \cong H_3^+$.

The *orbifold* construction is possible whenever the theory carries the action of a finite group G . Taking the orbifold of such a theory amounts to, first, projecting the Hilbert space onto the G -invariant subspace (*i.e.* states of the orbifold theory are states of the initial theory which are invariant under the action of G , *i.e.* such that for any element $g \in G$ and for any state $|\phi\rangle$, one has $|g\phi\rangle = |\phi\rangle$), then, if necessary, reinforce (restore) the modular invariance of the partition function on the torus by adding some twisted sectors to the space of states. More precisely, the partition function of the orbifold theory

⁴⁵An effective action for a field theory describes the physical system below a given energy scale or, equivalently, above a given length scale (which here is l_s).

⁴⁶For instance, the unitary minimal model with central charge $c = 1 - \frac{6}{m(m+1)}$ is equivalent to the coset $(\widehat{su}(2)_k \oplus \widehat{su}(2)_1) / \widehat{su}(2)_{k+1}$ with $k+2 = m$, where $\widehat{su}(2)_k$ is the affine Lie algebra at level k .

may be constructed in two steps. First, consider a twisted partition function on the torus, *i.e.* impose boundary conditions that are not periodic, but twisted by some elements a and b of G (for instance, a bosonic field ϕ would satisfy $\phi(z+1) = a\phi(z)$ and $\phi(z+\tau) = b\phi(z)$). Denote this partition function by Z_{ab} . Then, sum over all compatible boundary conditions:

$$Z_{\text{orbifold}} = \frac{1}{|G|} \sum_{a,b \in G \text{ s.t. } ab=ba} Z_{ab} \quad (89)$$

where $|G|$ is the cardinal (the number of elements) of the group G .

4.4.3 The fusion rules and the Verlinde formula

The representation \mathcal{H}_j of the meromorphic operator vertex algebra will be called the conjugate representation of an irreducible representation \mathcal{H}_i if and only if there exists at least one non-zero two-point function involving a state from \mathcal{H}_i and a state from \mathcal{H}_j . One then denotes j by i^\vee . When well defined (it is always assumed that it is the case here), the conjugation map is uniquely defined. It is bijective and involutive, *i.e.* the conjugate is unique and $(i^\vee)^\vee = i$.

The fusion coefficient N_{ij}^k is defined as the multiplicity with which the representation \mathcal{H}_k appears in the product $\mathcal{H}_i \otimes \mathcal{H}_j$ (for some more details on this, see *e.g.* [26]). It is therefore non-zero if and only if there exist fields Φ_{i,j,k^\vee} in the \mathcal{H}_{i,j,k^\vee} representations (respectively) such that the three-point function $\langle \Phi_i \Phi_j \Phi_{k^\vee} \rangle$ is non-zero (or equivalently if $C_{ijk^\vee} \neq 0$), which means that it encodes the dynamics (the possible couplings) of the theory. This definition assumes that the fusion product of any two irreducible representations of the meromorphic conformal field theory can be completely decomposed into irreducible representations. This is true for most rational conformal field theories, but not for logarithmic conformal field theories for instance. The fusion coefficients satisfy some symmetry properties: $N_{ij}^k = N_{ji}^k$ because the theory is local, moreover $N_{ijk} = N_{ij}^{k^\vee}$ is totally symmetric.

One may loosely define the *fusion algebra* by the following product:

$$\Phi_i \Phi_j = \sum_k N_{ij}^k \Phi_k \quad (90)$$

which is reminiscent of the operator product expansion.

It is convenient to define the fusion matrices⁴⁷ N_i which have coefficients $(N_i)_j^k = N_{ij}^k$. The associativity of the operator product expansion (crossing symmetry, see figure 6) implies that the fusion matrices are a representation of the fusion algebra and (equivalently) that the fusion matrices commute with

⁴⁷These fusion matrices should not be confused with the fusion (or fusing) matrix which was mentioned in the context of the axiom of duality and which will be considered again in section 4.5.

each other:

$$\begin{aligned}\sum_l (N_j)_i^l (N_k)_l^m &= \sum_l N_{jk}^l (N_l)_i^m \\ \sum_l (N_i)_j^l (N_k)_l^m &= \sum_l (N_k)_j^l (N_i)_l^m\end{aligned}\quad (91)$$

Moreover, the fusion matrices commute with their adjoints $(N_i)^\dagger = N_{i^\vee}$ and hence are normal, therefore diagonalizable and actually codiagonalizable. One can then show that⁴⁸:

$$N_{ij}^k = \sum_l \frac{S_i^l S_j^l (S^{-1})_l^k}{S_0^l} \quad (92)$$

An important result found by Verlinde [58] states that the S matrix that appears in (92) is actually the modular matrix that appeared in the S modular transformation of characters defined in (63), *i.e.* the modular S matrix diagonalizes the fusion matrices. Knowledge of the characters and of their modular properties therefore implies knowledge of the dynamics of the theory. Reciprocally, the fact that N_{ij}^k are integers puts strong constraints on the S matrix. Finally, the Verlinde formula implies that S_i^l/S_0^l form a representation of the fusion algebra:

$$\frac{S_i^l S_j^l}{S_0^l S_0^l} = \sum_k N_{ij}^k \frac{S_k^l}{S_0^l} \quad (93)$$

This property is still valid for some non-rational theories, like H_3^+ which is studied in section 6.

Some systematic understanding of the Verlinde formula was acquired on the basis of the axioms of conformal field theory [25], but a mathematical proof of the Verlinde formula for a large class of rational conformal field theories based on a minimal set of assumptions has only recently been provided [59]. The Verlinde formula is generically valid for Wess-Zumino-Witten models *i.e.* generic affine Kac-Moody algebras.

As a basic example, the character and S matrix of the $SU(2)_{k-2}$ Wess-Zumino-Witten model are (j, j' are the spins and label the representation):

$$\begin{aligned}\chi_j(g) &= \sum_{k=-j}^j e^{ik\theta} = \frac{\sin(j + \frac{1}{2})\theta}{\sin \frac{\theta}{2}} \\ S_j^{j'} &= \sqrt{\frac{2}{k}} \sin\left(\frac{\pi(2j+1)(2j'+1)}{k}\right)\end{aligned}\quad (94)$$

where the eigenvalues of the $SU(2)$ matrix g are $e^{\pm i\theta/2}$, and the fusion rules are:

$$\mathcal{D}_{j_1} \otimes \mathcal{D}_{j_2} = \bigoplus_{j=|j_1-j_2|}^{\min(j_1+j_2, k-2-j_1-j_2)} \mathcal{D}_j \quad (95)$$

⁴⁸Proof: the matrices being co-diagonalizable, $N_{ij}^k = \sum_l S_j^k \lambda_l^{(i)} (S^{-1})_l^k$. Taking $j=0$ and multiplying on the right by the S matrix, one obtains $\lambda_l^{(i)} = S_i^l/S_0^l$.

where the spins j_1 , j_2 and j belong to $\{0, \frac{1}{2}, \dots, \frac{k}{2}\}$ and label the $SU(2)$ representations \mathcal{D}_{j_i} , that are of dimension $2j_i + 1$.

4.4.4 Superconformal algebras

A few words should be said on superconformal algebras. Up to now this survey focused on bosonic theories, but one would like to incorporate fermions eventually. There exist several kinds of superconformal algebras, classified by their number N of supercurrents.

The $N = 1$ superconformal algebra appears in the theory of a free boson and a free Majorana fermion. It is also the symmetry algebra that usually appears in four-dimensional superstring theory (after a proper compactification), since it must be more easily connected to the standard model where supersymmetry is broken. The $N = 1$ superconformal algebra is generated by the modes of the energy-momentum tensor T together with a supercurrent G of conformal weight $3/2$. These modes satisfy the (anti-)commutation relations:

$$\begin{aligned} [L_m, G_r] &= \left(\frac{m}{2} - r\right) G_{m+r} \\ \{G_r, G_s\} &= 2L_{r+s} + \frac{c}{3} \left(r^2 - \frac{1}{4}\right) \delta_{r+s,0} \end{aligned} \quad (96)$$

The $N = 1$ superconformal field theory is unitary if and only if the central charge satisfies $c = \frac{3}{2} - \frac{12}{m(m+2)}$ with m a positive integer larger than 2.

The $N = 2$ superconformal algebra is also of interest, because it is the symmetry algebra of the worldsheet conformal field theory of space-time supersymmetric string theories (which live in ten dimensions). It is generated by the modes of the energy-momentum tensor T , two supercurrents G^\pm of weight $3/2$ and a $U(1)$ current J (of weight 1) which rotates the supercurrents. The modes of these fields satisfy:

$$\begin{aligned} [L_m, G_r^\pm] &= \left(\frac{m}{2} - r\right) G_{m+r}^\pm, & [J_m, G_r^\pm] &= \pm G_{m+r}^\pm \\ [L_m, J_n] &= -nJ_{m+n}, & \{G_r^\pm, G_s^\pm\} &= 0 \\ \{G_r^+, G_s^-\} &= 2L_{r+s} + (r-s)J_{r+s} + \frac{c}{3} \left(r^2 - \frac{1}{4}\right) \delta_{r+s,0} \end{aligned} \quad (97)$$

in the so-called NS (Neveu-Schwarz) sector, for which $G^\pm(e^{2i\pi}z) = G^\pm(z)$. There is also an R (Ramond) sector that is continuously connected to the NS sector by a transformation called spectral flow. Remark that the $N = 1$ superconformal algebra is a subalgebra of the $N = 2$ superconformal algebra.

There exist conformal field theories with more supersymmetry ($N = 4$ etc.), however this brief review will stop here.

4.5 Classical conformal field theory and group theory

SU(2) group coefficients The definition of Clebsch-Gordan and Racah coefficients is reviewed here in the case of the group $SU(2)$. The following definitions

can however be extended to other groups.

Clebsch-Gordan coefficients $C_{m_1 m_2 m}^{j_1 j_2 j}$ relate the two canonical orthonormal basis in the space $\mathcal{H}_{j_1} \otimes \mathcal{H}_{j_2} = \oplus_j \mathcal{H}_j$:

$$|j_1, m_1\rangle \otimes |j_2, m_2\rangle = \sum_{j, m} C_{m_1 m_2 m}^{j_1 j_2 j} |j, m\rangle \quad (98)$$

where $-j_1 \leq m_1 \leq j_1$, $-j_2 \leq m_2 \leq j_2$, $|j_1 - j_2| \leq j \leq j_1 + j_2$ and $-j \leq m \leq j$.

Racah coefficients $R(j_1 j_2 j_3, j_{12} j_{23}, j)$ relate two canonical orthonormal basis in the space $(\mathcal{H}_{j_1} \otimes \mathcal{H}_{j_2}) \otimes \mathcal{H}_{j_3} = \mathcal{H}_{j_1} \otimes (\mathcal{H}_{j_2} \otimes \mathcal{H}_{j_3})$:

$$\begin{aligned} c_m^{j_1 j_2 (j_{12}), j_3, j} &= \sum_{m_1, m_2, m_3} C_{m_1 m_2 m}^{j_1 j_2 j_{12}} C_{m_1 m_2 m}^{j_{12} j_3 j} (|j_1, m_1\rangle \otimes |j_2, m_2\rangle) \otimes |j_3, m_3\rangle \\ c_m^{j_1, j_2 j_3 (j_{23}), j} &= \sum_{m_1, m_2, m_3} C_{m_1 m_2 m}^{j_1 j_2 j_{23}} C_{m_2 m_3 m}^{j_2 j_3 j_{23}} |j_1, m_1\rangle \otimes (|j_2, m_2\rangle \otimes |j_3, m_3\rangle) \\ c_m^{j_1 j_2 (j_{12}), j_3, j} &= \sum_{j_{23}} R(j_1 j_2 j_3, j_{12} j_{23}, j) c_m^{j_1, j_2 j_3 (j_{23}), j} \end{aligned} \quad (99)$$

where $-j_i \leq m_i \leq j_i$ for all indices i . The Racah coefficients do not depend on m .

The classical limit of conformal field theory The *classical limit* of a conformal field theory is defined as the limit in which the conformal weights of all primary fields vanish, making all correlation functions independent of z . An example of such a limit is provided by the Wess-Zumino-Witten models in the limit $k \rightarrow \infty$, which is indeed the classical limit.

In the classical limit, conformal field theory is nothing but group theory, *i.e.* every compact group, either continuous or discrete, leads to a classical conformal field theory (meaning that it solves the polynomial equations that are needed for the duality axiom to hold), and reciprocally every conformal field theory corresponds to a group. The correspondence is explained in this section (see [25] for more details, and [19] for an introduction to group theory). It was at the core of the paper [2].

Since $h_i = 0$, the primary fields $\Phi_i(z)$ are actually independent of z , and one can think of them as forming a basis for the functions on the group G with the correspondence $\Phi_i \leftrightarrow f_i(g)$, $g \in G$, where f_i is a representation of the symmetry algebra of the theory (corresponding to \mathcal{H}_i). The operator product expansion is then simply the product of two functions on the group:

$$f_i(g) f_j(g) = \sum_k C_{ij}^k f_k(g) \quad (100)$$

while the correlation functions are given by a sum over the group (or an integral if the group is continuous):

$$\langle \Phi_{i_1} \dots \Phi_{i_n} \rangle = \sum_{g \in G} f_{i_1}(g) \dots f_{i_n}(g) \quad (101)$$

Other interesting objects in conformal field theories are the intertwiner operators. An intertwiner V_{ij}^k is simply the linear function that associates to any tensor product of states in the representation $\mathcal{H}_i \otimes \mathcal{H}_j$ the states that are in the resulting representation \mathcal{H}_k , with the coupling constant C_{ij}^k . Restricting to the group $SU(2)$ in order to give explicit formulas (the correspondence however is generic, at least for compact semi-simple groups) and using standard notations, the intertwiner operators are expressed in the limit in terms of the Clebsch-Gordan coefficients of the group and of the canonical basis vectors:

$$V_{j_1 j_2}^J = \sum_{m_1, m_2, M} |JM\rangle C_{m_1 m_2 M}^{j_1 j_2 J} \langle j_1 m_1 j_2 m_2 | \quad (102)$$

The fusion matrix is defined as:

$$V_{j j_2}^{j_1} V_{j_3 j_2}^{j_2} = \sum_{j_{12}} F_{j_{23} j_{12}} \begin{bmatrix} j & j_3 \\ j_1 & j_2 \end{bmatrix} V_{j_{12} j_2}^{j_1} V_{j j_3}^{j_{12}} \quad (103)$$

and is given by the Racah coefficients :

$$F_{j_{23} j_{12}} \begin{bmatrix} j & j_3 \\ j_1 & j_2 \end{bmatrix} = R(j_1 j_2 j_3, j_{12} j_{23}, j) \quad (104)$$

The pentagon equation is then known as the *Biedenharn-Elliott identity*. The fusion matrix F satisfies several symmetry properties, which can be equivalently given in terms of the Racah coefficients:

$$F_{pr} \begin{bmatrix} j & k \\ i & l \end{bmatrix} \sim F_{p^\vee r} \begin{bmatrix} k & j \\ l^\vee & i^\vee \end{bmatrix} \sim F_{pr^\vee} \begin{bmatrix} i^\vee & l \\ j^\vee & k \end{bmatrix} \quad (105)$$

where \sim stands for "equal up to a sign".

The notion of character also coincides in the classical limit. Although generic, it is easier to understand the correspondence in an explicit example, say $SU(2)$. The character of a representation of the group $SU(2)$ was written in equation (94). The character of a spin j representation of the affine algebra $\widehat{su(2)}_{k-2}$ is:

$$\chi_j(\tau, \nu) = Tr \left(e^{2i\pi\tau(L_0 - \frac{c}{24})} e^{2i\pi\nu j_0^3} \right) \xrightarrow{\nu \rightarrow 0} (2j+1)q^{h_j - \frac{c}{24}} + \sum_{n=1}^{\infty} c_n q^{h_j - \frac{c}{24} + n} \quad (106)$$

where the c_n are integer coefficients whose exact value is of no interest here. The classical limit amounts to the decoupling of the secondary fields (with conformal weight larger than the one of primary fields), which is realized as follows:

$$\lim_{\tau \rightarrow i\infty} \chi_j(\tau) q^{-h_j + \frac{c}{24}} = 2j+1 = \lim_{\theta \rightarrow 0} \chi_j(\theta) \quad (107)$$

This is consistent since the limit $\nu \rightarrow 0$ in (106) may be interpreted in terms of the group as $\theta \rightarrow 0$: indeed, both ν and θ parametrize the rotation, see also the

similar expressions of (94) and (106). Note also that $S_0^j/S_0^0 = 2j + 1$ is the dimension of the representation j .

In summary, the proper correspondence between concepts in each theory is:

Group	Chiral algebra	
Representations	Representations	
Clebsch-Gordan coefficients	Chiral vertex operators	
/ intertwiners	/ intertwiners	
Racah coefficients	Fusion matrix	
Character	Character	(108)
Functions on the group	Physical fields	
Product of functions on the group	Operator product expansion	
Average over the group	Physical correlation function	
of a product of functions		

Quantum groups Since classical conformal field theory can be identified to group representation theory, it is natural to expect that (quantum) conformal field theory is related to *quantum groups*. Quantum groups are a generalization of the notion of group - actually, they are no longer groups. They are obtained by exponentiation of a quantum analogue of standard (classical) Lie algebras, which are the convenient object to work with. For instance, the $su(2)$ algebra is realized in terms of the Pauli matrices. The commutation relations of this algebra are given by:

$$[J^3, J^\pm] = \pm 2J^\pm, \quad [J^+, J^-] = J^3 \quad (109)$$

where $J^\pm = \frac{\sigma_1 \pm i\sigma_2}{2}$ and $J^3 = \sigma_3$. The $U_q(su(2))$ quantum algebra is defined by:

$$[J^3, J^\pm] = \pm 2J^\pm, \quad [J^+, J^-] = \frac{q^{J^3/2} - q^{-J^3/2}}{q^{1/2} - q^{-1/2}} \quad (110)$$

and is the set of elements which are finite or infinite series of products of J^\pm and J^3 . In order to deal with finite series only, an equivalent definition relies on elements $k = q^{J^3/2}$, $k^{-1} = q^{-J^3/2}$ and uses the following (commutation) relations:

$$\begin{aligned} kk^{-1} &= k^{-1}k = 1, & kJ^\pm k^{-1} &= q^{\pm 1} \\ [J^+, J^-] &= \frac{k - k^{-1}}{q^{1/2} - q^{-1/2}} \end{aligned} \quad (111)$$

The quantum algebra $U_q(su(2))$ is therefore a q -deformation of the universal enveloping algebra of $su(2)$ (hence the notation), which is the set of all elements which can be written as a finite sum of products of elements of $su(2)$ (for instance, the quadratic Casimir $\frac{1}{2}(J^+J^- + J^-J^+) + J^3J^3$ is an element of $U(su(2))$). The classical limit $q \rightarrow 1$ restores the original $su(2)$ algebra. Finally, the representations of quantum algebras display different properties depending on whether the number q is a root of unity or not.

The correspondence between conformal field theory and quantum groups is not well understood in general, however it is established for compact groups. For instance, the quantum group $U_q(SU(n))$ at $q = e^{\frac{2i\pi}{k+n}}$ is related⁴⁹ to the Wess-Zumino-Witten theory of $SU(n)_k$. The most striking example of this relation is that the fusion matrix of the conformal field theory is given by the Racah coefficients of the quantum group, similarly to the classical limit case.

Quantum groups will be used in section 7.

4.6 Beyond rational conformal field theory.

This introduction to conformal field theory was restricted to rational conformal field theories. Non-rational theories, that is to say conformal field theories which have an infinite number of primary fields⁵⁰, are also of interest. They are essential to understand string theory in curved non-compact backgrounds (Wess-Zumino-Witten models for non-compact groups are non-rational), which is a necessary step to take before eventually addressing cosmological issues in string theory.

Non-rational conformal field theories display new properties that make them hard to deal with. For instance, the characters of representations of the operator vertex algebra may not form a representation of the modular group anymore, the Verlinde formula does not hold anymore *a priori*, the conjugation map may need a different definition from the one given in section 4.4 and the conformal weights and the central charge may not be rational numbers anymore either. Another striking feature is that some of the representations may depend on a continuous parameter, while the spectrum of rational theories was always discrete. Furthermore, the one-to-one correspondence between states and fields may not hold anymore. Because of all these new features, non-rational conformal field theories are not well understood yet (see [35] for a review of some examples of non-rational theories, including Liouville theory).

This dissertation was devoted to the study of non-rational conformal field theories, and tries to shed new light on their properties. Major examples of such theories include the pp-waves with Heisenberg symmetry, Liouville theory, the H_3^+ theory and the $SL(2, \mathbb{R})/U(1)$ Wess-Zumino-Witten theory. The next sections present the work that was done on these theories [1, 2].

⁴⁹A more general conjecture for semi-simple groups would be that $q = e^{\frac{2i\pi}{k+Q}}$.

⁵⁰The definition of rationality is actually not so clear yet, as several exist in the physics and mathematics literature. One reason why is that it is not clear which conditions make the theory easily tractable. Throughout this dissertation, a conformal field theory is called rational if and only if the corresponding vertex operator algebra only possesses finitely many irreducible representations, *i.e.* there is a finite number of primary fields.

5 Heisenberg algebras and pp-waves

5.1 Introduction

Plane wave (or pp-wave) backgrounds are one of the few maximally supersymmetric backgrounds of type IIB superstring that are known at this time (the other ones being ten-dimensional Minkowski space and $AdS_5 \times S^5$). Plane waves display interesting properties and have been studied for a while in the context of string theory. For instance, the σ -model can be shown to be conformally invariant to all orders in the α' expansion [60, 61, 62, 63, 64, 65, 66, 67] – a property due to the existence of a globally well-defined null Killing vector field. Moreover, the string can be quantized in the light-cone gauge (see *e.g.* [68]), where the Lagrangian becomes quadratic, which makes pp-waves a good configuration to study string theory in a background different from Minkowski space. Plane wave backgrounds may be described by Wess-Zumino-Witten models, and the Killing symmetries give rise to current algebra on the two-dimensional world-sheet [69]. The existence of this current algebra can be used to organize the operator algebra of the model, compute the exact spectrum, find a quasi-free field resolution, and compute the vacuum energy [70, 71]. The conformal field theory is non-rational and yet tractable. Its study may therefore help learn more about non-rational theories and develop new tools before attacking more complicated backgrounds. Moreover, the pp-wave geometry arises as a limit of $AdS_p \times S^q$ backgrounds, and, in the context of gravity / gauge theory correspondence, pp-waves are dual to large N limits of gauge theory. This property makes plane waves a good laboratory to study AdS/CFT correspondence and holography in a context where the dual string theory may be exactly solvable. In the prototype example of $\mathcal{N} = 4$ super Yang-Mills theory, this corresponds to taking the limit $N \rightarrow \infty$ together with $J \rightarrow \infty$ and keeping $\frac{N}{J^2}$ fixed (N is the number of colors and J is a charge of the $SO(6)$ R-symmetry). The associated limit of the dual gravitational background is the Penrose limit of the $AdS_5 \times S_5$ background studied in [72] and exhibits an Heisenberg symmetry (taking a Penrose limit consists in zooming in around a null geodesic). The exact light-cone spectrum of the associated σ -model was computed [68, 73, 74, 75, 76] and it was argued that it correctly matches the one obtained from super Yang-Mills theory [77]. Note also that pp-waves incorporate corrections to flat space results, hence their study allows further insight into AdS/CFT correspondence. For all these reasons it may be interesting to learn more about pp-waves and Heisenberg algebras.

The purpose of the following work is to study plane wave backgrounds exhibiting an \mathcal{H}_{2n+2} Heisenberg current algebra (n is a positive integer). Several results have already been obtained on this kind of pp-waves. In [78, 79], \mathcal{H}_4 and \mathcal{H}_6 have been studied, correlators have been calculated along with string amplitudes, free field or quasi free field representations have been exhibited, and holographic perspectives have been investigated. This work is indebted to these papers, since in particular it gives generalized formulas for correlators, that are valid for any $n \geq 1$.

Before anything else, it is worth studying how pp-wave backgrounds may appear in the context of string theory. Such backgrounds are related to configurations of intersecting fundamental (or F1) strings⁵¹ and NS5 branes⁵², as was pointed out in [78, 79]. More precisely, pp-waves can be obtained as the Penrose limit [72] of intersecting branes. A rather general method to do this has been presented in [80]. Several brane configurations are of interest: one NS5 only [81, 82, 83], one NS5 brane intersecting on an F1 [84], or two NS5 intersecting on an F1 [85]. It is possible to consider the near-horizon geometry [86] of these configurations, or also to study several charge limits, as was partially done in [87]. For instance, it is well-known that the near-horizon limit of the intersection of an NS5 brane with a fundamental string is just $AdS_3 \times S_3$ and that a Penrose limit of this configuration leads to a pp-wave with \mathcal{H}_6 symmetry, see *e.g.* [79]. Similarly, it is explained below how a configuration of 2 NS5 branes along with an F-string leads to a background with \mathcal{H}_8 symmetry.

The following work is organized as follows. The first section reviews the definition and properties of \mathcal{H}_{2n+2} Heisenberg algebras, including their representations. The second section explains how pp-wave backgrounds exhibiting such algebras for symmetry can be obtained as Penrose limits of configurations of intersecting branes, by studying and commenting several examples. Due to dimensional constraints (since critical superstring theory is defined in ten dimensions), n is restricted to $1 \leq n \leq 4$ in this section. The two, three and four-point correlation functions between primary fields of any conformal field theory exhibiting the \mathcal{H}_{2n+2} symmetry are calculated in a third and last section.

5.2 \mathcal{H}_{2n+2} Heisenberg algebra

This section introduces \mathcal{H}_{2n+2} Heisenberg algebras and reviews important results, mostly concerning their representations. These well-known results (see *e.g.* [78] and references therein) will be useful in the rest of the study, in particular when computing correlation functions and the operator product expansions in section 5.4.

⁵¹The fundamental string, or F1-string, is the original string. The name is used to distinguish it from other one-dimensional objects that may appear in the theory, like D -strings which are $D1$ branes (in type I and type IIB string theories) or solitonic strings.

⁵²Neveu Schwarz 5-branes in the type I and type II superstring theories are related to the two-form potential $B_{\mu\nu}$ in the following way. The fundamental string couples to $B^{(2)} = B_{\mu\nu}$ via a term $\int_{\mathcal{M}_2} B^{(2)}$ where \mathcal{M}_2 is the worldsheet of the string. The Hodge duality relates $B^{(2)}$ to a six-form potential $B^{(6)}$ by $dB^{(6)} = *dB^{(2)}$ (recall that superstring theories live in ten dimensions). This six-form couples to the NS5 brane, whose worldvolume is denoted by \mathcal{M}_6 , via a term $\int_{\mathcal{M}_6} B^{(6)}$. One may say that the NS5 brane is a magnetic dual to the F1 string.

5.2.1 Definition

The non-zero commutation relations between the generators of \mathcal{H}_{2n+2} are:

$$\begin{aligned} [P_\alpha^+, P_\beta^-] &= -2i\mu_\alpha\delta_{\alpha,\beta}K \\ [J, P_\alpha^\pm] &= \mp i\mu_\alpha P_\alpha^\pm \end{aligned} \quad (112)$$

where $1 \leq \alpha, \beta \leq n$ and the μ_α are real numbers. K is the central element of the algebra *i.e.* commutes with all other elements, while J rotates P_α^\pm . The algebra \mathcal{H}_{2n+2} is *not* semi-simple.

The algebra generically admits $n-1$ extra $U(1)$ generators I_a , $1 \leq a \leq n-1$, which satisfy:

$$[I_a, P_\alpha^\pm] = \mp i(\sigma_a)_\alpha^\alpha P_\alpha^\pm \quad (113)$$

where σ_a is the diagonal matrix associated to I_a . These matrices are given by the generators of the $n-1$ underlying $U(1)$ symmetries of $SU(n)$. Their explicit values are given below for the simplest cases $n=2, 3$ and 4. For $n=2$:

$$\sigma_1 = \begin{pmatrix} 1 & 0 \\ 0 & -1 \end{pmatrix} \quad (114)$$

(this is a Pauli matrix) while for $n=3$:

$$\sigma_1 = \begin{pmatrix} 1 & 0 & 0 \\ 0 & -1 & 0 \\ 0 & 0 & 0 \end{pmatrix}, \quad \sigma_2 = \frac{1}{\sqrt{3}} \begin{pmatrix} 1 & 0 & 0 \\ 0 & 1 & 0 \\ 0 & 0 & -2 \end{pmatrix} \quad (115)$$

(these are the diagonal Gell-Mann matrices). Finally, for $n=4$:

$$\sigma_1 = \begin{pmatrix} 1 & 0 & 0 & 0 \\ 0 & -1 & 0 & 0 \\ 0 & 0 & 0 & 0 \\ 0 & 0 & 0 & 0 \end{pmatrix}, \quad \sigma_2 = \begin{pmatrix} 1 & 0 & 0 & 0 \\ 0 & 0 & 0 & 0 \\ 0 & 0 & -1 & 0 \\ 0 & 0 & 0 & 0 \end{pmatrix}, \quad \sigma_3 = \frac{1}{\sqrt{7}} \begin{pmatrix} 1 & 0 & 0 & 0 \\ 0 & 2 & 0 & 0 \\ 0 & 0 & 0 & 0 \\ 0 & 0 & 0 & -3 \end{pmatrix}$$

All these matrices satisfy $Tr I_i = 0$ and $Tr I_i^2 = 2$.

When all the μ_α are equal⁵³, the $U(1)$ symmetries are enhanced to $SU(n)$ with n^2-1 generators I_b that are then needed for a proper classification of the states of the theory. These generators satisfy:

$$[I_b, P_\alpha^+] = -i \sum_{\beta=1}^n (\sigma_b)_\alpha^\beta P_\beta^+, \quad [I_b, P_\alpha^-] = i \sum_{\beta=1}^n ({}^t\sigma_b)_\alpha^\beta P_\beta^- \quad (116)$$

where the matrices σ_b are the generators of a matrix representation of $SU(n)$.

⁵³The more general case of arbitrary commensurable μ_α , which is expected to display extra symmetry, is more complicated and will not be considered here.

The \mathcal{H}_{2n+2} algebra has two Casimir operators (up to quadratic order in the currents), the central element K and:

$$\mathcal{C} = 2JK + \frac{1}{2} \sum_{\alpha=1}^n (P_{\alpha}^{+} P_{\alpha}^{-} + P_{\alpha}^{-} P_{\alpha}^{+}) \quad (117)$$

Finally, the Sugawara construction can be carried out and holds the following expression of the stress-energy tensor T in terms of a bilinear combination of the currents [69, 78]:

$$T = \frac{1}{2} \left[\frac{1}{2} \sum_{\alpha=1}^n (P_{\alpha}^{+} P_{\alpha}^{-} + P_{\alpha}^{-} P_{\alpha}^{+}) + 2JK + K^2 \sum_{\alpha=1}^n \mu_{\alpha}^2 \right] \quad (118)$$

This formula differs from the generic formula given in (79) which is valid for semi-simple algebras only. In general, one must solve the Master equation in order to find the stress-energy tensor, see *e.g.* [69, 88, 89].

5.2.2 Representations

There are three types of unitary representations of the \mathcal{H}_{2n+2} Heisenberg group [70, 90]:

1. Lowest-weight representations $V_{p,\hat{j}}^{+}$, where⁵⁴ $0 < \max(\mu_{\alpha} p) < 1$ and $j \in \mathbb{R}$.

These representations are constructed starting from a state $|p, \hat{j}\rangle$ which satisfies:

$$P_{\alpha}^{+} |p, \hat{j}\rangle = 0, \quad K |p, \hat{j}\rangle = ip |p, \hat{j}\rangle, \quad J |p, \hat{j}\rangle = i\hat{j} |p, \hat{j}\rangle \quad (119)$$

and acting repeatedly with P_{α}^{-} . The value of the Casimir is $\mathcal{C} = -2p\hat{j} + p \sum_{\alpha=1}^n \mu_{\alpha}$ and the spectrum of J is given by⁵⁵ $\{\hat{j} + \sum_{\alpha=1}^n \mu_{\alpha} m_{\alpha} | m_{\alpha} \in \mathbb{N}\}$.

2. Highest-weight representations $V_{p,\hat{j}}^{-}$, where $0 < \max(\mu_{\alpha} p) < 1$ and $j \in \mathbb{R}$.

These representations are constructed starting from a state $|p, \hat{j}\rangle$ which satisfies:

$$P_{\alpha}^{-} |p, \hat{j}\rangle = 0, \quad K |p, \hat{j}\rangle = -ip |p, \hat{j}\rangle, \quad J |p, \hat{j}\rangle = i\hat{j} |p, \hat{j}\rangle \quad (120)$$

and acting repeatedly with P_{α}^{+} . The value of the Casimir is $\mathcal{C} = 2p\hat{j} + p \sum_{\alpha=1}^n \mu_{\alpha}$ and the spectrum of J is given by $\{\hat{j} - \sum_{\alpha=1}^n \mu_{\alpha} m_{\alpha} | m_{\alpha} \in \mathbb{N}\}$. The representation $V_{p,-\hat{j}}^{-}$ is conjugate⁵⁶ to $V_{p,\hat{j}}^{+}$.

3. Continuous representations $V_{s_{\alpha}, \hat{j}}^0$ where $p = 0$ and $s_{\alpha} \in \mathbb{R}_{+}$.

Here s_{α} is actually a shorthand notation for s_1, \dots, s_n (this shorthand notation will be used for other quantities later, namely for m_{α} and q_{α} in section 5.4). These representations are characterized by:

$$K |s_{\alpha}, \hat{j}\rangle = 0, \quad J |s_{\alpha}, \hat{j}\rangle = i\hat{j} |s_{\alpha}, \hat{j}\rangle, \quad P_{\alpha}^{\pm} |s_{\alpha}, \hat{j}\rangle \neq 0 \quad (121)$$

⁵⁴The range of p is restricted by a stringy cut-off, which can be lifted by considering spectral flowed representations (see [70, 82]). Such representations are not considered here, though.

⁵⁵Note that due to (112), P_{α}^{+} decreases the eigenvalue of J while P_{α}^{-} increases it (by μ_{α}).

⁵⁶Although the Wess-Zumino-Witten model based on the \mathcal{H}_{2n+2} algebra is a non-rational conformal theory, the conjugate can be defined along the lines of subsection 4.4.3.

The spectrum of J is then given by $\{\hat{j} + \sum_{\alpha=1}^n \mu_\alpha m_\alpha | m_\alpha \in \mathbb{Z}\}$ where $|\hat{j}| \leq \frac{\mu}{2}$ and $\mu = \min(\mu_1, \dots, \mu_n)$ (in the case of commensurable μ_α , this condition may be more restrictive). For continuous representations, there are n other Casimir operators besides K , denoted by $\mathcal{C}_\alpha = P_\alpha^+ P_\alpha^-$. Their values are $\mathcal{C}_\alpha = s_\alpha^2$. The representation $V_{-s_\alpha, \hat{j}}^0$ is isomorphic to $V_{s_\alpha, \hat{j}}^0$. The conjugate representation of $V_{s_\alpha, \hat{j}}^0$ is $V_{s_\alpha, -\hat{j}}^0$.

The one-dimensional (trivial, or identity) representation can be considered as a particular case of continuous representation, where the charges s_α and \hat{j} are zero.

The ground states of all these representations are assumed to be invariant under the $U(1)$ symmetries (or the $SU(n)$ symmetry if all the μ_α are equal), but for simplicity the associated quantum numbers will not be explicitly written.

Since the representations are infinite dimensional, it is very convenient to introduce charge variables in order to keep track of the various components of a given representation in a compact form. Following [78], the idea is to introduce n dimensionless complex charge variables x_α , and then to regroup the infinite number of fields that appear in a given representation of \mathcal{H}_{2n+2} into a single field. The three different kinds of (primary) fields are:

$$\begin{aligned} \Phi_{p, \hat{j}}^\pm(z, \bar{z}; x_\alpha, \bar{x}_\alpha) &= \sum_{m_\alpha, \bar{m}_\alpha=0}^{\infty} \prod_{\alpha=1}^n \frac{(x_\alpha \sqrt{\mu_\alpha p})^{m_\alpha}}{\sqrt{m_\alpha!}} \frac{(\bar{x}_\alpha \sqrt{\mu_\alpha p})^{\bar{m}_\alpha}}{\sqrt{\bar{m}_\alpha!}} R_{p, \hat{j}; m_\alpha, \bar{m}_\alpha}^\pm(z, \bar{z}) \\ \Phi_{s_\alpha, \hat{j}}^0(z, \bar{z}; x_\alpha, \bar{x}_\alpha) &= \sum_{m_\alpha, \bar{m}_\alpha=-\infty}^{\infty} \prod_{\alpha=1}^n (x_\alpha)^{m_\alpha} (\bar{x}_\alpha)^{\bar{m}_\alpha} R_{p, \hat{j}; m_\alpha, \bar{m}_\alpha}^0(z, \bar{z}) \end{aligned} \quad (122)$$

These fields will be generically denoted by Φ_ν^a where $a = \pm, 0$ indicates the kind of representation and $\nu = (p, \hat{j})$ for V^\pm representations while $\nu = (s_\alpha, \hat{j})$ for V^0 representations. The charge variables x_α must satisfy some conditions for the infinite sums in (122) to be well-defined, namely $|x_\alpha| < 1$ for $V_{p, \hat{j}}^\pm$ representations and $|x_\alpha| = 1$ *i.e.* $x_\alpha = e^{i\Phi_\alpha}$ with Φ_α a real number for $V_{s_\alpha, \hat{j}}^0$ representations.

The monomials $b_{m_\alpha}(x_\alpha) = \frac{(x_\alpha \sqrt{\mu_\alpha p})^{m_\alpha}}{\sqrt{m_\alpha!}}$ form an orthonormal basis of the space of entire series, with the measure:

$$\int d\mu_\alpha(x_\alpha) = \frac{\mu_\alpha p}{\pi} \int_{\mathbb{C}} d^2 x_\alpha e^{-\mu_\alpha p x_\alpha x_\alpha^*} \quad (123)$$

where $*$ indicates complex conjugation. Indeed:

$$\int b_{m_\alpha}(x_\alpha) b_{m'_\alpha}(x_\alpha)^* d\mu_\alpha(x_\alpha) = \delta_{m_\alpha, m'_\alpha} \quad (124)$$

The same kind of result holds for the monomials $c_{m_\alpha}(x_\alpha) = (x_\alpha)^{m_\alpha}$ with $x_\alpha = e^{i\Phi_\alpha}$, which form an orthonormal basis when using the measure:

$$\int d\mu_\alpha(x_\alpha) = \frac{1}{2\pi} \int_0^{2\pi} d\Phi_\alpha \quad (125)$$

The generators of the Heisenberg algebras (along with the ones corresponding to the $U(1)$'s or $SU(n)$) are represented (*i.e.* act) on the fields (122) as described below [90]. For the $V_{p,\hat{j}}^+$ representations:

$$\begin{aligned} P_{0,\alpha}^+ &= \sqrt{2}\partial_\alpha, & P_{0,\alpha}^- &= \sqrt{2}\mu_\alpha p x_\alpha, & K_0 &= \nu p \\ J_0 &= \nu \left(\hat{j} + \sum_{\alpha=1}^n \mu_\alpha x_\alpha \partial_\alpha \right), & I_{b,0} &= \nu \sum_{\alpha,\beta=1}^n x_\alpha (\sigma_b)_\alpha^\beta \partial_\beta \end{aligned} \quad (126)$$

Similarly, for the $V_{p,\hat{j}}^-$ representations:

$$\begin{aligned} P_{0,\alpha}^+ &= \sqrt{2}\mu_\alpha p x_\alpha, & P_{0,\alpha}^- &= \sqrt{2}\partial_\alpha, & K_0 &= -\nu p \\ J_0 &= \nu \left(\hat{j} - \sum_{\alpha=1}^n \mu_\alpha x_\alpha \partial_\alpha \right), & I_{b,0} &= -\nu \sum_{\alpha,\beta=1}^n x_\alpha (\sigma_a)_\alpha^\beta \partial_\beta \end{aligned} \quad (127)$$

Finally, for the $V_{s_\alpha,\hat{j}}^0$ representations⁵⁷ ($K_0 = 0$):

$$\begin{aligned} P_{0,\alpha}^+ &= \frac{s_\alpha}{x_\alpha}, & P_{0,\alpha}^- &= s_\alpha x_\alpha \\ J_0 &= \nu \left(\hat{j} + \sum_{\alpha=1}^n \mu_\alpha x_\alpha \partial_\alpha \right), & I_{a,0} &= \nu \sum_{\alpha=1}^n x_\alpha (\sigma_a)_\alpha^\alpha \partial_\alpha \end{aligned} \quad (128)$$

As expected, these generators satisfy the commutation relations (112). It is useful to keep in mind the homogeneity relations $\mu_\alpha p \sim s_\alpha \sim x_\alpha \sim 1$ and $\hat{j} \sim \mu_\alpha$ deduced from the above expressions.

Using the above representation along with the expression (118) that relates the stress-energy tensor to the currents, the conformal weight for fields in representations $V_{p,\hat{j}}^\pm$ is found to be:

$$h = \mp p \hat{j} + \frac{1}{2} \sum_{\alpha=1}^n \mu_\alpha p (1 - \mu_\alpha p) \quad (129)$$

while for fields in representations $V_{s_\alpha,\hat{j}}^0$:

$$h = \frac{1}{2} \sum_{\alpha=1}^n s_\alpha^2 \quad (130)$$

Finally, an important piece of information is the decomposition of the tensor

⁵⁷Note that in this case one can not represent I_b by $\nu \sum_{\alpha,\beta=1}^n x_\alpha (\sigma_a)_\alpha^\beta \partial_\beta$

products between unitary representations of the \mathcal{H}_{2n+2} algebra [90]:

$$\begin{aligned}
V_{p_1, \hat{j}_1}^+ \otimes V_{p_2, \hat{j}_2}^+ &= \sum_{m_1, m_2, \dots, m_n=0}^{\infty} V_{p_1+p_2, \hat{j}_1+\hat{j}_2+\sum_{\alpha=1}^n \mu_{\alpha} m_{\alpha}}^+ \\
V_{p_1, \hat{j}_1}^+ \otimes V_{p_2, \hat{j}_2}^- &= \sum_{m_1, m_2, \dots, m_n=0}^{\infty} V_{p_1-p_2, \hat{j}_1+\hat{j}_2-\sum_{\alpha=1}^n \mu_{\alpha} m_{\alpha}}^+ \quad , \quad p_1 > p_2 \\
V_{p_1, \hat{j}_1}^+ \otimes V_{p_2, \hat{j}_2}^- &= \sum_{m_1, m_2, \dots, m_n=0}^{\infty} V_{-p_1+p_2, \hat{j}_1+\hat{j}_2+\sum_{\alpha=1}^n \mu_{\alpha} m_{\alpha}}^- \quad , \quad p_1 < p_2 \\
V_{p, \hat{j}_1}^+ \otimes V_{p, \hat{j}_2}^- &= \int_0^{\infty} s_1 ds_1 \dots \int_0^{\infty} s_n ds_n V_{s_{\alpha}, \hat{j}_1+\hat{j}_2}^0 \\
V_{p, \hat{j}_1}^{\pm} \otimes V_{s_{\alpha}, \hat{j}_2}^0 &= \sum_{m_1, m_2, \dots, m_n=-\infty}^{\infty} V_{p, \hat{j}_1+\hat{j}_2+\sum_{\alpha=1}^n \mu_{\alpha} m_{\alpha}}^{\pm} \quad (131)
\end{aligned}$$

Note that when all μ_{α} are equal there are several terms⁵⁸ with the same $\hat{j} = \hat{j}_1 + \hat{j}_2 + \mu m$ in the sums appearing in (131). The existence of this multiplicity is precisely what is necessary in order to obtain $SU(n)$ invariant couplings, as will be explained in section 5.4.

5.2.3 Heisenberg algebras and string theory

Heisenberg algebras arise in string theory as the symmetry algebra of some backgrounds, as will be explained in section 5.3. These backgrounds, called pp-waves, are of the form⁵⁹:

$$ds^2 = 2dudv - \frac{1}{4} \left(\sum_{\alpha=1}^n \mu_{\alpha}^2 y_{\alpha}^2 \right) du^2 + \sum_{\alpha=1}^n (dy_{1\alpha}^2 + dy_{2\alpha}^2) \quad (132)$$

where $y_{\alpha}^2 = y_{1\alpha}^2 + y_{2\alpha}^2$. They are supported by an NS-NS totally antisymmetric field strength:

$$H = \sum_{\alpha=1}^n \mu_{\alpha} du \wedge dy_{1\alpha} \wedge dy_{2\alpha} \quad (133)$$

and the dilaton is constant. The H field is necessary for the generalized gravity equations (86) to hold. The only non-trivial component of the Ricci tensor is $R_{uu} = \frac{1}{4} \sum_{\alpha=1}^n \mu_{\alpha}^2$. The central charge is determined by equation (87) to be $c = 2n + 2$ *i.e.* it is precisely the space-time dimension (or the dimension of the Lie algebra \mathcal{H}_{2n+2} – this is generic, see [91]).

⁵⁸The number of such terms is C_{m+n-1}^m for $SU(n)$.

⁵⁹Note that it is always possible to multiply the du^2 term of the metric by any positive constant λ^2 , by changing coordinates, $u = \lambda u'$ and $v = v'/\lambda$. This manipulation amounts to an overall rescaling of the μ_{α} . The case $\mu_{\alpha} = 0$ for all α corresponds to flat space.

A change of coordinates makes more obvious the fact that pp-waves are indeed gravitational plane-waves. Starting from (132) and defining:

$$\begin{aligned} u &= u' , & y_{i\alpha} &= y'_{i\alpha} \frac{\sin \mu_\alpha u'}{2\mu_\alpha} \\ v &= v' - \frac{1}{4} \sum_{\alpha=1}^n \frac{\sin 2\mu_\alpha u'}{2\mu_\alpha} (y'_{1,\alpha}{}^2 + y'_{2,\alpha}{}^2) \end{aligned} \quad (134)$$

the metric becomes:

$$ds^2 = du' dv' + \sum_{\alpha=1}^n \left(\frac{\sin \mu_\alpha u'}{2\mu_\alpha} \right)^2 (dy'_{1,\alpha}{}^2 + dy'_{2,\alpha}{}^2) \quad (135)$$

As first realized in [69] for the case $n = 1$ and then in [92] for generic n , the σ -models corresponding to Hpp-waves, given in (85), are Wess-Zumino-Witten models based on the \mathcal{H}_{2n+2} Heisenberg group (it can be checked by explicitly computing the Wess-Zumino-Witten action (73) for a matrix field g valued in a matrix representation of the group \mathcal{H}_{2n+2} – the metric comes from the σ -model term, while the field strength H comes from the triple derivative). Because superstrings (in which one is eventually interested in, though only bosonic strings are considered here) live in ten dimensions, n is restricted to $1 \leq n \leq 4$ when studying string theory backgrounds. Otherwise it may be any positive integer.

The current algebra separates in a left (holomorphic) part and a right (anti-holomorphic) part. Since both parts can be treated in the exact same way, the focus will be put on the left part only. The right part, when needed, will be characterized by barred expressions. The (holomorphic) current algebra is defined by the following operator product expansions:

$$\begin{aligned} P_\alpha^+(z) P_\beta^-(w) &\sim \frac{2\delta_\alpha^\beta}{(z-w)^2} - \frac{2i\mu_\alpha \delta_\alpha^\beta}{z-w} K(w) \\ J(z) P_\alpha^\pm(w) &\sim \mp \frac{i\mu_\alpha}{z-w} P_\alpha^\pm(w) \\ J(z) K(w) &\sim \frac{1}{(z-w)^2} \end{aligned} \quad (136)$$

where $1 \leq \alpha, \beta \leq n$. These operator product expansions correspond to the following commutation relations for the left-moving current modes:

$$\begin{aligned} [P_{\alpha,n}^+, P_{\beta,m}^-] &= 2n\delta_\alpha^\beta \delta_{n+m,0} - 2i\mu_\alpha \delta_\alpha^\beta K_{n+m} , & [J_n, K_m] &= n\delta_{n+m,0} \\ [J_n, P_{\alpha,m}^+] &= -i\mu_\alpha P_{\alpha,n+m}^+ , & [J_n, P_{\alpha,m}^-] &= i\mu_\alpha P_{\alpha,n+m}^- \end{aligned} \quad (137)$$

The zero-modes satisfy the commutation relations (112). The spectral flow acts on the Heisenberg algebra according to:

$$\begin{aligned} \tilde{P}_{\alpha,n}^+ &= P_{\alpha,n-w}^+ , & \tilde{P}_{\alpha,n}^- &= P_{\alpha,n+w}^- , & \tilde{J}_n &= J_n \\ \tilde{K}_n &= K_n - w\delta_{n,0} , & \tilde{L}_n &= L_n - wJ_n \end{aligned} \quad (138)$$

where w is an integer. The spectral-flowed modes satisfy the same commutation relations as the original modes (the two corresponding algebras are isomorphic).

Finally, the operator product expansions between the currents and the primary vertex operators (122) can be written in a compact form:

$$\mathcal{J}^A(z)\Phi_\nu^a(w;x) = -\frac{\mathcal{J}_{0,a}^A\Phi_\nu^a(w;x)}{z-w} \quad (139)$$

where A labels the \mathcal{H}_{2n+2} currents and the $\mathcal{J}_{0,a}^A$ are the differential operators that realize the action of the zero-modes \mathcal{J}_0^A on a given representation (a, ν) . These operators were given in relations (126), (127) and (128).

These results will be used to compute two, three and four-point correlation functions in section 5.4.

5.3 Heisenberg algebras in string theory

Intersecting brane configurations have been widely studied [84, 93, 94, 95]. Penrose limits [96] have equally received a lot of attention in the past years [72, 80, 97]. This section relies on these results in order to explain how Hpp-wave backgrounds appear as Penrose limits of brane configurations.

Before moving on to explicit brane intersections, some precisions concerning conventions, the S-duality as well as the Penrose limit may be useful. Indeed, several papers in the literature study configurations of D1 and D5 branes in type IIB superstring theory. These configurations are related to the ones studied here in type IIB theory⁶⁰, with F1 strings and NS5 branes, by the S-duality, which acts on the background fields according to⁶¹:

$$\begin{aligned} \Phi' &= -\Phi \\ G'_{E,\mu\nu} &= G'_{\mu\nu}e^{-\Phi'/4} = e^{-\Phi/4}G_{\mu\nu} = G_{E,\mu\nu} \end{aligned} \quad (140)$$

where $G_{\mu\nu}$ is the string metric (which is the metric which has been used everywhere in the dissertation, and in particular in (86) or (88)), and $G_{E,\mu\nu}$ is the Einstein metric. The Einstein metric⁶² is sometimes used because it has the nice properties that it is invariant under S-duality and that it diagonalizes the kinetic terms of the metric and of the dilaton in the effective action (88). All the results that follow are given in the string frame. The S-duality exchanges

⁶⁰Type IIB theory is favored in the context of the present study since it contains D1, D5 and NS5 branes, which is not the case for type IIA which only contains even dimensional D-branes. Moreover, type IIB string theory is self-dual under S-duality. Finally, NS5 branes are preferred to D5 branes since their background have an NS-NS B field which can be included in a worldsheet description (conformal field theory point of view) according to Polyakov's action (85). On the contrary, D5 branes lead to non-zero Ramond-Ramond (RR) fields which are not well understood from a conformal viewpoint.

⁶¹Since the string coupling is $g_s = e^{\phi/2}$, this duality relates weakly coupled theories to strongly coupled ones.

⁶²The above definition (140) is only valid in ten dimensions. More generally, in D dimensions $G_{E,\mu\nu} = e^{-\frac{2\phi}{D-2}}G_{\mu\nu}$.

the D1 brane (D string) and the fundamental (F1) string, and the D5 brane and the NS5 brane.

Moreover, some authors use a normalization for the dilaton that differs from the one used here by a factor two. In this dissertation, the normalization is fixed by the expressions of the low-energy equations of motion for the background fields (86) or by their effective action (88). It is consistent with the above relation defining the Einstein metric from the string metric, and with the expression of the string coupling $g_s = e^{\phi/2}$.

The Penrose limit is obtained by zooming in around null geodesics, and leads to pp-wave space-times. Light-like (null) geodesic trajectories satisfy the following equations:

$$\frac{d^2 x^\mu}{ds^2} + \Gamma_{\nu\rho}^\mu \frac{dx^\nu}{ds} \frac{dx^\rho}{ds} = 0, \quad g_{\mu\nu} \frac{dx^\mu}{ds} \frac{dx^\nu}{ds} = 0 \quad (141)$$

where the $\Gamma_{\nu\rho}^\mu$ are the Christoffel symbols of the metric $g_{\mu\nu}$, which for the three-sphere and the anti-de Sitter space (relevant in the near-horizon limit presented below) are given in appendix A.

5.3.1 One NS5 brane and one F1 string

The solution of the low-energy effective action (88) corresponding to an NS5 brane intersecting with a fundamental string is [84]:

$$\begin{aligned} ds^2 &= \frac{1}{H_1} (-dt^2 + dx^2) + \sum_{i=1}^4 dx_i^2 + H_5 (dr^2 + r^2 d\Omega_3^2) \\ e^\Phi &= g_s^2 \frac{H_5}{H_1} \\ H_{txr} &= \frac{d}{dr} H_1^{-1} = \frac{2\alpha' q_1 r}{(\alpha' q_1 + r^2)^2}, \quad H_{\phi\theta\psi} = 2\alpha' q_5 \sin^2 \phi \sin \theta \end{aligned} \quad (142)$$

where Ω_3 is a three-sphere:

$$d\Omega_3^2 = d\phi^2 + \sin^2 \phi (d\theta^2 + \sin^2 \theta d\psi^2) \quad (143)$$

and where:

$$H_1(r) = 1 + \frac{\alpha' q_1}{r^2}, \quad H_5(r) = 1 + \frac{\alpha' q_5}{r^2} \quad (144)$$

These functions are harmonic⁶³ on the overall transverse space (the $dr^2 + r^2 d\Omega_3^2$ part of the metric). Finally, g_s is the ten dimensional string coupling constant (remark that for $r \rightarrow \infty$, the dilaton verifies $e^{\phi/2} = g_s$) and q_1 and q_5 are respectively the charge of the string and the charge of the NS5 brane. The component of the H field created by the NS5 brane is related to the volume

⁶³The names H_1 and H_5 stand for *Harmonic* functions and should not be mistaken with the field strength of the antisymmetric tensor $H_{\mu\nu\rho}$.

form of the three-sphere, $\omega_3 = \sin^2 \phi \sin \theta d\phi d\theta d\psi$ where $0 \leq \phi \leq 2\pi$, $0 \leq \theta \leq \pi$ and $0 \leq \psi \leq \pi$, which is normalized so that $\int_{S^3} \omega_3 = 2\pi^2$. Hence:

$$\int_{S^3} H = 4\pi^2 \alpha' q_5 \quad (145)$$

with integer charge q_5 . Finally, the field strength is sometimes written as:

$$H = dt \wedge dx \wedge d(H_1^{-1}) + *dH_5 \quad (146)$$

where $*$ is the Hodge dual⁶⁴ on the four dimensional space r, ϕ, θ and ψ . An formula equivalent to (142) for the field strength, using Euclidean coordinates y_i on this space, is $H_{y_i y_j y_k} = \epsilon_{ijkl} \frac{\partial H_5}{\partial y_l}$.

Penrose limit of the NS5/F1 background It is possible to take the Penrose limit for a generic null geodesics of the above NS5/F1 configuration (142). The method for doing so is explained in [80]. The result is rather complicated and does not correspond to \mathcal{H}_{2n+2} symmetric spaces like the ones studied here (132). It is however presented below in order to motivate the interest in the near-horizon limit, which gives rise to backgrounds with Heisenberg symmetry, as will be seen later. The following calculations also explain how to compute the Penrose limit after having performed the near-horizon limit.

Starting from the NS5/F1 configuration (142), a first step is to change variables to adapted ones:

$$u = u(r), \quad v = t + l\phi + a(r), \quad z = \phi + b(r) \quad (147)$$

where l is an arbitrary length constant parametrizing the null geodesic. It can be understood as the angular momentum of the massless particle whose motion is described by the null geodesic [80]. This change of coordinates brings part of the initial metric (142):

$$ds^2 = -H_1(r)^{-1} dt^2 + H_5(r) (dr^2 + r^2 d\phi^2) \quad (148)$$

to the form:

$$ds^2 = 2dudv - H_1^{-1} dv^2 + 2lH_1^{-1} dvdz + (r^2 H_5 - l^2 H_1^{-1}) dz^2 \quad (149)$$

The equality between the two metrics gives formulas for the functions u , a and b :

$$\begin{aligned} a'(r) &= \sqrt{H_5 H_1 - \frac{l^2}{r^2}}, & b'(r) &= -\frac{l/r^2}{\sqrt{H_5 H_1 - l^2/r^2}} \\ u'(r) &= Q(r) = \frac{r H_5}{\sqrt{r^2 H_5 H_1 - l^2}} \end{aligned} \quad (150)$$

⁶⁴The Hodge dual, denoted by a $*$, relates p -forms to $(D-p)$ -forms where D is the spacetime dimension. Its action on components is $*A_{\mu_1 \dots \mu_{D-p}} = \frac{\sqrt{-\det g_{\mu\nu}}}{p!} \epsilon_{\mu_1 \dots \mu_{D-p} \nu_1 \dots \nu_p} A_{\nu_1 \dots \nu_p}$ where ϵ is the D -dimensional totally antisymmetric Levi-Civita symbol and g is the metric which is used to lower and raise indices.

The length l cannot take any value. For the change of variables to be consistent, the argument of the square root appearing in a' , b' or u' has to be positive. Hence:

$$l \leq \sqrt{\alpha' q_1} + \sqrt{\alpha' q_5} \quad (151)$$

The Penrose limit can then be taken, by first rescaling the coordinates:

$$u = U, \quad v = \lambda^2 V, \quad y = \lambda Y, \quad (152)$$

where y stands generically for all coordinates x , x_i , z , as well as y_1 and y_2 defined in terms of coordinates on the three-sphere (143) by:

$$y_1 = \theta \cos \psi, \quad y_2 = \theta \sin \psi \quad (153)$$

The coordinates r , ψ and t are not rescaled. In the Penrose limit $\lambda \rightarrow 0$, the definition of z yields $\phi = -b(r)$. Moreover, the new metric and field strength are related to the old ones by a rescaling:

$$ds_{[new]}^2 = \lambda^{-2} ds^2, \quad H_{\mu\nu\rho[new]} = \lambda^{-2} H_{\mu\nu\rho} \quad (154)$$

The new metric writes:

$$\begin{aligned} ds^2 = & 2dUdV + (r^2 H_5(r) - l^2 H_1(r)^{-1}) dZ^2 + H_1(r)^{-1} dX^2 \\ & + H_5(r) r^2 \sin^2 b(r) (dY_1^2 + dY_2^2) + dX_1^2 + dX_2^2 + dX_3^2 + dX_4^2 \end{aligned} \quad (155)$$

and the field strength and dilaton are:

$$\begin{aligned} H_{UXZ} &= \frac{2l\alpha' q_1}{r^3 H_1(r)^2 H_5(r)} \sqrt{H_1(r) H_5(r) - \frac{l^2}{r^2}} \\ H_{UY_1 Y_2} &= \frac{2l\alpha' q_5}{r^3 H_5(r)} \sin^2 b(r), \quad e^\Phi = g_s^2 \frac{H_5(r)}{H_1(r)} \end{aligned} \quad (156)$$

One last change of coordinates:

$$\begin{aligned} U &= u, & X &= \sqrt{H_1} x \\ Z &= \frac{1}{\sqrt{r^2 H_5 - l^2/H_1}} z, & Y_i &= \frac{1}{r \sin b \sqrt{H_5}} y_i \\ V &= v + \frac{1}{2} \frac{\partial_u H_1^{-\frac{1}{2}}}{H_1^{-\frac{1}{2}}} x^2 + \frac{1}{2} \frac{\partial_u (r H_5^{\frac{1}{2}} \sin b)}{r H_5^{\frac{1}{2}} \sin b} (y_1^2 + y_2^2) + \frac{1}{2} \frac{\partial_u \sqrt{r^2 H_5 - l^2 H_1^{-1}}}{\sqrt{r^2 H_5 - l^2 H_1^{-1}}} z^2 \end{aligned} \quad (157)$$

is necessary in order to obtain the more usual Brinkman (pp-wave) form [72]:

$$ds^2 = 2dudv + \mathcal{A}du^2 + dx^2 + dz^2 + dy_1^2 + dy_2^2 + \sum_{i=1}^4 dx_i^2 \quad (158)$$

where \mathcal{A} is a complicated expression that depends on u (since $r = r(u)$):

$$\begin{aligned}
\mathcal{A} &= A_z z^2 + A_x x^2 + A_y (y_1^2 + y_2^2) \\
A_z &= \frac{1}{\sqrt{r^2 H_5 - l^2 H_1^{-1}}} \left(-Q^{-3} \partial_r Q \partial_r \sqrt{r^2 H_5 - l^2 H_1^{-1}} \right. \\
&\quad \left. + Q^{-2} \partial_r^2 \sqrt{r^2 H_5 - l^2 H_1^{-1}} \right) \\
A_x &= \sqrt{H_1} \left(-Q^{-3} \partial_r Q \partial_r H_1^{-\frac{1}{2}} + Q^{-2} \partial_r^2 H_1^{-\frac{1}{2}} \right) \\
A_y &= (r \sqrt{H_5} \sin b)^{-1} \left(-Q^{-3} \partial_r Q \partial_r (r \sqrt{H_5} \sin b) + Q^{-2} \partial_r^2 (r \sqrt{H_5} \sin b) \right)
\end{aligned} \tag{159}$$

Finally, the associated field strength of the antisymmetric tensor and dilaton are:

$$\begin{aligned}
e^\Phi &= g_s^2 \frac{H_5}{H_1} \\
H_{uxz} &= \frac{2l\alpha' q_1}{r^4 H_1 H_5}, \quad H_{uy_1 y_2} = \frac{2l\alpha' q_5}{r^4 H_5^2}
\end{aligned} \tag{160}$$

Penrose limit of the near-horizon geometry Since a general Penrose limit of the NS5/F1 configuration (142) is rather complicated, it is natural to turn to simplifying limits. A physically sensible one is the near-horizon limit, which is achieved by considering $r/\sqrt{\alpha'} \rightarrow 0$, with fixed charges q_1 and q_5 . This leads to the following solution:

$$\begin{aligned}
ds^2 &= \frac{r^2}{\alpha' q_1} (-dt^2 + dx^2) + \alpha' q_5 \frac{dr^2}{r^2} + \alpha' q_5 d\Omega_3^2 + \sum_{i=1}^4 dx_i^2 \\
H_{txr} &= \frac{2r}{\alpha' q_1}, \quad H_{\phi\theta\psi} = 2\alpha' q_5 \sin^2 \phi \sin \theta, \quad e^\Phi = g_s^2 \frac{q_5}{q_1}
\end{aligned} \tag{161}$$

The dilaton becomes constant. This is the well-known geometry of $AdS_3 \times S_3 \times \mathbb{R}^4$, in Poincaré coordinates (see (248)). The AdS_3 radius is $R = \sqrt{\alpha' q_5}$ which is equal to the radius of the S^3 sphere.

The (general) Penrose limit may be taken, and the result is obtained by using the formulas of the previous paragraph for $H_{1,5} = \frac{\alpha' q_{1,5}}{r^2}$ respectively:

$$\begin{aligned}
ds^2 &= 2dudv - \frac{l^2}{\alpha'^2 q_5^2} (x^2 + z^2 + y_1^2 + y_2^2) du^2 + dx^2 + dz^2 + dy_1^2 + dy_2^2 + \sum_{i=1}^4 dx_i^2 \\
H_{uxz} &= \frac{2l}{\alpha' q_5}, \quad H_{uy_1 y_2} = \frac{2l}{\alpha' q_5}, \quad e^\Phi = g_s^2 \frac{q_5}{q_1}
\end{aligned} \tag{162}$$

where l is an arbitrary constant. In particular, $l = 0$ corresponds to a radial null geodesic and leads to flat space with zero field strength.

The only non-trivial gravity equation :

$$R_{uu} + 2\partial_u^2\Phi = \frac{1}{2}H_{uxz}^2 + \frac{1}{2}H_{uy_1y_2}^2 \quad (163)$$

is satisfied, where $R_{uu} = 4\frac{l^2}{q_5^2}$ is just the opposite of the sum of the coefficients appearing in front of du^2 in the metric (162).

This configuration is an Hpp-wave with the Heisenberg current algebra \mathcal{H}_6 . Note that here $\mu_1 = \mu_2 = \frac{2l}{\alpha'q_5}$ (it is not possible to obtain $\mu_1 \neq \mu_2$ in this way), therefore there is also an enhanced $SU(2)$ symmetry. This will motivate some computations later, see *e.g.* (190) and (192). Another useful remark is that μ_1, μ_2 have the dimension of an inverse length (see a remark after formula (128)).

Case $q_1 = 0$: one NS5 brane only The simpler case for which there is actually no fundamental string [81, 82] also deserves some comment. The near-horizon limit of an NS5 brane is obtained by setting $q_1 = 0$ in (142) and then by taking the limit $r/\sqrt{\alpha'} \rightarrow 0$:

$$\begin{aligned} ds^2 &= (-dt^2 + dx^2) + \alpha'q_5\frac{dr^2}{r^2} + \alpha'q_5d\Omega_3^2 + \sum_{i=1}^4 dx_i^2 \\ e^\Phi &= g_s^2\frac{\alpha'q_5}{r^2} \quad H_{\phi\theta\psi} = 2\alpha'q_5\sin^2\phi\sin\theta \end{aligned} \quad (164)$$

This configuration has a linear dilaton. The most general Penrose limit is:

$$\begin{aligned} ds^2 &= 2dudv - \frac{l^2}{\alpha'^2q_5^2}(y_1^2 + y_2^2)du^2 + dx^2 + dz^2 + dy_1^2 + dy_2^2 + \sum_{i=1}^4 dx_i^2 \\ \Phi &= \Phi_0 - \frac{2}{\alpha'q_5}\sqrt{\alpha'q_5 - l^2}u, \quad H_{uy_1y_2} = \frac{2l}{\alpha'q_5} \end{aligned} \quad (165)$$

where there is still a linear dilaton (Φ_0 is a constant depending on the choice of function $u(r)$). This background solves the only non-trivial gravity equation:

$$R_{uu} + 2\partial_u^2\Phi = \frac{1}{2}H_{uy_1y_2}^2 \quad (166)$$

The solution would exhibit an \mathcal{H}_4 symmetry if there was no linear dilaton. A solution consists in setting $l^2 = \alpha'q_5$, which makes the dilaton constant. This seems to fix $\mu_1 = 2/\sqrt{\alpha'q_5}$, but an appropriate scaling of the coordinates u and v allows to consider any μ_1 .

5.3.2 Two NS5 branes and one F1 string

The solution of the equations of generalized gravity corresponding to the configuration of 2 NS5 branes orthogonally intersecting on a fundamental string [85, 93] is:

$$ds^2 = \frac{1}{H_1^+H_1^-}(-dt^2 + dz^2) + H_5^+d\vec{x}_+^2 + H_5^-d\vec{x}_-^2 \quad (167)$$

where:

$$\begin{aligned} H_1^+ &= 1 + \frac{\alpha' q_1}{x_+^2}, & H_1^- &= 1 + \frac{\alpha' q_1}{x_-^2} \\ H_5^+ &= 1 + \frac{\alpha' Q_5^+}{x_+^2}, & H_5^- &= 1 + \frac{\alpha' Q_5^-}{x_-^2} \end{aligned} \quad (168)$$

with $x_\pm^2 = \vec{x}_\pm^2$ and:

$$d\vec{x}_\pm^2 = dx_\pm^2 + x_\pm^2 d\Omega_{3,\pm}^2, \quad d\Omega_{3,\pm}^2 = d\phi_\pm^2 + \sin^2 \phi_\pm (d\theta_\pm^2 + \sin^2 \theta_\pm d\psi_\pm^2) \quad (169)$$

The charges of the NS5 branes are Q_5^+ and Q_5^- , and q_1 is the density of charge of the F-string smeared along the \vec{x} and \vec{y} planes. The dilaton and the field strength of the antisymmetric tensor are:

$$\begin{aligned} e^\Phi &= g_s^2 \frac{H_5^+ H_5^-}{H_1^+ H_1^-} \\ H_{\phi_\pm \theta_\pm \psi_\pm} &= 2\alpha' Q_5^\pm \sin^2 \phi_\pm \sin \theta_\pm, & H_{txx\pm} &= \frac{d}{dx_\pm} (H_1^+ H_1^-)^{-1} \end{aligned} \quad (170)$$

5.3.3 Penrose limit of the near-horizon geometry

As in the case of one NS5 brane only, treating the general case of any Penrose limit, without taking the near-horizon limit first, is complicated and of not much interest for the present study.

Moreover, once the near-horizon limit, leading to the geometry of $AdS_3 \times S^3 \times S^3 \times \mathbb{R}$, has been taken, it is possible to restrict to the simplest null geodesic followed by a particle moving along the axis of AdS_3 and spinning around the equators of the two three-spheres. This strategy in the case of one NS5 brane leads to the same result as the one found in the previous subsection. The situation is the same for two NS5 branes.

The near-horizon geometry of (167) and (170), is obtained by taking the limit $x_\pm/\sqrt{\alpha'} \rightarrow 0$ with the charges held fixed. Under the change of coordinates

$$u = \sqrt{\frac{Q_5^+ + Q_5^-}{\alpha'^2 q_1^2 Q_5^+ Q_5^-}} xy, \quad \theta = \frac{1}{\sqrt{Q_5^+ Q_5^-}} (-Q_5^+ \ln x + Q_5^- \ln y) \quad (171)$$

the metric, dilaton and field strength become:

$$\begin{aligned} ds^2 &= \alpha' \frac{Q_5^+ Q_5^-}{Q_5^+ + Q_5^-} \left(u^2 (-dt^2 + dz^2) + \frac{du^2}{u^2} \right) + \alpha' Q_5^+ d\Omega_{3,+}^2 \\ &\quad + \alpha' Q_5^- d\Omega_{3,-}^2 + \alpha' \frac{Q_5^+ Q_5^-}{Q_5^+ + Q_5^-} d\theta^2 \\ e^\Phi &= g_s^2 \frac{Q_5^+ Q_5^-}{q_1^2} \\ H_{\psi_\pm \theta_\pm \phi_\pm} &= 2\alpha' Q_5^\pm \sin^2 \psi_\pm \sin \theta_\pm, & H_{tx_5 u} &= 2\alpha' \frac{Q_5^+ Q_5^-}{Q_5^+ + Q_5^-} u \end{aligned} \quad (172)$$

It is worth pointing out that this pure Neveu-Schwarz (NS) solution can be constructed as an exact worldsheet conformal field theory, using the products of affine algebras $\widehat{sl}(2, \mathbb{R})_k \times \widehat{su}(2)_{k_+} \times \widehat{su}(2)_{k_-} \times \widehat{u}(1)_{k'}$, where $k = k' = \frac{Q_5^+ Q_5^-}{Q_5^+ + Q_5^-}$ and $k_{\pm} = Q_5^{\pm}$ satisfy $\frac{1}{k} = \frac{1}{k_+} + \frac{1}{k_-}$. This remark justifies the treatment carried out in the upcoming section 5.4. The Penrose limit can be more easily calculated by changing the metric slightly to:

$$\begin{aligned}
ds^2 &= \alpha' \frac{Q_5^+ Q_5^-}{Q_5^+ + Q_5^-} (-\cosh^2 \rho_1 dt^2 + d\rho_1^2 + \sinh^2 \rho_1 d\phi_1^2) \\
&+ \alpha' Q_5^+ (\cos^2 \theta_2 d\psi_2^2 + d\theta_2^2 + \sin^2 \theta_2 d\phi_2^2) \\
&+ \alpha' Q_5^- (\cos^2 \theta_3 d\psi_3^2 + d\theta_3^2 + \sin^2 \theta_3 d\phi_3^2) + \alpha' \frac{Q_5^+ Q_5^-}{Q_5^+ + Q_5^-} d\theta^2
\end{aligned} \tag{173}$$

Then change variables to:

$$\begin{aligned}
t &= \frac{\mu_1 u}{2} - \frac{v}{\mu_1 l^2} + \frac{y\beta}{l}, & \rho_1 &= \frac{r_1}{l} \\
\psi_2 &= \frac{\mu_2 u}{2} + \frac{v}{2\mu_2 R_+^2} + \frac{y\beta'}{R_+}, & \theta_2 &= \frac{r_2}{R_+} \\
\psi_3 &= \frac{\mu_3 u}{2} + \frac{v}{2\mu_3 R_-^2} + \frac{y\beta'}{R_-}, & \theta_3 &= \frac{r_3}{R_-}
\end{aligned} \tag{174}$$

with λ a real number, $l^2 = \alpha' \frac{Q_5^+ Q_5^-}{Q_5^+ + Q_5^-}$, $R_+^2 = \alpha' Q_5^+$ and $R_-^2 = \alpha' Q_5^-$, and:

$$2\beta'^2 = 1 + \beta^2, \quad \beta^2 (\mu_2 Q_5^+ - \mu_3 Q_5^-)^2 = (\mu_2 Q_5^+ + \mu_3 Q_5^-)^2 \tag{175}$$

The Penrose limit is $\lambda \rightarrow \infty$ with $\mu_1^2 \frac{Q_5^+ Q_5^-}{Q_5^+ + Q_5^-} = \mu_2^2 Q_5^+ + \mu_3^2 Q_5^-$, and the metric and the field strength are rescaled in a way analogous to (154) (the same limit may equivalently be obtained by sending the charges Q_5^{\pm} to infinity). The resulting background exhibits an \mathcal{H}_8 symmetry⁶⁵:

$$\begin{aligned}
ds^2 &= 2dudv - \frac{1}{4} \sum_{i=1}^3 \mu_i^2 r_i^2 du^2 + \sum_{i=1}^3 (dr_i^2 + r_i^2 d\phi_i^2) + dy^2 + d\theta^2 \\
e^{\Phi} &= g_s^2 \frac{Q_5^+ Q_5^-}{q_1^2} \\
H_{ur_1\phi_1} &= \mu_1 r_1, & H_{ur_2\phi_2} &= \mu_2 r_2, & H_{ur_3\phi_3} &= \mu_3 r_3
\end{aligned} \tag{176}$$

Note, however, that not all possible sets of (μ_1, μ_2, μ_3) can be achieved in this way. For a given configuration of charges, there is the relation:

$$\mu_1^2 = \mu_2^2 (1 + \rho) + \mu_3^2 \left(1 + \frac{1}{\rho}\right), \quad \rho = \frac{Q_5^+}{Q_5^-} \tag{177}$$

⁶⁵Defining $x_{1i} = r_i \cos \phi_i$ and $x_{2i} = r_i \sin \phi_i$, one gets the correct $H_{ux_{1i}x_{2i}} = \mu_i$ that appeared in (132).

where the charge q_1 does *not* appear (this is similar to the case with only one NS5 brane). Equivalently, solving the above equation for ρ which may take any positive rational value if all possible charge configurations are considered:

$$\rho = \frac{1}{2\mu_2^2} \left(\mu_1^2 - \mu_2^2 - \mu_3^2 \pm \sqrt{(\mu_1^2 - \mu_2^2 - \mu_3^2)^2 - 4\mu_2^2\mu_3^2} \right) \in \mathbb{Q}^+ \quad (178)$$

For instance, any \mathcal{H}_6 algebra with $(\mu_1, \mu_2, 0)$ can be achieved (where μ_1 and μ_2 may or may not be commensurable), but $\mu_1 = \mu_2 = \mu_3 = 1$ cannot be.

5.4 \mathcal{H}_{2n+2} correlation functions

Two, three and four-point correlation functions of the kind $\langle \prod_{i=1}^{i_{\max}} \Phi_{\nu_i}^{a_i} \rangle$, also denoted by $\langle a_1 \dots a_{i_{\max}} \rangle$ where $a_i = \pm, 0$ is the type of the representation, are computed in this section. This work is indebted to [78, 79], since the results presented here are generalizations (displaying some differences) of the results obtained in these papers.

Two kinds of tools will be used in order to compute correlation functions (whose z dependence is standard and has been reviewed in section 4.2). The first one consists of the Ward identities, which encode the fact that the correlation functions must be invariant under the Heisenberg group \mathcal{H}_{2n+2} . The Ward identities are sufficient to calculate the entire x dependence of the two and three-point functions. Overall constants remain, which are not determined by the worldsheet or target space symmetries. The constants appearing in the two-point function will be chosen arbitrarily in order to fix the normalization of the fields, while the coefficients $C_{a_1 a_2 a_3}$ in the three-point function are determined once the conformal blocks used in the four-point functions have been found.

The second tool is the Knizhnik-Zamolodchikov equation [55] which comes from the fact that the stress-energy tensor can be quadratically expressed in terms of the currents, see (118) and also (81). It will be necessary to compute four-point functions.

5.4.1 Two-point functions

Consider a two-point function of the form $\langle \Phi_{\nu_1}^{a_1} \Phi_{\nu_2}^{a_2} \rangle$, which will also be denoted by $\langle a_1 a_2 \rangle$. The Ward identity for K directly shows that only two kinds of such correlation functions are actually non zero: $\langle + - \rangle$ and $\langle 00 \rangle$.

The remaining Ward identities lead to the expression of the two-point functions. For $\langle + - \rangle$:

$$\begin{aligned} \left\langle \Phi_{p_1, \hat{j}_1}^+(z_1, \bar{z}_1; x_{1\alpha}, \bar{x}_{1\alpha}) \Phi_{p_2, \hat{j}_2}^-(z_2, \bar{z}_2; x_{2\alpha}, \bar{x}_{2\alpha}) \right\rangle = \\ \frac{1}{|z_{12}|^{4h}} \left| \prod_{\alpha=1}^n e^{-\mu_\alpha p_1 x_{1\alpha} x_{2\alpha}} \right|^2 \delta(p_1 - p_2) \delta(\hat{j}_1 + \hat{j}_2) \end{aligned} \quad (179)$$

where $h = h_1 = h_2$ is the conformal weight of both fields Φ_{p_1, \hat{j}_1}^+ and Φ_{p_2, \hat{j}_2}^- , and the shorthand notation $|f(z; x)|^2$ stands for $f(z; x)f(\bar{z}; \bar{x})$, for any function f . For $\langle 00 \rangle$:

$$\begin{aligned} \langle \Phi_{s_{1\alpha}, \hat{j}_1}^0(z_1, \bar{z}_1; x_{1\alpha}, \bar{x}_{1\alpha}) \Phi_{s_{2\alpha}, \hat{j}_2}^0(z_2, \bar{z}_2; x_{2\alpha}, \bar{x}_{2\alpha}) \rangle = \\ \frac{(2\pi)^2}{|z_{12}|^{4h}} \prod_{\alpha=1}^n \frac{\delta(s_{1\alpha} - s_{2\alpha})}{s_{1\alpha}} |\delta(\phi_{1\alpha} - \phi_{2\alpha} - \pi)|^2 \delta(\hat{j}_1 + \hat{j}_2) \end{aligned} \quad (180)$$

where $x_{i\alpha} = e^{i\phi_{i\alpha}}$, $\delta(\phi_{1\alpha} - \phi_{2\alpha} - \pi)$ is defined modulo 2π and $h = h_1 = h_2$ is the conformal weight of both fields $\Phi_{s_{1\alpha}, \hat{j}_1}^0$ and $\Phi_{s_{2\alpha}, \hat{j}_2}^0$. The extra constant $(2\pi)^2 \prod_{\alpha=1}^n \frac{1}{s_{\alpha}}$ will prove to be useful later when considering operator product expansions.

5.4.2 Three-point functions

The Ward identity for K implies that the non-zero three-point correlation functions are of the kind $\langle ++ - \rangle$, $\langle + - 0 \rangle$ or $\langle 000 \rangle$, and permutations and conjugate of these. Conjugate correlation functions can be obtained by changing the x charges of V^0 representations to $-1/x$ (under these transformations Ward identities and Knizhnik-Zamolodchikov equations map into one another). For instance, schematically (C is the conjugation map):

$$\begin{aligned} C \left(\left\langle \Phi_{p_1, \hat{j}_1}^- (x_{1\alpha}) \Phi_{p_2, \hat{j}_2}^+ (x_{2\alpha}) \Phi_{s_{3\alpha}, \hat{j}_3}^0 (x_{3\alpha}) \right\rangle \right) \\ = \left\langle \Phi_{p_1, -\hat{j}_1}^+ (x_{1\alpha}) \Phi_{p_2, -\hat{j}_2}^- (x_{2\alpha}) \Phi_{s_{3\alpha}, -\hat{j}_3}^0 (-x_{3\alpha}) \right\rangle = \\ = \left\langle \Phi_{p_1, \hat{j}_1}^- (x_{1\alpha}) \Phi_{p_2, \hat{j}_2}^+ (x_{2\alpha}) \Phi_{s_{3\alpha}, \hat{j}_3}^0 \left(-\frac{1}{x_{3\alpha}} \right) \right\rangle \end{aligned} \quad (181)$$

as can be verified in (185) and (186) below.

Three-point functions are determined by conformal invariance on the world-sheet to be of the form:

$$\begin{aligned} \langle \Phi_{\nu_1}^{a_1}(z_1, \bar{z}_1; x_{1\alpha}, \bar{x}_{1\alpha}) \Phi_{\nu_2}^{a_2}(z_2, \bar{z}_2; x_{2\alpha}, \bar{x}_{2\alpha}) \Phi_{\nu_3}^{a_3}(z_3, \bar{z}_3; x_{3\alpha}, \bar{x}_{3\alpha}) \rangle = \\ \frac{C_{a_1 a_2 a_3}(\nu_1, \nu_2, \nu_3) K_{a_1 a_2 a_3}(x_1, \bar{x}_1, x_2, \bar{x}_2, x_3, \bar{x}_3)}{|z_{12}|^{2(h_1+h_2-h_3)} |z_{13}|^{2(h_1+h_3-h_2)} |z_{23}|^{2(h_2+h_3-h_1)}} \end{aligned} \quad (182)$$

where $C_{a_1 a_2 a_3}$ are the quantum structure constants of the conformal field theory, see (50). They are totally symmetric. Formulas for these constants will be given in this section, although they are computed thanks to constraints provided by the conformal blocks given below in the study of the four-point function⁶⁶. The ‘kinematical’ coefficients $K_{a_1 a_2 a_3}$, also known as \mathcal{H}_{2n+2} Clebsch-Gordon

⁶⁶More precisely, different expansions of the four-point function in terms of conformal blocks can be written, namely in the s-channel for $z \sim 0$ or in the t-channel for $z \sim 1$. Crossing symmetry requires that these expansions are equal, hence providing constraints that lead to the computation of the fusion matrix (mentioned in section 4.2) and eventually of the coefficients $C_{a_1 a_2 a_3}$.

coefficients, contain all the dependence on the $\mathcal{H}_{2n+2}^L \times \mathcal{H}_{2n+2}^R$ charge variables x and \bar{x} .

For generic values of μ_α , *i.e.* for μ_α incommensurable, the functions $K_{a_1 a_2 a_3}$ are completely fixed by the global Ward identities. Otherwise, things get more complicated. The generic case where no μ_α 's are commensurable is discussed below. The extremal case where all μ_α 's are equal is mentioned afterwards.

$\langle + + - \rangle$ correlator According to (131) the correlation function $\langle + + - \rangle$ is non-vanishing only when $p_1 + p_2 = p_3$ and $L = -\sum_{i=1}^3 \hat{j}_i = \sum_{\alpha=1}^n \mu_\alpha q_\alpha$, with q_α positive integers. The global Ward identities can be unambiguously solved and the result is⁶⁷:

$$K_{++-}(q_\alpha) = \left| \prod_{\alpha=1}^n e^{-\mu_\alpha x_{3\alpha}(p_1 x_{1\alpha} + p_2 x_{2\alpha})} (x_{2\alpha} - x_{1\alpha})^{q_\alpha} \right|^2 \quad (183)$$

The corresponding three-point coupling was computed in [78]:

$$\begin{aligned} C_{++-}(q_\alpha; p_1, p_2) &= \prod_{\alpha=1}^n \frac{1}{q_\alpha!} \left(\tilde{C}_{\alpha,++-}(p_1, p_2) \right)^{\frac{1}{2} + q_\alpha} \\ \tilde{C}_{\alpha,++-}(p_1, p_2) &= \frac{\gamma(\mu_\alpha(p_1 + p_2))}{\gamma(\mu_\alpha p_1) \gamma(\mu_\alpha p_2)} \end{aligned} \quad (184)$$

where $\gamma(x) = \Gamma(x)/\Gamma(1-x)$ and Γ is the standard Gamma function.

$\langle + - 0 \rangle$ correlator Similarly the $\langle + - 0 \rangle$ coupling can be non-zero only when $p_1 = p_2 = p$ and $L = -\sum_{i=1}^3 \hat{j}_i = \sum_{\alpha=1}^n \mu_\alpha q_\alpha$, with q_α positive or negative integers. The global Ward identities lead to:

$$K_{+-0}(q_\alpha) = \left| \prod_{\alpha=1}^n e^{-\mu_\alpha p x_{1\alpha} x_{2\alpha} - \frac{s_\alpha}{\sqrt{2}} \left(\frac{x_{1\alpha}}{x_{3\alpha}} + x_{2\alpha} x_{3\alpha} \right)} x_{3\alpha}^{q_\alpha} \right|^2 \quad (185)$$

Moreover [78]:

$$C_{+-0}(p; s_\alpha) = \prod_{\alpha=1}^n e^{\frac{s_\alpha^2}{2} (\psi(\mu_\alpha p) + \psi(1 - \mu_\alpha p) - 2\psi(1))} \quad (186)$$

where $\psi(x) = \frac{d \ln \Gamma(x)}{dx}$ is the digamma function. The normalization of this coefficient was fixed by the requirement that $\langle \Phi_{p_1, \hat{j}_1}^+ \Phi_{p_2, \hat{j}_2}^- \Phi_{0,0}^0 \rangle = \langle \Phi_{p_1, \hat{j}_1}^+ \Phi_{p_2, \hat{j}_2}^- \rangle$ (recall that the identity operator is in $\Phi_{0,0}^0$).

⁶⁷The δ -functions for the conservation rules of the quantum numbers p and \hat{j} are always implied and will not be written explicitly anymore.

$\langle 000 \rangle$ correlator Finally, the coupling between three Φ^0 vertex operators is non-zero only when:

$$s_{3\alpha} e^{i\eta_\alpha} = -s_{1\alpha} - s_{2\alpha} e^{i\xi_\alpha} \quad (187)$$

where $\xi_\alpha = \phi_{2\alpha} - \phi_{1\alpha}$, $\eta_\alpha = \phi_{3\alpha} - \phi_{1\alpha}$ and $x_{i\alpha} = e^{i\Phi_{i\alpha}}$. It can be written as:

$$K_{000}(\phi_{1\alpha}, \phi_{2\alpha}, \phi_{3\alpha}) = \prod_{\alpha=1}^n \frac{8\pi\delta(\xi_\alpha - \bar{\xi}_\alpha)\delta(\eta_\alpha - \bar{\eta}_\alpha)}{2s_{1\alpha}s_{2\alpha}|\sin\xi_\alpha|} e^{-iq_\alpha(\phi_{1\alpha} + \bar{\phi}_{1\alpha})/3} \quad (188)$$

where $L = -\sum_{i=1}^3 \hat{j}_i = \sum_{\alpha=1}^n \mu_\alpha q_\alpha$ with q_α positive or negative integers. This expression has the drawback of not being explicitly symmetric in the indices 1, 2 and 3, but it is simple and concise. Remark that:

$$\begin{aligned} \sqrt{4s_1^2 s_2^2 - (s_3^2 - s_1^2 - s_2^2)^2} &= 2s_1 s_2 |\sin\xi| \\ \sqrt{4s_1^2 s_3^2 - (s_2^2 - s_1^2 - s_3^2)^2} &= 2s_1 s_3 |\sin\eta| \end{aligned} \quad (189)$$

This implies that there is only one degree of freedom in the three sets of variables $\Phi_{i\alpha}$. It was chosen to be $\Phi_{1\alpha}$.

As discussed in subsection 5.2, when all μ_α 's are equal (to, say, μ) the plane wave background displays an additional $SU(n)$ symmetry. At the same time it can be seen from (131) that there are also new possible couplings. They precisely combine to give an $SU(n)$ invariant result. Considering again the three-point coupling containing only Φ^\pm vertex operators, the $SU(n)$ invariant result is obtained after summing over all the couplings $C_{+++}K_{+++}(q_\alpha)$ with $\sum_{\alpha=1}^n q_\alpha = L/\mu = Q$ a positive integer:

$$\begin{aligned} C_{+++}K_{+++}(Q) &= \sum_{q_1=0}^Q \dots \sum_{q_{n-1}=0}^{Q-q_1 \dots - q_{n-2}} C_{+++}K_{+++}(q_1, \dots, Q - q_1 - \dots - q_{n-1}) \\ &= \frac{1}{Q!} \left[\frac{\gamma(\mu p_3)}{\gamma(\mu p_1)\gamma(\mu p_2)} \right]^{\frac{n}{2}+Q} \left| e^{-\mu \sum_{\alpha=1}^n x_{3\alpha}(p_1 x_{1\alpha} + p_2 x_{2\alpha})} \right|^2 \\ &\quad \times \|x_2 - x_1\|^{2Q} \end{aligned} \quad (190)$$

where $\|x\|^2 \equiv \sum_{\alpha=1}^n |x_\alpha|^2$ is indeed $SU(n)$ invariant. It can be checked that the above combination satisfies the Ward identities associated to the currents I_b .

Turning to the $\langle + - 0 \rangle$ correlator, the sums over q_α become independent of each other since q_α can take any positive or negative integer value. Using the Poisson formula:

$$\sum_{q \in \mathbb{Z}} e^{2i\pi q x} = \sum_{k \in \mathbb{Z}} \delta(k - x) \quad (191)$$

one obtains the $SU(n)$ invariant result:

$$\begin{aligned}
C_{+-0}K_{+-0}(Q) &= \prod_{\alpha=1}^n \left| e^{-\mu p_1 x_{1\alpha} x_{2\alpha} - \frac{s_\alpha}{\sqrt{2}} \left(\frac{x_{1\alpha}}{x_{3\alpha}} + x_{2\alpha} x_{3\alpha} \right)} \right|^2 \left(\frac{\|x_3\|^2}{n} \right)^Q \\
&\quad \times e^{\frac{1}{2} \sum_{\alpha=1}^n s_\alpha^2 (\psi(\mu p) + \psi(1-\mu p) - 2\psi(1))} \\
&\quad \times \prod_{\alpha=1}^n \delta \left(\frac{\Phi_{3\alpha} + \bar{\Phi}_{3\alpha} - \Phi_{3n} - \bar{\Phi}_{3n}}{2\pi} \right) \quad (192)
\end{aligned}$$

i.e. the $SU(n)$ symmetry imposes the constraint $|x_{3\alpha}|^2 = |x_{3n}|^2$ for all α .

Operator product expansion The operator product expansions can be deduced from the formulas of the two and three-point correlation functions. The generic formula reads⁶⁸:

$$\begin{aligned}
&\Phi_{\nu_1}^{a_1}(z_1, \bar{z}_1; x_{1\alpha}, \bar{x}_{1\alpha}) \Phi_{\nu_2}^{a_2}(z_2, \bar{z}_2; x_{2\alpha}, \bar{x}_{2\alpha}) \\
&= \frac{1}{|z_{12}|^{2(h_1+h_2-h_3)}} \int d\sigma_{a_3} \prod_{\alpha=1}^n \int d\mu_\alpha(x_\alpha) \int d\mu_\alpha(\bar{x}_\alpha) C_{a_1 a_2}^{a_3}(\nu_1, \nu_2, \nu_3) \\
&\quad K_{a_1 a_2}^{a_3}(\nu_1, \nu_2, \nu_3; x_{1\alpha}, x_{2\alpha}, x_{3\alpha}, \bar{x}_{1\alpha}, \bar{x}_{2\alpha}, \bar{x}_{3\alpha}) \Phi_{\nu_3}^{a_3}(z_3, \bar{z}_3; x_{3\alpha}, \bar{x}_{3\alpha}) \quad (194)
\end{aligned}$$

where the measures over the quantum numbers are [78]:

$$\begin{aligned}
\int d\sigma_\pm &= \int_0^1 dp \int_{-\infty}^\infty d\hat{j} \\
\int d\sigma_0 &= \int_0^\infty s ds \int_{-\frac{\#}{2}}^{\frac{\#}{2}} d\hat{j} \quad (195)
\end{aligned}$$

and where:

$$\begin{aligned}
C_{a_1 a_2}^{a_3}(\nu_1, \nu_2, \nu_3) &= C_{a_1 a_2 a_3^\vee}(\nu_1, \nu_2, \nu_3^\vee) \\
K_{a_1 a_2}^{a_3}(\nu_1, \nu_2, \nu_3; x_{1\alpha}, x_{2\alpha}, x_{3\alpha}, \bar{x}_{1\alpha}, \bar{x}_{2\alpha}, \bar{x}_{3\alpha}) &= \\
&\quad K_{a_1 a_2 a_3^\vee}(\nu_1, \nu_2, \nu_3^\vee; x_{1\alpha}, x_{2\alpha}, x_{3\alpha}^\vee, \bar{x}_{1\alpha}, \bar{x}_{2\alpha}, \bar{x}_{3\alpha}^\vee) \quad (196)
\end{aligned}$$

where \vee indicates the conjugate representation: $(s_\alpha, \hat{j})^\vee = (s_\alpha, -\hat{j})$, $(p, \hat{j})^\vee = (p, -\hat{j})$, $x_{3\alpha}^\vee = -x_{3\alpha}^*$ for V^\pm representations (x^* is the complex conjugate of x) and $x_{3\alpha}^\vee = -x_{3\alpha}$ for V^0 representations (same for $\bar{x}_{3\alpha}^\vee$).

⁶⁸A useful result obtained from (124) is:

$$\int d\mu_\alpha(x_\alpha) e^{\sqrt{\mu_\alpha} \bar{p} x_\alpha A} e^{\sqrt{\mu_\alpha} p x_\alpha^* B} = e^{AB} \quad (193)$$

where A and B stand for any functions independent of x_α, x_α^* .

5.4.3 Four-point functions

In general, worldsheet conformal invariance and global Ward identities constrain the four-point function to be of the form (compare with formula (51)):

$$\begin{aligned} & \langle \Phi_{\nu_1}^{a_1}(z_1, \bar{z}_1; x_1, \bar{x}_1) \Phi_{\nu_2}^{a_2}(z_2, \bar{z}_2; x_2, \bar{x}_2) \Phi_{\nu_3}^{a_3}(z_3, \bar{z}_3; x_3, \bar{x}_3) \Phi_{\nu_4}^{a_4}(z_4, \bar{z}_4; x_4, \bar{x}_4) \rangle \\ & = G(z_i, \bar{z}_i; x_i, \bar{x}_i) = \prod_{i < j}^4 |z_{ij}|^{2(\frac{h}{3} - h_i - h_j)} K(x_i, \bar{x}_i) \mathcal{G}(z, \bar{z}; x, \bar{x}) \end{aligned} \quad (197)$$

where h_i is the conformal weights of the field Φ_i , $h = \sum_{i=1}^4 h_i$, and the $SL(2, \mathbb{C})$ invariant cross-ratios z, \bar{z} are defined according to

$$z = \frac{z_{12}z_{34}}{z_{13}z_{24}}, \quad \bar{z} = \frac{\bar{z}_{12}\bar{z}_{34}}{\bar{z}_{13}\bar{z}_{24}} \quad (198)$$

The function K and the expressions of the \mathcal{H}_{2n+2} invariants x and \bar{x} in terms of the x_i and \bar{x}_i are fixed by the global Heisenberg symmetry but are different for each type of correlators. Their explicit form will be given later.

The Knizhnik-Zamolodchikov equation [55] will be necessary in order to calculate \mathcal{G} . It comes from introducing the following equality:

$$L_{-1} = \frac{1}{2} \sum_{\alpha=1}^n (P_{-1}^+ P_0^- + P_{-1}^- P_0^+) + J_{-1} K_0 + K_{-1} J_0 + K_{-1} K_0 \sum_{\alpha=1}^n \mu_\alpha^2 \quad (199)$$

coming from the expression of the stress tensor in terms of the currents (118), inside the four-point function. This leads to the equations, for any $i, 1 \leq i \leq 4$:

$$\begin{aligned} \partial_{z_i} G & = \sum_{j=1, j \neq i}^4 \frac{1}{z_{ij}} \left[\frac{1}{2} \sum_{\alpha=1}^n (P_{\alpha,0,i}^+ P_{\alpha,0,j}^- + P_{\alpha,0,i}^- P_{\alpha,0,j}^+) + J_{0,i} K_{0,j} + K_{0,i} J_{0,j} \right. \\ & \quad \left. + K_{0,i} K_{0,j} \sum_{\alpha=1}^n \mu_\alpha^2 \right] G \end{aligned} \quad (200)$$

where the $P_{\alpha,0,i}^\pm, J_{0,i}$ and $K_{0,i}$ are the differential operators introduced in relations (126), (127) and (128) (the subscript i indicates the field $\Phi_{\nu_i}^{a_i}$ on which these operators act).

When all μ_α are equal, the symmetry is enhanced and an extra $SU(n)$ symmetry must be considered. This is the same procedure that was used for the three-point functions and reflects the existence of new couplings between states in \mathcal{H}_{2n+2} representations at the enhanced symmetry point.

The formulas of all types of non-zero four-point correlation functions (up to conjugation and permutation) are given below.

$\langle + + + - \rangle$ correlator Consider a correlator of the form:

$$G_{++++} = \left\langle \Phi_{p_1, \hat{j}_1}^+ \Phi_{p_2, \hat{j}_2}^+ \Phi_{p_3, \hat{j}_3}^+ \Phi_{p_4, \hat{j}_4}^- \right\rangle, \quad p_1 + p_2 + p_3 = p_4 \quad (201)$$

From the decomposition of the tensor products of \mathcal{H}_{2n+2} representations displayed in (131) it follows that the correlator vanishes for $L = -\sum_{i=1}^4 \hat{j}_i < 0$, while for $L \geq 0$, $L = \sum_{\alpha=1}^n \mu_\alpha q_\alpha$ with q_α positive integers, the correlator decomposes into the sum of a finite number $N = \prod_{\alpha=1}^n (q_\alpha + 1)$ of conformal blocks [23] which correspond to the propagation in the s -channel of the representations $V_{p_1+p_2, \hat{j}_1+\hat{j}_2+\sum_{\alpha=1}^n \mu_\alpha m_\alpha}^+$ with $m_\alpha = 0, \dots, q_\alpha$.

Global \mathcal{H}_{2n+2} symmetry (*i.e.* Ward identities) yields:

$$K_{++++}(q_\alpha) = \prod_{\alpha=1}^n \left| e^{-\mu_\alpha x_{4\alpha}(p_1 x_{1\alpha} + p_2 x_{2\alpha} + p_3 x_{3\alpha})} (x_{3\alpha} - x_{1\alpha})^{q_\alpha} \right|^2 \quad (202)$$

up to any function of the n invariants:

$$x_\alpha = \frac{x_{2\alpha} - x_{1\alpha}}{x_{3\alpha} - x_{1\alpha}} \quad (203)$$

Thanks to the operator product expansion (194), the amplitude can be decomposed in a sum over the conformal blocks and writes⁶⁹:

$$\begin{aligned} \mathcal{G}_{++++}(q_\alpha; z, \bar{z}; x_\alpha, \bar{x}_\alpha) &= \sum_{m_1=0}^{q_1} \sum_{m_2=0}^{q_2} \dots \sum_{m_n=0}^{q_n} C_{++++} \left(p_1, p_2, p_1 + p_2; \hat{j}_1, \hat{j}_2, \hat{j}_1 + \hat{j}_2 + \sum_{\alpha=1}^n \mu_\alpha m_\alpha \right) \\ &\quad \times C_{--} \left(p_4, p_3, p_4 - p_3; \hat{j}_4, \hat{j}_3, \hat{j}_3 + \hat{j}_4 + \sum_{\alpha=1}^n \mu_\alpha m'_\alpha \right) \\ &\quad \times \mathcal{F}_{m_\alpha}(z; x_\alpha) \bar{\mathcal{F}}_{m'_\alpha}(\bar{z}; \bar{x}_\alpha) \end{aligned} \quad (204)$$

where $m_\alpha + m'_\alpha = q_\alpha$. Then, it is possible to set $\mathcal{F}_{m_\alpha} = z^{\kappa_{12}}(1-z)^{\kappa_{14}} F_{m_\alpha}$ (the way to treat the right conformal block $\bar{\mathcal{F}}_{m'_\alpha}$ is exactly similar and will not be detailed here), where:

$$\begin{aligned} \kappa_{12} &= h_1 + h_2 - \frac{h}{3} - \hat{j}_2 p_1 - \hat{j}_1 p_2 - p_1 p_2 \sum_{\alpha=1}^n \mu_\alpha^2, \\ \kappa_{14} &= h_1 + h_4 - \frac{h}{3} - \hat{j}_4 p_1 + \hat{j}_1 p_4 + p_1 p_4 \sum_{\alpha=1}^n \mu_\alpha^2 - p_1 \sum_{\alpha=1}^n \mu_\alpha + L(p_2 + p_3) \end{aligned} \quad (205)$$

⁶⁹This kind of decomposition will be used for all kinds of four-point correlation functions, but will not be explicitly written anymore.

and where the F_{m_α} satisfy the following Knizhnik-Zamolodchikov equation⁷⁰:

$$\begin{aligned} \partial_z F_{m_\alpha}(z; x_\alpha) &= -\frac{1}{z} \sum_{\alpha=1}^n \mu_\alpha [(p_1 x_\alpha + p_2 x_\alpha (1 - x_\alpha)) \partial_{x_\alpha} + q_\alpha p_2 x_\alpha] F_{m_\alpha}(z, x_\alpha) \\ &- \frac{1}{1-z} \sum_{\alpha=1}^n \mu_\alpha [(1 - x_\alpha)(p_2 x_\alpha + p_3) \partial_{x_\alpha} - q_\alpha p_2 (1 - x_\alpha)] F_{m_\alpha}(z, x_\alpha) \end{aligned} \quad (206)$$

The explicit form of the conformal blocks is:

$$F_{m_\alpha}(z; x_\alpha) = \prod_{\alpha=1}^n f_\alpha(z; x_\alpha)^{m_\alpha} g_\alpha(z; x_\alpha)^{q_\alpha - m_\alpha} \quad (207)$$

where $0 \leq m_\alpha \leq q_\alpha$. The solution of the Knizhnik-Zamolodchikov equation is⁷¹:

$$\begin{aligned} f_\alpha(z; x_\alpha) &= \frac{\mu_\alpha p_3}{1 - \mu_\alpha(p_1 + p_2)} z^{1 - \mu_\alpha(p_1 + p_2)} \varphi_{0,\alpha}(z) - x_\alpha z^{-\mu_\alpha(p_1 + p_2)} \varphi_{1,\alpha}(z), \\ g_\alpha(z; x_\alpha) &= \gamma_{0,\alpha}(z) - \frac{x_\alpha p_2}{p_1 + p_2} \gamma_{1,\alpha}(z) \end{aligned} \quad (208)$$

and:

$$\begin{aligned} \varphi_{0,\alpha}(z) &= {}_2F_1(1 - \mu_\alpha p_1, 1 + \mu_\alpha p_3; 2 - \mu_\alpha(p_1 + p_2); z) \\ \varphi_{1,\alpha}(z) &= {}_2F_1(1 - \mu_\alpha p_1, \mu_\alpha p_3; 1 - \mu_\alpha(p_1 + p_2); z) \\ \gamma_{0,\alpha}(z) &= {}_2F_1(\mu_\alpha p_2, \mu_\alpha p_4; \mu_\alpha(p_1 + p_2); z) \\ \gamma_{1,\alpha}(z) &= {}_2F_1(1 + \mu_\alpha p_2, \mu_\alpha p_4; 1 + \mu_\alpha(p_1 + p_2); z) \end{aligned} \quad (209)$$

where ${}_2F_1(a, b; c; z)$ is the standard ${}_2F_1$ hypergeometric function.

It is now possible to reconstruct the four-point function as a monodromy invariant⁷² combination of the conformal blocks, and the result is:

$$\begin{aligned} \mathcal{G}_{++++}(q_\alpha; z, \bar{z}; x_\alpha, \bar{x}_\alpha) &= |z|^{2\kappa_{12}} |1 - z|^{2\kappa_{14}} \prod_{\alpha=1}^n \frac{\sqrt{\tau_\alpha}}{q_\alpha!} \\ &\times \left(\tilde{C}_{\alpha,++-}(p_1, p_2) |f_\alpha(z, x_\alpha)|^2 + \tilde{C}_{\alpha,++-}(p_3, p_4 - p_3) |g_\alpha(z, x_\alpha)|^2 \right)^{q_\alpha} \end{aligned} \quad (210)$$

where

$$\tau_\alpha = \tilde{C}_{\alpha,++-}(p_1, p_2) \tilde{C}_{\alpha,++-}(p_3, p_4 - p_3) \quad (211)$$

⁷⁰This equation is found by explicitly writing equation (200) for, say, $i = 1$, and then by choosing $z_3 = \infty$ as it is allowed by conformal invariance on the sphere. The other points may be chosen to be $z_1 = z$, $z_2 = 0$ and $z_4 = 1$. The same method applies for the other kinds of four-point functions

⁷¹It is most easily checked by considering first $m_\alpha = 0$, and then the generic case.

⁷²For a quantity which is locally single-valued, the monodromy is the multi-valuedness around non-trivial closed paths. A monodromy invariant quantity is single-valued even after completion of non-trivial closed paths ($z \rightarrow e^{2i\pi} z$ for instance).

When all μ_α are equal to μ , $L/\mu = \sum_{\alpha=1}^n q_\alpha = Q$ a positive integer. The $SU(n)$ invariant combination is:

$$\begin{aligned}
K\mathcal{G}_{++++}(Q) &= \sum_{q_1=0}^Q \dots \sum_{q_{n-1}=0}^{Q-q_1-\dots-q_{n-2}} K\mathcal{G}_{++++}(q_1, \dots, Q - \dots - q_{n-2}) \\
&= |z|^{2\kappa_{12}} |1-z|^{2\kappa_{14}} \frac{\tau^{\frac{n}{2}}}{Q!} \left| e^{-\mu \sum_{\alpha=1}^n x_{4\alpha} (p_1 x_{1\alpha} + p_2 x_{2\alpha} + p_3 x_{3\alpha})} \right|^2 \\
&\quad \times \left(\sum_{\alpha=1}^n \tilde{C}_{++-}(p_1, p_2) |x_{31\alpha} f(\mu, z, x_\alpha)|^2 \right. \\
&\quad \left. + \tilde{C}_{++-}(p_3, p_4 - p_3) |x_{31\alpha} g(\mu, z, x_\alpha)|^2 \right)^Q \quad (212)
\end{aligned}$$

$\langle + - + - \rangle$ **correlator** The next class of correlator is of the following form:

$$G_{+-+-} = \left\langle \Phi_{p_1, \hat{j}_1}^+ \Phi_{p_2, \hat{j}_2}^- \Phi_{p_3, \hat{j}_3}^+ \Phi_{p_4, \hat{j}_4}^- \right\rangle, \quad p_1 + p_3 = p_2 + p_4 \quad (213)$$

The Ward identities give:

$$K_{+-+-} = \prod_{\alpha=1}^n \left| e^{-\mu_\alpha P x_\alpha - \mu_\alpha p_2 x_{1\alpha} x_{2\alpha} - \mu_\alpha p_3 x_{3\alpha} x_{4\alpha} - \mu_\alpha (p_1 - p_2) x_{1\alpha} x_{4\alpha}} (x_{1\alpha} - x_{3\alpha})^{q_\alpha} \right|^2 \quad (214)$$

where $P = \frac{1}{4}(p_1 - 2p_2 - p_3)$ and $L = -\sum_{i=1}^4 \hat{j}_i = \sum_{\alpha=1}^n \mu_\alpha q_\alpha$, with q_α positive integers, and up to any function of the n invariants:

$$x_\alpha = (x_{1\alpha} - x_{3\alpha})(x_{2\alpha} - x_{4\alpha}) \quad (215)$$

Note that solving the Ward identities naturally leads to formula (214), however the factor $e^{-\mu_\alpha P x_\alpha}$ may be removed (*i.e.* set $P = 0$ everywhere) from the expression of K_{+-+-} , since this quantity is defined up to any function of x_α . This term will be kept however, in order for the following results to be comparable with [78, 79]. The final result is of course independant of the choice that is made. Passing to the conformal blocks and setting $\mathcal{F}_{m_\alpha} = z^{\kappa_{12}} (1-z)^{\kappa_{14}} F_{m_\alpha}$, where:

$$\begin{aligned}
\kappa_{12} &= h_1 + h_2 - \frac{h}{3} - \hat{j}_2 p_1 + \hat{j}_1 p_2 + p_1 p_2 \sum_{\alpha=1}^n \mu_\alpha^2 - p_2 \sum_{\alpha=1}^n \mu_\alpha \\
\kappa_{14} &= h_1 + h_4 - \frac{h}{3} - \hat{j}_4 p_1 + \hat{j}_1 p_4 + p_1 p_4 \sum_{\alpha=1}^n \mu_\alpha^2 - p_4 \sum_{\alpha=1}^n \mu_\alpha \quad (216)
\end{aligned}$$

it is found that the functions F_{m_α} solve the following Knizhnik-Zamolodchikov equation:

$$\begin{aligned}
z(1-z)\partial_z F_{m_\alpha}(z; x_\alpha) &= \sum_{\alpha=1}^n \left[x_\alpha \partial_{x_\alpha}^2 + (\mu_\alpha(p_1 - p_2 - 2P)x_\alpha + 1 + q_\alpha) \partial_{x_\alpha} \right. \\
&\quad \left. + \frac{x_\alpha}{4} \mu_\alpha^2 P(p_2 - p_1 + P) - \mu_\alpha P(1 + q_\alpha) \right] F_{m_\alpha}(z; x_\alpha) \\
&\quad - z \sum_{\alpha=1}^n \left[\mu_\alpha(p_1 + p_3)x_\alpha \partial_{x_\alpha} - \frac{x_\alpha}{4} \mu_\alpha^2 (p_2 p_3 + P(p_1 + p_3)) \right. \\
&\quad \left. + \mu_\alpha p_3(1 + q_\alpha) \right] F_{m_\alpha}(z; x_\alpha)
\end{aligned} \tag{217}$$

The conformal blocks are of the form⁷³:

$$\begin{aligned}
F_{m_\alpha}(z; x_\alpha) &= \prod_{\alpha=1}^n \nu_{m_\alpha} \frac{e^{\mu_\alpha x_\alpha P + \mu_\alpha x_\alpha z p_3 - x_\alpha z(1-z)\partial_z \ln f_{1,\alpha}(z)}}{(f_{1,\alpha}(z))^{1+q_\alpha}} \\
&\quad \times L_{m_\alpha}^{q_\alpha}(x_\alpha g_\alpha(z)) \left(\frac{f_{2,\alpha}(z)}{f_{1,\alpha}(z)} \right)^{m_\alpha}
\end{aligned} \tag{218}$$

where m_α are positive integers and L_m^q is the m-th generalized Laguerre polynomial:

$$\begin{aligned}
L_m^q(z) &= \sum_{k=0}^m (-1)^k \frac{\Gamma(m+q+1)}{(m-k)! \Gamma(k+q+1)} \frac{z^k}{k!} \\
&= \frac{\Gamma(m+q+1)}{m! \Gamma(q+1)} {}_1F_1(-m; q+1; z)
\end{aligned} \tag{219}$$

where ${}_1F_1$ is a hypergeometric function. The functions appearing in (218) are:

$$\begin{aligned}
f_{1,\alpha}(z) &= {}_2F_1(\mu_\alpha p_3, 1 - \mu_\alpha p_1; 1 - \mu_\alpha p_1 + \mu_\alpha p_2; z) \\
f_{2,\alpha}(z) &= z^{\mu(p_1 - p_2)} {}_2F_1(\mu_\alpha p_4, 1 - \mu_\alpha p_2; 1 - \mu_\alpha p_2 + \mu_\alpha p_1; z) \\
g_\alpha(z) &= -z(1-z)\partial_z \ln \left(\frac{f_{2,\alpha}(z)}{f_{1,\alpha}(z)} \right)
\end{aligned} \tag{220}$$

and [78]:

$$\nu_{m_\alpha} = \frac{m_\alpha!}{(\mu_\alpha(p_1 - p_2))^{m_\alpha}} \tag{221}$$

The functions $f_{1,\alpha}$, $f_{2,\alpha}$ are only defined as solutions of a second-order differential equation, which is the same in each case (so that $f_{1,\alpha}$ and $f_{2,\alpha}$ form a basis of solutions). It is therefore not clear which combination of these functions should eventually appear in the four-point function. This uncertainty is solved

⁷³The only dependence of the conformal blocks in the parameter P is in the term $e^{\mu_\alpha x_\alpha P}$, which precisely cancels the dependence of K_{+-+} , making the four-point function independent of P as expected.

by requiring the correlation function to be crossing-symmetric, which in this case amounts to the symmetry $2 \leftrightarrow 4$ and $z \rightarrow 1 - z$. The four-point correlator can be written in a compact form using the combinations:

$$\begin{aligned}
S_\alpha(z, \bar{z}) &= |f_{1\alpha}(z)|^2 - \rho_\alpha |f_{2\alpha}(z)|^2 \\
\rho_\alpha &= \frac{\tilde{C}_{\alpha,++-}(p_2, p_1 - p_2) \tilde{C}_{\alpha,++-}(p_3, p_4 - p_3)}{\mu_\alpha^2 (p_1 - p_2)^2} \\
\zeta_\alpha &= \frac{2\sqrt{\rho_\alpha} |\mu_\alpha (p_1 - p_2) x_\alpha z^b (1 - z)^{c_\alpha}|}{S_\alpha(z, \bar{z})} \\
\tau_\alpha &= \tilde{C}_{\alpha,++-}(p_2, p_1 - p_2)^{\frac{1-a}{2}} \tilde{C}_{\alpha,++-}(p_3, p_4 - p_3)^{\frac{1+a}{2}} \quad (222)
\end{aligned}$$

and using the formula:

$$\sum_{m=0}^{\infty} \frac{L_m^q(x)}{\Gamma(m+q+1)} y^m = e^y (xy)^{-q/2} J_q(2\sqrt{xy}) \quad (223)$$

where J_q is the Bessel function of the first kind, which is related to the modified Bessel function of the first kind by $J_q(ix) = i^q I_q(x)$. The resulting expression is:

$$\begin{aligned}
\mathcal{G}_{q_\alpha}(z, \bar{z}; x_\alpha, \bar{x}_\alpha) &= |z|^{2\kappa_{12}} |1 - z|^{2\kappa_{14}} \prod_{\alpha=1}^n \frac{\tau_\alpha}{S_\alpha(z, \bar{z})} |x_\alpha z^b (1 - z)^{c_\alpha}|^{-q_\alpha} \\
&\quad \times \left| e^{\mu_\alpha p_3 x_\alpha z - x_\alpha z (1-z) \partial_z \ln S_\alpha(z, \bar{z})} \right|^2 I_{q_\alpha}(\zeta_\alpha) \quad (224)
\end{aligned}$$

When all the μ_α 's are equal to μ , the $SU(n)$ invariant correlator is given by the sum over all $q_\alpha \in \mathbb{Z}$, $1 \leq \alpha \leq n - 1$ with $q_n = Q - \sum_{\alpha=1}^{n-1} q_\alpha$ and $Q = L/\mu$. The addition formula for Bessel functions:

$$\sum_{m=-\infty}^{\infty} I_m(x) I_{n-m}(y) = I_n(x+y) \quad (225)$$

leads to:

$$\begin{aligned}
K_{+--+} \mathcal{G}_{+--+}(Q) &= \frac{\tau |z|^{2\kappa_{12} - bQ} |1 - z|^{2\kappa_{14} - cQ}}{S(z, \bar{z})^2} \frac{\|x_{13}\|^Q}{\|x_{24}\|^Q} I_Q(\zeta) \quad (226) \\
&\quad \times \prod_{\alpha=1}^n \left| e^{-\mu_\alpha p_2 x_{1\alpha} x_{2\alpha} - \mu_\alpha p_3 x_{3\alpha} x_{4\alpha} - \mu_\alpha (p_1 - p_2) x_{1\alpha} x_{4\alpha}} \right|^2 \\
&\quad \times \left| e^{xz(\mu p_3 - (1-z)\partial_z \ln S(\mu, z))} \right|^2 \left| e^{xz(\mu p_3 - (1-z)\partial_z \ln S(\mu, z))} \right|^2
\end{aligned}$$

where:

$$\zeta = \frac{2\sqrt{\rho} |\mu (p_1 - p_2) z^b (1 - z)^c|}{S(z, \bar{z})} \|x_{13}\| \|x_{24}\| \quad (227)$$

with the $SU(n)$ invariants $x = x_{13} \cdot x_{24} = \sum_{\alpha=1}^n (x_{1\alpha} - x_{3\alpha})(x_{2\alpha} - x_{4\alpha})$ as well as $\|x_{ij}\|^2 = \sum_{\alpha=1}^n |x_{i\alpha} - x_{j\alpha}|^2$.

$\langle ++-0 \rangle$ **correlator** Another kind of non-zero correlator is:

$$G_{++-0} = \left\langle \Phi_{p_1, \hat{j}_1}^+ \Phi_{p_2, \hat{j}_2}^+ \Phi_{p_3, \hat{j}_3}^- \Phi_{s_{4\alpha}, \hat{j}_4}^0 \right\rangle, \quad p_1 + p_2 = p_3 \quad (228)$$

The global symmetry constraints lead to:

$$K_{++-0}(q_\alpha) = \prod_{\alpha=1}^n \left| e^{-\mu_\alpha x_{3\alpha}(p_1 x_{1\alpha} + p_2 x_{2\alpha}) - \frac{s_{4\alpha}}{\sqrt{2}} x_{3\alpha} x_{4\alpha} - \frac{s_{4\alpha}}{2\sqrt{2}} \frac{x_{1\alpha} + x_{2\alpha}}{x_{4\alpha}}} x_{4\alpha}^{q_\alpha} \right|^2 \quad (229)$$

where $L = -\sum_{i=1}^4 \hat{j}_i = \sum_{\alpha=1}^n \mu_\alpha q_\alpha$, q_α positive integers, and up to any function of the n invariants:

$$x_\alpha = \frac{x_{1\alpha} - x_{2\alpha}}{x_{4\alpha}} \quad (230)$$

The conformal blocks can be rewritten as:

$$\mathcal{F}_{m_\alpha}(z; x_\alpha) = z^{\kappa_{12}} (1-z)^{\kappa_{14}} F_{m_\alpha}(z; x_\alpha) \quad (231)$$

where m_α are positive integers, and:

$$\begin{aligned} \kappa_{12} &= h_1 + h_2 - \frac{h}{3} - p_1 \hat{j}_2 - p_2 \hat{j}_1 - p_1 p_2 \sum_{\alpha=1}^n \mu_\alpha^2 \\ \kappa_{14} &= h_1 + h_4 - \frac{h}{3} - p_1 \hat{j}_4 - L p_1 - \frac{1}{4} \sum_{\alpha=1}^n s_{4\alpha}^2 \end{aligned} \quad (232)$$

The Knizhnik-Zamolodchikov equation then reads:

$$\begin{aligned} z(1-z)\partial_z F_{m_\alpha}(z; x_\alpha) &= -\sum_{\alpha=1}^n \left[\mu_\alpha p_3 x_\alpha \partial_{x_\alpha} + \frac{s_{4\alpha}}{2\sqrt{2}} \mu_\alpha (p_1 - p_2) x_\alpha \right] F_{m_\alpha}(z, x_\alpha) \\ &+ z \sum_{\alpha=1}^n \left[\left(\mu_\alpha p_2 x_\alpha - \frac{s_{4\alpha}}{\sqrt{2}} \right) \partial_{x_\alpha} - \frac{s_{4\alpha} \mu_\alpha p_2}{2\sqrt{2}} x_\alpha \right] F_{m_\alpha}(z, x_\alpha) \end{aligned} \quad (233)$$

and the solutions are:

$$F_{m_\alpha}(z; x_\alpha) = \prod_{\alpha=1}^n (s_{4\alpha} \varphi_\alpha(z) + x_\alpha \omega_\alpha(z))^{m_\alpha} e^{s_{4\alpha}^2 \eta_\alpha(z) + s_\alpha x_\alpha \chi_\alpha(z)} \quad (234)$$

where the following functions were introduced:

$$\begin{aligned} \varphi_\alpha(z) &= \frac{z^{1-\mu_\alpha p_3}}{\sqrt{2}(1-\mu_\alpha p_3)} {}_2F_1(1-\mu_\alpha p_1, 1-\mu_\alpha p_3; 2-\mu_\alpha p_3; z) \\ \omega_\alpha(z) &= -z^{-\mu_\alpha p_3} (1-z)^{\mu_\alpha p_1} \\ \chi_\alpha(z) &= -\frac{1}{2\sqrt{2}} + \frac{p_2}{\sqrt{2} p_3} (1-z) {}_2F_1(1+\mu_\alpha p_2, 1; 1+\mu_\alpha p_3; z) \\ \eta_\alpha(z) &= -\frac{z p_2}{2 p_3} {}_3F_2(1+\mu_\alpha p_2, 1, 1; 1+\mu_\alpha p_3, 2; z) - \frac{1}{4} \ln(1-z) \end{aligned} \quad (235)$$

The four-point function is then given by:

$$\begin{aligned} \mathcal{G}_{++-0}(z, \bar{z}; x_\alpha, \bar{x}^\alpha) &= |z|^{2\kappa_{12}} |1-z|^{2\kappa_{14}} \prod_{\alpha=1}^n \left(\tilde{C}_{\alpha,++-}(p_1, p_2) \right)^{\frac{1}{2}} \\ &\times C_{+-0}(p_3, s_{4\alpha}) e^{\tilde{C}_{\alpha,++-}(p_1, p_2) |s_{4\alpha} \varphi_\alpha(z) + x_\alpha \omega_\alpha(z)|^2} \left| e^{s_{4\alpha}^2 \eta_\alpha(z) + s_{4\alpha} x_\alpha \chi_\alpha(z)} \right|^2 \end{aligned} \quad (236)$$

The $SU(n)$ invariant correlator for all μ_α equal to μ is obtained by summing over $q_\alpha \in \mathbb{Z}$, $1 \leq \alpha \leq n$ with $\sum_{\alpha=1}^n q_\alpha = Q = L/\mu$, in a similar way as in the case of $\langle + - 0 \rangle$, since the only dependence in q_α is $x_{4\alpha}^{q_\alpha} = e^{i\Phi_{4\alpha} q_\alpha}$.

$\langle + - 0 0 \rangle$ **correlator** The last kind of non-trivial correlator is:

$$\left\langle \Phi_{p_1, \hat{j}_1}^+ \Phi_{p_2, \hat{j}_2}^- \Phi_{s_{3\alpha}, \hat{j}_3}^0 \Phi_{s_{4\alpha}, \hat{j}_4}^0 \right\rangle, \quad p_1 = p_2 = p \quad (237)$$

The Ward identities give:

$$K_{+-00}(q_\alpha) = \prod_{\alpha=1}^n \left| e^{-\mu_\alpha p x_{1\alpha} x_{2\alpha} - \frac{x_{1\alpha}}{\sqrt{2}} \left(\frac{s_{3\alpha}}{x_{3\alpha}} + \frac{s_{4\alpha}}{x_{4\alpha}} \right) - \frac{x_{2\alpha}}{\sqrt{2}} (s_{3\alpha} x_{3\alpha} + s_{4\alpha} x_{4\alpha})} x_{3\alpha}^{q_\alpha} \right|^2 \quad (238)$$

up to any function of the n invariants $x_\alpha = \frac{x_{3\alpha}}{x_{4\alpha}}$.

The conformal blocks are simpler when the correlator is decomposed around $z = 1$, since there is no interaction between two V^0 representations in the t-channel. Setting $u = 1 - z$:

$$\mathcal{F}_{m_\alpha}(u; x_\alpha) = (1-u)^{\kappa_{12}} u^{\kappa_{14}} F_{m_\alpha}(u; x_\alpha) \quad (239)$$

where $m_\alpha \in \mathbb{Z}$ and:

$$\begin{aligned} \kappa_{12} &= h_1 + h_2 - \frac{h}{3} + p^2 + p(j_1 - j_2) - p_2 \sum_{\alpha=1}^n \mu_\alpha + \frac{1}{2} \sum_{\alpha=1}^n (s_{3\alpha}^2 + s_{4\alpha}^2) \\ &= \frac{1}{2} \sum_{\alpha=1}^n (s_{3\alpha}^2 + s_{4\alpha}^2) - \frac{h}{3} \\ \kappa_{14} &= h_1 + h_4 - \frac{h}{3} - p\hat{j}_4 - \frac{1}{2} \sum_{\alpha=1}^n s_{4\alpha}^2 \end{aligned} \quad (240)$$

the Knizhnik-Zamolodchikov equation reads:

$$\begin{aligned} \partial_u F_{m_\alpha}(u; x_\alpha) &= -\frac{1}{u} \sum_{\alpha=1}^n \left[-\mu_\alpha p x_\alpha \partial_{x_\alpha} + \frac{s_{3\alpha} s_{4\alpha}}{2x_\alpha} \right] F_{m_\alpha}(u; x_\alpha) \\ &\quad - \frac{1}{1-u} \sum_{\alpha=1}^n \frac{s_{3\alpha} s_{4\alpha}}{2} \left(x_\alpha + \frac{1}{x_\alpha} \right) F_{m_\alpha}(u; x_\alpha) \end{aligned} \quad (241)$$

and has the solutions:

$$F_{m_\alpha}(u; x_\alpha) = \prod_{\alpha=1}^n \left(\frac{1}{x_\alpha} u^{-\mu_\alpha p} \right)^{m_\alpha} e^{\frac{1}{x_\alpha} \omega_\alpha(u) + x_\alpha \chi_\alpha(u)} \quad (242)$$

where:

$$\begin{aligned}\omega_\alpha(u) &= -\frac{s_{3\alpha}s_{4\alpha}}{2\mu_\alpha p} {}_2F_1(\mu_\alpha p, 1; 1 + \mu_\alpha p; u) \\ \chi_\alpha(u) &= -\frac{s_{3\alpha}s_{4\alpha}}{2(1 - \mu_\alpha p)} u {}_2F_1(1 - \mu_\alpha p, 1; 2 - \mu_\alpha p; u)\end{aligned}\quad (243)$$

The four-point function is then given by:

$$\begin{aligned}\mathcal{G}_{+-00}(u, \bar{u}; x_\alpha, \bar{x}_\alpha) &= |u|^{2\kappa_{14}} |1 - u|^{2\kappa_{12}} \prod_{\alpha=1}^n C_{\alpha,+ -0}(p, s_3) C_{\alpha,- +0}(p, s_4) \\ &\quad \times \left| e^{\frac{1}{x_\alpha} \omega_\alpha(u) + x_\alpha \chi_\alpha(u)} \right|^2 \sum_{m_\alpha \in \mathbb{Z}} \left| \frac{1}{x_\alpha} u^{-\mu_\alpha p} \right|^{2m_\alpha}\end{aligned}\quad (244)$$

so $|u| = 1$ otherwise the correlation function diverges, and then the phases of u and x_α are related. This implies $|x_\alpha|^2 = |x_n|^2$.

The $SU(n)$ invariant correlator for all μ_α 's equal to μ is straightforward to obtain after summing over $q_\alpha \in \mathbb{Z}$, $1 \leq \alpha \leq n$ with $\sum_{\alpha=1}^n q_\alpha = Q = L/\mu$ since the only q_α -dependant term in $K\mathcal{G}_{+-00}$ is $x_{3\alpha}^{q_\alpha} = e^{i\Phi_{3\alpha} q_\alpha}$, just like the $\langle + - 0 \rangle$ case.

$\langle 0000 \rangle$ correlator This is the last kind of non-zero four-point correlation functions. It is a trivial case (this correlator is the same as in flat space, since flat space corresponds to $\mu_\alpha = 0$ which is essentially equivalent, as far as the Knizhnik-Zamolodchikov equation is concerned, to the condition $p = 0$ satisfied by V^0 representations).

5.5 Conclusion

All Heisenberg algebras that may appear in string theory have been studied in this work, hence generalizing results previously obtained for the special cases of \mathcal{H}_4 and \mathcal{H}_6 . This kind of algebra appears in string theory as the underlying symmetry of Hpp-wave backgrounds that can be seen as the Penrose limit of the near-horizon of configurations of intersecting NS5 branes and fundamental strings. It is worth noting that the brane configurations presented here give rise to non-trivial limits like deformed AdS_3 spaces, see *e.g.* [87]. Representations of Heisenberg algebras have been studied and two, three and four-point correlation functions between primary states have been calculated for generic n using conformal field theory techniques.

6 A Verlinde formula in non-rational conformal field theories

6.1 Introduction

This section reviews the work done in [1], in which the fusion properties of several non-rational boundary conformal field theories were studied. The notions and objects that will be studied here, namely current algebras, fusion rules, Verlinde formula, boundary states and modular S matrix, were presented in the introductory sections 4.3 and 4.4 in the context of rational conformal field theories, which are rather well understood nowadays.

Indeed, the algebraic structure of rational theories is well-known (lowest-weight representations, characters or currents, for instance), and the modular S matrix plays a major role there. The Verlinde formula [58], that has been proved for all rational theories, shows that the fusion is given once the modular transformation of the characters of the theory is known. Moreover, the Verlinde formula leads to the construction of a set of boundary states, called the Cardy states [47], that have a reasonable boundary spectrum. These states have found many applications in string theory as describing non-perturbative states carrying open string excitations. In non-rational conformal field theories as well, the analogue of the Verlinde formula that is discussed here allows for an efficient construction of a subset of boundary states, directly from the modular data [98, 99]. Thus, a systematic analysis of the Verlinde formula should be useful in constructing D-branes in (non-trivial, non-compact) string theory backgrounds.

Non-rational theories are far less understood, because they exhibit many new features that were mentioned in section 4.6. These theories are of much interest. They appear in cosmological contexts, for instance when studying two-dimensional black holes. They also arise in the context of the AdS/CFT correspondence. Some examples of non-rational conformal field theories include bosonic and supersymmetric Liouville theory and their duals (the bosonic and supersymmetric cosets $SL(2, \mathbb{R})/U(1)$) as well as the H_3^+ theory, which were studied in [1].

In order to gain some insight of the structure of non-rational conformal theories, it may be interesting to see if it is possible to extend some results valid for rational theories and, if yes, how. Considering the importance of the Verlinde formula, which codes the dynamics of the theory, it may be worth investigating whether this particular algebraic structure can be extended to the non-rational case. Although many results on characters, their modular transformation properties and the boundary states are known (see *e.g.* [98, 99, 100, 101, 102, 103, 104]), it may be useful to review and supplement them in particular in the light of the possibility of extending the Verlinde formula to a subsector of non-rational conformal field theories.

In [1], a generalized Verlinde formula that is valid in a subset of these theories was written (this subset relies on the presence of null states *i.e.* on degenerate representations – degenerate representations have already proved to be useful in

rational theories, see subsection 4.2.5). The fusion rules of the theories were also studied, and Cardy-type brane calculations were reviewed and extended (they depend on a reflection coefficient which is not present for rational theories, see [98] which mentions this feature for non-degenerate representations of Liouville theory).

The following sections present the results of [1] for the H_3^+ theory only, but in some more detail. Results concerning Liouville theory and the $SL(2, \mathbb{R})/U(1)$ coset can be found in the original paper (Liouville theory is the simplest case in which every formula could be obtained without complications. In particular, the characters are well-defined, the one-point function is related to the modular S matrix and to the reflection amplitude, and the Verlinde-like formula is expressed in terms of residues). They are very similar to the results found for the H_3^+ theory, in the sense that the generalized Cardy formula and the extended Verlinde formula have the same structure. The fusion rules have been considered for two degenerate fields and for one degenerate and one non-degenerate field.

A conclusion attempts to delineate generic expectations for the domain of validity of the Verlinde formula in non-rational conformal field theories.

In summary, a generalization of the Verlinde formula was obtained. It is applicable to the fusion of degenerate representations with generic ones and to the fusion of two degenerate representations. The formula requires an analytic continuation in the Fourier transformed free index of the formula that shows that the modular S matrix gives a representation of the fusion coefficients. The fusion coefficients then appear as non-trivial residues of poles in the transformed function on the complex plane. The analysis shows that the relation between the modular S matrix and the fusion coefficients is in fact more general than the relations encoded in the standard boundary states (*i.e.* the reflection amplitude plays a role here).

6.2 The H_3^+ theory

The H_3^+ Wess-Zumino-Witten model has been much studied in the literature [41, 42, 105, 106, 107, 108, 109, 110, 111, 112, 113, 114]. It describes strings moving on the Euclidean analogue of the AdS_3 space (recall that there is no R-R charges in this background, which makes a conformal approach possible). Although this model is not a good physical theory, because it is not unitary, it is interesting in many respects. It is one of the simplest non-compact curved backgrounds and therefore represents a first step in understanding string theory in non-trivial backgrounds. The model is also exactly solvable [42], making insights into a quantum regime possible. Moreover, H_3^+ is related to several other theories, like the Euclidean two-dimensional black hole, which is unitary, or to Liouville theory (obtained from H_3^+ after a twist, and then by modding out a Borel subgroup⁷⁴, *i.e.* a maximal connected solvable subgroup). Finally,

⁷⁴This means that the results obtained in [1] for Liouville theory should descend from the results for H_3^+ . It was nevertheless interesting to check the Verlinde formula explicitly.

understanding Euclidean AdS_3 helps understanding the AdS/CFT correspondence [86], which states that string theory on backgrounds with AdS_3 should be equivalent to a two-dimensional conformal field theory on the boundary of AdS_3 .

This section reviews various results on the H_3^+ theory. It presents the Wess-Zumino-Witten model, the $\widehat{sl(2, \mathbb{R})}_{k+2}$ affine algebra and its representations, and correlation functions of primary fields. The fusion of representations, when one of the two representations is degenerate, is derived from the corresponding generic three-point function for representations in the unitary spectrum by analytic continuation and a careful analysis of the analytic structure of the operator product expansion. This is done in some detail since it is used in the main section 6.3 to perform checks on the Verlinde formula.

6.2.1 H_3^+ Wess-Zumino-Witten model and Euclidean AdS_3 space

The set H_3^+ is defined as:

$$H_3^+ = \{H \in \mathcal{M}(2, \mathbb{C}) | H^\dagger = H, \det(H) = 1, \text{tr}(H) > 0\}$$

Any element $g \in H_3^+$ can be written as:

$$\begin{aligned} g &= mm^\dagger = e^{\gamma\sigma_+} e^{-\Phi\sigma_3} e^{\bar{\gamma}\sigma_-} \\ &= \frac{1}{l} \begin{pmatrix} x_0 + x_3 & x_1 + ix_2 \\ x_1 - ix_2 & x_0 - x_3 \end{pmatrix} = \begin{pmatrix} e^\Phi \gamma \bar{\gamma} + e^{-\Phi} & e^\Phi \gamma \\ e^\Phi \bar{\gamma} & e^\Phi \end{pmatrix} \end{aligned} \quad (245)$$

where x_i and Φ are real numbers, $\bar{\gamma}$ is the complex conjugate of γ ⁷⁵, $\sigma_\pm = \frac{1}{2}(\sigma_1 \pm i\sigma_2)$ (σ_i are the Pauli matrices) and:

$$m = \begin{pmatrix} e^{-\Phi/2} & e^{\Phi/2} \gamma \\ 0 & e^{\Phi/2} \end{pmatrix} \quad (246)$$

Since $m \in SL(2, \mathbb{C})$ and g is invariant under $m \rightarrow mU$ for any element $U \in SU(2)$, it can be shown that H_3^+ is isomorphic to the coset $SL(2, \mathbb{C})/SU(2)$. Note also that under $x_2 \rightarrow ix_2$, $g \in SL(2, \mathbb{R})$.

Without Ramond-Ramond charges, bosonic string theory in the Euclidean AdS_3 background is described by the Wess-Zumino-Witten model for H_3^+ . Although H_3^+ is not a group, the model can be properly defined as a coset $SL(2, \mathbb{C})/SU(2)$. However, the action may be computed by directly plugging elements of H_3^+ in the definition of Wess-Zumino-Witten.

The Euclidean AdS_3 space is a maximally symmetric space⁷⁶ defined as the set of points verifying:

$$x_1^2 + x_2^2 + x_3^2 - x_0^2 = -l^2 \quad (247)$$

⁷⁵That is to say, $\bar{\gamma} = \gamma^*$. The complex conjugate is denoted by $*$, while a bar like in $\bar{\gamma}$ means that the conjugation constraint may be relaxed if needed.

⁷⁶Maximally symmetric spaces are spaces which preserve the largest possible number of symmetries (or Killing vectors). Basically, Minkowski, de Sitter and Anti-de Sitter spaces are maximally symmetric. Since string theory on Minkowski space is rather well understood, a natural step is to try to understand it on dS or AdS spaces. De Sitter spaces are preferred from a phenomenological point of view, since they have a correct positive cosmological constant

where $x_i/l \in \mathbb{R}$ for all indices i , and $l/l_s > 0$ is the constant curvature radius of AdS_3 in string length units (the condition (247) is equivalent to $\det g = 1$). The above equation actually defines two connected spaces, depending on whether $x_0 \geq l$ or $x_0 \leq -l$. Both are equivalent and it is possible to restrict to $x_0 \geq l$. This space is precisely the H_3^+ manifold (to which the identity belongs).

Euclidean AdS_3 has the following metric, given in several useful sets of coordinates:

$$\begin{aligned}
ds^2 &= dx_1^2 + dx_2^2 + dx_3^2 - dx_0^2 \\
&= \frac{1}{1 + \frac{r^2}{l^2}} dr^2 + r^2 d\theta^2 + \left(1 + \frac{r^2}{l^2}\right) d\tau^2 \\
&= l^2 (ch^2 \rho d\tau^2 + d\rho^2 + sh^2 \rho d\theta^2) \\
&= l^2 \left(\frac{du^2}{u^2} + u^2 d\gamma d\bar{\gamma} \right) \\
&= l^2 (d\Phi^2 + e^{2\Phi} d\gamma d\bar{\gamma})
\end{aligned} \tag{248}$$

where the last two lines define the Poincaré coordinates $u, \gamma, \bar{\gamma}$ or $\Phi, \gamma, \bar{\gamma}$. The metric reduces to flat space in the limit $r/l \rightarrow 0$. This is how free fields appear when studying the associated Wess-Zumino-Witten model. The different expressions of the metric are related by the following changes of coordinates:

$$\begin{aligned}
x_0 &= \sqrt{l^2 + r^2} ch\tau, & x_2 &= \sqrt{l^2 + r^2} sh\tau \\
x_1 &= r \cos \theta, & x_3 &= r \sin \theta \\
sh\rho &= \frac{r}{l}, & u &= e^\Phi \\
e^\Phi &= \frac{x_0 - x_3}{l}, & \gamma &= \frac{x_1 + ix_2}{x_0 - x_3}, & \bar{\gamma} &= \frac{x_1 - ix_2}{x_0 - x_3}
\end{aligned} \tag{249}$$

Lorentzian AdS_3 can be obtained from Euclidean AdS_3 by setting $\tau = it$ where t is the lorentzian time (then x_2 picks up an i factor). Note that all coordinates are real, except γ and $\bar{\gamma}$ which are complex conjugate in Euclidean AdS_3 , but are real (and unrelated) in Lorentzian AdS_3 .

The H_3^+ model is classically defined by the Lagrangian (in the Poincaré coordinates):

$$\mathcal{L} = \frac{k+2}{\pi} (\partial\Phi\bar{\partial}\Phi + e^{2\Phi}\partial\gamma\bar{\partial}\bar{\gamma}) \tag{250}$$

The Ricci tensor and the Ricci scalar are:

$$R_{\mu\nu} = -\frac{2}{l^2} g_{\mu\nu}, \quad R = -\frac{6}{l^2} \tag{251}$$

(AdS spaces yield a negative cosmological constant). However, they are more difficult to deal with, because of the existence of a horizon, or also because it is difficult to find solutions of supergravity with a dS space. These are reasons why AdS spaces are much studied. Another reason that was already mentioned is that AdS spaces arise in the AdS/CFT correspondence.

The Laplacian Δ is given by:

$$\begin{aligned}
\Delta &= \frac{e^{2\phi}}{\sqrt{-g}} \partial_\mu (e^{-2\phi} \sqrt{-g} g^{\mu\nu} \partial_\nu) \\
&= \frac{1}{l^2} \left(\frac{1}{u} \partial_u (u^3 \partial_u) + \frac{4}{u^2} \partial_\gamma \partial_{\bar{\gamma}} \right) \\
&= \frac{1}{l^2} (\partial_\Phi^2 + 2\partial_\Phi + 4e^{-2\Phi} \partial_\gamma \partial_{\bar{\gamma}}) \\
&= \frac{1}{l^2} \left(\frac{1}{1 + \frac{r^2}{l^2}} \partial_\tau^2 + \frac{l^2}{r} \partial_r \left(r \left(1 + \frac{r^2}{l^2} \right) \partial_r \right) + \frac{l^2}{r^2} \partial_\theta \right) \\
&= \frac{1}{l^2} \left(\frac{1}{\cosh^2 \rho} \partial_\tau^2 + \frac{1}{\sinh 2\rho} \partial_\rho (\sinh 2\rho \partial_\rho) + \frac{1}{\sinh^2 \rho} \partial_\phi \right) \\
&= \partial_{x_1}^2 + \partial_{x_2}^2 + \partial_{x_3}^2 - \partial_{x_0}^2
\end{aligned} \tag{252}$$

where ϕ is the dilaton, which is constant here, and $g = \det g_{\mu\nu} = -\frac{l^2}{4} e^{2\Phi}$.

Euclidean AdS_3 background is a solution of the generalized gravity equations (86), with no dilaton and ($H = dB$):

$$\begin{aligned}
H &= l^2 e^{2\Phi} d\Phi \wedge d\gamma \wedge d\bar{\gamma} = -l^2 \sinh(2\rho) d\theta \wedge d\rho \wedge d\tau \\
B &= \frac{l^2}{2} e^{2\Phi} d\gamma \wedge d\bar{\gamma} = l^2 \sinh^2 \rho d\theta \wedge d\tau
\end{aligned}$$

Note that the H field is complex⁷⁷ (it would be real for lorentzian AdS_3). In the last formula the invariance of H under any constant change in B was used to remove a component $B_{\rho\theta} = -il^2$ that comes from a tensor calculation based on $B_{\gamma\bar{\gamma}}$. Moreover, equation (87) relates the level $k+2$ of the Wess-Zumino-Witten model⁷⁸ to the cosmological constant parameter l :

$$l^2 = 2kl_s^2 \tag{253}$$

⁷⁷This is what eventually causes the theory to be non-unitary. This also explains why the Euclidean black hole, which descends from H_3^+ , is unitary: there is no more H field because of dimensional reasons.

⁷⁸The dual Coxeter number of $SL(2, \mathbb{R})$ is $Q = -2$. Naming the level $k' = k + 2$ is a choice that will prove to be convenient later when dealing with factors $k' + Q = k$.

6.2.2 Current algebra and primary fields

The Wess-Zumino-Witten action for H_3^+ has the $SL(2, \mathbb{C}) \times SL(2, \mathbb{C})^\dagger$ symmetry⁷⁹. The left currents are defined by:

$$\begin{aligned}
J(z) &= -(k+2)\partial_z g g^{-1} = \frac{1}{2} (J^+(z)T^- + J^-(z)T^+) - J^3(z)T^3 \\
J^+(z) &= -(k+2) (-4\gamma\partial_z\Phi - 2\partial_z\gamma + 2e^{2\Phi}\gamma^2\partial_x\bar{\gamma}) \\
J^-(z) &= -\frac{k+2}{2}e^{2\Phi}\partial_z\bar{\gamma} \\
J^3(z) &= -(k+2) (2e^{2\Phi}\gamma\partial_z\bar{\gamma} - 2\partial_z\Phi)
\end{aligned} \tag{254}$$

where $T^{\pm,3}$ form a 2×2 matrix representation of the $sl(2, \mathbb{R})$ algebra:

$$\begin{aligned}
T^3 &= -\frac{1}{2}\sigma_3 = \frac{1}{2} \begin{pmatrix} -1 & 0 \\ 0 & 1 \end{pmatrix} \\
T^+ &= \frac{1}{2}(\sigma_1 - i\sigma_2) = \begin{pmatrix} 0 & 0 \\ 1 & 0 \end{pmatrix} \\
T^- &= -\frac{1}{2}(\sigma_1 + i\sigma_2) = \begin{pmatrix} 0 & -1 \\ 0 & 0 \end{pmatrix}
\end{aligned} \tag{255}$$

The currents satisfy the following operator product expansions (the right sector behaves just like the left sector and is denoted by barred expressions):

$$\begin{aligned}
J^3(z)J^3(w) &= -\frac{k+2}{(z-w)^2} \\
J^3(z)J^\pm(w) &= \pm \frac{J^\pm(w)}{z-w} \\
J^+(z)J^-(w) &= \frac{2(k+2)}{(z-w)^2} - \frac{2J^3(w)}{z-w}
\end{aligned} \tag{256}$$

The modes of the currents verify the commutation relations of the $\widehat{sl(2, \mathbb{R})}_{k+2}$ algebra:

$$\begin{aligned}
[J_n^3, J_m^3] &= -(k+2)n\delta_{n+m,0} \\
[J_n^3, J_m^\pm] &= \pm J_{n+m}^\pm \\
[J_n^+, J_m^-] &= 2(k+2)n\delta_{n+m,0} - 2J_{n+m}^3
\end{aligned} \tag{257}$$

Just like the matrices $T^{\pm,3}$, the zero modes $J_0^{\pm,3}$ belong to the $sl(2, \mathbb{R})$ algebra:

$$\begin{aligned}
[J_0^3, J_0^\pm] &= \pm J_0^\pm \\
[J_0^+, J_0^-] &= -2J_0^3
\end{aligned} \tag{258}$$

⁷⁹Unlike ordinary Wess-Zumino-Witten models, left and right symmetries are here conjugate of each other. This originates from the fact that H_3^+ is not a group and the model is only properly defined as a coset $SL(2, \mathbb{C})/SU(2)$. Moreover, $SL(2, \mathbb{C})$ and $SL(2, \mathbb{R})$ are closely related. The study will refer to $SL(2, \mathbb{R})$ results whenever they are relevant, since this group is more commonly studied in the literature.

The metric for this algebra is:

$$g_{33} = -1, \quad g_{+-} = g_{-+} = \frac{1}{2} \quad (259)$$

The stress-energy tensor is obtained by the Sugawara construction⁸⁰:

$$T(z) = \frac{1}{k} \left(\frac{1}{2} : J^+(z)J^-(z) + J^-(z)J^+(z) : - : J^3(z)J^3(z) : \right) \quad (260)$$

where normal ordering is denoted by $: \cdot :$. The central charge of the model is $c = 3 + \frac{6}{k}$, and the Casimir is:

$$\mathcal{C} = J_0^2 = \frac{1}{2} (J_0^+ J_0^- + J_0^- J_0^+) - (J_0^3)^2 \quad (261)$$

Primary fields are of the form (j is called the spin):

$$\begin{aligned} \Phi_j(x, \bar{x}; z, \bar{z}|g) &= \frac{2j-1}{\pi} \left[(1-x) g(z, \bar{z}) \begin{pmatrix} 1 \\ -\bar{x} \end{pmatrix} \right]^{-2j} \\ &= \frac{2j-1}{\pi} (e^{-\Phi} + e^{\Phi|\gamma-x|^2})^{-2j} \end{aligned} \quad (262)$$

where x and $\bar{x} = x^*$ are auxiliary complex coordinates that keep track of the H_3^+ symmetry. The operator Φ_j has conformal weight $h_j = -\frac{j(j-1)}{k}$. The factor in front of (262) finds its justification in the fact that the primary fields are properly normalized in the sense that:

$$\int_{H_3^+} dg (\Phi_j(x, \bar{x}|g))^\dagger \Phi_{j'}(x', \bar{x}'|g) = 2\pi \delta(x-x') \delta(\bar{x}-\bar{x}') \delta(j-j') \quad (263)$$

These fields form a basis of plane waves for integrable functions on H_3^+ (see [41] for more details):

$$L^2(H_3^+) = \int_{\frac{1}{2} + i\mathbb{R}_+} \mathcal{H}_j \quad (264)$$

where \mathcal{H}_j is a continuous representation of $SL(2, \mathbb{C})$, which acts on functions of the complex variable according to⁸¹:

$$[T_j(A)]f(x) = |cx+d|^{-4j} f(Ax) \quad (265)$$

where A is any matrix in $SL(2, \mathbb{C})$:

$$A = \begin{pmatrix} a & b \\ c & d \end{pmatrix}, \quad Ax = \frac{ax+b}{cx+d} \quad (266)$$

⁸⁰On the contrary to (79), there is no overall factor $\frac{1}{2}$ here because of a different choice of normalization in the length of the root of the algebra, which is rather standard in the literature.

⁸¹Any irreducible representation T of a group G on a Hilbert space is equivalent to a representation by shift operators in some space of scalar functions on G . Hence the appearance of the kind of representation T_j considered here.

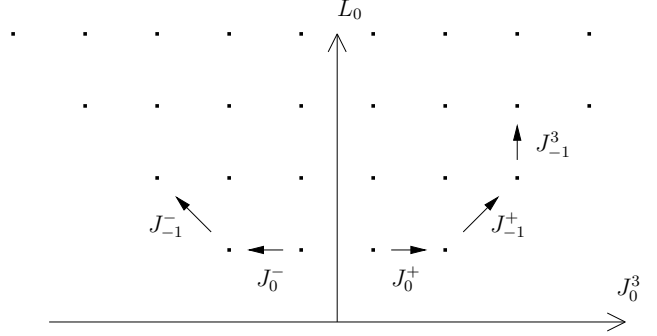

Figure 9: A degenerate representation of the affine Lie algebra $\widehat{sl(2, \mathbb{R})}_{k+2}$, built from a finite representation of the Lie algebra $sl(2, \mathbb{R})$. Each dot indicates a state in the representation. Arrows indicate how the currents act on these states.

The representation T_j is implemented on functions over H_3^+ via the transform:

$$F_j(x, \bar{x}) = \int_{H_3^+} \Phi_j(x, \bar{x}|g) f(g) dg \quad (267)$$

where the kernel $\Phi_j(x, \bar{x}|g)$ plays the role of plane waves of the theory and satisfies:

$$\Phi_j(x; \bar{x}; z, \bar{z}|A^{-1}gA^{-1\dagger}) = |cx + d|^{-4j} \Phi_j(Ax; \bar{A}\bar{x}; z, \bar{z}|g) \quad (268)$$

This is consistent with the $SL(2, \mathbb{C}) \times SL(2, \mathbb{C})^\dagger$ symmetry of the theory, which transforms a matrix $g \in H_3^+$ to AgA^\dagger .

The relation (268) shows that there exists some kind of correspondence between x (and its conjugate \bar{x}) and the coordinates on AdS_3 . This correspondence is not well understood yet. An example is:

$$Ax = ax + b \quad \longleftrightarrow \quad \begin{aligned} e^\Phi &\rightarrow |a|e^\Phi \\ \gamma &\rightarrow \frac{1}{|a|}(\gamma - b) \end{aligned} \quad (269)$$

Like any plane-wave, the primary fields are eigenfunctions of the Laplacian Δ , and satisfy:

$$\Delta \Phi_j(x; \bar{x}; z, \bar{z}|g) = 4 \frac{j(j-1)}{l^2} \Phi_j(x; \bar{x}; z, \bar{z}|g) \quad (270)$$

As suggested by (264), the spectrum (Hilbert space) of the H_3^+ theory consists of (irreducible) continuous representations of the current algebra, for which the spin is $j = \frac{1}{2} + i\lambda$ with $\lambda \in \mathbb{R}_+^*$. The spectrum does not include other irreducible representations of $sl(2, \mathbb{R})$, like discrete representations.

Another class of representations is interesting, though. It is built from finite representations of $sl(2, \mathbb{R})$, as shown in figure 9. These representations are

degenerate, and several results valid for continuous representations do not hold for finite ones⁸² (like the reflection or the Fourier transform defined below in (276)). The spin is then $j = \frac{1-u}{2}$, with $u \in \mathbb{N}^*$. The degenerate representations will be used later in order to shed some light on the structure of the theory.

The zero modes of the current algebra are realized as derivatives on the space of functions of, say, the variables Φ , γ and $\bar{\gamma}$: just as the currents express the invariance of the action under $g(z, \bar{z}) \rightarrow \Omega(z)g(z, \bar{z})\Omega^\dagger(\bar{z})$, the zero modes express its invariance under $g(z, \bar{z}) \rightarrow hg(z, \bar{z})h^\dagger$ with $h \in SL(2, \mathbb{R})$. They must satisfy⁸³ $J_0^{3,\pm}g = -T^{3,\pm}g$ and are found to be:

$$\begin{aligned} J_0^3 &= \gamma\partial_\gamma - \frac{1}{2}\partial_\Phi \\ J_0^+ &= \gamma^2\partial_\gamma - \gamma\partial_\Phi - e^{-2\Phi}\partial_{\bar{\gamma}}, \quad J_0^- = \partial_\gamma \end{aligned} \quad (271)$$

or, equivalently ($a = \pm, 3$):

$$J^a(z)\Phi_j(x; \bar{x}; w, \bar{w}|g) = -\frac{D^a\Phi_j(x; \bar{x}; w, \bar{w}|g)}{z-w} \quad (272)$$

where:

$$D^3 = x\partial_x + j, \quad D^+ = x^2\partial_x + 2jx, \quad D^- = \partial_x \quad (273)$$

as it can be verified using (271) that indeed:

$$J_0^a\Phi_j(x; \bar{x}; z, \bar{z}|g) = -D^a\Phi_j(x; \bar{x}; z, \bar{z}|g) \quad (274)$$

These relations are consistent with (270) since $\Delta = -\frac{4}{12}J_0^2$.

The invariance of the conformal weight h_j under $j \rightarrow 1-j$ suggests that representations built from j and $1-j$ must be equivalent, and indeed the fields Φ_j and Φ_{1-j} satisfy a reflection relation:

$$\Phi_j(x, \bar{x}; z, \bar{z}|g) = \frac{2j-1}{\pi}\mathcal{R}(j) \int_{\mathbb{C}} d^2y |x-y|^{-4j} \Phi_{1-j}(y, \bar{y}; z, \bar{z}|g) \quad (275)$$

where the reflection amplitude is $\mathcal{R}(j) = -1$ and gets quantum corrections when considering the quantum one-point function, see (303). The reflection amplitude satisfies $\mathcal{R}(j)\mathcal{R}(1-j) = 1$. Note that the reflection relates fields with spins $j = \frac{1}{2} + i\lambda$ with $\lambda \in \mathbb{R}_+^*$ to fields with $\lambda \in \mathbb{R}_-^*$. This is why it is possible to restrict to $\lambda > 0$.

Primary fields were previously expressed in what may be called the x basis. However, another basis is very convenient: the m basis. It is mentioned here

⁸²By an abuse of notation, degenerate representations of $\widehat{sl(2, \mathbb{R})}_{k+2}$ built from finite representations of $sl(2, \mathbb{R})$ will also be called finite representations, even though they have an infinite number of states.

⁸³The extra sign is necessary in order for both sets of generators to have the same commutation relations. The reason for the extra sign in (272) is the same.

since it is widely used in the literature. One goes from one basis to the other by using a generalized Fourier transform [41]:

$$\begin{aligned}\Phi_{j;m,\bar{m}}(z,\bar{z}|g) &= \int_{\mathbb{C}} d^2x e^{i\text{arg}(x)} |x|^{2j-2+ip} \Phi_j(x;\bar{x};z,\bar{z}|g) \\ \Phi_j(x;\bar{x};z,\bar{z}|g) &= \frac{1}{(2\pi)^2} \sum_{n \in \mathbb{Z}} \int_{\mathbb{R}} dp e^{-in\text{arg}(x)} |x|^{-2j-ip} \Phi_{j;m,\bar{m}}(z,\bar{z}|g)\end{aligned}\quad (276)$$

where $m = \frac{1}{2}(n + ip)$ and $\bar{m} = \frac{1}{2}(-n + ip)$, $n \in \mathbb{Z}$ (this is required for the integrals to be well defined) and $p \in \mathbb{R}$. In the m basis, the operator product expansions with the currents are:

$$\begin{aligned}J^3(z,\bar{z})\Phi_{j;m,\bar{m}}(w,\bar{w}|g) &= \frac{m}{z-w} \Phi_{j;m,\bar{m}}(z,\bar{z}|g) \\ J^\pm(z,\bar{z})\Phi_{j;m,\bar{m}}(w,\bar{w}|g) &= \frac{\pm j + m}{z-w} \Phi_{j;m\pm 1,\bar{m}}(z,\bar{z}|g)\end{aligned}\quad (277)$$

with similar results for $\bar{J}^a \Phi_{j;m,\bar{m}}$. This is coherent with $J_0^2 = -j(j-1)$. As shown by the above relation, fields in the m basis have the advantage that they are eigenvectors of the current J^3 . It may nevertheless be considered simpler to encode an infinity of fields $\Phi_{j;m,\bar{m}}$ in one single field $\Phi_j(x,\bar{x})$. Moreover, manipulating a function of the complex variable may be of some use. This is the strategy that was followed in section 5. It will be used again here, although some properties of the fields $\Phi_{j;m,\bar{m}}$ will also be mentioned.

Fourier-transforming the reflection relation (275), one obtains:

$$\Phi_{j;m,\bar{m}}(z,\bar{z}|g) = \mathcal{R}(j;m,\bar{m}) \Phi_{1-j;m,\bar{m}}(z,\bar{z}|g) \quad (278)$$

where:

$$\mathcal{R}(j;m,\bar{m}) = (2j-1)\mathcal{R}(j) \frac{\Gamma(j+m)\Gamma(j-\bar{m})\Gamma(1-2j)}{\Gamma(1-j+m)\Gamma(1-j-\bar{m})\Gamma(2j)} \quad (279)$$

The reflection coefficient satisfies $\mathcal{R}(j;m,\bar{m})\mathcal{R}(1-j;m,\bar{m}) = 1$. Finally, the fields $\Phi_{j;m,\bar{m}}$ are normalized according to:

$$\int_{H_3^+} dg (\Phi_{j,m,\bar{m}}(g))^\dagger \Phi_{j,m,\bar{m}}(g) = (2\pi)^3 \delta_{n,n'} \delta(p-p') \delta(j-j') \quad (280)$$

6.2.3 Correlation functions and fusion

The two and three-point functions are key elements of a conformal field theory. For the H_3^+ model, the two-point function in the x basis is:

$$\begin{aligned}\langle \Phi_{j_1}(x_1,\bar{x}_1; z_1,\bar{z}_1) \Phi_{j_2}(x_2,\bar{x}_2; z_2,\bar{z}_2) \rangle \\ = \frac{A(j_1)}{|z_{12}|^{4h_{j_1}}} \left(\delta^2(x_{12}) \delta(1-j_1-j_2) + \frac{\mathcal{R}(j_1)}{\pi} |x_{12}|^{-4j_1} \delta(j_1-j_2) \right)\end{aligned}\quad (281)$$

where:

$$A(j) = A(1-j) = -\frac{\pi^3}{(2j-1)^2} \quad (282)$$

In the m basis, the two-point function is:

$$\begin{aligned} & \langle \Phi_{j_1; m_1, \bar{m}_1}(z_1, \bar{z}_1) \Phi_{j_2; m_2, \bar{m}_2}(z_2, \bar{z}_2) \rangle \\ &= \frac{\delta^2(m_1 + m_2)}{|z_{12}|^{4h_1}} A(j_1) (\delta(1-j_1-j_2) + \mathcal{R}(j_1; m_1, \bar{m}_1) \delta(j_1-j_2)) \end{aligned} \quad (283)$$

where:

$$\delta^2(m) = \int_{\mathbb{C}} d^2x x^{m-1} \bar{x}^{\bar{m}-1} = 4\pi^2 \delta(m + \bar{m}) \delta_{m-\bar{m}, 0} \quad (284)$$

The three-point function in the x basis is:

$$\langle \Phi_{j_1}(x_1, \bar{x}_1; z_1, \bar{z}_1) \Phi_{j_2}(x_2, \bar{x}_2; z_2, \bar{z}_2) \Phi_{j_3}(x_3, \bar{x}_3; z_3, \bar{z}_3) \rangle = \frac{D(j_1, j_2, j_3)}{\prod_{k < l} |z_{kl}|^{2h_{kl}} |x_{kl}|^{2j_{kl}}} \quad (285)$$

where $k, l \in \{1, 2, 3\}$ and $h_{kl} = h_k + h_l - h_m$, with $m \in \{1, 2, 3\}$ and $m \neq k, l$ (same for j_{kl}), and:

$$\begin{aligned} D(j_1, j_2, j_3) &= \frac{\pi}{2k} \left(k^{1/k} \frac{\Gamma(1+1/k)}{\Gamma(1-1/k)} \right)^{1-j_1-j_2-j_3} \\ &\times \frac{\Upsilon(b)\Upsilon(2bj_1)\Upsilon(2bj_2)\Upsilon(2bj_3)}{\Upsilon(b(j_1+j_2+j_3-1))\Upsilon(bj_{12})\Upsilon(bj_{13})\Upsilon(bj_{23})} \end{aligned} \quad (286)$$

where $b^2 = 1/k$ and the Υ function is defined in appendix A equation (414). Some authors [105, 113] use a special function G instead of Υ . These functions are related via (the overall constant can be set to one because only a ratio of G or of Υ functions appears in the three point function):

$$G(x) = b^{-b^2x(x+1+b^{-2})} \Upsilon^{-1}(-bx) \quad (287)$$

The coefficient D satisfies the following relation, imposed by the reflection property of primary fields:

$$\frac{D(j_1, j_2, j_3)}{D(j_1, j_2, 1-j_3)} = \mathcal{R}(j_3) \gamma(1-2j_3) \gamma(j_{13}) \gamma(j_{23})$$

In the m basis, the three-point function is:

$$\begin{aligned} & \langle \Phi_{j_1; m_1, \bar{m}_1}(z_1, \bar{z}_1) \Phi_{j_2; m_2, \bar{m}_2}(z_2, \bar{z}_2) \Phi_{j_3; m_3, \bar{m}_3}(z_3, \bar{z}_3) \rangle \\ &= \prod_{k < l} \frac{1}{|z_{kl}|^{2h_{kl}}} D(j_1, j_2, j_3) \delta^2(m_1 + m_2 + m_3) W(j_a; m_a, \bar{m}_a) \end{aligned} \quad (288)$$

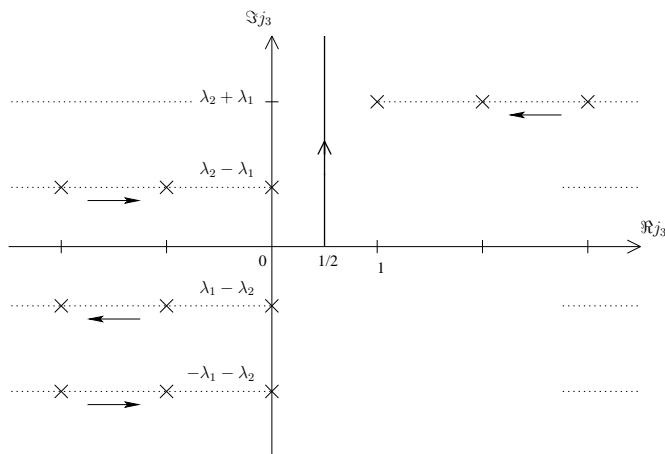

Figure 10: Integration contour and poles for the operator product expansion of a degenerate field and a non-degenerate field. The dotted lines indicate the poles, and the arrows indicate in which direction the poles move when λ_1 acquires an increasing imaginary part.

where:

$$\int_{\mathbb{C}} d^2 x_1 \int_{\mathbb{C}} d^2 x_2 \int_{\mathbb{C}} d^2 x_3 x_1^{j_1+m_1-1} \bar{x}_1^{j_1+\bar{m}_1-1} x_2^{j_2+m_2-1} \bar{x}_2^{j_2+\bar{m}_2-1} x_3^{j_3+m_3-1} \bar{x}_3^{j_3+\bar{m}_3-1} |x_1 - x_3|^{-2j_{13}} |x_2 - x_3|^{-2j_{23}} |x_1 - x_2|^{-2j_{12}} = \delta^2(m_1 + m_2 + m_3) W(j_a; m_a, \bar{m}_a)$$

The reflection property of the primary fields $\Phi_{j;m,\bar{m}}$ imposes a constraint on $W(j_a; m_a, \bar{m}_a)$, similar to relation (288) for the function D . The function W has a complicated expression, which has been calculated in [110].

Finally, the operator product expansion between two primary fields is determined by consistency of the operator product expansion with the two and three-point functions. In the x basis, it is given by:

$$\begin{aligned} & \Phi_{j_1}(x_1, \bar{x}_1; z_1, \bar{z}_1) \Phi_{j_2}(x_2, \bar{x}_2; z_2, \bar{z}_2) \\ & \underset{z_1 \rightarrow z_2}{\sim} \int_{\frac{1}{2} + i\mathbb{R}_+} dj_3 \frac{1}{|z_{12}|^{2h_{12}}} \int_{\mathbb{C}} d^2 x_3 \prod_{k < l} \frac{1}{|x_{kl}|^{2j_{kl}}} \frac{D(j_1, j_2, j_3)}{A(j_3)} \Phi_{1-j_3}(x_3, \bar{x}_3; z_2, \bar{z}_2) \end{aligned} \quad (289)$$

where $j_3 = \frac{1}{2} + i\lambda_3$. The operator product expansion in the m basis is obtained in a similar way.

From the above results given for primary fields associated to non-degenerate continuous representations (for which all factors are well defined), and especially from the operator product expansion, one can find the fusion rules between degenerate and non-degenerate fields. Indeed, the three point function is analytic in its arguments and can be analytically continued to the whole complex plane. This however requires a little bit of work, as will be seen below. The fusion

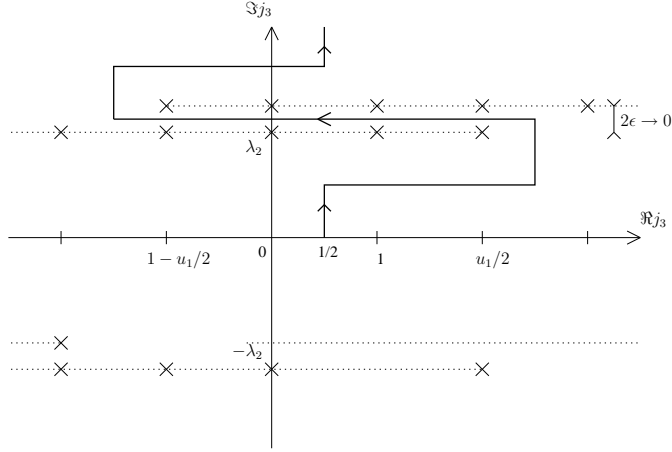

Figure 11: Integration contour and poles for the operator product expansion of a degenerate field and a non-degenerate field.

coefficient $\mathcal{N}_{j_1, j_2}^{j_3}$ is defined to be one if Φ_{1-j_3} appears with a non-zero factor in the operator product expansion of Φ_{j_1} and Φ_{j_2} , and zero otherwise.

In order to find the fusion for a degenerate and a non-degenerate representation, one deforms the contour of integration of the operator product expansion [105, 110], from the initial situation shown in figure 10 for which $j_1 = \frac{1}{2} + i\lambda_1$, $j_2 = \frac{1}{2} + i\lambda_2$, $\lambda_1, \lambda_2 \in \mathbb{R}_+$, to the case $\lambda_1 = i\frac{u_1}{2} + \epsilon$, with $u_1 \in \mathbb{N}^*$ and ϵ a positive infinitesimal number, shown in figure 11. The figures show the poles of $D(j_1, j_2, j_3)$ in the j_3 complex plane. They lie on the dotted lines (some of them are pictured as crosses). For instance, poles of $\Upsilon(bj_{13})$ are located at $j_3 = i(\lambda_2 - \lambda_1) - mk - n$ or at $j_3 = i(\lambda_2 - \lambda_1) + (m+1)k + (n+1)$ where m, n are positive integers⁸⁴. One should also take into account zeros in the numerator of $D(j_1, j_2, j_3)$ that appear in the limit $\epsilon \rightarrow 0$. Arrows in figure 10 indicate in which direction poles move when the imaginary part of λ_1 increases from 0 up to $\frac{u_1}{2}$. For $\epsilon \rightarrow 0$, the contour of integration is pinched between some poles (note that when two of these poles merge, there is an extra zero factor coming from $\Upsilon(2j_1 b)$ which make the total residue non-zero). Then, pulling the integration contour over the poles, the integral is transformed into a sum over all non-zero residues (there is no other contribution to the operator product expansion, because in the limit $\epsilon \rightarrow 0$, $D(j_1, j_2, j_3) = 0$ except at its poles). The final result is consistent with the expectation for the fusion of degenerate and non-degenerate representations in H_3^+ and it is given in the next section in equation (323) (where the notation is $u = 2J + 1$).

For the fusion of two degenerate representations, one starts again from figure 10, but then deforms the integration contour to $\lambda_1 \rightarrow i\frac{u_1}{2} + \frac{\epsilon}{2}$ and

⁸⁴The poles located at $j_3 = i(\lambda_2 - \lambda_1) + (m+1)k + (n+1)$ will not play any role here since k is assumed to be non-rational.

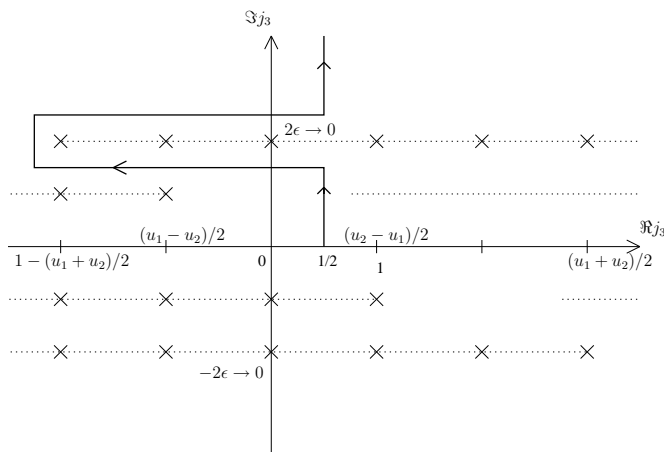

Figure 12: Integration contour and poles for the operator product expansion of two degenerate fields.

$\lambda_2 \rightarrow i\frac{u_2}{2} + \frac{3\epsilon}{2}$, as shown in figure 12 in the case $u_2 \geq u_1$. Just as before, the contour of integration is pinched between some poles, which are going to contribute to the fusion *i.e.* to a sum over residues. The result is given later in equation (309).

6.3 The hyperbolic three-plane H_3^+

This section focuses on the properties of characters in the H_3^+ theory and on brane computations for spherical branes and AdS_2 branes [107], with finite representations in the open string channel.

As mentioned in the previous section, two kinds of representations of the affine Lie algebra of $SL(2, \mathbb{R})$ will be of interest here: continuous non-degenerate representations, labeled by their spin $j = \frac{1}{2} + i\lambda$ where $\lambda \in \mathbb{R}_+$, and degenerate representations (generated by the current algebra from a finite representation of the Lie algebra of dimension $u = 2J + 1$, see figure 9), of spin $j = \frac{1-u}{2} = -J$, where u is a strictly positive integer *i.e.* J is a positive half-integer (such representations are non-unitary unless $J = 0$). The degenerate representation $J = 0$ will play the role of the identity in the Verlinde formula. The characters of a non-degenerate and of a degenerate representation are respectively [108]:

$$\chi_\lambda(\tau) = \frac{q^{\lambda^2/k}}{\eta(\tau)^3}, \quad \chi_J(\tau) = (2J + 1) \frac{q^{-(2J+1)^2/(4k)}}{\eta(\tau)^3} \quad (290)$$

where the level $k + 2$ is real, non-rational and strictly positive and η is the Dedekind function, defined in appendix A in relation (411). These formulas deserve some comments.

Since the above characters are characters of current algebras, a proper definition would add extra variables in order to keep track of all quantum numbers,

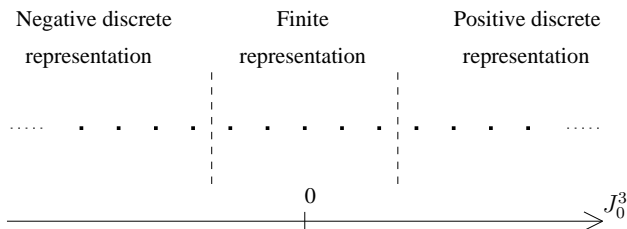

Figure 13: A continuous representation of the zero modes (or Lie algebra) of $SL(2, \mathbb{R})$. Each dot corresponds to a state. The figure shows how a continuous representation decomposes into the sum of two (conjugate) discrete representations and of a finite representation, sandwiched by the discrete representations. These states play the role of primary states of the associated affine Lie algebra representation.

see footnote 32. As explained in [108], this may be done for degenerate representations by defining:

$$\chi_J(\tau, \nu) = \text{Tr} \left(q^{L_0 - \frac{c}{24}} z^{J_0^3} \right) = \frac{2 \sin(\pi \nu (2J + 1)) q^{-(2J+1)^2 / (4k)}}{\theta_1(\tau, \nu)} \quad (291)$$

where $q = e^{2i\pi\tau}$ and $z = e^{2i\pi\nu}$ and θ_1 is defined in appendix A, relation (412). The above formula connects with the definition of the character in (290) in the limit $\nu \rightarrow 0$ in which the character simplifies: $\chi_J(\tau, \nu \rightarrow 0) = \chi_J(\tau)$. The ν dependence is of no use for the upcoming considerations. Things are much more complicated for the characters of continuous representations, since the result would be infinite as a consequence of the infinite number of states of the zero modes (Lie algebra) representation. Several approaches may then be considered. None of them seems entirely satisfying (a rigorous treatment is probably an open and interesting problem). One possibility, used in [108], is to realize that the character of continuous representations appears in the modular transformation of the degenerate characters, and moreover to identify the continuous characters as expressions obtained from a generalization of the finite characters:

$$\chi_\lambda(\tau) = (1 - 2j) \frac{q^{\lambda^2/k}}{\eta(\tau)^3} = -2i\lambda \frac{q^{\lambda^2/k}}{\eta(\tau)^3}, \quad \chi_J(\tau) = \chi_{\lambda=i(\frac{1}{2}+J)}(\tau) \quad (292)$$

This has the advantage that the S matrix then squares to the identity (see below for manipulations on this issue). However, it is not consistent with the intuitive picture (emerging from considerations on the spectrum of J_0^3 , see figure 13 or *e.g.* [115]) that continuous representations are equivalent to the sum of two discrete representations and a finite representation (since (292) identifies continuous representations with finite ones only). A more rigorous but also more complicated treatment, evoked in [19] (see also [116]), may consist in defining distributions instead of characters. It may also be possible to regularize the infinite sum in the character. The choice that was made here in equation (290),

and also in [107], amounts to *not* summing over the zero modes (*i.e.* consider the subset of the continuous representation generated from only one primary field). This choice has the advantage of yielding a simple result. Moreover, this choice eventually proves to agree with the normalization of the field Φ_j (see *e.g.* equation (305) below). Finally, it is justified *a posteriori* considering the sensible formulas that will be deduced from the continuous character, in the context of Cardy states and Verlinde formula.

The modular transformations of the characters are (see [108] for the degenerate case):

$$\begin{aligned}\chi_J(\tau') &= \int_0^\infty S_J^\lambda \chi_\lambda(\tau) d\lambda, & S_J^\lambda &= 4\lambda \sqrt{\frac{2}{k}} \sinh\left(\frac{2\pi\lambda(2J+1)}{k}\right) \\ \chi_\lambda(\tau') &= \int_0^\infty S_\lambda^{\lambda'}(\tau') \chi_{\lambda'}(\tau) d\lambda', & S_\lambda^{\lambda'}(\tau') &= -\frac{2}{i\tau} \sqrt{\frac{2}{k}} \frac{\lambda}{\lambda'} \cos\left(\frac{4\pi\lambda\lambda'}{k}\right)\end{aligned}\quad (293)$$

where $\tau' = -\frac{1}{\tau}$. The component $S_\lambda^{\lambda'}$ of the modular matrix depends on τ . This is quite different from rational theories, but not so surprising since the non-degenerate characters of H_3^+ have a similar expression to the ones of Liouville theory (for which the modular matrix does not depend on τ), except for an extra factor $\eta(\tau)^{-2}$. This factor accounts for the τ dependence of the modular transformation, since $\eta(-\frac{1}{\tau}) = \sqrt{-i\tau} \eta(\tau)$.

Just like the characters, the above modular transformation also deserve some comments. Indeed, since the modular transforms are expressed as integrals, a density of states may be hidden in the formulas (293), and a proper definition of the modular matrix would rather be $\chi_i(-1/\tau) = \int S_i^\lambda \chi_\lambda(\tau) N(\lambda) d\lambda$. These considerations are not of much importance for the present study. Indeed, they would amount to a renormalization of the modular matrix $S_i^\lambda \rightarrow S_i^\lambda / N(\lambda)$. This renormalization may be incorporated in a redefinition of the primary fields, see *e.g.* (305), and is of no importance in the Verlinde formula, see *e.g.* (311).

Interesting remarks arise when computing the square of the modular S matrix, which is expected to be the identity. In the non-degenerate sector, the proof follows from the standard formula for the Dirac distribution:

$$\frac{1}{2\pi} \int_{-\infty}^{\infty} e^{ikx} dk = \delta(x) \quad (294)$$

In the degenerate sector, the proof is more subtle. It is explained below in some detail, since it is a useful foreshadowing of the techniques used later. The first step consists in unfolding the second integral:

$$\chi_J(\tau) = \int_0^\infty 4\lambda \sqrt{\frac{2}{k}} \sinh\left(\frac{2\pi\lambda(2J+1)}{k}\right) \int_{-\infty}^{\infty} -\frac{1}{i\tau} \sqrt{\frac{2}{k}} e^{\frac{4i\pi\lambda\lambda'}{k}} \chi_{\lambda'}(\tau) d\lambda' d\lambda \quad (295)$$

The integrals cannot be switched otherwise the λ integral would become divergent. It is however possible to shift the λ' integral off the real axis and give it a

positive imaginary part $\alpha > J + \frac{1}{2}$, not encountering any poles, to render the λ integral finite after exchange of the order of permutations (see [98] for a similar manipulation):

$$\chi_J(\tau) = \int_{-\infty+i\alpha}^{\infty+i\alpha} -\frac{8\lambda}{i\tau k} \int_0^\infty \sinh\left(\frac{2\pi\lambda(2J+1)}{k}\right) e^{\frac{4i\pi\lambda\lambda'}{k}} d\lambda \chi_{\lambda'}(\tau) d\lambda' \quad (296)$$

Integrating over λ yields:

$$\chi_J(\tau) = \int_{-\infty+i\alpha}^{\infty+i\alpha} -\frac{4k}{i\tau} \left(\frac{1}{(2\pi(2J+1) + 4i\pi\lambda')^2} - \frac{1}{(-2\pi(2J+1) + 4i\pi\lambda')^2} \right) \times \chi_{\lambda'}(\tau) d\lambda' \quad (297)$$

Finally, shifting the λ' integral back to the real axis leads to:

$$\chi_J(\tau) = (2J+1)\chi_{\lambda'=i(J+\frac{1}{2})}(\tau) \quad (298)$$

since the integral over the real axis is zero (the integrand is odd) and a pole is picked up, thanks to the standard formula for holomorphic functions f :

$$\frac{1}{2i\pi} \oint_z \frac{f(w)}{(w-z)^n} dw = \frac{1}{n!} \frac{d^n f}{dz^n}(z) \quad (299)$$

where the contour encircles z and is oriented in the trigonometric sense (the opposite sense yields a minus sign).

The above results may now be put to good use by writing a generalized Verlinde formula.

6.3.1 Degenerate representations

For a spherical brane, the one-point function is⁸⁵:

$$\langle \Phi^\lambda(x|z) \rangle_J = \frac{(1+x\bar{x})^{-2i\lambda-1}}{|z-\bar{z}|^{2h_\lambda}} \Gamma\left(1 - \frac{2i\lambda}{k}\right) \frac{\sinh\left(\frac{2\pi\lambda(2J+1)}{k}\right)}{\sin\left(\frac{\pi(2J+1)}{k}\right)} \frac{-i\nu^{-i\lambda+\frac{1}{2}}}{2\pi\Gamma\left(1 - \frac{1}{k}\right)} \quad (300)$$

where:

$$h_\lambda = -\frac{j(j-1)}{k} = \frac{1}{k} \left(\lambda^2 + \frac{1}{4} \right), \quad \nu = \frac{\Gamma\left(1 - \frac{1}{k}\right)}{\Gamma\left(1 + \frac{1}{k}\right)} \quad (301)$$

This wave-function satisfies the usual reflection property:

$$\langle \Phi^\lambda(x|z) \rangle_J = \frac{2i\lambda}{\pi} \mathcal{R}(\lambda) \int_{\mathbb{C}} d^2y |x-y|^{-4i\lambda-2} \langle \Phi^{-\lambda}(y|z) \rangle_J \quad (302)$$

⁸⁵Remark that the x -dependence is precisely the one of the classical wave-function $\Phi_j(x, \bar{x}|g)$ for g equals to the identity *i.e.* $\phi = \gamma = \bar{\gamma} = 0$. Hence the reflection relation (302).

where $\mathcal{R}(\lambda)$ is given by:

$$\mathcal{R}(\lambda) = -\frac{\Gamma\left(1 - \frac{2i\lambda}{k}\right)}{\Gamma\left(1 + \frac{2i\lambda}{k}\right)} \nu^{-2i\lambda} \quad (303)$$

and satisfies $\mathcal{R}(\lambda)\mathcal{R}(-\lambda) = 1$. The boundary state related to the one-point function is⁸⁶:

$${}_B\langle J|\lambda; x\rangle = 2 \sin\left(\frac{\pi(2J+1)}{k}\right) \frac{(8\pi^2/k)^{\frac{1}{4}}}{\sqrt{\sin\left(\frac{\pi}{k}\right)}} {}_B\left\langle \Phi^\lambda\left(x\left|\frac{i}{2}\right.\right)\right\rangle_J \quad (304)$$

Note that $\langle \lambda; x|J\rangle_B \equiv ({}_B\langle J|\lambda; x\rangle)^* = {}_B\langle J|-\lambda; x\rangle$.

The boundary state is related to the modular transformation in the following way⁸⁷:

$${}_B\langle J|\lambda; x\rangle \sqrt{\mathcal{R}(-\lambda)} = \frac{S_J^\lambda}{\sqrt{S_0^\lambda}} \frac{(1+x\bar{x})^{-2i\lambda-1}}{\sqrt{\pi}} \quad (305)$$

This should be compared with the construction of boundary states that was mentioned in the case of rational theories at the end of section 4.3, in relation with Cardy's constraint. The $1/\sqrt{\pi}$ factor is a good normalization of the x, \bar{x} term in the sense that:

$$\frac{1}{\pi} \int_{\mathbb{C}} (1+x\bar{x})^{-2} d^2x = 1 \quad (306)$$

This integral appears in the calculation of the annulus amplitude for two spherical branes. Using relation (305), this amplitude reads:

$$\begin{aligned} {}_B\langle J'|q'^{H/2}|J\rangle_B &= \int_0^\infty d\lambda \int_{\mathbb{C}} d^2x {}_B\langle J'|\lambda; x\rangle \langle \lambda; x|J\rangle_B \chi_\lambda(q') \\ &= \int_0^\infty d\lambda \frac{S_J^\lambda S_{J'}^\lambda}{S_0^\lambda} \chi_\lambda(q') = \sum_{J''=|J-J'|}^{J+J'} \chi_{J''}(q) \end{aligned} \quad (307)$$

where $H = \frac{L_0 + \bar{L}_0}{2} - \frac{c}{24}$ is the Hamiltonian on the plane. The following formula was used:

$$\sinh(nx) \sinh(n'x) = \sum_{n''=|n-n'|+1}^{n+n'+1} \sinh x \sinh(n''x) \quad (308)$$

⁸⁶The normalization of the boundary state is different from [107] in order for the partition function to be normalized with respect to the fusion of representations, see (307) below. The same will be true for boundary states associated to non-degenerate representations.

⁸⁷There is a subtlety because the square root of $\mathcal{R}(-\lambda)$, which is a complex number, is not well defined. Here i is identified with $\sqrt{-1}$. This subtlety is of no importance in (307).

It is possible to rewrite the above partition function of boundary operators in terms of the fusion coefficients, which for finite degenerate representations were found in subsection 6.2.3 to be:

$$\mathcal{N}_{J;J'}^{J''} = \begin{cases} 1 & \text{if } \begin{cases} |J - J'| \leq J'' \leq J + J' \\ J + J' + J'' \in \mathbb{N} \end{cases} \\ 0 & \text{else} \end{cases} \quad (309)$$

Hence:

$${}_B \langle J' | q'^{H_P/2} | J \rangle_B = \sum_{J'' \in \frac{1}{2}\mathbb{N}} \mathcal{N}_{J;J'}^{J''} \chi_{J''}(q) \quad (310)$$

Comparing equations (307) and (310):

$$\frac{S_{J^\lambda} S_{J'^\lambda}}{S_0^\lambda} = \sum_{J'' \in \frac{1}{2}\mathbb{N}} \mathcal{N}_{J;J'}^{J''} S_{J''^\lambda} \quad (311)$$

This relation shows that the rescaled modular matrix $S_{J^\lambda}/S_0^\lambda$ represents the fusion ring. From the above formula, in unitary rational conformal field theories, one inverts the S matrix to find the Verlinde formula. There is no such inverse here. However, a similar issue arised when checking in (295) to (298) that the S matrix squared to the identity, schematically: $\chi_J(\tau) = S_{J^\lambda} S_{\lambda'} \chi_{\lambda'}(\tau)$. Proceeding by analogy with this case, it seems natural to define the Fourier transform of the above relation (311) with respect to the free momentum index λ . This transform encodes the fusion coefficients as the residues of its poles. More precisely, a natural analytic continuation of the usual sum of modular S matrices appearing in the Verlinde formula is:

$$f(z) = \int_0^\infty \frac{S_{J^\lambda} S_{J'^\lambda}}{S_0^\lambda} e^{4i\pi\sqrt{\frac{2}{k}}\lambda z} \frac{d\lambda}{\lambda} \quad (312)$$

which is well defined for $\Im z > \frac{2(J+J'+1)}{\sqrt{2k}}$. The kernel with a $1/\lambda$ used above may seem a bit artificial. This is probably because the correct measure for λ was neglected here (and it is due to the term λ in S_{J^λ} , which is related to the choice of continuous character). The factor $1/\lambda$ is added in order for the fusion coefficients to be expressed as the residues of the function f (otherwise the poles of the functions would be second-order poles, see (297), and the residues would be zero). This is natural in analogy with Liouville theory, or with the case of a degenerate and a non-degenerate representation, where the fusion coefficients are indeed given as residues.

The function f can be extended by analytic continuation to the whole complex plane, except for some poles whose set is precisely given by⁸⁸ $\{\pm z_{J''} = \pm \frac{i}{2\sqrt{2k}}(2J'' + 1) | \mathcal{N}_{J;J'}^{J''} \neq 0\}$. The fusion coefficients are given by the residues of the function f :

$$2i\pi \operatorname{Residue}_{z=z_{J''}}(f) = \mathcal{N}_{J;J'}^{J''} \quad (313)$$

⁸⁸The \pm sign is an artefact arising from reflection. Only one set of poles is relevant for the fusion.

6.3.2 Degenerate and non-degenerate representations

This case shares properties with the one involving two degenerate representations.

The one-point function for a continuous AdS_2 brane (related to a non-degenerate representation $j = \frac{1}{2} + \imath\lambda'$) is [107]⁸⁹:

$$\langle \Phi^\lambda(x|z) \rangle_{\lambda'} = -\frac{|x + \bar{x}|^{-2\imath\lambda-1}}{|z - \bar{z}|^{2h_\lambda}} \nu^{-\imath\lambda} \left(\frac{k}{8}\right)^{\frac{1}{4}} \Gamma\left(1 - \frac{2\imath\lambda}{k}\right) e^{-\frac{4\imath\pi\lambda\lambda'}{k} \text{sign}(x+\bar{x})} \quad (314)$$

The boundary state is defined as:

$${}_B\langle \lambda' | \lambda; x \rangle = \frac{2\sqrt{2}}{\pi} {}_B\left\langle \Phi^\lambda\left(x \middle| \frac{\imath}{2}\right) \right\rangle_r \quad (315)$$

As was pointed out in [107], it is necessary to define a regularized boundary state in order to be able to calculate the annulus amplitude ${}_{B,reg.}\langle r' | q^{H_p/2} | r \rangle_{B,reg.}$. However, this regularization is not needed for the calculation of ${}_B\langle r | q^{H_p/2} | s \rangle_B$. It can be checked that the result would be the same using the regularized state $|r\rangle_{B,reg.}$ and then taking the well defined limits in all the cut-offs. Indeed, there is no divergence with the spherical branes since they are compact and associated to finite representations. This is also the reason why, in the configurations studied in these notes, the open string spectrum is finite *i.e.* the amplitude is expressed as a (finite) sum, and not an integral (a consequence is that there is no need for the density of states that was computed in [107]).

The following calculations will use the Fourier transform (276) of the boundary states, like in [107], because calculations are simpler in this basis and also because it is the one that is used for regularizing the $|r\rangle_B$ boundary state. The Fourier transform of a continuous boundary state is obtained thanks to the relation:

$$\int_{-\frac{\pi}{2}}^{\frac{\pi}{2}} (2 \cos \theta)^{\nu-1} e^{\imath\beta\theta} d\theta = \frac{\pi}{\nu B\left(\frac{\nu+\beta+1}{2}, \frac{\nu-\beta+1}{2}\right)} \quad (316)$$

where B is the Beta function, defined by $B(x, y) = \frac{\Gamma(x)\Gamma(y)}{\Gamma(x+y)}$. This relation yields:

$$\begin{aligned} {}_B\langle \lambda' | \lambda; n, p \rangle &= \int_{\mathbb{C}} d^2x e^{\imath n \arg(x)} |x|^{2\imath\lambda - \imath p - 1} {}_B\langle r | \lambda; x \rangle \\ &= 2\pi \delta(p) A(\lambda' | \lambda; n) \end{aligned} \quad (317)$$

where $n \in \mathbb{Z}$, $p \in \mathbb{R}$ and:

$$\begin{aligned} A(\lambda' | \lambda; n) &= 4 \left(\frac{k}{2}\right)^{\frac{1}{4}} \nu^{-\imath\lambda} \Gamma\left(1 - \frac{2\imath\lambda}{k}\right) \frac{\Gamma(-2\imath\lambda)}{\Gamma\left(\frac{1+n}{2} - \imath\lambda\right) \Gamma\left(\frac{1-n}{2} - \imath\lambda\right)} \\ &\quad \times \left(\frac{1 + (-1)^n}{2} \cos\left(\frac{4\pi\lambda\lambda'}{k}\right) - \frac{1 + (-1)^{n+1}}{2} \imath \sin\left(\frac{4\pi\lambda\lambda'}{k}\right) \right) \end{aligned} \quad (318)$$

⁸⁹The A_b constant used in [107] is here assumed to be real. This is not of much importance since a phase could be removed in the definition of the boundary state.

It is worth noticing that no analogue of the formula (305) can be written for the boundary state of a non-degenerate representation (either in the x basis or in the n, p basis). For Liouville theory and the $SL(2, \mathbb{R})/U(1)$ coset there is no such difficulty and analogues of (305) can be written for boundary states associated to both degenerate and non-degenerate representations.

Thanks to the formula:

$$\int_0^\infty \frac{r^{\mu-1} dr}{(1+r)^\nu} = \frac{\Gamma(\mu)\Gamma(\nu-\mu)}{\Gamma(\nu)} \quad (319)$$

the Fourier transform of a degenerate boundary state reads:

$$\begin{aligned} {}_B\langle J|\lambda; n, p\rangle &= -i(8k)^{\frac{1}{4}} \nu^{-i\lambda} \Gamma\left(1 - \frac{2i\lambda}{k}\right) \sinh\left(\frac{2\pi\lambda(2J+1)}{k}\right) \\ &\quad \times \frac{\Gamma(\frac{1-i\nu}{2} + i\lambda)\Gamma(\frac{1+i\nu}{2} + i\lambda)}{\Gamma(1+2i\lambda)} \delta_{n,0} \end{aligned} \quad (320)$$

The annulus amplitude for a spherical brane and an AdS_2 brane is then:

$$\begin{aligned} {}_B\langle \lambda' | q'^{H_P/2} | J \rangle_B &= \int_0^\infty d\lambda \frac{1}{(2\pi)^2} \sum_{n \in \mathbb{N}} \int_{\mathbb{R}} dp \chi_\lambda(q') {}_B\langle \lambda' | \lambda; n, p \rangle \langle \lambda; n, p | J \rangle_B \\ &= \frac{1}{i\tau} \int_0^\infty \frac{S_{\lambda'}^\lambda(\tau) S_J^\lambda}{S_0^\lambda} \chi_\lambda(q') d\lambda \\ &= \frac{1}{i\tau} \sum_{J'+\frac{1}{2}=-J}^J \chi_{\lambda'+i(2J'+1)/2}(q) \end{aligned} \quad (321)$$

where $q' = e^{2i\pi\tau'}$ and $\chi_{\lambda'+i(2J'+1)/2}(q) = \frac{q^{b^2(\lambda'+i(2J'+1)/2)^2}}{\eta(\tau)^3}$. The following formulas were used in the last line:

$$\begin{aligned} \frac{\sinh nx}{\sinh x} &= \sum_{n'=1-n, 2}^{n-1} e^{n'x} \\ 2 \cos a \cos b &= \cos(a+b) + \cos(a-b) \end{aligned} \quad (322)$$

where the sum is over $n+n'-1$ even. Once again, it is possible to rewrite the annulus amplitude in terms of the fusion coefficients, which for a degenerate and a non-degenerate representations were in section 6.2.3 found to be:

$$\mathcal{N}_{\lambda; J}^{\lambda', J'} = \begin{cases} 1 & \text{if } \begin{cases} -J \leq J' + \frac{1}{2} \leq J, & J + J' + \frac{1}{2} \in \mathbb{N} \\ \lambda = \lambda' \end{cases} \\ 0 & \text{else} \end{cases} \quad (323)$$

The annulus amplitude is then:

$${}_B\langle \lambda' | q'^{H_P/2} | J \rangle_B = \frac{1}{i\tau} \int_0^\infty d\lambda \sum_{J' \in \frac{1}{2}\mathbb{N}} \mathcal{N}_{\lambda; J}^{\lambda', J'} S_{\lambda', J'}^\lambda(\tau) \chi_\lambda(q) \quad (324)$$

which implies that:

$$\frac{S_{\lambda'}^\lambda(\tau)S_J^\lambda}{S_0^\lambda} = \sum_{J' \in \frac{1}{2}\mathbb{N}} \mathcal{N}_{\lambda'; J}^{\lambda', J'} S_{\lambda', J'}^\lambda(\tau) \quad (325)$$

This relation can be inverted like in (312) in order to write a Verlinde-like formula:

$$f(z) = \int_0^\infty \frac{S_{\lambda'}^\lambda(\tau)S_J^\lambda}{S_0^\lambda} e^{2i\pi\sqrt{\frac{2}{k}}\lambda z} d\lambda \quad (326)$$

where $\Im z > \frac{2J}{\sqrt{2k}}$. The above function can be extended by analytic continuation to the whole complex plane, except for some poles, whose set is equal to $\{z_{J'} = -\frac{i}{\sqrt{2k}}(2J' + 1) \pm \sqrt{\frac{2}{k}}\lambda' | \mathcal{N}_{\lambda'; J}^{\lambda', J'} \neq 0\}$. The fusion coefficients are therefore given by the residues of the function f :

$$2i\pi \text{Residue}_{z=z_{J'}}(f) = \mathcal{N}_{\lambda'; J}^{\lambda', J'} \quad (327)$$

6.3.3 Generalization

Finally, it is possible to formally generalize the above results obtained for a non-degenerate representation λ' to any non-degenerate representation labeled by $\tilde{\lambda}' \in \mathbb{C}$ such that $\tilde{\lambda}' \neq i(J + \frac{1}{2})$ for any half-integer J . These representations reduce to the usual non-degenerate unitary representations when $\tilde{\lambda}'$ has no imaginary part. The character, modular transformation and wave function are the same as (290), (293) and (314) respectively, replacing λ' by $\tilde{\lambda}'$. The annulus amplitude for these non-unitary non-degenerate representations is:

$${}_B \langle \tilde{\lambda}' | q^{H_P/2} | J \rangle_B = \frac{1}{i\tau} \sum_{J' + \frac{1}{2} = -J}^J \chi_{\tilde{\lambda}' + i(J' + \frac{1}{2})}(q) \quad (328)$$

This expression, again, agrees with the fusion coefficients:

$$\mathcal{N}_{\tilde{\lambda}'; J}^{\tilde{\lambda}'} = \begin{cases} 1 & \text{if } \begin{cases} \Im(\tilde{\lambda}' - \tilde{\lambda}) = i(J' + \frac{1}{2}) \text{ with } 2J' \in \mathbb{N} \\ -J \leq J' + \frac{1}{2} \leq J, \quad J + J' + \frac{1}{2} \in \mathbb{N} \\ \Re \tilde{\lambda}' = \Re \tilde{\lambda} \end{cases} \\ 0 & \text{else} \end{cases} \quad (329)$$

A formula similar to equation (327) can be obtained. In deriving these relations, the idea of extending the Verlinde formula into the domain of complexified momenta was briefly explored. See some comments in the conclusion.

6.4 Conclusion

This dissertation has reviewed the H_3^+ theory explicitly, but not other non-rational conformal field theories like bosonic Liouville theory and the supersymmetric coset $SL(2, \mathbb{R})/U(1)$ ⁹⁰, which were treated along with H_3^+ in [1].

⁹⁰Recall that the bosonic coset $SL(2, \mathbb{R})/U(1)$ is dual to bosonic Liouville, and the same kind of relation holds for the supersymmetric theories. See *e.g.* [117].

The other theories behave in a similar manner, that is to say: for each theory there exist degenerate and non-degenerate representations, for which the characters and their modular transformations are known, and so are the one-point wave-functions for branes and the reflection parameter (that are related to the modular S -matrix by a generic formula [98]). In each theory it is possible to write an analogue of the Verlinde formula, both for two degenerate representations or for one degenerate and one non-degenerate representations, and to check the extension of Cardy's condition for boundary states.

The formulas that were found apply only to a subset of representations, involving the fusion (or modular transformation matrices) of degenerate representations. These representations are characterized by null vectors appearing in the associated chiral Verma module. It is known that these representations are crucial when deriving differential equations for the (bulk and boundary) correlation functions of the non-degenerate fields by postulating the decoupling of null vectors. Thus, degenerate representations have already been put to good use to determine the structure of non-rational conformal field theories through differential methods. One can view the results on the generalized Verlinde formula for degenerate representations as laying bare some of the algebraic structure underlying solutions for the unitary sector of non-rational conformal field theories (even though degenerate representations may not be contained in the unitary conformal field theory spectrum).⁹¹

Moreover, an ubiquitous phenomenon appeared in these notes. Instead of concentrating on quantities which depend on a real variable parameterizing the unitary (continuous, say) spectrum of a non-rational conformal field theory, it is possible to consider functions of a complexified parameter. This is familiar from the analysis of discrete contributions to partition functions [111, 119], from the determination of the moduli space of FZZT branes in minimal string theories and its properties [120], from the determination of the fusion of degenerate representations from the fusion of non-degenerate ones, and now from the fact that the generalized Verlinde formula is based on this same idea (*i.e.* rendering a function regular by complexifying a momentum, and then extending the domain of definition of the regularized function over the complex plane). Some new examples of connections of the Verlinde type have been presented here, between modular transformation properties and fusion of non-unitary representations, associated to complexified momenta. Although these complexifications

⁹¹As is well known, non-unitary sectors of conformal field theories are not only interesting for two-dimensional physics (*e.g.* the Yang-Lee edge singularity), but also arise in the covariant quantization of unitary string theories (for instance, the conformal theory of ghosts in bosonic theory is non-unitary since the two ghost fields have conformal weights 2 and -1). See *e.g.* [118] for some comments on non-unitary conformal field theories. The Yang-Lee singularity appears in the description of the zeros of the partition function of a lattice theory, like the Ising model, in the scaling limit in which the number of sites becomes infinite. Near a specific value of the electromagnetic field, the density of zeros follow a power law as a function of the field. The critical exponent is described by a minimal model of central charge $c = -22/5$, which contains two primary fields of conformal weights 0 and $-1/5$, and is therefore non-unitary. One needs to keep the distinction between unitary conformal field theories and unitary string theories always carefully in mind.

may seem formal on occasion, they may point towards quite generic structures underlying non-rational conformal field theories, which may be more naturally defined in a complexified external parameter space (*e.g.* bulk coupling constants, external momenta, boundary coupling constants).

In the context of string theoretic applications of the branes of non-rational conformal field theories, it is clear that a generalized Verlinde formula is expected to be at work for branes that are localized (or boundary state calculations involving at least one localized brane). The localization of the associated open string avoids having to deal with volume divergences (see *e.g.* [107]), which is crucial for the calculations presented here⁹².

Apart from the new calculations performed in [1], one may be able to apply the techniques developed here to a further variety of non-rational conformal field theories, including theories with $N = 4$ superconformal symmetry, with $N = 2$ extended superconformal symmetry at central charge $c = 9$, the \mathcal{H}_{2n+2} models (*e.g.* the localized $S(-1)$ brane in H_4 [121]), and the bosonic $SL(2, \mathbb{R})/U(1)$ model. Further open problems include an analysis of the mechanics of both fusion and modular transformations at rational values for the central charge (some results are already known, see *e.g.* [122]).

One hope is that an understanding of these sectors that connect analytic to algebraic properties of non-rational conformal field theories will allow for more efficient algebraic constructions of boundary conformal field theories. These in turn would allow for a better understanding of for instance D-branes in non-compact Calabi-Yau's and the spectrum of open strings living on them, to name only one application.

⁹²It would be interesting to find regularizations of brane partition functions that grow like the volume of a non-compact space, and that are consistent with all the symmetries of the theory.

7 Rigid open strings, Lie algebras and star products

This section presents the results of [2]. In order not to paraphrase the whole paper, a few unnecessary parts of it will be simply mentioned, while other parts will be treated in more detail. Some elements of group theory, especially adjoint and co-adjoint representations, have been reviewed in section 3. They will prove to be useful here.

7.1 Introduction

The work [2] focused on the study of a class of non-commutative theories that arise as a semi-classical limit of open strings on D-branes in group manifolds, which was first discussed in [123]. Since then non-commutative theories [124] have received a lot of attention. It generically arises in string theory in a limit in which the background anti-symmetric tensor dominates. See [125] for a review. The present study was motivated by the physics of open strings, but is not restricted to this setting only (non-commutativity is natural in open string theory since the interaction of open strings involves the joining of the endpoints and is similar to matrix multiplication). One hope was to learn more about non-local theories of quantum gravity (string theory, for instance). Another motivation was to connect physics to the mathematics of star product theory.

The semi-classical limit gives rise to rigid open strings on group manifolds, whose dynamics can be elegantly coded in group theory coefficients ($3j$ and $6j$ symbols). In the case of compact groups, the results of [126] were extended to the case of multiple branes and the results of [127] were reformulated in a diagrammatic formalism (all of this is a simplified version of rational boundary conformal field theories), while for non-compact groups, the construction gives rise to new associative products. The associative product constructed in this way is directly related to the boundary vertex operator algebra of open strings on symmetry preserving branes in Wess-Zumino-Witten models, including the case of non-compact groups. The groups $SU(2)$ and $SL(2, \mathbb{R})$ (or rather an isomorphic group, $SU(1, 1)$) are treated explicitly. The precise relation of the semi-classical open string dynamics to Berezin quantization and to star product theory was also discussed in [2] and is mentioned here.

In particular, the study firstly concentrates on a semi-classical limit of open strings on generic group manifolds. This has the advantage of considerably simplifying the analysis of the open string dynamics (while sacrificing finite bulk curvature effects), and provides an elegant semi-classical picture of open string dynamics on group manifolds. In order to present it, and to show its generality, the theory of quantization of co-adjoint orbits (which describes the behavior of one end of an open string), the quantization of pairs of orbits (for the two endpoints of an open string) and the composition of operators on the resulting Hilbert spaces (corresponding to the concatenation of open strings) are discussed.

Again, for compact Lie groups this part of the analysis is a simpler, limiting version of the analysis of chiral classical conformal field theory [25], or boundary vertex operator algebras [48]. Providing an intuitive and precise picture for the semi-classical limit of rational boundary conformal field theory may however be interesting in its own right. Furthermore, the picture also applies to non-rational boundary conformal field theory which is much less understood. Thus, the construction is put to good use, by being explicitly applied to the example of non-compact groups.

The possibility to extend the intuitive picture that holds for the quantization of orbits of Lie groups in the semi-classical limit to quantum Lie groups is also discussed. In doing so, one should recuperate the full solution to rational boundary conformal field theories in the case of symmetry preserving D-branes in Wess-Zumino-Witten models on compact groups. The construction should generalize to non-compact groups.

Since the dissertation refers to a lot of concepts that have been highly developed by different communities, it is not possible to review them all fully. The strategy followed in [2] was to first illustrate the concepts in the simple case of the group $SU(2)$. It is roughly the same here, although the non-compact group $SU(1,1)$ is treated in more detail. The way to obtain more general results on these structures and to include the case of quantum groups is sketched by citing the relevant references. The following work is organized as follows: section 7.2, in relation with section 3, provides a mathematical background for the following work, section 7.3 reviews the orbit method, section 7.4 generalizes it to pairs of orbits, introduces and analyzes the action for rigid open strings on group manifolds, and discusses the interaction of strings, section 7.5 applies the construction to the $SU(2)$ group and section 7.6 and 7.7 review the structure constants for the $SU(1,1) \equiv SL(2, \mathbb{R})$ case and work out how the formalism applies to this non-compact case. Finally, the case of quantum groups is treated in section 7.8.

7.2 Mathematical introduction

The method of orbits has been widely studied [22, 128]. This section provides a mathematical introduction to the basic features of co-adjoint orbits (see section 3.3 for a definition), symplectic geometry and geometric quantization. It is a necessary background to understand the following sections.

7.2.1 Different points of view on orbits

The dual g^* of the Lie algebra g associated to the Lie group G can be thought of as a *Poisson manifold*, *i.e.* a smooth manifold such that the Poisson brackets:

$$\{f_1, f_2\} = f^{ab} {}_c J^c \partial_a f_1 \partial_b f_2 \quad (330)$$

(where J^c are the generators of the algebra and $f^{ab} {}_c$ its structure constants) define a Lie algebra on the space of smooth functions on g^* . Then the linear functions on g^* form a Lie algebra isomorphic to g^* , since $\{J^a, J^b\} = f^{ab} {}_c J^c$.

The bivector $c = f^{ab}{}_c J^c \partial_a \partial_b$ induces a *symplectic form* on g^* , *i.e.* a differential 2-form that is non-degenerate and closed. Now, g^* as a Poisson manifold can be uniquely foliated by its *symplectic leaves*⁹³, and these symplectic leaves are exactly the co-adjoint orbits. This connects the theory of orbits and the theory of symplectic structures, and is the starting point for the more specific remarks of the next paragraph.

The connection between orbits and symplectic geometry is made clearer by the observation that on each co-adjoint orbit $\Omega \subset g^*$ seen as a differential manifold, there is a canonically defined G -invariant symplectic form ω (which is the restriction of the symplectic form induced by the bivector c to the symplectic leaf Ω). This implies that Ω must be of even dimension $2n$ (n integer), and that $\omega^n \neq 0$. The generic notation for an n -form σ on a manifold M , its exterior derivative and its integral are:

$$\begin{aligned}\sigma &= \frac{1}{n!} \sigma_{\mu_1 \dots \mu_n} dx^{\mu_1} \wedge \dots \wedge dx^{\mu_n} \\ d\sigma &= \frac{1}{n!} \frac{\partial \sigma_{\mu_1 \dots \mu_n}}{\partial x^{\mu_\lambda}} dx^{\mu_\lambda} \wedge dx^{\mu_1} \wedge \dots \wedge dx^{\mu_n} \\ \int_M \sigma &= \text{Vol } M = \int_M \sigma_{1 \dots n} d^n x\end{aligned}\tag{331}$$

The value of the canonical symplectic form in $\lambda \in \Omega$ is:

$$\omega_\lambda(ad_X^* \lambda, ad_Y^* \lambda) = B_\lambda(X, Y) = \langle \lambda, [X, Y] \rangle\tag{332}$$

where B_λ is a natural skew-symmetric bilinear form on g whose kernel is $stab(\lambda)$ and $X, Y \in g$. Although not obvious in the above formulation, ω_λ does not depend on λ . The canonical symplectic form is related to the exterior derivative of the *Liouville one-form*⁹⁴ (see [22, 129]):

$$\theta_\lambda(g) = \langle \lambda, g^{-1} dg \rangle\tag{333}$$

where g is a group element of the Lie group G and $\langle \lambda, g^{-1} dg \rangle$ denotes the evaluation of λ on the element of the Lie algebra $g^{-1} dg$. The evaluation \langle, \rangle is assumed to be bilinear and invariant under the action of the group G .

A *homogeneous* space (with respect to a "motion" group G) is a set which coincides with the orbit, under the action of G , of one of its points. An orbit Ω is therefore, by definition, a homogeneous (symplectic) manifold. There is a one-to-one correspondence between homogeneous spaces and quotient groups G/H where H is a subgroup of G that is the stabilizer of one point of the homogeneous space. This justifies the identification $\Omega_\lambda \sim G/Stab(\lambda)$ if λ is a point of the orbit $\Omega = \Omega_\lambda$. Moreover, this implies that orbits can be seen as *flag*

⁹³Each leaf is a submanifold of the Poisson manifold, and each leaf is a symplectic manifold itself. Two points lie in the same leaf if they are joined by the integral curve of a Hamiltonian vector field.

⁹⁴In canonical notations from Hamiltonian mechanics, the Liouville one-form is simply pdq .

manifolds (and therefore as homogeneous *Kähler manifolds*⁹⁵). A flag manifold is a coset space of the form G/H with H a subgroup of G . In the $SU(2)$ case, the S^2 spheres are *full flag manifolds* since they are cosets with respect to the maximal abelian subgroup of $SU(2)$, namely $U(1)$.

Finally, a set X on which a group G acts splits into its orbits under the action of the group. For instance, \mathbb{R}^3 splits into two-spheres under the action of $SU(2)$ and $\mathbb{R}^{2,1}$ splits into hyperboloids, the cone (without the origin) and the origin point under the action of $SO(2,1) \equiv SL(2,\mathbb{R})$. See *e.g.* figure 23. Note that this statement is related to the above remark on the unique foliation of Poisson manifolds, with their symplectic leaves.

7.2.2 Quantization

Geometric quantization [130, 131] (see also [132]) is a process which constructs quantum objects starting from the geometry of the classical ones. It has the advantage of being rather intuitive. The link is established by associating (quantized) co-adjoint orbits to irreducible unitary representations. The one-to-one correspondence in the case of (compact) Lie groups has been studied in several papers, see *e.g.* [22, 133]. More precisely, geometric quantization associates a separable Hilbert space to a symplectic manifold (Ω, ω) , by singling out a class of smooth real-valued functions on Ω (called the quantizable functions) and mapping them to operators.

A Kähler manifold (Ω, ω) is quantizable if there exists over Ω a hermitian holomorphic line bundle with a connexion ∇ of curvature $-2i\pi\omega$ [134, 135]. When Ω is a co-adjoint orbit, with ω the canonical symplectic form, the existence of a proper connexion is equivalent to the condition that the orbit is *integral*, *i.e.* that for every geometric 2-cycle C in Ω , $\int_C \omega \in \mathbb{Z}$ (remark that for $SU(2)$ the only 2-cycle is the whole two-sphere). Therefore an orbit can only be quantized if it is integral.

The correspondence between the co-adjoint orbits and irreducible (unitary) representations is given by the Borel-Weil-Bott theorem (which holds at least for all compact connected Lie groups). A consequence is the relation:

$$\dim \mathcal{H}_\kappa = \theta \text{Vol } \Omega_{\kappa+\rho}, \quad \text{Vol } \Omega = \int_{\Omega} \frac{\omega^n}{n!} \quad (334)$$

where ρ is half the sum of the positive roots of the algebra \mathfrak{g} (it is $\frac{1}{2}$ for $SU(2)$ or $SL(2,\mathbb{R})$), κ labels the representation (the Hilbert space \mathcal{H}) and θ is a function introduced in [134] (it is related to the concept of coherent state), which is a constant since orbits are homogeneous spaces (assuming that the quantization line bundle is also homogeneous). This is consistent with the physical idea that the dimension of the quantum phase space is equal to the volume of the classical phase space in Planck units. Focusing on the $SU(2)$ case, note also

⁹⁵Recall that a complex manifold M is Kähler if in every tangent space to this manifold there is a hermitian form such that its real part defines a Riemannian metric on M and its imaginary part defines a symplectic structure. Here, the Riemannian metric is induced by the group metric.

that, because of the presence of ρ , the trivial representation $j = 0$ does *not* correspond to the point, but has a non-zero volume phase space (corresponding to a non-zero energy for the lowest-energy state of a quantum system having $SU(2)$ symmetry).

Finally, an important consequence of the fact that θ is a constant is that Berezin's quantization [136] of a co-adjoint orbit coincides with geometric quantization (see also a nice presentation of Berezin's quantization in terms of coherent states in [137], chapter 2).

7.2.3 Star product and classical limit

The connection to star product theory is established in [135] for compact groups, where Berezin's quantization procedure is used to define on an algebra of functions on an orbit a formal differential star product. Indeed, once a quantization map $f \rightarrow \mathcal{M}(f)$ has been defined, it is possible to define a product in the following way:

$$f_1 * f_2 = \mathcal{M}^{-1}(\mathcal{M}(f_1)\mathcal{M}(f_2)) \quad (335)$$

where $\mathcal{M}(f_1)\mathcal{M}(f_2)$ is the product of operators. The star (*) product on orbits of a Lie group G is G -invariant. This product is an associative deformation of the usual product of smooth functions and can be defined as an (*a priori* formal) asymptotic expansion according to the definition of star products (the first term is the usual product, and the second term is related to the Poisson brackets). Finally, when the orbit is a (compact) hermitian symmetric⁹⁶ space, the asymptotic expansion of the star product is convergent. This implies that in the limit in which the expansion parameter tends to zero, one recuperates the usual product.

Finally, the connection with the classical limit was made in [134, 135]. It relies on the fact that the quantization bundles over the orbit (and the orbit as well) are homogeneous. When the overall multiplicative factor of the symplectic form is sent to infinity (this corresponds for $SU(2)$ to the size of the sphere, or the dimension of the $SU(2)$ representation, being sent to infinity), then the algebra of quantizable functions on the orbit (which is equivalent to a set of symbols, or operators, in the Hilbert space, via the quantization map) grows and eventually becomes dense in the algebra of smooth functions on the orbit.

7.3 Co-adjoint orbit quantization

This section starts by building an elementary picture of open string interactions, by concentrating on one of the endpoints of the open string (see figure 14). The associated degrees of freedom are quantized using the mathematical framework of the orbit method⁹⁷.

⁹⁶This is the case for complete Riemannian spaces if and only if the curvature tensor is covariantly constant (Cartan-Ambrose-Hicks theorem).

⁹⁷Open strings provide an intuitive picture for most of the models developed here, since they can be embedded in open string theory (one thing to check is that the group under study



Figure 14: The study first concentrates on one endpoint of an open string.

7.3.1 An electric charge in the presence of a magnetic monopole

This subsection shows how the results that are discussed later originate from a physical context, by analyzing the quantization of a charged particle on a sphere, with a magnetic monopole sitting at the center of the sphere. The particle will only interact electromagnetically. The quantization of the particle then boils down to the quantization of a co-adjoint orbit of $SU(2)$.

The magnetic monopole The setting consists of the three-dimensional flat space \mathbb{R}^3 , with spherical coordinates:

$$x^1 = r \sin \theta \cos \phi, \quad x^2 = r \sin \theta \sin \phi, \quad x^3 = r \cos \theta \quad (336)$$

and of a magnetic monopole of integer charge n placed at the origin of the coordinate system $x^i = 0$. The magnetic field it generates is described in terms of the vector potentials:

$$\begin{aligned} A^\pm &= \frac{n}{2}(\pm 1 - \cos \theta)d\phi \\ F &= dA^\pm = \frac{n}{2} \sin \theta d\theta \wedge d\phi \end{aligned} \quad (337)$$

where the vector potentials A^\pm are valid near north ($\theta = 0$) and south ($\theta = \pi$) poles respectively. They are related by a gauge transformation $A^+ = A^- + d(n\phi)$, which is well defined provided n is indeed integer.

A charged particle on the sphere The next step is to introduce a charged particle, and to constrain it on a sphere in the presence of the magnetic monopole (see figure 15). The action in the large magnetic field limit is the electromagnetic coupling only [133, 138]:

$$S = \iota \int A^\pm = \iota \frac{n}{2} \int d\tau (\pm 1 - \cos \theta) \dot{\phi} \quad (338)$$

The equations of motion are then derived. They imply that the velocity of the particle is zero. The solutions to the equations of motion thus correspond to the particle sitting at a fixed point of the two-sphere. Thus, the classical phase space, which is the space of classical solutions, is the two-sphere.

The global symmetries of the problem at hand are the $SU(2)$ rotations which act transitively on the phase space. The charges associated to the $SU(2)$ global

is such that the total central charge can be set to zero). However, a large part of the analysis applies in a more general context.

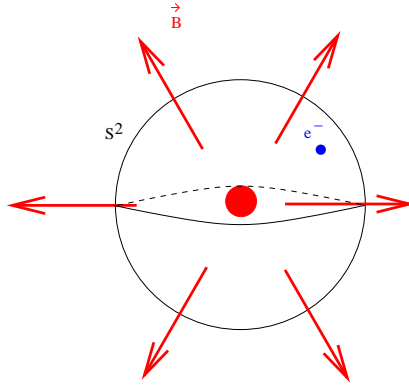

Figure 15: An electron bound to a sphere, with a magnetic monopole in the middle of the sphere.

symmetries are the positions x^i of the particle, which are indeed conserved (since the particle does not move). They can be shown to satisfy $SU(2)$ commutation relations under the Dirac bracket (see *e.g.* [139]). The Hamiltonian of the purely topological action (338) is zero.

The quantization of the spherical phase space There are many ways to understand the quantization of the above system of electric charge and magnetic monopole, and to see why the number n must be integer.

The phase space can be quantized to find the Hilbert space. The dimension of the Hilbert space is the number of Planck cells that fit into the two-sphere. The symplectic form arising from the action is the volume form of the two-sphere with quantized overall coefficient, and consequently the number of Planck cells in phase space is computed to be the integer number $\frac{1}{2\pi} \int_{S^2} \frac{n}{2} \sin \theta d\theta d\phi = n$. In the geometric quantization viewpoint presented in section 7.2, this amounts to the fact that the orbit must be integral. Since the group $SU(2)$ is represented on the Hilbert space, the Hilbert space of the particle is a spin $j = \frac{n-1}{2}$ representation of $SU(2)$. The group acts transitively on the classical phase space, and is represented irreducibly on the quantum Hilbert space.

Another reason for the quantization of n was already evoked and is related to the gauge transformation of the vector potentials. The result is obtained by requiring that the action $S = \imath \int A^\pm$ be unambiguously defined (up to a multiple of $2\imath\pi$) for closed worldline trajectories. This constraint comes from quantum theory in which $\exp(S)$ is the weight of the path integral. Since the action can be computed by calculating the flux either through the cap or the bowl (*i.e.* filling in the Wilson loop (see figure 16) either over the north or the south pole), the difference (divided by $2\imath\pi$), which is precisely equal to n , must be an integer.

Thus, the (half-integer) quantization of spin j in this context is re-interpreted in the electron/magnetic monopole system as being associated to the Dirac

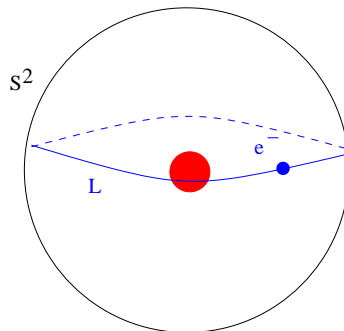

Figure 16: The (blue) curve traced by the electron associated to a Wilson loop. The Wilson loop can be computed by calculating the flux through the upper cap (– the hat –) or the lower cap (– the bowl –), and must be unambiguous.

quantization condition for the product of electric and magnetic charge n .

In the context of Feynman path integral, an interesting work concerning the quantization of co-adjoint orbits of $SU(2)$ is [140]. It shows that not all states propagate on the orbit, and that the unitarity of the path integral, obtained by projecting out the states that do not propagate, leads to a quantization of the radius of the sphere. The quantization condition is similar to the one used for the Dirac monopole (mentioned here in terms of the gauge field A^\pm) or for the Wess-Zumino-Witten models.

The functional integral has also been used in [133] to quantize the orbits of $SU(2)$, with the same action as (338) (up to boundary terms). Once again, [133] obtains unitary representations of $SU(2)$ for integer n . Interestingly, the character was computed as an integral around a closed path, and the result agrees with the $SU(2)$ characters given in (94) (for integer n). See also [138]. It is worth noting that different regularizations of the path integral exist (see *e.g.* the appendix of [115]). These different regularizations give slight shifts in the interpretation of the coefficient of the action (as twice the spin or rather $2j + 1$). The difference can be understood as different types of geometric quantization (see section 7.2), one identifying \mathcal{H}_κ with Ω_κ , the other with $\Omega_{\kappa+\rho}$. The correct prescription is the one chosen here and explicitly written in (334). The condition that the orbit $\Omega_{\kappa+\rho} = \Omega_j$ be quantizable is equivalent to the quantization of the spin j .

Moreover, the quantization condition is discussed in [141] in terms of the phase of the wave-functional related to the boundary state associated to the D-brane (*i.e.* the two-sphere), which must not be ambiguous. Once again, the condition arises from the fact that a closed loop can be contracted in two different ways (this is similar to the condition on the gauge field A^\pm).

Finally, a clear and pedestrian way to understand the quantization of the sphere in terms of the $SU(2)$ structure is to start from the algebra of functions on the sphere and then try to find a quantum analogue *i.e.* an algebra of

(hermitian) operators (matrices) verifying [142]:

$$[X_a, X_b] = i\epsilon_{abc}X_c, \quad C = \sum_{a=1}^3 X_a^2 = c \cdot \mathbf{1} \quad (339)$$

where the X_a are the quantum analogues of the classical coordinates x_a (and the Casimir is the analogue of the radius of the sphere). The operators X_a form a representation of $SU(2)$, and the Casimir element is required to be proportional to the identity. This is only true if the representation is irreducible *i.e.* corresponds to a half-integer spin j . Hence, the irreducible representations provide quantizations of a discrete set of two-spheres. This discretization condition is equivalent to the condition that n be integer-valued.

See subsection 7.4.3 for more details on the quantization procedure, in a more general context.

7.3.2 A classical particle on a co-adjoint orbit

To generalize the well-known facts discussed above, observe that the gauge potential can be viewed as arising from the Liouville one-form defined in equation (333). Once the one-form is defined, it is possible to pull it back onto the worldline L of a particle via the map of the particle into the group manifold $g: L \mapsto G: \tau \mapsto g(\tau)$, in order to define the action of the particle as the integral over the worldline of this one-form. For the case of $SU(2)$, this action precisely coincides with the action introduced above [133]. More precisely, using Euler angles $g = e^{i\frac{\phi}{2}\sigma_3} e^{i\frac{\theta}{2}\sigma_1} e^{i\frac{\psi}{2}\sigma_3}$, one finds the correct action:

$$S = \int \left\langle \frac{n}{2}\sigma_3, g^{-1}dg \right\rangle = \int Tr \left(\frac{n}{2}\sigma_3, g^{-1}dg \right) = i\frac{n}{2} \int d\tau (\pm 1 - \cos\theta)\dot{\phi} \quad (340)$$

up to boundary terms. This action can now be generalized to any group manifold, once an element λ of the dual Lie algebra is given [133]:

$$S = \int_L d\tau \langle \lambda, g^{-1}\partial_\tau g \rangle \quad (341)$$

Again, the Hamiltonian corresponding to the action is zero. The global symmetry of the action is G which acts on the particle trajectory $g(\tau)$ by multiplication on the left. The local symmetry (the gauge group) is the stabilizer of λ , and acts by multiplication on the right⁹⁸. The local symmetry makes for the fact

⁹⁸The global symmetry is clear, but the invariance of the action under the local transformation is not straightforward. Under a local transformation, the Lagrangian becomes:

$$\langle \lambda, (gh)^{-1}\partial_\tau(gh) \rangle = \langle h\lambda h^{-1}, g^{-1}\partial_\tau g \rangle + \langle \lambda, h^{-1}\partial_\tau h \rangle \quad (342)$$

The first term on the right-hand side of the equation gives back the original Lagrangian when $h \in Stab(\lambda)$. The second term is actually a total derivative, hence does not matter. This may be shown by first proving the result when h is infinitesimally close to any given element in the group (using that $h^{-1}\partial_\tau h$ is an element of the algebra), then by cutting the integral in the action into infinitesimal steps, and finally by putting everything together. See also [129], formula (9).

that the particle is interpreted not as moving on the full group manifold G , but rather on the manifold $G/Stab(\lambda)$, which coincides with the phase space and is the co-adjoint orbit Ω_λ . For the case of $SU(2)$, this is a two-sphere since $SU(2)/U(1) = S^2$.

The conserved Noether charges associated to the global symmetry group are $I = Ad_g^* \lambda = g \lambda g^{-1}$ and they satisfy the Dirac brackets with the structure constants equal to the structure constants of the Lie algebra of the group [139]. The charges I are the generalization of the positions x^i . For instance, in the case $G = SU(2)$, expressing g in Euler coordinates and choosing $\lambda = \sigma_3$, one obtains $I = \cos \theta \sigma_3 + \sin \theta (\sin \phi \sigma_1 + \cos \phi \sigma_2)$ which indeed yields the coordinates of a two-sphere in the vector space g^* . The symmetry group G acts transitively on the phase space. The global charges and functions thereof are gauge invariant observables of the theory.

7.4 Rigid strings

7.4.1 Generalization

The above results valid for $SU(2)$ can be generalized to (*a priori*) any Lie group. Another generalization consists in considering two points instead of one, in order to describe the two endpoints of a string. These two points will have opposite charge and are connected by a spring that is represented by a potential term in the action that is proportional to the distance squared between the two endpoints of the string⁹⁹. Assuming that a non-degenerate bilinear invariant metric on the Lie algebra exists¹⁰⁰ (the existence of such a metric implies that one can identify the Lie algebra with its dual, as will be done below), the action of the rigid string on the group manifold G is given by:

$$S = \int_L d\tau (\langle \lambda_I, g_I^{-1} \partial_\tau g_I \rangle - \langle \lambda_F, g_F^{-1} \partial_\tau g_F \rangle) + \frac{K}{2} \int_L d\tau \langle g_I \lambda_I g_I^{-1} - g_F \lambda_F g_F^{-1}, g_I \lambda_I g_I^{-1} - g_F \lambda_F g_F^{-1} \rangle \quad (343)$$

where K parametrizes the strength of the interaction, $g_{I,F}$ are the endpoints of the string which live on the manifolds (co-adjoint orbits) $G/Stab(\lambda_{I,F})$ respectively, and $\lambda_{I,F}$ are elements of the dual of the Lie algebra g^* .

The local symmetry group (gauge transformation of $g_{I,F}$) is $Stab(\lambda_I) \times Stab(\lambda_F)$, while the global symmetry group is broken, by the interaction term, to the diagonal left action on both group elements¹⁰¹.

⁹⁹The fact that strings may behave like dipoles was already explained in [143], in a large (magnetic) field limit for the case of flat space. The joining and separation of the dipoles studied in [143] is described by a gauge theory on the non-commutative plane.

¹⁰⁰In a matrix representation of a semi-simple algebra, the metric contraction is simply given by the trace: $\langle A, B \rangle = \text{Tr}(AB)$. It is indeed bilinear and G -invariant.

¹⁰¹This is to be compared to the symmetry of a usual spring in flat space under overall translation.

The classical dynamics of the system is solved for as follows. The equations of motion are:

$$\begin{aligned}\partial_\tau(g_I\lambda_I g_I^{-1}) + K[g_I\lambda_I g_I^{-1}, g_F\lambda_F g_F^{-1}] &= 0 \\ -\partial_\tau(g_F\lambda_F g_F^{-1}) + K[g_F\lambda_F g_F^{-1}, g_I\lambda_I g_I^{-1}] &= 0\end{aligned}\quad (344)$$

where $[\cdot, \cdot]$ denotes the commutator. It is convenient to introduce the (non-conserved) charges $I_I = g_I\lambda_I g_I^{-1}$ and $I_F = -g_F\lambda_F g_F^{-1}$. They generate the same algebra (because of the opposite sign of the charges and of the symplectic structures for the final point compared to the initial point). The second charge I_F corresponds to *minus* the position of the final end-point of the string. Moreover, both $I_{I,F}$ lie on a given orbit, and $\langle I_I, I_I \rangle = \langle \lambda_I, \lambda_I \rangle$ (similarly for the final point). The sum of these charges is conserved:

$$\partial_\tau(I_I + I_F) = 0 \quad (345)$$

It generates the simultaneous translation (global diagonal action of the group) $g_{I,F} \mapsto h g_{I,F}$ where h is any element of G . The equations of motion can be rewritten in terms of the charges $I_{I,F}$:

$$\begin{aligned}\partial_\tau I_I - K[I_I, I_F] &= 0 \\ \partial_\tau I_F + K[I_I, I_F] &= 0\end{aligned}\quad (346)$$

The difference $I_I - I_F$ can now be computed to be:

$$\begin{aligned}\partial_\tau(I_I - I_F) &= 2K[I_I, I_F] = K[I_I - I_F, I_I + I_F] \\ I_I - I_F &= e^{-\tau K(I_I + I_F)}(I_I - I_F)_0 e^{\tau K(I_I + I_F)}\end{aligned}\quad (347)$$

This is the solution to the classical dynamics, given an initial condition $(I_I - I_F)_0$ and a constant charge $\Delta = I_I + I_F$. The motion of the individual endpoints follows from the above relations:

$$\begin{aligned}I_I &= \frac{1}{2}e^{-\tau K\Delta}(I_I - I_F)_0 e^{\tau K\Delta} + \frac{\Delta}{2} \\ I_F &= -\frac{1}{2}e^{-\tau K\Delta}(I_I - I_F)_0 e^{\tau K\Delta} + \frac{\Delta}{2}\end{aligned}\quad (348)$$

The conserved quantity Δ is interpreted as the length vector of the string. Indeed, it measures the fixed difference vector (in the Lie algebra) between the initial and final points of the string. The Hamiltonian is proportional to the length squared of the string $\langle \Delta, \Delta \rangle$, which is quite reminiscent of the usual spring. The motion is then dictated by conjugation of the initial vector $(I_I - I_F)_0$ by the group element which is the exponential of the length vector times the elapsed time times the parameter K .

It is worth considering the example of the group $SU(2)$ in order to illustrate the concreteness of the above solution, which is generically valid. Consider two different orbits $\lambda_{I,F}$ (*i.e.* spheres of different radii) and a length vector $I_I + I_F$ proportional to σ_3 . Conjugation by a vector proportional to σ_1 , say, will then

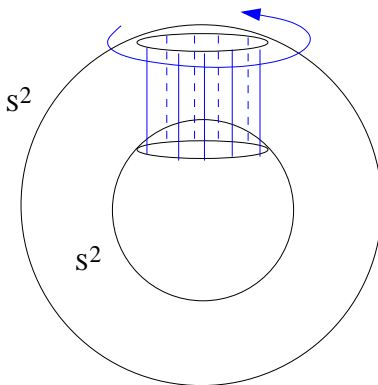

Figure 17: A rigid string stretching between two different $su(2)$ orbits, and rotating.

lead to a velocity in the σ_2 direction. This means that the rigid string rotates around the central axis parallel to itself, see figure 17. Finally, assuming that $\lambda_{I,F} = \frac{1}{2}n_{I,F}\sigma_3$, the length squared of the string is computed to be:

$$\langle \Delta, \Delta \rangle = \frac{1}{2} (n_I^2 + n_F^2 + 2n_I n_F \cos \theta) \quad (349)$$

where $g_F^{-1} g_I = e^{i\frac{\phi}{2}\sigma_3} e^{i\frac{\theta}{2}\sigma_1} e^{i\frac{\psi}{2}\sigma_3}$ in the Euler angles. Using similar assumptions, the length squared of the string for the group $SU(1,1)$ becomes:

$$\langle \Delta, \Delta \rangle = -\frac{1}{2} (n_I^2 + n_F^2 + 2n_I n_F \cosh t) \quad (350)$$

since Euler angles for $SU(1,1)$ are obtained from the $SU(2)$ case by setting $\theta = -it$. The orbits are labeled by $\lambda_{I,F} = \frac{1}{2}n_{I,F}\sigma_3$.

7.4.2 A check from Wess-Zumino-Witten models

The statement that the action (343) does describe open strings on Lie groups deserves some more explanation.

For open strings on group manifolds described by a bulk Wess-Zumino-Witten model, the solutions to the classical equations of motion factorize into a left-moving and a right-moving part:

$$\begin{aligned} g &: \text{strip} \rightarrow G \\ (\sigma, \tau) &\mapsto g(\sigma, \tau) = g_+(\sigma + \tau)g_-(\sigma - \tau) \end{aligned} \quad (351)$$

where the strip is the product of intervals $[-\frac{\pi}{2}; \frac{\pi}{2}] \times \mathbb{R}$. The left-moving and right-moving conserved currents are:

$$J_+ = -\partial_+ g g^{-1}, \quad J_- = g^{-1} \partial_- g \quad (352)$$

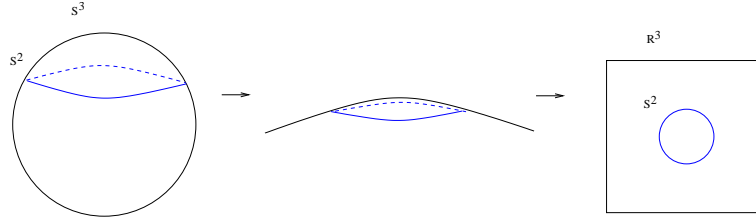

Figure 18: The limit turning a conjugacy class into an orbit for the example of $G = SU(2)$. The size of the conjugacy class (orbit) is kept fixed, while rescaling the group metric until it becomes flat.

where $x^\pm = \sigma \pm \tau$. The ansatz:

$$g_+ = e^{x^+ T_+} g_+^0, \quad g_- = (g_-^0)^{-1} e^{x^- T_-} \quad (353)$$

solves the equations of motion. The Dirichlet boundary condition imposes that $-J_+ = J_- = T_+ = T_- = T$ where T belongs to the Lie algebra of G . The complete solution to the equations of motion with the boundary conditions (where $g^0 = g_+^0 (g_-^0)^{-1}$) is then:

$$g(\sigma, \tau) = e^{x^+ T} g^0 e^{x^- T} = e^{\tau T} (e^{\sigma T} g^0 e^{\sigma T}) e^{-\tau T} \quad (354)$$

The latter form of the solution shows that every rigid string bit (at fixed value for σ) moves along its own conjugacy class. In the rigid open string limit of interest [127], the motion of the string is concentrated near a given point (say, the identity) of the group manifold. See figure 18 for a geometric picture of this limit in the case of $SU(2)$ (the metric is rescaled such that the group manifold becomes flat. This involves sending the level of the associated Wess-Zumino-Witten model to infinity, however the volume of the conjugacy class under study is kept fixed. This means that it will be a conjugacy class very close to, say, the identity of the group manifold. The group manifold is then approximated by its tangent space, which is the Lie algebra. The conjugacy class of an element near the identity is therefore equivalently described by the orbit of the associated element of the Lie algebra. This is how the relevance of orbits in this limit becomes manifest). The limit can be implemented in the study of the classical solution by assuming that $e^{\sigma T} g^0 e^{\sigma T}$ is near the identity. Putting $g^0 = e^{X^0}$ and $g = e^X$:

$$X(\sigma, \tau) = e^{\tau T} (X^0 + 2\sigma T) e^{-\tau T} \quad (355)$$

It is clear that the two end-points of the open string now behave precisely as in the system described by the action (343), namely, they move along orbits in the Lie algebra in agreement with the above description. By comparing equations (348) and (355), one can identify the parameters $\Delta = -2\pi T$, $(I_I - I_F)_0 = 2X_0$ and $\tau = 2\pi K \tau'$, where τ is the time used here, to be distinguished from the

time used in the previous subsection. The comparison shows that the charges $I_{I,F}$ are indeed the positions of the endpoints of the string on the Lie algebra.

Finally, the results of [144] support the above picture. This paper carefully defines and analyzes the rigid open string limit for the $SU(2)$ case, starting from the Wess-Zumino-Witten action for open strings. This action is the sum of four terms, the non-linear σ -model term and the Wess-Zumino term for the worldsheet, and two extra terms for the coupling of the two endpoints of the string to the gauge fields living on the spherical D2-brane (recall that these branes are stable [145]). In the scaling limit¹⁰² where the volume of the brane is kept fixed, while the bulk is flattened (semi-classical limit $k \rightarrow \infty$, in which the excitations of the string decouple), [144] shows that the action reduces to an action for two oppositely charged point particles interacting through a spring. Once the equations of motion are plugged in the action (turning it into a single integral since the string is rigid), the resulting action coincides with the one given in equation (343) when restricted to the case of the group $G = SU(2)$. The Hamiltonian, which is the last term in (343), is found in [144] to be the squared length of the string times an elastic constant. The one-form arises from the electromagnetic field on the D-branes, while the Hamiltonian arises from the bulk length term, and the kinetic term vanishes (as in flat space [143]) in the limit.

The above considerations and verifications seems convincing enough. The limiting procedure on the action must generalize to all groups with a non-degenerate invariant metric. Therefore, the system (343) describes the classical open string dynamics in the rigid limit, and it seems reasonable to think that the quantization of the system also faithfully represents aspects of quantum mechanical open string theory.

7.4.3 The rigid open string Hilbert space

In the quantum theory, the Hilbert space is a tensor product of irreducible representations $\lambda_I \otimes \bar{\lambda}_F$ (the conjugate representation accounts for the opposite sign of the charges of the string endpoints). The use of a conjugate representation may be understood in terms of the interaction of strings, which will be discussed later. Indeed, two strings may interact when endpoints are on the same orbit *i.e.* when they are in product representations $\lambda_1 \otimes \lambda_{2'}$ and $\lambda_2 \otimes \lambda_{3'}$. The result must be a string in the representation $\lambda_1 \otimes \lambda_{3'}$, which is possible only if the identity representation is in the tensor product $\lambda_{2'} \otimes \lambda_2$, which is only the case is $\lambda_{2'} = \bar{\lambda}_2$ by definition of the conjugate representation (at least for compact groups). Moreover, it may be checked in the product computations of section 7.5 and 7.7 that the presence of the conjugate representation is necessary for a coherent conservation of the quantum numbers labeled by m or n .

The interaction term (proportional to the tension of the string) *i.e.* the open string Hamiltonian breaks the $G \times G$ global symmetry to the diagonal subgroup. Since one tends to work in a basis where the Hamiltonian is diagonal, it is natural

¹⁰²This is the decoupling limit which in string theory leads to non-commutative geometry, see *e.g.* [123].

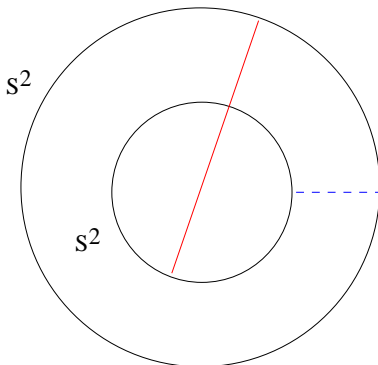

Figure 19: A (blue dashed) string of minimal length and a (red) string of maximal length, stretching between two $su(2)$ orbits.

to decompose the tensor product Hilbert space into representations that are irreducible under the (unbroken diagonal) subgroup: $\lambda_I \otimes \bar{\lambda}_F = \sum_L C_{IF}^L \lambda_L$. The weight λ_L is interpreted as being associated to the length of the string (and therefore also to the position of the center of mass of the string). Indeed, note that the conserved quantities classifying the representations will include the quadratic Casimir of the diagonal symmetry group (– which is associated to the conserved charge $\langle I_I + I_F, I_I + I_F \rangle$ in the classical dynamics –), which is nothing but the length of the string squared. After quantization this quadratic Casimir is proportional to the conformal weight associated to the vertex operator of the open string state.

There is a slight change in perspective in the way in which the open string Hilbert space arises here. If the open string (σ -model) action was directly quantized, then the different components of the open string Hilbert space would arise from *integrating* over all possible lengths T/K of the rigid open string. From the two-particle perspective that is developed here, the same open string Hilbert space arises as a *tensor product* of two single particle Hilbert spaces. After decomposing the tensor product Hilbert space into irreducible representations, it can be checked that the resulting Hilbert spaces coincide.

Returning to the simple example of $SU(2)$, and fixing for instance that the open string begins and ends on one given D-brane labeled by $j = j_I = j_F$, the Hilbert space is decomposed into representations of spins $l = 0, 1, \dots, 2j$ which correspond to a string of length zero up to the maximal extension $2j$. The quadratic Casimir will in this case be roughly proportional to the length squared, as is the dimension of the (primary) open string vertex operator : $h_{open} = l(l+1)/(k+2)$. A minimal and a maximal length string, in the case of a string ending on two different orbits j_I and j_F of $su(2)$, with length related to $|j_I - j_F|$ and $j_I + j_F$ respectively, are pictured in figure 19. They correspond to the minimal and maximal spins occurring in the tensor product decomposition $j_I \otimes j_F$.



Figure 20: Concatenating two strings produces a third.

To summarize, there exist general formulas for the semi-classical open string spectrum between *any* two (symmetric) branes (that correspond to conjugacy classes on group manifolds, or rather, orbits in the Lie algebra). The generality of the formulas follows from the understanding of the quantization of (co-)adjoint orbits.

7.4.4 Interactions of open strings

The free classical dynamics of open strings have been analyzed above, and the free string has been quantized. In the case where the Hilbert space is finite-dimensional, its dimension is the product of the dimensions of the irreducible representations of which it is the tensor product. Therefore, each string state for an open string stretching between orbits $\lambda_{I,F}$ is represented by a $d(\lambda_I) \times d(\lambda_F)$ matrix (where $d(\lambda_I), d(\lambda_F)$ denote the dimensions of the representations associated to the weights λ_I, λ_F respectively).

Since open strings interact by combining and splitting, which happens when open string endpoints touch, it is natural to assume that open string interactions are coded by the multiplication of the above matrices (or more generally by the composition of linear maps *i.e.* infinite matrices). The final end of a first (oriented) open string will interact with the initial end of a second (oriented) open string. This is the well-known picture that underlies the intuition for open string field theory [146], see figure 20.

The products constructed below, which correspond to the interaction of open strings, are intimately related to the operator product expansion of boundary fields. For simplicity, the following comments are restricted to $SU(2)$. The boundary field $\phi_{m_{12}}^{j_{12}}$ (associated to an open string, just like bulk fields correspond to closed strings) may be assigned [127] to an element $Y_{m_{12}}^{j_{12}}$ of a vector space which has dimension $(2j_1 + 1)(2j_2 + 1)$ and which up to an isomorphism (as associative algebras) can be assumed to be the space of $(2j_1 + 1) \times (2j_2 + 1)$ matrices. A convenient basis for this vector space, which will be used later in sections 7.5 and 7.7, consists of the matrices¹⁰³ $C_{\dot{m}_{12}}^{j_1 j_2 j_{12}}$ where the dots indicate the row and column indices of the matrix *i.e.* of the Clebsch-Gordan coefficients.

¹⁰³As a check,

$$\sum_{j_{12}=|j_1-j_2|}^{j_1+j_2} (2j_{12} + 1) = (2j_1 + 1)(2j_2 + 1) \quad (356)$$

which agrees with the $SU(2)$ fusion rules. This relation may also be seen as originating from (93) and from the remark that in the classical limit S_0^j/S_0^0 is equal to the dimension of the representation j .

Since the open string interactions are communicated by their endpoints, the interactions are non-local from the point of view of the center of mass of the open strings. Associativity of the open string interactions will be clear from the associativity of matrix multiplication, or from the associativity of the operation of concatenating open strings. However, when translated in the non-local language adapted to the center of mass of the open string, it is frequently less transparent. As will be shown later, it is related to non-trivial identities in group theory and the theory of special functions.

The associative product that is constructed is well-known for the case of compact groups, from the analysis of boundary rational conformal field theory, and from the associativity of the boundary vertex operator algebra [25, 50, 52, 147, 148, 149]. For rational conformal field theories, which include Wess-Zumino-Witten models on compact groups, the formulas developed below in section 7.5 in the case of $SU(2)$ are but a toy version of the boundary conformal field theory results.

Although the case of $SU(2)$ is already known, it is instructive in its own right, and is treated in detail below. The non-rational case of $SL(2, \mathbb{R})$ does not fall in the framework of boundary (rational) conformal field theory as developed hitherto. The construction is therefore put to good use by explicitly treating this case. Note that, while the Clebsch-Gordan and Racah coefficients (or equivalently in the $3j$ and $6j$ (Wigner) symbols, which are respectively proportional to Clebsch-Gordan and Racah coefficients and display more symmetry, see [150] or also [19], chapter 8) of $SU(2)$ display more symmetry than the ones of $SL(2, \mathbb{R})$, the latter have a more generic structure¹⁰⁴.

7.5 A compact example: $SU(2)$

In this section, the formalism developed previously in order to treat the interaction of strings is applied to the case of the compact Lie group $SU(2)$ in great detail. A convenient diagrammatical language is presented in order to be able to show associativity of the resulting product in terms of group theory.

7.5.1 The kinematical $3j$ symbol

It was explained in subsection 7.4.3 that the tensor product representation (corresponding to the two endpoints of the string) must be decomposed into irreducible representations of the symmetry group. This is a purely kinematical operation from the perspective of open string theory. In order to implement this decomposition, it is possible to choose a basis in the space of matrices (*i.e.* the tensor product representation) that consists of the Clebsch-Gordan coefficients. Since these are not symmetric under cyclic permutation, the following section will deal with rescaled matrix elements, namely the $3j$ Wigner symbol. Due to its symmetry properties, the $3j$ symbol can be represented by a

¹⁰⁴For instance, the invariance of the condition $|j_1 - j_2| \leq j \leq j_1 + j_2$ under permutation of the spins in the $SU(2)$ case is not expected generically. Only a symmetry $j_1 \leftrightarrow j_2$ coming from the symmetry of the tensor product is.

(kinematic) cubic vertex¹⁰⁵:

$$\begin{array}{c}
 \downarrow j, -m \\
 \swarrow \quad \searrow \\
 j_1, m_1 \quad j_2, m_2
 \end{array}
 = \begin{pmatrix} j_1 & j_2 & j \\ m_1 & m_2 & -m \end{pmatrix}
 = \frac{(-1)^{j_1-j_2+m}}{\sqrt{2j+1}} C_{m_1 m_2 m}^{j_1 j_2 j} \quad (357)$$

The explicit formula for the Clebsch-Gordan coefficients reads:

$$\begin{aligned}
 C_{m_1 m_2 m}^{j_1 j_2 j} &= (-1)^{j_1+j_2-j} \sqrt{2j+1} \sqrt{\frac{(j_1-j_2+j)!(j_2-j_1+j)!}{(j_1+j_2+j+1)!(j_1+j_2-j)!}} \\
 &\times \sqrt{\frac{(j_1-m_1)!(j_2+m_2)!(j-m)!(j+m)!}{(j_1+m_1)!(j_2-m_2)!}} \\
 &\times \frac{1}{(j-j_1+m_2)!(j-j_2-m_1)!} \\
 &\times {}_3F_2 \left(\begin{matrix} j-j_1-j_2, & -j_1-m_1, & -j_2+m_2 \\ j-j_1+m_2+1, & j-j_2-m_1+1 \end{matrix} ; 1 \right) \quad (358)
 \end{aligned}$$

The conventions are that j_i and m_i are half-integers, with j_i positive and $-j_i \leq m_i \leq j_i$. Moreover, $m_1 + m_2 - m = 0$ and $|j_1 - j_2| \leq j \leq j_1 + j_2$. If these conditions are not satisfied, the Clebsch-Gordan coefficient is zero¹⁰⁶. Conservation of the quantum number m can be read very easily from the diagrammatic notation (357). The dimension of the $SU(2)$ representation is $2j_i + 1$ and the Casimir is $j_i(j_i + 1)$. A useful reference for Clebsch-Gordan and Racah coefficients (or equivalently $3j$ and $6j$ Wigner symbols) of the $SU(2)$ group is [19].

One remark should be made concerning the arrows that appear in the diagrammatic notation, since their direction does matter. More precisely, changing the direction of an arrow amounts to multiplying the vertex by a propagator which is the $1j$ Wigner symbol introduced in [150]:

$$\begin{pmatrix} j \\ m \quad m' \end{pmatrix} = \sqrt{2j+1} \begin{pmatrix} j & 0 & j \\ m & 0 & m' \end{pmatrix} = (-1)^{j+m} \delta_{m,-m'} \quad (359)$$

Although simply a sign in the case of $SU(2)$, it may become more complicated

¹⁰⁵The diagrams are close cousins of those familiar from boundary conformal field theory. Closely related diagrams have been developed in [126] (and references therein), in the context of spin networks. The present coding in diagrams differs slightly from [126], in order for the correspondence between diagrams and $3j$ symbols to agree with the symmetries of the structure constants including the signs. Moreover, the metric on the space of $3j$ symbols as defined in [150] is taken into account. The connection of these open string interactions to spin networks deserves further study.

¹⁰⁶This result comes from the expression of the $3j$ symbol and the appearance of infinities in the Γ functions (factorials) when the above-stated conditions are not satisfied. The only exception is the condition that $m_1 + m_2 - m = 0$, which should be enforced with a Kronecker symbol (which will however be dropped for the sake of conciseness).

for other groups. For instance:

$$\begin{aligned}
 \begin{array}{c} \uparrow j, m \\ \swarrow j_1, m_1 \quad \searrow j_2, m_2 \end{array} &= \begin{pmatrix} j_1 & j_2 & m \\ m_1 & m_2 & j \end{pmatrix} & (360) \\
 &= \begin{pmatrix} j_1 & j_2 & j \\ m_1 & m_2 & -m \end{pmatrix} \begin{pmatrix} j \\ -m & m \end{pmatrix}
 \end{aligned}$$

while for changing the direction of the j_1 arrow, one would have to multiply the $3j$ symbol by $(-1)^{j_1+m_1}$. Another remark is that the overall inward direction which was chosen for the arrows in (357) was arbitrary:

$$\begin{array}{c} \downarrow j, -m \\ \swarrow j_1, m_1 \quad \searrow j_2, m_2 \end{array} = \begin{array}{c} \uparrow j, -m \\ \swarrow j_1, m_1 \quad \searrow j_2, m_2 \end{array} \quad (361)$$

i.e. one may as well choose to represent the $3j$ symbol by a vertex with all arrows pointing outwards.

The diagrammatic notation proves to be convenient since it reflects in a rather natural way the symmetries of the $3j$ symbol. Most notably, it immediately reflects their invariance under circular permutation of its indices. Beside cyclic permutation, two other useful symmetry properties of the $3j$ symbols are:

$$\begin{array}{c} \downarrow j, -m \\ \swarrow j_1, m_1 \quad \searrow j_2, m_2 \end{array} = (-1)^{j_1+j_2+j} \begin{array}{c} \downarrow j, m \\ \swarrow j_1, -m_1 \quad \searrow j_2, -m_2 \end{array} \quad (362)$$

$$= (-1)^{j_1+j_2+j} \begin{array}{c} \downarrow j, -m \\ \swarrow j_2, m_2 \quad \searrow j_1, m_1 \end{array} \quad (363)$$

Note that permuting any two branches, whatever the direction of the arrows, always amounts to a multiplication by $(-1)^{j_1+j_2+j}$, while (362) is only true when all arrows point inwards or outwards. Otherwise, extra signs appear due to the $1j$ symbols.

Concatenation of $3j$ symbols will be used below. It is always possible to concatenate $3j$ symbols when arrow directions are aligned and the labels j_i, m_i coincide. Concatenation implies that all internal half-integers m_i are summed over. The sums will always be finite since only a finite number of $3j$ symbols are non-zero.

The $3j$ symbols satisfy orthogonality and completeness relations¹⁰⁷:

$$\begin{array}{c} \circlearrowleft \\ \uparrow j', m' \\ \downarrow j, m \\ \circlearrowright \end{array} \begin{array}{c} \leftarrow j_1 \\ \rightarrow j_2 \end{array} = \begin{array}{c} \uparrow j', m' \\ \circlearrowleft \\ \downarrow j, m \\ \circlearrowright \end{array} \begin{array}{c} \leftarrow j_1 \\ \rightarrow j_2 \end{array} = \frac{(-1)^{j_1+j_2+j}}{2j+1} \delta_{j,j'} \delta_{m,m'} \quad (366)$$

and

$$\sum_j (2j+1) \begin{array}{c} j_1, m_1 \\ \searrow \\ j \\ \swarrow \\ j_2, m_2 \end{array} \begin{array}{c} \swarrow \\ j \\ \searrow \\ j_1, m'_1 \end{array} \begin{array}{c} \swarrow \\ j_2, m'_2 \\ \searrow \\ j_1, m'_1 \end{array} = \delta_{m_1, m'_1} \delta_{m_2, m'_2} \quad (367)$$

7.5.2 The dynamical $6j$ symbol

This subsection reviews some useful results concerning the $6j$ Wigner symbol. This symbol can be expressed in terms of four Clebsch-Gordan coefficients:

$$\left\{ \begin{array}{ccc} j_1 & j_2 & j_{12} \\ j_3 & j & j_{23} \end{array} \right\} = \frac{(-1)^{j_1+j_2+j_3+j}}{\sqrt{(2j_{12}+1)(2j_{23}+1)(2j+1)}} \quad (368)$$

$$\times \sum_{m_1, m_2, m_3 \in \frac{1}{2}\mathbb{N}} C_{m_1 m_2 m}^{j_1 j_2 j_{12}} C_{m_{12} m_3 m}^{j_{12} j_3 j} C_{m_2 m_3 m_{23}}^{j_2 j_3 j_{23}} C_{m_1 m_{23} m}^{j_1 j_{23} j}$$

In the diagrammatic notation, in terms of $1j$ and $3j$ symbols, (368) is simply:

$$\left\{ \begin{array}{ccc} j_1 & j_2 & j_{12} \\ j_3 & j & j_{23} \end{array} \right\} = \begin{array}{c} \circlearrowleft \\ \uparrow j_{12} \\ \downarrow j \\ \circlearrowright \end{array} \begin{array}{c} \swarrow j_1 \\ \searrow j_3 \\ \swarrow j_2 \\ \searrow j_{23} \end{array} \quad (369)$$

The $6j$ symbol has a large group of symmetry, consisting of 144 elements and generated by the transformations:

$$\begin{array}{ll} (1) \left\{ \begin{array}{l} j_1 \leftrightarrow j_2 \\ j_3 \leftrightarrow j \end{array} \right. & , \quad (2) \left\{ \begin{array}{l} j_1 \leftrightarrow j_{12} \\ j_3 \leftrightarrow j_{23} \end{array} \right. & (370) \\ (3) \left\{ \begin{array}{l} j_1 \leftrightarrow j_3 \\ j_2 \leftrightarrow j \end{array} \right. & , \quad (4) \left\{ \begin{array}{l} j_{1,2,3} \rightarrow l - j_{1,2,3} \\ j \rightarrow l - j \end{array} \right. & \end{array}$$

¹⁰⁷For the reader's convenience, the same relations in a more familiar form, *i.e.* in terms of Clebsch-Gordan coefficients, are:

$$\sum_{j, m \in \frac{1}{2}\mathbb{N}} C_{m_1 m_2 m}^{j_1 j_2 j} C_{m'_1 m'_2 m}^{j_1 j_2 j} = \delta_{m_1, m'_1} \delta_{m_2, m'_2} \quad (364)$$

$$\sum_{m_1, m_2 \in \frac{1}{2}\mathbb{N}} C_{m_1 m_2 m}^{j_1 j_2 j} C_{m_1 m_2 m'}^{j_1 j_2 j'} = \delta_{j, j'} \delta_{m, m'} \quad (365)$$

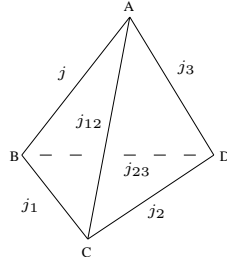

Figure 21: The $6j$ symbol as a tetrahedron.

where $l = \frac{1}{2}(j_1 + j_2 + j_3 + j)$. The $6j$ symbol is invariant under any of these transformations, therefore under any permutation of its columns. An interesting well-known remark is that this group of symmetries includes the symmetries of a tetrahedron [150], *i.e.* one should see the planar representation of the $6j$ symbol (369) as a projection of the tetrahedron pictured in figure 21 on the plane BCD (with properly added arrows¹⁰⁸). From this representation, it is clear that the result should be invariant of which tip of the tetrahedron is used in order to project and obtain a planar diagram. To be more precise, the symmetries of the tetrahedron generate transformations (1), (2) and (3) (but not transformation (4)), with the following correspondence:

- transformation (1) \longleftrightarrow invert and project from tip A
- transformation (2) \longleftrightarrow invert and project from tip B
- transformation (3) \longleftrightarrow project from tip C
- transformation (1), then (2) \longleftrightarrow project from tip D

where inverting the tetrahedron means that its mirror image is taken with respect to the plane opposite to the tip which is projected.

¹⁰⁸It may be worth noting that no arrows are drawn on the tetrahedron. Doing so would result in a complication since inverting the tetrahedron means exchanging left and right and therefore changing directions of arrows, *i.e.* actually multiplying the $6j$ symbol by an extra sign:

$$\begin{array}{c}
 \begin{array}{c}
 \xrightarrow{j_{23}} \\
 \diagdown \quad \diagup \\
 j \quad j_3 \\
 \diagup \quad \diagdown \\
 \uparrow j_{12} \\
 \leftarrow j_1 \quad \rightarrow j_2
 \end{array}
 \quad = \quad (-1)^{2j_1+2j_3} \quad
 \begin{array}{c}
 \xleftarrow{j_{23}} \\
 \diagdown \quad \diagup \\
 j \quad j_3 \\
 \diagup \quad \diagdown \\
 \uparrow j_{12} \\
 \leftarrow j_1 \quad \rightarrow j_2
 \end{array}
 \end{array}
 \quad (371)$$

The diagram on the right-hand side of (371) has the same symmetry properties of the $6j$ Wigner symbol, listed in (370).

Two important formulas will be needed later. The first one is the recoupling identity, which can be seen as an s-channel – t-channel duality:

$$\begin{aligned}
 \begin{array}{c} j_1, m_1 \nearrow \\ \diagdown \\ j_2, m_2 \nearrow \\ \diagdown \\ j_3, m_3 \nearrow \\ \diagdown \\ j_{23} \end{array} &= \sum_{j_{12} \in \frac{1}{2}\mathbb{N}} (2j_{12} + 1)(-1)^{-j_1+j_2+j_3+j} \begin{array}{c} j_{23} \\ \nearrow \\ j_1 \quad j_3 \\ \searrow \\ j_{12} \\ \nearrow \\ j_2 \end{array} \\
 & \quad \begin{array}{c} j_1, m_1 \nearrow \\ \diagdown \\ j_2, m_2 \nearrow \end{array} \begin{array}{c} j_{12} \\ \nearrow \\ j_3, m_3 \nearrow \\ \diagdown \\ j_3, -m \end{array} \end{aligned} \quad (372)$$

This identity originates from the definition of the $3j$ and $6j$ symbols as transformations of bases. Together with the orthogonality relation for the $3j$ symbol (366), it implies equation (368) for the $6j$ symbol. The second formula is known as the Biedenharn-Elliott identity (and follows from the associativity of the tensor product of representations):

$$\begin{aligned}
 \sum_{j_{23} \in \frac{1}{2}\mathbb{N}} (2j_{23} + 1)(-1)^J & \begin{array}{c} j_{23} \\ \nearrow \\ j_1 \quad j_3 \\ \searrow \\ j_{12} \\ \nearrow \\ j_2 \end{array} \\
 &= \begin{array}{c} j_{234} \\ \nearrow \\ j_1 \quad j_4 \\ \searrow \\ j_{123} \\ \nearrow \\ j_2 \end{array} \begin{array}{c} j_{234} \\ \nearrow \\ j_1 \quad j_4 \\ \searrow \\ j_{123} \\ \nearrow \\ j_2 \end{array} \begin{array}{c} j_{34} \\ \nearrow \\ j_2 \quad j_4 \\ \searrow \\ j_{23} \\ \nearrow \\ j_3 \end{array} \\
 &= \begin{array}{c} j_{34} \\ \nearrow \\ j_{12} \quad j_4 \\ \searrow \\ j_{123} \\ \nearrow \\ j_3 \end{array} \begin{array}{c} j_{234} \\ \nearrow \\ j_1 \quad j_4 \\ \searrow \\ j_{12} \\ \nearrow \\ j_2 \end{array} \end{aligned} \quad (373)$$

where $J = j_1 + j_2 + j_3 + j_4 + j + j_{12} + j_{23} + j_{34} + j_{123} + j_{234}$. One last relation can be obtained from the recoupling identity (372) and the orthogonality property (366) and reads:

$$\begin{array}{c} j_{12}, m_{12} \\ \nearrow \\ j_3 \\ \searrow \\ j_2, m_2 \end{array} \begin{array}{c} j \\ \nearrow \\ j_1, m_1 \nearrow \\ \diagdown \\ j_{23} \end{array} = (-1)^{j_1-j_2+j_{12}+2j} \begin{array}{c} j_{23} \\ \nearrow \\ j_1 \quad j_3 \\ \searrow \\ j_{12} \\ \nearrow \\ j_2 \end{array} \begin{array}{c} j_{12}, m_{12} \\ \nearrow \\ j_2, m_2 \end{array} \quad (374)$$

7.5.3 Interaction and associativity

This subsection explains how to code the interaction of open strings, which is the matrix product, in terms of the diagrammatic notation. Multiplication of matrices corresponds to concatenating diagrams, with the convention that internal lines are summed over. Then, the cubic rigid string interaction vertex¹⁰⁹, which is a dynamical quantity, is computed. The different nature of the cubic vertex from the kinematical one is indicated by color-coding: bold blue branches

¹⁰⁹It codes the operator product expansion of the boundary vertex operator algebra. The operator product expansion of the boundary fields (which is mapped to the product of operators

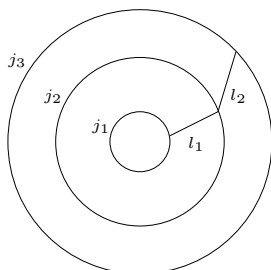

Figure 22: Two strings interacting.

indicate centers of mass (spin l_i), while thin black branches indicate branes (spin j_i).

A string stretching between two $SU(2)$ orbits labeled by their spins j_1 and j_2 respectively, with its center of mass in the representation l , will be represented by the following matrix elements:

$$[\Theta_m^l]_{n_1 n_2}^{j_1 j_2} = \begin{array}{c} \downarrow l, -m \\ \nearrow j_1, n_1 \quad \searrow j_2, n_2 \end{array} \quad (376)$$

Two strings may interact if their endpoints move in the same $SU(2)$ orbits, see figure 22. This interaction is encoded in the multiplication of the associated matrices, which can be decomposed as a sum:

$$[\Theta_{m_1}^{l_1}]_{n_1 n_2}^{j_1 j_2} \times [\Theta_{m_2}^{l_2}]_{n_2 n_3}^{j_2 j_3} = \sum_{l_{12}, m_{12} \in \frac{1}{2}\mathbb{N}} c_{l_{12}, m_{12}} [\Theta_{m_{12}}^{l_{12}}]_{n_1 n_3}^{j_1 j_3} \quad (377)$$

where l_{12} is a representation in the tensor product of l_1 and l_2 , and where the coefficient $c_{l_{12}, m_{12}}$ can be computed using (366) and (374):

$$c_{l_{12}, m_{12}} = (-1)^{\alpha_c} (2l_{12} + 1) \begin{array}{c} \begin{array}{c} \nearrow j_2 \\ \searrow j_3 \\ \uparrow j_1 \end{array} \\ \begin{array}{c} \nearrow l_1 \\ \searrow l_2 \\ \uparrow l_{12} \end{array} \end{array} \begin{array}{c} \downarrow l_{12}, m_{12} \\ \nearrow l_1, m_1 \\ \searrow l_2, m_2 \end{array} \quad (378)$$

where $\alpha_c = j_1 + j_3 + 2l_2 - l_{12}$ (see *e.g.* [127, 151] for earlier occurrences of this product for the case of a fixed orbit j). Since the (cubic rigid string) interaction vertex is now known, and therefore the product of open string operators, associativity for the string interaction can be checked directly in the present non-local

constructed here) is:

$$\psi_{m_{12}}^{j_{12}}(x) \psi_{m_{23}}^{j_{23}}(y) = \sum_{j, m} (x - y)^{h_{j_{12}} + h_{j_{23}} - h_j} c_{m_{12} m_{23} m}^{j_{12} j_{23} j} \psi_m^j(y) \quad (375)$$

The expansion coefficients c are the interaction coefficients given below in (378) and (398) (not to be confused with the Clebsch-Gordan coefficients).

formalism (instead of using the map to the multiplication of matrices). The proof of the associativity of the product reads:

$$\begin{aligned}
& \left([\Theta_{m_1}^{l_1}]_{n_1 n_2}^{j_1 j_2} \times [\Theta_{m_2}^{l_2}]_{n_2 n_3}^{j_2 j_3} \right) \times [\Theta_{m_3}^{l_3}]_{n_3 n_4}^{j_3 j_4} \\
&= \sum_{l_{12}, m_{12}} c_{l_{12}, m_{12}} [\Theta_{m_{12}}^{l_{12}}]_{n_1 n_3}^{j_1 j_3} \times [\Theta_{m_3}^{l_3}]_{n_3 n_4}^{j_3 j_4} \\
&= \sum_{l_{12}, l} (-1)^{2j_1 + j_3 + j_4 + 2l_2 + 2l_3 - l_{12} - l} (2l_{12} + 1)(2l + 1)
\end{aligned}$$

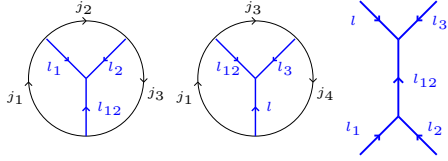
(379)

$$\begin{aligned}
&= \sum_{l_{12}, l} (-1)^{2j_1 + j_3 + j_4 - l_{12} - l_2 - l_3 + l_1 - 2l} (2l_{12} + 1)(2l_{23} + 1)(2l + 1)
\end{aligned}$$

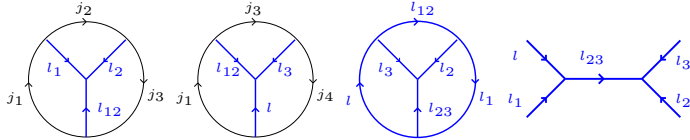
(380)

$$\begin{aligned}
&= \sum_{l_{23}, l} (-1)^{j_1 + j_2 + 2j_4 + 2l_3 - l_{23} - l} (2l_{23} + 1)(2l + 1)
\end{aligned}$$

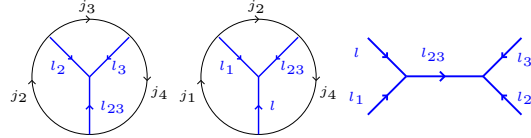
(381)

$$\begin{aligned}
&= \sum_{l_{23}, m_{23}} c_{l_{23}, m_{23}} [\Theta_{m_1}^{l_1}]_{n_1 n_2}^{j_1 j_2} \times [\Theta_{m_{23}}^{l_{23}}]_{n_2 n_4}^{j_2 j_4} \\
&= [\Theta_{m_1}^{l_1}]_{n_1 n_2}^{j_1 j_2} \times \left([\Theta_{m_2}^{l_2}]_{m_2 m_3}^{j_2 j_3} \times [\Theta_{m_3}^{l_3}]_{m_3 m_4}^{j_3 j_4} \right)
\end{aligned}$$

(382)

The recoupling identity (372) is used to go from (379) to (380) and the Biedenharn-Elliott identity (373) is used to go from (380) to (381). The proof is very general. In particular, it generalizes the diagrammatic proof of [126] to the case of differing initial and final orbits. It only makes use of generic properties of groups like associativity of the tensor product composition (which appears as a key ingredient in the associativity of the string interaction). As will be seen later, it applies to cases not considered before in the literature.

7.5.4 Quantum group $U_q(SU(2))$

Although this will be stressed again later, it is worth noting at this time that the above calculations generalize to the case of the quantum group $U_q(SU(2))$

(introduced in section 4.5). Indeed, all the results that were needed in the above computations remain true for quantum groups. Most formulas remain unchanged except under minor transformations, mostly of the kind $n \rightarrow [n]$ where:

$$[n] = [n]_q = \frac{q^{\frac{n}{2}} - q^{-\frac{n}{2}}}{q^{\frac{1}{2}} - q^{-\frac{1}{2}}}, \quad \lim_{q \rightarrow 1} [n] = n \quad (388)$$

(some extra powers of q may also appear). The representation theory of $U_q(SU(2))$ has been studied in [152]. An important point is that results are quite different depending on whether q is a root of unity or not¹¹⁰. Indeed, if q is a root of unity then $[n]$ may be zero for some integers n . For instance, the fusion rules for generic q are the same as the fusion rules of the classical group $SU(2)$, but for $q = e^{\frac{2i\pi}{k+2}}$ they agree with the fusion rules of the affine $\widehat{su(2)}_k$ algebra as given in (95). The $U_q(SU(2))$ group coefficients and their symmetries have been studied in *e.g.* [153, 154, 155, 156], which were restricted to the case where q is *not* a root of unity. While the case of generic q is interesting from a mathematical point of view, it does not allow to treat the important case from a string theory viewpoint. The above calculations, generalized to $U_q(SU(2))$ for q not a root of unity, may then remain valid in the limit when q becomes a root of unity.

7.5.5 The relation to (rational) boundary conformal field theory

The diagrammar above can be viewed as a special case of the work of [52, 148] (and follow-ups) on the algebra of boundary conformal field theories. The diagrams and diagrammatic techniques are (for the case of $SU(2)$) semi-classical limits of the analysis done in these papers for rational conformal field theories.

The fact that group theory forms a representation of classical chiral conformal field theory data has been known since the seminal work [25] on axioms of conformal field theory (the $3j$ symbols correspond to intertwiners and the $6j$ symbols to fusion matrices, see section 4.5). However, it has almost exclusively been applied to finite or compact groups, and to rational conformal field theories. A notable exception is the treatment of the H_4 group in [78, 121]. Also, a physical situation to which the classical limit applies was left undetermined in [25] as well as in many other works on realizations of chiral conformal field theory data. In particular, it was already noticed in the work [25] that the classical limit of chiral conformal field theory would not be applicable to bulk quantities like the torus partition function. Presently, this is understood from the fact that the chiral conformal field theory data may be thought off as applying to open string dynamics, and that the bulk theory flattens to a Lie algebra (of infinite volume).

The simple model developed here gives an intuitive physical picture of all the relevant ingredients, even illuminating the (well-known) formulas of the compact

¹¹⁰The number q must be a root of unity of the form $q = e^{\frac{2i\pi}{k+2}}$ in order to connect to conformal field theory via the identification of the fusing matrix and the Racah coefficients – k is the level of the associated $SU(2)$ Wess-Zumino-Witten model.

case. That this extra intuition is useful will become clear in the following. Indeed, the construction works for any group (having a non-degenerate metric), including non-compact groups. In particular, it applies to the semi-classical limit of models that fall *outside* the framework of rational conformal field theory considered in [52, 148] (see also [25, 50, 147, 149]).

Note that it is traditional to represent the matrices Θ_m^l as matrix elements of the corresponding spherical functions. In this way, one obtains an associative product of (quantized) spherical functions, see equation (378). If concentrating on a fixed brane and on the open strings living on it, one obtains the fuzzy sphere function algebra [151, 157], which is also the Berezin quantization of the sphere. Note that this construction generalizes to a function algebra for spherical functions associated to different orbits, and to the case of spherical functions on generic orbits (or flag manifolds). All these function algebras are associative and non-commutative.

Now that explicit formulas for the compact case of S^2 branes associated to $SU(2)$ have been given, it is time to proceed and to produce new results for the rigid open string limit of non-compact branes associated to $SL(2, \mathbb{R})$, in order to illustrate the utility of the approach. A geometric description of the orbits, of the tensor product and of the interactions is provided before giving explicit results.

7.6 Remarks on $SL(2, \mathbb{R})$ orbits, representations and fusion

While the algebraic structure of $SU(2)$ is rather simple (for instance, there is only one class of orbits, namely two-spheres), the structure of $SL(2, \mathbb{R})$ is more complicated. Before giving explicit results of associative products for open strings living on the $SL(2, \mathbb{R})$ manifold, this section develops intuition on the kind of string interactions that will be described later in section 7.7.

7.6.1 Orbits and representations

Unitary irreducible representations of $SL(2, \mathbb{R})$ are as follows. If the universal covering group is considered (*i.e.* AdS_3 with non-compact time), there are five types of representations:

- The principal continuous series, for which $j = \frac{1}{2} + \nu\lambda$ with $\lambda \in \mathbb{R}_+^*$, and $m = m_0 + n$ with $0 \leq m_0 < 1$ and $n \in \mathbb{Z}$.
- The supplementary series, for which $\frac{1}{2} \leq j < \max(m_0, 1 - m_0)$ and $m = m_0 + n$, with $0 \leq m_0 < 1$ and $n \in \mathbb{Z}$.
- The highest-weight (negative) discrete series, for which $j \geq \frac{1}{2}$ and $m = -j - n$, with $n \in \mathbb{N}$. The highest-weight state is characterized by $J_0^+ |j, m = -j\rangle = 0$.
- The lowest-weight (positive) discrete series, for which $j \geq \frac{1}{2}$ and $m = j + n$, with $n \in \mathbb{N}$. The lowest-weight state is characterized by $J_0^- |j, m = j\rangle = 0$.

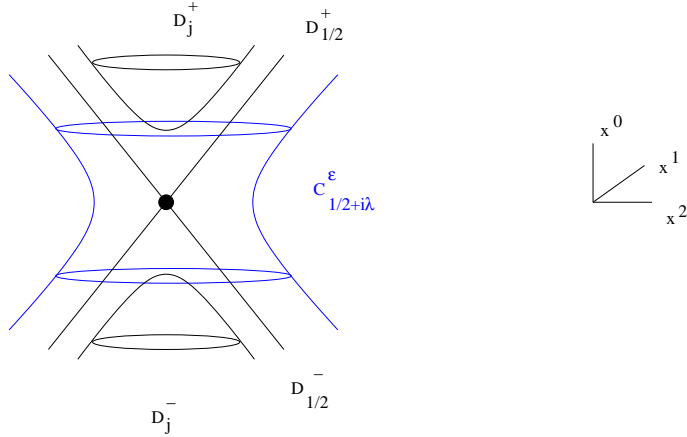

Figure 23: The $sl(2, \mathbb{R})$ co-adjoint orbits. One-sheeted hyperboloids correspond to continuous representations and two-sheeted hyperboloids to discrete representations (the upper sheet being associated to positive discrete representations and the lower sheet to negative ones). The future and past light-cone (with the point at the origin removed) correspond to the special cases of discrete representations with $j = \frac{1}{2}$ while the point at the origin represents the trivial (identity) representation.

- The trivial (identity) representation, for which $J_0^2 = 0$ and $J_0^3 = 0$.

where the current notations are the same as in subsection 6.2.2. If one does not consider the universal covering group (*i.e.* time is compact, defined on $[0; 2\pi]$ only), then there are stronger conditions: for the continuous serie, $\epsilon = m_0 = 0$ or $\frac{1}{2}$, for the supplementary serie, $m_0 = 0$, and for the discrete series, $2j \in \mathbb{N}$. The continuous and discrete series will then be denoted by C_λ^ϵ and \mathcal{D}_j^\pm . Positive and negative discrete representations are conjugate of each other.

The co-adjoint orbits of $SL(2, \mathbb{R})$ are given in¹¹¹ figure 23. Vectors representing strings can be drawn between these orbits (with their endpoints lying on the orbits), like in figures 24 and 25 for instance. Formally identifying the x^0 coordinate with a time, these vectors define future and past time-like, light-like and space-like vectors. The time-like vectors correspond to discrete representations while the continuous representations correspond to space-like vectors (see *e.g.* [115] for a detailed discussion of the correspondence). For example, consider a space-like oriented string which starts and ends on a given positive discrete orbit (see figure 25). Its first endpoint which is a positively charged particle is then

¹¹¹The hyperboloid shape is obtained from the orbit invariant $TrX^2 = TrX_0^2$ if $X = gX_0g^{-1}$. Identifying the algebra with its dual and using the basis (12) to express $X = x_1c_1 + x_2c_2 + x_0c_3$ leads to $x_1^2 + x_2^2 - x_0^2 = 2TrX_0$. This is actually a consequence of the isomorphism $sl(2, \mathbb{R}) \sim so(2, 1)$. The result would be the same for $SU(1, 1)$. See [22, 115] for more details. Finally, the $j = \frac{1}{2}$ discrete representations are a special case since they do not appear in the decomposition of representations on quadratically integrable functions on $SL(2, \mathbb{R})$, nor in the spectrum.

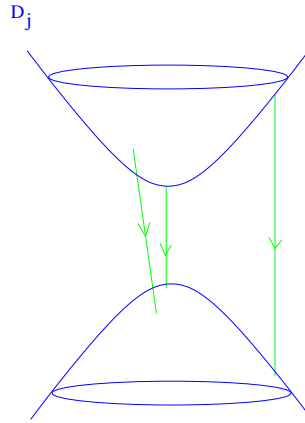

Figure 24: Some past time-like strings starting on a future discrete orbit and ending on a past discrete orbit.

associated to a lowest weight representation and its negatively charged second endpoint is associated to a highest weight representation (indeed, recall that the quantum Hilbert space is a tensor product $\lambda_I \otimes \bar{\lambda}_F$ where $\lambda_I, \bar{\lambda}_F$ are the spins labeling the representations in which the initial and final endpoints of the string live). There are strings corresponding to any tensor product combination, and the whole picture is consistent with the fusion, as explained below.

7.6.2 The geometry of tensor product decomposition

The tensor product decompositions of $SL(2, \mathbb{R})$ representations are necessary in order to understand the irreducible representations in which the center-of-mass

wave-functions transform. They are [158]:

$$\mathcal{D}_{j_1}^\pm \otimes \mathcal{D}_{j_2}^\pm = \oplus_{j \geq j_1 + j_2} \mathcal{D}_j^\pm \quad (384)$$

$$\begin{aligned} \mathcal{D}_{j_1}^+ \otimes \mathcal{D}_{j_2}^- &= \int_0^\infty d\lambda \mathcal{C}_\lambda^\epsilon + \Theta(j_1 - j_2 - 1) \oplus_{j=j_{\min}}^{j_1 - j_2} \mathcal{D}_j^+ \\ &\quad + \Theta(j_2 - j_1 - 1) \oplus_{j=j_{\min}}^{j_2 - j_1} \mathcal{D}_j^- \\ &\text{where } \epsilon = 0, j_{\min} = 1 \text{ if } j_1 + j_2 \text{ is integer} \\ &\text{and } \epsilon = \frac{1}{2}, j_{\min} = \frac{3}{2} \text{ otherwise} \end{aligned}$$

$$\begin{aligned} \mathcal{D}_{j_1}^\pm \otimes \mathcal{C}_{\lambda_2}^{\epsilon_2} &= \int_0^\infty d\lambda \mathcal{C}_\lambda^\epsilon \oplus_{j \geq j_{\min}} \mathcal{D}_j^\pm \\ &\text{where } \epsilon = 0, j_{\min} = 1 \text{ if } j_1 + \epsilon_2 \text{ is integer} \\ &\text{and } \epsilon = \frac{1}{2}, j_{\min} = \frac{3}{2} \text{ otherwise} \end{aligned}$$

$$\begin{aligned} \mathcal{C}_{\lambda_1}^{\epsilon_1} \otimes \mathcal{C}_{\lambda_2}^{\epsilon_2} &= \oplus_{j \geq j_{\min}} \mathcal{D}_j^+ \oplus_{j \geq j_{\min}} \mathcal{D}_j^- \oplus 2 \int_0^\infty d\lambda \mathcal{C}_\lambda^\epsilon \\ &\text{where } \epsilon = 0, j_{\min} = 1 \text{ if } \epsilon_1 + \epsilon_2 \text{ is integer} \\ &\text{and } \epsilon = \frac{1}{2}, j_{\min} = \frac{3}{2} \text{ otherwise} \end{aligned}$$

where $\mathcal{D}_{j_i}^\pm$ are discrete representations and $\mathcal{C}_{\lambda_i}^{\epsilon_i}$ are continuous representations, j_i is a half-integer verifying $j_i \geq \frac{1}{2}$, $\epsilon_i = 0$ or $\frac{1}{2}$ and $0 < \lambda_i < \infty$. The function $\Theta(x)$ is the Heaviside function that gives 1 if $x \geq 0$ and 0 otherwise. These tensor product decompositions are interpretable geometrically. Namely, the possible difference vectors (within the vector space that is the Lie algebra) of the positions of the open string stretching between two orbits are associated to representatives of orbits that give rise to representations appearing in the tensor product decomposition. This is indeed the case:

- the difference of a past time-like vector and a future time-like vector is a past time-like vector. Its minimal length depends on the minimal lengths of these vectors. This explains the first relation in (384). See figure 24.
- The difference of two future time-like vectors can give either a space-like vector (see figure 25), or depending on their relative length, a future time-like or a past time-like vector. This geometry corresponds to the second relation in (384).
- The difference of a future time-like vector and a space-like vector either gives a space-like vector, or a future time-like vector. See the third relation in (384).
- The difference of two space-like vectors can take any form, as is shown by the tensor product in the last line in (384).

This list shows the coherence of one example of a correspondence between the representation theory and the geometric (quantization) picture.

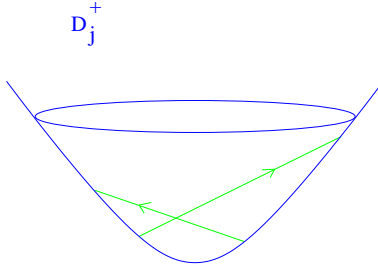

Figure 25: A few space-like strings starting and ending on a given discrete orbit.

7.6.3 Interactions

Since there are many sorts of (rigid open) strings, it is possible to realize associative products arising from string concatenation in many different spaces. For the sake of simplicity, the following section 7.7 concentrate on a very particular case. The construction however is generic for all discrete and continuous representations. See [158, 159, 160] for results on group coefficients of $SU(1, 1)$ including continuous representations. Also, [161] discusses continuous representations of $U_q(SL(2, \mathbb{R}))$.

The intuitive picture of the sort of concatenation that underlies the associative products presented in section 7.7, and their generalizations, is as follows. Consider the case where all the representations involved are discrete representations. A first open string may stretch from an upward oriented discrete orbit $\mathcal{D}_{j_1}^+$ to another $\mathcal{D}_{j_2}^+$ orbit, corresponding to a tensor product representation $\mathcal{D}_{j_1}^+ \otimes \mathcal{D}_{j_2}^-$, and a second string may stretch from the $\mathcal{D}_{j_2}^+$ orbit to a third $\mathcal{D}_{j_3}^+$ orbit, corresponding to a tensor product representation $\mathcal{D}_{j_2}^+ \otimes \mathcal{D}_{j_3}^-$. The resulting concatenated string will be in the representation $\mathcal{D}_{j_1}^+ \otimes \mathcal{D}_{j_3}^-$. Assuming that $j_1 \geq j_2 \geq j_3$, the tensor product decomposition for all three strings will contain positive discrete representations \mathcal{D}_j^+ . This example is chosen to present the following explicit calculations because it yields the simplest group coefficients.

7.7 A non-compact example: $SL(2, \mathbb{R}) \equiv SU(1, 1)$

This section explains how one may build an associative product describing the interaction of open strings in an $SL(2, \mathbb{R})$ Wess-Zumino-Witten model. The study will actually concentrate on the $SU(1, 1)$ group, which is isomorphic to $SL(2, \mathbb{R})$, as was observed in section 3.1, relation (4). Indeed, the group coefficients (Clebsch-Gordan and Racah) of $SU(1, 1)$ have been extensively studied in the literature [160, 162, 163], which makes it more convenient to work with. Moreover, this section is restricted to discrete representations. Finally, contrarily to the $SU(2)$ case the following treatment of $SU(1, 1)$ will not rely on diagrams. There are several reasons for this. Firstly, the diagrammatical notation may be inconvenient when the $3j$ symbol is not symmetric under cyclic permutation of its branches, since (in the notation adopted for $SU(2)$) some

all-blue, symmetric vertices may appear in the computations. Secondly, the $6j$ symbol cannot be represented as in (369) since the coding in (369) implies a sum which would be infinite in the case of $SU(1,1)$. Finally, this gives the opportunity to use a different but more standard (and equivalent) treatment.

7.7.1 The kinematical $3j$ symbol

By convention for discrete representations j and m are half-integers with $m \geq j \geq 0$. Positive discrete series will be labeled by j and m while negative discrete series will be labeled by j and $-m$. The study of discrete representations of $SU(1,1)$ is made easier by their connection to $SU(2)$. For instance, $3j$ symbols of $SU(1,1)$ are related to $3j$ symbols of $SU(2)$ [162]:

$$\begin{pmatrix} j_1 & j_2 & j \\ m_1 & m_2 & m \end{pmatrix}_{SU(1,1)} = \begin{pmatrix} j'_1 & j'_2 & j' \\ m'_1 & m'_2 & -m' \end{pmatrix}_{SU(2)} \quad (385)$$

The sign difference in front of m in relation (385) between $SU(2)$ and $SU(1,1)$ is there to accomodate the notation and to hopefully make positive and negative discrete representations easier to identify. At this point all representations are positive discrete representations. Negative discrete representations will appear when considering permutations of the columns of the $3j$ symbols. Since this section is restricted to the group $SU(1,1)$, there can be no misunderstanding and the $SU(1,1)$ subscript will be dropped from $3j$ and $6j$ symbols.

The conditions for the $3j$ symbols to be non-zero transform correctly from $SU(2)$ to $SU(1,1)$ through the correspondence, which is:

$$\begin{aligned} j'_1 &= \frac{1}{2}(-j_1 + j_2 + m_1 + m_2 - 1) & j_1 &= \frac{1}{2}(-j'_1 + j'_2 + m'_1 + m'_2 + 1) \\ j'_2 &= \frac{1}{2}(j_1 - j_2 + m_1 + m_2 - 1) & j_2 &= \frac{1}{2}(j'_1 - j'_2 + m'_1 + m'_2 + 1) \\ j' &= j - 1 & j &= j' + 1 \\ m'_1 &= \frac{1}{2}(j_1 + j_2 - m_1 + m_2 - 1) & m_1 &= \frac{1}{2}(j'_1 + j'_2 - m'_1 + m'_2 + 1) \\ m'_2 &= \frac{1}{2}(j_1 + j_2 + m_1 - m_2 - 1) & m_2 &= \frac{1}{2}(j'_1 + j'_2 + m'_1 - m'_2 + 1) \\ m' &= j_1 + j_2 - 1 & m &= j'_1 + j'_2 + 1 \end{aligned} \quad (386)$$

For instance $j' \geq m'$ corresponds to $j \geq j_1 + j_2$. Moreover, $m = m_1 + m_2$ otherwise the $3j$ symbol is zero.

The explicit formula¹¹² for the $3j$ symbol is [160, 162]:

$$\begin{aligned}
\begin{pmatrix} j_1 & j_2 & j \\ m_1 & m_2 & m \end{pmatrix} &= (-1)^{j_1-m_1} \sqrt{(j+j_1+j_2-2)!} \\
&\times \sqrt{(j+j_1-j_2-1)!(j-j_1+j_2-1)!(j-j_1-j_2)!} \\
&\times \sqrt{\frac{(m+j-1)!(m-j)!}{(m_2+j_2-1)!(m_2-j_2)!(m_1+j_1-1)!(m_1-j_1)!}} \\
&\times \frac{(m_2+j_2-1)!(m_2-j_2)!}{(m+j-1)!(m-j)!} \\
&\times \frac{1}{(j+j_1-m_2-1)!(j-j_1-m_2)!} \\
&\times {}_3F_2 \left(\begin{matrix} j-m, & 1-j_1-m_1, & j_1-m_1 \\ j+j_2-m_1, & j-j_2-m_1+1 \end{matrix} ; 1 \right)
\end{aligned} \tag{387}$$

Because of the close connection between $SU(2)$ and $SU(1, 1)$, all the results that are needed for the following study follow from the simpler study of $SU(2)$, see [160, 162]. The symmetries of the $3j$ symbol given by the above expression are studied in appendix B.

The $3j$ symbol satisfies the usual orthogonality relation (it is a direct consequence of their definition as a matrix of change of basis and of the choice to take them real):

$$\sum_{m_1, m_2} \begin{pmatrix} j_1 & j_2 & j \\ m_1 & m_2 & m \end{pmatrix} \begin{pmatrix} j_1 & j_2 & j' \\ m_1 & m_2 & m' \end{pmatrix} = \frac{1}{2j-1} \delta_{j,j'} \delta_{m,m'} \tag{388}$$

where m and m' are held fixed in the sum. This relation still holds if one changes any positive discrete representation into a negative one.

7.7.2 The dynamical $6j$ symbol

Like the $3j$ symbols, the $SU(1, 1)$ $6j$ symbol corresponds by definition to a change of basis – see the beginning of section 4.5, or [19] chapter 8 for more details. By definition:

$$\begin{aligned}
\begin{pmatrix} j_1 & j_2 & j_{12} \\ m_1 & m_2 & m_{12} \end{pmatrix} \begin{pmatrix} j_{12} & j_3 & j \\ m_{12} & m_3 & m \end{pmatrix} &= \sum_{l_{23}} (-1)^{j_1+j_2+j_3+j} (2j_{23}-1) \\
&\times \begin{pmatrix} j_2 & j_3 & j_{23} \\ m_2 & m_3 & m_{23} \end{pmatrix} \begin{pmatrix} j_1 & j_{23} & j \\ m_1 & m_{23} & m \end{pmatrix} \left\{ \begin{matrix} j_1 & j_2 & j_{12} \\ j_3 & j & j_{23} \end{matrix} \right\}_{+++}^{+++}
\end{aligned} \tag{389}$$

where the notation $+++$ that appears in $6j$ symbol is used to specify that all the representations are positive discrete representations. Negative discrete representations will be signaled by a *minus* sign. Using the orthogonality relation

¹¹²There is a sign difference with the $3j$ symbol that would be found by using strictly identification (386). This is convenient and of not much importance.

(388):

$$\begin{aligned} & \sum_{m_2, m_3} \left(\begin{array}{ccc} j_1 & j_2 & j_{12} \\ m_1 & m_2 & m_{12} \end{array} \right) \left(\begin{array}{ccc} j_{12} & j_3 & j \\ m_{12} & m_3 & m \end{array} \right) \left(\begin{array}{ccc} j_2 & j_3 & j_{23} \\ m_2 & m_3 & m_{23} \end{array} \right) \\ & = (-1)^{j_1+j_2+j_3+j} \left(\begin{array}{ccc} j_1 & j_{23} & j \\ m_1 & m_{23} & m \end{array} \right) \left\{ \begin{array}{ccc} j_1 & j_2 & j_{12} \\ j_3 & j & j_{23} \end{array} \right\}_{+++}^{+++} \end{aligned} \quad (390)$$

Finally, using the orthogonality relation one more time, the $6j$ symbol may be expressed in terms of $3j$ symbols (note that the $6j$ symbol is real since the $3j$ symbols were chosen to be real):

$$\begin{aligned} & \left\{ \begin{array}{ccc} j_1 & j_2 & j_{12} \\ j_3 & j & j_{23} \end{array} \right\}_{+++}^{+++} = (-1)^{j_1+j_2+j_3+j} (2j-1) \\ & \sum_{m_1, m_2, m_3} \left(\begin{array}{ccc} j_1 & j_2 & j_{12} \\ m_1 & m_2 & m_{12} \end{array} \right) \left(\begin{array}{ccc} j_{12} & j_3 & j \\ m_{12} & m_3 & m \end{array} \right) \\ & \quad \times \left(\begin{array}{ccc} j_2 & j_3 & j_{23} \\ m_2 & m_3 & m_{23} \end{array} \right) \left(\begin{array}{ccc} j_1 & j_{23} & j \\ m_1 & m_{23} & m \end{array} \right) \end{aligned} \quad (391)$$

The $6j$ symbol seems to depend on m , but it actually does not¹¹³. For the group $SU(2)$ the above equation can be rewritten as a sum of the four $3j$ symbols over all possible quantum numbers m_i , see equation (368) and the equivalent diagrammatic expression in (369) (the $6j$ symbols had three loops *i.e.* three sums – over m_1, m_2 and m_3). This however is not possible for $SU(1, 1)$ because there is an infinite number of states in the representation \mathcal{D}_j^\pm (summing over m would lead to an infinite result).

The symmetries of the $6j$ symbol can be deduced from the symmetries of $3j$ symbols and from permutations of spins and identifications in relations (389), (390) and (391). The inversion (unitarity) property of the $6j$ symbol:

$$\begin{aligned} & \sum_{j_{12}} \sqrt{(2j_{23}-1)(2j'_{23}-1)(2j_{12}-1)} \\ & \quad \left\{ \begin{array}{ccc} j_1 & j_2 & j_{12} \\ j_3 & j & j_{23} \end{array} \right\}_{+++}^{+++} \left\{ \begin{array}{ccc} j_1 & j_2 & j_{12} \\ j_3 & j & j'_{23} \end{array} \right\}_{+++}^{+++} = \delta_{j_{23}, j'_{23}} \end{aligned} \quad (392)$$

allows to write an equivalent definition of the $6j$ symbol:

$$\begin{aligned} & \left(\begin{array}{ccc} j_2 & j_3 & j_{23} \\ m_2 & m_3 & m_{23} \end{array} \right) \left(\begin{array}{ccc} j_1 & j_{23} & j \\ m_1 & m_{23} & m \end{array} \right) = \sum_{l_{12}} (-1)^{j_1+j_2+j_3+j} (2j_{12}-1) \\ & \quad \times \left(\begin{array}{ccc} j_1 & j_2 & j_{12} \\ m_1 & m_2 & m_{12} \end{array} \right) \left(\begin{array}{ccc} j_{12} & j_3 & j \\ m_{12} & m_3 & m \end{array} \right) \left\{ \begin{array}{ccc} j_1 & j_2 & j_{12} \\ j_3 & j & j_{23} \end{array} \right\}_{+++}^{+++} \end{aligned} \quad (393)$$

¹¹³In order to be convinced of this result, observe that a dependence in m would not be consistent with the symmetries of the $6j$ symbol which are discussed below. This fact already holds for the group $SU(2)$.

Relations that may be needed are of the form:

$$\begin{aligned}
\left\{ \begin{array}{ccc} j_1 & j_2 & j_{12} \\ j_3 & j & j_{23} \end{array} \right\}_{+++}^{+++} &= \left\{ \begin{array}{ccc} j_1 & j_2 & j_{12} \\ j_3 & j & j_{23} \end{array} \right\}_{---}^{---} = \left\{ \begin{array}{ccc} j_3 & j_2 & j_{23} \\ j_1 & j & j_{12} \end{array} \right\}_{+++}^{+++} \\
\left\{ \begin{array}{ccc} l_1 & l_2 & l_{12} \\ j_3 & j_1 & j_2 \end{array} \right\}_{+++}^{+++} &= (-1)^{l_1+l_2-l_{12}} \left\{ \begin{array}{ccc} l_2 & l_1 & l_{12} \\ j_1 & j_3 & j_2 \end{array} \right\}_{---}^{+++} \\
\left\{ \begin{array}{ccc} l_1 & j_2 & j_1 \\ j_3 & l_{12} & j_2 \end{array} \right\}_{-++}^{+++} &= (-1)^{2j_2-1} \left\{ \begin{array}{ccc} l_1 & l_2 & l_{12} \\ j_3 & j_1 & j_2 \end{array} \right\}_{+++}^{+++}
\end{aligned} \tag{394}$$

Finally, the Biedenharn-Elliott identity for $SU(1, 1)$ reads:

$$\begin{aligned}
\sum_{l_{12}} (2l_{12} - 1) (-1)^J \left[\begin{array}{ccc} l_2 & l_1 & l_{12} \\ j_1 & j_3 & j_2 \end{array} \right]_{---}^{+++} \left[\begin{array}{ccc} l_3 & l_{12} & l \\ j_1 & j_4 & j_3 \end{array} \right]_{---}^{+++} \\
\times \left[\begin{array}{ccc} l_3 & l_2 & l_{23} \\ l_1 & l & l_{12} \end{array} \right]_{+++}^{+++} &= \left[\begin{array}{ccc} l_{23} & l_1 & l \\ j_1 & j_4 & j_2 \end{array} \right]_{---}^{+++} \left[\begin{array}{ccc} l_3 & l_2 & l_{23} \\ j_2 & j_4 & j_3 \end{array} \right]_{---}^{+++}
\end{aligned} \tag{395}$$

where $J = j_1 + j_2 + j_3 + j_4 + l_1 + l_2 + l_3 + l_{12} + l_{23} + l$. For consistency reasons one must make sure that each spin is always in either a positive or in a negative discrete representation. All these relations remain valid (up to a sign, which may be different) if any representation j_i is replaced by its conjugate representation.

7.7.3 Interaction and associativity

The string interactions are studied in this subsection. As mentioned in subsection 7.6.3, several distinct interactions may be considered. The geometric intuition developed in the previous section 7.6 allows to understand the correspondence between open string interactions and products. The key ingredient is that the interaction must be consistent with the tensor product decomposition (384). Also, the fact that the first endpoint of the string is chosen to be in the representation of the brane on which it lives while the second endpoint is in the conjugate representation is essential for consistent conservation of the quantum number m . Here, the focus is put on open strings that are past time-like vectors connecting upward-oriented discrete orbits. They are represented by:

$$\left[\Theta_m^l \right]_{n_1 n_2}^{j_1 j_2} = (-1)^{j_2 - n_2 + 1} \left(\begin{array}{ccc} j_1 & j_2 & l \\ n_1 & -n_2 & m \end{array} \right) = \begin{array}{c} \downarrow l, -m \\ \nearrow j_1, n_1 \quad \searrow j_2, n_2 \end{array} \tag{396}$$

The thick blue branch corresponding to the representation l and the two other branches do not have the same status (whereas it would exceptionally be true for the group $SU(2)$). Indeed, while symmetry between j_1 and j_2 follows directly from the definition of the $3j$ symbol as a change of basis in the tensor product space, the third spin j is not necessarily on the same footing. The extra sign in (396) is the $SU(1, 1)$ $1j$ symbol.

The product that codes the interaction of strings is:

$$[\Theta_{m_1}^{l_1}]_{n_1 n_2}^{j_1 j_2} \times [\Theta_{m_2}^{l_2}]_{n_2 n_3}^{j_2 j_3} = \sum_{l_{12} \in \frac{1}{2}\mathbb{N}} c_{l_{12}, m_{12}} [\Theta_{m_{12}}^{l_{12}}]_{n_1 n_3}^{j_1 j_3} \quad (397)$$

where the coefficient $c_{l_{12}, m_{12}}$ reads ($\alpha_c = j_1 - j_2 + l_{12} + j_2 + j_3$):

$$c_{l_{12}, m_{12}} = (-1)^{\alpha_c} (2l_{12} - 1) \begin{pmatrix} l_1 & l_2 & l_{12} \\ m_1 & m_2 & m_{12} \end{pmatrix} \left\{ \begin{matrix} l_1 & j_2 & j_1 \\ j_3 & l_{12} & l_2 \end{matrix} \right\}_{+++}^{-++} \quad (398)$$

The proof of the associativity is much similar to the $SU(2)$ case:

$$\begin{aligned} & \left([\Theta_{m_1}^{l_1}]_{n_1 n_2}^{j_1 j_2} \times [\Theta_{m_2}^{l_2}]_{n_2 n_3}^{j_2 j_3} \right) \times [\Theta_{m_3}^{l_3}]_{n_3 n_4}^{j_3 j_4} = \sum_{l_{12}, l} c_{l_{12}, m_{12}} c_{l, m} [\Theta_m^l]_{n_1 n_4}^{j_1 j_4} \\ &= \sum_{l_{12}, l} (-1)^{2l_1 + l_{12} + j_3 - j_1} (-1)^{2l_{12} + l + j_4 - j_1} (2l_{12} - 1) (2l - 1) \begin{pmatrix} l_1 & l_2 & l_{12} \\ m_1 & m_2 & m_{12} \end{pmatrix} \\ & \quad \times \begin{pmatrix} l_{12} & l_3 & l \\ m_{12} & m_3 & m \end{pmatrix} \left\{ \begin{matrix} l_1 & j_2 & j_1 \\ j_3 & l_{12} & l_2 \end{matrix} \right\}_{-++}^{+++} \left\{ \begin{matrix} l_{12} & j_3 & j_1 \\ j_4 & l & l_3 \end{matrix} \right\}_{-++}^{+++} \\ &= \sum_{l_{12}, l_{23}, l} (-1)^{2l_1 + l_{12} + j_3 - j_1} (-1)^{2l_{12} + l + j_4 - j_1} (-1)^{l_1 + l_2 + l_3 + l} (2l_{12} - 1) (2l_{23} - 1) \\ & \quad \times (2l - 1) \begin{pmatrix} l_2 & l_3 & l_{23} \\ m_2 & m_3 & m_{23} \end{pmatrix} \begin{pmatrix} l_1 & l_{23} & l \\ m_1 & m_{23} & m \end{pmatrix} \\ & \quad \times \left\{ \begin{matrix} l_1 & j_2 & j_1 \\ j_3 & l_{12} & l_2 \end{matrix} \right\}_{-++}^{+++} \left\{ \begin{matrix} l_{12} & j_3 & j_1 \\ j_4 & l & l_3 \end{matrix} \right\}_{-++}^{+++} \left\{ \begin{matrix} l_1 & l_2 & l_{12} \\ l_3 & l & l_{23} \end{matrix} \right\}_{+++}^{+++} \\ &= \sum_{l_{23}, l} (-1)^{2l_2 + l_{23} + j_4 - j_2} (-1)^{2l_1 + l + j_4 - j_1} (2l_{23} - 1) (2l - 1) \begin{pmatrix} l_2 & l_3 & l_{23} \\ m_2 & m_3 & m_{23} \end{pmatrix} \\ & \quad \begin{pmatrix} l_1 & l_{23} & l \\ m_1 & m_{23} & m \end{pmatrix} \left\{ \begin{matrix} l_2 & j_3 & j_2 \\ j_4 & l_{23} & l_3 \end{matrix} \right\}_{-++}^{+++} \left\{ \begin{matrix} l_1 & j_2 & j_1 \\ j_4 & l & l_{23} \end{matrix} \right\}_{-++}^{+++} \\ &= \sum_{l_{23}, l} c_{l_{23}, m_{23}} c_{l, m} [\Theta_m^l]_{n_1 n_4}^{j_1 j_4} = [\Theta_{m_1}^{l_1}]_{n_1 n_2}^{j_1 j_2} \times \left([\Theta_{m_2}^{l_2}]_{n_2 n_3}^{j_2 j_3} \times [\Theta_{m_3}^{l_3}]_{n_3 n_4}^{j_3 j_4} \right) \quad (399) \end{aligned}$$

This extends the well-known analysis for the group $SU(2)$ to a non-compact case. The above relations give formulas for associative products for open string wavefunctions transforming in the discrete representations of $SU(1, 1) \equiv SL(2, \mathbb{R})$. They provide a construction of fuzzy hyperboloids, and an extension of the associative product to situations in which more than one discrete orbit is involved.

7.7.4 Quantum group $U_q(SU(1, 1))$

Similarly to the $SU(2)$ case, the above computations can be extended to the quantum group $U_q(SU(1, 1))$ (see [162] for a definition and a study of this quantum group). All the necessary formulas remain valid in this case. It is worth

noting that although $SU(1, 1)$ and $SL(2, \mathbb{R})$ are equivalent, $U_q(SU(1, 1))$ and $U_q(SL(2, \mathbb{R}))$ are *not*. This puts some restrictions to the possible applications of the study and is an incentive to study more specifically $U_q(SL(2, \mathbb{R}))$ and its differences from $U_q(SU(1, 1))$. As an example of the correspondence between quantum and classical results, the $3j$ symbol is a direct extension of the classical case [162]:

$$\begin{aligned}
\left[\begin{array}{ccc} j_1 & j_2 & j \\ m_1 & m_2 & m \end{array} \right]_q &= (-1)^{j_1 - m_1} q^{\frac{1}{4}(j(j-1) + j_1(j_1-1) - j_2(j_2-1)) - \frac{m_1(m-1)}{2}} \\
&\times \sqrt{[j - j_1 - j_2]![j - j_1 + j_2 - 1]![j + j_1 - j_2 - 1]![j + j_1 + j_2 - 2]!} \\
&\times \sqrt{\frac{[m - j]![m_1 - j_1]![m_1 + j_1 - 1]![m_2 - j_2]![m_2 + j_2 - 1]!}{[m + j - 1]!}} \\
&\sum_{n \geq 0} (-1)^n q^{\frac{n}{2}(m+j-1)} \frac{1}{[n]![m - j - n]![m_1 - j_1 - n]![m_1 + j_1 - n - 1]!} \\
&\cdot \frac{1}{[j - j_2 - m_1 + n]![j + j_2 - m_1 + n - 1]!} \quad (400)
\end{aligned}$$

where the sum is taken over all n such that integers in the sum (say, $m - j - n$) are all positive. This formula reduces to (387) in the classical limit $q \rightarrow 1$. In the same way, one can construct the $U_q(SU(1, 1))$ $6j$ -symbol [162]. This defines again via equation (397) an associative product. Finally, note that since the level of the $SL(2, \mathbb{R})$ Wess-Zumino-Witten model needs not be integer, the difficulties encountered for the quantum group $U_q(SU(2))$ for $q = e^{\frac{2i\pi}{k+2}}$ a root of unity may not appear here.

7.8 Associative products based on quantum groups

A possible extension of the construction of associative products presented above is discussed in this section. It involves the replacement of groups by quantum groups, and may be related to the dynamics of open strings. Until more work has been done in this subject, this section remains in some parts speculative.

The construction of the associative product follows by now familiar paths, and was discussed in the previous sections (along with possible difficulties for q a root of unity). However, the point-particle action needs to be replaced by the action for a particle on a co-adjoint orbit. The relevant symplectic form (which can be integrated to the point-particle one-form Lagrangian) is the one constructed by [164] in full generality for any Lie bi-algebra (see also earlier work [165, 166] – another interesting generalization is given [129]). For a very concrete example, see [140]. Quantizing the Alekseev-Malkin action will provide for a Hilbert space on which a natural set of observables [140] acts irreducibly as quantum group generators.

By considering the sum of two such actions, for two independent particles, one creates a quantum system with a Hilbert space which is the tensor product of two irreducible representations of the quantum group. An (open string,

quadratic Casimir) Hamiltonian will break the symmetry to a diagonal quantum subgroup, and the tensor product can be decomposed accordingly. More importantly, the tensor product structure of the Hilbert space will naturally allow to define an associative product for wave-functions living within the tensor product Hilbert space. The associative product can be expressed in terms of $3j$ and $6j$ symbols for the quantum group, exactly as was done previously for ordinary Lie groups. That is the construction which applies to at least all cases in which the symplectic form is known [164].

An appealing picture then arises: in the case where the quantum group corresponds to an ordinary Lie group allowing for a Wess-Zumino-Witten model, the associative product thus constructed may coincide with the associative product between primary boundary vertex operators living on symmetry preserving branes.

There is some evidence for the above picture scattered over the literature. For instance, the symplectic form of [164] reduces to the Kirillov symplectic form in the classical limit, thus allowing to recuperate the rigid open string limit. The symplectic form also has the required quantum group symmetry. The case of the $SU(2)$ Poisson Lie group has been treated in the literature. It has been explicitly shown using a canonical analysis [165, 166, 167] that the symplectic form of [164] after quantization consistent with the symmetries gives rise to a Hilbert space that represents the $U_q(SU(2))$ quantum group irreducibly. Alternatively, a path integral analysis performed in detail in [140] identifies the observables that act as quantum group generators on the Hilbert space. Now, quantizing two such particle actions independently will give rise to a tensor product of irreducible representations of the quantum group. Following the procedure described above, the operators living in the tensor products should compose according to the law governed by the $3j$ and $6j$ symbols. Modulo the discussion of the previous sections, the composition is associative since the proof in sections 7.5 (and 7.7) can be extended to the case of quantum groups. Finally, the multiplication law is expected to coincide with the multiplication law for boundary vertex operators¹¹⁴, independently derived through entirely different methods in *e.g.* [127], see also [168]. If indeed correct, this should hold generically, at least for compact groups. Some analysis of orbit quantization for generic quantum groups is in the mathematical literature (see *e.g.* [169, 170]). Finally, it seems clear *a posteriori* from the solution to the Cardy-Lewellen constraints for compact Wess-Zumino-Witten models (see *e.g.* [148], or also the case of a particular non-compact Wess-Zumino-Witten model [78, 121]) for symmetry preserving branes that the above products should coincide, since they should have identical coefficients (given in terms of quantum $3j$ and $6j$ symbols).

For a first step in the direction discussed above, see [171, 172] which studies the quantization of the q -deformed fuzzy sphere (some results include the case where q is a root of unity). Two approaches are considered, one relying on

¹¹⁴A point that needs better understanding is the statement in [127] that the correct product for finite level conformal field theory should involve a *classical* $3j$ symbol and a *quantum* $6j$ symbol, which is non-associative but only quasi-associative (*i.e.* obeys an associative relation modified by Drinfeld's re-associator).

quasi-associative algebras as introduced in [127], the other relying on associative algebras (similarly to what is here suggested). The two approaches are essentially equivalent, though the associative case is favored from a mathematical viewpoint when trying to write Lagrangians (for theories having $U_q(SU(2))$ as a gauge group).

Eventually, the above picture may allow to code the dynamics of the full fluctuating open string (in the perturbative regime) in the (local) dynamics of two endpoints, by firstly quantizing the endpoints in a way consistent with the quantum group symmetry, and by determining the product of primary boundary vertex operators, and by secondly using the affine Kac-Moody symmetry to derive the operator product of descendents.

The above statements lead to new solutions to the Cardy-Lewellen constraints (as for instance for symmetry preserving branes in extended Heisenberg groups \mathcal{H}_{2n+2} [91, 173]), even in cases where one has trouble defining the conformal field theory directly from an action principle. A case in point is the $SL(2, \mathbb{R})$ conformal field theory, which is difficult to define directly due to the Lorentzian signature of the curved group. Steps towards defining the theory via analytic continuation from the H_3^+ conformal field theory, or via modified Knizhnik-Zamolodchikov equations, were taken in [112, 174]. It is crucial to observe that the analysis of sections 7.6 and 7.7 remains valid in the case of the quantum group $U_q(SU(1, 1))$ (though, once again, results for $U_q(SL(2, \mathbb{R}))$ may differ since the two quantum algebras are not equivalent). A future Lorentzian analytic continuation of an $H_3^+ \equiv SL(2, \mathbb{C})/SU(2)$ boundary conformal field theory will presumably need to match the new solution to the Cardy-Lewellen constraint given here. This squares well with the fact that the $6j$ symbols of the quantum group form a basis of the solution for the boundary three-point function of Liouville theory [161, 175], when combined with the observation that in the bulk, Liouville theory and the H_3^+ model are closely related (see *e.g.* [176]).¹¹⁵

7.9 Conclusions and open problems

The paper [2] has added connections between subjects that have an extended literature by themselves. In particular, it reviewed the connection of the orbit method in representation theory to the quantization of a particle on an orbit, and its relation to geometric quantization. Secondly, it was observed that the construction can be applied to the two endpoints of an open string, and that this leads to a tensor product of representations via the orbit method and geometric quantization. Thirdly, string concatenation leads to an associative product for operators (or the associated functions) living in the tensor product Hilbert spaces. The construction has the considerable generality of the orbit method.

The formalism was explicitly applied to the known example of $SU(2)$ and to the non-compact group $SL(2, \mathbb{R})$, for which a product was constructed for

¹¹⁵Note that bosonic Liouville theory is obtained from $SL(2, \mathbb{R})$ by gauging a light-like direction.

the case of discrete representations. References to the (mathematics) literature were used to explain that, in the case of $SU(2)$, the fuzzy sphere is an example of Berezin quantization, and to connect to the theory of star products.

Moreover, the construction was argued to extend to full solutions of boundary conformal field theory, in particular including the case of non-compact groups. This is related to the fact that the associative products that were build can be extended to the case of quantum groups.

Several issues would deserve further exploration. First, the intuitive picture of a string stretching between two co-adjoint orbits of a Lie group corresponding to an intertwiner between three representations (after tensor product decomposition) is attractive. In particular, it is natural to ask about an associative string interaction. For instance, what may be the meaning of the associative product of Virasoro or affine Kac-Moody intertwiners? Also, one would like to understand better the link between the associative products on orbits constructed here, and the associative products on the Poincaré disc constructed in the mathematics literature [177, 178].

Moreover, it would be important to further explore the geometry of D-branes as orbits of quantum groups. This can be attacked by more directly linking chiral conformal field theory to the theory of D-brane boundary states, and in particular in regard to the quantum group symmetry (see *e.g.* [152, 165, 166, 179] and references therein). A related issue would consist in extending the construction discussed here to twisted (co-)adjoint orbits [180]. Even more importantly, it would be interesting to carry out explicit calculations for the case of physical (stable) branes in backgrounds presenting an $SL(2, \mathbb{R})$ symmetry (or even a non semi-simple symmetry algebra, like the Heisenberg algebras \mathcal{H}_{2n+2}). This would be the opportunity to discuss the level-matching condition and the on-shell (physical) condition for string states, $(L_n - \delta_{n,0})|physical\rangle = 0$ for any positive integer n , which were disregarded here¹¹⁶.

Finally, one may wish to understand explicitly (following [144]) how the action (343) arises as a limit of open string theory in a generic context, and how it may be generalized to supersymmetric theories.

In summary, the present discussion of the quantization of pairs of conjugacy classes (in particular of non-compact groups) from various perspectives, including the string theoretic, symplectic geometric and boundary conformal field theory viewpoint, may lead to further useful cross-fertilization.

¹¹⁶Remark however that the level-matching condition simply relates the left and right part of the theory and must be easily satisfied. As for the on-shell condition for the case of compact groups, it can be satisfied by adding an extra non-compact group (in order to account for the time in the string background) and by appropriately fixing the energy of the string in terms of its other parameters.

8 Conclusion of the dissertation and perspectives

A number of non-rational conformal field theories were studied in the dissertation and several new results were found. Correlation functions for theories having a Heisenberg algebra \mathcal{H}_{2n+2} for symmetry were calculated, and the origin of this symmetry was explained by using branes in the context of string theory. A Verlinde-like formula was written for Liouville theory, the H_3^+ theory and the supersymmetric coset $SL(2, \mathbb{R})/U(1)$, and it was checked that a generalized Cardy formula holds. Finally, open strings whose endpoints live on co-adjoint orbits of Lie algebras (like $su(2)$ or $su(1, 1) \equiv sl(2, \mathbb{R})$) were studied in the context of the semi-classical limit of conformal field theory.

Several questions remain open and may motivate future work.

In the context of the Heisenberg algebras, it is not clear yet how backgrounds with any \mathcal{H}_8 or \mathcal{H}_{10} symmetry emerge from string theory. Moreover, the Heisenberg algebra is invariant under a spectral flow, which gives rise to new representations. It would be interesting to generalize the Knizhnik-Zamolodchikov equation to these spectral-flowed representations (possibly along the lines of [174]) and to write the corresponding four-point functions.

As for the Verlinde formula, it may be worth checking its validity for other non-rational theories having degenerate representations. Finding a more rigorous approach than the one used in the dissertation may also be illuminating (understand characters of continuous representations, incorporate a measure for continuous spin).

Finally, the model built in [2] awaits new developments. It may be interesting to treat non semi-simple Lie algebras which possess a non-degenerate metric (like \mathcal{H}_{2n+2}), or to write a supersymmetric analogue. The case of twisted co-adjoint orbits is unclear. It would allow to describe a larger class of branes. Checking that the open strings are physical also remains to be done in the case of non-compact groups. Explicit calculations in the context of physical branes for a non-rational theory are desirable. A rigorous extension of this work to the quantum group case *i.e.* a treatment of the full conformal field theory (without using the semi-classical limit), including a discussion of the (non-)associativity and of the brane dynamics, would also be interesting. From a more mathematical point of view, the study of generic star-products as realized in the context of string theory offers appealing perspectives.

9 Acknowledgments

I am much indebted to the people I worked with. I address my warmest thanks to Jan Troost for his help and for numerous valuable discussions. It was great working with him. I also thank Pierre Beliaevsky for our collaboration. Finally, I thank Elias Kiritsis who accepted to be my supervisor and made this dissertation doable.

I thank the referees Vladimir Dotsenko and Michel Bauer, as well as Costas Bachas and Boris Pioline, who kindly accepted to read this dissertation and be part of the jury.

I also thank Bertrand Roehner for several valuable discussions on other fields of science.

Many thanks to my family: my brother, parents and grand-parents, and all the others.

Finally, I would like to thank all my friends for their support during my PhD studies, and all the people who were doing a PhD in string theory like myself and who contributed to the student's seminar at LPT ENS: Sébastien Ray, Jérôme Levie, Domenico Orlando, Chloé Papineau, Davide Cassani, Pedro Vieira, Pascal Grange, Yacine Dolivet, Maria-Cristina Timirgazu, Raphaël Benichou, Yann Michel and Tristan Catelin, without forgetting those who were studying other fields of research, namely Alexei Lokhov, Xavier Lacroze, Arnaud Basson, Guillaume Charpiat, Marc Glisse, Raphaël Cote, Pierre Senellart, Marc Wouts, Sophie Hirel and (last but not least) Guillaume Lafon (trick question: find who shouldn't be on this list...). And thanks to all the other people that I could not name.

A Various useful results

This appendix collects well-known useful formulas, for the commodity of the reader.

Integrals The gaussian integral reads:

$$\int_{-\infty}^{\infty} e^{-ax^2/2+bx} dx = \sqrt{\frac{2\pi}{a}} e^{\frac{b^2}{2a}} \quad (401)$$

The Dotsenko-Fateev integral [181] is given by:

$$\begin{aligned} I_n(\alpha, \beta, \rho) &= \int \prod_{i=1}^n d^2 y_i |y_i|^{2\alpha} |1 - y_i|^{2\beta} \prod_{i<j} |y_i - y_j|^{4\rho} \\ &= \pi^n n! \prod_{l=0}^{n-1} \frac{\gamma((l+1)\rho)}{\gamma(\rho)} \frac{\gamma(1+\alpha+l\rho)\gamma(1+\beta+l\rho)}{\gamma(2+\alpha+\beta+(n-1+l)\rho)} \end{aligned} \quad (402)$$

Another integral is:

$$\begin{aligned} \int_{\mathbb{C}} d^2 y |x - y|^{-4j-4} y^{j-m} \bar{y}^{j-\bar{m}} &= \pi \frac{\Gamma(1+j-m)\Gamma(1+j+\bar{m})}{\Gamma(-j-m)\Gamma(-j+\bar{m})} \\ &\quad \times \frac{\Gamma(-2j-1)}{\Gamma(2j+2)} x^{-j-1-m} \bar{x}^{-j-1-\bar{m}} \end{aligned} \quad (403)$$

where $m - \bar{m} \in \mathbb{Z}$ and $\Re j > -1$. Finally, for $n, m \in \mathbb{Z}$ (see [114]):

$$\int_{\mathbb{C}} \frac{d^2 x}{\pi} |x|^{2a} x^n |1-x|^{2b} (1-x)^m = \frac{\Gamma(a+n+1)\Gamma(b+m+1)\Gamma(-a-b-1)}{\Gamma(-a)\Gamma(-b)\Gamma(a+b+n+m+2)} \quad (404)$$

Special functions The Γ function satisfies the following relations:

$$\begin{aligned} \Gamma(z)\Gamma(1-z) &= \frac{\pi}{\sin \pi z} \\ \Gamma(-n+\epsilon) &\underset{0}{\sim} \frac{(-1)^n}{\Gamma(n+1)} \frac{1}{\epsilon}, \quad n \in \mathbb{N} \\ \Gamma(x) &\underset{\infty}{\sim} x^{x-\frac{1}{2}} e^{-x} \sqrt{2\pi} \left(1 + \frac{1}{12x} + \frac{1}{288x^2} + O\left(\frac{1}{x^3}\right) \right) \end{aligned} \quad (405)$$

were $|\arg x| < \pi$ in the last line. It is rather standard to define the γ function as:

$$\gamma(z) = \frac{\Gamma(z)}{\Gamma(1-z)} \quad (406)$$

The Dirac distribution may be equivalently defined as several limits:

$$\begin{aligned} \delta(x) &= \lim_{\epsilon \rightarrow 0} \frac{1}{\pi x} \sin \frac{x}{\epsilon} = \lim_{\epsilon \rightarrow 0} \frac{1}{2\sqrt{\pi\epsilon}} e^{-\frac{x^2}{4\epsilon}} \\ &= \lim_{\epsilon \rightarrow 0} \frac{1}{\pi} \frac{\epsilon}{x^2 + \epsilon^2} = \lim_{\epsilon \rightarrow 0} \epsilon |x|^{\epsilon-1} \end{aligned} \quad (407)$$

and satisfies the convenient equality:

$$\delta(x) = \frac{1}{2\pi} \int_{-\infty}^{\infty} e^{ikx} dk \quad (408)$$

In particular, it may be used with the Poisson formula:

$$\begin{aligned} \sum_{n \in \mathbb{Z}} f(n) &= \sum_{k \in \mathbb{Z}} \int_{-\infty}^{\infty} f(x) e^{-2i\pi kx} dx \\ \sum_{q \in \mathbb{Z}} e^{2i\pi qx} &= \sum_{k \in \mathbb{Z}} \delta(k - x) \end{aligned} \quad (409)$$

Some relations involving hypergeometric functions are:

$$\begin{aligned} {}_2F_1(a, b; c; z) &= (1-z)^{c-a-b} {}_2F_1(c-a, c-b; c; z) \\ {}_2F_1(a, b; c; z) &= \frac{\Gamma(c)\Gamma(c-a-b)}{\Gamma(c-a)\Gamma(c-b)} {}_2F_1(a, b; 1+a+b-c; 1-z) \\ &\quad + \frac{\Gamma(c)\Gamma(a+b-c)}{\Gamma(a)\Gamma(b)} (1-z)^{c-a-b} \\ &\quad \times {}_2F_1(c-a, c-b; 1+c-a-b; 1-z) \\ \frac{d^n}{dz^n} {}_2F_1(a, b; c; z) &= \frac{(a)_n (b)_n}{(c)_n} {}_2F_1(a+n, b+n; c+n; z) \end{aligned} \quad (410)$$

The Dedekind function verifies:

$$\eta(\tau) = q^{\frac{1}{24}} \prod_{n=1}^{\infty} (1-q^n), \quad \eta\left(-\frac{1}{\tau}\right) = \sqrt{-i\tau} \eta(\tau) \quad (411)$$

while the function θ_1 is defined by:

$$\begin{aligned} \theta_1(\tau, \nu) &= 2q^{1/8} \sin \pi u \prod_{n=1}^{\infty} (1-zq^n)(1-q^n)(1-z^{-1}q^n) \\ &= \sum_{n \in \mathbb{Z}} q^{\frac{1}{2}(n-\frac{1}{2})^2} e^{2i\pi(\nu-\frac{1}{2})(n-\frac{1}{2})} \end{aligned} \quad (412)$$

and satisfies the following modular properties:

$$\begin{aligned} \theta_1(\tau+1, \nu) &= e^{\frac{i\pi}{4}} \theta_1(\tau, \nu) \\ \theta_1\left(-\frac{1}{\tau}, \frac{\nu}{\tau}\right) &= -i\sqrt{-i\tau} e^{i\pi\nu^2/\tau} \theta_1(\tau, \nu) \end{aligned} \quad (413)$$

where $q = e^{2i\pi\tau}$ and $z = e^{2i\pi\nu}$. The special function Υ is defined on the strip $0 < \Re(x) < Q$ by the following integral representation:

$$\ln(\Upsilon(x)) = \int_0^{\infty} \frac{dt}{t} \left[\left(\frac{Q}{2} - x\right)^2 e^{-t} - \frac{sh^2\left(\left(\frac{Q}{2} - x\right)\frac{t}{2}\right)}{sh\left(\frac{bt}{2}\right) sh\left(\frac{t}{2b}\right)} \right] \quad (414)$$

where $Q = b + 1/b$ and $b \in \mathbb{R}^*$. The function Υ can be extended to the whole complex plane, thanks to the relations:

$$\begin{aligned}\Upsilon(x+b) &= \gamma(bx)b^{1-2bx}\Upsilon(x) \\ \Upsilon(x+1/b) &= \gamma(x/b)b^{2x/b-1}\Upsilon(x)\end{aligned}\quad (415)$$

The function Υ is an entire function of the variable x with zeroes at $x = -x_{m,n}$ and at $x = Q + x_{m,n}$, with $x_{m,n} = m/b + nb$ and $m, n \in \mathbb{N}$. Other relations satisfied by the function Υ are:

$$\Upsilon(Q-x) = \Upsilon(x), \quad \Upsilon(Q/2) = 1, \quad \Upsilon'(0) = \Upsilon(b) \quad (416)$$

Christoffel symbols The metric and the non-zero components of the Christoffel symbols for the S^3 space are:

$$\begin{aligned}ds^2 &= l^2 (d\phi^2 + \sin^2 \phi (d\theta^2 + \sin^2 \theta d\psi^2)) \\ \Gamma_{\theta\theta}^\phi &= -\frac{1}{2} \sin 2\phi, \quad \Gamma_{\psi\psi}^\phi = -\frac{1}{2} \sin 2\phi \sin^2 \theta, \quad \Gamma_{\phi\theta}^\theta = \cot \phi \\ \Gamma_{\psi\psi}^\theta &= -\frac{1}{2} \sin 2\theta, \quad \Gamma_{\phi\psi}^\psi = \cot \phi, \quad \Gamma_{\theta\psi}^\psi = \cot \theta\end{aligned}\quad (417)$$

or:

$$\begin{aligned}ds^2 &= l^2 (\cos^2 \theta d\phi^2 + d\theta^2 + \sin^2 \theta d\psi^2) \\ \Gamma_{\theta\phi}^\phi &= -\tan \theta, \quad \Gamma_{\phi\phi}^\theta = -\Gamma_{\psi\psi}^\theta = \frac{1}{2} \sin 2\theta, \quad \Gamma_{\theta\psi}^\psi = \cot \theta\end{aligned}\quad (418)$$

while for the AdS_3 space:

$$\begin{aligned}ds^2 &= l^2 \left(\frac{du^2}{u^2} + u^2 (-dt^2 + dx^2) \right) \\ \Gamma_{tu}^t &= \frac{1}{u}, \quad \Gamma_{xu}^x = \frac{1}{u}, \quad \Gamma_{tt}^u = -\Gamma_{xx}^u = u^3, \quad \Gamma_{uu}^u = -\frac{1}{u}\end{aligned}\quad (419)$$

or:

$$\begin{aligned}ds^2 &= l^2 (-\cosh^2 \rho dt^2 + d\rho^2 + \sinh^2 \rho d\phi^2) \\ \Gamma_{t\rho}^t &= \tanh \rho, \quad \Gamma_{tt}^\rho = \Gamma_{\phi\phi}^\rho = \frac{1}{2} \sinh 2\rho, \quad \Gamma_{\rho\phi}^\phi = \coth \rho\end{aligned}\quad (420)$$

SU(2) and Pauli matrices $SU(2)$ is the group of two by two complex unitary matrices of determinant one. A basis of the Lie algebra $su(2)$ is given by the Pauli matrices:

$$\begin{aligned}\sigma_1 &= \begin{pmatrix} 0 & 1 \\ 1 & 0 \end{pmatrix}, & \sigma_2 &= \begin{pmatrix} 0 & -i \\ i & 0 \end{pmatrix} \\ \sigma_3 &= \begin{pmatrix} 1 & 0 \\ 0 & -1 \end{pmatrix}\end{aligned}\quad (421)$$

which satisfy:

$$\begin{aligned}
\sigma_i \sigma_j &= \delta_{ij} + i \epsilon_{ijk} \sigma_k, & \text{Tr} \sigma_i &= 0 \\
[\sigma_i; \sigma_j] &= 2i \epsilon_{ijk} \sigma_k, & \sigma_i^\dagger &= \sigma_i \\
\{\sigma_i; \sigma_j\} &= 2\delta_{ij}. & &
\end{aligned} \tag{422}$$

Any matrix in $SU(2)$ may be written in the form:

$$U = \cos \frac{\theta}{2} - i \vec{\sigma} \cdot \vec{n} \sin \frac{\theta}{2} = e^{-i\theta \vec{\sigma} \cdot \vec{n} / 2} \tag{423}$$

where θ is a real number and $|\vec{n}| = 1$. Another standard expression uses Euler angles:

$$g = e^{i\frac{\phi}{2}\sigma_3} e^{i\frac{\theta}{2}\sigma_1} e^{i\frac{\psi}{2}\sigma_3} \tag{424}$$

where ϕ , ψ and θ are real numbers.

B ${}_3F_2(1)$ hypergeometric functions and $3j$ symbol transformations

This appendix reviews several relations between ${}_3F_2(1)$ hypergeometric functions [182, 183, 184, 185] and use them to show how the symmetry properties of $SU(2)$ or $SU(1, 1)$ $3j$ symbols can be determined (see also [19]). These symmetries are used in section 7. Although the content of this appendix is mostly well-known, the integer limit in the hypergeometric function and the full set of transformations of $3j$ symbols of $SU(2)$ or $SU(1, 1)$ are usually not explicitly mentioned in the literature. It is presented here in detail.

B.1 Whipple functions

Whipple's notation is a very compact way to write down the various transformations relating different ${}_3F_2(1)$ functions¹¹⁷. This notation relies on six complex parameters r_i , $i = 0, 1, \dots, 5$, which obey the following condition:

$$r_0 + r_1 + r_2 + r_3 + r_4 + r_5 = 0 \quad (425)$$

and therefore encode the five degrees of freedom of ${}_3F_2(1)$ functions. Another set of convenient variables is:

$$\begin{aligned} \alpha_{lmn} &= \frac{1}{2} + r_l + r_m + r_n \\ \beta_{lm} &= 1 + r_l - r_m \end{aligned} \quad (426)$$

Some simple remarks are in order: α_{lmn} is completely symmetric and satisfies $\alpha_{lmn} = 1 - \alpha_{ijk}$ due to equation (425) (where the indices i, j, k are all different from l, m, n), moreover $\beta_{lm} = 2 - \beta_{ml}$.

Using the above notation, the (Thomae-)Whipple functions are:

$$\begin{aligned} F_p(l; m, n) &= \frac{1}{\Gamma(\alpha_{ghj}, \beta_{ml}, \beta_{nl})} {}_3F_2 \left(\begin{matrix} \alpha_{gmn}, \alpha_{hmn}, \alpha_{jmn} \\ \beta_{ml}, \beta_{nl} \end{matrix} ; 1 \right) \\ F_n(l; m, n) &= \frac{1}{\Gamma(\alpha_{lmn}, \beta_{lm}, \beta_{ln})} {}_3F_2 \left(\begin{matrix} \alpha_{lgh}, \alpha_{lgj}, \alpha_{lhj} \\ \beta_{lm}, \beta_{ln} \end{matrix} ; 1 \right) \end{aligned} \quad (427)$$

where g, h and j are indices all different from l, m and n . Note that any $F_n(l; m, n)$ function is obtained from the corresponding $F_p(l; m, n)$ function by changing the signs of all the parameters r_i . The function $F_p(l; m, n)$ is well-defined if $\Re \alpha_{ghj} > 0$ and $F_n(l; m, n)$ is well-defined if $\Re \alpha_{lmn} > 0$. This is related to the fact that the defining series for ${}_3F_2(a_1, a_2, a_3; b_1, b_2; 1)$ is well-defined if and only if $s = b_1 + b_2 - a_1 - a_2 - a_3$ is such that it has a strictly positive real part, assuming that no argument is a negative integer. Things

¹¹⁷An ${}_3F_2(1)$ function is a hypergeometric function of five complex arguments of the kind ${}_3F_2(a_1, a_2, a_3; b_1, b_2; 1) = \sum_{n=0}^{\infty} \frac{(a_1)_n (a_2)_n (a_3)_n}{(b_1)_n (b_2)_n} \frac{1}{n!}$ where $(a)_n = \frac{\Gamma(a+n)}{\Gamma(a)}$ is the Pochhammer symbol.

are a little different if at least one a_i is a negative integer, since in this case ${}_3F_2(a_1, a_2, a_3; b_1, b_2; 1)$ can be expressed as a finite sum and there is no more requirement on s . There is however a complication if some a_i 's and some b_j 's are negative integers at the same time, for in this case there is no clear limiting procedure that would allow a definition of ${}_3F_2(1)$. Assuming that $a_{i_0} = -N$ is the largest of all negative integers a_i and that any b_j that is a negative integer is smaller than $1 - N$, a reasonable and commonly used definition is:

$${}_3F_2 \left(\begin{matrix} a_1, a_2, a_3 \\ b_1, b_2 \end{matrix} ; 1 \right) = \sum_{n=0}^N \frac{(a_1)_n (a_2)_n (a_3)_n}{(b_1)_n (b_2)_n} \frac{1}{n!} \quad (428)$$

i.e. the infinite sum has been truncated. In the same spirit, a formula that is necessary to connect finite sum expressions of $3j$ symbols and Whipple functions is:

$$\frac{1}{\Gamma(b_1)\Gamma(b_2)} {}_3F_2 \left(\begin{matrix} a_1, a_2, a_3 \\ b_1, b_2 \end{matrix} ; 1 \right) = \sum_{n=1}^{-\max a_i} \frac{(a_1)_n (a_2)_n (a_3)_n}{\Gamma(b_1 + n)\Gamma(b_2 + n)} \frac{1}{n!} \quad (429)$$

where some a_i 's and some b_j 's are negative integers at the same time, and under the assumption that $1 + \max a_i \leq \min b_j$. The maximum and minimum are taken over the sets of negative a_i, b_j .

B.2 Another useful notation

One often wishes to manipulate expressions of the kind ${}_3F_2(a, b, c; d, e; 1)$. This new notation may be introduced by choosing:

$$F_p(0; 4, 5) = \frac{1}{\Gamma(s, d, e)} {}_3F_2(a, b, c; d, e; 1) \quad (430)$$

where $s = d + e - a - b - c$. This fixes the following correspondence table:

$$\begin{array}{lll} \beta_{01} = 2 - s - a & \beta_{02} = 2 - s - b & \beta_{03} = 2 - s - c \\ \beta_{10} = s + a & \beta_{12} = a - b + 1 & \beta_{13} = a - c + 1 \\ \beta_{20} = s + b & \beta_{21} = b - a + 1 & \beta_{23} = b - c + 1 \\ \beta_{30} = s + c & \beta_{31} = c - a + 1 & \beta_{32} = c - b + 1 \\ \beta_{40} = d & \beta_{41} = b + c - e + 1 & \beta_{42} = a + c - e + 1 \\ \beta_{50} = e & \beta_{51} = b + c - d + 1 & \beta_{52} = a + c - d + 1 \\ \beta_{04} = 2 - d & \beta_{05} = 2 - e & \\ \beta_{14} = e - b - c + 1 & \beta_{15} = d - b - c + 1 & \\ \beta_{24} = e - a - c + 1 & \beta_{25} = d - a - c + 1 & \\ \beta_{34} = e - a - b + 1 & \beta_{35} = d - a - b + 1 & \\ \beta_{43} = a + b - e + 1 & \beta_{45} = d - e + 1 & \\ \beta_{53} = a + b - d + 1 & \beta_{54} = e - d + 1 & \end{array} \quad (431)$$

and:

$$\begin{aligned}
\alpha_{012} &= 1 - c & \alpha_{013} &= 1 - b & \alpha_{014} &= a - e + 1 \\
\alpha_{023} &= 1 - a & \alpha_{024} &= b - e + 1 & \alpha_{025} &= b - d + 1 \\
\alpha_{034} &= c - e + 1 & \alpha_{035} &= c - d + 1 & \alpha_{045} &= 1 - s \\
\alpha_{123} &= s & \alpha_{124} &= d - c & \alpha_{125} &= e - c \\
\alpha_{134} &= d - b & \alpha_{135} &= e - b & \alpha_{145} &= a \\
\alpha_{234} &= d - a & \alpha_{235} &= e - a & \alpha_{245} &= b \\
\alpha_{015} &= a - d + 1 & \alpha_{345} &= c & &
\end{aligned} \tag{432}$$

This implies a correspondence between trivial transformations of ${}_3F_2(1)$ functions:

$$\begin{array}{ccc}
\text{Whipple's notation} & \text{a, b, c, d, e notation} & \\
1 \leftrightarrow 2 & a \leftrightarrow b & \\
1 \leftrightarrow 3 & a \leftrightarrow c & \\
4 \leftrightarrow 5 & d \leftrightarrow e &
\end{array} \tag{433}$$

B.3 Two-term and three-term relations

There exist many relations between ${}_3F_2(1)$ functions. They originate from considerations on equations that these functions satisfy. These relations are standard and can be elegantly written in Whipple's notation. They are of two kinds. The first one consists of two-term relations:

$$\begin{aligned}
F_p(l; m, n) &= F_p(l; m', n') \\
F_n(l; m, n) &= F_n(l; m', n')
\end{aligned} \tag{434}$$

which are equivalent to the statement that both $F_p(l; m, n)$ and $F_n(l; m, n)$ actually do not depend on m and n (and therefore will be denoted by $F_p(l)$ and $F_n(l)$). The second kind of relations are three-term relations:

$$\begin{aligned}
\frac{\sin \pi \beta_{23}}{\pi \Gamma(\alpha_{023})} F_p(0) &= \frac{F_n(2)}{\Gamma(\alpha_{134}, \alpha_{135}, \alpha_{345})} - \frac{F_n(3)}{\Gamma(\alpha_{124}, \alpha_{125}, \alpha_{245})} \\
\frac{\sin \pi \beta_{32}}{\pi \Gamma(\alpha_{145})} F_n(0) &= \frac{F_p(2)}{\Gamma(\alpha_{012}, \alpha_{024}, \alpha_{025})} - \frac{F_p(3)}{\Gamma(\alpha_{013}, \alpha_{034}, \alpha_{035})} \\
\frac{\sin \pi \beta_{45} F_p(0)}{\Gamma(\alpha_{012}, \alpha_{013}, \alpha_{023})} &= -\frac{\sin \pi \beta_{50} F_p(4)}{\Gamma(\alpha_{124}, \alpha_{134}, \alpha_{234})} - \frac{\sin \pi \beta_{04} F_p(5)}{\Gamma(\alpha_{125}, \alpha_{135}, \alpha_{235})} \\
\frac{\sin \pi \beta_{54} F_n(0)}{\Gamma(\alpha_{145}, \alpha_{245}, \alpha_{345})} &= -\frac{\sin \pi \beta_{05} F_n(4)}{\Gamma(\alpha_{015}, \alpha_{025}, \alpha_{035})} - \frac{\sin \pi \beta_{40} F_n(5)}{\Gamma(\alpha_{014}, \alpha_{024}, \alpha_{034})} \\
\frac{F_p(0)}{\Gamma(\alpha_{012}, \alpha_{013}, \alpha_{023}, \alpha_{014}, \alpha_{024}, \alpha_{034})} &= K_0 F_p(5) - \frac{\sin \beta_{05} F_n(0)}{\Gamma(\alpha_{123}, \alpha_{124}, \alpha_{134}, \alpha_{234})} \\
\frac{F_n(0)}{\Gamma(\alpha_{125}, \alpha_{135}, \alpha_{235}, \alpha_{145}, \alpha_{245}, \alpha_{345})} &= K_0 F_n(5) - \frac{\sin \beta_{50} F_p(0)}{\Gamma(\alpha_{015}, \alpha_{025}, \alpha_{035}, \alpha_{045})}
\end{aligned} \tag{435}$$

where:

$$K_0 = \frac{1}{\pi^3} (\sin \pi \alpha_{145} \sin \pi \alpha_{245} \sin \pi \alpha_{345} + \sin \pi \alpha_{123} \sin \pi \beta_{40} \sin \pi \beta_{50}) \tag{436}$$

These six identities, up to permutation of indices, give 120 independent relations between ${}_3F_2(1)$ functions. The three-term relations may reduce to two-term relations when one or more α_{lmn} is a negative integer, as will be seen below.

B.4 An integer limit of Whipple's relations

Since Whipple's three-term relations are valid in the generic case of complex parameters α_{lmn} , β_{lm} , relations in the case of integer parameters should be obtained from a limiting procedure. With no loss of generality, it is possible to choose:

$$\begin{aligned} \alpha_{145} &= -n + \epsilon, & \alpha_{014} &= -n_2 + \epsilon_2 \\ \alpha_{245} &= -n'_1 + \epsilon'_1, & \alpha_{015} &= -n'_2 + \epsilon'_2 \\ \alpha_{345} &= -n_1 + \epsilon_1 \end{aligned} \tag{437}$$

where $\epsilon, \epsilon_1, \epsilon'_1, \epsilon_2, \epsilon'_2$ are infinitesimally small real parameters. The behavior of all other parameters α_{lmn} , β_{lm} is then fixed. In order to connect with the expressions of the $3j$ symbols later, it is furthermore assumed that the other negative α_{lmn} parameters are α_{024} , α_{034} , α_{025} , α_{035} and α_{045} .

Although the infinitesimal parameters may be anything a priori, they must actually satisfy some consistency conditions which originate from considerations on the $3j$ symbols of the groups $SU(2)$ and $SU(1,1)$ – in which this study is eventually interested. These constraints imply that only very few limiting procedures can be considered. To be more precise, the fact that all $3j$ symbols are real and that all ratios of $3j$ symbols of $SU(2)$ (or, equivalently, of $SU(1,1)$, see [150, 160]), are of modulus one implies that:

$$|\epsilon| = |\epsilon_1| = |\epsilon'_1| = |\epsilon_2| = |\epsilon'_2| \tag{438}$$

and that the relative signs between ϵ 's must be of the following kinds only (up to a global sign that is used to fix $\epsilon > 0$):

$$\begin{array}{cccccc} \epsilon & \epsilon_1 & \epsilon'_1 & \epsilon_2 & \epsilon'_2 & \\ + & + & + & + & - & \\ + & + & + & - & + & \\ + & + & - & + & + & \\ + & - & + & + & + & \\ + & + & + & - & - & \\ + & - & - & + & + & \end{array} \tag{439}$$

A consequence is that half of the Whipple functions are finite in the integer limit (like $F_p(0)$), while the others tend to zero. Once the possible limiting procedures are known, it is possible to find the following two-term relations resulting from

equations (435) in the integer limit $\epsilon \rightarrow 0$:

$$\begin{aligned}
\frac{F_p(0)}{\Gamma(\alpha_{012}, \alpha_{013}, \alpha_{023})} &= (-1)^{\beta_{05}-1} \frac{F_p(5)}{\Gamma(\alpha_{125}, \alpha_{135}, \alpha_{235})} \\
\Gamma(\alpha_{013}, \alpha_{134}, \alpha_{135}) F_n(1) &= (-1)^{\beta_{12}-1} \Gamma(\alpha_{023}, \alpha_{234}, \alpha_{235}) F_n(2) \\
\Gamma(\alpha_{234}, \alpha_{235}) F_p(0) &= (-1)^{\alpha_{145}} \Gamma(\alpha_{012}, \alpha_{013}) F_n(1) \\
\frac{F_p(2)}{\Gamma(\alpha_{123}, \alpha_{234}, \alpha_{124})} &= (-1)^{\beta_{20}-1} \frac{F_p(0)}{\Gamma(\alpha_{013}, \alpha_{014}, \alpha_{034})} \\
\Gamma(\alpha_{234}, \alpha_{024}, \alpha_{245}) F_n(4) &= (-1)^{\beta_{41}-1} \Gamma(\alpha_{123}, \alpha_{124}, \alpha_{125}) F_n(1) \quad (440)
\end{aligned}$$

where, in each relation, it is possible to exchange indices 1, 2 and 3 as well as 0, 4 and 5. These transformations are the only ones that leave the set of negative α_{lmn} invariant.

B.5 Transformations of $SU(2)$ and $SU(1, 1)$ $3j$ symbols

The relations (440) are used here in order to write the symmetry relations for $SU(2)$ and $SU(1, 1)$ $3j$ symbols. The expressions of these $3j$ symbols were given in equations (357) and (387). A useful notation is

$$\begin{aligned}
\left(\begin{array}{ccc} j_1 & j_2 & j \\ m_1 & m_2 & -m \end{array} \right)_{SU(2)} &= \left| \begin{array}{ccc} -j_1 + j_2 + j & j_1 - j_2 + j & j_1 + j_2 - j \\ j_1 + m_1 & j_2 + m_2 & j - m \\ j_1 - m_1 & j_2 - m_2 & j + m \end{array} \right| \quad (441) \\
\left(\begin{array}{ccc} j_1 & j_2 & j \\ m_1 & m_2 & -m \end{array} \right)_{SU(1,1)} &= \left| \begin{array}{ccc} j_1 - j_2 + j - 1 & -j_1 + j_2 + j - 1 & m - j \\ j_2 + m_2 - 1 & j_1 + m_1 - 1 & j - j_1 - j_2 \\ -j_1 + m_1 & -j_2 + m_2 & j + j_1 + j_2 - 2 \end{array} \right|
\end{aligned}$$

In this matrix notation, the sum of any row or of any column of the above matrices is a constant, equal to $j_1 + j_2 + j$ for $SU(2)$ and to $m + j - 2$ for $SU(1, 1)$. Moreover, all the coefficients of the matrices are positive integers. For both groups, Whipple's notation is introduced by identifying:

$$\begin{aligned}
\left(\begin{array}{ccc} j_1 & j_2 & j \\ m_1 & m_2 & -m \end{array} \right) &\sim \sqrt{\Gamma \left(\begin{array}{c} \alpha_{124}, \alpha_{125}, \alpha_{134}, \alpha_{135}, \alpha_{234}, \alpha_{235}, \alpha_{123} \\ \alpha_{012}, \alpha_{013}, \alpha_{023} \end{array} \right)} \\
&\times F_p(0; 4, 5) \quad (442)
\end{aligned}$$

up to a sign that was fixed in (357) and (387). More precisely:

$$\begin{array}{cc}
SU(2) & SU(1,1) \\
r_0 = -j + \frac{m_1 - m_2}{3} - \frac{1}{2} & r_0 = -j + \frac{m_1 - m_2}{3} + \frac{1}{2} \\
r_1 = j + \frac{m_1 - m_2}{3} + \frac{1}{2} & r_1 = j + \frac{m_1 - m_2}{3} - \frac{1}{2} \\
r_2 = j_2 - \frac{2m_1 + m_2}{3} + \frac{1}{2} & r_2 = -j_1 + \frac{m_1 + 2m_2}{3} + \frac{1}{2} \\
r_3 = j_1 + \frac{m_1 + 2m_2}{3} + \frac{1}{2} & r_3 = j_1 + \frac{m_1 + 2m_2}{3} - \frac{1}{2} \\
r_4 = -j_1 + \frac{m_1 + 2m_2}{3} - \frac{1}{2} & r_4 = j_2 - \frac{2m_1 + m_2}{3} - \frac{1}{2} \\
r_5 = -j_2 - \frac{2m_1 + m_2}{3} - \frac{1}{2} & r_5 = -j_2 - \frac{2m_1 + m_2}{3} + \frac{1}{2}
\end{array} \quad (443)$$

For both groups $SU(2)$ and $SU(1,1)$, the set of all possible symmetry transformations of the $3j$ symbols is generated by the transformation that sends all r_i to $-r_i$ and by all possible permutations of Whipple indices (this is clear from the two-term relations (440) that relate any Whipple function to any other Whipple function). In terms of j_i and m_i , these transformations consist of all possible permutations of rows or columns in the matrix notation of the $3j$ symbol introduced in relation (441), plus the transposition of the matrix and the exchanges of j_i with $-1 - j_i$ for the group $SU(2)$, or $1 - j_i$ for the group $SU(1,1)$. Any $3j$ symbol obtained by such transformations is equal to any other $3j$ symbol up to a phase, which can be calculated using relations (440).

Some examples of transformations include:

$$\begin{array}{cc}
\text{Whipple's notation} & \text{a, b, c, d, e notation} \\
3 \leftrightarrow 4 & j_1 \rightarrow -1 - j_1 \\
2 \leftrightarrow 5 & j_2 \rightarrow -1 - j_2 \\
0 \leftrightarrow 1 & j \rightarrow -1 - j \\
0 \leftrightarrow 5 & \text{transposition}
\end{array} \quad (444)$$

for $SU(2)$ while in the case of $SU(1,1)$, the correspondence is:

$$\begin{array}{cc}
\text{Whipple's notation} & \text{a, b, c, d, e notation} \\
2 \leftrightarrow 3 & j_1 \rightarrow 1 - j_1 \\
4 \leftrightarrow 5 & j_2 \rightarrow 1 - j_2 \\
0 \leftrightarrow 1 & j \rightarrow 1 - j \\
0 \leftrightarrow 5 & \text{transposition}
\end{array} \quad (445)$$

Other examples of the correspondence between the two notations are more complicated.

One last remark is in order before listing all the symmetries of the $SU(1,1)$ $3j$ symbols. From the above relations it is a priori straightforward to find these symmetry relations. There is however one subtlety that arises in some cases: Γ

function prefactors may contribute to the overall sign that relate any $3j$ symbol to any other $3j$ symbol. Recall for instance the expression of the $SU(1, 1)$ $3j$ symbol that was given in equation (387). It is not clear whether one should put a given Γ function (say $\Gamma(m_1 + j_1)$ for instance) inside or outside the square root, since this does not matter when only positive discrete representations are involved. It would however matter if one would try to compute $3j$ symbols involving negative discrete representations. This is precisely how this last subtlety is solved, using a result from [160] which says that the $3j$ symbols for all-positive or all-negative discrete representations are equal. This requires that some Γ functions be placed outside of the square root, as was done in (387). The symmetry relations of the $SU(1, 1)$ $3j$ symbols then follow directly from equations (440)¹¹⁸. For instance:

$$\begin{aligned}
\begin{pmatrix} j_1 & j_2 & j \\ m_1 & m_2 & m \end{pmatrix} &= \begin{pmatrix} j_1 & j_2 & j \\ -m_1 & -m_2 & -m \end{pmatrix} = (-1)^{j_1+j_2-j} \begin{pmatrix} j_2 & j_1 & j \\ m_2 & m_1 & m \end{pmatrix} \\
&= (-1)^{j_1-j+m_2+1} \begin{pmatrix} j & j_2 & j_1 \\ m & -m_2 & m_1 \end{pmatrix} = (-1)^{j_1-m_1+1} \begin{pmatrix} j & j_1 & j_2 \\ m & -m_1 & m_2 \end{pmatrix} \\
&= (-1)^{j_2-j+m_1} \begin{pmatrix} j_1 & j & j_2 \\ m_1 & -m & -m_2 \end{pmatrix} = (-1)^{j_2-m_2} \begin{pmatrix} j_2 & j & j_1 \\ m_2 & -m & -m_1 \end{pmatrix} \\
&= (-1)^{j_2+m_2} \begin{pmatrix} j_2 & j & j_1 \\ -m_2 & m_1 & m_1 \end{pmatrix} = (-1)^{j_1+m_1+1} \begin{pmatrix} j & j_1 & j_2 \\ -m & m_1 & -m_2 \end{pmatrix}
\end{aligned} \tag{446}$$

¹¹⁸One must be cautious when deriving these results because the symmetry $j_1 \leftrightarrow j_2 \leftrightarrow j$ that was valid for $SU(2)$ does not hold anymore for $SU(1, 1)$. This is why the diagrammatic notation was not used in section 7.7. The reason is that this symmetry left the set of negative $\alpha_{l,m,n}$ invariant in the case of $SU(2)$, while this is not true for $SU(1, 1)$. However, the symmetry $j_1 \leftrightarrow j_2$ is still valid.

Index

- H_3^+ , 83
- $SL(2, \mathbb{R})$, $SU(1, 1)$, 10, 12, 86, 134
- $SU(2)$, 10, 121
- Υ function, 91, 147

- Adjoint representation, 16
- Adjoint/co-adjoint orbit, 16, 114
- Associative product, 127, 139
- Associativity
 - of $SU(2)$ product, 128
 - of $SU(1, 1)$ product, 139
- Axiom of duality, 30, 38

- Berezin's quantization, 109
- Biedenharn-Elliott identity, 48, 126, 138
- Boundary state, 34, 36, 98, 100
- Brane, 32, 59
- Bulk theory, 33

- Cardy's constraint, 36, 98
- Central charge, 26, 40, 43, 57, 87
- Character, 34, 94
- Chiral (sector), 23
- Classical limit (of a CFT), 47
- Clebsch-Gordan coefficients (3j symbol), 47, 122, 135, 154
- Cluster property, 24
- Co-adjoint representation, 16
- Conformal
 - blocks, 30, 73
 - bootstrap, 23
 - field theory, 18
 - symmetry, 17
 - Ward identities, 31
 - weight, 22, 41, 56, 87
- Conjugacy class, 15
- Conjugate action (of a group), 15
- Continuity (boundary) condition, 33
- Correlation function, 28, 67, 90
- Coset, 43, 81, 83
- Crossing symmetry, 23, 68

- Dedekind function, 94, 147

- Degenerate (state, field), 31
- Degenerate (state, field), 82, 88
- Descendant theory, 33
- Dotsenko-Fateev integral, 146

- Equivalent representation, 14, 87
- Euclidean AdS_3 , 83

- Fusion coefficient, 99
- Fusion algebra, 44
- Fusion coefficient, 44, 101

- Generalized gravity equations, 43
- Generalized gravity equations, 64
- Geodesic, 60
- Geometric quantization, 108
- Group character, 15, 48

- Heisenberg algebra, 53
- Homogeneous (space), 107

- Irreducible representation, 14, 31
- Ishibashi state, 34

- Kähler manifold, 108
- Killing form, 13
- Knizhnik-Zamolodchikov equation, 40, 67

- Level, 39
- Lie algebra, 11
- Lie group, 10
- Liouville theory, 32, 81
- Locality (of fields), 21

- Möbius group, 18, 28
- Modular group, 34, 37
- Modulus, 37

- Non-rational (CFT), 50
- NS5 brane, 60

- Operator product expansion, 22, 26, 27, 58, 86
- Orbifold, 43

Partition function, 35, 37, 98, 101
 Pauli matrices, 12, 49, 53, 83, 148
 Penrose limit, 60
 Poincaré coordinates, 63, 84
 Point particle limit, 19
 Polyakov's action, 19
 Polyakov's action (modified), 42
 Primary fields, 22

 Quantum group, 49, 140

 Racah coefficients (6j symbol), 47,
 48, 124, 136
 Rational (CFT), 20
 Representation, 14, 30, 41, 45

 Secondary (state, field), 31
 Simple/semi-simple Lie algebra, 13
 Stabilizer, 15, 113
 State/field correspondence, 20
 Stress-energy tensor, 25, 54, 87
 String, 7, 52
 String theory, 7
 Sugawara construction, 40
 Superconformal algebra, 46

 Torus, 37
 Twisted representation, 25

 Unitary representation, 14
 Universal covering group, 10, 130
 Universal enveloping algebra, 49

 Verlinde formula, 45, 99, 102
 Verma module, 31
 Virasoro algebra, 26

 Wave-function (one-point function),
 35, 97, 100
 Wess-Zumino-Witten model, 38, 51,
 82, 116
 Whipple functions, 150
 Witt algebra, 27

References

- [1] C. Jogo and J. Troost, arXiv:hep-th/0601085, published in Physical Review D (Vol. 74, No. 10).
- [2] P. Bieliavsky, C. Jogo and J. Troost, arXiv:hep-th/0610329, to be published in Nuclear Physics B.
- [3] J. Scherk and J. H. Schwarz, Nucl. Phys. B **81** (1974) 118.
- [4] M.B. Green, J.H. Schwarz et E. Witten, Superstring theory, volume 1 and 2, Cambridge University Press, 1987.
- [5] D. Lust and S. Theisen, Lectures in String Theory, Lecture Notes in Physics, 346, Springer Verlag, 1989.
- [6] J. Polchinski, arXiv:hep-th/9411028.
- [7] E. Kiritsis, “*Introduction to String Theory*”, Leuven University Press, 1998, 315 p, ISBN 90 6186 8947, [arXiv:hep-th/9709062].
- [8] J. Polchinski, String theory, volume 1 (An introduction to the bosonic string) and 2 (Superstring theory and beyond), Cambridge University Press, 1998.
- [9] B. Zwiebach, A first course in string theory, Cambridge University Press, 2004.
- [10] O. Schramm, Israel J. Math. 118 (2000), 221–288. [math.PR/9904022]
- [11] S. Rohde and O. Schramm, arXiv:math.pr/0106036.
- [12] M. Bauer and D. Bernard, Phys. Lett. B **543** (2002) 135 [arXiv:math-ph/0206028].
- [13] M. Bauer and D. Bernard, Commun. Math. Phys. **239** (2003) 493 [arXiv:hep-th/0210015].
- [14] C. . (. Itzykson, H. . (. Saleur and J. B. . Zuber, *SINGAPORE, SINGAPORE: WORLD SCIENTIFIC (1988) 979p*
- [15] P. Fendley, F. Lesage and H. Saleur, J. Statist. Phys. **85** (1996) 211 [arXiv:cond-mat/9510055].
- [16] I. Affleck, Acta Phys. Polon. B **26** (1995) 1869 [arXiv:cond-mat/9512099].
- [17] I. Antoniadis, N. Arkani-Hamed, S. Dimopoulos and G. R. Dvali, Phys. Lett. B **436** (1998) 257 [arXiv:hep-ph/9804398].
- [18] N. Arkani-Hamed, S. Dimopoulos and G. R. Dvali, Phys. Lett. B **429** (1998) 263 [arXiv:hep-ph/9803315].

- [19] N. Vilenkin and A. Klymik, Representation of Lie groups and Special Functions, Volume 1, mathematics and its applications, Kluwer academic publisher, 1993.
- [20] T. Masson, course on differential geometry, available at http://qcd.th.u-psud.fr/page_perso/Masson/ [in French only].
- [21] P. Di Francesco, P. Mathieu and D. Senechal, Conformal field theory, Springer New-York 1997.
- [22] A. A. Kirillov, “Elements of the theory of representations”, Springer-Verlag, Berlin-New York, 1976, and especially “Lectures on the orbit method”, Graduate studies in Mathematics, 64, AMS, Rhode Island, 2004.
- [23] A. A. Belavin, A. M. Polyakov and A. B. Zamolodchikov, Nucl. Phys. B **241** (1984) 333.
- [24] V. S. Dotsenko, RIMS-559 IN *KYOTO 1986, PROCEEDINGS, CONFORMAL FIELD THEORY AND SOLVABLE LATTICE MODELS* 123-170. KYOTO UNIV. - RIMS-559 (86,REC.JAN.87) 84 P. (SEE CONFERENCE INDEX)
- [25] G. W. Moore and N. Seiberg, Commun. Math. Phys. **123** (1989) 177.
- [26] G. W. Moore and N. Seiberg, RU-89-32 Presented at Trieste Spring School 1989
- [27] P. H. Ginsparg, arXiv:hep-th/9108028.
- [28] V. Dotsenko, Prepared for NATO Advanced Study Institute: Frontiers in Particle Physics, Cargese, France, 1-13 Aug 1994
- [29] A. N. Schellekens, Fortsch. Phys. **44** (1996) 605.
- [30] J. Fuchs, arXiv:hep-th/9702194.
- [31] M. R. Gaberdiel, Rept. Prog. Phys. **63** (2000) 607 [arXiv:hep-th/9910156].
- [32] M. R. Gaberdiel, Fortsch. Phys. **50** (2002) 783.
- [33] M. R. Gaberdiel, arXiv:hep-th/0509027.
- [34] V. Dotsenko, Course on conformal field theory [in French], available at: <http://www.lpthe.jussieu.fr/DEA/dotsenko.html>
- [35] V. Schomerus, Phys. Rept. **431** (2006) 39 [arXiv:hep-th/0509155].
- [36] V. Riva and J. L. Cardy, Phys. Lett. B **622** (2005) 339 [arXiv:hep-th/0504197].
- [37] L. Brink, P. Di Vecchia and P. S. Howe, Phys. Lett. B **65** (1976) 471.

- [38] L. Brink, P. Di Vecchia and P. S. Howe, Nucl. Phys. B **118** (1977) 76.
- [39] A. M. Polyakov, Phys. Lett. B **103** (1981) 207.
- [40] V. Gurarie, Nucl. Phys. B **410** (1993) 535 [arXiv:hep-th/9303160].
- [41] J. Teschner, Nucl. Phys. B **546** (1999) 369 [arXiv:hep-th/9712258].
- [42] J. Teschner, Nucl. Phys. B **546** (1999) 390 [arXiv:hep-th/9712256].
- [43] V. I. Ogievetsky, “Infinite-dimensional algebra of general covariance group as the closure of finite-dimensional algebras of conformal and linear groups,” Lett. Nuovo Cim. **8** (1973) 988.
- [44] Kac, Lecture notes in Physics 94 (1979) 441
- [45] B. L. Feigin and D. B. Fuks, Funct. Anal. Appl. **16** (1982) 114 [Funkt. Anal. Pril. **16** (1982) 47].
- [46] N. Ishibashi, Mod. Phys. Lett. A **4** (1989) 251.
- [47] J. L. Cardy, Nucl. Phys. B **324** (1989) 581.
- [48] J. L. Cardy and D. C. Lewellen, Phys. Lett. B **259**, 274 (1991).
- [49] D. C. Lewellen, Nucl. Phys. B **372** (1992) 654.
- [50] G. Pradisi, A. Sagnotti and Y. S. Stanev, “Completeness Conditions for Boundary Operators in 2D Conformal Field Theory,” Phys. Lett. B **381** (1996) 97 [arXiv:hep-th/9603097].
- [51] A. Recknagel and V. Schomerus, Nucl. Phys. B **531** (1998) 185 [arXiv:hep-th/9712186].
- [52] R. E. Behrend, P. A. Pearce, V. B. Petkova and J. B. Zuber, Nucl. Phys. B **570** (2000) 525 [Nucl. Phys. B **579** (2000) 707] [arXiv:hep-th/9908036].
- [53] E. Witten, Commun. Math. Phys. **92** (1984) 455.
- [54] A. M. Polyakov and P. B. Wiegmann, Phys. Lett. B **131** (1983) 121.
- [55] V. G. Knizhnik and A. B. Zamolodchikov, Nucl. Phys. B **247** (1984) 83.
- [56] H. Sugawara, Phys. Rev. **170** (1968) 1659.
- [57] C. M. Sommerfield, Phys. Rev. **176** (1968) 2019.
- [58] E. Verlinde, Nucl. Phys. B **300** (1988) 360.
- [59] Y. Z. Huang, Proc. Nat. Acad. Sci. **102**, 5352 (2005) [arXiv:math.qa/0412261].
- [60] D. Amati and C. Klimcik, Phys. Lett. B **219** (1989) 443.

- [61] D. Amati and C. Klimcik, Phys. Lett. B **210** (1988) 92.
- [62] H. J. de Vega and N. G. Sanchez, Nucl. Phys. B **317** (1989) 731.
- [63] G. T. Horowitz and A. R. Steif, Phys. Rev. Lett. **64** (1990) 260.
- [64] A. R. Steif, Phys. Rev. D **42** (1990) 2150.
- [65] A. A. Tseytlin, Nucl. Phys. B **390** (1993) 153 [arXiv:hep-th/9209023].
- [66] A. A. Tseytlin, Phys. Lett. B **288** (1992) 279 [arXiv:hep-th/9205058].
- [67] A. A. Tseytlin, Phys. Rev. D **47** (1993) 3421 [arXiv:hep-th/9211061].
- [68] R. R. Metsaev and A. A. Tseytlin, Phys. Rev. D **65**, 126004 (2002) [arXiv:hep-th/0202109].
- [69] C. R. Nappi and E. Witten, Phys. Rev. Lett. **71** (1993) 3751 [arXiv:hep-th/9310112].
- [70] E. Kiritsis and C. Kounnas, Phys. Lett. B **320** (1994) 264 [Addendum-ibid. B **325** (1994) 536] [arXiv:hep-th/9310202].
- [71] E. Kiritsis, C. Kounnas and D. Lust, Phys. Lett. B **331**, 321 (1994) [arXiv:hep-th/9404114].
- [72] M. Blau, J. Figueroa-O'Farrill, C. Hull and G. Papadopoulos, Class. Quant. Grav. **19** (2002) L87 [arXiv:hep-th/0201081].
- [73] R. R. Metsaev, Nucl. Phys. B **625** (2002) 70 [arXiv:hep-th/0112044].
- [74] J. M. Maldacena and L. Maoz, JHEP **0212** (2002) 046 [arXiv:hep-th/0207284].
- [75] I. Bakas and J. Sonnenschein, JHEP **0212** (2002) 049 [arXiv:hep-th/0211257].
- [76] G. Papadopoulos, J. G. Russo and A. A. Tseytlin, Class. Quant. Grav. **20** (2003) 969 [arXiv:hep-th/0211289].
- [77] D. Berenstein, J. M. Maldacena and H. Nastase, JHEP **0204** (2002) 013 [arXiv:hep-th/0202021].
- [78] G. D'Appollonio and E. Kiritsis, Nucl. Phys. B **674**, 80 (2003) [arXiv:hep-th/0305081].
- [79] M. Bianchi, G. D'Appollonio, E. Kiritsis and O. Zapata, JHEP **0404** (2004) 074 [arXiv:hep-th/0402004].
- [80] M. Blau, J. Figueroa-O'Farrill and G. Papadopoulos, Class. Quant. Grav. **19** (2002) 4753 [arXiv:hep-th/0202111].

- [81] J. Gomis and H. Ooguri, Nucl. Phys. B **635** (2002) 106 [arXiv:hep-th/0202157].
- [82] E. Kiritsis and B. Pioline, JHEP **0208** (2002) 048 [arXiv:hep-th/0204004].
- [83] V. E. Hubeny, M. Rangamani and E. P. Verlinde, JHEP **0210** (2002) 020 [arXiv:hep-th/0205258].
- [84] A. A. Tseytlin, Mod. Phys. Lett. A **11** (1996) 689 [arXiv:hep-th/9601177].
- [85] J. P. Gauntlett, G. W. Gibbons, G. Papadopoulos and P. K. Townsend, Nucl. Phys. B **500** (1997) 133 [arXiv:hep-th/9702202].
- [86] J. M. Maldacena, Adv. Theor. Math. Phys. **2** (1998) 231 [Int. J. Theor. Phys. **38** (1999) 1113] [arXiv:hep-th/9711200].
- [87] D. Israel, C. Kounnas and M. P. Petropoulos, JHEP **0310** (2003) 028 [arXiv:hep-th/0306053].
- [88] M. B. Halpern and E. Kiritsis, Mod. Phys. Lett. A **4** (1989) 1373.
- [89] M. B. Halpern, E. Kiritsis, N. A. Obers and K. Clubok, Phys. Rept. **265** (1996) 1 [arXiv:hep-th/9501144].
- [90] W. Miller Jr., Lie theory and special functions, Academic press, NY 1968.
- [91] J. M. Figueroa-O'Farrill and S. Stanciu, Phys. Lett. B **327** (1994) 40 [arXiv:hep-th/9402035].
- [92] A. A. Kehagias and P. A. A. Meessen, Phys. Lett. B **331**, 77 (1994) [arXiv:hep-th/9403041].
- [93] N. Itzhaki, A. A. Tseytlin and S. Yankielowicz, Phys. Lett. B **432** (1998) 298 [arXiv:hep-th/9803103].
- [94] A. A. Tseytlin, Class. Quant. Grav. **14** (1997) 2085 [arXiv:hep-th/9702163].
- [95] S. Gukov, E. Martinec, G. W. Moore and A. Strominger, Adv. Theor. Math. Phys. **9** (2005) 435 [arXiv:hep-th/0403090].
- [96] Penrose, Roger (1976). "Any spacetime has a plane wave as a limit". Differential Geometry and Relativity, 271-275.
- [97] H. Lu and J. F. Vazquez-Poritz, Class. Quant. Grav. **19** (2002) 4059 [arXiv:hep-th/0204001].
- [98] J. Teschner, arXiv:hep-th/0009138.
- [99] T. Eguchi and Y. Sugawara, JHEP **0401**, 025 (2004) [arXiv:hep-th/0311141].
- [100] V. Fateev, A. B. Zamolodchikov and A. B. Zamolodchikov, arXiv:hep-th/0001012.

- [101] A. B. Zamolodchikov and A. B. Zamolodchikov, arXiv:hep-th/0101152.
- [102] D. Israel, A. Pakman and J. Troost, Nucl. Phys. B **710**, 529 (2005) [arXiv:hep-th/0405259].
- [103] A. Fotopoulos, V. Niarchos and N. Prezas, Nucl. Phys. B **710**, 309 (2005) [arXiv:hep-th/0406017].
- [104] C. Ahn, M. Stanishkov and M. Yamamoto, JHEP **0407** (2004) 057 [arXiv:hep-th/0405274].
- [105] J. Teschner, Nucl. Phys. B **571** (2000) 555 [arXiv:hep-th/9906215].
- [106] N. Ishibashi, K. Okuyama and Y. Satoh, Nucl. Phys. B **588** (2000) 149 [arXiv:hep-th/0005152].
- [107] B. Ponsot, V. Schomerus and J. Teschner, JHEP **0202** (2002) 016 [arXiv:hep-th/0112198].
- [108] A. Giveon, D. Kutasov and A. Schwimmer, Nucl. Phys. B **615** (2001) 133 [arXiv:hep-th/0106005].
- [109] K. Hosomichi and Y. Satoh, Mod. Phys. Lett. A **17** (2002) 683 [arXiv:hep-th/0105283].
- [110] Y. Satoh, Nucl. Phys. B **629** (2002) 188 [arXiv:hep-th/0109059].
- [111] J. M. Maldacena, H. Ooguri and J. Son, J. Math. Phys. **42**, 2961 (2001) [arXiv:hep-th/0005183].
- [112] J. M. Maldacena and H. Ooguri, Phys. Rev. D **65** (2002) 106006 [arXiv:hep-th/0111180].
- [113] G. Giribet and C. Nunez, JHEP **0106** (2001) 010 [arXiv:hep-th/0105200].
- [114] A. Giveon and D. Kutasov, Nucl. Phys. B **621** (2002) 303 [arXiv:hep-th/0106004].
- [115] J. Troost and A. Tsuchiya, JHEP **0306** (2003) 029 [arXiv:hep-th/0304211].
- [116] S. Bal, K. V. Shajesh and D. Basu, J. Math. Phys. **38** (1997) 3209 [arXiv:hep-th/9611236].
- [117] K. Hori and A. Kapustin, Phys. Rev. D **66** (2002) 010001 [arXiv:hep-th/0104202].
- [118] T. Gannon, Nucl. Phys. B **670** (2003) 335 [arXiv:hep-th/0305070].
- [119] A. Hanany, N. Prezas and J. Troost, JHEP **0204**, 014 (2002) [arXiv:hep-th/0202129].

- [120] N. Seiberg and D. Shih, JHEP **0402** (2004) 021 [arXiv:hep-th/0312170].
- [121] G. D’Appollonio and E. Kiritsis, Nucl. Phys. B **712**, 433 (2005) [arXiv:hep-th/0410269].
- [122] H. Awata and Y. Yamada, Mod. Phys. Lett. A **7**, 1185 (1992).
Nucl. Phys. B **251** (1985) 691.
- [123] N. Seiberg and E. Witten, JHEP **9909** (1999) 032 [arXiv:hep-th/9908142].
- [124] H. S. Snyder, Phys. Rev. **71** (1947) 38.
- [125] M. R. Douglas and N. A. Nekrasov, Rev. Mod. Phys. **73** (2001) 977 [arXiv:hep-th/0106048].
- [126] L. Freidel and K. Krasnov, J. Math. Phys. **43**, 1737 (2002) [arXiv:hep-th/0103070].
- [127] A. Y. Alekseev, A. Recknagel and V. Schomerus, JHEP **9909** (1999) 023 [arXiv:hep-th/9908040].
- [128] Merits and demerits of the orbit method, Bull. Amer. Math. Soc. **36** (1999), 433-488.
- [129] A. Alekseev and S. L. Shatashvili, Nucl. Phys. B **323** (1989) 719.
- [130] B. Kostant, Quantization and unitary representations I: Prequantization. In: Lectures in Modern Analysis and Applications III, Lect. Notes Math. **170**, 87-207, Springer, Berlin, 1970.
- [131] J.M. Souriau, Structure des systmes dynamiques, Dunod, 1970.
- [132] N. M. J. Woodhouse, “Geometric Quantization”, New York, USA: Clarendon (1992).
- [133] A. Alekseev, L. D. Faddeev and S. L. Shatashvili, J. Geom. Phys. **5** (1988) 391.
- [134] J. Rawnsley, M. Cahen and S. Gutt, J. Geom. Phys. **7**, 45 (1990).
- [135] J. Rawnsley, M. Cahen and S. Gutt, Quantization Of Kähler Manifolds. II
- [136] F. Berezin, Sov. Math. Izv. **38** (1974) 1116; Sov. Math. Izv. **39** (1975) 363; Comm. Math. Phys. **40** (1975) 153; Comm. Math. Phys. **63** (1978) 131.
- [137] A. M. Perelomov, “Generalized Coherent States And Their Applications,”
- [138] H. B. Nielsen and D. Rohrlich, Nucl. Phys. B **299** (1988) 471.

- [139] A. P. Balachandran, G. Marmo, B. S. Skagerstam and A. Stern, Lect. Notes Phys. **188** (1983) 1.
- [140] B. Morariu, Int. J. Mod. Phys. A **14** (1999) 919 [arXiv:physics/9710010].
- [141] A. Y. Alekseev and V. Schomerus, Phys. Rev. D **60** (1999) 061901 [arXiv:hep-th/9812193].
- [142] A. Y. Alekseev, A. Recknagel and V. Schomerus, Mod. Phys. Lett. A **16** (2001) 325 [arXiv:hep-th/0104054].
- [143] D. Bigatti and L. Susskind, Phys. Rev. D **62** (2000) 066004 [arXiv:hep-th/9908056].
- [144] B. Morariu, Nucl. Phys. B **734**, 156 (2006) [arXiv:hep-th/0408018].
- [145] C. Bachas, M. R. Douglas and C. Schweigert, JHEP **0005** (2000) 048 [arXiv:hep-th/0003037].
- [146] E. Witten, Nucl. Phys. B **268**, 253 (1986).
- [147] I. Runkel, Nucl. Phys. B **549**, 563 (1999) [arXiv:hep-th/9811178].
- [148] G. Felder, J. Frohlich, J. Fuchs and C. Schweigert, J. Geom. Phys. **34** (2000) 162 [arXiv:hep-th/9909030].
- [149] G. Felder, J. Frohlich, J. Fuchs and C. Schweigert, Compos. Math. **131** (2002) 189 [arXiv:hep-th/9912239].
- [150] E. P. Wigner., In Quantum Theory of Angular Momentum, eds. L. C. Biedenharn, H. van Dam, pp. 89-133. New York: Academic Press, 1965. (Original: 1940 (unpublished).)
- [151] J. Hoppe, Int. J. Mod. Phys. A **4**, 5235 (1989).
- [152] L. Alvarez-Gaume, C. Gomez and G. Sierra, Phys. Lett. B **220** (1989) 142.
- [153] B. Y. Hou, B. Y. Hou and Z. Q. Ma, Commun. Theor. Phys. **13**, 341 (1990).
- [154] B. Y. Hou, B. Y. Hou and Z. Q. Ma, BIHEP-TH-89-7
- [155] Z. Q. Ma, "QUANTUM $sl(2)$ ENVELOPING ALGEBRA AND REPRESENTATIONS OF BRAID GROUP"
- [156] N. Vilenkin and A. Klymik, Representation of Lie groups and Special Functions, Volume 3, mathematics and its applications, Kluwer academic publisher, 1993.
- [157] J. Madore, Class. Quant. Grav. **9**, 69 (1992).

- [158] N. Mukunda and B. Radhakrishnan, *J. Math. Phys.* **15** (1974) 1320.
- [159] K. Wang, *J. Math. Phys.* **11** (1970) 2077.
- [160] S. Davids, arXiv:gr-qc/0110114.
- [161] B. Ponsot and J. Teschner, *Commun. Math. Phys.* **224**, 613 (2001) [arXiv:math.qa/0007097].
- [162] N. A. Liskova and A. N. Kirillov, *Int. J. Mod. Phys. A* **7S1B**, 611 (1992) [arXiv:hep-th/9212064].
- [163] S. Davids, *J. Math. Phys.* **41** (2000) 924 [arXiv:gr-qc/9807061].
- [164] A. Y. Alekseev and A. Z. Malkin, *Commun. Math. Phys.* **162** (1994) 147 [arXiv:/9303038].
- [165] K. Gawedzki, *Commun. Math. Phys.* **139** (1991) 201.
- [166] F. Falcat and K. Gawedzki, arXiv:hep-th/9109023.
- [167] M. f. Chu and P. Goddard, *Phys. Lett. B* **337**, 285 (1994) [arXiv:hep-th/9407116].
- [168] P. Podles, *Lett. Math. Phys.* **14**, 193 (1987).
- [169] B. Jurco and P. Stovicek, *Comm. Math. Phys.* 152, no. 1 (1993), 97
- [170] B. Jurco and P. Stovicek, *Commun.Math.Phys.* 182 (1996) 221 [arxiv:hep-th/9403114].
- [171] H. Grosse, J. Madore and H. Steinacker, *J. Geom. Phys.* **38** (2001) 308 [arXiv:hep-th/0005273].
- [172] H. Grosse, J. Madore and H. Steinacker, *J. Geom. Phys.* **43** (2002) 205 [arXiv:hep-th/0103164].
- [173] K. Sfetsos, *Phys. Rev. D* **50** (1994) 2784 [arXiv:hep-th/9402031].
- [174] S. Ribault, *JHEP* **0509**, 045 (2005) [arXiv:hep-th/0507114].
- [175] B. Ponsot and J. Teschner, *Nucl. Phys. B* **622**, 309 (2002) [arXiv:hep-th/0110244].
- [176] S. Ribault and J. Teschner, *JHEP* **0506**, 014 (2005) [arXiv:hep-th/0502048].
- [177] A. Unterberger et J. Unterberger, *C. R. Acad. Sci. Paris Ser. I Math.* 296 (1983), no. 11, 465–468.
- [178] A. Unterberger et J. Unterberger, *Ann. Sci. Ecole Norm. Sup. (4)* 21 (1988), no. 1

- [179] A. Y. Alekseev and I. T. Todorov, Nucl. Phys. B **421**, 413 (1994) [arXiv:hep-th/9307026].
- [180] A. Y. Alekseev, S. Fredenhagen, T. Quella and V. Schomerus, Nucl. Phys. B **646** (2002) 127 [arXiv:hep-th/0205123].
- [181] V. S. Dotsenko and V. A. Fateev, Nucl. Phys. B **240** (1984) 312.
- [182] Whipple, F. J. W. "Well-Poised Series and Other Generalized Hypergeometric Series." Proc. London Math. Soc. Ser. 2 25, 525-544, 1926.
- [183] Whipple, F. J. W. "On Well-Poised Series, Generalized Hypergeometric Series Having Parameters in Pairs, Each Pair with the Same Sum." Proc. London Math. Soc. 24, 247-263, 1926.
- [184] Whipple, F. J. W. "A Fundamental Relation Between Generalized Hypergeometric Series." Proc. London Math. Soc. 26, 257-272, 1927.
- [185] Lucy Joan Slater. Generalized Hypergeometric Functions. Cambridge University Press, 1966.