



HAL
open science

Analysis of parabolic/Hamilton-Jacobi systems modelizing the dynamics of dislocation densities inabounded domain

Hassan Ibrahim

► **To cite this version:**

Hassan Ibrahim. Analysis of parabolic/Hamilton-Jacobi systems modelizing the dynamics of dislocation densities inabounded domain. Mathematics [math]. Ecole des Ponts ParisTech, 2008. English. NNT: . pastel-00004186

HAL Id: pastel-00004186

<https://pastel.hal.science/pastel-00004186>

Submitted on 26 Sep 2008

HAL is a multi-disciplinary open access archive for the deposit and dissemination of scientific research documents, whether they are published or not. The documents may come from teaching and research institutions in France or abroad, or from public or private research centers.

L'archive ouverte pluridisciplinaire **HAL**, est destinée au dépôt et à la diffusion de documents scientifiques de niveau recherche, publiés ou non, émanant des établissements d'enseignement et de recherche français ou étrangers, des laboratoires publics ou privés.



THÈSE

présentée pour l'obtention du titre de

DOCTEUR DE L'ÉCOLE NATIONALE DES PONTS ET CHAUSSEES

Spécialité : Mathématiques et Informatique

par

Hassan IBRAHIM

Sujet :

**Analyse de systèmes parabolique/Hamilton-Jacobi
modélisant la dynamique de densités
de dislocations en domaine borné.**

Soutenue le 30 juin 2008 devant le jury composé de :

M. Guy BARLES	Examineur
M. Jérôme DRONIOU	Rapporteur
M. Messoud EFENDIEV	Examineur
M. Mustapha JAZAR	Co-Directeur de thèse
M. Régis MONNEAU	Directeur de thèse
M. Nabil NASSIF	Examineur
M. Benoît PERTHAME	Rapporteur
M. Juan Luis VÁZQUEZ	Président

*À mes parents Jinane et Ali,
à ma sœur Lamya,
à mon frère Hussein.*

Acknowledgements

First of all, I am deeply grateful to my advisor Régis Monneau for introducing me to the world of research with continuous guidance and encouragement. Besides being a real pleasure, working with you has been the opportunity to grasp from various scientific fields. Thank you for the warm welcome since my arrival to the ENPC in September 2005. Thank you for the support, patience and confidence you have given. Your rigorous mathematics as well as the originality of your work will always be an example for me.

I am very grateful to my co-advisor Mustapha Jazar for his constant attention throughout my Ph.D. and my DEA. I greatly appreciate his personal qualities as well as his careful orientation. The discussions we had together during my presence in the Lebanese University in Beirut and in Tripoli were always fruitful. I also thank him for the opportunity to meet Régis, and for his encouragement to choose the way of scientific research.

I would like to express my gratitude to Jérôme Droniou who has kindly accepted to write a report on my Ph.D. His very constructive remarks have improved several parts of the Ph.D. manuscript.

Benoît Perthame has also kindly accepted the task of writing a report on my Ph.D. I really thank him for his interest in my work.

It is an honor for me that Guy Barles, Messoud Efendiev, Nabil Nassif and Juan Luis Vázquez have accepted to take part of my Ph.D. jury. I would like to express my special thanks to all of them.

I wish to express my sincere recognition to the Dean of the faculty of sciences at the Lebanese University Ali Mniemneh, and to Raafat Talhouk for their advises and enthusiasm especially during my DEA.

I thank all the members of the CERMICS laboratory at the ENPC. This laboratory has been an exceptional place to carry out my Ph.D. I also thank Sylvie Berte, Khadija Elouali and Martine Ouhanna for their tremendous and efficient work of secretary.

Many thanks to the “PDE and materials” group of the CERMICS : Ariela Briani, Elisabetta Carlini, Ahmad El Hajj, Mohammed El Rhabi, Nicolas Forcadel, Amin Ghorbel and Cyril Imbert. They have made me feel at home when I first arrived to France. Particularly, I would like to thank Ahmad El Hajj and Cyril Imbert for several scientific discussions we had together.

I would like to thank all the members fo the two ACI “dynamique des dislocations” and “mouvement d’interfaces avec termes non-locaux”. Particularly, Nathael Alibaud, Guy Barles, Pierre Cardaliaguet and Olivier Ley for their scientific contributions that appeared through many talks in the field of my studies.

I also thank Raphael Danchin, Robert Eymard, Daniel Ostrov and Julien Vovelle for their answers on my questions during the preparation of my Ph.D.

I want to thank the MA3N network and CIMPA for their financial support during my stay in Lebanon. Also I want thank the “École Nationale des Ponts et Chaussées” for the financial support during my stay in France.

I would like to thank all the members of the mathematics departement at the faculty of sciences of the Lebanese University, in particular my colleagues, Lina Abdallah, Ayman Kachmar, Zaynab Salloum, Mohammad El Smaily and Ali Tarhini for their invaluable friendship. I should not forget Houda Faour that I have met during my second year of my Ph.D. while she was preparing her DEA. I have really enjoyed our mathematical discussions at the Lebanese University in Beirut and Tripoli. Her kindness, friendship and support are highly appreciated.

A big thanks to my colleague/friend Bassam, his fiancée Fatima, to Ramzi, Mahmoud and my uncle Jamal for their constant support when I have needed it the most. The nice moments we had shared together are really unforgettable.

I thank my parents, my sister and my brother. This Ph.D. thesis would not have been possible without your unlimited support and love. Finally, I would like to express my gratitude to Amal who has made the difficult time of working on my Ph.D. easier and even enjoyable.

Résumé : Cette thèse porte sur l'étude théorique d'un modèle mathématique provenant de l'étude de la dynamique de densités de dislocations dans les cristaux de petite taille. Cette dynamique est modélisée par un système non linéaire couplé parabolique/Hamilton-Jacobi. Les dislocations sont des lignes de défauts qui se déplacent dans les cristaux lorsque ceux-ci sont soumis à des contraintes extérieures. De façon indépendante, tout à la fin de la thèse, nous présentons une méthode numérique pour le transport de fronts.

Dans le cœur de la thèse, trois types d'équations sont considérées : équations de Hamilton-Jacobi non linéaires, lois de conservation scalaires, et équations paraboliques singulières.

Nous traitons un système parabolique/Hamilton-Jacobi singulier où la singularité apparaît par la présence de l'inverse du gradient. Notre système prend en considération l'effet à courte distance entre dislocations, ainsi que la formation des couches limites. Nous étudions l'existence, l'unicité et la régularité des solutions du système. Cette étude repose en grande partie sur la théorie des solutions de viscosité ; des solutions entropique et des solutions classiques. Deux cas principaux sont considérés : le cas où les contraintes extérieures sont nulles, et le cas où elles sont constantes (non nécessairement nulles).

Abstract : This thesis is concerned with the theoretical study of a mathematical model arising from the study of the dynamics of dislocation densities in crystals of small size. This dynamics is modeled by parabolic/Hamilton-Jacobi nonlinear coupled system. Dislocations are linear defects which move in crystals when those are subjected to exterior stresses. Independently, at the end of the thesis, we present, in a short chapter, a numerical method for the transport of fronts.

In this thesis, three types of equations are considered : non-linear first order Hamilton-Jacobi equations, scalar conservations laws, and singular parabolic equations.

We treat a singular parabolic/Hamilton-Jacobi system where the singularity appears from the presence of the inverse of the gradient. Our system takes into consideration the short range dislocation-dislocation interactions, as well as the formation of boundary layers. We study the existence, uniqueness and the regularity of the solutions of this system. This study relies essentially on the theory of viscosity solutions ; the theory of entropy and classical solutions. Two main cases are considered : the case of zero exterior stresses, and the case of constant exterior stresses (not necessarily zero).



Publications issues de la thèse

Articles acceptés

- *Existence and uniqueness for a nonlinear parabolic/Hamilton-Jacobi coupled system describing the dynamics of dislocation densities*, à paraître dans Ann. Inst. H. Poincaré Anal. Non Linéaire, (2007). (cf. chapitre 3)

Articles preprints

- (avec M. Jazar et R. Monneau) *Dynamics of dislocation densities in a bounded channel. Part I : smooth solutions to a singular parabolic system*, preprint déposé sur HAL. (cf. chapitre 4)

- (avec M. Jazar et R. Monneau) *Dynamics of dislocation densities in a bounded channel. Part II : existence of weak solutions to a singular Hamilton-Jacobi/parabolic strongly coupled system*, preprint déposé sur HAL. (cf. chapitre 5)

Rapport de recherche

- (Equipe EDP et matériaux-CERMICS & CEA) *Résultats préliminaires sur quelques algorithmes pour les équations de transport*. (cf. chapitre 6)

Sommaire

1	Introduction générale	1
1	Motivation physique	2
1.1	Dislocations : une brève introduction	2
1.2	Le modèle de Groma, Czikor et Zaiser	3
2	Système non-linéaire parabolique/Hamilton-Jacobi	9
2.1	Situation du problème	9
2.2	Résultats de viscosité sur l'intervalle borné $I = (0, 1)$. . .	10
2.3	Résultat entropique sur tout l'espace \mathbb{R}	13
3	Système parabolique singulier fortement couplé	13
3.1	Situation du problème	13
3.2	Un résultat d'existence et d'unicité	16
4	Système non linéaire parabolique/Hamilton-Jacobi fortement cou- plé	19
4.1	Situation du problème	19
4.2	Existence des solutions de viscosité	20
4.3	Simulations	22
5	Test numériques préliminaires	23
2	General introduction	27
1	Physical motivation	28
1.1	Dislocations : brief introduction	28
1.2	The model of Groma, Czikor and Zaiser	29
2	Nonlinear parabolic/Hamilton-Jacobi system	35
2.1	Setting of the problem	35
2.2	Viscosity results on the bounded interval $I = (0, 1)$	36
2.3	An entropy result on the whole space \mathbb{R}	39
3	Strongly coupled singular parabolic system	39
3.1	Setting of the problem	39
3.2	Existence and uniqueness result	42
4	Strongly coupled nonlinear parabolic/Hamilton-Jacobi system . .	45
4.1	Setting of the problem	45

4.2	Existence of viscosity solutions	45
4.3	Simulations	47
5	Preliminary numerical tests	48
3	Existence et unicité pour un système couplé parabolique/Hamilton-Jacobi non-linéaire décrivant la dynamique des densités des dislocations	51
1	Introduction	52
1.1	Physical motivation	52
1.2	Main results	54
1.3	Organization of the paper	57
2	Notations and Preliminaries	57
2.1	Viscosity solution : definition and properties	59
2.2	Entropy solution : definition and properties	65
2.3	Entropy-Viscosity relation	67
3	The approximate problem	70
4	Proof of Theorem 1.6	76
4.1	Gradient estimates.	76
4.2	Local boundedness in $W^{1,\infty}$	79
4.3	Proof of theorem 1.6	79
5	Problem with boundary conditions	80
5.1	Brief physical motivation	80
5.2	Statement of the main results on a bounded interval	82
5.3	Preliminary results	83
5.4	Proofs of Theorems 5.1, 5.2	88
6	Appendix : Proof of Theorem 2.16	91
4	Dynamics of dislocation densities in a bounded channel. Part I : smooth solutions to a singular parabolic system	103
1	Introduction	104
1.1	Setting of the problem	104
1.2	Statement of the main result	106
1.3	Brief review of the literature	106
1.4	Strategy of the proof	108
1.5	Organization of the paper	108
2	Tools : theory of parabolic equations	109
2.1	L^p and C^α theory of parabolic equations	109
2.2	BMO theory for parabolic equation	115
3	A comparison principle	117
4	Short time existence, uniqueness, and regularity	125
4.1	Short-time existence and uniqueness of a truncated system	125

4.2	Regularity of the solution	132
5	Exponential bounds	136
6	An upper bound for the $W_2^{2,1}$ norm of ρ_{xxx}	143
7	An upper bound for the BMO norm of ρ_{xxx}	152
8	L^∞ bound for ρ_{xxx} and <i>revisited</i> results	156
9	Long time existence and uniqueness	161
10	Appendix A : miscellaneous parabolic estimates	164
11	Appendix B : parabolic BMO theory	166
5	Dynamics of dislocation densities in a bounded channel. Part II : existence of weak solutions to a singular Hamilton-Jacobi/parabolic strongly coupled system	177
1	Introduction	178
1.1	Physical motivation and setting of the problem	178
1.2	Setting of the problem	179
1.3	Statement of the main result	181
1.4	Organization of the paper	182
2	Strategy of the proof	182
3	Tools : miscellaneous parabolic results, viscosity solution, and Or- licz spaces	184
3.1	Miscellaneous parabolic results	184
3.2	Viscosity solution : definition and stability result	186
3.3	Orlicz spaces : definition and properties	187
4	The regularized problem	188
5	Entropy inequality	190
6	An interior estimate	195
7	Proof of the main theorem	198
8	Appendix	205
6	Résultats préliminaires sur quelques algorithmes pour les equa- tions de transport	209
1	Introduction : rappel au cas d'une équation eikonale non convexe	210
2	Une première approche basée sur les fronts	213
2.1	Un algorithme basé sur les fronts + et -	213
2.2	Quelques éléments sur la discrétisation des droites	215
2.3	Applications au calcul de la vitesse effective de la droite, prédite par l'algorithme basé sur les fronts + et -	217
2.4	Inconvénients de l'algorithme précédent	220
2.5	Ce que pouvait être un bon algorithme ?	221
3	Un algorithme de splitting	222
3.1	Préambule	222

SOMMAIRE

3.2	Un algorithme basé sur le splitting	222
4	Simulations numériques pour l'algorithme de splitting	224
4.1	Simulation 1 : Cas d'un cercle avec une vitesse constante $\vec{a} = (1, 2)$	224
4.2	Simulation 2 : Cas d'un carré qui tourne, $\vec{a} = (-y, x)$. . .	226
5	Conclusion	227
	Appendix : remarks on the model of Groma-Csikor-Zaiser	229

Chapitre 1

Introduction générale

Cette thèse porte sur l'étude théorique d'un modèle mathématique provenant de l'étude de la dynamique de densités de dislocations dans les cristaux. Cette dynamique est modélisée par un système non linéaire couplé parabolique/Hamilton-Jacobi, et l'on s'intéresse à l'existence et l'unicité des solutions du système. Les dislocations sont des lignes de défauts qui se déplacent dans les cristaux lorsque ceux-ci sont soumis à des contraintes extérieures.

De façon indépendante, tout à la fin de la thèse, est présentée dans un court chapitre, une méthode numérique pour le transport de fronts. Dans le cœur de la thèse, trois types d'équations sont considérées :

1. Equations de Hamilton-Jacobi non linéaires du premier ordre.
2. Les lois de conservation scalaires.
3. Equations paraboliques singulières.

Pour toutes ces équations, le but principal de l'étude étant l'existence, l'unicité et la régularité des solutions. Cette introduction a pour but de donner un aperçu des résultats obtenus. Dans la première section, on donne une brève description physique de la dynamique de densités de dislocations dans les cristaux. Une motivation physique du modèle spécial auquel on s'intéresse est donnée aussi. Dans les sections 2, 3 et 4, on présente les résultats mathématiques concernant notre modèle décrivant la dynamique de densités de dislocations. La section 5 est consacrée à la présentation d'une méthode numérique pour le transport de fronts.

Afin de mettre en relief les nouvelles idées et ne pas se perdre dans les détails techniques, on a donné des énoncés simplifiés dans cette introduction générale.

Pour les énoncés précis, on renvoie le lecteur aux chapitres suivants.

1 Motivation physique

1.1 Dislocations : une brève introduction

Les dislocations sont des lignes de défaut, ou bien irrégularité dans une structure cristalline. Schématiquement, ce sont des zones dans lesquelles les atomes sont mal placés dans le réseau atomique cristallin parfait. La théorie a été mathématiquement développée par V. Volterra⁽¹⁾. Les dislocations sont des phénomènes non stationnaires et leur mouvement est l'explication principale de la déformation plastique dans les cristaux métalliques (voir Nabarro [76], et Hirth, Lothe [51] pour une présentation physique récente).



FIG. 1.1 – Les dislocations dans l'acier inoxydable.

Les dislocations ont une longueur typique de l'ordre de $10^{-6}m$ et une épaisseur de l'ordre $10^{-9}m$. Ils ont été introduits par Orowan [78], Polanyi [83] et Taylor [90] en 1934 comme l'une des principales explications au niveau microscopique de la déformation plastique macroscopique des cristaux. Ces concepts ont été confirmés en 1956 par la première observation directe des dislocations par Hirsch, Horne et Whelan [50], et par Bollmann [5], grâce aux microscopes électroniques. Sous l'effet du champ de contrainte, ces dislocations peuvent se déplacer dans un plan cristallographique bien défini appelé "plan de glissement". Une dislocation est caractérisée par deux vecteurs : le vecteur $\vec{\xi}$ qui est parallèle à

¹L'article original [92] de Vito Volterra date de 1907.

la ligne de dislocation, et le vecteur de Burgers \vec{b} décrivant le déplacement associé. En utilisant ces termes $\vec{\xi}$ et \vec{b} , deux types de dislocations peuvent être présentés :

1. Dislocation coin : le vecteur de Burgers \vec{b} est perpendiculaire à $\vec{\xi}$
2. Dislocation vis : le vecteur de Burgers \vec{b} est parallèle à $\vec{\xi}$.

En fait, ces deux types de dislocations sont seulement les formes extrêmes de l'éventuelle structure de dislocations qui peuvent arriver. La plupart des dislocations sont des formes hybrides de ces deux formes.

Dans cette thèse, on étudie la dynamique de lignes de dislocations coins dans un matériau borné. La quantité de dislocations dans un cristal est représentée par sa densité qui est définie comme étant le nombre des lignes de dislocations traversant une section unitaire.

Comprendre le comportement des dislocations est la clé pour la compréhension d'une partie essentielle de la microstructure des cristaux solides. En effet, le comportement et les propriétés des dislocations affectent directement la force et la dureté des matériaux structuraux. Cependant, dans cette thèse, on se concentre seulement sur l'analyse mathématique d'un modèle particulier décrivant la dynamique de densités de dislocation dans un domaine de petite taille.

1.2 Le modèle de Groma, Czikor et Zaiser

Dans [46], Groma, Czikor et Zaiser ont proposé un modèle 2-dimensionnel décrivant la dynamique de densités de dislocations coins parallèles dans un cristal 3-dimensionnel borné. Le terme "densités de dislocations" surgit du fait que les dislocations coins peuvent être classifiées comme étant **positives** ou **négatives** selon la direction de leurs vecteurs de Burgers. Ce modèle a été introduit pour décrire l'accumulation possible des dislocations sur la frontière du matériau. Il met en valeur l'évolution de ces deux types de densités en prenant en compte les interactions à courte distance entre dislocations.

Rentrons plus en profondeur dans le modèle. Supposons l'existence d'un certain nombre de dislocations coins dans un canal de largeur finie dans la direction x et ayant une extension infinie dans la direction y (voir la Figure 1.2). Le canal est borné par des murs qui sont impénétrables par les dislocations (i.e., la déformation plastique dans les murs est zéro). Les lignes de dislocations sont supposées être perpendiculaire au plan x - y , et se mouvant dans la direction x , i.e.

1. La ligne de dislocation $\vec{\xi}$ est perpendiculaire à x et y .
2. Le vecteur de Burgers \vec{b} est parallèle à l'axe des x .

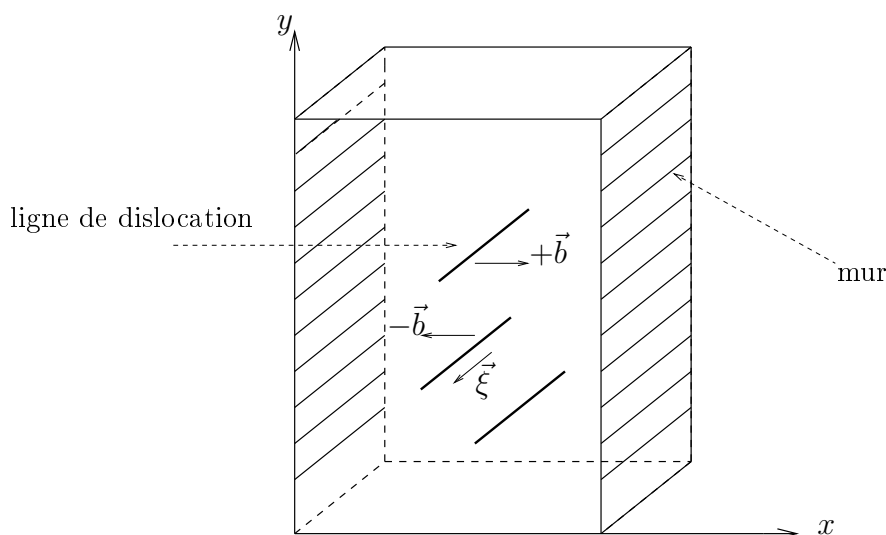

FIG. 1.2 – Le modèle de Groma, Czikor et Zaiser.

Tout l'assemblage est plongé dans un cristal infini où les dislocations peuvent bouger sous l'action d'un certain champ de contrainte extérieure constante $\tau \neq 0$, et/ou sous l'action du champ de contrainte créé par les dislocations elles mêmes. Les forces internes créées par les dislocations sont conséquence directe des interactions à courtes et longues distance entre elles dans le matériau même.

On s'intéresse à un modèle simplifié où l'on suppose une configuration particulière de lignes de dislocation.

Un modèle unidimensionnel simplifié.

On suppose que le problème est **invariant par translation** dans la direction y . En d'autres termes, on suppose que, si (\mathcal{S}) est une section perpendiculaire aux lignes de dislocations, alors l'arrangement des points de dislocation dans (\mathcal{S}) est invariant par translation dans la direction y . La distribution de points de dislocations dans (\mathcal{S}) est montrée dans la Figure 1.3. Suite aux hypothèses faites sur l'arrangement des dislocations (voir Figure 1.3), on peut déduire que l'étude de la dynamique des points de dislocation sur la ligne (\mathcal{L}) donne l'information complète de la dynamique des lignes de dislocation dans le canal. En conclusion,

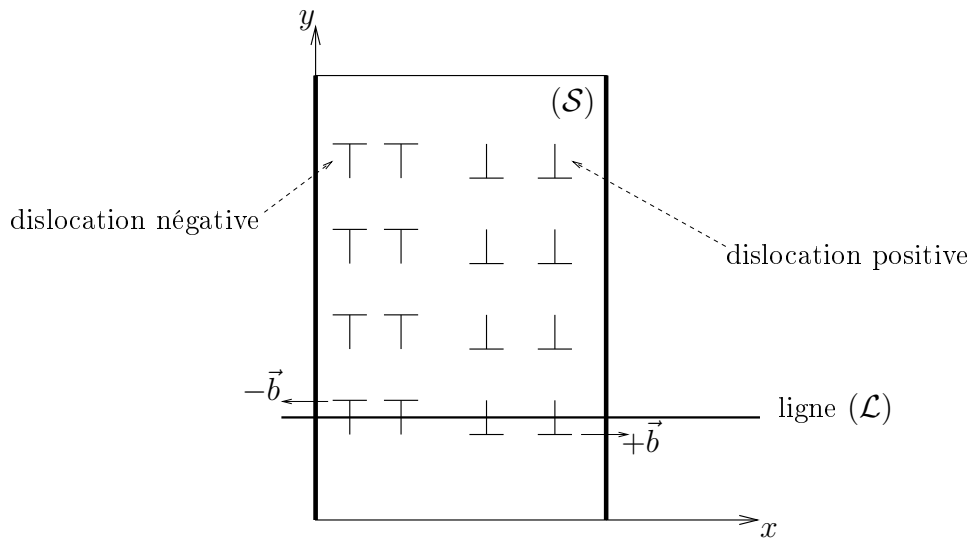

FIG. 1.3 – Points de dislocation dans une section.

on peut écrire que :

dynamique dans $(\mathcal{L}) \implies$ dynamique dans $(\mathcal{S}) \implies$ dynamique dans un canal borné.

Groma, Csikor et Zaiser [46] ont formulé, à partir du mouvement des dislocations individuelles, une description continue en termes de densités de dislocation. Il a été expliqué par Groma et Balogh [44, 45], pour un système de dislocations parallèles, qu'une description continue peut être dérivée des équations de mouvement des dislocations individuelles. En utilisant une approche différente, une description continue d'un système de dislocations courbées en 3-D a été formulée (voir El-Azab [30], et Monneau [74] et leurs références). Cependant, un **inconvé-**
nient majeur de ces premières investigations est que, afin d'obtenir un ensemble fermé d'équations, les interactions à courte distance entre dislocations ont été négligées et les interactions entre dislocations ont été décrites seulement par leur contribution longue distance. Cette description n'a pas permis de formuler mathématiquement ce qui se passe à la frontière du matériau.

Remark 1.1 *Dans notre cadre particulier, voir Figure 1.3, les dislocations sont relativement proche les unes des autres. Ceci est dû à leur présence dans une petite zone borné par des murs. Dans ce cas, les interactions à longue distance entre dislocations sont nulles et donc le modèle présenté dans Groma, Balogh [45] n'est plus approprié pour décrire l'évolution de densités de dislocations. Cependant, pour le modèle décrit dans Groma, Balogh [45], on renvoie le lecteur à El Hajj [31], et El Hajj, Forcadel [32] pour une étude mathématique et numérique 1-D, et à Cannone, El Hajj, Monneau et Ribaud [10] pour un résultat d'existence 2-D.*

Dans [46], Groma, Csikor et Zaiser ont réussi à modéliser l'effet des interactions à courte distance entre dislocations par une contrainte locale de type gradient. La formulation mathématique exacte va être présentée maintenant.

La formulation mathématique du modèle unidimensionnel.

Soient θ^+ et θ^- les densités positives et négatives de dislocations respectivement. En suivant la dernière discussion, les dislocations sont bornées par des murs séparés par une distance finie de longueur ℓ (prendre $\ell = 1$). Typiquement, les dislocations positives/négatives sont celles qui se déplacent vers le mur droit/gauche. Dans le cas où le champ de contrainte constant appliqué τ est différent de zéro, notre système est un système de “pile-up” double où les dislocations positives s'accumulent au mur droit, tandis que les dislocations négative s'accumulent au mur gauche (voir Figure 1.4). Pour une étude mathématique de plusieurs modèles

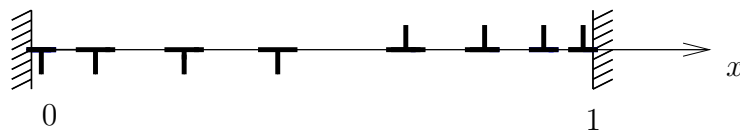

FIG. 1.4 – Un système de “pile-up” double.

de “pile-ups” de dislocations, on renvoie le lecteur au Voskoboinikov, Chapman, Ockendon, Allwright [93], Carpio, Chapman, Velázquez [12], Wood, Head [95], et Hirth, Lothe [51].

Le système couplé décrivant l'évolution de densités de dislocations θ^+ et θ^- s'écrit (voir Groma, Csikor et Zaiser [46]) :

$$\begin{cases} \theta_t^+ = \left[\left(\frac{\theta_x^+ - \theta_x^-}{\theta^+ + \theta^-} - \tau \right) \theta^+ \right]_x & \text{sur } (0, 1) \times (0, T), \\ \theta_t^- = \left[- \left(\frac{\theta_x^+ - \theta_x^-}{\theta^+ + \theta^-} - \tau \right) \theta^- \right]_x & \text{sur } (0, 1) \times (0, T), \end{cases} \quad (1.1)$$

avec les conditions initiales :

$$\theta^+(x, 0) = \theta_0^+(x) \quad \text{et} \quad \theta^-(x, 0) = \theta_0^-(x).$$

Ici $T > 0$ est un réel positif fixé et τ est le champ de contrainte extérieure supposé constant. Le terme $\frac{\theta_x^+ - \theta_x^-}{\theta^+ + \theta^-}$ qui apparait dans (1.1) représente le champ de contrainte locale décrivant les interactions à courte distance entre dislocations. Dans les modèles présentés dans la Remarque 1.1, ce terme a été mis à zéro. Dans ce cas, le système (1.1) décrit la translation des dislocations en suivant la

vitesse τ , sans prendre en considération la formation des couches limites. Pour cette raison, des conditions au bord périodiques ont été considérées dans l'étude mathématique de ces systèmes. En fait, l'utilisation des conditions au bord périodiques est une façon de voir ce qui se passe à l'intérieur du matériau loin de sa frontière.

L'objectif essentiel de cette thèse est d'examiner l'existence et l'unicité des solutions de (1.1) sous des conditions au bord appropriées qui vont être clarifiées ci-après. Soit

$$I := (0, 1), \quad \text{et} \quad I_T := I \times (0, T).$$

On considère une forme intégrée de (1.1) et on pose

$$\rho_x^\pm = \theta^\pm, \quad \rho = \rho^+ - \rho^- \quad \text{et} \quad \kappa = \rho^+ + \rho^-, \quad (1.2)$$

pour obtenir (au moins formellement), pour des valeurs spéciales des constantes d'intégration, le système suivant en terme de ρ et κ :

$$\begin{cases} \kappa_t \kappa_x = \rho_t \rho_x & \text{sur } I_T \\ \rho_t = \rho_{xx} - \tau \kappa_x & \text{sur } I_T, \end{cases} \quad (1.3)$$

avec les conditions initiales :

$$\kappa(x, 0) = \kappa^0(x) \quad \text{et} \quad \rho(x, 0) = \rho^0(x).$$

On va donner maintenant les deux conditions essentielles concernant ρ et κ .

Conditions physiquement consistantes.

Condition 1. Les deux termes θ^+ et θ^- représentent deux densités positives. Puisque par (1.2),

$$\theta^\pm = \frac{\kappa_x \pm \rho_x}{2},$$

Le fait que $\theta^\pm \geq 0$ est traduit dans le langage de ρ et κ par la condition suivante :

$$\kappa_x \geq |\rho_x|. \quad (1.4)$$

Cette condition doit être satisfaite afin de pouvoir donner sens au système (1.1).

Condition 2. La deuxième condition est

$$\rho(1, t) = \rho(0, t), \quad \forall t \geq 0. \quad (1.5)$$

Cette condition est nécessaire pour l'équilibre du modèle physique qui commence avec le même nombre de dislocations positives et négatives. Pour être plus précis,

soit n^+ et n^- le nombre total des dilocations positives et négatives respectivement en $t = 0$. On suppose qu'il n'existe ni annihilation ni création de dislocations dans le matériau. Il y a donc conservation des n^+ et n^- au cours du temps. Cela peut être formulé mathématiquement par (voir (1.2) ci-dessus) :

$$\begin{aligned} \rho(1, t) - \rho(0, t) &= \int_0^1 \rho_x(x, t) dx, \\ &= \int_0^1 (\theta^+(x, t) - \theta^-(x, t)) dx, \\ &= n^+ - n^- = 0. \end{aligned}$$

Ainsi, on retrouve (1.5).

Les conditions au bord.

Pour formuler heuristiquement les conditions aux bords (en $x = 0$ et $x = 1$), on suppose d'abord que $\kappa_x \neq 0$ en $x = 0, 1$. On rappelle que puisque les murs sont impénétrables par les dislocations, alors le flux de dislocations à la frontière doit être zéro, ce qui exige :

$$\overbrace{(\theta_x^+ - \theta_x^-) - \tau(\theta^+ + \theta^-)}^{\Phi} = 0, \quad \text{en } x \in \{0, 1\}. \quad (1.6)$$

En écrivant le système (1.3) en terme de ρ , κ et Φ , on obtient

$$\begin{cases} \kappa_t = (\rho_x / \kappa_x) \Phi, \\ \rho_t = \Phi. \end{cases} \quad (1.7)$$

A partir de (1.6) et (1.7), et si $\kappa_x \neq 0$ en $x = 0$ et $x = 1$, on peut formellement déduire que ρ et κ sont constants le long des murs frontières. Cela suggère de mettre des conditions de Dirichlet au bord pour ρ et κ . Écrivons maintenant le système complet d'une façon précise.

Le système complet.

De tout ce qui précède, le système complet est exprimé par le système couplé suivant :

$$\begin{cases} \kappa_t \kappa_x = \rho_t \rho_x, & \text{sur } I_T, \\ \kappa(x, 0) = \kappa^0(x), & \text{sur } I, \\ \kappa(0, t) = \kappa^0(0) \quad \text{et} \quad \kappa(1, t) = \kappa^0(1), & \forall t \in [0, T], \end{cases} \quad (1.8)$$

et

$$\begin{cases} \rho_t = \rho_{xx} - \tau \kappa_x, & \text{sur } I_T, \\ \rho(x, 0) = \rho^0(x), & \text{sur } I, \\ \rho(0, t) = \rho(1, t) = 0, & \forall t \in [0, T]. \end{cases} \quad (1.9)$$

Ces équations sont le cœur de notre analyse mathématique où l'on étudie l'existence et l'unicité des solutions dans deux cas différents.

Les deux cas.

Pour l'étude du système (1.8)-(1.9), on commence par le cas où $\tau = 0$. Dans ce cas, le système devient faiblement couplé dans le sens que l'on peut résoudre d'abord l'équation en ρ , puis l'équation en κ . Le deuxième cas est un cas général où $\tau \neq 0$. Notre système devient donc fortement couplé et plus compliqué. Écrivons donc les deux cas :

Cas A. La contrainte extérieure τ appliqué au matériau est **zéro**.

Cas B. La contrainte extérieure τ appliqué au matériau est constante **différente de zéro**.

2 Système non-linéaire parabolique/Hamilton-Jacobi

Cette section est un assemblage des résultats du Chapitre 3, où l'on étudie le système (1.8)-(1.9) dans le cas $\tau = 0$. Dans cette section, on présente nos théorèmes principaux ; on montre les difficultés majeures, et on discute des idées clés qui nous ont permis de surmonter ces difficultés.

2.1 Situation du problème

On étudie l'existence et l'unicité des solutions du système parabolique/Hamilton-Jacobi (1.8) et (1.9) dans le **Cas A**. Cette étude est faite dans le cadre des solutions de viscosité (pour la définition des solutions de viscosité pour les équations de Hamilton-Jacobi, on renvoie le lecteur aux Définitions 2.3, 2.5 du Chapitre 3). La notion de solutions de viscosité a été introduite par Crandall et Lions [22] pour résoudre les équations de Hamilton-Jacobi du premier ordre. La théorie a été ensuite étendue pour les équations du second ordre et a connu un grand développement après les travaux de Jensen [58] et de Ishii [57].

On réécrit le système (1.8)-(1.9) dans le cas où $\tau = 0$, on arrive au système de Dirichlet suivant :

$$\begin{cases} \kappa_t \kappa_x = \rho_t \rho_x, & \text{sur } I_T, \\ \kappa(x, 0) = \kappa^0(x), & \text{sur } I, \\ \kappa(0, t) = \kappa^0(0) \quad \text{et} \quad \kappa(1, t) = \kappa^0(1), & \forall t \in [0, T], \end{cases} \quad (2.10)$$

et

$$\begin{cases} \rho_t = \rho_{xx}, & \text{sur } I_T, \\ \rho(x, 0) = \rho^0(x), & \text{sur } I, \\ \rho(0, t) = \rho(1, t) = 0, & \forall t \in [0, T]. \end{cases} \quad (2.11)$$

Rappelons que κ_x et ρ_x doivent satisfaire “dans un certain sens” la condition (1.4), i.e.

$$\kappa_x \geq |\rho_x| \quad \text{sur } I_T.$$

Il est utile de noter que le système ci-dessus (2.10)-(2.11) est maintenant un système faiblement couplé. Plus précisément, on peut résoudre l'équation de la chaleur (2.11), et puis insérer sa solution ρ dans (2.10), transformant le problème en la résolution d'une seule équation de type Hamilton-Jacobi qui peut être formulée comme suivant :

$$\begin{cases} \kappa_t = \frac{\rho_x \rho_{xx}}{\kappa_x} = F(x, t, \kappa_x) & \text{sur } I_T, \\ \kappa(x, 0) = \kappa^0(x) \in Lip(I), \\ \kappa(0, t) = \kappa^0(0) \quad \text{et} \quad \kappa(1, t) = \kappa^0(1), & \forall t \in [0, T], \end{cases} \quad (2.12)$$

avec

$$\kappa_x^0 \geq |\rho_x^0| \quad \text{sur } I. \quad (2.13)$$

2.2 Résultats de viscosité sur l'intervalle borné $I = (0, 1)$

La première difficulté apparait en résolvant (2.12) lorsqu'on divise par κ_x . Cela donne lieu à une singularité aux points où $\kappa_x = 0$, et qui peut arriver même en $t = 0$ (voir la condition (2.13) ci-dessus). On surmonte cette difficulté en prenant une approximation spéciale de (2.13), où l'on empêche κ_x^0 de s'annuler. Le théorème suivant est ainsi prouvé.

Théorème 2.1 (*Existence et unicité d'une solution de viscosité, $\varepsilon > 0$*)
 Soient $T > 0$ et $\varepsilon > 0$ deux constantes. Soient $\kappa^0 \in Lip(I)$, et $\rho^0 \in C_0^\infty(I)$ vérifiant :

$$\kappa_x^0 \geq G_\varepsilon(\rho_x^0), \quad G_\varepsilon(x) = \sqrt{x^2 + \varepsilon^2}. \quad (2.14)$$

2. Système non-linéaire parabolique/Hamilton-Jacobi

Etant donné la solution ρ de l'équation de la chaleur (2.11), il existe une solution de viscosité $\kappa \in Lip(I_T)$ de (2.10), unique parmi celles vérifiant :

$$\kappa_x \geq G_\varepsilon(\rho_x) \quad \text{p.p. dans } I_T. \quad (2.15)$$

La difficulté principale en prouvant ce résultat est de démontrer la minoration (2.15) de κ_x . L'argument formel pour surmonter cette difficulté est d'observer d'abord que κ_x est une solution de l'équation dérivée de (2.12) :

$$w_t = (F(x, t, w))_x, \quad (2.16)$$

tandis que, par simple calculs, on peut montrer (voir Lemme 3.4 de Chapitre 3) que $G_\varepsilon(\rho_x)$ satisfait :

$$(G_\varepsilon(\rho_x))_t \leq (F(x, t, G_\varepsilon(\rho_x)))_x, \quad (2.17)$$

et donc $G_\varepsilon(\rho_x)$ est une sous-solution de (2.16). En utilisant un principe de comparaison, avec (2.14), on arrive facilement au résultat. Ces arguments formels peuvent être formulés rigoureusement en utilisant une relation entre les solutions de viscosité des équations de Hamilton-Jacobi et les solutions entropiques des lois de conservation scalaires. Cette relation montre que, sous certaines hypothèses de régularités, si κ est une solution de viscosité de l'équation de Hamilton-Jacobi suivante sur tout l'espace :

$$\begin{cases} \kappa_t = \frac{\rho_x \rho_{xx}}{\kappa_x} = F(x, t, \kappa_x), & \text{sur } \mathbb{R} \times (0, T), \\ \kappa(x, 0) = \kappa^0(x), & \text{sur } \mathbb{R}, \end{cases}$$

où ρ est la solution de l'équation de la chaleur :

$$\begin{cases} \rho_t = \rho_{xx}, & \text{sur } \mathbb{R} \times (0, T), \\ \rho(x, 0) = \rho^0(x), & \text{sur } \mathbb{R}, \end{cases} \quad (2.18)$$

alors $w = \kappa_x$ est une solution entropique de la loi de conservation scalaire suivant :

$$\begin{cases} w_t = (F(x, t, w))_x & \text{sur } \mathbb{R} \times (0, T), \\ w(x, 0) = w^0(x) = \kappa_x^0(x), & \text{sur } \mathbb{R}. \end{cases} \quad (2.19)$$

De plus, la régularité de la fonction $G_\varepsilon(\rho_x)$ permet d'avoir l'inégalité (2.17) p.p. dans $\mathbb{R} \times (0, T)$, alors $G_\varepsilon(\rho_x)$ est une sous-solution entropique de (2.19). En utilisant l'inégalité entre la donnée initiale (2.14), et le principe de comparaison de Kružkov (voir Théorème 2.16 du Chapitre 3), on obtient que :

$$\kappa_x \geq G_\varepsilon(\rho_x).$$

Rappelons que les solutions entropiques ont été d'abord introduites par Kruřkov [63] comme étant la seule solution “physiquement” admissible parmi toutes les solutions faibles (distributionnelles) aux lois de conservation scalaires. La théorie des solutions entropiques a été ensuite largement développée. Des définitions équivalentes aux solutions entropiques pour les lois de conservation scalaires avec données initiales simplement essentiellement bornées L^∞ sont données via des solutions entropiques processus (voir Eymard, Gallouët et Herbin [35, 36]), ou bien via la formulation cinétique (voir Lions, Perthame, Tadmor [70], Perthame [81], et Perthame, Tadmor [82]). Une notion de solution entropique faible via le couple entropie-flux est donnée dans Otto [80]. Pour la définition des solutions entropiques que l'on va utiliser dans notre travail, on renvoie le lecteur à la Définition 2.12 du Chapitre 3.

Il est utile de noter que l'on doit faire attention à deux points importants lors des preuves rigoureuses. Le premier point est que la relation ci-dessus entre les solutions de viscosité et les solutions entropiques est valide sur \mathbb{R} . Ceci exige, à un certain moment, de faire un prolongement approprié du problème à partir de l'intervalle borné I dans l'espace entier \mathbb{R} ; pour se servir de cette relation, et puis retourner de nouveau à I . Le deuxième point est que le Principe de Comparaison original de Kruřkov [63] a été prouvé sous certaines conditions de régularité de la fonction F que l'on n'a pas. Cela nécessite de suivre les idées de Kruřkov [63], et Eymard, Gallouët, Herbin [35] et d'adapter leurs preuves à notre cas avec une régularité moindre (voir Théorème 2.16 et sa preuve dans l'Appendice du Chapitre 3).

Une autre voie envisageable pour prouver la minoration (2.15) du gradient κ_x aurait été de rester dans le cadre des solutions de viscosité. En effet, il y a quelques résultats sur la minoration du gradient des solutions de viscosité des équations de Hamilton-Jacobi. Un résultat intéressant à ce sujet peut être trouvé dans Ley [67]. Dans cet article, l'auteur donne une borne inférieure pour le gradient spatial de la solution de viscosité des équations de Hamilton-Jacobi du premier ordre :

$$u_t + F(x, t, u_x) = 0,$$

sous certaines conditions sur le Hamiltonien $F(x, t, p)$ incluant sa convexité en la variable p . Malheureusement, ce n'est pas notre cas (voir équation (2.12)) avec

$$F(x, t, p) = \frac{\rho_x(x, t)\rho_{xx}(x, t)}{p},$$

et cela ne nous permet pas d'utiliser directement le cadre solutions de viscosité pour établir la minoration sur κ_x .

3. Système parabolique singulier fortement couplé

Le résultat suivant est un résultat d'existence de (2.10) sous la condition originale (2.13) sur le gradient κ_x^0 .

Théorème 2.2 (*Existence d'une solution de viscosité, $\varepsilon = 0$*)

Soient $T > 0$, $\kappa^0 \in Lip(I)$ et $\rho^0 \in C_0^\infty(I)$. Si la condition (2.13) est satisfaite p.p. dans I , et si ρ est la solution de (2.11), alors il existe une solution de viscosité $\kappa \in Lip(I_T)$ de (2.10) satisfaisant :

$$\kappa_x \geq |\rho_x|, \quad p.p. \text{ dans } I_T.$$

La preuve de ce théorème vient directement du passage à la limite $\varepsilon \rightarrow 0$ dans la famille des solutions données par le Théorème 2.1.

2.3 Résultat entropique sur tout l'espace \mathbb{R}

Dans la preuve du Théorème 2.1, la fonction κ_x est en fait une solution entropique de (2.19). En effet, cela peut être considéré comme un résultat en soit.

Théorème 2.3 (*Existence et unicité d'une solution entropique, $\varepsilon > 0$*)

Soit $T > 0$. Prenons $w^0 \in L^\infty(\mathbb{R})$ et $\rho^0 \in C_0^\infty(\mathbb{R})$ tels que, $w^0 \geq G_\varepsilon(\rho_x^0)$ p.p. dans \mathbb{R} , pour une certaine constante $\varepsilon > 0$. Alors, étant donné ρ , l'unique solution de l'équation de la chaleur (2.18), il existe une solution entropie $w \in L^\infty(Q_T)$ de (2.19), unique parmi les solutions entropiques satisfaisants :

$$w \geq G_\varepsilon(\rho_x) \quad p.p. \text{ dans } \mathbb{R} \times (0, T).$$

3 Système parabolique singulier fortement couplé

Dans cette section on présente le résultat principal du Chapitre 4, qui peut être considéré comme le point de départ pour la résolution du système (1.8)-(1.9) dans le **Cas B** (le cas où $\tau \neq 0$). On étudie l'existence, l'unicité et la régularité des solutions d'un système parabolique singulier fortement couplé.

3.1 Situation du problème

Soit $T > 0$. On considère le système parabolique couplé suivant :

$$\begin{cases} \kappa_t = \varepsilon \kappa_{xx} + \frac{\rho_x \rho_{xx}}{\kappa_x} - \tau \rho_x & \text{sur } I_T \\ \rho_t = (1 + \varepsilon) \rho_{xx} - \tau \kappa_x & \text{sur } I_T, \end{cases} \quad (3.20)$$

avec les conditions initiales :

$$\begin{cases} \kappa(x, 0) = \kappa^0(x) & \text{sur } I \\ \rho(x, 0) = \rho^0(x) & \text{sur } I, \end{cases} \quad (3.21)$$

et les conditions au bord :

$$\begin{cases} \kappa(0, t) = \kappa^0(0) \text{ et } \kappa(1, t) = \kappa^0(1), & \forall t \in [0, T], \\ \rho(0, t) = \rho(1, t) = 0, & \forall t \in [0, T], \end{cases} \quad (3.22)$$

où $\varepsilon > 0$, $\tau \neq 0$ sont des réels fixés. Ce système est un système parabolique fortement couplé avec une singularité qui provient de la division par κ_x dans la première équation de (3.20). Dans le but d'empêcher une telle singularité, on impose l'inégalité stricte suivante sur la donnée initiale :

$$\kappa_x^0 > |\rho_x^0| \quad \text{sur } I. \quad (3.23)$$

On s'intéresse à l'existence et l'unicité des solutions régulières (ρ, κ) de (3.20)-(3.21)-(3.22), sous la condition (3.23).

Le choix du système (3.20). La première question que l'on peut se demander est à propos du choix spécial du système (3.20). Rappelons au lecteur que notre but final est de résoudre (1.8)-(1.9) dans le cas général où $\tau \neq 0$. Pour cette raison, on a pris (3.20) comme une approximation régularisée de (1.8)-(1.9). D'autres choix de systèmes approchés sont aussi possible. Par exemple, le système suivant :

$$\begin{cases} \kappa_t = \varepsilon \kappa_{xx} + \frac{\rho_x \rho_{xx}}{\kappa_x} - \tau \rho_x & \text{sur } I_T \\ \rho_t = \rho_{xx} - \tau \kappa_x & \text{sur } I_T, \end{cases} \quad (3.24)$$

peut être aussi considéré comme une approximation de (1.8)-(1.9). Cependant, ce qui risque d'arriver est la perte de l'inégalité

$$\kappa_x > |\rho_x|,$$

qui est cruciale dans notre étude. En effet, on n'est pas capable de prouver cette inégalité pour (3.24), et même pour beaucoup d'autres systèmes approchés que l'on a essayé. Au contraire, le système (3.20) est particulièrement construit dans le but de vérifier un **principe de comparaison** (voir Proposition 3.1 du Chapitre 4) qui implique l'inégalité ci-dessus.

Bref rappel de la littérature. On n'a pas trouvé dans la littérature des travaux portants sur des systèmes paraboliques singuliers proche de (3.20). Cependant,

3. Système parabolique singulier fortement couplé

plusieurs systèmes paraboliques impliquant des termes singuliers ont été largement étudiés dans divers aspects. Des équations paraboliques dégénérées et singulières ont été intensivement étudiées par DiBenedetto et al. (voir par exemple DiBenedetto *et al.* [17, 24–27] et les références citées). Les auteurs considèrent les solutions d'équations paraboliques singulières ou dégénérées avec les coefficients mesurables dont le prototype est une équation de la chaleur avec p -Laplacien :

$$u_t - \operatorname{div}(|\nabla u|^{p-2}\nabla u) = 0, \quad p > 2 \text{ ou } 1 < p < 2.$$

L'étude inclut la continuité locale de type Hölder des solutions faibles bornées, bornitude locale et globale des solutions faibles, estimations intrinsèques et estimations globales de Harnack. D'autres équations paraboliques du type milieu poreux :

$$u_t - \Delta u^m = 0, \quad 0 < m < 1,$$

sont examinées dans Quirós, Vázquez [84], et DiBenedetto *et al.* [28, 29]. Ces équations sont singulières aux points où $u = 0$. Dans DiBenedetto, Kwong, Vespi [28], les auteurs étudient, pour des valeurs particulières de m , le comportement de la solution au voisinage des points de singularité. En particulier, ils prouvent que les solutions positives sont analytiques en espace et au moins Lipschitz en temps. Cependant, dans DiBenedetto, Kwong [29], une estimation intrinsèque de Harnack pour les solutions faibles positives est établie pour un certain interval optimal du paramètre m . Dans Quirós, Vázquez [84], les auteurs étudient le comportement asymptotique des solutions faibles en domaine extérieur avec des valeurs au bord qui sont constantes en temps. Une autre classe d'équations paraboliques singulières est la suivante :

$$u_t = u_{xx} + \frac{b}{x}u_x, \tag{3.25}$$

b étant une constante. Une telle équation est liée aux problèmes à symétrie axiale ainsi qu'aux problèmes issus de la théorie de la probabilité. De nombreux travaux sont faits sur (3.25), y compris des théorèmes d'existence, d'unicité et de représentation pour la solution (avec conditions au bord de type Dirichlet ou Neumann). En outre, la différentiabilité et les propriétés de régularité sont étudiées (pour les références, voir Colton [20], Speranza [89], Alexiades [2], et Chan, Wong [16]). Une forme plus générale de (3.25), y compris des équations semi linéaires, est traitée dans Mooney [75], Chan, Kaper [14], Chan, Chen [15], et Maugeri [71].

Un type important d'équations qui peuvent être indirectement liées à notre système sont les équations paraboliques semi-linéaires :

$$u_t = \Delta u + |u|^{p-1}u, \quad p > 1. \tag{3.26}$$

Plusieurs auteurs ont étudiés les phénomènes d'explosion pour les solutions de l'équation ci-dessus (voir par exemple Zaag [96], Merle, Zaag [72, 73], Souplet *et*

al. [47,85,88]). Cela inclut des estimations uniformes au temps d'explosion, ainsi que la recherche concernant le taux initial d'explosion. L'équation (3.26) peut être liée d'une façon ou d'une autre à la première équation de (3.20), mais avec une singularité de la forme $1/\kappa$. Ceci peut être formellement vu si l'on suppose d'abord que $u \geq 0$, et puis on applique le changement suivant des variables $u = 1/v$. Dans ce cas-ci, l'équation (3.26) devient :

$$v_t = \Delta v - \frac{2|\nabla v|^2}{v} - v^{2-p},$$

et alors si $p = 3$, on obtient :

$$v_t = \Delta v - \frac{1}{v}(1 + 2|\nabla v|^2). \quad (3.27)$$

Puisque la solution u de (3.26) peut exploser en temps fini $t = T$, alors v peut s'annuler à $t = T$, et donc l'équation (3.27) peut avoir des singularités semblables à ceux de la première équation (3.20), mais avec un terme en $1/v$ dans l'équation et non pas un terme en $1/v_x$.

3.2 Un résultat d'existence et d'unicité

Le Théorème principal concernant le système (3.20)-(3.21)-(3.22) est le suivant :

Théorème 3.1 (*Existence et unicité des solutions régulières*)

Soit $\rho^0, \kappa^0 \in C^\infty(\bar{I})$ satisfaisant la condition (3.23) et

$$\begin{cases} (1 + \varepsilon)\rho_{xx}^0 = \tau\kappa_x^0 & \text{sur } \partial I \\ (1 + \varepsilon)\kappa_{xx}^0 = \tau\rho_x^0 & \text{sur } \partial I. \end{cases} \quad (3.28)$$

Alors, il existe une unique solution globale (ρ, κ) du système (3.20)-(3.21)-(3.22) satisfaisant :

$$\rho, \kappa \in C^{3+\alpha, \frac{3+\alpha}{2}}(\bar{I} \times [0, \infty)) \cap C^\infty(I \times (0, \infty)), \quad \forall \alpha \in (0, 1),$$

avec

$$\kappa_x > |\rho_x| \quad \text{sur } \bar{I} \times [0, \infty). \quad (3.29)$$

Les conditions au bord (3.28) que l'on a imposé sur la donnée initiale sont naturelles ici. En effet, supposons ρ et κ sont des solutions suffisamment régulières de (3.20)-(3.21)-(3.22). A partir de (3.22), on sait que ρ et κ sont constantes sur

3. Système parabolique singulier fortement couplé

$\partial I \times [0, T]$, et alors $\rho_t = \kappa_t = 0$ sur $\partial I \times [0, T]$. En utilisant cette information avec le système (3.20) satisfaite par ρ et κ , on obtient :

$$\begin{cases} 0 = \varepsilon \kappa_{xx} + \frac{\rho_x \rho_{xx}}{\kappa_x} - \tau \rho_x & \text{sur } \partial I \times [0, T] \\ 0 = (1 + \varepsilon) \rho_{xx} - \tau \kappa_x & \text{sur } \partial I \times [0, T], \end{cases}$$

Ce qui implique immédiatement (3.28).

La régularité $C^{3+\alpha, \frac{3+\alpha}{2}}$ de la solution est la régularité maximale que nous pouvons obtenir “jusqu’à la frontière”. Ceci est dû au fait que nous augmentons la régularité, d’une manière itérative, en utilisant chaque fois, la théorie de Hölder pour les équations paraboliques (voir Théorème 2.1 du Chapitre 4). Cependant, la théorie de Hölder pour les équations paraboliques exige un certain ordre de compatibilité entre les données initiales, et, grosso modo : plus que nous augmentons l’ordre de compatibilité, plus nous augmentons la régularité. Dans notre cas, les conditions au bord (3.22) et (3.28) augmentent l’ordre de compatibilité jusqu’à 1, et par conséquent nous obtenons la régularité $C^{3+\alpha, \frac{3+\alpha}{2}}$ jusqu’à la frontière.

L’effet de la division par κ_x . La manière classique de prouver l’existence d’une solution globale en temps d’un problème parabolique, est de montrer l’existence d’une solution locale en temps en appliquant un argument de point fixe sur un espace approprié, et de réitérer ensuite après avoir obtenu quelques bonnes estimations *a priori*. Nous emploierons cette méthode pour trouver notre solution. Mentionnons qu’en temps court $T > 0$, nous pouvons facilement trouver une solution régulière de (3.20)-(3.21)-(3.22) qui satisfait :

$$\kappa_x > |\rho_x|, \quad \text{sur } I_T,$$

ce qui linéarise en quelque sorte la première équation (3.20) satisfaite par κ . Dans ce cas-ci, les estimations bien connues pour les équations paraboliques linéaires donnent quelques bonnes estimations *a priori*, mais pas une minoration appropriée dans la norme L^∞ de κ_x afin d’éviter la division par 0. Par conséquent, en réitérant, il peut se produire que $\kappa_x = 0$ et donc que le procédé s’arrête.

Dans les prochains arguments, beaucoup de constantes qui peuvent dépendre du temps sont remplacées par 0 ou 1. Ceci est fait afin d’éviter des confusions techniques, et de faire une présentation plus claire des idées essentielles.

Première minoration de κ_x . On va essayer de surmonter le problème de la division de la κ_x en trouvant une borne inférieure via un **principe de comparaison** qui est prouvé pour (3.20)-(3.21)-(3.22). Ce principe de comparaison

permet de prouver l'inégalité suivante sur $\bar{I}_T := \bar{I} \times [0, T]$:

$$\kappa_x(x, t) \geq \sqrt{\gamma^2(t) + \rho_x^2(x, t)}, \quad (3.30)$$

où γ est une fonction décroissante satisfaisant l'équation différentielle ordinaire simple suivante :

$$\gamma' \geq - (1 + \|\rho_{xxx}\|_{L^\infty(I_T)}) \gamma \quad \text{sur } (0, T). \quad (3.31)$$

Le terme $\|\rho_{xxx}\|_{L^\infty(I_T)}$ qui apparait dans (3.31) vient en dérivant le système (3.20) par rapport à x . Nous pouvons facilement remarquer que la solution γ de (3.31) pourrait s'annuler si $\|\rho_{xxx}\|_{L^\infty(I_T)}$ devient infiniment grand. Par conséquent, l'inégalité (3.30) n'est pas une bonne minoration de κ_x à moins que $\|\rho_{xxx}\|_{L^\infty(I_T)}$ soit bien contrôlée, et cela sera la prochaine étape.

Une inégalité parabolique de type Kozono-Taniuchi. Les estimations C^α pour les équations paraboliques donne un contrôle de $\|\rho_{xxx}\|_{L^\infty(I_T)}$ de la forme :

$$\|\rho_{xxx}\|_{L^\infty(I_T)} \leq \frac{1}{\gamma(T)}, \quad (3.32)$$

qui, utilisée dans (3.31), n'empêche pas κ_x de s'annuler. Il est utile de mentionner que les estimations L^p habituelles pour les équations paraboliques sont valides pour $1 < p < \infty$, et pas pour $p = \infty$.

Une théorie "intermédiaire" des équations paraboliques est la théorie $BMO^{(2)}$ (Bounded Mean Oscillation). Les estimations BMO donnent un contrôle de la norme BMO de ρ_{xxx} indépendant de γ :

$$\|\rho_{xxx}\|_{BMO(I_T)} \leq 1. \quad (3.33)$$

Dans notre travail, on prouve une inégalité parabolique de type Kozono-Taniuchi qui contrôle la norme L^∞ d'une fonction par sa norme BMO et par le logarithme de sa norme dans un certain espace de Sobolev. Cette inégalité s'écrit formellement :

$$\|\rho_{xxx}\|_{L^\infty(I_T)} \leq \|\rho_{xxx}\|_{BMO(I_T)} \left(1 + \log^+ \|\rho_{xxx}\|_{BMO(I_T)} + \log^+ \|\rho_{xxx}\|_{W_2^{2,1}(I_T)} \right). \quad (3.34)$$

Par ailleurs, une estimation utile qui peut être obtenue à partir de la théorie L^p est une estimation de la forme :

$$\|\rho_{xxx}\|_{W_2^{2,1}(I_T)} \leq \frac{1}{\gamma^4(T)}. \quad (3.35)$$

²L'espace BMO a été présenté par John et Nirenberg, voir [59].

4. Système non linéaire parabolique/Hamilton-Jacobi fortement couplé

En utilisant (3.33), (3.34) et (3.35), on obtient finalement :

$$\|\rho_{xxx}\|_{L^\infty(I_T)} \leq 4 \log \left(\frac{1}{\gamma(T)} \right), \quad (3.36)$$

qui est meilleur de (3.32).

L'original de l'inégalité de Sobolev logarithmique (3.34) a été trouvé dans Brézis, Gallouët [8], et Brézis, Wainger [9] (voir également Engler [33]), où les auteurs ont étudié, dans un cadre elliptique et non pas parabolique, la relation entre L^∞ , W_r^k et W_p^s , si $\|u\|_{W_r^k} \leq 1$ pour $kr = n$. Cette estimation a été appliquée pour prouver l'existence des solutions globales de l'équation de Schrödinger non-linéaire (voir Brézis, Gallouët [8], et Hayashi, von Wahl [48]). L'inégalité originale de Kozono-Taniuchi [61, Theorem 1] est prouvée dans le cas elliptique. Les idées de la preuve de la version parabolique de cette inégalité sont données en Appendice B du Chapitre 4.

En utilisant l'inégalité (3.36) dans l'inéquation différentielle ordinaire (3.31) sur γ , et en suivant tous les termes cachés, on obtient

$$\kappa_x(\cdot, t) \geq \gamma(t) \geq e^{-e^t} \quad \text{avec} \quad c = e^t,$$

et on obtient alors, les estimations *a priori* suivantes :

$$\|\rho(\cdot, t)\|_{C^3(\bar{I})} \leq e^{e^t} \quad \text{et} \quad \|\kappa(\cdot, t)\|_{C^3(\bar{I})} \leq e^{e^t}.$$

L'existence globale de la solution découle par itération en temps.

4 Système non linéaire parabolique/Hamilton-Jacobi fortement couplé

Cette section présente le résultat principal du Chapitre 5 où l'on étudie l'existence d'une solution mixte viscosité-distribution du système (1.8)-(1.9) dans le **Cas B**. Ce résultat peut être considéré comme la limite du Théorème 3.1 lorsqu'on fait $\varepsilon = 0$.

4.1 Situation du problème

On s'intéresse à l'existence des solutions du système (1.8)-(1.9) dans le cas $\tau \neq 0$, et sous la condition (1.4). On rappelle le système couplé :

$$\begin{cases} \kappa_t \kappa_x = \rho_t \rho_x & \text{sur} \quad I \times (0, T) \\ \rho_t = \rho_{xx} - \tau \kappa_x & \text{sur} \quad I \times (0, T), \end{cases} \quad (4.37)$$

avec les conditions initiales sur I :

$$\kappa(x, 0) = \kappa^0(x), \quad \rho(x, 0) = \rho^0(x), \quad (4.38)$$

et les conditions au bord

$$\begin{cases} \kappa(0, t) = \kappa^0(0) \text{ et } \kappa(1, t) = \kappa^0(1), & \forall t \in [0, T], \\ \rho(0, t) = \rho(1, t) = 0, & \forall t \in [0, T], \end{cases} \quad (4.39)$$

Les conditions initiales sont maintenant soumises à la condition suivante :

$$\kappa_x^0 \geq |\rho_x^0| \quad \text{sur } I. \quad (4.40)$$

Le système (4.37) peut être vu comme limite du système (3.20) où nous avons ajouté le terme $-\varepsilon\Delta$. Par conséquent, l'idée naturelle est de passer à la limite lorsque $\varepsilon \rightarrow 0$. Cette méthode s'appelle "viscosité évanescence" qui est usuelle afin d'approcher les solutions de viscosité pour une équation de Hamilton-Jacobi. La littérature sur cette méthode est très riche et on peut citer par exemple le livre de Barles [3], Sinai [87], et Huang, Wang, et Teo [52].

4.2 Existence des solutions de viscosité

Le théorème principal concernant le système (4.37), (4.38), (4.39) et (4.40) est le suivant :

Théorème 4.1 (*Existence globale d'une solution mixte*)

Soient ρ^0 et κ^0 deux fonctions suffisamment régulières satisfaisants (4.40). Alors il existe

$$(\rho, \kappa) \in (C(\bar{I} \times [0, \infty)))^2, \quad \rho \in C^1(I \times (0, \infty)),$$

solution de (4.37), (4.38) et (4.39) satisfaisant :

$$\kappa_x \geq |\rho_x| \quad \text{dans } \mathcal{D}'(I \times (0, T)). \quad (4.41)$$

Cependant, cette solution doit être interprétée au sens suivant :

1. κ est une solution de viscosité de $\kappa_t \kappa_x = \rho_t \rho_x$ dans $I_T = I \times (0, T)$,
2. ρ est une solution distributionnelle de $\rho_t = \rho_{xx} - \tau \kappa_x$ dans I_T ,
3. Les conditions initiales et au bord sont satisfaites ponctuellement.

Remark 4.2 Par souci de non confusion, on appelle $(\rho^\varepsilon, \kappa^\varepsilon)$, la solution obtenue par le Théorème 3.1.

4. Système non linéaire parabolique/Hamilton-Jacobi fortement couplé

La difficulté majeure est que l'on doit travailler avec l'équation

$$\kappa_t \kappa_x = \rho_t \rho_x. \quad (4.42)$$

L'idée est de passer à la limite lorsque $\varepsilon \rightarrow 0$ dans la famille des solutions régulières κ^ε obtenues par le Théorème 3.1. Pour cette raison, nous avons besoin d'un cadre où l'équation (4.42), satisfaite par κ , est stable par passage à la limite. La régularité C^1 de ρ est prévisible puisqu'il satisfait une équation parabolique (la deuxième équation de (4.37)). Dans ce cas-ci ρ_t et ρ_x sont continues et par conséquent le Hamiltonien de (4.42) est également continu. Puis, en supposant $\kappa_x > 0$, on peut interpréter κ comme solution de viscosité de (4.42). Ceci nous ramène naturellement vers le cadre des solutions de viscosité où la propriété de stabilité est satisfaite (voir Barles [3, Lemma 2.3]).

La convergence de κ^ε vers une fonction continue κ est faite par l'intermédiaire du contrôle local, uniformément par rapport à ε , du module de continuité de κ^ε en espace et en temps³. Ceci laisse déduire la convergence uniforme locale de κ^ε .

Le contrôle uniforme du module de continuité en espace est fait en utilisant une inégalité entropique qui s'avère valide pour le système approché (3.20) (voir Proposition 5.1 du Chapitre 5). Cette inégalité entropique peut être facilement comprise. Par exemple, si l'on met $\varepsilon = 0$ et $\tau = 0$, nous pouvons formellement vérifier que l'entropie des densités de dislocation

$$\theta^\pm = \frac{\kappa_x \pm \rho_x}{2},$$

définie par

$$S(t) = \int_I \sum_{\pm} \theta^\pm(., t) \log \theta^\pm(., t)$$

satisfait

$$\frac{dS(t)}{dt} = - \int_I \frac{(\theta_x^+ - \theta_x^-)^2}{\theta^+ + \theta^-} \leq 0,$$

et alors on obtient $S(t) \leq S(0)$ ce qui contrôle l'entropie uniformément en temps.

Le contrôle uniforme du module de continuité en temps est fait par l'intermédiaire d'une borne sur $\kappa_t^\varepsilon - \varepsilon \kappa_{xx}^\varepsilon$ uniformément en ε .

Finalement, la condition (4.41) découle directement en passant à la limite en utilisant (3.29), i.e. $\kappa_x^\varepsilon > |\rho_x^\varepsilon|$.

³Ceci est une conséquence directe du Théorème d'Arzelà-Ascoli.

4.3 Simulations

En utilisant les équations de l'élasticité (voir l'Appendice de la thèse), ensemble avec le système (1.3) en termes de ρ et κ , on peut calculer le déplacement dans le matériau. On considère le cas d'un cristal avec un contrainte de cisaillement τ appliquée sur les murs frontières (voir Figure 1.5). Dans la Figure

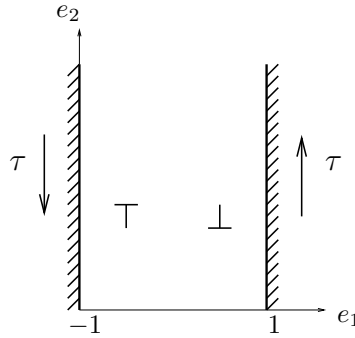

FIG. 1.5 – Géométrie du matériau.

1.6, on montre successivement l'état initial du cristal au temps $t = 0$ sans aucune contrainte appliquée, puis la déformation (élastique) instantanée du cristal lorsqu'on applique la contrainte de cisaillement $\tau > 0$ au temps $t = 0^+$. La déformation du cristal évolue en temps et finalement converge numériquement vers une déformation particulière qui est montrée à la dernière figure après un temps vraiment long. Ce type de comportement est appelé élasto-visco-plasticité en mécanique car le matériau met du temps pour réagir à la contrainte appliquée. De plus, sur la dernière figure, on remarque la présence de couches limites. Cet effet est directement relié à l'introduction du "back stress" $\tau_b = \frac{\theta_x^+ - \theta_x^-}{\theta^+ + \theta^-}$ dans le modèle (1.1).

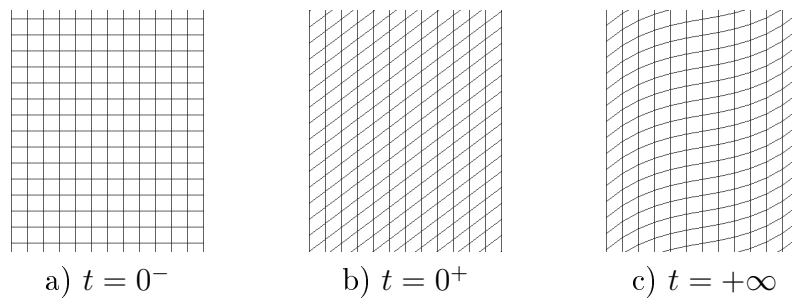

FIG. 1.6 – Déformation d'un cristal pour le modèle (1.3).

5 Compléments numériques pour un problème indépendant de type transport

On s'intéresse au calcul numérique des solutions des équations aux dérivées partielles de type transport :

$$\begin{cases} u_t = \vec{a} \cdot \nabla u & \text{sur } \mathbb{R}^2 \times (0, T) \\ u(x, 0) = u^0(x) \in \{+1, -1\} & \text{sur } \mathbb{R}^2, \end{cases} \quad (5.43)$$

où $\vec{a}(x, t) = (a_1(x, t), a_2(x, t))$ est le champ de vecteur vitesse. On considère une discrétisation de l'espace \mathbb{R}^2 :

$$x_I = (x_{i_1}, x_{i_2}) = (i_1 \Delta x, i_2 \Delta x),$$

avec $I = (i_1, i_2) \in \mathbb{Z}^2$, et Δx est le pas en espace. La fonction u^0 est donnée par :

$$u_0(x_I) = \begin{cases} +1 & \text{si } x_I \in \Omega_0, \quad \Omega_0 \subset \mathbb{R}^2 \text{ est un ouvert,} \\ -1 & \text{sinon.} \end{cases}$$

Ici u^0 permet de représenter une courbe $\partial\Omega_0$ dans \mathbb{R}^2 . En effet, on peut formellement écrire : $\partial\Omega_0 = \partial\{x_I; u_0(x_I) = +1\}$. Alors l'évolution en temps de la fonction u_0 représente le transport de la courbe $\partial\Omega_0$ suivant le champ de vecteurs \vec{a} . Le but est d'écrire un algorithme pour calculer la solution de (5.43).

Dans le cas spécial où $\vec{a} = c(x, t) \frac{\nabla u}{|\nabla u|}$, l'équation (5.43) est dite équation eikonale :

$$\begin{cases} u_t = c(x, t) |\nabla u| & \text{sur } \mathbb{R}^2 \times (0, T) \\ u(x, 0) = u^0(x) \in \{+1, -1\} & \text{sur } \mathbb{R}^2, \end{cases}$$

qui modélise l'évolution de fronts dans la direction normale. Dans ce cas, un algorithme basé sur la méthode "Fast Marching" (voir Sethian [86] et Tsitsiklis [91]), est présenté dans Carlini, Falcone, Forcadel et Monneau [11]. Cet algorithme est une extension de la méthode Fast Marching classique puisque ce nouveau schéma peut traiter une vitesse $c(x, t)$ qui dépend du temps sans aucune restriction sur son signe.

On a essayé d'explorer les idées de Carlini, Falcone, Forcadel et Monneau [11], et de les adapter pour l'équation de transport (5.43). Dans cette direction, on a proposé plusieurs algorithmes qui semblent, après avoir effectué des tests numériques, ne pas translater les fronts à la bonne vitesse, même dans le cas où \vec{a} est constant.

Un algorithme du type *splitting* est alors introduit. L'idée du *splitting* est de séparer la translation de x_{i_1} suivant la vitesse a_1 , et la translation de x_{i_2} suivant la vitesse a_2 . L'avantage de cet algorithme est qu'il translate exactement les coins et les lignes droites d'un front donné, si le vecteur vitesse \vec{a} est constant (nous renvoyons à la Section 3 du Chapitre 6 pour le détails de l'algorithme).

Test numérique : cas d'un carré en rotation. Un test numérique est effectué avec un carré évoluant suivant un champ de vecteur \vec{a} qui dépend seulement de la variable d'espace. On prend le cas d'un carré en rotation, i.e. $\vec{a} = (-x_{i_2}, x_{i_1})$. Les simulations suivantes sont alors obtenues :

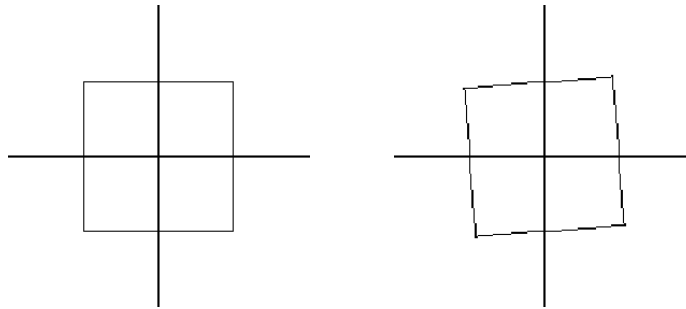

FIG. 1.7 – Images 0, 38

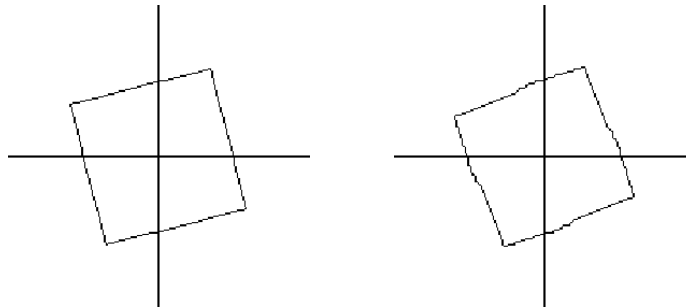

FIG. 1.8 – Images 149, 241

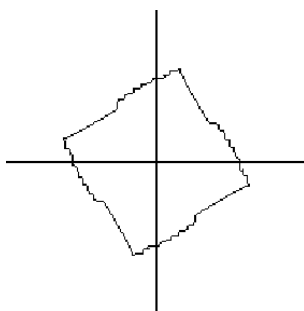

FIG. 1.9 – Image 373

Ce test numérique montre que notre algorithme proposé de type *splitting* peut créer donc des instabilités (voir Figure 1.9). L'étape suivante serait d'améliorer cet algorithme afin de pallier cet inconvénient.

Chapitre 2

General introduction⁽¹⁾

This thesis is concerned with the theoretical study of a mathematical model arising from the study of the dynamics of dislocation densities in crystals. This dynamics is modeled through a non-linear coupled system of a parabolic and a Hamilton-Jacobi equation, and we are interested in the existence and uniqueness of solutions of this system. Dislocations are linear defects which move in crystals when those are subjected to exterior stresses.

Independently, at the end of the thesis, we present, in a short chapter, a numerical method for the transport of fronts. In this thesis, three main types of equations are considered :

1. Non-linear first order Hamilton-Jacobi equations.
2. Scalar conservations laws.
3. Singular parabolic equations.

For all situations, the main goal of the study is the existence, uniqueness and regularity of the solutions of the above equations. This introduction aims to give an overview of the results that we have obtained. In the first section, we start by giving a brief physical description of dislocations and dislocation densities in crystals. A physical motivation of the special model of our interest is given as well. In sections 2, 3 and 4, we present the mathematical results concerning our model describing the dynamics of dislocation densities. Section 5 is devoted to present a numerical method for fronts transport.

In order to shed light on the important ideas and to ensure that they are not

¹This chapter is the english translation of the general introduction presented in Chapter 1.

lost in the technic, we have given simplified announcements of the results in this general introduction. For the precise announcements, we send the reader to the chapters that follow.

1 Physical motivation

1.1 Dislocations : brief introduction

Dislocations are line defects, or irregularity within a crystal structure. Schematically, they are areas where the atoms are out of position in the perfect atomic crystal lattice. The theory was mathematically developed by V. Volterra⁽²⁾. Dislocations are a non-stationary phenomena and their motion is the main explanation of the plastic deformation in metallic crystals (see Nabarro [76] and Hirth, Lothe [51] for a recent physical presentation).



FIG. 2.1 – Dislocations in stainless steel.

Dislocations have a typical length of order $10^{-6}m$ and a thickness of order $10^{-9}m$. They have been introduced by Orowan [78], Polanyi [83] and Taylor [90] in 1934 as one of the principal explanations at the microscopic scale of the macroscopic plastic deformations of crystals. This concept was confirmed in 1956 by the first direct observation of dislocations by Hirsch, Horne and Whelan [50], and by Bollmann [5], thanks to the electron microscopy. Under the effect of stress fields, these dislocations can move in a well defined crystallographic planes called “slip planes”. A dislocation is characterized by two vectors : the dislocation line $\vec{\xi}$ describing its line direction and the Burgers vector \vec{b} describing the associated

²The original paper [92] of Vito Volterra goes back to 1907.

displacement. Using these terms $\vec{\xi}$ and \vec{b} , two basic types of dislocations can be presented :

1. Edge dislocations : the Burgers vector \vec{b} is perpendicular to $\vec{\xi}$.
2. Screw dislocations : the Burgers vector \vec{b} is parallel to $\vec{\xi}$.

Actually, edge and screw dislocations are just extreme forms of the possible dislocation structure that can occur. Most dislocations are a hybrid of the edge and the screw forms.

In this thesis, we study the dynamics of straight parallel edge dislocations in a bounded material. The quantity of dislocations in a crystal is represented by its density which is defined as the number of dislocation lines traversing a unit section.

Understanding the behavior of dislocations is a key to understanding an essential part of the microstructure of crystalline solids. In fact, the behavior and the properties of dislocations directly affect the strength and toughness of structural materials. However, in this thesis, we will only concentrate on the mathematical analysis of a particular model describing the dynamics of dislocation densities in a small domain.

1.2 The model of Groma, Czikor and Zaiser

In [46], Groma, Czikor and Zaiser have proposed a 2-dimensional model describing the dynamics of parallel edge dislocations densities in a bounded 3-dimensional crystal. The term “dislocations densities” arises from the fact that edge dislocations could be classified as being **positive** or **negative** according to the direction of their Burgers vector. This model has been introduced to describe the possible accumulation of dislocations on the boundary layer of the material. It sheds light on the evolution of the “two type” densities taking into consideration the short range dislocation-dislocation interactions.

Let us go deeper into the model. Assume the existence of a certain number of parallel edge dislocations in a bounded channel of a finite width in the x -direction and an infinite extension in the y -direction (see Figure 2.2). The channel is bounded by walls that are impenetrable by dislocations (i.e., the plastic deformation in the walls is zero). The dislocation lines are supposed to be perpendicular to the xy -plane, and moving in the x -direction, i.e.

1. The dislocation line $\vec{\xi}$ is perpendicular to x and y .
2. The Burgers vector \vec{b} is parallel to x .

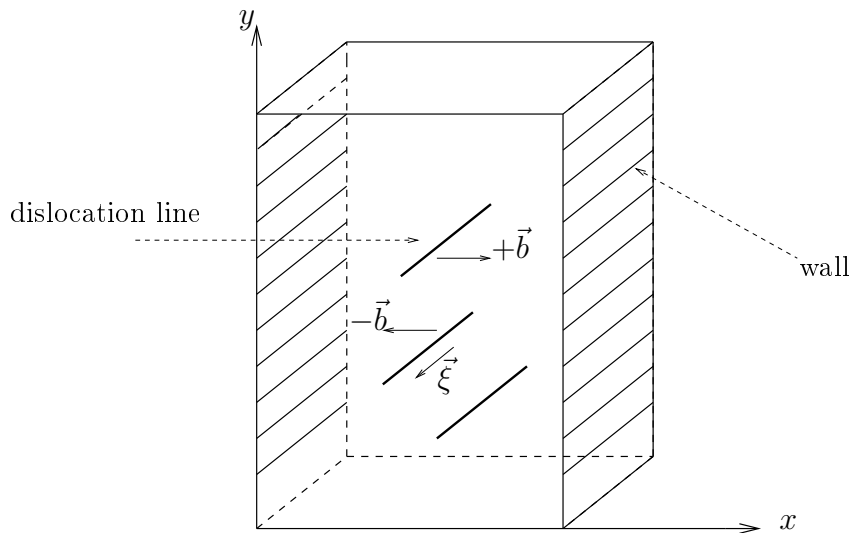

FIG. 2.2 – The model of Groma, Czikor and Caizer.

The whole assembly is embedded in an infinite crystal where dislocations can move under the action of some constant exterior stress field $\tau \neq 0$, and/or under the action of the stress field created by dislocations themselves. The internal stresses created by dislocations are the direct consequence of the short and the long range dislocation-dislocation interactions inside the material.

We are interested in a simplified model where we suppose a particular configuration of the dislocation lines.

A simplified 1-dimensional model.

We assume that the problem is **invariant by translation** in the y -direction. In other words, we suppose that, if (\mathcal{S}) is a cross-sectional surface perpendicular to the dislocation lines, then the arrangement of dislocation points in (\mathcal{S}) is invariant by translation in the y -direction (see Figure 2.3). In this case, we can deduce that studying the dynamics of dislocation points on the line (\mathcal{L}) (see Figure 2.3) gives the complete information of the dynamics of dislocation lines in the channel. As a summary, we can write that :

dynamics in $(\mathcal{L}) \implies$ dynamics in $(\mathcal{S}) \implies$ dynamics in the bounded channel.

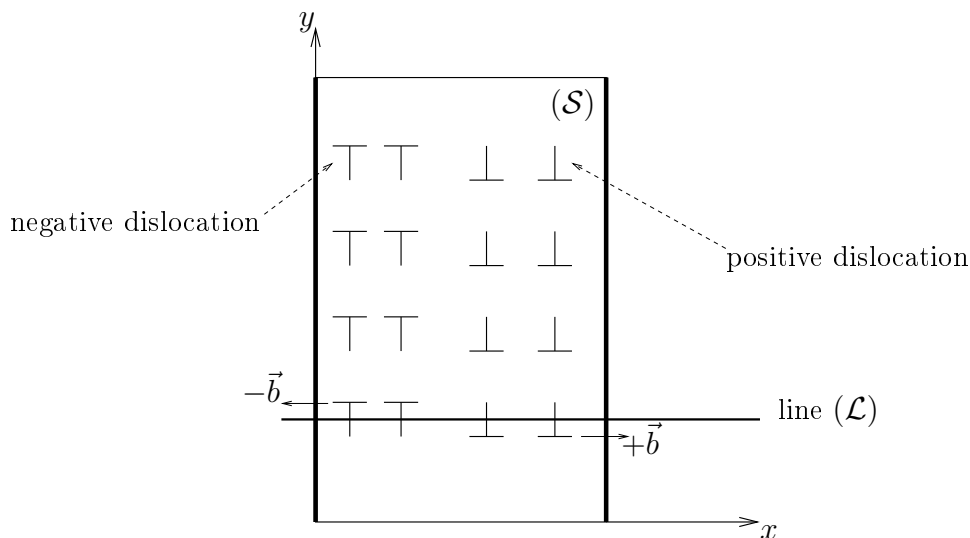

FIG. 2.3 – Dislocation points in a cross-sectional surface.

Groma, Csikor and Zaiser [46] have formulated, starting from the motion of individual dislocations, a continuum description in terms of the dislocations densities. It has been explained by Groma and Balogh [44, 45] that for a system of straight parallel dislocations a continuum description can be derived from the equations of motion of individual dislocations. Using a different approach, a continuum description of a system of curved dislocations in three dimensions was also formulated (see El-Azab [30], and Monneau [74] and the references therein). However, a major **drawback** of these earlier investigations is that in order to get a closed set of equations, short range dislocation-dislocation correlations have been neglected and dislocation-dislocation interactions were only described by the long range contribution. This description does not permit to mathematically formulate what is really happening near the boundary of a given material.

Remark 1.1 *In our particular framework, see Figure 2.3, dislocations are relatively close to each other. This is due to their presence in a small length that is bounded by walls. In this case, long range dislocation-dislocation interactions are zero and hence the models presented in Groma and Balogh [45] is no longer suitable to describe the evolution of the dislocations densities. However, for the model described in Groma, Balogh [45], we send the reader to El Hajj [31], El Hajj, Forcadel [32] for a one-dimensional mathematical and numerical study, and to Cannone, El Hajj, Monneau, and Ribaud [10] for a two-dimensional existence result.*

In [46], Groma, Csikor and Zaiser have succeeded to modelize the effect of the short range dislocation-dislocation correlations by a local stress which scales like

a gradient term. The exact mathematical formulation of their model will now be presented.

The mathematical formulation of the 1-dimensional model.

Let θ^+ and θ^- represent the density of the positive and negative dislocations respectively. According to our previous discussion, dislocations are bounded by walls that are separated by a distance of a finite length l (take $l = 1$). Typically, positive/negative dislocations are those moving to the right/left wall. In the case where the constant applied stress field τ is different from zero, our system is a double pile-up system where positive dislocations accumulate at the right wall, while negative dislocations accumulate at the left wall (see Figure 2.4). For a

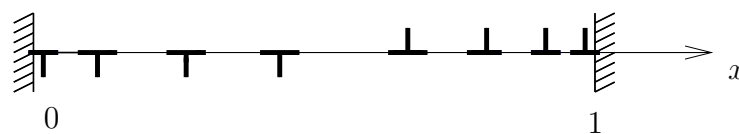

FIG. 2.4 – A double pile-up system.

mathematical study of various models of dislocation pile-ups, we send the reader to Voskoboinikov, Chapman, Ockendon, Allwright [93], Carpio, Chapman, Velázquez [12], Wood, Head [95], and Hirth, Lothe [51].

The coupled system describing the evolution of the non-negative dislocations densities θ^+ and θ^- reads (see Groma, Csikor and Zaiser [46]) :

$$\begin{cases} \theta_t^+ = \left[\left(\frac{\theta_x^+ - \theta_x^-}{\theta^+ + \theta^-} - \tau \right) \theta^+ \right]_x & \text{on } (0, 1) \times (0, T), \\ \theta_t^- = \left[- \left(\frac{\theta_x^+ - \theta_x^-}{\theta^+ + \theta^-} - \tau \right) \theta^- \right]_x & \text{on } (0, 1) \times (0, T), \end{cases} \quad (1.1)$$

with the initial conditions :

$$\theta^+(x, 0) = \theta_0^+(x) \quad \text{and} \quad \theta^-(x, 0) = \theta_0^-(x).$$

Here $T > 0$ is a fixed positive real number and τ is the exterior stress field which is supposed to be constant. The term $\frac{\theta_x^+ - \theta_x^-}{\theta^+ + \theta^-}$ appearing in (1.1) stands for the local stress field describing the short range interactions between dislocations. In the models presented in Remark 1.1, this term was set to be zero. In this case, system (1.1) describes the translation of dislocations following the velocity τ , without taking into account the formation of the boundary layer. For this reason, periodic boundary conditions were naturally considered in the mathematical

study of those systems. In fact, the use of periodic boundary conditions is a way of regarding what is going on in the interior of a material away from its boundary.

The main objective of this thesis is to examine the existence and uniqueness of solutions of (1.1) under suitable boundary conditions that will be clarified in the forthcoming arguments. Let

$$I := (0, 1), \quad \text{and} \quad I_T := I \times (0, T).$$

We consider an integrated form of (1.1) and we let

$$\rho_x^\pm = \theta^\pm, \quad \rho = \rho^+ - \rho^- \quad \text{and} \quad \kappa = \rho^+ + \rho^-, \quad (1.2)$$

to obtain (at least formally), for special values of the constants of integration, the following system in terms of ρ and κ :

$$\begin{cases} \kappa_t \kappa_x = \rho_t \rho_x & \text{on } I_T \\ \rho_t = \rho_{xx} - \tau \kappa_x & \text{on } I_T, \end{cases} \quad (1.3)$$

with the initial conditions :

$$\kappa(x, 0) = \kappa^0(x) \quad \text{and} \quad \rho(x, 0) = \rho^0(x).$$

We move now to give two essential conditions concerning ρ and κ .

Physically relevant conditions.

Condition 1. The two terms θ^+ and θ^- represent two non-negative densities. Since by (1.2),

$$\theta^\pm = \frac{\kappa_x \pm \rho_x}{2},$$

the fact that $\theta^\pm \geq 0$ is translated in the language of ρ and κ to the following condition :

$$\kappa_x \geq |\rho_x|. \quad (1.4)$$

This condition has to be satisfied in order to give sense to the system (1.1).

Condition 2. The second condition is

$$\rho(1, t) = \rho(0, t), \quad \forall t \geq 0. \quad (1.5)$$

This condition has to do with the balance of the physical model that starts with the same number of positive and negative dislocations. To be more precise, let n^+ and n^- be the total number of positive and negative dislocations respectively at

$t = 0$. We assume that there is neither annihilation nor creation of dislocations inside the material. Hence there is a conservation of n^+ and n^- with respect to time. This could be mathematically formulated as follows (see (1.2) above) :

$$\begin{aligned} \rho(1, t) - \rho(0, t) &= \int_0^1 \rho_x(x, t) dx, \\ &= \int_0^1 (\theta^+(x, t) - \theta^-(x, t)) dx, \\ &= n^+ - n^- = 0. \end{aligned}$$

Therefore we obtain (1.5).

The boundary conditions.

To formulate heuristically the boundary conditions at the walls located at $x = 0$ and $x = 1$, we first suppose that $\kappa_x \neq 0$ at $x = 0, 1$. We recall that since the walls of the channel are impenetrable by dislocations, then the dislocation fluxes at the boundary must be zero, which requires that :

$$\overbrace{(\theta_x^+ - \theta_x^-) - \tau(\theta^+ + \theta^-)}^{\Phi} = 0, \quad \text{at } x \in \{0, 1\}. \quad (1.6)$$

Rewriting system (1.3) in terms of ρ , κ and Φ , we get

$$\begin{cases} \kappa_t = (\rho_x / \kappa_x) \Phi, \\ \rho_t = \Phi. \end{cases} \quad (1.7)$$

Using (1.6), (1.7), and the fact that $\kappa_x \neq 0$ at $x = 0, 1$, we can formally deduce that

$$\rho_t = \kappa_t = 0 \quad \text{on } \partial I \times [0, T],$$

hence ρ and κ are constants along the boundary walls. This gives inspiration that the convenient boundary conditions of system (1.3) are the Dirichlet boundary conditions. We now move to write down precisely the complete system.

The complete system.

From all what precedes, the complete system is expressed by the following coupled Dirichlet boundary value problems :

$$\begin{cases} \kappa_t \kappa_x = \rho_t \rho_x, & \text{on } I_T, \\ \kappa(x, 0) = \kappa^0(x), & \text{on } I, \\ \kappa(0, t) = \kappa^0(0) \quad \text{and} \quad \kappa(1, t) = \kappa^0(1), & \forall t \in [0, T], \end{cases} \quad (1.8)$$

and

$$\begin{cases} \rho_t = \rho_{xx} - \tau \kappa_x, & \text{on } I_T, \\ \rho(x, 0) = \rho^0(x), & \text{on } I, \\ \rho(0, t) = \rho(1, t) = 0, & \forall t \in [0, T]. \end{cases} \quad (1.9)$$

These equations are the core of our mathematical analysis where we study the existence and uniqueness of solutions in two different cases.

The two cases.

In studying system (1.8)-(1.9), we first start with the case where $\tau = 0$. In this case, the system becomes weakly coupled in the sense that we can first solve the equation of ρ , and then the equation of κ . The second case is the general case where $\tau \neq 0$. Our system thus becomes strongly coupled and more complicated. As a summary, we write down the two cases :

Case A. The exterior stress τ applied to the material is **zero**.

Case B. The exterior stress τ is a constant **different from zero**.

2 Nonlinear parabolic/Hamilton-Jacobi system

This section is an assembly of the results of Chapter 3, where we study the system (1.8)-(1.9) in the case $\tau = 0$. In this section, we present our main theorems ; we point out the main difficulties, and we discuss the key ideas that permit to overcome them.

2.1 Setting of the problem

We study the existence and uniqueness of solutions of the parabolic/Hamilton-Jacobi system (1.8)-(1.9) in **Case A**, the case of zero applied exterior stresses. This study is done in the framework of viscosity solutions (for the definition of viscosity solutions for Hamilton-Jacobi equations, we send the reader to Definitions 2.3, 2.5 of Chapter 3). Viscosity solutions have been introduced by Crandall and Lions [22] for solving Hamilton-Jacobi equations of first order. The theory was then extended to second order equations where it has known a wide development after the works of Jensen [58] and of Ishii [57].

We rewrite system (1.8)-(1.9) in the case where $\tau = 0$, we arrive to the follo-

wing system of Dirichlet boundary value problems :

$$\begin{cases} \kappa_t \kappa_x = \rho_t \rho_x, & \text{on } I_T, \\ \kappa(x, 0) = \kappa^0(x), & \text{on } I, \\ \kappa(0, t) = \kappa^0(0) \quad \text{and} \quad \kappa(1, t) = \kappa^0(1), & \forall t \in [0, T], \end{cases} \quad (2.10)$$

and

$$\begin{cases} \rho_t = \rho_{xx}, & \text{on } I_T, \\ \rho(x, 0) = \rho^0(x), & \text{on } I, \\ \rho(0, t) = \rho(1, t) = 0, & \forall t \in [0, T]. \end{cases} \quad (2.11)$$

Recall that κ_x and ρ_x have to satisfy “in some sense” the condition (1.4), i.e.

$$\kappa_x \geq |\rho_x| \quad \text{on } I_T.$$

It is worth noticing that the above system (2.10)-(2.11) is now a weakly coupled system. More precisely, one can solve the heat equation (2.11) by itself, and then plug its solution ρ into (2.10), transforming the problem to solving a single Hamilton-Jacobi equation that can be reformulated as follows :

$$\begin{cases} \kappa_t = \frac{\rho_x \rho_{xx}}{\kappa_x} = F(x, t, \kappa_x) & \text{on } I_T, \\ \kappa(x, 0) = \kappa^0(x) \in Lip(I), \\ \kappa(0, t) = \kappa^0(0) \quad \text{and} \quad \kappa(1, t) = \kappa^0(1), & \forall t \in [0, T], \end{cases} \quad (2.12)$$

with

$$\kappa_x^0 \geq |\rho_x^0| \quad \text{on } I. \quad (2.13)$$

2.2 Viscosity results on the bounded interval $I = (0, 1)$

The first apparent problem in solving (2.12) is that we divide by κ_x . This creates a singularity at the points where $\kappa_x = 0$, that can even be true at $t = 0$ (see the above condition (2.13)). We overcome this problem by taking a special approximation of (2.13), where we prevent κ_x^0 from having 0 values. The following theorem is thus proved.

Theorem 2.1 (*Existence and uniqueness of a viscosity solution, $\varepsilon > 0$*)
 Let $T > 0$ and $\varepsilon > 0$ be two constants. Take $\kappa^0 \in Lip(I)$, and $\rho^0 \in C_0^\infty(I)$ satisfying :

$$\kappa_x^0 \geq G_\varepsilon(\rho_x^0), \quad G_\varepsilon(x) = \sqrt{x^2 + \varepsilon^2}. \quad (2.14)$$

Given the solution ρ of the heat equation (2.11), there exists a viscosity solution $\kappa \in Lip(I_T)$ of (2.10), unique among those satisfying :

$$\kappa_x \geq G_\varepsilon(\rho_x) \quad \text{a.e. in } I_T. \quad (2.15)$$

The principal difficulty in proving this result is to show the minoration (2.15) of κ_x . The formal argument to overcome this difficulty is to remark first that κ_x is a solution of the derived equation of (2.12) :

$$w_t = (F(x, t, w))_x, \quad (2.16)$$

while, by simple computations, we can show (see Lemma 3.4 of Chapter 3) that $G_\varepsilon(\rho_x)$ satisfies :

$$(G_\varepsilon(\rho_x))_t \leq (F(x, t, G_\varepsilon(\rho_x)))_x, \quad (2.17)$$

and hence $G_\varepsilon(\rho_x)$ is a sub-solution of (2.16). Using a comparison principle, together with (2.14), we easily arrive to the result. These formal arguments can be made rigorous by using a relation between viscosity solutions of Hamilton-Jacobi equations and entropy solutions of scalar conservation laws. This relation asserts that, under some regularity assumptions, if κ is a viscosity solution of the following Hamilton-Jacobi equation in the whole space :

$$\begin{cases} \kappa_t = \frac{\rho_x \rho_{xx}}{\kappa_x} = F(x, t, \kappa_x), & \text{on } \mathbb{R} \times (0, T), \\ \kappa(x, 0) = \kappa^0(x), & \text{on } \mathbb{R}, \end{cases} \quad (2.18)$$

where ρ is the solution of the heat equation :

$$\begin{cases} \rho_t = \rho_{xx}, & \text{on } \mathbb{R} \times (0, T), \\ \rho(x, 0) = \rho^0(x), & \text{on } \mathbb{R}, \end{cases} \quad (2.19)$$

then $w = \kappa_x$ is an entropy solution of the following scalar conservation laws :

$$\begin{cases} w_t = (F(x, t, w))_x & \text{on } \mathbb{R} \times (0, T), \\ w(x, 0) = w^0(x) = \kappa_x^0(x), & \text{on } \mathbb{R}. \end{cases} \quad (2.20)$$

Moreover, the regularity of the function $G_\varepsilon(\rho_x)$ permits to have inequality (2.17) a.e. in $\mathbb{R} \times (0, T)$, therefore $G_\varepsilon(\rho_x)$ is an entropy sub-solution of (2.20). By using the inequality between the initial data (2.14), and Kruřkov Comparison Principle (see Theorem 2.16 of Chapter 3), we obtain that :

$$\kappa_x \geq G_\varepsilon(\rho_x).$$

Let us recall that entropy solutions were first introduced by Kruřkov [63] as the only physically admissible solutions among all weak (distributional) solutions to scalar conservation laws. The theory of entropy solutions was then widely developed. Equivalent definitions of entropy solutions for scalar conservation laws with merely essentially bounded L^∞ data are given via the entropy process solutions

(see Eymard, Gallouët and Herbin [35, 36]), or via the kinetic formulation (see Lions, Perthame, Tadmor [70], Perthame [81] and Perthame, Tadmor [82]). A notion of a weak entropy solution via the entropy-flux pairs is given in Otto [80]. For the definition of entropy solutions that will be used in our work, we send the reader to Definition 2.12 of Chapter 3.

It is worth mentioning that we need to give a special attention on two important points while making the rigorous proof. The first point is that the above relation between viscosity and entropy solutions is valid on \mathbb{R} . This requires, at some stage, to make a suitable extension of the problem from the bounded interval I into the whole space \mathbb{R} ; to make use of this relation, and then to return back to I . The second point is that the original Kružkov Comparison Principle [63] was proved under certain regularity on the function F that we do not have. This necessitates to follow the ideas of Kružkov [63] and Eymard, Gallouët, Herbin [35], to adapt their proofs for our case of less regularity (see Theorem 2.16 and its proof in the Appendix of Chapter 3).

Another possibility to prove the minoration (2.15) of the gradient κ_x was to stay in the viscosity solutions framework. In fact, there are few results on the minoration of the gradient of viscosity solutions for Hamilton-Jacobi equations. An interesting result on this subject could be found in Ley [67]. In that paper, the author gives a lower bound for the spatial gradient of the viscosity solution of first order Hamilton-jacobi equations :

$$u_t + F(x, t, u_x) = 0,$$

under some conditions on the Hamiltonian $F(x, t, p)$ including its convexity in the p -variable. Unfortunately, this is not our case (see equation (2.12)) with

$$F(x, t, p) = \frac{\rho_x(x, t)\rho_{xx}(x, t)}{p},$$

and that does not permit us to use directly the viscosity solutions framework for establishing the minoration on κ_x .

The next result is an existence result of (2.10) under the original condition (2.13) on the gradient κ_x^0 .

Theorem 2.2 (*Existence of a viscosity solution, $\varepsilon = 0$*)

Let $T > 0$, $\kappa^0 \in Lip(I)$ and $\rho^0 \in C_0^\infty(I)$. If the condition (2.13) is satisfied a.e. in I , and if ρ is the solution of (2.11), then there exists a viscosity solution $\kappa \in Lip(I_T)$ of (2.10) satisfying :

$$\kappa_x \geq |\rho_x|, \quad \text{a.e. in } I_T.$$

The proof of this theorem comes directly from the passage to the limit $\varepsilon \rightarrow 0$ in the family of solutions given by Theorem 2.1.

2.3 An entropy result on the whole space \mathbb{R}

In the proof of Theorem 2.1, the function κ_x was found to be an entropy solution of (2.20). In fact, this can be a byproduct result by itself.

Theorem 2.3 (*Existence and uniqueness of an entropy solution, $\varepsilon > 0$*)
Let $T > 0$. Take $w^0 \in L^\infty(\mathbb{R})$ and $\rho^0 \in C_0^\infty(\mathbb{R})$ such that, $w^0 \geq G_\varepsilon(\rho_x^0)$ a.e. in \mathbb{R} , for some constant $\varepsilon > 0$. Then, given ρ ; the unique solution of the heat equation (2.19), there exists an entropy solution $w \in L^\infty(Q_T)$ of (2.20), unique among the entropy solutions satisfying :

$$w \geq G_\varepsilon(\rho_x) \quad \text{a.e. in } \mathbb{R} \times (0, T).$$

3 Strongly coupled singular parabolic system

This section presents the principal result of Chapter 4, that can be considered as the starting point for solving the system (1.8)-(1.9) in **Case B** (the case where $\tau \neq 0$). We study the existence, uniqueness and regularity of smooth solutions of a strongly coupled singular parabolic system.

3.1 Setting of the problem

Let $T > 0$. We consider the following coupled parabolic system :

$$\begin{cases} \kappa_t = \varepsilon \kappa_{xx} + \frac{\rho_x \rho_{xx}}{\kappa_x} - \tau \rho_x & \text{on } I_T \\ \rho_t = (1 + \varepsilon) \rho_{xx} - \tau \kappa_x & \text{on } I_T, \end{cases} \quad (3.21)$$

with the initial conditions :

$$\begin{cases} \kappa(x, 0) = \kappa^0(x) & \text{on } I \\ \rho(x, 0) = \rho^0(x) & \text{on } I, \end{cases} \quad (3.22)$$

and the boundary conditions :

$$\begin{cases} \kappa(0, t) = \kappa^0(0) \text{ and } \kappa(1, t) = \kappa^0(1), & \forall t \in [0, T], \\ \rho(0, t) = \rho(1, t) = 0, & \forall t \in [0, T], \end{cases} \quad (3.23)$$

where $\varepsilon > 0$, $\tau \neq 0$ are fixed real numbers. This system is a strongly coupled parabolic system with a singularity that arises from the division by κ_x in the first

equation of (3.21). In order to avoid such singularity, we impose the following strict inequality on the initial data :

$$\kappa_x^0 > |\rho_x^0| \quad \text{on } I. \quad (3.24)$$

We are interested in the existence and uniqueness of smooth solutions (ρ, κ) of (3.21)-(3.22)-(3.23), under the condition (3.24).

The choice of system (3.21). The first question that could be asked is about the special choice of system (3.21). Let us remind the reader that the final goal is to solve (1.8)-(1.9) in the general case $\tau \neq 0$. For this reason, we have taken (3.21) as a regularized approximation of (1.8)-(1.9). Other choices of other approximate systems was also possible. For example, an approximation of (1.8)-(1.9) includes as a particular case the choice of the following system :

$$\begin{cases} \kappa_t = \varepsilon \kappa_{xx} + \frac{\rho_x \rho_{xx}}{\kappa_x} - \tau \rho_x & \text{on } I_T \\ \rho_t = \rho_{xx} - \tau \kappa_x & \text{on } I_T. \end{cases} \quad (3.25)$$

However, the dangerous situation that may happen is to lose the inequality

$$\kappa_x > |\rho_x|,$$

which is crucial in our study. In fact, we are not able to show this inequality for (3.25), and even for many other approximate systems that we have tried. On the contrary, system (3.21) is particularly constructed in order to satisfy a **comparison principle** (see Proposition 3.1 of Chapter 4) that gives the above inequality.

Brief review of the literature. We have not found singular parabolic systems that are closely related to (3.21). However, many different parabolic problems involving singular terms have been widely studied in various aspects. Degenerate and singular parabolic equations have been extensively studied by DiBenedetto et al. (see for instance DiBenedetto *et al.* [17,24–27] and the references therein). The authors regard the solutions of singular or degenerate parabolic equations with measurable coefficients whose prototype is a heat equation with p -Laplacian :

$$u_t - \operatorname{div} (|\nabla u|^{p-2} \nabla u) = 0, \quad p > 2 \quad \text{or} \quad 1 < p < 2.$$

The study includes local Hölder continuity of bounded weak solutions, local and global boundedness of weak solutions and local intrinsic and global Harnack estimates. Other parabolic equations of the porous medium type :

$$u_t - \Delta u^m = 0, \quad 0 < m < 1,$$

are examined in Quirós, Vázquez [84], DiBenedetto *et al.* [28, 29]. These equations are singular at points where $u = 0$. In DiBenedetto, Kwong, Vespri [28], the authors investigate, for special range of m , the behavior of the solution near the points of singularity. In particular, they show that nonnegative solutions are analytic in the space variables and at least Lipschitz continuous in time. However, in DiBenedetto, Kwong [29], an intrinsic Harnack estimate for nonnegative weak solutions is established for some optimal range of the parameter m . In Quirós, Vázquez [84], the authors study the asymptotic behavior of weak solutions in exterior domains with boundary data that are constant in time. Other class of singular parabolic equations are of the form :

$$u_t = u_{xx} + \frac{b}{x}u_x, \quad (3.26)$$

b is a certain constant. Such an equation is related to axially symmetric problems and also occurs in probability theory. A wide study of (3.26) is done. This includes the existence, uniqueness and the representation theorems for the solution (Dirichlet and Neumann boundary conditions are treated as well). In addition, differentiability and regularity properties are investigated (for the references, see Colton [20], Speranza [89], Alexiades [2], and Chan, Wong [16]). A more general form of (3.26), including semilinear equations, is treated in Mooney [75], Chan, Kaper [14], Chan, Chen [15], and Maugeri [71].

An important type of equations that can be indirectly related to our system is semilinear parabolic equations :

$$u_t = \Delta u + |u|^{p-1}u, \quad p > 1. \quad (3.27)$$

Many authors have studied the blow-up phenomena for solutions of the above equation (see for instance Zaag [96], Merle, Zaag [72, 73], Souplet *et al.* [47, 85, 88]). This study includes uniform estimates at the blow-up time, as well as the investigation of upper bounds for the initial blow-up rate. Equation (3.27) can be somehow related to the first equation of (3.21), but with a singularity of the form $1/\kappa$. This can be formally seen if we first suppose that $u \geq 0$, and then we apply the following change of variables $u = 1/v$. In this case, equation (3.27) becomes :

$$v_t = \Delta v - \frac{2|\nabla v|^2}{v} - v^{2-p},$$

and hence if $p = 3$, we obtain :

$$v_t = \Delta v - \frac{1}{v}(1 + 2|\nabla v|^2). \quad (3.28)$$

Since the solution u of (3.27) may blow-up at a finite time $t = T$, then v may vanishes at $t = T$, and therefore equation (3.28) faces similar singularity to that of the first equation of (3.21), but in terms of $1/v$ and not of $1/v_x$.

3.2 Existence and uniqueness result

The main theorem concerning system (3.21)-(3.22)-(3.23) is the following :

Theorem 3.1 (*Existence and uniqueness of smooth solutions*)

Let $\rho^0, \kappa^0 \in C^\infty(\bar{I})$ satisfying condition (3.24) and

$$\begin{cases} (1 + \varepsilon)\rho_{xx}^0 = \tau\kappa_x^0 & \text{on } \partial I \\ (1 + \varepsilon)\kappa_{xx}^0 = \tau\rho_x^0 & \text{on } \partial I. \end{cases} \quad (3.29)$$

Then, there exists a unique global solution (ρ, κ) of system (3.21)-(3.22)-(3.23) satisfying :

$$\rho, \kappa \in C^{3+\alpha, \frac{3+\alpha}{2}}(\bar{I} \times [0, \infty)) \cap C^\infty(I \times (0, \infty)), \quad \forall \alpha \in (0, 1), \quad (3.30)$$

with

$$\kappa_x > |\rho_x| \quad \text{on } \bar{I} \times [0, \infty). \quad (3.31)$$

The boundary conditions (3.29) that we have imposed on the initial data are natural here. In fact, suppose ρ and κ are sufficiently regular solutions of (3.21)-(3.22)-(3.23). From (3.23), we know that ρ and κ are constants on $\partial I \times [0, T]$, and therefore $\rho_t = \kappa_t = 0$ on $\partial I \times [0, T]$. Using this information together with system (3.21) satisfied by ρ and κ , we get :

$$\begin{cases} 0 = \varepsilon\kappa_{xx} + \frac{\rho_x\rho_{xx}}{\kappa_x} - \tau\rho_x & \text{on } \partial I \times [0, T] \\ 0 = (1 + \varepsilon)\rho_{xx} - \tau\kappa_x & \text{on } \partial I \times [0, T], \end{cases} \quad (3.32)$$

that immediately implies (3.29).

The regularity $C^{3+\alpha, \frac{3+\alpha}{2}}$ of the solution is the maximal regularity that we are able to obtain “up to the boundary”. This is due to the fact that we are increasing the regularity, in an iterative way, by using, each time, the Hölder theory of parabolic equations (see Theorem 2.1 of Chapter 4). However, the Hölder theory of parabolic equations requires a certain order of compatibility between the given data, and, roughly speaking : the more we increase the compatibility order, the more we increase the regularity. In our case, the boundary conditions (3.23) and (3.29) raise the compatibility order up to 1, and hence we obtain the $C^{3+\alpha, \frac{3+\alpha}{2}}$ regularity up to the boundary.

The effect of the division by κ_x . The classical way to prove the existence of a long-time solution of a parabolic problem, is to show the existence of a short-time solution by applying a fixed point argument on suitable spaces, and then to

3. Strongly coupled singular parabolic system

iterate after having good *a priori* estimates. We will use this method to find our solution. Let us mention that at a short time $T > 0$, we can easily find a smooth solution of (3.21)-(3.22)-(3.23) that satisfies :

$$\kappa_x > |\rho_x|, \quad \text{on } I_T, \quad (3.33)$$

which somehow linearizes the first equation of (3.21) satisfied by κ . In this case, the well-known estimates for linear parabolic equations give some good *a priori* estimates, but not a suitable minoration in the L^∞ norm of κ_x in order to avoid dividing by 0. Hence, while iterating, it may happen that $\kappa_x = 0$ and therefore the procedure stops.

In the forthcoming arguments, many constants that may depend on time are set to be 0 or 1. This is done in order to avoid technical confusions, and to clearly present the essential ideas.

First minoration of κ_x . We will try to overcome the problem of dividing by κ_x by finding a lower bound via a **comparison principle** that is shown to be satisfied for (3.21)-(3.22)-(3.23). This comparison principle leads to the following inequality on $\overline{I_T} := \bar{I} \times [0, T]$:

$$\kappa_x(x, t) \geq \sqrt{\gamma^2(t) + \rho_x^2(x, t)}, \quad (3.34)$$

where γ is a decreasing function satisfying the simple ordinary differential equation :

$$\gamma'(t) \geq - (1 + \|\rho_{xxx}\|_{L^\infty(I_T)}) \gamma(t), \quad t \in (0, T). \quad (3.35)$$

The term $\|\rho_{xxx}\|_{L^\infty(I_T)}$ appearing in (3.35) comes from deriving system (3.21) with respect to x while doing the computations. We can easily remark that the solution γ of (3.35) could vanish if $\|\rho_{xxx}\|_{L^\infty(I_T)}$ becomes infinitely large. Therefore, inequality (3.34) is not a good minoration of κ_x unless $\|\rho_{xxx}\|_{L^\infty(I_T)}$ is well controlled, and this what will be illustrated in the next step.

A Kozono-Taniuchi parabolic inequality. The C^α estimates for parabolic equations give a control of $\|\rho_{xxx}\|_{L^\infty(I_T)}$ of the form :

$$\|\rho_{xxx}\|_{L^\infty(I_T)} \leq \frac{1}{\gamma(T)}, \quad (3.36)$$

which, if plugged in (3.35), does not prevent κ_x from vanishing. It is worth mentioning that the usual L^p estimates for parabolic equations are valid for $1 < p < \infty$, and not for $p = \infty$.

An “intermediate” theory of parabolic equations is the $BMO^{(3)}$ (bounded mean oscillation) theory. The BMO estimates give a control of the BMO norm of ρ_{xxx} (see Lemma 7.5 of Chapter 4) independent of γ :

$$\|\rho_{xxx}\|_{BMO(I_T)} \leq 1. \quad (3.37)$$

In our work we prove a Kozono-Taniuchi parabolic type inequality that controls the L^∞ norm of a given function by its BMO norm and by the logarithm of its norm in some Sobolev space. This inequality formally reads :

$$\|\rho_{xxx}\|_{L^\infty(I_T)} \leq \|\rho_{xxx}\|_{BMO(I_T)} \left(1 + \log^+ \|\rho_{xxx}\|_{BMO(I_T)} + \log^+ \|\rho_{xxx}\|_{W_2^{2,1}(I_T)}\right). \quad (3.38)$$

Also, a useful estimate that can be obtained from the L^p theory (see Lemma 6.3 of Chapter 4) is an estimate of the form :

$$\|\rho_{xxx}\|_{W_2^{2,1}(I_T)} \leq \frac{1}{\gamma^4(T)}. \quad (3.39)$$

Using (3.37), (3.38) and (3.39), we finally get :

$$\|\rho_{xxx}\|_{L^\infty(I_T)} \leq 4 \log \left(\frac{1}{\gamma(T)} \right), \quad (3.40)$$

which is better than (3.36).

The original type of the logarithmic Sobolev inequality (3.38) was found in Brézis, Gallouët [8], and Brézis, Wainger [9] (see also Engler [33]), where the authors investigated, in the elliptic framework and not in the parabolic one, the relation between L^∞ , W_r^k and W_p^s , provided $\|u\|_{W_r^k} \leq 1$ for $kr = n$. This estimate was applied to prove existence of global solutions to the nonlinear Schrödinger equation (see Brézis, Gallouët [8], and Hayashi, von Wahl [48]). The original Kozono-Taniuchi inequality [61, Theorem 1] is proved in the elliptic case. A sketch of the proof of the parabolic version of this inequality is given in Appendix B of Chapter 4.

By using the inequality (3.40) into the ordinary differential inequality (3.35), and by following all the hidden terms, we obtain

$$\kappa_x(\cdot, t) \geq \gamma(t) \geq e^{-e^{ct}} \quad \text{with } c = e^t,$$

and hence we get the following *a priori* estimates :

$$\|\rho(\cdot, t)\|_{C^3(\bar{I})} \leq e^{e^{e^t}} \quad \text{and} \quad \|\kappa(\cdot, t)\|_{C^3(\bar{I})} \leq e^{e^{e^t}}.$$

The existence of the long-time solution then follows by time iteration.

³The BMO space was introduced by John and Nirenberg, see [59].

4 Strongly coupled nonlinear parabolic/Hamilton-Jacobi system

This section presents the principal result of Chapter 5 where we study the existence of a viscosity-distribution mixed solution of system (1.8)-(1.9) in the **Case B**. This result can be considered as the limit of Theorem 3.1 as we set $\varepsilon = 0$.

4.1 Setting of the problem

We are interested in the existence of solutions of system (1.8)-(1.9) in the case $\tau \neq 0$, and under the condition (1.4). We recall the coupled system :

$$\begin{cases} \kappa_t \kappa_x = \rho_t \rho_x & \text{on } I \times (0, T) \\ \rho_t = \rho_{xx} - \tau \kappa_x & \text{on } I \times (0, T), \end{cases} \quad (4.41)$$

with the initial conditions on I :

$$\kappa(x, 0) = \kappa^0(x), \quad \rho(x, 0) = \rho^0(x), \quad (4.42)$$

and the boundary conditions

$$\begin{cases} \kappa(0, t) = \kappa^0(0) \text{ and } \kappa(1, t) = \kappa^0(1), & \forall t \in [0, T], \\ \rho(0, t) = \rho(1, t) = 0, & \forall t \in [0, T], \end{cases} \quad (4.43)$$

The initial conditions are now submitted to the following condition :

$$\kappa_x^0 \geq |\rho_x^0| \quad \text{on } I. \quad (4.44)$$

System (4.41) can be viewed as the limit of system (3.21) where we added the $-\varepsilon \Delta$ term. Therefore, the natural idea is to pass to the limit as $\varepsilon \rightarrow 0$. This method is called the vanishing viscosity method which is common in order to approach viscosity solutions for a Hamilton-Jacobi equation. The literature on this topic is very rich and one can cite for instance the book of Barles [3] and the references therein, see also Sinai [87], Huang, Wang, and Teo [52].

4.2 Existence of viscosity solutions

The main theorem concerning system (4.41), (4.42), (4.43) and (4.44) is the following :

Theorem 4.1 (*Existence of a long-time mixed type solution*)

Let ρ^0 and κ^0 be two sufficiently regular functions satisfying (4.44). Then there exists

$$(\rho, \kappa) \in (C(\bar{I} \times [0, \infty)))^2, \quad \rho \in C^1(I \times (0, \infty)), \quad (4.45)$$

solution of (4.41), (4.42) and (4.43) satisfying :

$$\kappa_x \geq |\rho_x| \quad \text{in} \quad \mathcal{D}'(I \times (0, T)). \quad (4.46)$$

However, this solution has to be interpreted in the following sense :

1. κ is a viscosity solution of $\kappa_t \kappa_x = \rho_t \rho_x$ in $I_T = I \times (0, T)$,
2. ρ is a distributional solution of $\rho_t = \rho_{xx} - \tau \kappa_x$ in I_T ,
3. the initial and boundary conditions are satisfied pointwisely.

Remark 4.2 For the sake of distinction, we call $(\rho^\varepsilon, \kappa^\varepsilon)$, the solution obtained by Theorem 3.1.

The main difficulty we have to face is to work with the equation

$$\kappa_t \kappa_x = \rho_t \rho_x. \quad (4.47)$$

The idea is to pass to the limit as $\varepsilon \rightarrow 0$ in the family of smooth solutions κ^ε obtained by Theorem 3.1. For this reason, we need a framework where the equation (4.47) is stable under approximation. Roughly speaking, the regularity C^1 of ρ is expected since it satisfies a parabolic equation (the second equation of (4.41)). In this case ρ_t and ρ_x are both continuous and hence the Hamiltonian of (4.47) is also continuous. Then, assuming $\kappa_x > 0$, we can interpret κ as a viscosity solution of (4.47). This takes us in a natural way to the framework of viscosity solutions where the stability property is well satisfied (see Barles [3, Lemma 2.3]).

The convergence of κ^ε to a continuous function κ is made via the local control, uniformly in ε , of the modulus of continuity of κ^ε in space and in time⁽⁴⁾. This permits to deduce the local uniform convergence of κ^ε .

The uniform control of the space modulus of continuity is done using an entropy inequality that is shown to be valid for the approximated system (3.21) (see Proposition 5.1 of Chapter 5). This entropy inequality can be easily understood. For instance, if we set $\varepsilon = 0$ and $\tau = 0$, we can formally check that the entropy of the dislocation densities

$$\theta^\pm = \frac{\kappa_x \pm \rho_x}{2},$$

⁴This is a direct consequence of the Arzelà-Ascoli Theorem.

defined by

$$S(t) = \int_I \sum_{\pm} \theta^{\pm}(\cdot, t) \log \theta^{\pm}(\cdot, t)$$

satisfies

$$\frac{dS(t)}{dt} = - \int_I \frac{(\theta_x^+ - \theta_x^-)^2}{\theta^+ + \theta^-} \leq 0,$$

and hence we get $S(t) \leq S(0)$ which controls the entropy uniformly in time.

The uniform control of the entropy leads to an ε -uniform control of the space modulus of continuity of κ^ε (see Proposition 5.4 of Chapter 5).

On the other hand, the uniform control of the time modulus of continuity is done via a bound on $\kappa_t^\varepsilon - \varepsilon \kappa_{xx}^\varepsilon$ uniformly in ε (see Lemma 3.4 of Chapter 5).

Finally, the condition (4.46) comes directly by passing to the limit in the sequence of inequalities $\kappa_x^\varepsilon > |\rho_x^\varepsilon|$ (see (3.31)).

4.3 Simulations

Using the equations of elasticity (see the Appendix of the thesis), together with the system (1.3) in terms of ρ and κ , we can calculate the displacement inside the material. We consider the case of a crystal with a shear stress τ applied on the boundary walls (see Figure 2.5). In Figure 2.6, we show successively the

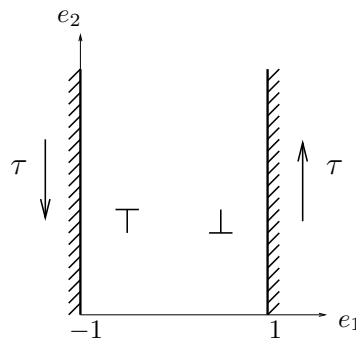

FIG. 2.5 – Geometry of the material.

initial state of the crystal at time $t = 0$ without any applied stress, then the instantaneous (elastic) deformation of the crystal when we apply the shear stress $\tau > 0$ at time $t = 0^+$. The deformation of the crystal evolves in time and finally converges numerically to some particular deformation which is shown on the last picture after a very long time. This kind of behaviour is called elasto-viscoplasticity in mechanics because the material takes time to respond to the applied

stress. Moreover, on the last picture, we observe the presence of boundary layer deformations. This effect is directly related to the introduction of the back stress $\tau_b = \frac{\theta_x^+ - \theta_x^-}{\theta^+ + \theta^-}$ in the model (1.1).

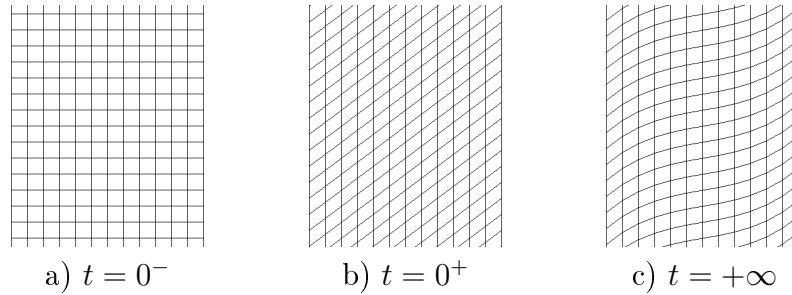

FIG. 2.6 – Deformation of a crystal for model (1.3).

5 Numerical complement for an independent problem of transport type

We are interested in the numerical calculus of the solutions of partial differential equations of transport type :

$$\begin{cases} u_t = \vec{a} \cdot \nabla u & \text{on } \mathbb{R}^2 \times (0, T) \\ u(x, 0) = u^0(x) \in \{+1, -1\} & \text{on } \mathbb{R}^2, \end{cases} \quad (5.48)$$

where $\vec{a}(x, t) = (a_1(x, t), a_2(x, t))$ is the velocity vector field. We consider a discretization of the space \mathbb{R}^2 :

$$x_I = (x_{i_1}, x_{i_2}) = (i_1 \Delta x, i_2 \Delta x),$$

with $I = (i_1, i_2) \in \mathbb{Z}^2$, and Δx is a space step. The function u^0 is given by :

$$u_0(x_I) = \begin{cases} +1 & \text{if } x_I \in \Omega_0, \quad \Omega_0 \subset \mathbb{R}^2 \text{ is an open set,} \\ -1 & \text{otherwise.} \end{cases}$$

Here, the function u_0 permits to represent a curve $\partial\Omega_0$ in \mathbb{R}^2 . In fact, we can formally write : $\partial\Omega_0 = \partial\{x_I; u_0(x_I) = +1\}$. Then the evolution of the function u_0 with respect to time represents the transport of the curve $\partial\Omega_0$ following the vector field \vec{a} . The goal is to write an algorithm in order to calculate the solution of (5.48).

In the special case where $\vec{a} = c(x, t) \frac{\nabla u}{|\nabla u|}$, equation (5.48) is now called the eikonal equation :

$$\begin{cases} u_t = c(x, t) |\nabla u| & \text{on } \mathbb{R}^2 \times (0, T) \\ u(x, 0) = u^0(x) \in \{+1, -1\} & \text{on } \mathbb{R}^2, \end{cases}$$

that modelizes front evolutions in the normal direction. In this case, an algorithm based on the ‘‘Fast Marching’’ Method (see Sethian [86], and Tsitsiklis [91]), is presented in Carlini, Falcone, Forcadel, and Monneau [11]. This algorithm is an extension of the classical Fast Marching Method since the new scheme can deal with a time-dependent velocity $c(x, t)$ without any restriction on its sign.

We have been trying to explore the ideas of Carlini, Falcone, Forcadel, and Monneau [11], and to adapt them for transport equations (5.48). In this direction, we have proposed several algorithms that seem, after doing numerical tests, not translating the fronts at the good speed, even in the case where \vec{a} is constant.

An algorithm of the *splitting* type is then introduced (for the details, see Subsection 3.2 of Chapter 6). The idea of *splitting* is to separate the translation of x_{i_1} following the velocity a_1 , and the translation of x_{i_2} following the velocity a_2 . The advantage of this algorithm is that it translates (in an exact manner) the corners and the straight lines of a given front at the good speed, if the velocity vector \vec{a} is constant.

Numerical test : case of a rotating square. A numerical test is done for a moving square following a vector field \vec{a} that depends only on space. We consider the case of a rotating square, i.e. $\vec{a} = (-x_{i_2}, x_{i_1})$. The following numerical simulations are thus obtained :

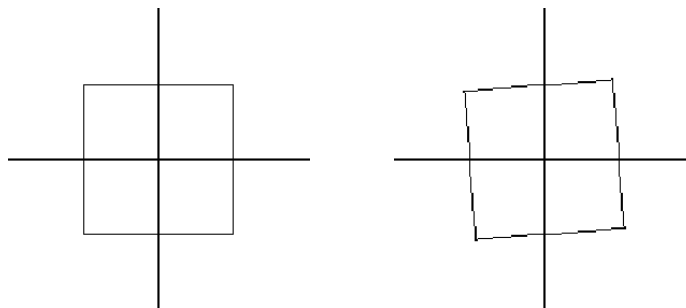

FIG. 2.7 – Images 0, 38

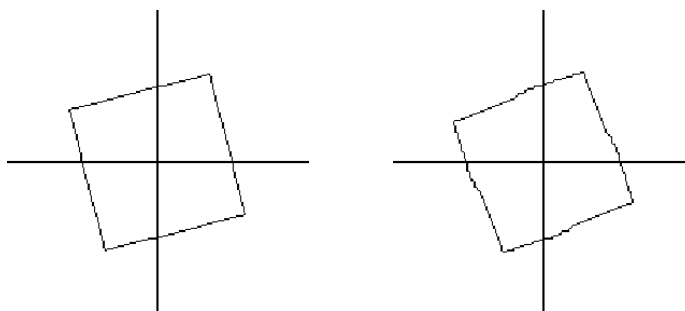

FIG. 2.8 – Images 149, 241

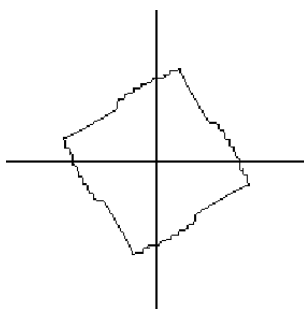

FIG. 2.9 – Image 373

This numerical test shows that our proposed algorithm of the *splitting* type can create some instabilities (see Figure 2.9). The following step will be to improve this algorithm in order to overcome such inconvenience.

Chapitre 3

Existence et unicité pour un système couplé parabolique/Hamilton-Jacobi non-linéaire décrivant la dynamique des densités des dislocations

Ce chapitre est une version longue et détaillé d'un article à paraître dans *Annales de l'Institut Henri Poincaré, Non Linear Analysis*.

Nous étudions un modèle mathématique décrivant la dynamique de densités de dislocations dans les cristaux. Ce modèle s'écrit comme un système 1D couplant une équation parabolique et une équation d'Hamilton-Jacobi du premier ordre. On montre l'existence et l'unicité d'une solution de viscosité dans la classe des fonctions ayant un gradient minoré pour tout temps ainsi qu'au temps initial. De plus, on montre l'existence d'une solution de viscosité sans cette condition sur la donnée initiale. On présente également un résultat d'existence et d'unicité pour une solution entropique d'un système obtenu par dérivation spatiale. L'unicité de cette solution entropique a lieu dans la classe des solutions minorées. Pour montrer ces résultats, on utilise une relation entre les lois de conservation scalaire et les équations de Hamilton-Jacobi, principalement pour obtenir des contrôles du gradient. Cette étude a lieu dans \mathbb{R} et dans un domaine borné avec des conditions aux bords appropriées.

Existence and uniqueness for a nonlinear parabolic/Hamilton-Jacobi coupled system describing the dynamics of dislocation densities

H. Ibrahim

*CERMICS, École Nationale des Ponts et Chaussées
6 & 8, avenue Blaise Pascal, Cité Descartes,
Champs sur Marne, 77455 Marne-La-Vallée Cedex 2, FRANCE*

Abstract

We study a mathematical model describing the dynamics of dislocation densities in crystals. This model is expressed as a one-dimensional system of a parabolic equation and a first order Hamilton-Jacobi equation that are coupled together. We show the existence and uniqueness of a viscosity solution among those assuming a lower-bound on their gradient for all time including the initial data. Moreover, we show the existence of a viscosity solution when we have no such restriction on the initial data. We also state a result of existence and uniqueness of an entropy solution of the system obtained by spatial derivation. The uniqueness of this entropy solution holds in the class of “bounded from below” solutions. In order to prove these results, we use a relation between scalar conservation laws and Hamilton-Jacobi equations, mainly to get some gradient estimates. This study will take place in \mathbb{R} , and on a bounded domain with suitable boundary conditions.

AMS Classification : 70H20, 35L65, 49L25, 54C70, 74H20, 74H25.

Key words : Hamilton-Jacobi equations, scalar conservation laws, viscosity solutions, entropy solutions, dynamics of dislocation densities.

1 Introduction

1.1 Physical motivation

A dislocation is a defect, or irregularity within a crystal structure that can be observed by electron microscopy. The theory was originally developed by Vito Volterra in 1905. Dislocations are a non-stationary phenomena and their motion is the main explanation of the plastic deformation in metallic crystals (see [51, 76] for a recent physical presentation).

Geometrically, each dislocation is characterized by a physical quantity called the Burgers vector, which is responsible for its orientation and magnitude. Dislocations are classified as being positive or negative due to the orientation of its Burgers vector, and they can move in certain crystallographic directions.

Starting from the motion of individual dislocations, a continuum description can be derived by adopting a formulation of dislocation dynamics in terms of appropriately defined dislocation densities, namely the density of positive and negative dislocations. In this paper we are interested in the model described by Groma, Csikor and Zaiser [46], that sheds light on the evolution of the dynamics of the “two type” densities of a system of straight parallel dislocations, taking into consideration the influence of the short range dislocation-dislocation interactions. The model was originally presented in $\mathbb{R}^2 \times (0, T)$ as follows :

$$\begin{cases} \frac{\partial \theta^+}{\partial t} + \mathbf{b} \cdot \frac{\partial}{\partial \mathbf{r}} \left[\theta^+ \left\{ (\tau_{sc} + \tau_{eff}) - AD \frac{\mathbf{b}}{(\theta^+ + \theta^-)} \cdot \frac{\partial}{\partial \mathbf{r}} (\theta^+ - \theta^-) \right\} \right] = 0, \\ \frac{\partial \theta^-}{\partial t} - \mathbf{b} \cdot \frac{\partial}{\partial \mathbf{r}} \left[\theta^- \left\{ (\tau_{sc} + \tau_{eff}) - AD \frac{\mathbf{b}}{(\theta^+ + \theta^-)} \cdot \frac{\partial}{\partial \mathbf{r}} (\theta^+ - \theta^-) \right\} \right] = 0. \end{cases} \quad (1.1)$$

Where $T > 0$, $\mathbf{r} = (x, y)$ represents the spatial variable, \mathbf{b} is the burger’s vector, $\theta^+(\mathbf{r}, t)$ and $\theta^-(\mathbf{r}, t)$ denote the densities of the positive and negative dislocations respectively. The quantity A is defined by the formula $A = \mu/[2\pi(1-\nu)]$, where μ is the shear modulus and ν is the Poisson ratio. D is a non-dimensional constant. Stress fields are represented through the self-consistent stress $\tau_{sc}(\mathbf{r}, t)$, and the effective stress $\tau_{eff}(\mathbf{r}, t)$. $\frac{\partial}{\partial \mathbf{r}}$ denotes the gradient with respect to the coordinate vector \mathbf{r} . An earlier investigation of the continuum description of the dynamics of dislocation densities has been done in [45]. However, a major drawback of these investigations is that the short range dislocation-dislocation correlations have been neglected and dislocation-dislocation interactions were described only by the long-range term which is the self-consistent stress field. Moreover, for the model described in [45], we refer the reader to [31, 32] for a one-dimensional mathematical and numerical study, and to [10] for a two-dimensional existence result.

In our work, we are interested in a particular setting of (1.1) where we make the following assumptions :

- (a1) the quantities in equations (1.1) are independent of y ,
- (a2) $\mathbf{b} = (1, 0)$, and the constants A and D are set to be 1,
- (a3) the effective stress is assumed to be zero.

Remark 1.1 (a1) gives that the self-consistent stress τ_{sc} is null; this is a consequence of the definition of τ_{sc} (see [46]).

Assumptions (a1)-(a2)-(a3) permit rewriting the original model as a **1D** problem in $\mathbb{R} \times (0, T)$:

$$\begin{cases} \theta_t^+(x, t) - \left(\theta^+(x, t) \left(\frac{\theta_x^+(x, t) - \theta_x^-(x, t)}{\theta^+(x, t) + \theta^-(x, t)} \right) \right)_x = 0, \\ \theta_t^-(x, t) + \left(\theta^-(x, t) \left(\frac{\theta_x^+(x, t) - \theta_x^-(x, t)}{\theta^+(x, t) + \theta^-(x, t)} \right) \right)_x = 0. \end{cases} \quad (1.2)$$

We consider an integrated form of (1.2) and we let :

$$\rho_x^\pm = \theta^\pm, \quad \theta = \theta^+ + \theta^-, \quad \rho = \rho^+ - \rho^- \quad \text{and} \quad \kappa = \rho^+ + \rho^-, \quad (1.3)$$

in order to obtain, for special values of the constants of integration, the following system of PDEs in terms of ρ and κ :

$$\begin{cases} \kappa_t \kappa_x = \rho_t \rho_x & \text{in } Q_T := \mathbb{R} \times (0, T), \\ \kappa(x, 0) = \kappa^0(x) & \text{in } \mathbb{R}, \end{cases} \quad (1.4)$$

and

$$\begin{cases} \rho_t = \rho_{xx} & \text{in } Q_T, \\ \rho(x, 0) = \rho^0(x) & \text{in } \mathbb{R}, \end{cases} \quad (1.5)$$

where $T > 0$ is a fixed constant. Enough regularity on the initial data will be given in order to impose the physically relevant condition,

$$\kappa_x^0 \geq |\rho_x^0|. \quad (1.6)$$

This condition is natural : it indicates nothing but the positivity of the dislocation densities $\theta^\pm(x, 0)$ at the initial time (see (1.3)).

1.2 Main results

In this paper, we show the existence and uniqueness of a viscosity solution κ of (1.4) in the class of all Lipschitz continuous viscosity solutions having special “bounded from below” spatial gradients. However, we show the existence of a Lipschitz continuous viscosity solution of (1.4) when this restriction is relaxed. A relation between scalar conservation laws and Hamilton-Jacobi equations will be exploited to get almost all our gradient controls of κ . This relation, that will

be made precise later, will also lead to a result of existence and uniqueness of a bounded entropy solution of the following equation :

$$\begin{cases} \theta_t = \left(\frac{\rho_x \rho_{xx}}{\theta} \right)_x & \text{in } Q_T, \\ \theta(x, 0) = \theta^0(x) & \text{in } \mathbb{R}, \end{cases} \quad (1.7)$$

which is deduced formally by taking a spatial derivation of (1.4). The uniqueness of this entropy solution is always restricted to the class of bounded entropy solutions with a special lower-bound.

Let $Lip(\mathbb{R})$ denotes :

$$Lip(\mathbb{R}) = \{f : \mathbb{R} \mapsto \mathbb{R}; f \text{ is a Lipschitz continuous function}\}.$$

We prove the following theorems :

Theorem 1.2 (*Existence and uniqueness of a viscosity solution*)

Let $T > 0$. Take $\kappa^0 \in Lip(\mathbb{R})$ and $\rho^0 \in C_0^\infty(\mathbb{R})$ as initial data that satisfy :

$$\kappa_x^0 \geq \sqrt{(\rho_x^0)^2 + \epsilon^2} \quad \text{a.e. in } \mathbb{R}, \quad (1.8)$$

for some constant $\epsilon > 0$. Then, given the solution ρ of (1.5), there exists a viscosity solution $\kappa \in Lip(\bar{Q}_T)$ of (1.4), unique among the viscosity solutions satisfying :

$$\kappa_x \geq \sqrt{\rho_x^2 + \epsilon^2} \quad \text{a.e. in } \bar{Q}_T.$$

Theorem 1.3 (*Existence and uniqueness of an entropy solution*)

Let $T > 0$. Take $\theta^0 \in L^\infty(\mathbb{R})$ and $\rho^0 \in C_0^\infty(\mathbb{R})$ such that,

$$\theta^0 \geq \sqrt{(\rho_x^0)^2 + \epsilon^2} \quad \text{a.e. in } \mathbb{R},$$

for some constant $\epsilon > 0$. Then, there exists an entropy solution $\theta \in L^\infty(\bar{Q}_T)$ of (1.7), unique among the entropy solutions satisfying :

$$\theta \geq \sqrt{\rho_x^2 + \epsilon^2} \quad \text{a.e. in } \bar{Q}_T.$$

Moreover, we have $\theta = \kappa_x$, where κ is the solution given by Theorem 1.2.

The notion of viscosity solutions and entropy solutions will be recalled in section 2. We now relate these results to our one-dimensional problem (1.2). Remarking that $\rho_x = \theta^+ - \theta^-$ and $\kappa_x = \theta^+ + \theta^-$, we have as a consequence :

Corollary 1.4 (*Existence and uniqueness for problem (1.2)*)

Let $T > 0$. Let θ_0^+ and θ_0^- be two given functions representing the initial positive and negative dislocation densities respectively. If the following conditions are satisfied :

$$(1) \theta_0^+ - \theta_0^- \in C_0^\infty(\mathbb{R}),$$

$$(2) \theta_0^+, \theta_0^- \in L^\infty(\mathbb{R}),$$

together with,

$$\theta_0^+ + \theta_0^- \geq \sqrt{(\theta_0^+ - \theta_0^-)^2 + \epsilon^2} \quad \text{a.e. in } \mathbb{R},$$

then there exists a solution $(\theta^+, \theta^-) \in (L^\infty(Q_T))^2$ to the system (1.2), in the sense of Theorems 1.2 and 1.3, unique among those satisfying :

$$\theta^+ + \theta^- \geq \sqrt{(\theta^+ - \theta^-)^2 + \epsilon^2} \quad \text{a.e. in } \bar{Q}_T.$$

Remark 1.5 Conditions (1) and (2) are sufficient requirements for the compatibility with the regularity of ρ^0 and κ^0 previously stated.

Theorem 1.6 (*Existence of a viscosity solution, case $\epsilon = 0$*)

Let $T > 0$, $\kappa^0 \in Lip(\mathbb{R})$ and $\rho^0 \in C_0^\infty(\mathbb{R})$. If the condition (1.6) is satisfied a.e. in \mathbb{R} , then there exists a viscosity solution $\kappa \in Lip(\bar{Q}_T)$ of (1.4) satisfying :

$$\kappa_x \geq |\rho_x| \quad \text{a.e. in } \bar{Q}_T. \quad (1.9)$$

Remark 1.7 In the limit case where $\epsilon = 0$, we remark that having (1.9) was intuitively expected due to the positivity of the dislocation densities θ^+ and θ^- . This reflects in some way the well-posedness of the model (1.2) of the dynamics of dislocation densities. We also remark that our result of existence of a solution of (1.4) under (1.9) still holds if we start with $\kappa_x^0 = \rho_x^0 = 0$ on some interval of the real line. In other words, we can imagine that we start with the probability of the formation of no dislocation zones.

Problem with boundary conditions.

We consider once again problem (1.4), similar results to that announced above will be shown on a bounded interval of the real line with Dirichlet boundary conditions (see section 5). This problem corresponds physically to the study of the dynamics of dislocation densities in a part of a material with the geometry of a slab (see [46]).

1.3 Organization of the paper

The paper is organized as follows. In section 2, we start by stating the definition of viscosity and entropy solutions with some of their properties. In section 3, we prove the existence and uniqueness of a viscosity solution to an approximated problem of (1.4), namely Proposition 3.1, and we move on, giving additional properties of our approximated solution (Proposition 3.2) and consequently proving Theorems 1.2 and 1.3. In section 4, we present the proof of Theorem 1.6. section 5 is devoted to the study of problem (1.4) on a bounded domain with suitable boundary conditions. Finally, section 6 is an appendix containing a sketch of the proof to the classical comparison principle of scalar conservation laws adapted to our equation with low regularity.

2 Notations and Preliminaries

We first fix some notations. If Ω is an open subset of \mathbb{R}^n , k is a positive integer, we denote by $C^k(\Omega)$ the space of all real valued k times continuously differentiable functions. $C_0^k(\Omega)$ is the subspace of $C^k(\Omega)$ consisting of function of compact support in Ω , and $C_b^k(\Omega) = C^k(\Omega) \cap W^{k,\infty}(\Omega)$ where $W^{k,\infty}(\Omega)$ is defined below. Furthermore, let $UC(\Omega)$ and $Lip(\Omega)$ denote the spaces of uniformly continuous functions and Lipschitz continuous functions on Ω respectively. The Sobolev space $W^{m,p}(\Omega)$ with $m \geq 1$ an integer and $p : 1 \leq p \leq \infty$ a real, is defined by

$$W^{n,p}(\Omega) = \left\{ u \in L^p(\Omega) \left| \begin{array}{l} \forall \alpha \text{ with } |\alpha| \leq n \ \exists f_\alpha \in L^p(\Omega) \text{ such that} \\ \int_{\Omega} u D^\alpha \phi = (-1)^{|\alpha|} \int_{\Omega} f_\alpha \phi \ \forall \phi \in C_0^\infty(\Omega) \end{array} \right. \right\},$$

where we denote $D^\alpha u = f_\alpha$. This space equipped with the norm

$$\|u\|_{W^{n,p}} = \sum_{0 \leq |\alpha| \leq n} \|D^\alpha u\|_{L^p}$$

is a Banach space. In what follows, $T > 0$. A map $m : [0, \infty) \mapsto [0, \infty)$ that satisfy

- m is continuous and non-decreasing ;
- $\lim_{x \rightarrow 0^+} m(x) = 0$;
- $m(a + b) \leq m(a) + m(b)$ for $a, b \geq 0$;

is said to be “a modulus”, and $UC_x(\Omega \times [0, T])$ denotes the space of those $u \in C(\Omega \times [0, T])$ for which there is a modulus m and $r > 0$ such that

$$|u(x, t) - u(y, t)| \leq m(|x - y|) \text{ for } x, y \in \Omega, |x - y| \leq r \text{ and } t \in [0, T].$$

We will deal with two types of equations :

1. Hamilton-Jacobi equation :

$$\begin{cases} u_t + F(x, t, u_x) = 0 & \text{in } Q_T, \\ u(x, 0) = u^0(x) & \text{in } \mathbb{R}, \end{cases} \quad (2.10)$$

2. Scalar conservation laws :

$$\begin{cases} v_t + (F(x, t, v))_x = 0 & \text{in } Q_T, \\ v(x, 0) = v^0(x) & \text{in } \mathbb{R}, \end{cases} \quad (2.11)$$

where

$$\begin{aligned} F : \mathbb{R} \times [0, T] \times \mathbb{R} &\rightarrow \mathbb{R} \\ (x, t, u) &\mapsto F(x, t, u) \end{aligned}$$

is called the Hamiltonian in the Hamilton-Jacobi equations and the flux function in the scalar conservation laws. We will agree on the continuity of this function, while additional and specific regularity will be given when it is needed.

Remark 2.1 *We will use the function F as a notation for the Hamiltonian/flux function. Although F might differ from one equation to another, it will be clarified in all what follows.*

Remark 2.2 *The major part of this work concerns a Hamiltonian/flux function of a special form, namely :*

$$F(x, t, u) = g(x, t)f(u), \quad (2.12)$$

where such forms often arise in problems of physical interest including traffic flow [94] and two-phase flow in porous media [43].

We start by defining the notion of viscosity solution to Hamilton-Jacobi equations (2.10), and entropy solution to scalar conservation laws (2.11) with a flux function given by Remark 2.2, as well as some results about existence, uniqueness, and regularity properties of these solutions. We will end by a classical relation between these two problems. These results will be needed throughout this paper, precise references for the proofs will be mentioned later on.

2.1 Viscosity solution : definition and properties

Definition 2.3 (*[22], Viscosity solution : non-stationary case*)

1) A function $u \in C(Q_T; \mathbb{R})$ is a viscosity sub-solution of

$$u_t + F(x, t, u_x) = 0 \quad \text{in } Q_T, \quad (2.13)$$

if for every $\phi \in C^1(Q_T)$, whenever $u - \phi$ attains a local maximum at $(x_0, t_0) \in Q_T$, then

$$\phi_t(x_0, t_0) + F(x_0, t_0, \phi_x(x_0, t_0)) \leq 0.$$

2) A function $u \in C(Q_T; \mathbb{R})$ is a viscosity super-solution of (2.13) if for every $\phi \in C^1(Q_T)$, whenever $u - \phi$ attains a local minimum at $(x_0, t_0) \in Q_T$, then

$$\phi_t(x_0, t_0) + F(x_0, t_0, \phi_x(x_0, t_0)) \geq 0.$$

3) A function $u \in C(Q_T; \mathbb{R})$ is a viscosity solution of (2.13) if it is both a viscosity sub- and super-solution of (2.13).

4) A function $u \in C(\bar{Q}_T; \mathbb{R})$ is a viscosity solution of the initial value problem (2.10) if u is a viscosity solution of (2.13) and $u(x, 0) = u^0(x)$ in \mathbb{R} .

It is worth mentioning here that if a viscosity solution of a Hamilton-Jacobi equation is differentiable at a certain point, then it solves the equation there (see [22, Corollary I.6]). An equivalent definition depending on the sub- and super-differential of a continuous function is now presented. This definition will be used for the demonstration of Proposition 2.10. Let us recall that the sub- and the super-differential of a continuous function $u \in C(\mathbb{R}^n \times (0, T))$, at a point $(x, t) \in \mathbb{R}^n \times (0, T)$, are defined as the closed convex sets :

$$D^{1,-}u(x, t) = \left\{ (p, \alpha) \in \mathbb{R}^n \times \mathbb{R} : \liminf_{(y,s) \rightarrow (x,t)} \frac{u(y, s) - u(x, t) - (p \cdot (y - x) + \alpha \cdot (s - t))}{|y - x| + |s - t|} \geq 0 \right\},$$

and

$$D^{1,+}u(x, t) = \left\{ (p, \alpha) \in \mathbb{R}^n \times \mathbb{R} : \limsup_{(y,s) \rightarrow (x,t)} \frac{u(y, s) - u(x, t) - (p \cdot (y - x) + \alpha \cdot (s - t))}{|y - x| + |s - t|} \leq 0 \right\},$$

respectively.

Definition 2.4 (*Equivalent definition of viscosity solution*)

1) A function $u \in C(\mathbb{R}^n \times (0, T))$ is a viscosity super-solution of (2.10) if and only if, for every $(x, t) \in \mathbb{R}^n \times (0, T)$:

$$\forall (p, \alpha) \in D^{1,-}u(x, t), \quad \alpha + F(x, t, p) \geq 0. \quad (2.14)$$

2) A function $u \in C(\mathbb{R}^n \times (0, T))$ is a viscosity sub-solution of (2.10) if and only if, for every $(x, t) \in \mathbb{R}^n \times (0, T)$:

$$\forall (p, \alpha) \in D^{1,+}u(x, t), \quad \alpha + F(x, t, p) \leq 0. \quad (2.15)$$

This definition is more local, for it permits verification that a given explicit function is a viscosity solution in a more classical way, i.e. using the derivative calculus. A similar definition, that will be used later, could be given in the stationary case. Let $\Omega \subset \mathbb{R}^n$ be an open domain, and consider the PDE

$$F(x, u(x), \nabla u(x)) = 0, \quad \forall x \in \Omega, \quad (2.16)$$

where $F : \Omega \times \mathbb{R} \times \mathbb{R}^n \mapsto \mathbb{R}$ is a continuous mapping.

Definition 2.5 (*Viscosity solution : stationary case*)

A continuous function $u : \Omega \mapsto \mathbb{R}$ is a viscosity sub-solution of the PDE (2.16) if for any continuously differentiable function $\phi : \Omega \mapsto \mathbb{R}$ and any local maximum $x_0 \in \Omega$ of $u - \phi$, one has

$$F(x_0, u(x_0), \nabla \phi(x_0)) \leq 0.$$

Similarly, if at any local minimum point $x_0 \in \Omega$ of $u - \phi$, one has

$$F(x_0, u(x_0), \nabla \phi(x_0)) \geq 0,$$

then u is a viscosity super-solution. Finally, if u is both a viscosity sub-solution and a viscosity super-solution, then u is called a viscosity solution.

In fact, this definition is used for interpreting solutions of (1.4) in the viscosity sense. Furthermore, we say that u is a viscosity solution of the Dirichlet problem (2.16) with $u = \zeta \in C(\partial\Omega)$ if :

- (1) $u \in C(\bar{\Omega})$,
- (2) u is a viscosity solution of (2.16) in Ω ,
- (3) $u = \zeta$ on $\partial\Omega$.

For a better understanding of the viscosity interpretation of boundary conditions of Hamilton-Jacobi equations, we refer the reader to [3, section 4.2].

Now, we will proceed by giving the main results concerning viscosity solutions of (2.10). In order to have existence and uniqueness, the Hamiltonian F will be restricted by the following conditions :

(F0) $F \in C(\mathbb{R} \times [0, T] \times \mathbb{R})$;

(F1) for each $R > 0$ there is a constant C_R such that for all $(x, t, p), (y, t, q) \in \mathbb{R} \times [0, T] \times [-R, R]$,

$$|F(x, t, p) - F(y, t, q)| \leq C_R(|p - q| + |x - y|);$$

(F2) there is a constant C_F such that for all $(t, p) \in [0, T] \times \mathbb{R}$ and all $x, y \in \mathbb{R}$,

$$|F(x, t, p) - F(y, t, p)| \leq C_F|x - y|(1 + |p|).$$

We use these conditions to write down some results on viscosity solutions.

Theorem 2.6 (Comparison, [23, Theorem 1])

Let F satisfy **(F0)**-**(F1)**-**(F2)**. If $u, \bar{u} \in UC_x(\bar{Q}_T)$ are two viscosity sub- and super-solution of the Hamilton-Jacobi equation (2.10) respectively, with

$$u(x, 0) \leq \bar{u}(x, 0) \quad \text{in } \mathbb{R},$$

then $u \leq \bar{u}$ in \bar{Q}_T .

Theorem 2.7 (Existence, [23, Theorem 1])

Let F satisfy **(F0)**-**(F1)**-**(F2)**. If $u^0 \in UC(\mathbb{R})$, then (2.10) has a viscosity solution $u \in UC_x(\bar{Q}_T)$.

Remark 2.8 The ‘‘comparison’’ theorem stated above gives the uniqueness of the viscosity solution.

Remark 2.9 In the case where the Hamiltonian has the form

$$F(x, t, u) = g(x, t)f(u),$$

the following conditions :

(V0) $f \in C_b^1(\mathbb{R}; \mathbb{R})$,

(V1) $g \in C_b(\bar{Q}_T; \mathbb{R})$,

(V2) $g_x \in L^\infty(\bar{Q}_T)$,

imply (F0)-(F1)-(F2) together with the boundedness of the Hamiltonian.

The next proposition reflects the behavior of viscosity solutions under additional regularity assumptions on u^0 and F .

Proposition 2.10 (Additional regularity of the viscosity solution)

Let $F = gf$ satisfy (V0)-(V1)-(V2). If $u^0 \in Lip(\mathbb{R})$ and $u \in UC_x(\bar{Q}_T)$ is the unique viscosity solution of (2.10), then $u \in Lip(\bar{Q}_T)$.

Proof. Consider the function u^ϵ defined on $\mathbb{R} \times [0, T]$ by :

$$u^\epsilon(x, t) = \sup_{y \in \mathbb{R}} \left\{ u(y, t) - e^{kt} \frac{|x - y|^2}{2\epsilon} \right\}.$$

By [56, Theorem 3], the function u satisfies,

$$|u(x, t)| \leq c^*(|x| + 1) \quad \text{for } (x, t) \in \mathbb{R} \times [0, T],$$

where c^* is a positive constant. Therefore, u is a sublinear function for every time $t \in [0, T]$. The function u^ϵ is defined via a supremum which is attained because of the sublinearity of the function u (a quadratic function always control a linear one); the supremum can be achieved at several points; let x_ϵ be one of them, so we can write

$$u^\epsilon(x, t) = u(x_\epsilon, t) - e^{kt} \frac{|x - x_\epsilon|^2}{2\epsilon}.$$

We are going to prove that for $(p, \alpha) \in \mathbb{R} \times \mathbb{R}$, we have :

$$(p, \alpha) \in D^{1,+}u^\epsilon(x, t) \Rightarrow \left(p, \alpha + ke^{kt} \frac{|x - x_\epsilon|^2}{2\epsilon} \right) \in D^{1,+}u(x_\epsilon, t). \quad (2.17)$$

Since $(p, \alpha) \in D^{1,+}u^\epsilon(x, t)$, then we can write for $(y, s) \sim (x, t)$ that,

$$L = u^\epsilon(y, s) \leq u^\epsilon(x, t) + \alpha(s - t) + p(y - x) + o(|s - t| + |y - x|) = R, \quad (2.18)$$

where the left side L of (2.18) satisfies,

$$L \geq u(z, s) - e^{ks} \frac{|z - y|^2}{2\epsilon}, \quad z \in \mathbb{R}, \quad (2.19)$$

and the right side R of (2.18) satisfies,

$$R \leq u(x_\epsilon, t) - e^{kt} \frac{|x - x_\epsilon|^2}{2\epsilon} + \alpha(s - t) + p(y - x) + o(|s - t| + |y - x|). \quad (2.20)$$

Choose z such that $z - y = x_\epsilon - x$, then

$$z = x_\epsilon + (y - x) \sim x_\epsilon, \text{ since } y \sim x. \quad (2.21)$$

Combining (2.18), (2.19), (2.20) and (2.21) together, we get

$$\begin{aligned} u(x_\epsilon + (y - x), s) - e^{ks} \frac{|x - x_\epsilon|^2}{2\epsilon} &\leq \\ u(x_\epsilon, t) - e^{kt} \frac{|x - x_\epsilon|^2}{2\epsilon} + \alpha(s - t) + p(z - x_\epsilon) + o(|s - t| + |z - x_\epsilon|), \end{aligned}$$

and hence,

$$\begin{aligned} u(z, s) &\leq u(x_\epsilon, t) + (e^{ks} - e^{kt}) \frac{|x - x_\epsilon|^2}{2\epsilon} \\ &\quad + \alpha(s - t) + p(z - x_\epsilon) + o(|s - t| + |z - x_\epsilon|). \end{aligned} \quad (2.22)$$

We have

$$(e^{ks} - e^{kt}) \frac{|x - x_\epsilon|^2}{2\epsilon} = ke^{kt} \frac{|x - x_\epsilon|^2}{2\epsilon} (s - t) + o(|s - t|),$$

then using inequality (2.22), we get

$$\begin{aligned} u(z, s) &\leq u(x_\epsilon, t) + \left(\alpha + ke^{kt} \frac{|x - x_\epsilon|^2}{2\epsilon} \right) (s - t) \\ &\quad + p(z - x_\epsilon) + o(|s - t| + |z - x_\epsilon|), \end{aligned}$$

which proves that

$$\left(\alpha + ke^{kt} \frac{|x - x_\epsilon|^2}{2\epsilon}, p \right) \in D^{1,+}u(x_\epsilon, t),$$

and hence statement (2.17) is true. Since u is a viscosity sub-solution of (2.10), we have

$$\alpha + ke^{kt} \frac{|x - x_\epsilon|^2}{2\epsilon} + F(x_\epsilon, t, p) \leq 0.$$

We use (V0)-(V1)-(V2) to get

$$\begin{aligned} \alpha + ke^{kt} \frac{|x - x_\epsilon|^2}{2\epsilon} + F(x, t, p) &\leq F(x, t, p) - F(x_\epsilon, t, p), \\ &\leq C|x - x_\epsilon|, \end{aligned}$$

where

$$C = \|f\|_{L^\infty(\mathbb{R})} \|g_x\|_{L^\infty(Q)},$$

and therefore,

$$\begin{aligned} \alpha + F(x, t, p) &\leq C|x - x_\epsilon| - ke^{kt} \frac{|x - x_\epsilon|^2}{2\epsilon}, \\ &\leq Cr_\epsilon - k \frac{r_\epsilon^2}{2\epsilon}, \\ &\leq \sup_{r>0} \left(Cr - \frac{kr^2}{2\epsilon} \right), \end{aligned}$$

where $r_\epsilon = |x - x_\epsilon|$. At the maximum \bar{r} , we have $C = \frac{k\bar{r}}{\epsilon}$. By choosing $k = \frac{C^2}{2}$, we get

$$\alpha + F(x, t, p) \leq \epsilon.$$

This inequality shows that $v^\epsilon = u^\epsilon - \epsilon t$ is a viscosity sub-solution of (2.10) with $v^\epsilon(x, 0) = u^\epsilon(x, 0)$. By the comparison principle, we have

$$\begin{aligned} v^\epsilon(x, t) - u(x, t) &\leq \sup_{x \in \mathbb{R}} (v^\epsilon(x, 0) - u^0(x)), \\ &\leq \sup_{x \in \mathbb{R}} (u^\epsilon(x, 0) - u^0(x)), \\ &\leq \sup_{x \in \mathbb{R}} \left(\sup_{y \in \mathbb{R}} \left\{ u^0(y) - \frac{|x - y|^2}{2\epsilon} \right\} - u^0(x) \right), \\ &\leq \sup_{x, y \in \mathbb{R}} \left(\gamma|x - y| - \frac{|x - y|^2}{2\epsilon} \right), \\ &\leq \sup_{r \geq 0} \left(\gamma r - \frac{r^2}{2\epsilon} \right) = \frac{\gamma^2 \epsilon}{2}, \end{aligned}$$

where γ is the Lipschitz constant of the function u^0 , and $r = |x - y|$. This altogether shows the following inequality for $x, y \in \mathbb{R}$:

$$u(y, t) - e^{kt} \frac{|x - y|^2}{2\epsilon} \leq u^\epsilon(x, t) \leq u(x, t) + \epsilon t + \frac{\gamma^2 \epsilon}{2}. \quad (2.23)$$

Remark here that k is a fixed, previously chosen constant. Inequality (2.23) yields :

$$u(y, t) - u(x, t) \leq e^{kt} \frac{|x - y|^2}{2\epsilon} + \left(t + \frac{\gamma^2}{2} \right) \epsilon = \zeta/\epsilon + \beta\epsilon, \quad (2.24)$$

where $\zeta = e^{kt} \frac{|x - y|^2}{2}$ and $\beta = \left(t + \frac{\gamma^2}{2} \right)$. We minimize inequality (2.24) over ϵ to obtain,

$$\begin{aligned} u(y, t) - u(x, t) &\leq 2\sqrt{\zeta\beta}, \\ &\leq e^{\frac{kt}{2}} \sqrt{2} \sqrt{t + \frac{\gamma^2}{2}} |x - y|. \end{aligned}$$

Since this inequality holds $\forall x, y \in \mathbb{R}$, exchanging x with y yields,

$$|u(x, t) - u(y, t)| \leq C(F, u_0)|x - y| \quad \forall x, y \in \mathbb{R} \text{ and } t \in [0, T].$$

This shows that the function u is Lipschitz continuous in x , uniformly in time t . To prove the Lipschitz continuity in time, we mainly use the result of [56, Theorem 3] with the fact that $u_t = -F(x, t, u_x)$, and the boundedness of the Hamiltonian. \square

Remark 2.11 *It is worth mentioning that the space Lipschitz constant of the function u depends on C , where C appears in **(F1)** for $p = q$, and on the Lipschitz constant γ of the function u_0 . While the time Lipschitz constant depends on the bound of the Hamiltonian.*

2.2 Entropy solution : definition and properties

Definition 2.12 (*Entropy sub-/super-solution*)

Let $F(x, t, v) = g(x, t)f(v)$ with $g, g_x \in L^\infty_{loc}(Q_T; \mathbb{R})$ and $f \in C^1(\mathbb{R}; \mathbb{R})$. A function $v \in L^\infty(Q_T; \mathbb{R})$ is an entropy sub-solution of (2.11) with bounded initial data $v^0 \in L^\infty(\mathbb{R})$ if it satisfies :

$$\int_{Q_T} \left[\eta_i(v(x, t))\phi_t(x, t) + \Phi(v(x, t))g(x, t)\phi_x(x, t) + h(v(x, t))g_x(x, t)\phi(x, t) \right] dxdt + \int_{\mathbb{R}} \eta_i(v^0(x))\phi(x, 0)dx \geq 0, \quad (2.25)$$

$\forall \phi \in C_0^1(\mathbb{R} \times [0, T]; \mathbb{R}_+)$, for any non-decreasing convex function $\eta_i \in C^1(\mathbb{R}; \mathbb{R})$, $\Phi \in C^1(\mathbb{R}; \mathbb{R})$ such that :

$$\Phi' = f' \eta_i', \quad \text{and} \quad h = \Phi - f \eta_i'. \quad (2.26)$$

An entropy super-solution of (2.11) is defined by replacing in (2.25) η_i with η_d ; a non-increasing convex function. An entropy solution is defined as being both entropy sub- and super-solution. In other words, it verifies (2.25) for any convex function $\eta \in C^1(\mathbb{R}; \mathbb{R})$.

A well know characterization of the entropy solution is that :

Proposition 2.13 *A function $v \in L^\infty(Q_T)$ is an entropy sub-solution of (2.11) if and only if $\forall k \in \mathbb{R}$, $\phi \in C_0^1(\mathbb{R} \times [0, T]; \mathbb{R}_+)$, one has :*

$$\int_{Q_T} \left[(v(x, t) - k)^+ \phi_t(x, t) + \text{sgn}^+(v(x, t) - k)(f(v(x, t)) - f(k))g(x, t)\phi_x(x, t) - \text{sgn}^+(v(x, t) - k)f(k)g_x(x, t)\phi(x, t) \right] dxdt + \int_{\mathbb{R}} (v^0(x) - k)^+ \phi(x, 0)dx \geq 0, \quad (2.27)$$

Where $a^\pm = \frac{1}{2}(|a| \pm a)$ and $\text{sgn}^\pm(x) = \frac{1}{2}(\text{sgn}(x) \pm 1)$. An entropy super-solution of (2.11) is defined replacing in (2.27) $(\cdot)^+$, sgn^+ by $(\cdot)^-$, sgn^- .

This characterization can be deduced from (2.25), by using regularizations of the function $(\cdot - k)^+$. Also (2.25) may be obtained from (2.27) by approximating any non-decreasing convex function $\eta_i \in C^1(\mathbb{R}; \mathbb{R})$ by a sequence of functions of the form : $\eta_i^{(n)}(\cdot) = \sum_1^n \beta_i^{(n)}(\cdot - k_i^{(n)})^+$, with $\beta_i^{(n)} \geq 0$.

Entropy solution was first introduced by Kruřkov [63] as the only physically admissible solution among all weak (distributional) solutions to scalar conservation laws. These weak solutions lack the fact of being unique for it is easy to construct multiple weak solutions to Cauchy problems (2.11), see [66]. The theory of entropy solutions was then widely developed in [35, 36, 70, 80–82]. Equivalent definitions of entropy solutions for scalar conservation laws with merely essentially bounded L^∞ data are given via the entropy process solutions (see [35, 36]), or via the kinetic formulation (see [70, 81, 82]). A notion of a weak entropy solution via the entropy-flux pairs is given in [80].

Our next definition concerns classical sub-/super-solution to scalar conservation laws. This kind of solutions are shown to be entropy solutions, for the details see Lemma 3.3.

Definition 2.14 (Classical solution to scalar conservation laws)

Let $F(x, t, v) = g(x, t)f(v)$ with $g, g_x \in L^\infty_{loc}(Q_T; \mathbb{R})$ and $f \in C^1(\mathbb{R}; \mathbb{R})$. A function $v \in W^{1,\infty}(Q_T)$ is said to be a classical sub-solution of (2.11) with $v^0(x) = v(x, 0)$ if it satisfies

$$v_t(x, t) + (F(x, t, v(x, t)))_x \leq 0 \quad \text{a.e. in } Q_T. \quad (2.28)$$

Classical super-solutions are defined by replacing “ \leq ” with “ \geq ” in (2.28), and classical solutions are defined to be both classical sub- and super-solutions.

We move now to some results on entropy solutions depicted from [63].

Theorem 2.15 (Kruřkov’s Existence Theorem)

Let F, v^0 be given by Definition 2.12, and the following conditions hold :

(E0) $f \in C_b^1(\mathbb{R})$,

(E1) $g, g_x \in C_b(\bar{Q}_T)$,

(E2) $g_{xx} \in C(\bar{Q}_T)$,

then there exists an entropy solution $v \in L^\infty(Q_T)$ of (2.11).

In fact, Kruřkov's conditions for existence were given for a general flux function [63, section 4]. However, in subsection 5.4 of the same paper, a weak version of these conditions, that can be easily checked in the case $F(x, t, v) = g(x, t)f(v)$ and **(E0)**-**(E1)**-**(E2)**, is presented. Furthermore, uniqueness follows from the following comparison principle.

Theorem 2.16 (*Comparison Principle*)

Let F be given by Definition 2.12 with f satisfying **(E0)**, and g satisfies,

(E3) $g \in W^{1,\infty}(\bar{Q}_T)$.

Let $u(x, t), v(x, t) \in L^\infty(Q_T)$ be two entropy sub-/super-solutions of (2.11) with initial data $u^0, v^0 \in L^\infty(\mathbb{R})$. Suppose that,

$$u^0(x) \leq v^0(x) \quad \text{a.e. in } \mathbb{R},$$

then

$$u(x, t) \leq v(x, t) \quad \text{a.e. in } \bar{Q}_T.$$

Proof. See section 6, Appendix. □

It is worth noticing that in [63], the proof of the existence of entropy solutions of (2.11) is made through a parabolic regularization of (2.11) and passing to the limit, with respect to the L^1 convergence on compacts, in a convenient space.

At this stage, we are ready to present a relation that sometimes holds between scalar conservation laws and Hamilton-Jacobi equations in one-dimensional space.

2.3 Entropy-Viscosity relation

Formally, by differentiating (2.10) with respect to x and defining $v = u_x$, we see that (2.10) is equivalent to the scalar conservation law (2.11) with $v^0 = u_x^0$ and the same F . This equivalence of the two problems has been exploited in order to translate some numerical methods for hyperbolic conservation laws to methods for Hamilton-Jacobi equations. Moreover, several proofs were given in the one dimensional case. The usual proof of this relation depends strongly on the known results about existence and uniqueness of the solutions of the two problems together with the convergence of the viscosity method (see [21, 62, 69]). Another proof of this relation could be found in [13] via the definition of viscosity/entropy inequalities, while a direct proof could also be found in [60] using the front tracking method. The case of a Hamiltonian of the form (2.12) is also treated even when $g(x, t)$ is allowed to be discontinuous in the (x, t) plane along

a finite number of (possibly intersected) curves, see [79].

In our work, the above stated relation will be successfully used to get some gradient estimates of κ . Although several approaches were given to establish this connection, we will present for the reader's convenience, a proof similar to that given in [21, Theorem 2.2]. For every Hamiltonian/flux function $F = gf$ and every $u^0 \in Lip(\mathbb{R})$, let

$$\mathcal{E}\mathcal{V} = \{(\mathbf{V0}), (\mathbf{V1}), (\mathbf{V2}), (\mathbf{E0}), (\mathbf{E1}), (\mathbf{E2}), (\mathbf{E3})\},$$

in other words,

$$\mathcal{E}\mathcal{V} = \left\{ \begin{array}{l} \text{The set of all conditions on } f \text{ and } g \text{ ensuring the} \\ \text{existence and uniqueness of a Lipschitz continuous viscosity} \\ \text{solution } u \in Lip(\bar{Q}_T) \text{ of (2.10), and of an entropy} \\ \text{solution } v \in L^\infty(Q_T) \text{ of (2.11), with } v^0 = u_x^0 \in L^\infty(\mathbb{R}). \end{array} \right.$$

Theorem 2.17 (A link between viscosity and entropy solutions)

Let $F = gf$ with $g \in C^2(\bar{Q}_T)$, $u^0 \in Lip(\mathbb{R})$ and $\mathcal{E}\mathcal{V}$ satisfied. Then,

$$v = u_x \quad \text{a.e. in } Q_T.$$

Sketch of the proof. Let $\varepsilon > 0$ and $\delta > 0$. We start the proof by making a parabolic regularization of equation (2.10) and a smooth regularization of u_0 and we solve the following parabolic equation :

$$\begin{cases} u_t^{\varepsilon,\delta} + F(x, t, u_x^{\varepsilon,\delta}) = \varepsilon u_{xx}^{\varepsilon,\delta} & \text{in } \mathbb{R} \times (0, T), \\ u^{\varepsilon,\delta}(x, 0) = u^{0,\delta}(x) & \text{in } \mathbb{R}. \end{cases} \quad (2.29)$$

For the sake of simplicity, we will denote $u^{\varepsilon,\delta}$ by w and $u^{0,\delta}$ by w^0 . Note that the first equation of (2.29) can be viewed as the heat equation with a source term F . Thus, we have :

$$\begin{cases} w_t - \varepsilon w_{xx} = F[w](x, t) & \text{in } Q_T, \\ w(x, 0) = w^0 & \text{in } \mathbb{R}, \end{cases} \quad (2.30)$$

with $F[w](x, t) = F(x, t, w_x(x, t))$. From the classical theory of heat equations, since $F[w] \in L_{loc}^p(Q_T)$ and $w^0 \in W_{loc}^{1,p}(\mathbb{R})$, there exists a unique solution w of (2.30) such that

$$w \in W_p^{2,1}(\Omega) \quad \forall \Omega \subset\subset Q_T \text{ and } 1 < p < \infty.$$

Here the space $W_p^{2,1}(\Omega)$, $p \geq 1$ is the Banach space consisting of all functions $w \in L^p(\Omega)$ having generalized derivatives of the form w_t and w_{xx} in $L^p(\Omega)$. For

more details, see [65, Theorem 9.1]. We also notice that the space $W_p^{2,1}(\Omega)$ is continuously injected in the Hölder space $C^{\alpha,\alpha/2}(\Omega)$ for $\alpha = 2 - \frac{3}{p}$ and $p > \frac{3}{2}$, see [65]. We use now a bootstrap argument to increase the regularity of w , taking in each stage, the new regularity of $F[w]$ and the regularity of w^0 . Finally, we get that $w \in C^{3,1}(\mathbb{R} \times [0, T])$ (three times continuously differentiable in space and one time continuously differentiable in time). From the maximum principle and the L^p -estimates of the heat equation, see [7, 65], it follows the uniform bound of $u^{\varepsilon,\delta}$ in $W_{loc}^{1,p}(Q_T)$, for $p > 2$. Therefore, we get as $\delta \rightarrow 0$ and $\varepsilon \rightarrow 0$ that :

$$u^{\varepsilon,\delta} \rightarrow u \quad \text{in } C(\mathbb{R} \times [0, T]),$$

with $u(x, 0) = u^0$. We now make use of the stability theorem, [3, Théorème 2.3], twice on the equation (2.29) to get that the limit u is the unique viscosity solution of (2.10). Hence, we have for any $\phi \in C_0^\infty(Q_T)$

$$\begin{aligned} \lim_{\varepsilon \rightarrow 0, \delta \rightarrow 0} \int_0^T \int_{\mathbb{R}} u_x^{\varepsilon,\delta} \phi \, dx \, dt &= - \lim_{\varepsilon \rightarrow 0, \delta \rightarrow 0} \int_0^T \int_{\mathbb{R}} u^{\varepsilon,\delta} \phi_x \, dx \, dt \\ &= - \int_0^T \int_{\mathbb{R}} u \phi_x \, dx \, dt = \int_0^T \int_{\mathbb{R}} u_x \phi \, dx \, dt. \end{aligned}$$

The appearance of u_x follows since $u \in Lip(\bar{Q}_T)$. Moreover, as a regular solution, the function $v^{\varepsilon,\delta} = u_x^{\varepsilon,\delta}$ solves the derived problem

$$\begin{cases} v_t^{\varepsilon,\delta} + (F(x, t, v^{\varepsilon,\delta}))_x = \varepsilon v_{xx}^{\varepsilon,\delta} & \text{in } \mathbb{R} \times (0, T), \\ v^{\varepsilon,\delta}(x, 0) = u_x^{0,\delta}(x) & \text{in } \mathbb{R}, \end{cases} \quad (2.31)$$

and, according to [63, Theorem 4], the sequence $v^{\varepsilon,\delta}$ converge in $L_{loc}^1(\bar{Q}_T)$, as $\varepsilon \rightarrow 0$ and $\delta \rightarrow 0$, to the entropy solution v of (2.11). Then, for any $\phi \in C_0^\infty(Q_T)$,

$$\lim_{\varepsilon \rightarrow 0, \delta \rightarrow 0} \int_0^T \int_{\mathbb{R}} v^{\varepsilon,\delta} \phi \, dx \, dt = \int_0^T \int_{\mathbb{R}} v \phi \, dx \, dt.$$

Consequently,

$$\int_0^T \int_{\mathbb{R}} u_x \phi \, dx \, dt = \int_0^T \int_{\mathbb{R}} v \phi \, dx \, dt,$$

and $u_x = v$ a.e. in Q_T . □

Remark 2.18 *The converse of the previous theorem holds under certain assumptions (see [19, 60]).*

Remark 2.19 *In the multidimensional case this one-to-one correspondence no longer exists, instead the gradient $v = \nabla u$ satisfies formally a non-strict hyperbolic system of conservation laws (see [62, 69]).*

Throughout sections 3 and 4, ρ will always be the solution of the heat equation (1.5). The properties of the solution of the heat equation with such a regular initial data will be frequently used, we refer the reader to [7, 34] for details.

3 The approximate problem

In this section, we approximate (1.4) and we pose a more restrictive condition (see condition (1.8)) on the gradient of the initial data than of the physically relevant one (1.6). We prove a result of existence and uniqueness of this approximate problem, namely Theorem 1.2, and the reader will notice at the end of this section that this restrictive condition is satisfied for all time, and this what cancels the approximation in the structure of (1.4) and returns it to its original one. Finally we present the proof of Theorem 1.3.

For every $a > 0$, we build up an approximation function $f_a \in C_b^1(\mathbb{R})$ of the function $\frac{1}{x}$ defined by :

$$f_a(x) = \begin{cases} \frac{1}{x} & \text{if } x \geq a, \\ \frac{2a-x}{a^2 + a^2(x-a)^2} & \text{otherwise.} \end{cases} \quad (3.32)$$

Proposition 3.1 *For any $a > 0$, let f_a be defined by (3.32) and $H \in C^1(\mathbb{R})$ be a scalar-valued function. If*

$$F_a(x, t, u) = -H(\rho_x(x, t))\rho_{xx}(x, t)f_a(u) \quad (3.33)$$

and $\kappa^0 \in Lip(\mathbb{R})$, then the Hamilton-Jacobi equation

$$\begin{cases} \kappa_t + F_a(x, t, \kappa_x) = 0 & \text{in } Q_T, \\ \kappa(x, 0) = \kappa^0(x) & \text{in } \mathbb{R}, \end{cases} \quad (3.34)$$

has a unique viscosity solution $\kappa \in Lip(\bar{Q}_T)$.

Proof. The proof is easily concluded from Theorems 2.6, 2.7 and Proposition 2.10, after checking that the conditions **(V0)**-**(V1)**-**(V2)** are satisfied with

$$g(x, t) = -H(\rho_x(x, t))\rho_{xx}(x, t). \quad (3.35)$$

The condition **(V0)** is trivial, while for **(V1)**, we just use the fact that H is bounded on compacts and the fact that $|\rho_{xx}(x, t)| \leq \|\rho_{xx}^0\|_{L^\infty(\mathbb{R})}$ in \bar{Q}_T . For the

condition **(V2)**, the regularity of ρ and H permits to compute the spatial derivative of g in \bar{Q}_T , thus we have :

$$g_x = -(H'(\rho_x)\rho_{xx}^2 + H(\rho_x)\rho_{xxx}).$$

The uniform bound of the spatial derivatives, up to the third order, of the solution of the heat equation, and the boundedness of H' on compacts gives immediately **(V2)**. \square

In the following proposition, we show a lower-bound estimate for the gradient of κ obtained in Proposition 3.1. It is worth mentioning that a result of lower-bound gradient estimates for first-order Hamilton-Jacobi equations could be found in [67, Theorem 4.2]. However, this result holds for Hamiltonians $F(x, t, u)$ that are convex in the u -variable, using only the viscosity theory techniques. This is not the case here, and in order to obtain our lower-bound estimates, we need to use the viscosity/entropy theory techniques. In particular, we have the following :

Proposition 3.2 *Let $G \in C^3(\mathbb{R}; \mathbb{R})$ satisfying the following conditions :*

$$(G1) \quad G(x) \geq G(0) > 0,$$

$$(G2) \quad G'' \geq 0.$$

Moreover, let

$$H = GG' \quad \text{and} \quad 0 < a \leq G(0).$$

If κ^0 satisfies :

$$\kappa_x^0(x) \geq G(\rho_x^0(x)), \quad \text{a.e. in } \mathbb{R},$$

then the solution κ obtained from Proposition 3.1 satisfies :

$$\kappa_x(x, t) \geq G(\rho_x(x, t)) \quad \text{a.e. in } \bar{Q}_T. \quad (3.36)$$

In order to prove Proposition 3.2, we first show that $G(\rho_x)$ is an entropy sub-solution of

$$\begin{cases} \omega_t + (F(x, t, \omega))_x = 0 & \text{in } Q_T, \\ \omega(x, 0) = \omega^0(x) & \text{in } \mathbb{R}, \end{cases} \quad (3.37)$$

with $w^0 = G(\rho_x^0)$ and $F = F_a$ is the same as in (3.33) (we remove the index a for simplicity). Before going further, we will pause to prove a lemma which makes it easier to reach our goal.

Lemma 3.3 (Classical sub-solutions are entropy sub-solutions)

Let $v \in W^{1,\infty}(Q_T)$ be a classical sub-solution of (2.11) with $v^0(x) = v(x, 0)$, then v is an entropy sub-solution.

Proof. Let η_i , Φ , h and ϕ be given by Definition 2.12. Multiplying inequality (2.28) by $\eta'_i(v)\phi$ does not change its sign. Hence, after developing, we have :

$$\eta'_i(v)v_t\phi + \eta'_i(v)g_x f(v)\phi + \eta'_i(v)g f'(v)v_x\phi \leq 0, \quad \text{a.e. in } Q_T, \quad (3.38)$$

and since v is Lipschitz continuous, we use the chain-rule formula together with (2.26) to rewrite (3.38) as :

$$(\eta_i(v))_t\phi + g_x f(v)\eta'_i(v)\phi + g(\Phi(v))_x\phi \leq 0, \quad \text{a.e. in } Q_T. \quad (3.39)$$

Upon integrating (3.39) over Q_T and transferring derivatives with respect to t and x to the test function, we obtain :

$$\int_{Q_T} \left[\eta_i(v(x, t))\phi_t(x, t) + \Phi(v(x, t))g(x, t)\phi_x(x, t) + h(v(x, t))g_x(x, t)\phi(x, t) \right] dxdt + \int_{\mathbb{R}} \eta_i(v^0(x))\phi(x, 0)dx \geq 0, \quad (3.40)$$

which ends the proof. \square

Following the same arguments, classical super-solutions are shown to be entropy super-solutions. We return now to the function $G(\rho_x)$ and we are ready to show that it is indeed an entropy sub-solution of (3.37). In particular, we have the following :

Lemma 3.4 *The function $G(\rho_x)$ defined on Q_T is a classical sub-solution of (3.37) with initial data $G(\rho_x^0)$, hence an entropy sub-solution.*

Proof of Lemma 3.4. First, it is easily seen that $G(\rho_x) \in W^{1,\infty}(Q_T)$. Define the scalar valued quantity B on Q_T by :

$$B(x, t) = \partial_t(G(\rho_x(x, t))) + \partial_x(F(x, t, G(\rho_x(x, t)))).$$

Since $0 < a \leq G(0)$, we use (G1) to get $f_a(G(\rho_x)) = 1/G(\rho_x)$ and we observe that,

$$\begin{aligned} B &= G'(\rho_x)\rho_{xt} - \partial_x \left(\frac{H(\rho_x)\rho_{xx}}{G(\rho_x)} \right) \\ &= G'(\rho_x)\rho_{xxx} - \left(\frac{G(\rho_x)[H'(\rho_x)\rho_{xx}^2 + H(\rho_x)\rho_{xxx}] - (G'(\rho_x)\rho_{xx}^2 H(\rho_x))}{G^2(\rho_x)} \right) \\ &= \frac{G(\rho_x)\rho_{xxx}(G(\rho_x)G'(\rho_x) - H(\rho_x)) - \rho_{xx}^2(H'(\rho_x)G(\rho_x) - H(\rho_x)G'(\rho_x))}{G^2(\rho_x)} \\ &= -\rho_{xx}^2 G''(\rho_x). \end{aligned}$$

The condition (G2) gives immediately that $B \leq 0$. This proves that $G(\rho_x)$ is a classical sub-solution of equation (3.37) and hence an entropy sub-solution. \square

Proof of Proposition 3.2. From the definition of H and the properties of ρ , it is easy to check that $g \in C^2(\bar{Q}_T)$ and that \mathcal{EV} is fully satisfied. Hence, we are in the framework of Theorem 2.17 with $u^0 = \kappa^0$. This theorem gives that κ_x is the unique entropy solution of (3.37) with $w^0 = \kappa_x^0$. Moreover, by the previous lemma, $G(\rho_x)$ is an entropy sub-solution of (3.37). Since

$$\kappa_x^0 \geq G(\rho_x^0), \quad \text{a.e. in } \mathbb{R},$$

we can apply the Comparison Theorem 2.16 to get the desired result. \square

It is worth notable here that we do not know how to obtain the lower-bound on the spatial gradient κ_x using the viscosity framework directly. However, for the case of the upper-bound, we can do so (see Remark 4.1). At this stage, fix some $\epsilon > 0$, and let

$$G^\epsilon(x) = \sqrt{x^2 + \epsilon^2} \quad \text{and} \quad a = G^\epsilon(0) = \epsilon.$$

It is clear that $G^\epsilon(x)$ satisfies the conditions (G1)-(G2) with

$$H^\epsilon(x) = x,$$

and the Hamiltonian F from (3.33) takes now the following shape :

$$F_\epsilon(x, t, u) = -\rho_x(x, t)\rho_{xx}(x, t)f_\epsilon(u). \quad (3.41)$$

Moreover, we have the following corollary which is an immediate consequence of Propositions 3.1 and 3.2.

Corollary 3.5 *There exists a unique viscosity solution $\kappa \in Lip(\bar{Q}_T)$ of*

$$\begin{cases} \kappa_t + F_\epsilon(x, t, \kappa_x) = 0 & \text{in } Q_T, \\ \kappa(x, 0) = \kappa^0 \in Lip(\mathbb{R}) & \text{in } \mathbb{R}, \end{cases} \quad (3.42)$$

with κ_x^0 satisfies :

$$\kappa_x^0 \geq \sqrt{(\rho_x^0)^2 + \epsilon^2} \quad \text{a.e. in } \mathbb{R}. \quad (3.43)$$

Moreover, this solution κ satisfies :

$$\kappa_x \geq \sqrt{\rho_x^2 + \epsilon^2} \quad \text{a.e. in } \bar{Q}_T. \quad (3.44)$$

The following lemma will be used in the proof of Theorem 1.2.

Lemma 3.6 *Let \bar{c} be an arbitrary real constant and take $\psi \in Lip(\mathbb{R}; \mathbb{R})$ satisfying :*

$$\psi_x \geq \bar{c} \quad \text{a.e. in } \mathbb{R}.$$

If $\zeta \in C^1(\mathbb{R}; \mathbb{R})$ is such that $\psi - \zeta$ has a local maximum or local minimum at some point $x_0 \in \mathbb{R}$, then

$$\zeta_x(x_0) \geq \bar{c}.$$

Proof. Suppose that $\psi - \zeta$ has a local minimum at the point x_0 ; this ensures the existence of a certain $r > 0$ such that

$$(\psi - \zeta)(x) \geq (\psi - \zeta)(x_0) \quad \forall x; |x - x_0| < r.$$

We argue by contradiction. Assuming $\zeta_x(x_0) < \bar{c}$ leads, from the continuity of ζ_x , to the existence of $r' \in (0, r)$ such that

$$\zeta_x(x) < \bar{c} \quad \forall x; |x - x_0| < r'. \quad (3.45)$$

Let y_0 be a point such that $|y_0 - x_0| < r'$ and $y_0 < x_0$. Reexpressing (3.45), we get

$$(\zeta - \bar{c}x)_x(x) < 0 \quad \forall x \in (y_0, x_0),$$

and hence

$$\int_{y_0}^{x_0} [(\psi - \bar{c}x)_x(x) - (\zeta - \bar{c}x)_x(x)] dx > 0,$$

which implies that

$$(\psi - \zeta)(x_0) > (\psi - \zeta)(y_0),$$

and hence a contradiction. We remark that the case of a local maximum can be treated in a similar way. \square

Now, we are ready to present the proofs of the first two theorems announced in section 1.

Proof of Theorem 1.2. Let $\kappa \in Lip(\bar{Q}_T)$ be the solution of (3.42) obtained in Corollary 3.5. Let us show that it is the unique viscosity solution of (1.4) among those verifying (3.44). To do this, we consider a test function $\phi \in C^1(Q_T)$ such that $\kappa - \phi$ has a local minimum at some point $(x_0, t_0) \in Q_T$. Proposition 2.10, together with inequality (3.44) gives that

$$\kappa(\cdot, t_0) \in Lip(\mathbb{R}) \quad \text{and} \quad \kappa_x(\cdot, t_0) \geq \epsilon \quad \text{a.e. in } \mathbb{R}.$$

We make use of Lemma 3.6 with $\psi(\cdot) = \kappa(\cdot, t_0)$ and $\zeta(\cdot) = \phi(\cdot, t_0)$ to get

$$\phi_x(x_0, t_0) \geq \epsilon. \quad (3.46)$$

Since κ is a viscosity super-solution of

$$\kappa_t - f_\epsilon(\kappa_x)\rho_x\rho_{xx} = 0 \quad \text{in } Q_T,$$

we have

$$\phi_t(x_0, t_0) - f_\epsilon(\phi_x(x_0, t_0))\rho_x(x_0, t_0)\rho_{xx}(x_0, t_0) \geq 0.$$

However, from (3.46), we get

$$\phi_t(x_0, t_0)\phi_x(x_0, t_0) - \rho_x(x_0, t_0)\rho_{xx}(x_0, t_0) \geq 0,$$

and hence κ is a viscosity super-solution of

$$\kappa_t\kappa_x = \rho_x\rho_{xx} \quad \text{in } Q_T.$$

In the same way, we can show that κ is a viscosity sub-solution of the above equation and hence a viscosity solution. The uniqueness of this solution comes from the uniqueness of the viscosity solution of (3.42) by reversing the above reasoning. \square

Remark 3.7 Notice that the first equation of (1.4) can be viewed as a Hamilton-Jacobi equation of the type

$$F(X, \nabla\kappa) = 0 \quad \text{in } Q_T,$$

where $F : Q_T \times \mathbb{R}^2 \mapsto \mathbb{R}$ defined by :

$$F(X, p) = p_1p_2 - \rho_x(X)\rho_{xx}(X),$$

with $X = (x, t)$ and $p = (p_1, p_2)$.

Proof of Theorem 1.3. Let $\theta = \kappa_x$. By Theorem 2.17, θ is the unique entropy solution of

$$\begin{cases} \theta_t = (\rho_x\rho_{xx}f_\epsilon(\theta))_x & \text{in } Q_T, \\ \theta(x, 0) = \theta^0(x) & \text{in } \mathbb{R}, \end{cases}$$

with

$$\theta^0(x) = \kappa_x^0(x) \geq \sqrt{(\rho_x^0)^2 + \epsilon^2}, \quad \text{a.e. in } \mathbb{R}.$$

Moreover, from Corollary 3.5, we have

$$\theta \geq \sqrt{\rho_x^2 + \epsilon^2} \quad \text{a.e. in } \bar{Q}_T,$$

from which we deduce that $f_\epsilon(\theta) = \frac{1}{\theta}$ and hence our theorem holds. \square

4 Proof of Theorem 1.6

We turn our attention now to Theorem 1.6. Let $0 < \epsilon < 1$ be a fixed constant and take

$$\kappa^{0,\epsilon}(x) = \kappa^0(x) + \epsilon x. \quad (4.47)$$

It is easy to check that the function $\kappa^{0,\epsilon}$ belongs to $Lip(\mathbb{R})$, and by condition (1.6) we get for a.e. $x \in \mathbb{R}$,

$$\begin{aligned} \kappa_x^{0,\epsilon}(x) &= \kappa_x^0(x) + \epsilon, \\ &\geq \sqrt{(\rho_x^0(x))^2 + \epsilon^2}. \end{aligned}$$

From Theorem 1.2, there exists a family of viscosity solutions $\kappa^\epsilon \in Lip(\bar{Q}_T)$ to the initial value problem (1.4) that satisfy :

$$\kappa_x^\epsilon \geq \sqrt{\rho_x^2 + \epsilon^2} \quad \text{a.e. in } \bar{Q}_T.$$

We will try to extract a subsequence of κ^ϵ that converges, in a suitable space, to the desired solution

4.1 Gradient estimates.

Uniform bounds for the space-time gradients of κ^ϵ will play an essential role in the determination of our subsequence.

I. ϵ -uniform upper-bound for κ_t^ϵ .

Starting with the time gradient, we have for a.e. $(x, t) \in Q_T$:

$$\kappa_t^\epsilon(x, t) \kappa_x^\epsilon(x, t) = \rho_x(x, t) \rho_{xx}(x, t), \quad (4.48)$$

and

$$\kappa_x^\epsilon(x, t) \geq \sqrt{\rho_x^2(x, t) + \epsilon^2} > 0 \quad \text{a.e. in } \bar{Q}_T. \quad (4.49)$$

If $\rho_x(x, t) = 0$ for some Lebesgue point (x, t) of κ_x^ϵ and κ_t^ϵ , it follows from (4.48) and (4.49) that $\kappa_t^\epsilon(x, t) = 0$. Otherwise, and since by (4.49) $\kappa_x^\epsilon \geq |\rho_x|$, we conclude that :

$$|\kappa_t^\epsilon| \leq \|\rho_{xx}^0\|_{L^\infty(\mathbb{R})} \quad \text{a.e. in } Q_T, \quad (4.50)$$

and hence we obtain an ϵ -uniform bound of κ_t^ϵ .

For the space gradient, we argue in a slightly different way. The key point for obtaining the uniform bound of κ_t^ϵ was the minoration of κ_x^ϵ by $|\rho_x|$ so, roughly speaking, if we want to follow the same previous steps using the symmetry of (4.48) in κ_t^ϵ and κ_x^ϵ , one should also have an appropriate minoration of $|\kappa_t^\epsilon|$ by a

well controlled function which no longer exists.

II. Formal calculus and best candidate.

We seek to find the best candidate to be an upper-bound of κ_x^ϵ . For this reason, we regard formally what is happening at the maximum of κ_x^ϵ . Dividing both sides of (4.48) by κ_x^ϵ and differentiating with respect to the spatial variable, we get :

$$\kappa_{xt}^\epsilon = \frac{\rho_{xx}^2 + \rho_x \rho_{xxx}}{\kappa_x^\epsilon} - \frac{\kappa_{xx}^\epsilon \rho_x \rho_{xx}}{(\kappa_x^\epsilon)^2}. \quad (4.51)$$

Notice that $\kappa_{xx}^\epsilon = 0$ at the maximum of κ_x^ϵ . Multiplying equality (4.51) by κ_x^ϵ and integrating between 0 and t , we obtain :

$$\int_0^t \frac{d}{d\tau} \left(\frac{1}{2} (\kappa_x^\epsilon)^2 \right) d\tau = \int_0^t (\rho_{xx}^2 + \rho_x \rho_{xxx}) d\tau,$$

then

$$(\kappa_x^\epsilon(x, t))^2 = (\kappa_x^{0,\epsilon}(x))^2 + 2 \int_0^t (\rho_{xx}^2(x, \tau) + \rho_x(x, \tau) \rho_{xxx}(x, \tau)) d\tau,$$

and hence,

$$|\kappa_x^\epsilon| \leq \sqrt{2c_1 t + c_2},$$

where

$$c_1 = \|(\rho_{xx}^0)^2\|_{L^\infty(\mathbb{R})} + \|\rho_x^0\|_{L^\infty(\mathbb{R})} \|\rho_{xxx}^0\|_{L^\infty(\mathbb{R})},$$

and

$$c_2 = (\|\kappa_x^0\|_{L^\infty(\mathbb{R})} + 1)^2.$$

The reason of taking c_2 as above easily follows since $\kappa_x^{0,\epsilon} = \kappa_x^0 + \epsilon$, by taking ϵ small enough, namely less than 1.

III. ϵ -uniform upper-bound for κ_x^ϵ .

Define the function S by :

$$S(x, t) = \sqrt{2c_1 t + c_2}.$$

Let us show that S is an entropy super-solution of (3.37) with F given by (3.41) and $w^0(x) = S(x, 0)$. Indeed, we remark that $S \in W^{1,\infty}(Q_T)$, and we know that for every $(x, t) \in Q_T$ we have,

$$S(x, t) \geq \sqrt{c_2} = \|\kappa_x^0\|_{L^\infty(\mathbb{R})} + 1 \geq \epsilon,$$

then

$$f_\epsilon(S(x, t)) = \frac{1}{S(x, t)} \quad \forall (x, t) \in Q_T. \quad (4.52)$$

The regularity of the function S permits to inject it directly into the first equation of (3.37). Therefore, using (4.52), we have

$$\begin{aligned} S_t - \left(\frac{\rho_x \rho_{xx}}{S} \right)_x &= \frac{c_1}{\sqrt{2c_1 t + c_2}} - \frac{\rho_{xx}^2 + \rho_x \rho_{xxx}}{\sqrt{2c_1 t + c_2}}, \\ &= \frac{c_1 - (\rho_{xx}^2 + \rho_x \rho_{xxx})}{\sqrt{2c_1 t + c_2}}, \\ &\geq 0, \end{aligned}$$

which proves, by Lemma 3.3, that S is an entropy super-solution of (3.37). From the discussion of the proof of Proposition 3.2, we know that κ_x^ϵ is an entropy solution of (3.37) hence an entropy sub-solution. Since for $\epsilon < 1$ and a.e. $x \in \mathbb{R}$, we have,

$$\begin{aligned} \kappa_x^{0,\epsilon}(x) &= \kappa_x^0(x) + \epsilon, \\ &\leq \|\kappa_x^0\|_{L^\infty(\mathbb{R})} + 1, \\ &\leq \sqrt{c_2} = S(x, 0), \end{aligned}$$

then we can use the Comparison Theorem 2.16 of scalar conservation laws to obtain :

$$\kappa_x^\epsilon(x, t) \leq \sqrt{c_1 t + c_2} \leq \sqrt{c_1 T + c_2} \quad \text{a.e. in } \bar{Q}_T, \quad (4.53)$$

and hence we get an ϵ -uniform bound for κ_x^ϵ .

Remark 4.1 *We were able to obtain this ϵ -uniform upper-bound of κ_x^ϵ by using the viscosity theory techniques. In fact, we claim that $\zeta^{1,\epsilon}(x, y, t) = \kappa^\epsilon(x, t) - \kappa^\epsilon(y, t)$ and $\zeta^2(x, y, t) = (x - y)S(t)$ are two viscosity sub-/super-solutions of the following Hamilton-Jacobi equation :*

$$\frac{\partial w}{\partial t} = F(x, t, w_x) - F(y, t, -w_y) \quad \text{in } \mathcal{D} = \{(x, y, t); x > y \text{ and } t > 0\}$$

with initial data $\zeta^{1,\epsilon}(x, y, 0) = \kappa^{0,\epsilon}(x) - \kappa^{0,\epsilon}(y)$ and $\zeta^2(x, y, 0) = (x - y)S(0)$ respectively. Here F is given by (3.41). The claim is easy for ζ^2 , and we refer to [23] when κ^ϵ is a continuous viscosity solution of (3.42). We also notice that : $\zeta^{1,\epsilon}(x, y, 0) \leq \zeta^2(x, y, 0) \quad \forall (x, y, 0) \in \mathcal{D}$, and $\zeta^{1,\epsilon}(x, y, t) = \zeta^2(x, y, t) = 0$ for $x = y, t \geq 0$. Moreover, since $\zeta^{1,\epsilon}$ and ζ^2 are continuous functions, we use the comparison principle of viscosity solutions (see [3]) to obtain :

$$\kappa^\epsilon(x, t) - \kappa^\epsilon(y, t) \leq (x - y)S(t) \quad \forall (x, y, t) \in \bar{\mathcal{D}},$$

hence, the estimate (4.53) holds.

4.2 Local boundedness in $W^{1,\infty}$.

We now show that the family $(\kappa^\epsilon)_{0 < \epsilon < 1}$ is locally bounded in $W^{1,\infty}(Q_T)$. Let $K \subset\subset Q_T$ be a compactly contained subset of Q_T , and $(x, t) \in K$. Since κ^ϵ is Lipschitz continuous, we can write,

$$|\kappa^\epsilon(x, t) - \kappa^{0,\epsilon}(0)| \leq C_{lip}^\epsilon |(x, t)|,$$

where C_{lip}^ϵ is the Lipschitz constant of κ^ϵ which is independent of ϵ from the previous estimates, namely (4.50) and (4.53). Call this constant \bar{C} . From the definition of $\kappa^{0,\epsilon}(0)$ given by (4.47), it follows that,

$$\begin{aligned} |\kappa^\epsilon(x, t)| &\leq \bar{C} |(x, t)| + |\kappa^0(0)|, \\ &\leq \bar{C} \max_{(y,\tau) \in K} |(y, \tau)| + |\kappa^0(0)|, \end{aligned}$$

which is finite since K is bounded and hence, $(\kappa^\epsilon)_{0 < \epsilon < 1}$ is uniformly bounded in $C(K)$. This, together with the uniform gradient estimates, gives the local boundedness of κ^ϵ in $W^{1,\infty}(\bar{Q}_T)$.

4.3 Proof of theorem 1.6

At this point, we have the necessary tools to give the proof of Theorem 1.6. We first recall that κ^ϵ is a viscosity solution of an equation of the type (4.48), with a Hamiltonian independent of ϵ (see Remark 3.7) and $\kappa^{0,\epsilon} \rightarrow \kappa^0$ locally uniformly in \mathbb{R} . By Ascoli's Theorem, there is a subsequence, called again κ^ϵ , that converges to $\kappa \in Lip(\bar{Q}_T)$ locally uniformly, and by the stability theorem (see [3, Theorem 2.3]), κ is a viscosity solution of the initial value problem

$$\begin{cases} \kappa_t \kappa_x = \rho_x \rho_{xx} & \text{in } Q_T, \\ \kappa(x, 0) = \kappa^0(x) & \text{in } \mathbb{R}. \end{cases} \quad (4.54)$$

To end the proof, we still have to show the inequality

$$\kappa_x \geq |\rho_x| \quad \text{a.e. in } \bar{Q}_T.$$

Again by Theorem 1.2, our κ^ϵ verifies for a.e. $(x, t) \in \bar{Q}_T$,

$$\kappa_x^\epsilon(x, t) \geq \sqrt{\rho_x^2(x, t) + \epsilon^2} \geq |\rho_x(x, t)|. \quad (4.55)$$

Passing to the limit $\epsilon \rightarrow 0$ in (4.55) in the sense of distributions, and since κ is Lipschitz continuous, we immediately get :

$$\kappa_x \geq |\rho_x| \quad \text{a.e. in } \bar{Q}_T.$$

and the required inequality follows. □

5 Problem with boundary conditions

In this part of the paper, we deal with the same problem structure but with boundary conditions of the Dirichlet type. This sort of boundary conditions arises naturally in a special model of dislocation dynamics and will be explained in the following subsection. Our notations are kept untouched; the terms θ^+ , θ^- , ρ and κ still have the same physical meaning, while the domain is changed into the open and bounded interval

$$I := (0, 1),$$

of the real line. Although this problem seems to be an independent one, we will try to benefit the results of the previous sections by considering a trick of extension and restriction, in order to apply some of the previous results of the whole space problem.

5.1 Brief physical motivation

To illustrate some physical motivations of the boundary value problem, we consider a constrained channel deforming in simple shear (see [46]). A channel of width 1 in the x -direction and infinite extension in the y -direction is bounded by walls that are impenetrable for dislocations (see Figure 3.1). The motion of the positive and negative dislocations corresponds to the x -direction. This is a

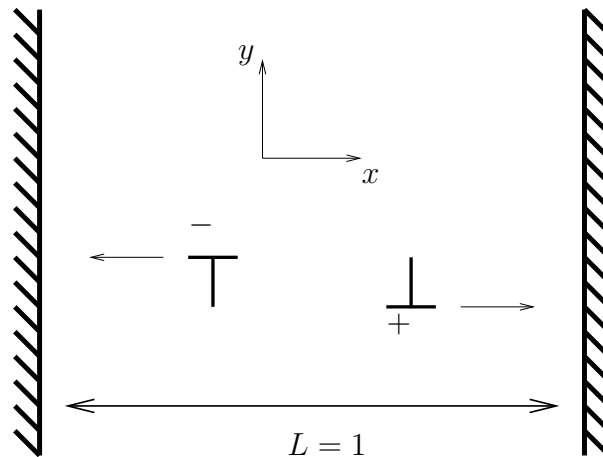

FIG. 3.1 – Geometry of a constrained channel

simplified version of a system studied by Van der Giessen and coworkers [18], where the simplifications stem from the fact that :

5. Problem with boundary conditions

- only a single slip system is assumed to be active, such that reactions between dislocations of different type need not be considered ;
- the boundary conditions reduce to "no flux" conditions for the dislocation fluxes at the boundary walls.

The mathematical formulation of this model, as expressed in [46], is the system (1.2) posed on $I \times (0, T)$:

$$\begin{cases} \partial_t \theta^+(x, t) - \partial_x \left(\theta^+(x, t) \left(\frac{\theta_x^+(x, t) - \theta_x^-(x, t)}{\theta^+(x, t) + \theta^-(x, t)} \right) \right) = 0, \\ \partial_t \theta^-(x, t) + \partial_x \left(\theta^-(x, t) \left(\frac{\theta_x^+(x, t) - \theta_x^-(x, t)}{\theta^+(x, t) + \theta^-(x, t)} \right) \right) = 0. \end{cases} \quad (5.56)$$

To formulate heuristically the boundary conditions at the walls located at $x = 0$ and $x = 1$, we note that the dislocation fluxes at the walls must be zero, which requires that

$$\overbrace{\partial_x(\theta^+ - \theta^-)}^{\Phi} = 0, \quad \text{at} \quad x \in \{0, 1\}. \quad (5.57)$$

Rewriting system (5.56) in a special integrated form in terms of ρ , κ and Φ , we get

$$\begin{cases} \kappa_t = (\rho_x / \kappa_x) \Phi, \\ \rho_t = \Phi. \end{cases} \quad (5.58)$$

Using (5.57) into the system (5.58), we can formally deduce that ρ and κ are constants along the boundary walls. Therefore, the remaining of this paper focuses attention on the study of the following coupled Dirichlet boundary problems :

$$\begin{cases} \rho_t = \rho_{xx}, & \text{in } I \times (0, \infty), \\ \rho(x, 0) = \rho^0(x), & \text{in } I, \\ \rho(0, t) = \rho(1, t) = 0, & \forall t \in [0, \infty), \end{cases} \quad (5.59)$$

and

$$\begin{cases} \kappa_t \kappa_x = \rho_t \rho_x, & \text{in } I \times (0, T), \\ \kappa(x, 0) = \kappa^0(x), & \text{in } I, \\ \kappa(0, t) = \kappa(0, 0) \quad \text{and} \quad \kappa(1, t) = \kappa(1, 0), & \forall t \in [0, T]. \end{cases} \quad (5.60)$$

Denote I_T by :

$$I_T = I \times (0, T).$$

There are two natural assumptions concerning ρ^0 and κ^0 , the first one is again the positivity of the dislocation densities θ^+ and θ^- at the initial time, which yields to the following condition :

$$\kappa_x^0 \geq |\rho_x^0|, \quad (5.61)$$

and the second one has to do with the balance of the physical model that starts with the same number of positive and negative dislocations. In other words, if n^+ and n^- are the total number of positive and negative dislocations respectively at $t = 0$ then :

$$\begin{aligned} \rho^0(1) - \rho^0(0) &= \int_0^1 \rho_x^0(x) dx, \\ &= \int_0^1 (\theta^+(x, 0) - \theta^-(x, 0)) dx, \\ &= n^+ - n^- = 0, \end{aligned}$$

this shows that $\rho^0(1) = \rho^0(0)$ and this is what appears in (5.59). Up to now, formal relations between the initial conditions are only expressed. Whereas, required regularity, together with the announcement of the main results will be stated in the next subsection.

5.2 Statement of the main results on a bounded interval

From now on, the reader should not be confused with the term ρ that will always be the unique solution of the classical heat equation (5.59). The two main theorems that we are going to prove are :

Theorem 5.1 (*Existence and uniqueness of a viscosity solution*)

Let $T > 0$ and $\epsilon > 0$ be two constants. Take

$$\kappa^0 \in Lip(I) \quad (5.62)$$

and $\rho^0 \in C_0^\infty(I)$ satisfying :

$$\kappa_x^0 \geq G(\rho_x^0) \quad a.e. \text{ in } I,$$

where

$$G(x) = \sqrt{x^2 + \epsilon^2},$$

then there exists a viscosity solution $\kappa \in Lip(\bar{I}_T)$ of (5.60), unique among those satisfying :

$$\kappa_x \geq G(\rho_x) \quad a.e. \text{ in } \bar{I}_T. \quad (5.63)$$

Theorem 5.2 (*Existence of a viscosity solution*)

Let $T > 0$ and $\kappa^0 \in Lip(I)$. Under the condition (5.61) satisfied a.e. in I , there exists a viscosity solution $\kappa \in Lip(\bar{I}_T)$ of (5.60) satisfying :

$$\kappa_x \geq |\rho_x|, \quad \text{a.e. in } \bar{I}_T.$$

5.3 Preliminary results

Before proceeding with the proof of our theorems, we have to introduce some essential tools that are the core of the "extension and restriction" method that we are going to use. We start by extending the function κ^0 given by (5.62) to $\hat{\kappa}^0 \in Lip(\mathbb{R})$ in the following way :

$$\hat{\kappa}^0(x) = \begin{cases} \kappa^0(x) & \text{if } x \in [0, 1], \\ (\|\rho_x^0\|_{L^\infty(I)} + \epsilon)(x - 1) + \kappa^0(1) & \text{if } x \geq 1, \\ (\|\rho_x^0\|_{L^\infty(I)} + \epsilon)x + \kappa^0(0) & \text{if } x \leq 0. \end{cases} \quad (5.64)$$

Extension of ρ over $\mathbb{R} \times [0, T]$.

Consider the function $\hat{\rho}$ defined on $[0, 2] \times [0, T]$ by

$$\hat{\rho}(x, t) = \begin{cases} \rho(x, t) & \text{if } (x, t) \in \bar{I}_T, \\ -\rho(2 - x, t) & \text{otherwise,} \end{cases} \quad (5.65)$$

this is just a C^1 antisymmetry of ρ with respect to the line $x = 1$. The continuation of $\hat{\rho}$ to $\mathbb{R} \times [0, T]$ is made by spatial periodicity of period 2. A simple computation yields, for $(x, t) \in (1, 2) \times (0, T)$:

$$\hat{\rho}_t(x, t) = -\rho_t(2 - x, t) \quad \text{and} \quad \hat{\rho}_{xx}(x, t) = -\rho_{xx}(2 - x, t),$$

and hence it is easy to verify that $\hat{\rho}|_{[1,2] \times [0,T]}$ solves (5.59) with I replaced with the interval $(1, 2)$ and ρ^0 replaced with its symmetry with respect to the point $x = 1$; the boundary conditions are unchanged and the regularity of the initial condition is conserved. To be more precise, we write down some useful properties of $\hat{\rho}$.

Regularity properties of $\hat{\rho}$.

Let r and s are two positive integers such that $s \leq 2$. From the construction of $\hat{\rho}$ and the above discussion, we get the following :

$$\begin{aligned} \text{i) } & \hat{\rho}_t \text{ and } \hat{\rho}_x \text{ are in } C(\mathbb{R} \times [0, T]), \\ \text{ii) } & \hat{\rho} = 0 \text{ on } \mathbb{Z} \times [0, T], \\ \text{iii) } & \hat{\rho}_t = \hat{\rho}_{xx} \text{ on } (\mathbb{R} \setminus \mathbb{Z}) \times (0, T), \\ \text{iv) } & \|\partial_t^r \partial_x^s \hat{\rho}(\cdot, t)\|_{L^\infty(\mathbb{R})} \leq C, \quad \forall t \in [0, T], \end{aligned} \quad (5.66)$$

where C is a certain constant and the limitation $s \leq 2$ comes from the spatial antisymmetry. These conditions are valid thanks to the way of construction of the function $\hat{\rho}$ and to the maximum principle of the solution of the heat equation on bounded domains (see [7, 34]).

Let

$$\hat{g}(x, t) = -\hat{\rho}_t(x, t)\hat{\rho}_x(x, t). \quad (5.67)$$

From the above discussion, it is worth noticing that this function is a Lipschitz continuous function in the x -variable. Consider the initial value problem defined by :

$$\begin{cases} u_t + \hat{g}f_\varepsilon(u_x) = 0 & \text{in } Q_T, \\ u(x, 0) = \hat{\kappa}^0(x) & \text{in } \mathbb{R}. \end{cases} \quad (5.68)$$

This is a Hamilton-Jacobi equation with a Hamiltonian $F \in C(\bar{Q}_T \times \mathbb{R})$ defined by :

$$F(x, t, u) = \hat{g}(x, t)f_\varepsilon(u).$$

From the regularity of $\hat{\rho}$ and f_ε , we can directly see that **(V0)**-**(V1)**-**(V2)** are all satisfied. Moreover, since $\hat{\kappa}^0$ is a Lipschitz continuous function, we get the following proposition as a direct consequence of Theorems 2.6, 2.7 and Proposition 2.10.

Proposition 5.3 *There exists a unique viscosity solution $\hat{\kappa} \in Lip(\bar{Q}_T)$ of (5.68).*

The following three lemmas will be used in the proof of Theorem 5.1.

Lemma 5.4 (Entropy sub-solution)

The function $G(\hat{\rho}_x)$ is an entropy sub-solution of

$$\begin{cases} w_t + (\hat{g}f_\varepsilon(w))_x = 0, & \text{in } Q_T, \\ w(x, 0) = w^0(x) & \text{in } \mathbb{R}, \end{cases} \quad (5.69)$$

where f_ε is given by (3.32), and $w^0(x) = G(\hat{\rho}_x(x, 0))$.

Proof. Similar to Lemma 3.4. □

Lemma 5.5 (Differentiability property)

Let $u(x, t)$ be a differentiable function with respect to (x, t) a.e. in Q_T . Define the set M by :

$$M = \{x \in \mathbb{R}; u \text{ is differentiable a.e. in } \{x\} \times (0, T)\},$$

then M is dense in \mathbb{R} .

Proof. Define \mathcal{L}^n , $n \in \mathbb{N}$ to be the Lebesgue n -dimensional measure. Let $N \subset Q_T$ be the set defined by :

$$N = \{(x, t) \in Q_T; u \text{ is not differentiable on } (x, t)\},$$

and let \mathbb{I}_N be the characteristic function of the set N . Since $\mathcal{L}^2(N) = 0$, we can write,

$$\int_{Q_T} \mathbb{I}_N(x, t) dx dt = 0.$$

Using Fubini's theorem we get

$$\int_{\mathbb{R}} g(x) dx = 0, \quad \text{with } g(x) = \left(\int_0^T \mathbb{I}_N(x, t) dt \right) \geq 0,$$

then

$$g = 0 \quad \text{a.e. in } \mathbb{R}$$

and consequently

$$J = \{x; g(x) \neq 0\} \quad \text{verifies } \mathcal{L}^1(J) = 0.$$

In other words,

$$\forall x \in \mathbb{R} \setminus J, \quad u(x, \cdot) \text{ is differentiable with respect to } t \text{ a.e. in } (0, T),$$

hence $\mathbb{R} \setminus J \subset M$ which implies our lemma. □

In the next lemma, we show a lower-bound estimate for the gradient of $\hat{\kappa}$ analogue to (5.63). This was previously done for κ_x in the case where g is a twice continuously differentiable function using mainly Theorems 2.17 and 2.16. Here, the way of extending the function ρ over \bar{Q}_T makes \hat{g} loose some of the regularity stated in Theorem 2.17. However, the following lemma shows that a similar result holds in the case $\hat{g} \in W^{1,\infty}(\bar{Q}_T)$.

Lemma 5.6 (Existence of an entropy solution)

The function $\hat{\kappa}_x \in L^\infty(Q_T)$ ($\hat{\kappa}$ is given by Proposition 5.3) is an entropy solution of (5.69) with initial data $w^0 = \hat{\kappa}_x^0 \in L^\infty(\mathbb{R})$.

Proof of Lemma 5.6. Let \tilde{g} be an extension of the function \hat{g} on \mathbb{R}^2 defined by :

$$\tilde{g}(x, t) = \begin{cases} \hat{g}(x, t) & \text{if } (x, t) \in \bar{Q}_T, \\ \hat{g}(x, T) & \text{if } t > T, \\ \hat{g}(x, 0) & \text{if } t < 0. \end{cases} \quad (5.70)$$

Consider a sequence of mollifiers ξ^n in \mathbb{R}^2 and let $\tilde{g}^n = \tilde{g} * \xi^n$. Remark that, from the standard properties of the mollifier sequence, we have $\tilde{g}^n \in C^\infty(\mathbb{R}^2)$ and :

$$\tilde{g}^n \rightarrow \hat{g} \text{ uniformly on compacts in } \bar{Q}_T, \quad (5.71)$$

and

$$\tilde{g}_x^n \rightarrow \hat{g}_x \text{ in } L^p_{loc}(Q_T), \quad 1 \leq p < \infty, \quad (5.72)$$

together with the following estimates :

$$\|\partial_t^r \partial_x^s \tilde{g}^n\|_{L^\infty(\bar{Q}_T)} \leq \|\partial_t^r \partial_x^s \hat{g}\|_{L^\infty(\bar{Q}_T)} \text{ for } r, s \in \mathbb{N}, r + s \leq 1. \quad (5.73)$$

Now, take again the Hamilton-Jacobi equation (5.68) with \hat{g} replaced with \tilde{g}^n :

$$\begin{cases} u_t + \tilde{g}^n f_\epsilon(u_x) = 0 & \text{in } \mathbb{R} \times (0, T), \\ u(x, 0) = \hat{\kappa}^0(x) & \text{in } \mathbb{R}, \end{cases} \quad (5.74)$$

and notice that the above properties of the function \tilde{g}^n enters us into the framework of Theorem 2.17. Thus, we have a unique viscosity solution $\tilde{\kappa}^n \in Lip(\bar{Q}_T)$ of (5.74) with initial condition $\hat{\kappa}^0$ whose spatial derivative $\tilde{\kappa}_x^n \in L^\infty(Q_T)$ is an entropy solution of the corresponding derived equation with initial data $\hat{\kappa}_x^0$. From Remark 2.11 and (5.73), we deduce that the sequence $(\tilde{\kappa}^n)_{n \geq 1}$ is locally uniformly bounded in $W^{1,\infty}(\bar{Q}_T)$ and that :

$$\|\tilde{\kappa}_x^n\|_{L^\infty(Q_T)} \leq \|\hat{\kappa}_x^0\|_{L^\infty(\mathbb{R})} + T \|\hat{g}_x\|_{L^\infty(Q_T)} \|f_\epsilon\|_{L^\infty(\mathbb{R})}. \quad (5.75)$$

Moreover, from (5.71), we use again the Stability Theorem of viscosity solutions [3, Theorem 2.3], and we obtain :

$$\tilde{\kappa}^n \rightarrow \hat{\kappa} \text{ locally uniformly in } \bar{Q}_T. \quad (5.76)$$

Back to the entropy solution, we write down the entropy inequality (see Definition 2.12) satisfied by $\tilde{\kappa}_x^n$:

$$\int_{Q_T} \left(\eta(\tilde{\kappa}_x^n) \phi_t + \Phi(\tilde{\kappa}_x^n) \tilde{g}^n \phi_x + h(\tilde{\kappa}_x^n) \tilde{g}_x^n \phi \right) dx dt + \int_{\mathbb{R}} \eta(\hat{\kappa}_x^0) \phi(x, 0) dx \geq 0, \quad (5.77)$$

where η, Φ, h and ϕ are given by Definition 2.12. Taking (5.75) into consideration, we use a property of bounded sequences in $L^\infty(Q_T)$ (see [35, Proposition 3]) that guarantees the existence of a subsequence (call it again $\tilde{\kappa}_x^n$) so that, for any function $\psi \in C(\mathbb{R}; \mathbb{R})$,

$$\psi(\tilde{\kappa}_x^n) \rightarrow U_\psi \text{ weak-}\star \text{ in } L^\infty(Q_T). \quad (5.78)$$

Furthermore, there exists $\mu \in L^\infty(Q_T \times (0, 1))$ such that :

$$\int_0^1 \psi(\mu(x, t, \alpha)) d\alpha = U_\psi(x, t), \quad \text{for a.e. } (x, t) \in Q_T. \quad (5.79)$$

Applying (5.78) with ψ replaced with η , Φ and h respectively, and using (5.79), we get :

$$\begin{cases} \eta(\tilde{\kappa}_x^n(\cdot)) \rightarrow \int_0^1 \eta(\mu(\cdot, \alpha)) d\alpha & \text{weak-}\star & \text{in } L^\infty(Q_T), \\ \Phi(\tilde{\kappa}_x^n(\cdot)) \rightarrow \int_0^1 \Phi(\mu(\cdot, \alpha)) d\alpha & \text{weak-}\star & \text{in } L^\infty(Q_T), \\ h(\tilde{\kappa}_x^n(\cdot)) \rightarrow \int_0^1 h(\mu(\cdot, \alpha)) d\alpha & \text{weak-}\star & \text{in } L^\infty(Q_T). \end{cases} \quad (5.80)$$

This, together with (5.71), (5.72) permits to pass to the limit in (5.77) in the distributional sense, hence we get :

$$\begin{aligned} \int_{Q_T} \int_0^1 \left(\eta(\mu(\cdot, \alpha)) \phi_t + \Phi(\mu(\cdot, \alpha)) \hat{g} \phi_x + h(\mu(\cdot, \alpha)) \hat{g}_x \phi \right) dx dt d\alpha + \\ \int_{\mathbb{R}} \eta(\hat{\kappa}_x^0) \phi(x, 0) dx \geq 0. \end{aligned} \quad (5.81)$$

In [35, Theorem 3], the function μ satisfying (5.81) is called an entropy process solution. It has been proved to be unique and independent of α . Although this result in [35] was for a divergence-free function $\hat{g} \in C^1(\bar{Q}_T)$, we remark that it can be adapted to the case of any function $\hat{g} \in W^{1, \infty}(\bar{Q}_T)$ (see for instance Remark 6.2 and the proof of [35, Theorem 3]). Using this, we infer the existence of a function $z \in L^\infty(Q_T)$ such that :

$$z(x, t) = \mu(x, t, \alpha), \quad \text{for a.e. } (x, t, \alpha) \in Q_T \times (0, 1), \quad (5.82)$$

hence, z is an entropy solution of (5.69). We now make use of (5.82) and we apply equality (5.79) for $\psi(x) = x$ to obtain,

$$z = \text{weak-}\star \lim_{n \rightarrow \infty} \tilde{\kappa}_x^n \quad \text{in } L^\infty(Q_T). \quad (5.83)$$

From (5.83) and (5.76) we deduce that,

$$z(x, t) = \hat{\kappa}_x(x, t) \quad \text{a.e. in } Q_T,$$

which completes the proof of Lemma 5.6. □

5.4 Proofs of Theorems 5.1, 5.2

Proof of Theorem 5.1.

We claim that $\kappa = \hat{\kappa}|_{\bar{I}_T}$ is the required solution.

Boundary conditions. In order to recover the boundary conditions given by (5.60) on $\partial I \times [0, T]$, we proceed as follows. Let M be the set defined by Lemma 5.5 and let $x \in M$. For every $t \in [0, T]$, we write :

$$\begin{aligned} |\hat{\kappa}(x, t) - \hat{\kappa}(x, 0)| &\leq \int_0^t |\hat{\kappa}_s(x, s)| ds \leq \int_0^t |F(x, s, \hat{\kappa}_x(x, s))| ds \\ &\leq \int_0^t (|F(0, s, \hat{\kappa}_x(x, s))| + C|x|) ds. \end{aligned}$$

In these inequalities we have used the fact that $\hat{\kappa}$ is a Lipschitz continuous viscosity solution of (5.68) and hence it verifies the equation in Q_T at the points where it is differentiable (see for instance [3]). Also, we have used the condition **(F1)** with $p = q$ and $C_R = C$, a constant independent of R . Now from (5.66)-(ii), we deduce that :

$$|F(0, s, \hat{\kappa}_x(x, s))| = |\hat{\rho}_x(0, s)\hat{\rho}_t(0, s)f_\epsilon(\hat{\kappa}_x(x, s))| = 0, \quad \text{for a.e. } s \in (0, t),$$

and hence we get

$$|\hat{\kappa}(x, t) - \hat{\kappa}(x, 0)| \leq C|x|t. \quad (5.84)$$

Since M is a dense subset of \mathbb{R} , we pass to the limit in (5.84) as $x \rightarrow 0$ and the equality

$$\hat{\kappa}(0, t) = \hat{\kappa}(0, 0) = \kappa^0(0) \quad \forall t \in [0, T]$$

holds. Similarly, we can verify that $\hat{\kappa}(1, t) = \hat{\kappa}(1, 0) = \kappa^0(1)$ for all $t \in [0, T]$.

Inequality (5.63) and existence of a solution. The extension $\hat{\kappa}^0$ of κ^0 outside the interval I is a linear extension of slope $\|\rho_x^0\|_{L^\infty(I)} + \epsilon$, therefore we have,

$$\hat{\kappa}_x^0(\cdot) \geq \sqrt{(\hat{\rho}_x^0(\cdot))^2 + \epsilon^2} = G(\hat{\rho}_x^0(\cdot)), \quad \text{a.e. in } \mathbb{R}. \quad (5.85)$$

From Lemma 5.6, we know that $\hat{\kappa}_x$ is an entropy solution of equation (5.69) and from Lemma 5.4, we know that $G(\hat{\rho}_x)$ is an entropy sub-solution of (5.69). Since (5.85) holds, we use the Comparison Theorem 2.16 to get,

$$\hat{\kappa}_x(x, t) \geq \sqrt{\hat{\rho}_x^2(x, t) + \epsilon^2} \geq \epsilon > 0, \quad \text{for a.e. } (x, t) \in \bar{Q}_T. \quad (5.86)$$

and hence

$$\kappa_x \geq G(\rho_x) \quad \text{a.e. in } \bar{I}_T.$$

Take κ to be the restriction of $\hat{\kappa}$ on \bar{I}_T where $\hat{\kappa}^0$ and $\hat{\rho}$ have their automatic replacements κ^0 and ρ respectively on this subdomain. It is clear that $\kappa \in Lip(\bar{I}_T)$ is a viscosity solution of :

$$\begin{cases} \kappa_t + gf_\epsilon(\kappa_x) = 0 & \text{in } I_T, \\ \kappa(x, 0) = \kappa^0(x) & \text{in } I, \\ \kappa(0, t) = \kappa^0(0) \quad \text{and} \quad \kappa(1, t) = \kappa^0(1) & \forall 0 \leq t \leq T, \end{cases} \quad (5.87)$$

where $g(x, t) = -\rho_t(x, t)\rho_x(x, t)$ and $\kappa_x(x, t) \geq G(\rho_x(x, t))$ for a.e. $(x, t) \in \bar{I}_T$. We also notice that κ is a viscosity solution of (5.60), for it suffices to follow the same steps of the passage from the viscosity solution of (3.42) to the viscosity solution of (1.4) (see the proof of Theorem 1.2 for details).

Uniqueness among solutions satisfying (5.63). Since the function

$$\bar{H}(x, t, u) = g(x, t)f_\epsilon(u) \in C(\bar{I}_T \times \mathbb{R})$$

satisfies for a fixed t :

$$|\bar{H}(x, t, u) - \bar{H}(y, t, u)| \leq C(|x - y|(1 + |u|)),$$

for every $x, y \in (0, 1)$ and $u \in \mathbb{R}$, we use [3, Theorem 2.8] to show that κ is the unique viscosity solution of (5.87). We claim that κ is the unique viscosity solution of (5.60). Indeed, we can also follow the same mechanism as in the proof of Theorem 1.2. \square

We now move towards the proof of Theorem 5.2 that has the same flavor of what was done in section 4. We just need to care about the change in the structure of our problem and the boundary conditions. Our first step will be the following lemma.

Lemma 5.7 *Let c_1 and c_2 be two positive constants defined respectively by :*

$$c_1 = \|(\rho_{xx}^0)^2\|_{L^\infty(I)} + \|\rho_x^0\|_{L^\infty(I)}\|\rho_{xxx}^0\|_{L^\infty(I)},$$

and

$$c_2 = (\|\kappa_x^0\|_{L^\infty(I)} + 1)^2.$$

Then the function \bar{S} defined on Q_T by :

$$\bar{S}(x, t) = \sqrt{2c_1t + c_2}$$

is an entropy super-solution of (5.69) with

$$w^0(x) = \bar{S}(x, 0) = \|\kappa_x^0\|_{L^\infty(I)} + 1.$$

Proof. See subsection 4.1-III, together with the regularity properties of the function $\hat{\rho}$ given in subsection 5.3. \square

Proof of Theorem 5.2. Let $\epsilon > 0$ be a fixed constant. Define $\hat{\kappa}^{0,\epsilon} \in Lip(\mathbb{R})$ by :

$$\hat{\kappa}^{0,\epsilon}(x) = \begin{cases} \kappa^0(x) + \epsilon x & \text{if } x \in [0, 1], \\ (\|\kappa_x^0\|_{L^\infty(I)} + \epsilon)(x - 1) + (\kappa^0(1) + \epsilon) & \text{if } x \geq 1, \\ (\|\kappa_x^0\|_{L^\infty(I)} + \epsilon)x + \kappa^0(0) & \text{if } x \leq 0. \end{cases} \quad (5.88)$$

Since $\kappa_x^0 \geq |\rho_x^0|$ a.e. in I , it is clear that for a.e. $x \in \mathbb{R}$ we have

$$\hat{\kappa}_x^{0,\epsilon} \geq G(\hat{\rho}_x^0),$$

and hence, from the discussion of the proof of Theorem 5.1, there exists a unique viscosity solution $\hat{\kappa}^\epsilon \in Lip(\bar{Q}_T)$ of

$$\begin{cases} \hat{\kappa}_t^\epsilon \hat{\kappa}_x^\epsilon = \hat{\rho}_t \hat{\rho}_x & \text{in } Q_T, \\ \hat{\kappa}^\epsilon(x, 0) = \hat{\kappa}^{0,\epsilon}(x) \in Lip(\mathbb{R}) & \text{in } \mathbb{R}, \end{cases} \quad (5.89)$$

unique among those satisfying :

$$\hat{\kappa}_x^\epsilon \geq G(\hat{\rho}_x) \quad \text{a.e. in } \bar{Q}_T. \quad (5.90)$$

Assume without loss of generality that $\epsilon < 1$. The ϵ -uniform bound for $\hat{\kappa}_t^\epsilon$ is trivial, it suffices to use directly the equation satisfied by $\hat{\kappa}^\epsilon$ together with (5.90). And the ϵ -uniform bound for $\hat{\kappa}_x^\epsilon$ follows from Lemma 5.7 and Theorem 2.16 since

$$\hat{\kappa}_x^\epsilon(x, 0) \leq \|\kappa_x^0\|_{L^\infty(I)} + \epsilon \leq \|\kappa_x^0\|_{L^\infty(I)} + 1 = \sqrt{c_2} = \bar{S}(x, 0).$$

Following exactly the same technic of section 4, namely the proof of Theorem 1.6, we get that the sequence $\hat{\kappa}^\epsilon$ converges locally uniformly to $\hat{\kappa}$ in \bar{Q}_T with $\hat{\kappa} \in Lip(\bar{Q}_T)$ satisfies,

$$\hat{\kappa}_x \geq |\hat{\rho}_x| \quad \text{a.e. in } \bar{Q}_T \quad (5.91)$$

and

$$\hat{\kappa}(x, 0) = \hat{\kappa}_0(x) \quad \text{in } \mathbb{R}, \quad (5.92)$$

where $\hat{\kappa}_0$ is the uniform limit of the sequence $\hat{\kappa}^{0,\epsilon}$ in \mathbb{R} . Theorem 5.1 guarantees that

$$\hat{\kappa}^\epsilon(0, t) = \hat{\kappa}^{0,\epsilon}(0) = \kappa^0(0), \quad (5.93)$$

and

$$\hat{\kappa}^\epsilon(1, t) = \hat{\kappa}^{0,\epsilon}(1) = \kappa^0(1) + \epsilon, \quad (5.94)$$

for all $t \in [0, T]$. From (5.93), (5.94) and the pointwise convergence, up to a subsequence, of $\hat{\kappa}^\epsilon$ to $\hat{\kappa}$, we deduce that

$$\hat{\kappa}(0, t) = \lim_{\epsilon \rightarrow 0} \hat{\kappa}^\epsilon(0, t) = \kappa^0(0), \quad \forall t \in [0, T], \quad (5.95)$$

and

$$\hat{\kappa}(1, t) = \lim_{\epsilon \rightarrow 0} \hat{\kappa}^\epsilon(1, t) = \lim_{\epsilon \rightarrow 0} (\kappa^0(1) + \epsilon) = \kappa^0(1) \quad \forall t \in [0, T]. \quad (5.96)$$

Take κ to be the restriction of $\hat{\kappa}$ over \bar{I}_T ; $\hat{\rho}$ and $\hat{\kappa}_0$ have their automatic replacements ρ and κ^0 respectively on this restricted domain. From (5.91), (5.92), (5.95) and (5.96), we deduce that κ is the required solution. \square

6 Appendix : Proof of Theorem 2.16

We will work on the entropy inequality (2.27) satisfied by u and its analogue satisfied by v , using the dedoubling variable technique of Kruřkov (see [63]) and following the same steps of [35, Theorem 3], taking into consideration the new modifications arising from the fact that we are dealing with sub-/super-entropy solutions and the fact that $g \in W^{1,\infty}(\bar{Q}_T)$ is not a gradient-free function.

The proof can be divided into three steps. Denote B_r by $B_r = \{x \in \mathbb{R}; |x| \leq r\}$ for any $r > 0$, $F^\pm(u, v) = \text{sgn}^\pm(u - v)(f(u) - f(v))$,

$$y^\infty = \|y\|_{L^\infty(Q_T)} \quad \text{for every } y \in L^\infty(Q_T) \quad (6.97)$$

and

$$M_f = \max_{|x| \leq \max(u^\infty, v^\infty)} |f'(x)|. \quad (6.98)$$

In step 1, we prove that the initial conditions u^0, v^0 satisfy for any $a > 0$:

$$\lim_{\tau \rightarrow 0} \frac{1}{\tau} \int_0^\tau \int_{B_a} (u(x, t) - u^0(x))^+ dx dt = 0, \quad (6.99)$$

$$\lim_{\tau \rightarrow 0} \frac{1}{\tau} \int_0^\tau \int_{B_a} (v(x, t) - v^0(x))^- dx dt = 0, \quad (6.100)$$

respectively.

In step 2, The following relation between u and v is shown :

$$\int_{Q_T} [(u(x, t) - v(x, t))^+ \psi_t + F^+(u(x, t), v(x, t))g(x, t)\psi_x] dx dt \geq 0, \quad (6.101)$$

for every $\psi \in C_0^1(\mathbb{R} \times (0, T); \mathbb{R}_+)$.

After that, we define $A(t)$ for $0 < t < \min(T, \frac{a}{\omega})$ and $\omega = g^\infty M_f$, by :

$$A(t) = \int_{B_{a-\omega t}} (u(x, t) - v(x, t))^+ dx. \quad (6.102)$$

In step 3, we show that A is non-increasing a.e. in $(0, \min(T, \frac{a}{\omega}))$ and we deduce that

$$u(x, t) \leq v(x, t) \quad \text{a.e. in } Q_T.$$

Step 1 : Proof of (6.99), (6.100).

Let ξ^n be a sequence of mollifiers in \mathbb{R} with $\xi^1 = \xi$. Recall that the function $\xi \in C_0^\infty(\mathbb{R})$ satisfies the following properties :

$$\begin{aligned} \text{supp}(\xi) &= \{x \in \mathbb{R}, \xi(x) \neq 0\} \subset B_1; \\ \xi &\geq 0, \quad \xi(-x) = \xi(x); \\ \int_{B_1} \xi(x) dx &= 1; \\ \xi^n(x) &= n\xi(nx). \end{aligned} \quad (6.103)$$

Let $\tau \in \mathbb{R}$ such that $0 < \tau < T$ and define the function γ by :

$$\gamma(t) = \begin{cases} \frac{\tau - t}{\tau} & \text{if } 0 \leq t \leq \tau, \\ 0 & \text{if } t > \tau. \end{cases} \quad (6.104)$$

Take $a > 0$ and a test function $\psi \in C_0^\infty(\mathbb{R}; \mathbb{R}_+)$ such that,

$$\psi(x) = 1 \quad \text{for } x \in B_a.$$

Let $y \in \mathbb{R}$ be a Lebesgue point of u^0 and we make use of inequality (2.27) with $k = u^0(y)$ and the test function $\phi(x, t) = \psi(x)\gamma(t)\xi^n(x - y)$. Integrating the resulting inequality with respect to y over \mathbb{R} yields :

$$\mathbb{T}_1(n, \tau) + \mathbb{T}_2(n, \tau) + \mathbb{T}_3(n, \tau) + \mathbb{T}_4(n) \geq 0, \quad (6.105)$$

with

$$\mathbb{T}_1(n, \tau) = -\frac{1}{\tau} \int_0^\tau \int_{\mathbb{R}^2} (u(x, t) - u^0(y))^+ \psi(x) \xi^n(x - y) dx dy dt, \quad (6.106)$$

$$\mathbb{T}_2(n, \tau) = \int_0^\tau \int_{\mathbb{R}^2} F^+(u(x, t), u^0(y)) g(x, t) \gamma(t) (\psi(x) \xi^n(x - y))_x dx dy dt, \quad (6.107)$$

$$\mathbb{T}_3(n, \tau) = - \int_0^\tau \int_{\mathbb{R}^2} \operatorname{sgn}^+(u(x, t) - u^0(y)) f(u^0(y)) g_x(x, t) \gamma(t) \psi(x) \xi^n(x - y) dx dy dt \quad (6.108)$$

and

$$\mathbb{T}_4(n) = \int_{\mathbb{R}^2} (u^0(x) - u^0(y))^+ \psi(x) \xi^n(x - y) dx dy. \quad (6.109)$$

Using the change of variables : $x = x'$, $y = x' - \frac{y'}{n}$ in (6.106), and denoting again by (x, y) the new variables (x', y') yields :

$$\mathbb{T}_1(n, \tau) = - \frac{1}{\tau} \int_0^\tau \int_{B_1} \int_{\mathbb{R}} \left(u(x, t) - u^0 \left(x - \frac{y}{n} \right) \right)^+ \psi(x) \xi(y) dx dy dt, \quad (6.110)$$

Using that,

$$(u - v)^+ - (u - w)^+ \leq (w - v)^+ \quad \forall u, v, w \in \mathbb{R}, \quad (6.111)$$

we infer that :

$$\begin{aligned} \mathbb{T}_1(n, \tau) + \overbrace{\frac{1}{\tau} \int_0^\tau \int_{\mathbb{R}} (u(x, t) - u^0(x))^+ \psi(x) dx dt}^{\mathbb{T}^*(\tau)} \leq \\ \psi^\infty \int_{K_\psi} \int_{B_1} \left| u^0 \left(x - \frac{y}{n} \right) - u^0(x) \right| \xi(y) dy dx, \end{aligned} \quad (6.112)$$

where K_ψ is the support of ψ . Same upper-bound, independent of τ , could be obtained for $\mathbb{T}_4(n)$. Furthermore, since $u^0 \in L^\infty(\mathbb{R})$, and is thus integrable over K_ψ , we use the Lebesgue differentiation Theorem to show that the right side of (6.112) tends to 0 when n becomes large. Now, let $\epsilon > 0$, $\exists n_0$ such that

$$\mathbb{T}_1(n_0, \tau) + \mathbb{T}^*(\tau) < \frac{\epsilon}{4} \quad \text{and} \quad \mathbb{T}_4(n_0) < \frac{\epsilon}{4}, \quad \forall \tau > 0. \quad (6.113)$$

We also remark that the integrands of the right hand sides of (6.107) and (6.108) are bounded and hence, for this particular n_0 we can choose some τ_0 such that $\forall 0 < \tau < \tau_0$, we have :

$$|\mathbb{T}_2(n_0, \tau)| < \frac{\epsilon}{4} \quad \text{and} \quad |\mathbb{T}_3(n_0, \tau)| < \frac{\epsilon}{4}. \quad (6.114)$$

From (6.113), (6.114) and (6.105), we infer that,

$$0 < \mathbb{T}^*(\tau) < \epsilon, \quad \forall 0 < \tau < \tau_0.$$

Since $\psi(x) = 1$ over B_a , (6.99) is proven. Arguing in the same way, we can prove (6.100). The slight difference is using a similar inequality of (6.111) with $(\cdot)^+$ replaced with $(\cdot)^-$.

Step 2 : Proof of (6.101).

It suffices to prove (6.101) for any function $\psi \in C_0^\infty(Q_T; \mathbb{R}_+)$. We may also assume, without loss of generality, that there is some $c > 0$ such that $\psi(x, t) = 0$ for $t \in (0, c) \cup (T - c, T)$. For $n > \frac{1}{c}$, let ξ^n be the usual mollifier sequence in \mathbb{R} and consider the function $\phi(x, t, y, s)$ defined for $(x, t) \in Q_T$ and $(y, s) \in Q_T$ by,

$$\phi(x, t, y, s) = \psi\left(\frac{x+y}{2}, \frac{t+s}{2}\right) \xi^n(x-y) \xi^n(t-s).$$

The function ϕ hence satisfies

$$\phi(\cdot, \cdot, y, s) \in C_0^\infty(Q_T; \mathbb{R}_+) \quad \text{and} \quad \phi(x, t, \cdot, \cdot) \in C_0^\infty(Q_T; \mathbb{R}_+).$$

Fix some $(y, s) \in Q_T$ for which the function v is well defined (this is valid almost everywhere). Since u is an entropy sub-solution of (2.11), we consider the relation (2.27) satisfied by u with $k = v(y, s)$ and the test function $\phi(\cdot, \cdot, y, s)$. Upon integrating this inequality with respect to (y, s) over Q_T , we get :

$$\begin{aligned} & \int_{Q_T^2} \left\{ (u(x, t) - v(y, s))^+ \phi_t(x, t, y, s) + F^+(u(x, t), v(y, s)) g(x, t) \phi_x(x, t, y, s) \right. \\ & \left. - \text{sgn}^+(u(x, t) - v(y, s)) f(v(y, s)) g_x(x, t) \phi(x, t, y, s) \right\} dx dt dy ds \geq 0. \end{aligned} \quad (6.115)$$

Similar inequality could be obtained since v is an entropy super-solution of (2.11). We just swap $+$, u and (x, t) with $-$, v and (y, s) respectively, hence :

$$\begin{aligned} & \int_{Q_T^2} \left\{ (v(y, s) - u(x, t))^- \phi_s(x, t, y, s) + F^-(v(y, s), u(x, t)) g(y, s) \phi_y(x, t, y, s) \right. \\ & \left. - \text{sgn}^-(v(y, s) - u(x, t)) f(u(x, t)) g_x(y, s) \phi(x, t, y, s) \right\} dx dt dy ds \geq 0. \end{aligned} \quad (6.116)$$

Summing (6.115) and (6.116) and using the elementary identities :

$$x^- = (-x)^+ \quad \text{and} \quad \text{sgn}^-(x) = -\text{sgn}^+(-x), \quad \forall x \in \mathbb{R},$$

we get, for $u = u(x, t)$ and $v = v(y, s)$,

$$\mathcal{Z}_1 + \mathcal{Z}_2 + \mathcal{Z}_3 \geq 0, \quad (6.117)$$

with :

$$\mathcal{Z}_1 = \int_{Q_T^2} (u - v)^+ (\phi_t + \phi_s)(x, y, t, s) dx dt dy ds, \quad (6.118)$$

$$\mathcal{Z}_2 = \int_{Q_T^2} F^+(u, v)[g(x, t)\phi_x(x, y, t, s) + g(y, s)\phi_y(x, y, t, s)]dxdt dy ds, \quad (6.119)$$

$$\mathcal{Z}_3 = \int_{Q_T^2} \text{sgn}^+(u - v)[f(u)g_x(y, s) - f(v)g_x(x, t)]\phi(x, y, t, s)dxdt dy ds. \quad (6.120)$$

We now compute the first partial derivatives of the function ϕ . For $(x, t, y, s) \in Q_T \times Q_T$, we have :

$$\begin{aligned} \phi_t(x, t, y, s) = \xi^n(x - y) & \left(\frac{1}{2}\psi_t \left(\frac{x + y}{2}, \frac{t + s}{2} \right) \xi^n(t - s) \right. \\ & \left. + \psi \left(\frac{x + y}{2}, \frac{t + s}{2} \right) \xi^n'(t - s) \right), \end{aligned} \quad (6.121)$$

$$\begin{aligned} \phi_s(x, t, y, s) = \xi^n(x - y) & \left(\frac{1}{2}\psi_t \left(\frac{x + y}{2}, \frac{t + s}{2} \right) \xi^n(t - s) \right. \\ & \left. - \psi \left(\frac{x + y}{2}, \frac{t + s}{2} \right) \xi^n'(t - s) \right), \end{aligned} \quad (6.122)$$

$$\begin{aligned} \phi_x(x, t, y, s) = \xi^n(t - s) & \left(\frac{1}{2}\psi_x \left(\frac{x + y}{2}, \frac{t + s}{2} \right) \xi^n(x - y) \right. \\ & \left. + \psi \left(\frac{x + y}{2}, \frac{t + s}{2} \right) \xi^n'(x - y) \right), \end{aligned} \quad (6.123)$$

$$\begin{aligned} \phi_y(x, t, y, s) = \xi^n(t - s) & \left(\frac{1}{2}\psi_x \left(\frac{x + y}{2}, \frac{t + s}{2} \right) \xi^n(x - y) \right. \\ & \left. - \psi \left(\frac{x + y}{2}, \frac{t + s}{2} \right) \xi^n'(x - y) \right). \end{aligned} \quad (6.124)$$

Using these relations in (6.117) and performing the following change of variables,

$$x' = (x + y)/2, \quad y' = n(x - y), \quad t' = (t + s)/2, \quad s' = n(t - s);$$

denote the new variables x', t', y', s' by x, t, y, s and $\mathcal{Q}_4 = Q_T \times B_1^2$. Also, for the simplicity of expressions, denote

$$x^+ = x + \frac{y}{2n}, \quad t^+ = t + \frac{s}{2n}, \quad x^- = x - \frac{y}{2n}, \quad t^- = t - \frac{s}{2n}.$$

This altogether yields :

$$\mathcal{X}_1 + \mathcal{X}_2 + \mathcal{X}_3 + \mathcal{X}_4 \geq 0, \quad (6.125)$$

with :

$$\mathcal{X}_1 = \int_{\mathcal{Q}_4} (u(x^+, t^+) - v(x^-, t^-))^+ \psi_t(x, t) \xi(y) \xi(s) dx dt dy ds, \quad (6.126)$$

$$\mathcal{X}_2 = \frac{1}{2} \int_{\mathcal{Q}_4} F^+(u(x^+, t^+), v(x^-, t^-))(g(x^+, t^+) + g(x^-, t^-)) \times \psi_x(x, t) \xi(y) \xi(s) dx dt dy ds, \quad (6.127)$$

$$\mathcal{X}_3 = \int_{\mathcal{Q}_4} F^+(u(x^+, t^+), v(x^-, t^-))(g(x^+, t^+) - g(x^-, t^-)) \times \psi(x, t) n \xi'(y) \xi(s) dx dt dy ds, \quad (6.128)$$

$$\mathcal{X}_4 = \int_{\mathcal{Q}_4} \text{sgn}^+(u(x^+, t^+) - v(x^-, t^-)) [f(u(x^+, t^+))g_x(x^-, t^-) - f(v(x^-, t^-))g_x(x^+, t^+)] \psi(x, t) \xi(y) \xi(s) dx dt dy ds. \quad (6.129)$$

At this point, it is worth mentioning that we will frequently use the following Lemma from [62].

Lemma 6.1 *If $\Gamma \in Lip(\mathbb{R})$ satisfies $|\Gamma(u) - \Gamma(v)| \leq C_0|u - v|$, then the function*

$$H(u, v) = \text{sgn}^+(u - v)(\Gamma(u) - \Gamma(v))$$

satisfies $|H(u, v) - H(u', v')| \leq C_0(|u - u'| + |v - v'|)$ (see [63, Lemma 3]).

Consider now (6.126). Since $(u - v)^+ = \text{sgn}^+(u - v)(u - v)$, we make use of Lemma 6.1 to obtain :

$$\left| \mathcal{X}_1 - \int_{Q_T} (u(x, t) - v(x, t))^+ \psi_t(x, t) dx dt \right| \leq \left\{ \int_{K_\psi} \int_{B_1^2} |u(x^+, t^+) - u(x, t)| (\psi_t)^\infty \xi(y) \xi(s) dx dt dy ds + \int_{K_\psi} \int_{B_1^2} |v(x^-, t^-) - v(x, t)| (\psi_t)^\infty \xi(y) \xi(s) dx dt dy ds \right\},$$

where, by the Lebesgue Differentiation/Dominated Theorems, the right hand side of this inequality tends to 0 as $n \rightarrow \infty$, and hence :

$$\mathcal{X}_1 \rightarrow \int_{Q_T} (u(x, t) - v(x, t))^+ \psi_t(x, t) dx dt \quad \text{as } n \rightarrow \infty. \quad (6.130)$$

Let us now turn to (6.127); using the fact that $g \in W^{1,\infty}(Q_T)$ and hence Lipschitz continuous over the compact K_ψ , and the fact that $F^+(u, v)$ is Lipschitz

continuous in u and v (see Lemma 6.1), we get :

$$\begin{aligned}
 & \left| \mathcal{X}_2 - \int_{Q_T} F^+(u(x,t), v(x,t))g(x,t)\psi_x(x,t)dxdt \right| \leq \\
 & g^\infty M_f \psi_x^\infty \left\{ \int_{K_\psi} \int_{B_1^2} |u(x^+, t^+) - u(x,t)| \xi(y)\xi(s) dx dt dy ds \right. \\
 & \left. + \int_{K_\psi} \int_{B_1^2} |v(x^-, t^-) - v(x,t)| \xi(y)\xi(s) \right\} dx dt dy ds \\
 & + \frac{1}{n} C((g_x)^\infty, (g_t)^\infty, (\psi_x)^\infty, M_f, u^\infty, v^\infty, T),
 \end{aligned} \tag{6.131}$$

and also, by the Lebesgue Differentiation/Dominated Theorems, the left hand side of this inequality tends to 0 as $n \rightarrow \infty$, hence :

$$\mathcal{X}_2 \rightarrow \int_{Q_T} F^+(u(x,t), v(x,t))g(x,t)\psi_x(x,t)dxdt \quad \text{as } n \rightarrow \infty. \tag{6.132}$$

We now study the two terms \mathcal{X}_3^n and \mathcal{X}_4^n . From the fact that $g \in W^{1,\infty}(\bar{Q}_T)$, we remark that for a.e. $(x,t,y,s) \in Q_T \times Q_T$, we have :

$$g(x^-, t^-) - g(x^+, t^+) = g_x(x^+, t^+)(-y/n) + g_t(x^-, t^-)(-s/n) + L^n(x,t,y,s).$$

where

$$L^n(x,t,y,s) = \int_{t^+}^{t^-} (g_t(x^-, z) - g_t(x^-, t^-))dz + \int_{x^+}^{x^-} (g_x(w, t^+) - g_x(x^+, t^+))dw$$

and for a.e. $(x,t,y,s) \in \mathcal{Q}_4$, we have :

$$nL^n \rightarrow 0, \quad \text{as } n \rightarrow \infty.$$

This is obtained via the Lebesgue Differentiation Theorem. We also remark that the term $g_x(x^-, t^-)$ in \mathcal{X}_4^n could be replaced with $g_x(x^+, t^+)$, since this adds a term that approaches 0 as n becomes large. This term will be omitted throughout what follows and we denote the new \mathcal{X}_4^n by $\tilde{\mathcal{X}}_4^n$. From these two remarks, we rewrite \mathcal{X}_3^n and $\tilde{\mathcal{X}}_4^n$ to get :

$$\begin{aligned}
 \mathcal{X}_3^n &= \int_{\mathcal{Q}_4} \text{sgn}^+(u(x^+, t^+) - v(x^-, t^-))(f(u(x^+, t^+)) - f(v(x^-, t^-))) \\
 & (yg_x(x^+, t^+) + sg_t(x^-, t^-))\psi(x,t)\xi'(y)\xi(s)dx dt dy ds + \overbrace{\int_{\mathcal{Q}_4} nL^n(x,t,y,s)dx dt dy ds}^{\mathcal{L}(n)},
 \end{aligned} \tag{6.133}$$

where $\mathcal{L}(n) \rightarrow 0$ as $n \rightarrow \infty$ (Lebesgue Dominated Theorem), and

$$\tilde{\mathcal{X}}_4^n = \int_{\mathcal{Q}_4} \text{sgn}^+(u(x^+, t^+) - v(x^-, t^-)) (f(u(x^+, t^+)) - f(v(x^-, t^-))) g_x(x^+, t^+) \psi(x, t) \xi(y) \xi(s) dx dt dy ds. \quad (6.134)$$

We denote the new \mathcal{X}_3^n by $\tilde{\mathcal{X}}_3^n$. Let $\mathcal{X}_{34}^n = \tilde{\mathcal{X}}_3^n + \tilde{\mathcal{X}}_4^n$, hence :

$$\begin{aligned} \mathcal{X}_{34}^n &= \overbrace{\int_{\mathcal{Q}_4} F^+(u(x^+, t^+), v(x^-, t^-)) g_x(x^+, t^+) \psi(x, t) (y\xi(y)\xi(s))_y dx dt dy ds}^{\mathcal{X}_{34}^{1n}} \\ &+ \overbrace{\int_{\mathcal{Q}_4} F^+(u(x^+, t^+), v(x^-, t^-)) g_t(x^-, t^-) \psi(x, t) (s\xi(y)\xi(s))_y dx dt dy ds}^{\mathcal{X}_{34}^{2n}}. \end{aligned} \quad (6.135)$$

In \mathcal{X}_{34}^{1n} , the term $\psi(x, t)$ could be replaced with $\psi(x^+, t^+)$, for this also adds a term getting small when $n \rightarrow \infty$. We keep the same notations for \mathcal{X}_{34}^{1n} . Since $y\xi(y)\xi(s)$ is a compactly supported smooth function in \mathcal{Q}_4 , we have :

$$\int_{\mathcal{Q}_4} F^+(u(x^+, t^+), v(x^+, t^+)) g_x(x^+, t^+) \psi(x^+, t^+) (y\xi(y)\xi(s))_y dx dt dy ds = 0. \quad (6.136)$$

Moreover, since $F^+(u, v)$ is Lipschitz continuous, we obtain :

$$\begin{aligned} &\left| \mathcal{X}_{34}^{1n} - \int_{\mathcal{Q}_4} F^+(u(x^+, t^+), v(x^+, t^+)) g_x(x^+, t^+) \psi(x^+, t^+) (y\xi(y)\xi(s))_y dx dt dy ds \right| \\ &\leq M_f (g_x)^\infty \psi^\infty \int_{K_\psi} \int_{B_1^2} |v(x^+, t^+) - v(x^-, t^-)| dx dt dy ds, \end{aligned} \quad (6.137)$$

where K_ψ is the support of ψ . Therefore, by the Lebesgue Differentiation/Dominated Theorems, we deduce that the right hand side of (6.137) tends to 0 as $n \rightarrow \infty$, hence we have :

$$\mathcal{X}_{34}^{1n} \rightarrow 0 \quad \text{as } n \rightarrow \infty. \quad (6.138)$$

In a similar way we can show that

$$\mathcal{X}_{34}^{2n} \rightarrow 0 \quad \text{as } n \rightarrow \infty. \quad (6.139)$$

From (6.130), (6.132), (6.138) and (6.139), passing to the limit in (6.125) yields (6.101), which concludes the proof of step 2.

Step 3 : $u(x, t) \leq v(x, t)$ **a.e. in Q_T .**

Let us first show that the function $A(t)$ defined in (6.102) is non-increasing a.e. in $(0, \min(T, \frac{a}{\omega}))$. Take $a > 0$ and recall that $\omega = g^\infty M_f$; let $0 < t_1 < t_2 < \min(T, \frac{a}{\omega})$, $0 < \epsilon < \min(t_1, \min(T, \frac{a}{\omega} - t_2))$, and $\delta > 0$. Consider the function $\phi \in C_0^1(\mathbb{R}_+, [0, 1])$ such that $\phi(x) = 1 \ \forall x \in [0, a]$, $\phi(x) = 0 \ \forall x \in [a + \delta, \infty)$, and $\phi' \leq 0$. Define r_ϵ by :

$$r_\epsilon(t) = \begin{cases} 0 & \text{if } 0 \leq t \leq t_1 - \epsilon \\ \frac{t - (t_1 - \epsilon)}{\epsilon} & \text{if } t_1 - \epsilon \leq t \leq t_1 \\ 1 & \text{if } t_1 \leq t \leq t_2 \\ \frac{(t_2 + \epsilon) - t}{\epsilon} & \text{if } t_2 \leq t \leq t_2 + \epsilon \\ 0 & \text{if } t_2 + \epsilon \leq t \leq \infty. \end{cases} \quad (6.140)$$

One can take in (6.101) the test function

$$\psi(x, t) = \phi(|x| + \omega t) r_\epsilon(t).$$

This yields :

$$\begin{aligned} & \overbrace{\frac{1}{\epsilon} \int_{t_1 - \epsilon}^{t_1} \int_{\mathbb{R}} (u(x, t) - v(x, t))^+ \phi(|x| + \omega t) dx dt}^{E_1(\delta, \epsilon)} - \\ & \overbrace{\frac{1}{\epsilon} \int_{t_2}^{t_2 + \epsilon} \int_{\mathbb{R}} (u(x, t) - v(x, t))^+ \phi(|x| + \omega t) dx dt}^{E_2(\delta, \epsilon)} \geq E(\delta, \epsilon), \end{aligned} \quad (6.141)$$

with

$$\begin{aligned} E(\delta, \epsilon) &= - \int_0^T \int_{\mathbb{R}} [\omega(u(x, t) - v(x, t))^+ + \text{sgn}^+((u(x, t) - v(x, t))) \times \\ & (f(u(x, t)) - f(v(x, t))) \frac{x}{|x|} g(x, t)] \phi'(|x| + \omega t) r_\epsilon(t) dx dt. \end{aligned} \quad (6.142)$$

We claim that $E(\delta, \epsilon) \geq 0$. Indeed, since $\phi' \leq 0$ and $r_\epsilon \geq 0$, it suffices to show that

$$\begin{aligned} & \omega(u(x, t) - v(x, t))^+ + \text{sgn}^+((u(x, t) - v(x, t))) \times \\ & (f(u(x, t)) - f(v(x, t))) \frac{x}{|x|} g(x, t) \geq 0 \quad \text{a.e. in } Q_T. \end{aligned} \quad (6.143)$$

Two cases can be considered, either $u(x, t) \leq v(x, t)$; in this case it is easy to verify (6.143), or $u(x, t) > v(x, t)$; in this case we use, from the definition of ω , the fact that

$$(f(u(x, t)) - f(v(x, t))) \frac{x}{|x|} g(x, t) \geq -\omega(u(x, t) - v(x, t)),$$

hence our claim holds. Relation (6.141) now holds with $E(\delta, \epsilon)$ replaced with 0. We regard the integrand term of $E_1(\delta, \epsilon)$ in (6.141) and we notice that for $t_1 - \epsilon < t < t_1$, we have :

$$(u(x, t) - v(x, t))^+ \phi(|x| + \omega t) = (u(x, t) - v(x, t))^+ \phi(|x| + \omega t) \mathbb{I}_{A'_\delta},$$

where $\mathbb{I}_{A'_\delta}$ is the characteristic function of the set A'_δ defined by :

$$A'_\delta = \{(x, t); t_1 - \epsilon < t < t_1, 0 < |x| + \omega t < a + \delta\}.$$

Remark that the set A'_δ shrinks, as δ becomes small, to

$$A' = \{(x, t); t_1 - \epsilon < t < t_1, 0 < |x| + \omega t \leq a\}$$

with $\phi(|x| + \omega t) \equiv 1$ over A' . It is easy now to see that as $\delta \rightarrow 0$

$$(u(x, t) - v(x, t))^+ \phi(|x| + \omega t) \mathbb{I}_{A'_\delta} \rightarrow (u(x, t) - v(x, t))^+ \mathbb{I}_{A'} \text{ a.e. in } Q_T.$$

However, since $(u(x, t) - v(x, t))^+ \in L^\infty(Q_T)$, we use the Lebesgue Dominated Theorem to get :

$$E_1(\delta, \epsilon) \rightarrow \frac{1}{\epsilon} \int_{t_1 - \epsilon}^{t_1} \int_{B_{a - \omega t}} (u(x, t) - v(x, t))^+ dx dt \text{ as } \delta \rightarrow 0, \quad (6.144)$$

in other words,

$$E_1(\delta, \epsilon) \rightarrow \frac{1}{\epsilon} \int_{t_1 - \epsilon}^{t_1} A(t) dt \text{ as } \delta \rightarrow 0, \quad (6.145)$$

with $A(t)$ given by (6.102). Similar arguments shows that :

$$E_2(\delta, \epsilon) \rightarrow \frac{1}{\epsilon} \int_{t_2}^{t_2 - \epsilon} A(t) dt \text{ as } \delta \rightarrow 0. \quad (6.146)$$

Note that $A \in L^1(0, T)$; let t_1 and t_2 be Lebesgue points of the function A such that $0 < t_1 < t_2 < \min(T, \frac{a}{\omega})$, one can easily deduce from (6.145) and (6.141) letting ϵ tends to 0 that

$$A(t_1) \geq A(t_2),$$

hence A is a.e. non-increasing. We use this property enjoyed by A to get the comparison principle. In fact, using the elementary identities :

$$\begin{aligned} (u - v)^+ &\leq (u - w)^+ + (v - w)^- \\ (u - v)^- &\leq (u - w)^- + (v - w)^+ \end{aligned}$$

$\forall u, v, w \in \mathbb{R}$, we calculate for a.e. $(x, t) \in Q_T$:

$$(u(x, t) - v(x, t))^+ \leq (u(x, t) - u^0(x))^+ + (v(x, t) - v^0(x))^- + (u^0(x) - v^0(x))^+.$$

Since $u^0(x) \leq v^0(x)$ a.e. in \mathbb{R} , we get for a.e. $(x, t) \in Q_T$:

$$(u(x, t) - v(x, t))^+ \leq (u(x, t) - u^0(x))^+ + (v(x, t) - v^0(x))^- . \quad (6.147)$$

Using (6.147), for $\tau \in (0, T)$, we calculate :

$$\begin{aligned} \frac{1}{\tau} \int_0^\tau A(t) dt &\leq \frac{1}{\tau} \int_0^\tau \int_{B_a} (u(x, t) - v(x, t))^+ dx dt \leq \\ &\frac{1}{\tau} \int_0^\tau \int_{B_a} (u(x, t) - u^0(x))^+ dx dt + \frac{1}{\tau} \int_0^\tau \int_{B_a} (v(x, t) - v^0(x))^- dx dt. \end{aligned} \quad (6.148)$$

From (6.99), (6.100) and the passage to the limit as $\tau \rightarrow 0$ in (6.148), we deduce that,

$$\frac{1}{\tau} \int_0^\tau A(t) dt \rightarrow 0 \quad \text{as } \tau \rightarrow 0. \quad (6.149)$$

Thus, since A is a.e. non-increasing on $(0, \tau)$, and $A(t) \geq 0$ for a.e. $t \in (0, \min(T, \frac{a}{\omega}))$, one then has

$$A(t) = 0 \quad \text{for a.e. } t \in \left(0, \min\left(T, \frac{a}{\omega}\right)\right).$$

Since a is arbitrary, we deduce that,

$$u(x, t) \leq v(x, t) \quad \text{a.e. in } Q_T,$$

and the result follows. □

Remark 6.2 *In [35], the entropy process solution $\mu(x, t, \alpha)$ was proved to be independent of α for a divergence-free function $g \in C^1(\bar{Q}_T)$. However, for the case of a general non divergence-free function $g \in W^{1,\infty}(\bar{Q}_T)$, same result can be shown by adapting the same proof as in [35, Theorem 3] taking into account the slight modifications that could be deduced from the proof of Theorem (2.16). More precisely, the treatment of the two terms \mathcal{X}_3^n and \mathcal{X}_4^n in Step 2.*

Acknowledgments

The author would like to thank R. Monneau and C. Imbert for fruitful discussions in the preparation of this paper. We also thank A. El-Hajj, R. Eymard, N. Forcadel, M. Jazar and J. Vovelle for their remarks. Finally, this work was partially supported by The Mathematical Analysis and Applications Arab Network (MA3N) and by The contract JC called ‘‘ACI jeunes chercheuses et jeunes chercheurs’’ of the French Ministry of Research (2003-2007).

Chapitre 4

Dynamics of dislocation densities in a bounded channel. Part I : smooth solutions to a singular parabolic system

Ce chapitre est issu d'un travail en collaboration avec M. Jazar et R. Monneau [54].

Dans ce travail, nous étudions un problème de Dirichlet pour un système parabolique couplé et singulier. La singularité vient de la présence de l'inverse du gradient de la solution. Ce système décrit un modèle approximatif de la dynamique des densités de dislocations dans un domaine borné et soumis à une contrainte extérieure. Le système d'équations est écrit sur un intervalle borné et exige une attention spéciale au bord. Nous montrons l'existence et l'unicité de solutions régulières, en utilisant deux outils principaux : un principe de comparaison sur le gradient qui amène la singularité, et une inégalité du type Kozono-Taniuchi parabolique.

Dynamics of dislocation densities in a bounded channel. Part I : smooth solutions to a singular parabolic system

H. Ibrahim^{*}, M. Jazar[†], R. Monneau^{*}

^{*}*CERMICS, École Nationale des Ponts et Chaussées
6 & 8, avenue Blaise Pascal, Cité Descartes,
Champs sur Marne, 77455 Marne-La-Vallée Cedex 2, FRANCE*

[†]*Lebanese University, Mathematics department,
P.O. Box 826, Kobbah Tripoli, Liban*

Abstract

We study a coupled system of two parabolic equations in one space dimension. This system is singular because of the presence of one term with the inverse of the gradient of the solution. Our system describes an approximate model of the dynamics of dislocation densities in a bounded channel submitted to an exterior applied stress. The system of equations is written on a bounded interval and requires a special attention to the boundary layer. The proof of existence and uniqueness is done under the use of two main tools : a certain comparison principle on the gradient of the solution, and a Kozono-Taniuchi parabolic type inequality.

AMS Classification : 35K50, 35K40, 35K55, 42B35, 42B99.

Key words : Boundary value problems for parabolic systems, nonlinear PDE of parabolic type, *BMO* spaces, logarithmic Sobolev inequality.

1 Introduction

1.1 Setting of the problem

In this paper, we are concerned in the study of the following singular parabolic system :

$$\begin{cases} \kappa_t = \varepsilon \kappa_{xx} + \frac{\rho_x \rho_{xx}}{\kappa_x} - \tau \rho_x & \text{on } I \times (0, \infty) \\ \rho_t = (1 + \varepsilon) \rho_{xx} - \tau \kappa_x & \text{on } I \times (0, \infty), \end{cases} \quad (1.1)$$

with the initial conditions :

$$\kappa(x, 0) = \kappa^0(x) \quad \text{and} \quad \rho(x, 0) = \rho^0(x), \quad (1.2)$$

and the boundary conditions :

$$\begin{cases} \kappa(0, \cdot) = \kappa^0(0) & \text{and} & \kappa(1, \cdot) = \kappa^0(1), \\ \rho(0, \cdot) = \rho(1, \cdot) = 0, \end{cases} \quad (1.3)$$

where

$$\varepsilon > 0, \quad \tau \neq 0,$$

are fixed constants, and

$$I := (0, 1)$$

is the open and bounded interval of \mathbb{R} .

The goal is to show the long-time existence and uniqueness of a smooth solution of (1.1), (1.2) and (1.3). Our motivation comes from a problem of studying the dynamics of dislocation densities in a constrained channel submitted to an exterior applied stress. In fact, system (1.1) can be seen as an approximate model of an integrated form of the model described in [46]. This model [46], that describes the evolution of the dislocation densities inside a crystal, reads :

$$\begin{cases} \theta_t^+ = \left[\left(\frac{\theta_x^+ - \theta_x^-}{\theta^+ + \theta^-} - \tau \right) \theta^+ \right]_x & \text{on} \quad I \times (0, T), \\ \theta_t^- = \left[- \left(\frac{\theta_x^+ - \theta_x^-}{\theta^+ + \theta^-} - \tau \right) \theta^- \right]_x & \text{on} \quad I \times (0, T), \end{cases} \quad (1.4)$$

with τ representing the exterior stress field. The integrated form of system (1.4) can be deduced from (1.1), by letting $\varepsilon = 0$; spatially differentiating the resulting system; and by considering

$$\rho_x^\pm = \theta^\pm, \quad \rho = \rho^+ - \rho^-, \quad \kappa = \rho^+ + \rho^-. \quad (1.5)$$

Here θ^+ and θ^- represent the densities of the positive and negative dislocations respectively (see [51, 76] for a physical study of dislocations).

The next challenge (that will be the motivation of another work by the authors) is to show some kind of convergence of the solution $(\rho^\varepsilon, \kappa^\varepsilon)$ of (1.1) to the solution of the integrated form of (1.4) as $\varepsilon \rightarrow 0$.

1.2 Statement of the main result

The main result of this paper is :

Theorem 1.1 (*Existence and uniqueness of a solution*)

Let $0 < \alpha < 1$. Let ρ^0, κ^0 satisfying :

$$\rho^0, \kappa^0 \in C^\infty(\bar{I}), \quad \rho^0(0) = \rho^0(1) = \kappa^0(0) = 0, \quad \kappa^0(1) = 1, \quad (1.6)$$

$$\begin{cases} (1 + \varepsilon)\rho_{xx}^0 = \tau\kappa_x^0 & \text{on } \partial I \\ (1 + \varepsilon)\kappa_{xx}^0 = \tau\rho_x^0 & \text{on } \partial I, \end{cases} \quad (1.7)$$

and

$$\min_{x \in I} (\kappa_x^0(x) - |\rho_x^0(x)|) > 0. \quad (1.8)$$

Then there exists a unique global solution (ρ, κ) of system (1.1), (1.2) and (1.3) satisfying

$$(\rho, \kappa) \in C^{3+\alpha, \frac{3+\alpha}{2}}(\bar{I} \times [0, T]) \quad \text{for any } T > 0, \quad (1.9)$$

and

$$(\rho, \kappa) \in C^\infty(\bar{I} \times [\zeta, \infty)), \quad \forall \zeta > 0. \quad (1.10)$$

Moreover, this solution also satisfies :

$$\kappa_x > |\rho_x| \quad \text{on } \bar{I} \times [0, \infty). \quad (1.11)$$

Remark 1.2 Conditions (1.7) are natural here. Indeed, the regularity (1.9) of the solution of (1.1) with the boundary conditions (1.2) and (1.3) imply in particular condition.

Remark 1.3 Remark that the choice $\kappa^0(0) = 0$ and $\kappa^0(1) = 1$ does not reduce the generality of the problem, because the problem is linear and equation (1.1) does not see the constants.

1.3 Brief review of the literature

Parabolic problems involving singular terms have been widely studied in various aspects. Degenerate and singular parabolic equations have been extensively studied by DiBenedetto et al. (see for instance [17, 24–27] and the references therein). The authors regard the solutions of singular or degenerate parabolic equations with measurable coefficients whose prototype is :

$$u_t - \operatorname{div} (|\nabla u|^{p-2} \nabla u) = 0, \quad p > 2 \quad \text{or} \quad 1 < p < 2.$$

The study includes local Hölder continuity of bounded weak solutions, local and global boundedness of weak solutions and local intrinsic and global Harnack estimates. Other parabolic equations of the type

$$u_t - \Delta u^m = 0, \quad 0 < m < 1,$$

are examined in [24, 28, 29]. These equations are singular at points where $u = 0$. In [28], the authors investigate, for special range of m , the behavior of the solution near the points of singularity. In particular, they show that nonnegative solutions are analytic in the space variables and at least Lipschitz continuous in time. However, in [29], an intrinsic Harnack estimate for nonnegative weak solutions is established for some optimal range of the parameter m . Other class of singular parabolic equations are of the form :

$$u_t = u_{xx} + \frac{b}{x}u_x, \quad (1.12)$$

b is a certain constant. Such an equation is related to axially symmetric problems and also occurs in probability theory. A wide study of (1.12), including existence, uniqueness and representation theorems for the solution are proved (Dirichlet and Neumann boundary conditions are treated as well). In addition, differentiability and regularity properties are investigated (for the references, see [2, 16, 20, 89]). A more general form of (1.12), including semilinear equations, is treated in [14, 15, 71, 75].

An important type of equations that can be indirectly related to our system are semilinear parabolic equations :

$$u_t = \Delta u + |u|^{p-1}u, \quad p > 1. \quad (1.13)$$

Many authors have studied the blow-up phenomena for solutions of the above equation (see for instance [47, 72, 73, 85, 88, 96]). This study includes uniform estimates at the blow-up time, as well as the investigation of upper bounds for the initial blow-up rate. Equation (1.13) can be somehow related to the first equation of (1.1), but with a singularity of the form $1/\kappa$. This can be formally seen if we first suppose that $u \geq 0$, and then we apply the following change of variables $u = 1/v$. In this case, equation (1.13) becomes :

$$v_t = \Delta v - \frac{2|\nabla v|^2}{v} - v^{2-p},$$

and hence if $p = 3$, we obtain :

$$v_t = \Delta v - \frac{1}{v}(1 + 2|\nabla v|^2). \quad (1.14)$$

Since the solution u of (1.13) may blow-up at a finite time $t = T$, then v may vanishes at $t = T$, and therefore equation (1.14) faces similar singularity to that of the first equation of (1.1), but in terms of the solution itself.

1.4 Strategy of the proof

The existence and uniqueness is made by using a fixed point argument after a slight artificial modification in the denominator κ_x of the first equation of (1.1) in order to avoid dividing by zero. We will first show the short time existence, proving in particular that

$$\kappa_x(x, t) \geq \sqrt{\gamma^2(t) + \rho_x^2(x, t)} > 0, \quad (1.15)$$

for initial conditions satisfying :

$$\kappa_x(x, 0) \geq \sqrt{\gamma^2(0) + \rho_x^2(x, 0)}$$

with some suitable $\gamma(t) > 0$. The only, but dangerous, inconvenience is that the function γ depends strongly on $\|\rho_{xxx}\|_\infty$, roughly speaking :

$$\gamma' \simeq -\|\rho_{xxx}\|_\infty \gamma, \quad (1.16)$$

where $\|\rho_{xxx}\|_\infty$ does not have, a priori, a good control independent of γ . Here where a logarithmic estimate interferes (see section 2, Theorem 2.16) to obtain an upper bound of $\|\rho_{xxx}\|_\infty$ of the form

$$\|\rho_{xxx}\|_\infty \leq E \left(1 + \log^+ \frac{E}{\gamma^m} \right),$$

where E is an exponential function in time, and $m \in \mathbb{N}$. This allows, with (1.16), to have a good lower bound on γ independent of $\|\rho_{xxx}\|_\infty$. After that, due to some *a priori* estimates, we will move to show the global time existence. One key point here is that $\left| \frac{\rho_x}{\kappa_x} \right| \leq 1$ which somehow linearizes the first equation of (1.1), and then allows the global existence.

1.5 Organization of the paper

This paper is organized as follows : In section 2, we present the tools needed throughout this work ; this includes a brief recall on the L^p , C^α and the *BMO* theory for parabolic equations. In section 3, we show a comparison principle associated to (1.1) that will play a crucial rule in the long time existence of the solution as well as the positivity of κ_x . In section 4, we present a result of short time existence, uniqueness and regularity of a solution (ρ, κ) of an artificially modified system of (1.1). section 5 is devoted to give some exponential bounds of the solution given in section 4. In section 6, we show a control of the $W_2^{2,1}$ norm of ρ_{xxx} . In a similar way, we show a control of the *BMO* norm of ρ_{xxx} in section 7. In section 8, we use a Kozono-Taniuchi parabolic type inequality to control the L^∞ norm of ρ_{xxx} . Thanks to this L^∞ control, we will improve the comparison principle of section 3. In section 9, we prove our main result : Theorem 1.1. Finally, sections 10, 11 are appendices where we present the proofs of some standard results.

2 Tools : theory of parabolic equations

We start with some basic notations and terminology.

Abridged notation.

- I_T is the cylinder $I \times (0, T)$; \bar{I} is the closure of I ; $\overline{I_T}$ is the closure of I_T ; ∂I is the boundary of I .

- $\|\cdot\|_{L^p(X)} = \|\cdot\|_{p,X}$, X is a Banach space, $p \geq 1$.

- S_T is the lateral boundary of I_T , or more precisely, $S_T = \partial I \times (0, T)$.

- $\partial^p I_T$ is the parabolic boundary of I_T , i.e. $\partial^p I_T = \overline{S_T} \cup (I \times \{t = 0\})$.

- $D_y^s u = \frac{\partial^s u}{\partial y^s}$, u is a function depending on the parameter y , $s \in \mathbb{N}$.

- $[l]$ is the floor part of $l \in \mathbb{R}$.

- $Q_r = Q_r(x_0, t_0)$ is the lower parabolic cylinder given by :

$$Q_r = \{(x, t); |x - x_0| < r, t_0 - r^2 < t < t_0\}, r > 0, (x_0, t_0) \in I_T.$$

- $|\Omega|$ is the n -dimensional Lebesgue measure of the open set $\Omega \subset \mathbb{R}^n$.

- $m_\Omega(u) = \frac{1}{|\Omega|} \int_\Omega u$ is the average integral of the $u \in L^1(\Omega)$ over $\Omega \subset \mathbb{R}^n$.

2.1 L^p and C^α theory of parabolic equations

A major part of this work deals with the following typical problem in parabolic theory :

$$\begin{cases} u_t = \varepsilon u_{xx} + f & \text{on } I_T \\ u(x, 0) = \phi & \text{on } I \\ u = \Phi & \text{on } \partial I \times (0, T), \end{cases} \quad (2.17)$$

where $T > 0$ and $\varepsilon > 0$. A wide literature on the existence and uniqueness of solutions of (2.17) in different function spaces could be found for instance in [65], [41] and [68]. We will deal mainly with two types of spaces :

1. **The Sobolev space** $W_p^{2,1}(I_T)$, $1 < p < \infty$ which is the Banach space consisting of the elements in $L^p(I_T)$ having generalized derivatives of the

form $D_t^r D_x^s u$, with r and s two non-negative integers satisfying the inequality $2r + s \leq 2$, also in $L^p(I_T)$. The norm in this space is defined by the equality

$$\|u\|_{W_p^{2,1}(I_T)} = \sum_{i=0}^2 \sum_{2r+s=i} \|D_t^r D_x^s u\|_{p, I_T}.$$

2. **The Hölder spaces** $C^\ell(\bar{I})$ and $C^{\ell, \ell/2}(\overline{I_T})$, $\ell > 0$ a nonintegral positive number. The Hölder space $C^\ell(\bar{I})$ is the Banach space of all functions $v(x)$ that are continuous in \bar{I} , together with all derivatives up to order $[\ell]$, and have a finite norm

$$|v|_I^{(\ell)} = \langle v \rangle_I^{(\ell)} + \sum_{j=0}^{[\ell]} \langle v \rangle_I^{(j)}, \quad (2.18)$$

where

$$\begin{aligned} \langle v \rangle_I^{(0)} &= |v|_I^{(0)} = \|v\|_{\infty, I}, \\ \langle v \rangle_I^{(j)} &= |D_x^j v|_I^{(0)}, \quad \langle v \rangle_I^{(\ell)} = \langle D_x^{[\ell]} v \rangle_I^{(\ell-[\ell])}, \end{aligned}$$

with

$$\langle v \rangle_I^{(\alpha)} = \inf\{c; |v(x) - v(x')| \leq c|x - x'|^\alpha, x, x' \in \bar{I}\}, \quad 0 < \alpha < 1. \quad (2.19)$$

The Hölder space $C^{\ell, \ell/2}(\overline{I_T})$ is the Banach space of functions $v(x, t)$ that are continuous in $\overline{I_T}$, together with all derivatives of the form $D_t^r D_x^s v$ for $2r + s < \ell$, and have a finite norm

$$|v|_{I_T}^{(\ell)} = \langle v \rangle_{I_T}^{(\ell)} + \sum_{j=0}^{[\ell]} \langle v \rangle_{I_T}^{(j)}, \quad (2.20)$$

where

$$\begin{aligned} \langle v \rangle_{I_T}^{(0)} &= |v|_{I_T}^{(0)} = \|v\|_{\infty, I_T}, \\ \langle v \rangle_{I_T}^{(j)} &= \sum_{2r+s=j} |D_t^r D_x^s v|_{I_T}^{(0)}, \\ \langle v \rangle_{I_T}^{(\ell)} &= \langle v \rangle_{x, I_T}^{(\ell)} + \langle v \rangle_{t, I_T}^{(\ell/2)}, \end{aligned}$$

and

$$\langle v \rangle_{x, I_T}^{(\ell)} = \sum_{2r+s=[\ell]} \langle D_t^r D_x^s v \rangle_{x, I_T}^{(\ell-[\ell])}, \quad (2.21)$$

$$\langle v \rangle_{t, I_T}^{(\ell/2)} = \sum_{0 < \ell - 2r - s < 2} \langle D_t^r D_x^s v \rangle_{t, I_T}^{(\frac{\ell-2r-s}{2})} \quad (2.22)$$

with

$$\langle v \rangle_{x, I_T}^{(\alpha)} = \inf \{c; |v(x, t) - v(x', t)| \leq c|x - x'|^\alpha, (x, t), (x', t) \in \overline{I_T}\}, \quad 0 < \alpha < 1, \quad (2.23)$$

$$\langle v \rangle_{t, I_T}^{(\alpha)} = \inf \{c; |v(x, t) - v(x, t')| \leq c|t - t'|^\alpha, (x, t), (x, t') \in \overline{I_T}\}, \quad 0 < \alpha < 1. \quad (2.24)$$

The above definitions could be found in [65, section 1]. Now, we write down the compatibility conditions of order 0 and 1. These compatibility conditions concern the given data ϕ , Φ and f of problem (2.17).

Compatibility condition of order 0. Let $\phi \in C(\bar{I})$ and $\Phi \in C(\bar{S}_T)$. We say that the compatibility condition of order 0 is satisfied if

$$\phi|_{\partial I} = \Phi|_{t=0}. \quad (2.25)$$

Compatibility condition of order 1. Let $\phi \in C^2(\bar{I})$, $\Phi \in C^1(\bar{S}_T)$ and $f \in C(\bar{I}_T)$. We say that the compatibility condition of order 1 is satisfied if (2.25) is satisfied and in addition we have :

$$(\varepsilon\phi_{xx} + f)|_{\partial I} = \frac{\partial\Phi}{\partial t}|_{t=0}. \quad (2.26)$$

We state two results of existence and uniqueness adapted to our special problem. We begin by presenting the solvability of parabolic equations in Hölder spaces.

Theorem 2.1 (Solvability in Hölder spaces, [65, Theorem 5.2])

Suppose $0 < \alpha < 2$, a non-integral number. Then for any $f \in C^{\alpha, \alpha/2}(\bar{I}_T)$,

$$\phi \in C^{2+\alpha}(\bar{I}) \quad \text{and} \quad \Phi \in C^{1+\alpha/2}(\bar{S}_T),$$

satisfying the compatibility condition of order 1 (see (2.25) and (2.26)), problem (2.17) has a unique solution $u \in C^{2+\alpha, 1+\alpha/2}(\bar{I}_T)$ satisfying the following inequality :

$$|u|_{I_T}^{(2+\alpha)} \leq c^H \left(|f|_{I_T}^{(\alpha)} + |\phi|_I^{(2+\alpha)} + |\Phi|_{S_T}^{(1+\alpha/2)} \right), \quad (2.27)$$

for some $c^H = c^H(\varepsilon, \alpha, T) > 0$.

Remark 2.2 (Estimating $c^H(\varepsilon, \alpha, T)$)

The constant appearing in the above Hölder estimate (2.27) can be estimated as follows :

$$c^H(\varepsilon, \alpha, T) \leq (T + 1)^2 e^{c(T+1)}, \quad (2.28)$$

where $c = c(\varepsilon, \alpha) > 0$ is a positive constant. In order to obtain (2.28), we consider three cases for the time T .

Case 1, $T = 1$. In this case, we obtain $c^H(\varepsilon, \alpha, T) = c(\varepsilon, \alpha) > 1$.

Case 2, $T < 1$. We linearly extend the function Φ from $[0, T]$ to $[0, 1]$, and we extend the function f from $\overline{I_T}$ to $\overline{I_1}$ by $f(x, t) = f(x, T)$ for $T \leq t \leq 1$. In this case, We have the same result of Case $T = 1$.

Case 3, $T > 1$. Take $n \in \mathbb{N}$ such that $n \leq T \leq n + 1$. We obtain the estimate (2.28) on c^H by iteration. Let $F = |f|_{I_T}^{(\alpha)} + |\Phi|_{S_T}^{(1+\alpha/2)}$. We know that :

$$|u|_{I_T}^{(2+\alpha)} \leq \sum_{k=1}^n |u|_{I \times (k-1, k)}^{(2+\alpha)} + |u|_{I \times (n, T)}^{(2+\alpha)}. \quad (2.29)$$

We use the fact that $|u(\cdot, j)|_I^{(2+\alpha)} \leq |u|_{I \times (j-1, j)}^{(2+\alpha)}$, $j \in \mathbb{N}$, and $1 \leq j \leq n$, we first compute for $c = c(\varepsilon, \alpha)$ given in Case 1 :

$$\begin{aligned} |u|_{I \times (n, T)}^{(2+\alpha)} &\leq \sum_{i=1}^{n+1} c^i F + c^{n+1} |\phi|_I^{(2+\alpha)} \\ &\leq (n+1)c^{n+1} \left(F + |\phi|_I^{(2+\alpha)} \right), \end{aligned}$$

where for the last line, we have used the fact that $c > 1$. The other terms of (2.29) can be estimated in a similar way. Since $n+1 \leq T+1$, the estimate (2.28) directly follows.

We now present the solvability in Sobolev spaces. Recall the norm of fractional Sobolev spaces. If $f \in W_p^s(a, b)$, $s > 0$ and $1 < p < \infty$, then

$$\|f\|_{W_p^s(a, b)} = \|f\|_{W_p^{[s]}(a, b)} + \left(\int_a^b \int_a^b \frac{|f^{([s])}(x) - f^{([s])}(y)|^p}{|x - y|^{1+(s-[s])p}} \right)^{1/p}. \quad (2.30)$$

Theorem 2.3 (Solvability in Sobolev spaces, [65, Theorem 9.1])

Let $p > 1$, $\varepsilon > 0$ and $T > 0$. For any $f \in L^p(I_T)$,

$$\phi \in W_p^{2-2/p}(I) \quad \text{and} \quad \Phi \in W_p^{1-1/2p}(S_T), \quad (2.31)$$

*with $p \neq 3/2$ ($p = 3/2$ is called the **singular** index) satisfying in the case $p > 3/2$ the compatibility condition of order zero (see (2.25)), there exists a unique solution $u \in W_p^{2,1}(I_T)$ of (2.17) satisfying the following estimate :*

$$\|u\|_{W_p^{2,1}(I_T)} \leq c \left(\|f\|_{p, I_T} + \|\phi\|_{W_p^{2-2/p}(I)} + \|\Phi\|_{W_p^{1-1/2p}(S_T)} \right), \quad (2.32)$$

for some $c = c(\varepsilon, p, T) > 0$.

Remark 2.4 (Neumann conditions)

An analogous theorem of Theorem 2.3 is valid for problem (2.17), but with Neumann boundary conditions

$$u_x = 0 \quad \text{on} \quad S_T.$$

The singular index in this case will be $p = 3$, see [65, Chapter 4, section 10].

Remark 2.5 We recall that there exists a constant $c = c(p, T) > 0$ such that if $\varphi \in W_p^{2,1}(I_T)$, $\varphi|_{I \times \{0\}} = \phi$ and $\varphi|_{S_T} = \Phi$, then

$$\|\phi\|_{W_p^{2-2/p}(I \times \{0\})} + \|\Phi\|_{W_p^{1-1/2p}(S_T)} \leq c \|\varphi\|_{W_p^{2,1}(I_T)}.$$

Remark 2.6 (The sense of the compatibility condition stated in Theorem 2.3)

Remark that in the case $p > 3/2$, the two functions ϕ and Φ presented in (2.31) are continuous up to the boundary, i.e. $\phi \in C(\bar{I})$ and $\Phi \in C(\bar{S}_T)$. This is due to the fact that we have

$$s = 1 - 1/2p > 2/3 \quad \text{and} \quad s' = 2 - 2/p > 2/3,$$

hence

$$sp > n \quad \text{and} \quad s'p > n,$$

where $n = 1$ is the space dimension. In this case the fractional Sobolev embedding [1] gives the result, and a sense of the compatibility condition stated in Theorem 2.3 is then given.

For a better understanding of the spaces stated in the above two theorems, especially fractional Sobolev spaces, we send the reader to [1] or [65]. The dependence of the constant c of Theorem 2.3 on the variable T will be of notable importance and this what is emphasized by the next lemma.

Lemma 2.7 (The constant c given by (2.32) : case $\phi = 0$ and $\Phi = 0$)

Under the same hypothesis of Theorem 2.3, with

$$\phi = 0 \quad \text{and} \quad \Phi = 0,$$

the estimate (2.32) can be written as :

$$\frac{\|u\|_{p,I_T}}{T} + \frac{\|u_x\|_{p,I_T}}{\sqrt{T}} + \|u_{xx}\|_{p,I_T} + \|u_t\|_{p,I_T} \leq c \|f\|_{p,I_T}, \quad (2.33)$$

where $c = c(\varepsilon, p) > 0$ is a positive constant depending only on p and ε .

The proof of this lemma will be done in Appendix A. Moreover, We will frequently make use of the following two lemmas also depicted from [65].

Lemma 2.8 (*Sobolev embedding in Hölder spaces, [65, Lemma 3.3]*)

(i) (Case $p > 3$). For any function $u \in W_p^{2,1}(I_T)$, if $\alpha = 1 - 3/p > 0$, i.e. $p > 3$, then

$$u \in C^{1+\alpha, \frac{1+\alpha}{2}}(\overline{I_T}), \quad \text{and} \quad |u|_{I_T}^{(1+\alpha)} \leq c \|u\|_{W_p^{2,1}(I_T)}, \quad c = c(p, T) > 0. \quad (2.34)$$

However, in terms of u_x , we have that $u_x \in C^{\alpha, \alpha/2}(\overline{I_T})$ satisfying the following estimates :

$$\|u_x\|_{\infty, I_T} \leq c \left\{ \delta^\alpha (\|u_t\|_{p, I_T} + \|u_{xx}\|_{p, I_T}) + \delta^{\alpha-2} \|u\|_{p, I_T} \right\}, \quad c = c(p) > 0, \quad (2.35)$$

and

$$\langle u_x \rangle_{I_T}^{(\alpha)} \leq c \left\{ \|u_t\|_{p, I_T} + \|u_{xx}\|_{p, I_T} + \frac{1}{\delta^2} \|u\|_{p, I_T} \right\}, \quad c = c(p) > 0. \quad (2.36)$$

(ii) (Case $p > 3/2$). If $u \in W_p^{2,1}(I_T)$ with $p > 3/2$, then $u \in C(\overline{I_T})$, and we have the following estimate :

$$\|u\|_{\infty, I_T} \leq c \left\{ \delta^{2-3/p} (\|u_t\|_{p, I_T} + \|u_{xx}\|_{p, I_T}) + \delta^{-3/p} \|u\|_{p, I_T} \right\}, \quad c = c(p) > 0. \quad (2.37)$$

In both cases $\delta = \min\{1/2, \sqrt{T}\}$.

Lemma 2.9 (*Trace of functions in $W_p^{2,1}(I_T)$, [65, Lemma 3.4]*)

If $u \in W_p^{2,1}(I_T)$, $p > 1$, then for $2r + s < 2 - 2/p$, we have

$$D_t^r D_x^s u|_{t=0} \in W_p^{2-2r-s-2/p}(I) \quad (2.38)$$

and

$$\|u\|_{W_p^{2-2r-s-2/p}(I)} \leq c(T) \|u\|_{W_p^{2,1}(I_T)}. \quad (2.39)$$

In addition, for $2r + s < 2 - 1/p$, we have

$$D_t^r D_x^s u|_{\overline{S_T}} \in W_p^{1-r-s/2-1/2p}(\overline{S_T}) \quad (2.40)$$

and

$$\|u\|_{W_p^{1-r-s/2-1/2p}(\overline{S_T})} \leq c(T) \|u\|_{W_p^{2,1}(I_T)}. \quad (2.41)$$

A useful technical lemma will now be presented. The proof of this lemma will be done in Appendix A.

Lemma 2.10 (*L^∞ control of the spatial derivative*)

Let $p > 3$ and let $0 < T \leq 1/4$ (this condition is taken for simplification). Then for every $u \in W_p^{2,1}(I_T)$ with

$$u = 0 \quad \text{on} \quad \partial^p(I_T)$$

in the trace sense (see Lemma (2.9)), there exists a constant $c(T, p) > 0$ such that

$$\|u_x\|_{\infty, I_T} \leq c(T, p) \|u\|_{W_p^{2,1}(I_T)}, \quad (2.42)$$

with

$$c(T, p) = c(p) T^{\frac{p-3}{2p}} \rightarrow 0 \quad \text{as } T \rightarrow 0. \quad (2.43)$$

2.2 BMO theory for parabolic equation

A very useful tool in this paper is the limit case of the L^p theory, $1 < p < \infty$, for parabolic equations, which is the *BMO* theory. Roughly speaking, if the function f appearing in (2.17) is in L^p for some $1 < p < \infty$, then we expect our solution u to have u_t and u_{xx} also in L^p . This is no longer valid in the limit case, i.e. when $p = \infty$. In this case, it is shown that the solution u of the parabolic equation have u_t and u_{xx} in the parabolic/anisotropic *BMO* space (bounded mean oscillation) that is convenient to give its definition here.

Definition 2.11 (*Parabolic/Anisotropic BMO spaces*)

A function $u \in L^1_{loc}(I_T)$ is said to be of bounded mean oscillation, $u \in BMO(I_T)$, if the quantity

$$\sup_{Q_r \subset I_T} \left(\frac{1}{|Q_r|} \int_{Q_r} |u - m_{Q_r}(u)| \right)$$

is finite. Here the supremum is taken over all parabolic lower cylinders Q_r (see the beginning of section 2 for the notation).

Remark 2.12 *The functions in the $BMO(I_T)$ space are defined up to an additive constant. Moreover, the parabolic space $BMO(I_T)$, which will be refereed, for simplicity, as the $BMO(I_T)$ space, and sometimes, where there is no confusion, as BMO space, is a Banach space equipped with the norm,*

$$\|u\|_{BMO(I_T)} = \sup_{Q_r \subset I_T} \left(\frac{1}{|Q_r|} \int_{Q_r} |u - m_{Q_r}(u)| \right). \quad (2.44)$$

We move now to the two main theorems of this subsection ; the *BMO* theory for parabolic equations, and the Kozono-Taniuchi parabolic type inequality. To be more precise, we have the following :

Theorem 2.13 (*BMO theory for parabolic equations*)

Take $0 < T_1 \leq T$. Consider the following Cauchy problem :

$$\begin{cases} u_t = \varepsilon u_{xx} + f & \text{on } \mathbb{R} \times (0, T), \\ u(x, 0) = 0. \end{cases} \quad (2.45)$$

If $f \in L^\infty(\mathbb{R} \times (0, T))$ and f is a $2I$ -periodic function in space, i.e.

$$f(x + 2, t) = f(x, t),$$

then there exists a unique solution $u \in BMO(\mathbb{R} \times (0, T))$ of (2.45) with

$$u_t, u_{xx} \in BMO(\mathbb{R} \times (0, T)).$$

Moreover, there exists $c > 0$ that may depend on T_1 but independent of T such that :

$$\|u_t\|_{BMO(\mathbb{R} \times (0, T))} + \|u_{xx}\|_{BMO(\mathbb{R} \times (0, T))} \leq c[\|f\|_{BMO(\mathbb{R} \times (0, T))} + m_{2I \times (0, T)}(|f|)]. \quad (2.46)$$

The proof of this theorem will be presented in Appendix B. The next theorem shows an estimate concerning parabolic BMO spaces. This estimate, which will play an essential role in our later analysis, is a sort of control of the L^∞ norm of a given function by its BMO norm and the logarithm of its norm in a certain Sobolev space. It can also be considered as the parabolic version on a bounded domain I_T of the Kozono-Taniuchi inequality (see [61]) that we recall here.

Theorem 2.14 (*The Kozono-Taniuchi inequality in the elliptic case, [61, Theorem 1]*)

Let $1 < p < \infty$ and let $s > n/p$. There is a constant $C = C(n, p, s)$ such that the estimate

$$\|f\|_{\infty, \mathbb{R}^n} \leq C \left(1 + \|f\|_{BMO(\mathbb{R}^n)} \left(1 + \log^+ \|f\|_{W_p^s(\mathbb{R}^n)} \right) \right) \quad (2.47)$$

holds for all $f \in W_p^s(\mathbb{R}^n)$.

Remark 2.15 *It is worth mentioning that the BMO norm appearing in (2.47) is the elliptic BMO norm, i.e. the one where the supremum is taken over ordinary balls*

$$B_r(X_0) = \{X \in \mathbb{R}^n; |X - X_0| < r\}.$$

The original type of the logarithmic Sobolev inequality was found in [8, 9] (see also [33]), where the authors investigated the relation between L^∞ , W_r^k and W_p^s and proved that there holds the embedding

$$\|u\|_{L^\infty(\mathbb{R}^n)} \leq C \left(1 + \log^+ \frac{r-1}{r} \left(1 + \|u\|_{W_p^s(\mathbb{R}^n)} \right) \right), \quad sp > n$$

provided $\|u\|_{W_r^k} \leq 1$ for $kr = n$. This estimate was applied to prove existence of global solutions to the nonlinear Schrödinger equation (see [8, 48]). Similar embedding for vector functions u with $\operatorname{div} u = 0$ was investigated in [4],

$$\|\nabla u\|_{L^\infty(\mathbb{R}^n)} \leq C \left(1 + \|\operatorname{rot} u\|_{L^\infty(\mathbb{R}^n)} \left(1 + \log^+ \|u\|_{W_p^{s+1}(\mathbb{R}^n)} \right) + \|\operatorname{rot} u\|_{L^2(\mathbb{R}^n)} \right), \quad (2.48)$$

with $sp > n$, where they made use of this estimate to give a blow-up criterion of solutions to the Euler equations. Estimate (2.47) is an improvement of (2.48) where a sharp version of (2.47) can be found in [77].

In our work, we need to have an estimate similar to (2.47), but for the parabolic BMO space and on the bounded domain I_T . This will be essential, on one hand, to show a suitable positive lower bound of κ_x (κ given by Theorem 1.1), and on the other hand, to show the long time existence of our solution. Indeed, there is a similar inequality and this is what will be illustrated by the next theorem.

Theorem 2.16 (A Kozono-Taniuchi parabolic type inequality)

Let $v \in L^\infty(I_T) \cap W_2^{2,1}(I_T)$, then there exists a constant $c = c(T) > 0$ such that the estimate

$$\|v\|_{\infty, I_T} \leq c \|v\|_{\overline{BMO}(I_T)} \left(1 + \log^+ \|v\|_{W_2^{2,1}(I_T)} + \log^+ \|v\|_{\overline{BMO}(I_T)} \right), \quad (2.49)$$

holds, with

$$\|v\|_{\overline{BMO}(I_T)} = \|v\|_{BMO(I_T)} + \|v\|_{1, I_T}.$$

This inequality is first shown over $\mathbb{R}_x \times \mathbb{R}_t$, then it is deduced over I_T (for a sketch of the proof, see Appendix B).

3 A comparison principle

Proposition 3.1 (A comparison principle for system (1.1))

Let

$$(\rho, \kappa) \in (C^{3+\alpha, \frac{3+\alpha}{2}}(\overline{I_T}))^2, \quad \text{for some } 0 < \alpha < 1,$$

be a solution of (1.1), (1.2) and (1.3) with $\kappa_x > 0$. Suppose that

$$|\rho_{xxx}| \leq \tilde{c} \quad \text{on } \overline{I_T}, \quad (3.50)$$

for some constant $\tilde{c} > 0$. Suppose furthermore that :

$$\alpha_0 = \min_I(\kappa_x^0 - |\rho_x^0|) > 0. \quad (3.51)$$

Then there exists a continuous non-increasing function $\gamma(t) > 0$ such that :

$$\kappa_x(x, t) \geq \sqrt{\gamma^2(t) + \rho_x^2(x, t)} \quad \text{over } \overline{I_T}. \quad (3.52)$$

Moreover γ satisfies $\gamma(t) \geq \gamma(0)e^{-(\tilde{c}+c)t}$ for some constants (independent of T) : $\gamma(0) > 0$ only depending on α_0 , and $c > 0$ only depending on ε and τ .

Proof. Throughout the proof, we will extensively use the following notation :

$$G_a(y) = \sqrt{a^2 + y^2} \quad a, y \in \mathbb{R}. \quad (3.53)$$

Without loss of generality (up to a change of variables in (x, t) and a re-definition of τ), assume in the proof that

$$I = (-1, 1).$$

Define the quantity M by :

$$M(x, t) = \kappa_x(x, t) - G_{\gamma(t)}(\rho_x(x, t)), \quad (x, t) \in \overline{I_T}, \quad (3.54)$$

$\gamma(t) > 0$ is a function to be determined. The proof could be divided into five steps.

Step 1. (Partial differential inequality satisfied by M)

We do the following computations in I_T :

$$M_t = \kappa_{xt} - G'_{\gamma}(\rho_x)\rho_{xt} - \frac{\gamma\gamma'}{\sqrt{\gamma^2 + \rho_x^2}}, \quad (3.55)$$

$$M_x = \kappa_{xx} - G'_{\gamma}(\rho_x)\rho_{xx}, \quad M_{xx} = \kappa_{xxx} - G''_{\gamma}(\rho_x)\rho_{xx}^2 - G'_{\gamma}(\rho_x)\rho_{xxx}, \quad (3.56)$$

and from (1.1) we deduce that

$$\begin{cases} \kappa_{xt} = \varepsilon\kappa_{xxx} + \frac{\rho_{xx}^2}{\kappa_x} + \frac{\rho_x\rho_{xxx}}{\kappa_x} - \frac{\rho_x\rho_{xx}\kappa_{xx}}{\kappa_x^2} - \tau\rho_{xx}, \\ \rho_{xt} = (1 + \varepsilon)\rho_{xxx} - \tau\kappa_{xx}. \end{cases} \quad (3.57)$$

We set

$$\Gamma = \frac{\gamma\gamma'}{\sqrt{\gamma^2 + \rho_x^2}}.$$

From (3.55), (3.56) and (3.57), we get :

$$\begin{aligned} M_t &= \varepsilon(\kappa_{xxx} - G'_{\gamma}(\rho_x)\rho_{xxx}) + \left(\frac{\rho_{xx}^2}{\kappa_x} - \frac{\rho_x\rho_{xx}\kappa_{xx}}{\kappa_x^2} \right) \\ &\quad + \left(\frac{\rho_x\rho_{xxx}}{\kappa_x} - G'_{\gamma}(\rho_x)\rho_{xxx} \right) - \tau(\rho_{xx} - G'_{\gamma}(\rho_x)\kappa_{xx}) - \Gamma \\ &= \varepsilon(M_{xx} + G''_{\gamma}(\rho_x)\rho_{xx}^2) + \left(\frac{\rho_{xx}^2}{\kappa_x} - \frac{\rho_x\rho_{xx}}{\kappa_x^2}M_x - \frac{\rho_x\rho_{xx}^2G'_{\gamma}(\rho_x)}{\kappa_x^2} \right) \\ &\quad - \frac{\rho_{xxx}G'_{\gamma}(\rho_x)}{\kappa_x}M - \tau(\rho_{xx} - G'_{\gamma}(\rho_x)\kappa_{xx}) - \Gamma, \end{aligned}$$

where we have used in the last line that $G'_\gamma(y)G_\gamma(y) = y$. Define the function F_γ by :

$$F_\gamma(y) = y - \gamma \arctan(y/\gamma),$$

we note that $F'_\gamma = (G'_\gamma)^2$ and hence we have :

$$\begin{aligned} M_t &= \varepsilon M_{xx} + \varepsilon G''_\gamma(\rho_x)\rho_{xx}^2 - \frac{\rho_x\rho_{xx}}{\kappa_x^2}M_x + \frac{\rho_{xx}^2}{\kappa_x^2}[M + G_\gamma(\rho_x) - G'_\gamma(\rho_x)\rho_x] \\ &\quad - \frac{\rho_{xxx}G'_\gamma(\rho_x)}{\kappa_x}M - \tau[F'_\gamma(\rho_x)\rho_{xx} + (1 - F'_\gamma(\rho_x))\rho_{xx} - G'_\gamma(\rho_x)\kappa_{xx}] - \Gamma \\ &= \varepsilon M_{xx} + \varepsilon G''_\gamma(\rho_x)\rho_{xx}^2 - \frac{\rho_x\rho_{xx}}{\kappa_x^2}M_x + \frac{\rho_{xx}^2}{\kappa_x^2}M + \frac{\rho_{xxx}}{\kappa_x^2}(G_\gamma(\rho_x) - G'_\gamma(\rho_x)\rho_x) \\ &\quad - \frac{\rho_{xxx}G'_\gamma(\rho_x)}{\kappa_x}M + \tau G'_\gamma(\rho_x)M_x - \tau(1 - F'_\gamma(\rho_x))\rho_{xx} - \Gamma, \end{aligned}$$

therefore

$$\begin{aligned} M_t &= \varepsilon M_{xx} + \left(\tau G'_\gamma(\rho_x) - \frac{\rho_x\rho_{xx}}{\kappa_x^2} \right) M_x + \left(\frac{\rho_{xx}^2}{\kappa_x^2} - \frac{\rho_{xxx}G'_\gamma(\rho_x)}{\kappa_x} \right) M \\ &\quad + \varepsilon G''_\gamma(\rho_x)\rho_{xx}^2 + \frac{\rho_{xxx}}{\kappa_x^2}[G_\gamma(\rho_x) - G'_\gamma(\rho_x)\rho_x] - \tau(1 - F'_\gamma(\rho_x))\rho_{xx} - \Gamma. \end{aligned} \tag{3.58}$$

We notice that

$$G''_\gamma(y) = \frac{\gamma^2}{(\gamma^2 + y^2)^{3/2}} \quad \text{and} \quad 1 - F'_\gamma(y) = \frac{\gamma^2}{\gamma^2 + y^2}.$$

Using Young's inequality $2ab \leq a^2 + b^2$, we have :

$$\frac{\tau\gamma^2|\rho_{xx}|}{\gamma^2 + \rho_x^2} \leq \frac{\varepsilon\gamma^2\rho_{xx}^2}{(\gamma^2 + \rho_x^2)^{3/2}} + \frac{\gamma^2\tau^2}{4\varepsilon\sqrt{\gamma^2 + \rho_x^2}}. \tag{3.59}$$

Plugging (3.59) into (3.58), we get :

$$\begin{aligned} M_t &\geq \varepsilon M_{xx} + \left(\tau G'_\gamma(\rho_x) - \frac{\rho_x\rho_{xx}}{\kappa_x^2} \right) M_x \\ &\quad + \left(\frac{\rho_{xx}^2}{\kappa_x^2} - \frac{\rho_{xxx}G'_\gamma(\rho_x)}{\kappa_x} \right) M - \frac{\gamma^2\tau^2}{4\varepsilon\sqrt{\gamma^2 + \rho_x^2}} - \frac{\gamma\gamma'}{\sqrt{\gamma^2 + \rho_x^2}}. \end{aligned} \tag{3.60}$$

Step 2. (The boundary conditions for M)

The boundary conditions (1.3), and the PDEs of system (1.1) imply the following equalities on the boundary (using the smoothness of the solution up to the boundary),

$$\begin{cases} \varepsilon\kappa_{xx} + \frac{\rho_x\rho_{xx}}{\kappa_x} - \tau\rho_x = 0 & \text{on } \partial I \times [0, T] \\ (1 + \varepsilon)\rho_{xx} - \tau\kappa_x = 0 & \text{on } \partial I \times [0, T]. \end{cases} \quad (3.61)$$

In particular (3.61) implies

$$M_x = -\frac{\tau}{1 + \varepsilon}G'_\gamma(\rho_x)M \quad \text{on } \partial I \times [0, T]. \quad (3.62)$$

To deal with the boundary condition (3.62), we now introduce the following change of unknown function :

$$\overline{M}(x, t) = \cosh(\beta x)M(x, t), \quad (x, t) \in \overline{I_T}. \quad (3.63)$$

We calculate \overline{M} on the boundary of I to get :

$$\overline{M}_x = \left(\beta \tanh(\beta x) - \frac{\tau}{1 + \varepsilon}G'_\gamma(\rho_x) \right) \overline{M} \quad \text{on } \partial I \times [0, T]. \quad (3.64)$$

We claim that it is impossible for \overline{M} to have a positive minimum at the boundary of I . Indeed we have

$$\overline{M} \text{ has a positive minimum at } x = 1 \quad \Rightarrow \quad \overline{M}_x \leq 0;$$

$$\overline{M} \text{ has a positive minimum at } x = -1 \quad \Rightarrow \quad \overline{M}_x \geq 0.$$

Both cases violate the equation (3.64) in the case of the choice of β satisfying :

$$\beta \tanh \beta \geq \frac{\tau}{1 + \varepsilon}, \quad (3.65)$$

and hence the minimum of \overline{M} is attained inside the interval I . We make the following calculation inside I_T .

$$\begin{aligned} M_t &= \frac{\overline{M}_t}{\cosh(\beta x)}, \quad M_x = \frac{1}{\cosh(\beta x)}\overline{M}_x - \frac{\beta \tanh(\beta x)}{\cosh(\beta x)}\overline{M}, \\ M_{xx} &= \frac{1}{\cosh(\beta x)}\overline{M}_{xx} - \frac{2\beta \tanh(\beta x)}{\cosh(\beta x)}\overline{M}_x + \frac{\beta^2(2 \tanh^2(\beta x) - 1)}{\cosh(\beta x)}\overline{M}. \end{aligned}$$

Using the previous identities into (3.60), we obtain :

$$\begin{aligned} \overline{M}_t &\geq \varepsilon\overline{M}_{xx} + \left[\tau G'_\gamma(\rho_x) - \frac{\rho_x\rho_{xx}}{\kappa_x^2} - 2\beta\varepsilon \tanh(\beta x) \right] \overline{M}_x - \frac{\cosh(\beta x)\gamma^2\tau^2}{4\varepsilon\sqrt{\gamma^2 + \rho_x^2}} - \frac{\cosh(\beta x)\gamma\gamma'}{\sqrt{\gamma^2 + \rho_x^2}} \\ &+ \left[\frac{\rho_{xx}^2}{\kappa_x^2} - \frac{\rho_{xxx}G'_\gamma(\rho_x)}{\kappa_x} - \beta \tanh(\beta x) \left(\tau G'_\gamma(\rho_x) - \frac{\rho_x\rho_{xx}}{\kappa_x^2} \right) + \varepsilon\beta^2(2 \tanh^2(\beta x) - 1) \right] \overline{M}. \end{aligned} \quad (3.66)$$

Step 3. (The inequality satisfied by the minimum of \overline{M})

Let

$$\overline{m}(t) = \min_{x \in I} \overline{M}(x, t).$$

Since the minimum is attained inside I , and since \overline{M} is regular, there exists $x_0(t) \in I$ such that $\overline{m}(t) = \overline{M}(x_0(t), t)$. We remark that we have :

$$\overline{M}_x(x_0(t), t) = 0, \quad \text{and} \quad \overline{M}_{xx}(x_0(t), t) \geq 0,$$

and hence we write down the equation satisfied by \overline{m} , we get (indeed in the viscosity sense) :

$$\overline{m}_t \geq \overbrace{\left(\frac{\rho_{xx}^2}{\kappa_x^2} - \frac{\rho_{xxx} G'_\gamma(\rho_x)}{\kappa_x} - \beta \tanh(\beta x) \left(\tau G'_\gamma(\rho_x) - \frac{\rho_x \rho_{xx}}{\kappa_x^2} \right) + \varepsilon \beta^2 (2 \tanh^2(\beta x) - 1) \right)}^R \overline{m} - \frac{\cosh(\beta x) \gamma^2 \tau^2}{4\varepsilon \sqrt{\gamma^2 + \rho_x^2}} - \frac{\cosh(\beta x) \gamma \gamma'}{\sqrt{\gamma^2 + \rho_x^2}} \quad \text{at} \quad (x_0(t), t). \quad (3.67)$$

For the definition of viscosity sub-/super-solutions, see [3]. In order to prove (3.67), we first note that the inequality satisfied by \overline{M} at the point $(x_0(t), t) \in I \times (0, T)$ reads (see (3.66)) :

$$\overline{M}_t(x_0(t), t) \geq R(x_0(t), t) \overline{M}(x_0(t), t) + S(x_0(t), t), \quad (3.68)$$

with

$$S(x, t) = -\frac{\tau^2 \cosh(\beta x) \gamma^2(t)}{4\varepsilon \sqrt{\gamma^2(t) + \rho_x^2(x, t)}} - \frac{\cosh(\beta x) \gamma(t) \gamma'(t)}{\sqrt{\gamma^2(t) + \rho_x^2(x, t)}}.$$

Let $\phi \in C^1(0, T)$ be a function such that $\overline{m} - \phi$ has a local minimum at t . Since $\overline{m}(\cdot) \leq \overline{M}(x_0(t), \cdot)$ in $(0, T)$, we deduce that $\overline{M}(x_0(t), \cdot) - \phi(\cdot)$ has a local minimum at t and therefore $\overline{M}_t(x_0(t), t) = \phi_t(t)$. Hence using (3.68), we obtain :

$$\phi_t(t) \geq R(x_0(t), t) \overline{m}(t) + S(x_0(t), t),$$

which implies that \overline{m} satisfies (3.67) in the viscosity sense.

Step 4. (Estimate of the term R)

We turn our attention now to the term R from (3.67). By Young's inequality $2ab \leq a^2 + b^2$, we have :

$$\beta \tau \tanh(\beta x) G'_\gamma(\rho_x) \leq 2\varepsilon \beta^2 \tanh^2(\beta x) + \frac{\tau^2}{8\varepsilon} (G'_\gamma(\rho_x))^2, \quad (3.69)$$

therefore the term R satisfies :

$$R \geq \frac{\rho_{xx}^2}{\kappa_x^2} + \beta \tanh(\beta x) \frac{\rho_x \rho_{xx}}{\kappa_x^2} - \frac{\rho_{xxx} G'_\gamma(\rho_x)}{\kappa_x} - \frac{\tau^2}{8\varepsilon} (G'_\gamma(\rho_x))^2 - \varepsilon \beta^2. \quad (3.70)$$

Moreover, using again the identity $ab \geq -\frac{a^2}{2} - \frac{b^2}{2}$, we get

$$\beta \tanh(\beta x) \frac{\rho_x \rho_{xx}}{\kappa_x^2} = \left(\frac{\sqrt{2} \rho_{xx}}{\kappa_x} \right) \left(\frac{\beta \tanh(\beta x) \rho_x}{\sqrt{2} \kappa_x} \right) \geq -\frac{\rho_{xx}^2}{\kappa_x^2} - \frac{\beta^2 \tanh^2(\beta x) \rho_x^2}{4 \kappa_x^2},$$

and hence (3.70) implies

$$R \geq -\frac{\rho_{xxx} G'_\gamma(\rho_x)}{\kappa_x} - \frac{\beta^2 \tanh^2(\beta x) \rho_x^2}{4 \kappa_x^2} - \frac{\tau^2}{8\varepsilon} (G'_\gamma(\rho_x))^2 - \varepsilon \beta^2. \quad (3.71)$$

By the hypothesis (3.51), for all $\beta \in \mathbb{R}$, there exists a unique $\eta = \eta(\beta) > 0$ satisfying :

$$\eta^2 = \min_{x \in I} [\cosh(\beta x) (\kappa_x^0(x) - \sqrt{(\rho_x^0(x))^2 + \eta^2})]. \quad (3.72)$$

Define

$$\alpha_1 = \gamma(0) = \eta(\beta), \text{ where } \beta \text{ satisfies (3.65)}. \quad (3.73)$$

From (3.72), we know that

$$\overline{m}(0) = \alpha_1^2 > 0,$$

and the continuity of \overline{m} preserves its positivity at least for short time. Then, as long as \overline{m} is positive, we have

$$\kappa_x \geq \sqrt{\gamma^2 + \rho_x^2}. \quad (3.74)$$

By using (3.74), (3.50), and the basic identities

$$|\tanh(x)| \leq 1 \quad \text{and} \quad |G'_\gamma| \leq 1,$$

inequality (3.71) implies :

$$\begin{aligned} R &\geq -\frac{|\rho_{xxx}|}{\sqrt{\gamma^2 + \rho_x^2}} - \frac{\beta^2}{4} - \frac{\tau^2}{8\varepsilon} - \varepsilon \beta^2 \\ &\geq -\frac{\tilde{c}}{\sqrt{\gamma^2 + \rho_x^2}} - \frac{\beta^2}{4} - \frac{\tau^2}{8\varepsilon} - \varepsilon \beta^2 \\ &\geq -\frac{\tilde{c}}{\sqrt{\gamma^2 + \rho_x^2}} - c_1, \end{aligned} \quad (3.75)$$

where

$$c_1 = \frac{\beta^2}{4} + \frac{\tau^2}{8\varepsilon} + \varepsilon\beta^2.$$

Step 5. (The choice of γ and conclusion)

When $\gamma' \leq 0$, from (3.67), (3.75) and the fact that :

$$\begin{aligned} \cosh \beta x &\leq \cosh \beta, & x \in (-1, 1), \\ \cosh \beta x &\geq 1, & x \in \mathbb{R}, \end{aligned}$$

we get

$$\overline{m}_t \geq - \left(\frac{\tilde{c}}{\sqrt{\gamma^2 + \rho_x^2}} + c_1 \right) \overline{m} - \left(\frac{\tau^2 \cosh \beta}{4\varepsilon} \right) \frac{\gamma^2}{\sqrt{\gamma^2 + \rho_x^2}} - \frac{\gamma\gamma'}{\sqrt{\gamma^2 + \rho_x^2}}. \quad (3.76)$$

We remind the reader that ρ_x appearing in the previous inequality have the following form :

$$\rho_x = \rho_x(x_0(t), t),$$

where

$$\overline{m}(t) = \overline{M}(x_0(t), t), \quad x_0(t) \in I. \quad (3.77)$$

Two cases can be considered :

Case A : $\overline{m} = \gamma^2$ smooth.

Assume first that γ is C^1 (which is not the case in general). Then we plug the function $\overline{m} = \gamma^2$ in (3.76) to deduce when $\gamma' \leq 0$:

$$\left(2 + \frac{1}{\sqrt{\gamma^2 + \rho_x^2}} \right) \gamma\gamma' \geq - \left(\frac{\tilde{c}}{\sqrt{\gamma^2 + \rho_x^2}} + c_1 \right) \gamma^2 - c_2 \frac{\gamma^2}{\sqrt{\gamma^2 + \rho_x^2}} \quad (3.78)$$

with

$$c_2 = \frac{\tau^2 \cosh \beta}{4\varepsilon}.$$

Let

$$c^* = \max(c_1, c_2), \quad (3.79)$$

inequality (3.78) implies :

$$\gamma\gamma' \geq - \left[\frac{\tilde{c} + c^*(1 + \sqrt{\gamma^2 + \rho_x^2})}{1 + 2\sqrt{\gamma^2 + \rho_x^2}} \right] \gamma^2,$$

hence

$$\gamma\gamma' \geq -(\tilde{c} + c^*)\gamma^2. \quad (3.80)$$

In other terms

$$\overline{m}_t \geq -2(\tilde{c} + c^*)\overline{m}.$$

This directly implies that $\overline{m}(t) \geq \overline{m}(0)e^{-2(\tilde{c}+c^*)t}$.

Case B : the general case.

Simply choose

$$\gamma(t) = \alpha_1 e^{-(\tilde{c}+c^*)t}, \quad (3.81)$$

where c^* is given by (3.79), and α_1 is given by (3.73). We claim that γ^2 is a sub-solution of (3.76). Indeed, the function γ given by (3.81) is constructed in such a way that γ^2 is a sub-solution of (3.76). To see this, we remark that γ solves the equality that corresponds to the inequality (3.80) and then it solves (3.80) with the reverse inequality. Hence, coming back from (3.80), we can see that γ^2 is a sub-solution of (3.76). Since

$$\gamma^2(0) = \alpha_1^2 = \overline{m}(0),$$

we deduce that

$$\overline{m}(t) \geq \gamma^2(t). \quad (3.82)$$

The fact that $\overline{m} > 0$ implies that $\overline{m} \geq \gamma^2$ directly gives that :

$$\overline{m}(t) > 0, \quad \forall t \in [0, T],$$

therefore

$$\kappa_x(x, t) \geq \sqrt{\gamma^2(t) + \rho_x^2(x, t)}, \quad (x, t) \in \overline{I_T}.$$

Finally, remark that

$$\alpha_1^2 \geq \min(\kappa_x^0 - \sqrt{(\rho_x^0)^2 + \alpha_1^2}) \geq \min(\kappa_x^0 - \rho_x^0 - \alpha_1) \geq \alpha_0 - \alpha_1,$$

i.e. $\alpha_1^2 + \alpha_1 \geq \alpha_0$. If $\alpha_1 \leq 1$, then $2\alpha_1^2 \geq \alpha_0$, therefore in general

$$\alpha_1 \geq \min\left(1, \sqrt{\frac{\alpha_0}{2}}\right) =: \alpha_2. \quad (3.83)$$

Inequality (3.82) implies in particular that we have

$$\kappa_x \geq \sqrt{\rho_x^2 + \gamma^2(t)}.$$

Finally, this result is still true with $\gamma(0) = \alpha_1 = \alpha_2$. □

4 Short time existence, uniqueness, and regularity

In this section, we will prove a result of short time existence, uniqueness and regularity of a solution of problem (1.1), (1.2) and (1.3). This could be done in two steps. At the first step, we show a short time existence and uniqueness result of a truncated system of equations that will be specified later. At the second step, we show an improved regularity of this solution by a bootstrap argument.

4.1 Short-time existence and uniqueness of a truncated system

Fix a time $T_0 > 0$. Consider the following system defined on $I \times (T_0, T_0 + T)$ by :

$$\begin{cases} \kappa_t = \varepsilon \kappa_{xx} + \frac{\rho_{xx} T_{2M_0}(\rho_x)}{(\gamma_0/2) + (\kappa_x - \gamma_0/2)^+} - \tau \rho_x & \text{in } I \times (T_0, T_0 + T) \\ \rho_t = (1 + \varepsilon) \rho_{xx} - \tau \kappa_x & \text{in } I \times (T_0, T_0 + T), \end{cases} \quad (4.84)$$

with $M_0 > 0$ and $\gamma_0 > 0$ are two positive constants. Here, the function $T_a(x)$, $x \in \mathbb{R}$ and $a > 0$, is called a truncation function and is given by :

$$T_a(x) = \begin{cases} a & \text{if } x \geq a \\ x & \text{if } |x| < a \\ -a & \text{if } x \leq -a. \end{cases} \quad (4.85)$$

The initial conditions are :

$$\begin{cases} \rho(x, T_0) = \rho^{T_0}(x) & \text{in } I \times \{t = T_0\} \\ \kappa(x, T_0) = \kappa^{T_0}(x) & \text{in } I \times \{t = T_0\}, \end{cases} \quad (4.86)$$

and the boundary conditions :

$$\begin{cases} \rho(0, t) = \rho(1, t) = 0 & \text{for } T_0 \leq t \leq T_0 + T \\ \kappa(0, t) = 0 \text{ and } \kappa(1, t) = 1 & \text{for } T_0 \leq t \leq T_0 + T. \end{cases} \quad (4.87)$$

Remark 4.1 (*The terms p and α*)

In all what follows, and unless otherwise precised, the term p is a fixed positive real number such that

$$p > 3,$$

and the term $0 < \alpha < 1$ is a fixed real number that is related to p by the following relation

$$\alpha = 1 - 3/p.$$

We write down our next proposition :

Proposition 4.2 (*Short time existence and uniqueness*)

Let $p > 3$, and $T_0 \geq 0$. Let

$$\rho^{T_0}, \kappa^{T_0} \in C^\infty(\bar{I} \times \{T_0\}), \quad \alpha = 1 - 3/p, \quad (4.88)$$

be two given functions such that :

$$\begin{cases} \rho^{T_0}(0) = \rho^{T_0}(1) = 0 \\ \kappa^{T_0}(0) = 0 \quad \text{and} \quad \kappa^{T_0}(1) = 1, \end{cases} \quad (4.89)$$

$$\kappa_x^{T_0} \geq \gamma_0 \quad \text{in} \quad I \times \{t = T_0\}, \quad (4.90)$$

and

$$|\rho_x^{T_0}| \leq M_0 \quad \text{in} \quad I \times \{t = T_0\}, \quad (4.91)$$

where $\gamma_0 > 0$ and $M_0 > 0$ are two given positive real numbers. Suppose that for some $\eta, \beta > 0$, we have

$$\|\rho_{xx}^{T_0}\|_{\infty, I} \leq \eta \quad \text{and} \quad \|D_x^s \kappa^{T_0}\|_{\infty, I} \leq \beta, \quad s = 1, 2. \quad (4.92)$$

Then there exists

$$T = T(\eta, \beta, M_0, \gamma_0, \varepsilon, \tau, p) > 0,$$

such that the system (4.84), (4.86) and (4.87) admits a unique solution

$$(\rho, \kappa) \in (W_p^{2,1}(I \times (T_0, T_0 + T)))^2.$$

Moreover, this solution satisfies

$$\kappa_x \geq \gamma_0/2 \quad \text{in} \quad \bar{I} \times [T_0, T_0 + T], \quad (4.93)$$

and

$$|\rho_x| \leq 2M_0 \quad \text{in} \quad \bar{I} \times [T_0, T_0 + T]. \quad (4.94)$$

Remark 4.3 Remark that the regularity (4.88) of the initial conditions that we have considered is somehow strange and not natural for a result of existence in the Sobolev space $W_p^{2,1}$. In fact, the regularity (4.88), which is natural in connection with the main theorem of this paper (see Theorem 1.1), was just taken for the simplification of the forthcoming announcements of our results.

Remark 4.4 It is worth noticing that (4.89) justifies the compatibility of zero order with the boundary conditions (4.87) (see (2.25)).

Proof of Proposition (4.2). Let

$$I_{T_0, T} = I \times (T_0, T_0 + T) \quad \text{and} \quad Y = W_p^{2,1}(I_{T_0, T}).$$

We will prove the existence and uniqueness for T small enough using a fixed point argument. Define the application Ψ by :

$$\begin{aligned} \Psi : Y^2 &\longmapsto Y^2 \\ (\hat{\rho}, \hat{\kappa}) &\longmapsto \Psi(\hat{\rho}, \hat{\kappa}) = (\rho, \kappa), \end{aligned} \tag{4.95}$$

where (ρ, κ) is a solution of the following system :

$$\begin{cases} \kappa_t = \varepsilon \kappa_{xx} + \frac{\rho_{xx} T_{2M_0}(\hat{\rho}_x)}{(\gamma_0/2) + (\hat{\kappa}_x - \gamma_0/2)^+} - \tau \hat{\rho}_x & \text{in } I_{T_0, T}, \\ \rho_t = (1 + \varepsilon) \rho_{xx} - \tau \hat{\kappa}_x & \text{in } I_{T_0, T}, \end{cases} \tag{4.96}$$

with the same initial and boundary conditions given by (4.86) and (4.87) respectively. Recall that ρ^{T_0} and κ^{T_0} verify (4.89). Hence we deduce from Theorem 2.3 (using on one hand, the fact that the source terms of both equations of (4.96) are in $L^p(I_{T_0, T})$; the fact that $\rho^{T_0}, \kappa^{T_0} \in W_p^{2-2/p}(I \times \{T_0\})$ “this is a direct consequence of (4.88)”, and on the other hand, the compatibility of the boundary conditions (see Remark 4.4)), the existence and uniqueness of the solution $(\rho, \kappa) \in Y^2$ of (4.96), (4.86) and (4.87). We claim that Ψ is a contraction map over some suitable closed subset of Y^2 for T small enough. Let us clarify that the constant c that will frequently appear in the proof may vary from line to line but always has the form :

$$c = c(\varepsilon, p, \tau) > 0.$$

Assume we are searching for some $T > 0$ such that

$$0 < T < 1/4.$$

The proof is divided into three steps.

Step 1. (Defining the map Ψ over a suitable subset)

Let λ be any fixed constant. Define D_λ^ρ and D_λ^κ as the two closed subsets of Y given by :

$$D_\lambda^\rho = \{u \in Y; \|u_x\|_{p, I_{T_0, T}} \leq \lambda, \quad u = \rho^{T_0} \text{ on } \partial^p I_{T_0, T}\} \tag{4.97}$$

and

$$D_\lambda^\kappa = \{v \in Y; \|v_x\|_{p, I_{T_0, T}} \leq \lambda, \quad v = \kappa^{T_0} \text{ on } \partial^p I_{T_0, T}\}. \tag{4.98}$$

We will prove that Ψ is a well defined map over $D_\lambda^\rho \times D_\lambda^\kappa$ into itself, at least for sufficiently small time T . Let $(\hat{\rho}, \hat{\kappa}) \in D_\lambda^\rho \times D_\lambda^\kappa$ and let

$$\Psi(\hat{\rho}, \hat{\kappa}) = (\rho, \kappa).$$

We use system (4.96) to write down some estimates. Take

$$\bar{\rho}(x, t) = \rho(x, t) - \rho^{T_0}(x) \quad \text{and} \quad \bar{\kappa}(x, t) = \kappa(x, t) - \kappa^{T_0}(x). \quad (4.99)$$

From (4.96), the equations satisfied by $\bar{\rho}$ and $\bar{\kappa}$ are :

$$\begin{cases} \bar{\rho}_t = (1 + \varepsilon)\bar{\rho}_{xx} + (1 + \varepsilon)\rho_{xx}^{T_0} - \tau\hat{\kappa}_x & \text{on } I_{T_0, T}, \\ \bar{\rho} = 0 & \text{on } \partial^p I_{T_0, T}, \end{cases} \quad (4.100)$$

and

$$\begin{cases} \bar{\kappa}_t = \varepsilon\bar{\kappa}_{xx} + \frac{(\bar{\rho}_{xx} + \rho_{xx}^{T_0})T_{2M_0}(\hat{\rho}_x)}{(\gamma_0/2) + (\hat{\kappa}_x - \gamma_0/2)^+} + \varepsilon\kappa_{xx}^{T_0} - \tau\hat{\rho}_x & \text{on } I_{T_0, T}, \\ \bar{\kappa} = 0 & \text{on } \partial^p I_{T_0, T}, \end{cases} \quad (4.101)$$

respectively. We use equation (4.100) together with the estimate (2.33), we obtain

$$\begin{aligned} \|\bar{\rho}_x\|_{p, I_{T_0, T}} &\leq c\sqrt{T} (\|\rho_{xx}^{T_0}\|_{p, I_{T_0, T}} + \|\hat{\kappa}_x\|_{p, I_{T_0, T}}) \\ &\leq c\sqrt{T} (T^{1/p}\|\rho_{xx}^{T_0}\|_{p, I} + \lambda) \\ &\leq cT^{1/p} (\eta + \lambda), \end{aligned}$$

and from (4.99), we deduce that

$$\|\rho_x\|_{p, I_{T_0, T}} \leq cT^{1/p} (\eta + \lambda + M_0). \quad (4.102)$$

Therefore, choosing T satisfying :

$$T \leq \left(\frac{\lambda}{c(\eta + \lambda + M_0)} \right)^p \quad (4.103)$$

ensures that $\|\rho_x\|_{p, I_{T_0, T}} \leq \lambda$ and hence

$$\rho \in D_\lambda^\rho.$$

In the same way, we use equation (4.101) with the estimate (2.33) to obtain

$$\begin{aligned} \|\bar{\kappa}_x\|_{p, I_{T_0, T}} &\leq c\sqrt{T} \left[\frac{4M_0}{\gamma_0} \|\rho_{xx}\|_{p, I_{T_0, T}} + T^{1/p} \|\kappa_{xx}^{T_0}\|_{p, I} + \|\hat{\rho}_x\|_{p, I_{T_0, T}} \right] \\ &\leq c\sqrt{T} \left[\frac{4M_0}{\gamma_0} (T^{1/p}\eta + \lambda) + T^{1/p}\beta + \lambda \right] \\ &\leq cT^{1/p} \left[\frac{4M_0}{\gamma_0} (\eta + \lambda) + \beta + \lambda \right], \end{aligned} \quad (4.104)$$

4. Short time existence, uniqueness, and regularity

where we have used again, passing from the first to the second line, the equation (4.100) together with the estimate (2.33). Precisely, we have used that :

$$\|\bar{\rho}_{xx}\|_{p,I_{T_0,T}} \leq c(T^{1/p}\eta + \lambda).$$

From (4.104) and (4.99), we deduce that

$$\|\kappa_x\|_{p,I_{T_0,T}} \leq cT^{1/p} \left[\frac{4M_0}{\gamma_0} (\eta + \lambda) + \beta + \lambda \right]. \quad (4.105)$$

In this case, choosing

$$T \leq \left(\frac{\lambda}{c \left(\frac{4M_0}{\gamma_0} (\eta + \lambda) + \beta + \lambda \right)} \right)^p \quad (4.106)$$

ensures that $\|\kappa_x\|_{p,I_{T_0,T}} \leq \lambda$ and hence

$$\kappa \in D_\lambda^\kappa.$$

From (4.103) and (4.106), we deduce that for sufficiently small time T , the map Ψ is a well defined map from $D_\lambda^\rho \times D_\lambda^\kappa$ into itself.

Step 2. (Ψ is a contraction map)

Let

$$\Psi(\hat{\rho}, \hat{\kappa}) = (\rho, \kappa) \quad \text{and} \quad \Psi(\hat{\rho}', \hat{\kappa}') = (\rho', \kappa').$$

The couple $(\rho - \rho', \kappa - \kappa')$ is the solution of the following system :

$$\begin{cases} (\kappa - \kappa')_t = \varepsilon(\kappa - \kappa')_{xx} + \frac{\rho_{xx} T_{2M_0}(\hat{\rho}_x)}{(\gamma_0/2) + (\hat{\kappa}_x - \gamma_0/2)^+} \\ \quad - \frac{\rho'_{xx} T_{2M_0}(\hat{\rho}'_x)}{(\gamma_0/2) + (\hat{\kappa}'_x - \gamma_0/2)^+} - \tau(\hat{\rho} - \hat{\rho}')_x & \text{in } I_{T_0,T} \\ (\rho - \rho')_t = (1 + \varepsilon)(\rho - \rho')_{xx} - \tau(\hat{\kappa} - \hat{\kappa}')_x & \text{in } I_{T_0,T}, \end{cases} \quad (4.107)$$

with

$$(\rho - \rho', \kappa - \kappa') = (0, 0) \quad \text{on} \quad \partial^p I_{T_0,T}. \quad (4.108)$$

Step 2.1. From the second equation of (4.107), and (2.33), we have :

$$\|\rho - \rho'\|_Y \leq c\|(\hat{\kappa} - \hat{\kappa}')_x\|_{p,I_{T_0,T}}. \quad (4.109)$$

By the boundary conditions (4.108) and the L^p parabolic estimate (2.33), we deduce that for some $c > 0$, we have :

$$\|(\hat{\kappa} - \hat{\kappa}')_x\|_{p,I_{T_0,T}} \leq c\sqrt{T}\|(\hat{\kappa} - \hat{\kappa}')_t - (\hat{\kappa} - \hat{\kappa}')_{xx}\|_{p,I_{T_0,T}} \leq c\sqrt{T}\|\hat{\kappa} - \hat{\kappa}'\|_Y. \quad (4.110)$$

Therefore from (4.109),

$$\|\rho - \rho'\|_Y \leq c\sqrt{T}\|\hat{\kappa} - \hat{\kappa}'\|_Y, \quad (4.111)$$

Step 2.2. Let F be the function given by :

$$F = \frac{\rho_{xx}T_{2M_0}(\hat{\rho}_x)}{(\gamma_0/2) + (\hat{\kappa}_x - \gamma_0/2)^+} - \frac{\rho'_{xx}T_{2M_0}(\hat{\rho}'_x)}{(\gamma_0/2) + (\hat{\kappa}'_x - \gamma_0/2)^+} - \tau(\hat{\rho} - \hat{\rho}')_x. \quad (4.112)$$

From the first equation of (4.107) and using (2.33), we get

$$\|\kappa - \kappa'\|_Y \leq c\|F\|_{p,I_{T_0,T}}, \quad (4.113)$$

The function F can be rewritten as follows :

$$\begin{aligned} F + \tau(\hat{\rho} - \hat{\rho}')_x &= \overbrace{\frac{T_{2M_0}(\hat{\rho}_x)}{(\gamma_0/2) + (\hat{\kappa}_x - \gamma_0/2)^+}(\rho_{xx} - \rho'_{xx})}^{A_1} + \overbrace{\frac{\rho'_{xx}(T_{2M_0}(\hat{\rho}_x) - T_{2M_0}(\hat{\rho}'_x))}{(\gamma_0/2) + (\hat{\kappa}_x - \gamma_0/2)^+}}^{A_2} \\ &+ \overbrace{\rho'_{xx}T_{2M_0}(\hat{\rho}'_x)}^{A_3} \left(\frac{1}{(\gamma_0/2) + (\hat{\kappa}_x - \gamma_0/2)^+} - \frac{1}{(\gamma_0/2) + (\hat{\kappa}'_x - \gamma_0/2)^+} \right). \end{aligned} \quad (4.114)$$

We are going to use the system (4.107), (4.108) together with the inequality (2.33) in order to estimate each term of (4.114). First, from (4.111), we have :

$$\begin{aligned} \|A_1\|_{p,I_{T_0,T}} &\leq 4\frac{M_0}{\gamma_0}\|(\rho - \rho')_{xx}\|_{p,I_{T_0,T}} \\ &\leq c\frac{M_0}{\gamma_0}\sqrt{T}\|\hat{\kappa} - \hat{\kappa}'\|_Y. \end{aligned} \quad (4.115)$$

For the term A_2 , we proceed as follows. We apply the L^∞ control of the spatial derivative (see Lemma 2.10) to the function $\hat{\rho} - \hat{\rho}'$, we get :

$$\|(\hat{\rho} - \hat{\rho}')_x\|_{\infty,I_{T_0,T}} \leq cT^{\frac{p-3}{2p}}\|\hat{\rho} - \hat{\rho}'\|_Y. \quad (4.116)$$

For the term ρ'_{xx} , we first remark that if we let $\bar{\rho}' = \rho' - \rho^{T_0}$, this function satisfies (4.100) with $\hat{\kappa}_x$ replaced by $\hat{\kappa}'_x$, and hence we deduce that

$$\|\rho'_{xx}\|_{p,I_{T_0,T}} \leq c(\eta + \lambda). \quad (4.117)$$

From (4.116) and (4.117), we deduce that

$$\|A_2\|_{p,I_{T_0,T}} \leq c\frac{(\eta + \lambda)}{\gamma_0}T^{\frac{p-3}{2p}}\|\hat{\rho} - \hat{\rho}'\|_Y. \quad (4.118)$$

4. Short time existence, uniqueness, and regularity

The term A_3 could be treated in a similar way as the term A_2 , and we obtain the following estimate :

$$\|A_3\|_{p, I_{T_0}, T} \leq c \frac{M_0(\eta + \lambda)}{\gamma_0^2} T^{\frac{p-3}{2p}} \|\hat{\kappa} - \hat{\kappa}'\|_Y. \quad (4.119)$$

Also we have

$$\|(\hat{\rho} - \hat{\rho}')_x\|_{p, I_{T_0}, T} \leq c\sqrt{T} \|(\hat{\rho} - \hat{\rho}')_t - (\hat{\rho} - \hat{\rho}')_{xx}\|_{p, I_{T_0}, T} \leq c\sqrt{T} \|\hat{\rho} - \hat{\rho}'\|_Y.$$

Step 2.3. From (4.111) in Step 2.1, and (4.113) in step 2.2, we finally get :

$$\|\Psi(\hat{\rho}, \hat{\kappa}) - \Psi(\hat{\rho}', \hat{\kappa}')\|_{Y^2} \leq cT^{\frac{p-3}{2p}} \left[1 + \frac{M_0}{\gamma_0} + \frac{\eta + \lambda}{\gamma_0} \left(1 + \frac{M_0}{\gamma_0} \right) \right] \|(\hat{\rho}, \hat{\kappa}) - (\hat{\rho}', \hat{\kappa}')\|_{Y^2},$$

and therefore, taking T satisfying :

$$T < \left(\frac{1}{c \left(1 + \frac{M_0}{\gamma_0} + \frac{\eta + \lambda}{\gamma_0} \left(1 + \frac{M_0}{\gamma_0} \right) \right)} \right)^{\frac{2p}{p-3}}, \quad (4.120)$$

(4.103) and (4.106), we deduce that Ψ is a contraction from $D_\lambda^p \times D_\lambda^k$ into itself.

Step 3. (Conclusion)

In order to terminate the proof, it remains to show (4.93) and (4.94), again for sufficiently small time T . In fact, this will be done by controlling the modulus of continuity in time of ρ_x and κ_x uniformly with respect to T . The time T that we will use in Step 3 is that determined by (4.103), (4.106) and (4.120), ensuring existence and uniqueness. However, additional conditions will be imposed on T so that the inequalities (4.93) and (4.94) are valid on \bar{Q}_T .

Step 3.1. (Controlling the quantity ρ_x)

Indeed, from estimate (2.36), we deduce that

$$\begin{aligned} \langle \bar{\rho}_x \rangle_{I_{T_0}, T}^{(\alpha)} &\leq c \left(\|\bar{\rho}_t\|_{p, I_{T_0}, T} + \|\bar{\rho}_{xx}\|_{p, I_{T_0}, T} + \frac{1}{T} \|\bar{\rho}\|_{p, I_{T_0}, T} \right) \\ &\leq c(\eta + \lambda), \end{aligned}$$

where for the last line we have used estimate (2.33) for equation (4.100). Hence we have

$$\langle \bar{\rho}_x \rangle_{t, I_{T_0}, T}^{(\alpha/2)} \leq c(\eta + \lambda).$$

Call $m_1 = c(\eta + \lambda)$, and recall that $\bar{\rho} = \rho - \rho^{T_0}$, we therefore obtain

$$\langle \rho_x \rangle_{t, I_{T_0, T}}^{(\alpha/2)} \leq m_1. \quad (4.121)$$

From (2.24), (4.91), and (4.121), we deduce that for any $(x, t) \in \bar{Q}_T$, we have

$$|\rho_x(x, t)| \leq m_1 T^{\alpha/2} + M_0,$$

and then for

$$T \leq \left(\frac{M_0}{m_1} \right)^{2/\alpha}, \quad (4.122)$$

we obtain

$$|\rho_x| \leq 2M_0, \quad \forall (x, t) \in \bar{Q}_T.$$

Step 3.2. (Controlling the quantity κ_x)

We argue in a similar manner in order to control $\langle \kappa_x \rangle_{t, I_{T_0, T}}^{(\alpha/2)}$. Again, using (4.101), (2.36) and (2.33), we deduce that

$$\langle \kappa_x \rangle_{t, I_{T_0, T}}^{(\alpha/2)} \leq m_2, \quad (4.123)$$

with

$$m_2 = c \left(\frac{4M_0}{\gamma_0} (\eta + \lambda) + \beta + \lambda \right).$$

Following the same arguments as above, we obtain that for

$$T \leq \left(\frac{\gamma_0}{2m_2} \right)^{2/\alpha}, \quad (4.124)$$

we have

$$\kappa_x \geq \gamma_0/2, \quad \forall (x, t) \in \bar{Q}_T.$$

By choosing T verifying (4.103), (4.106), (4.120), (4.122) and (4.124), we reach the end of the proof. \square

4.2 Regularity of the solution

This subsection is devoted to show that the solution of (4.84), (4.86) and (4.87) enjoys more regularity than the one indicated in Proposition 4.2. This will be done using a special bootstrap argument, together with the Hölder regularity of solutions of parabolic equations.

Remark 4.5 (*The computations of Proposition 3.1*)

The following proposition shows that the solution of (4.84), (4.86) and (4.87) has the sufficient regularity so that the calculation of the proof of the comparison principle (Proposition 3.1) can be done.

Proposition 4.6 (*Regularity of the solution : bootstrap argument*)

Under the same hypothesis of Proposition 4.2, let ρ^{T_0} and κ^{T_0} satisfy :

$$(1 + \varepsilon)\rho_{xx}^{T_0} = \tau\kappa_x^{T_0} \quad \text{at } \partial I, \quad (4.125)$$

and

$$(1 + \varepsilon)\kappa_{xx}^{T_0} = \tau\rho_x^{T_0} \quad \text{at } \partial I. \quad (4.126)$$

Then the unique solution $(\rho, \kappa) \in Y^2$ given by Proposition 4.2, satisfying (4.93) and (4.94), is in fact more regular. To be more precise, it satisfies :

$$\rho \in C^{3+\alpha, \frac{3+\alpha}{2}}(\bar{I} \times [T_0, T_0 + T]), \quad \alpha = 1 - 3/p, \quad (4.127)$$

and

$$\kappa \in C^{3+\alpha, \frac{3+\alpha}{2}}(\bar{I} \times [T_0, T_0 + T]), \quad \alpha = 1 - 3/p, \quad (4.128)$$

where T is the time given by Proposition 4.2. Moreover, we have :

$$(\rho, \kappa) \in \left(C^\infty(I \times (T_0, T_0 + T)) \right)^2, \quad (4.129)$$

precisely,

$$(\rho, \kappa) \in \left(C^\infty[\bar{I} \times [T_0 + \delta, T_0 + T]] \right)^2, \quad \forall 0 < \delta < T. \quad (4.130)$$

Proof. Let us first indicate that since, from (4.93) and (4.94), $\kappa_x \geq \gamma_0/2$ and $|\rho_x| \leq 2M_0$, then

$$T_{2M_0}(\rho_x) = \rho_x \quad \text{and} \quad (\gamma_0/2) + (\kappa_x - \gamma_0/2)^+ = \kappa_x,$$

therefore the system (4.84) can be rewritten as :

$$\begin{cases} \kappa_t = \varepsilon\kappa_{xx} + \frac{\rho_x\rho_{xx}}{\kappa_x} - \tau\rho_x & \text{on } I \times (T_0, T_0 + T) \\ \rho_t = (1 + \varepsilon)\rho_{xx} - \tau\kappa_x & \text{on } I \times (T_0, T_0 + T). \end{cases} \quad (4.131)$$

For the sake of simplicity, let us suppose that $T_0 = 0$. We first write system (4.131) as a two “separate” equations :

$$\begin{cases} \rho_t = (1 + \varepsilon)\rho_{xx} - \tau\kappa_x & \text{on } I_T = I \times (0, T) \\ \rho(x, 0) = \rho^0(x) & \text{on } I \\ \rho(x, t) = 0 \quad x \in \partial I, t \in [0, T]. \end{cases} \quad (4.132)$$

and

$$\begin{cases} \kappa_t = \varepsilon \kappa_{xx} + \frac{\rho_x \rho_{xx}}{\kappa_x} - \tau \rho_x & \text{on } I_T \\ \kappa(x, 0) = \kappa^0(x) & \text{on } I \\ \kappa(0, t) = 0 \quad \text{and} \quad \kappa(1, t) = 1, \quad t \in [0, T], \end{cases} \quad (4.133)$$

where we set $\rho^0 = \rho^{T_0}$ and $\kappa^0 = \kappa^{T_0}$. The proof could be divided into three steps.

Step 1. (The Hölder regularity of the solution)

Since $\kappa \in W_p^{2,1}(I_T)$, we use Lemma 2.8 to deduce that $\kappa_x \in C^{\alpha, \alpha/2}(\overline{I_T})$. From the boundary conditions of system (4.132) and form (4.125) we deduce the compatibility of order 1 for the equation (4.132). Also, we have $\rho^0 \in C^{2+\alpha}(\bar{I})$. This altogether permits using the solvability of (4.132) in Hölder spaces (see Theorem 2.1) to deduce that

$$\rho \in C^{2+\alpha, 1+\alpha/2}(\overline{I_T}), \quad \alpha = 1 - 3/p, \quad (4.134)$$

in particular, we have

$$\rho, \rho_t, \rho_x, \rho_{xx} \in C^{\alpha, \alpha/2}(\overline{I_T}). \quad (4.135)$$

From (4.135) and the fact that $\kappa_x \geq \gamma_0/2$, we deduce that the source term $\frac{\rho_x \rho_{xx}}{\kappa_x} - \tau \rho_x$ of system (4.133) lies in $C^{\alpha, \alpha/2}(\overline{I_T})$. We also have, from (4.93), (4.125) and (4.126), that :

$$\begin{aligned} \varepsilon \kappa_{xx}^0 + \frac{\rho_x^0 \rho_{xx}^0}{\kappa_x^0} - \tau \rho_x^0 \Big|_{\partial I} &= \varepsilon \kappa_{xx}^0 + \frac{\tau \rho_x^0 \kappa_x^0}{(1 + \varepsilon) \kappa_x^0} - \tau \rho_x^0 \Big|_{\partial I} \\ &= \frac{\varepsilon}{1 + \varepsilon} \left((1 + \varepsilon) \kappa_{xx}^0 - \tau \rho_x^0 \right) \Big|_{\partial I} \\ &= 0. \end{aligned}$$

This, together with the constant boundary condition of system (4.133), ensures the compatibility of order 1, and hence we reuse Theorem 2.1 to deduce that

$$\kappa \in C^{2+\alpha, 1+\alpha/2}(\overline{I_T}), \quad \alpha = 1 - 3/p. \quad (4.136)$$

Step 2. (The increment of the Hölder regularity)

From (4.136), we see that the regularity of the source term of system (4.132) is increased. In fact, now

$$\kappa_x \in C^{1+\alpha, \frac{1+\alpha}{2}}(\overline{I_T}), \quad \alpha = 1 - 3/p. \quad (4.137)$$

However, in order to use the Hölder solvability for the system (4.132), in particular Theorem 2.1, with this new obtained regularity of the source term (4.137), we just

4. Short time existence, uniqueness, and regularity

need to check that the compatibility of the boundary conditions is not altered. Indeed, this is the case since

$$0 < 1 + \alpha < 2.$$

We also remark from (4.88) that $\rho^0 \in C^{2+(1+\alpha)}(\bar{I})$, and therefore, we can use Theorem 2.1 to deduce that

$$\rho \in C^{3+\alpha, \frac{3+\alpha}{2}}(\bar{I}_T), \quad (4.138)$$

hence (4.127) is satisfied. Similarly, as in Step 1, (4.138) increases the regularity of the source term of system (4.133) hence

$$\frac{\rho_x \rho_{xx}}{\kappa_x} - \tau \rho_x \in C^{1+\alpha, \frac{1+\alpha}{2}}(\bar{I}_T).$$

Again the compatibility between the boundary conditions of system (4.133) is unchanged, and (4.88), we know that $\kappa^0 \in C^{2+(1+\alpha)}(\bar{I})$. Therefore, upon reusing Theorem 2.1, we deduce that

$$\kappa \in C^{3+\alpha, \frac{3+\alpha}{2}}(\bar{I}_T), \quad (4.139)$$

hence (4.128) is satisfied and the proof is done.

Step 3. (The C^∞ regularity)

At this point, we will show how to obtain more regularity of the solution (ρ, κ) away from the initial data. Remark that if we want to follow similar arguments of what was done in the previous two steps, we might think of increasing the regularity of ρ by using the Hölder solvability, Theorem 2.1, and the fact that $\kappa_x \in C^{2+\alpha, \frac{2+\alpha}{2}}(\bar{I}_T)$ (see (4.139) above). In fact, this requires higher order compatibility conditions that are not satisfied having only (4.125) and (4.126). We send the reader to [65, Chapter 4, section 5, page 319] for the details of these compatibility conditions. To overcome this difficulty, we introduce the following function. Let $0 < \delta < T$, define the test function $\bar{\varphi}_\delta \in C^\infty[0, T]$ by :

$$\bar{\varphi}_\delta(t) = \begin{cases} 0 & \text{if } 0 \leq t \leq \delta/3 \\ \bar{\varphi}_\delta(t) \in (0, 1) & \text{if } \delta/3 < t < 2\delta/3 \\ 1 & \text{if } 2\delta/3 \leq t \leq T. \end{cases} \quad (4.140)$$

We introduce the quantities

$$\bar{\rho} = \rho \bar{\varphi}_\delta \quad \text{and} \quad \bar{\kappa} = \kappa \bar{\varphi}_\delta. \quad (4.141)$$

We can easily check that these quantities satisfy two parabolic equations with the higher order compatibility of the initial data are all satisfied. By the bootstrap argument (see Steps 1, 2 above), we get :

$$(\bar{\rho}, \bar{\kappa}) \in C^\infty(\bar{I}_T).$$

From (4.140) and (4.141), we deduce that

$$(\bar{\rho}, \bar{\kappa}) = (\rho, \kappa) \quad \text{on} \quad [2\delta/3, T],$$

hence the C^∞ regularity (4.129) and (4.130) are both satisfied. \square

5 Exponential bounds

In this section, we will give some exponential bounds of the solution given by Proposition (4.2) and having the regularity shown by Proposition (4.6).

It is very important, throughout all this section, to precise our notation concerning the constants that may certainly vary from line to line. Let us mention that a constant depending on time will be denoted by $c(T)$. Those who do not depend on T will be simply denoted by c . In all other cases, we will follow the changing of the constants in a precise manner.

Proposition 5.1 (*Exponential bound in time for $\|(\rho_x(\cdot, t), \kappa_x(\cdot, t))\|_{\infty, I}$*)
Let

$$(\rho, \kappa) \in C^{3+\alpha, \frac{3+\alpha}{2}}(\bar{I} \times [0, \infty)) \cap C^\infty(I \times (0, \infty)) \cap C^\infty(\bar{I} \times [\delta, \infty)), \quad \forall \delta > 0,$$

be a long time solution of the following system :

$$\begin{cases} \kappa_t = \varepsilon \kappa_{xx} + \frac{\rho_x \rho_{xx}}{\kappa_x} - \tau \rho_x & \text{on} \quad I \times (0, \infty) \\ \rho_t = (1 + \varepsilon) \rho_{xx} - \tau \kappa_x & \text{on} \quad I \times (0, \infty), \end{cases} \quad (5.142)$$

with $\rho(x, 0) = \rho^0(x)$, $\kappa(x, 0) = \kappa^0(x)$, and the boundary conditions

$$\rho(0, \cdot) = \rho(1, \cdot) = 0 \quad \text{on} \quad \partial I \times [0, \infty), \quad (5.143)$$

$$\kappa(0, \cdot) = 0, \quad \kappa(1, \cdot) = 1 \quad \text{on} \quad \partial I \times [0, \infty). \quad (5.144)$$

Suppose furthermore that

$$B = \frac{\rho_x}{\kappa_x} \quad \text{satisfies} \quad \|B\|_\infty < 1.$$

Then we have

$$\|(\rho_x(\cdot, t), \kappa_x(\cdot, t))\|_{\infty, I} \leq ce^{ct}, \quad (5.145)$$

where

$$c = c\left(\|\rho^0\|_{W_p^{2-2/p}(I)}, \|\kappa^0\|_{W_p^{2-2/p}(I)}\right) \geq 1, \quad p > 3.$$

Remark 5.2 (Improved exponential bound)

Concerning the exponential bound (5.145), we can even get

$$\|(\rho_x(\cdot, t), \kappa_x(\cdot, t))\|_{\infty, I} \leq cae^{ct},$$

where $a = \left(1 + \|\rho^0\|_{W_p^{2-2/p}(I)} + \|\kappa^0\|_{W_p^{2-2/p}(I)}\right)$, and $c > 0$ is a fixed constant independent of $\|\rho^0\|_{W_p^{2-2/p}(I)}$ and $\|\kappa^0\|_{W_p^{2-2/p}(I)}$ (see the final step of the following proof). However, this result will not be used in that refined form.

Proof of Proposition 5.1. We use the special coupling of the system (5.142) to find our *a priori* estimate. Roughly speaking, the fact that κ_x appears as a source term in the second equation of system (5.142) permits, by the L^p theory for parabolic equations, to have L^p bounds, in terms of $\|\kappa_x\|_{p, I_T}$, on ρ_x and ρ_{xx} which in their turn appear in the source terms of the first equation of (5.142) satisfied by κ . All this permits to deduce our estimates. To be more precise, let $T > 0$ an arbitrarily fixed time.

Step 1. (estimating κ_x in the L^p norm)

Let κ' be the solution of the following equation :

$$\begin{cases} \kappa'_t = \kappa'_{xx} & \text{on } I_T \\ \kappa' = \kappa & \text{on } \partial^p I_T. \end{cases} \quad (5.146)$$

As a solution of a parabolic equation, we use the L^p parabolic estimate (2.32) to the function κ' to deduce that :

$$\|\kappa'\|_{W_p^{2,1}(I_T)} \leq c(T) \left(\|\kappa^0\|_{W_p^{2-2/p}(I)} + 1\right), \quad (5.147)$$

where the term 1 comes from the value of $\kappa' = \kappa$ on S_T . Take

$$\bar{\kappa} = \kappa - \kappa', \quad (5.148)$$

then the system satisfied by $\bar{\kappa}$ reads :

$$\begin{cases} \bar{\kappa}_t = \bar{\kappa}_{xx} - (\kappa'_t - \varepsilon\kappa'_{xx}) + \frac{\rho_x\rho_{xx}}{\kappa_x} - \tau\rho_x & \text{on } I_T \\ \bar{\kappa} = 0 & \text{on } \partial^p I_T. \end{cases} \quad (5.149)$$

Using the special version (2.33) of the parabolic L^p estimate to the function $\bar{\kappa}$, we obtain :

$$\|\bar{\kappa}_x\|_{p,I_T} \leq c\sqrt{T} \left(\|\kappa'_t\|_{p,I_T} + \|\kappa'_{xx}\|_{p,I_T} + \|\rho_{xx}\|_{p,I_T} + \|\rho_x\|_{p,I_T} \right), \quad (5.150)$$

where we have plugged into the constant c the terms ε, τ, p and $\|B\|_\infty$. Combining (5.147), (5.148) and (5.150), we get :

$$\|\kappa_x\|_{p,I_T} \leq c(T) \left(\|\kappa^0\|_{W_p^{2-2/p}(I)} + 1 \right) + c\sqrt{T}\|\rho\|_{W_p^{2,1}(I_T)}. \quad (5.151)$$

The term $\|\rho\|_{W_p^{2,1}(I_T)}$ appearing in the previous inequality is going to be estimated in the next step.

Step 2. (estimating ρ in the $W_p^{2,1}$ norm)

As in Step 1, let $\rho', \bar{\rho}$ be the two function defined similarly as $\kappa', \bar{\kappa}$ respectively (see (5.146) and (5.148)). ρ' satisfies an inequality similar to (5.147) that reads :

$$\|\rho'\|_{W_p^{2,1}(I_T)} \leq c(T)\|\rho^0\|_{W_p^{2-2/p}(I)}. \quad (5.152)$$

The term 1 has disappeared because $\rho' = \rho = 0$ on $\overline{S_T}$. We write the system satisfied by $\bar{\rho}$, we obtain :

$$\begin{cases} \bar{\rho}_t = (1 + \varepsilon)\bar{\rho}_{xx} + ((1 + \varepsilon)\rho'_{xx} - \rho'_t) - \tau\kappa_x & \text{on } I_T \\ \bar{\rho}(x, 0) = 0 & \text{on } \partial^p I_T, \end{cases} \quad (5.153)$$

hence the following estimate on $\bar{\rho}$, due to the special L^p interior estimate (2.33), holds :

$$\|\bar{\rho}\|_{W_p^{2,1}(I_T)} \leq c(\|\rho'_t\|_{p,I_T} + \|\rho'_{xx}\|_{p,I_T} + \|\kappa_x\|_{p,I_T}). \quad (5.154)$$

Again, we have plugged ε, τ and p into the constant c , and we have assumed that $T \leq 1$. Combining (5.152) and (5.154), we get in terms of ρ :

$$\|\rho\|_{W_p^{2,1}(I_T)} \leq c(T)\|\rho^0\|_{W_p^{2-2/p}(I)} + c\|\kappa_x\|_{p,I_T}. \quad (5.155)$$

We will use this estimate in order to have a control on $\|\kappa_x\|_{p,I_T}$ for sufficiently small time.

Step 3. (Estimate on a small time interval)

From (5.151) and (5.155), we deduce that :

$$\|\kappa_x\|_{p,I_T} \leq c(T) \left(\|\kappa^0\|_{W_p^{2-2/p}(I)} + \|\rho^0\|_{W_p^{2-2/p}(I)} + 1 \right) + c\sqrt{T}\|\kappa_x\|_{p,I_T}. \quad (5.156)$$

Let us remind the reader that all constants c and $c(T)$ have been changing from line to line. In fact, the important thing is whether they depend on T or not. Let

$$T^* = \frac{1}{2c^2}, \quad c \text{ is the constant appearing in (5.156),}$$

we deduce, from (5.156), that

$$\|\kappa_x\|_{p, I_{T^*}} \leq c_3 \left(\|\kappa^0\|_{W_p^{2-2/p}(I)} + \|\rho^0\|_{W_p^{2-2/p}(I)} + 1 \right),$$

where $c_3 = c_3(T^*) > 0$ is a positive constant which depends on T^* . From the special coupling of system (5.142), and the above estimate, we can deduce that :

$$\|(\rho, \kappa)\|_{W_p^{2,1}(I_{T^*})} \leq c_4 \left(\|\kappa^0\|_{W_p^{2-2/p}(I)} + \|\rho^0\|_{W_p^{2-2/p}(I)} + 1 \right), \quad (5.157)$$

with $c_4 = c_4(T^*) > 0$ also a positive constant depending on T^* but independent of the initial data.

Step 4. (The exponential estimate by iteration)

Now we move to show the exponential bound. Set

$$f(t) = \|(\rho, \kappa)\|_{W_p^{2,1}(I \times (t, t+T^*))}, \quad h(t) = \|(\rho_x, \kappa_x)\|_{\infty, I \times (t, t+T^*)},$$

and

$$g(t) = \|\kappa(\cdot, t)\|_{W_p^{2-2/p}(I)} + \|\rho(\cdot, t)\|_{W_p^{2-2/p}(I)}. \quad (5.158)$$

We have proved in Step 3, estimate (5.157), that

$$f(0) \leq c_4[g(0) + 1],$$

and we know, from the Lemma 2.9 “trace of $W_p^{2,1}$ functions”, estimate (2.39), that

$$g(T^*) \leq c_5 f(0), \quad c_5 = c_5(T^*) > 0,$$

hence for $\lambda = 1 + c_4 c_5 > 1$, we get :

$$g(T^*) + 1 \leq \lambda[g(0) + 1].$$

Therefore, for $n \in \mathbb{N}$, $n \geq 1$, by iteration we have :

$$g(nT^*) + 1 \leq \lambda^n [g(0) + 1],$$

and hence

$$f(nT^*) \leq c_4 \lambda^n [g(0) + 1]. \quad (5.159)$$

From the Sobolev embedding in Hölder spaces, Lemma 2.8, estimate (2.35), we know that

$$h(nT^*) \leq c_6 f(nT^*), \quad c_6 = c_6(T^*) > 0. \quad (5.160)$$

Combining (5.159) and (5.160), we obtain

$$h(nT^*) \leq c_7 \lambda^n [g(0) + 1], \quad c_7 = c_4 c_6. \quad (5.161)$$

Using the fact that

$$h(t) \leq h(nT^*) + h((n+1)T^*), \quad \text{if } nT^* \leq t \leq (n+1)T^*,$$

we deduce, from (5.161), that :

$$h(t) \leq c_8 [g(0) + 1] e^{c_9 t},$$

where

$$c_8 = (1 + \lambda)c_7, \quad c_9 = \frac{\mu}{T^*} \quad \text{with } \mu = \log \lambda.$$

Since

$$\|(\rho_x(\cdot, t), \kappa_x(\cdot, t))\|_{\infty, I} \leq h(t),$$

the result easily follows. \square

Remark 5.3 (*Exponential bound for $|\rho_x|_{I \times (t, t+T^*)}^{(\alpha)}$ and $|\kappa_x|_{I \times (t, t+T^*)}^{(\alpha)}$*)

We remark that from the Sobolev embedding in Hölder spaces (see Lemma 2.8) :

$$W_p^{2,1}(I_T) \hookrightarrow C^{1+\alpha, \frac{1+\alpha}{2}}(\overline{I_T}), \quad p > 3,$$

the previous result could be improved to an exponential bound of $|\rho_x|_{I \times (t, t+T^)}^{(\alpha)}$ and $|\kappa_x|_{I \times (t, t+T^*)}^{(\alpha)}$, namely :*

$$|\rho_x|_{I \times (t, t+T^*)}^{(\alpha)} \leq c e^{ct} \quad \text{and} \quad |\kappa_x|_{I \times (t, t+T^*)}^{(\alpha)} \leq c e^{ct}, \quad (5.162)$$

where $c > 0$ is a positive constant only depending on the initial conditions.

Proposition 5.4 (*Exponential bound in time for $\|\rho_{xx}(\cdot, t)\|_{\infty, I}$*)

Under the same hypothesis of Proposition 5.1, we have

$$\|\rho_{xx}(\cdot, t)\|_{\infty, I} \leq c A e^{ct}, \quad t \geq 0, \quad (5.163)$$

where

$$A = 1 + \|\rho^0\|_{W_p^{2-2/p}(I)} + \|\kappa^0\|_{W_p^{2-2/p}(I)} + |\rho^0|_I^{(2+\alpha)},$$

and $c > 0$ is a fixed positive constant independent of the initial data.

Proof. Throughout the proof, we will omit, without loss of generality, the dependence on $\|B\|_\infty$. The ideas of the proof are somehow contained in the proof of the previous proposition. In fact, we will not only show the exponential bound for the L^∞ norm of ρ_{xx} , but also for the C^α norm. The proof is done in two steps.

Step 1. (Estimating ρ in the $C^{2+\alpha, \frac{2+\alpha}{2}}$ norm)

We start by writing down the Hölder estimate (2.27) for the second equation of (5.142). Indeed, since $\kappa_x \in C^{\alpha, \alpha/2}(\overline{I_T})$, and since the compatibility conditions of order 1 are satisfied, we have that :

$$|\rho|_{I_T}^{(2+\alpha)} \leq c(T) \left(|\kappa_x|_{I_T}^{(\alpha)} + |\rho^0|_I^{(2+\alpha)} \right). \quad (5.164)$$

We aim to control $|\kappa_x|_{I_T}^{(\alpha)}$ for an arbitrarily fixed small time. Following the same arguments of Steps 1 and 2 of Proposition 5.1, we get (for a sufficiently small time T) an estimate of $\|\bar{\kappa}\|_{W_p^{2,1}(I_T)}$, similar to (5.156), that reads :

$$\|\bar{\kappa}\|_{W_p^{2,1}(I_T)} \leq c(T) \left(1 + \|\rho^0\|_{W_p^{2-2/p}(I)} + \|\kappa^0\|_{W_p^{2-2/p}(I)} \right) + c\|\kappa_x\|_{p, I_T}, \quad (5.165)$$

where $\bar{\kappa}$ is given by (5.148). Using the Sobolev embedding in Hölder spaces, namely estimates (2.35) and (2.36), together with the fact that $\bar{\kappa} = 0$ on the parabolic boundary $\partial^p I_T$, we get :

$$\|\bar{\kappa}_x\|_{\infty, I_T} \leq c \left\{ T^{\alpha/2} (\|\bar{\kappa}_t\|_{p, I_T} + \|\bar{\kappa}_{xx}\|_{p, I_T}) + T^{\frac{\alpha}{2}-1} \|\bar{\kappa}\|_{p, I_T} \right\} \leq cT^{\frac{p-3}{2p}} \|\bar{\kappa}\|_{W_p^{2,1}(I_T)}, \quad (5.166)$$

and

$$\langle \bar{\kappa}_x \rangle_{I_T}^{(\alpha)} \leq c \left\{ \|\bar{\kappa}_t\|_{p, I_T} + \|\bar{\kappa}_{xx}\|_{p, I_T} + \frac{1}{T} \|\bar{\kappa}\|_{p, I_T} \right\} \leq c\|\bar{\kappa}\|_{W_p^{2,1}(I_T)}, \quad (5.167)$$

where p and α are always given by Remark 4.1. We notice that for the first equation (5.166), we have used Lemma 2.10 (the ideas are contained in the proof of this lemma, see Appendix A), while for the second one (5.167), we have applied estimate (2.33) for the term $\|\bar{\kappa}\|_{p, I_T}$. Combining (5.166) and (5.167), we deduce (for T small enough) that :

$$|\bar{\kappa}_x|_{I_T}^{(\alpha)} \leq c\|\bar{\kappa}\|_{W_p^{2,1}(I_T)}, \quad c > 0 \text{ independent of } T,$$

and hence, from (5.165) and the definition (5.148) of $\bar{\kappa}$, we obtain :

$$|\kappa_x|_{I_T}^{(\alpha)} \leq c(T) \left(1 + \|\rho^0\|_{W_p^{2-2/p}(I)} + \|\kappa^0\|_{W_p^{2-2/p}(I)} \right) + c\|\kappa_x\|_{p, I_T}. \quad (5.168)$$

For the term where it interferes the κ' , we have used the following :

$$|\kappa'_x|_{I_T}^{(\alpha)} \leq c(T) \|\kappa'\|_{W_p^{2,1}(I_T)} \leq c(T) \left(\|\kappa^0\|_{W_p^{2-2/p}(I)} + 1 \right).$$

Having in mind that the term $\|\kappa_x\|_{p,I_T}$ satisfies :

$$\|\kappa_x\|_{p,I_T} \leq T^{1/p} |\kappa_x|_{I_T}^{(\alpha)},$$

inequality (5.168) can be written :

$$(1 - cT^{1/p}) |\kappa_x|_{I_T}^{(\alpha)} \leq c(T) \left(1 + \|\rho^0\|_{W_p^{2-2/p}(I)} + \|\kappa^0\|_{W_p^{2-2/p}(I)} \right),$$

and hence for T^* small enough, namely

$$T^* = \frac{1}{2c^p},$$

we get

$$|\kappa_x|_{I_{T^*}}^{(\alpha)} \leq c_{10} \left(1 + \|\rho^0\|_{W_p^{2-2/p}(I)} + \|\kappa^0\|_{W_p^{2-2/p}(I)} \right), \quad c_{10} = c_{10}(T^*) > 0. \quad (5.169)$$

Plugging (5.169) into (5.164), we deduce that :

$$|\rho|_{I_{T^*}}^{(2+\alpha)} \leq c_{11} \left(1 + \|\rho^0\|_{W_p^{2-2/p}(I)} + \|\kappa^0\|_{W_p^{2-2/p}(I)} + |\rho^0|_I^{(2+\alpha)} \right), \quad c_{11} = c_{11}(T^*) \geq 1. \quad (5.170)$$

Here we consider $c_{11} \geq 1$ for technical reasons.

Step 2. (The exponential estimate by iteration)

This is similar to Step 4 of Proposition 5.1. We first notice that the arguments presented in that step can be adapted to get an exponential bound on the function g given by (5.158). Indeed, we use (5.159) and the estimate of the traces of functions in Sobolev spaces (see Lemma 2.9, estimate (2.39)), to deduce that, for every $t \geq 0$:

$$g(t) \leq c_{12} [1 + g(0)] e^{c_{12}t}, \quad (5.171)$$

with $c_{12} \geq 1$ is a fixed positive constant independent of the initial conditions. Also here $c_{12} \geq 1$ is taken for technical reasons. Let

$$\bar{f}(t) = |\rho|_{I \times (t, t+T^*)}^{(2+\alpha)}, \quad T^* \text{ is given in Step 1.}$$

From (5.170) and (5.171), we know that

$$\begin{aligned} \bar{f}(0) &\leq c_{11} \left(1 + g(0) + |\rho^0|_I^{(2+\alpha)} \right) \\ &\leq c_{11} + c_{11}c_{12} [1 + g(0)] + c_{11} |\rho^0|_I^{(2+\alpha)}. \end{aligned}$$

In a similar way, knowing that $c_{11} \geq 1$ and $c_{12} \geq 1$, we obtain :

$$\begin{aligned} \bar{f}(T^*) &\leq c_{11} (1 + g(T^*) + \bar{f}(0)) \\ &\leq 2c_{11}^2 + 2c_{11}^2 c_{12} [1 + g(0)] e^{c_{12} T^*} + c_{11}^2 |\rho^0|_I^{(2+\alpha)}, \end{aligned}$$

and hence, by iteration, we get for every $n \in \mathbb{N}$:

$$\bar{f}(nT^*) \leq (n+1)c_{11}^{n+1} + (n+1)c_{11}^{n+1} c_{12} [1 + g(0)] e^{nc_{12} T^*} + c_{11}^{n+1} |\rho^0|_I^{(2+\alpha)}.$$

From this inequality, and the fact that for $nT^* \leq t \leq (n+1)T^*$, we have $\bar{f}(t) \leq \bar{f}(nT^*) + \bar{f}((n+1)T^*)$, we easily arrive to the result (see the conclusion of Step 4 of Proposition 5.1). \square

Remark 5.5 (*Exponential bound for $|\rho|_{I \times (t, t+T^*)}^{(2+\alpha)}$*)

Proposition 5.4, as it appears in the proof, gives an exponential bound, not only for $\|\rho(\cdot, t)\|_{\infty, I}$, but also for $|\rho|_{I \times (t, t+T^)}^{(2+\alpha)}$.*

6 An upper bound for the $W_2^{2,1}$ norm of ρ_{xxx}

This section is devoted to give a suitable upper bound for the $W_2^{2,1}$ norm of ρ_{xxx} . This result will be a consequence of the control of the $W_2^{2,1}$ norm of κ_t and κ_{xx} . The goal is to use this upper bound in the Kozono-Taniuchi inequality (see inequality (2.49) of Theorem 2.16) in order to control the L^∞ norm of ρ_{xxx} . Let us consider the following hypothesis.

(H1). The term \bar{T} is a fixed time that satisfies :

$$0 < T_1 \leq \bar{T}, \tag{6.172}$$

where T_1 is an arbitrarily small fixed number.

(H2). The function κ_x satisfies :

$$\kappa_x(x, t) \geq \gamma(t) > 0, \quad t \in [0, \bar{T}], \tag{6.173}$$

where $\gamma(t)$ is a positive decreasing function with $\gamma(0) < 1$.

Let

$$\mathcal{D} = I_{\bar{T}}, \tag{6.174}$$

we start with the first lemma.

Lemma 6.1 ($W_2^{2,1}$ bound for κ_t and κ_{xx})

Under hypothesis (H1)-(H2), and under the same hypothesis of Proposition 5.1, we have :

$$\|\kappa_t, \kappa_{xx}\|_{W_2^{2,1}(\mathcal{D})} \leq \frac{E}{\gamma^4},$$

where

$$\gamma := \gamma(\bar{T}),$$

and

$$E = de^{d\bar{T}},$$

where $d \geq 1$ is a positive constant depending on the initial conditions but independent of \bar{T} , and will be given at the end of the proof.

Remark 6.2 (*The constant E depending on time*)

Let us stress on the fact that, throughout the proof, the term $E = de^{d\bar{T}}$ of Lemma 6.1 might vary from line to line. In other words, the term d in the expression of E might certainly vary from line to line, but always satisfying the fact of just being dependent on the initial data of the problem. The different E 's appearing in different estimates can be made the same by simply taking the maximum between them. Therefore they will all be denoted by the same letter E .

Proof. Define the functions u and v by :

$$u(x, t) = \rho_t(x, t) \quad \text{and} \quad v(x, t) = \kappa_t(x, t).$$

We write down the equations satisfied by u and v respectively :

$$\begin{cases} u_t = (1 + \varepsilon)u_{xx} - \tau v_x & \text{on } \mathcal{D}, \\ u|_{S_{\bar{T}}} = 0, \\ u|_{t=0} = u^0 := (1 + \varepsilon)\rho_{xx}^0 - \tau\kappa_x^0 & \text{on } I, \end{cases} \quad (6.175)$$

and with $B = \frac{\rho_x}{\kappa_x}$:

$$\begin{cases} v_t = \varepsilon v_{xx} + \frac{\rho_{xx}}{\kappa_x} u_x + B u_{xx} - B \frac{\rho_{xx}}{\kappa_x} v_x - \tau u_x & \text{on } \mathcal{D}, \\ v|_{S_{\bar{T}}} = 0, \\ v|_{t=0} = v^0 := \varepsilon \kappa_{xx}^0 + \frac{\rho_x^0 \rho_{xx}^0}{\kappa_x^0} - \tau \rho_x^0 & \text{on } I. \end{cases} \quad (6.176)$$

The proof could be divided into three steps. As a first step, we will estimate the $L^\infty(\mathcal{D})$ norm of the term $v_x = \kappa_{tx}$. In the second step, we will control the $W_2^{2,1}(\mathcal{D})$ norm of $v = \kappa_t$. Finally, in the third step, we will show how to deduce a similar

control on the $W_2^{2,1}(\mathcal{D})$ norm of κ_{xx} .

Step 1. (Estimating $\|v_x\|_{\infty, \mathcal{D}}$)

Since $v_x = \kappa_{tx}$, it is worth recalling the equation satisfied by κ :

$$\kappa_t = \varepsilon \kappa_{xx} + \frac{\rho_x \rho_{xx}}{\kappa_x} - \tau \rho_x. \quad (6.177)$$

In Step 3 of Proposition 4.6, we have shown that $\kappa \in C^{3+\alpha, \frac{3+\alpha}{2}}$. Therefore, writing the parabolic Hölder estimate (see (2.27)), we obtain :

$$\|\kappa_{tx}\|_{\infty, \mathcal{D}} \leq |\kappa|_{\mathcal{D}}^{(3+\alpha)} \leq c^H \left(1 + \left| \frac{\rho_x \rho_{xx}}{\kappa_x} \right|_{\mathcal{D}}^{(1+\alpha)} + |\rho_x|_{\mathcal{D}}^{(1+\alpha)} \right), \quad (6.178)$$

where the term 1 comes from the boundary conditions, and $c^H > 0$ is the positive constant given by (2.28) that can be estimated as $c^H \leq E$. We use the elementary identity

$$|fg|_{\mathcal{D}}^{(1+\alpha)} \leq \|f\|_{\infty, \mathcal{D}} |g|_{\mathcal{D}}^{(1+\alpha)} + \|g\|_{\infty, \mathcal{D}} |f|_{\mathcal{D}}^{(1+\alpha)} + \|f_x\|_{\infty, \mathcal{D}} |g|_{\mathcal{D}}^{(\alpha)} + \|g_x\|_{\infty, \mathcal{D}} |f|_{\mathcal{D}}^{(\alpha)},$$

to the term $\left| \frac{\rho_x \rho_{xx}}{\kappa_x} \right|_{\mathcal{D}}^{(1+\alpha)}$ with $f = \frac{\rho_x}{\kappa_x}$ and $g = \rho_{xx}$, we get :

$$\begin{aligned} \left| \frac{\rho_x \rho_{xx}}{\kappa_x} \right|_{\mathcal{D}}^{(1+\alpha)} &\leq 3|\rho|_{\mathcal{D}}^{(3+\alpha)} + \|\rho_{xx}\|_{\infty, \mathcal{D}} \left\langle \frac{\rho_x}{\kappa_x} \right\rangle_{\mathcal{D}}^{(1+\alpha)} + \|\rho_{xxx}\|_{\infty, \mathcal{D}} \left\langle \frac{\rho_x}{\kappa_x} \right\rangle_{\mathcal{D}}^{(\alpha)} \\ &+ \frac{2|\rho|_{\mathcal{D}}^{(2+\alpha)}}{\gamma} (\|\rho_{xx}\|_{\infty, \mathcal{D}} + \|\kappa_{xx}\|_{\infty, \mathcal{D}}), \end{aligned} \quad (6.179)$$

where we have used the fact that $\kappa_x \geq \gamma$ and $\kappa_x \geq |\rho_x|$. We plug (6.179) in (6.178), we obtain :

$$\|\kappa_{tx}\|_{\infty, \mathcal{D}} \leq E \left(1 + |\rho|_{\mathcal{D}}^{(3+\alpha)} + \left\langle \frac{\rho_x}{\kappa_x} \right\rangle_{\mathcal{D}}^{(1+\alpha)} + |\rho|_{\mathcal{D}}^{(3+\alpha)} \left\langle \frac{\rho_x}{\kappa_x} \right\rangle_{\mathcal{D}}^{(\alpha)} + \frac{1}{\gamma} \left(1 + |\kappa|_{\mathcal{D}}^{(2+\alpha)} \right) \right), \quad (6.180)$$

where we have used the fact that the term $|\rho|_{\mathcal{D}}^{(2+\alpha)}$ has an exponential bound (see Remark 5.5) of the form $|\rho|_{\mathcal{D}}^{(2+\alpha)} \leq E$. It is worth noticing that the term E appearing in (6.180) is the maximum between different E 's that might exist as different bounds. This will be frequently used for the sake of simplicity.

Step 1.1. (Estimating $\left\langle \frac{\rho_x}{\kappa_x} \right\rangle_{\mathcal{D}}^{(1+\alpha)}$)

From the definition of the Hölder norm (see (2.20) and the notation therein), we see that in order to control $\left\langle \frac{\rho_x}{\kappa_x} \right\rangle_{\mathcal{D}}^{(1+\alpha)}$, it suffices to control the three quantities :

$$\left\langle \frac{\rho_x}{\kappa_x} \right\rangle_{t,\mathcal{D}}^{\left(\frac{1+\alpha}{2}\right)}, \quad \left\langle \left(\frac{\rho_x}{\kappa_x} \right)_x \right\rangle_{x,\mathcal{D}}^{(\alpha)}, \quad \text{and} \quad \left\langle \left(\frac{\rho_x}{\kappa_x} \right)_x \right\rangle_{t,\mathcal{D}}^{\left(\frac{\alpha}{2}\right)}.$$

We use the the following identity :

$$\left\langle \frac{f}{g} \right\rangle_{t,\mathcal{D}}^{(\alpha)} \leq \left\| \frac{f}{g} \right\|_{\infty,\mathcal{D}} \left\| \frac{1}{g} \right\|_{\infty,\mathcal{D}} \langle g \rangle_{t,\mathcal{D}}^{(\alpha)} + \left\| \frac{1}{g} \right\|_{\infty,\mathcal{D}} \langle f \rangle_{t,\mathcal{D}}^{(\alpha)},$$

with $f = \rho_x$ and $g = \kappa_x$, we get

$$\left\langle \frac{\rho_x}{\kappa_x} \right\rangle_{t,\mathcal{D}}^{\left(\frac{1+\alpha}{2}\right)} \leq \frac{1}{\gamma} \left(\langle \rho_x \rangle_{t,\mathcal{D}}^{\left(\frac{1+\alpha}{2}\right)} + \langle \kappa_x \rangle_{t,\mathcal{D}}^{\left(\frac{1+\alpha}{2}\right)} \right). \quad (6.181)$$

Similarly, we obtain :

$$\left\langle \frac{\rho_{xx}}{\kappa_x} \right\rangle_{x,\mathcal{D}}^{(\alpha)} \leq \frac{\|\rho_{xx}\|_{\infty,\mathcal{D}}}{\gamma^2} \langle \kappa_x \rangle_{x,\mathcal{D}}^{(\alpha)} + \frac{\langle \rho_{xx} \rangle_{x,\mathcal{D}}^{(\alpha)}}{\gamma}. \quad (6.182)$$

We also use the inequality :

$$\langle fg \rangle_{x,\mathcal{D}}^{(\alpha)} \leq \|f\|_{\infty,\mathcal{D}} \langle g \rangle_{x,\mathcal{D}}^{(\alpha)} + \|g\|_{\infty,\mathcal{D}} \langle f \rangle_{x,\mathcal{D}}^{(\alpha)},$$

with $f = \frac{\kappa_{xx}}{\kappa_x}$ and $g = \frac{\rho_x}{\kappa_x}$, we get :

$$\left\langle \frac{\kappa_{xx}\rho_x}{\kappa_x^2} \right\rangle_{x,\mathcal{D}}^{(\alpha)} \leq \frac{\langle \kappa_{xx} \rangle_{x,\mathcal{D}}^{(\alpha)}}{\gamma} + \frac{\|\kappa_{xx}\|_{\infty,\mathcal{D}}}{\gamma^2} \langle \rho_x \rangle_{x,\mathcal{D}}^{(\alpha)} + \frac{\|\kappa_{xx}\|_{\infty,\mathcal{D}}}{\gamma^2} \langle \kappa_x \rangle_{x,\mathcal{D}}^{(\alpha)}. \quad (6.183)$$

Similarly, we get

$$\left\langle \frac{\rho_{xx}}{\kappa_x} \right\rangle_{t,\mathcal{D}}^{\left(\frac{\alpha}{2}\right)} \leq \frac{\|\rho_{xx}\|_{\infty,\mathcal{D}}}{\gamma^2} \langle \kappa_x \rangle_{t,\mathcal{D}}^{\left(\frac{\alpha}{2}\right)} + \frac{\langle \rho_{xx} \rangle_{t,\mathcal{D}}^{\left(\frac{\alpha}{2}\right)}}{\gamma}, \quad (6.184)$$

and

$$\left\langle \frac{\kappa_{xx}\rho_x}{\kappa_x^2} \right\rangle_{t,\mathcal{D}}^{\left(\frac{\alpha}{2}\right)} \leq \frac{\langle \kappa_{xx} \rangle_{t,\mathcal{D}}^{\left(\frac{\alpha}{2}\right)}}{\gamma} + \frac{\|\kappa_{xx}\|_{\infty,\mathcal{D}}}{\gamma^2} \langle \rho_x \rangle_{t,\mathcal{D}}^{\left(\frac{\alpha}{2}\right)} + \frac{\|\kappa_{xx}\|_{\infty,\mathcal{D}}}{\gamma^2} \langle \kappa_x \rangle_{t,\mathcal{D}}^{\left(\frac{\alpha}{2}\right)}. \quad (6.185)$$

Collecting the above inequalities (6.181), (6.182), (6.183), (6.184), and (6.185) yield :

$$\left\langle \frac{\rho_x}{\kappa_x} \right\rangle_{\mathcal{D}}^{(1+\alpha)} \leq \frac{E}{\gamma^2} \left(1 + |\kappa|_{\mathcal{D}}^{(2+\alpha)} + \|\kappa_{xx}\|_{\infty,\mathcal{D}} \langle \kappa_x \rangle_{\mathcal{D}}^{(\alpha)} \right), \quad (6.186)$$

where we have used the fact that $1 \leq \frac{E}{\gamma}$, $\gamma \leq 1$ and $|\rho|_{\mathcal{D}}^{(2+\alpha)} \leq E$ (see Remark 5.5).

Step 1.2. (Estimating $|\rho|_{\mathcal{D}}^{(3+\alpha)}$ and $|\kappa|_{\mathcal{D}}^{(2+\alpha)}$)

We recall the equation satisfied by ρ :

$$\rho_t = (1 + \varepsilon)\rho_{xx} - \tau\kappa_x. \quad (6.187)$$

As for the term κ at the beginning of this Step 1, we have the following estimate for ρ :

$$|\rho|_{\mathcal{D}}^{(3+\alpha)} \leq E \left(1 + |\kappa|_{\mathcal{D}}^{(2+\alpha)} \right). \quad (6.188)$$

Having a second look at the equation (6.177) of κ , we can use again the parabolic Hölder estimate but for a lower order. In fact, we have :

$$|\kappa|_{\mathcal{D}}^{(2+\alpha)} \leq E \left(1 + \left| \frac{\rho_x \rho_{xx}}{\kappa_x} \right|_{\mathcal{D}}^{(\alpha)} + |\rho_x|_{\mathcal{D}}^{(\alpha)} \right).$$

Similar computations to those in Step 1.1 yield :

$$|\kappa|_{\mathcal{D}}^{(2+\alpha)} \leq \frac{E}{\gamma} \left(1 + |\kappa_x|_{\mathcal{D}}^{(\alpha)} \right), \quad (6.189)$$

and hence from (6.188), we also get a similar estimate for $|\rho|_{\mathcal{D}}^{(3+\alpha)}$:

$$|\rho|_{\mathcal{D}}^{(3+\alpha)} \leq \frac{E}{\gamma} \left(1 + |\kappa_x|_{\mathcal{D}}^{(\alpha)} \right). \quad (6.190)$$

Step 1.3. (The estimate for $\|\kappa_{tx}\|_{\infty, \mathcal{D}}$)

By combining (6.180), (6.186), (6.189), (6.190), and by using the fact that $|\kappa_x|_{\mathcal{D}}^{(\alpha)}$ has an exponential estimate (see estimate (5.162) of Remark 5.3), we deduce that :

$$\|\kappa_{tx}\|_{\infty, \mathcal{D}} \leq \frac{E}{\gamma^3}, \quad (6.191)$$

where we have frequently used that $\gamma \leq 1$, and we have always taken the maximum of all the exponential bounds of the $E = de^{d\bar{T}}$ form.

Step 2. (Estimating $\|v\|_{W_2^{2,1}(\mathcal{D})}$)

We turn our attention to the equation (6.175) satisfied by u . We will show that we are in the good framework for applying the L^2 theory of parabolic equations. In fact, note first that $u = \rho_t \in C(\bar{\mathcal{D}})$, and hence the compatibility condition of

order 0 is satisfied. Moreover, since $v_x = \kappa_{tx} \in C(\bar{\mathcal{D}})$ then $v_x \in L^2(\mathcal{D})$. Finally, the initial data satisfies $u^0 \in C^{1+\alpha}(\bar{I})$, hence $u^0 \in W_2^1(I)$. The above arguments show that the L^2 theory for parabolic equations (see Theorem 2.3) can be applied to the function u , therefore we get :

$$u \in W_2^{2,1}(\mathcal{D}) \implies \rho_t, \rho_{tt}, \rho_{tx}, \rho_{txx} \in L^2(\mathcal{D}),$$

with the following estimate :

$$\|u\|_{W_2^{2,1}(\mathcal{D})} \leq E(1 + \|v_x\|_{2,\mathcal{D}}). \quad (6.192)$$

Here the term E of the previous inequality hides in it all the constant c of the Sobolev estimate (see (2.32) and (2.33)), where this constant c behaves like \bar{T} or $\sqrt{\bar{T}}$. Also the term 1 in (6.192) comes from the initial data. Since $v_x = \kappa_{tx}$, we plug the estimate (6.191) obtained in Step 1.3 into (6.192), we get

$$\|u\|_{W_2^{2,1}(\mathcal{D})} \leq E \left(1 + \sqrt{\bar{T}} \frac{E}{\gamma^3} \right).$$

Using some elementary identities, we finally obtain :

$$\|u\|_{W_2^{2,1}(\mathcal{D})} \leq \frac{E}{\gamma^3}. \quad (6.193)$$

Let us remind the reader that the term E is changing from line to line. We now consider equation (6.176) satisfied by v . In fact, for the same reasons as above with the new fact that $u \in W_2^{2,1}(\mathcal{D})$, we can easily deduce that we are in the good framework for the L^2 theory applied to v . Indeed, we have :

$$v \in W_2^{2,1}(\mathcal{D}) \implies \kappa_t, \kappa_{tt}, \kappa_{tx}, \kappa_{txx} \in L^2(\mathcal{D}),$$

with the following estimate :

$$\begin{aligned} \|v\|_{W_2^{2,1}(\mathcal{D})} \leq E \left(1 + \left\| \frac{\rho_{xx}}{\kappa_x} \right\|_{\infty,\mathcal{D}} \|u_x\|_{2,\mathcal{D}} + \|B\|_{\infty,\mathcal{D}} \|u_{xx}\|_{2,\mathcal{D}} \right. \\ \left. + \|B\|_{\infty,\mathcal{D}} \left\| \frac{\rho_{xx}}{\kappa_x} \right\|_{\infty,\mathcal{D}} \|v_x\|_{2,\mathcal{D}} + \|u_x\|_{2,\mathcal{D}} \right), \end{aligned} \quad (6.194)$$

hence from (6.191), (6.193), and some repeated computations, we deduce from (6.194) that :

$$\|\kappa_t\|_{W_2^{2,1}(\mathcal{D})} \leq \frac{E}{\gamma^4}. \quad (6.195)$$

As a byproduct of this last inequality, we can also get, using the Sobolev embedding Lemma (see Lemma 2.8-(ii)), that :

$$\|\kappa_t\|_{\infty,\mathcal{D}} \leq \frac{E}{\gamma^4}.$$

Remark that we can even get a better control by simply integrating (6.191) with respect to x , hence we obtain :

$$\|\kappa_t\|_{\infty, \mathcal{D}} \leq \frac{E}{\gamma^3}. \quad (6.196)$$

Step 3. (Estimating $\|\kappa_{xx}\|_{W_2^{2,1}(\mathcal{D})}$)

The estimate of $\|\kappa_{xx}\|_{W_2^{2,1}(\mathcal{D})}$ requires a special attention. We will mainly use the equations (6.187) and (6.177) satisfied by ρ and κ respectively. The four parts $\|\kappa_{xx}\|_{2, \mathcal{D}}$, $\|\kappa_{xxt}\|_{2, \mathcal{D}}$, $\|\kappa_{xxx}\|_{2, \mathcal{D}}$ and $\|\kappa_{xxxx}\|_{2, \mathcal{D}}$ of the above norm will be estimated separately.

Step 3.1. (Estimate of $\|\kappa_{xx}\|_{2, \mathcal{D}}$)

This can be easily deduced from the equation (6.177) of κ . Indeed, this equation gives :

$$\begin{aligned} \|\kappa_{xx}\|_{2, \mathcal{D}} &\leq E \left(\|\kappa_t\|_{2, \mathcal{D}} + \sqrt{T} \|\rho_{xx}\|_{\infty, \mathcal{D}} + \sqrt{T} \|\rho_x\|_{\infty, \mathcal{D}} \right), \\ &\leq \frac{E}{\gamma^3}, \end{aligned} \quad (6.197)$$

where for the last line, we have used estimate (6.196), and the exponential bounds on $\|\rho_x\|_{\infty, \mathcal{D}}$ and $\|\rho_{xx}\|_{\infty, \mathcal{D}}$. Indeed, by the same way, we can even get, from the L^∞ bound (6.196) on κ_t , that

$$\|\kappa_{xx}\|_{\infty, \mathcal{D}} \leq \frac{E}{\gamma^3}. \quad (6.198)$$

Step 3.2. (Estimate of $\|\kappa_{xxt}\|_{2, \mathcal{D}}$)

As an immediate consequence of (6.195), we get

$$\|\kappa_{xxt}\|_{2, \mathcal{D}} \leq \frac{E}{\gamma^4}.$$

Step 3.3. (Estimate of $\|\kappa_{xxx}\|_{2, \mathcal{D}}$)

Using (6.190), we deduce that

$$\|\rho_{xxx}\|_{\infty, \mathcal{D}} \leq \frac{E}{\gamma} \left(1 + |\kappa_x|_{\mathcal{D}}^{(\alpha)} \right),$$

therefore, the fact that $|\kappa_x|_{\mathcal{D}}^{(\alpha)} \leq E$ (see Remark 5.3) gives :

$$\|\rho_{xxx}\|_{2,\mathcal{D}} \leq \frac{E}{\gamma}, \quad (6.199)$$

and hence (6.189) implies that :

$$\|\kappa_{xx}\|_{\infty,\mathcal{D}} \leq \frac{E}{\gamma}.$$

This will be used in estimating $\|\kappa_{xxt}\|_{2,\mathcal{D}}$. In fact, we derive the equation (6.177) satisfied by κ , with respect to x , we obtain :

$$\kappa_{tx} = \varepsilon \kappa_{xxx} + \frac{\rho_{xx}^2}{\kappa_x} + \frac{\rho_x \rho_{xxx}}{\kappa_x} - \frac{\rho_x \kappa_{xx} \rho_{xx}}{\kappa_x^2} - \tau \rho_{xx}, \quad (6.200)$$

and hence, using (6.199), we get :

$$\|\kappa_{xxx}\|_{2,\mathcal{D}} \leq \frac{E}{\gamma^3}. \quad (6.201)$$

Step 3.4. (Estimate of $\|\kappa_{xxxx}\|_{2,\mathcal{D}}$)

We first derive (6.187) two times in x , we deduce (using (6.193)) that $\|\rho_{xxxx}\|_{2,\mathcal{D}}$ has the same upper bound as $\|\kappa_{xxx}\|_{2,\mathcal{D}}$, i.e.

$$\|\rho_{xxxx}\|_{2,\mathcal{D}} \leq \frac{E}{\gamma^3}. \quad (6.202)$$

We derive the equation (6.200) once more with respect to x :

$$\begin{aligned} \kappa_{txx} &= \varepsilon \kappa_{xxxx} + \frac{2\rho_{xx}\rho_{xxx}}{\kappa_x} - \frac{\kappa_{xx}\rho_{xx}^2}{\kappa_x^2} + \frac{\rho_x\rho_{xxxx}}{\kappa_x} - \frac{\rho_x\rho_{xxx}\kappa_{xx}}{\kappa_x^2} \\ &\quad - \frac{\rho_{xx}^2\kappa_{xx}}{\kappa_x^2} - \frac{\rho_x\rho_{xx}\kappa_{xxx}}{\kappa_x^2} - \frac{\rho_x\kappa_{xx}\rho_{xxx}}{\kappa_x^2} + \frac{2\kappa_{xx}^2\rho_x\rho_{xx}}{\kappa_x^3} - \tau\rho_{xxx}, \end{aligned}$$

and we use (6.202) and our controls obtained in the previous steps, in order to deduce that :

$$\|\kappa_{xxxx}\|_{2,\mathcal{D}} \leq \frac{E}{\gamma^4}. \quad (6.203)$$

In fact, the highest power comes from estimating the following term :

$$\left\| \frac{\kappa_{xx}^2 \rho_x \rho_{xx}}{\kappa_x^3} \right\|_{2,\mathcal{D}} \leq \left\| \frac{\kappa_{xx}^2 \rho_{xx}}{\kappa_x^2} \right\|_{\infty,\mathcal{D}} \sqrt{T} \leq E \left(\frac{1}{\gamma} \right)^2 \left(\frac{1}{\gamma^2} \right) = \frac{E}{\gamma^4},$$

6. An upper bound for the $W_2^{2,1}$ norm of ρ_{xxx}

where we have used the L^∞ estimate of $\|\kappa_{xx}\|_{\infty, \mathcal{D}}$. All other estimates are easily deduced. Let us just state how to estimate the other term were $\|\kappa_{xx}\|_{\infty, \mathcal{D}}$ interferes. In fact, we have :

$$\left\| \frac{\rho_x \rho_{xxx} \kappa_{xx}}{\kappa_x^2} \right\|_{2, \mathcal{D}} \leq \left\| \frac{\kappa_{xx}}{\kappa_x} \right\|_{\infty, \mathcal{D}} \|\rho_{xxx}\|_{2, \mathcal{D}} \leq E \left(\frac{1}{\gamma} \right) \left(\frac{1}{\gamma} \right) \left(\frac{1}{\gamma} \right).$$

Step 3.4. (Conclusion)

From the above estimates (6.197), (6.201) and (6.203), we finally deduce that :

$$\|\kappa_{xx}\|_{W_2^{2,1}(\mathcal{D})} \leq \frac{E}{\gamma^4}. \quad (6.204)$$

This terminates the proof. □

We move now to the main result of this section.

Lemma 6.3 ($W_2^{2,1}$ bound for ρ_{xxx})

Under the same hypothesis of Lemma 6.1, we have :

$$\|\rho_{xxx}\|_{W_2^{2,1}(\mathcal{D})} \leq \frac{E}{\gamma^4}.$$

Proof. From Step 3 of Proposition 4.6, we know that

$$(\rho, \kappa) \in C^\infty(\bar{I} \times [\delta, \bar{T}]), \quad \forall 0 < \delta < \bar{T}.$$

Therefore, we do the following computations over $\bar{\mathcal{D}} \setminus (\bar{I} \times \{t = 0\})$. Indeed, we derive twice the equation of ρ with respect to x , we get

$$\rho_{xxt} = (1 + \varepsilon)\rho_{xxxx} - \tau\kappa_{xxx},$$

where on $S_{\bar{T}}$, we have :

$$(1 + \varepsilon)\rho_{xx} = \tau\kappa_x \implies \rho_{xxt} = \frac{\tau\kappa_{xt}}{1 + \varepsilon}.$$

Combining the above two equations, we obtain :

$$\rho_{xxxx} = \partial_x \left(\frac{\tau}{(1 + \varepsilon)^2} \kappa_t + \frac{\tau}{1 + \varepsilon} \kappa_{xx} \right) \quad \text{on } S_{\bar{T}}. \quad (6.205)$$

Set

$$\bar{\kappa} = \frac{\tau}{(1 + \varepsilon)^2} \kappa_t + \frac{\tau}{1 + \varepsilon} \kappa_{xx} \quad \text{and} \quad w = \rho_{xxx}$$

and

$$\bar{w} = w - \bar{\kappa}.$$

We write down, after doing some computations, the equation satisfied by \bar{w} :

$$\begin{cases} \bar{w}_t = (1 + \varepsilon)\bar{w}_{xx} - \frac{\tau}{(1 + \varepsilon)^2}\kappa_{tt} & \text{on } \mathcal{D} \\ \bar{w}_x|_{S_{\bar{T}}} = 0 & \text{on } S_{\bar{T}} \\ \bar{w}|_{t=0} := \bar{w}^0 = \rho_{xxx}^0 - \frac{\tau(1 + 2\varepsilon)}{(1 + \varepsilon)^2}\kappa_{xx}^0 - \frac{\tau}{(1 + \varepsilon)^2}\frac{\rho_x^0\rho_{xx}^0}{\kappa_x^0} + \frac{\tau^2}{(1 + \varepsilon)^2}\rho_x^0. \end{cases} \quad (6.206)$$

Let us show that the framework of the L^2 theory for parabolic equations with Neumann boundary conditions (see Theorem 2.3 and Remark 2.4 that follows) is well satisfied. First, from Step 2 of Lemma 6.1, we know that $\kappa_{tt} \in L^2(\mathcal{D})$. Moreover, since we have supposed $(\rho^0, \kappa^0) \in (C^\infty(\bar{I}))^2$, then we eventually have $\bar{w}^0 \in W_2^1(I)$. We note that the compatibility conditions are not necessary in this case because the singular index in the Neumann framework is 3 (see Remark 2.4). These arguments permit to use the L^2 theory of parabolic equations with Neumann boundary conditions, hence we get :

$$\bar{w} \in W_2^{2,1}(\mathcal{D}),$$

and

$$\|\bar{w}\|_{W_2^{2,1}(\mathcal{D})} \leq E(1 + \|\kappa_{tt}\|_{2,\mathcal{D}}). \quad (6.207)$$

Since $\bar{w} = w - \bar{\kappa}$, we deduce, from (6.207), that :

$$\|\rho_{xxx}\|_{W_2^{2,1}(\mathcal{D})} \leq E \left(1 + \|\kappa_{tt}\|_{2,\mathcal{D}} + \|\kappa_t\|_{W_2^{2,1}(\mathcal{D})} + \|\kappa_{xx}\|_{W_2^{2,1}(\mathcal{D})} \right), \quad (6.208)$$

and eventually (6.208) with Lemma 6.1 gives immediately the result. \square

7 An upper bound for the BMO norm of ρ_{xxx}

This section is devoted to give a suitable upper bound for the BMO norm of ρ_{xxx} . This result will be a consequence of the control of the BMO norm of a suitable extension of κ_{xx} . As in the previous section, the goal is to use this upper bound in the Kozono-Taniuchi inequality (see inequality (2.49) of Theorem 2.16) in order to control the L^∞ norm of ρ_{xxx} . We first give some useful definitions.

Definition 7.1 (*The “symmetric and periodic” extension of a function*)

Let $f \in C(\bar{I}_{\bar{T}})$ be a continuous function, we define f^{sym} as the function constructed out of f , first by symmetry with respect to the line $x = 0$ over the interval $(-1, 0)$, i.e.

$$f(-x, t) = f(x, t),$$

and then by spatial periodicity with

$$f(x+2, t) = f(x, t).$$

Definition 7.2 (*The “antisymmetric and periodic” extension of a function*)

Let $f \in C(\overline{I_{\overline{T}}})$ be a continuous function, we define the function f^{asym} over $\mathbb{R} \times (0, \overline{T})$, first by the antisymmetry of f with respect to the line $x = 0$ over the interval $(-1, 0)$, i.e.

$$f(-x, t) = -f(x, t),$$

and then by spatial periodicity with

$$f(x+2, t) = f(x, t).$$

We start with the following lemma that reflects a useful relation between the BMO norm of f^{sym} and f^{asym} .

Lemma 7.3 (*A relation between f^{sym} and f^{asym}*)

Let $f \in C(\overline{I_{\overline{T}}})$, then :

$$\|f^{sym}\|_{BMO(\mathbb{R} \times (0, T))} \leq c \left(\|f^{asym}\|_{BMO(\mathbb{R} \times (0, T))} + m_{2I \times (0, T)} (|f^{sym}|) \right).$$

The proof of this lemma will be presented in Appendix B. The next lemma gives a control of the BMO norm of $(\kappa_{xx})^{asym}$.

Lemma 7.4 (*BMO bound for $(\kappa_{xx})^{asym}$*)

Under hypothesis (H1), and under the same hypothesis of Proposition 5.1, we have :

$$\|(\kappa_{xx})^{asym}\|_{BMO(\mathbb{R} \times (0, \overline{T}))} \leq ce^{c\overline{T}}, \quad (7.209)$$

where $c > 0$ is a constant depending on the initial conditions (but independent of \overline{T}). The function $(\kappa_{xx})^{asym}$ is given via Definition 7.2.

Proof. Let $\bar{\kappa}(x, t) = \kappa(x, t) - \kappa^0(x)$. We notice that $\bar{\kappa}|_{S_{\overline{T}}} = 0$, therefore $\bar{\kappa}^{asym}$ satisfies :

$$\begin{cases} \bar{\kappa}_t^{asym} = \varepsilon \bar{\kappa}_{xx}^{asym} + \frac{(\rho_x)^{asym} \rho_{xx}^{asym}}{(\kappa_x)^{asym}} - \tau(\rho_x)^{asym} + \varepsilon (\kappa_{xx}^0)^{asym} & \text{on } \mathbb{R} \times (0, \overline{T}) \\ \bar{\kappa}^{asym}(x, 0) = 0. \end{cases} \quad (7.210)$$

where, from Propositions 5.1 and 5.4, and the fact that

$$\left\| \frac{(\rho_x)^{asym}}{(\kappa_x)^{asym}} \right\|_{\infty, \mathbb{R} \times (0, \overline{T})} < 1,$$

we have :

$$\left\| \frac{(\rho_x)^{asym} \rho_{xx}^{asym}}{(\kappa_x)^{asym}} - \tau(\rho_x)^{asym} + \varepsilon(\kappa_{xx}^0)^{asym} \right\|_{\infty, \mathbb{R} \times (0, \bar{T})} \leq c e^{c\bar{T}}, \quad (7.211)$$

$c > 0$ is a constant depending on the initial conditions. From (7.211), we use the *BMO* theory for parabolic equations (Theorem 2.13), particularly (2.46), to deduce that :

$$\|\bar{\kappa}_{xx}^{asym}\|_{BMO(\mathbb{R} \times (0, \bar{T}))} \leq c e^{c\bar{T}},$$

and hence the result follows. \square

We now present the principal result of this section.

Lemma 7.5 (BMO bound for ρ_{xxx})

Under hypothesis (H1)-(H2), and under the same hypothesis of Proposition 5.1, we have :

$$\|\rho_{xxx}\|_{BMO(\mathcal{D})} \leq E, \quad (7.212)$$

where E is the same as in Remark 6.2.

Proof. The proof is based on the following simple observation on the boundary $S_{\bar{T}}$. In fact, recall that the Hölder regularity $C^{3+\alpha, \frac{3+\alpha}{2}}$, up to the boundary, for the solution (ρ, κ) permits using to conclude that :

$$\begin{cases} (1 + \varepsilon)\rho_{xx} = \tau\kappa_x & \text{on } \overline{S_{\bar{T}}} \\ (1 + \varepsilon)\kappa_{xx} = \tau\rho_x & \text{on } \overline{S_{\bar{T}}}. \end{cases}$$

hence a simple computation yields that :

$$\rho_{xx} = \partial_x \left(\frac{\tau\kappa}{1 + \varepsilon} \right). \quad (7.213)$$

Let

$$\bar{\kappa} = \frac{\tau\kappa}{1 + \varepsilon},$$

we write down the equation satisfied by $\bar{\kappa}$:

$$\begin{cases} \bar{\kappa}_t = \varepsilon\bar{\kappa}_{xx} + \frac{\tau}{1 + \varepsilon} \frac{\rho_x \rho_{xx}}{\kappa_x} - \frac{\tau^2}{1 + \varepsilon} \rho_x & \text{on } \mathcal{D} \\ \bar{\kappa}|_{t=0} := \bar{\kappa}^0 = \frac{\tau\kappa^0}{1 + \varepsilon} & \text{on } I \\ \bar{\kappa}|_{S_{\bar{T}}} = \frac{\tau\kappa}{1 + \varepsilon}|_{S_{\bar{T}}} \\ \bar{\kappa}_x|_{S_{\bar{T}}} = \rho_{xx}. \end{cases} \quad (7.214)$$

Let

$$v = \rho_x,$$

we also write the equation satisfied by v :

$$\begin{cases} v_t = (1 + \varepsilon)v_{xx} - \tau\kappa_{xx} & \text{on } \mathcal{D} \\ v|_{t=0} = v^0 := \rho_x^0 & \text{on } I \\ v|_{S_{\overline{T}}} = \rho_x \\ v_x|_{S_{\overline{T}}} = \rho_{xx}. \end{cases} \quad (7.215)$$

Take

$$\bar{v} = v - \bar{\kappa},$$

the equation satisfied by \bar{v} reads :

$$\begin{cases} \bar{v}_t = (1 + \varepsilon)\bar{v}_{xx} - \frac{\varepsilon\tau}{1 + \varepsilon}\kappa_{xx} - \frac{\tau}{1 + \varepsilon}\frac{\rho_x\rho_{xx}}{\kappa_x} + \frac{\tau^2}{1 + \varepsilon}\rho_x & \text{on } \mathcal{D} \\ \bar{v}|_{t=0} = \bar{v}^0 := \rho_x^0 - \frac{\tau}{1 + \varepsilon}\kappa^0 & \text{on } I \\ \bar{v}_x|_{S_{\overline{T}}} = 0. \end{cases} \quad (7.216)$$

We can assume, without loss of generality, that the initial condition $\bar{v}^0 = 0$. This is because being non-zero just adds a constant depending on the initial conditions in the final estimate that we are looking for. From the fact that $\bar{v}_x|_{S_{\overline{T}}} = 0$, we can easily deduce that the function \bar{v}^{sym} satisfies :

$$\begin{cases} \bar{v}_t^{sym} = (1 + \varepsilon)\bar{v}_{xx}^{sym} + \overbrace{\frac{\tau^2}{1 + \varepsilon}(\rho_x)^{sym} - \frac{\tau}{1 + \varepsilon}\frac{(\rho_x)^{sym}(\rho_{xx})^{sym}}{(\kappa_x)^{sym}} - \frac{\varepsilon\tau}{1 + \varepsilon}(\kappa_{xx})^{sym}}^g & \text{on } \mathbb{R} \times (0, \overline{T}) \\ \bar{v}^{sym}(x, 0) = 0 & \text{on } \mathbb{R}, \end{cases}$$

therefore, using the *BMO* estimate (2.46) for parabolic equations, to the function \bar{v} , one gets :

$$\|\bar{v}_{xx}^{sym}\|_{BMO(\mathbb{R} \times (0, \overline{T}))} \leq c \left[\|g\|_{BMO(\mathbb{R} \times (0, \overline{T}))} + m_{2I \times (0, \overline{T})}(|g|) \right]. \quad (7.217)$$

From Propositions 5.1, 5.4, we deduce that

$$\|g\|_{BMO(\mathbb{R} \times (0, \overline{T}))} \leq E + \|(\kappa_{xx})^{sym}\|_{BMO(\mathbb{R} \times (0, \overline{T}))}, \quad (7.218)$$

and

$$m_{2I \times (0, \overline{T})}(|g|) \leq E + m_{2I \times (0, \overline{T})}(|(\kappa_{xx})^{sym}|). \quad (7.219)$$

Recall the definition of the term E from Remark 6.2. At this stage, we write the following estimate :

$$\|(\kappa_{xx})^{sym}\|_{BMO(\mathbb{R}\times(0,\bar{T}))} \leq c \left[\|(\kappa_{xx})^{asym}\|_{BMO(\mathbb{R}\times(0,\bar{T}))} + m_{2I\times(0,\bar{T})}(|(\kappa_{xx})^{sym}|) \right], \quad (7.220)$$

which can be deduced using Lemma 7.3. The constant $c > 0$ appearing in (7.220) is independent of \bar{T} . Finally, we deduce that :

$$\begin{aligned} \|\bar{v}_{xx}^{sym}\|_{BMO(\mathbb{R}\times(0,\bar{T}))} &\leq c \left[E + \|(\kappa_{xx})^{asym}\|_{BMO(\mathbb{R}\times(0,\bar{T}))} + m_{2I\times(0,\bar{T})}(|(\kappa_{xx})^{sym}|) \right] \\ &\leq c \left[E + m_{2I\times(0,\bar{T})}(|(\kappa_{xx})^{sym}|) \right] \\ &\leq c \left[E + (1/\bar{T})\|\kappa_{xx}\|_{1,\mathcal{D}} \right] \\ &\leq c \left[E + \bar{T}^{-1/p}\|\kappa_{xx}\|_{p,\mathcal{D}} \right], \end{aligned}$$

where we have used (7.217), (7.218), (7.219) and (7.220) for the first line, and Lemma 7.4 for the second line. For the last line, we have used that $p > 3$. From (H1) and (5.157), we know that :

$$\bar{T}^{-1/p}\|\kappa_{xx}\|_{p,\mathcal{D}} \leq T_1^{-1/p}E.$$

From the above two inequalities, and since $\bar{v}_{xx} = \rho_{xxx} - \frac{\tau\kappa_{xx}}{1+\varepsilon}$, we easily arrive to our result. \square

8 L^∞ bound for ρ_{xxx} and *revisited* results

In this section, we use the results of sections 5, 6 and 7, in order to give an L^∞ bound for ρ_{xxx} via the Kozono-Taniuchi inequality. The next step is to improve some previously obtained results.

Proposition 8.1 (L^∞ bound for ρ_{xxx})

Under hypothesis (H1)-(H2), and under the same hypothesis of Proposition 5.1, we have :

$$\|\rho_{xxx}\|_{\infty,\mathcal{D}} \leq E \left(1 + \log^+ \frac{E}{\gamma^4} \right). \quad (8.221)$$

Proof. Applying estimate (2.49) to the function ρ_{xxx} over \mathcal{D} , we get :

$$\|\rho_{xxx}\|_{\infty,\mathcal{D}} \leq c\|\rho_{xxx}\|_{\overline{BMO}(\mathcal{D})} \left(1 + \log^+ \|\rho_{xxx}\|_{W_2^{2,1}(\mathcal{D})} + \log^+ \|\rho_{xxx}\|_{\overline{BMO}(\mathcal{D})} \right), \quad (8.222)$$

where we remind the reader that

$$\|\rho_{xxx}\|_{\overline{BMO}(\mathcal{D})} = \|\rho_{xxx}\|_{BMO(\mathcal{D})} + \|\rho_{xxx}\|_{1,\mathcal{D}}.$$

Using (8.222) together with Lemmas 7.5 and 6.3, lead to the result. The only term left to control is $\|\rho_{xxx}\|_{1,\mathcal{D}}$. In fact, we know that :

$$\|\rho_{xxx}\|_{1,\mathcal{D}} \leq \bar{T}^{1-\frac{1}{p}} \|\rho_{xxx}\|_{p,\mathcal{D}}, \quad (8.223)$$

and since, by repeating the same arguments of the proof of Lemma 7.5, and of Lemma 2.7 (see Appendix A), using the L^p estimates for parabolic equations instead of the *BMO* ones, we can conclude that :

$$\|\rho_{xxx}\|_{p,\mathcal{D}} \leq c(1 + \|\kappa_{xx}\|_{p,\mathcal{D}}),$$

where from (5.157), we finally get :

$$\|\rho_{xxx}\|_{p,\mathcal{D}} \leq ce^{c\bar{T}}.$$

This inequality together with (8.223) terminates the proof. □

Remark 8.2 (*Improving the comparison principle*)

The L^∞ bound on ρ_{xxx} given by Proposition 8.1 shows that we can improve our choice of the function γ of Proposition 3.1. Although the function γ was essentially used, on one hand, to ensure the positivity of κ_x for all time $t \geq 0$, and on the other hand, for the boundedness of the ratio $\frac{\rho_x}{\kappa_x}$, it was insufficient for showing the long time existence of (ρ, κ) given by Propositions 4.2 and 4.6; this lies from the fact that γ strongly depends, and in a dangerous way, on ρ_{xxx} (see inequality (3.80)). The remedy of this inconvenience is to revisit the comparison principle “Proposition 3.1” with the new information given by Proposition 8.1, namely estimate (8.221).

Now, we show that we can even improve estimate (8.221) by eliminating the restrictive hypothesis (H1) and changing somehow the constant E appearing in (8.221). To be more precise, we write down our next corollary.

Corollary 8.3 (*Proposition 8.1, revisited*)

Under hypothesis (H2), and under the same hypothesis of Proposition 5.1. Let

$$T > 0,$$

be any fixed time. Then we have :

$$\|\rho_{xxx}\|_{\infty,I_T} \leq E \left(1 + \log^+ \frac{E}{\gamma^4} \right). \quad (8.224)$$

Proof. We know, from Propositions 4.2, 4.6, used for $T_0 = 0$, that there exists some small $\delta_1 > 0$ only depending on the initial conditions, with :

$$\|\rho_{xxx}\|_{\infty, I_{\delta_1}} \leq c_{13}, \quad (8.225)$$

where $c_{13} > 0$ is a constant only depending on the initial conditions. We now apply Proposition 8.1 with

$$T_1 := \delta_1,$$

we get

$$\|\rho_{xxx}\|_{\infty, I_T} \leq E \left(1 + \log^+ \frac{E}{\gamma^4} \right) \quad \text{if } T \geq \delta_1, \quad (8.226)$$

where it is important to indicate that the term $E = E(\delta_1)$ appearing in (8.226) depends on $T_1 = \delta_1$ (see for instance the end of the proof of Lemma 7.5). Combining (8.225) and (8.226), we deduce that $\forall T > 0$:

$$\|\rho_{xxx}\|_{\infty, I_T} \leq c_{13} + E \left(1 + \log^+ \frac{E}{\gamma^4} \right),$$

and hence the result follows. \square

The following proposition reflects how to improve Proposition 3.1.

Proposition 8.4 (*The comparison principle, revisited*)

Under the same hypothesis of Corollary 8.3, and under the condition (3.51), we have :

$$\kappa_x(x, t) \geq \sqrt{\bar{\gamma}^2(t) + \rho_x^2(x, t)}, \quad \forall t \geq 0 \quad (8.227)$$

where $\bar{\gamma} > 0$ is a positive decreasing function depending on the initial conditions, and will be given in the proof.

Proof. In Proposition 3.1, we have that \tilde{c} (recall (3.50)) is a bound on $\|\rho_{xxx}\|_{\infty, I_T}$. From the *a priori* estimate (8.224) we can choose

$$\tilde{c} = E(T) \left(1 + \log^+ \frac{E(T)}{\gamma^4(T)} \right), \quad (8.228)$$

for any $T > 0$. We assume that $\gamma(t)$ is a continuous decreasing function, and that the solution (ρ, κ) satisfies :

$$\kappa_x(x, t) \geq \gamma(t) > 0, \quad t \in [0, T].$$

Therefore, from the proof of Proposition 3.1, we have that

$$\bar{m} = \inf_{x \in I} \left(\cosh(\beta x) \left(\kappa_x - \sqrt{\gamma^2 + \rho_x^2} \right) \right),$$

satisfies (3.76) on $(0, T)$. Here β satisfies (3.65) with $I = (-1, 1)$. Therefore, using (8.228), we obtain

$$\overline{m}_t \geq - \left(\frac{E(T) \left(1 + \log^+ \frac{E(T)}{\gamma^4(T)} \right)}{\sqrt{\gamma^2 + \rho_x^2}} + c_1 \right) \overline{m} - \frac{c_2 \gamma^2}{\sqrt{\gamma^2 + \rho_x^2}} - \frac{\gamma \gamma'}{\sqrt{\gamma^2 + \rho_x^2}}, \quad t \in (0, T), \quad (8.229)$$

with $c_1 = \frac{\beta^2}{4} + \frac{\tau^2}{8\varepsilon} + \varepsilon\beta^2$, and $c_2 = \frac{\tau^2 \cosh \beta}{4\varepsilon}$. Since (8.229) is true for any $T > 0$, we deduce that :

$$\begin{aligned} \overline{m}_t(t) \geq - \left(\frac{E(t) \left(1 + \log^+ \frac{E(t)}{\gamma^4(t)} \right)}{\sqrt{\gamma^2(t) + \rho_x^2(x_0(t), t)}} + c_1 \right) \overline{m}(t) - \frac{c_2 \gamma^2(t)}{\sqrt{\gamma^2(t) + \rho_x^2(x_0(t), t)}} \\ - \frac{\gamma(t) \gamma'(t)}{\sqrt{\gamma^2(t) + \rho_x^2(x_0(t), t)}}, \quad t \in (0, T), \end{aligned} \quad (8.230)$$

(recall the definition of x_0 by (3.77)). Following the same reasoning of the proof of Proposition 3.1, in particular Step 5, Case A, we know that, as long as $\overline{m} = \gamma^2$ is a solution of (8.230) with $\gamma \in C^1$, $\gamma' < 0$ (which is not the case in general), we have (see (3.80)) :

$$\gamma'(t) \geq - \left(c^* + E(t) \left(1 + \log^+ \frac{E(t)}{\gamma^4(t)} \right) \right) \gamma(t), \quad c^* \text{ given by (3.79)}, \quad t \in (0, T). \quad (8.231)$$

Inequality (8.231) gives inspiration to the choice of $\overline{\gamma}$ as a solution of the following ODE :

$$\begin{cases} \overline{\gamma}'(t) = - \left(c^* + E(t) \left(1 + \log^+ \frac{E(t)}{\overline{\gamma}^4(t)} \right) \right) \overline{\gamma}(t), & t \in (0, T) \\ \overline{\gamma}(0) = \alpha_2, \end{cases} \quad (8.232)$$

where α_2 is given by (3.83). It is easy to check that $\overline{\gamma}^2$ is a subsolution of (8.230), hence

$$\overline{m} \geq \overline{\gamma}^2 > 0,$$

with

$$\overline{m}(t) = \inf_{x \in I} \left(\cosh(\beta x) \left(\kappa_x(x, t) - \sqrt{\overline{\gamma}^2(t) + \rho_x^2(x, t)} \right) \right).$$

As a summary we can write, as long as

$$\overline{m} > 0 \quad \text{on} \quad [0, T], \quad (8.233)$$

we have

$$\overline{m} \geq \overline{\gamma}^2 \quad \text{on} \quad [0, T]. \quad (8.234)$$

Finally, from (8.233), (8.234) and the short-time existence result, we easily deduce that $\overline{m} > 0$ for all time and

$$\kappa_x(x, t) \geq \sqrt{\overline{\gamma}^2(t) + \rho_x^2(x, t)},$$

then the result follows. \square

In fact, Proposition 8.4, can be used to improve our L^∞ exponential bounds found in Propositions 5.1 and 5.4. This will be the result of the next proposition.

Proposition 8.5 *Under the same hypothesis of Proposition 8.4. Let α_2 given by (3.83) satisfies :*

$$0 < \alpha_2 < 1,$$

then the solution $(\rho, \kappa) \in C^{3+\alpha, \frac{3+\alpha}{2}}(\overline{I_T})$, $\forall T > 0$, satisfies :

$$\kappa_x(\cdot, t) \geq e^{-e^{e^{b(t+1)}}}, \quad \forall t \geq 0, \quad (8.235)$$

$$|\rho(\cdot, t)|_I^{(3+\alpha)} \leq e^{e^{e^{b(t+1)}}}, \quad \forall t \geq 0, \quad (8.236)$$

and

$$|\kappa(\cdot, t)|_I^{(3+\alpha)} \leq e^{e^{e^{b(t+1)}}}, \quad \forall t \geq 0. \quad (8.237)$$

Here $b > 0$ is a positive constant depending on the initial conditions and the fixed terms of the problem, but independent of time.

Proof. The proof of this proposition could be divided into three steps.

Step 1. (Minoration of $\overline{\gamma}$ by $\underline{\gamma}$)

From the ODE (8.232) satisfied by $\overline{\gamma}$, and after doing some computations using the fact that $E(t) = de^{dt}$ is an increasing function over $(0, T)$, we get $\forall t \in (0, T)$:

$$\begin{aligned} \overline{\gamma}'(t) &= - \left[c^* + E(t) \left(1 + \log^+ \frac{E(t)}{\overline{\gamma}^4(t)} \right) \right] \overline{\gamma}(t) \\ &\geq - \left[c^* + E(T) \left(1 + |\log d| + E(T) + 4|\log \overline{\gamma}(t)| \right) \right] \overline{\gamma}(t) \\ &\geq - \underline{d}e^{dT} \left(1 + |\log \overline{\gamma}(t)| \right) \overline{\gamma}(t), \end{aligned}$$

where

$$\underline{d} = \max(4a, 2d), \quad \text{and} \quad a = \max(c^*, 4d, d|\log d|, d^2).$$

Let

$$\underline{E}(t) = \underline{d}e^{dt}.$$

Define $\underline{\gamma}$ as the solution of the following ODE :

$$\begin{cases} \underline{\gamma}'(t) = -\underline{E}(T) \left(1 + |\log \underline{\gamma}(t)|\right) \underline{\gamma}(t), & t \in (0, T) \\ \underline{\gamma}(0) = \alpha_2. \end{cases} \quad (8.238)$$

From (8.238) and the above inequalities, we deduce that

$$\bar{\gamma}(t) \geq \underline{\gamma}(t), \quad \forall t \in (0, T).$$

Step 2. (Explicit minoration of $\bar{\gamma}$)

It is clear that the decreasing function

$$\underline{\gamma}_T(t) = e^{1-(1-\log \alpha_2)e^{\underline{E}(T)t}} < 1 \quad (8.239)$$

is the solution of (8.238), and hence

$$\bar{\gamma}(t) \geq e^{1-(1-\log \alpha_2)e^{\underline{E}(T)t}}, \quad t \in (0, T),$$

then we get (by the continuity of $\bar{\gamma}$ at $t = T$) :

$$\begin{aligned} \bar{\gamma}(t) &\geq e^{1-(1-\log \alpha_2)e^{\underline{E}(T)t}} \\ &\geq e^{-e^{b(t+1)}}, \quad \forall t \geq 0, \end{aligned} \quad (8.240)$$

for some constant $b > 0$ depending on the initial conditions and some other fixed terms, but independent of t . Inequality (8.235) directly follows from (8.227) and (8.240).

Step 3. (Estimate of $|\kappa|_{I_T}^{(3+\alpha)}$, $|\rho|_{I_T}^{(3+\alpha)}$ and conclusion)

From the proof of Lemma 6.1, we can easily deduce that the estimate of $\|\kappa_{tx}\|_{\infty, \mathcal{D}}$ (see (6.191)) is also true replacing $\|\kappa_{tx}\|_{\infty, \mathcal{D}}$ by $|\kappa|_{\mathcal{D}}^{(3+\alpha)}$. Therefore, from (6.190), (6.191) and (8.240), we deduce the result. \square

9 Long time existence and uniqueness

Now we are ready to show the main result of this paper, namely Theorem 1.1.

Proof of Theorem 1.1. Define the set \mathcal{B} by :

$$\mathcal{B} = \left\{ \begin{array}{l} T > 0; \exists! \text{ solution } (\rho, \kappa) \in C^{3+\alpha, \frac{3+\alpha}{2}}(\overline{I_T}) \text{ of} \\ (1.1), (1.2) \text{ and } (1.3), \text{ satisfying } (1.11) \end{array} \right\}. \quad (9.241)$$

The proof could be divided into two steps.

Step 1. (\mathcal{B} is a non-empty set)

The inequality (1.8) ensures the existence of $\bar{\gamma}(0) = \alpha_2 > 0$ given by (3.73), such that

$$\kappa_x^0 \geq \bar{\gamma}(0) \quad \text{on} \quad \bar{I}, \quad (9.242)$$

which together with (1.6) permits to apply the short-time existence result (Proposition 4.2). Hence there is some $T_1 > 0$ and a unique solution $(\rho, \kappa) \in W_p^{2,1}(I_{T_1})$, of (1.1), (1.2) and (1.3), with

$$\kappa_x \geq \frac{\bar{\gamma}(0)}{2} > 0 \quad \text{on} \quad \overline{I_{T_1}}. \quad (9.243)$$

From the boundary conditions of the initial data (1.7), we deduce, using Proposition 4.6, that this solution from $W_p^{2,1}(I_{T_1})$ is in fact $C^{3+\alpha, \frac{3+\alpha}{2}}(\overline{I_{T_1}})$ and therefore

$$|\rho_{xxx}| \leq \tilde{c}_1 \quad \text{on} \quad \overline{I_{T_1}}, \quad (9.244)$$

for some $\tilde{c}_1 > 0$. From (9.243), (9.244) and (1.8), we can use Proposition 3.1 where it follows that

$$\left| \frac{\rho_x}{\kappa_x} \right| < 1. \quad (9.245)$$

The above identities (9.243) and (9.245) show that

$$T_1 \in \mathcal{B},$$

and hence

$$\mathcal{B} \neq \emptyset.$$

Set

$$T_\infty = \sup \mathcal{B},$$

our next step is to prove that $T_\infty = \infty$.

Step 2. ($T_\infty = \infty$)

We will argue by contradiction. Suppose $T_1 \leq T_\infty < \infty$. In this case, let $\delta > 0$ be an arbitrary small positive constant, then there exist some $T \in \mathcal{B}$ such that

$$T_\infty - \delta < T < T_\infty.$$

Since $T \in \mathcal{B}$, we recall from (8.235) that :

$$\kappa_x(\cdot, t) \geq e^{-e^{e^{b(t+1)}}}, \quad \forall 0 \leq t \leq T,$$

and we recall from (8.236)-(8.237) that :

$$|\rho(\cdot, t)|_I^{(3+\alpha)} \leq e^{e^{b(t+1)}} \quad \text{and} \quad |\kappa(\cdot, t)|_I^{(3+\alpha)} \leq e^{e^{b(t+1)}}, \quad 0 \leq t \leq T. \quad (9.246)$$

We are going to apply Proposition 4.2 with $T_0 = T_\infty - \delta$. In fact, as a consequence of (8.235), we have :

$$\kappa_x(\cdot, T_\infty - \delta) \geq e^{-e^{b(T_\infty - \delta + 1)}} \geq e^{-e^{b(T_\infty + 1)}} =: \gamma_1 > 0. \quad (9.247)$$

Moreover, from (9.246), we deduce that

$$|\rho_x(\cdot, T_\infty - \delta)| \leq e^{e^{b(T_\infty + 1)}} =: M_1, \quad (9.248)$$

$$\|\rho_{xx}(\cdot, T_\infty - \delta)\|_{\infty, I} \leq \eta_1 := M_1 \quad \text{and} \quad \|D_x^s \kappa(\cdot, T_\infty - \delta)\|_{\infty, I} \leq \beta_1 := M_1, \quad (9.249)$$

for $s = 1, 2$. From (9.247), (9.248) and (9.249), we use Proposition 4.2 to obtain some

$$T^* = T^*(\eta_1, \beta_1, M_1, \gamma_1, \varepsilon, \tau, p) > 0 \quad (9.250)$$

such that there exists a unique solution $(\rho, \kappa) \in W_p^{2,1}(I \times (T_0, T_0 + T^*))$, $p = \frac{3}{1-\alpha}$, of (1.1), (4.86) and (4.87) with $T_0 = T_\infty - \delta$ and

$$\kappa_x \geq \frac{\gamma_1}{2} > 0 \quad \text{on} \quad \bar{I} \times [T_\infty - \delta, T_\infty - \delta + T^*]. \quad (9.251)$$

Again by (9.247), (9.248) and (9.249), we can easily check that the quantities γ_1 , M_1 , η_1 and β_1 are independent of δ , and then T^* given by (9.250) is also independent of δ . However, we have by Propositions 3.1 and 8.4 that :

$$\kappa_x(\cdot, T_\infty - \delta) \geq \sqrt{\bar{\gamma}^2(T_\infty - \delta) + \rho_x^2(\cdot, T_\infty - \delta)},$$

then

$$\min_I \left(\kappa_x(\cdot, T_\infty - \delta) - |\rho_x(\cdot, T_\infty - \delta)| \right) > 0. \quad (9.252)$$

The compatibility conditions (4.125) and (4.126) are valid for $T_0 = T_\infty - \delta$ and this is due to the fact that the equation is satisfied in a strong sense up to the boundary where ρ and κ are constants. This argument together with (9.252) permit, using first, Proposition 4.6 on the regularity $C^{3+\alpha, \frac{3+\alpha}{2}}$, and then Proposition 8.4 on the minoration of κ_x , to increase the regularity of this solution and then show that

$$\kappa_x > 0 \quad \text{and} \quad \left| \frac{\rho_x}{\kappa_x} \right| < 1 \quad \text{on} \quad \bar{I} \times [T_\infty - \delta, T_\infty - \delta + T^*]. \quad (9.253)$$

From (9.253) and the above arguments, we find that

$$T_\infty - \delta + T^* \in \mathcal{B},$$

with $T^* > 0$ independent of δ . By choosing

$$0 < \delta < T^*,$$

we deduce that

$$T_\infty - \delta + T^* > T_\infty,$$

which contradicts the definition of $T_\infty = \sup \mathcal{B}$. Therefore $T_\infty = \infty$. To complete the proof, we have to indicate that the C^∞ regularity (1.10) is automatically satisfied (see Step 3 of Proposition 4.6). \square

10 Appendix A : miscellaneous parabolic estimates

A1. Proof of Lemma 2.7 (L^p estimate for parabolic equations)

As a first step, we will prove the result in the case where $\varepsilon = 1$, and in a second step, we will move to the case $\varepsilon > 0$. It is worth noticing that the term c may take several values only depending on p .

Step 1. (The estimate : case $\varepsilon = 1$)

Suppose $\varepsilon = 1$. Recall that $u \in W_p^{2,1}(I_T)$, $p > 1$ is the unique solution of (2.17) with $f \in L^p(I_T)$ and $\phi = \Phi = 0$. Let \tilde{u} be a special extension of the function u defined over $\mathbb{R} \times (0, T)$ by :

$$\begin{cases} \tilde{u}(x, t) = u(x, t) & \text{if } 0 \leq x \leq 1 \\ \tilde{u}(x, t) = -u(2-x, t) & \text{if } 1 \leq x \leq 2 \\ \tilde{u}(x+2, t) = \tilde{u}(x, t) & \text{otherwise.} \end{cases} \quad (10.254)$$

In exactly the same way, we can define \tilde{f} out of the function f . It is easy to verify that \tilde{u} satisfies :

$$\begin{cases} \tilde{u}_t = \tilde{u}_{xx} + \tilde{f} & \text{on } \mathbb{R} \times (0, T) \\ \tilde{u}(x, 0) = 0, & \text{on } \mathbb{R}. \\ \tilde{u}(x, t) = 0, & x \in \mathbb{Z}. \end{cases} \quad (10.255)$$

Take a test function $\phi^n(x)$, $n \in \mathbb{N}$ defined on \mathbb{R} by :

$$\begin{cases} \phi^n(x) = 1 & \text{if } x \in (0, 2n) \\ \phi^n(x) = 0 & \text{if } x \geq 2n+1 \text{ or } x \leq -1. \end{cases} \quad (10.256)$$

and set

$$J_T = 2I \times (0, T).$$

Define \bar{u} by

$$\bar{u} = \tilde{u}\phi^n, \quad (10.257)$$

this function satisfies :

$$\begin{cases} \bar{u}_t = \bar{u}_{xx} + \bar{f}, & \text{on } \mathbb{R} \times (0, T) \\ \bar{u}(x, 0) = 0, & \text{on } \mathbb{R}, \end{cases} \quad (10.258)$$

with

$$\bar{f} = \tilde{f}\phi^n - \tilde{u}\phi_{xx}^n - 2\tilde{u}_x\phi_x^n. \quad (10.259)$$

The parabolic Calderon-Zygmund estimates (see [68, Proposition 7.11, page 168]) ensures the existence of a constant $c = c(p) > 0$ such that

$$\|\bar{u}_t\|_{p, \mathbb{R} \times (0, T)} + \|\bar{u}_{xx}\|_{p, \mathbb{R} \times (0, T)} \leq c\|\bar{f}\|_{p, \mathbb{R} \times (0, T)}, \quad (10.260)$$

where from (10.256), (10.257), (10.259) and (10.260), we deduce that

$$n(\|\tilde{u}_t\|_{p, J_T} + \|\tilde{u}_{xx}\|_{p, J_T}) + O(1) \leq cn\|\tilde{f}\|_{p, J_T} \quad (10.261)$$

with $O(1)$ remains bounded as $n \rightarrow \infty$. Dividing (10.261) by n and taking the limit as $n \rightarrow \infty$, we deduce that

$$\|\tilde{u}_t\|_{p, J_T} + \|\tilde{u}_{xx}\|_{p, J_T} \leq c\|\tilde{f}\|_{p, J_T},$$

hence by (10.254), we obtain

$$\|u_t\|_{p, I_T} + \|u_{xx}\|_{p, I_T} \leq c\|f\|_{p, I_T}, \quad c = c(p) > 0. \quad (10.262)$$

Since $u \in W_p^{2,1}(I_T)$ with $u|_{t=0} = 0$, we use [65, Lemma 4.5, page 305] to get

$$\|u\|_{p, I_T} \leq cT(\|u_t\|_{p, I_T} + \|u_{xx}\|_{p, I_T}) \quad (10.263)$$

and

$$\|u_x\|_{p, I_T} \leq c\sqrt{T}(\|u_t\|_{p, I_T} + \|u_{xx}\|_{p, I_T}). \quad (10.264)$$

Combining (10.262), (10.263) and (10.264), we deduce that

$$\frac{1}{T}\|u\|_{p, I_T} + \frac{1}{\sqrt{T}}\|u_x\|_{p, I_T} + \|u_{xx}\|_{p, I_T} + \|u_t\|_{p, I_T} \leq c\|f\|_{p, I_T}. \quad (10.265)$$

Step 2. (The estimate : general case $\varepsilon > 0$)

To get the general inequality, we consider the following rescaling of the function u :

$$\hat{u}(x, t) = u(x, t/\varepsilon), \quad (x, t) \in I_{\varepsilon T}, \quad (10.266)$$

which allows to get the desired result. \square

A2. Proof of Lemma 2.10 (L^∞ control of the spatial derivative)

Since $u \in W_p^{2,1}(I_T)$ for $p > 3$, we know from Lemma 2.8 that $u_x \in C^{\alpha, \alpha/2}(\overline{I_T})$ for $\alpha = 1 - \frac{3}{p}$. In this case, we use the estimate (2.35) with $\delta = \sqrt{T}$, we obtain

$$\|u_x\|_{\infty, I_T} \leq c(p) \{T^{\frac{\alpha}{2}} (\|u_t\|_{p, I_T} + \|u_{xx}\|_{p, I_T}) + T^{\frac{\alpha}{2}-1} \|u\|_{p, I_T}\}. \quad (10.267)$$

Remark that the fact that $u = 0$ on the parabolic boundary $\partial^p I_T$, and that it satisfies the simple equation :

$$\begin{cases} u_t = u_{xx} + f, & f = u_t - u_{xx} \\ u = 0 & \text{on } \partial^p I_T, \end{cases} \quad (10.268)$$

permits to apply estimate (2.33) to the function u . Hence (10.267) becomes (with a different nature of $c(p)$) :

$$\begin{aligned} \|u_x\|_{\infty, I_T} &\leq c(p) \{T^{\frac{\alpha}{2}} \|u_t - u_{xx}\|_{p, I_T} + T^{\frac{\alpha}{2}-1} T \|u_t - u_{xx}\|_{p, I_T}\} \\ &\leq c(p) T^{\frac{\alpha}{2}} \|u\|_{W_p^{2,1}(I_T)} \\ &\leq c(p) T^{\frac{p-3}{2p}} \|u\|_{W_p^{2,1}(I_T)}, \end{aligned}$$

and the result follows. \square

11 Appendix B : parabolic *BMO* theory

B0. Proof of Lemma 7.3. We divide the proof into two steps.

Step 1. (treatment of small parabolic cubes)

Let us consider parabolic cubes $Q = Q_r(x_0, t_0) \subset \mathbb{R} \times (0, T)$ with $0 < r \leq \frac{1}{2}$. Assume, without loss of generality, that $1 < x_0 < 2$ (the other cases can be treated similarly). Define the left and the right neighbor cubes of $Q_r(x_0, t_0)$ by :

$$Q^- = Q_r^-(1 - r, t_0),$$

and

$$Q^+ = Q_r^+(1 + r, t_0),$$

respectively. Since $2r \leq 1$, then

$$Q^- \subset (0, 1) \times (0, T) \quad \text{and} \quad Q^+ \subset (1, 2) \times (0, T).$$

Using the fact that for any function $g \in L^1(\Omega)$:

$$\int_{\Omega} |g - m_{\Omega}(g)| \leq 2 \int_{\Omega} |g - c|, \quad \forall c \in \mathbb{R},$$

We compute :

$$\begin{aligned} \frac{1}{|Q|} \int_Q |f^{sym} - m_Q(f^{sym})| &\leq \frac{2}{|Q|} \int_Q |f^{sym} + m_{Q^+}(f^{asym})| \\ &\leq \frac{2}{|Q^-|} \int_{Q^-} |f^{sym} + m_{Q^+}(f^{asym})| \\ &\quad + \frac{2}{|Q^+|} \int_{Q^+} |f^{sym} + m_{Q^+}(f^{asym})|. \end{aligned} \quad (11.269)$$

We know that from the properties of f^{sym} and f^{asym} that :

$$m_{Q^+}(f^{asym}) = -m_{Q^-}(f^{sym}),$$

and

$$f^{sym} = -f^{asym} \quad \text{on } Q^+, \quad \text{and} \quad f^{sym} = f^{asym} \quad \text{on } Q^-.$$

Using the above two inequalities in (11.269), we get :

$$\begin{aligned} \frac{1}{|Q|} \int_Q |f^{sym} - m_Q(f^{sym})| &\leq \frac{2}{|Q^-|} \int_{Q^-} |f^{sym} - m_{Q^-}(f^{sym})| \\ &\quad + \frac{2}{|Q^+|} \int_{Q^+} |f^{asym} - m_{Q^+}(f^{asym})| \\ &\leq \frac{2}{|Q^-|} \int_{Q^-} |f^{asym} - m_{Q^-}(f^{asym})| \\ &\quad + \frac{2}{|Q^+|} \int_{Q^+} |f^{asym} - m_{Q^+}(f^{asym})| \\ &\leq 4 \|f^{asym}\|_{BMO(\mathbb{R} \times (0, T))}. \end{aligned}$$

Step 2. (treatment of big parabolic cubes)

Consider parabolic cubes $Q = Q_r \subset \mathbb{R} \times (0, T)$ such that $r > \frac{1}{2}$. In this case, we compute :

$$\begin{aligned} \frac{1}{|Q|} \int_Q |f^{sym} - m_Q(f^{sym})| &\leq \frac{2}{|Q|} \int_Q |f^{sym}| \\ &\leq \frac{2N}{|Q|} \int_{2I \times (0, T)} |f^{sym}|, \end{aligned}$$

with

$$|Q| \sim N \times |2I \times (0, T)|,$$

therefore

$$\frac{1}{|Q|} \int_Q |f^{sym} - m_Q(f^{sym})| \leq c m_{2I \times (0, T)}(|f^{sym}|).$$

Steps 1 and 2 directly implies the result. \square

B1. Proof of Theorem 2.13 (*BMO* estimate for parabolic equations)

Let f be a bounded function defined on $\mathbb{R} \times (0, T)$ satisfying $f(x+2, t) = f(x, t)$. We extend the function f to $\mathbb{R} \times \mathbb{R}_+$, first by symmetry with respect to the line $\{t = T\}$ and after that by time periodicity of period $2T$; call this function \tilde{f} . Set \bar{u} as the solution of the following equation :

$$\begin{cases} \bar{u}_t = \varepsilon \bar{u}_{xx} + \tilde{f} & \text{on } \mathbb{R} \times \mathbb{R}_+ \\ \bar{u}(x, 0) = 0. \end{cases} \quad (11.270)$$

We apply the standard result of *BMO* theory for parabolic equations. Since $f \in L^\infty(\mathbb{R} \times (0, T))$, then $\tilde{f} \in BMO(\mathbb{R} \times \mathbb{R}_+)$, and hence we obtain that

$$\bar{u}_t, \bar{u}_{xx} \in BMO(\mathbb{R} \times \mathbb{R}_+),$$

with the following estimate :

$$\|\bar{u}_t\|_{BMO(\mathbb{R} \times \mathbb{R}_+)} + \|\bar{u}_{xx}\|_{BMO(\mathbb{R} \times \mathbb{R}_+)} \leq c \|\tilde{f}\|_{BMO(\mathbb{R} \times \mathbb{R}_+)}, \quad (11.271)$$

and hence (from the definition of the *BMO* space),

$$\|\bar{u}_t\|_{BMO(\mathbb{R} \times (0, T))} + \|\bar{u}_{xx}\|_{BMO(\mathbb{R} \times (0, T))} \leq c \|\tilde{f}\|_{BMO(\mathbb{R} \times \mathbb{R}_+)}. \quad (11.272)$$

The *BMO* theory for parabolic equations, particularly estimate (11.271) is rather classical. This is due to the fact that the solution of (11.270) can be expressed in terms of the heat kernel Γ defined by :

$$\Gamma(x, t) = \begin{cases} (4\pi\varepsilon t)^{-1/2} e^{-\frac{x^2}{4\varepsilon t}}, & \text{for } t > 0 \\ 0 & \text{for } t \leq 0, \end{cases}$$

in the following way :

$$\bar{u}(x, t) = \int_{\mathbb{R} \times \mathbb{R}_+} \Gamma(x - \xi, t - s) \tilde{f}(\xi, s) d\xi ds.$$

As a matter of fact, it is shown in [38] that Γ_{xx} is a parabolic Calderon-Zygmund kernel (here we are working in nonhomogeneous metric spaces in which the variable t accounts for twice the variable x). Therefore $\Gamma_{xx} : BMO \rightarrow BMO$ is a bounded linear operator. This result is quite technical and can be adapted from its elliptic version (see [6, Theorem 3.4]). It is less difficult to show that $\Gamma_{xx} : L^\infty \rightarrow BMO$, a bounded linear operator (see for instance [49, Lemma 3.3]).

Having (11.272) in hands, it remains to show that

$$\|\tilde{f}\|_{BMO(\mathbb{R} \times \mathbb{R}_+)} \leq c (\|f\|_{BMO(\mathbb{R} \times (0, T))} + m_{2I \times (0, T)}(|f|)), \quad (11.273)$$

with $c > 0$ independent of T . This can be divided into three steps :

Step 1. (treatment of small parabolic cubes)

We consider parabolic cubes $Q_r = Q_r(x_0, t_0)$, $(x_0, t_0) \in \mathbb{R} \times \mathbb{R}_+$, with

$$r \leq \sqrt{T}.$$

Let us estimate the term

$$\frac{1}{|Q_r|} \int_{Q_r} |\tilde{f} - m_{Q_r} \tilde{f}|.$$

Assume, without loss of generality, that

$$T \leq t_0 < 2T.$$

In fact, any other case can be done in a similar way because of the time symmetry of the function \tilde{f} . Two cases can be considered. If $r^2 < t_0 - T$ then the cube Q_r lies in the strip $\mathbb{R} \times (T, 2T)$ and in this case

$$\frac{1}{|Q_r|} \int_{Q_r} |\tilde{f} - m_{Q_r} \tilde{f}| \leq \|f\|_{BMO(\mathbb{R} \times (0, T))}.$$

The other case is when

$$r^2 \geq t_0 - T.$$

In this case, define Q_r^a and Q_r^b , the above and the below parabolic cubes, as follows :

$$Q_r^a = Q_r(x_0, T + r^2) \quad \text{and} \quad Q_r^b = Q_r(x_0, T).$$

Since

$$T - r^2 < t_0 - r^2 \leq T < t_0 \leq T + r^2,$$

then

$$Q_r \subset (Q_r^a \cup Q_r^b).$$

Moreover, we have :

$$|Q_r| = |Q_r^a| = |Q_r^b|.$$

We compute :

$$\begin{aligned} \frac{1}{|Q_r|} \int_{Q_r} |\tilde{f} - m_{Q_r} \tilde{f}| &\leq \frac{2}{|Q_r|} \int_{Q_r} |\tilde{f} - 2m_{Q_r^b} \tilde{f} + m_{Q_r^a} \tilde{f}| \\ &\leq \frac{4}{|Q_r|} \int_{Q_r} |\tilde{f} - m_{Q_r^b} \tilde{f}| + \frac{2}{|Q_r|} \int_{Q_r} |\tilde{f} - m_{Q_r^a} \tilde{f}| \\ &\leq \frac{4}{|Q_r|} \int_{Q_r^a} |\tilde{f} - m_{Q_r^b} \tilde{f}| + \frac{4}{|Q_r|} \int_{Q_r^b} |\tilde{f} - m_{Q_r^b} \tilde{f}| + \\ &\quad \frac{2}{|Q_r|} \int_{Q_r^a} |\tilde{f} - m_{Q_r^a} \tilde{f}| + \frac{2}{|Q_r|} \int_{Q_r^b} |\tilde{f} - m_{Q_r^a} \tilde{f}|. \end{aligned}$$

We remark (from the symmetry-in-time of the function \tilde{f}) that :

$$m_{Q_r^a} \tilde{f} = m_{Q_r^b} \tilde{f},$$

and

$$\int_{Q_r^a} |\tilde{f} - c| = \int_{Q_r^b} |f - c|, \quad \forall c \in \mathbb{R}.$$

Therefore the above inequalities give that :

$$\frac{1}{|Q_r|} \int_{Q_r} |\tilde{f} - m_{Q_r} \tilde{f}| \leq 16 \|f\|_{BMO(\mathbb{R} \times (0, T))}. \quad (11.274)$$

Step 2. (treatment of big parabolic cubes)

Consider now parabolic cubes $Q_r \subset \mathbb{R} \times \mathbb{R}_+$, $r > \sqrt{T}$. Suppose first that $r > 1$. Because of the symmetry-in-time of the function \tilde{f} , and its spatial periodicity, we compute :

$$\begin{aligned} \frac{1}{|Q_r|} \int_{Q_r} |\tilde{f} - m_{Q_r} \tilde{f}| &\leq \frac{2}{|Q_r|} \int_{Q_r} |\tilde{f}| \\ &\leq \frac{2N}{|Q_r|} \int_{2I \times (0, T)} |f|, \end{aligned}$$

where N is the minimum number of domains D of the form $D = (k, k+2) \times (nT, (n+1)T)$, $k \in \mathbb{Z}$ and $n \in \mathbb{N}$, that cover Q_r . Here

$$|Q_r| \sim N \times |2I \times (0, T)|, \quad N > 1.$$

Therefore, the above inequalities give :

$$\frac{1}{|Q_r|} \int_{Q_r} |\tilde{f} - m_{Q_r} \tilde{f}| \leq c m_{2I \times (0,T)}(|f|). \quad (11.275)$$

Now suppose that $\sqrt{T} < r \leq 1$. In this case we use the fact that $0 < T_1 \leq T$, we compute :

$$\begin{aligned} \frac{1}{|Q_r|} \int_{Q_r} |\tilde{f} - m_{Q_r} \tilde{f}| &\leq \frac{2}{|Q_r|} \int_{Q_r} |\tilde{f}| \\ &\leq \frac{2N}{|Q_r|} \int_{2I \times (0,T)} |f| \\ &\leq \frac{N}{T_1^{3/2}} \int_{2I \times (0,T)} |f|. \end{aligned}$$

Here $N \sim \frac{1}{T} > 1$, and hence

$$\frac{1}{|Q_r|} \int_{Q_r} |\tilde{f} - m_{Q_r} \tilde{f}| \leq c(T_1) m_{2I \times (0,T)}(|f|). \quad (11.276)$$

Step 3. (conclusion)

Combining (11.274), (11.275) and (11.276), we obtain our result. \square

B2. Sketch of the proof of Theorem 2.16 (a Kozono-Taniuchi parabolic type inequality)

The proof of the Kozono-Taniuchi parabolic type inequality will be a consequence of the following theorem where we give an analogue estimate over $\mathbb{R}_x \times \mathbb{R}_t$. More precisely, we have :

Theorem 11.1 (A Kozono-Taniuchi space-time parabolic type inequality)

Let $u \in C_0^\infty(\mathbb{R}^2)$, $\text{supp } u \in Q_R$. Then we have

$$\|u\|_{\infty, \mathbb{R}^2} \leq c \|u\|_{\overline{BMO}(\mathbb{R}^2)} \left(1 + \log^+ \|u\|_{\overline{BMO}(\mathbb{R}^2)} + \log^+ \|u\|_{W_2^{2,1}(\mathbb{R}^2)} \right), \quad (11.277)$$

where

$$\|u\|_{\overline{BMO}} = \|u\|_{BMO} + \|u\|_{L^1},$$

and $c = c(R) > 0$ is a positive constant.

Sketch of the Proof of Theorem 11.1. First, we need to define some notations and spaces. Let $X = (x, t) \in \mathbb{R}^2$, we define the parabolic distance of X from the origin by :

$$|X|_p = (x^4 + t^2)^{1/2} \sim x^2 + |t|. \quad (11.278)$$

We write the parabolic version of the Littlewood-Paley dyadic decomposition. Let $\phi_j(X)$ be the inverse Fourier transform of the j -th component of the parabolic dyadic decomposition $\hat{\phi} = \{\hat{\phi}_j(\xi)\}_{j=0}^\infty \subset S(\mathbb{R}^2)$, $S(\mathbb{R}^2)$ is the Schwartz space, with

$$\begin{aligned} \text{supp } \hat{\phi}_0 &\subset \{\xi; |\xi|_p \leq 2\}, \\ \text{supp } \hat{\phi}_j &\subset \{\xi; 2^{j-1} \leq |\xi|_p \leq 2^{j+1}\} \quad \text{if } j \in \mathbb{N}, \quad j \geq 1. \end{aligned} \quad (11.279)$$

Here $\xi = (\xi_x, \xi_t) \in \mathbb{R}^2$, and we have :

$$\sum_0^\infty \hat{\phi}_j(\xi) = 1.$$

The Lizorkin-Triebel space $\dot{F}_{p,\rho}^\gamma$

Let $\gamma \geq 0$. Let $1 \leq p < \infty$, $1 \leq \rho \leq \infty$ (or $p = \infty$, $1 \leq \rho < \infty$). We define the parabolic Lizorkin-Triebel space by

$$\dot{F}_{p,\rho}^\gamma = \{u \in S'(\mathbb{R}^2); \|u\|_{\dot{F}_{p,\rho}^\gamma} < \infty\}, \quad (11.280)$$

where

$$\|u\|_{\dot{F}_{p,\rho}^\gamma} = \left\| \left(\sum_{j=0}^\infty 2^{j\gamma\rho} |\phi_j * u|^\rho \right)^{1/\rho} \right\|_{p, \mathbb{R}^2}. \quad (11.281)$$

The ideas of the proof could be separated into several steps.

Step 1. Let $\gamma > 0$. We compute :

$$\begin{aligned} \|u\|_\infty &\leq \|u\|_{\dot{F}_{\infty,1}^0} \\ &\leq \left\| \sum_{0 \leq j \leq N} |\phi_j * u| \right\|_\infty + \left\| \sum_{j > N} 2^{-j\gamma} 2^{j\gamma} |\phi_j * u| \right\|_\infty \\ &\leq \left\| N^{1/2} \left(\sum_{0 \leq j < N} |\phi_j * u|^2 \right)^{1/2} \right\|_\infty + c_\gamma 2^{-\gamma N} \left\| \left(\sum_{j \geq N} (2^{j\gamma} |\phi_j * u|)^2 \right)^{1/2} \right\|_\infty \\ &\leq N^{1/2} \|u\|_{\dot{F}_{\infty,2}^0} + c_\gamma 2^{-\gamma N} \|u\|_{\dot{F}_{\infty,2}^\gamma}, \end{aligned} \quad (11.282)$$

where $c_\gamma \simeq \frac{1}{\gamma}$. Now we optimize (11.282) in N . For each u , we set

$$N \simeq \log_{2^\gamma} \left(c_\gamma \frac{\|u\|_{\dot{F}_{\infty,2}^\gamma}}{\|u\|_{\dot{F}_{\infty,2}^0}} \right),$$

we finally obtain

$$\|u\|_\infty \leq \|u\|_{\dot{F}_{\infty,1}^0} \leq c \|u\|_{\dot{F}_{\infty,2}^0} \left(1 + \left(\frac{1}{\gamma} \log^+ \frac{\|u\|_{\dot{F}_{\infty,2}^\gamma}}{\|u\|_{\dot{F}_{\infty,2}^0}} \right)^{1/2} \right). \quad (11.283)$$

Step 2. Using the fact that $u \in C_0^\infty(\mathbb{R}^2)$, we get :

$$|\phi_0 * u| \leq c \|u\|_{L^1}$$

and

$$|\phi_j * u| \leq c \|u\|_{BMO}, \quad \forall j \geq 1,$$

and then we obtain :

$$\|u\|_{\dot{F}_{\infty,2}^0} \leq \|u\|_{BMO}^{1/2} \|u\|_{\dot{F}_{\infty,1}^0}^{1/2}. \quad (11.284)$$

Using (11.283) with (11.284), we deduce that :

$$\frac{\|u\|_{\dot{F}_{\infty,1}^0}}{\|u\|_{BMO}} \leq c \left(1 + \log^+ \|u\|_{\dot{F}_{\infty,2}^\gamma} + \log^+ \|u\|_{BMO} + \log^+ \frac{\|u\|_{\dot{F}_{\infty,1}^0}}{\|u\|_{BMO}} \right),$$

hence

$$\|u\|_\infty \leq \|u\|_{\dot{F}_{\infty,1}^0} \leq c \|u\|_{BMO} \left(1 + \log^+ \|u\|_{\dot{F}_{\infty,2}^\gamma} + \log^+ \|u\|_{BMO} \right). \quad (11.285)$$

Step 3. ($\|u\|_{\dot{F}_{\infty,2}^\gamma} \leq c \|u\|_{W_2^{2,1}}$, with $0 < \gamma < \frac{1}{2}$)

Recall that

$$\|u\|_{\dot{F}_{\infty,2}^\gamma} = \left\| \left(\sum_{j \geq 0} (2^{\gamma j} |\phi_j * u|)^2 \right)^{1/2} \right\|_\infty.$$

We calculate

$$\begin{aligned} 2^{\gamma j} (\phi_j * u)(0) &= 2^{\gamma j} \int \hat{\phi}_j^* \cdot \hat{u} \\ &= 2^{\gamma j} \int \frac{\hat{\phi}_j^*}{\xi_x^2 + |\xi_t|} \cdot \hat{u} \cdot (\xi_x^2 + |\xi_t|), \end{aligned}$$

where ϕ_j^* is the complex conjugate of ϕ_j , and $\check{u}(x) = u(-x)$. Therefore, from Cauchy-Schwartz inequality and the fact that

$$\hat{\phi}_j = 0 \quad \text{if} \quad (\xi_x^2 + |\xi_t|)^{1/2} < 2^{j-1},$$

we obtain :

$$\begin{aligned} 2^{\gamma j} |\phi_j * u| &\leq 2^{\gamma j} \left(\int \frac{\hat{\phi}_j^2}{(\xi_x^2 + |\xi_t|)^2} \right)^{1/2} \left(\int |\hat{u}|^2 (\xi_x^2 + |\xi_t|)^2 \right)^{1/2} \\ &\leq \frac{c}{2^{j(\frac{1}{2}-\gamma)}} \|u\|_{W_2^{2,1}}. \end{aligned}$$

Finally, we get

$$\|u\|_{\dot{F}_{\infty,2}^\gamma} \leq c \|u\|_{W_2^{2,1}} \left(\sum_{j \geq 0} \frac{1}{2^{2j(\frac{1}{2}-\gamma)}} \right)^{1/2}, \quad (11.286)$$

where the above series converges since $\gamma < \frac{1}{2}$.

Step 4. (Conclusion)

Combining (11.285) from Step 2, and (11.286) from Step 3, we get the required result. \square

Back to the sketch of the proof of Theorem 2.16. Let v defined on $I \times (0, T)$. Take \tilde{v} as the special extension of the function v defined as follows :

$$\tilde{v}(x, t) = -3v(-x, t) + 4v(-x/2, t) \quad \forall -1 < x < 0.$$

The continuation to $\mathbb{R} \times (0, T)$ is made by spatial periodicity. The extension in time will be done, first by symmetry with respect to $\{t = 0\}$, and after that by time periodicity of period $2T$. Define the two zones \mathcal{Z}_1 and \mathcal{Z}_2 as follows :

$$\mathcal{Z}_1 = \{(x, t); -1/3 < x < 4/3, -T/3 < t < 4T/3\},$$

and

$$\mathcal{Z}_2 = \{(x, t); -2/3 < x < 5/3, -2T/3 < t < 5T/3\}.$$

Take ψ a cut-off function such that

$$\psi = 1 \text{ on } \mathcal{Z}_1, \quad \text{and} \quad \psi = 0 \text{ on } \mathbb{R}^2 \setminus \mathcal{Z}_2.$$

Let

$$u = \tilde{v}\psi,$$

we apply Theorem 11.1 to the function u , we get

$$\|v\|_{\infty, I_T} \leq c \|\tilde{v}\psi\|_{\overline{BMO}(\mathbb{R}^2)} \left(1 + \log^+ \|\tilde{v}\psi\|_{\overline{BMO}(\mathbb{R}^2)} + \log^+ \|\tilde{v}\psi\|_{W_2^{2,1}(\mathbb{R}^2)}\right). \quad (11.287)$$

The special extension of the function v permits to write :

$$\|\tilde{v}\psi\|_{W_2^{2,1}(\mathbb{R}^2)} \leq c \|v\|_{W_1^{2,1}(I_T)}. \quad (11.288)$$

Moreover, repeating similar arguments as in the proof of Theorem 2.13, Steps 1 and 2, we can treat relatively small cubes Q^s or relatively big cubes Q^b for the *BMO* norm of $\|\tilde{v}\psi\|_{\overline{BMO}(\mathbb{R}^2)}$. As a final consequence, we get

$$\frac{1}{|Q^i|} \int |\tilde{v}\psi - m_{Q^i}(\tilde{v}\psi)| \leq \|v\|_{\overline{BMO}(I_T)}, \quad i \in \{s, b\}.$$

The only new case that we need to take care about is when the cube intersects the zone $\mathcal{Z}_2 \setminus \mathcal{Z}_1$ where $\psi \neq 0, 1$. In this case we use the fact that

$$\|\tilde{v}\psi\|_{BMO} \leq c \|v\|_{BMO} + \|\tilde{v}\psi\|_{L^1},$$

which return us to one of the above two cases considered above. Therefore, we obtain

$$\|\tilde{v}\psi\|_{\overline{BMO}(\mathbb{R}^2)} \leq c \|v\|_{\overline{BMO}(I_T)}. \quad (11.289)$$

From (11.287), (11.288) and (11.289), the result follows. \square

Chapitre 5

Dynamics of dislocation densities in a bounded channel. Part II : existence of weak solutions to a singular Hamilton-Jacobi/parabolic strongly coupled system

Ce chapitre est issu d'un travail en collaboration avec M. Jazar et R. Monneau [55].

Nous étudions un système 1D couplant une équation parabolique et une équation d'Hamilton-Jacobi singulière. Ce système décrit la dynamique de densités de dislocations dans un matériau soumis à une contrainte extérieure appliquée. Notre système est une extension naturel de celui étudié dans [53] où la contrainte a été mise à zéro. Les équations sont écrites sur un intervalle borné et demandent une attention particulière sur le bord. Pour ce système, nous montrons un résultat d'existence d'une solution. L'idée de la preuve consiste à considérer d'abord une régularisation parabolique, et ensuite de passer à la limite. Pour le système régularisé, un résultat d'existence et d'unicité globale a été montré dans [54]. Nous montrons quelques bornes uniformes sur cette solution en utilisant en particulier une estimation entropique pour les densités.

Dynamics of dislocation densities in a bounded channel. Part II : existence of weak solutions to a singular Hamilton-Jacobi/parabolic strongly coupled system

H. Ibrahim*, M. Jazar[†], R. Monneau*

**CERMICS, École Nationale des Ponts et Chaussées
6 & 8, avenue Blaise Pascal, Cité Descartes,
Champs sur Marne, 77455 Marne-La-Vallée Cedex 2, FRANCE*

*[†]Lebanese University, Mathematics department,
P.O. Box 826, Kobbah Tripoli, Liban*

Abstract

We study a strongly coupled system of a parabolic equation and a singular Hamilton-Jacobi equation in one space dimension. This system describes the dynamics of dislocation densities in a material submitted to an exterior applied stress. Our system is a natural extension of that studied in [53] where the applied stress was set to be zero. The equations are written on a bounded interval and require special attention to the boundary layer. For this system, we prove a result of existence of a solution. The method of the proof consists in considering first a parabolic regularization of the full system, and then passing to the limit. For this regularized system, a result of global existence and uniqueness of a solution has been given in [54]. We show some uniform bounds on this solution which uses in particular an entropy estimate for the densities.

AMS Classification : 70H20, 49L25, 54C70, 46E30, 74H25.

Key words : Hamilton-Jacobi equations, viscosity solutions, entropy, Orlicz spaces, dynamics of dislocation densities.

1 Introduction

1.1 Physical motivation and setting of the problem

In [46], Groma, Czikor and Zaiser have proposed a model describing the dynamics of dislocation densities. Dislocations are defects in crystals that move when

a stress field is applied on the material. These defects are one of the main explanations of the elastoviscoplasticity behavior of metals (see [39] and [40] for various models relating dislocations and elastoviscoplastic properties of metals). This model has been introduced to describe the possible accumulation of dislocations on the boundary layer of a bounded channel. More precisely, let us call θ^+ and θ^- , the densities of the positive and negative dislocations respectively. In fact, dislocations are distinguished by the sign of their Burgers vector \vec{b} (see [51] for a description of the Burgers vector). The non-negative densities $\theta^+(x, t)$ and $\theta^-(x, t)$ are governed by the following system :

$$\begin{cases} \theta_t^+ = \left[\left(\frac{\theta_x^+ - \theta_x^-}{\theta^+ + \theta^-} - \tau \right) \theta^+ \right]_x & \text{in } I \times (0, T), \\ \theta_t^- = \left[- \left(\frac{\theta_x^+ - \theta_x^-}{\theta^+ + \theta^-} - \tau \right) \theta^- \right]_x & \text{in } I \times (0, T), \end{cases} \quad (1.1)$$

where τ is the stress field, $T > 0$, and $I := (0, 1) \subset \mathbb{R}$. The channel is bounded by walls that are impenetrable by dislocations (i.e., the plastic deformation in the walls is zero). In this case the boundary conditions are represented by the zero flux condition, i.e.

$$\frac{\theta_x^+ - \theta_x^-}{\theta^+ + \theta^-} - \tau = 0, \quad \text{at } x = 0 \text{ and } x = 1. \quad (1.2)$$

The original model in [46] is written in two space dimensions (x, y) . Here, system (1.1) corresponds to a situation where the problem is assumed invariant by translation in the y direction. In that case τ appears to be the applied stress field and will be assumed to be a constant. However, the term $\frac{\theta_x^+ - \theta_x^-}{\theta^+ + \theta^-}$ is called the back stress and can be interpreted as the contribution to the stress of the short-range interactions between dislocations. This term was, for instance, neglected in the Groma-Balogh model [45]. Moreover, for the model described in [45], we refer the reader to [31, 32] for a one-dimensional mathematical and numerical study, and to [10] for a two-dimensional existence result. The special case $\tau = 0$ for system (1.1) has been studied in [53] where a result of existence and uniqueness has been proved. In the present paper we study the case where $\tau \neq 0$.

1.2 Setting of the problem

We consider an integrated form of (1.1) and we let

$$\rho_x^\pm = \theta^\pm, \quad \rho = \rho^+ - \rho^- \quad \text{and} \quad \kappa = \rho^+ + \rho^-,$$

to obtain (at least formally), for special values of the constants of integration, the following system in terms of ρ and κ :

$$\begin{cases} \kappa_t \kappa_x = \rho_t \rho_x & \text{on } I \times (0, T) \\ \rho_t = \rho_{xx} - \tau \kappa_x & \text{on } I \times (0, T), \end{cases} \quad (1.3)$$

with the initial conditions :

$$\kappa(x, 0) = \kappa^0(x) \quad \text{and} \quad \rho(x, 0) = \rho^0(x). \quad (1.4)$$

To formulate heuristically the boundary conditions at the walls located at $x = 0$ and $x = 1$, we suppose that $\kappa_x \neq 0$ at $x = 0$ and $x = 1$. We note that the dislocation fluxes at the walls must be zero, which require (see 1.2) that :

$$\overbrace{(\theta_x^+ - \theta_x^-) - \tau(\theta^+ + \theta^-)}^{\Phi} = 0, \quad \text{at } x = 0 \quad \text{and} \quad x = 1. \quad (1.5)$$

Rewriting system (1.3) in terms of ρ , κ and Φ , we get

$$\begin{cases} \kappa_t = (\rho_x / \kappa_x) \Phi, \\ \rho_t = \Phi. \end{cases} \quad (1.6)$$

From (1.5) and (1.6), we deduce that

$$\rho_t(0, \cdot) = \rho_t(1, \cdot) = 0. \quad (1.7)$$

Also, from (1.5) and (1.6), and if $\kappa_x \neq 0$ at $x = 0$ and $x = 1$, we deduce that

$$\kappa_t(0, \cdot) = \kappa_t(1, \cdot) = 0. \quad (1.8)$$

Using (1.7) and (1.8), we can formally reformulate the boundary conditions as follows :

$$\begin{cases} \kappa(0, \cdot) = 0 \quad \text{and} \quad \kappa(1, \cdot) = 1, \\ \rho(0, \cdot) = \rho(1, \cdot) = 0, \end{cases} \quad (1.9)$$

where we have taken the zero normalization for ρ on the boundary of the interval.

The positivity of θ^+ and θ^- reduces in terms of ρ and κ to the following condition :

$$\kappa_x \geq |\rho_x|, \quad (1.10)$$

and hence a natural assumption to be considered concerning the initial conditions ρ^0 and κ^0 is to satisfy

$$\kappa_x^0 \geq |\rho_x^0| \quad \text{on } I. \quad (1.11)$$

Problem (1.3), (1.4) and (1.9), in the case $\tau = 0$, has been studied in [53] where a result of existence and uniqueness is given using the viscosity/entropy solution framework. Let us just mention that in this situation, system (1.3) becomes decoupled and easier to be handled.

1.3 Statement of the main result

In this paper, we assume that τ is a real constant,

$$\tau \neq 0$$

and we examine the existence of solutions of (1.3), (1.4) and (1.9). To be more precise, our main result is :

Theorem 1.1 (*Existence of a solution*)

Let $\rho^0, \kappa^0 \in C^\infty(\bar{I})$ satisfying (1.11),

$$\kappa^0(0) = \rho^0(0) = \rho^0(1) = 0, \quad \kappa^0(1) = 1 \quad (1.12)$$

and the additional conditions :

$$D_x^s \rho^0(x) = D_x^s \kappa^0(x) = 0, \quad s = 1, 2, \quad x = 0, 1. \quad (1.13)$$

Then there exists (ρ, κ) such that for every $T > 0$:

$$(\rho, \kappa) \in (C(\bar{I} \times [0, T]))^2 \quad \text{and} \quad \rho \in C^1(I \times (0, T)),$$

solution of (1.3), (1.4) and (1.9). Moreover, this solution satisfies (1.10) in the distributional sense, i.e.

$$\kappa_x \geq |\rho_x| \quad \text{in} \quad \mathcal{D}'(I \times (0, T)). \quad (1.14)$$

However, the solution has to be interpreted in the following sense :

1. κ is a viscosity solution of $\kappa_t \kappa_x = \rho_t \rho_x$ in $I_T := I \times (0, T)$,
2. ρ is a distributional solution of $\rho_t = \rho_{xx} - \tau \kappa_x$ in I_T ,
3. the initial and boundary conditions are satisfied pointwisely.

Remark 1.2 (*Compatibility of the approximated solution*)

The method of the proof of Theorem 1.1 consists in considering a parabolic regularization of (1.3), and then passing to the limit. This method is called the “vanishing viscosity” method. We use a result of global existence and uniqueness of the regularized system from [54], which requires some compatibility conditions on the initial data of the problem. The above boundary conditions (1.13) was taken for achieving the compatibility at the regularized level.

Remark 1.3 The C^∞ regularity of ρ^0 and κ^0 , together with the additional conditions (1.13) seems to be essentially technical.

Vanishing viscosity method is common in order to approach viscosity solutions for a Hamilton-Jacobi equation. It consists to add $\varepsilon\Delta$ to the Hamilton-Jacobi equation $H(x, u, Du) = 0$ and then obtain a more standard parabolic equation, after that we need to pass to the limit $\varepsilon \rightarrow 0$. The literature is very rich and one can cite for instance [3] and the references therein, see also [52, 87].

In our case, we are interested in a singular Hamilton-Jacobi equation, strongly coupled with a parabolic equation. The singularity comes from the following formal formulation of the first equation of (1.3) :

$$\kappa_t = \frac{\rho_t \rho_x}{\kappa_x},$$

that becomes a singular parabolic equation after adding the $\varepsilon\Delta$ term :

$$\kappa_t = \frac{\rho_t \rho_x}{\kappa_x} + \varepsilon \kappa_{xx}.$$

For a mathematical treatment of the above equation and various singular parabolic equations, see [54] and the references therein.

1.4 Organization of the paper

This paper is organized as follows : in section 2, we present the strategy of the proof. In section 3, we present the tools needed throughout this work. This includes some miscellaneous results for parabolic equations ; a brief recall to the definition and the stability result of viscosity solutions ; and a brief recall to Orlicz spaces. In section 4, we show how to choose the regularized solution. An entropy inequality used to determine some uniform bounds on the regularized solution is presented in section 5. Further uniform bounds and convergence arguments are done in section 6. Finally, section 7 is devoted to the proof of our main result : Theorem 1.1. Finally, section 8 is an appendix where we show the proofs of some standard results.

2 Strategy of the proof

The main difficulty we have to face is to work with the equation

$$\kappa_t \kappa_x = \rho_t \rho_x. \tag{2.15}$$

Since ρ solves itself a parabolic equation (see (1.3)), we expect enough regularity on ρ (indeed ρ is C^1), and then we need a framework where the equation on κ is stable under approximation. This property is naturally satisfied in the framework

of viscosity solutions. Then, assuming $\kappa_x \geq 0$, we interpret κ as the viscosity solution of (2.15). Assuming (1.11), we will indeed show that

$$M := \kappa_x - |\rho_x| \geq 0.$$

This is formally true because M formally satisfies :

$$M_t = bM_x + cM,$$

with

$$b = \tau \operatorname{sgn}(\rho_x) - \frac{\rho_x \rho_{xx}}{\kappa_x^2},$$

and

$$c = \frac{\rho_{xx}^2}{\kappa_x^2} - \frac{\rho_{xxx} \operatorname{sgn}(\rho_x)}{\kappa_x}.$$

By a maximum principle argument, we see that in order to guarantee that $M \geq 0$ is true for every time, we have somehow to control the L^∞ -norm of ρ_{xxx}/κ_x . This seems hopeless, because we would need to control moreover $\kappa_x > 0$ from below. The idea is then to replace system (1.3) by a suitable regularized system, which is the following for $\varepsilon > 0$:

$$\begin{cases} \kappa_t^\varepsilon = \varepsilon \kappa_{xx}^\varepsilon + \frac{\rho_x^\varepsilon \rho_{xx}^\varepsilon}{\kappa_x^\varepsilon} - \tau \rho_x^\varepsilon & \text{in } I \times (0, \infty) \\ \rho_t^\varepsilon = (1 + \varepsilon) \rho_{xx}^\varepsilon - \tau \kappa_x^\varepsilon & \text{in } I \times (0, \infty), \end{cases} \quad (2.16)$$

with the initial conditions :

$$\kappa^\varepsilon(x, \cdot) = \kappa^{0,\varepsilon}(x), \quad \rho^\varepsilon(x, \cdot) = \rho^{0,\varepsilon}(x), \quad (2.17)$$

and the boundary conditions :

$$\begin{cases} \kappa^\varepsilon(0, \cdot) = \kappa^{0,\varepsilon}(0), & \kappa^\varepsilon(1, \cdot) = \kappa^{0,\varepsilon}(1) \\ \rho^\varepsilon(0, \cdot) = \rho^{0,\varepsilon}(0), & \rho^\varepsilon(1, \cdot) = \rho^{0,\varepsilon}(1), \end{cases} \quad (2.18)$$

This system formally reduces to (1.3) for $\varepsilon = 0$, with initial conditions (1.4) and boundary conditions (1.9). In fact, system (2.16), (2.17) and (2.18) has (under some conditions on the initial and boundary data) a unique smooth global solution (see [54, Theorem 1.1]) for $\alpha \in (0, 1)$:

$$(\rho^\varepsilon, \kappa^\varepsilon) \in C^{3+\alpha, \frac{3+\alpha}{2}}(\bar{I} \times [0, \infty)) \cap C^\infty(I \times (0, \infty)).$$

This result will be clearly presented in the tools (see Theorem 3.1, Section 3). The next step is to find some uniform bounds (independent of ε) on this solution ;

this is done via :

(1) an entropy inequality shown to be valid for our special approximated model (2.16);

(2) a bound on $\kappa_t^\varepsilon - \varepsilon \kappa_{xx}^\varepsilon$ uniformly in ε .

In fact, (1) guarantees the global uniform-in-time control of the modulus of continuity in space of our approximated solution, while (2) guarantees the local uniform-in-space control of the modulus of continuity in time. The entropy inequality can be easily understood. For instance, for $\varepsilon = 0$ and $\tau = 0$, we can formally check that the entropy of the dislocation densities

$$\theta^\pm = \frac{\kappa_x \pm \rho_x}{2},$$

defined by :

$$S(t) = \int_I \sum_{\pm} \theta^\pm(., t) \log(\theta^\pm(., t)),$$

satisfies :

$$\frac{dS(t)}{dt} = - \int_I \frac{(\theta_x^+ - \theta_x^-)^2}{\theta^+ + \theta^-} \leq 0.$$

Therefore we get $S(t) \leq S(0)$ which controls the entropy uniformly in time. Finally, we need to pass to the limit $\varepsilon \rightarrow 0$ in the approximated solution after multiplying the first equation of (2.16) by κ_x^ε . Having enough control on the approximated solutions, we can find a solution of the limit equation using in particular the stability of viscosity solutions of Hamilton-Jacobi equations. However, the passage to the limit in the second equation of (2.16) is done in the distributional sense.

3 Tools : miscellaneous parabolic results, viscosity solution, and Orlicz spaces

3.1 Miscellaneous parabolic results

We first fix some notations. Denote

$$I_T := I \times (0, T), \quad \bar{I}_T := \bar{I} \times [0, T] \quad \text{and} \quad \partial^p I_T := I \cup (\partial I \times [0, T]).$$

Define the Sobolev space $W_p^{2,1}(I_T)$, $1 < p < \infty$ by :

$$W_p^{2,1}(I_T) := \{u \in L^p(I_T); (u_t, u_x, u_{xx}) \in (L^p(I_T))^3\}.$$

3. Tools : miscellaneous parabolic results, viscosity solution, and Orlicz spaces

We start with a result of global existence and uniqueness of smooth solutions of the regularized system (2.16), with the initial and boundary conditions (2.17) and (2.18).

Theorem 3.1 (*Global existence for the regularized system, [54, Theorem 1.1]*)

Let $0 < \alpha < 1$ and $0 < \varepsilon < 1$. Let $\rho^{0,\varepsilon}, \kappa^{0,\varepsilon}$ satisfying :

$$\rho^{0,\varepsilon}, \kappa^{0,\varepsilon} \in C^\infty(\bar{I}), \quad \rho^{0,\varepsilon}(0) = \rho^{0,\varepsilon}(1) = \kappa^{0,\varepsilon}(0) = 0, \quad \kappa^{0,\varepsilon}(1) = 1, \quad (3.19)$$

$$\begin{cases} (1 + \varepsilon)\rho_{xx}^{0,\varepsilon} = \tau\kappa_x^{0,\varepsilon} & \text{on } \partial I \\ (1 + \varepsilon)\kappa_{xx}^{0,\varepsilon} = \tau\rho_x^{0,\varepsilon} & \text{on } \partial I, \end{cases} \quad (3.20)$$

and

$$\min_{x \in I} (\kappa_x^{0,\varepsilon}(x) - |\rho_x^{0,\varepsilon}(x)|) > 0. \quad (3.21)$$

Then there exists a unique global solution

$$(\rho^\varepsilon, \kappa^\varepsilon) \in C^{3+\alpha, \frac{3+\alpha}{2}}(\bar{I} \times [0, \infty)) \cap C^\infty(I \times (0, \infty)), \quad (3.22)$$

of the system (2.16), (2.17) and (2.18). Moreover, this solution satisfies :

$$\kappa_x^\varepsilon > |\rho_x^\varepsilon| \quad \text{on } \bar{I} \times [0, \infty). \quad (3.23)$$

Remark 3.2 *Conditions (3.20) are natural here. Indeed, the regularity (3.22) of the solution of equation (2.16) with boundary conditions (2.17) and (2.18) imply in particular condition (3.20).*

Remark 3.3 (*Uniform L^∞ bound on ρ^ε and κ^ε*)

We remark, from (2.18), (3.19) and the inequality (3.23), that :

$$\|\rho^\varepsilon\|_{L^\infty(\bar{I} \times [0, \infty))} \leq 1 \quad \text{and} \quad \|\kappa^\varepsilon\|_{L^\infty(\bar{I} \times [0, \infty))} \leq 1. \quad (3.24)$$

We now present two technical lemmas that will be used in the proof of Theorem 1.1. The proofs of these lemmas will be given in the Appendix.

Lemma 3.4 (*Control of the modulus of continuity in time uniformly in ε*)

Let $p > 3$, and

$$u^\varepsilon \in W_p^{2,1}(I_T). \quad (3.25)$$

Suppose furthermore that the sequences

$$(u^\varepsilon)_\varepsilon \quad \text{and} \quad (f^\varepsilon)_\varepsilon = (u_t^\varepsilon - \varepsilon u_{xx}^\varepsilon)_\varepsilon, \quad (3.26)$$

are locally bounded in I_T uniformly for $\varepsilon \in (0, 1)$. Then for every $V \subset\subset I_T$, there exist two constants $c > 0$, $\varepsilon_0 > 0$ depending on V , and $0 < \beta < 1$ such that for all $0 < \varepsilon < \varepsilon_0$:

$$\frac{|u^\varepsilon(x, t+h) - u^\varepsilon(x, t)|}{h^\beta} \leq c, \quad \forall (x, t), (x, t+h) \in V. \quad (3.27)$$

Lemma 3.5 (An interior estimate for the heat equation)

let $a \in C^\infty(I_T) \cap L^1(I_T)$ satisfying :

$$a_t = a_{xx} \quad \text{on} \quad I_T, \quad (3.28)$$

then for any $V \subset\subset I_T$, an open set, we have :

$$\|a\|_{p,V} \leq c \|a\|_{1,I_T}, \quad \forall 1 < p < \infty, \quad (3.29)$$

with $c = c(p, V) > 0$ is a positive constant.

3.2 Viscosity solution : definition and stability result

Let $\Omega \subset \mathbb{R}^n$ be an open domain, and consider the following Hamilton-Jacobi equation :

$$F(x, u(x), Du(x), D^2u(x)) = 0, \quad \forall x \in \Omega, \quad (3.30)$$

where $F : \Omega \times \mathbb{R} \times \mathbb{R}^n \times M_{sym}^{n \times n} \mapsto \mathbb{R}$ is a continuous mapping.

Definition 3.6 (Viscosity solution of Hamilton-Jacobi equations)

A continuous function $u : \Omega \mapsto \mathbb{R}$ is a viscosity sub-solution of (3.30) if for any $\phi \in C^2(\Omega; \mathbb{R})$ and any local maximum $x_0 \in \Omega$ of $u - \phi$, one has

$$F(x_0, u(x_0), D\phi(x_0), D^2\phi(x_0)) \leq 0.$$

Similarly, u is a viscosity super-solution of (3.30), if at any local minimum point $x_0 \in \Omega$ of $u - \phi$, one has

$$F(x_0, u(x_0), D\phi(x_0), D^2\phi(x_0)) \geq 0.$$

Finally, if u is both a viscosity sub-solution and a viscosity super-solution, then u is called a viscosity solution.

To get a "non-empty" and useful definition, it is usually assumed that F is elliptic (see [3]). This notion of ellipticity will be indirectly used in Section 7. In fact, this definition is used for interpreting solutions of the first equation of (1.3) in the viscosity sense. This will be shown in Section 5. To be more precise, in the case where $\Omega = I_T$, we say that u is a viscosity solution of the Dirichlet problem (3.30) with $u = \zeta \in C(\partial^p I_T)$ if :

- (1) $u \in C(\overline{I_T})$,
- (2) u is a viscosity solution of (3.30) in I_T ,
- (3) $u = \zeta$ on $\partial^p I_T$.

For a better understanding of the viscosity interpretation of boundary conditions of Hamilton-Jacobi equations, we refer the reader to [3, Section 4.2]. We now state the stability result for viscosity solutions of Hamilton-Jacobi equations. An important result concerning viscosity solutions is presented by the following theorem :

Theorem 3.7 (Stability of viscosity solutions, [3, Lemma 2.3])

Suppose that, for $\varepsilon > 0$, $u^\varepsilon \in C(\Omega)$ is a viscosity sub-solution (resp. super-solution) of the equation

$$H^\varepsilon(x, u^\varepsilon, Du^\varepsilon, D^2u^\varepsilon) = 0 \quad \text{in } \Omega, \quad (3.31)$$

where $(H^\varepsilon)_\varepsilon$ is a sequence of continuous functions. If $u^\varepsilon \rightarrow u$ locally uniformly in Ω and if $H^\varepsilon \rightarrow H$ locally uniformly in $\Omega \times \mathbb{R} \times \mathbb{R}^n \times M_{sym}^{n \times n}$, then u is a viscosity sub-solution (resp. super-solution) of the equation :

$$H(x, u, Du, D^2u) = 0 \quad \text{in } \Omega. \quad (3.32)$$

3.3 Orlicz spaces : definition and properties

We recall the definition of an Orlicz space and some of its properties (for details see [1]). A real valued function $\Psi : [0, \infty) \rightarrow \mathbb{R}$ is called a Young function if

$$\Psi(t) = \int_0^t \psi(s)ds,$$

where $\psi : [0, \infty) \rightarrow [0, \infty)$ satisfying :

- $\psi(0) = 0$, $\psi > 0$ on $(0, \infty)$, $\psi(t) \rightarrow \infty$ as $t \rightarrow \infty$;
- ψ is non-decreasing and right continuous at any point $s \geq 0$.

Let Ψ be a Young function. The Orlicz class $K_\Psi(I)$ is the set of equivalence classes of real-valued measurable functions u on I satisfying

$$\int_I \Psi(|u(x)|)dx < +\infty.$$

Definition 3.8 (Orlicz spaces)

The Orlicz space $L_\Psi(I)$ is the linear span of $K_\Psi(I)$ supplemented with the Luxemburg norm

$$\|u\|_{L_\Psi(I)} = \inf \left\{ k > 0; \int_I \Psi \left(\frac{|u(x)|}{k} \right) \leq 1 \right\}, \quad (3.33)$$

and with this norm, the Orlicz space is a Banach space.

The function

$$\Phi(t) = \int_0^t \phi(s) ds, \quad \phi(s) = \sup_{\psi(t) \leq s} t,$$

is called the complementary Young function of Ψ . An example of such pair of complementary Young functions is the following :

$$\Psi(s) = (1 + s) \log(1 + s) - s \quad \text{and} \quad \Phi(s) = e^s - s - 1. \quad (3.34)$$

We now state a lemma giving two useful properties of Orlicz spaces that will be used in the proof of Lemma 5.4.

Lemma 3.9 (Norm control and Hölder inequality, [64])

If $u \in L_\Psi(I)$ for some Young function Ψ , then we have :

$$\|u\|_{L_\Psi(I)} \leq 1 + \int_I \Psi(|u(x)|) dx. \quad (3.35)$$

Moreover, if $v \in L_\Phi(I)$, Φ being the complementary Young function of Ψ , then we have the following Hölder inequality :

$$\left| \int_I uv dx \right| \leq 2 \|u\|_{L_\Psi(I)} \|v\|_{L_\Phi(I)}. \quad (3.36)$$

4 The regularized problem

As we have already mentioned, we will use a parabolic regularization of (1.3), and a result of global existence of this regularized system from [54] (see Theorem 3.1). In order to use this result, we need to give a special attention to the conditions on the initial data of the approximated system $\rho^{0,\varepsilon}$ and $\kappa^{0,\varepsilon}$ (see (3.19), (3.20) and (3.21)). This section aims to show how to choose the suitable initial data $\rho^{0,\varepsilon}$ and $\kappa^{0,\varepsilon}$ in order to benefit Theorem 3.1.

Let ρ^0 and κ^0 be the functions given in Theorem 1.1. Set

$$\rho^{0,\varepsilon} = \frac{\rho^0 + \varepsilon \tau \phi}{(1 + \varepsilon)^2}, \quad (4.37)$$

and

$$\kappa^{0,\varepsilon} = \frac{\kappa^0 + \varepsilon x}{1 + \varepsilon}, \quad (4.38)$$

with the function ϕ defined by :

$$\phi(x) = \frac{1}{\tau^2} [1 - \cos \tau(x^2 - x)]. \quad (4.39)$$

The function ϕ enjoys some properties that are shown in the following lemma.

Lemma 4.1 (Properties of ϕ)

The function ϕ given by (4.39) satisfies the following properties :

$$(P1) \quad \phi, \phi' |_{\partial I} = 0;$$

$$(P2) \quad \phi'' |_{\partial I} = 1;$$

$$(P3) \quad |\phi'(x)| < 1/|\tau| \quad \text{for } x \in \bar{I}.$$

Proof. (P1) and (P2) directly follows by simple computations. For (P3), we calculate on \bar{I} :

$$\begin{aligned} |\phi'(x)| &= (1/|\tau|)|2x - 1| |\sin \tau(x^2 - x)| \\ &\leq 1/|\tau|. \end{aligned}$$

In order to obtain the strict inequality, we remark that

$$|2x - 1| |\sin \tau(x^2 - x)| \neq 1 \quad \text{on } \bar{I},$$

hence $|\phi'(x)| < 1/|\tau|$. □

Form the above lemma, and from the construction of $\rho^{0,\varepsilon}$ and $\kappa^{0,\varepsilon}$ (see (4.37) and (4.38)) together with the properties enjoyed by ρ^0 and κ^0 (see (1.12) and (1.13)), we write down some properties of $\rho^{0,\varepsilon}$ and $\kappa^{0,\varepsilon}$.

Lemma 4.2 (Properties of $\rho^{0,\varepsilon}$ and $\kappa^{0,\varepsilon}$)

The functions $\rho^{0,\varepsilon}$ and $\kappa^{0,\varepsilon}$ given respectively by (4.37) and (4.38), satisfy the following properties :

$$(P4) \quad \rho^{0,\varepsilon}(0) = \rho^{0,\varepsilon}(1) = \kappa^{0,\varepsilon}(0) = 0 \quad \text{and} \quad \kappa^{0,\varepsilon}(1) = 1;$$

$$(P5) \quad (1 + \varepsilon)\kappa_{xx}^{0,\varepsilon} |_{\partial I} = \tau\rho_x^{0,\varepsilon} |_{\partial I} \quad \text{and} \quad (1 + \varepsilon)\rho_{xx}^{0,\varepsilon} |_{\partial I} = \tau\kappa_x^{0,\varepsilon} |_{\partial I};$$

$$(P6) \quad \kappa_x^{0,\varepsilon} \geq |\rho_x^{0,\varepsilon}| + \frac{\varepsilon(1 - |\tau||\phi'|)}{1 + \varepsilon} > |\rho_x^{0,\varepsilon}|.$$

Proof. We only show (P5) and (P6). For (P5), we calculate :

$$\rho_x^{0,\varepsilon} = \frac{\rho_x^0 + \varepsilon\tau\phi'}{(1 + \varepsilon)^2}, \quad \rho_{xx}^{0,\varepsilon} = \frac{\rho_{xx}^0 + \varepsilon\tau\phi''}{(1 + \varepsilon)^2}, \tag{4.40}$$

and

$$\kappa_x^{0,\varepsilon} = \frac{\kappa_x^0 + \varepsilon}{1 + \varepsilon}, \quad \kappa_{xx}^{0,\varepsilon} = \frac{\kappa_{xx}^0}{1 + \varepsilon}.$$

Therefore, on ∂I , we have :

$$(1 + \varepsilon)\rho_{xx}^{0,\varepsilon} = \tau \left(\frac{\varepsilon}{1 + \varepsilon} \right) = \tau\kappa_x^{0,\varepsilon},$$

and

$$(1 + \varepsilon)\kappa_{xx}^{0,\varepsilon} = \tau\rho_x^{0,\varepsilon} = 0,$$

where we have used (P1) and (P2) from Lemma 4.1, and the properties (1.12), (1.13) of ρ^0 and κ^0 on ∂I . For (P6), we proceed as follows. We first use the inequality (1.11) between ρ_x^0 and κ_x^0 , to deduce that :

$$\kappa_x^{0,\varepsilon} = \frac{\kappa_x^0 + \varepsilon}{1 + \varepsilon} \geq \frac{|\rho_x^0| + \varepsilon}{1 + \varepsilon},$$

and then from the left identity of (4.40), we deduce that :

$$\rho_x^0 = (1 + \varepsilon)^2 \rho_x^{0,\varepsilon} - \varepsilon\tau\phi',$$

therefore

$$\kappa_x^{0,\varepsilon} \geq (1 + \varepsilon)|\rho_x^{0,\varepsilon}| + \frac{\varepsilon(1 - |\tau||\phi'|)}{1 + \varepsilon}.$$

The inequality (P6) then directly follows. \square

Remark 4.3 (*The regularized solution* $(\rho^\varepsilon, \kappa^\varepsilon)$)

Properties (P4)-(P5)-(P6) of Lemma 4.2 implies condition (3.19)-(3.20)-(3.21) of Theorem 3.1. In this case, call

$$(\rho^\varepsilon, \kappa^\varepsilon), \tag{4.41}$$

the solution of (2.16), (2.17) and (2.18), given in Theorem 3.1, with the initial conditions

$$\rho(x, 0) = \rho^{0,\varepsilon} \quad \text{and} \quad \kappa(x, 0) = \kappa^{0,\varepsilon},$$

that are given by (4.37) and (4.38) respectively.

5 Entropy inequality

Proposition 5.1 (*Entropy inequality*)

Let $(\rho^\varepsilon, \kappa^\varepsilon)$ be the regular solution given by (4.41). Define $\theta^{\pm,\varepsilon}$ by :

$$\theta^{\pm,\varepsilon} = \frac{\kappa_x^\varepsilon \pm \rho_x^\varepsilon}{2}, \tag{5.42}$$

then the quantity $S(t)$ given by :

$$S(t) = \int_I \sum_{\pm} \theta^{\pm, \varepsilon}(x, t) \log \theta^{\pm, \varepsilon}(x, t) dx, \quad (5.43)$$

satisfies for every $t \geq 0$:

$$S(t) \leq S(0) + \frac{\tau^2 t}{4}. \quad (5.44)$$

Proof. From (3.23), we know that

$$\kappa_x^\varepsilon > |\rho_x^\varepsilon|,$$

hence

$$\theta^{\pm, \varepsilon} > 0,$$

and the term $\log(\theta^{\pm, \varepsilon})$ is well defined. Also from the regularity (3.22) of the solution $(\rho^\varepsilon, \kappa^\varepsilon)$, we know that

$$\theta^{\pm, \varepsilon}(\cdot, t) \in C(\bar{I}), \quad \forall t \geq 0,$$

hence the term $S(t)$ is well defined. We derive system (2.16) with respect to x , and we write it in terms of $\theta^{\pm, \varepsilon}$, we get :

$$\begin{cases} \theta_t^{+, \varepsilon} = \left[\left(\frac{(\theta^{+, \varepsilon} - \theta^{-, \varepsilon})_x}{\theta^{+, \varepsilon} + \theta^{-, \varepsilon}} - \tau \right) \theta^{+, \varepsilon} + \varepsilon \theta_x^{+, \varepsilon} \right]_x \\ \theta_t^{-, \varepsilon} = \left[- \left(\frac{(\theta^{+, \varepsilon} - \theta^{-, \varepsilon})_x}{\theta^{+, \varepsilon} + \theta^{-, \varepsilon}} - \tau \right) \theta^{-, \varepsilon} + \varepsilon \theta_x^{-, \varepsilon} \right]_x. \end{cases} \quad (5.45)$$

We first remark that :

$$\left(\frac{(\theta^{+, \varepsilon} - \theta^{-, \varepsilon})_x}{\theta^{+, \varepsilon} + \theta^{-, \varepsilon}} - \tau \right) \theta^{+, \varepsilon} + \varepsilon \theta_x^{+, \varepsilon} = \frac{\kappa_t + \rho_t}{2}$$

and

$$- \left(\frac{(\theta^{+, \varepsilon} - \theta^{-, \varepsilon})_x}{\theta^{+, \varepsilon} + \theta^{-, \varepsilon}} - \tau \right) \theta^{-, \varepsilon} + \varepsilon \theta_x^{-, \varepsilon} = \frac{\kappa_t - \rho_t}{2}.$$

Since κ_t^ε and ρ_t^ε are zeros on $\partial I \times [0, \infty)$, then

$$\left(\frac{(\theta^{+, \varepsilon} - \theta^{-, \varepsilon})_x}{\theta^{+, \varepsilon} + \theta^{-, \varepsilon}} - \tau \right) \theta^{+, \varepsilon} + \varepsilon \theta_x^{+, \varepsilon} = - \left(\frac{(\theta^{+, \varepsilon} - \theta^{-, \varepsilon})_x}{\theta^{+, \varepsilon} + \theta^{-, \varepsilon}} - \tau \right) \theta^{-, \varepsilon} + \varepsilon \theta_x^{-, \varepsilon} = 0 \text{ on } \partial I \times [0, \infty). \quad (5.46)$$

Using (5.46), we compute for $t \geq 0$:

$$\begin{aligned}
 S'(t) &= \sum_{\pm} \int_I \theta_t^{\pm, \varepsilon} \log(\theta^{\pm, \varepsilon}) + \theta_t^{\pm, \varepsilon}, \\
 &= \sum_{\pm} \int_I \mp \left(\frac{(\theta^{+, \varepsilon} - \theta^{-, \varepsilon})_x}{\theta^{+, \varepsilon} + \theta^{-, \varepsilon}} - \tau \right) \theta_x^{\pm, \varepsilon} - \varepsilon \frac{(\theta_x^{\pm, \varepsilon})^2}{\theta^{\pm, \varepsilon}}, \\
 &= \int_I -\frac{(\theta_x^{+, \varepsilon} - \theta_x^{-, \varepsilon})^2}{\theta^{+, \varepsilon} + \theta^{-, \varepsilon}} + \tau(\theta_x^{+, \varepsilon} - \theta_x^{-, \varepsilon}) - \varepsilon \left(\frac{(\theta_x^{+, \varepsilon})^2}{\theta^{+, \varepsilon}} + \frac{(\theta_x^{-, \varepsilon})^2}{\theta^{-, \varepsilon}} \right).
 \end{aligned}$$

By Young's Inequality, we have :

$$|\theta_x^{+, \varepsilon} - \theta_x^{-, \varepsilon}| \leq \frac{1}{\tau} \frac{(\theta_x^{+, \varepsilon} - \theta_x^{-, \varepsilon})^2}{\theta^{+, \varepsilon} + \theta^{-, \varepsilon}} + \frac{\tau}{4} (\theta^{+, \varepsilon} + \theta^{-, \varepsilon}),$$

and hence

$$\begin{aligned}
 S'(t) &\leq \int_I \frac{\tau^2}{4} (\theta^{+, \varepsilon} + \theta^{-, \varepsilon}) - \varepsilon \left(\frac{(\theta_x^{+, \varepsilon})^2}{\theta^{+, \varepsilon}} + \frac{(\theta_x^{-, \varepsilon})^2}{\theta^{-, \varepsilon}} \right) \\
 &\leq \frac{\tau^2}{4} \int_I (\theta^{+, \varepsilon} + \theta^{-, \varepsilon}).
 \end{aligned}$$

Moreover, we have from (2.18), that

$$\int_I (\theta^{+, \varepsilon}(\cdot, t) + \theta^{-, \varepsilon}(\cdot, t)) = \int_I \kappa_x^\varepsilon(\cdot, t) = \kappa^\varepsilon(1, t) - \kappa^\varepsilon(0, t) = 1,$$

and therefore

$$S'(t) \leq \frac{\tau^2}{4}.$$

Integrating the previous inequality from 0 to t , we get (5.44). \square

An immediate corollary of Proposition 5.1 is the following :

Corollary 5.2 (*Special control of κ_x^ε*)

For all $t \geq 0$, we have :

$$\int_I \kappa_x^\varepsilon(x, t) \log(\kappa_x^\varepsilon(x, t)) dx \leq S(0) + \frac{\tau^2 t}{4} + 1, \quad (5.47)$$

where S is given by (5.43).

The proof of Corollary 5.2 depends on the inequality shown by the next lemma.

Lemma 5.3 For every $x, y > 0$, we have :

$$(x + y) \log(x + y) \leq x \log(x) + y \log(y) + x \log(2) + y. \quad (5.48)$$

Proof. Fix $y > 0$. consider the function f defined by :

$$f(x) = (x + y) \log(x + y) - x \log(x) - y \log(y) - x \log(2) - y, \quad x > 0. \quad (5.49)$$

We claim that $f(x) \leq 0$ for every $x > 0$. Indeed, we have $\lim_{x \rightarrow 0^+} f(x) = -y < 0$. We compute

$$f'(x) = \log(x + y) - \log(x) - \log(2), \quad (5.50)$$

and we remark that this is always a decreasing function with

$$\lim_{x \rightarrow 0^+} f'(x) = +\infty \quad \text{and} \quad \lim_{x \rightarrow +\infty} f'(x) = -\log(2),$$

hence the function $f(x)$ can only be positive if $f(x_0) > 0$ where x_0 satisfies

$$f'(x_0) = 0.$$

A simple computation shows that $x_0 = y$, then

$$\begin{aligned} f(y) &= 2y \log(2y) - 2y \log(y) - y \log(2) - y \\ &= 2y \log(2) + 2y \log(y) - 2y \log(y) - y \log(2) - y \\ &= y \log(2) - y < 0, \end{aligned}$$

and therefore $f(x) \leq 0, \forall x > 0$, which ends the proof. □

Proof of Corollary 5.2. From (5.42), it follows that

$$\kappa_x^\varepsilon = \theta^{+, \varepsilon} + \theta^{-, \varepsilon} > 0.$$

Then we have for $t \geq 0$:

$$\begin{aligned} \int_I \kappa_x^\varepsilon \log \kappa_x^\varepsilon &= \int_I (\theta^{+, \varepsilon} + \theta^{-, \varepsilon}) \log(\theta^{+, \varepsilon} + \theta^{-, \varepsilon}) \\ &\leq \int_I \theta^{+, \varepsilon} \log(\theta^{+, \varepsilon}) + \theta^{-, \varepsilon} \log(\theta^{-, \varepsilon}) + \theta^{+, \varepsilon} \log 2 + \theta^{-, \varepsilon} \\ &\leq \int_I \theta^{+, \varepsilon} \log(\theta^{+, \varepsilon}) + \theta^{-, \varepsilon} \log(\theta^{-, \varepsilon}) + \frac{1}{2}(\log 2 + 1) \\ &\leq S(t) + 1. \end{aligned}$$

Here we have used Lemma 5.3 with $x = \theta^{+, \varepsilon}$ and $y = \theta^{-, \varepsilon}$ for the second line, and we have used for the third line, the fact that

$$\int_I \theta^{\pm, \varepsilon} = \frac{1}{2} \int_I \kappa_x \pm \rho_x = \frac{1}{2} [\kappa(1, \cdot) - \kappa(0, \cdot)] = 1/2.$$

Using (5.44), the result follows. □

Lemma 5.4 (*Control of the modulus of continuity in space*)

Let $u \in C^1(I)$, $u_x > 0$, satisfying

$$\int_I u_x \log(u_x) \leq c_1, \quad (5.51)$$

then we have for any $x, x+h \in I$:

$$|u(x+h) - u(x)| \leq \frac{c_2(1+c_1)}{|\log h|}, \quad (5.52)$$

where $c_2 > 0$ is a universal constant.

Proof. Let $x, x+h \in I$.

Step 1. ($u_x \in L_\Psi(x, x+h)$ with Ψ given in (3.34))

We compute

$$\begin{aligned} \int_x^{x+h} \Psi(u_x) &= \int_x^{x+h} (1+u_x) \log(1+u_x) - u_x \\ &\leq \int_I (1+u_x) \log(1+u_x) - u_x \\ &\leq \int_I u_x \log(u_x) + \log 2 \\ &\leq c_1 + \log 2, \end{aligned}$$

where we have used (5.48) in the third line, and (5.51) in the last line. Hence from (3.35), we get

$$\|u_x\|_{L_\Psi(x, x+h)} \leq c_1 + 1 + \log 2,$$

and hence $u_x \in L_\Psi(x, x+h)$.

Step 2. (Estimating the modulus of continuity)

It is easy to check that the function 1 lies in $L_\Phi(x, x+h)$, Φ is also given by (3.34). Therefore, by Hölder inequality (3.36), we obtain :

$$\begin{aligned} |u(x+h) - u(x)| &= \left| \int_x^{x+h} u_x \cdot 1 \right| \\ &\leq 2 \|u_x\|_{L_\Psi(x, x+h)} \|1\|_{L_\Phi(x, x+h)} \\ &\leq 2(c_1 + 1 + \log 2) \|1\|_{L_\Phi(x, x+h)}. \end{aligned} \quad (5.53)$$

We turn our attention now to the term $\|1\|_{L_\Phi(x, x+h)}$. We have

$$\begin{aligned} \|1\|_{L_\Phi(x, x+h)} &= \inf \left\{ k > 0; \int_x^{x+h} \Phi \left(\frac{1}{k} \right) \leq 1 \right\} \\ &= \inf \left\{ k > 0; \int_x^{x+h} (e^{1/k} - 1/k - 1) \leq 1 \right\} \\ &= \inf \{ k > 0; h(e^{1/k} - 1/k - 1) \leq 1 \} \\ &\leq -\frac{1}{\log(h)}, \end{aligned}$$

where we have used in the last line the fact that for $0 < h < 1$ and $k = -\frac{1}{\log(h)}$, the following inequality holds :

$$h(e^{1/k} - 1/k - 1) \leq 1.$$

Hence, (5.53) implies

$$|u(x+h) - u(x)| \leq 2(c_1 + 1 + \log 2) \frac{1}{|\log h|},$$

and then (5.52) follows. □

Remark 5.5 *As mentioned to us by Jérôme Droniou, it is possible to estimate directly the quantity $|u(x+h) - u(x)| \leq \frac{A}{|\log h|}$ by splitting the integral $\int_x^{x+h} u_x$ on the set where u_x is bigger and lower than λ , and then optimizing on the parameter λ .*

6 An interior estimate

In this section, we give an interior estimate for the term

$$A^\varepsilon = \rho_x^\varepsilon - \tau \kappa^\varepsilon. \tag{6.54}$$

that will be used in the passage to the limit as ε goes to zero in the regularized system. We start by deriving an equation satisfied by A^ε .

Lemma 6.1 *The quantity A^ε given by (6.54) satisfies for any $T > 0$:*

$$A_t^\varepsilon = (1 + \varepsilon) A_{xx}^\varepsilon - \frac{\tau \rho_x^\varepsilon}{\kappa_x^\varepsilon} A_x^\varepsilon. \tag{6.55}$$

Proof. From (2.16), we calculate :

$$\begin{aligned}
 A_t^\varepsilon &= \rho_{tx}^\varepsilon - \tau \kappa_t^\varepsilon \\
 &= (1 + \varepsilon) \rho_{xxx}^\varepsilon - \tau \kappa_{xx}^\varepsilon - \tau \left(\varepsilon \kappa_{xx}^\varepsilon + \frac{\rho_x^\varepsilon \rho_{xx}^\varepsilon}{\kappa_x^\varepsilon} - \tau \rho_x^\varepsilon \right) \\
 &= (1 + \varepsilon) (\rho_{xxx}^\varepsilon - \tau \kappa_{xx}^\varepsilon) - \frac{\tau \rho_x^\varepsilon}{\kappa_x^\varepsilon} (\rho_{xx}^\varepsilon - \tau \kappa_x^\varepsilon) \\
 &= (1 + \varepsilon) A_{xx}^\varepsilon - \frac{\tau \rho_x^\varepsilon}{\kappa_x^\varepsilon} A_x^\varepsilon,
 \end{aligned}$$

hence (6.55) is satisfied. \square

We now show an interior L^p estimate concerning the term A^ε . This estimate gives a control on the local L^p norm of A^ε by its global L^1 norm over I_T , and it will be used in the following section. More precisely, we have the following lemma.

Lemma 6.2 (Interior L^p estimate)

Let $0 < \varepsilon < 1$ and $1 < p < \infty$. Then the quantity A^ε given by (6.54) satisfies :

$$\|A^\varepsilon\|_{p,V} \leq c (\|A^\varepsilon\|_{1,I_T} + 1), \quad (6.56)$$

where V is an open subset of I_T such that $V \subset\subset I_T$, and $c = c(p, V) > 0$ is a constant independent of ε .

Proof. Throughout the proof, the term $c = c(p, V) > 0$ is a positive constant independent of ε , and it may vary from line to line. A simple computation gives :

$$\begin{aligned}
 -\tau \frac{\rho_x^\varepsilon}{\kappa_x^\varepsilon} A_x^\varepsilon &= -\tau \frac{\rho_x^\varepsilon}{\kappa_x^\varepsilon} (\rho_{xx}^\varepsilon - \tau \kappa_x^\varepsilon) \\
 &= -\tau \frac{\rho_x^\varepsilon \rho_{xx}^\varepsilon}{\kappa_x^\varepsilon} + \tau^2 \rho_x^\varepsilon \\
 &= -\tau (\kappa_t^\varepsilon - \varepsilon \kappa_{xx}^\varepsilon).
 \end{aligned} \quad (6.57)$$

Define $\bar{\kappa}^\varepsilon$ as the unique solution of

$$\begin{cases} \bar{\kappa}_t^\varepsilon = (1 + \varepsilon) \bar{\kappa}_{xx}^\varepsilon + \kappa^\varepsilon & \text{on } I_T, \\ \bar{\kappa}^\varepsilon = 0 & \text{on } \partial^p I_T, \end{cases} \quad (6.58)$$

where the existence and uniqueness of this equation is a direct consequence of the L^p theory for parabolic equations (see for instance [65, Theorem 9.1]) using in particular the fact that $\kappa^\varepsilon \in C^1(\bar{I}_T)$. Moreover, from the regularity (3.22) of κ^ε , we can deduce that $\bar{\kappa}^\varepsilon \in C^\infty(I_T)$. Let \bar{A}^ε be given by :

$$\bar{A}^\varepsilon = -\tau (\bar{\kappa}_t^\varepsilon - \varepsilon \bar{\kappa}_{xx}^\varepsilon), \quad (6.59)$$

and

$$a^\varepsilon = A^\varepsilon - \bar{A}^\varepsilon. \quad (6.60)$$

We calculate :

$$\begin{aligned} \bar{A}_t^\varepsilon &= -\tau[\bar{\kappa}_{tt}^\varepsilon - \varepsilon\bar{\kappa}_{xxt}^\varepsilon] \\ &= -\tau[(1+\varepsilon)\bar{\kappa}_{xxt}^\varepsilon + \kappa_t^\varepsilon - \varepsilon((1+\varepsilon)\bar{\kappa}_{xxxx}^\varepsilon + \kappa_{xx}^\varepsilon)] \\ &= -\tau(1+\varepsilon)(\bar{\kappa}_{xxt}^\varepsilon - \varepsilon\bar{\kappa}_{xxxx}^\varepsilon) - \tau(\kappa_t^\varepsilon - \varepsilon\kappa_{xx}^\varepsilon) \\ &= (1+\varepsilon)\bar{A}_{xx}^\varepsilon - \frac{\tau\rho_x^\varepsilon}{\kappa_x^\varepsilon}A_x^\varepsilon, \end{aligned}$$

where for the first two line, we have used (6.58), and for the last line, we have used (6.57). In this case, we obtain :

$$\begin{aligned} a_t^\varepsilon &= A_t^\varepsilon - \bar{A}_t^\varepsilon \\ &= (1+\varepsilon)A_{xx}^\varepsilon - \frac{\tau\rho_x^\varepsilon}{\kappa_x^\varepsilon}A_x^\varepsilon - (1+\varepsilon)\bar{A}_{xx}^\varepsilon + \frac{\tau\rho_x^\varepsilon}{\kappa_x^\varepsilon}A_x^\varepsilon \\ &= (1+\varepsilon)(A_{xx}^\varepsilon - \bar{A}_{xx}^\varepsilon) \\ &= (1+\varepsilon)a_{xx}^\varepsilon, \end{aligned}$$

where for the first line, we have used the equation (6.55). We apply Lemma 3.5 to the function a^ε , after doing parabolic rescaling of the form $\tilde{a}^\varepsilon(x, t) = a^\varepsilon(x, \frac{t}{1+\varepsilon})$, we get :

$$\|a^\varepsilon\|_{p,V} \leq c(1+\varepsilon)^{1-\frac{1}{p}}\|a^\varepsilon\|_{1,I_T},$$

and since $0 < \varepsilon < 1$, we finally obtain

$$\|a^\varepsilon\|_{p,V} \leq c\|a^\varepsilon\|_{1,I_T}. \quad (6.61)$$

From the definition of a^ε (see (6.60) above), and the above inequality (6.61), we finally deduce that :

$$\|A^\varepsilon\|_{p,V} \leq c(\|A^\varepsilon\|_{1,I_T} + \|\bar{A}^\varepsilon\|_{p,I_T}). \quad (6.62)$$

In order to complete the proof, we need to control the term $\|\bar{A}^\varepsilon\|_{p,I_T}$ in (6.62). We use the equation (6.58) satisfied by $\bar{\kappa}^\varepsilon$ to obtain :

$$\begin{aligned} \|\bar{A}^\varepsilon\|_{p,I_T} &= \tau\|\bar{\kappa}_t^\varepsilon - \varepsilon\bar{\kappa}_{xx}^\varepsilon\|_{p,I_T} \\ &= \tau\|\bar{\kappa}_{xx}^\varepsilon + \kappa^\varepsilon\|_{p,I_T} \\ &\leq c(\|\bar{\kappa}_{xx}^\varepsilon\|_{p,I_T} + \|\kappa^\varepsilon\|_{p,I_T}). \end{aligned} \quad (6.63)$$

The L^p estimates for parabolic equations (see [54, Lemma 2.7]) applied to (6.58) gives :

$$\|\bar{\kappa}_{xx}^\varepsilon\|_{p,I_T} \leq \frac{c}{1+\varepsilon}\|\kappa^\varepsilon\|_{p,I_T},$$

then (6.63), together with the fact that $0 \leq \kappa^\varepsilon \leq 1$ implies :

$$\|\bar{A}^\varepsilon\|_{p,I_T} \leq c\|\kappa^\varepsilon\|_{p,I_T} \leq cT^{1/p},$$

hence the result follows. \square

7 Proof of the main theorem

At this stage, we are ready to present the proof of our main result (Theorem 1.1). This depends essentially on the passage to the limit in the family of solutions $(\rho^\varepsilon, \kappa^\varepsilon)$ of system (2.16). Since $\kappa_x^\varepsilon \neq 0$, we multiply the first equation of (2.16) by κ_x^ε and we rewrite system (2.16) in terms of A^ε , we obtain :

$$\begin{cases} \kappa_t^\varepsilon \kappa_x^\varepsilon = \varepsilon \kappa_x^\varepsilon \kappa_{xx}^\varepsilon + \rho_x^\varepsilon A_x^\varepsilon & \text{on } I_T \\ \rho_t^\varepsilon = \varepsilon \rho_{xx}^\varepsilon + A_x^\varepsilon & \text{on } I_T. \end{cases} \quad (7.64)$$

We will pass to the limit in the framework of viscosity solutions for the first equation of (7.64), and in the distributional sense for the second equation. We start with the following proposition.

Proposition 7.1 (Local uniform convergence)

The sequences $(\rho^\varepsilon)_\varepsilon$, $(\rho_x^\varepsilon)_\varepsilon$, $(\kappa^\varepsilon)_\varepsilon$, $(A^\varepsilon)_\varepsilon$ and $(A_x^\varepsilon)_\varepsilon$ converge (up to extraction of a subsequence) locally uniformly in I_T as ε goes to zero.

Proof. Let V be an open compactly contained subset of I_T . The constants that will appear in the proof are all independent of ε . However, they may depend on other fixed parameters including V . The idea is to give an ε -uniform control of the modulus of continuity in space and in time of the quantities mentioned in Proposition 7.1, which gives the local uniform convergence. The ε -uniform control on the space modulus of continuity will be derived from the Corollary 5.2 and Lemma 5.4, while the ε -uniform control on the time modulus of continuity will be derived from Lemma 3.4. The proof is divided into five steps.

Step 1. (Convergence of A^ε and A_x^ε)

From (3.23), we know that $\left\| \frac{\rho_x^\varepsilon}{\kappa_x^\varepsilon} \right\|_\infty \leq 1$. We apply the interior L^p , $p > 1$, estimates for parabolic equations (see for instance [68, Theorem 7.13, page 172]) to the term A^ε satisfying (6.55), we obtain :

$$\|A^\varepsilon\|_{W_p^{2,1}(V)} \leq c_3 \|A^\varepsilon\|_{p,V'}, \quad (7.65)$$

where V' is any open subset of I_T satisfying $V \subset\subset V' \subset\subset I_T$. The constant $c_3 = c_3(p, \tau, V, V')$ can be chosen independent of ε first by applying a parabolic

rescaling of (6.55), and then using the fact that the factor multiplied by A_{xx}^ε in (6.55) satisfies $1 \leq 1 + \varepsilon \leq 2$. At this point, we apply Lemma 6.2 for A^ε on V' , we get :

$$\|A^\varepsilon\|_{p,V'} \leq c_4(\|A^\varepsilon\|_{1,I_T} + 1), \quad (7.66)$$

and hence the above two equations (7.65) and (7.66) give :

$$\|A^\varepsilon\|_{W_p^{2,1}(V)} \leq c_5(\|A^\varepsilon\|_{1,I_T} + 1). \quad (7.67)$$

We estimate the right hand side of (7.67) in the following way :

$$\begin{aligned} \|A^\varepsilon\|_{1,I_T} &= \int_{I_T} |\rho_x^\varepsilon - \tau \kappa^\varepsilon| \\ &\leq \int_{I_T} \kappa_x^\varepsilon + \tau |\kappa^\varepsilon| \\ &\leq (1 + \tau)T, \end{aligned}$$

where we have used the fact that $|\rho_x^\varepsilon| < \kappa_x^\varepsilon$ (see (3.23) of Theorem 3.1) in the second line, and the fact that $0 \leq \kappa^\varepsilon \leq 1$ (see Remark 3.3) in the last line. Therefore, inequality (7.67) implies :

$$\|A^\varepsilon\|_{W_p^{2,1}(V)} \leq c_6, \quad 1 < p < \infty. \quad (7.68)$$

We use the above inequality for $p > 3$. In this case, the Sobolev embedding in Hölder spaces (see [54, Lemma 2.8]) gives :

$$W_p^{2,1}(V) \hookrightarrow C^{1+\alpha, \frac{1+\alpha}{2}}(V), \quad \alpha = 1 - 3/p$$

and hence (7.68) implies :

$$\|A^\varepsilon\|_{C^{1+\alpha, \frac{1+\alpha}{2}}(V)} \leq c_7, \quad (7.69)$$

which guarantees the equicontinuity and the equiboundedness of $(A^\varepsilon)_\varepsilon$ and $(A_x^\varepsilon)_\varepsilon$. By the Arzela-Ascoli Theorem (see for instance [7]), we finally obtain

$$A^\varepsilon \longrightarrow A \quad \text{and} \quad A_x^\varepsilon \longrightarrow A_x, \quad (7.70)$$

up to a subsequence, uniformly on V as $\varepsilon \rightarrow 0$.

Step 2. (Convergence of κ^ε)

We control the modulus of continuity of κ^ε in space and in time, locally uniformly with respect to ε .

Step 2.1. (Control of the modulus of continuity in time)

The first equation of (7.64) gives :

$$\kappa_t^\varepsilon = \varepsilon \kappa_{xx}^\varepsilon + \frac{\rho_x^\varepsilon}{\kappa_x^\varepsilon} A_x^\varepsilon,$$

and hence, using the fact that $\left\| \frac{\rho_x^\varepsilon}{\kappa_x^\varepsilon} \right\|_\infty \leq 1$, together with (7.69), we get :

$$\|\kappa_t^\varepsilon - \varepsilon \kappa_{xx}^\varepsilon\|_{\infty, V} \leq \left\| \frac{\rho_x^\varepsilon}{\kappa_x^\varepsilon} \right\|_{\infty, V} \|A_x\|_{\infty, V} \leq c_7. \quad (7.71)$$

Also, by (3.24), we have :

$$\|\kappa^\varepsilon\|_{\infty, V} \leq 1.$$

This uniform bound on κ^ε together with (7.71) permit to use Lemma 3.4 to conclude that

$$|\kappa^\varepsilon(x, t) - \kappa^\varepsilon(x, t + h)| \leq c_8 h^\beta, \quad (x, t), (x, t + h) \in V, \quad 0 < \beta < 1, \quad (7.72)$$

which controls the modulus of continuity of κ^ε with respect to t uniformly in ε . We now move to control the modulus of continuity in space.

Step 2.2 (An ε -uniform bound on $S(0)$)

Recall the definition (5.43) of $S(t)$:

$$S(t) = \int_I \sum_{\pm} \theta^{\pm, \varepsilon}(x, t) \log \theta^{\pm, \varepsilon}(x, t) dx,$$

with

$$\theta^{\pm, \varepsilon} = \frac{\kappa_x^\varepsilon \pm \rho_x^\varepsilon}{2}.$$

Hence

$$S(0) = \int_I \frac{\kappa_x^{0, \varepsilon} + \rho_x^{0, \varepsilon}}{2} \log \left(\frac{\kappa_x^{0, \varepsilon} + \rho_x^{0, \varepsilon}}{2} \right) + \int_I \frac{\kappa_x^{0, \varepsilon} - \rho_x^{0, \varepsilon}}{2} \log \left(\frac{\kappa_x^{0, \varepsilon} - \rho_x^{0, \varepsilon}}{2} \right).$$

Using the elementary identity $x \log x \leq x^2$ and $(x \pm y)^2 \leq 2(x^2 + y^2)$, we compute :

$$\begin{aligned} S(0) &\leq \int_I \left(\frac{\kappa_x^{0, \varepsilon} + \rho_x^{0, \varepsilon}}{2} \right)^2 + \int_I \left(\frac{\kappa_x^{0, \varepsilon} - \rho_x^{0, \varepsilon}}{2} \right)^2 \\ &\leq \|\rho_x^{0, \varepsilon}\|_{2, I}^2 + \|\kappa_x^{0, \varepsilon}\|_{2, I}^2. \end{aligned} \quad (7.73)$$

From (4.37) and (4.38), we know that :

$$|\rho_x^{0,\varepsilon}| = \left| \frac{\rho_x^0 + \varepsilon\tau\phi'}{(1+\varepsilon)^2} \right| \leq \frac{|\rho_x^0| + \varepsilon}{(1+\varepsilon)^2} \leq |\rho_x^0| + 1,$$

and

$$|\kappa_x^{0,\varepsilon}| = \left| \frac{\kappa_x^0 + \varepsilon}{1+\varepsilon} \right| \leq |\kappa_x^0| + 1.$$

Using the above two inequalities into (7.73), we deduce that :

$$S(0) \leq 2(\|\rho_x^0\|_{2,I}^2 + \|\kappa_x^0\|_{2,I}^2 + 2).$$

Step 2.3. (Control of the modulus of continuity in space and conclusion)

We use the uniform bound obtained for $S(0)$ in Step 2.1, together with the special control (5.47) of κ_x^ε given in Corollary 5.2, we get for all $0 \leq t \leq T$:

$$\int_I \kappa_x^\varepsilon(x, t) \log(\kappa_x^\varepsilon(x, t)) dx \leq 2(\|\rho_x^0\|_{2,I}^2 + \|\kappa_x^0\|_{2,I}^2 + 2) + \frac{\tau^2 T}{4} + 1,$$

therefore

$$\int_I \kappa_x^\varepsilon(x, t) \log(\kappa_x^\varepsilon(x, t)) dx \leq c_9, \quad \forall 0 \leq t \leq T. \quad (7.74)$$

Inequality (7.74) permit to use Lemma 5.4, hence we obtain :

$$|\kappa^\varepsilon(x+h, t) - \kappa^\varepsilon(x, t)| \leq \frac{c_{10}}{|\log h|}, \quad (x, t), (x+h, t) \in I_T, \quad (7.75)$$

Inequalities (7.72) and (7.75) give the equicontinuity of the sequence $(\kappa^\varepsilon)_\varepsilon$ on V , and again by the Arzela-Ascoli Theorem, we get :

$$\kappa^\varepsilon \rightarrow \kappa, \quad (7.76)$$

up to a subsequence, uniformly on V as $\varepsilon \rightarrow 0$.

Step 3. (Convergence of ρ^ε)

As in step 2, we control the modulus of continuity of ρ^ε in space and in time, locally uniformly with respect to ε .

Step 3.1. (Control of the modulus of continuity in time)

The second equation of (7.64) gives :

$$\rho_t^\varepsilon - \varepsilon\rho_{xx}^\varepsilon = A_x^\varepsilon,$$

hence, from (7.69), we deduce that :

$$\|\rho_t^\varepsilon - \varepsilon \rho_{xx}^\varepsilon\|_{\infty, V} \leq c_7,$$

and from (3.24), we have :

$$\|\rho^\varepsilon\|_{\infty, V} \leq 1.$$

The above two inequalities permit to use Lemma 3.4, we finally get :

$$|\rho^\varepsilon(x, t) - \rho^\varepsilon(x, t + h)| \leq c_8 h^\beta, \quad (x, t), (x, t + h) \in V, \quad 0 < \beta < 1, \quad (7.77)$$

which controls the modulus of continuity of ρ^ε with respect to t uniformly in ε .

Step 3.2. (Control of the modulus of continuity in space and conclusion)

The control of the space modulus of continuity is based on the following observation. From (3.23), we know that $|\rho_x^\varepsilon| \leq \kappa_x^\varepsilon$ on I_T . Using this inequality, we get, for every $(x, t), (x + h, t) \in I_T$:

$$|\rho^\varepsilon(x + h, t) - \rho^\varepsilon(x, t)| \leq \int_x^{x+h} |\rho_x^\varepsilon(y, t)| dy \leq \int_x^{x+h} \kappa_x^\varepsilon(y, t) dy \leq |\kappa^\varepsilon(x + h, t) - \kappa^\varepsilon(x, t)|.$$

Inequality (7.75) gives immediately that :

$$|\rho^\varepsilon(x + h, t) - \rho^\varepsilon(x, t)| \leq \frac{c_{10}}{|\log h|}, \quad (x, t), (x + h, t) \in I_T. \quad (7.78)$$

From (7.77) and (7.78), we deduce that :

$$\rho^\varepsilon \rightarrow \rho, \quad (7.79)$$

up to a subsequence, uniformly on V as $\varepsilon \rightarrow 0$.

Step 4. (Convergence of ρ_x^ε and conclusion)

In fact, this follows from Step 1, Step 2, and the fact that

$$\rho_x^\varepsilon = A^\varepsilon + \tau \kappa^\varepsilon \rightarrow \rho_x, \quad (7.80)$$

uniformly on V as $\varepsilon \rightarrow 0$. In this case, we also deduce that

$$A = \rho_x - \tau \kappa.$$

The proof of Proposition 7.1 is done. □

We now move to the proof of the main result.

Proof of Theorem 1.1. We first remark that κ^ε is a viscosity solution of the first equation of (7.64) :

$$\kappa_t^\varepsilon \kappa_x^\varepsilon - \varepsilon \kappa_x^\varepsilon \kappa_{xx}^\varepsilon - \rho_x^\varepsilon A_x^\varepsilon = 0 \quad \text{on } I_T. \quad (7.81)$$

Indeed, let $\phi \in C^2(I_T)$ such that $\kappa^\varepsilon - \phi$ has a local maximum at some point $(x_0, t_0) \in I_T$. Then $D\kappa^\varepsilon = D\phi$ and $D^2\kappa^\varepsilon \leq D^2\phi$. From this and the fact that $\kappa_x^\varepsilon > 0$, we calculate at (x_0, t_0) :

$$\begin{aligned} \phi_t \phi_x - \varepsilon \phi_x \phi_{xx} - \rho_x^\varepsilon A_x^\varepsilon &= \kappa_t^\varepsilon \kappa_x^\varepsilon - \varepsilon \kappa_x^\varepsilon \phi_{xx} - \rho_x^\varepsilon A_x^\varepsilon \\ &\leq \kappa_t^\varepsilon \kappa_x^\varepsilon - \varepsilon \kappa_x^\varepsilon \kappa_{xx}^\varepsilon - \rho_x^\varepsilon A_x^\varepsilon \\ &\leq 0. \end{aligned}$$

On the other hand, if $\kappa^\varepsilon - \phi$ has a local minimum at (x_0, t_0) , we similarly get :

$$\phi_t \phi_x - \varepsilon \phi_x \phi_{xx} - \rho_x^\varepsilon A_x^\varepsilon \geq 0,$$

and hence κ^ε is a viscosity solution.

Remark 7.2 The equation (7.81) can be viewed as the following Hamilton-Jacobi equation of second order :

$$H^\varepsilon(X, D\kappa^\varepsilon, D^2\kappa^\varepsilon) = 0, \quad X = (x, t) \in I_T \quad (7.82)$$

with

$$D\kappa^\varepsilon = (\kappa_x^\varepsilon, \kappa_t^\varepsilon) \quad \text{and} \quad D^2\kappa^\varepsilon = \begin{pmatrix} \kappa_{xx}^\varepsilon & \kappa_{xt}^\varepsilon \\ \kappa_{tx}^\varepsilon & \kappa_{tt}^\varepsilon \end{pmatrix},$$

where H^ε is the Hamiltonian function given by :

$$\begin{aligned} H^\varepsilon : I_T \times \mathbb{R}^2 \times M_{sym}^{2 \times 2} &\longrightarrow \mathbb{R} \\ (X, p, M) &\longmapsto H^\varepsilon(X, p, M) = p_1 p_2 - \varepsilon p_1 M_{11} - \rho_x^\varepsilon(X) A_x^\varepsilon(X), \end{aligned} \quad (7.83)$$

$p = (p_1, p_2)$ and $M = (M_{ij})_{i,j=1,2}$.

From (7.70) and (7.80), we deduce that $(H^\varepsilon)_\varepsilon$ converges locally uniformly in $I_T \times \mathbb{R}^2 \times M_{sym}^{2 \times 2}$ to the function H given by :

$$\begin{aligned} H : I_T \times \mathbb{R}^2 \times M_{sym}^{2 \times 2} &\longrightarrow \mathbb{R} \\ (X, p, M) &\longmapsto H(X, p, M) = p_1 p_2 - \rho_x(X) A_x(X). \end{aligned} \quad (7.84)$$

This, together with the local uniform convergence of κ^ε to κ (see 7.76), and the fact that κ^ε is a viscosity solution of (7.81), permit to use the stability of viscosity solutions (see Theorem 3.7), which proves that κ is a viscosity solution of

$$H(X, D\kappa, D^2\kappa) = \kappa_t \kappa_x - \rho_x A_x = 0 \quad \text{in } I_T. \quad (7.85)$$

We now pass to the limit $\varepsilon \rightarrow 0$ in the second equation of (7.64), we obtain

$$\rho_t = A_x \quad \text{in } \mathcal{D}'(I_T). \quad (7.86)$$

From (7.85) and (7.86), we get :

1. κ is a viscosity solution of $\kappa_t \kappa_x = \rho_t \rho_x$ in I_T ;
2. ρ is a distributional solution of $\rho_t = \rho_{xx} - \tau \kappa_x$ in I_T .

Let us now prove inequality (1.14). Let $\phi \in C_0^\infty(I_T)$ be a non-negative test function. From (3.23), we know that

$$\kappa_x^\varepsilon > |\rho_x^\varepsilon| \quad \text{in } I_T,$$

and hence

$$\kappa_x^\varepsilon > \rho_x^\varepsilon \quad \text{and} \quad \kappa_x^\varepsilon > -\rho_x^\varepsilon \quad \text{in } I_T.$$

Multiplying these inequalities by a test function $\phi \in \mathcal{D}(I_T)$, $\phi \geq 0$; integrating by parts over I_T , and passing to the limit as $\varepsilon \rightarrow 0$, we obtain

$$\kappa_x \geq \rho_x \quad \text{and} \quad \kappa_x \geq -\rho_x \quad \text{in } \mathcal{D}'(I_T),$$

therefore

$$\kappa_x \geq |\rho_x| \quad \text{in } \mathcal{D}'(I_T).$$

Finally, let us show that the two solutions ρ and κ can be extended by continuity to the parabolic boundary of I_T , in order to retrieve the initial and boundary conditions. Indeed, the local uniform convergence $(\rho^\varepsilon, \kappa^\varepsilon) \rightarrow (\rho, \kappa)$, together with the uniform control of the modulus of continuity of these solutions :

- with respect to x near $\partial I \times [0, T]$ by (7.75) and (7.78);
- with respect to t near $I \times \{t = 0\}$, away from 0 and 1 by (7.72) and (7.77),

and the fact that $\kappa^{0,\varepsilon} \rightarrow \kappa^0$, $\rho^{0,\varepsilon} \rightarrow \rho^0$ uniformly in \bar{I} ,

$$\kappa^\varepsilon(0, \cdot) \rightarrow 0, \quad \kappa^\varepsilon(1, \cdot) = 1, \quad \rho^\varepsilon = 0 \quad \text{on } \partial I \times [0, T],$$

show that $(\rho, \kappa) \in (C(\bar{I}_T))^2$, so the initial and boundary conditions are satisfied pointwisely, and the proof of the main result is done. \square

8 Appendix

A1. Proof of Lemma 3.4 (control of the modulus of continuity in time)

Let V be a compactly contained subset of I_T . Throughout the proof, the constant c may take several values but only depending on V . Since $V \subset\subset I_T$, then there is a rectangular cube of the form

$$\mathcal{Q} = (x_1, x_2) \times (t_1, t_2),$$

such that $V \subset\subset \mathcal{Q} \subset\subset I_T$. In this case, there exists a constant ε_0 , also depending on V such that for any

$$0 < \varepsilon < \varepsilon_0,$$

and any $(x, t) \in V$, we have :

$$(x - 2\sqrt{\varepsilon}, x + 2\sqrt{\varepsilon}) \times \{t\} \subset \mathcal{Q}.$$

Moreover, for any $(x, t), (x, t+h) \in V$, we can always find two intervals \mathcal{I} and \mathcal{J} such that

$$(t, t+h) \subset \mathcal{I} \subset\subset \mathcal{J},$$

with

$$\{x\} \times \mathcal{I} \subset \mathcal{Q} \quad \text{and} \quad \{x\} \times \mathcal{J} \subset \mathcal{Q}.$$

Let us indicate that these intervals might have different lengths depending on h and V but we always have

$$|\mathcal{J}|, |\mathcal{I}| \leq |t_2 - t_1|.$$

Consider the following rescaling of the function u^ε defined by :

$$\tilde{u}^\varepsilon(x, t) = u^\varepsilon(\sqrt{\varepsilon}x, t). \quad (8.87)$$

This function satisfies

$$\tilde{u}_t^\varepsilon = \tilde{u}_{xx}^\varepsilon + \tilde{f}^\varepsilon, \quad (x, t) \in (0, 1/\sqrt{\varepsilon}) \times (0, T),$$

where $\tilde{f}^\varepsilon(x, t) = f^\varepsilon(\sqrt{\varepsilon}x, t)$. Take $(x_0, t_0), (x_0, t_0 + h)$ in V , and let

$$\mathcal{Q}_1 = (x_0 - \sqrt{\varepsilon}, x_0 + \sqrt{\varepsilon}) \times \mathcal{I} \quad \text{and} \quad \mathcal{Q}_2 = (x_0 - 2\sqrt{\varepsilon}, x_0 + 2\sqrt{\varepsilon}) \times \mathcal{J}.$$

These two cylinders are transformed by the above rescaling into

$$\tilde{\mathcal{Q}}_1 = \left(\frac{x_0}{\sqrt{\varepsilon}} - 1, \frac{x_0}{\sqrt{\varepsilon}} + 1 \right) \times \mathcal{I} \quad \text{and} \quad \tilde{\mathcal{Q}}_2 = \left(\frac{x_0}{\sqrt{\varepsilon}} - 2, \frac{x_0}{\sqrt{\varepsilon}} + 2 \right) \times \mathcal{J}.$$

We apply the interior L^p , $p > 3$, estimates for parabolic equations (see for instance [68, Theorem 7.13, page 172]) to the function \tilde{u}^ε over the domains $\tilde{\mathcal{Q}}_1 \subset\subset \tilde{\mathcal{Q}}_2$, we get

$$\|\tilde{u}^\varepsilon\|_{W_p^{2,1}(\tilde{\mathcal{Q}}_1)} \leq c(\|\tilde{u}^\varepsilon\|_{p,\tilde{\mathcal{Q}}_2} + \|\tilde{f}^\varepsilon\|_{p,\tilde{\mathcal{Q}}_2}). \quad (8.88)$$

We compute :

$$\begin{aligned} \|\tilde{u}^\varepsilon\|_{L^p(\tilde{\mathcal{Q}}_2)}^p &= \int_{\tilde{\mathcal{Q}}_2} |\tilde{u}^\varepsilon(x, t)|^p dx dt \\ &= \int_{\tilde{\mathcal{Q}}_2} |u^\varepsilon(\sqrt{\varepsilon}x, t)|^p dx dt \\ &= \frac{1}{\sqrt{\varepsilon}} \int_{\mathcal{Q}_2} |u^\varepsilon(y, t)|^p dy dt \\ &\leq c, \end{aligned} \quad (8.89)$$

where for the last line, we have used the local uniform boundedness of $(u^\varepsilon)_\varepsilon$, and in exactly the same way (from the local uniform boundedness of $(f^\varepsilon)_\varepsilon$) we obtain :

$$\|\tilde{f}^\varepsilon\|_{L^p(\tilde{\mathcal{Q}}_2)}^p \leq c. \quad (8.90)$$

Therefore, from (8.89), (8.90), inequality (8.88) implies :

$$\|\tilde{u}^\varepsilon\|_{W_p^{2,1}(\tilde{\mathcal{Q}}_1)} \leq c. \quad (8.91)$$

We use the Sobolev embedding in Hölder spaces (see for instance Lemma [54, Lemma 2.8]) :

$$W_p^{2,1}(\tilde{\mathcal{Q}}_1) \hookrightarrow C^{1+\alpha, \frac{1+\alpha}{2}}(\tilde{\mathcal{Q}}_1), \quad p > 3, \quad \alpha = 1 - 3/p,$$

to obtain, from (8.91), that :

$$\|\tilde{u}^\varepsilon\|_{C^{1+\alpha, \frac{1+\alpha}{2}}(\tilde{\mathcal{Q}}_1)} \leq c,$$

and hence

$$\frac{|\tilde{u}^\varepsilon(x_0/\sqrt{\varepsilon}, t_0 + h) - \tilde{u}^\varepsilon(x_0/\sqrt{\varepsilon}, t_0)|}{h^{\frac{1+\alpha}{2}}} \leq c,$$

then from (8.87),

$$\frac{|u^\varepsilon(x_0, t_0 + h) - u^\varepsilon(x_0, t_0)|}{h^{\frac{1+\alpha}{2}}} \leq c.$$

Choosing $\beta = \frac{1+\alpha}{2}$ we get the desired result. \square

A2. Proof of Lemma 3.5 (An interior estimate for the heat equation)

Recall that a is a solution of the heat equation on I_T ,

$$a_t = a_{xx}.$$

The proof of lemma 3.5 depends mainly on a mean value formula for solutions of the heat equations. Usually, basic mean value formulae of the solution of the heat equation are expressed through unbounded kernels (see for example [37, Theorem 1]), where a can be expressed as :

$$a(x_0, t_0) = (4\pi r^2)^{-1/2} \int_{\Omega_r(x_0, t_0)} a(x, t) \frac{(x_0 - x)^2}{4(t_0 - t)^2} dx dt. \quad (8.92)$$

Here, $(x_0, t_0) \in I_T$, $(x, t) \in \Omega_r(X_0)$, and $r > 0$ small enough in order to ensure that the parabolic ball of radius r :

$$\Omega_r(x_0, t_0) = \left\{ (x, t); t_0 - r^2 < t < t_0, (x - x_0)^2 < 2(t_0 - t) \log \left(\frac{r^2}{t_0 - t} \right) \right\} \subset I_T. \quad (8.93)$$

In our case, we need a mean value formula similar to (8.92) but with a bounded kernel on $\Omega_r(x_0, t_0)$. In [42], the authors have given such a representation formula for the solution of the heat equation. We present their result in a simplified version.

Theorem 8.1 (*Mean value formula with bounded kernels, [42, Theorem 3.1]*)

Let $u \in C^2(\mathcal{D})$ be a solution of the heat equation :

$$u_t = u_{xx} \quad \text{on} \quad \mathcal{D},$$

where \mathcal{D} is an open subset of \mathbb{R}^2 containing the modified unit parabolic ball $\Omega'_1(0, 0)$, with

$$\Omega'_1(0, 0) = \{(x, t); -1 < t < 0, x^2 < 8t \log(-t)\}.$$

Then we have :

$$u(0, 0) = \int_{\Omega'_1(0, 0)} u(x, t) E(x, t) dx dt, \quad (8.94)$$

where the kernel E satisfies :

$$\|E(x, t)\|_{\infty, \Omega'_1(0, 0)} \leq c, \quad (8.95)$$

and $c > 0$ is a fixed positive constant.

Remark 8.2 *The above Theorem is an application of [42, Theorem 3.1] in the case $m = 3$. In this case, an explicit expression of E is given by :*

$$E(x, t) = \frac{\omega_3}{16\pi^2} (-x^2 + 8t \log(-t))^{3/2} \left[\frac{x^2}{4t^2} + \frac{3(-x^2 + 8t \log(-t))}{20t^2} \right],$$

where ω_3 is the volume of the unit ball in \mathbb{R}^3 . For a more general expression of E , we send the reader to [42, Equality (3.6) of Theorem 3.1].

Using the parabolic rescaling, we can obtain a similar mean value representation at any $(x_0, t_0) \in \mathbb{R}^2$. More precisely, we have :

Corollary 8.3 (Mean value formula at any point) $(x_0, t_0) \in \mathbb{R}^2$

Let $u \in C^2(\mathcal{D})$ be a solution of the heat equation :

$$u_t = u_{xx} \quad \text{on } \mathcal{D},$$

where \mathcal{D} is an open subset of \mathbb{R}^2 containing the modified unit parabolic ball $\Omega'_r(x_0, t_0)$, $r > 0$, with

$$\Omega'_r(x_0, t_0) = \left\{ (x, t); t_0 - r^2 < t < t_0, \quad |x - x_0|^2 < 8(t_0 - t) \log\left(\frac{r^2}{t_0 - t}\right) \right\}.$$

Then we have :

$$u(x_0, t_0) = \frac{\bar{c}}{|\Omega'_r(x_0, t_0)|} \int_{\Omega'_r(x_0, t_0)} u(x, t) E\left(\frac{x - x_0}{r}, \frac{t - t_0}{r^2}\right) dx dt, \quad (8.96)$$

where $\bar{c} > 0$ and $|\Omega'_r(x_0, t_0)| = \bar{c}r^3$.

Back to the proof of Lemma 3.5. Since $V \subset\subset I_T$, then there exists a fixed

$$r_0 = r_0(\text{dist}(V, \partial^p I_T)),$$

such that :

$$\Omega'_{r_0}(x_0, t_0) \subset I_T, \quad \forall (x_0, t_0) \in V.$$

We use the mean value formula (8.96) at the point (x_0, t_0) , we obtain :

$$a(x_0, t_0) = r_0^{-3} \int_{\Omega'_{r_0}(x_0, t_0)} a(x, t) E\left(\frac{x - x_0}{r_0}, \frac{t - t_0}{r_0^2}\right) dx dt,$$

and hence from the L^∞ bound (8.95) of E on $\Omega'_1(0, 0)$, we deduce that :

$$\|a\|_{\infty, V} \leq cr_0^{-3} \|a\|_{1, I_T},$$

where the constant c is given by (8.95). Finally, we obtain :

$$\|a\|_{p, V} \leq cr_0^{-3} |V|^{1/p} \|a\|_{1, I_T},$$

and the result follows. □

Chapitre 6

Résultats préliminaires sur quelques algorithmes pour les équations de transport

Ce chapitre présente quelques résultats numériques préliminaires obtenus dans le cadre d'un contrat CEA/CERMICS portant sur les méthodes Fast Marching appliquées aux équations de type transport. Ont participé à ces discussions : O. Bokanowski, A. Briani, A. El Hajj, N. Forcadel, A. Ghorbel, P. Hoch, H. Ibrahim, C. Imbert et R. Monneau. L'objectif est d'explorer les idées de la méthode Fast Marching classique [86] et de les appliquer pour les équations de transport. Cette méthode repose sur l'équation level set pour l'évolution d'un front avec une vitesse normale. Dans cette direction, nous discutons plusieurs algorithmes, et nous présentons quelques tests numériques d'un algorithme basé sur le *splitting*.

Résultats préliminaires sur quelques algorithmes pour les équations de transport

CERMICS - Equipe EDP et matériaux

℘

CEA

Toutes les simulations numériques ont été effectuées par :

H. Ibrahim

Résumé

Nous rassemblons ici quelques résultats préliminaires obtenus dans le cadre d'un contrat CEA/CERMICS-ENPC portant sur les méthodes Fast Marching appliquées aux équations de type transport.

1 Introduction : rappel au cas d'une équation eikonale non convexe

Dans le cas d'une équation eikonale non-convexe, la méthode "Fast Marching" permet de propager un domaine Ω suivant le vecteur $c\vec{n}$ où $c(x, t)$ est une fonction donnée et \vec{n} le vecteur normal à Ω .

Dans ce qui suit, on va donner l'idée générale de la démarche de l'algorithme. On le décompose en plusieurs étapes et dans chaque étape on l'applique au cas particulier où

$$\Omega = \{(x, y) \in \mathbb{R}^2; y > x\}, \quad c > 0. \quad (\star)$$

Prenons Ω un ouvert dans \mathbb{R}^2 . Nous discrétisons l'espace comme suit :

$$x_I = (x_{i_1}, x_{i_2}) = (i_1\Delta x, i_2\Delta x),$$

où $I = (i_1, i_2) \in \mathbb{Z}^2$, et $\Delta x > 0$ est un pas de l'espace. Les voisinages d'un point $I \in \mathbb{Z}^2$ sont les quatre premiers points à gauche, droite, haut et bas (voir Figure 6.1).

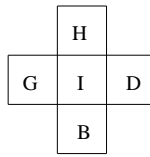

FIG. 6.1 – Voisinages d'un point

Étape 0.

À l'étape $n = 0$, on a :

$$\Omega_0 = \Omega$$

et θ_I^0 est une fonction représentant Ω_0 , définie par :

$$\theta_I^0 = \begin{cases} +1, & \text{si } x_I \in \Omega_0, \\ -1, & \text{sinon,} \end{cases}$$

$$F_{\pm}^0 = \partial\{I, \theta_I^0 = \mp 1\},$$

et

$$F^0 = F_+^0 \cup F_-^0.$$

Dans notre cas particulier (\star), voir Figure 6.2 pour une représentation géométrique.

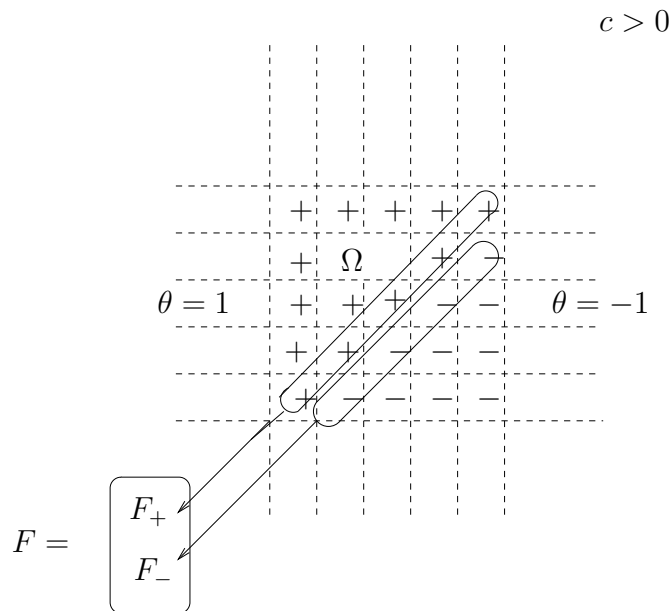

FIG. 6.2 – Représentation géométrique pour (\star).

Maintenant, on commence à expliquer l'algorithme pour $n = 1$.

Étape 1.

On initialise le temps dans F^0 :

$$u_I^0 = 0 \quad \text{sur } F^0$$

Étape 2.

On initialise \hat{u}^{n-1} sur tout le maillage :

$$\hat{u}_{\pm, J}^{n-1} = \begin{cases} u_J^{n-1} & \text{pour } J \in F_{\pm}^{n-1} \\ \infty & \text{sinon.} \end{cases}$$

Étape 3.

Cette étape va être intéressante pour trouver les points qui ont une chance de bouger. On calcule \tilde{u}^{n-1} sur F^{n-1} comme suit :

pour $I \in F_{\pm}^{n-1}$, on a

(a) si $\pm c_I^{n-1} \geq 0$, $\tilde{u}_I^{n-1} = \infty$,

(b) si $\pm c_I^{n-1} < 0$, on calcule \tilde{u}_I^{n-1} comme solution de l'équation suivante :

$$\sum_{k=1}^2 \left(\max_{\pm} \left(0, \tilde{u}_I^{n-1} - \hat{u}_{+, I^k, \pm}^{n-1} \right) \right)^2 = \frac{(\Delta x)^2}{|c_I^{n-1}|^2} \quad \text{si } I \in F_-^{n-1},$$

$$\sum_{k=1}^2 \left(\max_{\pm} \left(0, \tilde{u}_I^{n-1} - \hat{u}_{-, I^k, \pm}^{n-1} \right) \right)^2 = \frac{(\Delta x)^2}{|c_I^{n-1}|^2} \quad \text{si } I \in F_+^{n-1},$$

où

$$I^{1, \pm} = (i_1 \pm 1, i_2), I^{2, \pm} = (i_1, i_2 \pm 1).$$

En remarquant que (a) représente le cas des points qui ne bougent pas. Ce qui correspond à F_+ dans (\star) . En outre, dans (b) on calcule le temps aux points qui ont une chance de bouger en passant par la discrétisation de l'équation $|\nabla u| = c$. Ce qui correspond à F_- dans (\star) .

Étape 4.

Pour trouver les points indiqués dans l'Étape 3, il suffit de définir

$$\tilde{t}_n = \min\{\tilde{u}_I^{n-1}, I \in F^{n-1}\};$$

ce minimum est atteint aux points qui vont bouger. Si \tilde{t}_n est assez grand, on le modifie pour bien contrôler la propagation (voir les étapes 7, 8 et 9, page 6 dans [11]). Sinon, on accepte ces points où le minimum est atteint et on note par

$$NA_{\pm}^n = \{I \in F_{\pm}^{n-1}, \tilde{u}_I^{n-1} = \tilde{t}_n\}, NA^n = NA_-^n \cup NA_+^n$$

l'ensemble des points "new accepted". On peut vérifier facilement que $NA = F_-$ dans (\star) . Pour terminer, on réinitialise θ_I^n :

$$\theta_I^n = \begin{cases} -1 & \text{si } I \in NA_+^n \\ +1 & \text{si } I \in NA_-^n \\ \theta_I^{n-1} & \text{sinon} \end{cases}$$

On redéfinit F^n de la même façon que dans l'Étape 0 et on réinitialise u^n sur F^n (voir étape 12, page 6 dans [11]).

On remarque que dans notre exemple (\star) , les points de F^- vont changer leur signe de $-$ en $+$. Ce qui montre que le domaine Ω défini dans (\star) bouge bien comme il faut.

2 Une première approche basée sur les fronts

2.1 Un algorithme basé sur les fronts $+$ et $-$

Nous nous mettons dans la situation d'un champ de vecteur a constant (en espace et surtout en temps) pour simplifier.

Mise en place.

Nous supposons donné au temps initial :

$$\begin{cases} \theta_I^0 \in \{+1, -1\}, \forall I \in \mathbb{Z}^2 \\ A^0 \text{ un sous-ensemble de } F^0 \subset \mathbb{Z}^2 \\ \tilde{\theta}_I^0 = \theta_I^0, \forall I \in F^0. \end{cases}$$

Ici le front F^0 sera défini ci-dessous. L'ensemble A^0 est un peu artificiel au temps initial, mais peut décrire l'ensemble des points récemment acceptés (hypothétiquement dans le passé).

Nous allons construire par récurrence une suite de temps t_n , et $\theta_I^n \in \{+1, -1\}$ et d'ensembles A^n . Nous allons aussi construire des valeurs $\tilde{\theta}_I^n$ sur le front (définies ci-dessous).

Notons les fronts

$$F_+^n = \partial \{\theta^n = -1\}, \quad F_-^n = \partial \{\theta^n = +1\}, \quad F^n = F_+^n \cup F_-^n.$$

Ici on rappelle que $\partial E = V(E) \setminus E$ avec V le voisinage discret. Nous supposons donné au temps t_n , les quantités :

$$\begin{cases} \theta_I^n \in \{+1, -1\}, \forall I \in \mathbb{Z}^2 \\ A^n \subset F^n \\ \tilde{\theta}_I^n \in \mathbb{R}, \forall I \in F^n \\ \tilde{\theta}_I^n = \theta_I^n, \quad \forall I \in A^n \\ \text{si } I \in F^n \setminus A^n, \text{ alors } \begin{cases} \tilde{\theta}_I^n < 1 & \text{si } \theta_I^n = -1 \\ \tilde{\theta}_I^n > -1 & \text{si } \theta_I^n = 1 \end{cases} \end{cases} \quad (2.1)$$

Construction de l'étape $n + 1$.

Nous allons construire un temps $t_{n+1} > t_n$ et les quantités $\theta_I^{n+1}, F^{n+1}, A^{n+1}, \tilde{\theta}_I^{n+1}$. Pour $I \in F^n$, on pose

$$\tilde{\theta}_I^n(t_n) = \tilde{\theta}_I^n,$$

et pour $t > t_n$,

$$\frac{1}{2} \dot{\tilde{\theta}}_I^n(t) = \begin{cases} \sum_{\alpha=1,2} |a_\alpha| \theta_{I^{\varepsilon_\alpha, \alpha}}^n 1_{\{I^{\varepsilon_\alpha, \alpha} \in \mathbb{Z}^2 \setminus (F^n \setminus A^n)\}} & \text{si } I \in F_\pm^n \setminus A^n \\ 0 & \text{si } I \in A^n, \end{cases}$$

avec $\varepsilon_\alpha = -\text{sgn}(a_\alpha)$, et où pour $I = (i_1, i_2)$, on note

$$I^{\pm,1} = (i_1 \pm 1, i_2), \quad I^{\pm,2} = (i_1, i_2 \pm 1).$$

On définit alors

$$t_{n+1} = \sup \left\{ t > t_n, -\theta_I^n \tilde{\theta}_I^n(t) < 1, \forall I \in F^n \right\}.$$

On définit alors les nouveaux points acceptés, par

$$NA^{n+1} = \left\{ I \in F^n, -\theta_I^n \tilde{\theta}_I^n(t_{n+1}) = 1 \right\},$$

et on pose

$$\theta_I^{n+1} = \begin{cases} -\theta_I^n & \text{si } I \in NA^{n+1} \\ \theta_I^n & \text{si } I \in \mathbb{Z}^2 \setminus NA^{n+1} \end{cases}$$

$$A^{n+1} = NA^{n+1} \cup \tilde{A}^n$$

où

$$\tilde{A}^n := \left\{ I \in A^n \cap F^{n+1} \left| \begin{array}{l} \text{il n'existe pas de points } J \in (V(I) \setminus \{I\}) \cap NA^{n+1} \\ \text{tels que } \theta_J^{n+1} \neq \theta_I^{n+1} \end{array} \right. \right\}$$

et pour $I \in F^{n+1}$:

$$\tilde{\theta}_I^{n+1} = \begin{cases} \tilde{\theta}_I^n(t_{n+1}) & \text{si } I \in F^n \cap F^{n+1} \\ \theta_I^{n+1} & \text{si } I \in F^{n+1} \setminus F^n. \end{cases}$$

Il est alors facile de voir que $-\theta_I^{n+1}\tilde{\theta}_I^{n+1} < 1$ pour $I \in F^{n+1}$, ce qui prouve en particulier les propriétés de (2.1) sont vérifiées à l'étape $n + 1$.

Remarque 1 : il faudrait vérifier que $t_{n+1} < +\infty$!

Remarque 2 : Attention, ici $\tilde{\theta}$ peut sortir de l'intervalle $[-1, 1]$. Par exemple, partant de -1 , il peut descendre sous la valeur -1 avant de remonter à la valeur 1 .

Question : Le schéma est-il monotone ? Quel rôle joue l'ensemble A^n dans cette monotonie ?

2.2 Quelques éléments sur la discrétisation des droites

Nous rassemblons ici quelques remarques (fondamentales, mais relativement élémentaires) sur la bonne discrétisation des droites sur un réseau \mathbb{Z}^2 .

Pour fixer les idées considérons le demi-plan

$$\Pi = \left\{ X = (x_1, x_2) \in \mathbb{R}^2, \quad x_2 \geq \frac{P}{Q}x_1 \right\}$$

avec

$$P, Q \in \mathbb{N}, \quad 1 \leq P \leq Q, \quad P \text{ et } Q \text{ premiers entre eux.}$$

Nous allons identifier $\Pi \cap \mathbb{Z}^2$, pour cela, nous avons besoin d'une petite construction arithmétique.

Construction arithmétique.

Pour $j = 1, \dots, P$, effectuons la division euclidienne

$$jQ = k_jP + r_j, \quad 0 \leq r_j < P$$

avec des entiers naturels k_j, r_j . Remarquons en particulier que par construction, on a $k_{j+1} \geq k_j + 1$. On pose alors

$$X_0 = (0, 0), \quad X_j = (k_j, j) \quad \text{pour } j = 1, \dots, P$$

et

$$B_0 = \{X_0\} \cup \left(\bigcup_{j=0}^{P-1} \{X_j + (r, 1), \quad r = 1, \dots, k_{j+1} - k_j\} \right),$$

$$D_0 = \bigcup_{k \in \mathbb{Z}} \{kX_P + B_0\},$$

$$\Pi_0 = D_0 + \mathbb{N} \cdot (0, 1).$$

On peut alors vérifier (avec un peu de travail) le résultat suivant :

Proposition 2.1 (Identification d'un demi-espace sur un réseau)

On a $\Pi \cap \mathbb{Z}^2 = \Pi_0$.

On note

$$f(X) = Qx_2 - Px_1.$$

Avec du travail, il est possible de voir qu'on a le résultat suivant :

Proposition 2.2 (Complément arithmétique)

Il existe $Y^* = (y_1^*, y_2^*)$ tel que $f(Y^*) = -1$, et

$$\begin{cases} 0 \leq y_1^* < Q, & 0 \leq y_2^* < P \\ Y^* \in D_0 + (0, -1). \end{cases}$$

De plus

$$\begin{cases} \{X \in \mathbb{Z}^2, f(X) \geq 0\} = \Pi_0 \\ \{X \in \mathbb{Z}^2, f(X) = 0\} = \bigcup_{k \in \mathbb{Z}} \{kX_P\} \\ \{X \in \mathbb{Z}^2, 0 > f(X) > -1\} = \emptyset \\ \{X \in \mathbb{Z}^2, f(X) = -1\} = \bigcup_{k \in \mathbb{Z}} \{Y^* + kX_P\}. \end{cases}$$

Ce résultat s'interprète en disant qu'à chaque avancée discrète de la droite (la droite descend dans le plan), on accepte un seul nouveau point par tranche de Q cases horizontales. Par ailleurs la structure de la droite discrétisée est la même à translation près suivant Y^* .

Par exemple pour la droite D_0 les derniers points sont $(0, 0) \bmod(X_P)$. Pour la droite suivante, les derniers points acceptés sont les $Y^* \bmod(X_P)$, et le nouveau front compte alors un nouveau point, précisément $Y^* + (0, -1) \bmod(X_P)$. Ce nouveau point du front va occuper successivement les Q cases relatives possibles sur le front au fur et à mesure de l'avancée de la droite.

- Précisément, il va rester d'abord $Q - P$ étapes avec ses voisins de gauche et de droite hors de la région atteinte par la droite.

- Puis, il va rester P étapes avec son voisin de gauche atteint par la droite.
- Enfin, à la dernière étape, ce point sera atteint par la droite.

2.3 Applications au calcul de la vitesse effective de la droite, prédite par l'algorithme basé sur les fronts + et -.

On définit la normale à la droite $\nu = \frac{1}{\sqrt{P^2+Q^2}} (P, -Q)$. On s'intéresse au cas où le champ de vitesse $a = (a_1, a_2)$ vérifie

$$a \cdot \nu > 0.$$

Pour la droite D_0 le dernier point accepté est l'origine X_0 . Le nouveau point du front est $Z = (0, -1)$. On pose donc $\tilde{\theta}_Z^0 = -1$.

I : Calcul dans le cas : $a_1, a_2 > 0$ sur le front -.

Pendant $Q - P$ étapes, les voisins upwind de Z ont un θ égal à -1 . Seulement, le voisin upwind horizontal fait partie du front -, et par conséquent ne peut pas contribuer au calcul de $\dot{\tilde{\theta}}$. Par périodicité discrète, on peut supposer que chaque étape a lieu sur un intervalle de temps $\Delta t > 0$ identique. On tire donc

$$\tilde{\theta}_Z^{Q-P} = \tilde{\theta}_Z^0 - 2(Q - P)\Delta t a_2 < -1.$$

Puis au cours des P étapes suivantes, le voisin $Z + (-1, 0)$ a un θ égal à 1 (et est un point accepté faisant partie des A^n pour $Q - P \leq n \leq Q - 1$). Ainsi, on a

$$1 = \tilde{\theta}_Z^Q = \tilde{\theta}_Z^{Q-P} + 2P\Delta t (-a_2 + a_1)$$

ce qui donne

$$2 = \tilde{\theta}_Z^Q - \tilde{\theta}_Z^0 = 2\Delta t (-Qa_2 + Pa_1).$$

D'où

$$\Delta t = 1/(a \cdot \nu \sqrt{P^2 + Q^2}).$$

Remarquons maintenant que la distance effective parcourue par la droite durant ces Q étapes, est $Y^* \cdot \nu = 1/\sqrt{P^2 + Q^2}$. La vitesse normale effective est donc (distance divisée par le temps)

$$Y^* \cdot \nu / (\Delta t) = a \cdot \nu$$

ce qui est effectivement le résultat voulu.

Sur le front +.

Remarquons que le dernier point accepté, par exemple l'origine $(0, 0)$ (au temps

initial) fait alors partie du front $+$. Il pourrait a priori évoluer. Si on ne se rappelait pas qu'il s'agit d'un point de A^0 , on aurait (si on oubliait aussi qu'on a éventuellement $(-1, 0) \in F_+^0$)

$$\frac{1}{2}\dot{\theta} = a_1 - a_2 \geq 0$$

ce qui est parfait. En revanche si on se rappelle (et si on est dans ce cas-là) que $(-1, 0) \in F_+^0$, alors on obtient seulement :

$$\frac{1}{2}\dot{\theta} = -a_2 < 0$$

ce qui aurait tendance à faire disparaître le point $(0, 0)$ juste accepté, par exemple en un intervalle de temps $\Delta t' = 1/a_2$ qui peut être inférieur à Δt , si a_2 vérifie

$$\frac{P}{Q+1}a_1 < a_2 < \frac{P}{Q}a_1.$$

Ce n'est pas raisonnable, et cela justifie donc l'utilisation des ensembles A^n .

II : Calcul dans le cas : $a_1 > 0, a_2 < 0$ sur le front $-$.

Ici, le voisin upwind vertical de Z a un θ toujours égal à 1. Par ailleurs, pendant $Q - P$ étapes, le voisin upwind horizontal de Z a un θ égal à -1 . Comme dans le cas précédent, le voisin upwind horizontal fait partie du front $-$, et par conséquent ne peut pas contribuer au calcul de $\dot{\theta}$. En supposant toujours que chaque étape a lieu sur un intervalle de temps $\Delta t > 0$ identique, on tire donc

$$\tilde{\theta}_Z^{Q-P} = \tilde{\theta}_Z^0 - 2(Q - P)\Delta t a_2 > -1.$$

Puis au cours des P étapes suivantes, le voisin $Z + (-1, 0)$ a un θ égal à 1 (et est un point accepté faisant partie des A^n pour $Q - P \leq n \leq Q - 1$). Ainsi, on a

$$1 = \tilde{\theta}_Z^Q = \tilde{\theta}_Z^{Q-P} + 2P\Delta t (-a_2 + a_1)$$

ce qui donne

$$2 = \tilde{\theta}_Z^Q - \tilde{\theta}_Z^0 = 2\Delta t (-Qa_2 + Pa_1)$$

et a nouveau le Δt est le même qu'au cas précédent, et donc la vitesse effective est la bonne.

Sur le front $+$.

Si on ne se rappelait pas que $(0, 0)$ est un point de A^0 , on aurait (si on oubliait aussi qu'on a éventuellement $(-1, 0) \in F_+^0$)

$$\frac{1}{2}\dot{\theta} = a_1 - a_2 \geq 0$$

ce qui est parfait. De même, si on se rappelle (et si on est dans ce cas-là) que $(-1, 0) \in F_+^0$, alors on obtient :

$$\frac{1}{2} \dot{\tilde{\theta}} = -a_2 > 0$$

ce qui est tout aussi bon. Dans ce cas-là, l'utilisation des ensembles A^n ne semble pas nécessaire.

III : Calcul dans le cas : $a_1, a_2 < 0$ sur le front $-$.

Ici encore, le voisin upwind vertical de Z a un θ toujours égal à 1. Tant que le point $(1, 0)$ n'a pas été accepté, le voisin upwind horizontal de Z (cad $Z + (1, 0)$) ne fait pas partie du front $-$, et par conséquent il contribue au calcul de $\dot{\tilde{\theta}}$. Cela a lieu durant P étapes. La raison est que $f((1, 0)) = -P$, et donc que le point $(1, 0)$ est accepté exactement après P étapes.

En supposant toujours que chaque étape a lieu sur un intervalle de temps $\Delta t > 0$ identique, on tire donc

$$\tilde{\theta}_Z^P = \tilde{\theta}_Z^0 + 2P\Delta t (a_1 - a_2)$$

(qui est inférieur à -1 si $a_1 < a_2$, et supérieur sinon). Puis au cours des $Q - P$ étapes suivantes, le voisin $Z + (1, 0)$ fait alors partie du front $-$, et par conséquent ne peut pas contribuer au calcul de $\dot{\tilde{\theta}}$. Ainsi, on a

$$1 = \tilde{\theta}_Z^Q = \tilde{\theta}_Z^P - 2(Q - P)\Delta t a_2$$

ce qui donne

$$2 = \tilde{\theta}_Z^Q - \tilde{\theta}_Z^0 = 2\Delta t (-Qa_2 + Pa_1)$$

et a nouveau le Δt est le même qu'au cas précédent, et donc la vitesse effective est encore la bonne.

Sur le front $+$.

Si on ne se rappelait pas que $(0, 0)$ est un point de A^0 , on aurait (et ici $(1, 0) \in F_-^0$)

$$\frac{1}{2} \dot{\tilde{\theta}} = a_1 - a_2$$

(qui est positif si $a_1 > a_2$ (bon cas) et négatif si $a_1 < a_2$ (mauvais cas). Ainsi on pourrait avoir $\Delta t' = 1/(a_2 - a_1) < \Delta t$ si

$$\frac{P}{Q}(-a_1) < -a_2 < \frac{P+1}{Q+1}(-a_1).$$

Ici il n'y a pas d'autre cas, car on ne peut pas avoir $(1, 0) \in F_+^0$, dès la première itération. Ici encore, l'utilisation des ensembles A^n semble nécessaire.

Remarque : Il faudrait éventuellement voir dans le menu détail, ce qui se passe sur les points du front +, pour les autres points que le dernier accepté, dans la situation précédente inchangée.

2.4 Inconvénients de l'algorithme précédent

L'algorithme précédent n'est pas monotone, comme le montre l'exemple suivant.

Exemple 1

On considère l'évolution avec donnée initiale

$$\theta_I^0 = 1 \quad \text{si et seulement si} \quad I = (I_1, I_2) \quad \text{avec} \quad I_1 \geq 1 \quad \text{ou} \quad (I_1 = 1 \quad \text{et} \quad I_2 \leq 0)$$

et θ^0 égal à -1 dans le complémentaire, avec l'initialisation $\tilde{\theta}^0 = \theta^0$. On suppose que

$$a = (a_1, a_2) \quad \text{avec} \quad a_1, a_2 < 0,$$

le vecteur a étant suffisamment proche de la verticale. On peut comparer à l'évolution ayant pour donnée initiale

$$\underline{\theta}_I^0 = 1 \quad \text{si et seulement si} \quad I = (I_1, I_2) \quad \text{avec} \quad I_1 \geq 1$$

avec l'initialisation $\tilde{\theta}^0 = \underline{\theta}^0$. On trouve après quelques étapes que le principe d'inclusion n'est pas respecté.

Par ailleurs l'algorithme peut créer des **oscillations sur le front pour des droites qui se propagent**. Cela vient du fait qu'il n'y a pas unicité des solutions périodiques en temps qui permettent de propager les droites avec cet algorithme. La propagation des droites à la bonne vitesse, comme vérifié dans la section précédente supposait certaines valeurs particulières de $\tilde{\theta}$ sur le front au temps initial. Comme le montre l'exemple suivant, on obtient d'autres modes de propagation possible, qui exhibent des oscillations du front (non-convexité du front).

Exemple 2

On considère la donnée initiale

$$\theta_I^0 = 1 \quad \text{si et seulement si} \quad I = (I_1, I_2) \quad \text{avec} \quad I_2 \leq 3I_1$$

avec l'initialisation $\tilde{\theta}^0 = \theta^0$. On suppose que

$$a = (a_1, a_2) \quad \text{avec} \quad a_1, a_2 < 0,$$

le vecteur a étant suffisamment proche de la verticale. Après quelques étapes, on tombe sur une solution périodique en temps, exhibant un front qui peut prendre deux formes (une étape sur deux) : la forme classique approximant une droite, et une forme non convexe présentant des oscillations.

L'inspection des exemples précédents montre que le schéma est particulièrement **non monotone** dans les cas qui correspondent au **cas I** de la section précédente ou bien au **cas III** si $|a_1| > |a_2|$. Ces deux cas sont les cas à problème, qu'il va falloir corriger dans la section suivante.

2.5 Ce que pouvait être un bon algorithme ?

Précisons d'abord qu'on ne cherche pas un algorithme qui soit complètement monotone. On demande seulement les deux propriétés suivantes :

1. **Consistance** : il existe une évolution des droites qui les propage à la bonne vitesse (en préservant le fait que le front est un graphe monotone dans un repère adapté parallèle aux axes du maillage).
2. **Monotonie** : les évolutions précédentes des droites fournissent des fonctions barrières (dont on ne peut briser le principe d'inclusion).

En d'autres termes, on ne demande l'existence d'un **principe de comparaison uniquement lorsqu'on compare aux droites** (mais pas aux ensembles en général).

En préambule, on remarque que dans certains cas, faire évoluer les $\tilde{\theta}$ en chaque point du front, est équivalent à faire évoluer les "parties connexes" du front. Ces parties connexes sont des barres, et on peut les faire évoluer en regardant l'évolution du "bloc" et non pas celle de ses constituants individuels. Il y a plusieurs intérêts à faire cela :

1. on retrouve l'interprétation réservoir, qui était le point de départ.
2. on retrouve la monotonie sur ces blocs dans les cas II et III (mais pas dans le cas I, sans rien faire d'autre).
3. on n'a pas à définir l'ensemble A^n , car pour savoir si c'est le front $+$ ou $-$ qui est activé, il suffit de calculer le $\dot{\theta}$ du bloc. C'est le signe de $\dot{\theta}$ qui va indiquer quelle zone est en train de grandir, et donc quel front il faut activer.

3 Un algorithme de splitting

3.1 Préambule

Nous avons renoncé à l'algorithme de la sous-section 2.1, basé sur les fronts $+$ et $-$, car il ne propage pas correctement les coins. Nous allons introduire un nouveau algorithme de type splitting.

3.2 Un algorithme basé sur le splitting

On suppose (si nécessaire pour simplifier) que la donnée initiale ne contient que des blocs de cases 2×2 (cela évite d'avoir deux cases noires qui se touchent sur la diagonale, le tout sur fond blanc). On travaille avec $a_\alpha \geq 0$ pour $\alpha = 1, 2$.

On définit $F^{n,\alpha}$ comme d'habitude, càd

$$F^{n,\alpha} = \{I \in \mathbb{Z}^2, \theta_{I^{\alpha,-}}^n \neq \theta_I^n\}, \quad F_{\pm}^{n,\alpha} = F^{n,\alpha} \cap \{\theta^n = \pm 1\},$$

et on considère en plus les coins supérieurs droits

$$C^n = \{I, I^{1,-} \in F^{n,2}, I^{2,-} \in F^{n,1}, \text{ et } \theta_I^n = \theta_{I^{1,-}}^n = \theta_{I^{2,-}}^n\}.$$

On va définir $\tilde{\theta}^{n,\alpha}$ partout sur

$$\overline{F}^{n,\alpha} = F^{n,\alpha} \cup C^n$$

vérifiant l'évolution suivante pour $I \in \overline{F}^{n,\alpha}$:

$$\tilde{\theta}_I^{n,\alpha}(t_n) = \tilde{\theta}_I^{n,\alpha}, \quad \dot{\tilde{\theta}}_I^{n,\alpha}(t) = |a_\alpha|$$

et on pose

$$\overline{F}^n = \bigcup_{\alpha=1,2} \overline{F}^{n,\alpha}.$$

On définit alors l'ensemble des points acceptés (du premier coup) :

$$A^{n+1,\alpha} = \{I \notin C^n, \tilde{\theta}_I^{n,\alpha}(t_{n+1}) = 1\},$$

$$A^{n+1} = \bigcup_{\alpha=1,2} \{I \in A^{n+1,\alpha} \text{ et } I^{\alpha,-} \notin A^{n+1,\bar{\alpha}}\},$$

où

$$\bar{\alpha} = \begin{cases} 2 & \text{si } \alpha = 1 \\ 1 & \text{si } \alpha = 2. \end{cases}$$

On définit aussi l'ensemble complémentaire des points acceptés (les coins supérieurs droits acceptés)

$$\hat{A}^{n+1} = \{I, \quad I^{1,-} \in A^{n+1,2}, \quad I^{2,-} \in A^{n+1,1}\}$$

et l'ensemble complet des points acceptés

$$\overline{A}^{n+1} = \hat{A}^{n+1} \cup A^{n+1}.$$

On remet alors à jour les θ :

$$\theta_I^{n+1} = \begin{cases} -\theta_I^n & \text{si } I \in \overline{A}^{n+1} \\ \theta_I^n & \text{sinon.} \end{cases}$$

Maintenant on procède ainsi pour tous les points $I \in \overline{F}^{n+1}$.

1. (Premier passage). Pour chaque $\alpha = 1, 2$ et pour tout $I \in \overline{F}^{n+1,\alpha} \cap \overline{F}^{n,\alpha}$, on définit

$$\tilde{\theta}_I^{n+1,\alpha} := \tilde{\theta}_I^{n,\alpha}(t_{n+1}).$$

Si $I \in C^n \cap \overline{F}^{n+1,\alpha}$ et $I^{\alpha,-} \in A^{n+1,\alpha} \cup \hat{A}^{n+1}$ alors on pose

$$\tilde{\theta}_I^{n+1,\alpha} := 0.$$

Si $I \in \overline{F}^{n+1,\alpha} \setminus \overline{F}^{n,\alpha}$, alors on pose aussi

$$\tilde{\theta}_I^{n+1,\alpha} := 0.$$

2. (Points acceptés). Si $I \in A^{n+1,\alpha} \setminus A^{n+1,\bar{\alpha}}$, on pose

$$\tilde{\theta}_I^{n+1,\bar{\alpha}} = \begin{cases} \tilde{\theta}_{I^{\alpha,-}}^{n,\bar{\alpha}}(t_{n+1}) & \text{si } I^{\alpha,-} \in F^{n,\bar{\alpha}} \\ 0 & \text{si } I^{\alpha,-} \notin F^{n,\bar{\alpha}}. \end{cases}$$

Si $I \in A^{n+1,1} \cap A^{n+1,2}$, on pose

$$\tilde{\theta}_I^{n+1,\alpha} = 0 \quad \text{pour } \alpha = 1, 2.$$

3. (Nouveaux coins). Si $I \in C^{n+1} \setminus C^n$, alors $J := (I^{1,-})^{2,-} \in \overline{A}^{n+1}$ et

$$\text{si } J \in \hat{A}^{n+1} \cup (A^{n+1,1} \cap A^{n+1,2}), \quad \tilde{\theta}_I^{n+1,\alpha} := 0 \quad \text{pour } \alpha = 1, 2$$

et si

$$J \in A^{n+1,\alpha} \setminus A^{n+1,\bar{\alpha}}, \quad \begin{cases} \tilde{\theta}_I^{n+1,\alpha} = 0 \\ \tilde{\theta}_I^{n+1,\bar{\alpha}} = \begin{cases} \tilde{\theta}_{I^{\alpha,-}}^{n,\bar{\alpha}}(t_{n+1}) & \text{si } I^{\alpha,-} \in \overline{F}^{n,\bar{\alpha}} \\ 0 & \text{sinon.} \end{cases} \end{cases}$$

4. (Nettoyage final). On pose pour tout $I \in \mathbb{Z}^2$

$$\tilde{\theta}_I^{n+1,\alpha} := 0 \quad \text{si } I \notin \overline{F}^{n+1,\alpha}.$$

De plus si $\tilde{\theta}_I^{n+1,\alpha} = 1$, alors on pose

$$\tilde{\theta}_I^{n+1,\alpha} = 0.$$

4 Simulations numériques pour l'algorithme de splitting

Nous présentons quelques simulations numériques associées à l'algorithme de splitting présenté dans la sous-section 3.2.

4.1 Simulation 1 : Cas d'un cercle avec une vitesse constante $\vec{a} = (1, 2)$

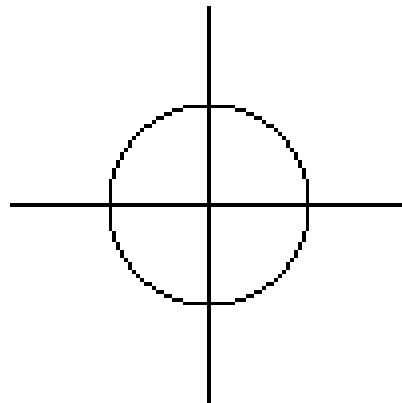

FIG. 6.3 – Image 0, $\vec{a} = (1, 2)$

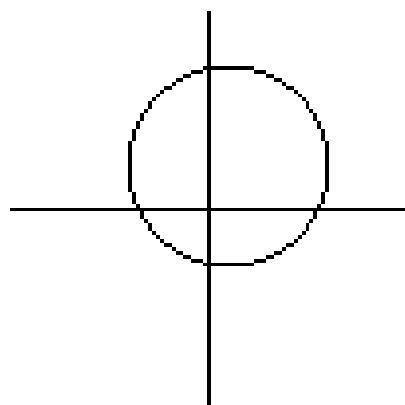

FIG. 6.4 – Image 10, $\vec{a} = (1, 2)$

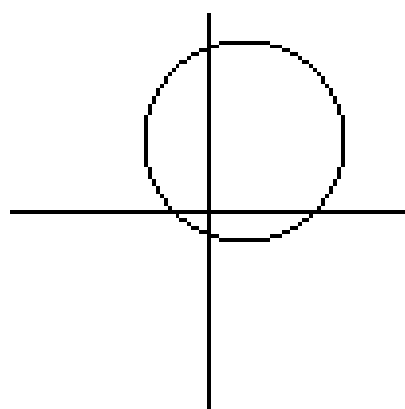

FIG. 6.5 – Image 18, $\vec{a} = (1, 2)$

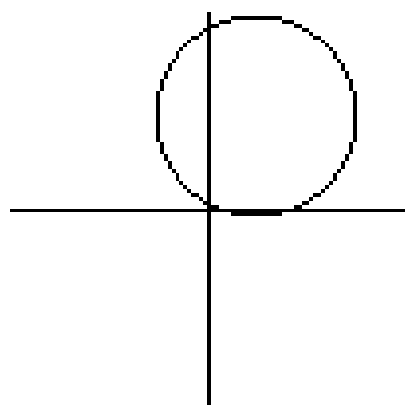

FIG. 6.6 – Image 23, $\vec{a} = (1, 2)$

4.2 Simulation 2 : Cas d'un carré qui tourne, $\vec{a} = (-y, x)$

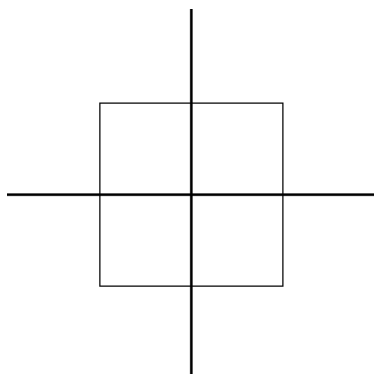

FIG. 6.7 - Image 0, $\vec{a} = (-y, x)$

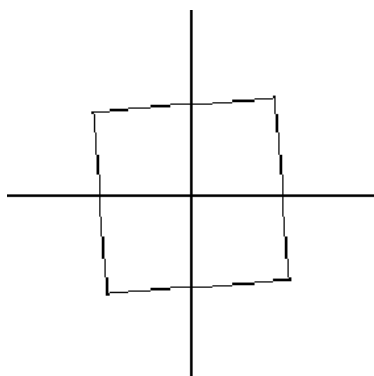

FIG. 6.8 - Image 38, $\vec{a} = (-y, x)$

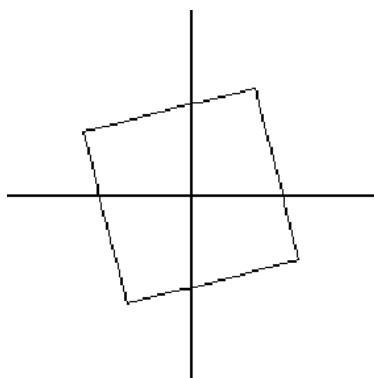
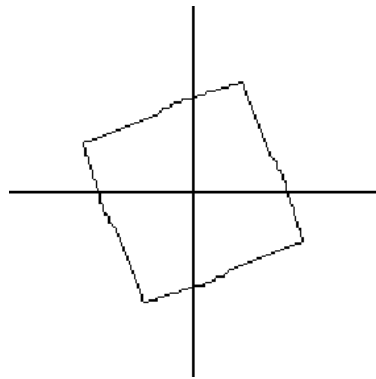
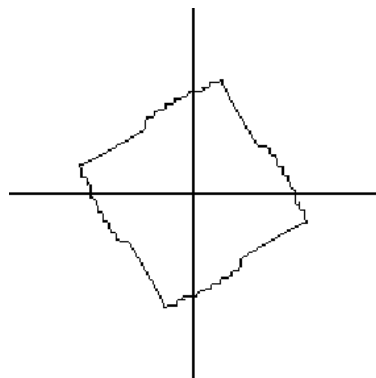

FIG. 6.9 - Image 149, $\vec{a} = (-y, x)$

FIG. 6.10 – Image 241, $\vec{a} = (-y, x)$ FIG. 6.11 – Image 373, $\vec{a} = (-y, x)$

5 Conclusion

L'algorithme de splitting, donné en sous-section 3.2, est exact sur les droites se propageant suivant un champ de vecteur constant. Cependant, il n'est pas monotone, ce qui crée des instabilités (voir Figure 6.11). Nous recherchons actuellement un algorithme monotone (éventuellement un peu non local).

Appendix : remarks on the model of Groma-Csikor-Zaiser

In what follows, we give some heuristic physical and mechanical interpretations of the model of Groma, Csikor and Zaiser [46]. This model describes the evolution of dislocations densities in a bounded crystal of length L (we take $L = 2$), and it takes into consideration the short range dislocation-dislocation interactions (see Figure 6.12). We recall that the original model in terms of the positive dislocation densities θ^+ and θ^- is expressed by the following system of equations :

$$\begin{cases} \theta_t^+ = \left[\left(\frac{\theta_x^+ - \theta_x^-}{\theta^+ + \theta^-} - \tau \right) \theta^+ \right]_x & \text{on } (-1, 1) \times \mathbb{R} \times (0, T), \\ \theta_t^- = \left[- \left(\frac{\theta_x^+ - \theta_x^-}{\theta^+ + \theta^-} - \tau \right) \theta^- \right]_x & \text{on } (-1, 1) \times \mathbb{R} \times (0, T), \end{cases} \quad (5.2)$$

where τ is the applied stress, and the non-local diffusion-like term

$$\tau_b = \frac{\theta_x^+ - \theta_x^-}{\theta^+ + \theta^-} \quad (5.3)$$

is called the local back stress which is a consequence of the influence of the interactions at a short distance between dislocations.

Letting

$$\rho_x^\pm = \theta^\pm, \quad \rho = \rho^+ - \rho^- \quad \text{and} \quad \kappa = \rho^+ + \rho^-, \quad (5.4)$$

the connection with plasticity theory is established through the shear strain γ that is related to the dislocation densities by the following relation :

$$\gamma(x) = \int^x (\theta^+ - \theta^-) dx,$$

hence

$$\gamma = \rho, \quad (5.5)$$

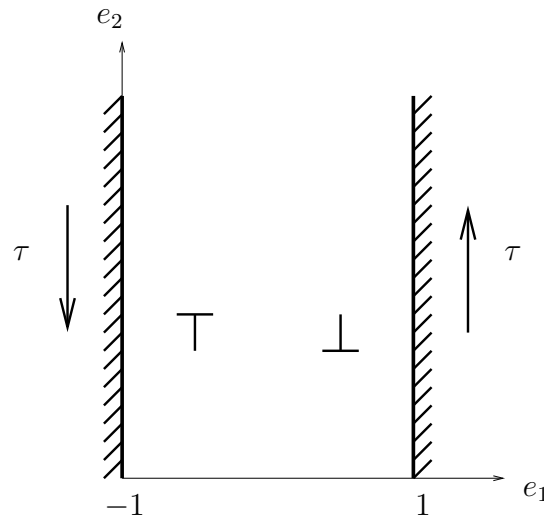

FIG. 6.12 – Geometry of the studied constrained channel.

where ρ represents the plastic deformation in the material.

Looking at the distribution of dislocation densities and strains within the channel, we find that at high stresses two boundary layers emerge near the walls. At equilibrium (after a long time), the structure of these boundary layers can be analyzed by noting that at high stresses all dislocations are close to the walls, with only negative dislocations at the left wall ($\rho_x = -\kappa_x$) and only positive dislocations at the right one ($\rho_x = \kappa_x$).

1. Coarse derivation of the back stress τ_b . For the sake of simplicity, we will put ourselves in the framework where we have N number of **positive** dislocations in an infinite material situated on $(-\infty, 0]$. Let $x_i, i = 1 \dots N$ be the position of the i -th dislocation after applying a high stress τ . Denote

$$\theta = \theta^+,$$

the density of the positive dislocations. The goal here is to give a coarse calculation in order to see how the diffusion term

$$\theta_x^+ - \theta_x^- = \theta_x^+ = \theta'$$

in the back stress τ_b (see 5.3) could be derived. The total stress σ applied at a

given dislocation at the position x_i can be given by :

$$\begin{aligned}\sigma &\simeq \left(\sum_{j \neq i} \sigma_0(x_i - x_j) - \sum(\text{mean-field stress}) \right) + \tau \\ &= \left(\sigma_0 * \sum_i \delta_{x_i} - \sum(\text{mean-field stress}) \right) + \tau.\end{aligned}\quad (5.6)$$

Here

$$\tau_b = \left(\sigma_0 * \sum_i \delta_{x_i} - \sum(\text{mean-field stress}) \right),$$

and $\sigma_0(x_i - x_j)$ is the shear stress created at x_i by a positive dislocation located at x_j , while the mean-field stress is due to the uniform distribution of the dislocations in the vertical direction (see Figure 2.3 of Chapter 2).

Derivation from statistical mechanics. The idea of the derivation of the back stress as it appears in the work of Groma, Csikor and Zaiser [46], relies on passing from the discrete dislocation system, i.e. the equations of motion of individual dislocations, to the continuum one by averaging over an ensemble of statistically equivalent dislocation systems (for details of the averaging procedure see [44,45]). It is worth mentioning that the discrete density of positive dislocations is given by :

$$\theta^D(x) = \sum_{i=1}^N \delta(x - x_i).$$

The dynamics of θ due to the continuum description is given by :

$$\theta_t = - \left(\tau\theta + \int \theta_{++}(x, y, t) \sigma_0(x - y) dy \right)_x,$$

where the two-particle density function appearing in the integral may be interpreted as follows : $\theta_{++}(x, y, t) dx dy$ is the joint probability to find at some time t a positive dislocation in an element of length dx at the point x and another positive dislocation in an element of length dy at y . The simplest possible assumption is that the two particle density function is a product of the single particle ones, i.e.

$$\theta_{++}(x, y, t) = \theta(x, t)\theta(y, t).$$

This assumption was considered by Groma and Balogh [45] in order to describe the dynamics of the dislocation densities without any short-range interactions (the dislocation arrangement are microscopically random).

On the other hand it has been demonstrated that the dislocation-dislocation correlations may introduce an internal length scale into the dislocation dynamics and into associated plasticity theories. In [46], the short range correlation effects was taken into account by assuming that

$$\theta_{++}(x, y, t) = \theta(x, t)\theta(y, t) (1 + d_{++}(x - y)),$$

where d_{++} corresponds to the correlation function in a homogeneous dislocation system. Finally, this gives rise to the diffusion-like local back stress that we are going to give another non-rigorous derivation of it.

Non-rigorous derivation. We return our attention to (5.6). The mean-field stress can be expressed in terms of σ_0 as follows :

$$\sum(\text{mean-field stress}) = N\sigma_0 * \theta.$$

Let l_i be a number related to x_i by the following relation :

$$l_i = \frac{(x_i - x_{i+1})}{2},$$

and let

$$N = \frac{1}{\varepsilon}.$$

Using the above identities and (5.6), we obtain :

$$\begin{aligned} \tau_b &\simeq -\frac{1}{\varepsilon}\sigma_0 * \theta + \sigma_0 * \sum_i \delta_{x_i} \\ &\simeq -\frac{1}{\varepsilon}\sigma_0 * \left(\theta - \varepsilon \sum_i \delta_{x_i} \right). \end{aligned}$$

We compute for a test function ϕ :

$$\begin{aligned} \langle \theta - \varepsilon \sum_i \delta_{x_i}, \phi \rangle &= \int \theta \phi - \varepsilon \sum_i \phi(x_i) \\ &\simeq \sum_i \int_{x_{i+1}}^{x_i} \theta \phi - \varepsilon \sum_i \phi(x_i). \end{aligned}$$

We apply Taylor's expansion of the function ϕ up to order 2, and we use the fact that :

$$l_i = \frac{(x_i - x_{i+1})}{2} \simeq \frac{\varepsilon}{2\theta(x_i)},$$

we finally obtain :

$$\begin{aligned}
\langle \theta - \varepsilon \sum_i \delta_{x_i}; \phi \rangle &\simeq \int \phi'' \frac{l^2}{6} + \text{higher order terms} \\
&\simeq \int \phi'' \frac{\varepsilon^2}{24\theta^2} + \text{h.o.t} \\
&\simeq \frac{\varepsilon^2}{24} \int \phi \left(\frac{1}{\theta^2} \right)'' + \text{h.o.t},
\end{aligned}$$

hence

$$\frac{1}{\varepsilon} \left(\theta - \varepsilon \sum_i \delta_{x_i} \right) \simeq \frac{\varepsilon}{24} \left(\frac{1}{\theta^2} \right)'' + \text{h.o.t},$$

therefore

$$\begin{aligned}
\tau_b &\simeq -\sigma_0 * \left(\frac{1}{\varepsilon} \left(\theta - \varepsilon \sum_i \delta_{x_i} \right) \right) \\
&\simeq -\frac{\varepsilon}{24} \sigma_0 * \left(\frac{1}{\theta^2} \right)'' \\
&\simeq -\frac{\varepsilon}{24} \sigma_0' * \left(-\frac{2\theta'}{\theta^3} \right) \\
&\simeq C \frac{\theta'}{\theta^3}, \quad C \text{ is a constant,}
\end{aligned}$$

which shows, in an approximate way, the presence of $\frac{\theta'}{\theta^3}$ instead of $\frac{\theta'}{\theta}$ in (5.3). At least we recover the presence of θ' .

2. Calculation of the displacement u inside the material. We write down the equations of the displacement vector u inside the material when this is applied to a constant exterior shear stress τ on the boundary walls. We consider a 2-dimensional crystal with the displacement vector :

$$u = (u_1, u_2) : \mathbb{R}^2 \mapsto \mathbb{R}^2.$$

For $x = (x_1, x_2)$ and an orthonormal basis (e_1, e_2) , we define the total strain by :

$$\varepsilon(u) = \frac{1}{2} (\nabla u + {}^t \nabla u), \tag{5.7}$$

i.e.

$$\varepsilon_{ij}(u) = \frac{1}{2} (\partial_j u_i + \partial_i u_j)$$

with

$$\partial_j u_i = \frac{\partial u_i}{\partial x_j}, \quad i, j = 1, 2.$$

This total strain can be decomposed into two parts as follows :

$$\varepsilon(u) = \varepsilon^e(u) + \varepsilon^p, \quad (5.8)$$

where $\varepsilon^e(u)$ is the elastic strain and ε^p is the plastic strain which is given by :

$$\varepsilon^p = \gamma \varepsilon^0, \quad (5.9)$$

with

$$\varepsilon^0 = \frac{1}{2}(e_1 \otimes e_2 + e_2 \otimes e_1) = \frac{1}{2} \begin{pmatrix} 0 & 1 \\ 1 & 0 \end{pmatrix},$$

in the special case of a single slip system where dislocations move following the Burgers vector $\vec{b} = e_1$ (for the details of our particular framework, see Section 1.2 of Chapter 2). Here γ is the resolved plastic strain that can be expressed in terms of the dislocation densities (see (5.4)) as :

$$\gamma = \rho^+ - \rho^- = \rho,$$

therefore (5.9) implies that

$$\varepsilon^p = \rho \varepsilon^0.$$

The stress field σ inside the crystal is given by :

$$\sigma = \Lambda : \varepsilon^e(u),$$

where for $i, j = 1, 2$,

$$\sigma_{ij} = (\Lambda : \varepsilon^e(u))_{ij} = 2\mu \varepsilon_{ij}^e(u) + \lambda \delta_{ij} \text{tr}(\varepsilon^e(u)), \quad (5.10)$$

with $\lambda, \mu > 0$ are the constants of Lamé coefficients of the crystal that are assumed (for simplification) to be isotropic, and δ_{ij} is the Kronecker delta symbol. This stress field σ has to satisfy the equation of elasticity :

$$\text{div} \sigma = 0,$$

that can be reformulated as :

$$\text{div} (2\mu \varepsilon(u) + \lambda \text{tr}(\varepsilon(u)) I_d) = \text{div} (2\mu \varepsilon^p + \lambda \text{tr}(\varepsilon^p) I_d),$$

which implies that :

$$\mu \Delta u + (\lambda + \mu) \nabla(\text{div} u) = \mu \begin{pmatrix} \partial_2 \rho \\ \partial_1 \rho \end{pmatrix} = \mu \begin{pmatrix} 0 \\ \partial_1 \rho \end{pmatrix}. \quad (5.11)$$

Here $\partial_2 \rho = 0$ is due to the homogeneity of the distribution of dislocations in the e_2 -direction (see Figure 2.3 of Chapter 2).

Calculation of u . We first calculate the value of the displacement u on the boundary walls. Remark first that since we are applying a constant shear stress field on the walls, the stress field σ there can be evaluated as : $\sigma \cdot n = \pm \tau e_2$, $n = \pm e_1$,

$$\sigma^b = \begin{pmatrix} 0 & \tau \\ \tau & 0 \end{pmatrix}, \quad \text{on } \partial I. \quad (5.12)$$

Using (5.12) and (5.10), we can derive the following equations on the boundary :

$$\begin{cases} \partial_1 u_1 = 0 & \text{on } x_1 = -1, 1, \\ \mu(\partial_1 u_2 - \rho) = \tau & \text{on } x_1 = -1, 1. \end{cases} \quad (5.13)$$

Equation (5.11) leads to the following two equations inside $I = (-1, 1)$:

$$\begin{cases} \partial_1[(\lambda + 2\mu)\partial_1 u_1] = 0 & \text{on } I \\ \partial_1(\partial_1 u_2 - \rho) = 0 & \text{on } I. \end{cases} \quad (5.14)$$

Combining (5.13) and (5.14) we deduce that :

$$\begin{cases} \partial_1 u_1 = 0 & \text{on } I \\ \partial_1 u_2 - \rho = \frac{\tau}{\mu} & \text{on } I. \end{cases} \quad (5.15)$$

By the antisymmetry of our particular configuration with respect to the line $x_1 = 0$, and the fact that we are applying a shear stress on the walls, we eventually have :

$$u_1(0, x_2) = u_2(0, x_2) = 0,$$

which together with (5.15) finally lead :

$$\begin{cases} u_1(x_1, x_2) = 0, & (x_1, x_2) \in I \times \mathbb{R} \\ u_2(x_1, x_2) = \frac{\tau}{\mu} x_1 + \int_0^{x_1} \rho(x) dx, & (x_1, x_2) \in I \times \mathbb{R}, \end{cases} \quad (5.16)$$

where ρ can be computed from the following coupled system derived (see 5.4) from (5.2) :

$$\begin{cases} \rho_t = \rho_{xx} - \tau \kappa_x & (x_1, x_2, t) \in I \times \mathbb{R} \times (0, T), \quad T > 0, \\ \kappa_t \kappa_x = \rho_t \rho_x & (x_1, x_2, t) \in I \times \mathbb{R} \times (0, T). \end{cases} \quad (5.17)$$

Heuristic remarks

As an elastoviscoplastic material of small size, the double-ended pile-up distribution of dislocations affects the internal contribution (displacement) of the material near the boundary (see Figures 6.13, 6.14 and 6.15). It appears that the crystal is perfectly elastic at a very small time $t = 0^+$, while the plastic contribution starts to take place at $t > 0$ with two boundary layers created at the walls (see Figure 6.15). The following figures are numerically computed after calculating the displacement u_2 (see (5.16)) by discretizing (5.17) in order to calculate ρ . Our numerical scheme will be given later.

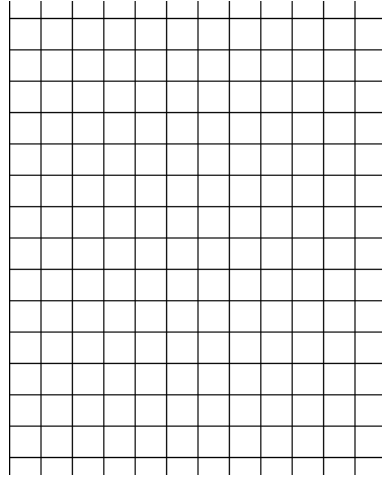

FIG. 6.13 – The material at $t = 0$.

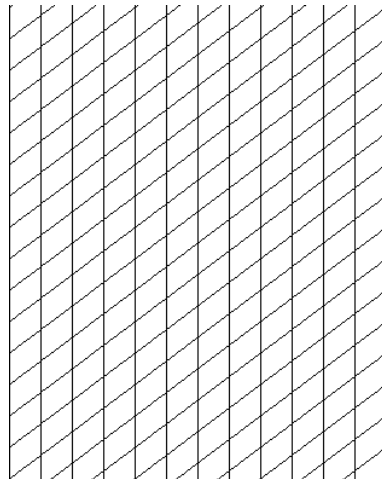

FIG. 6.14 – The elastic deformation at $t = 0^+$.

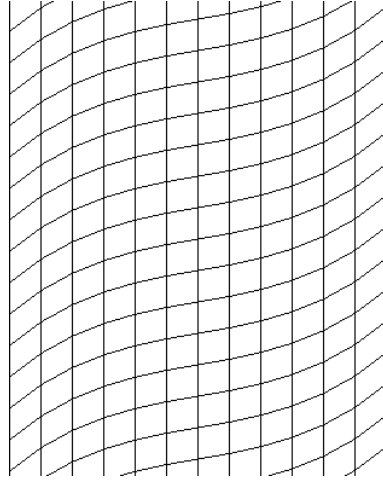

FIG. 6.15 – The total deformation at $t = +\infty$.

It is worth noticing that equations (5.15) enables us to find explicit formulas for the elastic and the plastic strain $\varepsilon^e(u)$ and ε^p . In fact, using (5.7) and (5.15), we deduce that :

$$\varepsilon(u) = \varepsilon^e(u) + \varepsilon^p = \frac{1}{2} \begin{pmatrix} 0 & \frac{\tau}{\mu} + \rho \\ \frac{\tau}{\mu} + \rho & 0 \end{pmatrix} = \varepsilon^e(u) + \frac{1}{2} \begin{pmatrix} 0 & \rho \\ \rho & 0 \end{pmatrix},$$

hence

$$\varepsilon^e(u) = \frac{1}{2} \begin{pmatrix} 0 & \frac{\tau}{\mu} \\ \frac{\tau}{\mu} & 0 \end{pmatrix} = \frac{\tau}{\mu} \varepsilon^0,$$

which is independent of ρ in this particular framework.

3. A proposed numerical scheme. We want to approximate the function u_2 given by (5.16) by proposing a numerical scheme to the system (5.17). Since the problem is invariant in the e_2 -direction, we will only make a discretization of the interval $I = (-1, 1)$. Given a mesh size Δx , Δt , we define

$$\Xi = \{i\Delta x, i \in \mathbb{Z}, i \in [-N, N]\}, \quad N = 1/\Delta x \in \mathbb{N},$$

as a discretization of I , and

$$\Xi_T = \Xi \times \{0, \dots, (\Delta t)N_T\},$$

as the whole grid mesh. Here N_T is the integer part of $T/\Delta t$. The discrete running point is (x_i, t_n) , $n \in \mathbb{N}$, with $x_i = i(\Delta x)$ and $t_n = n(\Delta t)$. The approximation of the functions ρ and κ at the node (x_i, t_n) will be represented by ρ_i^n and κ_i^n respectively. We choose the initial discretized function ρ_i^0 and κ_i^0 as follows :

$$\rho_i^0 = 0 \quad \text{and} \quad \kappa_i^0 = x_i. \quad (5.18)$$

Let

$$(\rho_x)_i^n = \frac{\rho_{i+1}^n - \rho_{i-1}^n}{2\Delta x}, \quad (\rho_{xx})_i^n = \frac{\rho_{i+1}^n + \rho_{i-1}^n - 2\rho_i^n}{(\Delta x)^2},$$

and

$$(\kappa_x)_i^{+n} = \frac{\kappa_{i+1}^n - \kappa_i^n}{\Delta x}, \quad (\kappa_x)_i^{-n} = \frac{\kappa_i^n - \kappa_{i-1}^n}{\Delta x}.$$

Define

$$(\kappa_x)_i^n = \begin{cases} [(\kappa_x)_i^{+n}]^+ & \text{if } (\rho_x)_i^n (\rho_{xx})_i^n \leq 0, \\ [(\kappa_x)_i^{-n}]^+ & \text{if } (\rho_x)_i^n (\rho_{xx})_i^n \geq 0, \end{cases}$$

where $a^+ = \max(a, 0)$. We consider for $|i| < N$, $0 \leq n \leq (\Delta t)N_T$, the following scheme :

$$\left\{ \begin{array}{l} \frac{\kappa_i^{n+1} - \kappa_i^n}{\Delta t} = \begin{cases} \frac{(\rho_x)_i^n (\rho_{xx})_i^n}{(\kappa_x)_i^n} - \tau(\rho_x)_i^n & \text{if } (\kappa_x)_i^n \neq 0 \\ -\tau(\rho_x)_i^n & \text{if } (\kappa_x)_i^n = 0 \end{cases} \\ \frac{\rho_i^{n+1} - \rho_i^n}{\Delta t} = (\rho_{xx})_i^n - \tau(\kappa_x)_i^n \\ \kappa_{-N}^n = -1 \quad \text{and} \quad \kappa_N^n = 1 \\ \rho_{-N}^n = \rho_N^n = 0 \end{array} \right\} \text{Dirichlet boundary conditions.} \quad (5.19)$$

We also assume the following CFL condition :

$$\Delta t \leq \begin{cases} \frac{1}{|(\rho_x)_i^n (\rho_{xx})_i^n|} \left(\frac{\kappa_{i+1}^n - \kappa_i^n}{\Delta x} \right) (\kappa_{i+1}^n - \kappa_i^n) & \text{if } (\rho_x)_i^n (\rho_{xx})_i^n \leq 0 \\ \frac{1}{|(\rho_x)_i^n (\rho_{xx})_i^n|} \left(\frac{\kappa_i^n - \kappa_{i-1}^n}{\Delta x} \right) (\kappa_i^n - \kappa_{i-1}^n) & \text{if } (\rho_x)_i^n (\rho_{xx})_i^n \geq 0. \end{cases} \quad (5.20)$$

Discretization of u_2 . The previous scheme, together with (5.16) permit to make the following discretization of u_2 :

$$(u_2)_i^n = \frac{\tau}{\mu} i(\Delta x) + \begin{cases} \sum_{j=1}^i \rho_j^n \Delta x & \text{if } i > 0, \\ -\sum_{j=i}^{-1} \rho_j^n \Delta x & \text{if } i < 0, \\ 0 & \text{if } i = 0. \end{cases} \quad (5.21)$$

4. Numerical simulations for (5.18)-(5.19), $\tau = 1.8$.

4.1. Evolution of ρ .

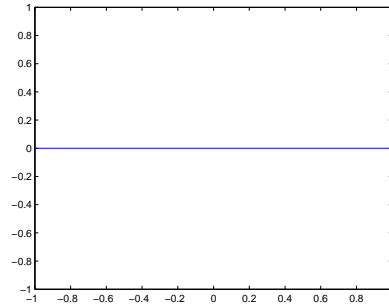

FIG. 6.16 – ρ at $t = 0$.

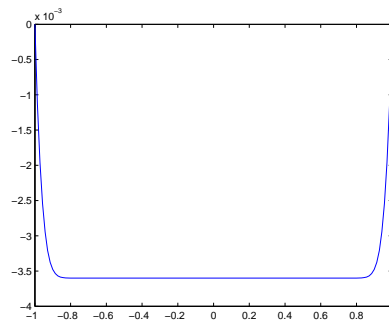

FIG. 6.17 – ρ at $t = 0.002$.

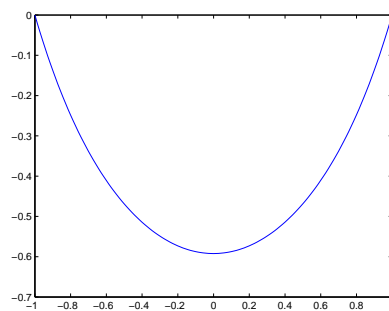

FIG. 6.18 – ρ at $t = 0.551$.

4.2. Evolution of κ .

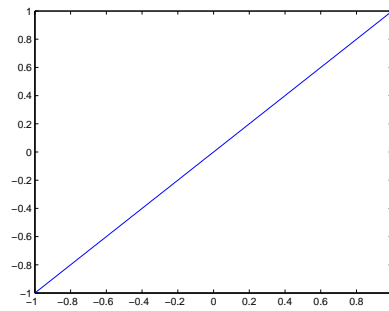

FIG. 6.19 – κ at $t = 0$.

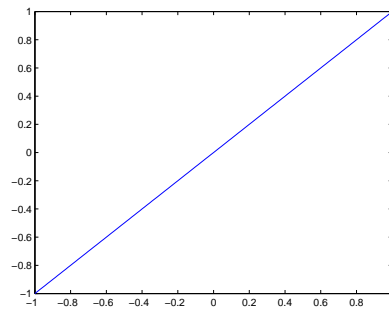

FIG. 6.20 – κ at $t = 0.002$.

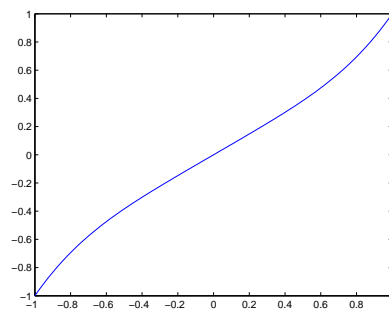

FIG. 6.21 – κ at $t = 0.551$.

4.3. Evolution of the positive dislocation density θ^+ .

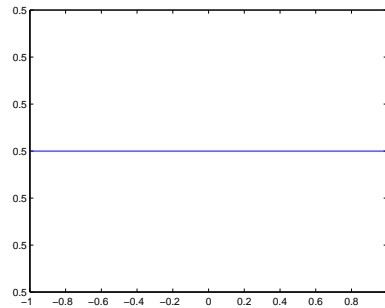

FIG. 6.22 – θ^+ at $t = 0$.

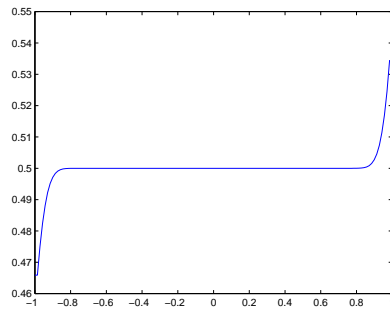

FIG. 6.23 – θ^+ at $t = 0.002$.

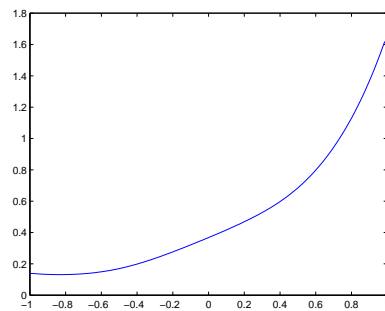

FIG. 6.24 – θ^+ at $t = 0.551$.

4.4. Evolution of the negative dislocation density θ^- .

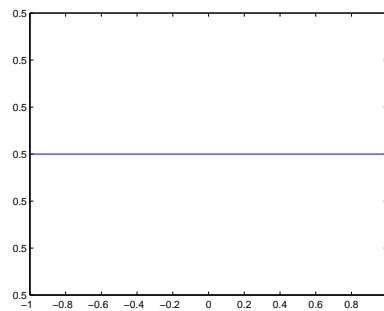

FIG. 6.25 – θ^- at $t = 0$.

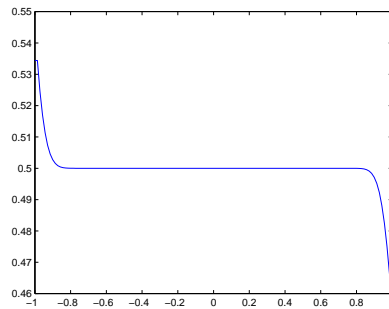

FIG. 6.26 – θ^- at $t = 0.002$.

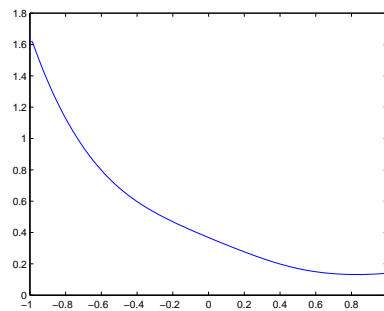

FIG. 6.27 – θ^- at $t = 0.551$.

Bibliographie

- [1] R. A. ADAMS, *Sobolev spaces*, Academic Press [A subsidiary of Harcourt Brace Jovanovich, Publishers], New York-London, 1975. Pure and Applied Mathematics, Vol. 65.
- [2] V. ALEXIADES, *A singular parabolic initial-boundary value problem in a non-cylindrical domain*, SIAM J. Math. Anal., 11 (1980), pp. 348–357.
- [3] G. BARLES, *Solutions de viscosité des équations de Hamilton-Jacobi*, vol. 17 of Mathématiques & Applications (Berlin) [Mathematics & Applications], Springer-Verlag, Paris, 1994.
- [4] J. T. BEALE, T. KATO, AND A. MAJDA, *Remarks on the breakdown of smooth solutions for the 3-D Euler equations*, Comm. Math. Phys., 94 (1984), pp. 61–66.
- [5] W. BOLLMANN, Phys. Rev., 103 (1956), pp. 1588–1589.
- [6] M. BRAMANTI AND L. BRANDOLINI, *Estimates of BMO type for singular integrals on spaces of homogeneous type and applications to hypoelliptic PDEs*, Rev. Mat. Iberoamericana, 21 (2005), pp. 511–556.
- [7] H. BREZIS, *Analyse fonctionnelle*, Collection Mathématiques Appliquées pour la Maîtrise. [Collection of Applied Mathematics for the Master's Degree], Masson, Paris, 1983. Théorie et applications. [Theory and applications].
- [8] H. BRÉZIS AND T. GALLOUËT, *Nonlinear Schrödinger evolution equations*, Nonlinear Anal., 4 (1980), pp. 677–681.
- [9] H. BRÉZIS AND S. WAINGER, *A note on limiting cases of Sobolev embeddings and convolution inequalities*, Comm. Partial Differential Equations, 5 (1980), pp. 773–789.
- [10] M. CANNONE, A. EL HAJJ, R. MONNEAU, AND F. RIBAUD, *Global existence of a system of non-linear transport equations describing the dynamics of dislocation densities*, preprint.
- [11] E. CARLINI, M. FALCONE, N. FORCADEL, AND R. MONNEAU, *Convergence of a generalized fast marching method for an eikonal equation with a velocity changing sign*, accepted for publication in SIAM J. Numer. Anal.

- [12] A. CARPIO, S. J. CHAPMAN, AND J. L. L. VELÁZQUEZ, *Pile-up solutions for some systems of conservation laws modelling dislocation interaction in crystals*, SIAM J. Appl. Math., 61 (2001), pp. 2168–2199 (electronic).
- [13] V. CASELLES, *Scalar conservation laws and Hamilton-Jacobi equations in one-space variable*, Nonlinear Anal., 18 (1992), pp. 461–469.
- [14] C. Y. CHAN AND H. G. KAPER, *Quenching for semilinear singular parabolic problems*, SIAM J. Math. Anal., 20 (1989), pp. 558–566.
- [15] C. Y. CHAN AND C. C. S., *A numerical method for semilinear singular parabolic quenching problems*, Quart. Appl. Math., 47 (1989), pp. 45–57.
- [16] C. Y. CHAN AND B. M. WONG, *Existence of classical solutions for singular parabolic problems*, Quart. Appl. Math., 53 (1995), pp. 201–213.
- [17] Y. Z. CHEN AND E. DIBENEDETTO, *On the Harnack inequality for non-negative solutions of singular parabolic equations*, in Degenerate diffusions (Minneapolis, MN, 1991), vol. 47 of IMA Vol. Math. Appl., Springer, New York, 1993, pp. 61–69.
- [18] H. H. M. CLEVERINGA, E. VAN DER GIESSEN, AND A. NEEDLEMAN, *A discrete dislocation analysis of mode I crack growth*, J. Mech. Phys. Solids, 48 (2000), pp. 1133–1157. The J. R. Willis 60th anniversary volume.
- [19] G. M. COCLITE AND N. H. RISEBRO, *Viscosity solutions of Hamilton-Jacobi equations with discontinuous coefficients*, preprint, (2000).
- [20] D. COLTON, *Cauchy's problem for a singular parabolic partial differential equation*, J. Differential Equations, 8 (1970), pp. 250–257.
- [21] L. CORRIAS, M. FALCONE, AND R. NATALINI, *Numerical schemes for conservation laws via Hamilton-Jacobi equations*, Math. Comp., 64 (1995), pp. 555–580, S13–S18.
- [22] M. G. CRANDALL AND P.-L. LIONS, *Viscosity solutions of Hamilton-Jacobi equations*, Trans. Amer. Math. Soc., 277 (1983), pp. 1–42.
- [23] ———, *On existence and uniqueness of solutions of Hamilton-Jacobi equations*, Nonlinear Anal., 10 (1986), pp. 353–370.
- [24] E. DIBENEDETTO, *Degenerate parabolic equations*, Universitext, Springer-Verlag, New York, 1993.
- [25] ———, *Degenerate and singular parabolic equations*, Recent advances in partial differential equations, RAM Res. Appl. Math., 30 (1994), pp. 55–84.
- [26] E. DIBENEDETTO AND Y.-Z. CHEN, *On the local behaviour of solutions of singular parabolic equations*, J. Rational Mech. Anal., 103 (1988), pp. 319–345.
- [27] ———, *Hölder estimates of solutions of singular parabolic equations with measurable coefficients*, J. Rational Mech. Anal., 118 (1992), pp. 257–271.

-
- [28] E. DiBENEDETTO, Y. KWONG, AND V. VESPRI, *Local space-analyticity of solutions of certain singular parabolic equations*, Indiana Univ. Math. J., 40 (1991), pp. 741–765.
- [29] E. DiBENEDETTO AND Y. C. KWONG, *Harnack estimates and extinction profile for weak solutions of certain singular parabolic equations*, Trans. Amer. Math. Soc., 330 (1992), pp. 783–811.
- [30] A. EL-AZAB, *Statistical mechanics treatment of the evolution of dislocation distributions in single crystals*, Phys. Rev. B, 61 (2000), pp. 11956–11966.
- [31] A. EL HAJJ, *Well-posedness theory for a non-conservative burgers type system arising in dislocation dynamics*, SIAM J. Math. Anal., 39 (2007), pp. 965–986.
- [32] A. EL HAJJ AND N. FORCADEL, *A convergent scheme for a non-local coupled system modelling dislocations densities dynamics*, Math. Comp., 77 (2008), pp. 789–812.
- [33] H. ENGLER, *An alternative proof of the Brezis-Wainger inequality*, Comm. Partial Differential Equations, 14 (1989), pp. 541–544.
- [34] L. C. EVANS, *Partial differential equations*, vol. 19 of Graduate Studies in Mathematics, American Mathematical Society, Providence, RI, 1998.
- [35] R. EYMARD, T. GALLOUËT, AND R. HERBIN, *Existence and uniqueness of the entropy solution to a nonlinear hyperbolic equation*, Chinese Ann. Math. Ser. B, 16 (1995), pp. 1–14. A Chinese summary appears in Chinese Ann. Math. Ser. A **16** (1995), no. 1, 119.
- [36] R. EYMARD, T. GALLOUËT, AND R. HERBIN, *Finite volume methods*, in Handbook of numerical analysis, Vol. VII, Handb. Numer. Anal., VII, North-Holland, Amsterdam, 2000, pp. 713–1020.
- [37] E. B. FABES AND N. GAROFALO, *Mean value properties of solutions to parabolic equations with variable coefficients*, J. Math. Anal. Appl., 121 (1987), pp. 305–316.
- [38] E. B. FABES AND N. M. RIVIÈRE, *Singular intervals with mixed homogeneity*, Studia Math., 27 (1966), pp. 19–38.
- [39] S. FOREST AND R. SEDLÁČEK, *Plastic slip distribution in two-phase laminate microstructures : dislocation based versus generalized continuum approaches*, Philosophical Magazine, 83 (2003), pp. 245–276.
- [40] D. FRANÇOIS, A. PINEAU, AND A. ZAOUI, *Comportement mécanique des matériaux*, vol. volume I : élasticité plasticité (1991), volume II : viscoplasticité, endommagement, mécanique de la rupture, mécanique du contact (1993), Hermès.
-

- [41] A. FRIEDMAN, *Partial differential equations of parabolic type*, Prentice-Hall Inc., Englewood Cliffs, N.J., 1964.
- [42] N. GAROFALO AND E. LANCONELLI, *Asymptotic behavior of fundamental solutions and potential theory of parabolic operators with variable coefficients*, Math. Ann., 283 (1989), pp. 211–239.
- [43] T. GIMSE AND N. H. RISEBRO, *A note on reservoir simulation for heterogeneous porous media*, Transp. Porous Media, 10 (1993), pp. 257–270.
- [44] I. GROMA, Phys. Rev. B 1997; 56 : 5807.
- [45] I. GROMA AND P. BALOGH, *Investigation of dislocation pattern formation in a two dimensional self-consistent field approximation*, Acta Mater, 47 (1999), pp. 3647–3654.
- [46] I. GROMA, F. F. CZIKOR, AND M. ZAISER, *Spatial correlations and higher-order gradient terms in a continuum description of dislocation dynamics*, Acta Mater, 51 (2003), pp. 1271–1281.
- [47] J.-S. GUO AND P. SOUPLET, *Fast rate of formation of dead-core for the heat equation with strong absorption and applications to fast blow-up*, Math. Ann., 331 (2005), pp. 651–667.
- [48] N. HAYASHI AND W. VON WAHL, *On the global strong solutions of coupled Klein-Gordon-Schrödinger equations*, J. Math. Soc. Japan, 39 (1987), pp. 489–497.
- [49] M. A. HERRERO, A. A. LACEY, AND J. J. L. VELÁZQUEZ, *Global existence for reaction-diffusion systems modelling ignition*, Arch. Rational Mech. Anal., 142 (1998), pp. 219–251.
- [50] P. HIRSCH, R. HORNE, AND W. M., Phil. Mag., 8 (1) (1956), pp. 677–684.
- [51] J. R. HIRTH AND L. LOTHE, *Theory of dislocations*, Second edition, Kreiger publishing company, Florida 32950, 1982.
- [52] C.-S. HUANG, S. WANG, AND K. L. TEO, *On application of an alternating direction method to Hamilton-Jacobi-Bellman equations*, in Proceedings of the International Conference on Boundary and Interior Layers—Computational and Asymptotic Methods (BAIL 2002), vol. 166, 2004, pp. 153–166.
- [53] H. IBRAHIM, *Existence and uniqueness for a non-linear parabolic/Hamilton-Jacobi coupled system describing the dynamics of dislocation densities*, to appear in Ann. Inst. H. Poincaré Anal. Non Linéaire, (2007).
- [54] H. IBRAHIM, M. JAZAR, AND R. MONNEAU, *Dynamics of dislocation densities in a bounded channel. Part I : smooth solutions to a singular coupled parabolic system*, preprint, HAL.

-
- [55] —, *Dynamics of dislocation densities in a bounded channel. Part II : existence of weak solutions to a singular hamilton-jacobi strongly coupled system*, in preparation.
- [56] H. ISHII, *Existence and uniqueness of solutions of Hamilton-Jacobi equations*, Funkcial. Ekvac., 29 (1986), pp. 167–188.
- [57] —, *On uniqueness and existence of viscosity solutions of fully nonlinear second-order elliptic PDEs*, Comm. Pure Appl. Math., 42 (1989), pp. 15–45.
- [58] R. JENSEN, *The maximum principle for viscosity solutions of fully nonlinear second order partial differential equations*, Arch. Rational Mech. Anal., 101 (1988), pp. 1–27.
- [59] F. JOHN AND L. NIRENBERG, *On functions of bounded mean oscillation*, Comm. Pure Appl. Math., 14 (1961), pp. 415–426.
- [60] K. H. KARLSEN AND N. H. RISEBRO, *A note on front tracking and equivalence between viscosity solutions of Hamilton-Jacobi equations and entropy solutions of scalar conservation laws*, Nonlinear Anal., 50 (2002), pp. 455–469.
- [61] H. KOZONO AND Y. TANIUCHI, *Limiting case of the Sobolev inequality in BMO, with application to the Euler equations*, Comm. Math. Phys., 214 (2000), pp. 191–200.
- [62] S. N. KRUŽKOV, *The Cauchy problem in the large for non-linear equations and for certain first-order quasilinear systems with several variables*, Dokl. Akad. Nauk SSSR, 155 (1964), pp. 743–746.
- [63] —, *First order quasilinear equations with several independent variables.*, Mat. Sb. (N.S.), 81 (123) (1970), pp. 228–255.
- [64] A. KUFNER, O. JOHN, AND S. FUČÍK, *Function spaces*, Noordhoff International Publishing, Leyden, 1977. Monographs and Textbooks on Mechanics of Solids and Fluids ; Mechanics : Analysis.
- [65] O. A. LADYŽENSKAJA, V. A. SOLONNIKOV, AND N. N. URAL'CEVA, *Linear and quasilinear equations of parabolic type*, Translated from the Russian by S. Smith. Translations of Mathematical Monographs, Vol. 23, American Mathematical Society, Providence, R.I., 1967.
- [66] P. D. LAX, *Hyperbolic systems of conservation laws and the mathematical theory of shock waves*, Society for Industrial and Applied Mathematics, Philadelphia, Pa., 1973. Conference Board of the Mathematical Sciences Regional Conference Series in Applied Mathematics, No. 11.
- [67] O. LEY, *Lower-bound gradient estimates for first-order Hamilton-Jacobi equations and applications to the regularity of propagating fronts*, Adv. Differential Equations, 6 (2001), pp. 547–576.
-

- [68] G. M. LIEBERMAN, *Second order parabolic differential equations*, World Scientific Publishing Co. Inc., River Edge, NJ, 1996.
- [69] P.-L. LIONS, *Generalized solutions of Hamilton-Jacobi equations*, vol. 69 of Research Notes in Mathematics, Pitman (Advanced Publishing Program), Boston, Mass., 1982.
- [70] P.-L. LIONS, B. PERTHAME, AND E. TADMOR, *A kinetic formulation of multidimensional scalar conservation laws and related equations*, J. Amer. Math. Soc., 7 (1994), pp. 169–191.
- [71] A. MAUGERI, *A boundary value problem for a class of singular parabolic equations*, Boll. Un. Mat. Ital. B (5), 17 (1980), pp. 325–339.
- [72] F. MERLE AND H. ZAAG, *Stability of the blow-up profile for equations of the type $u_t = \Delta u + |u|^{p-1}u$* , Duke Math. J., 86 (1997), pp. 143–195.
- [73] ———, *Optimal estimates for blowup rate and behavior for nonlinear heat equations*, Comm. Pure Appl. Math., 51 (1998), pp. 139–196.
- [74] R. MONNEAU, *A transport formulation for moving fronts and application to dislocation dynamics*, Interfaces Free Bound., 9 (2007), pp. 383–409.
- [75] J. W. MOONEY, *Efficient numerical algorithms for close estimation of critical parameters and quenching times in singular parabolic problems*, in Proceedings of the Second World Congress of Nonlinear Analysts, Part 2 (Athens, 1996), vol. 30, 1997, pp. 911–922.
- [76] F. R. N. NABARRO, *Theory of crystal dislocations*, Oxford, Clarendon Press, 1969.
- [77] T. OGAWA, *Sharp Sobolev inequality of logarithmic type and the limiting regularity condition to the harmonic heat flow*, SIAM J. Math. Anal., 34 (2003), pp. 1318–1330 (electronic).
- [78] E. OROWAN, Z. Phys., 89 (1934), pp. 605, 614, 634.
- [79] D. N. OSTROV, *Solutions of Hamilton-Jacobi equations and scalar conservation laws with discontinuous space-time dependence*, J. Differential Equations, 182 (2002), pp. 51–77.
- [80] F. OTTO, *Initial-boundary value problem for a scalar conservation law*, C. R. Acad. Sci. Paris Sér. I Math., 322 (1996), pp. 729–734.
- [81] B. PERTHAME, *Kinetic formulation of conservation laws*, vol. 21 of Oxford Lecture Series in Mathematics and its Applications, Oxford University Press, Oxford, 2002.
- [82] B. PERTHAME AND E. TADMOR, *A kinetic equation with kinetic entropy functions for scalar conservation laws*, Comm. Math. Phys., 136 (1991), pp. 501–517.

- [83] M. POLANYI, *Z. Phys.*, 89 (1934), p. 660.
- [84] F. QUIRÓS AND J. L. VÁZQUEZ, *Asymptotic behaviour of the porous media equation in an exterior domain*, *Ann. Scuola Norm. Sup. Pisa Cl. Sci. (4)*, 28 (1999), pp. 183–227.
- [85] P. QUITTNER, P. SOUPLLET, AND M. WINKLER, *Initial blow-up rates and universal bounds for nonlinear heat equations*, *J. Differential Equations*, 196 (2004), pp. 316–339.
- [86] J. A. SETHIAN, *A fast marching level set method for monotonically advancing fronts*, *Proc. Nat. Acad. Sci. U.S.A.*, 93 (1996), pp. 1591–1595.
- [87] Y. SINAI, *Parabolic perturbations of Hamilton-Jacobi equations*, *Fund. Math.*, 157 (1998), pp. 299–303.
- [88] P. SOUPLLET, *Blow-up behavior in nonlocal vs local heat equations*, in *Evolution equations : existence, regularity and singularities (Warsaw, 1998)*, vol. 52 of *Banach Center Publ.*, Polish Acad. Sci., Warsaw, 2000, pp. 221–226.
- [89] G. SPERANZA, *Nonhomogeneous boundary value problems for the singular parabolic equation $u_{xx} + (2\gamma/x)u_x - u_t = 0$* , *Matematiche (Catania)*, 36 (1981), pp. 136–148 (1983).
- [90] G. TAYLOR, *Proc. R. Soc. A*, 145 (1934), pp. 362–.
- [91] J. N. TSITSIKLIS, *Efficient algorithms for globally optimal trajectories*, *IEEE Trans. Automat. Control*, 40 (1995), pp. 1528–1538.
- [92] V. VOLTERRA, *Sur l'équilibre des corps élastiques multiples connexes*, *Ann. Sci. École Norm. Sup. (3)*, 24 (1907), pp. 401–517.
- [93] R. E. VOSKOBOINIKOV, S. J. CHAPMAN, J. R. OCKENDON, AND D. J. ALLWRIGHT, *Continuum and discrete models of dislocation pile-ups. I. Pile-up at a lock*, *J. Mech. Phys. Solids*, 55 (2007), pp. 2007–2025.
- [94] G. B. WHITHAM, *Linear and nonlinear waves*, *Pure and Applied Mathematics (New York)*, John Wiley & Sons Inc., New York, 1999. Reprint of the 1974 original, A Wiley-Interscience Publication.
- [95] W. W. WOOD AND A. K. HEAD, *Dislocation pile-ups and stress intensity factors*, *Quart. J. Mech. Appl. Math.*, 37 (1984), pp. 161–178.
- [96] H. ZAAG, *On the regularity of the blow-up set for semilinear heat equations*, *Ann. Inst. H. Poincaré Anal. Non Linéaire*, 19 (2002), pp. 505–542.