



HAL
open science

Distributed Resource Allocation in Wireless Networks

Sara Akbarzadeh

► **To cite this version:**

Sara Akbarzadeh. Distributed Resource Allocation in Wireless Networks. Networking and Internet Architecture [cs.NI]. Télécom ParisTech, 2010. English. NNT: . pastel-00549417

HAL Id: pastel-00549417

<https://pastel.hal.science/pastel-00549417>

Submitted on 21 Dec 2010

HAL is a multi-disciplinary open access archive for the deposit and dissemination of scientific research documents, whether they are published or not. The documents may come from teaching and research institutions in France or abroad, or from public or private research centers.

L'archive ouverte pluridisciplinaire **HAL**, est destinée au dépôt et à la diffusion de documents scientifiques de niveau recherche, publiés ou non, émanant des établissements d'enseignement et de recherche français ou étrangers, des laboratoires publics ou privés.



DISSERTATION

In Partial Fulfillment of the Requirements for the Degree of Doctor of
Philosophy from TELECOM ParisTech

Specialization: IT and Networks

Sara Akbarzadeh

On Distributed Resource Allocation in Wireless Networks

Defense scheduled on the 20th September 2010 before a committee
composed of:

Reporters	Mérouane Debbah, Ecole Supérieure D'Électricité Giorgio Matteo Vitetta, Università degli Studi di Modena
Examiners	Raymond Knopp, EURECOM Jean-Claude Belfiore, TELECOM ParisTech
Thesis supervisors	Laura Cottatellucci, EURECOM Christian Bonnet, EURECOM



THESE

présentée pour obtenir le grade de

Docteur de TELECOM ParisTech

Spécialité: Informatique et Réseaux

Sara Akbarzadeh

Algorithmes distribués d'allocation de ressources dans les réseaux sans fil

Soutenance prévue le 20 Septembre 2010 devant le jury composé de :

Rapporteurs	Mérouane Debbah, Ecole Supérieure D'Électricité Giorgio Matteo Vitetta, Università degli Studi di Modena
Examineurs	Raymond Knopp, EURECOM Jean-Claude Belfiore, TELECOM ParisTech
Directeurs de thèse	Laura Cottatellucci, EURECOM Christian Bonnet, EURECOM

Abstract

The full connectivity offered by the nature of wireless communication poses a vast number of benefits and challenges to the designers of future generation wireless networks. One of the main challenges being faced is dealing with the unresolvable interference at the receivers. It is widely recognized that the heart of this challenge lies in the design of resource allocation schemes which provide the best trade-off between efficiency and complexity

Exploration of this trade-off requires appropriate choices of performance metrics and mathematical models. In this regard, the thesis is concerned with certain technical and mathematical aspects of resource allocation in wireless networks. We specifically argue that an efficient resource allocation in wireless networks needs to take into account the following parameters: (i) rate of environment changes, (ii) traffic model, and (iii) amount of information available at transmitters. As mathematical tools for our investigation, we use optimization theory and game theory.

We are especially interested in distributed resource allocation in networks with slow fading channels and with partial channel side information at the transmitters. Transmitters with partial channel side information have exact information of their own channel as well as statistical knowledge of other channels. In such a context, the system is inherently impaired by a nonzero outage probability. We propose low complexity distributed algorithms for joint rate and power allocation, aiming at maximizing the individual throughput, defined as the successfully-received-information rate, under a power constraint. We study this problem in two network setups.

First, we consider throughput maximization in an OFDM-based MAC network with 2 transmitters. As well known, the problem is non-convex with exponential complexity in the number of transmitters and subcarriers. We introduce a two-level approach to the problem based on duality theory and Bayesian game theory. The trade-off between complexity and performance is investigated.

Secondly, we study the resource allocation problem in a single hop ad hoc

network. We relax the intrinsic assumption on infinite backlog of packets in the queues made in the previous study. Therefore, each transmitter is provided by a finite buffer. We introduce distributed cross-layer algorithms for joint admission control, rate and power allocation aiming at maximizing the individual and the global throughput. The problem is modeled as a stochastic game in which mixed strategies are based on the statistical knowledge of the states (channel attenuation and buffer length) of the other transmission pairs and on the exact knowledge of their own states.

Finally, we consider the same problem in a dense interference network with a large number of transmitter-receiver pairs. The asymptotic approach of large interference networks enables a considerable complexity reduction and is used to evaluate the performance of finite networks.

Résumé

La connectivité totale offerte par la communication sans fil pose un grand nombre d'avantages et de défis pour les concepteurs de la future génération des réseaux sans fil. Un des principaux défis qui se posent est lié à l'interférence au niveau des récepteurs. Il est bien reconnu que ce défi réside dans la conception des systèmes d'allocation des ressources qui offrent le meilleur compromis entre l'efficacité et la complexité.

L'exploration de ce compromis nécessite des choix judicieux d'indicateurs de performance et des modèles mathématiques. À cet égard, cette thèse est consacrée à certains aspects techniques et mathématiques d'allocation des ressources dans les réseaux sans fil. En particulier, nous démontrons que l'allocation de ressources efficace dans les réseaux sans fil doit prendre en compte les paramètres suivants: (i) le taux de changement de l'environnement, (ii) le modèle de trafic, et (iii) la quantité d'informations disponibles aux émetteurs. Comme modèles mathématiques dans cet étude, nous utilisons la théorie d'optimisation et la théorie des jeux.

Nous sommes particulièrement intéressés à l'allocation distribuée des ressources dans les réseaux avec des canaux à évanouissement lent et avec des informations partielles du canal aux émetteurs. Les émetteurs avec information partielle disposent d'informations exactes de leur propre canal ainsi que la connaissance statistique des autres canaux. Dans un tel contexte, le système est fondamentalement détérioré par une probabilité outage non nul. Nous proposons des algorithmes distribués à faible complexité d'allocation conjointe du débit et de la puissance visant à maximiser le "throughput" individuel, défini comme le débit d'information reçu avec succès, avec une contrainte de puissance. Nous étudions ce problème dans deux configurations réseau. Premièrement, nous considérons la maximisation du débit dans un réseau OFDM Mac avec 2 transmetteurs. Comme on le sait, le problème est non-convexe avec une complexité exponentielle du nombre des émetteurs et des sous-porteuses. Nous introduisons une approche à deux niveaux basée sur la théorie de la dualité et la théorie des jeux Bayésienne. Le compromis

entre la complexité et la performance est étudiée.

Deuxièmement, nous étudions le problème d'allocation de ressources dans un réseau ad hoc sans relais. Nous considérons une file d'attente avec un nombre limité de paquets. Par conséquent, chaque émetteur est assuré par une capacité limitée. Nous introduisons des algorithmes distribués d'intercouche pour le contrôle d'admission, l'allocation du débit et de puissance visant à maximiser le "throughput" individuel et global. Le problème est modélisé comme un jeu stochastique dans lequel les stratégies mixtes sont fondées sur les connaissances statistiques des états (atténuation du canal et longueur de la file d'attente) de la transmission d'autres paires d'émetteurs-récepteur et sur la connaissance exacte de leurs propres États.

Enfin, nous considérons le même problème dans un réseau dense d'interférences avec un grand nombre de paires d'émetteurs-récepteur. L'approche asymptotique des réseaux d'interférences dense permet une réduction considérable de la complexité et elle est utilisée pour évaluer les performances des réseaux finis.

Acknowledgements

My first thanks goes out to my thesis advisors: I would like to thank professor Christian Bonnet for providing me with the opportunity to work at EURECOM and for giving me the freedom to follow my interests. I would like also to thank professor Laura Cottatellucci, for her insightful and clear views, not only of the problem we pursued with but also of the PhD process as a whole. Thanks to her supervision I significantly improved my skills in developing a research topic.

I would also like to thank my friends at EURECOM and all over Cote d'Azur. For all pieces they added to my identity, I am forever thankful!

My special thanks to Giuliana, Randa, Zuleita, Ikbal, Daniel, and Kostas who always listened even when I didn't feel like talking! I would like to thank Carina and Rizwan, for being great lab-mates and providing an area when required as well as being great friends!

Mariam, Gillian, Florian, Phillipe, Virginia, Navid, Carine, Miriam, Leyla, Davide, Danesh, Lluis, Sebastian, Erick, Andrea, Matteo, Erhan, Marios, and Ruben ... I am grateful for all the colors you added to my moments!

I dedicate this thesis:

To my parents for the simple, and deep, fact that I love my life. Thanks for the love and strong basic skills you provided me with!

To my three angels, Bibigol, Mina and Farhad, for lending me the wings to fly!

To Laleh and Mehdi for their unconditional love and support.

To Bamdad that everything restarted at his birth.

Contents

Abstract	i
Resume	iii
Acknowledgements	v
Contents	vii
List of Figures	xi
Acronyms	xiii
Notations	xv
1 Algorithmes Distribués d'Allocation de Ressources	1
1.1 L'allocation de Ressources dans les Réseaux Sans Fil	3
1.1.1 L'allocation de ressources en OFDM MAC	5
1.1.2 L'approche Inter-couches d'allocation de ressources dans les Canaux d'Interférence	10
1.2 Les Préliminaires Mathématiques	12
1.2.1 Application de Jeux Bayésienne dans les Réseaux Sans Fil	12
1.2.2 Application des Jeux Stochastiques en Communica- tions Sans Fil	13
1.2.3 Application de la Théorie des Matrices Aléatoires en Communications Sans Fil	13
1.3 Plan de Thèse	14
1.4 Les Hypothèses	15
1.5 Structure de la Thèse	16
1.6 Nos Contributions à la Recherche	17
1.6.1 Chapitre 5	17
1.6.2 Chapitre 6	19
1.6.3 Chapitre 7	20
1.7 Conclusion	22

2	Introduction	25
2.1	Thesis Plan	27
2.2	Basic Assumptions	28
2.3	Outline of the Dissertation	29
2.4	Research Contributions	30
2.4.1	Chapter 5	30
2.4.2	Chapter 6	31
2.4.3	Chapter 7	31
3	Resource Allocation in Wireless Networks	33
3.1	Physical Layer and MAC Layer Characteristics	35
3.1.1	Wireless Links	35
3.1.2	Transmitters	37
3.1.3	Receivers	40
3.1.4	Multiple Access Techniques	41
3.1.5	Capacity Region	42
3.2	Resource Allocation	48
3.2.1	Resource Allocation in OFDM-based MAC	49
3.2.2	Cross-layer Resource Allocation in Interference Channel	54
4	Mathematical Preliminaries	57
4.1	Basic Math Concepts	57
4.2	Elements of Constrained Optimization	59
4.2.1	Duality Theory	60
4.2.2	KKT Conditions	62
4.3	Elements of Game Theory	63
4.3.1	Bayesian Game	69
4.3.2	Markov Equilibria of Stochastic Game	73
4.4	Random Matrix Theory in Wireless Communications	74
5	Distributed Resource Allocation in OFDM-based MAC	77
5.1	Introduction	77
5.2	System Model	78
5.3	Optimum Joint Power and Rate Allocation	80
5.4	Equilibria for Joint Power and Rate Allocation	82
5.4.1	Per Subcarrier Games \mathcal{G}_λ^n	85
5.4.2	Global Game	91
5.5	Algorithm	93
5.6	Conclusions	97
5.A	Proof of Lemma 1:	99

5.B	Proof of Lemma 2:	99
5.C	Analysis of The NEs on The Boundaries	99
5.C.1	Boundary of type B_1	100
5.C.2	Boundary of type B_2	101
6	Distributed Cross-Layer Resource Allocation in INs	105
6.1	Introduction	105
6.2	System Model	106
6.3	Problem Statement	109
6.3.1	Problem Statement as an K-player Game	111
6.4	Analysis of the Game	113
6.4.1	Nash Equilibrium	113
6.4.2	Symmetric Network	114
6.4.3	Best Response Algorithm	114
6.5	Numerical Results and Conclusions	115
7	Cross-Layer Design for Dense INs	119
7.1	Introduction	119
7.2	System Model	121
7.3	Preliminary Useful Tools	125
7.3.1	Some Convergence Results	125
7.3.2	Large System Analysis of the Receivers	126
7.4	Problem Statement	130
7.5	Game in Large Symmetric Interference Networks	133
7.6	Numerical Results	135
7.7	Conclusions	140
8	Conclusions and Future Work	143
8.1	Conclusion	143
8.2	Future Work	145

List of Figures

3.1	Multiple access channel	42
3.2	Capacity of two-user fast fading MAC with CSIT	44
3.3	Interference channel	46
3.4	Classes of two-user ICs	48
5.1	Aggregate throughput vs maximum available power at the transmitter, $K = 2, N = 10, g_1 = (1/3, 2/3), g_2 = (7/8, 1/8), \gamma_1 = (0.3, 0.7), \gamma_2 = (0.1, 0.9)$	97
5.2	Throughput per transmitter vs maximum available power at the transmitter, $K = 2, N = 10, g_1 = (1/3, 2/3), g_2 = (7/8, 1/8), \gamma_1 = (0.3, 0.7), \gamma_2 = (0.1, 0.9)$	98
5.3	Feasible region: the region corresponding to $\mathbf{p} > 0$	101
5.4	Position of boundary \tilde{B}_2 with respect to the feasible region	104
6.1	Definition of (a) RS and (b) NS	108
6.2	Policies in a symmetric two user network: $A - self - SU$ (circle mark) versus $A - self - SIC$ (cross and plus marks)	116
6.3	Optimal policies for scenario 2	117
7.1	Policies in a network with infinite transmissions	137
7.2	Throughput vs Eb/N0 for three different receivers	138
7.3	Throughput vs Eb/N0, Cross-layer vs. Conventional mechanisms	139
7.4	Throughput vs Eb/N0, performance of asymptotic ACL-(NP/KIS/MGD)in a network of finite transmissions	139

Acronyms

Here are the main acronyms used in this document. The meaning of an acronym is usually indicated once, when it first occurs in the text. The English acronyms are also used for the French summary.

AMC	Adaptive Modulation and Coding
AWGN	Additive White Gaussian Noise
BC	Broadcast Channel
BS	Base Station
CCSI	Complete Channel Side Information
CDMA	Code Division Multiple Access
CSI	Channel State Information
CSIR	Channel State Information at Receiver
CSIT	Channel State Information at Transmitter
COP	Constrained Optimization Problem
FDMA	Frequency Division Multiple Access
GSN	Global System for Mobile Communications
GPRS	General Packet Radio Service
IC	Interference Channel
i.i.d.	independent and identically distributed
IN	Interference Network
IWF	Iterative Water Filling
KKT	Karush-Kuhn-Tucker Optimality Conditions
LCP	Linear Complementarity Problem
MAC	Multiple Access Channel
MAC Layer	Medium Access Control Layer
MDP	Markov Decision Process
MIMO	Multiple Input Multiple Output
MMSE	Minimum Mean Square Error
NBS	Nash Bargaining Solution
NE	Nash Equilibrium

NLCP	Non-Linear Complementarity Problem
OFDM	Orthogonal Frequency Division Multiplexing
PA	Power Allocation
PCSI	Partial Channel Side Information
pdf	probability density function
PSTN	Public Switch Telephone Network
QoS	Quality of Service
QSI	Queue State Information
SDMA	Space Division Multiple Access
SIC	Successive Interference Cancellation
SINR	Signal-to-Interference-Noise Ratio
s.t.	subject to
WF	Water Filling

Notations

The boldface capital/small letters are used for matrices/vectors respectively. A superscript for a matrix/row-vector denotes the index of corresponding column-vector/element. A subscript of a matrix/row-vector is the index of corresponding row-vector/element.

\mathbb{R}	The set of all real numbers.
\mathbb{R}^+	The set of nonnegative reals.
$\mathbb{R}^{n \times m}$	the set of $n \times m$ matrices with real-valued entries.
\mathbf{X}_i^j	The (i,j)th element of the matrix \mathbf{X} .
\mathbf{x}_i	The i th element of vector \mathbf{x} .
\mathcal{X}	A finite set.
$ \mathcal{X} $	The cardinality of the finite set \mathcal{X} .
$\mathbb{P}(x)$	The probability mass function of a discrete random variable x .
max, min	maximize, minimize.
$\mathbb{E}(x)$	The expected value of x .
$\mathbf{1}$	The indicator function.

Chapter 1

Algorithmes Distribués d'Allocation de Ressources dans les Réseaux Sans Fil

Dans un réseau sans fil, les utilisateurs communiquent en émettant de l'énergie dans toutes les directions. Cela crée une connectivité totale entre tous les utilisateurs, et un lien isolé n'existe pas. L'un des défis de ce moyen de communication est d'affronter l'interférence que les différentes transmissions s'imposent l'un à l'autre.

La génération actuelle de réseau sans fil réduit la complexité du problème en utilisant des protocoles d'accès multiples, et en exploitant de l'atténuation naturelle du médium (par le contrôle de puissance ou la réutilisation des bandes de fréquences). Dans un tel contexte, une autorité centrale modifie les stratégies d'utilisateurs afin de satisfaire à un critère global. Toutefois, ces réseaux ne parviennent pas à bénéficier de la connectivité complète offerte par l'interface air.

La prochaine génération de réseau sans fil vise à exploiter la connectivité complète en affaiblissant la notion d'une autorité centrale (par exemple, la radio cognitive) ou l'annuler complètement (par exemple, les réseaux ad hoc) sans réduire la flexibilité totale et le niveau de services déjà offerts par les réseaux cellulaires. L'approche centralisée implique généralement des techniques d'optimisation compliquées et des charges de signalisation

qui croissent avec le nombre d'émetteurs et de récepteurs dans le réseau. Comme ces algorithmes ont tendance à être complexe et pas facilement extensible, des algorithmes décentralisés sont préférés dans les scénarios de prochaine génération. Différents niveaux de coopération entre les émetteurs et/ou les récepteurs peuvent être envisagés, mais en général, la délocalisation des mécanismes de contrôle, tels que l'attribution de débit et de la puissance, la planification, le contrôle d'admission, et le routage sont souhaités.

Dans les régimes décentralisés, les décisions concernant les paramètres du réseau (les débits et/ou les puissances) et des conditions de transmission sont effectuées par des émetteurs individuels a base de l'information sur *l'environnement* qui est localement disponible. Un régime efficace d'allocation de ressources nécessite un choix approprié d'une mesure de performance prenant en compte les deux paramètres suivants: (i) le rythme de modifications de l'environnement, et (ii) la quantité d'information disponible aux émetteurs. Récemment, une quantité considérable de recherche dans les réseaux multi-utilisateur a mis l'accent sur des modèles réalistes dans lesquels chaque terminal a une connaissance complète de son propre canal ainsi que la connaissance statistique des canaux des autres terminaux. Dans ce contexte, L'approche innovante de Shamaï et Wyner [1] suivie par les deux articles très référencés de Hanly et Tse [2,3] ont mis en place les fonctions de capacité qui conviennent pour les différents modèles de l'évanouissement et différents niveaux d'information des canaux aux émetteurs.

L'allocation de ressources dans les réseaux sans fil doit être adaptée non seulement aux changements dans les canaux de transmission, mais aussi aux applications. Ce sujet a été traditionnellement étudié soit par la théorie de l'information soit par la théorie de réseau de communication. Toutefois, afin de briser les barrières entre ces deux approches distinctes, il y a un besoin des modèles de communication qui rapproche la couche physique des couches supérieures grâce aux techniques inter-couche d'allocation de ressources.

L'allocation de ressources inter-couche permet une optimisation des ressources d'un réseau et permet aussi aux ingénieurs d'améliorer la qualité du signal, d'améliorer le réseau et l'utilisation des canaux, d'augmenter le débit, et de régler le problème de shadowing. Un exemple pertinent pour notre étude est que, l'affectation des ressources basée uniquement sur l'information de canal (CSI) est incapable de mettre à jour correctement l'allocation de débit en fonction de la dynamique du trafic d'arrivé. En ignorant le caractère aléatoire de l'arrivée des paquets et de files d'attente, telles approches peuvent garantir ni la stabilité des files d'attente, ni un délai d'attente acceptable. Les avantages de l'approche inter-couche et l'optimisation conjointe de ces mécanismes de contrôle sont bien connus dans les systèmes de communica-

tion sans fil (par exemple, [4] et références citées).

Les transmissions sur un support sans fil sont toujours affectuées par des interférences de transmissions des autres. En outre, certaines contraintes sont imposées par les appareils sans fil en raison des limites du système (telles que le charge limité de la batterie) et/ou d'exigences de service. Il est essentiel de prendre ces facteurs en compte dans la conception d'algorithmes pour l'allocation efficace des ressources. Par conséquent, un problème d'allocation de ressources est très souvent défini comme un problème d'optimisation sous contraintes (OPC). OPC est un domaine qui offre la possibilité d'optimiser certaines fonctions objectives compte tenue des limites imposées par le système ou les services. En outre, dans le cas de l'allocation de ressources distribuées, la théorie des jeux joue également un rôle important en offrant des méthodes moins complexes et plus évolutives. Un exemple de ceci, l'algorithme de Waterfilling itératif [5, 6], est défini dans la littérature basé sur la théorie de l'optimisation et également la théorie des jeux. Certaines caractéristiques des réseaux sans fil font la théorie des jeux un moyen pratique pour les analyser [7]: (i) les terminaux mobiles sont équipés d'un certain degré d'intelligence qui rend la configuration distribuée des décideurs possible, (ii) les appareils mobiles partagent des ressources communes qui implique une interaction naturelle entre eux, et (iii) les réseaux sans fil sont très structurés.

Dans ce qui suit, nous examinons d'abord les différents aspects de l'allocation de ressources dans les réseaux sans fil, compte tenue des hypothèses et des configurations différentes. En plus, on représente la littérature liées aux ces sujets. Nous présentons deux théories fondamentales, à savoir, la théorie d'optimisation sous contrainte et la théorie des jeux, ainsi que quelques exemples de leur application dans les communications sans fil, fournissant les principaux outils mathématiques utilisés dans cette thèse. Enfin, nous représentons le plan de thèse, l'hypothèse de base et les principales contributions.

1.1 L'allocation de Ressources dans les Réseaux Sans Fil

L'allocation de ressources est une évaluation pour décider la façon de diviser une quantité limitée (e.g., la puissance de transmission) ou restreinte (e.g., le débit) des ressources entre les individus qui sont en concurrence ou s'influencent mutuellement. Les ressources de communication sans fil varient selon les différentes configurations de réseau. Les ressources, dans cette étude, sont la puissance, le débit et la bande de fréquence. Les algo-

rithmes existants tentent de répartir séparément ou conjointement une ou plusieurs ressources.

Dans ce rapport, nous avons spécialement tenir compte de trois facteurs principaux qui influent sur le choix d'un régime d'allocation de ressources:

- Réserve de la file d'attente: La performance de scheduling a été principalement évalué en supposant qu'il existe une réserve infini de paquets dans chaque file d'attente. Afin d'évaluer le service reçu par un utilisateur dans un système qui contient diverses demandes de service, il est nécessaire de tenir compte de l'occupation des files d'attentes. Par exemple, un algorithme d'allocation de ressources qui offre à haut débit aux utilisateurs ayant des conditions favorables de canal auront tendance à satisfaire les demandes de service de ces utilisateurs plus tôt. Par conséquent, l'algorithme ferait face à une population d'utilisateurs avec une proportion plus élevée d'utilisateurs ayant des conditions de canal pauvres.
- Hypothèses sur canal: Les hypothèses liées au canal sont traitées de deux manières: (i) la disponibilité des informations d'état de canal, et (ii) la méthode d'accès au canal et la topologie de réseau. Une parfaite connaissance de l'état de canal a souvent été prise dans la littérature d'étude de la performance de scheduling. Bien que les systèmes 3G utilisent des mécanismes d'estimation de canal et mécanisme de rapport, les informations d'état de canal à la disposition de la station de base ne sont pas parfaites: ils sont retardées et souvent dépassées. En outre, le mécanisme de l'estimation du canal lui-même introduit des erreurs d'estimation de canal à la station mobile. Trois niveaux de connaissances peuvent être envisagées: une connaissance parfaite du canal, une connaissance imparfaite, et aucune connaissance. Il faut cependant noter que dans le cas intitulé par aucune connaissance on suppose toujours que les informations statistiques sont disponibles.

En ce qui concerne la méthode d'accès au canal et la topologie du réseau, l'hypothèse peut comprendre toutes les techniques suivantes: canal à accès multiple/canal de diffusion/canal d'interférence/TDMA/FDMA, ainsi que la considération de la diversité dans les systèmes CDMA et SDMA.

- Les contraintes de systèmes et de services: Les contraintes peuvent être divisées en deux classes: (i) les contraintes liées au système, y compris ressource limitée et le canal variant dans le temps et dans le fréquence,

(ii) les contraintes liées au service, y compris le débit minimum, la consommation maximum d'énergie, le délai maximum, la probabilité maximum d'outag.

Nous nous concentrons sur l'allocation distribuée de ressources dans les deux systèmes OFDM, à base de MAC et à base de canaux à interférences. Pour le système MAC OFDM, nous avons tenu compte d'un modèle classique considérant une seule couche (une réserve infinie de file d'attente). Une littérature étendue sur l'allocation de ressources dans des configurations OFDM et OFDMA est donnée dans [8]. Dans cette section, nous passons en revue la littérature sélectionnée qui est d'un intérêt particulier pour notre étude.

Pour le canal de l'interférences, en raison du fait que la stabilité des files d'attente est d'une importance particulière dans les réseaux ad hoc, nous avons étudié l'allocation de ressources *inter-couche*.

1.1.1 L'allocation de ressources en OFDM MAC

Il y a beaucoup de place pour exploiter le haut degré de flexibilité de la gestion des ressources radio dans le cadre de l'OFDM. Comme l'état du canal est différent aux différentes fréquences ou pour les différents utilisateurs dans un réseau, la performance du réseau peut être considérablement améliorée grâce à l'adaptation du débit des données sur chaque sous-porteuse, l'affectation dynamique sous-porteuse, et l'allocation adaptative de puissance et de débit.

Cette propriété des systèmes OFDM a conduit à la spécification des différents systèmes sur la base OFDM. Le système de radio numérique moderne en diffusion d'audio [9] et de vidéo [10] dépend d'OFDM. Une grande partie de l'Europe et l'Asie a adopté OFDM pour la diffusion terrestre de la télévision numérique (DVB-T, DVB-H et T-DMB) et radio numérique (Digital Radio Mondial, HD Radio et T-DMB). Certains standards bien connus pour réseau haut débit de Local Area Network (LAN), par exemple, IEEE 802.11a/g [11], sont fondés sur OFDM, ainsi que d'autres normes de réseau sans fil tels que IEEE 802.16 [12]. Toutefois, OFDM a aussi été appliqué aux canaux sélectifs en fréquence dans les réseaux filaires, comme dans le cas de Digital Subscriber Line (DSL) pour les systèmes de câbles à paire torsadée [13]. En raison de cette popularité récente du régime de transmission OFDM, il est également considéré comme candidat pour les extensions à haut débit des systèmes de communication de la troisième génération ainsi que pour la quatrième génération de systèmes de communication mobile. Il est également utilisé aujourd'hui dans la norme WiMedia/Ecma-368 pour les

réseaux Personal Area Networks (PAN) à haut débit dans le spectre de 3.1 à 10.6 GHz en bande ultralarge.

Les performances des systèmes sans fil OFDM peut être considérablement accru si la paire émetteur-récepteur d'adapter constamment les conditions de canal en cours. Pour les connexions *point à point*, l'émetteur génère une puissance et/ou une modulation (y compris éventuellement aussi l'encodage) par sous-porteuse. Les sous-porteuses avec des atténuations relativement faibles transmettent plus information, sous-porteuses avec des atténuations relativement élevées contribuent moins à la transmission. De la théorie d'information, l'algorithme de *Waterfilling*, compte tenu que tous les gains des canaux sont connus, fournit la capacité de la transmission point à point OFDM [14]. La capacité est obtenue en adaptant la puissance d'émission au gain du canal. Plus précisément, étant donné une puissance limitée de transmettre, plus de puissance est appliquée à zone de fréquence avec une faible atténuation par rapport aux autres fréquences. En supposant un gain moyen fixe de canal et une bande fixe de fréquence, la capacité du canal augmente si le canal est plus divers (par exemple, ayant plus de variance).

Dans le cas des systèmes multiaccess, le problème d'allocation de ressources est plus complexe. En plus de l'allocation de la puissance et de modulation par sous-porteuse, la mise à disposition sous-porteuses doivent être affectés à plusieurs terminaux. En général, un algorithme basé sur l'allocation disjointe des sous-porteuses et de la puissance n'est pas optimal.

Les aspects liés à la théorie d'information de ce problème sont étudiées principalement dans le cadre du canal MAC Gaussien ou du canal interference Gaussien, avec un évanouissement sélectifs en fréquence. Gallager a formulé le problème dans [15]. Dans [2], Tse et Hanly ont caractérisé la capacité ergodique du canal MAC Gaussien, variable dans le temps et sélectifs en fréquence, où la réponse en fréquence est continue. Le problème dans une dimension infinie (un domaine de fréquence continue) peut être transformé en une dimension finie (un domaine de fréquences discrètes), en divisant le spectre de fréquences dans un grand nombre de sous-porteuses orthogonales.

Dans ce contexte, les algorithmes centralisés et distribués itératifs qui convergent vers le point optimal de somme des débits, sur la limite de la région de capacité sont proposés respectivement par Yu et Lui dans [16] et par Huang et al. dans [17]. Certains articles a ajouté la restriction FDMA dans le modèle. FDMA, dans lequel plusieurs bandes sont pré-affectés à des utilisateurs sur une base non-recouvrement, est principalement utilisé dans les systèmes DSL comme une approche standard pour éliminer l'interférence multi-utilisateur. Dans [18], Yu et Cioffi ont proposé une méthode numérique

pour qui ils caractérisent la région atteintes par le système de Gaussien MAC avec ISI en vertu de la restriction FDMA, l'examen d'un nombre fini de cas de fréquence. Dans [19], Verdu et Cheng ont montré que la méthode optimale de waterfilling multi-utilisateur implique la superposition de la fréquence, par conséquence FDMA n'est pas optimale, sauf dans des cas particuliers.

La conception des systèmes de communication multi-porteuse implique souvent une maximisation de débit total sous certaines contraintes. [16] a fourni une méthode pour trouver la solution optimale globale pour ce problème. Bien que le document met l'accent sur le canal OFDM d'interférence, les mêmes résultats peuvent aussi être représentés dans le cas d'OFDM MAC. Il est montré que l'écart de la dualité d'un problème d'optimisation non-convexe est nul si le problème d'optimisation correspond à une condition de temps partagé. En outre, la condition de temps partagé est toujours satisfaite pour le problème d'optimisation multi-utilisateur du spectre radioélectrique dans les systèmes multi-porteuse lorsque le nombre de transporteurs de fréquence augmente vers l'infini.

En général, les problèmes d'optimisation dans les systèmes OFDM multi-utilisateur sont les problèmes NP-complets, avec une complexité exponentielle au nombre de sous-porteuses, pour les allocations fixes de puissance, ainsi que aux allocations de puissance, pour les numéros fixes de sous-porteuses. La formulation générale des problèmes d'optimisation pour l'allocation des sous-porteuses et des puissances pour les réseaux qui consistent des liens d'interférence sont fournis par Luo et Zhang dans [20]. Une partie de la complexité provient de la nature combinatoire du problème, en qu'il y a des nombreux sous-porteuses par émetteur, et chacun a un gain de canal différent (bien qu'il existe généralement une forte corrélation entre sous-porteuses voisines). En outre, le problème est non-convexe en cas ou l'interférence est pris en compte [21]. En plus de ces défis qui sont directement liés aux caractéristiques du problème d'optimisation, la variabilité dans le temps demande les algorithmes de faible complexité réalisables en temps réel. Une algorithme d'allocation de ressources à partir des informations d'état de canal exige que le mesure du canal, le feedback, le calcul, et la convergence des algorithmes sont tous effectués dans un intervalle de temps de cohérence. Cela pourrait être possible dans les systèmes centralisés et les scénarios de mobilité faible, mais il semble plus difficile autrement. Des efforts importants de la recherche actuelle dans les réseaux sans fil sont consacrés à la conception des algorithmes d'allocation des ressources basés sur l'information limitée du canal (l'information partielle et/ou statistique).

Malgré la complexité relativement élevée, l'amélioration potentielle de performance apportée par le régime dynamique de système OFDM est très

pertinente. Ainsi, des nombreux régimes sous-optimales ont été étudiés récemment. Le Waterfilling Itératif (IWF) est l'algorithme sous-optimal d'allocation de ressources la plupart du temps utilisé dans cette structure. Toutefois, le processus IWF ne cherche pas à trouver l'optimum global pour l'ensemble du réseau. Deux méthodes communes pour diminuer la complexité du problème sont les suivants: (i) réduire le nombre des variables de décision, (2) remplacer les optimisations centralisées par des algorithmes d'optimisation distribué ou du jeux.

Dans les systèmes centralisés avec CSI complète aux émetteurs, la plupart des recherches ont étudiées l'impact de la réduction de la complexité en réduisant le nombre des variables de décision dans le problème d'optimisation (en fixant certains d'entre eux). Un exemple courant dans le système OFDM est lorsque les sous-porteuses sont pré-assignés à des utilisateurs (FDMA). Dans ce cas, l'allocation optimale de puissance de tous les utilisateurs sur leurs sous-porteuses fixes sont évalués par l'algorithme d'allocation de ressources. Dans [22], Wong et al. ont proposé un algorithme OFDM multi-utilisateur pour l'allocation des sous-porteuse, du bit, et de la puissance pour minimiser la puissance totale de transmission. Cet algorithme est basé sur une répartition sous-optimale des sous-porteuse, suivi par une allocation des bits sur les sous-porteuses assignées. Dans [23], Thanabalasingham et al. ont examiné le problème de l'allocation conjointe des sous-porteuse et de la puissance pour le *downlink* d'un réseau multi-utilisateur multi-cellulaire OFDM. Ils ont étudié les dégradation des performances a cause de l'allocation statique sous-optimale des sous-porteuse ou de la puissance. Le modèle utilisé pour le canal prend en compte l'ombrage et la perte de chemin d'un rythme lognormal, mais pas de multipath fading sélectif en fréquence. Il est montré que les performances des deux algorithmes sous-optimaux sont presque aussi bien que l'algorithme optimal qui alloue conjointement sous-porteuses et densités spectrales de puissance vers les mobiles.

L'allocation centralisée des ressources dans un système multi-utilisateur est un problèmes d'optimisation sous contraintes dans un espace vectoriel. Ainsi, le remplacement d'un algorithme centralisée d'allocation multi-utilisateur des ressources par le correspondant distribué principalement réduit la complexité qui était imposée par la fonction non-convexe en raison de l'interférence. En outre, les décisions peuvent être fondées sur des données locales et la quantité de signalisation est réduite. La performance de l'algorithme distribué peut être utilisé comme une limite inférieure de la performance de l'algorithme centralisé correspondant.

L'hypothèse de la CSI complète à tous les émetteurs ne peuvent pas être réaliste dans les réseaux cellulaires mobiles qui comprennent les canaux vari-

ant dans le temps ainsi que dans les réseaux ad hoc. Dans ce cas, l'allocation des ressources doit être effectuée sur la base de la connaissance statistique de la condition du canal. Lorsque le canal évolue lentement, le système de communication est intrinsèquement affecté par l'événement d'outage. À cet égard, Hanly et Tse [3] introduit la notion de la région de capacité avec un délai limité. Ils ont proposé que on peut voir le canal à l'évanouissement sélectif en fréquence comme un canal variant dans le temps où, à chaque état de fading, une réponse en fréquence est spécifiée pour chaque utilisateur, ce qui représente la propagation par trajets multiples. Ainsi, il peut être considéré comme un ensemble des canaux parallèles, chacun conjointement spécifié par l'état de l'évanouissement et la fréquence. Afin d'avoir un retard limité dans ce canal, chaque utilisateur peut affecter des débits sur des différentes fréquences mais le débit minimum sommé sur les différentes fréquences doit être rempli pour chaque état de l'évanouissement. Dans [24], Hanly et al. ont considéré comme un problème de l'allocation de ressources fondé sur la probabilité d'outage pour les systèmes multi-utilisateur multicellulaire. Ils formulent le problème de probabilité d'outage min-max et le résolvent sous la contrainte que la puissance de transmettre à chaque station de base est plate. Si plus de puissance doit être affectée à un mobile afin de conserver une certaine qualité de service, par exemple, lorsque le mobile se déplace à proximité de la limites de la cellule, il y a deux manières indépendantes pour y parvenir: soit en augmentant le niveau de la puissance de cellules dans son ensemble, soit en augmentant la nombre de sous-porteuses attribuées au service mobile. Les auteurs ont considéré un second algorithme basé sur la répartition fixe des sous-porteuses et l'allocation dynamique de la puissance. Ils ont fait valoir que l'algorithme proposé a base de l'allocation plate de la puissance est significativement supérieur par rapport à l'objectif de minimiser la probabilité maximum d'outage.

Beaucoup de travail a été fait sur la théorie des jeux appliquée aux réseaux d'interférences comprenant les canaux à évanouissement sélectif en fréquence, avec le première article par Yu et al. [25], des articles ultérieurs de Scutari et al. (Voir [5] et ses références) et un article récent de Gaoning et al. [6]. Un sujet particulièrement intéressant est l'utilisation des jeux Nash généralisés sur le canal d'interférence faible [26].

Une autre manière de surmonter la sous-optimalité de l'approche concurrentielle est d'utiliser le concept des jeux répétés et de la dynamique d'apprentissage. Cette approche a été largement appliqué dans la répartition de la puissance [28–31]. L'allocation de puissance dans les réseaux d'interférence est en soi un processus répétitive et il est naturel de modéliser les interactions entre les utilisateurs par jeux répétés. Ces approches

introduisent une phase d'apprentissage qui fournit aux utilisateurs des informations (intelligence) pour prendre une décision correcte. La convergence de la dynamique d'apprentissage dans le jeu répété est le défi principal de ces régimes. En outre, ils supposent les canaux à évanouissements lentes.

Après cet aperçu de la littérature, nous mettons en évidence notre contribution sur le sujet. En fait, seuls quelques travaux dans la littérature sont concentrés sur le canal à évanouissement lent avec l'information partielle des canaux aux émetteurs. Dans [21], Etkin et al. ont considéré un canal d'interférence à évanouissement lent supposant une information partielle d'état de canal au début du jeu. En utilisant l'approche des jeux répétés, l'information sur le canal et les interactions est acquise. Récemment, Xiao Lei et al. [32] ont considéré un canal d'interférence à évanouissements par blocs ayant la connaissance de l'état des liens directs, mais seulement la connaissance statistique sur les liens interférents. Avec cette hypothèse, des communications fiables ne sont pas possibles et un certain niveau d'outage doit être toléré. Les auteurs ont considéré le jeu d'allocation de ressources pour une fonction à base des débits instantanés pour les événements d'outage. Dans ce contexte, ils ont étudiés les deux cas de répartition de la puissance pour un débit prédéfinis de transmission ainsi que l'allocation conjointe de la puissance et du débit.

1.1.2 L'approche Inter-couches d'allocation de ressources dans les Canaux d'Interférence

L'allocation de ressources fondée uniquement sur CSI n'est pas en mesure de mettre à jour correctement l'allocation de débit en fonction de la dynamique du trafic en entrée. En ignorant le caractère aléatoire de l'arrivée des paquets et des files d'attente, telles approches peuvent garantir ni la stabilité des files d'attente, ni le délai d'attente acceptable. Pour tenir compte des paramètres de files d'attente, les approches inter-couches sont nécessaires.

L'avantage de la conception inter-couches et l'optimisation conjointe de ces mécanismes de contrôle est bien connu dans les systèmes centralisés de communication (par exemple, [4] et les références citées).

Les approches centralisées inter-couches pour l'allocation de ressources ont été proposées à la fois pour la liaison uplink et la liaison downlink (canal de diffusion). La connaissance à la fois d'information d'état de canal (CSI) et d'information d'état de file d'attente (QSI) permet d'obtenir les stratégies avec un débit optimal, i.e. les stratégies qui atteignent la région de capacité ergodique d'un réseau des canaux à évanouissements [33, 34] (voir, par exemple Maximum Weighting Matching Scheduling - MWMS [35]). D'autres

approches, en dehors de l'optimalité de débit instantané, comme le retard moyen des files d'attente, ont été également l'objet d'études [4,36].

Les algorithmes décentralisés d'allocation de ressources dans les réseaux d'interférences est un problème complexe et intrigante, car la décision affecte de nombreux aspects fondamentaux de fonctionnement de la réseau et la performance qui en résulte. Plusieurs autres approches ont été proposées dans les deux régimes, conventionnels et inter-couches, et ayant considéré l'existence d'interférence. Deux approches principaux peuvent être identifiés: (I) les algorithmes basés sur des jeux répétés et la dynamique d'apprentissage, (ii) les jeux stochastiques sous contraintes.

La première approche a été principalement appliquée la répartition de puissance dans les systèmes couche-unique classique [30,31,37,38]. L'allocation de puissance dans les réseaux d'interférence est intrinsèquement un processus itératif et il est naturel de modéliser les interactions entre les utilisateurs avec des jeux répétés. Ces approches introduisent une phase d'apprentissage qui fournit aux utilisateurs des informations (intelligence) pour prendre une décision correcte. La convergence de la dynamique d'apprentissage dans le jeu répété est le défi principal de ces régimes. En outre, ils supposent les canaux à évanouissements lents.

Les jeux stochastiques sous contraintes ont été appliquées à la conception des algorithmes décentralisée inter-couches pour accès multiple. Dans [39], Altman et al. ont considérés un canal à évanouissement MAC avec les états du canal qui suivis une chaîne de Markov. En outre, chaque émetteur est fourni avec une file d'attente rempli par un processus de Poisson. Les jeux décentralisés égoïstes ou coopératifs, éventuellement corrélés, sont proposés pour optimiser une fonction d'utilité sous les contraintes sur le retard maximum de file d'attente et la puissance maximale. Considérant l'hypothèse du débit transmission fixe pour tous les utilisateurs ainsi que les communications fiables sont toujours possibles dans le contexte de la décentralisation, la fonction d'utilité pour le problème d'optimisation dans [39] est le débit moyenne maximale. Les algorithmes proposés permettent l'allocation de puissance et le contrôle d'admission (accepter ou rejeter les paquets entrants dans les files d'attente). Dans un système avec des mécanismes de contrôle décentralisé où chaque émetteur n'est pas au courant de la présence de brouilleurs (et leurs effets) et il est intrinsèquement soumis aux outages, l'hypothèse des communications fiables est assez forte. En outre, le contrainte d'un débit fixe dans toutes les conditions de canal ne permet pas une utilisation optimale du canal et une utilisation plus efficace du canal est prévu par le contrôle et l'adaptation du débit de transmission à CSI. Une extension de ces travaux précédant aux réseaux d'interférence est présenté dans le chapitre 6 et 7.

1.2 Les Préliminaires Mathématiques

Dans le chapitre 4, nous introduisons deux théories mathématiques fondamentales, à savoir la théorie de l'optimisation et la théorie des jeux. Notez que, seulement une extension de ces sujets qui sont pertinentes à notre étude est présentée ici. La première partie représente les concepts mathématiques de base qui sont utilisées dans les sections suivantes. Nous procédons par l'introduction de la théorie de l'optimisation et des sujets connexes, à savoir théorie de dualité et les conditions KKT. La définition du jeu suivi par l'introduction de deux catégories particulières de jeux, nommément les jeux bayésiens et les jeux stochastiques, ainsi que leur application dans la communication sans fil. Nous avons finalement donné une introduction brève à la théorie des matrices aléatoires.

1.2.1 Application de Jeux Bayésienne dans les Réseaux Sans Fil

Geoning et al., Dans leur récent ouvrage sur l'approche de la théorie des jeux bayésienne pour l'allocation de ressources distribuées dans un réseau comprenant les canaux à évanouissement et un modèle d'accès MAC [84], ont étudié l'utilisation de cette classe de jeux dans les systèmes multi-émetteur. Dans un travail précédent, El Gamal et al. introduit un jeu statique non coopératif dans le cadre des canaux à évanouissement et d'un modèle d'accès MAC comprenant 2 utilisateur, connu sous le nom *jeu waterfilling*. En supposant que les utilisateurs se font concurrence avec les débits de transmission comme un utilité et que ils ajustent leurs puissances comme leurs stratégies, les auteurs montrent qu'il existe un unique équilibre de Nash [86] qui correspond au point de la somme maximum des débits sur la région de capacité. Cette affirmation est un peu surprenant, car l'équilibre de Nash est en général inefficace par rapport à l'optimum de Pareto. Cependant, leurs résultats s'appuient sur le fait que les deux émetteurs ont une connaissance complète de la CSI, et en particulier, parfait CSI de tous les émetteurs dans le réseau. Cette hypothèse est rarement réalisable en pratique. Ainsi, ce jeu de répartition de puissance doit être reconstruit avec des hypothèses réalistes faites sur le niveau de connaissance des mobiles. En vertu de cette considération, il est d'un grand intérêt d'étudier plusieurs scénarios dans lesquels les mobiles ont des *informations incomplètes* au sujet de leurs composants, par exemple, une entité de transmission est au courant du gain de son propre canal, sans savoir le gain des canaux d'autres mobiles. Au cours des dix dernières années, des outils basé sur la théorie des jeux Bayésiens

n'ont été utilisés pour concevoir des stratégies d'allocation de ressources distribuées que dans certains contextes, par exemple, les réseaux CDMA [87,88], réseaux d'interférences multiporteuse [89,90], ainsi que MAC avec les canaux à évanouissement [84]. Le quatrième chapitre de la thèse actuelle représente notre contribution à ce sujet.

1.2.2 Application des Jeux Stochastiques en Communications Sans Fil

La dynamique des réseaux sans fil peuvent être classés en deux types, l'un est des perturbations dues à l'environnement, et l'autre est l'impact causé par les utilisateurs concurrents. Le comportement stochastique des concurrents, les canaux variables dans le temps vécu par l'utilisateur d'intérêt, et le trafic source variable dans le temps qui doit être transmises par l'utilisateur sont quelques exemples. Ces types de dynamiques sont généralement modélisées comme des processus stationnaires. Par exemple, l'utilisation de chaque canal par un utilisateur peut être modélisé comme un chaîne de Markov avec les états ON/OFF. Les conditions de canal peuvent être modélisées en utilisant un modèle de Markov à états finis. La loi d'arrivée des paquets du trafic source peut être modélisée comme un processus de Poisson 3.1.2. Une telle approche n'a été utilisée pour concevoir la répartition inter-couches des ressource que dans certains contextes, à savoir des jeux à somme nulle sous contrainte [100], radio cognitive [101] et MAC avec une contrainte de puissance [39]. L'extension ses travaux antérieurs aux réseaux d'interférence est présenté dans le chapitre 6 et 7.

1.2.3 Application de la Théorie des Matrices Aléatoires en Communications Sans Fil

Tse [43] et Verdú [42] en 1999 ont introduit la théorie des matrices aléatoires comme un outil pour analyser les systèmes mutli-utilisateur. Ils ont étudié les performances des récepteurs linéaires pour les systèmes CDMA, dans la limite où le nombre d'utilisateurs ainsi que la longueur d'étalement tend vers l'infini, avec un taux fixe. Dans ces scénarios asymptotique, l'utilisation de la théorie des matrices aléatoires conduit aux expressions explicites pour diverses mesures d'intérêt tels que la capacité ou le rapport signal-à-interférence plus bruit (SINR). Fait intéressant, il permet d'isoler les principaux paramètres d'intérêt qui déterminent la performance dans les nombreux modèles de systèmes de communication avec les modèles d'atténuation plus ou moins impliqués [42, 43, 102–104]. En outre, ces résultats asympto-

tiques fournissent de bonnes approximations pour les cas pratiques de taille finie. Une récente théorie des matrices aléatoires, centré sur les applications de la théorie de l'information, est donnée dans le livre de Tulino et Verdu [105]. Les effets d'interférence sur les performances d'un grand réseau sont étudiés dans [?,110]. L'extension de leur résultats vers le réseau d'interférence est présenté dans le chapitre 7.

1.3 Plan de Thèse

Les étapes méthodologiques principales pour atteindre l'objectif de la conception et l'analyse des performances des algorithmes distribués d'allocation de ressources sont énumérées ci-après.

- de définir le problème d'allocation de ressources qui est approprié pour les hypothèses de réseau, tels que (i) capacité de file d'attente, i.e., fini/infini, (ii) les hypothèses liées aux canaux (par exemple, la disponibilité des informations d'état de canal, la méthode d'accès au canal), et (iii) les contraintes du système et de service (par exemple, la puissance limitée, le délai tolérable).
- de revoir les fondements de la théorie de l'optimisation, ainsi que la théorie des jeux tels que: (i) la définition mathématique des problèmes d'optimisation sous contrainte et le problème correspondant en cadre de la théorie des jeux (ii) l'introduction du problème dual qui nous fournit une borne inférieure l'exécution du problème initial, et les conditions dans lesquelles cette borne est exacte, (iii) l'introduction de l'équilibre de Nash qui nous fournissent avec une limite inférieure sur la performance des solutions globalement optimales, et les conditions dans lesquelles cette borne est atteinte .
- de modéliser les problèmes d'allocation de ressources dans les communications sans fil multi-utilisateur comme des problèmes de théorie des jeux et de proposer des algorithmes itérative de complexité faible qui convergent vers l'équilibre de Nash du jeu en question.
- d'analyser le résultat de problème de la théorie des jeux, tels que l'existence d'un équilibre, son unicité possible, l'existence des stratégies purs ou mixtes.
- d'évaluer la performance des réseaux sans fil provenant des solutions de théorie des jeux en terme d'efficacité.

1.4 Les Hypothèses

Ce qui suit sont des hypothèses communes réalisés dans cette thèse

- L'allocation de ressources par intervalle de temps de transmission: le canal est supposé d'être à évanouissement par bloc, i.e. constante dans la durée d'un bloc. En outre, les codewords sont complètement transmis pendant un seul intervalle de temps. Ainsi, l'allocation de ressources doit être mis à jour chaque intervalle de temps.
- La disponibilité d'informations d'états: Nous supposons que chaque émetteur a une connaissance statistique des états de canaux des autres paires de communication (et des états de leur files d'attente) et une connaissance exacte de l'état de son propre canal (et sa propre file d'attente).
- La distribution de signal: Le signal est Gaussien. En pratique, le niveau de modulation est supposé être suffisamment élevée pour que l'information mutuelle est environ la capacité du canal. Par conséquent, la capacité du canal, $C = \log(1 + SNR)$, est utilisé comme débit réalisable par lien.
- La rationalité: Une des hypothèses, qui est très souvent considéré dans la théorie des jeux, est la rationalité [40, 41]. Cela signifie que chaque joueur toujours maximise son profit, étant ainsi en mesure de parfaitement calculer le résultat probabilistique de chaque action. Cependant, en réalité, cette hypothèse peut être raisonnablement approchée comme la rationalité d'un individu est limitée par l'information qu'il a et la quantité finie de temps il dispose pour prendre des décisions.

Les hypothèses liées aux certains chapitres, sont les suivants.

- le modèle de canal: Notre étude se concentre spécifiquement sur des canaux à évanouissements lents et ceci est l'hypothèse courante dans les chapitres 5 à 7. En outre, le modèle de canal est supposé être sélectif en fréquence dans le chapitre 5 et nous avons adopté le système d'accès Orthogonal Frequency Division Multiplexing (OFDM) dans le chapitre 5. Le canal dans les chapitres 6 et 7 est supposé être plate en fréquence.
- les procédés d'arrivées dans la file d'attente: Dans le chapitre 5, la performance du réseau est évalué en supposant un retard infini de paquets dans les files d'attente. Ainsi, le problème est défini comme une

allocation de ressources à une seule couche classique. Toutefois, dans les chapitres 6 et 7, nous avons considéré une capacité fini de paquets dans les files d'attente et nous adoptons l'allocation de ressources inter-couches.

- La méthode d'accès du canal et la structure du réseau: Dans le chapitre 5, nous nous concentrons sur le canal d'accès multiple (MAC), où 2 émetteurs indépendants à la fois communiquent avec un récepteur OFDM utilisant plus de N sous-porteuses. Dans les chapitres 6 et 7, nous considérons un réseau d'interférences (IN) avec K couples émetteur-récepteur. Nous supposons en outre que (i) les paires d'émetteur-récepteur communiquent directement, i.e., hop unique ou sans relais, (ii) chaque noeud est soit un émetteur ou un récepteur, et (iii) les émetteurs sont distincts bien que un noeud peut être la destination des flux différents.

1.5 Structure de la Thèse

Dans cette thèse, l'objectif principal est de représenter, théoriquement et mathématiquement, le sujet d'allocation de ressources dans un système multi-utilisateurs, par exemple, le canal d'accès multiples ou le canal d'interférences, et la façon d'obtenir des algorithmes de complexité faible qui nous fournissent un bon compromis performance-complexité par rapport à la performance de la méthode originale. Le contour de la thèse est la suivante. Le chapitre 3 examine les différents aspects de l'allocation de ressources dans les réseaux sans fil, avec des hypothèses et des configurations différentes, et les articles liés. Le chapitre 4 introduit deux théories fondamentales, à savoir, la théorie d'optimisation sous contrainte et la théorie des jeux, ainsi que quelques exemples de leur application dans les communications sans fil, fournissant les outils mathématiques principaux utilisés dans cette thèse. Aux chapitres 5 à 7, nous considérons l'allocation communes du débit et de la puissance dans les différents réseaux, supposant les canaux à évanouissements *lents* et que d'information partielle de l'état du canal est disponible aux émetteurs. Ici, l'information partielle sur l'état du canal signifie que chaque émetteur a connaissance de son propre lien, qui peut être estimé au niveau local, mais uniquement des informations statistiques sur les atténuations de puissances des autres émetteurs. Sous cette condition, le système de communication est intrinséquement affecté par l'événement d'outage et les émetteurs sont intéressés à maximiser le débit, c'est à dire le débit de l'information reçue par succès, ce qui permet d'événement d'outage. Nous

commençons notre étude par un exemple de réseau cellulaire en supposant retard infini de paquets dans les files d'attente. Ainsi, le chapitre 5 considère un système deux-utilisateur d'OFDM MAC avec un grand nombre de sous-porteuses. Nous modélisons la maximisation distribuée des débits dans un réseau de système OFDM MAC avec 2 émetteurs comme deux COPs parallèles. Compte-tenu de la solution optimale du problème dual comme une solution fournissant une borne inférieure sur la performance optimale du problème primaire et les équilibres de Nash comme une limite inférieure sur la performance de la solution globalement optimale, la complexité du problème est réduit en le représentant comme un jeu bayésien basé sur le problème dual (nous l'avons appelé jeu dual). Le compromis entre la performance et la complexité est discutée. Dans les deux prochains chapitres, nous relâchons l'hypothèse de backlog infini et impliquons l'état de la file d'attente dans nos décisions. Dans le chapitre 6, nous considérons une allocation de ressources distribuées inter-couche dans un réseau ad-hoc d'hop unique composé de K paires source-destination. Nous nous référons également à ce réseau en tant que réseau d'interférence (IN). Nous modélisons la maximisation de débit, compte tenu de l'état statistique (état du canal et l'état de file d'attente) des informations des autres utilisateurs, comme un jeu stochastique. En outre, nous proposons un algorithme itératif à un complexité faible basé sur la programmation linéaire (LP) pour obtenir des équilibres de Nash. Dans le cas d'un nombre fini de paires de communication, ce problème a un intensité de calcul extrêmement forte avec une complexité exponentielle dans le nombre d'utilisateurs. Chapitre 7 étend le problème à un réseau dense ad hoc, avec un grand nombre de paires d'émetteur-récepteur. L'approche asymptotique des réseaux larges à interférences permet une réduction considérable de la complexité et est utilisée pour évaluer la performance des réseaux finis. Les avantages d'une approche inter-couches par rapport d'une allocation de ressources en ignorant les états des files d'attente sont également évalués.

1.6 Nos Contributions à la Recherche

1.6.1 Chapitre 5

Dans la transmission à la bande large, les trajets multiples peut être résolu, et donc le canal a une mémoire. Un modèle approprié est le canal à l'évanouissement qui est variable dans le temps et sélectif en fréquence. Comme une large gamme de composants de fréquence est utilisé, il est très peu probable que toutes les parties du signal sera simultanément touchés par un évanouissement profond. Certaines modulations telles que OFDM

et CDMA sont bien adaptées à l'emploi de la diversité de fréquence pour fournir robustesse contre l'évanouissement.

L'OFDM divise le signal à large bande large en de nombreuses sous-porteuses modulées en bande étroite. Chaque sous-porteuse est exposé à un évanouissement plat plutôt qu'à un évanouissement sélectif en fréquence.

Le rôle principal joué par OFDM dans les réseaux sans fil des dernières technologies a initialisé une recherche très intense sur le réseau sans fil OFDM. Un examen des résultats existants sur l'allocation de ressources dans le canal d'accès multiples d'OFDM est donné dans la section 3.2.1. La complexité de l'obtention des solutions optimales globales ainsi que les compromis du remplacement de ces solutions optimales avec des solutions sous-optimales ou Equilibres de Nash ont été étudiés à travers des références respectives.

Dans ce chapitre, nous considérons l'allocation conjointe de débits et de puissances dans un système OFDM MAC deux-utilisateur avec un grand nombre de sous-porteuses et supposant l'information partielle d'état de canal à l'émetteur pour un canal à évanouissements *lents* et sélectifs en fréquence. Chaque émetteur a une connaissance de son propre état, qui peut être estimé localement, mais il n'a pas d'information sur les atténuations de puissance d'autres émetteurs. Dans ces conditions, les émetteurs sont intéressés à maximiser le débit, soit le débit des informations reçues correctement, permettant d'événements d'outage. Le débit total du système satisfait aux conditions de partage du temps dans [16] et l'approche de dualité est asymptotiquement l'allocation optimale des ressources où $N \rightarrow \infty$. Cependant, la complexité d'un algorithme d'optimisation est encore significativement élevé. Ensuite, nous considérons un jeu bayésienne basée sur la fonction sous-optimale obtenu du problème dual. Le jeu bayésienne se résume à un jeu *par sous-porteuse* et un jeu *global*. Les premiers jeux déterminent les équilibres de Nash pour la puissance et le débit paramétrique des coefficients de Lagrange des fonctions d'utilité duale. Le jeu global, basé sur la solution d'un ensemble des jeux sous-modulaire, fournit les valeurs des coefficients de Lagrange à l'équilibre de Nash bayésien. Nous proposons un algorithme pour la recherche de tous les équilibres de Nash bayésien de ce jeu. La performance de l'allocation conjointe de la puissance et du débit pour notre jeu est évaluée et comparée à la performance de l'allocation optimum de puissance et la répartition de puissance uniforme pour les deux cas des connaissances complètes et partielles du canal aux émetteurs.

Les simulations montrent que tous les NEs obtenus à partir du jeu sont ceux auxquels un seul émetteur émet avec pleine puissance et l'autre reste éteint. Au contraire, les allocations optimales de puissance pour le cas

d'informations complet d'état de canal contient des solutions qui ont la superposition de puissance de les deux utilisateurs sur le même canal. Toutefois, dans ce dernier cas, les solutions ne peuvent être obtenues par un algorithme itératif dont la convergence vers un point optimal local dépend du choix de la valeur initiale. La comparaison de la performance de solution optimale, obtenu en moyenne sur plusieurs points de départ, avec celui du NE choisis par les critères de sélection, montre que le NE est quasi optimale dans cette configuration du réseau.

La recherche menée dans ce chapitre a été présentée dans le document suivant

- S. Akbarzadeh and L. Cottatellucci and C. Bonnet, "Bayesian equilibria in slow fading OFDM systèmes with partial channel state information" *ICT Mobile Summit 2010, 19th Future Network & Mobile Summit*, June 16-18, 2010, Florence, Italy.

1.6.2 Chapitre 6

Ce chapitre étudie les algorithmes distribués inter-couches dans un réseau ad hoc single-hop pour l'allocation conjoint de puissance et de débit, la planification et le contrôle d'admission. Une littérature étendue du sujet est représenté dans Section 3.2.2. Nous continuons à nous concentrer sur les canaux à l'évanouissement lent avec des informations partielles du canal. Nous utilisons l'approche similaire à celle de [39] pour caractériser le réseau et les noeuds avec des modifications évidentes pour modéliser les caractéristiques particularités des reseaux ad hoc et des canaux à évanouissements lents. A savoir, nous considérons les canaux d'interférence au lieu de MAC.

Selon la même approche que dans le chapitre précédent, nous définissons une fonction d'utilité qui comptes pour la probabilité intrinsèque des événements d'ayant outage dans les réseaux à évanouissements lents et des mécanismes de contrôle décentralisée. La fonction d'utilité proposé maximise le débit du système défini comme le débit moyen des informations reçues avec succès. Cette optimisation est l'objet d'un constraint sur la puissance moyenne maximale de transmission.

Ce travail propose à la fois les stratégies décentralisés où chaque émetteur vise à maximiser son propre débit moyen d'information reçu avec succès (jeu égoïste) ou le débit du système (Jeu d'équipe) dans l'hypothèse de décodage seul-utilisateur à la récepteur (canal point à point) ou décodage multi-utilisateur (canal composé). La performance des stratégies différents est évaluée contre les stratégies obtenus de [39], en termes de débit, probabilité d'outage, et taux de rejet (la fraction de paquets arrivant pas accepté

dans les file d'attente). L'amélioration entre 19% et 68% pour le débit a été obtenue. Fait intéressant, les algorithmes itératifs d'optimisation avec points de départ différents gagnent le même équilibre si un algorithme de meilleure réponse avec un complexité faible est appliqué et que le décodage mono-utilisateur est utilisé aux récepteurs. Cela encourage à croire que l'équilibre de Nash obtenu est aussi un optimum de Pareto. Au contraire, lorsque décodage multi-utilisateur est appliqué au niveau des récepteurs, plusieurs équilibres sont obtenus avec les différences considérables en termes de débit. La Multiplicité des points équilibres et la convergence de l'approche meilleure réponse à un équilibre de Nash ont été que partiellement traitées dans ce travail et sont toujours objets de recherche.

La recherche menée dans ce chapitre a été présentée dans le document suivant

- S. Akbarzadeh, L. Cottatellucci, E. Altman and C. Bonnet "Distributed communication control mechanisms for ad hoc networks" *ICC'09, International Conference on Communications*, June 14-18, 2009, Dresden, Germany, pp 1-6.

1.6.3 Chapitre 7

Dans ce chapitre, nous intéressons plus spécialement au problème du chapitre 6 dans le cas difficile d'un réseau ad hoc dense. En fait, l'approche proposée dans le chapitre 6 a une complexité exponentielle du nombre d'utilisateurs. Ensuite, il est pratique et des intérêts théoriques de déterminer les algorithmes de complexité faible dans le cas des réseaux denses où le nombre de communications est très élevé.

Dans ce contexte, nous supposons que les liens entre l'émetteur et récepteur sont caractérisés par une sorte de diversité (par exemple dans l'espace ou dans la fréquence) et nous le référons comme le canal de vecteur avec N chemins de diversité. En outre, nous supposons que les N chemins de diversité sont aléatoires et K est le nombre de liens du réseau et N tend vers l'infini avec un rapport constant. Cette approche est motivée par le fait que la conception et l'analyse asymptotique du réseau dans les environnements aléatoires diminue la complexité d'une manière significative et fournit des résultats perspicaces pour les analyses. Ce modèle peut caractériser les réseaux d'interférence avec la diffusion des signaux transmis à partir des séquences aléatoires (Code Division Multiple Access - CDMA - dans les réseaux d'accès multiples), ou des systèmes à plusieurs antennes au récepteur, où le caractère aléatoire est due à canal à évanouissement. Dans

un tel contexte, lorsque le nombre d'utilisateurs et la diversité des chemins augmentent, les mesures fondamentales comme la capacité et SINR à la sortie d'un détecteur de récepteur convergent aux limites déterministiques.

L'analyse de performance des récepteurs différents (par exemple les filtres adoptés, linear minimum mean square error - LMMSE -, détecteur optimal), pour les canaux d'accès multiples représentés par un vecteur et dans un environnement aléatoire a été largement étudié dans la littérature (par exemple [42], [43], [44]). Nous étendrons ces résultats à des canaux d'interférence et les appliquer à la conception et l'analyse des algorithmes distribués inter-couches dans les grands réseaux d'interférences.

L'hypothèse d'analyse des réseaux larges à interférences entraîne deux grandes fonctionnalités fondamentales dans le système de contrôle du chapitre 6, caractérisée par un ensemble des variables discrètes de décision et un ensemble des variables discrètes de statistiques du canal. Tout d'abord, un réseau d'interférence avec un nombre limité d'utilisateurs et un mécanisme de contrôle décentralisé, une transmission est intrinsèquement soumise à un outage comme chaque émetteur n'est pas au courant des décisions des interféreurs et leurs effets. Au contraire, dans les canaux d'interférence d'un système large, l'effet des interféreurs tend vers une limite déterministique indépendamment des états instantanés des liens. D'abord, un émetteur peut éviter les événements d'outage par des algorithmes de contrôle. Deuxièmement, la complexité des algorithmes des couches basses, qui augmente de façon exponentielle avec le nombre d'utilisateurs en Chapitre 6, varie seulement selon le nombre des groupes d'utilisateurs, caractérisés par le même statistiques de canal dans un système large.

Pour les systèmes larges d'interférence nous considérons la conception inter-couches pour l'allocation conjointe de débit et de puissance, la planification et le contrôle d'admission de quatre différents types de récepteurs. A savoir, nous considérons deux récepteurs, l'un basé sur détection linéaire MMSE et l'autre sur la détection optimale et le dernier ce qui inclut le décodage de tous les utilisateurs ayant la même débit et la puissance reçue. Les récepteurs n'ont qu'une connaissance statistique des états de canaux des interféreurs. Un troisième récepteur est basé sur la fonction conjointe de la détection optimale et le décodage de tous les utilisateurs ayant la même puissance reçue et débit, mais avec une connaissance supplémentaire de la structure d'interférence au niveau du récepteur. Le quatrième récepteur décode conjointement et de manière optimale tous les utilisateurs décodable tout en sachant la structure d'interférence.

Nous comparons la performance des récepteurs avec les stratégies optimales conçues. Le décalage entre la performance des stratégies optimales

pour les grands systèmes et des stratégies optimales pour des systèmes finis est également évalué.

Les stratégies optimales obtenues avec l'approche asymptotique peut être effectivement appliquées dans les réseaux à interférence finie. En fait, nous avons étudié les pertes de performance due à l'application des stratégies conçues pour des conditions asymptotiques en réseau avec un nombre fini des communications actives. Nous avons observé que, même pour un réseau contenant 4 communications actives, la performance des réseaux finis atteint presque celle des réseaux à grande interférence. Des résultats similaires sont obtenus pour la comparaison réciproque. Nous avons comparé les performances d'un réseau fini quand les stratégies du réseau asymptotique est adaptées à celles obtenues avec des stratégies adaptées aux réseaux finis dans le chapitre 6. Même pour les cas les plus difficiles d'un réseau avec 2 paires de communication, la stratégie optimale du problème asymptotique est presque aussi bonne que la stratégie adaptée au réseau.

Nous avons aussi examiné les avantages d'une approche inter-couches par rapport à une allocation des algorithmes conventionnels en ignorant les états des files d'attente. Dans l'approche classique plus d'énergie est consommée pour l'envoi de certaine quantité de données comme il existe des cas où la puissance est répartie de satisfaire un certain débit bien qu'il n'y ait pas suffisamment de données dans la file d'attente pour atteindre ce débit. À négliger l'état de la file d'attente, on provoque une perte notable de performance comme la puissance n'est pas alloués de manière efficace.

Fait intéressant, la stratégie optimale du grand réseau étudié ici présente un découplage intéressant. Plus précisément, le débit est une fonction croissante de l'état file d'attente lorsque la puissance allouée est fonction de l'état du canal seulement.

La recherche menée dans ce chapitre a été présentée dans le document suivant

- S. Akbarzadeh, L. Cottatellucci and C. Bonnet, "Low complexity cross-layer design for dense interference networks" *WiOpt/PHYSCOMNET 2009, 7th International Symposium on Modeling and Optimization in Mobile, Ad Hoc, and Wireless Networks*, June 23-27, 2009, Seoul, Korea, pp 1-10.

1.7 Conclusion

Cette recherche a deux objectifs: concevoir et analyser la performance les algorithmes distribués d'allocation de ressources dans les canaux à évanouisse-

ments lents avec des informations partielles sur les canaux aux émetteurs. Nous avons développé des algorithmes en supposant que chaque émetteur dispose d'une information exacte de son propre canal ainsi que la connaissance statistique des autres canaux. Dans un tel contexte, le système est fondamentalement affectué par une probabilité d'outage non nul. Nous avons proposé des algorithmes distribués de faible complexité pour l'allocation conjointe de débit et de la répartition de puissance visant à maximiser le débit individuel, défini comme le taux d'information reçu par succès, en vertu d'une contrainte sur la puissance moyenne.

Nous avons commencé notre étude dans un réseau de système MAC OFDM, avec 2 émetteurs. Comme on le sait, le problème qui se pose est non-convexe avec une complexité exponentielle dans le nombre des émetteurs et des sous-porteuses. Nous avons introduit une simplification à deux niveaux au problème. Par une approche duale, on obtient l'allocation optimale des ressources asymptotiquement quand le nombre de sous-porteuses tend vers l'infini. Le problème dual a une complexité linéaire selon le nombre de sous-porteuses, mais sa complexité est toujours exponentielle selon le nombre d'utilisateurs. Nous avons introduit une approche sous-optimale à complexité faible sous la forme de jeu bayésien (jeu à information incomplète) comprenant 2 joueurs. Ce problème de jeu se résume en deux équations polynomiales à plusieurs variables, paramétriques en les multiplicateurs de Lagrange des deux utilisateurs, à travers lesquelles nous avons trouvé tous les NEs du problème. Nous avons en outre adopté la somme maximum de débits comme le critère de sélection d'un NE.

La performance des points de NE est comparée à la performance de l'allocation de puissance optimale pour le cas où l'information sur l'état de canal est complet et l'allocation uniforme de la puissance dans le cas d'information partielle de l'état de canal. Les simulations ont montré que tous les NEs obtenus à partir du jeu sont ceux où un seul émetteur transmet la puissance maximale et l'autre reste éteint. Au contraire, les allocations de puissance optimale pour le cas d'information complet d'état de canal contiennent des solutions qui ont la superposition des puissances de deux utilisateurs sur le même canal. Toutefois, dans ce dernier cas, les solutions ne peuvent être obtenues par un algorithme itératif dont la convergence vers un point optimal local dépend du choix de la valeur initiale. La comparaison des performances de la solution optimale et le NE, a montré que le NE est quasi optimal dans cette configuration du réseau.

Ensuite, nous avons étendu le problème en un seul bond dans un réseau ad hoc. Nous avons relâché l'hypothèse intrinsèque de la capacité infini de paquets dans les files d'attente fait dans l'étude précédente. Par conséquent,

chaque émetteur possède un buffer de taille bornée et accepte les paquets à partir d'une distribution de Poisson. Nous avons étudié les algorithmes inter-couche répartis de contrôle d'admission, l'allocation du débit et de la puissance visant à maximiser le débit d'individuel et le débit global. Les décisions sont fondées sur la connaissance statistique des états (atténuation du canal et la longueur de file d'attente) de la transmission d'autres couples et sur la connaissance exacte de leurs propres états. Ce problème est formulé comme un jeu stochastique avec stratégies mixtes. En outre, la structure du problème satisfait les conditions dans lesquelles les stratégies de point-col de jeux stochastiques existent entre les stratégies de Markov et sont plus faciles à calculer. Suite à cette observation, un algorithme itératif de meilleure réponse basé sur la programmation linéaire a été introduite. L'algorithme proposé apporte des améliorations considérables en forme d'une extension simple pour les réseaux ad hoc des algorithmes décentralisés qui est utilisée pour les canaux d'accès multiples dans la littérature .

Toutefois, dans un cadre fini, ce problème présente une complexité très élevée lorsque le nombre d'utilisateurs et/ou des états émetteur augmentent. Ce fait rend les approches inter-couches distribuées très coûteuses en calcul.

La complexité élevée des algorithmes distribués d'allocation de ressources pour les approches inter-couches nous ont motivés à considérer le même problème dans un réseau larg à interférence avec un grand nombre de paires d'émetteur-récepteur. L'approche asymptotique des réseaux large d'interférence permet une réduction considérable de la complexité. Plus précisément, la complexité ne varie pas selon le nombre d'utilisateurs mais selon le nombre de groupes d'utilisateurs ayant des statistiques identiques. Le problème a une complexité particulièrement faible dans le cas pratique des réseaux symétriques. Fait intéressant, la stratégie optimale du réseau de grandes interférences étudié ici présente un découplage entre les différents paramètres de décision. Plus précisément, le débit est une fonction croissante de l'état de la file d'attente alors que la puissance allouée est seulement une fonction de l'état du canal.

Nous avons étudié la perte de performance due à l'application des politiques conçues pour des conditions asymptotiques en réseau avec un nombre fini de communications actives et vice versa. Nous avons observé que, même pour un réseau contenant 4 communications actives, les deux stratégies ont pratiquement les mêmes performances. Nous avons aussi examiné les avantages d'une approche inter-couches par rapport à une allocation de ressources conventionnelles en ignorant les états des files d'attente. Les résultats suggèrent que négliger l'état de la file d'attente provoque une perte sévère de performances, puisque la puissance n'est pas allouée de manière efficace.

Chapter 2

Introduction

In a wireless medium, users communicate by radiating energy in all directions. This creates a natural inter-connection among all users, and an isolated link does not intrinsically exist. One of the challenges of this communication medium is to deal with the interference that different transmissions cause to each others.

The current generation of wireless networks reduces the problem complexity by using multiple access protocols, and exploiting the natural attenuation of the medium (power control, frequency reuse). In such a setting, a central authority adjust the strategies of users in order to satisfy a global criteria. However, these networks fail to benefit from the full connectivity offered by the air interface.

Next generation wireless networks aim at exploiting the full connectivity by weakening the notion of a central authority (e.g., cognitive radio) or removing it completely (e.g., ad hoc networks) without reducing the full flexibility and level of services already offered by cellular networks. The centralized approach usually involves sophisticated optimization techniques and signaling loads that grow with the number of transmitters and receivers in the network. As these algorithms tend to be complex and not easily scalable, decentralized algorithms are preferred in next generation scenarios. Different levels of cooperation among transmitters and/or receivers can be envisaged but in general the delocalization of control mechanisms, such as rate and power allocation, scheduling, admission control, and routing, is

desired.

In decentralized schemes, decisions concerning network parameters (rates and/or powers) and transmission conditions are made by individual transmitters based on locally available information about the transmission medium or *environment*. An efficient resource allocation scheme requires an appropriate choice of a performance metric based on the following two parameters: (i) rate of environment changes, and (ii) amount of information available at transmitters. Recently, a considerable amount of research in multiuser networks has focused on realistic models in which each node has complete knowledge of its own channel as well as statistical knowledge of the channels of the other nodes. In this context, Shamai and Wyner's pioneering approach [1] followed by Hanly and Tse's two highly referenced works [2,3] have introduced the capacity functions appropriate for different fading models and different levels of channel side information at the transmitters.

Resource allocation in wireless networks needs to be adapted not only to the changes in the transmission medium but also to the applications. This topic was traditionally approached either through information theory or communications network theory. However, to break down the barriers between these distinct approaches, there is a need for communication models which bridge the physical layer and the upper layers by providing cross-layer resource allocation techniques.

Cross-layer resource allocation allows optimization of network resources and enables engineers to improve signal quality, enhance network and spectrum utilization, increase throughput, and deal with the problem of shadowing. An example relevant to our study is that, resource allocation based solely on channel side information (CSI) is unable to update rate allocation properly according to the dynamics of input traffic. By ignoring the randomness in packet arrival and queueing, such approaches can guarantee neither the stability of queueing systems nor an acceptable queueing delay. The benefits of cross-layer design and joint optimization of these control mechanisms are well known in wireless communication systems (e.g., [4] and references therein).

Transmissions over a wireless medium are always subject to fading and unresolvable interference from other transmissions. In addition, some constraints are imposed by wireless devices due to the system limits (such as limited battery life) and/or service requirements. It is crucial to take these factors into account in the design of algorithms for efficient resource allocation. Therefore, resource allocation problems are very often defined as Constrained Optimization Problems (COPs). COP is a domain which provides the possibility to optimize certain objective functions subject to the

limits imposed by a system or services. Moreover, in the case of distributed resource allocation, game theory also plays a significant role in offering less complex and more scalable methods. An example of which, Iterative water filling algorithms [5, 6], are defined in literature based both on optimization theory and game theory. Some properties of wireless networks make game theory a convenient method for their analysis and design [7] : (i) mobile terminals are equipped with a certain degree of intelligence which makes the distributed decision-makers configuration possible, (ii) mobile devices share some common resources which implies natural interaction between them, and (iii) wireless networks are highly structured.

2.1 Thesis Plan

The main methodological steps to achieve the objective of design and performance analysis of distributed resource allocation algorithms are listed in the following.

- to define the resource allocation problem which is appropriate for network assumptions, such as (i) queue backlog, i.e, finite/infinite, (ii) channel related assumptions (e.g., availability of the channel state information, channel access method), and (iii) system and service constraints (e.g., limited power, maximum tolerable delay).
- to review the fundamentals of optimization theory as well as game theory such as: (i) the mathematical definition of constrained optimization problems and the corresponding game theory problem (ii) the introduction of the dual problem which provides us with a lower bound on the performance of the original problem, and the conditions under which this bound is tight, (iii) introduction of the Nash equilibria which provide us with a lower bound on the performance of the globally optimal solutions, and the conditions under which this bound is tight.
- to model the resource allocation problems in multiuser wireless communications as game-theoretical problems and propose low complexity iterative algorithms which converge to the Nash equilibria of the game in question.
- to analyze the outcome of game-theoretical problems, such as the existence of an equilibrium, its possible uniqueness, pure or mixed strategies.

- to evaluate the performance of wireless networks derived from game-theoretic solutions in terms of efficiency.

2.2 Basic Assumptions

The following are common assumptions made in this dissertation

- Resource allocation per transmission time slot: The channel is assumed to be block fading, i.e. constant within duration. Furthermore, code-words are completely transmitted during a single time slot. Thus, resource allocation needs to be updated every time slot.
- Availability of state information: We assume that transmitters have statistical knowledge of the channel (and buffer) states of the other communication pairs and exact knowledge of their own channel (and buffer) states.
- Signal distribution: The signal is assumed to be Gaussian. In practice, the modulation level is assumed to be high enough that the mutual information is approximately the channel capacity. Therefore, the channel capacity, $C = \log(1 + SNR)$, is used as the achievable rate per link.
- Rationality: One of the most common assumptions made in game theory is rationality [40,41]. It means that every player always maximizes her payoff, thus being able to perfectly calculate the probabilistic result of every action. However, in reality this assumption can only be reasonably approximated since the rationality of an individual is limited by the information they have, the cognitive limitations of their minds, and the finite amount of time they have to make decisions.

The assumptions relevant to certain chapter(s), are as follows.

- Channel model: Our study is specifically focused on slow fading channels and this is the common assumption in chapters 5 to 7. Additionally, the channel model is assumed to be frequency selective in chapter 5 and we adopted Orthogonal Frequency Division Multiplexing (OFDM) access scheme in Chapter 5. The channel in chapters 6 and 7 is assumed to be frequency flat.
- Queue backlogs: In chapter 5, the network performance is evaluated assuming an infinite backlog of packets in the queues. Thus, the problem

is defined as a conventional single-layer resource allocation. However, in chapters 6 and 7, we considered finite backlog of packets in the queues and we adopt cross-layer resource allocation.

- Channel access method and network structure: In chapter 5, we focus on the Multiple Access Channel (MAC) where 2 independent transmitters are simultaneously communicating with a receiver using OFDM over N sub-carriers. In chapters 6 and 7, we consider an Interference Network (IN) with K transmitter-receiver pairs. We further assume that (i) transmitter-receiver pairs communicate directly, i.e., single hop or no relaying, (ii) each node is either a transmitter or a receiver, and (iii) the transmitters are distinct while one node can be the destination of different information streams.

2.3 Outline of the Dissertation

In this thesis the primary focus is to theoretically and mathematically allocate resources in a multi-user system, e.g., multiple access channel or interference channel, and how to obtain low complexity algorithms which provide us a good trade-off performance-complexity compared to the performance of the original method. The outline of the thesis is as follows. Chapter 3 reviews the different aspects of resource allocation in wireless networks, with different assumptions and setups, and the related existing literature. Chapter 4 introduces two fundamental theories, namely, constrained optimization theory and game theory, as well as some examples of their application in wireless communications, providing the main mathematical tools used in this dissertation. In chapters 5 to 7, we consider the joint rate and power allocation in different network structures, assuming partial channel state information is available at the transmitters for *slow* fading channels. Here, partial channel state information means that each transmitter has knowledge of its own link, which can be estimated locally, but only statistical information about the other transmitters' power attenuations. Under this condition, the communication system is intrinsically affected by outage event and the transmitters are interested in maximizing the throughput, i.e. the rate of information successfully received, allowing for outage events. We start our study with an example of cellular network assuming infinite backlog of packets in the queues. Thus, Chapter 5 considers a two-user OFDM-based MAC system with a large number of subcarriers. We model the distributed throughput maximization in an OFDM-based MAC network with 2 transmitters as two parallel COPs. Considering the dual optimal as a solution providing a lower

bound on the performance of the primal optimal and the Nash equilibria as a lower bound on the performance of the globally optimal solution, the problem complexity is reduced by representing it as a Bayesian game based on the dual problem (we called it dual game). The trade-off between performance and complexity is discussed. In the next two chapters, we relax the infinite backlog assumption and involve the queue state in our decisions. In Chapter 6, we consider a distributed cross-layer resource allocation in a single hop ad-hoc network consisting of K source-destination pairs. We also refer to this network as interference network (IN). We model the throughput maximization, considering the statistical state (channel state and queue state) information of the other users, as a stochastic game. We further propose a low-complexity iterative algorithm based on Linear Programming (LP) to obtain Nash equilibria. In the case of a finite number of communication pairs, this problem is extremely computationally intensive with an exponential complexity in the number of users. Chapter 7 extends the problem to a dense ad hoc network, with a large number of transmitter-receiver pairs. The asymptotic approach of large interference networks enables a considerable complexity reduction and is used to evaluate the performance of finite networks. The benefits of a cross layer approach compared to a resource allocation ignoring the states of the queues are also assessed.

2.4 Research Contributions

2.4.1 Chapter 5

In this chapter, we consider a slow frequency selective fading multiple access channel (MAC) where 2 independent transmitters are simultaneously communicating with a receiver using orthogonal frequency division multiplexing (OFDM) over N sub-carriers. Each transmitter has partial knowledge of the channel state. In such a context, the system is inherently impaired by a nonzero outage probability. We propose a low complexity distributed algorithm for joint rate and power allocation aiming at maximizing the individual throughput, defined as the successfully-received-information rate, under a average power constraint. As is well known, the problem at hand is non-convex with exponential complexity in the number of transmitters and subcarriers. Inspired by effective almost optimum recent results using the duality principle, we propose a low complexity distributed algorithm based on Bayesian games and duality. We show that the Bayesian game boils down to a two-level game, referred to as a *per-subcarrier* game and a *global* game. The per-subcarrier game reduces to the solution of a linear system of equa-

tions while the global game boils down to the solution of several constrained submodular games. The provided algorithm determines all the possible Nash equilibria of the game, if they exist. The work carried out in this chapter was presented in the following paper

- S. Akbarzadeh and L. Cottatellucci and C. Bonnet, "Bayesian equilibria in slow fading OFDM systems with partial channel state information" *ICT Mobile Summit 2010, 19th Future Network & Mobile Summit*, June 16-18, 2010, Florence, Italy.

2.4.2 Chapter 6

In the previous chapter, we assumed infinite backlog of packets in the queues. In this chapter, we relax this assumption and define a cross-layer resource allocation which account for queue states in the strategy selection decisions. An interference network consisting of N source-destination pairs is considered. Each transmitter is endowed with a finite buffer and accepts packets from a Poisson distributed arrival process. The channel is described by a Markov chain. We investigate distributed algorithms for joint admission control, rate and power allocation aiming at maximizing the individual or the global throughput defined as the average information rate successfully received. The decisions are based on the statistical knowledge of the channel and buffer states of the other communication pairs and on the exact knowledge of one's own channel and buffer states. This problem is model as a stochastic game whose saddle point (mixed) policies exist among Markov strategies. Following this, a low complexity iterative best response algorithm based on linear programming is proposed.

The work carried out in this chapter was presented in the following paper

- S. Akbarzadeh, L. Cottatellucci, E. Altman and C. Bonnet "Distributed communication control mechanisms for ad hoc networks" *ICC'09, International Conference on Communications*, June 14-18, 2009, Dresden, Germany, pp 1-6.

2.4.3 Chapter 7

The problem introduced in Chapter 6, for a finite number of communication pairs, is extremely computationally intensive with an exponential complexity in the number of users. In this chapter, we consider the same problem in a dense IN with a large number ($K \rightarrow \infty$) of transmitter-receiver pairs. Each transmitter-receiver link is a fading vector channel with N diversity

paths whose statistics are described by a Markov chain. By assuming that $K, N \rightarrow \infty$ with constant ratio the algorithm complexity becomes substantially independent of the number of active communications and grows with the groups of users having distinct asymptotic channel statistics. The cross-layer design is investigated for different kind of decoders at the receiver. The benefits of a cross layer approach compared to a resource allocation ignoring the states of the queues are assessed. The performance loss due to the use of policies designed for asymptotic conditions and applied to networks with a finite number of active communications is studied. The work carried out in this chapter was presented in the following paper

- S. Akbarzadeh, L. Cottatellucci and C. Bonnet, "Low complexity cross-layer design for dense interference networks" *WiOpt/PHYSCOMNET 2009, 7th International Symposium on Modeling and Optimization in Mobile, Ad Hoc, and Wireless Networks*, June 23-27, 2009, Seoul, Korea, pp 1-10.

Chapter 3

Resource Allocation in Wireless Networks

It has been over 30 years since the two wireless networks structure, namely cellular and ad hoc, have been introduced in wireless communications. Although both concepts are initiated around the same time, the cellular technology is in a leading position in the current wireless networks.

Today, millions of people around the world use cellular phones. Cellular phones allow a person to make or receive a call from almost anywhere. Likewise, it allows a person to continue a phone conversation while on the move. Cellular communications is supported by an infrastructure called a cellular network, which integrates cellular phones into the Public Switched Telephone Network (PSTN). The cellular network has gone through three generations. The first generation of cellular networks were analog in nature. Two such standards are TACS (Total Access Communications System) in Europe and AMPS (Advanced Mobile Phone System) used in the United States and Australia. To accommodate more cellular phone subscribers, the second generation (2G) networks used digital TDMA (Time Division Multiple Access) and CDMA (Code Division Multiple Access) technologies to increase the network capacity. With digital technologies, digitized voice can be encoded and encrypted. Therefore, the 2G cellular networks were also more secure. GSM (Global System for Mobile Communications), the most popular standard for mobile telephony systems in the world, is an example of

2G systems. The third generation (3G) networks integrates cellular phones into the Internet world by providing high speed packet-switching data transmission in addition to circuit-switching voice transmission. Since 2002, the 3G cellular networks have been deployed in some parts of Asia, Europe, and the United States (e.g., EDGE and UMTS) and will be widely deployed in the coming years (e.g., LTE). The application services envisaged for this generation include wide-area wireless voice telephone, Internet access, video calls and TV, all in a mobile environment.

The merits of having an infrastructureless network were discovered in the 1970s and resulted in the introduction of *ad hoc* networks as new wireless technology. Ad hoc networks are suited for use in situations where infrastructure is either not available, is not required to be trustable or reliable but needed to be flexible and easy to be installed as in emergency situations. A few examples include: military soldiers in the field; sensors scattered throughout a city for biological detection; an infrastructureless network of notebook computers in a conference or campus setting; the forestry or lumber industry; rare animal tracking; space exploration; undersea operations; and temporary offices such as campaign headquarters. An ad hoc network is a possibly mobile collection of communications devices nodes that wish to communicate, but have no fixed infrastructure available, and have no predetermined organization of available links. Individual nodes are responsible for dynamically discovering which other nodes they can directly communicate with. Ad hoc networking is a *multi-layer* problem. The physical layer must adapt to rapid changes in link characteristics. The Medium Access Control layer (MAC layer) needs to minimize bit error rate, allow for fair access, and semi-reliably transport data over the shared wireless links in the presence of rapid changes and hidden or exposed terminals. The network layer needs to determine and distribute information used to calculate paths in a way that maintains efficiency when links change often and bandwidth is at a premium. It also needs to integrate smoothly with traditional, non ad hoc-aware internetworks and perform functions such as auto-configuration in this changing environment. The transport layer must be able to handle delay and packet loss statistics that are very different than wired networks. Finally, applications need to be designed to handle frequent disconnection and reconnection with peer applications as well as widely varying delay and packet loss characteristics.

In this dissertation, we focus on *single-hop* transmissions in either structures, cellular or ad hoc. For the cellular architecture, we focus on uplink transmission where there is a single receiver (base station) for all transmissions. For the ad hoc architecture, we assume that (i) transmitter-receiver

pairs communicate directly, i.e., no relays, (ii) one node cannot transmit and receive at the same time, and (iii) the transmitters are distinct while one node can be the destination of different information streams. Such a setting simplifies the network layer functionality as the routes between transmitter node and the receiver node is considered fixed. In the rest of this chapter, we review different aspects of resource allocation in wireless networks, with different assumptions and setups, and the related existing literature. First of all, we introduce physical layer and MAC layer characteristics. Then in second section, we introduce some essential features of resource allocation in wireless networks. Note that, in this chapter, the acronym "MAC" is employed to signify both "Multiple Access Channel" and "Medium Access Control". However, "MAC" as "Medium Access Control" is always succeeded by the word "layer".

3.1 Physical Layer and MAC Layer Characteristics

In this section, we first classify the wireless channels based on their variations in time and frequency domains. Next, we introduce some parameters of transmitters and receivers which are of special importance in our resource allocation analysis. Finally we introduce multiple access techniques as well as capacity or achievable rate regions of MAC and interference channel.

3.1.1 Wireless Links

Land-mobile communication is burdened with particular propagation complications compared to the channel characteristics in radio systems with fixed and carefully positioned antennas. The antenna height at a mobile terminal is usually very small, typically less than a few meters. Hence, the antenna is expected to have very little 'clearance', thus obstacles and reflecting surfaces in the vicinity of the antenna have a substantial influence on the characteristics of the propagation path. Moreover, the propagation characteristics change from place to place and, from time to time. Thus, the transmission path between the transmitter and the receiver can vary from simple direct line of sight to one that is severely obstructed by buildings, foliage, and the terrain.

In generic system studies, the mobile radio channel is usually evaluated from 'statistical' propagation models: no specific terrain data is considered, and channel parameters are modeled as stochastic variables. The mean signal strength for an arbitrary transmitter-receiver (T-R) separation is useful in estimating the radio coverage of a given transmitter whereas measures

of signal variability are key determinants in system design issues such as antenna diversity and signal coding. Three mutually independent, multiplicative propagation phenomena can usually be distinguished: *multipath fading*, *shadowing* and *large-scale path loss*.

Multipath propagation leads to rapid fluctuations of the phase and amplitude of the signal if the mobile moves over a distance in the order of a wave length or more. Multipath fading thus has a *small-scale* effect. Shadowing is a *medium-scale* effect: field strength variations occur if the antenna is displaced over distances larger than a few tens or hundreds of meters. The *large-scale* effects of path losses cause the received power to vary gradually due to signal attenuation determined by the geometry of the path profile in its entirety. This is in contrast to the local propagation mechanisms, which are determined by building and terrain features in the immediate vicinity of the antennas. The large-scale effects determine a power level averaged over an area of tens or hundreds of meters and therefore called the 'area-mean' power. Shadowing introduces additional fluctuations, so the received local-mean power varies around the area-mean. The term 'local-mean' is used to denote the signal level averaged over a few tens of wave lengths, typically 40 wavelengths. This ensures that the rapid fluctuations of the instantaneous received power due to multipath effects are largely removed.

Fading

Delay spread and *coherence bandwidth* are parameters which describe the time dispersive nature of the channel in a local area. The delay spread can be interpreted as the difference between the time of arrival of the first significant multipath component (typically the line-of-sight component) and the time of arrival of the last multipath component. If the multipath time delay spread equals D seconds, then the coherence bandwidth W_c in rad/s is given approximately by $W_c = \frac{2\pi}{D}$. However, these parameters do not offer information about the time varying nature of the channel caused by either relative motion between the mobile and base station, or by movement of objects in the channel. *Doppler spread* and *coherence time* are parameters which describe the time varying nature of the channel in a small-scale region. Doppler spread bandwidth is a measure of the spectral broadening caused by the time rate of change of the mobile radio channel and is defined as the range of frequencies over which the received Doppler spectrum is essentially non-zero. Coherence time T_c is the time domain dual of Doppler spread and is used to characterize the time varying nature of the frequency dispersive channel, in the time domain.

When time coherence is concerned, wireless channels are categorized as slow and fast fading. Fast fading occurs when the channel coherence time is much shorter than the delay requirement of the application. Slow fading arises if the channel coherence time is longer. In a fast fading channel, one can transmit the coded symbols over multiple fades of the channel, while in a slow fading channel, the channel is constant during the transmission of a codeword.

When coherence bandwidth is concerned, wireless channels are categorized into frequency-selective and flat fading. When the bandwidth of the input signal is much larger than the coherence bandwidth, the channel is said to be frequency-selective. When the bandwidth is considerably less than the coherence bandwidth, the channel is said to be frequency-flat, since it affects all signal frequencies in almost the same manner. Note that whether a channel is fast or slow fading, flat or frequency-selective fading depends not only on the wireless environment but also on the input signal and its applications, i.e., the delay requirement of the application, the bandwidth of the input signal.

An extended discussion on this topic can be followed in [45].

3.1.2 Transmitters

Applications and Traffic Source Models

Selecting the appropriate traffic source model to reflect the behavior of the users in a telecommunication system is an important issue in order to perform a successful design of new networks. Unlike existing GSM systems that primarily serve voice users and to some extent simple facsimile or short message services (SMS), next generation of wireless technologies supports a wide range of variable-bit-rate applications with high bandwidth efficiency.

Teletraffic engineering has been used for a long time to dimension telephone networks. Similar to the more sophisticated models described later, the voice users can be characterized in a layered structure. The most macroscopic behavior describes the activity of the user from the time of a connection setup until call termination. Within this period, the user will create talk spurts describing the time when the actively talks followed by periods of inactivity while listening to his counterpart. Since the activity phases continuously occupy the channel, the traffic generated by this type of users is usually characterized by an ON/OFF Process. Parameters for this type of traffic can be obtained from empirical measurements and consist of the mean interarrival time between connection setups, together with the mean

connection duration. In conventional systems and classical telephone networks, it has been widely accepted to use exponential distributions for both parameters resulting in a Poisson process description for voice users.

Poisson processes are examples of continuous-time Markov processes. A continuous-time Markov process is a stochastic process $\{X(t) : t \geq 0\}$ that satisfies the Markov property and takes values from a set called the state space; it is the continuous-time version of a Markov chain. The Markov property states that at any times $0 < t < s$, the conditional probability distribution of the process at time s given the whole history of the process up to and including time t , depends only on the state of the process at time t . In effect, the state of the process at time s is conditionally independent of the history of the process before time t , given the state of the process at time t .

While the characterization of voice users is fairly straightforward, the traffic generated by data users is highly dependent on the application and has a high burstiness, i.e., the variance of the interarrival times between data packets as well as the variance of the packet length can be very high. Therefore, due to the mostly feedback-oriented nature of packet oriented data applications the simple Poisson model is no longer sufficient and the correlation in the interarrival time distribution of the packet streams should be found.

Queueing Process

All data that enter the network are associated with a particular commodity, which minimally define the destination of the data, but might also specify other information, such as the source node of the data or its priority service class. These commodities can also be directly mapped into the type of traffic, e.g., audio, video, and data. Each node maintains a set of internal queues for sorting network layer data according to its commodity. The arrival event at a queue is due to the data generated at the upper layer as well as the data destined for the corresponding node, i.e., as a receiver or relay for the message. In addition, the queue length evolution at a node follows a random/deterministic process resulted from the processes modeling both the arrival and departure events at that node. More precisely, in all states except the empty queue and full queue (for finite queues), there are two events possible, (i) an arrival (which is possibly rejected), and (ii) a departure. The most commonly used model for transition instants between the possible queue states, namely *Markov decision process*, is of special interest to the study of stochastic games (Section 4.3.2).

Coding and Modulation

In 1948, Shannon demonstrated in a landmark paper [46] that, by proper encoding of the information, errors induced by noisy channel can be reduced to any desired level without sacrificing the rate of information transmission, as long as the information rate is less than the capacity of the channel. Since Shannon's work much effort has been expended on the problem of devising efficient encoding and decoding methods for error control in a noisy environment.

The channel encoder introduces, in a controlled manner, some redundancy in the binary information sequence that can be used at the receiver to overcome the effects of noise and interference encountered in the transmission of the signal through the channel. The binary sequence at the output of the channel encoder is passed to the digital modulator, which serves as the interface to the communication channel. Since nearly all the communication channels encountered in practice are capable of propagating electrical signals (waveforms), the primary purpose of the digital modulator is to map the binary information sequence into signal waveforms.

In wireless communication systems, the quality of a signal received by a destination node depends on the quality of the corresponding wireless link, i.e., the path loss, the shadowing and the fading as well as the interfering transmissions. In order to improve system capacity, peak data rate and coverage reliability, the signal transmitted to and by a particular user is modified to account for the signal quality variation through a process commonly referred to as link adaptation. Traditionally, CDMA systems have used fast power control as the preferred method for link adaptation. Recently, Adaptive Modulation and Coding (AMC) have offered an alternative link adaptation method that promises to raise the overall system capacity. AMC provides the flexibility to match the modulation-coding scheme to the average channel conditions for each user.

In addition, in multiuser communication systems, finding the capacity achieving coding and decoding schemes is recently of a great interest. The power control, single user subchannels (non overlapping time slots or frequency bands), superposition coding, and introduction of diversity paths (CDMA/MIMO) are few techniques used in transmitter side in order to achieve such a goal.

3.1.3 Receivers

At the receiving end of a multiuser system, the digital demodulator processes the channel-corrupted transmitted waveform and deduces the data symbols (binary or M-ary). This sequence of numbers is passed to the channel decoder, which attempts to reconstruct the original information sequence from knowledge of the code used by the channel encoder and the redundancy contained in the received data. The optimum receiver is defined as the receiver that selects the most probable sequence of information bits given the received signal observed over a time interval.

In vector access channel ¹, which is of special interest in our asymptotic study in Chapter 7, the optimum maximum-likelihood receiver [47] has a computational complexity that grows exponentially with the number of users. Such a high complexity serves as a motivation to devise suboptimum receivers having lower computational complexities. Near capacity receivers with lower complexity were proposed first in [48]. They have an iterative structure and consist of a multiuser detector followed by a bank of soft input-soft output single user (SISO-SU) decoders. The soft outputs of the SISO-SU decoders are fed back to the multiuser detector for the iterative procedure. Although, those receivers reduce drastically the complexity of the receiver in [48], their complexity is still very intensive for practical real time infrastructures. Typical receivers are often based on a multiuser detector followed by a bank of SISO-SU decoders.

The conventional single user detector, decorrelating detector, and minimum mean-square-error detector are the most used linear detectors.

In conventional single user detection, the receiver for each user consists of a demodulator that properly weights or match-filters the multiple received replica of the signal and passes the correlated output directly to the decoder. Since the detector is based on the single correlator output, the conventional detector neglects the presence of the other users of the channel or, equivalently, assume that the aggregate noise plus interference is white and Gaussian.

In case of orthogonal transmissions, the interference from the other users is completely removed and the conventional single user detector is optimum. In non-synchronous transmissions and/or for non-orthogonal signatures, this type of detector is vulnerable to interference from other users. Better performance in practical systems are obtained by using one of the two other

¹We refer as vector channel any multiuser communication system receiving multiple copies of the transmitted signal at the receiver. Typical examples of vector channels are CDMA and multiple input multiple output systems

detectors. The decorrelator is a linear detector that optimally cancels out the multiuser interference under the constraint of linearity. However, it does not account for the noise of the receiver. An additional linear approach is to minimize the mean square error of the received signal. This yields linear MMSE receiver which find the best tradeoff between the minimization of multiuser interference and noise cancelation.

A further multiuser decoding technique is called successive interference cancelation (SIC). This technique is based on removing the interfering signal waveforms from the received signal, one at a time as they are decoded. Typically, the user having the strongest received signal is demodulated first. After a signal has been decoded, the reconstructed information signal is subtracted from the received signal. This multiuser decoder is of primary theoretical interest since it achieves capacity [49]. However, in practical systems cancelation of erroneous systems could imply severe performance degradation [50].

3.1.4 Multiple Access Techniques

In wireless communications, limited number of radio channels are available. These channels are shared simultaneously by many mobile users using Multiple Access Techniques. Widely spread multi-access techniques are:

FDMA: Frequency Division Multiple Access is based on the frequency-division multiplex (FDM) scheme, which provides different frequency bands to different data-streams. In the FDMA case, the data streams are allocated to different users or nodes.

TDMA: Time Division Multiple Access allows several users to share the same frequency channel by schedule os their transmission in different time slots.

CDMA: Code Division Multiple Access is a channel access scheme employing spread-spectrum technology: different modulation waveform is assigned to each transmitter to allow multiple users to be multiplexed over the same physical link.

SDMA: Space Division multiple Access is a multiple input and multiple output (MIMO) based wireless communication technology. Multiple antennas at the transmitter enable to form beams that are directed to the user, possibly with nulls to other receivers, so as not to cause them interference.

However, the optimal multiuser resource allocation may involves superposition in a common channel, e.g., time slot or frequency band. This topic, in the context of OFDM, is discussed in Section 3.2.1.

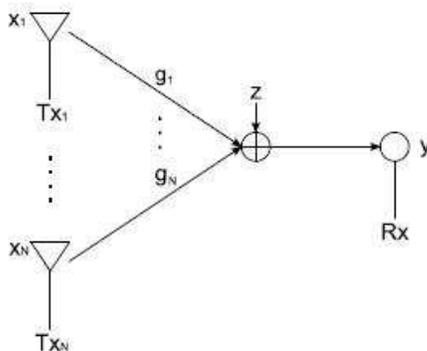

Figure 3.1: Multiple access channel

3.1.5 Capacity Region

The network capacity problem deals with finding the fundamental limits on achievable communication rates in wireless networks. A set of rates between source-destination pairs is called achievable if there exists a network control policy and a coding strategy that guarantee those rates. When time sharing is possible, the closure of the set of achievable rates is the capacity region of the network. Our main focus here is on networks containing simultaneous single-hop transmissions. In this respect, the related information theoretic results are those of MAC and interference channel.

Multiple Access Channel

This is the channel in which two or more senders send information to a common receiver (Figure 2.1). We consider K senders sending their corresponding messages S_1, S_2, \dots, S_K , over the channel. We denote a subset of senders by $J \subseteq \{1, 2, \dots, K\}$. Let J^c denote the complement of J . Let $R(J) = \sum_{i \in J} R_i$ denotes the sum of the rate of all users in subset J , and let $X(J) = \{X_i : i \in J\}$ be the vector of transmitted signals by the users in J . Then we have the following theorem.

Theorem 1. *The capacity region of the K -user multiple-access channel is the closure of the convex hull of the rate vectors satisfying (see e.g. [14])*

$$R(J) \leq I(X(J); Y | X(J^c)) \quad \text{for all } J \subseteq \{1, 2, \dots, K\} \quad (3.1)$$

for some product distribution $p_1(x_1)p_2(x_2)\dots p_K(x_K)$.

Now we discuss the *Gaussian multiple access channel* in somewhat more detail. The input-output equation for K -user MAC at time t can be written as

$$y(t) = \sum_{k=1}^K \sqrt{g_k(t)} x_k(t) + z(t) \quad (3.2)$$

where $x_k(t)$ and $g_k(t)$ are the input signal and fading gain of the k^{th} transmitter, respectively. The input signal $x_k(t)$ can be further written as $x_k(t) = \sqrt{p_k(t)} s_k(t)$ where $p_k(t)$ and $s_k(t)$ are user k 's transmit power and data with normalized power, respectively. User k is subject to an average transmit power constraint P_k^{max} . The variable $z(t)$ is assumed to be zero-mean white Gaussian noise with variance σ^2 .

We consider first the simple situation of MAC with time-invariant channels, and the signal of user k is attenuated by a constant factor of g_k at the receiver. The capacity region of a K -user time-invariant MAC is well known [14]. It is the set of all rate vectors $\mathbf{r} = \{r_1, \dots, r_K\}$ satisfying

$$\mathcal{R} = \left\{ (r_1, \dots, r_K) : 0 \leq \sum_{n \in \mathcal{X}} r_n \leq \mathcal{I}(\mathcal{X}), \forall \mathcal{X} \subseteq \{1, 2, \dots, K\} \right\} \quad (3.3)$$

where $\mathcal{I}(\mathcal{X})$ is defined as $\mathcal{I}(\mathcal{X}) = I(X_{\mathcal{X}}; Y)$, the mutual information between the input variable $X_{\mathcal{X}} = \{X_k\}_{k \in \mathcal{X}}$ and the output variable Y . Note that \mathcal{X} is any subset of users in $\{1, 2, \dots, K\}$. The channel capacity [46], denoted by $\mathcal{C}(\mathcal{X})$, is obtained by maximizing the mutual information over all possible input distributions $Pr(X_{\mathcal{X}})$,

$$\mathcal{C}(\mathcal{X}) = \max_{Pr(X_{\mathcal{X}})} I(X_{\mathcal{X}}; Y) = \log \left\{ 1 + \frac{\sum_{k \in \mathcal{X}} g_k p_k}{\sigma^2} \right\} \quad (3.4)$$

where the maximum is achieved when all the inputs X_1, \dots, X_K are independent Gaussian variables. We can derive the capacity region as

$$\mathcal{C} = \left\{ (r_1, \dots, r_K) : 0 \leq \sum_{k \in \mathcal{X}} r_k \leq \mathcal{C}(\mathcal{X}), \forall \mathcal{X} \subseteq \{1, 2, \dots, K\} \right\} \quad (3.5)$$

which is known to be a convex polytope. This capacity region has exactly $K!$ vertices in the positive quadrant, each is achievable by successive decoding using $K!$ possible decoding orders. Successive decoding consists in decoding the users sequentially by single user decoding and treating the users not decoded yet as noise. At each iteration, the decoded user signal is subtracted from the sum signal.

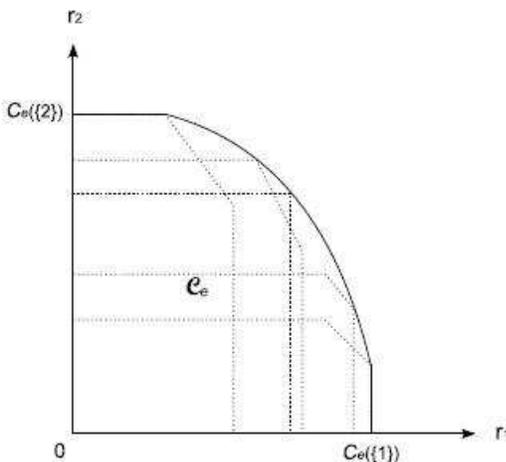

Figure 3.2: Capacity of two-user fast fading MAC with CSIT

Now, we consider the multiple access fading channel. In general, there are two notions of capacity for the fading channel depending on how fast the channel varies and the delay requirement of the application. The first is the classic notion of Shannon capacity directly applied to the fast fading channel. In this case, the fading process is assumed to be stationary and ergodic during the transmission of a codeword. Then the codeword length has to be sufficiently long such that during the codeword transmission all the channel states happen. Fast fading multiple access channels have been deeply investigated in the two cases as both transmitters and receiver have knowledge of the channel state and when the receiver has knowledge of the channel state but not the transmitters.

When channel state information (CSI) is perfectly known to the receiver but the transmitters do not have such information, the codewords cannot be chosen as a function of the CSI but the decoding can take advantage of such information. The capacity region of multiple access fast-fading channel is known [1,2], and is given by

$$\mathcal{C}_e = \left\{ (r_1, \dots, r_K) : 0 \leq \sum_{k \in \mathcal{X}} r_k \leq \mathcal{C}_e(\mathcal{X}), \forall \mathcal{X} \subseteq \{1, 2, \dots, K\} \right\} \quad (3.6)$$

Here, $\mathcal{C}_e(\mathcal{X})$ is the ergodic capacity

$$\mathcal{C}_e(\mathcal{X}) = \mathbb{E}_{\mathbf{g}} \left[\log \left(1 + \frac{\sum_{k \in \mathcal{X}} g_k p_k}{\sigma^2} \right) \right] \quad (3.7)$$

where $\mathbf{g} = \{g_1, \dots, g_K\}$ is a random vector having the stationary distribution of the joint fading process.

When channel state information at the transmitter (CSIT) is also available, the capacity region is a union of capacity regions (Figure 2.2), each corresponding to a feasible transmit power strategy [3]). A transmit power policy $\mathbf{p}(\cdot)$ is a mapping from the fading state space to \mathbb{R}_+^K . Given a joint fading state \mathbf{g} , $p_k(\mathbf{g})$ can be interpreted as the transmit power of user k . For a given power policy \mathbf{p} , we can write the set of rates in (3.6) as a function of \mathbf{p} , i.e., $\mathcal{C}(\mathbf{p})$. Thus, the capacity region for multiple access fast-fading channel with both CSI at the transmitter and CSI at the receiver (CSIR) can be written as

$$\tilde{\mathcal{C}}(\mathbf{p}) = \bigcup_{\mathbf{p} \in \mathcal{P}} \mathcal{C}(\mathbf{p}) \quad (3.8)$$

where \mathcal{P} is the set of all feasible transmit power strategies satisfying

$$\mathcal{P} = \{\mathbf{p} : \mathbb{E}[p_k(\mathbf{g})] \leq P_k^{\max}, \forall k\} \quad (3.9)$$

The second notation of capacity for fading channels is the concept of *delay limited* capacity. Let us turn now to slow fading channels where the delay requirements for the transmission of a codeword is shorter than the time scale for channel ergodicity. It is well known that the Shannon capacity is in general zero for slow-fading channels with CSIR only [46]. This is because with a strict delay constraint, the channel may remain in deep fading over the whole transmission duration of a codeword, and a nonzero possibility of error exists for any positive rate target. In this case, it is reasonable to allow a certain percentage of outage and try to achieve a rate target for the remainder of the time. With this in mind, we will later introduce an appropriate performance metric for our network settings in chapters 5 to 7.

The case of slow fading channels with full CSI at both ends has been addressed in [3] Assume that the set of possible fading states \mathcal{G} is bounded. The delay-limited capacity region for the case when all the transmitters and receivers know the current state of the channel is

$$\tilde{\mathcal{C}}_d(\mathbf{p}) = \bigcup_{\mathbf{p} \in \mathcal{P}} \bigcap_{\mathbf{g} \in \mathcal{G}} \mathcal{C}_g(\mathbf{g}, \mathbf{p}(\mathbf{g})) \quad (3.10)$$

where \mathcal{P} is the set of all feasible power control policies satisfying the average power constraints, and $\mathcal{C}_g(\mathbf{g}, \mathbf{p}(\mathbf{g}))$ is the capacity of the time-variant Gaussian multiaccess channel, for the channel realistic \mathbf{g} , given by

$$\mathcal{C}_g(\mathbf{g}, \mathbf{p}(\mathbf{g})) = \left\{ \mathbf{r} : \mathbf{r}(\mathcal{X}) \leq \log \left(1 + \frac{\sum_{k \in \mathcal{X}} g_k p_k}{\sigma^2} \right), \forall \mathcal{X} \subseteq \{1, 2, \dots, K\} \right\} \quad (3.11)$$

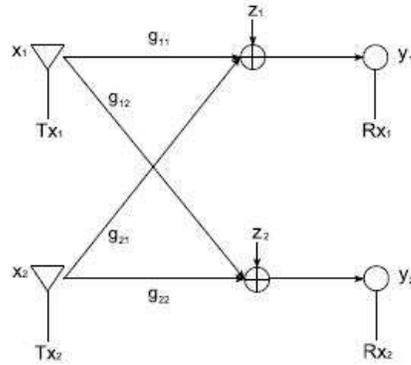

Figure 3.3: Interference channel

The intuitive content of the above equation is that a rate vector \mathbf{r} is achievable in the delay-limited sense if one can choose a feasible power control policy such that sufficient mutual information is maintained between the transmitters and the receiver at *all* fading states.

Interference Channel

The interference channel (IC) is currently object of intensive studies both in information and communications theory. IC consists of several transmitters aiming to convey independent messages to their corresponding receivers through a common channel (Figure 2.3). The study of this kind of channels was initiated by C. E. Shannon [51], and further by R. Ahlswede [52] who gave simple but fundamental inner and outer bounds to the capacity region. Ever since, several achievable rate regions as well as inner and outer bounds for capacity region are obtained by transforming the problem to one of the associated multiple-access or broadcast channel, i.e., [53–56]. Despite some special cases, such as very strong and strong interference and degraded IC, where the exact capacity region has been derived [57, 58], the characterization of the capacity region for the general case is still an open problem. Carleial [57] introduced the Gaussian IC with power constraints and showed that very strong interference is equivalent to no interference. In their pioneering work, Han and Kobayashi proposed a coding scheme in which the receivers are allowed to decode part of the interference as well as their own data [54]. Their achievable region in a two-user network is still the best inner bound for the capacity region. Specially, in their scheme, the message of each user is split into two independent parts, the common part and the private part. The common part is encoded such that both users can decode

it. The private part, on the other hand, can be decoded only by the intended receiver and the other receiver treats it as noise. Tse and Etkin [59] showed that the existing outer bounds can in fact be arbitrarily loose in some parameter ranges, and by deriving new outer bounds, they showed that a simplified Han-Kobayashi type scheme can achieve to within a single bit the capacity for all values of the channel parameters.

As an example, we represent the achievable rate region of a strong IC. Consider the two-user Gaussian IC. The input-output equations can be represented in standard form as

$$y_1 = x_1 + \sqrt{a}x_2 + z_1 \quad (3.12)$$

$$y_2 = \sqrt{b}x_1 + x_2 + z_2. \quad (3.13)$$

where x_i and y_i denote the input and output alphabets of user $i \in \{1, 2\}$, respectively, and z_1 and z_2 are standard random Gaussian variables. We assume $g_{11} = g_{22} = 1$, and the constants $a \geq 0$ and $b \geq 0$ represent the gains of the interference links. Furthermore, transmitter i is subject to the power constraint P_i^{\max} . Depending on a and b , the two-user Gaussian IC is classified into weak, strong, mixed, one-sided, and degraded Gaussian IC. In Figure 2.4, regions in ab -plane together with associated names are shown. Among all the classes shown in the figure, the capacity region of the strong Gaussian IC is fully characterized. In this case, the capacity region can be stated as the collection of all rate pairs (r_1, r_2) satisfying

$$r_1 \leq \gamma(p_1) \quad (3.14)$$

$$r_2 \leq \gamma(p_2) \quad (3.15)$$

$$r_1 + r_2 \leq \min\{\gamma(p_1 + ap_2), \gamma(bp_1 + p_2)\}. \quad (3.16)$$

where $\gamma(p) = \log(1 + \frac{p}{\sigma^2})$.

A review of the inner bounds and outer bounds for all the three classes is presented by Khandani et al. in [60]. Treating interference as noise is not always the best strategy. Since the interference caused by another user is intrinsically a codeword from a codebook, it is possible to decode the interference at the receiver side which results in transmitting at higher rates. By establishing certain properties of the *maximum decodable subset*, Khandani et al. proposed a polynomial time algorithm that separate the interfering users into two disjoint parts [61]: the users that the receiver is able to jointly decode their messages and its complement. They introduced an optimization problem that gives an achievable rate for this channel. Their proposed method on finding the maximum decodable subset of interferers is exploited in Chapter 7 where a SIC decoder is considered at the receivers.

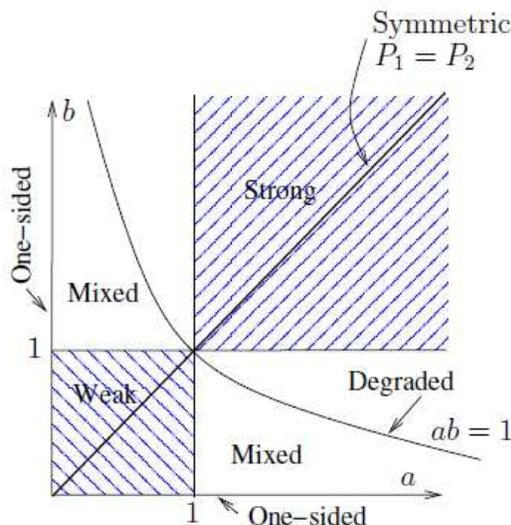

Figure 3.4: Classes of two-user ICs

3.2 Resource Allocation

Resource allocation is an assessment to decide about how to divide limited (e.g., power) or restricted (e.g., rate) amount of resources among individuals who compete or interact with each other. The wireless communication resources vary among different network setups. The resources, in this study, are power, rate, and frequency bandwidth. The existing algorithms are attempting to separately or jointly allocate one or more resources.

In the following review, we specifically take into account three main factors which affect the choice of a resource allocation scheme

- Queue backlog: The scheduling performance has been mostly evaluated assuming that there is an infinite backlog of packets in each queue. In order to evaluate the service received by a user in a system that contains variety of service demands, it is necessary to take into account the occupancy of the queues. For example, a resource allocation algorithm that provides high throughput to users with favorable channel conditions will tend to satisfy the service demands of these users sooner. As a result, the algorithm would be left facing a user population with a higher fraction of users with poor channel conditions.
- Channel related assumptions: The channel-related assumptions are

addressed in two ways: (i) availability of the channel state information, and (ii) channel access method and network topology. Perfect knowledge of the channel state has often been assumed in the literature studying the performance of opportunistic scheduling. Although 3G systems employ channel estimation and reporting mechanisms, the channel state information available to the base station is not perfect: it is delayed and often outdated. In addition, the channel estimation mechanism itself introduces channel estimation errors at the mobile station. Three levels of knowledge can be considered: perfect channel knowledge, imperfect knowledge, and no knowledge. Note however that no knowledge still assumes that the statistical information is available.

Regarding the channel access method and network topology, the assumption can include any following techniques: multiple access channel/broadcast channel/interference channel, TDMA/FDMA, as well as consideration of diversity paths in CDMA and SDMA.

- System and service constraints: The constraints can be divided into two classes: (i) system-related constraints including limited spectrum, limited energy, and variant channel in time and frequency, (ii) service-related constraints including minimum throughput, maximum delay, maximum outage probability, and maximum power consumption.

We focus on the distributed resource allocation in both OFDM-based MAC and interference channel. For OFDM-based MAC setting, we have taken into account the conventional single layer resource allocation (infinite queue backlog). An extended literature of resource allocation in OFDM and OFDMA setups is given in [8]. In this section, we review the selected literature which is of special interest for our study.

For the interference channel, due to the fact that queues' stability is of special importance in ad hoc networks, we studied the existing *cross-layer* resource allocations.

3.2.1 Resource Allocation in OFDM-based MAC

There is plenty of room to exploit the high degree of flexibility of radio resource management in the context of OFDM. Since channel frequency responses are different at different frequencies or for different users in a network, the performance of the network can be significantly improved through data rate adaptation over each subcarrier, dynamic subcarrier assignment,

and adaptive bit and power allocation.²

The performance of wireless OFDM systems can be significantly increased if the transmitter and receiver pair adapt constantly to the current channel conditions. For *point-to-point* connections the transmitter generates a power and/or modulation (possibly including also encoding) assignment per subcarrier. Sub-carriers with relatively low attenuations convey more information, sub-carriers with relatively high attenuations contribute less to the transmission. From information theory the *water-filling* algorithm, given all the channel gains are known, provides the capacity of the point-to-point OFDM transmission [14]. The capacity is achieved by adapting the transmit power to the channel gain. Roughly speaking, given a limited transmit power, more power is applied to frequency areas with a lower attenuation gain compared to the other frequencies. Assuming a fixed average channel gain and a fixed bandwidth, the capacity of the channel increases the more diverse the channel is (i.e., the higher the variance is).

In the case of multiaccess systems, the resource allocation problem is more complex. In addition to the power and modulation assignment per sub-carrier, the available sub-carriers have to be assigned to multiple terminals. In general, a resource allocation based on disjoint subcarrier assignment and power allocation is not optimal.

The information theoretical aspects of this problem are studied mostly in the frame of frequency-selective Gaussian MAC or interference channel. Gallager formulated the problem in [15]. In [2], Tse and Hanly characterized the ergodic capacity of a time-varying frequency-selective Gaussian MAC where the channel frequency response is continuous. The problem in an infinite dimension (a continuous frequency domain) can be transformed into a finite dimension (a discrete frequency domain) problem, by dividing the frequency spectrum into a large number of orthogonal subchannels.

²This property of OFDM systems has led to the specification of various systems based on OFDM. Modern digital audio [9] and video [10] broadcasting systems rely on OFDM. Much of Europe and Asia has adopted OFDM for terrestrial broadcasting of digital television (DVB-T, DVB-H and T-DMB) and radio (Digital Radio Mondial, HD Radio and T-DMB). Some well known High speed wireless Local Area Network (LAN) standards, e.g., IEEE 802.11a/g [?], are based on OFDM, as well as other wireless network standards such as IEEE 802.16 [12]. However, OFDM has also been applied to wired frequency-selective channels, as in the case of Digital Subscriber Line (DSL) systems for twisted-pair cables [13]. Due to this recent popularity of the OFDM transmission scheme, it is also considered as candidate for high-rate extensions to third generation communication systems as well as for forth generation mobile communication systems. It is also now being used in the WiMedia/Ecma-368 standard for high-speed wireless personal area networks (PAN) in the 3.1-10.6 GHz ultrawideband spectrum.

In this context, centralized and distributed iterative algorithms which converge to the sum-rate optimal point on the boundary of the capacity region are proposed respectively by Yu and Lui in [16] and by Huang et al. in [17]. Some early works added the FDMA restriction into the model. FDMA, in which multiple bands are pre-assigned to the users on a non-overlapping basis, is mainly used in DSL systems as a standard approach to eliminate the multiuser interference. In [18], Yu and Cioffi proposed a numerical method for characterizing the achievable rate region for Gaussian multiple access channel with ISI under the FDMA restriction, considering a finite number of frequency bins. Verdu and Cheng in [19] showed that the optimum multiuser waterfilling spectrum involves superposition in frequency, so FDMA alone is not optimal except in special cases.

The design of multicarrier communications systems often involves a maximization of the total throughput subject to system resource constraints. [16] provided a method for finding the global optimum for this problem. Although the paper focuses on OFDM interference channel but the same results can be represented in OFDM-based MAC as well. It is shown that the duality gap for a non-convex optimization problem is zero if the optimization problem satisfies a time-sharing condition. Further, the time-sharing condition is always satisfied for the multiuser spectrum optimization problem in multicarrier systems when the number of frequency carriers increases towards infinity.

In general, the optimization problems in multiuser OFDM systems are NP-complete problems, with exponential complexity both in the number of subcarriers, for fixed links, and in the number of links, for fixed numbers of subcarriers. General formulation of optimization problems for allocating subcarriers and powers for networks of interfering links are provided by Luo and Zhang in [20]. Part of the complexity comes from the combinatorial nature of the problem, in that there are many subcarriers per transmitter, and each has a different channel gain (although there are typically strong correlation between neighboring subcarriers). Further, the problem is non convex when interference is taken into account [21]. In addition to these challenges which directly related to the characteristics of the optimization problem, the time-varying property demand low complexity algorithms implementable in real-time. A spectrum allocation algorithm based on channel state information requires channel measurement, feedback, computation, and convergence in a coherence time interval. This could be possible in centralized systems and in low mobility scenarios but seems more difficult otherwise. Significant efforts of current research in wireless are devoted to the design of resource allocation algorithms based on limited (partial and/or statistical) channel

side information.

Despite the relatively high complexity, the potential performance improvements achieved by dynamic OFDM schemes is very relevant. Thus, many suboptimal schemes have been studied recently. Iterative waterfilling (IWF) is the mostly used resource allocation in this structure. However, the IWF process does not seek to find the global optimum for the entire network. Two common methods for decreasing the complexity of problem are: (i) reducing the number of decision variables, (2) replacing the centralized optimizations by the distributed ones or game.

In centralized systems with complete CSI at transmitters most researches have investigated the impact of reducing the complexity by reducing the number of decision variables in the optimization problem (by fixing some of them). A common example in OFDM system is when the subcarriers are pre-assigned to the users (FDMA). In this case, the optimal power allocation of all users over their fixed subcarriers are assessed by resource allocation algorithm. In [22], Wong et al. proposed a multiuser OFDM subcarrier, bit, and power allocation algorithm to minimize the total transmit power. This algorithm is based on a suboptimal subcarrier allocation, and a subsequent single-user bit allocation is applied on the allocated subcarriers. In [23], Thanabalasingham et al. considered the problem of joint subcarrier and power allocation for the *downlink* of a multiuser multi-cell OFDM cellular network. They investigated the performance degradation due to either the suboptimal static subcarrier allocation or flat transmit power spectrum. The model used for the channel takes into account the lognormal shadowing and path loss, but not frequency-selective multipath fading. It is shown that the performance of the two suboptimal algorithms is nearly as good as the optimal algorithm that jointly allocates subcarriers and power spectral densities to the mobiles.

Centralized multiuser resource allocations are constrained optimization problems in a vector space. Thus, replacing a centralized multiuser resource allocation by the corresponding distributed one mainly reduces the complexity imposed by non-convex utility functions due to the interference. Additionally, decisions can be made based on local information and the amount of signalling is reduced. The performance of the distributed algorithm can be used as a lower bound for the performance of the corresponding centralized algorithm.

The assumption of complete CSI at all transmitters may not be realistic in mobile cellular scenarios with time-varying channel conditions as well as in ad hoc networks. In this case, the resource allocation needs to be performed based on statistical knowledge of the channel conditions. When the

channel evolves slowly, the communication system is intrinsically affected by outage event. In this regard, Hanly and Tse [3] introduced the concept of delay-limited capacity region. They proposed that one can look upon the frequency-selective fading channel as a time-varying channel where, at each fading state, a frequency response is specified for each user, representing the multipath. Thus it can be viewed as a set of parallel channels, each one jointly specified by the fading state and the frequency. In order to be delay-limited in this channel, each user can allocate rates over the different frequencies but the minimum rate summed over the frequencies must be satisfied for each fading state. In [24], Hanly et al. considered an outage-probability-based resource allocation problem for multiuser, multi-cell system. They formulate a min-max outage probability problem and solve it under the constraint that the transmit power spectrum at each base station is flat. If more power must be allocated to a mobile to keep a certain quality of service, for example, when the mobile moves close to the cell boundary, there are two independent ways to achieve this: by increasing the cell power level as a whole, or by increasing the number of subcarriers allocated to the mobile. The authors considered a second algorithm based on fixed subcarrier allocation and dynamic power allocation. They argued that the proposed flat power algorithm is significantly superior with respect to the objective of minimizing the maximum outage probability.

Much work has been done on competitive game theory applied to frequency selective interference channel, with the early works of Yu et al. [25], subsequent works of Scutari et al. (see [5] and the references therein) and a recent paper by Gaoning et al. [6]. A particularly interesting topic is the use of generalized Nash games to the weak interference channel [26], and the algorithm in [27] which extends the fixed margin IWF to iterative pricing under fixed rate constraint.

An alternative way to overcome the suboptimality of the competitive approach is to use the concept of repeated games and learning dynamics. This approach has been extensively applied in power allocation [28–31]. Power allocation in interference networks is inherently a repetitive process and it is natural to model interactions among users by repeated games. These approaches introduce a learning phase which provides users with information (intelligence) to make a correct decision. The convergence of the learning dynamics in the repeated game is the main challenge of these schemes. Additionally, they assume slow fading channels.

Following this literature overview, now we highlight our contribution into the subject. In fact, only few works in literature are concentrated on slow fading channel with partial channel side information. In [21], Etkin et al.

considered a slow fading interference channel with initial partial channel state information. By using the approach of repeated games, information about the channel and the interactions is acquired. Recently, Xiao Lei et al. [32] considered a block fading interference channel with knowledge of the state of the direct links but only statistical knowledge on the interfering link. With this assumption, reliable communications are not possible and a certain level of outage has to be tolerated. The authors considered the resource allocation games for utility functions based on the real throughput accounting for the outage events. In this context they investigated the two cases of power allocation for predefined transmission rates as well as joint power and rate allocation.

3.2.2 Cross-layer Resource Allocation in Interference Channel

Resource allocation solely based on CSI is unable to update rate allocation properly according to the dynamics of the input traffic. By ignoring the randomness in packet arrival and queueing, such approaches can guarantee neither the stability of queueing systems nor the acceptable queueing delay. To account for queueing parameters, a cross layer approach is needed.

The benefit of cross-layer design and joint optimization of this control mechanisms are well known in centralized communication systems (e.g., [4] and references therein).

Centralized cross-layer approaches for resource allocation have been proposed both for the uplink and the downlink (broadcast channel). Awareness of both channel state information (CSI) and queue state information (QSI) enables for throughput optimal policies, i.e., policies which achieve the ergodic capacity region of a fading channel network [33,34] (see e.g., maximum weighting matching scheduling [35]). Other properties, besides the throughput optimality, like the average queueing delay, have been also object of studies [4,36].

The decentralized algorithms for resource allocation in interference networks is a complex and intriguing problem since the decision affects many fundamental operational aspects of the network and its resulting performance. Several alternative approaches have been proposed in both conventional and cross-layer schemes in interference networks. Two main streams can be identified: (i) schemes based on repeated games and learning dynamics, (ii) constrained stochastic games.

The first approach has been mainly applied for conventional single layer power allocation schemes [30,31,37,38]. Power allocation in interference

networks is inherently a repetitive process and it is natural to model interactions among users with repeated games. These approaches introduce a learning phase which provides users with information (intelligence) to make a correct decision. The convergence of the learning dynamics in the repeated game [37] is the main challenge of these schemes. Additionally, they assume slow varying channels.

Constrained stochastic games have been applied to decentralized cross layer design for multiple access. In [39], Altman et al. considered a MAC fading channel with channel states distributed according to a Markov chain. Furthermore, each transmitter is provided with a queue fed by a Poisson process. Decentralized selfish and cooperative games, eventually correlated, are proposed to optimize a utility function under the constraints on the maximum average queueing delay and maximum average power. Under the assumption of fixed transmission rate for all users and the assumption that reliable communications are always possible in the decentralized context, the utility function in [39] is the average maximum achievable rate. The proposed algorithms enable power allocation and admission control (accept or reject incoming packets in the queues). In a system with decentralized control mechanisms where each transmitter is not aware of the interferers' presence (and effects) and it is intrinsically subject to outage, the assumption of reliable communications is rather strong. Additionally, the constraint of a fix transmission rate in any channel condition does not allow for an optimal utilization of the channel and a more efficient use of the channel is expected by controlling and adapting the transmission rates to the CSI. An extension of the previous works to the interference networks is presented in chapter 6 and 7.

Chapter 4

Mathematical Preliminaries

In this chapter, we introduce two fundamental mathematical theories, namely optimization theory and game theory. Note that, only an extension of these topics which is relevant to our study is presented here. The first section represents the basic math concepts which are used in the later sections. We proceed by introducing the optimization theory and related topics, i.e. duality theory and KKT conditions. The definition of game followed by introduction of two special categories of games, namely Bayesian game and stochastic game, as well as their application in wireless communication. We finally gave a brief introduction to random matrix theory.

4.1 Basic Math Concepts

Definition 1. (*Stationary point*) Let $f : \mathcal{R}^n \rightarrow \mathcal{R}$ be a differentiable function in $\mathbf{x}_0 \in \mathcal{R}^n$. \mathbf{x}_0 is a stationary point of function $f(\mathbf{x})$ if $\nabla f(\mathbf{x})$, the gradient of $f(\mathbf{x})$, is null in \mathbf{x}_0 , i.e., $\nabla f(\mathbf{x})|_{\mathbf{x}_0} = 0$.

Definition 2. (*Bounded set:*) In an Euclidean space \mathbb{E}^n , a set \mathcal{C} is said to be bounded if and only if it is contained inside some hypersphere of finite radius.

Definition 3. (*Compact set*) A subset of an Euclidean space is called compact if it is closed and bounded.

Definition 4. (*Convex set*) In an Euclidean space \mathbb{E}^n , a set \mathcal{C} is convex if for every pair of points within \mathcal{C} , every point on the straight line segment that join them is also within \mathcal{C} , i.e., if for any $x_1, x_2 \in \mathcal{C}$ and any $\theta \in [0, 1]$, we have

$$\theta x_1 + (1 - \theta)x_2 \in \mathcal{C} \quad (4.1)$$

Definition 5. (*Lattice*) A lattice is a partially ordered set or poset in which any two elements have a unique supremum (the elements' least upper bound; called their joint) and a unique infimum (greatest lower bound; called their meet). In other words, a poset (L, \leq) is a lattice if it satisfies the following two conditions. For any $a, b \in L$, the set $\{a, b\}$, (i) has a joint $a \vee b$, and (ii) has a meet $a \wedge b$.

Definition 6. (*Sublattice*) A sublattice of a lattice L is a nonempty subset of L which is a lattice with the same meet and join operations as L . That is, if L is a lattice and M is a subset of L such that for every pair of elements $a, b \in M$ both $a \vee b$ and $a \wedge b$ are in M , then M is a sublattice of L .

Definition 7. (*Concave function*) A function $f : \mathcal{X} \rightarrow \mathbb{R}$ is concave if the domain of the function f is a convex set and if for any $x_1, x_2 \in \mathcal{X}$ and any $\theta \in [0, 1]$, we have

$$f(\theta x_1 + (1 - \theta)x_2) \geq \theta f(x_1) + (1 - \theta)f(x_2) \quad (4.2)$$

Definition 8. (*Quasi-concave function*) A function $f : \mathcal{X} \rightarrow \mathbb{R}$ is quasi-concave if the domain of the function f is a convex set and if for any $x_1, x_2 \in \mathcal{X}$ and any $\theta \in [0, 1]$, we have

$$f(\theta x_1 + (1 - \theta)x_2) \geq \min\{f(x_1), f(x_2)\} \quad (4.3)$$

Note that a concave function is quasi-concave.

Definition 9. (*Semi-continuous function*) An real-valued function f is upper (lower) semi-continuous at a point x_0 if, roughly speaking, the function values for arguments near x_0 are either equal to $f(x_0)$ or less than (greater than) $f(x_0)$.

Definition 10. (*Piecewise function*) A piecewise function is a function that is defined on a sequence of intervals. In addition, a piecewise linear function is a piecewise-defined function whose pieces are linear.

Definition 11. (*Supermodular function*) A function $f : \mathbb{R}^K \rightarrow \mathbb{R}$ is supermodular if

$$f(x \vee y) + f(x \wedge y) \geq f(x) + f(y) \quad (4.4)$$

for all $x, y \in \mathbb{R}^K$. If f is twice differentiable, then supermodularity is equivalent to the condition $\frac{\partial^2 f}{\partial z_i \partial z_j} \geq 0$ for all $i \neq j$. [62]

Definition 12. (Submodular function) A function $f : \mathbb{R}^K \rightarrow \mathbb{R}$ is submodular if

$$f(x \vee y) + f(x \wedge y) \leq f(x) + f(y) \quad (4.5)$$

for all $x, y \in \mathbb{R}^K$. If f is twice differentiable, then submodularity is equivalent to the condition $\frac{\partial^2 f}{\partial z_i \partial z_j} \leq 0$ for all $i \neq j$.

4.2 Elements of Constrained Optimization

Constrained optimization is the maximization (minimization) of an objective function subject to constraints on the possible values of the independent variable. Constraints can be either equality constraints or inequality constraints. Since the scalar-variable case follows easily from the vector one, only the latter is discussed here.

The typical constrained optimization problem has the

$$\begin{aligned} & \text{minimize} && f_o(\mathbf{x}) \\ & \text{s.t.} && f_i(\mathbf{x}) \leq 0 && i = 1, \dots, m \\ & && h_j(\mathbf{x}) = 0 && j = 1, \dots, p. \end{aligned} \quad (4.6)$$

with $\mathbf{x} \in \mathbb{R}^K$. The functions $f_i(\mathbf{x})$ define the inequality constraints and the $h_j(\mathbf{x})$ functions define the equality constraints. A point that satisfies all constraints is said to be a *feasible point*. An inequality constraint is said to be *active* at a feasible point \mathbf{x} if $f_i(\mathbf{x}) = 0$ and *inactive* if $f_i(\mathbf{x}) < 0$. Equality constraints are always active at any feasible point. To simplify notation we write $\mathbf{h} = [h_1, \dots, h_p]$ and $\mathbf{f} = [f_1, \dots, f_m]$, and the constraints now become $\mathbf{h}(\mathbf{x}) = 0$ and $\mathbf{f}(\mathbf{x}) \leq 0$. The convex optimization is defined as follows.

Definition 13. (Convex Optimization) A convex optimization problem is an optimization of form (4.6), where $f_i, i = 0, 1, \dots, m$ are convex functions, and $h_j, j = 1, \dots, p$ are affine functions.

Convex optimization problem has a unique minimizer, i.e., the optimal solutions set is a single point. Note that, strict convexity of the objective function is not sufficient to guarantee a unique optimum. In addition, each component of the constraint must be strictly convex to guarantee that the problem has a unique solution. Because of the constraints, being a stationary points (Definition 1) of $f(\cdot)$ is not a necessary neither a sufficient condition

to be solution to the constrained problem. In fact, the stationary points may not satisfy the constraints or the optimum is out of the boundary and the solutions to the constrained problem are often not stationary points of the objective function. Consequently, ad hoc techniques of searching for all stationary points of the objective function that also satisfy the constraint are not sufficient [63].

Classical approach to solving constrained optimization problems is the method of Lagrange multipliers. This approach converts the constrained optimization problem into an unconstrained optimization. The Lagrangian of a constrained optimization problem is defined to be the scalar-valued function $L(\mathbf{x}, \boldsymbol{\lambda}, \boldsymbol{\mu}) = f_o(\mathbf{x}) + \boldsymbol{\lambda}^T \mathbf{f}(\mathbf{x}) + \boldsymbol{\mu}^T \mathbf{h}(\mathbf{x})$, for any non-negative vectors of $\boldsymbol{\lambda}$ and $\boldsymbol{\mu}$. The essential observation is that stationary points of the Lagrangian are potential solutions of the constrained problem. This fact has led to introduction of several methods for solving constrained optimization problems, e.g., duality theory and Karush-Kuhn-Tucker (KKT) conditions. In the following, we first define the dual of problem (4.6). Next, we introduce KKT necessary conditions which can be used to investigate whether the dual optimal solutions coincide with the primal optimal solutions. KKT conditions are necessary for a solution in nonlinear programming to be optimal, provided that some regularity conditions are satisfied. For certain classes of optimizations, KKT conditions are sufficient as well. In such cases, this set of multivariate equations can be solved in order to obtain the global optimal solutions of problem (4.6). In mathematics, much research has been focused on methods for finding the closed form solutions of such a set of equations, e.g., linear complementarity problem and variational inequality problem (non-linear complementarity problem).

4.2.1 Duality Theory

The basic idea in Lagrangian duality is to take the constraints in (4.6) into account by augmenting the objective function with a weighted sum of the constraint functions. The Lagrangian $L : \mathbb{R}^K \times \mathbb{R}^m \times \mathbb{R}^p \rightarrow \mathbb{R}$ is defined as

$$L(\mathbf{x}, \boldsymbol{\lambda}, \boldsymbol{\mu}) = f_o(\mathbf{x}) + \sum_{i=1}^m \lambda_i f_i(\mathbf{x}) + \sum_{j=1}^p \mu_j h_j(\mathbf{x}) \quad (4.7)$$

We refer to λ_i as the *Lagrangian multiplier* associated with the i th inequality constraint $f_i(\mathbf{x}) \leq 0$; similarly we refer to μ_j as the Lagrangian multiplier associated with the j th equality constraint $h_j(\mathbf{x}) = 0$. We assume the feasible set $\mathcal{D} = \bigcap_{i=0}^m (f_i \leq 0) \cap \bigcap_{j=1}^p (h_j = 0)$ is nonempty, and denote a solution of (4.6) by \mathbf{p}^* .

The vector $\boldsymbol{\lambda}$ and $\boldsymbol{\mu}$ are called the *dual variables* or *Lagrange multiplier vectors* associated with the problem (4.6). We define the *Lagrange dual function* (or just *dual function*) as

$$g(\boldsymbol{\lambda}, \boldsymbol{\mu}) = \inf_{\boldsymbol{x} \in \mathcal{D}} \left(f_o(\boldsymbol{x}) + \sum_{i=1}^m \lambda_i f_i(\boldsymbol{x}) + \sum_{j=1}^p \mu_j h_j(\boldsymbol{x}) \right). \quad (4.8)$$

When the Lagrangian is unbounded below in \boldsymbol{x} , the dual function takes on the value $-\infty$. Since the dual function is the pointwise infimum of a family affine functions of $(\boldsymbol{\lambda}, \boldsymbol{\mu})$, it is concave, even when the problem (4.6) is not convex.

For each pair $(\boldsymbol{\lambda}, \boldsymbol{\mu})$ with $\boldsymbol{\lambda} \succeq 0$, (element-wise comparison) the Lagrange dual function gives us a lower bound on the optimal value \boldsymbol{p}^* of the optimization problem (4.6). Thus we have a lower bound that depends on some parameters $\boldsymbol{\lambda}, \boldsymbol{\mu}$. A natural question is: What is the best lower bound that can be obtained from the Lagrange dual function? This leads to the optimization problem

$$\begin{aligned} & \text{maximize} && g(\boldsymbol{\lambda}, \boldsymbol{\mu}) \\ & \text{s.t.} && \boldsymbol{\lambda} \succeq 0 \end{aligned} \quad (4.9)$$

This problem is called the *Lagrange dual problem* associated with the problem (4.6). In this context the original problem (4.6) is called the *primal problem*. The term dual feasible is to describe a pair $(\boldsymbol{\lambda}, \boldsymbol{\mu})$ with $\boldsymbol{\lambda} \succeq 0$ and $g(\boldsymbol{\lambda}, \boldsymbol{\mu}) > -\infty$. We refer to $(\boldsymbol{\lambda}^*, \boldsymbol{\mu}^*)$ as *dual optimal* or *optimal Lagrange multipliers* if they are optimal for the problem (4.9). The Lagrange dual problem (4.9) is a convex optimization problem, since the objective to be maximized is concave and the constraint set is convex. This is the case whether or not the primal problem is convex.

The optimal value of the Lagrange dual problem, which we denote \boldsymbol{d}^* , is, by definition, the best lower bound on \boldsymbol{p}^* that can be obtained from the Lagrange dual function. In particular, we have the simple but important inequality

$$\boldsymbol{d}^* \leq \boldsymbol{p}^* \quad (4.10)$$

which holds even if the original problem is not convex. This property is called *weak duality*. We refer to the difference $\boldsymbol{p}^* - \boldsymbol{d}^*$ as the gap between the optimal value of the primal problem and the best (i.e., greatest) lower bound on it that can be obtained from the Lagrange dual function. The optimal duality gap is always nonnegative. The bound (4.10) can sometimes be used to find a lower bound on the optimal value of a primal problem that

is difficult to solve, since the dual problem is always convex, and in many cases can be solved efficiently. In other words, dual feasible points allow us to determine how suboptimal a given feasible point is, without knowing the exact value of \mathbf{p}^* . If the equality

$$\mathbf{d}^* = \mathbf{p}^* \quad (4.11)$$

holds, i.e., the optimal duality gap is zero, then we say that *strong duality* holds. This means that the best bound that can be obtained from the Lagrange dual function is tight. Strong duality holds when the primal problem is convex. There are many results that establish conditions on the problem, beyond convexity, under which strong duality holds. These conditions are called constraint qualifications. One simple constraint qualification is *Slater's condition*: There exists an \mathbf{x} interior to \mathcal{D} such that

$$f_i(\mathbf{x}) < 0, \quad i = 1, \dots, m. \quad h(\mathbf{x}) = 0. \quad (4.12)$$

Such a point is sometimes called *strictly feasible*, since the inequality constraints hold with strict inequality.

In the context of nonconvex multiuser spectrum optimization problems in wireless communications, the duality theory plays a significant role. In Chapter 5, the multiuser spectrum optimization of multicarrier communications systems is modeled through its dual problem. In fact, [16] showed that the duality gap of nonconvex optimization problem for the multiuser spectrum optimization problem in *multicarrier* systems is zero when the number of frequency carriers goes to infinity. This observation leads to a low complexity algorithm which evaluates a tight lower bound on the performance optimal values.

An alternative way in order to check whether the solutions of Lagrange dual problem are optimal for primal problem, is to investigate whether they satisfy the KKT conditions.

4.2.2 KKT Conditions

We now assume that the function $f_o, \dots, f_m, h_1, \dots, h_p$ are differentiable (and therefore have open domains), but we make no assumptions yet about convexity. Let \mathbf{x}^* and $(\boldsymbol{\lambda}^*, \boldsymbol{\mu}^*)$ be any primal and dual optimal points with zero duality gap. Since \mathbf{x}^* minimizes $L(\mathbf{x}, \boldsymbol{\lambda}^*, \boldsymbol{\mu}^*)$ over \mathbf{x} , it follows that its gradient must vanish at \mathbf{x}^* , i.e.,

$$\nabla f_o(\mathbf{x}) + \sum_{i=1}^m \lambda_i \nabla f_i(\mathbf{x}) + \sum_{j=1}^p \mu_j \nabla h_j(\mathbf{x}) = 0 \quad (4.13)$$

Thus we have

$$f_i(\mathbf{x}^*) \leq 0, i = 1, \dots, m \quad (4.14)$$

$$h_i(\mathbf{x}^*) = 0, i = 1, \dots, p \quad (4.15)$$

$$\lambda_i^* \geq 0, i = 1, \dots, m \quad (4.16)$$

$$\lambda_i^* f_i(\mathbf{x}^*) = 0, i = 1, \dots, m \quad (4.17)$$

$$\nabla f_o(\mathbf{x}) + \sum_{i=1}^m \lambda_i \nabla f_i(\mathbf{x}) + \sum_{j=1}^p \mu_j \nabla h_j(\mathbf{x}) = 0 \quad (4.18)$$

which are called the Karush-Kuhn-Tucker (KKT) conditions [64]. To summarize, for *any* optimization problem with differentiable objective and constraint functions for which strong duality holds, any pair of optimal and dual optimal points must satisfy the KKT conditions. The KKT necessary conditions are sufficient for optimality if the objective function and the inequality constraints are continuously differentiable convex functions and the equality constraints are affine functions. The KKT conditions play an important role in optimization. In a few special cases it is possible to solve the KKT conditions (and therefore, the optimization problem) analytically. A common method is to transform the problem into a *Linear/Non-Linear Complementarity Problem*. Often, these problems boils down to some iterative algorithms where each iteration is a linear or quadretic programming problem. These approaches are out of the scope of this dissertation. The interested readers are referred to [65] or the reference book by Cottle [66].

4.3 Elements of Game Theory

Game theory is a field of applied mathematics that describes and analyzes interactive decision situations. It provides analytical tools to predict the outcome of complex interactions among rational entities, where rationality demands strict adherence to a strategy based on perceived or measured results. The main areas of application of game theory are economics, political science, biology and sociology. From the early 1990s, engineering and computer science have been added to this list. The rational decision makers in a game are referred to as players. In the most straightforward approach, players select a single action from a set of feasible actions. Interaction between the players is represented by the influence that each player has on the resulting outcome after all players have selected their actions. Each player evaluates the resulting outcome through a payoff or utility function representing her objectives.

Formally, a normal form of a game G is given by $G = (\mathcal{I}, \mathcal{A}, \{w_i\})$ where $\mathcal{I} = \{1, 2, \dots, K\}$ is the set of players (decision makers), \mathcal{A}_i is the action set (strategy set) for player i , $\mathcal{A} = \mathcal{A}_1 \times \mathcal{A}_2 \times \dots \times \mathcal{A}_K$ is the Cartesian product of the sets of actions available to each player, and $\{w_i\} = \{w_1, \dots, w_K\}$ is the set of utility functions that each player i wishes to maximize, where $w_i : \mathcal{A} \rightarrow \mathbb{R}$. An strategy can be either pure or mixed. A *pure strategy* provides a complete definition of how a player will play a game. However, a mixed strategy is an assignment of a probability to each pure strategy. This allows for a player to randomly select strategy. Since probabilities are continuous, there are infinitely many mixed strategies available to a player, even if their strategy set is finite. We focus on pure strategies first. Mixed strategies discussed in more detail in a subsequent section where we present stochastic games.

The utility can represent either a cost function or a payoff function. Without loss of generality, we considered a payoff function w_i and the corresponding maximization problem here. For every player i , the utility function is a function of the action chosen by player i , a_i and the actions chosen by all the players in the game other than player i , denoted as \mathbf{a}_{-i} . Together, a_i and \mathbf{a}_{-i} make up the action tuple \mathbf{a} . An action tuple is a unique choice of actions by each player. From this model, steady-state conditions known as *Nash equilibria* can be identified. Before describing the Nash equilibrium we define the best response of a player as an action that maximizes her payoff function for a given action tuple of the other players. Mathematically, $\bar{a}(a_{-i})$ is a best response by player i to a_{-i} if

$$\bar{a}(a_{-i}) \in \{a_i | a_i \in \mathcal{A}_i, \arg \max w_i(a_i, \mathbf{a}_{-i})\} \quad (4.19)$$

A Nash equilibrium (NE) is an action tuple that corresponds to the mutual best response: for each player i , the action selected is a best response to the actions of all others. Equivalently, a NE is an action tuple where no individual player can benefit from unilateral deviation. Formally, the action tuple $\mathbf{a}^* = (a_1^*, a_2^*, \dots, a_K^*)$ is a NE if

$$w_i(a_i^*, \mathbf{a}_{-i}^*) \geq w_i(a_i, \mathbf{a}_{-i}^*) \quad , \forall a_i \in \mathcal{A}_i, \forall i \in \mathcal{I} \quad (4.20)$$

The action tuples corresponding to the Nash equilibria are a consistent prediction of the outcome of the game, in the sense that if all players predict that a Nash equilibrium will occur then no player has any incentive to choose a different strategy. There are issues with using the Nash equilibrium as a prediction of likely outcomes (for instance, what happens when multiple such equilibria exist?). There are also refinements to the concept of Nash equilibrium tailored to certain classes of games.

	Normal	High
Normal	(win,win)	(win much,lose much)
High	(lose much,win much)	(lose,lose)

Table 4.1: Payoff matrix

There is no guarantee that a Nash equilibrium, when one exists, will correspond to an efficient or desirable outcome for a game (indeed, sometimes the opposite is true). *Pareto* optimality is often used as a measure of the efficiency of an outcome. An outcome is Pareto optimal if there is no other outcome that makes every player at least as well off while making at least one player better off. Mathematically, we can say that an action tuple $\mathbf{a} = (a_1, a_2, \dots, a_K)$ is Pareto optimal if and only if there exists no other action tuple $\mathbf{b} = (b_1, b_2, \dots, b_K) \in \mathcal{A}$ such that $w_i(\mathbf{b}) \geq w_i(\mathbf{a})$ for $i \in \mathcal{I}$ and $w_k(\mathbf{b}) > w_k(\mathbf{a})$, for at least one $k \in \mathcal{I}$.

Example: Prisoner's Dilemma in Wireless Communications A strategic games well-known for being non efficient is the Prisoners Dilemma. The game models a situation in which there are gains from cooperation but each player has an incentive to "free ride" whatever the other player chooses. This model is important because many other situations have similar structures. Consider a two-user MAC, in which two users (transmitters) compete to send information towards a single base station (receiver). Suppose that users can only transmit with one of the two power levels, i.e., normal power (denote by "Normal") or very high power (denote by "High"). They must decide simultaneously (without communication) which power level to choose. We can model this problem as a static game, in which the player set is $\mathcal{I} = \{1, 2\}$, and each player i has the same action set $\mathcal{A} = \{Normal, High\}$. Typically, the payoff set \mathbf{w} can be generalized to the following matrix shown in Table 3.1. In each entry (a, b) , the values a and b represent the payoffs of player 1 and 2, respectively. Intuitively, we have the following observations:

- If both users transmit with high power, they will suffer from the increased interference caused by the other, which results in a "lose-lose" situation.
- If one user transmit with normal power and the other transmits with high power, compared to the "lose-lose" case, the former will get a worse performance (denote by "lose much") and the latter will benefit from the reduced interference and enjoy a better performance (denote by "win much").

- if both users transmit with normal power, the result is "win-win".

Obviously, to find the solution of this problem is beyond the capability of optimization theory, since user 1's best strategy depends on the strategy chosen by user 2, which user 1 does not know, and reciprocally for user 2. One may guess that both users must strictly prefer to transmit with normal power, which results in "win-win". However, it is not the solution of this game, i.e., it is not a natural outcome of selfish and rational players. It might be quite surprising that the only solution, i.e., NE, of this game is the "lose-lose" situation. The reason is the following: from player 1's standpoint, she strictly prefers to choose "High", because she is always better off regardless of player 2's choice, since "win much" > "win" and "lose" > "lose much". And similarly for player 2. From Definition 4.20, the policy where both players choose "High" resulting in "lose-lose", is a NE, and it is the only strategy NE in this game.

Methodologies for Analyzing Equilibrium

In general, to analyze Nash equilibrium, one needs to consider three main aspects:

- Existence - Does an equilibrium exist?
- Uniqueness - Does there exist a unique equilibrium or multiple ones?
- Equilibrium selection - How to select an equilibrium from multiple ones?

Existence is the very first question that naturally comes into our mind, since it is known that, in general, an equilibrium point does not necessarily exist [67]. Mathematically speaking, proving the existence of an equilibrium is equivalent to prove the existence of a solution to a fixed-point problem. Since the existence of the fixed-point hints the existence of some strategy set which is a best response to itself, no player could increase her payoff by deviating, and so it is an equilibrium. In literature, there exists several theorems providing sufficient conditions for the existence of an equilibrium. There are many scenarios assuming usual wireless channel models and performance metrics where the existing theorems can be applied. For example, channel capacity (3.4) has desirable convexity properties satisfying the conditions of the following well-known theorem.

Theorem 2. (*Debreu's sufficient condition*) [68] *If the strategy sets \mathcal{A}_i are nonempty, compact, and convex subsets of an Euclidean space, and if the payoff functions w_i are continuous in \mathbf{a} and quasi-concave in a_i , there exists a pure strategy Nash equilibrium.*

Uniqueness of NE is the second fundamental problem that we need to address when the existence is ensured. The uniqueness of an equilibrium is a very desirable property, if we wish to predict what will be the network behavior. Unfortunately, there are not many general results for the uniqueness analysis. For *constrained concave K-person games*, useful sufficient conditions for the uniqueness of NE are provided in [69]. It is shown that the uniqueness is guaranteed if the payoff functions satisfy the so called *diagonally strictly concave* condition. However, there are many important scenarios where the equilibrium is not unique, e.g., routing games [70], coordination games [71], non-cooperative games with correlated constraints together with the concept of *generalized Nash equilibrium* [72], etc.

Equilibrium selection is a topic which lately attracted much research. However this area is outside the scope of the current dissertation.

If a game is non-concave, it may still have some appealing properties that ensure the existence of pure NE. This is the case for two interesting classes of games for which the existence of pure Nash equilibria is obtained under certain conditions, namely (i) the class of potential games [73]; (ii) the class of supermodular games [62].

Supermodular(submodular) games are those characterized by *strategic complementarities*. Informally, this means that with some technical conditions on the strategy space (essentially, the lattice property), the supermodular property ensures that the maximizer of a player's payoff function is increasing in the strategy values of the other players. Hence, although there is no direct coordination among the players, supermodularity (submodularity) still provides incentive for all the players to increase or decrease strategies in the same direction. In other words, the incentive of the players are *compatible*. An important implication of this monotonicity is that one can construct simple algorithms to compute Nash equilibria. Such algorithms generate a monotone sequence of strategies converging to Nash equilibria under mild technical conditions, such as compactness of the strategy space and continuity of the payoff functions [62, 74]. Supermodular games are interesting for a number of reasons including

- They arise in many models.
- One can establish the existence of a pure strategy equilibrium without requiring the quasiconcavity of the payoff functions.
- NEs can be attained using greedy best-response type algorithms.
- The equilibrium set is ordered, i.e., it has a smallest and a largest

element and there exists a simple method in order to converge to either ones.

The following monotonicity property in maximizing a supermodular function is known. This property implies that the maximizer with respect to a_i is increasing in \mathbf{a}_{-i} . Let

$$BR_i(\mathbf{a}_{-i}) = \arg \max_{a_i \in \mathcal{A}_i} w_i(a_i, \mathbf{a}_{-i}). \quad (4.21)$$

be the best response of user i to strategy \mathbf{a}_{-i} . Then, $\mathbf{a}_{-i} \leq \mathbf{a}'_{-i}$ implies $BR_i(\mathbf{a}_{-i}) \leq BR_i(\mathbf{a}'_{-i})$

In applications, it is often requested to allow the strategy space of each player to depend on the other player's strategy. Assume $\mathcal{S}_i(a_{-i})$ as the strategy space of player i , given other players' strategies are set to a_{-i} . Let us introduce the same property for strategy profiles.

Definition 14. (*Monotonicity of Strategy Profiles*) [74] *Let A and B denote two strategy spaces and \wedge and \vee denote the componentwise min and max operators. Let the order \preceq between two strategy spaces A and B defined as: $A \preceq B$, if for any $a \in A$ and $b \in B$, we have $a \wedge b \in A$ and $a \vee b \in B$. The strategy set $\mathcal{S}_i(a_{-i})$ satisfies the ascending property if $a_{-i} \leq a'_{-i}$ implies $\mathcal{S}_i(a_{-i}) \preceq \mathcal{S}_i(a'_{-i})$.*

We now introduce the class of supermodular(submodular) games.

Definition 15. (*Supermodular/submodular Game*) [74] *The strategic form game $(\mathcal{I}, (\mathcal{A}_i), (w_i))$ is a supermodular(submodular) game if for all i ,*

1. \mathcal{A}_i is a compact subset of \mathbb{R} or more generally \mathcal{A}_i is a sublattice of \mathbb{R}^K .
2. w_i is upper semi continuous in a_i and continuous in a_{-i}
3. the strategy profile \mathcal{A}_i satisfies the ascending property
4. function w_i is supermodular(submodular) in (a_i, a_{-i})

Topkis [62] proved that the equilibrium set in a supermodular game is ordered.

Corollary 1. *Assume $(\mathcal{I}, (\mathcal{A}_i), (w_i))$ is a supermodular game. Let*

$$BR_i(a_{-i}) = \arg \max_{a_i \in \mathcal{A}_i} w_i(a_i, a_{-i}). \quad (4.22)$$

then (i) $BR_i(a_{-i})$ has a greatest and least element, denoted by $\overline{BR}_i(a_{-i})$ and $\underline{BR}_i(a_{-i})$, (ii) if $\hat{a}_{-i} \geq a_{-i}$ then $\overline{BR}_i(\hat{a}_{-i}) \geq \overline{BR}_i(a_{-i})$ and $\underline{BR}_i(\hat{a}_{-i}) \geq \underline{BR}_i(a_{-i})$.

By [75], supermodular games have weak finite improvement path (FIP), i.e., from any initial action vector, there exists a sequence of selfish adaptations that lead to a NE. Specifically for supermodular games, when the decision rules for all players are best responses, play will converge to a NE [75].

In general, there exist multiple Nash equilibria for supermodular game. The convergence to a specific equilibrium point depends critically on the choice of strategy profile at each iteration and on the initial point of the algorithm. In other words, if all players starts at the smallest (largest) point of their strategy space and that, in each iteration they pick the smallest (largest) element of the sublattice of maximizers, the algorithm will converge to the smallest (largest) NE of the game.

The notion S-modularity was developed by Yao [74]. S-modularity allows the objective function to be supermodular in some variables and submodular in others. It models both compatible and conflicting incentives, and hence conveniently accommodates a wide variety of applications. As an example, power control in wireless network has been analyzed within this framework [31]. This is due to the fact that the capacity function in wireless communications is a supermodular function of the transmitting power and the interfering powers. Through S-modularity theory, the monotone convergence of distributed power control algorithms can be directly obtained [28,30,31,76–79].

The study of potential games is outside of the scope of this dissertation. The interested readers are recommended to refer to [73,80,81].

4.3.1 Bayesian Game

A game *with incomplete information* is a game wherein the players can begin to plan their moves while at least one player does not know the complete description of the game, i.e., he does not know either one or several of the following [82,83]:

- The payoff function of the other player(s)
- The available strategies of the other player(s)
- The information available to the other player(s)

We will introduce the notion of a player's type to describe the private information of a player. A player's type fully describes any information available to her which is not common knowledge. A player may have several types, even an infinity of types, one for each possible state of her private information. Each player knows her own type with complete certainty. Her

beliefs about other players' types are captured by a *common knowledge joint probability distribution* over the others' types.

We can think of the game as beginning with a move by Nature, which assigns a type to each player. Nature's move is imperfectly observed, however each player observes the type which nature has bestowed upon her, but no player directly observes the type bestowed upon any other player. We can think of the game which follows as being played by a single type of each player, where at least one player doesn't know which type of some other player she is facing.

To define a Bayesian game, we must specify a set of players $\mathcal{I} = 1, \dots, K$ and, for each player $i \in \mathcal{I}$, we must specify a set of possible actions \mathcal{A}_i , a set of possible types \mathcal{T}_i , a probability function p_i , and a utility function w_i . We denote a type profile as K-tuple of types, one for each player, i.e., $\mathbf{t} = (t_1, \dots, t_K) \in \mathcal{T} \equiv \prod_{i \in \mathcal{I}} \mathcal{T}_i$, where \mathcal{T} is the type-profile space. When we focus on the types of a player's opponents, we consider deleted type profiles of the form $\mathbf{t}_{-i} = (t_1, \dots, t_{i-1}, t_{i+1}, \dots, t_K) \in \mathcal{T}_{-i}$, the set of possible type excluding \mathcal{T}_i . The probability function $\mathbb{P}_i(\mathbf{t}_{-i}|t_i)$ in the Bayesian game is a function from \mathcal{T}_{-i} into $\Delta(\mathcal{T}_{-i})$, the set of probability distributions over \mathcal{T}_{-i} . That is, for any possible type $t_i \in \mathcal{T}_i$, the probability function must specify a probability distribution $\mathbb{P}_i(\cdot|t_i)$ over the set \mathcal{T}_{-i} , representing what player i would believe about the other players' type if his own type were t_i . For any player $i \in \mathcal{I}$, the utility function w_i in the Bayesian game must be a function from $\mathcal{T} \times \mathcal{A}$ into the real numbers \mathbb{R} . These structure together define a Bayesian game $\Gamma^b = (\mathcal{I}, (\mathcal{A}_i)_{i \in \mathcal{I}}, (\mathcal{T}_i)_{i \in \mathcal{I}}, (\mathbb{P}_i)_{i \in \mathcal{I}}, (w_i)_{i \in \mathcal{I}})$. When we study such a Bayesian game Γ^b , we assume that each player i knows the entire structure of the game and his own actual type in \mathcal{T}_i and this fact is common knowledge among all the players.

We assume that there is an objective probability distribution $\mathbb{P} \in \Delta(\mathcal{T})$ over the type space \mathcal{T} , which nature consults when assigning types. In other words, the probability with which nature draws the type profile $\mathbf{t} = (t_1, \dots, t_K)$ and hence assigns type t_1 to player 1, type t_2 to player 2, etc .. is $\mathbb{P}(\mathbf{t})$. The marginal distribution of player i 's type is $\mathbb{P}_i \in \Delta(\mathcal{T}_i)$, where

$$\mathbb{P}_i(t_i) = \sum_{\mathbf{t}_{-i} \in \mathcal{T}_{-i}} \mathbb{P}(t_i, \mathbf{t}_{-i}) \quad (4.23)$$

The beliefs of user i , denoted by $\mathbb{P}_i(\mathbf{t}_{-i}|t_i)$, represent that opponents' types are a particular deleted type profile $\mathbf{t}_{-i} \in \mathcal{T}_{-i}$ given that player i 's known type is t_i . By Bayes' Rule we have

$$\mathbb{P}_i(\mathbf{t}_{-i}|t_i) = \frac{\mathbb{P}(\mathbf{t})}{\mathbb{P}_i(t_i)} \quad (4.24)$$

Player i 's knowledge of her own type may or may not affect her beliefs about the types of her opponents. When players' types are independent, the probability of a particular type profile \mathbf{t} is just the product of the players' marginal distributions, each evaluated at the type t_j specified by \mathbf{t} , i.e., $\forall \mathbf{t} \in \mathcal{T}$,

$$\mathbb{P}(\mathbf{t}) = \prod_{j \in I} \mathbb{P}_j(t_j) \quad (4.25)$$

Therefore, when players' types are independent, player i 's subjective beliefs about others' types are independent of her own type:

$$\mathbb{P}_i(\mathbf{t}_{-i}|\mathbf{t}_i) = \prod_{j \in I \setminus \{i\}} \mathbb{P}_j(t_j) \quad (4.26)$$

A pure strategy for player i in a static Bayesian game is type contingent; it is a function $\sigma_i : \mathcal{T}_i \rightarrow \mathcal{A}_i$. The space of all such functions and hence player i 's pure-strategy space is $\Sigma_i = \mathcal{A}_i^{\mathcal{T}_i}$, i.e., \mathcal{A}_i possible strategies per user type. For a particular type t_i of player i , her strategy σ_i specifies some action $a_i = \sigma_i(t_i) \in \mathcal{A}_i$. A mixed strategy $u_i : \mathcal{T}_i \rightarrow \mathcal{A}_i$ for player i assigns a probability to each pure strategy $a_i \in \mathcal{A}_i$ for each type of player i ; i.e., $\forall t_i \in \mathcal{T}_i, u_i(a_i|t_i)$, where $u_i(a_i|t_i)$ indicates the probability of a_i given t_i . Since probabilities are continuous, there are infinitely many mixed strategies available to a player, even if their strategy set is finite.

Consider a particular player $i \in I$ and a particular one of her types $t_i \in \mathcal{T}_i$. Assume that her $K - 1$ opponents' types are described by some deleted type profile $\mathbf{t}_{-i} \in \mathcal{T}_{-i}$ and that they play some deleted action profile $\mathbf{a}_{-i} \in \mathcal{A}_{-i}$. If player i chooses an action $a_i \in \mathcal{A}_i$, her utility will be $w_i((a_i, \mathbf{a}_{-i}), (t_i, \mathbf{t}_{-i}))$.

Now assume player i knows the strategies $\mathbf{a}_{-i} \in \mathcal{A}_{-i}$ her opponents are playing; i.e., she knows what actions they would take for any given set of types. However, she doesn't know their realized types, so she doesn't know the actual deleted action profile \mathbf{a}_{-i} which will occur as a result of their type-contingent strategies. What action $a_i \in \mathcal{A}_i$ should player i choose? Although player i doesn't know \mathbf{t}_{-i} , she does know the probability distribution $\mathbb{P}(\mathbf{t})$ by which nature generates type profiles additionally she knows her own type t_i , upon which she conditions her subjective probability about the types \mathbf{t}_{-i} of her opponents. For any particular combination \mathbf{t}_{-i} of other players' types, player i assesses this combination the probability $\mathbb{P}_i(\mathbf{t}_{-i}|t_i)$. Therefore she

also adds this probability to the event that her opponents will choose the particular deleted action profile $\mathbf{a}_{-i}(\mathbf{t}_{-i}) \in \mathcal{A}_{-i}$. Player i 's *expected utility*, then, given player i 's knowledge of her own type t_i and of her opponents' type-contingent strategies \mathbf{a}_{-i} , corresponding to action $a_i \in \mathcal{A}_i$, is

$$\sum_{\mathbf{t}_{-i} \in \mathcal{T}_{-i}} \mathbb{P}_i(\mathbf{t}_{-i}|t_i) w_i((a_i, \mathbf{a}_{-i}(\mathbf{t}_{-i})), (t_i, \mathbf{t}_{-i})) \quad (4.27)$$

For a_i to be a best response by type t_i of player i , that choice must maximize over her action space \mathcal{A}_i . We define player i 's best-response $BR_i : \mathcal{A}_{-i} \times \mathcal{T}_i \rightarrow \mathcal{A}_i$, mapping opponents strategy profiles and player- i type into player- i actions, by

$$BR_i(\mathbf{a}_{-i}, t_i) = \arg \max_{a_i \in \mathcal{A}_i} \sum_{\mathbf{t}_{-i} \in \mathcal{T}_{-i}} \mathbb{P}_i(\mathbf{t}_{-i}|t_i) w_i((a_i, \mathbf{a}_{-i}(\mathbf{t}_{-i})), (t_i, \mathbf{t}_{-i})) \quad (4.28)$$

A Bayesian Nash equilibrium of a game of incomplete information is a strategy profile $\mathbf{a} \in \mathcal{A}$ maximizing the expected utility of every type of every player given the type contingent strategies of her opponents. Thus, the strategy profile \mathbf{a}^* is a pure strategy *Bayesian equilibrium* if for all $i \in \mathcal{I}$, all $\mathbf{t}_{-i} \in \mathcal{T}_{-i}$ and $t_i \in \mathcal{T}_i$

$$\mathbb{E}_{\mathbf{t}_{-i} \in \mathcal{T}_{-i}} w_i((a_i^*, \mathbf{a}_{-i}^*(\mathbf{t}_{-i})), (t_i, \mathbf{t}_{-i})) \geq \mathbb{E}_{\mathbf{t}_{-i} \in \mathcal{T}_{-i}} w_i((a_i, \mathbf{a}_{-i}^*(\mathbf{t}_{-i})), (t_i, \mathbf{t}_{-i})) \quad (4.29)$$

where

$$\mathbb{E}_{\mathbf{t}_{-i} \in \mathcal{T}_{-i}} w_i((a_i, \mathbf{a}_{-i}(\mathbf{t}_{-i})), (t_i, \mathbf{t}_{-i})) = \sum_{\mathbf{t}_{-i} \in \mathcal{T}_{-i}} \mathbb{P}_i(\mathbf{t}_{-i}|t_i) w_i((a_i, \mathbf{a}_{-i}(\mathbf{t}_{-i})), (t_i, \mathbf{t}_{-i})) \quad (4.30)$$

Application in Wireless Networks

Geoning He et al., in their recent work on Bayesian game-theoretic approach for distributed resource allocation in fading MAC [84], investigated the application of this class of games in multi-transmitter systems. In an earlier work, El Lai and El Gamal [85] introduced a static noncooperative game in the context of the two-user fading MAC, known as *waterfilling game*. By assuming that users compete maximizing their transmission rates by adjusting their transmit powers, the authors show that there exists a unique Nash equilibrium [86] which corresponds to the maximum sum-rate point of the

capacity region. This claim is somewhat surprising, since the Nash equilibrium is often inefficient compared to the Pareto optimality. However, their results rely on the fact that both transmitters have complete knowledge of the CSI, and in particular, perfect CSI of all transmitters in the network. This assumption is rarely realistic in practice. Thus, this power allocation game needs to be reconstructed with some realistic assumptions made about the knowledge level of mobile devices. Under this consideration, it is of great interest to investigate scenarios in which devices have *incomplete information* about their opponents, for example, a transmission entity is aware of its own channel gain, but unaware of the channel gains of other devices. Over the last ten years, Bayesian game-theoretic tools have been used to design distributed resource allocation strategies only in a few contexts, for example, CDMA networks [87, 88], multicarrier interference networks [89, 90], as well as fading MAC [84]. The fourth chapter of current dissertation represents our contribution to this topic.

4.3.2 Markov Equilibria of Stochastic Game

Stochastic games were first introduced by Shapley (1935) [91]. In such games, players meet for a number of periods. The nature of the game they play changes from one period to another and can be described by a *state variable*. That state variable evolves according to a *stochastic process* parameterized by the past history of the game. Stochastic games provide us with a way of modeling dynamic behavior in a changing environment. Full characterization of the set of equilibria of a stochastic game is an intractable problem in many cases, due to the complex dynamic structure of these equilibria. A more achievable objective consists in describing the *Markov equilibria* of a stochastic game. In Markov equilibria, player's action at every period is a function of the current state variables only. Strong existence results are obtained in the case of finite or countable state space in [92]. In [93], a proof of existence of stationary Markov equilibria in pure strategies for a class of stochastic games with a continuum of states is provided.

It is well known that identifying equilibrium policies (even in the absence of constraints) is hard. Unlike the situation in Markov Decision Process (MDP) in which strategies are known to exist (under suitable conditions), and unlike the situation in constrained MDPs with a multichain structure, in which optimal Markov policies exist [94–98], we know that equilibrium strategies in stochastic games depend in general on the whole history. This difficulty has motivated researchers to search for various possible structures of stochastic games in which saddle point policies exist among stationary

or Markov strategies and are easier to compute. In [99], Altman et al. considered a non-cooperative *constrained* stochastic game, which is called cost-coupled constrained stochastic games. In this paper, under certain conditions, the existence of NE among Markov strategies is proved.

Application in Wireless Communications

The dynamics in wireless networks can be categorized into two types, one is the disturbance due to the environment, and the other is the impact caused by competing users. The stochastic behavior of the competitors, the time-varying channel conditions experienced by the user of interest, and the time-varying source traffic that needs to be transmitted by the user are some of the examples. These types of dynamics are generally modeled as stationary processes. For instance, the use of each channel by a user can be modeled as a two-state Markov chain with ON/OFF states. The channel conditions can be modeled using a finite-state Markov model. The packet arrival of the source traffic can be modeled as a Poisson process (Section 3.1.2). Such an approach has been used to design the cross layer resource allocation only in a few contexts, namely zero-sum constrained games [100], cognitive radio [101], and MAC with power constraint [39]. The extension of these previous works to the interference networks is presented in chapters 6 and 7.

4.4 Random Matrix Theory in Wireless Communications

In 1999, Tse [43] and Verdu [42] adapted Random Matrix Theory as a tool to analyze multiuser systems. Both considered the performance of linear receivers for CDMA systems, in the limit when the number of users as well as the spreading length tend to infinity, with a fixed ratio. In such asymptotic scenarios, the use of random matrix theory leads to explicit expressions for various measures of interest such as capacity or signal to interference plus noise ratio (SINR). Interestingly, it enables to single out the main parameters of interest that determine the performance in numerous models of communication systems with more or less involved models of attenuation [42, 43, 102–104]. In addition, these asymptotic results provide good approximations for the practical finite size cases. A recent overview on the applications of random matrix theory to information theory is given in the book by Tulino and Verdu [105].

A typical question is to characterize the distribution of the eigenvalues

of random matrices. For finite matrix size this distribution itself is usually random. The real interest in random matrices surged when non-random limit distributions were derived for matrices whose dimensions tend to infinity, among others in 1955 by Wigner [106] and in 1967 by Marchenko and Pastur [107], under simple hypotheses on the distribution of the matrix elements. The introduction of Stieltjes transform [108, 109] then enabled to derive distributions for more general matrix forms: matrices with independent non-identically distributed elements or matrices with correlated elements.

Example of Application in Wireless Communications In information theory, communication over a noisy medium between one or several transmitters and a receiver is often considered. The model can be summarized by a single equation. A significant part of information theoretic literature focuses on vector memoryless channels of the form:

$$\mathbf{y} = \mathbf{H}\mathbf{s} + \mathbf{n} \quad (4.31)$$

Here, \mathbf{y} is the received signal vector of dimension N , if N is the number of received replicas of the transmitted signal. \mathbf{s} is the K -dimensional vector of transmitted signal vector, \mathbf{n} is additive white Gaussian noise with variance σ^2 , and \mathbf{H} is the channel matrix, representing the attenuation that affects the transmitted signal vector. Equation (4.31) covers the cases of a number of multiple access techniques, including but not limited to Code Division Multiple Access (CDMA), Orthogonal Frequency Division Multiple Access (OFDMA) and Multiple Input Multiple Output (MIMO). The characteristics of the channel matrix \mathbf{H} depends on the transmission technique and the channel model considered. Under some assumptions, the capacity perceived replica of transmitted signals is given by the following expression ¹.

$$C = \frac{1}{N} \log \det \left(\mathbf{I} + \frac{1}{\sigma^2} \mathbf{H}\mathbf{H}^H \right) \quad (4.32)$$

Considering the property that the determinant is equal to the product of the

¹For example, the capacity perceived replica of the transmitted signals related to average capacity per chip for CDMA systems, average capacity per received antennas for MIMO systems, average capacity per subcarrier in case of OFDM systems

eigenvalues,

$$C = \frac{1}{N} \sum_{i=1}^N N \log \left(1 + \frac{1}{\sigma^2} \lambda_i(\mathbf{H}\mathbf{H}^H) \right) \quad (4.33)$$

$$= \int \log \left(1 + \frac{1}{\sigma^2} \lambda \right) \frac{1}{N} \sum_{i=1}^N f(\lambda - \lambda_i(\mathbf{H}\mathbf{H}^H)) d\lambda \quad (4.34)$$

$$= \int \log \left(1 + \frac{1}{\sigma^2} \lambda \right) F^{\mathbf{H}\mathbf{H}^H}(\lambda) d\lambda, \quad (4.35)$$

where f denote the empirical probability density function and $F^{\mathbf{H}\mathbf{H}^H}$ denotes the empirical cumulative distribution function of eigenvalues of $\mathbf{H}\mathbf{H}^H$. Thus, as shown by the derivation above, the empirical eigenvalue distribution naturally appears in the expression of the capacity. The knowledge of the empirical eigenvalue distribution of a family of random matrices thus enables to get immediate insight on the performance of the corresponding communication system. In addition, even if the result is obtained in the asymptotic regime, when the dimension of the matrix both tend to infinity with a fixed ratio, the asymptotic results give very good approximations of finite-size system behavior, as shown by simulations, e.g., in Chapter 7.

The large system analysis of multiple access vector channels with random channel vectors is in [42–44]. Effects of interference on large network performance are investigated in [110, 111]. We use results of random matrix theory to design low complexity resource allocation algorithms for interference networks in Chapter 7.

Chapter 5

Distributed Resource Allocation in Slow Frequency-Selective Fading MAC

5.1 Introduction

In wideband transmission, the multipaths can be resolved, and hence the channel has memory. An appropriate model is the time-varying frequency-selective fading channel. Since a wide range of frequency components is used, it is highly unlikely that all parts of the signal will be simultaneously affected by a deep fade. Certain modulation schemes such as OFDM and CDMA are well-suited to employing frequency diversity to provide robustness to fading.

OFDM divides the wideband signal into many slowly modulated narrowband subcarriers, each exposed to flat fading rather than frequency selective fading.

The main role played by OFDM in the recent wireless networks technologies fueled a very intense research on OFDM-based wireless networks. A review of the existing results on resource allocation in OFDM-based multiple access channel is given in Section 3.2.1. The complexity of obtaining the global optimal solutions as well as the trade off in considering the sub-

optimal ones or Nash Equilibriums have been studied through the respective references.

In this chapter, we consider the joint rate and power allocation in a two-user OFDM-based MAC system with a large number of subcarriers and partial channel state information at the transmitters for *slow* frequency selective fading. Each transmitter has knowledge of its own link, which can be estimated locally, but no information about the other transmitter power attenuations. In these conditions, the transmitters are interested in maximizing the throughput, i.e. the rate of information successfully received, allowing for outage events. The total throughput of the system satisfies the time sharing conditions in [16] and the duality approach yields optimum resource allocation asymptotically as $N \rightarrow +\infty$. However, the complexity of an optimization algorithm is still significantly high. Then, we consider a Bayesian game based on suboptimal dual cost functions. The Bayesian game boils down into *per subcarrier* games and a *global* game. The first games determine Nash equilibria for power and rate allocation parametric in the Lagrangian coefficients of the dual utility functions. The following global game, based on the solution of a set of submodular games, provide the values of the Lagrangian coefficients at the Bayesian Nash equilibria. We propose an algorithm for the search of all the Bayesian Nash equilibria of the game. The performance of the joint power and rate allocation game is assessed and compared to the performance of the optimum power allocation and uniform power allocation for the two cases of complete and partial channel knowledge at the transmitters, respectively.

Simulations show that all the NEs obtained from the game are those wherein only one transmitter emits with full power and the other remains off. On the contrary, the optimum power allocations for the case of complete channel state information contains solutions which have the superposition of two users' power on the same channel. However, in the later case, the solutions can only be obtained through an iterative algorithm whose convergence to some local optimal point depends on the choice of the initial value. Comparing the performance of the optimal solution averaged over several initial points and the NE chosen through the selection criteria, shows that the NE performs near optimal in this network setup.

5.2 System Model

We consider a frequency selective multiple access channel (MAC) with $K = 2$ independent transmitters and a receiver. Orthogonal frequency division mul-

time-division multiplexing (OFDM) modulation over N subcarriers is applied. In each subcarrier the channel is flat fading. Power attenuation of the channel between transmitter k and the receiver over subcarrier n is denoted by g_k^n . Channel attenuations take values in a discrete set Φ_k^n with a certain probability distribution $\gamma_k^n(g_k^n)$. We assume that the channel is block fading, i.e. the channel is constant during the transmission of a codeword and changes from a codeword to the following one. Furthermore, we assume that each transmitter has a perfect knowledge of the channel attenuations of its own link, i.e. transmitter k knows exactly g_k^n , $n = 1, \dots, N$, and has statistical knowledge of the channel attenuations on all the links, i.e. $\gamma_k^n(g_k^n)$, $k \in \{1, 2\}$ and $n = 1, \dots, N$. Note that this is a realistic assumption for time division duplex (TDD) systems without feedback channels where the channels gains g_k^n from transmitter k to the destination can be estimated at the transmitter via the received signal from the destination assuming that the power attenuation in the two directions is identical (reciprocity principle). We denote by $p_k^n \in \mathbb{R}^+$ the power transmitted by user k on subcarrier n and by $R_k^n \in \mathbb{R}^+$ the information rate over the same subcarrier. The signal at the receiver is impaired by additive Gaussian noise with variance σ^2 and the receiver adopts single user decoding on each subcarrier. When the realizations of the channel attenuation vector and the transmitted power vector on subcarrier n are $\mathbf{g}^n = (g_1^n, g_2^n)$ and $\mathbf{p}^n = (p_1^n, p_2^n)$, respectively, the maximum achievable rate on subcarrier n by user k is¹

$$r_k^n(\mathbf{p}^n, \mathbf{g}^n) = \log \left(1 + \frac{p_k^n g_k^n}{\sigma^2 + \sum_{j \neq k} p_j^n g_j^n} \right). \quad (5.1)$$

If transmitter k transmits on subcarrier n with a rate R_k^n greater than $r_k^n(\mathbf{p}^n, \mathbf{g}^n)$, the transmitted information cannot be decoded reliably and an outage event happens. Because of the system assumptions, transmitter k has only statistical knowledge of the interference term $\sum_{j \neq k} p_j^n g_j^n$ which can be arbitrarily large or bounded by a maximum value $I_{\text{MAX},k}$. For any finite rate $R_k^n > \log \left(1 + \frac{p_j^n g_j^n}{\sigma^2 + I_{\text{MAX},k}} \right)$ there is a nonzero outage probability

$$\mathbb{P} \left\{ R_k^n > \log \left(1 + \frac{p_j^n g_j^n}{\sigma^2 + \sum_{j \neq k} p_j^n g_j^n} \right) \right\}. \quad (5.2)$$

¹Throughout this work $\log(\cdot)$ is the natural logarithm and the rates are expressed in nat/sec.

If the transmitter can tolerate a nonzero information loss² and considers too restrictive the guaranteed transmission rate $\log\left(1 + \frac{p_j^n g_j^n}{\sigma^2 + I_{\text{MAX},k}}\right)$, it can transmit at a rate R_k^n to attain a throughput

$$\rho_k^n = R_k^n \mathbb{P}\{R_k^n \leq r_k^n(\mathbf{g}^n, \mathbf{p}^n)\} \quad (5.3)$$

defined as the the average rate of information that can be successfully transmitted by transmitter k over subchannel n .

In this context, we study joint power and rate allocation strategies for a transmitter k under a power constraint for each transmitter³ k

$$\sum_{n=1}^N \mathbb{E}_{g_k^n} \{p_k^n(g_k^n)\} \leq \bar{P}_k. \quad (5.4)$$

5.3 Optimum Joint Power and Rate Allocation

In the case of complete channel state information (CSI) at all the transmitters, it is well known (see e.g. [16]) that the optimum rate allocation is given by $R_k^n = r_k^n(\mathbf{g}^n, \mathbf{p}^n)$ and the joint source and rate allocation reduces to the power allocation for the following constrained optimization problem

$$\max_{\mathbf{p}} v(\mathbf{p}, \mathbf{g}) \quad (5.5)$$

$$\text{subject to } \sum_{n=1}^N p_k^n \leq \bar{P}_k \quad k \in \{1, 2\} \quad (5.6)$$

where $\mathbf{p} = (\mathbf{p}^1, \dots, \mathbf{p}^N)$, $\mathbf{g} = (\mathbf{g}^1, \dots, \mathbf{g}^N)$ is given, and the objective function is defined as $v(\mathbf{p}, \mathbf{g}) = \sum_{k=1}^2 \sum_{n=1}^N r_k^n(\mathbf{g}^n, \mathbf{p}^n)$.

This problem is intrinsically non-convex and numerical optimization is difficult. As observed in [16], an exhaustive search would have a complexity exponential in the number of variables which is $2N$. In order to introduce a low complexity solution for this numerical problem we briefly recall the definition of time-sharing condition for an optimization problem of the form (5.5).

²This depends typically on the services supported by the communication. For example, voice services can tolerate a certain level of information loss.

³In the asymptotic case, $N \rightarrow \infty$, this is equivalent to $\sum_{n=1}^N p_k^n \leq \bar{P}_k$.

Definition 16. [16] Let \mathbf{p}^* and \mathbf{p}^Δ be the optimal solutions of the optimization problem (5.5) with $\bar{\mathbf{P}} = (\bar{P}_1, \bar{P}_2)$ equal to $\bar{\mathbf{P}}^* = (\bar{P}_1^*, \bar{P}_2^*)$ and $\bar{\mathbf{P}}^\Delta = (\bar{P}_1^\Delta, \bar{P}_2^\Delta)$, respectively. An optimization problem of the form (5.5) satisfies the time sharing condition if for any $\bar{\mathbf{P}}^*$ and $\bar{\mathbf{P}}^\Delta$, and for any $0 \leq \nu \leq 1$, there always exists a feasible solution \mathbf{p}^\diamond such that $\sum_n p_k^{n\diamond} \leq \nu \bar{\mathbf{P}}^* + (1-\nu)\bar{\mathbf{P}}^\Delta$, and $v(\mathbf{g}, \mathbf{p}^\diamond) \geq \nu v(\mathbf{g}, \mathbf{p}^*) + (1-\nu)v(\mathbf{g}, \mathbf{p}^\Delta)$.

By observing that [16]

- The dual problem (see e.g. [64] for a definition) of a primary problem of the form (5.5) has zero duality gap if the primary problem satisfies the time sharing conditions (see Theorem 1 in [16]);
- The problem (5.5) with $v(\mathbf{g}, \mathbf{p}) = \sum_k \sum_n r_k^n(\mathbf{g}^n, \mathbf{p}^n)$ satisfies the time sharing condition (see Theorem 2 in [16]) as $N \rightarrow \infty$;

the optimization (5.5) reduces to the optimization over the dual problem as $N \rightarrow \infty$. The dual problem has linear complexity in the number of sub-carriers. Note that the complexity is still exponential in the number of transmitters K .

In the case of partial channel knowledge at the transmitters, the joint power and rate allocation is solution to the optimization problem

$$\max_{(\mathbf{p}, \mathbf{R})} u(\mathbf{p}, \mathbf{R}, \mathbf{g}) \quad (5.7)$$

$$\text{subject to } \sum_{n=1}^N p_k^n \leq \bar{P}_k \quad k \in \{1, 2\} \quad (5.8)$$

where $\mathbf{R} = (\mathbf{R}^1, \dots, \mathbf{R}^N)$, $\mathbf{R}^n = (R_1^n, R_2^n)$, $\mathbf{g}_k = (g_k^1, \dots, g_k^N)$ and

$$u(\mathbf{p}, \mathbf{R}, \mathbf{g}) = \sum_{k=1}^2 \sum_{n=1}^N \mathbb{E}_{\mathbf{g}_k} \rho_k^n(g_k^n, p_k^n(\mathbf{g}_k), R_k^n(\mathbf{g}_k)). \quad (5.9)$$

Note that $\rho_k^n(g_k^n, p_k^n(\mathbf{g}_k), R_k^n(\mathbf{g}_k))$ coincides with the function defined in (5.3) but here we underline the dependence of the optimization variables p_k^n and R_k^n on \mathbf{g}_k , the partial knowledge of transmitter k on the channel.

Similarly to the optimization (5.5), the optimization (5.7) is not convex and has exponential complexity in $2N$ variables. As in [16], a low complexity approach based on the dual problem can be proposed and justified by the following Theorem 3.

Theorem 3. *The optimization problem (5.7) satisfies the time-sharing condition in the limit as $N \rightarrow \infty$.*

The proof of this theorem follows along the same lines as Theorem 1 in [16] and is omitted here.

Let us define the Lagrangian

$$L(\mathbf{p}, \mathbf{R}, \boldsymbol{\lambda}) = u(\mathbf{p}, \mathbf{R}, \mathbf{g}) + \sum_{k=1}^K \lambda_k (\bar{P}_k - \sum_{n=1}^N p_k^n), \quad (5.10)$$

with $\boldsymbol{\lambda} = (\lambda_1, \dots, \lambda_K)$, and the dual function

$$q(\boldsymbol{\lambda}) = \max_{(\mathbf{p}, \mathbf{R})} L(\mathbf{p}, \mathbf{R}, \boldsymbol{\lambda}). \quad (5.11)$$

The dual optimization problem is defined as

$$\min_{\boldsymbol{\lambda}} q(\boldsymbol{\lambda}) \quad (5.12)$$

$$\text{subject to } \lambda_k > 0. \quad (5.13)$$

It is worth noticing that the optimization in (5.11) boils down to N independent optimization problems

$$\max_{\mathbf{p}^n, \mathbf{R}^n} \sum_{k=1}^2 \mathbb{E}_{\mathbf{g}^n} (\rho_k^n(g_k, p_k^n(\mathbf{g}_k), R_k^n(\mathbf{g}_k)) - \lambda_k p_k^n). \quad (5.14)$$

The optimization (5.14) focuses on power and rate allocation in a single subcarrier and p_k^n and R_k^n depend only on the knowledge of g_k^n . The optimization (5.14) is still complex. In order to further reduce the complexity of the problem we introduce a Bayesian game.

5.4 Equilibria for Joint Power and Rate Allocation

The previous resource allocation problem can be formulated as a 2-player Bayesian game $\mathcal{G} \equiv (\mathcal{S}, \mathcal{T}, \mathcal{D}, \mathcal{U}, \mathcal{P})$, where $\mathcal{S} \equiv \{1, 2\}$ is the set of players/transmitters, $\mathcal{T} \equiv \mathcal{T}_1 \times \mathcal{T}_2$ is the type set consisting of all possible realizations of the channel attenuation \mathbf{g} with $\mathcal{T}_k = \{\mathbf{g}_k\}$ being the type set for transmitter k , \mathcal{D} is the action set defined by

$$\mathcal{D} \equiv \bigcup_{k=1}^K \left\{ \mathbf{d}_k \mid \mathbf{d}_k = (d_k^1, d_k^2, \dots, d_k^N), d_k^n = (R_k^n, p_k^n), \right. \\ \left. R_k^n \in \mathbb{R}_+, p_k^n \in \mathbb{R}_+ \text{ and } \sum_{n=1}^N \mathbb{E}_{g_k^n} \{p_k^n\} \leq \bar{P}_k \right\}. \quad (5.15)$$

Note that the set of strategies of each transmitter is orthogonal to the strategies of the others and consists of a vector of rate-power pairs, with the powers satisfying the average power constraint (5.4). In game \mathcal{G} , \mathcal{U} is the set of payoff functions with the payoff for transmitter k defined by

$$\rho_k(\mathbf{d}) = \mathbb{E}_{\mathbf{g}} \left(\sum_{n=1}^N R_k^n(\mathbf{g}_k) \mathbf{1} \left\{ R_k^n(\mathbf{g}_k) \leq \log \left(1 + \frac{p_k^n(\mathbf{g}_k) g_k^n}{\sigma^2 + \sum_{j \neq k} p_j^n(\mathbf{g}_j) g_j^n} \right) \right\} \right) \quad (5.16)$$

$$= \mathbb{E}_{g_k} \left(\sum_{n=1}^N R_k^n(\mathbf{g}_k) \Pr \left\{ R_k^n(\mathbf{g}_k) \leq \log \left(1 + \frac{p_k^n(\mathbf{g}_k) g_k^n}{\sigma^2 + \sum_{j \neq k} p_j^n(\mathbf{g}_j) g_j^n} \right) \mid \mathbf{g}_k \right\} \right) \quad (5.17)$$

where $\mathbf{d} = (\mathbf{d}_1, \mathbf{d}_2)$, $\mathbf{1}(\mathcal{E})$ is the indicator function equal to 1 if the event \mathcal{E} is verified and equal to zero elsewhere. Finally, in \mathcal{G} , \mathcal{P} is the probability set consisting of the probability functions of g_k^n .

Similarly to the optimization problem in Section 5.3, the game \mathcal{G} is not convex and a numerical solution is too demanding. By following the same approach as in Section 5.3 we look at an approximation of the solutions of game \mathcal{G} by considering the dual game $\mathcal{G}^D \equiv (\mathcal{S}, \mathcal{T}, \mathcal{D}^D, \mathcal{U}^D, \mathcal{P})$, where the set \mathcal{U}^D consists of the cost functions

$$C_k^D(\boldsymbol{\lambda}) = \mathbb{E}_{g_k} \max_{(\mathbf{R}_k(\mathbf{g}_k), \mathbf{P}_k(\mathbf{g}_k)) \in \mathcal{D}} L_k(\mathbf{p}, \mathbf{R}, \boldsymbol{\lambda}) \quad (5.18)$$

with

$$L_k(\mathbf{p}, \mathbf{R}, \boldsymbol{\lambda}) = \sum_{n=1}^N R_k^n(\mathbf{g}_k) \mathbb{P} \left\{ R_k^n(\mathbf{g}_k) \leq \log \left(1 + \frac{p_k^n(\mathbf{g}_k) g_k^n}{\sigma^2 + \sum_{j \neq k} p_j^n(\mathbf{g}_j) g_j^n} \right) \mid \mathbf{g}_k \right\} \\ + \lambda_k \left(\bar{P}_k - \sum_n \mathbb{E}_{g_k^n} \{p_k^n\} \right), \quad (5.19)$$

and the action set \mathcal{D}^D is based on the sets

$$\mathcal{D}_k^D = \{\lambda_k | \lambda_k > 0\}. \quad (5.20)$$

The dual game \mathcal{G}^D is convex in $\boldsymbol{\lambda}$. The Nash equilibrium is the vector $\boldsymbol{\lambda}$ such that

$$C_k^D(\lambda_k^*, \boldsymbol{\lambda}_{-k}^*) \leq C_k^D(\lambda_k, \boldsymbol{\lambda}_{-k}^*), \quad \forall \lambda_k > 0 \quad (5.21)$$

$$\boldsymbol{\lambda}_{-k} \equiv (\lambda_1, \dots, \lambda_{k-1}, \lambda_{k+1}, \dots, \lambda_K). \quad (5.22)$$

Note that, for each strategy $\boldsymbol{\lambda}$, the solutions of the system given by

$$\max_{(\mathbf{R}_k(\mathbf{g}_k), \mathbf{P}_k(\mathbf{g}_k)) \in (D)} \mathbb{E}_{\mathbf{g}_k} \{L_k(\mathbf{p}, \mathbf{R}, \boldsymbol{\lambda})\}, \quad \forall k \in \mathcal{S}. \quad (5.23)$$

are required. These solutions are the Nash equilibria of the game $\tilde{\mathcal{G}}_{\boldsymbol{\lambda}} \equiv (\mathcal{S}, \mathcal{T}, \mathcal{D}, \tilde{\mathcal{U}}, \mathcal{P})$, where the set of utility functions $\tilde{\mathcal{U}}$ consists of the functions $\mathbb{E}_{\mathbf{g}_k} \{L_k(\mathbf{p}, \mathbf{R}, \boldsymbol{\lambda})\}$, $k \in \mathcal{S}$.

By following the same lines as in the optimization problem, game $\tilde{\mathcal{G}}_{\boldsymbol{\lambda}}$ can be decomposed into N games, one for each subcarrier. Therefore, the solution of the game \mathcal{G}^D can be decomposed into the solutions of two level of games, a game for each subcarrier whose solutions are functions of the strategy $\boldsymbol{\lambda}$, and a global game based on the solutions of the games for the subcarriers. In the following, we analytically define these two level of games.

Per Subcarrier Game – We define N independent games, one for each subcarrier, in the parameter $\boldsymbol{\lambda}$, $\mathcal{G}_{\boldsymbol{\lambda}}^n \equiv (\mathcal{S}, \mathcal{T}^n, \mathcal{D}^n, \mathcal{U}_{\boldsymbol{\lambda}}^n, \mathcal{P}^n)$, where the type set of transmitter k is the set of possible realizations of g_k^n and \mathcal{T}^n is the product of the type sets of all transmitters. The set of actions \mathcal{D}^n is based on the feasible strategies of user k on subcarrier n , $\mathcal{D}_k^n \equiv (d_k^n | d_k^n = (R_k^n, p_k^n), R_k^n, p_k^n \in \mathbb{R}^+)$. The set of payoffs $\mathcal{U}_{\boldsymbol{\lambda}}^n$ is given by

$$q_k^n(\mathbf{d}^n; \boldsymbol{\lambda}) = \mathbb{E}_{\mathbf{g}_k} \left\{ R_k^n(\mathbf{g}_k) \mathbb{P} \left\{ R_k^n(\mathbf{g}_k) \leq \log \left(1 + \frac{p_k^n(\mathbf{g}_k) g_k^n}{\sigma^2 + \sum_{j \neq k} p_j^n(\mathbf{g}_j) g_j^n} \right) \middle| \mathbf{g}_k \right\} - \lambda_k p_k^n(\mathbf{g}_k) \right\}. \quad (5.24)$$

Finally, the probability set \mathcal{P}^n consists of the probability of channel attenuations g_k^n for $k = 1, 2$.

Global Game – It is the game defined by $\mathcal{G}_{\text{glob}} \equiv (\mathcal{S}, \mathcal{D}_{\text{glob}}, \mathcal{U}^D)$ where the cost function set is \mathcal{U}^D . The action set is $\mathcal{D}_{\text{glob}} \equiv (\boldsymbol{\lambda} | \lambda_k \in \mathbb{R}^+, k = 1, 2, \text{ and } \bar{P}_k - \sum_{n=1}^N \mathbb{E}_{\mathbf{g}_k^n} \{p_k^n(g_k^n, \boldsymbol{\lambda})\} \geq 0)$, where $p_k^n(g_k^n, \boldsymbol{\lambda})$ are the solutions

of the per subcarrier games parametric in $\boldsymbol{\lambda}$. Then, the definition of $\mathcal{D}_{\text{glob}}$ implies that only values of $\boldsymbol{\lambda}$ yielding solutions for $\mathcal{G}_{\boldsymbol{\lambda}}^n$ satisfying the constraint $\bar{P}_k - \sum_{n=1}^N \mathbb{E}_{g_k^n} \{p_k^n(g_k^n, \boldsymbol{\lambda})\} \geq 0$ are of interest for the game $\mathcal{G}_{\text{glob}}$. The cost functions $C_k^{\mathcal{D}}(\boldsymbol{\lambda})$ can be expressed as

$$C_k^{\mathcal{D}}(\boldsymbol{\lambda}) = \sum_{n=1}^N q_k^n(\bar{\mathbf{d}}^n(\boldsymbol{\lambda}); \boldsymbol{\lambda}) + \lambda_k \bar{P}_k \quad k = 1, 2 \quad (5.25)$$

with $\bar{\mathbf{d}}^n(\boldsymbol{\lambda})$ being the solution of the per subcarrier game $\mathcal{G}_{\boldsymbol{\lambda}}^n$. In the following subsections 5.4.1 and 5.4.2 we analyze independently the games $\mathcal{G}_{\text{sub}}^n$ and the global game $\mathcal{G}_{\boldsymbol{\lambda}}$, respectively. In Section 5.5 we provide an algorithm to determine all the Bayesian-Nash equilibria.

5.4.1 Per Subcarrier Games $\mathcal{G}_{\boldsymbol{\lambda}}^n$

We assume that the number of fading states per subcarrier per transmitter is equal to 2. For the sake of notation, we concatenate the power vectors of the two transmitters to form a 4-dimensional column vector, $\mathbf{p} = [p_{11}, p_{12}, p_{21}, p_{22}]^T$, where p_{kj} denotes the power allocation of user k in fading state j . The same notation is used later for channel gains and their probabilities, i.e. $\mathbf{g} = [g_{11}, g_{12}, g_{21}, g_{22}]^T$ and $\boldsymbol{\gamma} = [\gamma_{11}, \gamma_{12}, \gamma_{21}, \gamma_{22}]^T$. Thus, $\mathcal{S} \equiv \{1, 2\}$, the type set of transmitter k on subcarrier n is $\mathcal{T}^n \equiv \{g_{k,1}^n, g_{k,2}^n\}$ and the corresponding probability set is $\mathcal{P}^n \equiv \{\gamma_{k1}^n, \gamma_{k2}^n\}$. We denote the user of interest by subscript $k \in \{1, 2\}$ and the interfering user by subscript $m \in \{1, 2\}, m \neq k$.

In this section, we focus on the resource allocation of any arbitrary subcarrier. The payoff function (5.24) specializes as follows

$$q_k^n(\mathbf{p}^n, \mathbf{R}^n; \boldsymbol{\lambda}) = \gamma_{k1}^n \mathcal{W}_{k1}^n(\mathbf{p}^n, \mathbf{R}^n, \boldsymbol{\lambda}) + \gamma_{k2}^n \mathcal{W}_{k2}^n(\mathbf{p}^n, \mathbf{R}^n, \boldsymbol{\lambda}) \quad (5.26)$$

with

$$\begin{aligned} \mathcal{W}_{kh}^n(\mathbf{R}^n, \mathbf{p}^n, \boldsymbol{\lambda}) = & R_{kh}^n \left(\gamma_{m1}^n \mathbb{1} \left(R_{kh}^n \leq \log \left(1 + \frac{p_{kh}^n g_{kh}^n}{\sigma^2 + p_{m1}^n g_{m1}^n} \right) \right) \right. \\ & \left. + \gamma_{m2}^n \mathbb{1} \left(R_{kh}^n \leq \log \left(1 + \frac{p_{kh}^n g_{kh}^n}{\sigma^2 + p_{m2}^n g_{m2}^n} \right) \right) \right) - \lambda_k p_{kh}^n. \end{aligned} \quad (5.27)$$

Here, $R_{kh}^n = R_k^n(g_{kh}^n, \boldsymbol{\lambda})$ and $p_{kh}^n = p_k^n(g_{kh}^n, \boldsymbol{\lambda})$ are the rate and power allocated by transmitter k on subcarrier n when the channel realization is

g_{kh}^n , and R^n and p^n are the pairs (R_{k1}^n, R_{k2}^n) and (p_{k1}^n, p_{k2}^n) . Throughout this section, we consider a single subcarrier and omit the index n .

By considering the possible values of the indicator functions, (5.27) boils down to the following piecewise function (Chapter 4-Definition 10)

$$\mathcal{W}_{kh}(\mathbf{p}, \mathbf{R}, \boldsymbol{\lambda}) = \begin{cases} R_{kh} - \lambda_k p_{kh} & \frac{g_{kh} p_{kh}}{e^{R_{kh}-1}} - \sigma^2 \geq g_{mg} p_{mg} \\ \gamma_{ms} R_{kh} - \lambda_k p_{kh} & g_{m\ell} p_{m\ell} \leq \frac{g_{kh} p_{kh}}{e^{R_{kh}-1}} - \sigma^2 \leq g_{mg} p_{mg} \\ -\lambda_k p_{kh} & \frac{g_{kh} p_{kh}}{e^{R_{kh}-1}} - \sigma^2 \leq g_{m\ell} p_{m\ell} \end{cases} \quad (5.28)$$

where $g_{mg} p_{mg} = \max(g_{m1} p_{m1}, g_{m2} p_{m2})$ and $g_{m\ell} p_{m\ell} = \min(g_{m1} p_{m1}, g_{m2} p_{m2})$. In other words, index g and ℓ denote the *greatest* and the *lowest* interference, respectively.

When we aim at maximizing \mathcal{W}_{kh} , it is straightforward to recognize that the decision variables p_{kh} and R_{kh} are not independent, but for a certain value p_{kh} of the transmitted power, \mathcal{W}_{kh} is maximized for $R_{kh} = \log(1 + \frac{p_{kh} g_{kh}}{N_0 + p_{m*} g_{m*}})$, being $* \in \{g; \ell\}$. Therefore, our problem reduces to consider the following functions in \mathbf{p} and $\boldsymbol{\lambda}$

$$\mathcal{W}_{kh}(\mathbf{p}, \boldsymbol{\lambda}) = \begin{cases} \text{(I)} & \log(1 + \frac{g_{kh} p_{kh}}{g_{mg} p_{mg} + \sigma^2}) - \lambda_k p_{kh} \\ \text{(II)} & \gamma_{m\ell} \log(1 + \frac{g_{kh} p_{kh}}{g_{m\ell} p_{m\ell} + \sigma^2}) - \lambda_k p_{kh} \\ \text{(III)} & -\lambda_k p_{kh} \end{cases} \quad (5.29)$$

Taking into account the dependency of the decision variables R_{kh} and p_{kh} , the payoff function (5.26) reduces to

$$q_k(\mathbf{p}, \boldsymbol{\lambda}) = \gamma_{k1} \mathcal{W}_{k1}(\mathbf{p}, \boldsymbol{\lambda}) + \gamma_{k2} \mathcal{W}_{k2}(\mathbf{p}, \boldsymbol{\lambda}) \quad (5.30)$$

Note that $\mathcal{W}_{kh}(\mathbf{p}, \boldsymbol{\lambda})$ depends on p_{kh} , the power to be allocated in the channel state g_{kh} . Now, we assume that the power allocation of the interfering user and consequently the interference pairs $(g_{m1} p_{m1}, g_{m2} p_{m2})$ are known. Therefore, the greatest and the lowest interference can be obtained, i.e. $p_{mg} g_{mg}$ and $p_{m\ell} g_{m\ell}$. Then, the best response of user k to this interference would be given by

$$\tilde{p}_{kh} = \arg \max_{p_{kh}} \mathcal{W}_{kh}(\mathbf{p}, \boldsymbol{\lambda}), \quad \forall h \in \{1, 2\} \quad (5.31)$$

and the Nash equilibrium $\bar{\mathbf{p}}$ of the per subcarrier game satisfies the following condition

$$q_k(\bar{p}_k, \bar{p}_m, \boldsymbol{\lambda}) \geq q_k(p_k, \bar{p}_m, \boldsymbol{\lambda}); \forall k, m \in \{1, 2\}, k \neq m, \forall p_k \in \mathcal{R}_+. \quad (5.32)$$

Let us denote the three branches of the function (5.29) by $\mathcal{W}_{kh}^{(x)}$ where $x \in \{(I), (II), (III)\}$. In addition, we denote the best response in a specific branch x by $\tilde{p}_{kh}^{(x)}$ and by \mathbf{p}_{-kh} the vector obtained from \mathbf{p} by suppressing p_{kh} . In the following, we define three disjoint regions for the best response \tilde{p}_{kh} corresponding to the three branches of the function, i.e. $\mathcal{R}_{kh}^{(x)}$, $x \in \{(I), (II), (III)\}$. In other words, if $\tilde{p}_{kh} = \arg \max_{p_{kh}} \mathcal{W}_{kh}(\mathbf{p}, \boldsymbol{\lambda})$ belongs to the region $\mathcal{R}_{kh}^{(x)}$, it satisfies $\tilde{p}_{kh} = \arg \max_{p_{kh}} \mathcal{W}_{kh}^{(x)}(\mathbf{p}, \boldsymbol{\lambda})$.

The following disjoint regions for the best response \tilde{p}_{kh} can be defined: (1) $\mathcal{R}_{kh}^{(I)}$ where $\mathcal{W}_{kh}^{(I)}$ is the maximizing function, i.e. $\tilde{p}_{kh} = \arg \max_{p_{kh}} \mathcal{W}_{kh}^{(I)}(\mathbf{p}, \boldsymbol{\lambda})$. The function $\mathcal{W}_{kh}^{(I)}(\tilde{p}_{kh}^{(I)}, \mathbf{p}_{-kh}, \boldsymbol{\lambda})$ should be positive and the following inequality should be satisfied: $\mathcal{W}_{kh}^{(I)}(\tilde{p}_{kh}^{(I)}, \mathbf{p}_{-kh}, \boldsymbol{\lambda}) > \mathcal{W}_{kh}^{(II)}(\tilde{p}_{kh}^{(II)}, \boldsymbol{\lambda})$; (2) $\mathcal{R}_{kh}^{(II)}$ where $\mathcal{W}_{kh}^{(II)}$ is the maximizing function, i.e. $\tilde{p}_{kh} \in \arg \max_{p_{kh}} \mathcal{W}_{kh}^{(II)}(\mathbf{p}, \boldsymbol{\lambda})$. The function $\mathcal{W}_{kh}^{(II)}(\tilde{p}_{kh}^{(II)}, \mathbf{p}_{-kh}, \boldsymbol{\lambda})$ should be positive and the following inequality should be satisfied: $\mathcal{W}_{kh}^{(II)}(\tilde{p}_{kh}^{(II)}, \mathbf{p}_{-kh}, \boldsymbol{\lambda}) > \mathcal{W}_{kh}^{(I)}(\tilde{p}_{kh}^{(I)}, \boldsymbol{\lambda})$; (3) $\mathcal{R}_{kh}^{(III)}$ where both functions $\mathcal{W}_{kh}^{(I)}(\tilde{p}_{kh}^{(I)}, \mathbf{p}_{-kh}, \boldsymbol{\lambda})$ and $\mathcal{W}_{kh}^{(II)}(\tilde{p}_{kh}^{(II)}, \mathbf{p}_{-kh}, \boldsymbol{\lambda})$ are non-positive. The maximum value of \mathcal{W}_{kh} is equal to zero and $\tilde{p}_{kh} = 0$.

Note that, in a single piece, the function $\mathcal{W}_{kh}^{(x)}(\mathbf{p}, \boldsymbol{\lambda})$ is a concave function of p_{kh} . Therefore, the argument \tilde{p}_{kh} which maximizes $\mathcal{W}_{kh}(\mathbf{p}, \boldsymbol{\lambda})$ in each piece can be obtained directly by the first derivative. The resulting best response of player k is

$$\tilde{p}_{kh} = \begin{cases} \frac{1}{\lambda_k} - \frac{g_{mg}}{g_{kh}} p_{mg} - \frac{\sigma}{g_{kh}} & \in \mathcal{R}_{kh}^{(I)} \\ \frac{\gamma_{m\ell}}{\lambda_k} - \frac{g_{m\ell}}{g_{kh}} p_{m\ell} - \frac{\sigma}{g_{kh}} & \in \mathcal{R}_{kh}^{(II)} \\ 0 & \in \mathcal{R}_{kh}^{(III)} \end{cases} \quad (5.33)$$

The corresponding utility of user k , $\mathcal{W}_{kh}(\tilde{p}_{kh}, \mathbf{p}_{-kh}, \boldsymbol{\lambda})$, is given by the following piecewise function.

$$\mathcal{W}_{kh}(\tilde{p}_{kh}, \mathbf{p}_{-kh}, \boldsymbol{\lambda}) = \begin{cases} \log \frac{g_{kh}}{\lambda_k (g_{mg} p_{mg} + \sigma)} - 1 + \frac{\lambda_k}{g_{kh}} (g_{mg} p_{mg} + \sigma) & \mathbf{p}_m \in \mathcal{R}_{kh}^{(I)} \\ \log \frac{\gamma_{m\ell} g_{kh}}{\lambda_k (g_{m\ell} p_{m\ell} + \sigma)} - \gamma_{m\ell} + \frac{\lambda_k}{g_{kh}} (g_{m\ell} p_{m\ell} + \sigma) & \mathbf{p}_m \in \mathcal{R}_{kh}^{(II)} \\ 0 & \mathbf{p}_m \in \mathcal{R}_{kh}^{(III)} \end{cases} \quad (5.34)$$

Note that the pieces implies constraints on the power value \tilde{p}_{kh} specified as

follows.

$$\begin{aligned}
 \mathcal{R}_{kh}^{(I)} &\equiv \left\{ \mathbf{p}_m | \tilde{p}_{kh} > 0, p_{mg}g_{mg} \leq \frac{\tilde{p}_{kh}g_{kh}}{e^{\lambda_k \tilde{p}_{kh}} - 1} - \sigma, \right. \\
 &\left. \log\left(\frac{p_{ml}g_{ml} + \sigma}{p_{mg}g_{mg} + \sigma}\right) - 1 - \log \gamma_{ml} + \gamma_{ml} + \frac{\lambda_k}{g_{kh}}(p_{mg}g_{mg} - p_{ml}g_{ml}) > 0 \right\}. \\
 \mathcal{R}_{kh}^{(II)} &\equiv \left\{ \mathbf{p}_m | \tilde{p}_{kh} > 0, p_{ml}g_{ml} \leq \frac{\tilde{p}_{kh}g_{kh}}{e^{\frac{\lambda_k \tilde{p}_{kh}}{\gamma_{ml}}} - 1} - \sigma, \right. \\
 &\left. \log\left(\frac{p_{ml}g_{ml} + \sigma}{p_{mg}g_{mg} + \sigma}\right) - 1 - \log \gamma_{ml} + \gamma_{ml} + \frac{\lambda_k}{g_{kh}}(p_{mg}g_{mg} - p_{ml}g_{ml}) < 0 \right\}. \\
 \mathcal{R}_{kh}^{(III)} &\equiv \left\{ \mathbf{p}_m | p_{mg}g_{mg} \geq \frac{\tilde{p}_{kh}g_{kh}}{e^{\lambda_k \tilde{p}_{kh}} - 1} - \sigma, p_{ml}g_{ml} \geq \frac{\tilde{p}_{kh}g_{kh}}{e^{\frac{\lambda_k \tilde{p}_{kh}}{\gamma_{ml}}} - 1} - \sigma \right\} \quad (5.35)
 \end{aligned}$$

The pieces are defined by conditions which are functions of the interfering elements $(p_{ml}g_{ml}, p_{mg}g_{mg})$. Now, by making use of the best responses we determine the Nash equilibria for the per subcarrier game as the intersections of the best responses.

The following theorem provides the set of all power allocations which jointly maximize $\{\mathcal{W}_{11}, \mathcal{W}_{12}, \mathcal{W}_{21}, \mathcal{W}_{22}\}$. These are the Nash equilibria of the per subcarrier game $\mathcal{G}_{\text{sub}}^n$.

Theorem 4. *The per subcarrier game for a 2-transmitters network with the best responses defined as (5.31), has a unique NE if and only if the two following conditions are satisfied: (I) for a pair (λ_1, λ_2) , the matrix \mathbf{M} defined as*

$$\mathbf{M} = \begin{bmatrix} 1 & 0 & \{0, 0, \frac{g_{21}}{g_{11}}, \frac{g_{21}}{g_{11}}, 0\} & \{0, \frac{g_{22}}{g_{11}}, 0, 0, \frac{g_{22}}{g_{11}}\} \\ 0 & 1 & \{0, 0, \frac{g_{21}}{g_{12}}, \frac{g_{21}}{g_{12}}, 0\} & \{0, \frac{g_{22}}{g_{12}}, 0, 0, \frac{g_{22}}{g_{12}}\} \\ \{0, \frac{g_{11}}{g_{21}}, 0, 0, \frac{g_{11}}{g_{21}}\} & \{0, 0, \frac{g_{12}}{g_{21}}, \frac{g_{12}}{g_{21}}, 0\} & 1 & 0 \\ \{0, \frac{g_{11}}{g_{22}}, 0, 0, \frac{g_{11}}{g_{22}}\} & \{0, 0, \frac{g_{12}}{g_{22}}, \frac{g_{12}}{g_{22}}, 0\} & 0 & 1 \end{bmatrix} \quad (5.36)$$

is full rank, and (II) the unique solution $\bar{\mathbf{p}}$ of the system of equation

$$\bar{\mathbf{p}} = \mathbf{M}^{-1} \mathbf{b}(\lambda_1, \lambda_2), \quad (5.37)$$

with

$$\mathbf{b}(\lambda_1, \lambda_2) = \begin{bmatrix} \{0, \frac{1}{\lambda_1} - \frac{\sigma}{g_{11}}, \frac{\gamma_{21}}{\lambda_1} - \frac{\sigma}{g_{11}}, \frac{1}{\lambda_1} - \frac{\sigma}{g_{11}}, \frac{\gamma_{22}}{\lambda_1} - \frac{\sigma}{g_{11}}\} \\ \{0, \frac{1}{\lambda_1} - \frac{\sigma}{g_{12}}, \frac{\gamma_{21}}{\lambda_{12}} - \frac{\sigma}{g_{12}}, \frac{1}{\lambda_1} - \frac{\sigma}{g_{12}}, \frac{\gamma_{22}}{\lambda_1} - \frac{\sigma}{g_{12}}\} \\ \{0, \frac{1}{\lambda_2} - \frac{\sigma}{g_{21}}, \frac{\gamma_{12}}{\lambda_2} - \frac{\sigma}{g_{21}}, \frac{1}{\lambda_2} - \frac{\sigma}{g_{21}}, \frac{\gamma_{11}}{\lambda_2} - \frac{\sigma}{g_{21}}\} \\ \{0, \frac{1}{\lambda_2} - \frac{\sigma}{g_{22}}, \frac{\gamma_{12}}{\lambda_2} - \frac{\sigma}{g_{22}}, \frac{1}{\lambda_2} - \frac{\sigma}{g_{22}}, \frac{\gamma_{11}}{\lambda_2} - \frac{\sigma}{g_{22}}\} \end{bmatrix}$$

belongs to the regions defined by

$$\mathcal{R}_{\mathbf{p}} = \begin{bmatrix} \{\mathcal{R}_{11}^{(III)}, (\mathcal{R}_{11}^{(I)}|A2), (\mathcal{R}_{11}^{(II)}|A2), (\mathcal{R}_{11}^{(I)}|\hat{A}2), (\mathcal{R}_{11}^{(II)}|\hat{A}2)\} \\ \{\mathcal{R}_{12}^{(III)}, (\mathcal{R}_{12}^{(I)}|A2), (\mathcal{R}_{12}^{(II)}|A2), (\mathcal{R}_{12}^{(I)}|\hat{A}2), (\mathcal{R}_{12}^{(II)}|\hat{A}2)\} \\ \{\mathcal{R}_{21}^{(III)}, (\mathcal{R}_{21}^{(I)}|A1), (\mathcal{R}_{21}^{(II)}|A1), (\mathcal{R}_{21}^{(I)}|\hat{A}1), (\mathcal{R}_{21}^{(II)}|\hat{A}1)\} \\ \{\mathcal{R}_{22}^{(III)}, (\mathcal{R}_{22}^{(I)}|A1), (\mathcal{R}_{22}^{(II)}|A1), (\mathcal{R}_{22}^{(I)}|\hat{A}1), (\mathcal{R}_{22}^{(II)}|\hat{A}1)\} \end{bmatrix} \quad (5.38)$$

Here, $A1 \equiv \{(\bar{p}_{11}, \bar{p}_{12}) | \bar{p}_{11}g_{11} > \bar{p}_{12}g_{12}\}$ and $A2 \equiv \{(\bar{p}_{21}, \bar{p}_{22}) | \bar{p}_{22}g_{22} > \bar{p}_{21}g_{21}\}$. The complementary regions are denoted by $\hat{A}1$ and $\hat{A}2$. The notation $\{\cdot\}$ with several variables suggests that the corresponding element takes one of the values. In addition, the notation $(\cdot|.)$ conditions the region whereto the power of user of interest belongs, to an specific order of the interfering signal. In each row, there is a one-to-one correspondence between the values in $\{\cdot\}$ of \mathbf{M} , \mathbf{b} , and $\mathcal{R}_{\mathbf{p}}$.

Note that (5.37) provides the intersection of the best responses (5.33).

Remark 1: The condition that matrix \mathbf{M} is full rank implies that the matrix $\overline{\mathbf{M}}$ cannot be symmetric. Additionally, if $\text{rank}(\mathbf{M}) = \text{rank}(\overline{\mathbf{M}}) < 4$, where $\overline{\mathbf{M}}$ is the matrix built by concatenating the two matrices \mathbf{M} and \mathbf{b} , i.e. $[\mathbf{M}|\mathbf{b}]$, the system of equations $\mathbf{M}\mathbf{P} = \mathbf{b}(\lambda_1, \lambda_2)$ admits infinite solutions. They are Nash equilibria if they also belong to $\mathcal{R}_{\mathbf{p}}$. No NE exists if $\text{rank}(\mathbf{M}) \neq \text{rank}(\overline{\mathbf{M}})$. It is straightforward to verify that the condition $\text{rank}(\mathbf{M}) = \text{rank}(\overline{\mathbf{M}})$ enforces a linear restriction on the variables λ_1 and λ_2 . For the sake of notation, we denote this linear restriction by $F_{\text{rank}<4}(\boldsymbol{\lambda}) = 0$.

Remark 2: Taking into account the structure of vector $\mathbf{b}(\lambda_1, \lambda_2)$, in a given channel state $\mathbf{g} = [g_{11} \ g_{12} \ g_{21} \ g_{22}]^T$, the solution to system (5.37) can be expressed as a function of the pair (λ_1, λ_2) . Let us denote \mathbf{M}^{-1} by \mathbf{A} . We rewrite (5.37) as

$$\begin{bmatrix} \bar{p}_{11} \\ \bar{p}_{12} \\ \bar{p}_{21} \\ \bar{p}_{22} \end{bmatrix} = \begin{bmatrix} \mathbf{A}_1 & | & \mathbf{A}_2 \\ \hline \mathbf{A}_3 & | & \mathbf{A}_4 \end{bmatrix} \begin{bmatrix} b_{11}(\frac{1}{\lambda_1}, \sigma) \\ b_{12}(\frac{1}{\lambda_1}, \sigma) \\ b_{21}(\frac{1}{\lambda_2}, \sigma) \\ b_{22}(\frac{1}{\lambda_2}, \sigma) \end{bmatrix} \quad (5.39)$$

where $\mathbf{A}_i, i \in \{1, 2, 3, 4\}$ are 2×2 matrices. It can be verified that all the non-zero elements of \mathbf{A}_1 and \mathbf{A}_4 are positive and all the non-zero elements of \mathbf{A}_2 and \mathbf{A}_3 are negative.

Proposition 1. *Any non-zero power allocation of transmitter k at the Nash equilibrium of $\mathcal{G}_{\boldsymbol{\lambda}}^n$ is linear in the pair $(\frac{1}{\lambda_1}, \frac{1}{\lambda_2})$. Let us assume that the solution $\bar{\mathbf{p}}$ satisfies condition (II) of Theorem 4 with $\mathcal{R}_{\mathbf{p}} \equiv \mathcal{R}_{\mathbf{p}}^{\#}$, being $\mathcal{R}_{\mathbf{p}}^{\#}$ one of the possible regions defined by $\mathcal{R}_{\mathbf{p}}$. The corresponding region for vector $\boldsymbol{\lambda} =$*

$[\lambda_1, \lambda_2]$ is referred to as $\mathcal{R}_\lambda^\# = \{(\lambda_1, \lambda_2) | \lambda_1 > 0, \lambda_2 > 0, \bar{\mathbf{p}}(\lambda_1, \lambda_2) \in \mathcal{R}_p^\#\}$. Then

$$\bar{\mathbf{p}}(\lambda_1, \lambda_2) = \begin{bmatrix} \alpha_{11} & -\beta_{11} \\ \alpha_{12} & -\beta_{12} \\ -\beta_{21} & \alpha_{21} \\ -\beta_{22} & \alpha_{22} \end{bmatrix} \begin{bmatrix} \frac{1}{\lambda_1} \\ \frac{1}{\lambda_2} \end{bmatrix} - \begin{bmatrix} c_{11} \\ c_{12} \\ c_{21} \\ c_{22} \end{bmatrix} \sigma \quad (5.40)$$

for $(\lambda_1, \lambda_2) \in \mathcal{R}_\lambda^\#$ and being $\alpha_{i,j}, \beta_{ij}, c_{ij}$, with $i, j \in \{1, 2\}$ positive and depending on \mathbf{g}, γ , and $\mathcal{R}_p^\#$.

Let us denote the set of all possible regions \mathcal{R}_p defined in (5.38) by \mathcal{Y} . The cardinality of the set is \mathcal{N}_Y . We index the regions in an arbitrary order with a number between 1 and \mathcal{N}_Y and denote the index by y .

In the rest of this section, in order to simplify the analysis, we concentrate on a single region $\mathcal{R}_p^y, y \in \{1, \dots, \mathcal{N}_Y\}$. The following analysis holds in general for any arbitrary region. Hereafter, the region index y is considered as a parameter of the functions whenever a single region is intended, e.g., $\mathcal{W}_{kh}(y, \bar{\mathbf{p}}(\boldsymbol{\lambda}), \boldsymbol{\lambda})$.

Let us assume that $\bar{\mathbf{p}}_m \in \mathcal{R}_{kh}^{(I)}$. The value of the corresponding function in (5.34) is

$$\begin{aligned} \mathcal{W}_{kh}(y, \bar{\mathbf{p}}(\boldsymbol{\lambda}), \boldsymbol{\lambda}) = \log & \frac{g_{kh}}{\lambda_k (g_{mg} (\frac{\alpha_{mg}}{\lambda_m} - \frac{\beta_{mg}}{\lambda_k} - c_{mg}\sigma) + \sigma)} \\ & - 1 + \frac{\lambda_k}{g_{kh}} (g_{mg} (\frac{\alpha_{mg}}{\lambda_m} - \frac{\beta_{mg}}{\lambda_k} - c_{mg}\sigma) + \sigma) \end{aligned}$$

where, based on Proposition 1, the value of $\bar{\mathbf{p}}_m$ is replaced by $\frac{\alpha_{mg}}{\lambda_m} - \frac{\beta_{mg}}{\lambda_k} - c_{mg}\sigma$. Two properties of function $\mathcal{W}_{kh}(y, \bar{\mathbf{p}}(\boldsymbol{\lambda}), \boldsymbol{\lambda})$, namely submodularity (decreasing differences) and convexity, are presented in the following two lemmas. We will elaborate more on these properties in the next subsection.

Lemma 1. *The continuous and twice differentiable function $\mathcal{W}_{kh}(\boldsymbol{\lambda})$ has decreasing differences property.*

Proof: This lemma is proven in Appendix 5.A.

Lemma 2. *For a fix λ_m , the continuous and twice differentiable function $\mathcal{W}_{kh}(y, \bar{\mathbf{p}}(\boldsymbol{\lambda}), \boldsymbol{\lambda})$ is concave in λ_k when the pair (λ_k, λ_m) satisfies the following condition*

$$\{(\lambda_k, \lambda_m) | \lambda_k > 0, \lambda_m > 0, \bar{\mathbf{p}}(\lambda_k, \lambda_m) \geq 0\}. \quad (5.41)$$

Proof: The proof of this lemma is in Appendix 5.B. Note that the condition on the power $\bar{\mathbf{p}}(\lambda_k, \lambda_m)$ in (5.41) is implied by physical reasons and it is not restrictive for our study. In the following section, we consider a global game per each possible region \mathcal{R}_p and we discuss the existence of a Nash equilibrium in that region.

5.4.2 Global Game

We consider a network wherein all subcarriers have the same channel state distribution. In such a network the global game utility function (5.25) boils down to

$$C_k(\boldsymbol{\lambda}) = NL_k(\bar{\mathbf{d}}^n(\boldsymbol{\lambda}); \boldsymbol{\lambda}) + \lambda_k \bar{P}_k \quad k = 1, 2 \quad (5.42)$$

Let us consider the above problem in a single region $\mathcal{R}_p^y, y \in \{1, \dots, \mathcal{N}_Y\}$. In order to specialize all the functions as the ones of this region we add the variable y as a parameter to all the functions, e.g. $L_k(y, \bar{\mathbf{d}}^n(\boldsymbol{\lambda}); \boldsymbol{\lambda})$. From (5.42) and (5.30) we have

$$C_k(y, \boldsymbol{\lambda}) = N \left(\gamma_{k1} \mathcal{W}_{k1}(y, \bar{\mathbf{p}}(\boldsymbol{\lambda}), \boldsymbol{\lambda}) + \gamma_{k2} \mathcal{W}_{k2}(y, \bar{\mathbf{p}}(\boldsymbol{\lambda}), \boldsymbol{\lambda}) \right) + \lambda_k \bar{P}_k \quad k = 1, 2 \quad (5.43)$$

For further studies, we define the global game per region by $\mathcal{G}_{\text{glob}}^y \equiv (\mathcal{S}, \mathcal{D}_{\text{glob}}^y, \mathcal{U}_{\text{glob}}^y)$ where the cost functions $\mathcal{U}_{\text{glob}}^y$ are defined in (5.43) and the action set is $\mathcal{D}_{\text{glob}}^y \equiv \left(\boldsymbol{\lambda} | \bar{\mathbf{p}}(\boldsymbol{\lambda}) \in \mathcal{R}_p^y, \lambda_k \in \mathbb{R}_+, k = 1, 2 \right)$.

Let us define a relaxed game $\mathcal{G}_{\text{relaxed}}^y \equiv (\mathcal{S}, \mathcal{D}_{\text{relaxed}}^y, \mathcal{U}_{\text{glob}}^y)$ obtained by relaxing the condition of type $\mathcal{W}_{kh}^{(I)} \leq \mathcal{W}_{kh}^{(II)}$ (or $\mathcal{W}_{kh}^{(I)} \geq \mathcal{W}_{kh}^{(II)}$) from the set $\mathcal{D}_{\text{glob}}^y$. In other words, the action set is $\mathcal{D}_{\text{relaxed}}^y \equiv \left(\boldsymbol{\lambda} | \bar{p}_k(\boldsymbol{\lambda}) \geq 0 \text{ and } \bar{p}_{mg} g_{mg} = \max(\bar{p}_{m1} g_{m1}, \bar{p}_{m2} g_{m2}), \lambda_k \in \mathbb{R}_+, k = 1, 2 \right)$.

In the following, we prove the submodularity of $\mathcal{G}_{\text{relaxed}}^y$. Based on this property the existence of a Nash equilibrium for $\mathcal{G}_{\text{relaxed}}^y$ follows.

Theorem 5. *The two-player global game $\mathcal{G}_{\text{relaxed}}^y$ is a submodular game when the strategy set $\mathcal{D}_{\text{relaxed}}^y$ is not empty.*

Proof. A two player game $\mathcal{G}_{\text{relaxed}}^y$ is submodular if for each player $k \in \{1, 2\}$ the following conditions hold: (i) the strategy space is nonempty and compact sublattice; (ii) the strategy profile $\mathcal{D}_{\text{relaxed}}^y$ satisfies the ascending property; (iii) the utility function $C_k(y, \boldsymbol{\lambda})$ is continuous in both players' strategies, and has decreasing differences between λ_k and λ_m for $k, m \in \{1, 2\}, k \neq m$.

m . The validity of conditions (i) and (ii) can be verified directly from Appendix 5.C.1 and Lemma 5 of Appendix 5.C.2. The decreasing differences property of $C_k(y, \boldsymbol{\lambda})$ follows from Lemma 2. \square

Property 1. *Nash equilibria in $\overset{\circ}{\mathcal{D}}_{\text{relaxed}}^y$, the interior of $\mathcal{D}_{\text{relaxed}}^y$, are all the solutions of the system*

$$\frac{\partial C_k(y, \boldsymbol{\lambda})}{\partial \lambda_k} = 0, \quad k = 1, 2 \quad (5.44)$$

in $\overset{\circ}{\mathcal{D}}_{\text{relaxed}}^y$, if the per subcarrier game has a single NE. On the other hand, if the per subcarrier game has infinite NEs the condition $F_{\text{rank}<4}(\boldsymbol{\lambda}, \sigma) = 0$ should be satisfied (Remark 1). The KKT conditions for this case boils down into

$$\frac{\partial C_k(y, \boldsymbol{\lambda})}{\partial \lambda_k} + \mu_k \frac{\partial F_{\text{rank}<4}(\boldsymbol{\lambda}, \sigma)}{\partial \lambda_k} = 0 \quad (5.45)$$

$$\mu_k F_{\text{rank}<4}(\boldsymbol{\lambda}, \sigma) = 0 \quad k = 1, 2 \quad (5.46)$$

As the function $F_{\text{rank}<4}(\boldsymbol{\lambda}, \sigma)$ is linear, the KKT conditions are necessary and sufficient (Section 4.2.2).

Note that systems (5.44) and (5.45) is a system of rational functions in $\boldsymbol{\lambda}$, and all its solutions can be determined as roots of a polynomial in λ_k or λ_m .

Property 2. *The Nash equilibria of $\mathcal{G}_{\text{relaxed}}^y$ on the boundary satisfying $\bar{p}_{kh} = 0, k, h \in \{1, 2\}$ are Nash equilibria of $\mathcal{G}_{\text{glob}}$ only if they are Nash equilibria in $\overset{\circ}{\mathcal{D}}_{\text{relaxed}}^z$, the action set interior of the game $\mathcal{G}_{\text{relaxed}}^z$, where the region $\mathcal{R}_{\mathbf{p}}^z$ is obtained from the region $\mathcal{R}_{\mathbf{p}}^y$ by enforcing $\bar{p}_{kh} = 0$.*

Thanks to this property, we do not ignore any NE of the global game if we ignore the equilibrium at the boundary determined by $\tilde{p}_{kh} = 0$.

Lemma 3. *The Nash equilibria of $\mathcal{G}_{\text{glob}}^y$ on the boundary corresponding to a condition of type $\bar{p}_{m1}g_{m1} \geq \bar{p}_{m2}g_{m2}$ (or $\bar{p}_{m1}g_{m1} \leq \bar{p}_{m2}g_{m2}$) are Nash equilibria of $\mathcal{G}_{\text{glob}}$ only if they are Nash equilibria in $\overset{\circ}{\mathcal{D}}_{\text{relaxed}}^x$, the action set interior of the game $\mathcal{G}_{\text{relaxed}}^x$, where the $\mathcal{R}_{\mathbf{p}}^x$ is the region which shares the boundary of interest with $\mathcal{D}_{\text{glob}}^y$.*

Proof. This lemma is proven in Appendix 5.C.2 as straightforward consequence of Lemma 6 in the same appendix. \square

Property 3. Let λ^* be a NE of $\mathcal{G}_{\text{relaxed}}^y$ corresponding to the per subcarrier game equilibrium $\tilde{\mathbf{p}}^y(\lambda^*)$. λ^* is a NE of $\mathcal{G}_{\text{glob}}$ if and only if (1) it belongs to the actions set of the global game per region, $\mathcal{D}_{\text{glob}}^y$ and (2) it satisfies the following inequality

$$C_k(y, \lambda_k^*, \lambda_m^*) \leq C_k(z, \lambda_k, \lambda_m^*),$$

$$\forall \lambda_k \geq 0, k, m = 1, 2, k \neq m, \mathcal{R}_p^y \in \mathcal{Y}, \mathcal{R}_p^z \in \mathcal{Y}_{\text{cond}} \quad (5.47)$$

being $\mathcal{Y}_{\text{cond}}$ is a subset of \mathcal{Y} wherein the per subcarrier game strategy of transmitter m is identical to the one's in region \mathcal{R}_p^y .

Lemma 4. A NE of $\mathcal{G}_{\text{glob}}$ belongs to a boundary of type $\mathcal{W}_{kh}^{(I)} = \mathcal{W}_{kh}^{(II)}$, if and only if it is a NE for both regions sharing this boundary, i.e. the region $\mathcal{D}^{y^{(II)}} \subseteq \mathcal{D}_{\text{relaxed}}^y$ corresponding to condition $\mathcal{W}_{kh}^{(I)} \leq \mathcal{W}_{kh}^{(II)}$, and the region $\mathcal{D}^{y^{(I)}} \subseteq \mathcal{D}_{\text{relaxed}}^y$ corresponding to condition $\mathcal{W}_{kh}^{(I)} \geq \mathcal{W}_{kh}^{(II)}$. We refer to these two regions as side regions.

Let $d\mathcal{W}_{kh} = \mathcal{W}_{kh}^{(I)} - \mathcal{W}_{kh}^{(II)}$. The NEs of $\mathcal{G}_{\text{glob}}$ which belong to a boundary of type $d\mathcal{W}_{kh} = 0$ are a subset of the set of solutions to the following system of equations.

$$\frac{\partial C_k(y^{(I)}, \lambda)}{\partial \lambda_k} + \mu_k \frac{\partial d\mathcal{W}_{kh}}{\partial \lambda_k} = 0$$

$$\frac{\partial C_k(y^{(II)}, \lambda)}{\partial \lambda_k} + \mu_k \frac{\partial d\mathcal{W}_{kh}}{\partial \lambda_k} = 0$$

$$\mu_k d\mathcal{W}_{kh} = 0; \quad k = 1, 2. \quad (5.48)$$

Property 3, Lemma 4 and Theorem 3 yield the following theorem.

Theorem 6. The NEs of $\mathcal{G}_{\text{glob}}$ are the union of all the NEs of $\mathcal{G}_{\text{relaxed}}^y$ and the solutions of (5.48), for all $y \in \{1, \dots, \mathcal{N}_Y\}$, which (1) belong to $\mathcal{D}_{\text{glob}}^y$, and (2) satisfy condition (5.47).

5.5 Algorithm

The algorithm to determine the NE of the dual game \mathcal{G}^D consists in determining all the NEs of the \mathcal{N} relaxed games $\mathcal{G}_{\text{relaxed}}^y$ defined over the regions $\mathcal{R}_p^y \in \mathcal{Y}$. Then, among them, it selects the ones which satisfy all the conditions for being NE of the global game. Such conditions are expressed in Property 3. The algorithm is presented in Table 4.1. Note that the NE

obtained with this algorithm are not unique. A selection criterion has to be enforced to both transmitters in order to guarantee the convergence of the system toward to an equilibrium. Several criteria can be enforced. As an example we can propose the selection of the NE which maximizes the sum throughput for symmetric systems, i.e. systems with the same channel statistics for both transmitters.

We consider a 2-transmitter network in which the transmitters simultaneously communicate with a single receiver over 10 subcarriers. In the first set of results, the system parameters are set as follows. The channel gains for the two transmitters are set to $(g_{11}, g_{12}) = (1/3, 2/3)$; $(g_{21}, g_{22}) = (7/8, 1/8)$ and the corresponding probabilities are $(\gamma_{11}, \gamma_{12}) = (0.3, 0.7)$; $(\gamma_{21}, \gamma_{22}) = (0.1, 0.9)$. Note that the gap between the two gain levels for transmitter 2 is greater than the ones of transmitter 1. Moreover, the values of γ s indicate that for transmitter 2 the occurrence of the higher channel gain is less probable than the lower. A reversed situation occurs for transmitter 1. Additionally, we consider two levels of information at the transmitters: (i) $T - CCSI$: complete channel side information at both transmitters, (ii) $T - PCSI$: partial channel side information, i.e. each transmitter know its own channel state and the statistics of the other's links.

For $T - CCSI$, the problem is defined in (5.5). The power allocation algorithm based on the dual method introduced in [16] is implemented. The algorithm is detailed in Table 4.2 and assigns an initial value to the powers and the Lagrangian multipliers and iterates until convergence to a local optimum power allocation of the constrained optimization (5.5). Note that this algorithm converges into a local optimum depending on the initial value.

For $T - PCSI$, the distributed joint rate and power allocation is obtained via three different algorithms. The first two algorithms are based on heuristic approaches and the last one is the proposed algorithm in Table 4.1. Note that, unlike Algorithm II, Algorithm I is not iterative and will immediately provide all the NEs of the global game.

In both heuristic approaches, transmitter $k = 1, 2$ divides the maximum available power \bar{P}_k equally among the subcarriers. Let us assume $P_s = P_{\max}/N$. In the first approach, namely $EqPow1$, with the intention to avoid outage, we set the transmission rate on channel g_{kh} to $R_{kh} = \log(1 + \frac{P_s g_{kh}}{P_s g_{mg} + \sigma})$ where $g_{mg} = \max(g_{m1}, g_{m2})$. The value of the average throughput is $\rho_{kh} = R_{kh}$. In the second heuristic approach, namely $EqPow2$, we accept a certain level of outage. We calculate the two rates $R_{kh}^{mg} = \log(1 + \frac{P_s g_{kh}}{P_s g_{mg} + \sigma^2})$ and $R_{kh}^{ml} = \log(1 + \frac{P_s g_{kh}}{P_s g_{ml} + \sigma^2})$ where $g_{ml} = \min(g_{m1}, g_{m2})$. We further calculate the average throughput for both cases, i.e. $\rho_{kh}^{mg} = R_{kh}^{mg}$ and $\rho_{kh}^{ml} = \gamma_{ml} R_{kh}^{ml}$,

Algorithm I: finding the NEs of the global game for $T - PCSI$

```

Initialize  $\mathcal{E} = \emptyset$ .
for  $y \in \{1, \dots, \mathcal{N}_Y\}$ .
  Set matrix  $\mathbf{M}$  for  $\mathcal{R}_p^y$ .
  Initialize  $\mathcal{E}^y = \emptyset$ .
  if  $\text{rank}(\mathbf{M}) = 4$ .
    compute  $\mathbf{A} = \mathbf{M}^{-1}$ .
    compute  $\bar{\mathbf{p}}(\lambda_1, \lambda_2)$ .
  else determine constraints on  $\lambda$  such that  $\text{Rank}(\mathbf{M}) = \text{Rank}(\bar{\mathbf{M}})$ .
    determine the infinite solutions of  $\mathbf{M}\mathbf{p} = \mathbf{b}$  parametric
    in the unknown  $p_{kh}$ .
  endif.
  compute  $C_k(y, \lambda)$ ,  $k = 1, 2$ .
  find all the solutions  $\lambda$  of  $\frac{\partial C_k(y, \lambda)}{\partial \lambda_k} = 0$ ,  $k = 1, 2$ 
  find all the solutions of 5.48 if boundary  $d\mathcal{W}_{kh}$  pass through region  $y$ 
  collect all above solutions in the set  $\mathcal{E}^y$ .
  set  $\mathcal{E}^y = \mathcal{E}^y \cap \mathcal{D}_{\text{glob}}^y$ .
  for each  $\lambda^* \in \mathcal{E}^y$ 
    check=1
  for all  $\lambda_k$ 
    for all regions  $\mathcal{R}^z$  such that  $\mathcal{R}_p^z \in \mathcal{Y}_{\text{cond}}$ 
      if  $C_k(y, \lambda_k^*, \lambda_m^*) \leq C_k(z, \lambda_k, \lambda_m^*)$ 
        check =1.
      else
        check=0.
      endif.
    endfor.
  endfor.
  if check=1
     $\mathcal{E} = \mathcal{E} \cup \{(y, \lambda^*)\}$ 
  endif.
  set  $\mathcal{E} = \mathcal{E} \cup \mathcal{E}^y$ .
endfor
endfor

```

Table 5.1: Algorithm I: finding the NEs of the global game for $T - PCSI$

Iterative algorithm for $T - CCSI$

```

initilaize  $(\lambda_1, \lambda_2)$ 
repeate
  initilize  $\mathbf{p} = (p_{11}(g_{11}), p_{12}(g_{12}), p_{21}^n(g_{21}), p_{22}^n(g_{22}))$ 
  repeate
    for  $k = 1 : 2$ 
       $\mathbf{p}_k = \arg \max \mathbb{E}_{g_k^n} \sum_{k=1}^2 (r_k(\mathbf{g}^n, \mathbf{p}^n) - \lambda_k p_k^n(g_k))$ 
    end
  until  $\mathbf{p}$  converges
  update  $(\lambda_1, \lambda_2)$  using subgradient method
until  $(\lambda_1, \lambda_2)$  converges.

```

Table 5.2: Algorithm II: Iterative algorithm for $T - CCSI$

and we determine the maximum. Finally, we set the rate R_{kh} to the one corresponding to the maximum throughput.

Let us compare the performance of the above four algorithms. We adopt the throughput attained by each algorithm as performance measure and we plot it versus the maximum available power at the transmitter. The throughput here is in bits/sec. For the $T - CCSI$ optimization, the throughput is equal to the sum of the maximum achievable rate over each subcarrier. The maximum available powers at both transmitters are identical, i.e. $\bar{P}_1 = \bar{P}_2 = P_{\max}$. For the first set of simulations the noise power is fixed at $-5db$ and P_{\max} increases linearly from 0.3 W ($-5db$) to 28 W ($15db$).

Figure 4.1 compares the performance of Algorithm I for $T - PCSI$ and Algorithm II for $T - CCSI$ separately for the two transmitters. Note that the optimization based on Algorithm II does not guarantee the global optimum but only a local optimum. For Algorithm I we adopt the maximum sum throughput as selection criterion of a Nash equilibrium.

Interestingly, the simulations show that all the NE points obtained through Algorithm I are those wherein only one transmitter emits with the full power and the other remains off. This kind of result holds also for all the sets of parameters we consider for simulations. This suggests that Algorithm I can be simplified to finding the NEs in which only one transmitter emits. The set of the NE and/or retained NE after the application of a selection criterion includes the cases where transmitter k allocates the whole power in only one channel state g_{kh} , $h = 1, 2$ and/or when it divides the power optimally among the channel gains g_{k1} and g_{k2} assuming that there is no interference from the other transmitter.

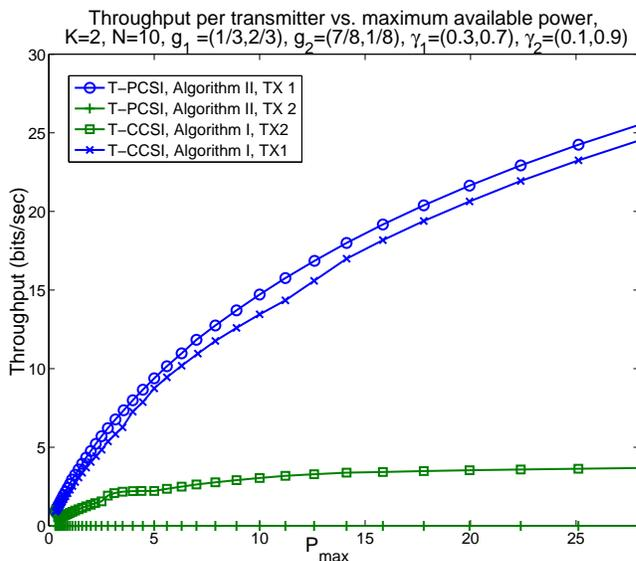

Figure 5.1: Aggregate throughput vs maximum available power at the transmitter, $K = 2, N = 10, g_1 = (1/3, 2/3), g_2 = (7/8, 1/8), \gamma_1 = (0.3, 0.7), \gamma_2 = (0.1, 0.9)$

By performing Algorithm II, Transmitters of type $T - CCSI$ have increasing throughput while the power budget increases.

Figure 4.2 shows the aggregate throughput obtained by the four algorithms. The two heuristic algorithms have a saturating behavior at very low power levels compared to the optimization and the game based algorithm. In other words, these algorithms are not able to exploit the additional available resources. Interestingly, the increase of the throughput for a NE in $T - PCSI$, follows closely the increase of the optimal power allocation in the case of $T - CCSI$.

5.6 Conclusions

The joint power and rate allocation in a two-user OFDM system with a large number of subcarriers and partial channel state information at the transmitters for slow frequency selective fading channel is studied. A total throughput maximization problem is introduced and it is proved that the dual approach yields optimum resource allocation asymptotically as $N \rightarrow +\infty$. Although, the dual problem has linear complexity in the number of

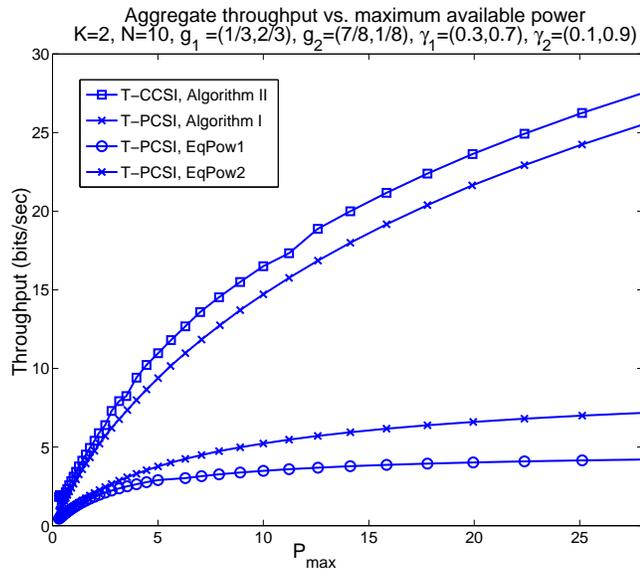

Figure 5.2: Throughput per transmitter vs maximum available power at the transmitter, $K = 2, N = 10, g_1 = (1/3, 2/3), g_2 = (7/8, 1/8), \gamma_1 = (0.3, 0.7), \gamma_2 = (0.1, 0.9)$

subcarriers, the complexity of per subcarrier optimization is still very high due to the fact that the objective function is not convex. A suboptimal low complexity approach is introduced in the form of 2-player game. We defined a two-level game, namely per subcarrier games and global game, whose NEs are obtained. Since the game admits multiple NEs, selection criteria are necessary. Thus we adopt the maximum sum throughput as selection criteria of a NE. The performance of such NE points is compared to the performance of the optimum power allocation for the case of complete channel state information and the uniform power allocation for the case of partial channel side information.

The simulations showed that all the NEs obtained from the game are characterized by the fact that only one transmitter emits with full power and the other remains off. On the contrary, the optimum power allocations for the case of complete channel state information contains solutions which have the superposition of two users' power on the same channel. However, in the later case, the solutions can only be obtained through an iterative algorithm whose convergence to some local optimal point depends on the choice of the initial value. Comparing the performance of the optimal solution averaged

over several initial points and the NE chosen through the selection criteria, shows that the NE performs near optimal in this network setup.

5.A Proof of Lemma 1:

The second derivative in λ_k is given by

$$\frac{\partial^2 \mathcal{W}_{kh}}{\partial \lambda_k \partial \lambda_k} = \frac{1}{\lambda_k^2} + \frac{g_{mg} \beta_{mg} \lambda_k (2(\frac{\alpha_{mg}}{\lambda_m} - \frac{\beta_{mg}}{\lambda_k} - c_{mg} \sigma) + \frac{\beta_{mg}}{\lambda_k} + \sigma)}{\lambda_k^4 (g_{mg} (\frac{\alpha_{mg}}{\lambda_m} - \frac{\beta_{mg}}{\lambda_k} - c_{mg} \sigma) + \sigma)^2}. \quad (5.49)$$

When the power $\bar{p}_{mg} = \frac{\alpha_{mg}}{\lambda_m} - \frac{\beta_{mg}}{\lambda_k} - c_{mg} \sigma$ is nonnegative, the second derivative is positive. Therefore, the function \mathcal{W}_{kh} is locally concave if condition (5.41) is satisfied.

5.B Proof of Lemma 2:

The decreasing difference property reduces to $\frac{\partial^2 \mathcal{W}_{kh}}{\partial \lambda_k \partial \lambda_m} \leq 0$ for all $\lambda_k, \lambda_m > 0$ when the second mixed derivative exists. Since

$$\frac{\partial^2 \mathcal{W}_{kh}}{\partial \lambda_k \partial \lambda_m} = \frac{-g_{mg}^2 \alpha_{mg} \beta_{mg}}{\lambda_m^2 \lambda_k^2 (g_{mg} (\frac{\alpha_{mg}}{\lambda_m} - \frac{\beta_{mg}}{\lambda_k} - c_{mg} \sigma) + \sigma)^2} - \frac{g_{mg} \alpha_{mg}}{g_{kh} \lambda_m^2} \quad (5.50)$$

and observing that all the coefficients appearing in (5.50) are positive it follows immediately that the second mixed derivative is negative for any pair λ_k, λ_m and the mixed derivative in (5.50) follows.

5.C Analysis of The NEs on The Boundaries

We define the following two boundaries:

- $B_1 \equiv \{(\lambda_1, \lambda_2) | \text{one of the power allocations tends to zero, i.e. } p_{kh}(\lambda_1, \lambda_2) \rightarrow 0, k, h \in \{1, 2\}\}$,
- $B_2 \equiv \{(\lambda_1, \lambda_2) | \text{for some } k \in \{1, 2\} : p_{k1}(\lambda_1, \lambda_2) g_{k1} = p_{k2}(\lambda_1, \lambda_2) g_{k2}\}$,

Note that the boundary B_1 is the boundary between valid values and non-valid values for power allocation. In other words, the region wherein one of the power allocations is negative is not valid. We call the region where all power elements are non-negative as *feasible region*. On the other hand, B_2 sets a boundary between two distinct pieces of the feasible region,

i.e., boundary between $p_{k1}g_{k1} \geq p_{k2}g_{k2}$ and $p_{k1}g_{k1} \leq p_{k2}g_{k2}$. The transition between these pieces will be studied in this section.

Moreover, as in our definition of the regions in (5.35) we considered a separate case for $p_{kh} = 0$, i.e., defined as $p_{kh} \in \mathcal{R}_{kh}^{(III)}$, the boundary B_1 is itself an independent region. In other words, all points on the boundary where a single power element $p_{kh} \rightarrow 0$, are interior to the region where that power element is equal to zero, $p_{kh} = 0$, while the other power elements stay the same.

5.C.1 Boundary of type B_1

For any non-zero power allocation of transmitter k , we have $P_{kh} = \frac{\alpha_{kh}}{\lambda_k} - \frac{\beta_{kh}}{\lambda_m} - c_{kh}\sigma^2 > 0$ for $k, m = 1, 2, k \neq m, h = 1, 2$. Three possible cases are:

- Z1: if $\beta_{kh} \neq 0$ and $c_{kh} \neq 0$
- Z2: if $\beta_{kh} \neq 0$ and $c_{kh} = 0$
- Z3: if $\beta_{kh} = 0$

Note that by definition $\alpha_{kh} \geq 1$. Lets assume a coordinate plane with λ_k and λ_m as the axis. In case Z1, on the boundary where $p_{kh} = 0$ the following relation is satisfied

$$\lambda_m = f_{kh}(\lambda_k) = \frac{\beta_{kh}\lambda_k}{\alpha_{kh} - c_{kh}\sigma^2\lambda_k} \quad (5.51)$$

The first and second derivatives of λ_m with respect to λ_k are positive. In case Z2, the boundary where $p_{kh} = 0$ is a line with a positive slope passing through the origin. In both cases, at $p_{kh} = 0$, λ_m is an increasing convex function of λ_k . Finally, in case Z3, the boundary where $p_{kh} = 0$ is the line $\lambda_k = \frac{\alpha_{kh}}{c_{kh}\sigma^2}$. Note that, the region corresponding to $p_{kh} \geq 0$ for each case is the region which is enveloped between the boundary curve and the axis corresponding to λ_m .

The region where the power vector satisfies $\mathbf{p} \geq 0$ is an intersection of the regions corresponding to all conditions $p_{kh} > 0, k, h = 1, 2$, one per each element. In general, the nonempty intersection is a sublattice and it is easy to verify that it satisfies the ascending property (Chapter 4-Definition 14) defined as follows.

$$\lambda_m \leq \lambda'_m \Rightarrow \mathcal{D}_k(\lambda_m) \prec \mathcal{D}_k(\lambda'_m) \quad (5.52)$$

The typical shape of a non-empty intersection is shown in Figure 4.3.

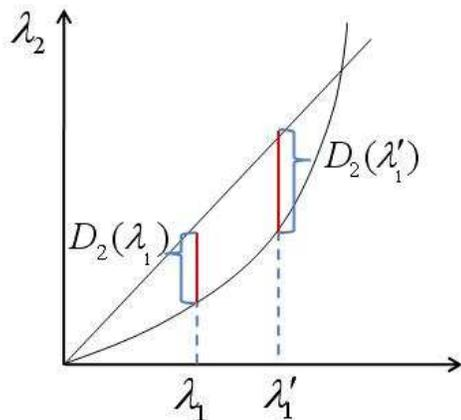

Figure 5.3: Feasible region: the region corresponding to $p > 0$

For further studies, we are also interested in the slop of the $f_{kh}(\lambda_k)$ at the origin, i.e. $(\lambda_1, \lambda_2) = (0, 0)$. In order to find the relative position of the boundaries we need to have a uniform definition for our coordinate plane. For this purpose, we define a coordinate plane with λ_2 as y-axis and λ_1 as the x-axis, denoted by $\lambda_2 - \lambda_1$ plane. The slop of the boundary corresponding to $p_{kh} = 0$ in such a plane is denoted by x_{kh}^0 and is defined as

$$x_{kh}^0 = \left. \frac{\partial \lambda_2}{\partial \lambda_1} \right|_{(\lambda_1, \lambda_2) = (0, 0)}, \quad k, h \in \{1, 2\}. \quad (5.53)$$

5.C.2 Boundary of type B_2

The analysis of boundaries of type B_2 can be summarized in following two lemmas.

Lemma 5. *The boundary B_2 divides the feasible region into two sublattices, each of which satisfies the ascending property.*

Lemma 6. *If a NE of the game $\mathcal{G}_{\text{glob}}$ belongs to a boundary of type B_2 , that point is an interior NE of the game $\mathcal{G}_{\text{glob}}^y$, where $\mathcal{R}_{\mathbf{p}}^y$ is one of the side regions, i.e., the regions sharing that boundary.*

We analyze B_2 through an example. However, the following analysis holds in general for any arbitrary region. We are specially interested in investigating the existence of a NE on such a boundary.

Lets assume the case where the only zero element of power vector is p_{22} . In addition, the conditions A1 and A2 are satisfied, i.e. $p_{11}g_{11} \geq p_{12}g_{12}$, and $p_{21}g_{21} \geq p_{22}g_{22}$. Further, we assume that (1) $p_{11} \in \mathcal{R}_{11}^{(II)}|A2$, (2) $p_{12} \in \mathcal{R}_{12}^{(I)}|A2$, (3) $p_{21} \in \mathcal{R}_{21}^{(I)}|A1$, and $p_{22} \in \mathcal{R}_{22}^{(III)}$.

We denote the NE of per-subcarrier game for this region by $\bar{\mathbf{p}}^*$. It is straightforward to see that if the NE $\bar{\mathbf{p}}^*$ is close to the boundary $\tilde{B}_2 \equiv \{(\lambda_1, \lambda_2) | g_{11}\bar{p}_{11}^*(\lambda_1, \lambda_2) = g_{12}\bar{p}_{12}^*(\lambda_1, \lambda_2)\}$, the greatest and the lowest interference to user 2 are almost equal and \bar{p}_{21}^* belongs to the region $\mathcal{R}_{21}^{(I)}$. Note that, the two power elements of user 1, \bar{p}_{11}^* and \bar{p}_{12}^* , are chosen to be non-zero. In other words, we provided a general example wherein the boundary \tilde{B}_2 does not coincide with a boundary B_1 .

Considering the above region, the power vector $\bar{\mathbf{p}}^*$ is as follows:

$$\begin{aligned}\bar{p}_{11}^* &= \frac{\gamma_{22}}{\lambda_1} - \frac{\sigma^2}{g_{11}} \\ \bar{p}_{12}^* &= \frac{1}{\lambda_1} - \frac{p_{21}g_{21}}{g_{12}} - \frac{\sigma^2}{g_{12}} \\ \bar{p}_{21}^* &= \frac{1}{\lambda_2} - \frac{p_{11}g_{11}}{g_{21}} - \frac{\sigma^2}{g_{21}} \\ \bar{p}_{22}^* &= 0.\end{aligned}\tag{5.54}$$

Therefore matrix \mathbf{M}^* is

$$\begin{bmatrix} 1 & 0 & 0 & \frac{g_{22}}{g_{11}} \\ 0 & 1 & \frac{g_{21}}{g_{12}} & 0 \\ \frac{g_{11}}{g_{21}} & 0 & 1 & 0 \\ 0 & 0 & 0 & 1 \end{bmatrix}\tag{5.55}$$

We have define d_{intf} as follows

$$\begin{aligned}d_{\text{intf}} &= g_{11}\bar{p}_{11}^* - g_{12}\bar{p}_{12}^* \\ &= g_{21}\bar{p}_{21}^* - \frac{g_{12} - \gamma_{22}g_{11}}{\lambda_1}\end{aligned}\tag{5.56}$$

The condition A1 implies that $d_{\text{intf}} \geq 0$.

Note that if $g_{12} - \gamma_{22}g_{11} < 0$, there is no possible positive solution for \bar{p}_{21}^* . Therefore, the boundary B_2 is outside the feasible region and no analysis need to be done on it. We now consider the opposite case where $g_{12} - \gamma_{22}g_{11} \geq 0$. Lets assume that the NE of the current region, $\mathcal{R}_{21}^{(I)}|A1$, approaches the

boundary \tilde{B}_2 where $d_{\text{intf}} = 0$. Replacing \bar{p}_{21}^* by its value in (5.54), we conclude that the equation $d_{\text{intf}} = 0$ in region $\mathcal{R}_{21}^{(I)}$ is satisfied if and only if

$$\frac{\lambda_2}{\lambda_1} = \frac{g_{21}}{g_{12}}. \quad (5.57)$$

Therefore, in the $\lambda_2 - \lambda_1$ plane, the line passing from origin with a slope equal to $\frac{g_{21}}{g_{12}}$ contains all the points belonging to the boundary \tilde{B}_2 .

The following two questions should be answered at this point: (1) is the boundary \tilde{B}_2 passing through the feasible region, i.e. satisfies $\mathbf{p} \geq 0$?, and if the answer is positive (2) is there any incentive for user 2 to deviate from this point and enter the region on the other side of the boundary \tilde{B}_2 , namely $\mathcal{R}_{21}^{(I)}|\hat{A}1$, where the condition $\hat{A}1$ implies $d_{\text{intf}} \leq 0$?

To answer the first question, we find the values of the initial slopes, x_{12}^0 and x_{21}^0 , for our example.

$$\begin{aligned} x_{12}^0 &= \frac{g_{21}}{g_{21} + \gamma_{22}g_{11}} \\ x_{21}^0 &= \frac{g_{21}}{\gamma_{22}g_{11}} \end{aligned} \quad (5.58)$$

Taking into account our basic assumption on $g_{12} - \gamma_{22}g_{11} > 0$, we conclude that the boundary \tilde{B}_2 pass through the feasible region. This fact is shown in Figure 4.4. For the sake of later reference, we call the regions $\mathcal{R}_{21}^{(I)}|\hat{A}1$ and $\mathcal{R}_{21}^{(I)}|\hat{A}1$ sharing boundary \tilde{B}_2 the *side regions*. It is straightforward to see that the side regions are sublattices and they satisfy the ascending property (Chapter 4-Definition 14). We can immediately conclude Lemma 5.

Now let us assume that, at the boundary \tilde{B}_2 , user 2 deviates and enters the region $\mathcal{R}_{21}^{(I)}|\hat{A}1$. We denote the per subcarrier NE of this region by $\bar{\mathbf{p}}^{**}$. Note that, following the same logics as for $\bar{\mathbf{p}}^*$, if the NE $\bar{\mathbf{p}}^{**}$ is close to \tilde{B}_2 , the power element \bar{p}_{21}^{**} belongs to the region $\mathcal{R}_{21}^{(I)}$.

The power vector $\bar{\mathbf{p}}^{**}$ is as follows:

$$\begin{aligned} \bar{p}_{11}^{**} &= \frac{\gamma_{22}}{\lambda_1} - \frac{\sigma^2}{g_{11}} \\ \bar{p}_{12}^{**} &= \frac{1}{\lambda_1} - \frac{p_{21}g_{21}}{g_{12}} - \frac{\sigma^2}{g_{12}} \\ \bar{p}_{21}^{**} &= \frac{1}{\lambda_2} - \frac{p_{12}g_{12}}{g_{21}} - \frac{\sigma^2}{g_{21}} \\ \bar{p}_{22}^{**} &= 0. \end{aligned} \quad (5.59)$$

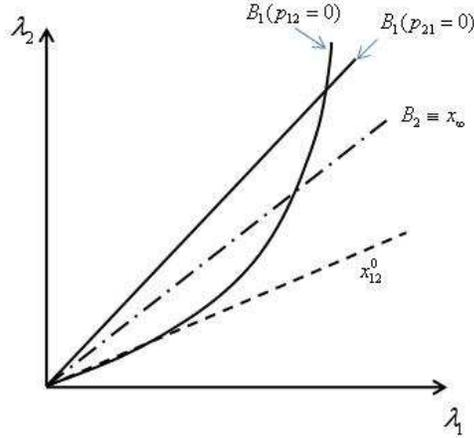

Figure 5.4: Position of boundary \tilde{B}_2 with respect to the feasible region

and matrix \mathbf{M}^{**} is

$$\begin{bmatrix} 1 & 0 & 0 & \frac{g_{22}}{g_{11}} \\ 0 & 1 & \frac{g_{21}}{g_{12}} & 0 \\ 0 & \frac{g_{12}}{g_{21}} & 1 & 0 \\ 0 & 0 & 0 & 1 \end{bmatrix} \quad (5.60)$$

The symmetric structure of the new matrix suggests that there exists solutions for p_{12} and p_{21} if and only if $\text{rank}(\mathbf{M}^{**}) = \text{rank}(\overline{\mathbf{M}^{**}}) = 3$ (Remark 1-Section 5.4.1). This condition is satisfied if $\frac{\lambda_2}{\lambda_1} = \frac{g_{21}}{g_{12}}$. We denote this ratio by x_∞ . Interestingly, this condition coincides with the condition (5.57) for the power element \bar{p}_{21}^* , in region $\mathcal{R}_{21}^{(I)}|A1$, being on the boundary \tilde{B}_2 (figure 4.4).

In general, crossing the boundary B_2 , the matrix \mathbf{M} of one of the side regions is of rank 3. Therefore, the above analysis is general and we conclude Lemma 6.

Thanks to this property, we do not ignore any NE of the global game if we ignore the equilibrium at the boundaries of type B_2 .

Chapter 6

Distributed Cross-Layer Resource Allocation in Slow Fading Interference Networks

6.1 Introduction

This chapter investigates distributed cross-layer algorithms in single-hop ad hoc networks for joint power and rate allocation, scheduling and admission control. An extended literature of the subject represented in Section 3.2.2. We keep our focus on slow fading channels with partial channel side information. We use similar approach as in [39] for characterizing the network and the nodes with obvious modifications to model the peculiarities of ad hoc networks and slow fading channels. Namely, we consider interfering channels instead of MAC.

Following the same approach as in the previous chapter, we define a utility function that accounts for the intrinsic probability of having outage events in networks with slow fading and decentralized control mechanisms. The proposed utility function maximizes the system throughput defined as the average information rate successfully received. This optimization is subject to a maximum average transmission power.

This work proposes both decentralized policies where each transmitter aims at maximizing its own average information rate successfully received

(selfish game) or the system throughput (team game) under the assumption of single user decoding at the receiver (point-to-point channel with interference noise) or multiuser decoding (compound channel). The performance of the various policies is assessed against the policy in [39] in terms of throughput, outage probability, and drop rate (fraction of arriving packets not accepted in the queue). Improvements between the 19% and the 68% for the throughput have been obtained. Interestingly, iterative optimization algorithms with different random initial points yield to the same equilibrium when a low complexity best response approach is applied and single user decoding is utilized at the receivers. This encourages to believe that the obtained equilibrium is also Pareto optimal. On the contrary, when multiuser decoding is applied at the receivers, multiple equilibria were obtained with considerable differences in terms of throughput. Multiplicity of the equilibria points, convergence of the best response approach eventually to a Nash equilibrium have been only partially addressed in this work and are still object of investigation.

6.2 System Model

We consider a system consisting of K arbitrary source-destination pairs sharing the same medium. For example, we may assume that these K pairs are chosen from a larger number of nodes in an ad hoc network. The time is uniformly slotted. We assume on our model that (i) one node cannot transmit and receive at the same time and (ii) the transmitters are distinct while one node can be the destination of different information streams. Thus, there are K transmitters and in general N_R receivers, with $N_R \leq K$, in the system. The channel is block fading with duration of a block equal to a time slot. Furthermore, codewords are completely transmitted during a single time slot. The channel in time slot $t \in \mathbb{N}$ is described by and $K \times N_R$ matrix $\mathbf{Y}(t)$ whose (i, j) element $y_i^j(t)$ is the power attenuation of the channel between transmitter i and receiver j . Throughout this work we refer to them as the channel states (CS). The matrix of channel states is shown in Figure (6.1). The row i includes the states of the channels from the transmitting node i to all the destination nodes. This is the vector of known CS information at node i and it is denoted by $\mathbf{y}_i(t)$. The j -th column includes the states of the channels from all the transmitting nodes to the receiver j . This is the column vector denoted by $\mathbf{y}^j(t)$. It contains all the CS information necessary to determine the signal to interference and noise ratio (SINR) at the destination node j at time slot t . Furthermore, each power attenuation y_i^j is modelled

as an ergodic Markov chain taking values in the discrete set E of cardinality L . For the sake of notation, we define a bijection between the set E and the set of the natural numbers $\{0, 1, \dots, L - 1\}$, $\varphi : E \rightarrow \{0, 1, \dots, L - 1\}$. Let its inverse be $\psi = \varphi^{-1}$. The Markov chain of y_i^j is defined by the transition matrix $\mathbf{T}(i, j)$ whose (k, ℓ) element $T_k^\ell(i, j)$ is the probability of transition from the CS $\psi(k)$ to the state $\psi(\ell)$. The conditional probability nature of $T_k^\ell(i, j)$ reflects on the fact that $\sum_{\ell=1}^L T_k^\ell(i, j) = 1$. We assume throughout that $\mathbf{T}(i, j)$ is irreducible and aperiodic as in [39]. The steady CS probability distribution of the channel between transmitter i and destination j is given by the column vector $\boldsymbol{\pi}(i, j)$.

At each node, packets arrive from the upper layer according to an independent and identically distributed arrival process $\gamma_i(t), t \in \mathbb{N}$ with arrival rate λ_i . Here $P(\gamma_i(t))$ is the probability of receiving $\gamma_i(t)$ packets at time instant t . The packets have constant length.

Each transmitter is endowed with a buffer of finite length. We denote by B_i the maximum length of the buffer at node i and by $q_i(t)$ number of queuing packets at the beginning of slot t . In the following, we address the variable $q_i(t)$ also as the queue state (QS). In a given time slot we assume that all the arrivals from the upper layer occur after transmission of packets to the network.

In each time slot, on the basis of the available information at time t transmitter i decides (a) the transmission power level $p_i \in \mathcal{P}_i$, where \mathcal{P}_i is a finite set of nonnegative reals including zero; (b) the number of packets to transmit $\mu_i \in \mathcal{M}_i$, with $\mathcal{M}_i = \{0, 1, \dots, M_i\}$ and $M_i \leq B_i$; (c) to accept or reject new packets arriving from upper layers. We denote with $c_i = 1$ and $c_i = 0$ the decision of accepting and rejecting the packets, respectively. Therefore, the action of the node i at time slot t is described by the triplet $a_i(t) = (p_i(t), \mu_i(t), c_i(t))$.

The information available at node i at time t is given by the pair $x_i(t) = (\mathbf{y}_i(t), q_i(t))$, i.e. the CSs from transmitter i to all receivers and the number of the packets in the queue at the beginning of time slot t (QS). We refer to the pair $x_i(t)$ as the transmitter state (TS). Additionally, each transmitter knows the statistics of the other channels and the statistics of the arrival process in the buffer.

For further studies it is convenient to define two other state variables for transmitter i , namely the receiver state (RS), and the network state (NS). RS is given by the pair $x^i(t) = (\mathbf{y}^i(t), q_i(t))$. In order to define the NS, we divide the information of the matrix into two sets: (i) row vector \mathbf{y}_i which is the TS of user i (ii) remaining row vectors in the matrix. We denote the latter set by \mathbf{y}_{-i} . Additionally, q_{-i} contains the queue states of users other

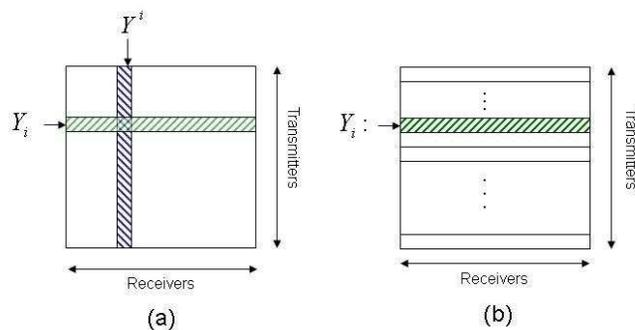

Figure 6.1: Definition of (a) RS and (b) NS

than user i . Therefore, NS is $x_{-i} = (\mathbf{y}_{-i}, q_{-i})$. In a similar way, we can denote the set of actions of other users by a_{-i} .

A complete characterization of transmitter i requires the diagram of its TS. The TS is a combination of channel state $y_i(t)$ and queue state $q_i(t)$. The CS transitions are independent of the buffer state. They are further independent of the action. As already mentioned each CS can independently be defined as a Markov chain. Then, the TS is also a Markov chain with transition probabilities $\mathbb{P}_{\mathbf{y}_i(t)\mathbf{y}_i(t+1)} = \prod_{j=1}^K T_{\varphi(y_i^j(t))}^{\varphi(y_i^j(t+1))}(i, j)$, i.e. the product of the transition probabilities from the CS $y_i^j(t)$ to the CS $y_i^j(t+1)$ or, equivalently, from $\varphi(y_i^j(t))$ to $\varphi(y_i^j(t+1))$. On the contrary, the queue state depends on the transmitter action. In fact, the dynamics of the queue length are given by $q_i(t+1) = \min([q_i(t) + c_i(t)\gamma_i(t) - \mu_i(t)]^+, B_i)$ and can be described as Markov decision chains (MDC). Its transition probability is denoted by $\mathbb{P}_{q_i(t)a_i(t)q_i(t+1)}$, the probability of transition from the queue state $q_i(t)$ to the queue state $q_i(t+1)$ when action $a_i(t)$ is adopted by the transmitter. Since the channel state is independent of the queue state, the transmitter state can also be described by a MDC with transition probability $\mathbb{P}_{x_i(t)a_i(t)x_i(t+1)}$, i.e. the probability of transition from the state $x_i(t)$ to state $x_i(t+1)$ when the action $a_i(t)$ is adopted. Here, $\mathbb{P}_{x_i(t)a_i(t)x_i(t+1)} = \mathbb{P}_{y_i(t)y_i(t+1)}\mathbb{P}_{q_i(t)a_i(t)q_i(t+1)}$.

The signal of the user of interest is impaired by the interfering signals and additive white Gaussian noise with variance σ^2 . We denote by d_i the index of destination node for traffic of transmitter i . When the power level choices of the active transmitters are $\mathbf{p} = (p_1, p_2, \dots, p_K)$, the RS vector for transmitter i is $x^i(t) = (\mathbf{y}^i(t), q_i(t))$, and the receiver performs single user decoding, the

maximum instantaneous achievable rate for the i -th communication pair is given by

$$r_i^{\text{SU}}(x^i(t), \mathbf{p}) = \log_2(1 + \text{SINR}_i^{\text{SU}}(x^i(t), \mathbf{p})) \quad (6.1)$$

where $\text{SINR}_i^{\text{SU}}$ is the signal to interference and noise ratio of node i at its destination d_i given by

$$\text{SINR}_i^{\text{SU}}(x^i(t), \mathbf{p}) = \begin{cases} \frac{y_i^{d_i}(t)p_i(t)}{\sigma^2 + \sum_{\substack{j \neq i \\ q_j(t) > 0}} y_i^{d_j}(t)p_j(t)}, & q_i(t) > 0 \\ 0, & \text{otherwise.} \end{cases}$$

If the receiver performs successive interference cancellation (SIC) decoding and, additionally, knows the transmission rate of the decodable interferers in the set $\mathcal{D}_i \equiv \{j_1, \dots, j_\ell\}$, the maximum instantaneous achievable rate for the i -th communication pair is given by

$$r_i^{\text{SIC}}(x^i(t), \mathbf{p}) = \log_2(1 + \text{SINR}_i^{\text{SIC}}(x^i(t), \mathbf{p})), \quad (6.2)$$

where

$$\text{SINR}_i^{\text{SIC}}(x^i(t), \mathbf{p}) = \begin{cases} \frac{y_i^{d_i}(t)p_i(t)}{\sigma^2 + \sum_{\substack{j \neq i \\ q_j(t) > 0 \\ j \notin \mathcal{D}_i}} y_i^{d_j}(t)p_j(t)}, & q_i(t) > 0 \\ 0, & \text{otherwise.} \end{cases}$$

In the following, we will write shortly $r_i(x^i(t), \mathbf{p})$ when it is irrelevant to specify the decoding approach.

6.3 Problem Statement

At each time slot, a node chooses its action without having a global view of the channel states and the other users' interference. There is no coordination among transmitters' actions and only local information is available at each node. Therefore, for any choice (p_i, μ_i) , there is no guarantee that the μ_i packets can be received correctly when the TS is x_i . In such scenario, we aim at maximizing the throughput, i.e. the average number of packets successfully received by the destination. We will consider two different approaches: (*A – self*) each user independently optimizes its strategy to maximize its

own throughput (selfish game); ($A - coop$) each user independently from others optimizes its strategy to maximize the joint throughput of the whole network (team game). Each approach can be investigated for two different kinds of receivers: (a) receivers performing single user decoding; (b) receiver performing SIC decoding. Approach Ax with decoding j , $j \in \{SU, SIC\}$, is addressed as $Ax - j$.

Let R be the rate required to transmit a packet in a time slot. The probability that $\mu_i(t)$ packets can be transmitted successfully in a time slot t by source i is

$$\Pr\{r_i(x^i(t), \mathbf{p}) \geq \mu_i(t)R\} \quad (6.3)$$

and the average throughput for source i is

$$\limsup_{T \rightarrow +\infty} \frac{1}{T} \sum_{t=0}^{T-1} E(\Pr\{r_i(x^i(t), \mathbf{p}) \geq \mu_i(t)R | x_i(0) = \beta_i\} \mu_i(t)R) \quad (6.4)$$

where the expectation is conditioned to $x_i(0) = \beta_i$, the initial TS of user i .

For physical and QoS reasons the transmitters are subjected to constraints on the average transmitted powers, on the average queue length, and eventually on the maximum outage probability. More specifically, the average power of transmitter i is constrained to a maximum value \bar{p}_i and the following upper bound is enforced

$$\limsup_{T \rightarrow +\infty} \frac{1}{T} \sum_{t=0}^{T-1} E\{p_i(x_i(t), a_i(t)) | x_i(0) = \beta_i\} \leq \bar{p}_i \quad (6.5)$$

where $p_i(x_i(t), a_i(t))$ is the power, eventually zero, transmitted by the source i at time instant t when the action $a_i(t)$ is selected. The expectation is conditioned to the initial TS $x_i(0) = \beta_i$ of transmitter i . Similarly, in order to keep the average delay of the packets limited, the average queue length is constrained by the following bound:

$$\limsup_{T \rightarrow +\infty} \frac{1}{T} \sum_{t=0}^{T-1} E\{q_i(t) | x_i(0) = \beta_i\} \leq \bar{q}_i \quad (6.6)$$

where \bar{q}_i is maximum allowed average queue and the expectation is conditioned to $x_i(0) = \beta_i$. Finally, the outage probability in the steady state is bounded by \bar{P}_i^{out}

$$\lim_{T \rightarrow +\infty} \Pr\{r_i(x_i(t), \mathbf{p}) < \mu_i(t)R_i(t) | x_i(0) = \beta_i\} \leq \bar{P}_i^{out}. \quad (6.7)$$

Note that the constraint on the outage probability holds in the steady state while in the transient of the MDC we assume that the system can eventually tolerate higher outage probability. Throughout, a policy of transmitter i is a deterministic or probabilistic application from the space of TS \mathcal{X}_i to the action space \mathcal{A}_i . Since the policies in stationary conditions of the Markov chain are dominating [39], in this paper we assume that the policy of a transmitter at time t is only a function of its current state and we omit the time indices. Then, a probabilistic (or mixed) policy of transmitter i is $u_i(a_i|x_i)$, i.e. the probability that mobile i chooses the action a_i when the state is x_i . The class of decentralized policies of mobile i is denoted by \mathcal{U}_i .

6.3.1 Problem Statement as an K -player Game

Let us formulate the previous problem as a stochastic K -player game. We denote by g_i the cardinality of the product set $\mathcal{K}_i = \mathcal{X}_i \times \mathcal{A}_i = \{(x_i, a_i) : x_i = (\mathbf{y}_i, q_i) \in \mathbf{x}_i, a_i = (p_i, \mu_i, c_i) \in \mathbf{a}_i(x_i)\}$ and by $\langle x_i, a_i \rangle_{n_i}$ the n_i -th element of \mathcal{K}_i . The payoff matrix $\mathbf{C}^{(i)}$ of transmitter i is a $g_1 \times g_2 \times \dots \times g_n$ matrix having K -dimensions and its element $c_{n_1, n_2, \dots, n_K}^{(i)}$ is the payoff of transmitter i when correspondingly to TS x_i it performs action a_i while the remaining users adopt the strategies $\langle x_k, a_k \rangle_{n_k}$ with $k \neq i$. In the selfish approach, when n_i is such that $\langle x_i, a_i \rangle_{n_i} = \langle x_i, (\underline{p}_i, \underline{\mu}_i, \underline{c}_i) \rangle$

$$c_{n_1, n_2, \dots, n_K}^{(i)} = R \underline{\mu}_i \mathbf{1}_{(r_i(x_i, \underline{p}_i) \geq \underline{\mu}_i R)}, \quad (6.8)$$

i.e. the payoff is nonzero and equal to $R \underline{\mu}_i$ if transmitter i can transmit $\underline{\mu}_i$ packets with power \underline{p}_i reliably. In the cooperative case

$$c_{n_1, n_2, \dots, n_K}^{(i)} = R \sum_{j=1}^K \underline{\mu}_j \mathbf{1}_{(r_i(x_i, \underline{p}_i) \geq \underline{\mu}_i R)}. \quad (6.9)$$

Let $z_i = z_i(x_i, a_i)$ be the joint probability that transmitter i performs action a_i while being in state x_i . It can be expressed by the row vector $\mathbf{z}_i = (z_i^1, z_i^2, \dots, z_i^{g_i})$. Then, the payoff ρ_i equals the average throughput in (6.4) and it is given by the multilinear form

$$\rho_i = \sum_{n_1=1}^{g_1} \sum_{n_2=1}^{g_2} \dots \sum_{n_K=1}^{g_K} c_{n_1 n_2 \dots n_K}^i z_1^{n_1} z_2^{n_2} \dots z_K^{n_K} = \mathbf{z}_i \mathbf{f}^i \quad (6.10)$$

where

$$\begin{aligned} \mathbf{f}^i &= \sum_{n_1=1}^{g_1} \cdots \sum_{n_{i-1}=1}^{g_{i-1}} \sum_{n_{i+1}=1}^{g_{i+1}} \cdots \sum_{n_K=1}^{g_K} c_{n_1 \dots n_{i-1} n_{i+1} \dots n_K}^{(i)} \\ &\times z_1^{n_1} \cdots z_{i-1}^{n_{i-1}} z_{i+1}^{n_{i+1}} \cdots z_K^{n_K}. \end{aligned}$$

The constrained optimization problem defined in (6.4)-(6.5) can be expressed in terms of joint probabilities \mathbf{z}_k as

$$\max_{z_i(x_i, a_i)} \sum_{x_i \in \mathbf{x}_i} \sum_{a_i \in \mathbf{a}_i} z_i(x_i, a_i) Pr\{r_i(x^i, \mathbf{p}) \geq \mu_i R\} \mu_i R \quad (6.11a)$$

Subject to:

$$\sum_{x_i \in \mathbf{x}_i} \sum_{a_i \in \mathbf{a}_i} z_i(x_i, a_i) [\delta_{r_i}(x_i) - P_{x_i a_i r_i}] = 0 \quad \forall r_i \in \mathbf{x}_i \quad (6.11b)$$

$$\sum_{x_i \in \mathbf{x}_i} \sum_{a_i \in \mathbf{a}_i} q_i z_i(x_i, a_i) \leq \bar{q}_i \quad (6.11c)$$

$$\sum_{x_i \in \mathbf{x}_i} \sum_{a_i \in \mathbf{a}_i} p(x_i, a_i) z_i(x_i, a_i) \leq \bar{p}_i \quad (6.11d)$$

$$\sum_{x_i \in \mathbf{x}_i} \sum_{a_i \in \mathbf{a}_i} Pr\{r_i(x^i, \mathbf{p}) < \mu_i R\} z_i(x_i, a_i) \leq \bar{P}_i^{out} \quad (6.11e)$$

$$z_i(x_i, a_i) = z_i((\mathbf{y}_i, q_i), (\mu_i, p_i, c_i) | q_i \leq \mu_i) = 0 \quad (6.11f)$$

$$z_i(x_i, a_i) \geq 0; \quad \forall (x_i, a_i) \in \mathcal{K}_i; \quad \sum_{(x_i, a_i) \in \mathcal{K}_i} z_i(x_i, a_i) = 1 \quad (6.11g)$$

where $\mathbb{P}_{x_i a_i r_i}$ is the probability to move from state x_i to state r_i when action a_i is performed. Additionally, (6.11b) guarantees that the graph of the obtained MDP is closed; (6.11c) and (6.11d) correspond to the constraints (6.5) and (6.6), respectively; (6.11f) eliminates the invalid pairs in \mathcal{K}_i such that the number of packets to be sent is higher than the number of packets in the queue.

Note that if the joint probabilities \mathbf{z}_k , with $k \neq i$ had been known the payoff ρ_i would have reduced to a linear equation and the optimal $\mathbf{z}_i = \mathbf{z}_i^*$ would have been solution of a linear program.

The optimal policy $u_i^*(a_i | x_i)$ of transmitter i can be immediately derived from \mathbf{z}_i^* in the steady state of the MDC system by the relation $u_i(a_i | x_i) = \frac{z_i^*(x_i, a_i)}{\sum_{a_i' \in \mathbf{a}_i} z_i^*(x_i, a_i')}$.

6.4 Analysis of the Game

For the sake of simplicity, the Nash equilibrium problem is represented as follows:

$$\begin{aligned} \min_{\mathbf{z}_i} \quad & -\mathbf{z}_i \mathbf{f}^{(i)} & (6.12a) \\ (b) \quad & \mathbf{A}_i \mathbf{z}_i^T + \mathbf{a}_i = 0 & (c) \quad \mathbf{B}_i \mathbf{z}_i^T + \mathbf{b}_i \leq 0 & (d) \quad \mathbf{z}_i^T \geq 0 \end{aligned}$$

where 6.12-(b) corresponds to the set of N_i^{eq} linear equality constraints and 6.12-(c) corresponds to the N_i^{ineq} linear inequality constraints.

6.4.1 Nash Equilibrium

The system of K -player constrained stochastic game (6.12) can be presented in the frame of a single non-linear complementarity problem (NLCP) or a variational inequality problem (VIP). In the following, we define our game in the frame of a nonlinear complementarity problem. Let us introduce the K Lagrangians

$$\mathcal{L}_i(\mathbf{z}_i, \mathbf{u}_i, \mathbf{v}_i) = -\rho_i + \mathbf{u}_i(\mathbf{A}_i \mathbf{z}_i^T + \mathbf{a}_i) + \mathbf{v}_i(\mathbf{B}_i \mathbf{z}_i^T + \mathbf{b}_i)$$

where \mathbf{u}_i and \mathbf{v}_i are row vectors of Lagrangian multipliers and $i = 1, \dots, K$. A Nash equilibrium necessarily satisfies the Karush-Kuhn-Tucker conditions

$$\begin{aligned} \boldsymbol{\theta}_{1i} &= \nabla_{\mathbf{z}_i} \mathcal{L}_i = -\mathbf{f}^i + \mathbf{u}_i \mathbf{A}_i + \mathbf{v}_i \mathbf{B}_i \\ \boldsymbol{\theta}_{2i} &= \nabla_{\mathbf{u}_i} \mathcal{L}_i = \mathbf{A}_i \mathbf{z}_i^T & \boldsymbol{\theta}_{3i} &= \nabla_{\mathbf{v}_i} \mathcal{L}_i = -\mathbf{B}_i \mathbf{z}_i^T \\ \mathbf{z}_i &\geq 0 & \mathbf{u}_i &\geq 0 & \mathbf{v}_i &\geq 0 \\ \mathbf{z}_i \boldsymbol{\theta}_{1i} &= 0 & \mathbf{u}_i \boldsymbol{\theta}_{2i} &= 0 & \mathbf{v}_i \boldsymbol{\theta}_{3i} &= 0. \end{aligned}$$

Let $\mathbf{w}_i = (\mathbf{z}_i, \mathbf{u}_i, \mathbf{v}_i)$ $\boldsymbol{\Theta}_i(\mathbf{w}_i) = (\boldsymbol{\theta}_{1i}^T, \boldsymbol{\theta}_{2i}^T, \boldsymbol{\theta}_{3i}^T)^T$, and by concatenating different transmitters' vectors $\mathbf{w} = (\mathbf{w}_1, \mathbf{w}_2, \dots, \mathbf{w}_K)$ and $\boldsymbol{\Theta}(\mathbf{w}) = (\boldsymbol{\theta}_1^T, \boldsymbol{\theta}_2^T, \dots, \boldsymbol{\theta}_K^T)^T$, we obtain the nonlinear complementarity problem

$$\boldsymbol{\Theta}(\mathbf{w}) \geq 0 \quad \mathbf{w}^T \geq 0 \quad \mathbf{w} \boldsymbol{\Theta}(\mathbf{w}) = 0 \quad (6.14)$$

in the $\sum_1^K [g_i + N_i^{eq} + N_i^{ineq}]$ unknowns \mathbf{w} .

The existence of Nash equilibria for a general class of constrained stochastic games, where players have independent state processes, is proven in [99]. Therefore, the solution set of the NLCP in (6.14) is nonempty for any finite number of users.

6.4.2 Symmetric Network

Let us consider the case as all the transmitters have the same statistics for the channels and the arrival processes and their sets of actions are the same. Additionally, the constraint parameters are identical. Equivalently, they have the same objectives and constraints. In such a case, an optimal policy is identical for all users. A NLCP in $g_i + N_i^{eq} + N_i^{ineq}$ unknown is obtained from (6.14) omitting index i and removing identical equations. In [112], an algorithm based on extragradient method for variational inequality problems is proposed. It converges whenever the solution set is not empty as our game [99]. The algorithm is iterative and based on quadratic programming. Its complexity depends on both the number of iterations and the number of projections at each iteration required for the convergence to the solution of the quadratic programming.

6.4.3 Best Response Algorithm

Because of the complexity of standard algorithms for NLCP, it is of great interest to investigate simpler approaches. As already mentioned, the game reduces to a LP when the strategies of $K - 1$ players is known. Thus, a low complexity iterative algorithm is obtained by choosing a transmitter i and the policies u_{-i} of the remaining transmitters arbitrarily and solving the corresponding LP. In this way, a complete set of policies is obtained. In the iterative steps, a different transmitter is selected, its policy at the previous step ignored and determined by linear programming based on the policies obtained at the previous step.

symmetric case

In the symmetric case, the algorithm is initialized assigning an arbitrary identical policy $u(0)(a|x)$ to $K - 1$ transmitters and determining the optimal policy for the remaining one. The new policy is assigned to $K - 1$ nodes for the following step. At each iteration we solve a LP and obtain a new policy $u(t+1)(a|x)$ using the policy $u(t)(a|x)$ for evaluating the payoff. Note that, if the algorithm converges, its fixed points are Nash equilibria of the K -player game. The convergence of the best response algorithm to Nash equilibrium is guaranteed only in a symmetric case, while in the general case the algorithm could converge to a point which is not a Nash equilibrium.

	K	N_R	B_i	L	M_i	$ \mathcal{P}_i $	\bar{p}_i	\bar{q}_i
Scn1	2	2	5	3	4	4	2	4
Scn2	3	3	4	3	4	3	2	4

Table 6.1: Network parameters

state index	0 1 2 3 4 5 6 ... 17
queue state	0 0 0 1 1 1 2 ... 6
channel state	0 1 2 0 1 2 0 ... 2

Table 6.2: Labelling of states

6.5 Numerical Results and Conclusions

In this section, we consider the two scenarios with parameters detailed in Table 5.1. The CS varies according to a Markov chain with the following transition probabilities: $T_0^0(i, j) = \frac{1}{2}$, $T_0^1(i, j) = \frac{1}{2}$, $T_{L-1}^{L-1}(i, j) = \frac{1}{2}$, $T_{L-1}^{L-2}(i, j) = \frac{1}{2}$; ($2 \leq k \leq K - 2$) $T_k^k(i, j) = \frac{1}{3}$, $T_k^{k-1}(i, j) = \frac{1}{3}$, $T_k^{k+1}(i, j) = \frac{1}{3}$. This means that at each time slot the channel preserves its state or changes by one unit.

The packet arrival process is described by a Poisson distribution with average rate $\lambda_i = 1$.

We perform a two-level admission control; one is done in our offline algorithm and set the variable c_i to 1/0 corresponding to the acceptance/rejection decision. However, as we only use one admission control flag c_i for all the possible number of packet arrivals, there exist situations where the remaining space of the queue is less than the number of packets arrived at the time. Therefore, a second (realtime) control is needed in order to drop the packets when the queue is full.

In the following, we compare the equilibrium policies and the performance of such strategies in the network. The performance measures are: (i) Throughput (TP), i.e. the number of packets per time slot correctly decoded by the receiver, (ii) Outage rate, i.e. the fraction of transmitted packets which can not be decoded correctly, (iii) Drop rate, i.e. the fraction

action index	0 1 2 3 4 5 6 7 8 9 ... 47
Num of packets	0 0 0 0 0 0 0 0 1 1 1 ... 6
power level	0 0 1 1 2 2 3 3 0 0 1... 3
accept/reject	0 1 0 1 0 1 0 1 0 1 0... 1

Table 6.3: Labelling of policies

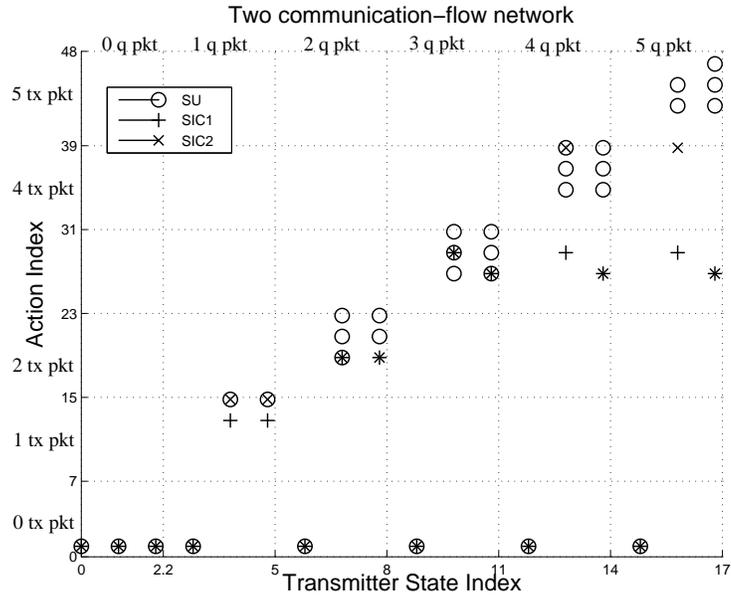

Figure 6.2: Policies in a symmetric two user network: $A - self - SU$ (circle mark) versus $A - self - SIC$ (cross and plus marks)

of arriving packets from upper layer which are rejected due to the admission control.

Let us focus on scenario 1. In Figure 5.2, we describe the equilibria policies obtained by the proposed algorithm in case of selfish game when SIC and SU decoding is performed at the receiver. The action index is presented in abscissa while the state index is represented in ordinate. Since the state index needs to address the pair of CS and QS, the indexing approach is presented in Table 5.2. Similarly, the Table 5.3 describe the mapping between action indices and the triplets (μ_i, p_i, c_i) .

As apparent from Figure 5.3, the best response algorithm converges to a single solution in $A - self - SU$ model while for $A - self - SIC$ model two distinct solutions are obtained.

The optimal policy for $A - self - SU$ does not transmit a packet when the channel is in the worst situation and the decision on the power level is irrelevant. For the two other CSs, namely medium and good, the decision on μ_i is not affected by the CSs. Therefore, in such cases the decision on the number of packets to be transmitted is only dependent on the queue state. However, a comparison between state 10 and 11 shows that less power is

	TP	Outage Rate	Drop rate
$A - self - SU$	0.49	0.42	0.15
$A - self - SIC1$	0.64	0.24	0.16
$A - self - SIC2$	0.69	0.19	0.15
$A - coop - SU$	0.5	0.4	0.17
Policy in [39]	0.41	0.35	0.37

Table 6.4: Comparison $A - self - SU$, $A - self - SIC$, and $A - coop - SU$ in terms of performance

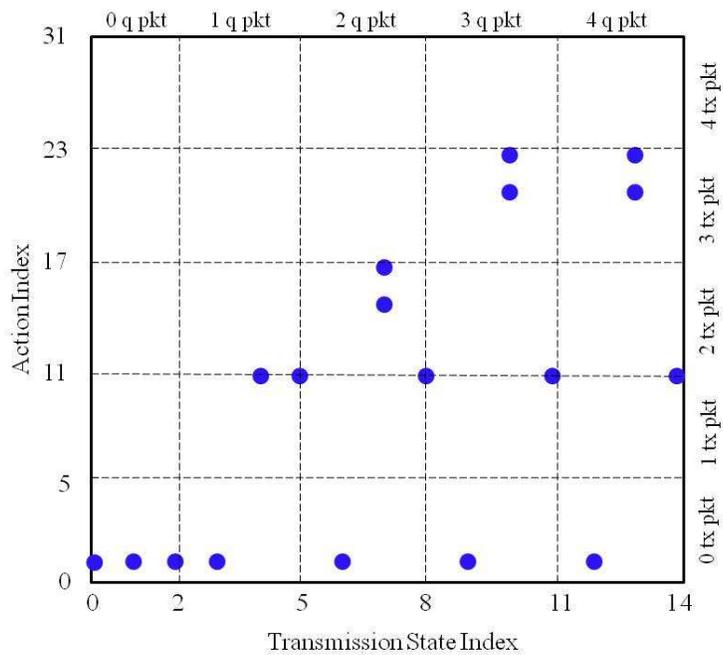

Figure 6.3: Optimal policies for scenario 2

needed when the channel state is good.

The optimal policies of $A - self - SIC$ have the following trends. Compared to $A - self - SU$, optimal policies for SIC tend to be more deterministic. More precisely, for $\mu_i > 0$, a single triplet $a_i = (\mu_i, p_i, c_i)$ is selected. In medium and good states of channel, the optimal policies of SIC transmit less or equal number of packets, comparing to SU. This yields a significantly lower probability of outage as evident from Table 5.4.

$A - coop - SU$ optimal policy shows little changes of decision in response to the QS changes. More specifically, the instantaneous rate, μ_i , does not increase as fast as in $A - self - SU$ in response to a queue length increase. Similar to $A - self - SIC$, one can conclude that $A - coop - SU$ transmits less packets but with lower probability of outage. However, the decrease in the probability of outage is not as significant as in $A - self - SIC$.

Table 5.4 compares the performance of the policy obtained by the approach in [39] and our proposed policies.

$A - self - SU$ shows sizable improvements of throughput and drop rate compared to the policy in [39]. The $A - self - SIC$ policies outperform considerably the $A - self - SU$ ones. The improvement in terms of throughput of $A - coop - SU$ over the $A - self - SU$ is not relevant.

In order to analyze the performance of the proposed algorithm in a network with more than 2 users, the optimal policy of $A - self - SU$ for Scenario 2 was determined (Figure 5.3). From simulations we obtained a single optimal policy, corresponding to a single Nash equilibria point. In such a case, the optimal policy becomes less and less sensitive to the queue length. In other words, the optimal action in a given channel state will gradually become fixed while the queue length increases.

Chapter 7

Cross-Layer Design for Dense Interference Networks

7.1 Introduction

In this chapter, we specialize the problem in Chapter 6 to the challenging case of a dense ad hoc network. In fact, the approach proposed in Chapter 6 has exponential complexities in the number of users. Then, it is of practical and theoretical interests to determine low complexity algorithms in case of dense networks where the number of communication flows is very high.

In this context, we assume that the links between transmitter and receiver are characterized by some kind of diversity (e.g. in space, frequency) and we refer to it as vector channels with N diversity paths. Furthermore, we assume that the N diversity paths are random and K , the number of network links, and N tend to infinity with constant ratio. This approach is motivated by the fact that the asymptotic design and analysis of the network in random environments significantly decreases the design complexity and provides insightful analysis results. This model may characterize interference networks with spreading of the transmitted signals based on random signature sequences (similarly to code division multiple access - CDMA - in multiple access networks), or systems with multiple antennas at the receiver, where the randomness is due to channel fading. In such settings, when the number of users and diversity paths grow, fundamental performance mea-

asures as capacity and signal to interference and noise ratio (SINR) at the output of a receiver detector converge to deterministic limits.

The performance analysis of various receivers (e.g. matched filters, linear minimum mean square error - LMMSE -, optimal detector), for multiple access vector channels in random environment has been extensively investigated in literature (e.g. [42], [43], [44]). We extend the results to interference channels and apply them to the design and analysis of *distributed* cross layer algorithms in large interference networks¹.

The assumption of large system analysis introduces two fundamental features into the system setting in Chapter 6, characterized by a discrete set of decision variables and a discrete set of channel statistics. Firstly, in an interference system with finite number of users and decentralized control mechanisms, a transmission is intrinsically subject to outage since each transmitter is not aware of the interferers' decisions and effects. On the contrary, in interference channels with infinite users, the effects of the interferers tends to a deterministic limit regardless of the instantaneous link states. Then, a transmitter can avoid outage events by convenient control algorithms. Secondly, the complexity of the cross layer algorithms, which increases exponentially with the number of users in Chapter 6, scales only with the number of groups of users characterized by the same channel statistics in large systems.

For large interference systems we consider the cross-layer design of rate and power allocation jointly with scheduling and admission control for four different kind of receivers with increasing complexity. Namely, we consider two receivers, one based on linear MMSE detection and the other on optimum detection and subsequent decoding of all users having the same rate and received power. The receivers have only statistical knowledge of the interferers' channel states. A third receiver is based on joint optimum detection and decoding of all users having same received power and rate but with additional knowledge of the interference structure at the receiver. The fourth receiver decodes jointly and optimally all the decodable users while knowing the interference structure.

We compare the performance of the receivers with the designed optimum policies. The mismatch between the performance of optimum policies for large systems and that of the optimum policies for finite systems is also assessed.

¹Hereinafter, we refer to interference networks with number of users and diversity paths growing to infinity with constant ratio as *large interference networks*.

7.2 System Model

We consider a system consisting of K arbitrary source-destination pairs sharing the same medium, (e.g. ad hoc network). We use the same index for the corresponding transmitter and receiver of a single source-destination pair. The time is uniformly slotted. We assume that the channels are Rayleigh fading and ergodic within a time slot, while the channel statistics change from a time slot to the following one.

Following the same approach as in Chapter 6 we define two sets of discrete variables representing states and actions of each transmitter.

The channel in time slot $t \in \mathbb{N}$ is described by an $K \times K$ matrix $\Sigma(t)$ whose (j, i) element $\sigma_j^i(t)$ is the average power attenuation of the channel between transmitter j and receiver i during time slot t . Throughout this work, we refer to them as the channel states (CS). The row j includes the states of the channels from the transmitting node j to all the destination nodes. This vector is denoted by $\sigma_j(t)$. The i -th column includes the states of the channels from all the transmitting nodes to the receiver i and it is denoted by the column vector $\sigma^i(t)$. It contains all the CS information necessary to determine the statistics of the signal to interference and noise ratio (SINR) at the destination node i at time slot t . Furthermore, each average power attenuation σ_j^i is modelled as an ergodic Markov chain taking values in the discrete set E of cardinality L . For the sake of notation, we define a bijection between the set E and the set of the natural numbers $\{0, 1, \dots, L-1\}$, $\varphi : E \rightarrow \{0, 1, \dots, L-1\}$. Let its inverse be $\psi = \varphi^{-1}$. The Markov chain of σ_j^i is defined by the transition matrix $\mathbf{T}(j, i)$ whose (k, ℓ) element $T_k^\ell(j, i)$ is the probability of transition from the CS $\psi(k)$ to the state $\psi(\ell)$. The conditional probability nature of $T_k^\ell(j, i)$ reflects on the fact that $\sum_{\ell=1}^L T_k^\ell(j, i) = 1$. We assume throughout that $\mathbf{T}(j, i)$ is irreducible and aperiodic as in [39]. The steady CS probability distribution of the channel between transmitter i and destination j is given by the column vector $\pi(i, j)$.

At each node, packets arrive from the upper layer according to an independent and identically distributed arrival process $\gamma_i(t), t \in \mathbb{K}$ with arrival rate λ_i . Here, $\mathbb{P}(\gamma_i(t))$ is the probability of receiving $\gamma_i(t)$ packets at time instant t . The packets have constant length.

Each transmitter is endowed with a buffer of finite length. We denote by B_i the maximum length of the buffer at node i and by $q_i(t)$ number of queuing packets at the beginning of slot t . In the following, we address the variable $q_i(t)$ also as the queue state (QS).

In each time slot, on the basis of the available information at time t transmitter i decides (a) the transmission power level $p_i \in \mathcal{P}_i$, where \mathcal{P}_i is

a finite set of nonnegative reals including zero; (b) the number of packets to transmit $\mu_i \in \mathcal{M}_i$, with $\mathcal{M}_i = \{0, 1, \dots, M_i\}$ and $M_i \leq B_i$; (c) to accept or reject new packets arriving from upper layers. We denote with $c_i = 1$ and $c_i = 0$ the decision of accepting and rejecting the packets, respectively. Therefore, the action of the node i at time slot t is described by the triplet $d_i(t) = (p_i(t), \mu_i(t), c_i(t))$.

The information available at node i at time t is given by the pair $x_i(t) = (\sigma_i^i(t), q_i(t))$, i.e. the CSs from transmitter i to receiver i and the number of the packets in the queue at the beginning of time slot t (QS). We refer to the pair $x_i(t)$ as the transmitter state (TS). Additionally, each transmitter knows the statistics of the other channels and the statistics of the arrival process in the buffer.

We assume that the link between a source and a destination is a vector channel with equal average power attenuation over all the N paths. A vector channel can model systems with several types of diversity (e.g. spatial diversity if the receivers are equipped with N antennas, frequency diversity if code division multiple access, CDMA, or orthogonal frequency division modulation, OFDM are selected as multiple access schemes).

The complex-valued channel model for receiver i is

$$\mathbf{y}^{(i)}[m] = \mathbf{S}[m]\mathbf{H}^{(i)} \left[\left\lfloor \frac{m}{N} \right\rfloor \right] \mathbf{A} \left[\left\lfloor \frac{m}{N} \right\rfloor \right] \mathbf{b}[m] + \mathbf{w}_i[m] \quad (7.1)$$

where m is the index for symbol intervals and depends on the frame interval t by the expression $m = tN + p$ with $p = 0, \dots, N-1$; $\mathbf{y}^{(i)}[m]$ and $\mathbf{b}[m]$ are the N -dimensional complex vectors of received signals by node i and transmitted symbols by all nodes, respectively. Here, $\mathbf{S}[m]$ is a $N \times K$ complex matrix with zero mean independent and identically distributed (i.i.d.) entries having variance $1/N$. The matrices $\mathbf{H}^{(i)} \left[\left\lfloor \frac{m}{N} \right\rfloor \right]$ and $\mathbf{A} \left[\left\lfloor \frac{m}{N} \right\rfloor \right]$ are diagonal with j -th diagonal elements equal to $\sqrt{\sigma_j^i(t)}$ and $\sqrt{p_j(t)}$, respectively. Finally, \mathbf{w}_i is the N dimensional complex vector of the additive white Gaussian noise with zero mean and unit variance. We assume that the transmitted signals $b_i[m]$ are i.i.d., with zero mean and unit variance.

In order to model a large interference network as $K \rightarrow \infty$, we assume that the transition matrices $\mathbf{T}(j, i)$ are taken from a finite set of transition matrices $\mathcal{T} = \{\mathbf{T}^{(1)}, \dots, \mathbf{T}^{(c)}\}$ and the channel between each transmitter and each receiver is described with probability $\mathbb{P}(\mathbf{T}^{(\ell)})$ by the transition matrix $\mathbf{T}^{(\ell)}$. The same property holds for each receiver.

If (7.1) models a CDMA system, the matrix $\mathbf{S}[m]$ includes the effects of the spreading sequences with spreading factor N and the randomness of a

Rayleigh fading channel. If (7.1) models K interfering single antennas transmitting to K receivers equipped with multiple antennas (SIMO systems), then the matrix $\mathbf{S}[m]$ accounts for the Rayleigh fading. In both cases, the matrix $\mathbf{H}^{(i)} \llbracket \frac{m}{N} \rrbracket$ models the effects of the pathloss. Eventual coupling effects among the receiving antennas in interfering SIMO systems are neglected in this model.

Throughout this work we will consider a system in the steady state. Thus, we will neglect the symbol interval m when its omission does not cause ambiguity. In the following section, conditions for the convergence to a steady state of the whole system will be detailed.

The probability mass function of the joint action and transmitter state in the steady state of the Markov decision chain is denoted by $\mathbb{P}(a_k, \boldsymbol{\sigma}_k, q_k)$. A policy of transmitter k is a deterministic or probabilistic application from the space of TS \mathcal{X}_k to the action space \mathcal{D}_k . A probabilistic (or mixed) policy of transmitter k is $u_k(d_k|x_k)$, i.e. the probability that mobile k chooses the action d_k when the state is x_k or equivalently, the conditional probability that user k chooses the action triplet (p_k, μ_k, c_k) conditioned to the transmitter state (σ_k^k, q_k) . The class of decentralized policies of mobile k is denoted by \mathcal{U}_k . If we assume that the user policies are known, then the probability mass function of $\mathbf{p}_k^i = p_k \sigma_k^i$, $k = 1 \dots K$, the average received power from transmitter k by receiver i is given by

$$\begin{aligned} \mathbb{P}(\mathbf{p}_k^i) &= \sum_{\substack{\sigma_k, p_k: \\ p_k \sigma_k^i = \mathbf{p}_k^i}} \sum_{c_k} \sum_{q_k} \sum_{\mu_k} \mathbb{P}(\boldsymbol{\sigma}_k, q_k) u_k(p_k, \mu_k, c_k | \sigma_k^k, q_k) \\ &= \sum_{\substack{\sigma_k, p_k: \\ p_k \sigma_k^i = \mathbf{p}_k^i}} \sum_{c_k} \sum_{q_k} \sum_{\mu_k} \mathbb{P}(\boldsymbol{\sigma}_k^k, q_k) \mathbb{P}(\boldsymbol{\sigma}_k^i) u_k(p_k, \mu_k, c_k | \sigma_k^k, q_k) \end{aligned} \quad (7.2)$$

where the second step is a consequence of the independence of σ_k^k and σ_k^i .

Let us notice that the empirical eigenvalue distribution of the matrix $\mathbf{H}^{(i)} \mathbf{A} \mathbf{A}^H \mathbf{H}^{(i)H}$ converges to the probability distribution function of the averaged received power \mathbf{p}_k^i , when the system is in the steady state ($t \rightarrow +\infty$) and the number of communication flows grows large ($K \rightarrow +\infty$)

Additionally, the assumptions on the finite cardinalities of the state and action sets induce a dynamic partition on the set of the K transmitter-receiver pairs for each given receiver i . This partition consists of a finite number of subsets: all the communication pairs having the *same received power* at the receiver i and the *same rate* at a certain time interval belong to the same group. We denote the total number of groups by $N_g^{(i)}$ and $\mathcal{G}_m^{(i)}$ is the m -th group. There exist a bijection between the set of groups $\mathcal{G}_m^{(i)}$ and

the set of pairs (\mathbf{p}_r^i, μ_s) . Let $K_1^{(i)}, K_2^{(i)}, \dots, K_{N_g}^{(i)}$, with $\sum_{m=1}^{N_g} K_m^{(i)} = K$, be the cardinality of the sets $\mathcal{G}_1^{(i)}, \mathcal{G}_2^{(i)}, \dots, \mathcal{G}_{N_g}^{(i)}$, respectively. Let us notice that, in general, the bijection depends on the block interval. However, when we consider the steady state and $N, K \rightarrow +\infty$, with $\frac{K}{N} \rightarrow \beta$, the convergence $\frac{K_m^{(i)}}{N} \rightarrow \beta_m^{(i)}$, with $\frac{\sum_{m=1}^{N_g} K_m^{(i)}}{N} = \frac{K}{N} = \beta$ holds. For further studies, it is useful to introduce the correlation matrix of the whole transmitted signals $\mathbf{R}^{(i)} = \mathbf{S}\mathbf{H}^{(i)}\mathbf{A}\mathbf{A}^H\mathbf{H}^{(i)H}\mathbf{S}^H$ and $\mathbf{R}_{\widehat{\mathcal{G}}^{(i)}}^{(i)}$ the correlation matrix of the signals transmitted by nodes in $\widehat{\mathcal{G}}^{(i)}$ and received by node i . The correlation matrix $\mathbf{R}_{\widehat{\mathcal{G}}^{(i)}}^{(i)}$ is obtained by setting $\mathbf{p}_m^i = 0$ in $\mathbf{R}^{(i)}$, for all transmitting nodes not in $\widehat{\mathcal{G}}^{(i)}$. Finally, we define the correlation matrix of the interfering signals to the signals of interest in $\widehat{\mathcal{G}}^{(i)}$, $\mathbf{R}_{\sim\widehat{\mathcal{G}}^{(i)}}^{(i)}$. It is obtained from $\mathbf{R}^{(i)}$ setting $\mathbf{p}_m^i = 0$ if the m -th transmitter is in $\widehat{\mathcal{G}}^{(i)}$.

Let us turn to the structure of the receiver at each node.

We will consider different receivers depending on the assumptions we make about (I) the level of knowledge of the interference available at the receiver; (II) the eventual use of a suboptimal receiver based on a preliminary pre-decoding processing (e.g. detection) followed by decoding; and (III) the type of the decoder, i.e. single-user/joint decoder. It is important to note that the aim of receiver k is to decode its own message of interest, i.e. the message transmitted by the corresponding transmitter k . The other messages are decoded if this is beneficial for decoding the message of interest. Based on these observations, we consider four approaches detailed in the following:

SG-MMSE/UIS/SGD (Single Group MMSE detection/ Unknown Interference Structure/Single Group Decoding): In this case we assume that the receiver k has knowledge only of the channel vectors $\sqrt{\mathbf{p}_i^k} \mathbf{s}_i^k$ for the communication flows which have the same received powers and transmission rate of the user of interest k , i.e. the transmitters in $\mathcal{G}_k^{(k)}$, but no knowledge of the others. The interference from the latter communication flows is considered as a white additive Gaussian signal. The receiver first detects the transmitted symbols for all the flows with known vector channels by a linear minimum mean square error (LMMSE) detector. Subsequently, it performs single-group decoding, i.e. it decodes jointly the information streams of the pairs in $\mathcal{G}_k^{(k)}$.

NP/UIS/SGD (No preprocessing/Unknown Interference Structure/Single Group Decoding): This case differs from the previous one

only in the fact that no pre-processing of the received signal is performed.

NP/KIS/SGD (No preprocessing/Known Interference Structure/Single Group Joint Decoding): The receiver k has knowledge of all the vector channels $\sqrt{\mathbf{p}_i^k \mathbf{s}_i^k}$. It decodes jointly the information streams of the single group $\mathcal{G}_m^{(k)}$ it belongs to, i.e. with the same received power as the user of interest \mathbf{p}_k^k and same rate μ_k . In the decoding it makes use of the knowledge about all the interference structure, i.e. the knowledge of the vector channels of all active streams.

NP/KIS/MGD (No preprocessing/Known Interference Structure/Multi Group Joint Decoding) All the vector channels of the active transmitters are known to receiver i . Then, receiver i identifies the maximum decodable set of information streams and decode them jointly while taking into account of the interference structure for the users which are not decoded.

Let us notice that the investigated receivers are in order of increasing performance in decoding the information of interest.

In the following we will denote by X_k the information bits (uncoded bits) transmitted by node k , by $X_{\mathcal{V}}$ the information bits transmitted by the transmitting nodes in the set \mathcal{V} . Finally, $I(X_{\mathcal{V}}; Y^{(k)})$ is the mutual information of the channel transmitting $X_{\mathcal{V}}$ and receiving $\mathbf{y}^{(k)}$.

7.3 Preliminary Useful Tools

In this section we will specialize known results on large multiple access networks and on the rate regions of interference channels to our interference networks with a large number of nodes. Additionally, key remarks will be stated.

7.3.1 Some Convergence Results

Let us consider the Markov chain with finite states which characterize the statistics of a channel between a transmitter and a receiver node. If we assume that the Markov chain is irreducible and aperiodic, then there is a unique stationary distribution which describes the steady state. Let us further assume that all the transmitter-receiver channels are described by the same Markov chain. Then, applying the Glivenko-Cantelli theorem

(e.g. [113]) the empirical distribution of the channel states in the matrix $\mathbf{H}^{(i)}$, for any i , as the system is in the steady state, converges almost surely to the unique stationary distribution of the unique Markov chain. If the policies of all users, $\mathcal{U}_k, k = 1, \dots, K$, are known and identical, then also the empirical distribution mass function of the received powers in the matrix $\mathbf{A}\mathbf{H}^{(i)}\mathbf{H}^{(i)H}\mathbf{A}^H$ converges almost surely to the distribution mass function (7.2). A similar convergence result can be obtained if the channels between a transmitter and a receiver are described by a Markov chain defined by a transition matrix belonging to a finite set with a given distribution $\mathbb{P}(\mathbf{T})$

This kind of convergence satisfies the conditions for the applicability of results on random large matrices (see e.g. [108]) which are the key tools to derive the following results.

7.3.2 Large System Analysis of the Receivers

The large system analysis of multiple access vector channels with random channel vectors is done in [42–44]. Effects of interference on large network performance are investigated in [110, 111]. The extension of their results to the interference network in Section 7.2 is presented here.

Without loss of generality, in the following we will focus on the transmitter-receiver pair 1 and we denote by $\mathcal{G}_1^{(1)}$ the group of all the communication flows with received power at receiver 1 and transmission rate equal to \mathbf{p}_1^1 and $\mu_1 R$, respectively.

In the case of a SG-MMSE/NIS/SGD receiver and the system size grows large with $K, N \rightarrow \infty$, $\frac{K}{N} \rightarrow \beta$ and $\frac{|\mathcal{G}_1^{(1)}|}{N} \rightarrow \beta_1^{(1)}$, the spectral efficiency per chip converges almost surely to [42]

$$\mathcal{C}^{mmse}(\text{SNR}, \beta_1^{(1)}) \rightarrow \beta_1^{(1)} \log_2(1 + \text{SNR} - \frac{1}{4}\mathcal{F}(\text{SNR}, \beta_1^{(1)})) \quad (7.3)$$

being $\mathcal{F}(x, z) = (\sqrt{x(1 + \sqrt{z})^2 + 1} - \sqrt{x(1 - \sqrt{z})^2 + 1})^2$ and SNR the signal to noise ratio accounting in the noise also the interference from other groups, i.e.

$$\text{SNR} = \frac{\mathbf{p}_1^{(1)}}{1 + \sum_{m \in \{2, \dots, N_g\}} \beta_m^{(1)} \mathbf{p}_m^{(1)}}. \quad (7.4)$$

The information stream of the pair in $\mathcal{G}_1^{(1)}$ can be decoded reliably if and only if

$$\mu_1 R \leq \frac{\mathcal{C}^{mmse}(\text{SNR}, \beta_1^{(1)})}{\beta_1^{(1)}}. \quad (7.5)$$

In fact, from the definition of group $\mathcal{G}_1^{(1)}$ and the capacity region of a multiple access channel, the elements of all the information flows in $\mathcal{G}_1^{(1)}$ are reliably decodable if the following infinite conditions are satisfied:

$$\begin{cases} \tilde{\beta}_1^{(1)} \mu_1 R \leq \mathcal{C}^{mmse}(\text{SNR}, \tilde{\beta}_1^{(1)}) & \text{for } 0 < \tilde{\beta}_1^{(1)} \leq \beta_1^{(1)}, \\ \mu_1 R \leq \log_2(1 + \text{SNR}) & \text{for any subset of } \mathcal{G}_1^{(1)} \text{ with} \\ & \text{finite cardinality and } N \rightarrow \infty. \end{cases} \quad (7.6)$$

The condition on the dominant face (7.5) implies all the infinite other conditions (7.6) since the term $\frac{\mathcal{C}^{mmse}(\text{SNR}, \tilde{\beta}_1^{(1)})}{\tilde{\beta}_1^{(1)}}$ is a decreasing function of $\tilde{\beta}_1^{(1)}$.

Let us notice that the effects of interference become deterministic if $\beta_j^{(1)}$ are deterministic.

The derivation of the large system performance for the NP/UIS/SGD receiver follows along similar lines when we observe that the spectral efficiency of the multiple access channel consisting of all the transmitters in $\mathcal{G}_1^{(1)}$ and the reference receiver 1 is given by [42]

$$\begin{aligned} \mathcal{C}^{\text{opt}}(\text{SNR}, \beta_1^{(1)}) &= \beta_1^{(1)} \log_2(1 + \text{SNR} - \frac{1}{4} \mathcal{F}(\text{SNR}, \beta_1^{(1)})) \\ &+ \log_2(1 + \text{SNR} \beta_1^{(1)} - \frac{1}{4} \mathcal{F}(\text{SNR}, \beta_1^{(1)})) - \frac{\log e}{4\text{SNR}} \mathcal{F}(\text{SNR}, \beta_1^{(1)}) \end{aligned}$$

with SNR defined in (7.4). Then, the information streams of the pairs in $\mathcal{G}_1^{(1)}$ can be decoded reliably by a NP/UIS/SGD receiver if and only if

$$\mu_1 R \leq \frac{\mathcal{C}^{\text{opt}}(\text{SNR}, \beta_1^{(1)})}{\beta_1^{(1)}}. \quad (7.7)$$

The performance of an NP/KIS/SGD receiver can be derived by using the fundamental relation on the mutual information

$$\begin{aligned} I(X_{\mathcal{G}_1^{(1)}}; Y^{(1)}) &= I(X_{\mathcal{G}_1^{(1)}}; Y^{(1)}) - I(X_{\sim \mathcal{G}_1^{(1)}}; Y^{(1)} | X_{\mathcal{G}_1^{(1)}}) \\ &= \log_2 \det(\mathbf{R}^{(1)} + \mathbf{I}) - \log_2 \det(\mathbf{R}_{\sim \mathcal{G}_1^{(1)}}^{(1)} + \mathbf{I}) \end{aligned} \quad (7.8)$$

where $\mathbf{X}_{\mathcal{G}_1^{(1)}}$ denotes the set of transmitted information streams in $\mathcal{G}_1^{(1)}$, $Y^{(1)}$ is the set of the received random signals at receiver 1, and $\mathbf{X}_{\sim \mathcal{G}_1^{(1)}}$ is

the set of all the information streams transmitted by the nodes in the set $\sim \mathcal{G}_1^{(1)} = \bigcup_{m=2}^{N_g} \mathcal{G}_m^{(1)}$.

In large systems, the spectral efficiency per chip at the receiver 1 when all the transmitted information are decoded (multiple access vector channel) is given by [43, 44]

$$\begin{aligned} \mathcal{C}^{(\text{MAC})}(\text{SNR}, \beta_1^{(1)}) &= \sum_{m=1}^{N_g} \beta_m^{(1)} \log_2(1 + \mathbf{p}_m^{(1)} \eta^{(1)}) \\ &\quad - \log_2 \eta^{(1)} + (\eta^{(1)} - 1) \log_2 e \end{aligned} \quad (7.9)$$

being $\eta^{(1)}$ the unique real nonnegative solution of the fixed point equation

$$\eta^{(1)} = \frac{1}{1 + \sum_{m=1}^{N_g} \beta_m \frac{\mathbf{p}_m^{(1)}}{1 + \mathbf{p}_m^{(1)} \eta^{(1)}}}. \quad (7.10)$$

Then, (7.8) and (7.9) yield the spectral efficiency per chip of an NP/KIS/SGD receiver

$$\begin{aligned} \mathcal{C}^{(\text{NP/KIS/SGD})}(\text{SNR}, \beta_1^{(1)}) &= \beta_1^{(1)} \log_2(1 + \mathbf{p}_1^{(1)} \eta^{(1)}) \\ &\quad + \sum_{m=2}^{N_g} \beta_m^{(1)} \log_2 \left(\frac{1 + \mathbf{p}_m^{(1)} \eta^{(1)}}{1 + \mathbf{p}_m^{(1)} \eta_{\sim \mathcal{G}_1^{(1)}}^{(1)}} \right) \\ &\quad + \log_2 \frac{\eta_{\sim \mathcal{G}_1^{(1)}}^{(1)}}{\eta^{(1)}} + (\eta^{(1)} - \eta_{\sim \mathcal{G}_1^{(1)}}^{(1)}) \log_2 e \end{aligned} \quad (7.11)$$

with $\eta^{(1)}$ given in (7.10) and $\eta_{\sim \mathcal{G}_1^{(1)}}^{(1)}$ satisfying the relation

$$\eta_{\sim \mathcal{G}_1^{(1)}}^{(1)} = \frac{1}{1 + \sum_{m=2}^{N_g} \beta_m \frac{\mathbf{p}_m^{(1)}}{1 + \mathbf{p}_m^{(1)} \eta_{\sim \mathcal{G}_1^{(1)}}^{(1)}}}. \quad (7.12)$$

Let us consider the multiuser efficiency $\eta^{(1)}$ of the NP/KIS/SGD receiver as a function of $\beta_1^{(1)}$ and observe that it is a decreasing function of $\beta_1^{(1)}$. Then, making use of this property and appealing to similar arguments to the ones adopted for the SG-MMSE/NIS/SGD receiver it can be shown that the a reliable communication is possible if and only if the rate $\mu_1 R$ in $\mathcal{G}_1^{(1)}$ satisfies the conditions on the dominant face of the rate region, i.e.

$$\mu_1 R \leq \frac{\mathcal{C}^{(\text{NP/KIS/SGD})}(\text{SNR}, \beta_1^{(1)})}{\beta_1^{(1)}}. \quad (7.13)$$

Let us consider now a NP/KIS/SGD receiver. We aim to provide necessary and sufficient conditions for a reliable decoding. Let us first observe that for each receiver there exist a unique maximal decodable set of transmitters, i.e. a set of transmitters which are jointly decodable by the receiver and is not a proper subset of any other decodable subset [61]. Furthermore,

Theorem 7. [61] *A subset $\widehat{\mathcal{G}}^{(1)} \subseteq \mathcal{G}^{(1)}$ is the unique maximal decodable subset at receiver 1 if and only if the transmitters' rates satisfy the following inequalities*

$$\begin{cases} \sum_{i \in \mathring{\mathcal{G}}^{(1)}} \mu_i R \leq I(X_{\mathring{\mathcal{G}}^{(1)}}; Y^{(1)} | X_{\widehat{\mathcal{G}}^{(1)} \setminus \mathring{\mathcal{G}}^{(1)}}) & \forall \mathring{\mathcal{G}}^{(1)} \subseteq \widehat{\mathcal{G}}^{(1)}, \\ \sum_{i \in \mathring{\mathcal{G}}^{(1)}} \mu_i R > I(X_{\mathring{\mathcal{G}}^{(1)}}; Y^{(1)} | X_{\widehat{\mathcal{G}}^{(1)}}) & \forall \mathring{\mathcal{G}}^{(1)} \subseteq \mathcal{G}^{(1)} \setminus \widehat{\mathcal{G}}^{(1)}. \end{cases} \quad (7.14)$$

This theorem was derived in [61] for finite sets $\mathcal{G}^{(1)}$ but it can be extended to infinite sets. In this case, conditions (7.14) consist of infinite inequalities and it is not of practical usefulness. Nevertheless, for our system, the partition of the transmitter-receiver pairs in groups $\mathcal{G}_m^{(i)}$, $m = 1, \dots, N_g$ can be utilized to reduce the set of conditions (7.14) to a finite set. In fact, the following properties derive from basic inequalities in information theory: (I) If a receiver is able to decode one transmitter in a group of users with identical received powers and transmission rates, it is able to decode all transmitted information by the users in the group. Equally, if a receiver is not able to decode jointly all the users with identical received powers and transmission rates it is not able to decode any single transmitted information by one user in the group. (II) If a receiver is able to decode two groups² of transmitters, the union is also decodable by the receiver. Thus, also for large systems we can conclude that if a transmitter of a group $\mathcal{G}_m^{(i)}$ belongs to the decodable set any other transmitter belonging to the same group is also decodable and the full set is included in the maximum decodable set³.

Then, the conditions on all the subsets $\mathcal{G}_m^{(i)}$ and (7.14) reduce to a finite set of conditions.

²Each group consists of users having same received powers and transmission rate.

³These properties hold thanks to the existence and uniqueness of the maximum decodable set [61] and the fact that all users in the same set have the same transmitted and received power.

Let us observe that the possible decodable sets for which to verify condition (7.14) are 2^{N_g} . Because of the exponential complexity of this step, it is of great interest to have low complexity algorithms. An algorithm with polynomial complexity is proposed in [61]. It is based on the submodular function $f(\mathcal{V}, \mathcal{S})$, with $\mathcal{V} \supseteq \mathcal{S} \supseteq \mathcal{G}$, and \mathcal{G} finite set transmitters⁴

$$f(\mathcal{V}, \mathcal{S}) = I(X_{\mathcal{V}}; Y^{(1)} | X_{\mathcal{S} \setminus \mathcal{V}}) - R_{\mathcal{V}} \quad (7.15)$$

and $R_{\mathcal{V}}$ is the sum of the rates of all the transmitters in \mathcal{V} . Note that $f(\mathcal{V}, \mathcal{S})$ is defined also for the empty set \emptyset , and $f(\emptyset, \mathcal{S}) = 0$. Additionally, the algorithm exploits well known polynomial time algorithms for the minimization of submodular functions [114, 115]. The application of this approach to a large system is almost straightforward when we determine the maximum decodable set up to a subset with zero measure. Then, if the communication of interest belongs to a set of zero measure, independently whether it is decodable or not.

The polynomial time algorithm to verify whether the information stream of the transmitter-receiver pair of interest in $\mathcal{G}^{(1)}$, with cardinality $|\mathcal{G}^{(1)}| \rightarrow \infty$ is decodable or not is detailed in Algorithm 1.

7.4 Problem Statement

The utility function for this problem is defined as the individual throughput of each transmission flow, i.e. the average number of information bits transmitted by a source and successfully received by the corresponding destination in the time unit. We are interested in finding the policies \mathcal{U}_k which maximize the individual throughput with some constraints while using one of the receivers described in Section II. With this aim, we investigate the problem introduced in Chapter 6 under the assumption that $\frac{K}{N} \rightarrow \beta > 0$ and β finite. We make use of mathematical results on random matrices successfully utilized in the analysis of several large systems.

In the rest of this section we introduce the throughput optimization problem as a stochastic game defined for the interference network under investigation.

At each time slot, a node chooses its action without having a global view of the channel states and the other users' interference. There is no coordination among transmitters' actions and only local information is available

⁴Note that the function $f(\mathcal{V}; \mathcal{S}) \geq 0$ if the sum rate of the information transmitted by nodes in \mathcal{V} is lower than the mutual information over the channel between the nodes in \mathcal{V} and the receiver when all the information transmitted by nodes in $\mathcal{S} \setminus \mathcal{V}$ is known at the receiver and the information transmitted by the nodes in $\mathcal{G}^{(1)} \setminus \mathcal{S}$ is treated as noise.

Algorithm 1 Decodable transmissions*Initial Step:*Set $\mathcal{S} = \bigcup_{\substack{\ell=1 \\ \beta_\ell^{(1)} \neq 0}} \mathcal{G}_\ell^{(1)}$.*Step 2:*Determine the set $\mathcal{V}_{\min} = \bigcup_{\substack{\ell=1 \\ \beta_\ell^{(1)} \neq 0}} \mathcal{G}_{i_\ell}^1 \subseteq \mathcal{S}$ with minimum cardinality that minimize the submodular function

$$\begin{aligned}
\tilde{f}(\mathcal{V}, \mathcal{S}) &= \lim_{\substack{K, N \rightarrow \infty \\ \frac{K}{N} \rightarrow \beta}} \frac{f(\mathcal{V}, \mathcal{S})}{N} \\
&= \sum_{\substack{\ell=1 \\ \mathcal{G}_\ell^{(1)} \notin \mathcal{S}}}^{N_g} \beta_\ell^{(1)} \log_2 \left(\frac{1 + \mathbf{p}_\ell^{(1)} \eta_{\mathcal{S} \setminus \mathcal{V}_{\min}}^{(1)}}{1 + \mathbf{p}_\ell^{(1)} \eta_{\mathcal{S}}^{(1)}} \right) \\
&\quad \sum_{\substack{\ell=1 \\ \mathcal{G}_\ell^{(1)} \in \mathcal{V}_{\min}}}^{N_g} \beta_\ell^{(1)} \log_2(1 + \mathbf{p}_\ell^{(1)} \eta_{\mathcal{S} \setminus \mathcal{V}_{\min}}^{(1)}) + \log_2 \frac{\eta_{\mathcal{S}}^{(1)}}{\eta_{\mathcal{S} \setminus \mathcal{V}_{\min}}^{(1)}} \\
&\quad + (\eta_{\mathcal{S} \setminus \mathcal{V}_{\min}}^{(1)} - \eta_{\mathcal{S}}^{(1)}) \log_2 e - \sum_{\substack{\ell=1 \\ \mathcal{G}_\ell^{(1)} \in \mathcal{V}_{\min}}}^{N_g} \mu_m \beta_m^{(1)} R.
\end{aligned}$$

with $\eta_{\mathcal{S} \setminus \mathcal{V}_{\min}}^{(1)}$ and $\eta_{\mathcal{S}}^{(1)}$ defined as in (7.12).*Step 3*Set $\mathcal{S} \leftarrow \mathcal{S} \setminus \mathcal{V}_{\min}^{(1)}$. If $\mathcal{V}_{\min}^{(1)} \neq \emptyset$ go to step 2.*Step 4*If $\mathcal{G}_1^{(1)} \subseteq \mathcal{S}$ then the transmitter-receiver pair 1 is decodable. STOP.*Step 5*If $\beta_1^{(1)} = 0$ then set \mathcal{V} to a singleton set containing the transmitter-receiver pair 1 and compute the function

$$\begin{aligned}
f_0(\mathcal{V}, \mathcal{S}) &= \lim_{\substack{K, N \rightarrow \infty \\ \frac{K}{N} \rightarrow \beta}} f(\mathcal{V}, \mathcal{S}) \\
&= \lim_{\substack{K, N \rightarrow \infty \\ \frac{K}{N} \rightarrow \beta}} \log_2 \det(\mathbf{R}_{\mathcal{S}} + \mathbf{p}_1^1 \mathbf{s}_1^{1H} \mathbf{s}_1^1 + \mathbf{I}) \\
&\quad - \log_2 \det(\mathbf{R}_{\mathcal{S}} + \mathbf{I}) - \mu_1 R = \log_2(1 + \mathbf{p}_1^1 \eta_{\mathcal{S}}) - \mu_1 R
\end{aligned}$$

with $\eta_{\mathcal{S}}$ defined as in (7.12).*Step 6*If $f_0(\mathcal{V}, \mathcal{S}) \geq 0$ then the transmitter-receiver pair 1 is decodable otherwise is not decodable. STOP.

at each node. Therefore, in the general case, for any choice (p_i, μ_i) , there is no guaranty that the μ_i transmitted packets can be received correctly when the TS is x_i .

However, for large interference networks, as $N, K \rightarrow \infty$ and $\frac{K}{N} \rightarrow \beta$, the total interference impairing user i can be replaced by a deterministic value. Therefore, during a block time t , $\mu_i(t)$ packets can be transmitted successfully by source i if the conditions derived in Section III for the achievable rates on the interference channel are satisfied. Namely, if an SG-MMSE/NIS/SGD receiver is adopted, the power and transmission rate are such that (7.5) is satisfied. For an NP/UIS/SGD receiver, condition (7.7) needs to be fulfilled. Condition (7.13) is required for reliable communications when NP/KIS/SGD receivers are utilized. Conditions for reliable communications over a system based on NP/KIS/SGD receivers are provided in (7.14) or, equivalently, in Algorithm 7.3.2.

Let $\mathbb{P}(\mu_k(t)R \text{ achievable} | x_k^k = \chi_0)$ be the probability of receiving correctly $\mu_k(t)$ transmitted packets at block time t , conditioned to $x_k(0) = \chi_0$, the initial state of user k . This probability depends on the choice of the receiver although it is not explicitly expressed by the adopted notation.

The average throughput for source k is

$$\limsup_{T \rightarrow +\infty} \frac{1}{T} \sum_{t=0}^{T-1} E\{\mathbb{P}(\mu_k(t)R | x_k^k(0) = \chi_0) \mu_k(t)R\} \quad (7.16)$$

where the expectation is conditioned to $x_k^k(0)$, the initial TS of user k .

For physical and QoS reasons the transmitters are subjected to constraints on the average transmitted powers and on the average queue length. More specifically, the average power of transmitter k is constrained to a maximum value \bar{p}_k and the following upper bound is enforced

$$\limsup_{T \rightarrow +\infty} \frac{1}{T} \sum_{t=0}^{T-1} E\{p_k(x_k(t), d_k(t)) | x_k(0) = \chi_0\} \leq \bar{p}_k \quad (7.17)$$

where $p_k(x_k(t), d_k(t))$ is the power, eventually zero, transmitted by the source k at time instant t when the action triplet $d_k(t)$ is selected. The expectation is conditioned to the initial TS $x_k(0) = \chi_0$ of transmitter k . Similarly, in order to keep the average delay of the packets limited, the average queue length is constrained by the following bound:

$$\limsup_{T \rightarrow +\infty} \frac{1}{T} \sum_{t=0}^{T-1} E\{q_k(t) | x_k(0) = \chi_0\} \leq \bar{q}_k \quad (7.18)$$

where \bar{q}_k is maximum allowed average queue and the expectation is conditioned to $x_k(0) = \chi_0$.

7.5 Game in Large Symmetric Interference Networks

In this section we restrict our investigation to a large symmetric interference network. A large symmetric interference network is characterized by the fact that all the channels are characterized by the same Markov chain and the statistically identical processes for the arrival processes. Additionally, their action sets and the constraint parameters are identical. Equivalently, in a large symmetric interference network all the users have the same objectives and constraints. In such a case, an optimal policy is identical for all users. Furthermore, the distributions of the received powers are equal for all users.

Therefore, here on, we omit the user index and generalized our analysis to any transmitter-receiver pair. We denote by κ the cardinality of the product set $\mathcal{K} = \mathcal{X} \times \mathcal{D} = \{(x, d) : x = (\sigma, q) \in \mathcal{X}, d = (p, \mu, c) \in \mathcal{D}\}$ and by $\langle x, d \rangle_n$ the n -th element of \mathcal{K} . In the asymptotic case, the other users' policies will influence the payoff function only through the asymptotic distribution of the received powers. If we denote this probability by $\mathbb{P}(\mathbf{p})$, the payoff function is

$$c(x, d, \mathbb{P}(\mathbf{p})) = \mu R 1(\mu R \text{ achievable}; \mathbb{P}(\mathbf{p})) \quad (7.19)$$

where $1(\cdot)$ is the indicator function. The payoff function can be computed for each given pair in \mathcal{K} and $\mathbb{P}(\mathbf{p})$ from conditions (7.5), (7.7), (7.13) or (7.14) according to the adopted decoding method.

Let $z = z(x, a)$ be the joint probability that the transmitter performs action a while being in state x . It can be expressed by the column vector $\mathbf{z} = (z_1, z_2, \dots, z_\kappa)^T$. Then, for a given received power distribution, the payoff ρ is given by the linear form

$$\rho(\mathbb{P}(\mathbf{p})) = \sum_{\langle x, d \rangle \in \mathcal{K}} c(x, d, \mathbb{P}(\mathbf{p})) z_n. \quad (7.20)$$

Therefore the constrained optimization problem defined in (7.16)-(7.18) can be expressed as follows

$$\max_{z(x,d)} \sum_{x \in \mathcal{X}} \sum_{d \in \mathcal{D}} z(x,d) \mu R1(\mu R \text{ achievable}; \mathbb{P}(\mathbf{p})) \quad (7.21a)$$

Subject to:

$$\sum_{x \in \mathcal{X}} \sum_{d \in \mathcal{D}} z(x,d) [\delta_r(x) - P_{xdr}] = 0 \quad \forall r \in \mathcal{X} \quad (7.21b)$$

$$\sum_{x \in \mathcal{X}} \sum_{d \in \mathcal{D}} p(x,d) z(x,d) \leq \bar{p} \quad (7.21c)$$

$$\sum_{x \in \mathcal{X}} \sum_{d \in \mathcal{D}} qz(x,d) \leq \bar{q} \quad (7.21d)$$

$$z(x,d) = 0 \quad \text{if } q \leq \mu \quad (7.21e)$$

$$z(x,d) \geq 0; \quad \forall (x,d) \in \mathcal{K}; \quad \sum_{(x,d) \in \mathcal{K}} z(x,d) = 1 \quad (7.21f)$$

where P_{xdr} is the probability to move from state x to state r when action d is performed. $\delta_r(x)$ is a delta function which is equal to 1 where $x = r$ and zero for other values of x . Additionally, (7.21b) guarantees that the graph of the obtained MDP is closed; (7.21c)-(7.21d) correspond to the constraints (7.17)-(7.18), respectively; (7.21e) eliminates the invalid pairs in \mathcal{K} such that the number of packets to be sent is not higher than the number of packets in the queue.

Note that if the distribution $\mathbb{P}(\mathbf{p})$ had been known (7.20) would have reduced to a linear equation and the optimal $\mathbf{z} = \mathbf{z}^*$ would have been solution of a linear program.

The optimal policy $u^*(d|x)$ of a transmitter can be immediately derived from \mathbf{z}^* in the steady state of the MDC system by the relation $u(d|x) = \frac{z^*(x,d)}{\sum_{d' \in \mathcal{D}} z^*(x,d')}$.

In a large symmetric network an equilibrium for the network is achieved when all the transmitters adopt the same policy $u(d|x)$ or $z(x,d)$. Since the probability of the received powers $\mathbb{P}(\mathbf{p})$ depends on $u(d|x)$, then the game (7.21) is intrinsically nonlinear and difficult to solve. Thus we propose a best response algorithm as solution of the game. We choose arbitrarily a policy for all the infinite transmitters except the reference pair 1. Based on such a policy it is possible to determine the probability of the received powers at receiver 1 by (7.2). Then, the new probability mass function $\mathbb{P}(\mathbf{p})$ is utilize to solve the linear problem defined in (7.21). This procedure can be iterated. If the algorithm converges the solution is a Nash equilibrium.

title	β	B_i	L	M_i	$ \mathcal{P}_i $	\bar{p}_i	\bar{q}_i
CL	2	5	3	5	4	1	2
Conv	2	—	3	5	4	1	2

Table 7.1: Network parameters

state index	0 1 2 3 4 5 6 ... 17
queue state	0 0 0 1 1 1 2 ... 5
channel state	0 1 2 0 1 2 0 ... 2

Table 7.2: Labelling of states

7.6 Numerical Results

In this section, we consider two methods for resource allocation. The first method is the cross-layer method proposed in this work and denoted shortly CL. The second method is the conventional resource allocation ignoring the state of queues. It is denoted shortly as Conv. We use the setting of a symmetric large interference network with parameters detailed in Table 6.1 for the comparisons presented here.

We compare the performance of the optimal game strategies, at receiver i , while using the three classes of receivers described in Section 7.2, namely (SG-MMSE/UIS/SIG), (NP/KIS/SGD), (NP/KIS/MGD). For the sake of brevity, we address the approaches as $Am - r$ where $m \in \{CL, Conv\}$ and $r \in \{(SG - MMSE/UIS/SIG), (NP/KIS/SGD), (NP/KIS/MGD)\}$.

In our setting, we assume that CS varies according to a Markov chain with the following transition probabilities: $T_0^0(i, j) = \frac{1}{2}, T_0^1(i, j) = \frac{1}{2}, T_{L-1}^{L-1}(i, j) = \frac{1}{2}, T_{L-1}^{L-2}(i, j) = \frac{1}{2}; (2 \leq k \leq L-2)T_k^k(i, j) = \frac{1}{3}, T_k^{k-1}(i, j) = \frac{1}{3}, T_k^{k+1}(i, j) = \frac{1}{3}$. This means that at each time slot the channel preserves its state or changes by one unit. The packet arrival process is described by a Poisson distribution with average rate $\lambda_i = 1$. In our simulations, we assume that the possible rates are multiple of $R = \frac{1}{2}$.

We perform a two-level admission control; one is defined by our offline

action index	0 1 2 3 4 5 6 7 8 9 ... 48
Num of packets	0 0 0 0 0 0 0 0 1 1 1 ... 5
power level	0 0 1 1 2 2 3 3 0 0 1... 3
accept/reject	0 1 0 1 0 1 0 1 0 1 0... 1

Table 7.3: Labelling of policies

policy and set the variable c_i to 1/0 corresponding to the acceptance/rejection decision. However, as we only use one admission control flag c_i for all the possible number of packet arrivals, there exist situations where the remaining space of the queue is less than the number of packets arrived at the time. The second (realtime) control is needed in order to drop the packets when the queue is full.

The algorithm in Section 7.5 converges for all the classes of receivers. The optimal policies are in general not unique and depend on the policy initializing the algorithm.

The optimal policies in Figure 6.1, are obtained in high SNR regime. This figure shows the equilibrium policies obtained by the proposed algorithm for the three classes of receivers. The action index is presented in abscissa while the state index is represented in ordinate. The state index addresses the pair of CS and QS. The indexing approach is presented in Table 6.2. Similarly, Table 6.3 describes the mapping between action indices and the triplets (μ_i, p_i, c_i) .

Interestingly, the optimal policies of the *large interference network* studied here have the following decoupling property: (I) decision on μ_i is not affected by the CSs and is an increasing function of the QS, and (II) the power level is independent from the queue level and only a function of CS. This property is specific of large interference networks and it does not hold in the general case of interference networks with finite users (Chapter 5).

For all three classes of receivers, the optimal policy does not transmit packets when the channel is in the worst situation. For two other channel states, namely medium and good, the decision on μ_i is a non-decreasing function of QS. The optimal policies for ACL-(SG-MMSE/UIS/SGD) yield transmissions with lower rates compared to the two other receivers. ACL-(NP/KIS/MGD) yields a number of transmitted packets not lower than the ACL-(NP/KIS/SGD) receiver at the same power.

At high SNR, the policies of the ACL-(NP/KIS/MGD) receiver yield transmission at the maximum allowed rate whenever the channel state of the transmitter is nonzero. In other words, the optimal rate is limited by the discrete rate set. In contrast, for the other two receivers the optimal rates are limited by the interference and they show an interference limited behavior. This observation helps us in a better understanding of the saturation behavior of the receivers in the following Figure 6.2-6.4.

Figure 6.2 shows the performance of optimal policies in our cross-layer approach for three classes of receivers. This figure shows the throughput obtained by each class of receivers versus the energy per bit per noise level, E_b/N_0 . The value of the throughput here is obtained through averaging

	TP	Outage Rate	Drop rate
policy of asymptotic problem	0.6	0.38	0.09
policy adapted to the finite problem	0.61	0.36	0.09

Table 7.4: comparison between the performance of the equilibrium policy obtained for the asymptotic problem and the one adapted to a 2-flow network (Chapter 6) in a network with 2 active communications

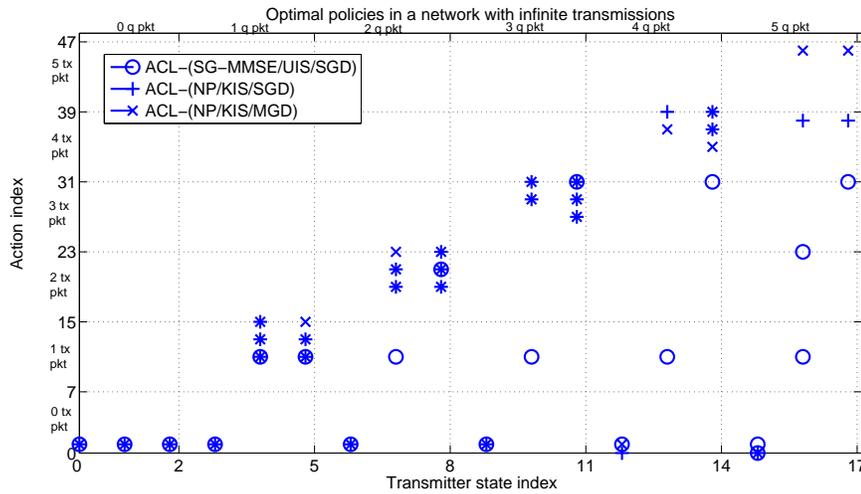

Figure 7.1: Policies in a network with infinite transmissions

the data rates of the equilibrium policies of our proposed algorithm over all transmitter states. To be compliant with the definition of throughput, the energy per bit per noise level is obtained by the same averaging function.

As the value of energy per bit per noise level increases, all receivers enter into a saturation mode. For the ACL-(NP/KIS/SGD) receiver, this behavior results from the fact that the optimal rate is limited by the discrete rate set. In contrast, for the other two cases, the throughput is interference limited.

Figure 6.3 compares the performances of cross-layer and conventional mechanisms while using the best receiver, namely ACL-(NP/KIS/SGD) and AConv-(NP/KIS/SGD). At the first glance, we can observe that in the conventional approach more power is consumed for sending a given packet. Indeed, the policies in this case are decided regardless of the queue states.

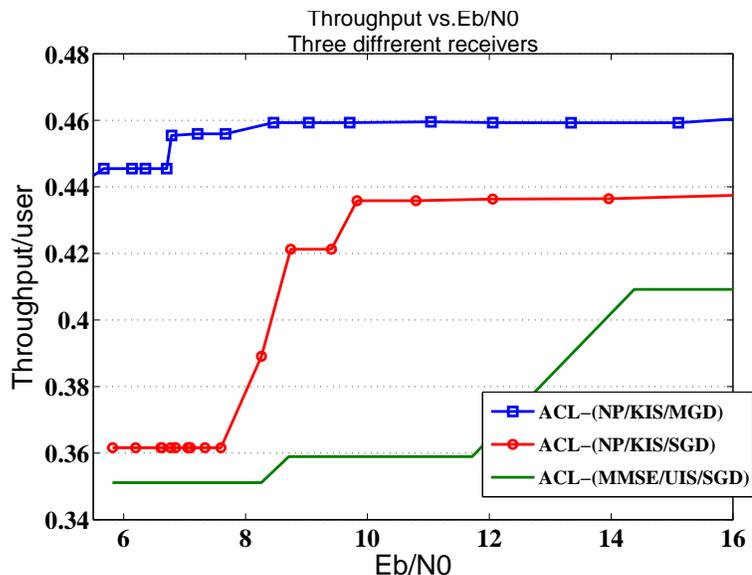

Figure 7.2: Throughput vs E_b/N_0 for three different receivers

Consequently, there exist cases where the power is adjusted to satisfy a certain rate while there is not enough data in the queue to provide that rate. In such cases, the remaining data in the queue is sent with a power level higher than needed.

Figure 6.4 represents the performance of the optimal policies obtained for the asymptotic case in networks with finite transmissions. We can observe that using the policies obtained from the asymptotic problem, even when the number of transmitter is very low, e.g. $K = 4$, the finite network performs almost as well as the large interference network. For $K = 8$ the performance of a finite network attains the asymptotic one.

Finally, we compare the performance of the policy adapted to a finite network of 2 communication flows (obtained in Chapter 6) with the one of the asymptotic problem. The performance measures here are: (i) Throughput (TP), i.e. the number of packets per time slot correctly decoded by the receiver, (ii) Outage rate, i.e. the fraction of transmitted packets which can not be decoded correctly, (iii) Drop rate, i.e. the fraction of arriving packets from upper layers which are rejected due to admission control. The value of the performance metrics for both policies are represented in Table 6.4. We can observe that in a network of 2 communication flows the policy obtained

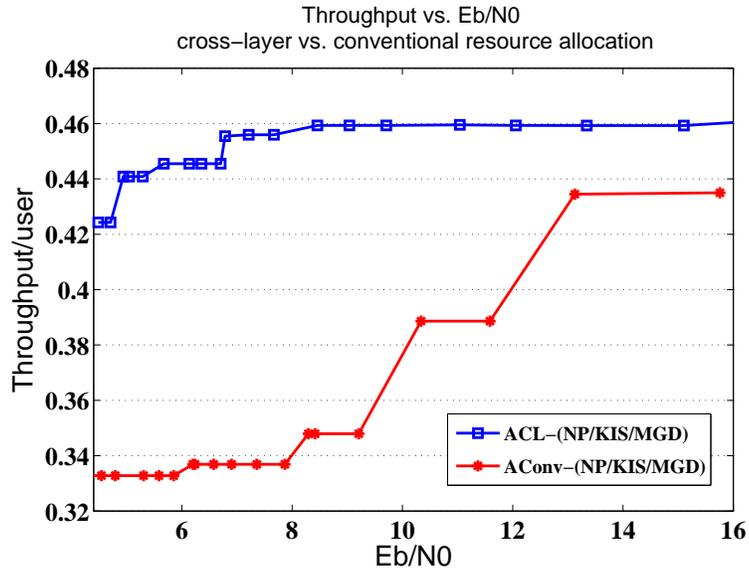

Figure 7.3: Throughput vs Eb/N0, Cross-layer vs. Conventional mechanisms

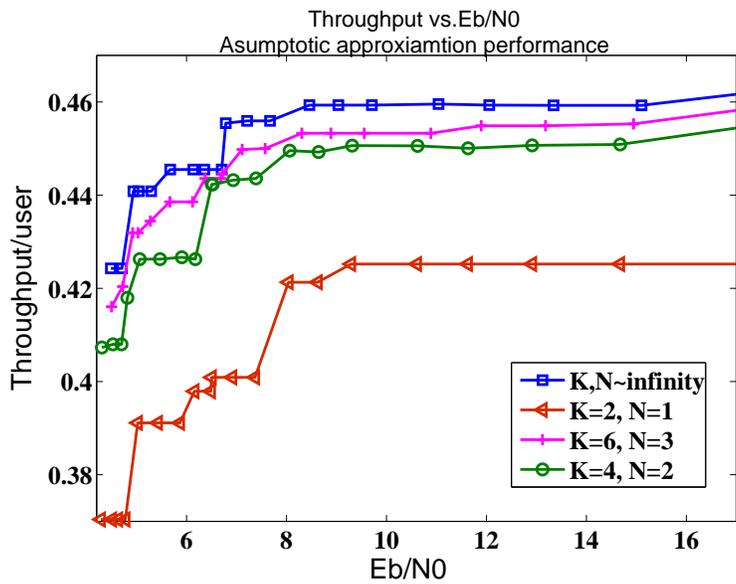

Figure 7.4: Throughput vs Eb/N0, performance of asymptotic ACL-(NP/KIS/MGD) in a network of finite transmissions

through the asymptotic problem, performs almost as well as the one adapted to this finite network. Therefore, also for a 2-flow network one can choose the less complex problem, i.e. the asymptotic one, for obtaining good policies.

7.7 Conclusions

In the current work, we considered a dense interference network with a large number ($K \rightarrow \infty$) of transmitter-receiver pairs. We investigated *distributed* algorithms for joint admission control, rate, and power allocation aiming at maximizing the individual throughput. The decisions are based on the statistical knowledge of the channel and buffer states of the other communication pairs and on the exact knowledge of their own channel and buffer states.

We considered different receivers depending on the assumptions we make about (I) the level of knowledge of the interference available at the receiver; (II) the eventual use of a suboptimal receiver based on a preliminary pre-decoding processing (e.g. detection) followed by decoding; and (III) the type of decoder, i.e. single-user/joint decoder.

In a finite framework, this problem presents an extremely high complexity when the number of users and/or transmitter states grows above a very limited range (e.g. 2, 3 users!). This makes distributed cross layer approaches very intensive. The asymptotic approach of large interference networks enables a sizable complexity reduction. More specifically, the complexity does not scale with the number of users but with the number of groups of users having identical statistics. The problem has an especially low complexity in the practical case of symmetric networks.

The optimal policies obtained with the asymptotic approach can be effectively applied in finite interference networks. In fact, we studied the performance loss due to the application of policies designed for asymptotic conditions in network with a finite number of active communications. We observed that even for a network containing 4 active communications, the performance of finite networks almost attains the one of large interference networks. Similar results are obtained for the converse comparison. We compare the performance of a finite network when an asymptotic approximation of the policies is adapted with the one obtained with policies tailored to the finite networks in Chapter 6. Even for the most challenging case of a network with 2 communication flows, the optimal policy of the asymptotic problem performs almost as well as the policy adapted to the network.

We further investigated the benefits of a cross layer approach compared

to a conventional resource allocation ignoring the states of the queues. In the conventional approach more power is consumed for sending a given amount of data as there exist cases where the power is allocated to satisfy a certain rate although there is not enough data in the queue to achieve that rate. To neglect the state of the queue causes a relevant performance loss since the power is not efficiently allocated.

Interestingly, the optimal policy of the large interference network studied here presents interesting decoupling properties. More specifically, the rate is an increasing function of the queue state only while the allocated power is a function of the channel state only.

Chapter 8

Conclusions and Future Work

In this thesis the primary focus was the issue of how to theoretically and mathematically model a distributed resource allocation in a multi-user system and how to obtain low complexity algorithms which provide us with a lower bound on the performance of the original problem. In our study, optimization theory, game theory, and random matrix theory, provide us mathematical tools to obtain optimal or suboptimal solutions with an affordable complexity. The trade-offs between complexity and performance has been investigated.

8.1 Conclusion

This work has the two fold objective of designing and analyzing the performance of distributed resource allocation algorithms in slow fading channels with partial channel side information at the transmitters. We developed algorithms assuming that each transmitter has an exact information of its own channel as well as the statistical knowledge of other channels. In such a context, the system is inherently impaired by a nonzero outage probability. We proposed low complexity distributed algorithms for joint rate and power allocation aiming at maximizing the individual throughput, defined as the successfully-received-information rate, under a power constraint.

We started our study in an OFDM-based MAC network with 2 transmitters. As well known, the problem at hand is non-convex with exponential

complexity in the number of transmitters and subcarriers. We introduced a two-level simplification to the problem. By exploiting the problem property that a dual approach yields optimum resource allocation asymptotically as the number of subcarriers tends to infinity, we proposed resource allocation algorithms based on duality. The dual problem has linear complexity in the number of subcarriers but its complexity is still exponential in the number of users. We introduced a suboptimal low complexity approach in the form of 2-player Bayesian game (game of incomplete information). This game problem boils down into two parallel multivariate polynomial equations, parametric in Lagrangian multipliers of the two users, through which we found all the NEs of the problem. We further adopted the maximum sum throughput as selection criteria of a NE.

The performance of such NE points is compared to the performance of the optimum power allocation for the case of complete channel state information and the uniform power allocation for the case of partial channel side information. The simulations showed that all the NEs obtained from the game are those wherein only one transmitter emits with full power and the other remains off. On the contrary, the optimum power allocations for the case of complete channel state information contains solutions which have the superposition of two users' power on the same channel. However, in the later case, the solutions can only be obtained through an iterative algorithm whose convergence to some local optimal point depends on the choice of the initial value. The comparison of the performance of the optimal solution and the NE, showed that the NE performs near optimal in this network setup.

Next, we extended the problem into a single hop ad hoc network. We relaxed the intrinsic assumption on infinite backlog of packets in the queues made in the previous study. Therefore, each transmitter is provided by a finite buffer and accept packets from a Poisson distribution. We investigated distributed cross-layer algorithms for joint admission control, rate and power allocation aiming at maximizing the individual and the global throughput. The decisions are based on the statistical knowledge of the states (channel attenuation and buffer length) of the other transmission pairs and on the exact knowledge of their own states. This problem is formulated as a stochastic game with mixed strategies. In addition, the problem structure satisfies the conditions by which the saddle point strategies of stochastic game exist among Markov strategies and are easier to compute. Following this observation, an iterative best response algorithm based on linear programming has been introduced. The proposed algorithm provide sizable improvements with respect to straightforward extension to ad hoc networks of decentralized algorithms for multiple access channels existing in literature.

However, in a finite framework, this problem presents an extremely high complexity when the number of users and/or transmitter states grows. This makes distributed cross layer approaches very intensive.

the high complexity of distributed resource allocation algorithms for cross-layer approaches motivated us to consider the same problem in a dense interference network with a large number of transmitter-receiver pairs. The asymptotic approach of large interference networks enables a considerable complexity reduction. More specifically, the complexity does not scale with the number of users but with the number of groups of users having identical statistics. The problem has an especially low complexity in the practical case of symmetric networks. Interestingly, the optimal policy of the large interference network studied here presents interesting decoupling properties. More specifically, the rate is an increasing function of the queue state only while the allocated power is a function of the channel state only.

We studied the performance loss due to the application of the policies designed for asymptotic conditions in network with a finite number of active communications and vice versa. We observed that even for a network containing 4 active communications, both policies perform almost the same. We further investigated the benefits of a cross layer approach compared to a conventional resource allocation ignoring the states of the queues. The results suggest that neglecting the state of the queue causes a relevant performance loss since the power is not efficiently allocated.

8.2 Future Work

The work presented in this dissertation can be extended in several ways:

- Regarding the problem in chapter 5: (i) obtaining the solutions of the original optimization problem with partial CSI (5.7), based on the distributed pricing method proposed in [30] is in vision; (ii) to extend the problem to more than two users and 2 channel states; (iii) to consider the same problem in continuous channels.
- Regarding the problem in Chapter 6: (i) to analytically prove the convergence of best response algorithm into the NE for general non-symmetric networks (ii) to extend the problem into *multi-hop* INs.
- To investigate the limiting point on the NE performance in our games of incomplete information as the number of users increase.

Bibliography

- [1] S. S. Shitz and A. D. Wyner, "Information-theoretic considerations for symmetric, cellular, multiple-access fading channels - Part II," *IEEE Trans. Inf. Theory*, 1997.
- [2] D. N. C. Tse and S. V. Hanly, "Multiaccess fading channels - Part I: Polymatroid structure, optimal resource allocation and throughput capacities," *IEEE Trans. Inf. Theory*, vol. 44, pp. 2796–2815, 1998.
- [3] S. V. Hanly and D. N. C. Tse, "Multi-access fading channels - Part II: Delay-limited capacities," *IEEE Trans. Inf. Theory*, vol. 44, pp. 2816–2831, 1998.
- [4] L. Georgiadis, M. J. Neely, and L. Tassiulas, *Resource allocation and cross-layer control in wireless networks*. Foundations and Trends in Networking, 2006.
- [5] G. Scutari, D. Palomar, and S. Barbarossa, "Asynchronous iterative waterfilling for Gaussian frequency-selective interference channels: A unified framework," *IEEE Trans. Inf. Theory*, vol. 54, pp. 2868–2878, 2008.
- [6] G. He, L. Cottatellucci, and M. Debbah, "The waterfilling game - theoretical framework for distributed wireless network information flow," *IEEE J. Sel. Areas Commun.*, 2009.
- [7] G. He, "A game theoretical approach to resource allocation in wireless networks," Ph.D. dissertation, Telecom Paris/EURECOM, 01 2010.
- [8] E. Vivier, *From theoretical capacity to system simulations*. WILEY, 2009.
- [9] *European Telecommunications Standards Institute (ETSI)*. *Radio broadcasting systems; Digital Audio Broadcasting (DAB) to mobile, portable and fixed receivers*, ETS Std. 300 401, 1995.

- [10] *European Telecommunications Standards Institute (ETSI). Radio broadcasting systems; Digital Audio Broadcasting (DAB) to mobile, Framing structure, channel coding, and modulation for digital terrestrial television*, EN Std. 300 744, Rev. 1.1.2, 1997.
- [11] *IEEE P802.11a, Supplement to Standard for Telecommunications and Information Exchange Between Systems - LAN/MAN Specific Requirements - Part 11: Wireless MAC and PHY Specifications: High Speed Physical Layer in the 5-GHz Band*, IEEE Std., Rev. 7.0, July 1999.
- [12] *IEEE 802.16, IEEE Standard for Local and Metropolitan Area Networks Part 16: Air Interface for Fixed Broadband Wireless Access Systems*, IEEE Std., April 2001.
- [13] J. A. Bingham, *ADSL, VDSL, and Multicarrier Modulation: Wiley Series in Telecommunications and Signal Processing*. New York, NY, USA: John Wiley and Sons, Inc., 2000.
- [14] T. M. Cover and J. A. Thomas, *Elements of information theory*. Wiley, 1991.
- [15] G. R. G and R. G. Gallager, "An inequality on the capacity region of multiaccess multipath channels," <http://hdl.handle.net/1721.1/3365>, 1994.
- [16] W. Yu and R. Lui, "Dual methods for nonconvex spectrum optimization of multicarrier systems," *IEEE Trans. Commun.*, vol. 54, pp. 1310–1322, 2006.
- [17] J. Huang, R. A. Berry, and M. L. Honig, "Distributed interference compensation for wireless networks," *IEEE J. Sel. Areas Commun.*, vol. 24, pp. 1074–1084, 2006.
- [18] W. Yu and J. M. Cioffi, "FDMA Capacity of the Gaussian Multiple Access Channel with ISI," *IEEE Trans. Commun.*, vol. 50, pp. 102–111, 2000.
- [19] R. S. Cheng and S. Verdu, "Gaussian multiaccess channels with ISI: Capacity region and multiuser water-filling," *IEEE Trans. Inf. Theory*, vol. 39, pp. 773–785, 1993.
- [20] Z.-Q. Luo and S. Zhang, "Dynamic spectrum management: complexity and duality," *IEEE Journal of Selected Topics in Signal Processing*, vol. 2, pp. 57–73, 2008.

-
- [21] R. Etkin, A. Parekh, and D. Tse, "Spectrum sharing for unlicensed bands," in *in IEEE DySPAN 2005*, 2005, pp. 251–258.
- [22] C. Y. Wong, R. S. Cheng, K. B. Letaief, and R. D. Murch, "Multiuser OFDM with adaptive subcarrier, bit, and power allocation," *IEEE Journal on Selected Areas of Communications*, vol. 17, pp. 1747–1758, 2006.
- [23] T. Thanabalasingham, S. V. Hanly, L. L. H. Andrew, and J. Papan-driopoulos, "Joint allocation of subcarriers and transmit powers in a multiuser OFDM cellular network," in *Proc. IEEE Int. Conf. on Communication*, 2006.
- [24] S. V. Hanly, L. L. H. Andrew, and T. Thanabalasingham, "Dynamic allocation of subcarriers and transmit powers in an OFDMA cellular network," *IEEE Trans. Inf. Theory*, vol. 55, pp. 5445–5462, 2009.
- [25] W. Yu, G. Ginis, and J. M. Cioffi, "Distributed multiuser power control for digital subscriber lines," *IEEE J. Sel. Areas Commun.*, vol. 20, pp. 1105–1115, 2002.
- [26] J. S. Pang, G. Scutari, F. Facchinei, and C. Wang, "Distributed power allocation with rate constraints in Gaussian frequency selective interference channels," *IEEE Trans. Inf. Theory*, vol. 54, pp. 3471–3489, 2008.
- [27] Y. Noam, A. Leshem, and S. Member, "Iterative power pricing for distributed spectrum coordination in DSL," *IEEE Trans. Commun.*, vol. 57, 2009.
- [28] C. U. Saraydar, N. B. Mandayam, and D. J. Goodman, "Efficient power control via pricing in wireless data networks," *IEEE Trans. Commun.*, 2000.
- [29] C. H. Papadimitriou, "Algorithms, Games, and the Internet," in *In STOC*. ACM Press, 2001, pp. 749–753.
- [30] J. Huang, R. A. Berry, and M. L. Honig, "Distributed interference compensation for wireless networks," *IEEE Trans. Commun.*, vol. 24, pp. 1074–1084, 2006.
- [31] E. Altman and Z. Altman, "S-Modular games and power control in wireless networks," *IEEE Transactions on Automatic Control*, vol. 48, pp. 839–842, 2003.

- [32] K. Avrachenkov, L. Cottatellucci, and A. Garnaev, "Equilibriums in slow fading interfering channels with partial knowledge of the channels," in *Submitted to INFOCOM*, 2010.
- [33] M. J. Neely, E. Modiano, C. E. Rohrs, and S. Member, "Power allocation and routing in multibeam satellites with time-varying channels," *IEEE Transactions on Networking*, vol. 11, pp. 138–152, 2003.
- [34] R. A. Berry and E. M. Yeh, "Cross-layer Wireless Resource Allocation: Fundamental Performance Limits," in *IEEE Trans. Signal Processing*, 2004, pp. 59–68.
- [35] L. Tassiulas and A. Ephremides, "Stability properties of constrained queueing systems and scheduling policies for maximum throughput in multihop radio networks," *IEEE Transaction on Automatic Control*, vol. 37, pp. 1936–1948, 1992.
- [36] K. Seong, R. Narasimhan, and J. M. Cioffi, "Queue proportional scheduling via geometric programming in fading broadcast channels," *IEEE J. Sel. Areas Commun.*, vol. 24, pp. 1593–1602, 2006.
- [37] C. Long, Q. Zhang, B. Li, H. Yang, and X. Guan, "Non-cooperative power control for wireless ad Hoc networks with repeated games," *IEEE J. Sel. Areas Commun.*, vol. 25, 2007.
- [38] C. U. Saraydar, N. B. Mandayam, and D. J. Goodman, "Efficient power control via pricing in wireless data networks," *IEEE Trans. Commun.*, 2000.
- [39] E. Altman, K. Avratchenkov, N. Bonneau, M. Debbah, R. El-Azouzi, and D. Menasche, "Constrained stochastic games in wireless networks," in *Proc. IEEE Global Telecomm. Conf.*, 2007, pp. 315–320.
- [40] H. A. Simon, "A behavioral model of rational choice," *The Quarterly Journal of economics*, vol. 69, pp. 99–118, 1955.
- [41] R. Aumann, "Backward induction and common knowledge of rationality," *Games and Economic Behavior*, vol. 8, pp. 6–19, 1995.
- [42] S. Verdú and S. Shamai, "Spectral efficiency of CDMA with random spreading," *IEEE Trans. Inform. Theory*, vol. 45, pp. 622–640, 1999.
- [43] D. N. C. Tse and S. V. Hanly, "Linear multiuser receivers: effective interference, effective bandwidth and user capacity," *IEEE Trans. Inform. Theory*, vol. 45, pp. 641–657, 1999.

-
- [44] S. S. (Shitz) and S. Verdú, “The impact of frequency-flat fading on the spectral efficiency of CDMA,” *IEEE Trans. Inf. Theory*, 2001.
- [45] J. G. Proakis, *Digital Communications, 4th Edition*. McGraw Hill, 2000.
- [46] C. Shannon, “A Mathematical Theory of communication,” *Communication, Bell System Technical Journal*, vol. 27, pp. 379–423, 1948.
- [47] T. R. Giallorenzi and S. Wilson, “Multiuser ML sequence estimator for convolutionally coded asynchronous DS-CDMA systems,” *IEEE Trans. Commun.*, vol. 44, pp. 997–1007, 1996.
- [48] M. Moher, “An iterative multiuser decoder for near capacity communications,” *IEEE Trans. Commun.*, vol. 46, pp. 870–880, 1998.
- [49] M. K. Varanasi and T. Guess, “Optimal decision feedback multiuser equalization with successive decoding achieves the total capacity of the Gaussian multiple-access channel,” in *Asilomar Conference on Signal, Systems, and Computers*, 1997.
- [50] R. R. Müller, “Multiuser receivers for randomly spread signals: Fundamental limits with and without decision-feedback,” *IEEE Trans. Inf. Theory*, vol. 47, pp. 268–283, 2000.
- [51] C. E. Shannon, “Two-way communication channels,” in *Symp. on Mathematical Statistics and Probability*, 1961, pp. 611–644.
- [52] R. Ahlswede, “The capacity region of channel with two senders and two receivers,” in *Annals Probabil*, 1974, pp. 805–814.
- [53] A. B. Carleial, “Interference channels,” *IEEE Trans. Inf. Theory*, pp. 60–70, 1978.
- [54] T. S. Han and K. Kobayashi, “A new achievable rate region for the interference channel,” *IEEE Trans. Inf. Theory*, vol. IT-27, pp. 49–60, 1981.
- [55] I. Sason, “On achievable rate regions for the Gaussian interference channel,” *IEEE Trans. Inf. Theory*, pp. 1345–1356, 2004.
- [56] A. S. Motahari and A. K. Khandani, “Capacity bounds for the Gaussian interference channel,” *arXiv:0801.1306v1*, 2008.

- [57] A. B. Carleial, "A case where interference does not reduce capacity," *IEEE Trans. Inf. Theory*, vol. IT-21, pp. 569–570, 1975.
- [58] H. Sato, "The capacity of the Gaussian interference channel under strong interference," *IEEE Trans. Inf. Theory*, vol. IT-27, pp. 786–788, 1981.
- [59] R. H. Etkin, D. N. C. Tse, and H. Wang, "Gaussian interference channel capacity to within one bit," *IEEE Trans. Inf. Theory*, 2007.
- [60] A. S. Motahari and A. K. Khandani, "Capacity bounds for the Gaussian interference channel," in *arXiv:0801.1306v1*, 2007.
- [61] A. S. Motahari and A. Khandani, "To decode the interference or to consider it as noise," *arXiv:0711.3176*, 2001.
- [62] D. M. Topkis, *Supermodularity and Complementarity*. Princeton University Press, 1998.
- [63] D. Johnson, *Constrained Optimization*. <http://cnx.org/content/m11223/1.2/>, 2003.
- [64] S. Boyd and L. Vandenberghe, *Convex Optimization*. New York: Cambridge University Press, 2007.
- [65] M. C. Ferris, "Computer sciences, university of wisconsin," <http://pages.cs.wisc.edu/~ferris/>.
- [66] R. W. Cottle, J. Pang, and R. E. Stone, *The Linear Complementarity Problem*. Academic Press, 1992.
- [67] D. Fudenberg and J. Tirole, *Game Theory*. MIT Press, 1991.
- [68] D. Debreu, "A social equilibrium existence theorem," in *Proceedings of the National Academy of Sciences*, 1952, pp. 886–893.
- [69] Rosen, "Existence and uniqueness of equilibrium points for concave N-Person games," *Econometrica*, vol. 33, pp. 520–534, 1965.
- [70] T. Roughgarden, E. Tardos, and Éva Tardos, "Bounding the inefficiency of equilibria in nonatomic congestion games," *Games and Economic Behavior*, vol. 47, pp. 389–403, 2002.
- [71] R. Cooper, *Coordination Games*. Cambridge University Press, 1998.

- [72] E. Altman and A. Shwartz, "Constrained Markov Games: Nash Equilibria," in *Annals of the International Society of Dynamic Games*. Birkhauser, 1995, pp. 303–323.
- [73] D. Monderer and L. S. Shapley, "Potential Games," *Games And Economic Behavior*, vol. 14, pp. 124–143, 1996.
- [74] D. D. Yao, "S-modular games, with queuing applications," *Queueing Systems*, vol. 21, pp. 449–475, 1995.
- [75] J. W. Friedman and C. Mezzetti, "Learning in games by random sampling," *Journal of Economic Theory*, vol. 98, pp. 55–84, 2001.
- [76] K. K. Leung, C. W. Sung, W. S. Wong, and T. M. Lok, "Convergence theorem for a general class of power control algorithms," in *Proc. IEEE Int. Conf. on Communication*, 2001, pp. 811–815.
- [77] C. W. Sung and W. S. Wong, "Mathematical aspects of the power control problem in mobile communication systems," in *Lectures at the Morningside Center of Mathematics*, 2000.
- [78] R. D. Yates, "A framework for uplink power control in cellular radio systems," *IEEE J. Sel. Areas Commun.*, vol. 13, pp. 1341–1347, 1996.
- [79] C. C. Wu and D. P. Bertsekas, "Distributed power control algorithms for wireless networks," *IEEE Trans. Vehicular Technology*, vol. 50, pp. 504–514, 1999.
- [80] O. Candogan, I. Menache, A. Ozdaglar, and P. A. Parrilo, "Flows and decomposition of games : harmonic and potential games," *arXiv:1005.2405v2*, 2010.
- [81] Q. jing and Z. Zheng, "Distributed resource allocation based on Game theory in multi-cell OFDMA systems ," *International journal of wireless information networks*, vol. 16, pp. 44–50, 2009.
- [82] J. Ratliff, *Static Games of Incomplete Information*. University of Arizona: Graduate-Level Course in Game Theory, 2005.
- [83] R. B. Myerson, *Game theory: Analysis of Conflict*. Cambridge, Massachusetts: Harvard University Press, 1997.
- [84] H. Gaoning, M. Debbah, and E. Altman, "A Bayesian game-theoretic approach for distributed resource allocation in fading multiple access

- channels,” *EURASIP Journal on Wireless Communications and Networking*, 2010.
- [85] L. Lai and H. E. Gamal, “The water-filling game in fading multiple-access channels,” *IEEE Trans. Inf. Theory*, vol. 54, pp. 2110 – 2122, 2008.
- [86] J. F. Nash, “Equilibrium points in N-person games,” *Proceedings of the National Academy of Sciences of the United States Of America*, pp. 48–49, 1950.
- [87] C. S. Jean and B. Jabbari, “Bayesian game-theoretic modeling of transmit power determination in a self-organizing CDMA wireless network,” in *Vehicular Technology Conferenc*, 2004, pp. 3496–3500.
- [88] T. Heikkinen, “A Minimax Game of Power Control in a Wireless Network under Incomplete Information,” Center for Discrete Mathematics and Theoretical Computer Science, Tech. Rep., 1999.
- [89] S. Adlakha, R. Johari, and A. Goldsmith, “Competition in wireless systems via Bayesian interference games,” in *arXiv:0709.0516v1*, 2007.
- [90] Y. Liu and H. Man, “A Bayesian game approach for intrusion detection in wireless ad hoc networks,” in *ACM International Conference Proceeding*, 2006.
- [91] L. S. Shapley, “Stochastic Games,” in *Proceedings of National Academy of Science*, 1953, pp. 1095–1100.
- [92] A. Fedegruen, “On N-person stochastic games with denumerable state space,” in *Advances in Applied Probability*, 1978, pp. 452–471.
- [93] L. O. Curtat, “Markov equilibria of stochastic games with complementarities,” *Games and Economic Behavior*, vol. 17, pp. 177–199, 1996.
- [94] A. Hordijk and L. C. M. Kallenberg, “Constrained undiscounted stochastic dynamic programming,” *Mathematics of Operations Research*, 1984.
- [95] —, “Linear programming and Markov games I,” *Game Theory and Mathematical Economics*, pp. 291–305, 1981.
- [96] —, “Linear programming and Markov games II,” *Game Theory and Mathematical Economics*, pp. 307–320, 1981.

-
- [97] M. Huang, R. P. Malhame, and P. E. Caines, "Nash strategies and adaptation for decentralized games involving weakly coupled agents," *IEEE CDC*, 2005.
- [98] L. C. M. Kallenberg, "Survey of linear programming for standard and nonstandard Markovian control problems, Part I: Theory," *ZOR Methods and Models in Operations Research*, 1994.
- [99] E. Altman, K. Avrachenkov, N. Bonneau, M. Debbah, R. El-Azouzi, and D. S. Menasche, "Constrained cost-coupled stochastic games with independent state processes," in *arXiv:cs/0703099v1*, 2006.
- [100] E. Altman, K. Avrachenkov, R. Marquez, and G. Miller, "Zero-sum constrained stochastic games with independent state processes," in *Mathematical Methods of Operations Research*, 2005.
- [101] F. Fangwen and M. van der Schaar, "Learning to Compete for Resources in Wireless Stochastic Games," *IEEE Trans. Vehicular Technology*, pp. 1904–1191, 2008.
- [102] J. Evans and D. N. C. Tse, "Large system performance of linear multiuser receivers in multipath fading channels," *IEEE Trans. Inf. Theory*, vol. 46, pp. 2059–2078, 2000.
- [103] S. S. (Shitz) and S. Verdú, "The impact of frequency-flat fading on the spectral efficiency of CDMA," *IEEE Trans. Inf. Theory*, 2001.
- [104] A. M. Tulino, L. Li, and S. Verdú, "Spectral efficiency of multicarrier CDMA," *IEEE Trans. Inf. Theory*, vol. 51, pp. 479–505, 2005.
- [105] A. Tulino and S. Verdú, *Random matrix theory and wireless communications*. Foundation and Trends in Communications and Information Theory, 2004.
- [106] E. Wigner, "Characteristic vectors of bordered matrices with infinite dimensions," *Ann. of Math.*, vol. 62, pp. 546–564, 1955.
- [107] V. A. Marcenko and L. A. Pastur, "Distribution of eigenvalues for some sets of random matrices," *Mathematics of the USSR-Sbornik*, vol. 1, pp. 457–483, 1967.
- [108] J. W. Silverstein and Z. D. Bai, "On the empirical distribution of eigenvalues of a class of large dimensional random matrices," *Journal of Multivariate Analysis*, vol. 54, pp. 175–192, 1995.

-
- [109] V. Girko, *Theory of random determinant*. Kluwer Academic Publishers, Dordrecht, Netherlands, 2004.
- [110] B. M. Zaidel, S. Member, S. S. (Shitz), and S. Verdú, “Multicell uplink spectral efficiency of coded DS-CDMA with random signatures,” *IEEE J. Sel. Areas Commun.*, vol. 19, pp. 1556–1568, 2001.
- [111] D. Aktas, M. N. Bacha, J. Evans, and S. Hanly, “Scaling results on the sum capacity of cellular networks with MIMO links,” *IEEE Trans. Inf. Theory*, vol. 52, pp. 3264–3274, 2006.
- [112] Y. J. Wang, N. H. Xiu, and J. Z. Zhang, “Modified extragradient method for variational inequalities and verification of solution existence,” *Journal of Optimization Theory And Applications*, pp. 167–183, 2003.
- [113] Patrick Billingsley and John Wiley, *Probability and Measure*. Wiley in probability and mathematical statistics, 1995.
- [114] A. Schrijver, “A combinatorial algorithm minimizing submodular functions in strongly polynomial time,” *Journal of Combinatorial Theory*, 2000.
- [115] S. Iwata, L. Fleischer, and S. Fujishige, “A combinatorial strongly polynomial algorithm for minimizing submodular functions,” *Journal of ACM*, 2001.