



HAL
open science

Synthesis of Alkynes and New Transformations Catalyzed by Gold(I) Complexes

Igor Jurberg

► **To cite this version:**

Igor Jurberg. Synthesis of Alkynes and New Transformations Catalyzed by Gold(I) Complexes. Catalysis. Ecole Polytechnique X, 2010. English. NNT : . pastel-00570064

HAL Id: pastel-00570064

<https://pastel.hal.science/pastel-00570064>

Submitted on 26 Feb 2011

HAL is a multi-disciplinary open access archive for the deposit and dissemination of scientific research documents, whether they are published or not. The documents may come from teaching and research institutions in France or abroad, or from public or private research centers.

L'archive ouverte pluridisciplinaire **HAL**, est destinée au dépôt et à la diffusion de documents scientifiques de niveau recherche, publiés ou non, émanant des établissements d'enseignement et de recherche français ou étrangers, des laboratoires publics ou privés.



Thesis submitted for the award of the degree of
DOCTOR OF PHILOSOPHY

In the field of
ORGANIC CHEMISTRY

by
Igor Dias JURBERG

**SYNTHESIS OF ALKYNES AND NEW TRANSFORMATIONS CATALYZED
BY GOLD(I) COMPLEXES**

Presented on December 6th, 2010 to a committee composed of:

Dr. Patrick PALE – President of the committee

Dr. Philippe BELMONT – Referee

Dr. Gwilherm EVANO – Referee

Dr. Samir ZARD – Examiner

Dr. Fabien GAGOSZ – Examiner

The work described in this thesis was carried out at the Laboratory of Organic Synthesis (DCSO), École Polytechnique, Palaiseau, France under the guidance of Dr. Fabien Gagosz and Prof. Dr. Samir Zard.

It was financially supported by Ecole Polytechnique and CNRS (Centre National de la Recherche Scientifique)



This manuscript was printed by CPM (Centre Poly-Media) of École Polytechnique (December 2010)



TABLE OF CONTENTS

ACKNOWLEDGEMENTS	7
CHAPTER 1: UNUSUAL APPROACH TO BRANCHED 3-ALKYNYLAMIDES AND TO 1,5-DIHIDROPYRROL-2-ONES	
1.1 INTRODUCTION: Alkyne Synthesis	10
1.1.1 Alkylation of terminal alkyne through a S _N 2-type reaction	10
1.1.2 Organometallic additions and coupling reactions	12
1.1.2.1 Aluminium	12
1.1.2.2 Copper	14
1.1.2.3 Boron	15
1.1.2.4 Zinc	17
1.1.2.5 Palladium	19
1.1.2.6 The Corey-Fuchs reaction	24
1.1.2.7 Homologation of Seyferth-Gilbert and variations of Bestmann and Ohira	25
1.2 ISOXAZOLONES: general properties, synthesis and reactivity	27
1.2.1 General properties of isoxazolones	27
1.2.2 Isoxazolone synthesis	28
1.2.3 Isoxazolone reactivity	30
1.2.4 Isoxazolones as masked alkynes: Literature background	32
1.2.4.1 Flash Vacuum Pyrolysis	32
1.2.4.2 Nitrosative Cleavage	33
1.3 RESULTS AND DISCUSSION	36
1.3.1 The Initial idea	36
1.4 CONCLUSION	47
1.5 PERSPECTIVES AND FURTHER DEVELOPMENTS	47
CHAPTER 2: INTRODUCTION TO GOLD CATALYSIS	
2.1 GOLD CHEMISTRY	53
2.1.1 Gold catalysts	53

2.1.2	Isolobal analogy of Au(I)	56
2.1.3	Au(I) geometry and enantioselective reactions	57
2.1.4	Relativistic effects	59
2.1.5	Au(I)-catalyzed nucleophilic addition to C-C multiple bonds: elementary steps	62
2.1.5.1	Nucleophilic addition to π -systems	63
2.1.5.2	Path A: trapping gold intermediates with electrophiles in a “1,1-fashion” and proto-deauration	64
2.1.5.3	Path B: trapping gold intermediates with electrophiles in a “1,2-fashion” and debate on the nature of the intermediate formed	68
2.1.5.4	The Dewar-Chatt-Duncanson model	74
2.1.6	Considerations on the nature of vinyl gold species	76
CHAPTER 3: SYNTHESIS OF FUNCTIONALIZED OXAZOLONES BY A SEQUENCE OF Cu(II)- AND Au(I)-CATALYZED TRANSFORMATIONS		
3.1	INTRODUCTION	79
3.1.1	Importance of 4-Oxazol-2-ones	79
3.1.2	Synthesis of 4-Oxazol-2-ones	79
3.1.3	Chemistry of Ynamines and Ynamides	81
3.1.3.1	Synthesis of Ynamides	84
3.2	Boc-CYCLIZATION ON ALKYNES: Literature background and previous work in our laboratory	88
3.3	RESULTS AND DISCUSSION	89
3.3.1	The initial idea	89
3.4	CONCLUSION	98
3.5	PERSPECTIVES AND FURTHER DEVELOPMENTS	99

CHAPTER 4: GOLD(I)-MEDIATED CYCLOISOMERIZATION OF 1,6-ENYNES – A SHORT DISGRESSION ON CATALYST COUNTER ION EFFECT AND REMOTE SUBSTITUENT CONTROL

4.1 INTRODUCTION: Gold catalyzed 1,6-enyne cycloisomerizations	102
4.1.1 Synthesis of 1-alkenyl-1-cyclopentenes	103
4.1.2 Synthesis of alkenylmethylene-cyclopentanes	106
4.1.3 Hydroxy-, alkoxy-, amine- and (hetero)aryl- addition/5- <i>exo</i> cycloisomerization Process with 1,6-enynes	107
4.1.4 Formal intramolecular [4+2] cycloadditions of alkenes with enynes and Arylalkynes	109
4.1.5 Synthesis of methylenecyclohexenes	110
4.1.6 Synthesis of bicyclo[4.1.0]heptanes	111
4.1.7 Nucleophilic addition/6- <i>endo</i> cyclization process with 1,6 enynes	113
4.1.8 Synthesis of bicyclo[3.2.0]heptanes	115
4.2 RESULTS AND DISCUSSION	118
4.2.1 The Initial idea	118
4.3 CONCLUSION	129
4.4 PERSPECTIVES AND FURTHER DEVELOPMENTS	130

CHAPTER 5: HYDROALKYLATION OF ALKYNYL ETHERS VIA A GOLD(I)-CATALYZED 1,5-HYDRIDE SHIFT/ CYCLIZATION SEQUENCE

5.1 INTRODUCTION: C-H activation processes and intramolecular redox reactions	134
5.1.1 C-H activation processes	134
5.1.2 Intramolecular redox reactions: literature background	138
5.2 RESULTS AND DISCUSSION	146
5.2.1 The initial idea	146
5.3 CONCLUSION	165

CHAPTER 6: FORMATION OF CINNOLINE DERIVATIVES BY A GOLD(I)-CATALYZED HYDROARYLATION OF *N*-PROPARGYL-*N'*-ARYLHYDRAZINES

6.1 INTRODUCTION: Intramolecular hydroarylation processes and Importance of Cinnoline derivatives	167
6.1.1 Intramolecular Hydroarylation Processes	167
6.1.2 Importance of cinnolines	170
6.2 RESULTS AND DISCUSSION	171
6.2.1 The initial idea	171

6.3 CONCLUSION	179
6.4 PERSPECTIVES AND FURTHER DEVELOPMENTS	180
APPENDICES A & B: ACRONYMS AND ABBREVIATIONS & EXPERIMENTAL SECTION	
APPENDIX A: Acronyms and abbreviations	182
A.1 Units	182
A.2 Chemical groups and compounds	182
A.3 Other acronyms and abbreviations	184
APPENDIX B: Experimental Section	186
B.1 General Methods	197
B.1.1 Reagents and Solvents	197
B.1.2 Experimental Procedures	197
B.1.3 Chromatography	197
B.1.4 Analytical Methods	198
B.1.5 Softwares	198
B.2 The catalysts synthesis	199
B.2.1 Synthesis of phosphine gold(I) bis(trifluoromethanesulfonyl)imidate complexes	199
B.2.2 Synthesis of phosphine gold chloride complexes	199
B.2.3 Synthesis of $\text{PR}_3\text{Au}(\text{NCCH}_3)\text{SbF}_6$	200
B.3 Synthesized Molecules	
B.3.1. Chapter1: Unusual approach to α -branched 3-alkynylamides and to 1,5-dihydropyrrol-2-ones	201
B.3.1.1 Synthesis of isoxazol-5-ones	201
B.3.1.2 Synthesis of α -branched alkynes and dihydropyrrolones	225
B.3.2 Chapter 3: Synthesis of functionalized oxazolones by a sequence of copper (II) and gold(I)-catalyzed transformations	255
B.3.2.1 Synthesis of ynamides <i>via</i> a Cu-mediated coupling reaction	255
B.3.2.2 Synthesis of 4-oxazolin-2-ones <i>via</i> a Au/ Ag-mediated rearrangement of <i>Boc</i> -ynamides	271
B.3.3 Chapter 4: Gold(I) mediated cycloisomerization of 1,6-enynes – a short digression on catalyst counter ion effect and remote substituent control	278
B.3.3.1 Synthesis of 1,6-enynes	278
B.3.3.2 Cycloisomerization reaction of 1,6-enynes	297
B.3.4 Chapter 5: Hydroalkylation of Alkynyl Ethers <i>via</i> a Gold(I)-Catalyzed 1,5-Hydride Shift/Cyclization Sequence	311
B.3.4.1 Synthesis of substrates bearing C(2)-THF and 1,3-dioxolane rings	311
B.3.4.2 Synthesis of substrates bearing C(3)-THF rings	330
B.3.4.3 Synthesis of benzyl butynyl ether derivatives	341
B.3.4.4 Au(I)-Catalyzed transformations	346

B.3.5 Chapter 6: Formation of cinnoline derivatives by a gold(I) mediated process	363
B.3.5.1 Synthesis of hydrazine derivatives	363
B.3.5.2 Au(I)-catalyzed Friedel-Crafts reaction	389
B.3.5.3 Synthesis of cinnoline derivatives via Au(I)-catalysis	403

ACKNOWLEDGEMENT:

I would like to express my deepest gratitude to Prof. Dr. Zard, Head of the Chemistry Department at the École Polytechnique and Director of the Laboratory of Organic Synthesis (DCSO) for accepting me as a member of the DCSO laboratories.

I would also like to express my greatest gratitude to my PhD advisor, Dr. Fabien Gagosz, whose dynamism I really appreciated during my PhD.

My sincere thanks go also to the members of the committee, Dr. Patrick Pale, Dr. Philippe Belmont, Dr. Gwilherm Evano, Dr. Samir Zard and Dr. Fabien Gagosz for accepting to judge this work.

I would like also to acknowledge École Polytechnique and the CNRS (Centre National de Recherche Scientifique) for funding my PhD work and the staff of EDX (École Doctorale de l'X): Michel Rosso, Dominique Gresillon, Fabrice Baronnet, Audrey Lemarechal and Dominique Conne for their competence in all the administrative tasks that we, PhD students, are so dependent of. My special recognition goes to Audrey Lemarechal: thank you for your availability, efficiency and good humor!

The permanent staff of DCSO labs deserves also my greatest appreciation: Dr. Béatrice-Quiclet-Sire, Dr. Joëlle Prunet, Dr. Jean Pierre Férézou, Lélia Lebon and Brigitte Oisline. You are the great responsables for the organization of the labs and this is really an important task, which allows the good running of everyone's research: thank you.

I equally thank Dr. Xavier F. Le Goff from the DCPH Laboratory of École Polytechnique for the X-ray analysis.

I thank also Dr. Didier Ferroud, my advisor during my 4-months internship in Sanofi-Aventis. Thank you for your guidance during this internship and your kindness.

My closer colleagues and friends in lab 5, from the present and past, Andrea K. Buzas, Florin Istrate, Benoît Bolte and Colombe Gronnier: you made the good atmosphere in lab 5. I am truly grateful to have met you all. I hope we can stay in touch in the future and I wish you all the best in your careers and personal lives! Andrea, you're really a great person and I specially appreciated to share the fumehood with you for a while. I hope you're doing fine!

I would like also to thank all other DCSO students from different labs, which I think I had less opportunity to discuss with, possibly because of the physical distance between labs, but who also deserve my sincere appreciation: Matthieu Corbet, Laurent Petit, Rama Heng,

Guillaume Revol, Frédéric Lebreux, Aurélien Biechy, Daniel Woollaston, Marie-Gabrielle Braun, Mehdi Boumediene, Alice Chevalley, Raphael Guignard, Luis German Lopez-Valdez and Remi Aouzal.

To my other closest friends and favourite post-docs: Diego Gamba-Sanchez, thank you for everything! You know what I think about almost everything. I don't have to write it here, right? You are a real good friend and I appreciated all our discussions about chemistry and life. Bill Hawkings: You are one of the nicest guys I've ever met! You helped me so much in so many things: you proof-read my thesis and you gave me invaluable advice in my research for post-doc, I'm truly grateful to you. We definitely share many points of views about everything! I hope you accomplish everything you want to. All my best wishes also to Jane and Oliver! Fernando Portela, Bernhard Kindler, Raphael Oriez, Cong Ma, Nina Toëlle, Michal Michalak, Wioletta Kosnik: you are great guys and I enjoyed all our beers and coffees together. It was great to spend some time with you all, inside and outside the lab!

To my great Brazilian friends, who have been with me since 2004 in our *Communauté brésilienne à l'X*, it was great to have you by my side during all these years. Lunch time was always one of my favorite parts of the day with you guys! Special thanks go to Vitor Sessak, Camilla Barbeta, Ricardo Malaquias, Bruno Moraes, Fabiana Munhoz, Philippe Sung, Alexandre Kbelo, Tiago Pantaleão, Pedro Peron, Rafael Marini, Murilo Vasconcelos, Pedro Natal, Giovanni Granato, Gustavo G. de Araújo and Renné Araújo.

To my friends, almost neighbors, Fernanda Jourdan and Davi Coelho, thank you for the good time, beers and the fun we had together!

Also, Isabela G. de Castro: you know how happy I am to have found you in Paris, don't you? It is just a pity we did not meet even earlier! I really like you.... (...and the rest I can tell you in your ears, when we will be alone...)

To my family: *Mãe, Pai, Arnon e Irmãos*, thank you for your support through all these years. It is only because you were by my side all this time that this work was possible. I miss you and you are always in my heart! *Saudades!*

CHAPTER 1: UNUSUAL APPROACH TO BRANCHED 3-ALKYNYLAMIDES AND TO 1,5-DIHIDROPYRROL-2-ONES

The work described in this chapter was performed individually and was reported in the journal *Organic Letters*: Jurberg, I. D.; Gagosz, F.; Zard, S.; *Org. Lett.*, **2010**, 12, 3, 416.

CHAPTER 1: UNUSUAL APPROACH TO BRANCHED 3-ALKYNYLAMIDES AND TO 1,5-DIHYDROPYRROL-2-ONES

1.1. INTRODUCTION: Alkyne synthesis

Because alkynes are possibly one of the most versatile functions in organic chemistry, being reported to participate in a countless number of transformations¹, new and original methodologies to assemble these molecules represent a constantly important endeavour.

Despite the rich variety of conceivable routes leading to acetylenic compounds, a comprehensive discussion of each method available in the literature is outside the scope of this introduction. The focus here will be given on some of the most representative procedures to synthesize these molecules, followed by a section with a special emphasis on the methodology developed in our laboratory, based on the use of isoxazolones.

1.1.1 Alkylation of terminal alkyne through a S_N2-type reaction

Terminal alkynes (pK_a = 24)² can be deprotonated by a strong base, thus generating an acetylide anion that can displace primary alkyl halides in a S_N2 fashion (scheme 1.1).

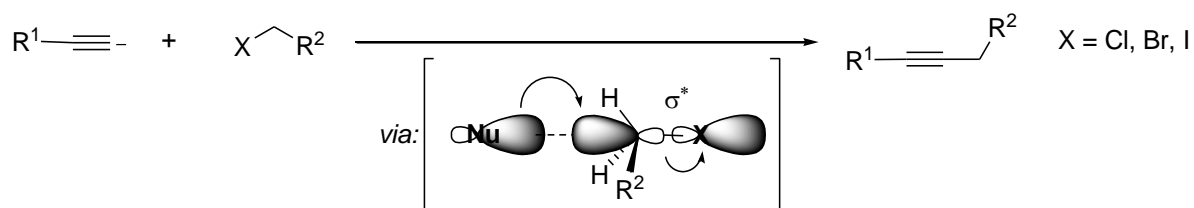

Scheme 1.1: Reaction of S_N2 displacement of a primary halide.

¹ For examples of addition reactions, using Au and Pt, see: (a) references chapter 2; using Ru, see: (b) Trost, B. M.; Ball, Z. T.; *J. Am. Chem. Soc.*, **2001**, 123, 12726; using Zn, see: (c) Alex, K.; Tillack, A.; Schwarz, N.; Beller, M.; *Angew. Chem. Int. Ed.*; **2008**, 47, 2304. For examples of cycloaddition reactions, see: (d) Gutnov, A.; Heller, B.; Fisher, C.; Drexler, H.-J.; Spannenberg, A.; Sundermann, B, Sundermann, C.; *Angew. Chem. Int. Ed.*, **2004**, 43, 3795. (e) Grecian, S.; Fokin, V. V.; *Angew. Chem. Int. Ed.*, **2008**, 47, 8285. For a cyclopropanation example, see: (f) Morandi, B.; Carreira, E. M.; *Angew. Chem. Int. Ed.*, **2010**, 49, 4294. For examples in metathesis reactions, see: (g) Fürstner, A.; Grela, K.; *Angew. Chem. Int. Ed.*, **2000**, 39, 7, 1234. (h) Kinoshita, A.; Sakakibara, N.; Mori, M.; *J. Am. Chem. Soc.*, **1997**, 119, 12388. (i) Clark, D. A.; Clark, J. R.; Diver, S. T.; *Org. Lett.*, 10, 10, **2008**, 2055. For examples of key steps using alkynes in total synthesis, see: (k) Trost, B. M.; Weiss, A. H.; *Angew. Chem. Int. Ed.*, **2007**, 46, 7664. (l) Trost, B. M.; Sieber, J. D.; Qian, W.; Dhawan, R.; Ball, Z. T.; *Angew. Chem. Int. Ed.*, **2009**, 48, 5478. (m) Reichard, H. A.; Rieger, J. C.; Micalizio, G. C.; *Angew. Chem. Int. Ed.*, **2008**, 47, 7837.

² All pK_a values were extracted from Evans pK_a table, available from the website: http://evans.harvard.edu/pdf/evans_pKa_table.pdf

This reaction of displacement allows a small level of variety³: one can perform simple alkylations, to attain terminal or internal alkynes (scheme 1.2). This reaction can be performed in liquid ammonia or in a polar aprotic solvent, such as HMPT (hexamethylphosphorous triamide, P(NMe₂)₃). Typical strong bases employed are sodium amide ($pK_{a\text{conjugate acid}}(\text{NH}_3) = 38$) or *n*-buthyllithium ($pK_{a\text{conjugate acid}}(n\text{-BuH}) = 48$).

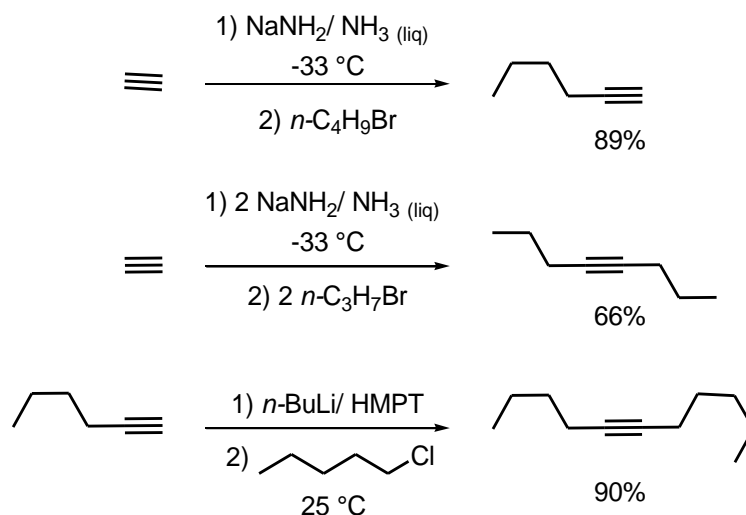

Scheme 1.2: Examples of application of different bases and electrophiles used in the synthesis of simple alkynes (extracted from ref. 3).

This method is useful as a general procedure for the synthesis of certain types of alkynes. It is also one among a not very large number of methods for the homologation of a carbon chain, another one being notably organometallic coupling reactions, which will be discussed in the next section.

A great limitation of this method comes from the fact that acetylides are very basic, thus being also capable of efficiently participating in elimination reactions (E2). For this reason, the reaction of S_N2-displacement can only be envisaged for the synthesis of alkynes using primary halides which do not have branches close to the reaction center (scheme 1.3).

³ Organometallics in Synthesis – A Manual. Manfres Schlosser (Editor), 2002, John Wiley & Sons Ltd. West Sussex.

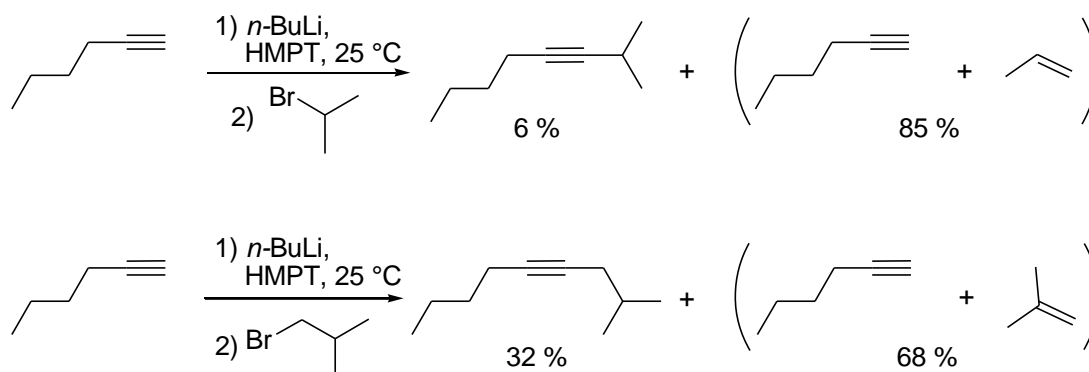

Scheme 1.3: Examples of reactions of type E2 taking place instead of the desired substitution pathway (extracted from ref. 3).

1.1.2 Organometallic additions and coupling reactions³

Bunsen was the first chemist to discover an organometallic coupling reaction in the 1850's, obtaining tetramethyldiarsane from cacodyl oxide, $[(\text{CH}_3)_2\text{As}]_2\text{O}$, and thus opening the doors for the work of Wanklin and Frankland in the following ten years. In the 1910's, Reformatzky, Grignard and Schrigin, and in the 1920's, Schlenk were responsible for confirming the power of the organometallic approach and to motivate many other chemists to that growing new domain.

The main strength of this method consists on the "umpolung"⁴ of RX to RM species, which considerably increases reactions scope (scheme 1.4).

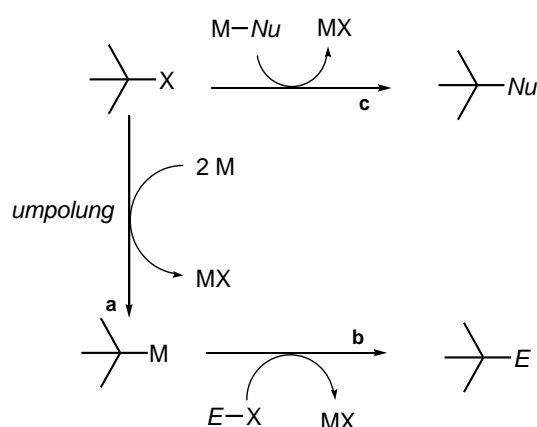

Scheme 1.4: Organometallic chemistry opens access to countless possibilities through the umpolung of previous electrophilic compounds (scheme 1.4 was extracted from ref. 3).

⁴ Expression created by G. Wittig and popularized by D. Seebach, it means "inverse poles". For a review on the subject, see: Gröbel, B.-T.; Seebach, D.; *Synthesis*, **1977**, 357.

A brief list of methods associated to alkyne synthesis using organometallic reagents will be presented below according to the metal employed.

1.1.2.1 Aluminium

The utilisation of organoalanes allows the Michael addition of acetylenic moieties to α,β -enones⁵. In contrast to the use of organocuprates, which are often employed in 1,4-additions, acetylenic cuprates can hardly participate, because the alkyne moiety binds very strongly to copper making further transfer difficult to proceed⁶.

Organoalanes can be prepared by converting the terminal alkyne into its lithiated derivative with *n*-BuLi and by treating the resulting mixture with diethylaluminium chloride (scheme 1.5).

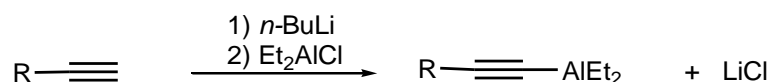

Scheme 1.5: Synthesis of alkynyl alanes from transmetalation of lithium derivatives.

The mixture containing the alane is treated with the α,β -unsaturated ketone to furnish after work-up, the γ,δ -alkynyl-ketone (scheme 1.6). The reaction is restricted to ketones which can adopt a *s*-cis conformation. Cyclic ketones, where the enone is found in a *s*-trans rigid conformation, such as 2-cyclohexenone, react with the alane to give only the tertiary carbinol derivative from the 1,2-addition, rather than the 1,4-addition adduct (not shown).

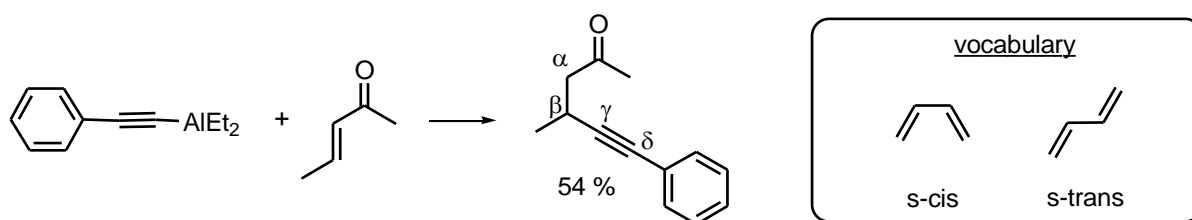

⁵ (a) Hooz, J., Layton, R. B., *J. Am. Chem. Soc.*, **1971**, 93, 7320. Application to prostaglandins synthesis: (b) Pappo, R.; Collins, P. W.; *Tetrahedron Lett.*, **1972**, 13, 26, 2627. (c) Collins, P. W.; Dajani, E. Z.; Bruhn, M. S.; Brown, C. H.; Palmer, J. R.; Pappo, R.; *Tetrahedron Lett.*, **1975**, 16, 48, 4217.

⁶ This led the use of acetylides as dummy ligands or place holders on cuprates, allowing the selective transfer of an alkyl or alkenyl group in the course of a Michael addition. Nevertheless, exceptions do exist: (a) Knöpfel, T. F.; Carreira, E.; *J. Am. Chem. Soc.*, **2003**, 125, 6054. (b) Knöpfel, T. F.; Zarotti, P.; Ichikawa, T.; Carreira, E. M.; *J. Am. Chem. Soc.*; **2005**, 127, 9682. For acetylides as cuprate dummy ligands, see: (c) Corey, E. J.; Beames, D. J.; *J. Am. Chem. Soc.*, **1972**, 94, 7210.

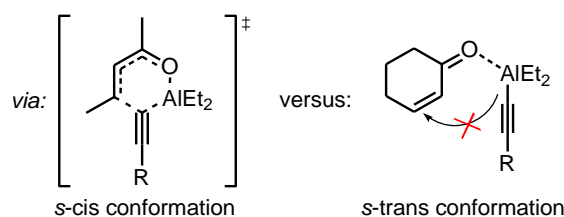

Scheme 1.6: An example of conjugate addition using an alane derivative^{5a}.

One way of correcting this limitation, thus allowing 1,4-additions on *s-trans* forms⁷ is the addition of Ni-catalysts and DiBAL-H in addition to the previous alane, which are capable of increasing considerably the yields.

1.1.2.2 Copper

1) Alkynyl (phenyl) iodonium tosylates⁸.

Iodonium groups are excellent leaving groups that allow, through the loss of neutral iodobenzene, the feasibility of nucleophilic acetylenic substitutions (S_NA), which are otherwise, commonly reported as unfavorable.

In this context, many nucleophiles were reported to add to alkynyl(phenyl)iodonium **1.1** affording the corresponding alkynes. Among them, Gilman cuprates R_2CuLi ⁹ are one of these viable nucleophiles, giving access to internal alkynes (scheme 1.7).

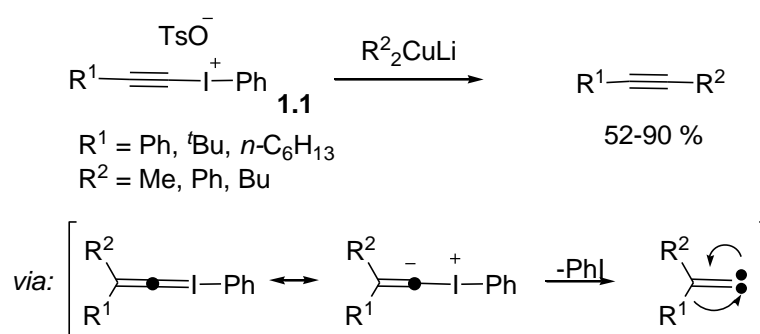

Scheme 1.7: Examples of Gilman cuprate additions to alkynyl(phenyl) iodonium compounds. In this regard, these species serve as masked alkynyl cations $RC\equiv C^+$, allowing umpolung

⁷ (a) Kwak, Y.-S.; Corey, E. J.; *Org. Lett.*; **2004**, 6, 19, 3385. (b) Schwartz, J.; Carr, D. B.; Hanse, R. T.; Dayrit, F. M.; *J. Org. Chem.*, **1980**, 45, 3053. (c) Hansen, R. T.; Carr, D.B.; Schwartz, D. B.; *J. Am. Chem. Soc.*, **1978**, 100, 2244.

⁸ Stang, P.; *Angew. Chem. Int. Ed.*, **1992**, 31, 274.

⁹ Kitamura, T.; Tanaka, T.; Taniguchi, H.; Stang, P.; *J. Chem. Soc. Perkins Trans. 1*, **1991**, 11, 2892.

reactions with nucleophiles, in contrast to the better known reaction of acetylides $\text{RC}\equiv\text{C}^-$ with electrophiles.

2) Transmetallation with alkynyl silanes¹⁰

The transmetallation between a trimethylsilylalkyne and catalytic amounts of CuCl is a simple way of generating alkynylcopper reagents capable of participating in acylation reactions with acyl chlorides. The use of CuCl has been demonstrated to be superior compared to its analogues CuBr, CuI or CuCN, which produced poor yields. The choice of the solvent proved to play an important role in the ligand exchange, with the best performances being found to be with 1,3-dimethylimidazolidinone (DMI) and dimethylformamide (DMF).

The metal exchange is sensitive to steric hindrance associated to the group bounded to the alkyne extremity, which suggests the existence of a π -complexation with CuCl in the reaction mechanism. Groups sensitive to acidic conditions, such as acetate and *tert*-butyldimethylsilyloxy groups are tolerated (scheme 1.8).

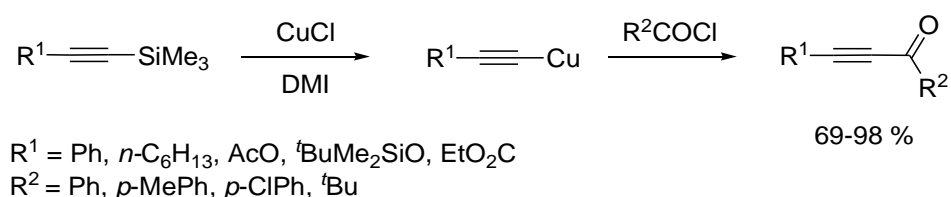

Scheme 1.8: Example of a transmetallation reaction between an alkynylsilane species and copper chloride followed by nucleophilic addition to acyl compounds.

1.1.2.3 Boron:

Treatment of lithium 1-alkynyltriorganoborates with iodine produces the corresponding alkynes with essentially quantitative yields under mild conditions¹¹. The reaction is applicable to a good variety of alkynyl derivatives bearing primary and secondary alkyl groups and aryl and organoboranes as well (scheme 1.9).

¹⁰ Ito, H.; Arimoto, K.; Sensui, H.; Hosomi, A.; *Tetrahedron Lett.*, **1997**, 38, 22, 3977.

¹¹ (a) Brown, H. C.; Sinclair, J. A.; Midland M. M.; *J. Am. Chem. Soc.*, **1973**, 95, 3080. (b) Suzuki, A.; Miyaura N.; Abiko, S.; Itoh M.; Midland, M. M.; Sinclair, J. A.; Brown, H. C.; *J. Org. Chem.*, **1986**, 51, 4507.

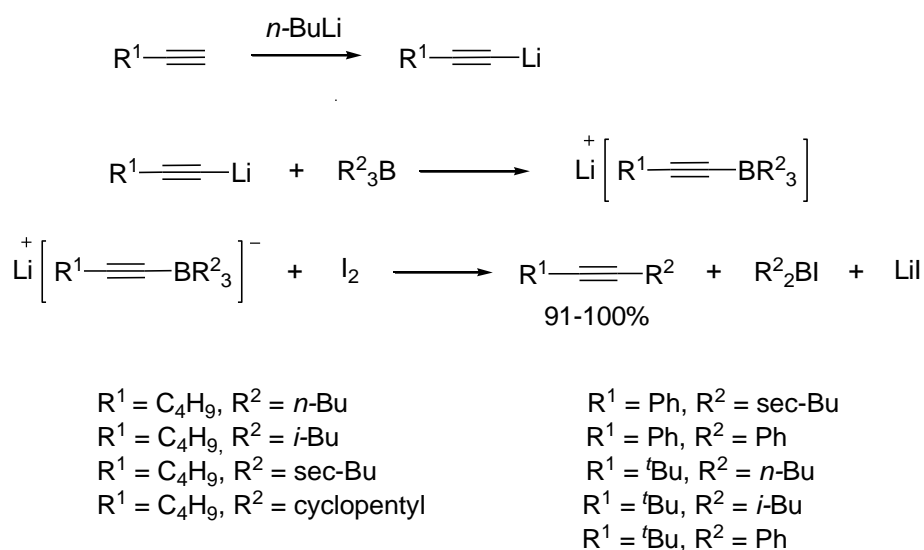

Scheme 1.9: Synthesis of alkynes from boron derivatives

Trialkyl boranes can be readily prepared *via* hydroboration. They react with lithium acetylides to produce the corresponding lithium 1-alkynyltrialkylborates, which upon treatment with iodine results in the migration of the alkyl group from boron to the more electron poor carbon atom, producing a putative β -iodovinylborane intermediate. This intermediate follows a further dehaloboration step to provide the corresponding alkyne (scheme 1.10).

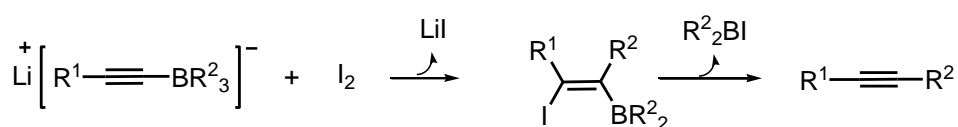

Scheme 1.10: Supposed β -iodovinylborane as intermediate in the iodine mediated cleavage of alkynylborate complexes.

The reaction of B-allenyl-9-boracyclo[3.3.1]nonane (B-allenyl-9-BBN) with compounds having a C=X group (X = O or N), such as aldehydes, ketones and imines, followed by the oxidation of the adduct thus obtained with hydrogen peroxide in an alkaline medium produces the corresponding homopropargylic alcohols and amines in good yields

and without the formation of the allene isomer in most of the cases, and only trace amounts in the case of imines¹² (scheme 1.11).

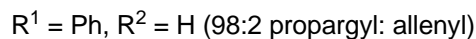
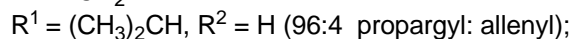
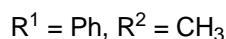
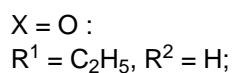
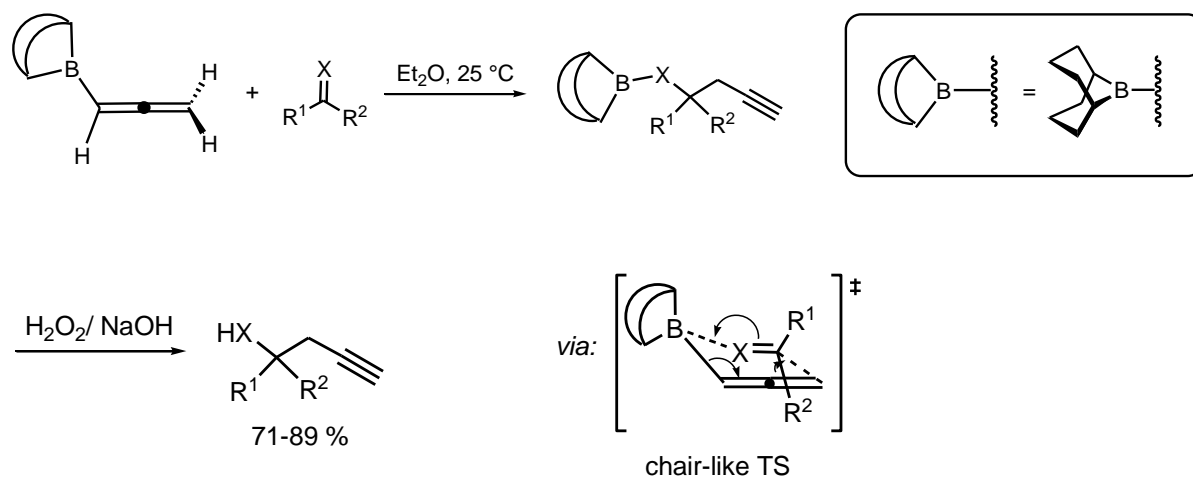

Scheme 1.11: Selected examples of homopropargyl alcohols and amines derived from allenylborane complexes.

1.1.2.4 Zinc

1) Addition of zinc acetylides to aldehydes

Some of the modern methods available in the literature use zinc acetylides in nucleophile additions with different degrees of complexity. Two examples are the (+)-*N*-methylephedrine ligand **1.2** reported by Carreira's group¹³ and the elaborate proline-derived dinuclear zinc catalyst system **1.3** reported by Trost's group¹⁴ (scheme 1.12).

¹² (a) Brown, H. C.; Khire U. R.; Narla, G.; Racherla, U. S.; *Tetrahedron Lett.*, **1993**, 34, 1, 15. (b) Brown, H. C.; Khire U. R.; Narla, G.; Racherla, U. S.; *J. Org. Chem.*, **1995**, 60, 544.

¹³ (a) Frantz, D. E.; Fässler, R.; Carreira E. M.; *J. Am. Chem. Soc.*, **2000**, 122, 1806. (b) Anand, N. K.; Carreira, E. M.; *J. Am. Chem. Soc.*, **2001**, 123, 9687. For the mechanism, see: (c) Noyori, R.; Kitamura, M.; *Angew. Chem. Int. Ed.*, **1991**, 30, 49.

¹⁴ Trost, B. M.; Weiss, A. H.; von Wangelin, A.; *J. Am. Chem. Soc.*, **2006**, 128, 8.

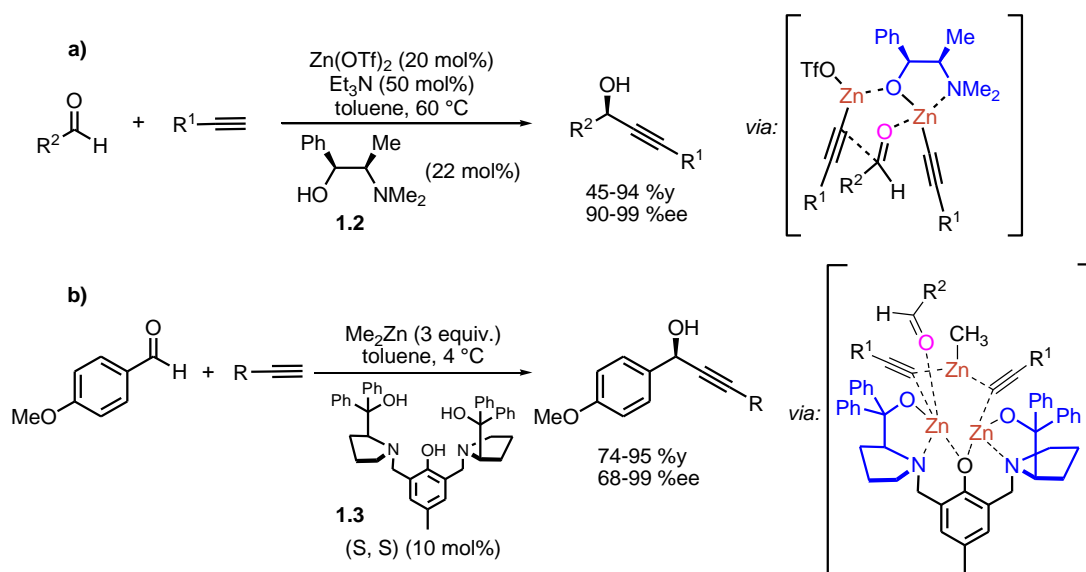

Scheme 1.12: Two examples of zinc acetylide additions to aldehydes, in **a)** using Carreira's (+)-N-methylephedrine ligand and in **b)** the proline-derived dinuclear zinc catalyst system reported by Trost.

2) Conjugate addition of zinc acetylides.

Conjugate addition reactions of organometallic species are well-established approaches for the stereoselective formation of carbon-carbon bonds. Besides the use of aluminium acetylides, zinc acetylides are also a worth-mentioning metal species useful in additions to α,β -enone derivatives. One example of such addition to an ephedrine derived Michael acceptor **1.4** provides enantiomerically enriched β -alkynyl acids in good yields¹⁵ (scheme 1.13).

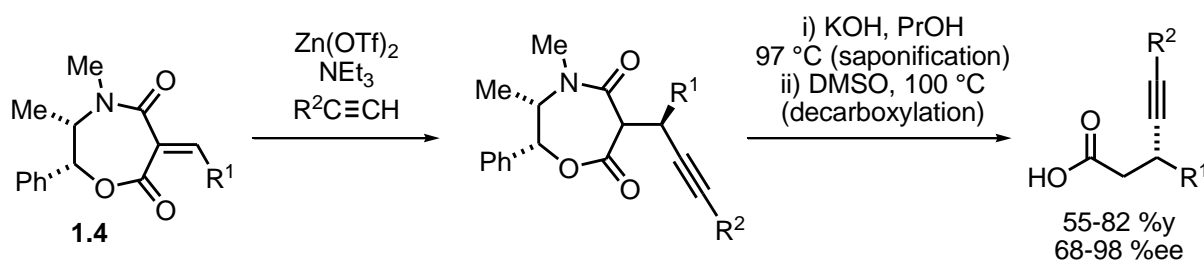

Scheme 1.13: Example of a conjugate addition of zinc acetylides using an ephedrine-derived Michael acceptor.

¹⁵ Knöpfel, T. F.; Boyall, D.; Carreira, E. M.; *Org. Lett.*, **2004**, 6, 13, 2281.

1.1.2.5 Palladium

The cross-coupling reactions of organic halides and organometallic species catalyzed by palladium follow canonically the three-steps cycle: oxidative addition, transmetalation and reductive elimination. In the first step, Pd^0L_n is inserted in the R-X bond to form the Pd^{2+} species through an oxidative addition, which is generally the rate-limiting step of the catalytic cycle. In the following step, the transmetalation, one of the substituents carried by the more electronegative metal, such as B, Zn, Si, Sn or Cu, is transferred to the more electropositive palladium species, in exchange for an halogen atom ($\text{X} = \text{Cl}, \text{Br}, \text{I}$). The final step is the reductive elimination, which liberates the coupled product $\text{R}^1\text{-R}^2$ and regenerates the active palladium species, Pd^0L_n (scheme 1.14).

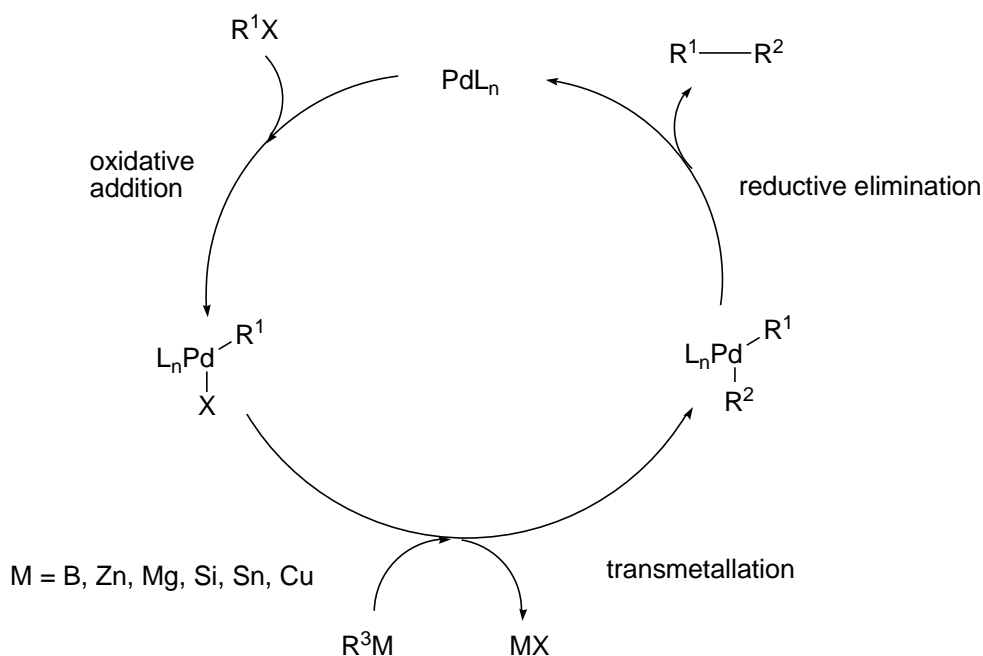

Scheme 1.14: The canonical catalytic cycle for palladium catalyzed cross-coupling reactions.

Many catalysts can be employed, a few examples are $\text{Pd}(\text{PPh}_3)_4$, $(\text{Ph}_3\text{P})_2\text{PdCl}_2$, and $(\text{MeCN})_2\text{PdCl}_2$. Depending on the nature of the transmetalating species, the palladium mediated cross-coupling reaction receives different names. Among the well established transmetalating agents¹⁶ are RMgX (Kumada), RZnX (Negishi), R^1SnR^2_3 (Stille), RSiX_3 (Hiyama), $\text{R}^1\text{B}(\text{OR}^2)_3$ (Suzuki) and $\text{RC}\equiv\text{CCu}$ (Sonogashira).

¹⁶ Negishi, E. -i.; Anastasia, L.; *Chem. Rev.*, **2003**, 103, 1979.

Organocopper and organoboron compounds mediated coupling reactions are maybe placed in a superior position to access alkynes; the Sonogashira reaction for obvious reasons, and the Suzuki coupling, due to the great advances this reaction has experienced in the past years. For this reason, these two cross-coupling reactions will receive more attention in this section.

1) Cross-coupling reaction of aryl and alkenyl halides with terminal alkynes catalyzed by Pd(0)/ Cu(I) (Sonogashira coupling)¹⁷.

The coupling reactions between aryl/alkenyl halides and terminal alkynes were reported independently in 1975 for the first time by three groups¹⁸. The first two methods^{18a,b} can be seen as an extension of the Heck reaction, applied to terminal alkynes. The third one^{18c}, on another hand, can be seen as an application of palladium catalysts to the reaction of Stephens-Castro¹⁹. Disconsidering these historical details, one usually refers to this reaction as it is most known, the Sonogashira reaction.

Terminal alkynes cross-couple with aryl and alkenyl halides in the presence of catalytic amounts of palladium and copper(I) iodide and a secondary or tertiary amine. The reaction conditions are mild and not very sensitive to moisture, precluding the necessity of distilled solvents and reagents. The most common employed catalysts are Pd(PPh₃)₄ and PdCl₂(PPh₃)₂ which are quickly transformed into Pd(PPh₃)₂ and [Pd(PPh₃)₂X]⁻, respectively, being the active species in the catalytic cycle. In many cases, Pd(OAc)₂ or (CH₃CN)₂PdCl₂ and two equivalents of a tertiary phosphine, L, and a terminal alkyne are employed to reduce the Pd(II) complexes *in situ* to the catalytic active species [Pd⁰].

Today, it is generally accepted that alkynyl copper derivatives are formed and transmetalated to RPdX species derived from the oxidative addition of the palladium active catalyst to the halide (scheme 1.15).

¹⁷ Review: (a) Chinchilla, R.; Najera, C.; *Chem. Rev.*, **2007**, 107, 874. (b) Sonogashira, K.; *J. Organomet. Chem.*, **2002**, 653, 46.

¹⁸ (a) Dieck, H. A.; Heck, F. R.; *J. Organomet. Chem.*, **1975**, 93, 259. (b) L. Cassar, *J. Organomet. Chem.*, **1975**, 93, 253. (c) Sonogashira, K.; Tohda, Y., Hagihara, N., *Tetrahedron Lett.*, **1975**, 16, 50, 4467.

¹⁹ Stephens, R. D.; Castro, C. E.; *J. Org. Chem.*, **1963**, 28, 3313.

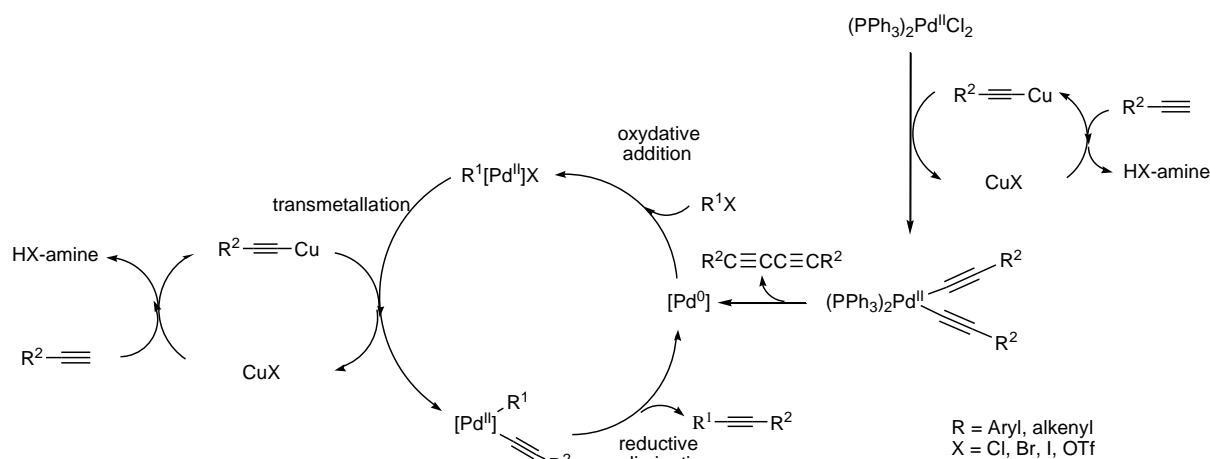

Scheme 1.15: The generally accepted catalytic cycle of the Sonogashira cross-coupling reaction.

Some examples of alkynes are shown below (scheme 1.16).

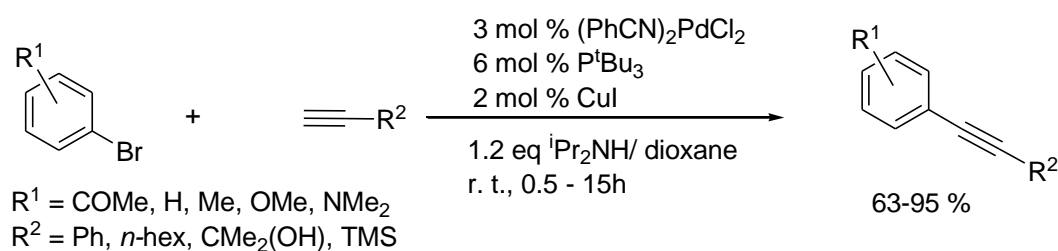

Scheme 1.16: Examples of application of the Sonogashira cross-coupling reaction.

Modifications of the original method were developed. Some examples are the use of Pd/C as a catalyst²⁰, the use of water as reaction solvent²¹ and even catalyst systems which do not need the use of copper(I) iodide²².

2) Cross-coupling of an aryl or alkenyl halide with boronic acid, borate esters or trifluoroborates catalyzed by Pd(0) (Suzuki coupling)²³

²⁰ (a) De La Rosa, M. A.; Velarde, E.; Guzman A.; *Synth. Comm.*, **1990**, 20, 13, 2059. (b) Cosford, N. D. P.; Bleicher, L.; *Synlett*, **1995**, 1115.

²¹ Beletskaya, I. P.; Olstaya, T. P.; Luzikova, E. V.; Sukhomlinova, L. L.; Bumagin, N. A.; *Tetrahedron Lett.*, **1996**, 37, 6, 897.

²² Nguetack, J.-F.; Bolitt V.; Sinou, D.; *Tetrahedron Lett.*, **1996**, 37, 31, 5527.

The Suzuki cross-coupling reaction or Suzuki-Miyaura, as it is also known, consists of a cross-coupling reaction between an aryl or alkenyl halide (or triflate) and a boronic acid, boronate ester or trifluoroborates²⁴ catalyzed by palladium in the presence of a base (some examples are aqueous solutions of NaOH, K₃PO₄, Na₂CO₃, or KF, CsF, etc.). An excellent compatibility with numerous functional groups is one of the most remarkable features of this transformation (scheme 1.17).

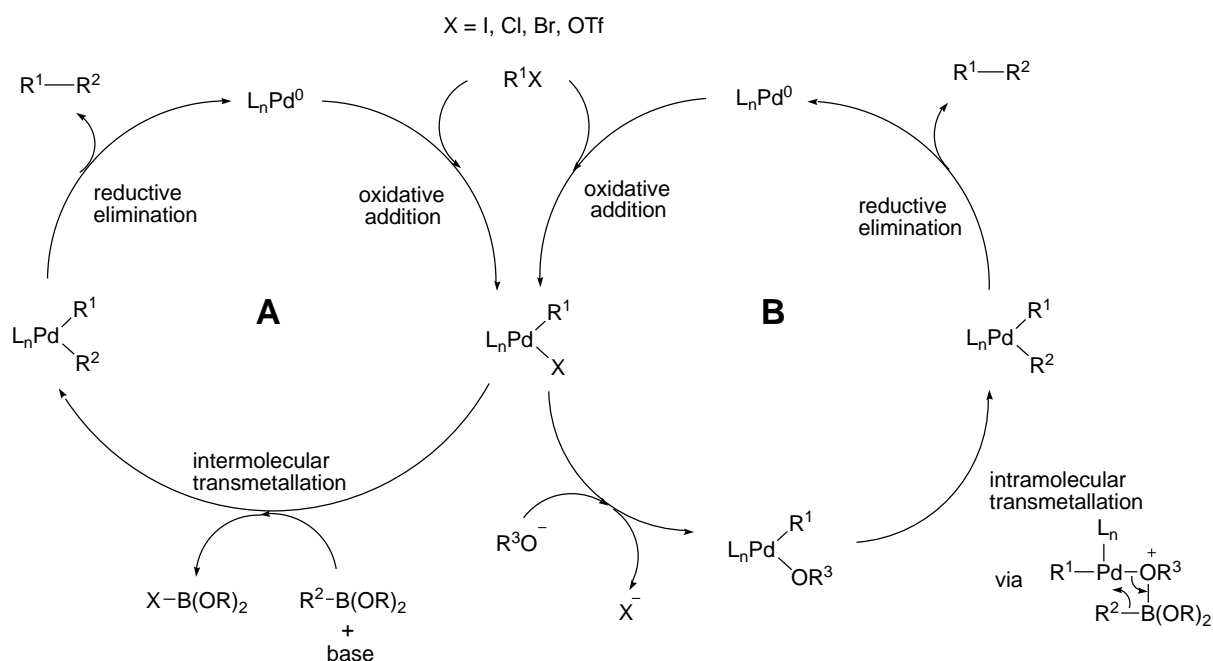

Scheme 1.17: A typical catalytic cycle of a Suzuki cross coupling reaction (extracted from ref. 23c).

The transmetalation between the Pd center and the organoboron compound (BL₃) does not proceed readily. Despite this fact, the nucleophilicity of the organoboron derivative can be enhanced due to the *in situ* generation of an “ate complex” (BL₄⁻) from the reaction with a base.

The reactivity of the X groups employed decrease in the order: I > OTf > Br >> Cl. Aryl and 1-alkenyl halides activated by the proximity of a electron-withdrawing group are more

²³ Reviews : (a) Miyaura, N.; Suzuki, A.; *Chem. Rev.*, **1995**, 95, 2457. (b) Suzuki, A.; *J. Organomet. Chem.*, **1999**, 576, 147. (c) Martin, R.; Buchwald, S.; *Acc. Chem. Res.*, **2008**, 41, 11, 1461.

²⁴ Reviews: (a) Molander, G. A.; Ellis, N., *Acc. Chem. Res.*, **2007**, 40, 275. (b) Molander, G. A.; Canturk, B.; *Angew. Chem. Int. Ed.*, **2009**, 48, 9240.

reactive towards the oxidative addition, than those compounds bearing an electron donating groups. This allows the use of chlorides in this coupling reaction.

Numerous catalysts can be employed, but the catalyst $\text{Pd}(\text{PPh}_3)_4$ is probably the most common. $\text{PdCl}_2(\text{PPh}_3)_2$ and $\text{Pd}(\text{OAc})_2 + \text{PPh}_3$ or other phosphine ligands are also efficient, since they are stable to air and easily reduced to the active $\text{Pd}(0)$ species.

The extension of the Suzuki reaction to alkynes²⁵ was developed from the observation that B-methoxy-9-BBN and an organometallic polar reagent of type RM (with R = alkynyl, TMSCH_2 or Me), allowed access to borate complexes having this R group which could be further transferred to functionalized aryl or alkenyl halides, thus furnishing compounds which were not envisaged before through the traditional Suzuki coupling reaction.

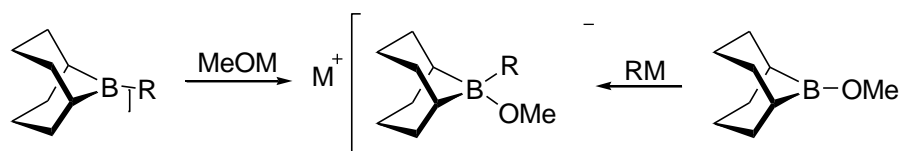

Scheme 1.18: Two complementary ways of preparing a borate complex to be employed in the Suzuki coupling reaction R = alkynyl, TMSCH_2 or Me . M = K , Na , Li .

The use of stoichiometric amounts of B-methoxy-9-BBN is not even necessary, because the partial regeneration of the borate complex after the transmetalation step is possible in the presence of the organometallic species $\text{R}^2\text{—}\equiv\text{—M}$ (scheme 1.19).

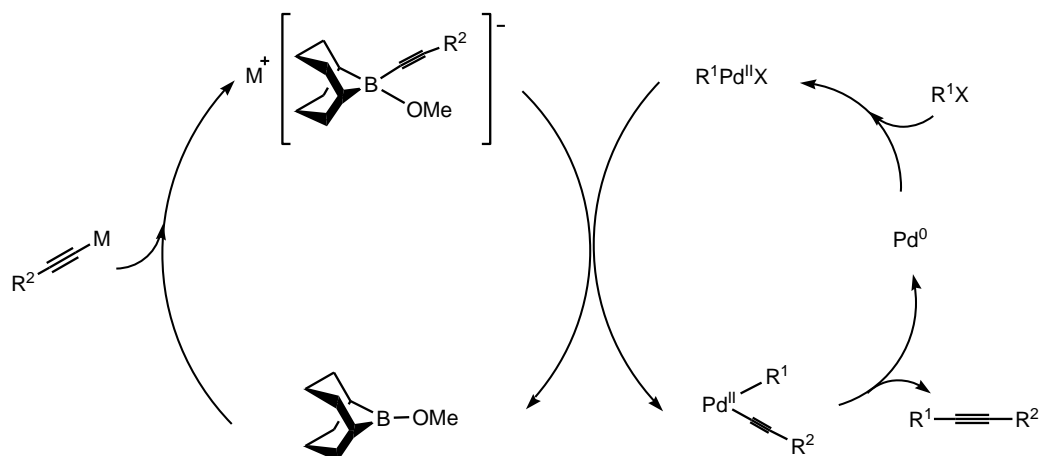

Scheme 1.19: Suzuki cross-coupling using sub-stoichiometric quantities of B-methoxy-9-BBN.

²⁵ (a) Soderquist, J. A.; Matos, K.; Rane, A.; Ramos, J.; *Tetrahedron Lett.*, **1995**, 36, 14, 2401. (b) Fürstner, A.; Seidel, G.; *Tetrahedron*, **1995**, 51, 11165.

Other reactions using borate esters were later developed for examples using $B(O^iPr)_3$ ²⁶ and $B(OMe)_3$ ²⁷ (scheme 1.20).

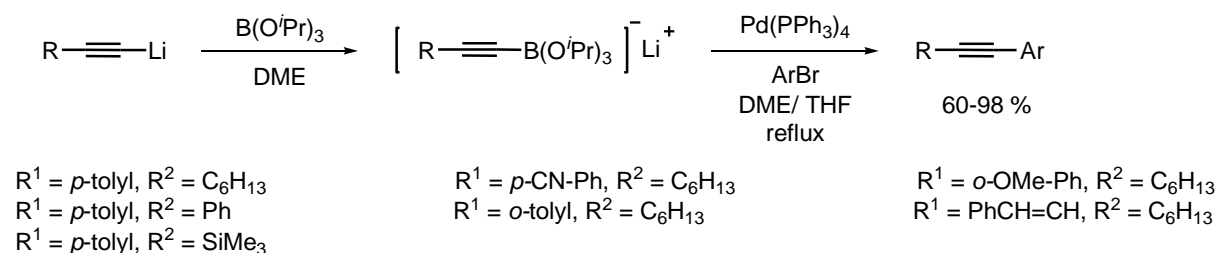

Scheme 1.20: Examples using $B(O^iPr)_3$ in the Suzuki cross-coupling reactions to synthesize alkynes.

1.1.2.6 The Corey-Fuchs reaction

The Corey-Fuchs²⁸ reaction consists of the homologation of aldehydes to either terminal alkynes, if the lithiated intermediate is quenched with a proton source or to an internal alkyne, if a suitable electrophile is added. This is a two-steps sequence, where a vinyl dibromo compound can be isolated as a first intermediate upon treatment of the aldehyde with triphenyl phosphine and carbon tetrabromide. The second step uses two equivalents of *n*-BuLi, the first equivalent deprotonates the vinyl hydrogen and force the elimination of *n*-BuH and LiBr, thus generating a bromoalkyne. The second equivalent of *n*-BuLi makes the exchange between bromo and lithium (scheme 1.21).

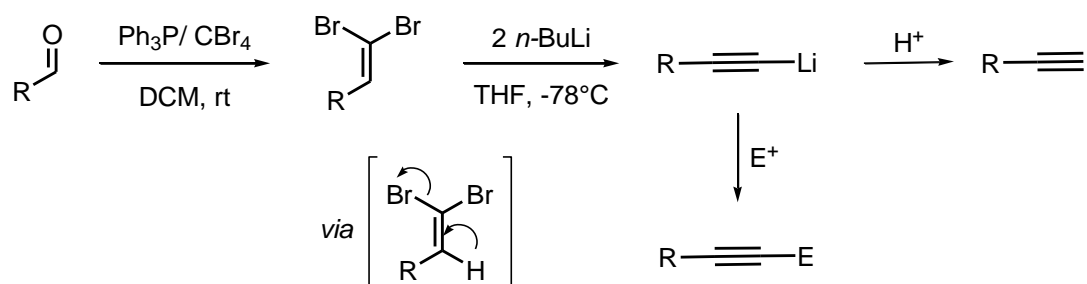

Scheme 1.21: The Corey-Fuchs reaction.

²⁶ Castanet, A.-S.; Colobert, F.; Schlama, T.; *Org. Lett.* **2000**, 2, 23, 3559.

²⁷ Colobert, F.; Castanet, A.-S.; Abillard, O.; *Eur. J. Org. Chem.*, **2005**, 3334.

²⁸ Corey, E. J., Fuchs, P. L.; *Tetrahedron Lett.* **1972**, 13, 36, 3769.

One problem of this method is the use of the strong base *n*-BuLi, which is going to limit the application of this route to more sensitive substrates.

1.1.2.7 Homologation of Seyferth-Gilbert and variations of Bestmann and Ohira

Another possible route to access alkynes is by using the Seyferth-Gilbert reagent, the diazocompound **1.5**²⁹. This method consists in the conversion of aldehydes and ketones into the corresponding alkyne, which will have its carbon chain increased by one carbon. This method can be seen as a response to the strong basic conditions employed in the Corey-Fuchs reaction: the milder conditions used here will grant a wider generality of application. The mechanism of this reaction is believed to follow a Horner-Wadsworth-Emmons olefination and then a Fritsch-Buttenberg-Wiechell rearrangement of the alkylidene carbene formed³⁰ (scheme 1.22):

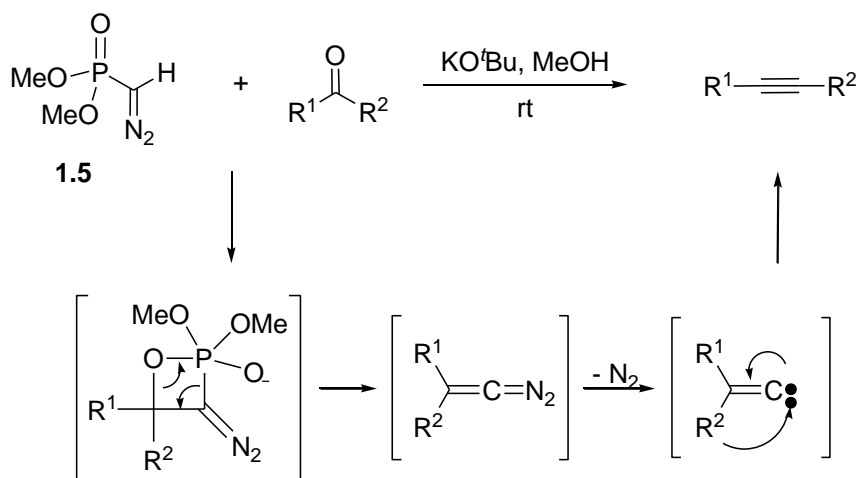

Scheme 1.22: The homologation of aldehydes to alkynes using the Seyferth-Gilbert reagent.

²⁹ (a) Seyferth, D.; Marmor, R. S.; Hilbert, P.; *J. Org. Chem.*, **1971**, 36, 10, 1379. (b) Gilbert, J. C.; Weerasooriya, U.; *J. Org. Chem.* **1982**, 47, 1837. (c) Hauske, J. R.; Dorff, P.; Julin, S.; Martinelli, G.; Bussolari, J.; *Tetrahedron Lett.*, **1992**, 33, 3715.

³⁰ Brown, D. G.; Velthuisen, E. J.; Commeford, J. R.; Brisbois, R. G.; Hoye, T. R.; *J. Org. Chem.* **1996**, 61, 2540.

Although the Seyferth-Gilbert reagent has become popular in synthesis³¹ and that the one-carbon homologation works smoothly, the multi-step procedure to synthesize this reagent is laborious^{29a}. In an effort to circumvent this, Bestmann³² exploited a first example reported by Ohira³³, developing an efficient way of generating the Seyferth-Gilbert reagent *in situ* from the cleavage of a β -keto group present in 1-diazo-2-oxopropylphosphonate (scheme 1.23).

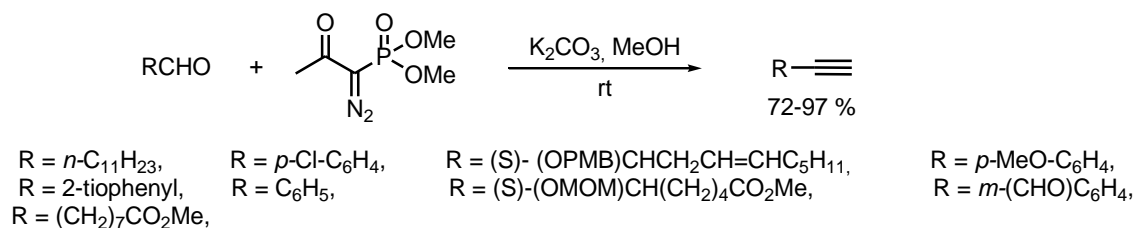

Scheme 1.23: Examples of alkynes synthesized using the Bestmann-Ohira modification.

From the R groups showed in scheme 1.23, one can see that the chiral center in the α -position to the carbonyl is not racemized during the reaction. The significant advantage of this reagent is that it can be prepared from the commercial products dimethyl-2-oxopropylphosphonate and the *p*-toluenesulfonylazide³⁴ in one step (not shown). A one-pot route for the same alkynes showed previously was also tested and produced the same products as the two-step sequence, with only a slight decrease in yields, 65-89%.

1.2 ISOXAZOLONES: general properties, synthesis and reactivity

Although, today, excellent methodologies are available in the literature to access alkynes, the continuing saga for new methodologies is a constant worth-while endeavor. In this regard, we will present now our efforts to assemble such molecules based on previous

³¹ For applications in total synthesis, see: (a) Nerenberg, J. B.; Hung, D. T.; Somers, P. K.; Schreiber, S. L.; *J. Am. Chem. Soc.* **1993**, 115, 12621. (b) Buszec, K. R.; Sato, N.; Jeong, Y.; *J. Am. Chem. Soc.*, **1994**, 116, 5511. (c) Heathcock, C. H.; Clasby, M.; Griffith, D. A.; Henke, B. R. Sharp, M. J.; Synlett., **1995**, 467. (d) Delpech, B.; Lett. R.; *Tetrahedron Lett.* **1989**, 30, 1521. For other applications: (e) Gilbert, J. C.; Giamalva, D. H.; Weerasooriya, U. J.; *J. Org. Chem.* **1983**, 48, 5251. (f) Gilbert, J. C.; Giamalva, D. H.; Baze, M. E.; *J. Org. Chem.*, **1985**, 50, 2557. (g) Walborsky, H. M. Topolski, M.; *J. Org. Chem.* **1994**, 59, 6014.

³² Müller, S.; Liepold B.; Roth, G. J.; Bestmann, H. J.; *Synlett*, **1996**, 521.

³³ Ohira, S.; *Synth. Commun.*; **1989**, 19, 561.

³⁴ Roth, G. J.; Liepold, B.; Müller, S. G.; Bestmann, H. J.; *Synthesis*, **2004**, 1, 59.

work in our laboratory using isoxazolones. This presentation will be preceded by a brief introduction of this heterocycle and some of the chemistry that can be performed from him.

1.2.1 General properties of isoxazolones

Isoxazolones do not constitute a new class of heterocyclic compounds. Their reactivity and tautomeric properties have been investigated since the beginning of the 20th century³⁵ and employed in many studies concerning the synthesis of other heterocycles, such as 1,3-oxazin-6-ones³⁶, pyrroles³⁷, imidazoles³⁸, tetrahydropyridines³⁹ and pyridopyrimidines⁴⁰. Additionally, human⁴¹ and anti-fungal⁴² activities have also been identified in isoxazolone derivatives. Two such compounds are presented below (Figure 1.1).

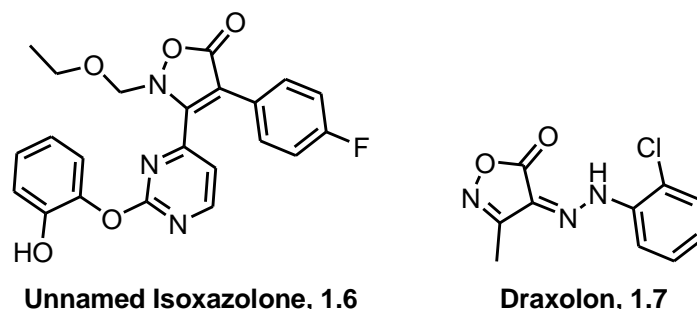

Figure 1.1: Examples of an isoxazolone based inhibitor of a tumor necrosis factor-alpha (TNF- α) **1.6**, and an arylhydrazonoisoxazolone derivative employed as fungicide, Drazoxolon **1.7**.

³⁵ For some examples of earlier reports, see: (a) Kohler, E. P.; Blatt, A. H.; *J. Am. Chem. Soc.*, **1928**, 50, 504. (b) Donleavy, J. J.; Gilbert, E. E.; *J. Am. Chem. Soc.*, **1937**, 59, 1072.

³⁶ (a) Beccalli, E. M.; La Rosa, C.; Marchesini, A.; *J. Org. Chem.*, **1984**, 49, 4287. (b) Beccalli, E. M.; Marchesini, A.; *J. Org. Chem.*; **1987**, 52, 1666. (c) Beccalli, E. M.; Marchesini, A.; *J. Org. Chem.*, **1987**, 52, 3426.

³⁷ Wentrup, C.; Wollweber, H.-J.; *J. Org. Chem.*, **1985**, 50, 2041.

³⁸ Beccalli, E. M.; Marchesini, A.; Pilati, T.; *Synthesis*, **1991**, 127.

³⁹ Risitano, F.; Grassi, G.; Foti, F.; Romeo, R.; *Synthesis*, **2002**, 1, 116.

⁴⁰ Tu, S.; Zhang, J.; Jia, R.; Jiang, B.; Zhang, Y.; Jiang, H.; *Org. Biomol. Chem.*, **2007**, 5, 1450.

⁴¹ (a) Laughlin, S. K.; Clark, M. P.; Djung, J. F.; Golebiowski, A.; Brugel, T. A.; Sabat, M.; Bookland, R. G.; Laufersweiler, M. J.; VanRens, J. C.; Townes, J. A.; De, B.; Hsieh, L. C.; Xu, S. C.; Walter, R. L.; Mekel, M. J.; Janusz, M. J.; *Bioorg. Med. Chem. Lett.*, **2005**, 15, 2399. (b) Laufer, S. A.; Margutti, S.; *J. Med. Chem.*, **2008**, 51, 2580.

⁴² (a) L. A. Summers, Byrde, R. J. W.; Hislop, E. C.; *Ann. Appl. Biol.*, **1968**, 62, 45. (b) Lehtonen, K.; Summers, L. A.; *Pestic. Sci.*, **1972**, 3, 357.

Isoxazolones can exist in three possible tautomeric forms, often called the OH form **1.8**, CH form **1.9**, and the NH form **1.10**. The population of each tautomer in solution will depend on the nature of the substituents R^1 , R^2 and the solvent they are dissolved in. Simple 3- and/or 4-substituted 5-isoxazolones tend to exist in the CH form in solvents of low polarity, such as $CDCl_3$. Depending on the substituents, the NH form might become more or less pronounced in solvents capable to supporting hydrogen bonds, such as $(CD_3)_2SO$. In strongly basic media (pyridine, piperidine and aqueous NaOH) the OH form and the ionized O^- form also enter the equilibrium (scheme 1.24)³⁷.

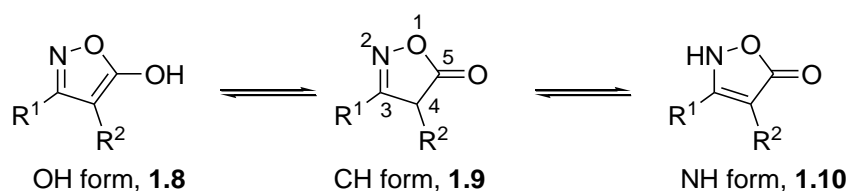

Scheme 1.24: Three tautomeric forms are possible in isoxazolone compounds.

1.2.2 Isoxazolone synthesis

Although the main method for the synthesis of isoxazolones is the condensation of hydroxylamine with β -ketoesters⁴³ (scheme 1.25a), other procedures less often exploited, such as the [3+2]-cycloaddition of nitrile oxides with esters⁴⁴ (scheme 1.25b) and the gold catalyzed rearrangement of O-propiolyl oxymes⁴⁵ (scheme 1.25c) exist.

⁴³ (a) Boulton, A. J.; Katritzky, A. R.; *Tetrahedron*, **1961**, 12, 41. (b) Abignente, E.; de Caprariis, P.; *J. Heterocyclic Chem.*, **1983**, 20, 1597.

⁴⁴ In German, base is *n*-BuLi: (a) Dannhardt, G.; Laufer, S.; Obergrusberger, I.; *Synthesis* **1989**, 27, 275. In Italian, base is $NaOH_{(aq)}$: Lo Vecchio, G.; Lamonica, G.; Cum, G.; *Gazz. Chim. Ital.*, **1963**, 93, 15.

⁴⁵ Nakamura, T.; Okamoto, M.; Terada, M.; *Org. Lett.*; **2010**, 12, 11, 2453.

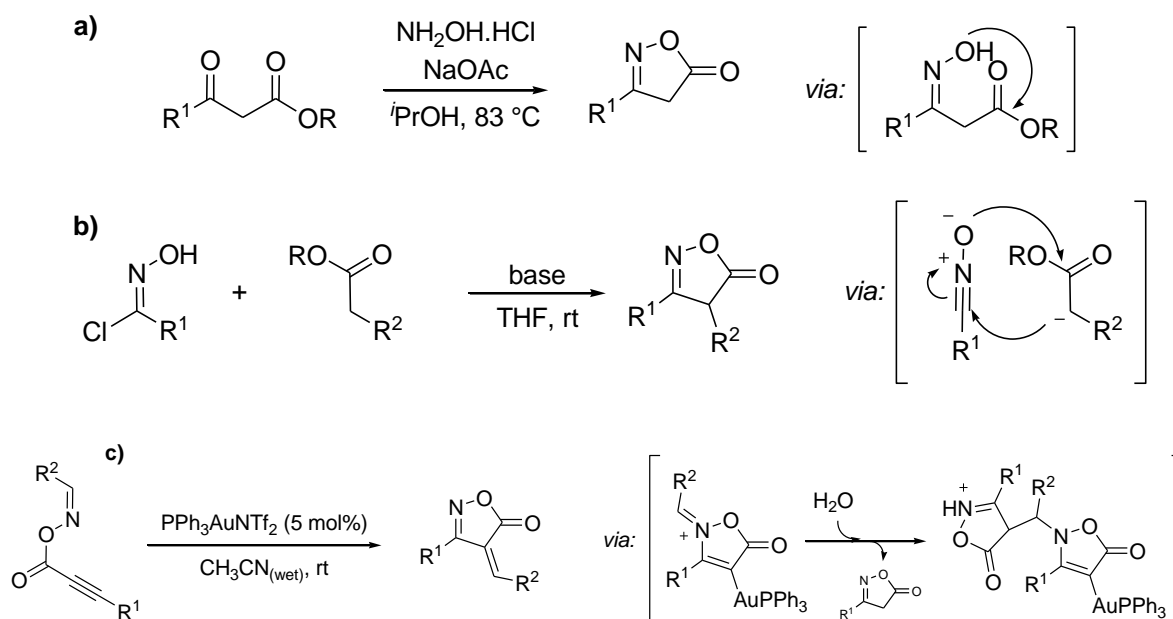

Scheme 1.25: Examples of possible routes to isoxazolones derivatives. Method exhibited in **a)** is the most often reported in the literature.

Scheme 1.25a shows the condensation of hydroxylamine with the β -ketoester, which occurs in general on the more electrophilic carbonyl group from the ketone⁴⁶. Nevertheless, contamination with 3-isoxazolones coming from the cyclization of a hydroxamic acid formed from the attack of hydroxylamine to the ester group of the β -ketoester can also be present. It is even possible, under controlled pH (around 10), to revert the selectivity for these compounds, instead of 5-isoxazolones⁴⁷ (not shown).

Scheme 1.25b shows the use of nitrile oxides, which can be synthesized *in situ* typically by two well-established methods⁴⁸. The first one derives from the condensation of aldehydes with hydroxylamines, followed by reaction of NaOX or NXS (X = Cl, Br, I), generating thus an hydroximinoyl halide, which upon treatment with a base, is capable of furnishing the nitrile oxide *in situ*⁴⁹. The second method is the Mukaiyama procedure, which derives from the reaction of a nitro alkane, phenyl isocyanate, triethylamine and DCC (*N,N'*-dicyclohexylcarbodiimide) or similar dehydration agent⁵⁰ (not shown).

⁴⁶ (a) Katritzky, A. R.; Barczynski, P.; Ostercamp, D. L.; Youssaf, T. I.; *J. Org. Chem.*, **1986**, 51, 4037. (b) De Sarlo, *Tetrahedron*, **1967**, 23, 831.

⁴⁷ Jacobsen, N.; Kolind-Andersen, H.; Christensen, J.; *Can. J. Chem.*, **1984**, 62, 1940.

⁴⁸ For an example of a third procedure recently reported in the literature using O-silylated hydroxamic acids, triflic anhydride and Et₃N, see: Carreira, E. M.; Bode, J. W.; Muri, D.; *Org. Lett.*, **2000**, 2, 539.

⁴⁹ Larsen, K. E.; Torssell, K. B. G.; *Tetrahedron*, **1984**, 40, 15, 2985.

⁵⁰ Mukaiyama, T.; Hoshino, T.; *J. Am. Chem. Soc.*, **1960**, 82, 5339.

Scheme 1.25c concerns a recent method based on the gold catalyzed cycloisomerization of O-propioloyl oximes. Although not as practical as the condensation of hydroxylamine to β -ketoesters, it is mentioned here as an anecdotal reference to gold catalyzed processes that will be more deeply discussed in the next chapters of this thesis.

1.2.3 Isoxazolone reactivity

Great richness of the chemistry demonstrated by isoxazolones can be attributed to the fact the α -hydrogens to the carbonyl group in position 4 have a pKa in the range of 4-6⁵¹. This important feature allows isoxazolones to participate as nucleophiles in many transformations, such as Michael additions⁵², chlorinations⁵³, condensations to aldehydes in Knoevenagel-type reactions⁵⁴ and Mannich reactions⁵⁵ (Scheme 1.26).

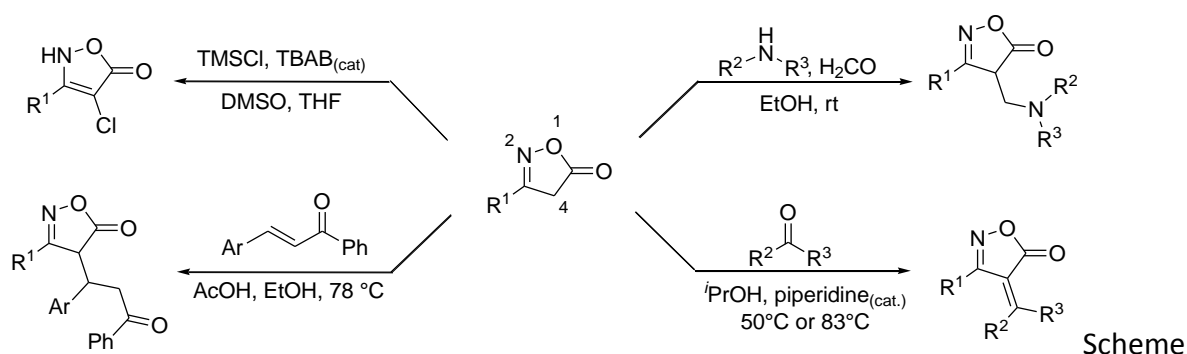

1.26: Examples of reactions derived from 5-isoxazolones

From the reactions listed above, Knoevenagel-type condensations with ketones and aldehydes are of particular interest, because the alkylidene isoxazolones formed serve as a Michael acceptor to a plethora of nucleophiles. Examples of such nucleophiles are hydrides⁵⁶, Grignard reagents⁵⁷, organozinc compounds^{57c}, cyanides⁵⁴, phosphonates⁵⁸, aromatic compounds^{57a,b} and isoxazolones⁵⁹ (Scheme 1.27).

⁵¹ See ref. 43a.

⁵² Risitano, F.; Grassi, G.; Foti, F.; Romeo, R.; *Synthesis*, **2002**, 1, 116.

⁵³ Huppé, S.; Rezaei, H.; Zard, S. Z.; *Chem. Comm.*, **2001**, 1894.

⁵⁴ Boivin, J.; Huppé, S.; Zard, S. Z.; *Tetrahedron Lett.*, **1996**, 37, 48, 8735.

⁵⁵ Barbieri, W.; Bernardi, L.; Coda, S.; Colo, V.; Diquál, G.; Palamidessi, G.; *Tetrahedron*, **1967**, 23, 4409.

⁵⁶ Using NaBH₄: (a) Beccalli, E. M.; Benincore, T.; Marchesini, A.; *Synthesis*, **1988**, 886. Using the Hantzsch ester: (b) Liu, Z.; Han, B.; Liu, Q.; Zhang, W.; Yang, L.; Liu, Z.-L.; Yu, W.; *Synlett*, **2005**, 10, 1579.

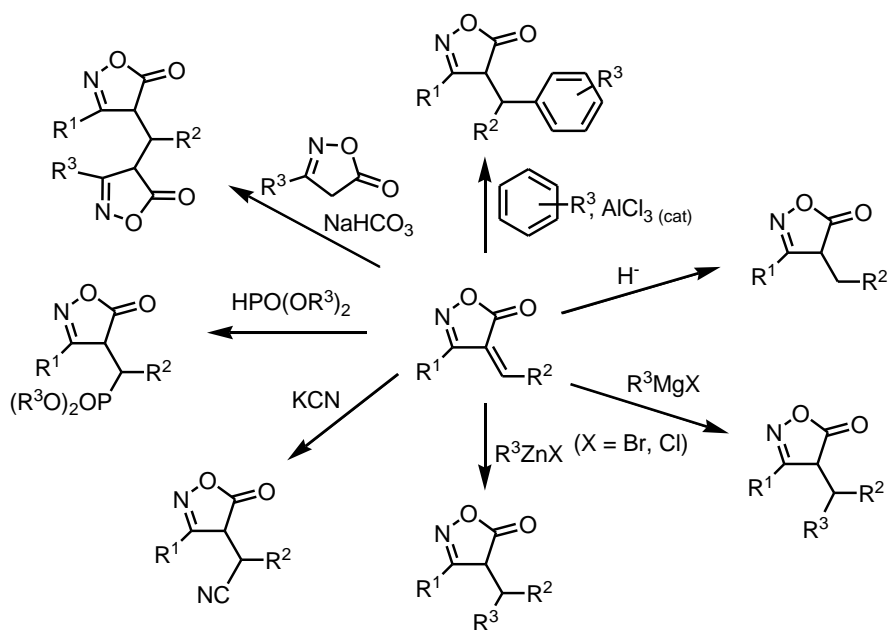

Scheme 1.27: Scope of possible nucleophiles that can be added to alkylidene isoxazolones.

Hydride addition to alkylidene isoxazolones is of special importance, because of the lack of selectivity between C- and N- alkylation. For instance, allylation of 3-phenyl-4-methyl-5-isoxazolone in the presence of sodium ethoxide affords a 2:1 mixture of NH-alkylated: CH-alkylated products (Scheme 1.28). Interestingly enough, in some cases, under high temperature, it is possible to force allyl chains to migrate following a 3,3-sigmatropic shift in favor of the CH-alkylated product⁶⁰ (scheme 1.28). Nevertheless, as a general trend, direct alkylation on the 4-position of 5-isoxazolones remains a difficult and unsolved problem.

⁵⁷ (a) Mustafa, A.; Asker, W.; Harhash, A. H.; Kassab, N. A. L.; *Tetrahedron*, **1963**, 19, 1577. (b) Mustafa, A.; Asker, W.; Harhash, A. H.; Kassab, N. A. L.; *Tetrahedron*, **1964**, 20, 1133. (c) Renard, D.; Rezaei, H.; Zard, S. Z.; *Synlett*, **2002**, 8, 1257.

⁵⁸ Nishiwaki, T.; Kondo, K.; *J. Chem. Soc., Perkin Transactions I*, **1972**, 90.

⁵⁹ Batra, S.; Akhtar, M. S.; Seth, M.; Bhaduri, A. P.; *J. Heterocyclic Chem.*, **1990**, 27, 337.

⁶⁰ Makisumi, Y.; Sasatani, T.; *Tetrahedron Lett.*, **1969**, 10, 7, 543.

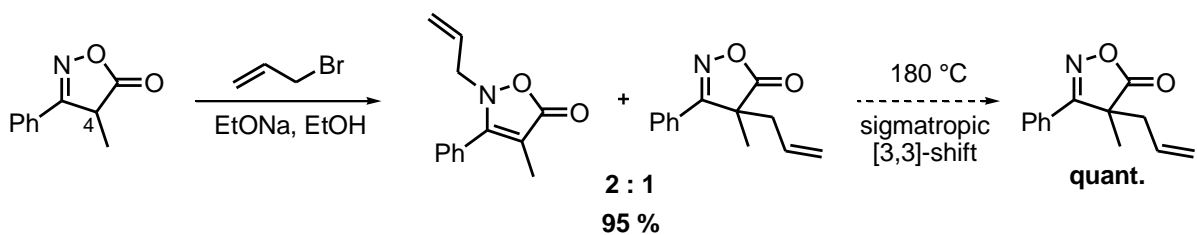

Scheme 1.28: Example of the difficulty of direct selective alkylation of 5-isoxazolones on position 4.

It is worth mentioning that alkylation of such compounds can be beautifully observed in light of the Curtin–Hammet principle⁶¹, which states that for a reaction which has a pair of reactive intermediates or reactants that interconvert rapidly, each going irreversibly to a different product, the product ratio will depend only on the difference in the free energy of the transition state (*i. e.* the reaction rates) going to each product and not on the equilibrium constant between the intermediates (scheme 1.29).

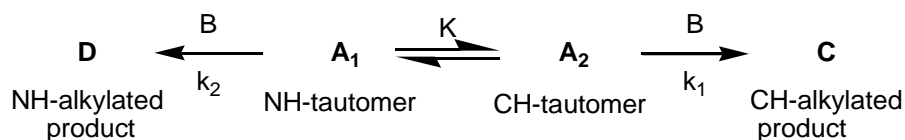

Scheme 1.29: Alkylation of isoxazolones can be seen as a perfect example falling in the Curtin-Hammett principle scenario.

1.2.4 Isoxazolones as masked alkynes: Literature background

1.2.4.1 Flash Vacuum Pyrolysis

Thermal decomposition of alkylidene Isoxazolones under flash vacuum pyrolysis (FVP) conditions have been previously described to furnish acetylene derivatives, which decompose to nitriles, CO₂ and vinylidenes⁶². Although excellent yields can be attained for the synthesis of simple acetylenes and this approach being also applicable to the synthesis of aminoacetylenes ($Z = R^2NHCH$ or R^2R^3NCH)⁶³, isocyanides ($Z = R^2N$)⁶⁴, isocyanamines ($Z =$

⁶¹ Side Reactions in Organic Synthesis: A Guide to successful Synthesis Design. F. Z. Dörwald. **2005**, Wiley-VCH, pp. 13-15.

⁶² (a) Wentrup, C.; Reichen, W.; *Helv. Chim. Acta.*, **1976**, 59, 2615. (b) Wentrup, C.; Winter, H.-W., *Angew. Chem. Int. Ed.*, **1978**, 17, 609.

⁶³ Winter, H.-W.; Wentrup, C.; *Angew. Chem. Int. Ed.*, **1980**, 19, 720.

⁶⁴ Wentrup, C.; Stutz, U.; Wollweber, H.-J.; *Angew. Chem. Int. Ed.*; **1978**, 17, 688.

RNHN)⁶⁵ and organic fulminates (Z = RON)⁶⁶, this procedure is clearly inappropriate for more sensitive substrates, due to the harsh conditions (scheme 1.30).

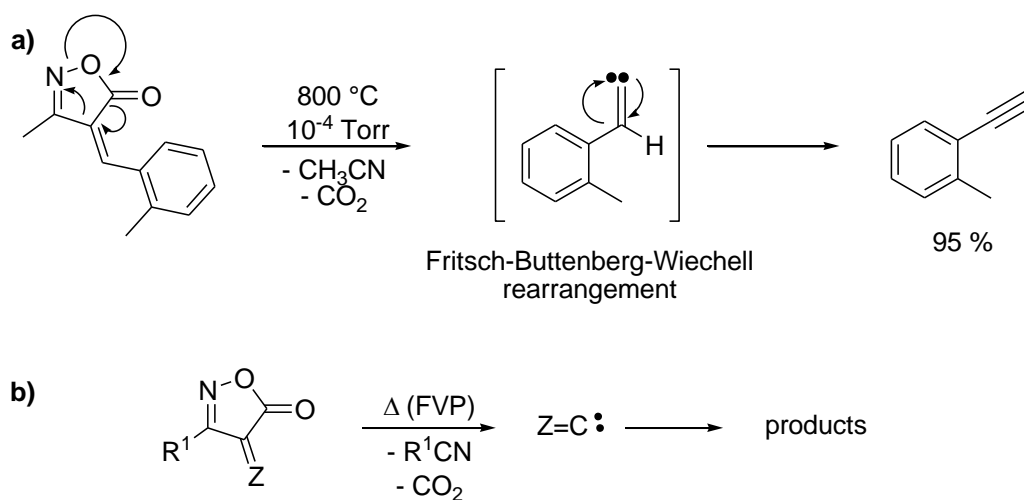

Scheme 1.30: a) An example of a simple alkyne synthesis through flash vacuum pyrolysis using alkylidene isoxazolones. b) Application of the principle of decomposition of isoxazolones through FVP is also possible to similar substrates, giving rise for example to aminoacetylenes (Z = R²R³NCH), isocyanides (Z = R²N), isocyanoamines (Z = R²NHN) and organic fulminates (Z = RON).

1.2.4.2 Nitrosative Cleavage

Based on the earlier work of Abidi⁶⁷, our laboratory identified the evolution of isoxazolones as a possible entry to the late intermediate of this alkylation process⁶⁸. Optimization of the reaction conditions implicated the use of sodium nitrite, ferrous sulfate, acetic acid and water⁶⁹. Sodium nitrite in aqueous acetic acid hydrolyzes to produce NO⁺, which can react either on the CH- or NH-isoxazolone tautomers, **1.9** or **1.10**, respectively, producing C-nitroso **1.11** or N-nitroso **1.12** adducts, respectively. Under reaction conditions,

⁶⁵ (a) Reichen, W.; Wentrup, C.; *Helv. Chim. Acta*, **1976**, 59, 2618. (b) Wentrup, C.; Winter, H.-W., *J. Org. Chem.*, **1981**, 46, 1045.

⁶⁶ Wentrup, C.; Gerecht, B.; Laqua, D.; Briehl, H.; Winter, H.-W.; Reisenauer, H. P.; Winnerwischer, M.; *J. Org. Chem.*, **1981**, 46, 1046.

⁶⁷ (a) Abidi, S. L.; *J. Chem. Soc., Chem. Comm.*, **1985**, 1222. (b) Abidi, S. L.; *Tetrahedron Lett.*, **1986**, 27, 267. (c) Abidi, S. L.; *J. Org. Chem.*, **1986**, 51, 2687.

⁶⁸ Zard, S. Z.; *Chem. Comm.*, **2002**, 1555.

⁶⁹ (a) Boivin, J.; Elkaim, L.; Ferro, P. G.; Zard, S. Z.; *Tetrahedron Lett.*, **1991**, 32, 39, 5321. (b) Elkaim, L.; *PhD Thesis*, Ecole Polytechnique, **1992**, pp 97-134.

these intermediates can undergo homolytic cleavage forming the persistent radical nitric oxide **1.13** and the resonance stabilized tertiary radical **1.14**. Nitric oxide is a gas and eventually escapes the reaction medium, leaving no other choice to radicals **1.14** but to dimerize (**1.15**). In order to suppress this competitive pathway, ferrous sulfate is added to the reaction mixture, because it turns out that FeSO_4 in the presence of sodium nitrite and acetic acid react to produce nitric oxide **1.13** *in situ*^{69b} (Scheme 1.31).

Because this is a reaction with radical intermediates, it goes without saying about the importance of thoroughly degassing the solutions beforehand. Otherwise, oxidation of nitric oxide **1.13** to nitrogen dioxide radical **1.16** by remaining oxygen can afford by-products, such as **1.17**. In the same way, the N-nitro compound **1.18** is also expected to form, but because the N-N bond is reasonably weak (dissociation energy of *ca.* 60 kcal.mol⁻¹, vs 105 kcal.mol⁻¹ for O-H, 108 kcal.mol⁻¹ for N-H, 105 kcal.mol⁻¹ for C-H bonds)⁷⁰, the reaction is expected to be reversible, due to the ease of the homolytic cleavage⁷¹ (this consideration is also valid for compound **1.12**).

Formation of the C-nitroso compound **1.11** should also be anticipated to be present in the reaction medium, albeit isolation of such a compound or derivatives thereof were never confirmed experimentally. This is probably because the formation of tertiary nitroso compounds is expected to be reversible⁷².

⁷⁰ (a) Szwarc, M.; *Proceedings of the royal society of London. Series A, Mathematical and Physical Sciences*, **1949**, 198, 1053, 267. (b) Blanksby, S.; Ellison, G. B.; *Acc. Chem. Res.*, **2003**, 36, 255.

⁷¹ Geiser, G.; Huber, J. R.; *Helv. Chim. Acta.*, **1981**, 64, 989.

⁷² Nitric Oxide Donors: for pharmaceutical and biological applications. Editors: Wang, P. G.; Cai, T. B.; Tanigushi, N.; Wiley-VCH, **2005**, pp. 55-72.

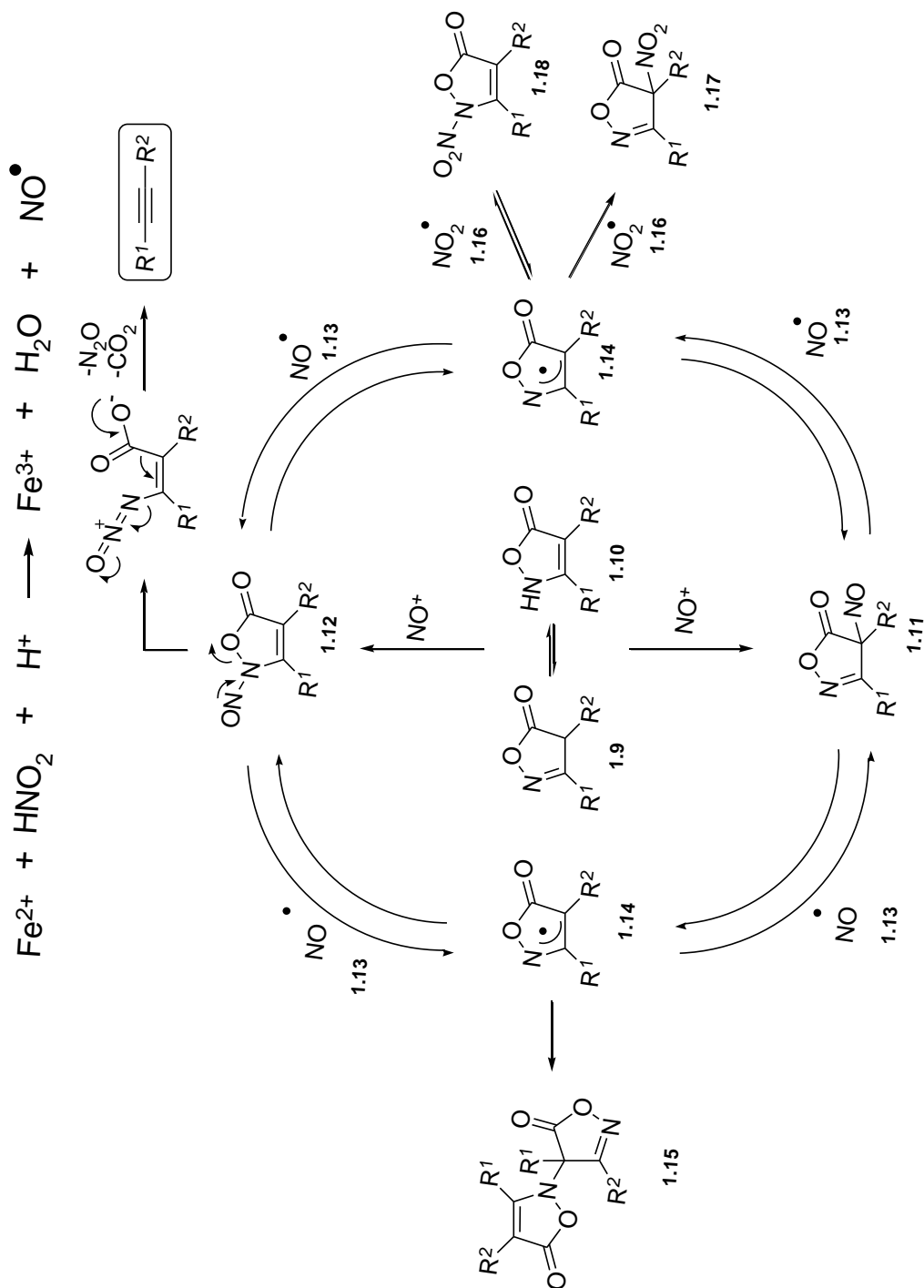

Scheme 1.31: Mechanism proposed for the nitrosative cleavage of isoxazolones with the formation of possible by-products avoided

From what we discussed above, one can see all isoxazolone derivatives shown in schemes 1.26 and 1.27 as potential precursors to alkynes. In light of these findings, further studies were carried in our laboratory employing different strategies and nucleophiles to alkylidene isoxazolones. Some examples extracted from previous reports^{73,74} can be seen below (scheme 1.32):

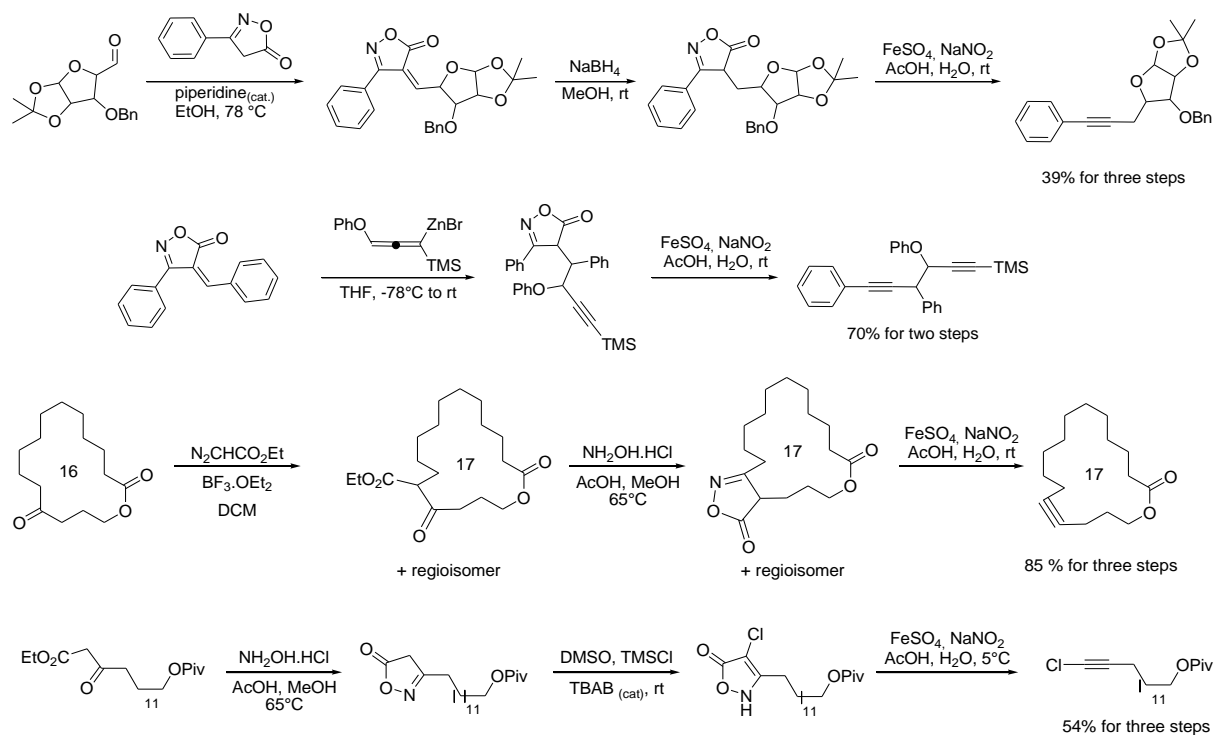

Scheme 1.32: Examples of alkynes synthesized in previous works performed in our laboratory.

1.3 RESULTS AND DISCUSSION

1.3.1 The Initial idea

During the work of this thesis, we were interested in the use of isocyanides **1.20** as nucleophiles to alkylidene isoxazolones **1.19**, allowing in this way, upon hydrolysis of the expected intermediate **1.21**, the access to isoxazolones bearing an amide moiety **1.22**.

⁷³ (a) See ref. 53 (b) See ref. 54 (c) See ref. 57c

⁷⁴ (d) Boivin, J.; Huppé, S.; Zard, S. Z.; *Tetrahedron Lett.*, **1995**, 36, 5737.

Further nitrosative cleavage of the isoxazolone ring would then afford the desired 3-alkynylamide **1.23** (scheme 1.33).

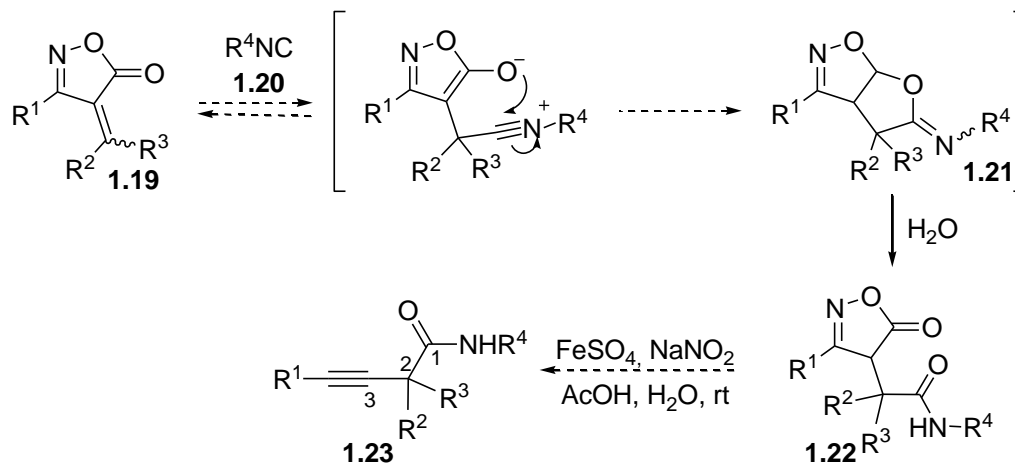

Scheme 1.33: Envisioned synthesis of 3-alkynylamides.

The synthesis of alkylidene isoxazolones **1.19** was accomplished through a Knoevenagel condensation of 5-isoxazolones **1.24** with ketones and aldehydes (scheme 1.34). Different aldehydes, such as cyclopropyl carboxaldehyde, thiophene 2-carboxaldehyde and *p*-tolualdehyde; and ketones, such as cyclopentanone and 2-propanone could be condensed to isoxazolones bearing a phenyl ring, an ester group, a benzylated alcohol and a homoallyl chain.

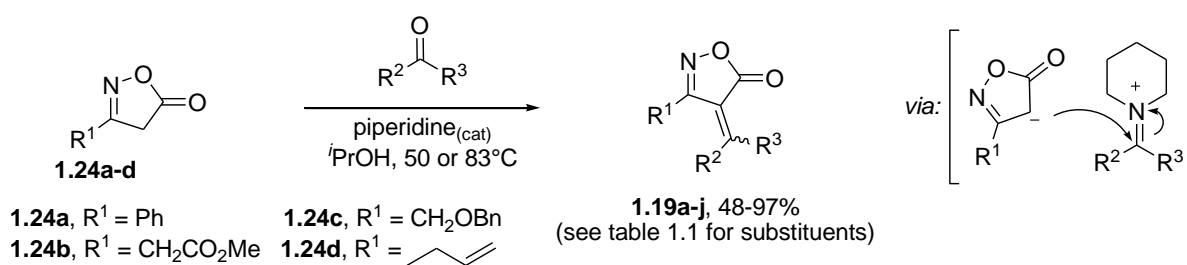

Scheme 1.34: The Knoevenagel condensation of isoxazolones and aldehydes or ketones.

As for the isocyanides, commercially available *tert*-butyl isocyanide **1.20a** gave generally the best results. The addition of freshly prepared isocyanoacetate **1.20b** and

benzyl isocyanide **1.20c** tended to afford significant lower yields. Isocyanides were synthesized in a two steps sequence⁷⁵ (scheme 1.35):

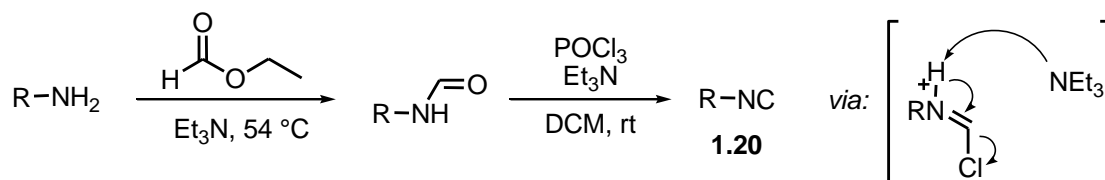

Scheme 1.35: Two-steps sequence employed for the synthesis of isocyanides. The reaction mechanism is believed to pass by an iminium-chloride intermediate typical for other dehydration reactions using POCl₃, such as the Vilsmeier-Haack reaction.

All the intermediates alkylidene isoxazolones **1.19a-j**, amides **1.22a-n** and α -branched alkynes **1.23a-n** synthesized in this work are indicated in table 1.1.

isoxazolone 1.19	isocyanide 1.20	amide 1.22	alkynylamide 1.23
<p>1.19a 85%</p>	<p>^tBuNC 1.20a</p>	<p>1.22a 100%</p>	<p>1.23a 92%</p>
<p>1.19b 97%</p>	<p>1.20a EtO₂CCH₂NC 1.20b PhCH₂NC 1.20c</p>	<p>1.22b R = ^tBu-, 58%</p> <p>1.22c R = EtO₂CCH₂-, 38%</p> <p>1.22d R = PhCH₂-, 57%</p>	<p>1.23b R = ^tBu-, 87%</p> <p>1.23c R = EtO₂CCH₂-, 81%</p> <p>1.23d R = PhCH₂-, 90%</p>
<p>1.19c 64%</p>	<p>1.20a</p>	<p>1.22e 24%</p>	<p>1.23e 92%</p>

⁷⁵ Park, W. K. C.; Auer, M.; Jaksche, H.; Wong, C.-H.; *J. Am. Chem. Soc.*, **1996**, 118, 10150.

isoxazolone 1.19	isocyanide 1.20	amide 1.22	alkynylamide 1.23
 1.19d 56%	1.20a	 1.22f 58%	 1.23f 76%
 1.19e 52%	1.20a	 1.22g 51%	 1.23g 71%
 1.19f 48%	1.20a	 1.22h 100%	 1.23h 9%
 1.19g 72%	1.20a	 1.22i 56%	 1.23i 15%
 1.19h 77%	1.20a	 1.22j 72%	 1.23j 47%
 1.19i 70%	1.20a 1.20c	 1.22k R = ^t Bu-, 89% 1.22l R = PhCH ₂ -, 30%	 1.23k R = ^t Bu-, 94% 1.23l R = PhCH ₂ -, 60%
 1.19j 61%	1.20a 1.20b	 1.22m R = ^t Bu-, 60% 1.22n R = EtO ₂ CCH ₂ -, 49%	 1.23m R = ^t Bu-, 68% 1.23n R = EtO ₂ CCH ₂ -, 70%

Table 1.1: 3-Alkynylamides synthesized during this work

Concerning the alkynylation step, we anticipated the possible formation of *N*-nitrosoamides by the nitrosation of the amide group under reaction conditions⁷⁶. Nevertheless, this was expected to be reversible⁷⁷, and it proved to have no consequence on reaction yields. For all compounds tested, yields were generally good, except for compounds **1.23h** and **1.23i**. This is possibly caused by the isomerization of the alkyne moiety to the allene form, due to the increased acidity of α -hydrogens to the carbonyl group. This ultimately generates a highly reactive Michael acceptor and creates the opportunity to diverse degradation pathways (scheme 1.36).

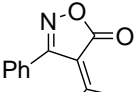
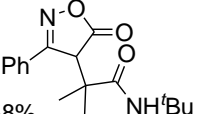
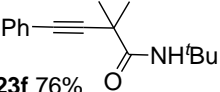
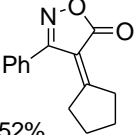
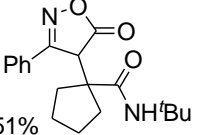
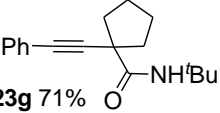
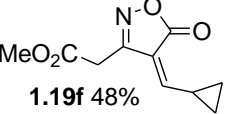
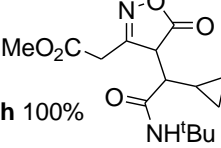
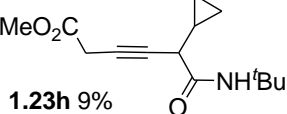
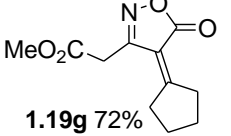
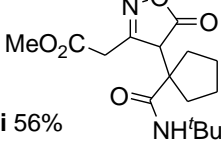
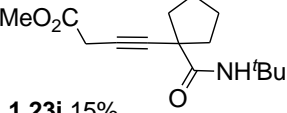
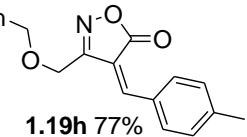
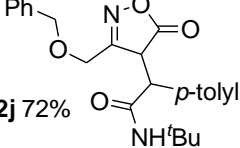
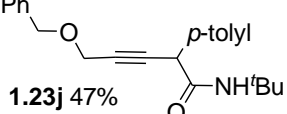
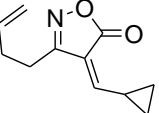
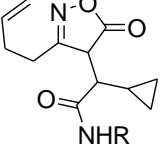
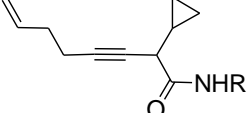
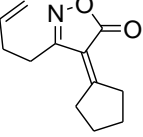
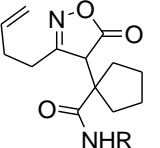
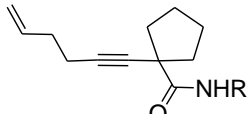
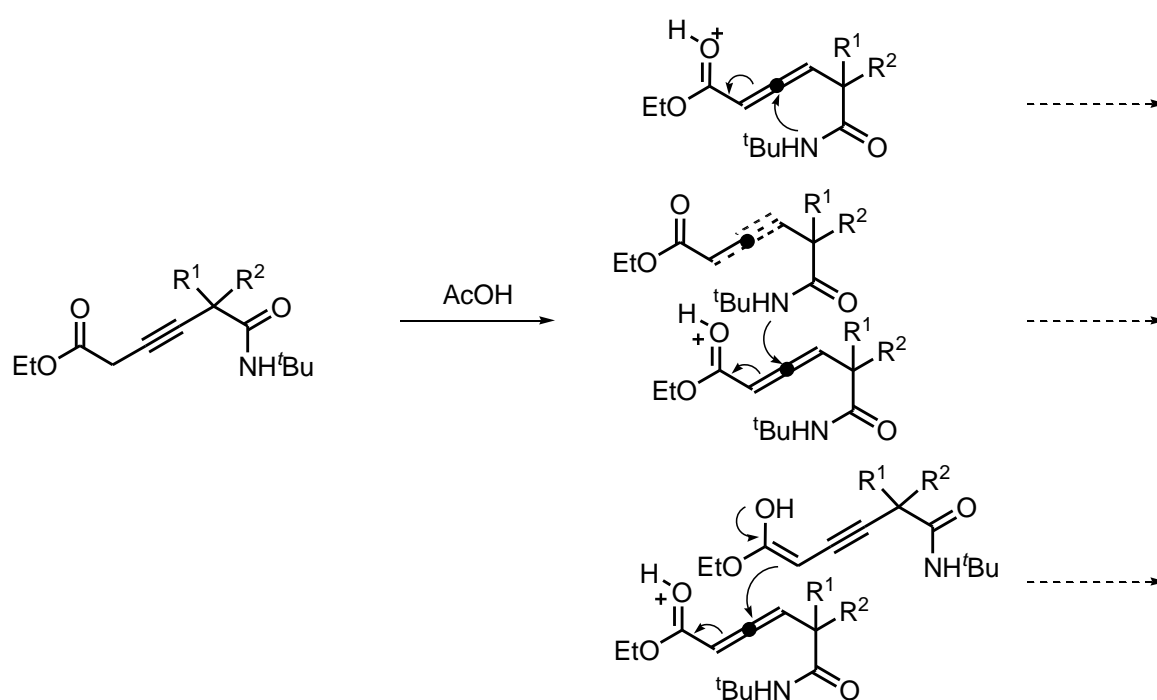

Scheme 1.36: Examples of possible degradation pathways for compounds **1.23h** and **1.23i**, hypothesized from a common allene precursor, which can ultimately even culminate in oligomerization products.

Also noteworthy is the fact that to all alkylidene isoxazolones derived from ketones **1.23f**, **-g**, **-i**, **-m** and **-n**, nitro compounds **1.17** were observed and isolated in some cases. This is a mechanistically intriguing observation, since the corresponding nitro products coming from the alkylidene isoxazolones derived from aldehydes were never observed. If

⁷⁶ (a) see ref. 71. For other examples, see: (b) Glatzhofer, D. T.; Roy, R. R.; Kossey, K. N.; *Org. Lett.*, **2002**, 4, 14, 2349. (c) Darbeau, R. W.; White, E. H.; *J. Org. Chem.*, **2000**, 65, 1121.

⁷⁷ See ref. 72, page 59.

oxygen is still present at the medium to a minor extent, promoting the oxidation of nitrous oxide **1.13** to nitro radical **1.16**, this would be expected to be approximately true to all other experiments as it would be associated to the inefficiency of the method chosen to degas the reaction solvent. Consequently, one can assume that the radical formed in the α -position to a quaternary carbon in intermediates of type **1.14** are more nucleophilic than tertiary ones (derived from aldehyde condensed isoxazolones) and the hindrance promoted by the α -quaternary carbon does not prevent the by-product formation of **1.17f**, **-g**, **-i**, **-m** and **-n** (scheme 1.37).

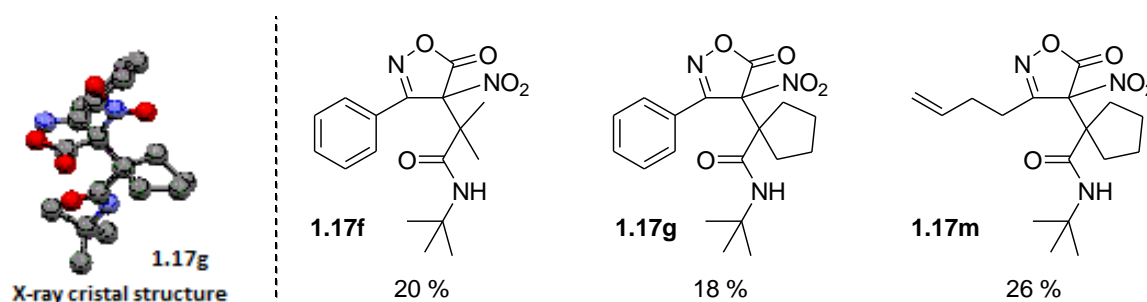

Scheme 1.37: By-products isolated during the alkyne synthesis of **1.23f**, **-g** and **-m**.

Once we have synthesized these alkynylamides **1.23a-n**, we were interested in typical gold cyclization products⁷⁸. It was with great disappointment, that we observed the inertness of these substrates to all the reaction conditions tried, with only starting material recovered (Scheme 1.38)⁷⁹.

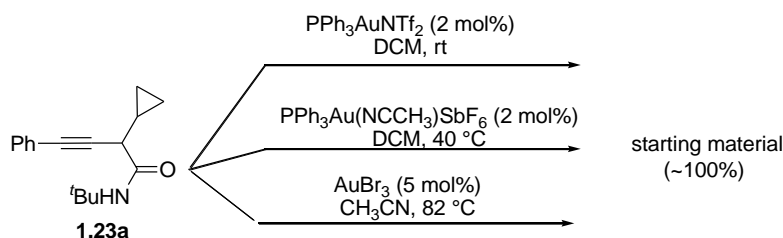

Scheme 1.38: Reaction conditions tried for gold catalyzed cyclo-isomerizations.

⁷⁸ See chapter 2 of this thesis for references on gold chemistry.

⁷⁹ For two examples of similar findings in close-related cyclizations using gold catalysts, see: (a) Bian, M.; Yao, W.; Ding, H.; Ma, C.; *J. Org. Chem.*; **2010**, 75, 269. (b) Fustero, S.; Fernández, B.; Bello, P.; del Pozo, C.; Arimitsu, S.; Hammond, G. B.; *Org. Lett.*, **2007**, 9, 21, 4251.

Next, we turned our attention to the use of *N*-iodosuccinimide (NIS), whose strong electrophilicity has already been taken advantage of in many past opportunities⁸⁰. Under classic conditions, namely **1.23a** with NIS (1.1 equiv.) and acetone at room temperature, we found the clean but incomplete conversion of substrate **1.23a** to iodo-cyclized product **1.25a**, with the reaction crude containing a 1:1 mixture of **1.23a**:**1.25a** (isolated yield of 45% for **1.25a**). In our next attempt, 2.2 equiv. of NIS were used and we were delighted to observe **1.25a** as the only product formed and an isolated yield of 72%. Nevertheless, the ¹H NMR signals of the aromatic ring from **1.25a** were splitted, suggesting a chiral environment in the proximity of the phenyl ring, which was not in agreement with the initially expected cyclized product **1.26**. The X-ray crystal structure of **1.25a** revealed actually that a molecule of water had been added, undoubtedly coming from the wet acetone employed (scheme 1.39).

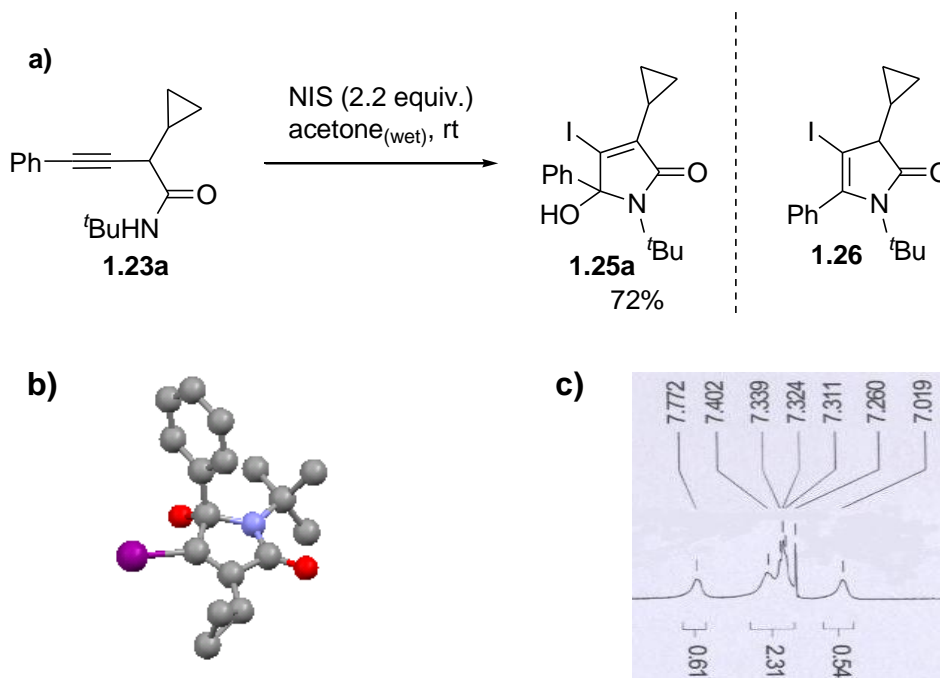

Scheme 1.39: **a)** NIS-promoted cyclization reaction with 3-alkynylamides. The obtained product **1.25a**, and the original imagined cyclization product **1.26**. **b)** X-ray cristal structure of compound **1.25a**. **c)** ¹H NMR splitted signals of the aromatic ring of compound **1.25a** (the

⁸⁰ For some cyclization examples, see: (a) Diaba, F.; Ricou, E.; Bonjoch, J.; *Org. Lett.*; **2007**, 9, 14, 2633. (b) Fischer, D.; Tomeba, H.; Pahadi, M. K.; Patil, N. T.; Yamamoto, Y.; *Angew. Chem. Int. Ed.*, **2007**, 46, 4764. (c) Li, J.; Fu, C.; Chai, G.; Ma, S.; *Adv. Synth. Catal.*, **2008**, 350, 1376.

broad signals are due to the congested environment and probably the reason for the inaccurate integrations, which should be 1:3:1).

Next, we envisioned that other nucleophiles such as methanol and allyl alcohol could also be used. To compete with the water dissolved in the acetone, a large excess of alcohol was employed (10 equiv.). In cases where the utilization of a not readily available alcohol is envisaged, further optimization is necessary (such as changing the reaction solvent) but this was not attempted. Furthermore, other nucleophiles can also prove suitable, but were not investigated. The results are summarized below (table 1.2).





alkynylamide	nucleophile	cyclized product
 <p>1.23a</p>	MeOH	 <p>1.25b 76%</p>
 <p>1.23a</p>		 <p>1.25c 72%</p>
 <p>1.23d</p>	H ₂ O	 <p>1.25d 68 %</p>
 <p>1.23l</p>	MeOH	 <p>1.25e 70 %</p>

Table 1.2 : Synthesis of 1,5-dihydropyrrol-2-ones based on the NIS-cyclization reaction of 3-alkynylamides.

The proposed mechanism for this cyclization reaction involves alkyne activation through iodonium intermediate **1.27**, followed by ring closure, which affords intermediate **1.26**. But the reaction does not stop at this point. As already mentioned, 1 equiv. of NIS

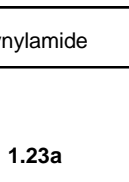
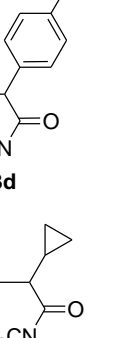
furnished a 1:1 mixture of **1.23**:**1.25**, which shows the greater nucleophilicity of **1.26** when compared to **1.23** toward NIS. Thus, the reaction goes further and a second iodonium intermediate, represented by the mesomeric form **1.28**, is rapidly quenched by a nucleophile present in the medium, *i. e.* either by water or by an alcohol molecule, to after HI elimination, produce the final compound **1.25** (scheme 1.40).

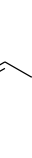

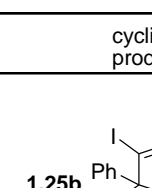
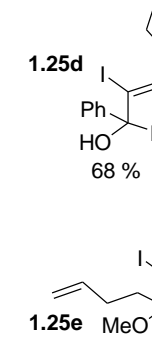
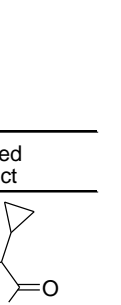
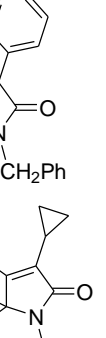
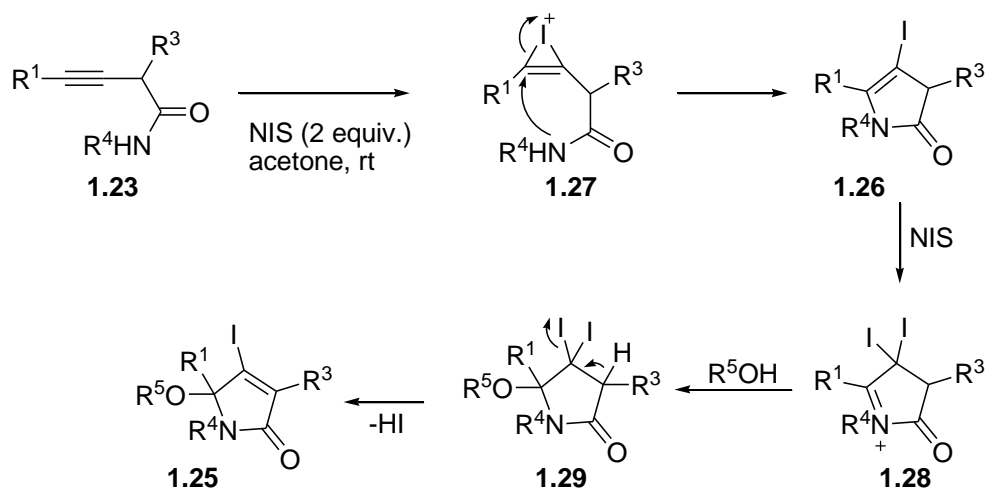
Scheme 1.40: Proposed mechanism for the NIS-promoted ring closure.

Because NIS is such a strong electrophile, an alternative mechanism could also be imagined with the iodination of the nitrogen atom⁸¹ of **1.23**, followed by nucleophilic attack from the alkyne moiety, which would also culminate in intermediate **1.26**. But this seems unlikely since alkynes tend to behave as electrophiles and not nucleophiles (due to both relatively low LUMO and HOMO orbitals). Furthermore, formation of a dihalide molecule followed by HX (X = halogen) elimination such as the one suggested in **1.29**, has already been described in the literature in a similar Pd-mediated cyclization event from 2,2-difluoropropargylic amides to give the corresponding fluoro hemiaminals⁸².

It is difficult to say at this point if this nitrogen promoted ring-closure is under kinetic or thermodynamic control (or both). Thermodynamic control would mean reversibility of the

⁸¹ For examples of heteroatom halogenations using NBX, (X = Br, I), see: N-Br formation (a) Wang, Z.; Zhang, Y.; Fu, H.; Jiang, Y.; Zhao, Y.; *Org. Lett.*, **2008**, 10, 9, 1863. O-I formation (b) Castanet, A.-S.; Colobert, F.; Broutin, P. E.; *Tetrahedron Lett.*, **2002**, 43, 5047.

⁸² Arimitsu, S.; Bottom, R. L.; Hammond, G. B.; *J. Fluorine Chem.*, **2008**, 129, 1047.

cyclization step. It is also interesting to note that iodolactonization of unsaturated amides often leads to lactones rather than lactams⁸³.

Furthermore, 5-hydroxypyrrol-2(5H)-ones of type **1.30** and their alkylidenepyrrolinones derivatives **1.31** exhibit a wide range of intriguing biological activities⁸⁴. Compound **1.30a** for example was found in the urine of patients with acute intermittent porphiria and its presence has been linked to psychiatric disorders^{84a}. Compound **1.30** (with R⁵ = H, alkyl) can be dehydrated upon reaction with a base (e.g. EtONa)^{84b} or acid (e.g. TFA)⁸⁵ to afford **1.31**. Such compounds, as **1.31a** for example, are remarkably efficient as sun-screens, as their maximum UV adsorbances are in the range of sun protecting compounds 290-346 nm^{84b} (Figure 1.2).

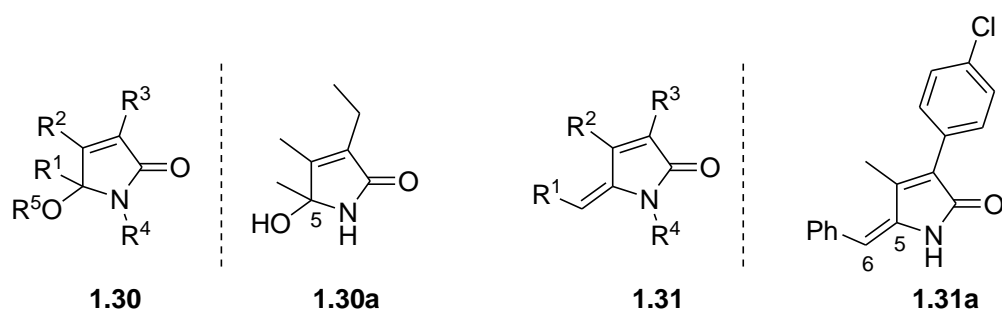

Figure 1.2: Examples of biological active 5-hydroxypyrrol-2(5H)-ones **1.30** and their derivatives alkylidenepyrrolinones **1.31**.

A noteworthy aspect of this transformation is the chemoselectivity for the *N*-cyclization product, without any trace of *O*-cyclized compound. This selectivity can possibly be explained using the HSAB (hard-soft acid-base) theory. NH is a softer nucleophile which should react with the softer I⁺-alkyne complex. Conversely, the oxygen from the amide carbonyl is a harder nucleophile and an alkyne moiety activated by a harder electrophile, such as a M⁺-alkyne complex, should afford the *O*-cyclized compound.

⁸³ Review: Robin, S.; Rousseau, G.; *Tetrahedron*, **1998**, 54, 13681.

⁸⁴(a) Woodridge, T. A.; Lightner, D. A.; *J. Heterocycl. Chem.*, **1977**, 14, 1283. (b) Anselmi, C.; Camparini, A.; Scotton, M.; *J. Heterocyclic Chem.*, **1983**, 20, 687.

⁸⁵ Snider, B. B.; Neubert, B. J.; *J. Org. Chem.*, **2004**, 69, 8952.

In this regard, two very appealing examples from the literature are the I₂-mediated N-cyclization⁸⁶ and the Ag⁺-mediated O-cyclization⁸⁷ of *o*-(1-alkynyl)benzamides (scheme 1.41).

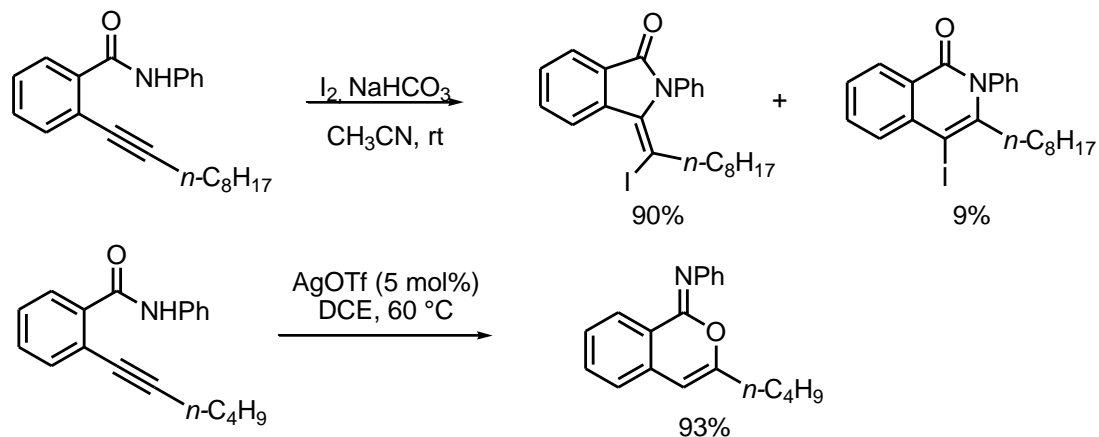

Scheme 1.41: Almost identical compounds are capable of producing chemoselective different E⁺-cyclized products depending on the nature of the electrophilic compound employed to activate the alkyne.

Among an enlisting number of transition metal-catalyzed transformations amenable to vinyl iodide species, one example of a Heck reaction was carried out with molecule **1.25c**, generating a third cycle, thus demonstrating the power of coupling reactions to create complexity (scheme 1.42).

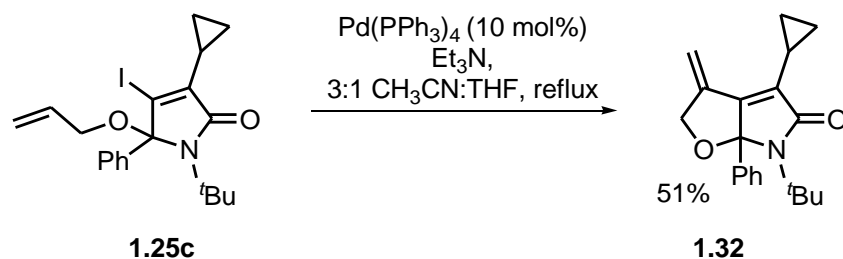

Scheme 1.42: The intramolecular Heck reaction of compound **1.25c** affords the tricycle **1.32** corresponding to a 5-*exo* trig cyclization.

⁸⁶ Yao, T.; Larock, R. C.; *J. Org. Chem.*; **2005**, 70, 1432.

⁸⁷ Bian, M.; Yao, W.; Ding, H.; Ma, C.; *J. Org. Chem.*, **2010**, 75, 269.

1.4 CONCLUSION

Alkylidene isoxazolones are commonly employed in Michael additions using multiple nucleophiles. In the work described in this chapter, we reported the first addition of isocyanides as such nucleophiles. The addition product is hydrolyzed to generate amide moieties. Nitrosative cleavage of the isoxazolones formed affords 3-alkynylamides, which can be cyclised in the presence of N-iodosuccinimide to give access to 1,5-dihydropyrrol-2-ones.

The methodology developed here not only represents a new way of synthesizing 3-alkynylamides, but also further extends the scope of possible nucleophiles to alkylidene isoxazolones, whereas others may still prove suitable.

1.5 PERSPECTIVES AND FURTHER DEVELOPMENTS

Further development of the chemistry of isoxazolones to access various substituted alkynes, whose majority are α -branched ones, can be envisaged. For instance, the addition of aromatics to alkylidene isoxazolones has already been described^{57a,b} but very few examples are reported. In addition, methods to propargylate arenes are also relatively scarce in the literature⁸⁸. Furthermore, the biological relevance and the rich chemistry of indoles⁸⁹ make these molecules important building blocks, whose new propargylation methods should constitute a worth-while endeavor (scheme 1.43).

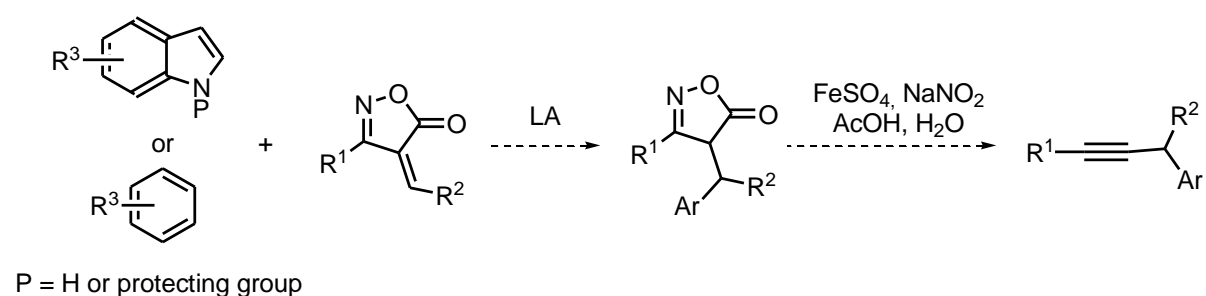

Scheme 1.43: A possible route envisioned to construct propargylated-arenes.

⁸⁸ Many of the methods available in the literature are S_N2 -type displacement reactions. For examples of other methods, see: (a) Ochiai, M.; Ito, T.; Takaoka, Y.; Masaki, Y.; *J. Am. Chem. Soc.*, **1991**, 113, 1319. (b) Li, C.; Wang, J.; *J. Org. Chem.*, **2007**, 72, 7431.

⁸⁹ Bandini, M.; Eichholzer, A.; *Angew. Chem. Int. Ed.*, **2009**, 9608.

Some of the Lewis acids described in the conjugate addition to α, β -enones and possibly applicable to Michael additions to alkylidene isoxazolones are $\text{BF}_3 \cdot \text{OEt}_2$, $\text{Yb}(\text{OTf})_3$, InBr_3 , AuCl_3 ⁸⁹ and ScCl_3 ⁹⁰ or HOTf (Brønsted acid)⁹¹. The zinc dinuclear catalyst developed by Trost's group presented in one of the introductory sections of this chapter (scheme 1.12b) can also be envisaged for an asymmetric version of conjugate addition⁹².

Other interesting nucleophiles are silyl enol derivatives⁹³ and xanthates⁹⁴, which to the best of our knowledge, have not been previously reported in the literature, and could be of great synthetic value (Figure 1.3).

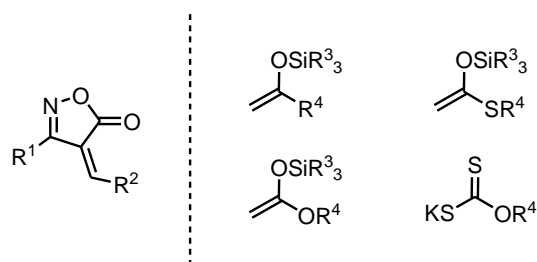

Figure 1.3: Possible nucleophiles in conjugate addition to alkylidene isoxazolones: silyl enol ethers and xanthates.

The formation of quaternary carbons upon conjugate additions also represents a great opportunity as a testing ground for asymmetric 1,4-additions. Due to the already well-established success of certain ligands and protocols to asymmetric conjugate additions, their usage can also be possibly envisioned to be effective in the asymmetric catalyzed addition of nucleophiles to alkylidene isoxazolones. Two examples of privileged ligands useful in conjugate additions (and other important organic reactions, see below) are bis(oxazoline) and Salen complexes (Figure 1.4)⁹⁵.

⁹⁰ Kawatsura, M.; Aburatani, S.; Uenishi, J.; *Tetrahedron*, **2007**, 63, 19, 4172.

⁹¹ Zhang, H. B.; Liu, L.; Liu, Y. L.; Chen, Y. J.; Wang, J.; Wang, D.; *Synthetic Comm.*, **2007**, 37, 2, 173.

⁹² The selectivity obtained for the pyrrol ring by Trost was the C-2 alkylation (and not C-3 which is generally the expected product): Trost, B. M.; Müller, C.; *J. Am. Chem. Soc.*, **2008**, 130, 2438.

⁹³ For examples of silyl enol ethers and silyl ketene acetals in conjugate additions, see: (a) Evans, D. A.; Rovis, T.; Kozlowski, M. C.; Tedrow, J. S.; *J. Am. Chem. Soc.*, **1999**, 121, 1994. (b) Evans, D. A.; Scheidt, K. A.; Johnston, J. N.; Willis, M.; *J. Am. Chem. Soc.*, **2001**, 123, 4480. (c) Mizukami, S. Kihara, N.; Endo, T.; *Tetrahedron Lett.*, **1993**, 34, 46, 7437. (d) Minowa, N.; Mukaiyama, T.; *Chem. Lett.*, **1987**, 1719.

⁹⁴ Review: Zard, S. Z.; *Angew. Chem. Int. Ed.*, **1997**, 36, 672. For examples of xanthate salts in conjugate additions, see: (b) Binot, G.; Quiclet-Sire, B.; Saleh, T.; Zard, S. Z.; *Synlett*, **2003**, 3, 382.

⁹⁵ (a) Yoon, T. P.; Jacobsen, E. N.; *Science*, **2003**, 299, 1691. (b) Johnson, J. S.; Evans, D. A.; *Acc. Chem. Soc.*, **2000**, 33, 325 (c) Schinnerl, M.; Seitz, M.; Kaiser, A.; and Reiser, O.; *Org. Lett.*, **2001**, 3, 26, 4259.

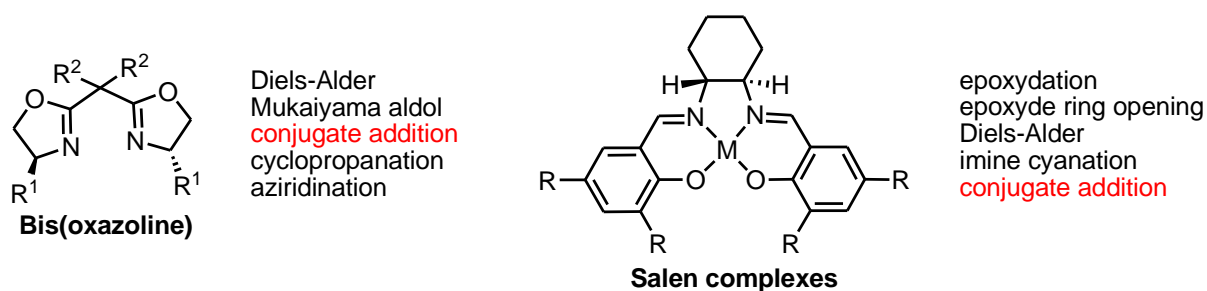
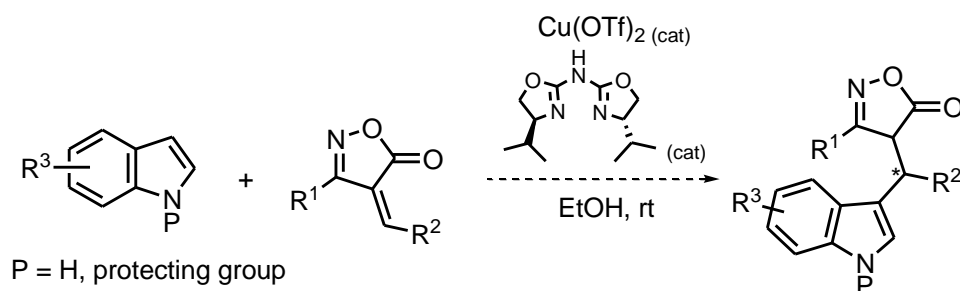

Figure 1.4: Examples of two possible competent ligands in the Michael addition to alkylidene isoxazolones, bis(oxazoline) and Salen complexes.

Azabis(oxazolines) ligands, a variant of the bis(oxazoline) ligands (see below), can be also potentially useful in Michael additions of indoles to alkylidene isoxazolones⁹⁶.



Scheme 1.44: A potential route to enantio-enriched substituted 3-propargyl indole precursors.

Another option to a conjugate asymmetric addition is the use of diorganozinc reagents due to their compatibility with many functional groups. Only a few diorganozinc R_2Zn reagents are commercially available, being Et_2Zn by far the most used. Nevertheless, these reagents can be readily prepared by $\text{RI}/\text{Et}_2\text{Zn}$ exchange or by hydroboration/transmetalation sequence (scheme 1.45)⁹⁷.

⁹⁶ Rasappan, R.; Hager, M.; Gissibl, A.; Reiser, O.; *Org. Lett.*, **2006**, 8, 26, 6099.

⁹⁷ (a) Alexakis, A.; Bäckvall, J. E.; Krause, N.; Pàlmies, O.; Diéguez, M.; *Chem Rev.*, **2008**, 108, 2796. (b) Feringa, B. L.; *Acc. Chem. Res.*, **2000**, 33, 346.

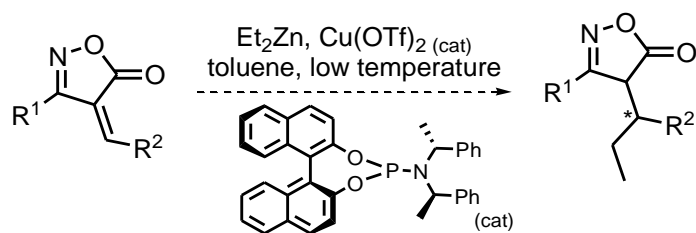

Scheme 1.45: A potential route to access α -branched chiral alkyne precursors.

Another possible extension of the alkyne synthesis developed in this chapter can be possibly envisaged to allenes. As previously seen in the introduction of this chapter, the Mannich reaction has already been reported with isoxazolones. One could possibly think that under the nitrosative conditions of the alkynylation step, further isomerization could take place, possibly mediated by the iron salts (Fe^{2+} and Fe^{3+}) present in the reaction mixture or by an additive eventually added, in analogy to the Crabbé reaction and variations thereof⁹⁸. Hopefully, the nitrosation of the amine moiety in the case of propargylamines showed in scheme 1.46, would also activate them as leaving groups towards isomerization⁹⁹. Subsequent extension to the asymmetric synthesis of allenes would directly follow using proline derivatives¹⁰⁰ in the place of the diisopropylamine (scheme 1.46).

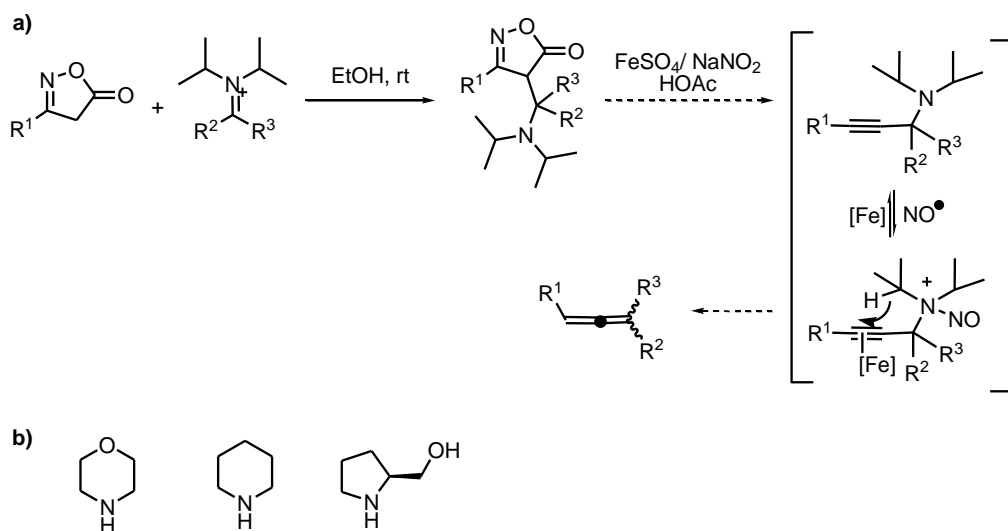

⁹⁸ (a) Crabbé, P.; Fillion, H.; André, D.; Luche, J.-L.; *J. Chem. Soc. Chem. Comm.*, **1979**, 859. (b) Kuang, J.; Ma, S.; *J. Org. Chem.*; **2009**, 74, 1763. (c) Kuang, J.; Ma, S.; *J. Am. Chem. Soc.*, **2010**, 132, 1786.

⁹⁹ For an example of such reactivity, see: Loeppky, R. N.; Outram, J. R.; Tomasik, W.; Faulconer, J. M.; *Tetrahedron Lett.*, **1983**, 24, 40, 4271.

¹⁰⁰ (a) Lo, V. K.-Y.; Wong, M. K.; Che, C.-M.; *Org. Lett.*, **2008**, 10, 3, 517. (b) Lo, V. K.-Y.; Zhou, C.-Y.; Wong, M.-K.; Che, C.-M.; *Chem. Comm.*, **2010**, 46, 213.

Scheme 1.46: **a)** Use of isoxazolones as a possible entry to allenes. **b)** Other successful secondary amines employed in related processes with an asymmetric version being described using the amino-alcohol derived from proline¹⁰⁰ can be envisioned as suitable amines to the Mannich reaction depicted in **a)**.

CHAPTER 2: INTRODUCTION TO GOLD CATALYSIS

This chapter is a brief overview of the gold chemistry reported in the literature. No results are presented in this chapter.

2.1 Gold chemistry

Gold chemistry has known a fulgurous development in the past thirty years. This can be easily observed if one considers the increasing number of publications of gold-catalyzed reactions (Figure 2.1)¹⁰¹.

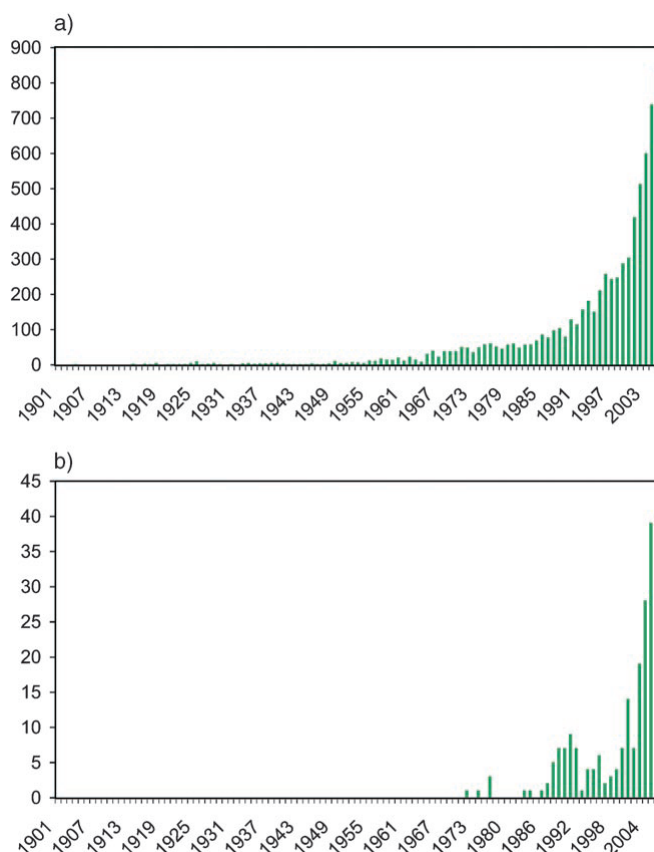

Figure 2.1: Number of publications in gold catalysis from the beginning of the 20th century until May 2006. In a) the number of publications concerning gold catalyzed reactions in general, in b) the number of publications concerning only homogeneous gold catalyzed reactions. By comparing both pictures, one can see that the initial scenario of gold catalysis was largely dominated by heterogeneous processes. (Figure 2.1 was extracted from ref. 101)

In this section, some of the most representative features exhibited by the unique and powerful reactivity of gold catalysts are going to be discussed with a main focus on Au(I)-

¹⁰¹ Hashmi, A. S. K.; Hutchings, G. H.; *Angew. Chem. Int. Ed.*, **2006**, 45, 7896.

catalyzed reactions. It is not our intention, by any means, to make a comprehensive digression on the rich plethora of gold reactions already reported in the literature¹⁰², but rather to present trends, properties and reactivity patterns, from where, we believe, most of gold-catalyzed transformations can be derived from.

2.1.1 Gold catalysts

Great interest has been paid to gold complexes in the past years due to two main aspects: 1) gold strong π -Lewis acidity and 2) gold's good potential to stabilize cationic reaction intermediates. The origin of these properties is now widely accepted to be relativistic effects (see paragraph 2.1.4).

Gold compounds exist in two oxidation states, Au^+ and Au^{3+} (not considering $\text{Au}(0)$ species). Complexes in both oxidation states are reported to be carbophilic, but Au(III) exhibits a thermodynamic preference for heteroatoms complexation, rather than carbon-carbon multiple bonds. In theoretical grounds, this was shown by Straub¹⁰³, who calculated the complexation preference of AuCl_3 to a carbonyl oxygen to be superior by 5.5 kcal/mol over a triple bond, and Yamamoto¹⁰⁴, who compared the computed heat of formation of complexes derived from AuCl , AuCl_3 and other representative Lewis acids with different electrophilic compounds (see table 2.1).

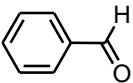
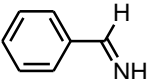
Lewis Acid	BCl_3	MgCl_2	AlCl_3	CuCl	CuCl_2	AgCl	AuCl	AuCl_3	PtCl_2
 1	18.9	34.5	40.7	37.4	25.4	26.4	33.1	35.9	46.9
 2	42.1	44.2	55.1	51.8	41.2	39.6	53.6	60.3	71.5

¹⁰² For recent reviews, please see: (a) Fürstner, A.; *Chem. Soc. Rev.*; **2009**, 38, 3208. (b) Gorin, D. J.; Sherry, B. D.; Toste, D.; *Chem. Rev.*, **2008**, 108, 3351. (c) Arcadi, A.; *Chem. Rev.*; **2008**, 108, 3266. (d) Li, Z.; Brouwer, C.; He, C.; *Chem. Rev.*; **2008**, 108, 3239. (e) Gorin, D. J.; Toste, F. D.; *Nature*, **2007**, 446, 395. (f) Fürstner, A.; Davies, P. W.; *Angew. Chem. Int. Ed.*, **2007**, 46, 3410. (g) Hashmi, A. S. K.; *Chem. Rev.*, **2007**, 107, 3180. (h) Pyykkö, P.; *Angew. Chem. Int. Ed.*, **2004**, 43, 4412

¹⁰³ Straub, B. F.; *Chem. Comm.*, **2004**, 1726.

¹⁰⁴ Yamamoto, Y.; *J. Org. Chem.*, **2007**, 72, 7817.

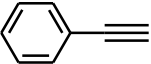
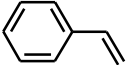
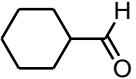
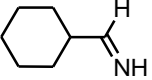
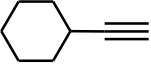
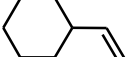
	3	0.9	15.2	19.1	33.1	14.3	22.6	34.7	32.5	49.4
	4	0.4	15.7	19.2	33.6	18.1	24.4	37.5	36.8	53.9
	5	17.2	33.1	38.7	36.6	23.9	26.0	32.7	35.1	38.9
	6	42.6	44.4	55.4	52.2	41.9	40.4	54.3	61.1	72.4
	7	1.3	18.7	18.4	35.3	16.1	25.2	36.2	30.9	49.5
	8	8.8	25.6	26.4	43.6	25.2	34.7	48.1	43.2	68.8

^a in the gas phase The heats of formation were calculated by subtraction of the absolute energies of the starting compounds from the absolute energy of the optimized complex between the substrate and the Lewis acid

Table 2.1: Computed heats of formation (B3LYP/SDD, kcal.mol⁻¹)^a of substrates **1-8** with common Lewis acids (Table 2.1 was extracted from ref. 104).

In practical grounds, possibly the most expressive example reported in the literature showing this dichotomy between Au(I) and Au(III) species was reported by Gevorgyan *et al.*¹⁰⁵. Starting from the same bromo allenylketone and using the same reaction conditions, but changing the gold catalyst, either (PEt₃)AuCl or AuCl₃, two different regioisomers of bromofuran were obtained. The explanation for this regioselectivity was believed to be the different gold affinities, Au(I) for the carbon-carbon multiple bond, and Au(III) for the oxygen from the ketone moiety.

¹⁰⁵ For the original report, see: (a) Sromek, A. W., Rubina, M., Gevorgyan, V.; *J. Am. Chem. Soc.*, **2005**, 127, 10500. For a theoretical study on the regioselectivity, see: (b) Xia, Y.; Dudnik, A. S.; Gevorgyan, V.; Li, Y.; *J. Am. Chem. Soc.*, **2008**, 130, 6940.

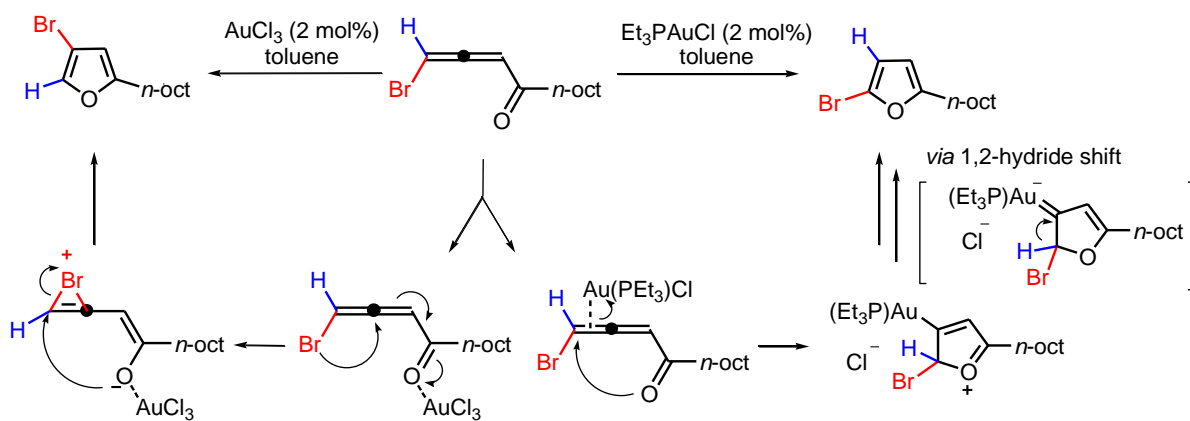

Scheme 2.1: Different regioisomers are obtained in the cycloisomerization of bromo allenyl ketones, depending on the nature of the gold catalyst employed. This is also one of the rare examples in the literature where a Au(I) neutral complex exhibited catalytic activity.

2.1.2 Isolobal analogy of Au(I)

$(R_3P)Au^+$ is isolobal to H^+ and LHg^{2+} fragments¹⁰⁶. At first glance, the isolobal relationship between $(R_3P)Au^+$, LHg^{2+} and H^+ and parallels in their reactivities could suggest that such metal templates can be considered as expensive equivalents of a proton with increased carbophilic character. This is not true. It is common knowledge that addition reactions to olefins or alkynes with a Brønsted acid usually require harsh conditions and potentially have numerous side reactions of the carbocation intermediate formed (Wagner Meerwein rearrangements, elimination reactions, oligomerization, etc.)¹⁰⁷.

Replacement of the proton by LHg^{2+} represents a typical solution to this aforementioned problem¹⁰⁸. LHg^{2+} is a large and polarizable cation, and as such a “soft” ion, LHg^{2+} has great affinity for the substrate and allows access to mild reaction conditions and high yields for the desired addition products. The concern of using mercury salts is their

¹⁰⁶ Hoffmann, R.; *Angew. Chem. Int. Ed.*, **1982**, 21, 711.

¹⁰⁷ Nevertheless, successful methods do exist. For some recent examples, see: (a) Li, Z.; Zhang, J.; Brouwer, C.; Yang, C-G.; Reich, N. W.; He, C.; *Org Lett.*, **2006**, 8, 19, 4175. (b) Yanagisawa, A.; Nezu, T.; Mohri, S.-I.; *Org Lett.*, **2009**, 11, 22, 5286. (c) Sanz, R.; Miguel, D.; Martínez, A.; Álvarez-Gutiérrez, J. M.; Rodríguez, F.; *Org. Lett.*; **2007**, 9, 10, 2027. (d) González-Rodríguez, C.; Escalante, L.; Varela, L. A.; Castedo, L.; Saá, C.; *Org. Lett.*, **2009**, 11, 7, 1531.

¹⁰⁸ For a general review concerning activation of π -systems with different metals, including Hg^{2+} , see: Freeman, F.; *Chem. Rev.*; **1975**, 75, 439.

toxicities. Although many addition reactions using alkynes¹⁰⁹ are catalytic in Hg^{2+} , the analogous reactions with alkenes are not, because the $\text{C}(\text{sp}^3)\text{-Hg}$ bond formed in the resulting intermediate is kinetically stable¹¹⁰. Thus, addition reactions to alkenes generally require an extra step to release the mercury appendage (generally $\text{NaBH}_4 + \text{OH}^-$) and have the great inconvenient of being stoichiometric in toxic mercury salts.

On the other hand, $(\text{R}_3\text{P})\text{Au}^+$ is essentially nontoxic, it has high affinity for carbon-carbon π -bonds and after each catalytic cycle, furnishes a kinetic labile $\text{C}(\text{sp}^3/\text{sp}^2)\text{-Au}$ bond that can be readily cleaved under the reaction conditions.

2.1.3 Au(I) geometry and enantioselective reactions

Au(I) species predominantly adopt a linear, bicoordinate geometry¹¹¹, and because of the limited number of coordination sites, generally one must remove a ligand from the neutral bicoordinate Au(I) complex in order to allow the access of the substrate to the coordination sphere of the catalyst.

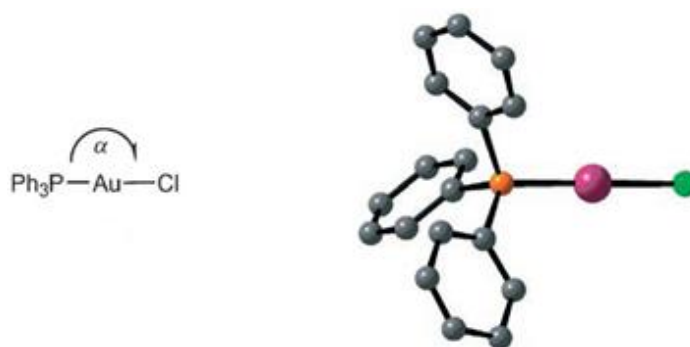

Figure 2.2: A typical Au(I) neutral complex, $\text{AuCl}(\text{PPh}_3)$ and its X-ray crystal structure with $\alpha = 179.6^\circ$, $d_{\text{Au-P}} = 2.235 \text{ \AA}$ and $d_{\text{Au-Cl}} = 2.279 \text{ \AA}$. The considerably long distance between Au and Cl indicates a substantial weakening of this bond^{102f}. (Figure 2.2 was extracted from ref. 102f)

¹⁰⁹ For some examples of addition to alkynes: (a) Imagawa, H.; Iyenaga, T.; Nishizawa, M.; *Org. Lett.*, **2005**, 7, 3, 451. (b) Nishizawa, M.; Yadav, V. K.; Skwarczynski, M.; Takao, H.; Imagawa, H.; Sugihara, T.; *Org. Lett.*; **2003**, 5, 10, 1609. (c) Biswas, G.; Ghorai, S.; Bhattacharjya, A.; *Org. Lett.*, **2006**, 8, 2, 313.

¹¹⁰ For some examples of addition to alkenes: (a) Nishizawa, M.; Takenaka, H.; Hirotsu, K.; Higuchi, T.; Hayashi, Y.; *J. Am. Chem. Soc.*, **1984**, 106, 4290. (b) Nishizawa, M.; Takenaka, H.; Hayashi, Y.; *J. Am. Chem. Soc.*, **1985**, 107, 522. (c) Namba, K.; Yamamoto, H.; Sasaki, I.; Mori, K.; Imagawa, H.; Nishizawa, M.; *Org. Lett.*; **2008**, 10, 9, 1767.

¹¹¹ (a) Carvajal, M. A.; Novoa, J. J.; Alvarez, S.; *J. Am. Chem. Soc.*, **2004**, 126, 1465. (b) Schwerdtfeger, P.; Hermann, H. L.; Schmidbauer, H.; *Inorg. Chem.*, **2003**, 42, 1334.

It is interesting to compare the previous structure of AuCl(PPh₃) to the three-coordinate homologue AuCl(PPh₃)₂¹¹²:

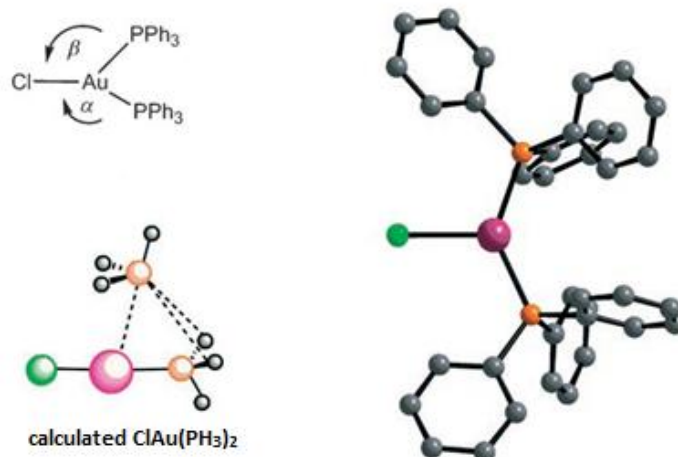

Figure 2.3: X-ray structure of AuCl(PPh₃)₂ with $\alpha = 115.1^\circ$, $\beta = 108.1^\circ$, $d_{\text{Au-P1}} = 2.230 \text{ \AA}$, $d_{\text{Au-P2}} = 2.313 \text{ \AA}$, $d_{\text{Au-Cl}} = 2.526 \text{ \AA}$. (Figure 2.3 was extracted from ref. 102f)

The greater distance observed in figure 2.3, with $d_{\text{Au-P2}} = 2.313 \text{ \AA}$ means that the third ligand PPh₃ is only weakly coordinated to the gold center. This evidence supports the apparent aversion of Au(I) complexes to adopt more than two ligands. This was also recognized in a theoretical study on the close-related structure AuCl(PH₃)₂, which is practically a linear species ($\alpha = 178.2^\circ$) and has the second phosphane bound only very loosely¹¹³. Curiously enough, in this three-coordinate gold complex, the second phosphane directs its lone electron pair toward the H atoms of the first PH₃ and not to the gold center.

One important consequence probably derived from this linear geometry is the difficulty of Au(I) complexes to participate in enantioselective processes (because the chiral ancillary ligand is diametrically opposed to the substrate). To circumvent this problem, a clever solution was proposed by Toste *et al.*¹¹⁴ based on the principle of *ion-pairing*¹¹⁵. This

¹¹² Khan, M.; Oldham, C.; Tuck, D.G.; *Can. J. Chem.*, **1981**, 59, 2714.

¹¹³ (a) Schwerdtfeger, P.; Hermann, H. L.; Schmidbauer, H.; *Inorg. Chem.*, **2003**, 42, 1334. (b) Bowmaker, G. A.; Schmidbauer, H.; Krüger, S.; Rösch, N.; *Inorg. Chem.*, **1997**, 36, 1754.

¹¹⁴(a) Lalonde, R. L.; Sherry, B. D.; Kang, E. J.; Toste, F. D.; *J. Am. Chem. Soc.*, **2007**, 129, 2452. (b) Hamilton, G. L.; Kang, E. J.; Mba, M.; Toste, F. D., *Science*, **2007**, 317, 496. (c) LaLonde, R. L.; Wang, Z. J.; Mba, M.; Lackner, A. D.; Toste, F. D., *Angew. Chem. Int. Ed.*, **2010**, 49, 598.

alternative approach takes advantage of the fact that gold(I) catalysts are positively charged. Therefore, the use of a negative charged *chiral counter-ion* would be closer to the substrate and would possibly be more efficient in inducing enantioselective transformations or “help” an eventual chiral ligand already bound to gold (it is important to note that in this new scenario with a chiral ligand and a chiral counter anion, “match” and “mismatch” situations are expected to be present, see figure 2.4). This concept represented not only a landmark in gold asymmetric catalysis, but also a further general principle that could be potentially expanded to other metal-ions based catalysis such as Pd, Rh, Ru, Ir, etc..

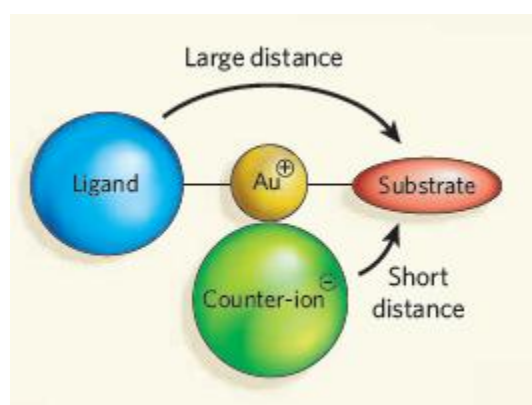

Figure 2.4: Schematic drawing of the concept of enantioselective induction through ion-pairing developed by Toste *et al.* (Figure 2.4 was extracted from ref. 115c).

2.1.4 Relativistic effects

As mentioned earlier, in section 2.1.1, relativistic effects were recognized as being the responsible factors for gold properties and reactivity. Indeed, Toste *et al.*^{102e} and others before him^{102h,116} identified strong relativistic manifestations on gold as being the reason for the contraction of orbitals *s* and *p*¹¹⁷. This contraction explains the increased ionization

¹¹⁵ For some examples and further discussion on *ion-pairing*, see: (a) Llewellyn, D. B.; Adamsom, D.; Arndtsen, B. A.; *Org. Lett.*, **2000**, 2, 26, 4165. (b) Zuccaccia, D.; Belpassi, L.; Tarantelli, F.; Macchioni, A.; *J. Am. Chem. Soc.*, **2009**, 131, 3170. (c) Hashmi, A. S. K.; *Nature*, **2007**, 449, 292.

¹¹⁶ (a) Pykkö, P.; *Chem. Rev.*, **1988**, 88, 563. (b) Pykkö, P.; *Angew. Chem. Int. Ed.*, **2002**, 41, 3573. (c) Schwartz, H.; *Angew. Chem. Int. Ed.*, **2003**, 42, 4442.

¹¹⁷ This can be seen as a consequence of the theory of special relativity applied to the Bohr atomic model, where the Bohr radius is given by $r_n = \frac{n^2 \hbar^2}{Zk_e e^2 m_e}$ and the velocity of an electron orbiting a nucleus of charge $q = Ze$ is given by $v_n = \frac{Zk_e e^2}{n\hbar} = \frac{Z\alpha c}{n}$. The value n is the principal quantum number, $\hbar = \frac{h}{2\pi} = 1.05 \times 10^{-34} \text{ J}\cdot\text{s}$ is the

energy of Au when compared to other group 11 elements, Cu and Ag, or Pt (group 10). As a consequence, electrons occupying outer orbitals of type *d* and *f* are better shielded by those electrons of inner *s* and *p* orbitals, and they feel a less effective attraction to the positive nuclear charge. This results in an expansion of *d* and *f* orbitals. Even if these relativistic effects tend to be present in all heavier atoms of the periodic table¹¹⁸, computational calculations show that they are more pronounced in elements which have their orbitals *5d* and *4f* fully occupied, and culminates with a maximum effect on gold (figure 2.5). Furthermore, it must be also mentioned that, even if all orbitals *s*, *p*, *d* and *f* exhibits to a certain extent the contraction and expansion effects mentioned above, in light of the frontier molecular orbital theory¹¹⁹, greater attention must be paid to the highest occupied molecular orbital (HOMO) and the lowest unoccupied molecular orbital (LUMO) of gold, i. e., the *5d* and *6s* orbitals, respectively¹²⁰.

reduced Planck constant, *Z* is the atomic number, $k_e = 9 \times 10^9 \text{ N} \cdot \text{m}^2 \cdot \text{C}^{-2}$ is the Coulomb constant, $e = 1.60 \times 10^{-19} \text{ C}$ is the charge of the electron (absolute value), m_e is the mass of the electron (equal to $9 \times 10^{-31} \text{ kg}$ in the rest state), $c = 3 \times 10^8 \text{ m} \cdot \text{s}^{-1}$ is the speed of light and $\alpha = \frac{k_e e^2}{\hbar c} \approx \frac{1}{137}$ is the fine structure constant. Because the special relativity states that $m = \gamma m_0$, with m being the relativistic mass, $\gamma = \frac{1}{\sqrt{1 - (\frac{v}{c})^2}}$

the Lorentz term and m_0 the rest mass (non-relativistic), one can see that if we consider an electron of speed v_n , which approaches c , then $m = m_e$ tends to become much greater than m_{0e} and as r_n is inversely proportional to m_e this implies that r_n tends to decrease. Note that this happens for all principal quantum numbers $n = 1, 2, 3$, etc.. considered (which demonstrates the contraction of inner orbitals *s* and *p*. Electrons in outer orbitals *d* and *f* are shielded by inner electrons and do not respond to the nuclear charge in the same way as *s* and *p* electrons. In other words, the Bohr atomic model is not valid any more). Paying attention now to the expression of the speed of an electron orbiting the nucleus, $v_n = \frac{Z}{137n} c$, one can see that electrons from heavier atoms are closer to the speed of light than lighter atoms and that the closer they are to the nucleus (smaller n values), the faster they move. Please note that the Bohr atomic model is valid only to the hydrogen atom (a proton and an electron) and hydrogenoid atoms (a positive nucleus of charge $+Ze$ and a single electron) but its use here is justified by the easier mathematical manipulation and for the fact that the Bohr model behaves well as a first order-approximation of its “modern” developments using quantum mechanics (the Schrödinger and Dirac equations). For a more detailed discussion on the Bohr atomic model and quantum mechanics, see: (a) *Mécanique Quantique*. Basdevant, J.-L.; Dalibard, J.; **2002**, Editions de l’Ecole Polytechnique. (b) *Introduction à la chimie quantique*. Leforestier, C.; **2005**, Dunod, Paris.

¹¹⁸ Pyykkö, P. & Desclaux, J. P.; *Acc. Chem. Res.*, **1979**, 12, 276.

¹¹⁹ For a pedagogical exposé, see (a) Carey, F. A.; Sundberg, R. J.; *Advanced Organic Chemistry. Part A: structure and mechanism*, Kluwer Academic/ Plenum Publishers, **2000**, 4th edition, Chapter 1. pp. 23-54. For further discussion in the literature, see (b) Houk, K. N.; *Acc. Chem. Res.*, **1975**, 11, 8, 361. (c) Yan, L.; Evans, J. N. S.; *J. Am. Chem. Soc.*, **1995**, 117, 29, 7756. (d) Ess, D. H.; Houk, K. N.; *J. Am. Chem. Soc.*, **2008**, 130, 31, 10187.

¹²⁰ For a much deeper discussion of relativistic effects on periodic elements, see ref. 116.

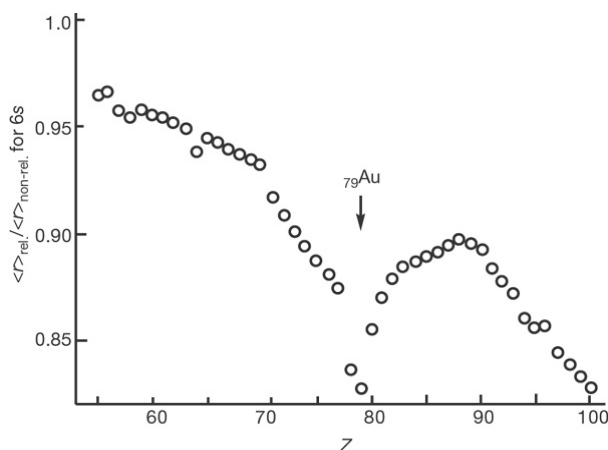

Figure 2.5: Pronounced relativistic effects accounts for the contraction of the 6s (LUMO) orbital in gold complexes, as well for its closest neighbors in the 6th line of the periodic table, Hg and Pt. (Figure 2.5 was extracted from ref. 118).

The contraction of the 6s orbital (LUMO) is responsible for a stabilization of this orbital when compared to the same orbital without relativistic considerations and this ultimately accounts for a greater Lewis acidity of Au(I) cationic complexes. This result also correlates with the strong electronegativity of gold (2.4 for Au, compared to 1.9 of Ag and 1.9 for Cu), which can also be seen as a consequence of the contraction of the 6s and 6p orbitals^{102e}. On the other hand, the expansion^{102e} of the 5d orbital (HOMO) is responsible for a destabilization of this orbital when compared to the same orbital without relativistic considerations and this ultimately results in a greater potential of Au(I) to stabilize carbocationic intermediates (Figure 2.6).

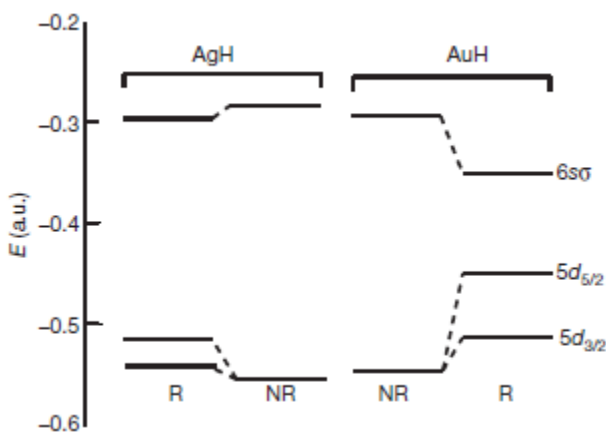
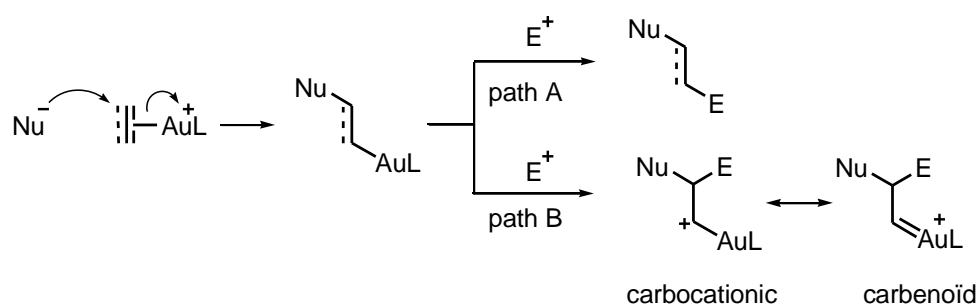

Figure 2.6: Using the Hartree-Fock model, calculated molecular orbital energies for AgH and AuH are compared above taking relativistic effects into consideration (R) and neglecting these effects (NR). From this picture, a third effect can be noted due to relativistic effects: the splitting of energy levels due to spin-orbit coupling^{102e} (Figure 2.6 was extracted from ref. 118).

Additionally, the expansion of the 5d orbital is also implicated in the poor nucleophilicity observed for gold metal species, because electrons in this orbital suffer a lower electronic repulsion from electrons in inner s and p orbitals. This makes electrons in the HOMO orbital of gold better hold to the nucleus and less available to nucleophilic additions, which is also mirrored in the inertness of Au(I) species to undergo oxidative additions, which is also mirrored in the inertness of Au(I) species to undergo oxidative additions¹²¹. Computational and experimental studies also reveals that reductive elimination from R₃LAu(III) complexes is equally unfavorable¹²². These observations are consistent with the broad reactivity exhibited for Au(I) and Au(III) complexes, which are observed to not easily interchange between oxidation states¹²³.

2.1.5 Au(I)-catalyzed nucleophilic addition to C-C multiple bonds: elementary steps.

The general scheme of a gold catalyzed nucleophilic addition is represented in scheme 2.2. This scheme gives an overview of the two main pathways envisaged when planning a gold catalyzed reaction.



Scheme 2.2: General plan when envisaging a gold catalyzed reaction, with two possibilities for trapping an electrophile, either in a “1,1-fashion” (path A) or in a “1,2-fashion” (path B).

¹²¹ Nakanishi, W.; Yamanaka, M.; Nakamura, E.; *J. Am. Chem. Soc.*, **2003**, 127, 1446.

¹²² (a) Komiya, S.; Albright, T. A.; Hoffmann, R.; Kochi, J. K.; *J. Am. Chem. Soc.*; **1976**, 98, 7255. (b) Komiya, S.; Kochi, J. K.; *J. Am. Chem. Soc.*, **1976**, 98, 7599.

¹²³ Nevertheless, this reactivity is possible: (a) Tamaki, A.; Kochi, J. K.; *J. Organometall. Chem.*, **1974**, 64, 411. (b) Zhang, G.; Cui, L.; Wang, Y.; Zhang, L.; *J. Am. Chem. Soc.*; **2010**, 132, 1474.

2.1.5.1 Nucleophilic addition to π -systems

The first step in scheme 2.2 consists of the activation of a π -system (alkene, alkyne or allene) by the important lowering of the LUMO orbital of the C-C multiple bond due to the contraction (stabilization) of the 6s orbital of gold. To this activated complex follows the nucleophilic addition, which is now widely accepted to proceed *via* a *trans* mechanism¹²⁴.

At this point, it is important to note that gold-alkyne complexes normally exhibit superior reactivity towards nucleophiles than gold-alkene complexes. This fact contrasts with studies¹²⁵ realized on Au⁺-ethylene and Au⁺-ethyne bondings, which indicates *ca.* 10 kcal.mol⁻¹ greater stabilization for the ethylene complex over the ethyne complex. The reason for this apparent contradiction is the fact that an alkyne has intrinsically lower LUMO and HOMO (by *ca.* 12 kcal.mol⁻¹) than the corresponding alkene (therefore being less nucleophilic and more electrophilic). Therefore, even if a gold-alkene is more stabilized than the corresponding gold-alkyne system, gold-alkyne systems are *overall* lower in energy than gold alkene-systems. Another way of describing this energy situation is saying that gold catalysts do not distinguish between alkenes and alkynes, being able to form activated complexes with both entities. Conversely, nucleophiles do distinguish between activated complexes, and they give priority to gold-alkyne ones (which is probably a kinetic phenomenon in origin).

Independent of which π -system is bounded to the metal catalyst, "activation" involves slippage $\eta^2 \rightarrow \eta^1$ of the metal fragment along the axis of the π -ligand, which in turn, leads to enhanced electrophilicity of C-C multiple bond. Nucleophilic addition proceeds due to the relaxation of symmetry in bonding orbitals, which allows mixing of previously orthogonal orbitals and facilitates charge transfer from the nucleophile to the π -ligand, and finally to the metal center. It is possible that such distortion is already present in the ground state structure (and not only in the transition state).

¹²⁴ Initial studies on the gold catalyzed addition of alcohols to alkynes suggested a *cis*-addition mechanism: (a) Teles, J. H.; Brode, S.; Chabanas, M.; *Angew. Chem. Int. Ed.*, **1998**, 37, 1415. For spectroscopic observation of reaction intermediates, which strongly supports the *trans*-addition pathway, see: (b) Casado, R.; Contel, M.; Laguna, M.; Romero, P.; Sanz, S.; *J. Am. Chem. Soc.*, **2003**, 125, 11925.

¹²⁵ (a) Hertwig, R. H.; Koch, W.; Schröder, D.; Schwartz, H.; *J. Phys. Chem.*, **1996**, 100, 12253. (b) Nechaev, M. S.; Rayon, V. M.; Frenking, G.; *J. Phys. Chem. A*, **2004**, 108, 3134.

Metal “slippage” has already been deeply studied through theoretical calculations¹²⁶, but just recently such $\eta^2 \rightarrow \eta^1$ displacement was experimentally investigated by the coordination of the gold complex $(\text{PPh}_3)\text{Au}^+$ to alkene **2.1**¹²⁷, which resulted in the complete regioselectivity for the end-on coordination of the π -system and the simultaneous formation of an imidazolium cation, as it was observed from the X-ray crystal structure of the resulting molecule, **2.2** (scheme 2.3). This reaction shows that significant charge density can be donated to a π -bond upon coordination to a suitable carbophilic metal fragment.

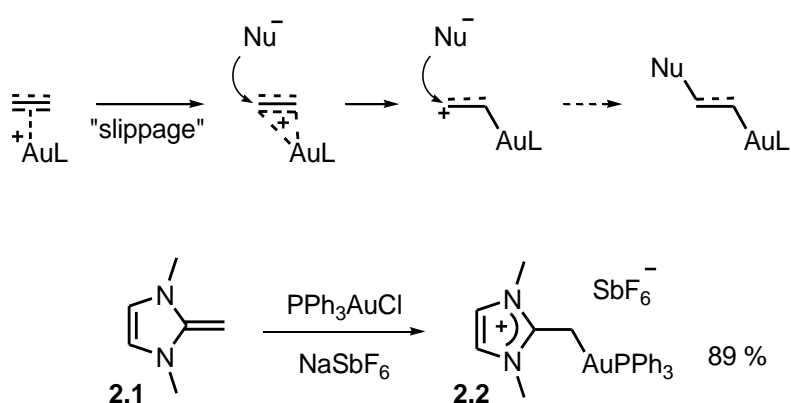

Scheme 2.3: Elementary steps of a gold(I)-catalyzed reaction of a π -system with a nucleophile (Scheme 2.3 was extracted from ref. 102a).

2.1.5.2 Path A: trapping gold intermediates with electrophiles in a “1,1-fashion” and proto-deauration.

Once the nucleophilic attack is done to the π -system, the new organo-gold obtained can evolve in contact with a suitable electrophile, either through path A, giving a 1,1-electrophilic trapped product or through path B, giving a 1,2-electrophilic trapped product (Scheme 2.2).

In the case of 1,1-trapping, the most common electrophiles are sources of halogens, such as Cl, Br, I or even F¹²⁸. Hashmi *et al.*^{128d} tried to extend the scope of suitable

¹²⁶ (a) Eisenstein, O.; Hoffmann, R.; *J. Am. Chem. Soc.*, **1981**, 103, 4308. (b) For molecular dynamic calculations, see: Senn, H. M.; Blöchl, P. E.; Togni, A.; *J. Am. Chem. Soc.*, **2000**, 122, 4098.

¹²⁷ Fürstner, A.; Alcarazo, M.; Goddard, R.; Lehmann, C. W.; *Angew. Chem. Int. Ed.*, **2008**, 47, 3210.

¹²⁸ For examples of trapping using NIS, see: (a) Yu, M.; Zhang, G.; Zhang, L.; *Org. Lett.*, **2007**, 9, 11, 2147. (b): Buzas, A.; Gagosz, F.; *Org. Lett.*, **2006**, 8, 3, 515. For the use of I₂ and TsOH, see: (c) Liu, L.-P.; Xu, B.; Mashuta, M. S.; Hammond, G. B.; *J. Am. Chem. Soc.*, **2008**, 130, 17642. For miscellaneous use of NCS, NBS, NIS, TFA, see: (d) Hashmi, A. S. K.; Ramamurthi, T. D.; Frank Rominger, F.; *J. Organom. Chem.*; **2009**, 694, 592. For NIS, NBS, NCS and selectfluor, see: (e) Schuler, M.; Silva, F.; Bobbio, C.; Tessier, A.; Gouverneur, V.; *Angew. Chem. Int. Ed.*,

electrophiles to enones, but no fruitful results were observed. Also worth mentioning are other strategies for trapping the organogold species using carbon¹²⁹, silicon¹³⁰ and sulfonyl¹³¹ electrophiles or *via* palladium catalyzed cross coupling reactions¹³². An impressive example is the reaction cascade leading to a final 1,1-electrophilic trapping by an iminium species, thus forming a new C-C bond (scheme 2.4).

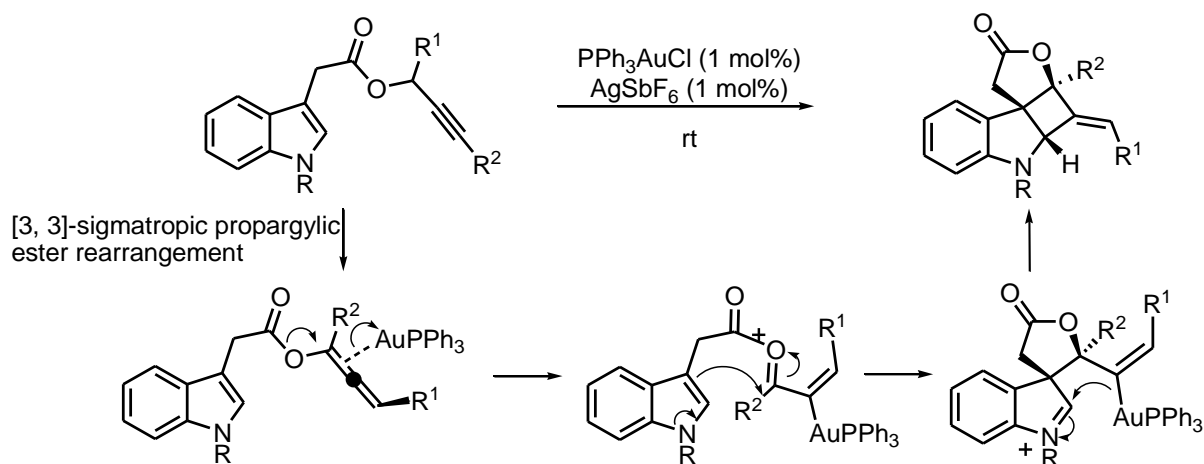

Scheme 2.4: An example of an impressive gold catalyzed cascade terminated by the trapping of the vinyl organogold intermediate leading to the formation of a C-C bond^{129a}.

Despite the successful cases mentioned above¹²⁸⁻¹³², it is not easy to trap organogold compounds. The difficulty in doing so arises from the great potential of these species to protodeaurate. Proto-deauration (or proto-demetalation as it is used when referring to a general metal) consists on the displacement of the gold metal center by a proton and is generally the key step for catalyst regeneration. Surprising as this seems, there is not a great body of experimental or theoretical information in the literature concerning the study of the

2008, 7927. For the use of $\text{Et}_3\text{N}\cdot\text{HF}$ as trapping agent, see: (f) Akana, J. A.; Bhattacharyya, K. X.; Müller, P.; Sadighi, J. P.; *J. Am. Chem. Soc.*, **2007**, 129, 7736.

¹²⁹ (a) Zhang, L.; *J. Am. Chem. Soc.*, **2005**, 127, 16804. (b) Nakamura, I.; Sato, T.; Yamamoto, Y.; *Angew. Chem. Int. Ed.*, **2006**, 45, 4473. (c) Dube, P.; Toste, F. D.; *J. Am. Chem. Soc.*; **2006**, 128, 12062.

¹³⁰ Nakamura, I.; Sato, T.; Terada, M.; Yamamoto, Y.; *Org. Lett.*, **2007**, 9, 4081.

¹³¹ Nakamura, I.; Yamagishi, U.; Song, D.; Konta, S.; Yamamoto, Y.; *Angew. Chem. Int. Ed.*; **2007**, 46, 2284.

¹³² (a) Shi, Y.; Roth, K. E.; Ramgren, S. D.; Blum, S. A.; *J. Am. Chem. Soc.*, **2009**, 131, 18022. (b) Shi, Y.; Ramgren, S. D.; Blum, S. A.; *Organometallics*, **2009**, 28, 1275. (c) Hashmi, A. S. K.; Löhtschutz, C.; Döpp, R.; Rudolph, M.; Ramamurthi, T. D.; Rominger, F.; *Angew. Chem. Int. Ed.*, **2009**, 48, 8243. (d) Hashmi, A. S. K.; Döpp, R.; Löhtschutz, C.; Rudolph, M.; Riedel, D.; Rominger, F.; *Adv. Synth. Cat.*, **2010**, 352, 1307. For a very successful case of cross coupling without Pd, see: (e) ref. 123b.

relative basicities of organogold species¹³³ or concerning the precise mechanism of the proto-deauration step, which is possibly due to the extremely fast nature of this process¹³⁴. Very recently, Blum *et al.* reported studies concerning the basicity of organogold compounds to follow the order: $sp^3 < sp < sp^2$ as it was observed with complexes **2.5** < **2.6** < **2.9** < **2.10**, but the pK_a values of the conjugate acids follow the order $sp \ll sp^2 < sp^3$ (i. e. acetylene $pK_a = 25$, ethylene $pK_a = 44$, methane $pK_a = 48$)¹³³. This basicity exhibited by vinylgold, phenylgold, and alkynylgold in comparison to methylgold suggests a stabilizing interaction of the C-C π -bond in the rate-limiting transition state. In addition, it has been reported in the literature a correlation between increased hyperconjugation ability and increased rate of protodemetalation for compounds of type R_3MPh , with $M = C, Si, Ge, Sn$ and Pb ¹³⁵. Based on these observations, a transition state involving the overlap of the Au-C σ -bond with the carbon π -bond was proposed¹³⁶ (Table 2.2, **b**). This hyperconjugation would further stabilize the developing cationic charge and generate an increased rate of protodeauration in **2.9** and **2.10** compared to methyl gold **2.5**, which cannot be stabilized in the same way and to alkynylgold **2.6**, which has reduced potential for hyperconjugative stabilization in the transition state. Furthermore, because the acetylene has a lower HOMO when compared to ethylene, alkynylgold **2.6** would be expected to have a lower energy π -system than alkenyl gold **2.10**, and thus the π -system of alkynylgold **2.6** would be less accessible for protonation.

a) Relative rates of protodemetalation of organogold compounds

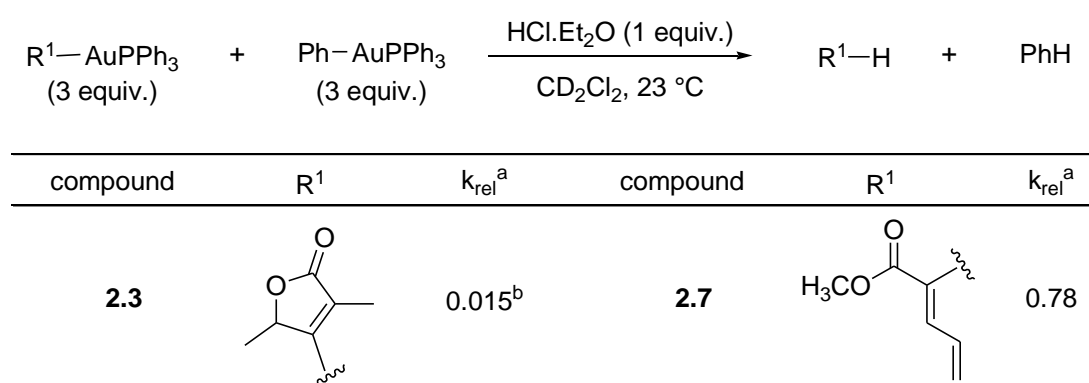

¹³³ For a very recent report on this subject, see: Roth, K.; Blum, S. A.; *Organometallics*, **2010**, 29, 1712. The pK_a 's extracted from this reference differs from the one mentioned in chapter 1 (p.10). This difference can be attributed to different functional groups present in the molecule.

¹³⁴ Proto-deauration is faster than β -hydrogen elimination: Hashmi, A. S. K.; *Catalysis Today*, **2007**, 122, 211.

¹³⁵ Berwin, H. J.; *J. Chem. Soc., Chem. Commun.*, **1972**, 237.

¹³⁶ (a) Gabelica, V.; Kresge, A. J.; *J. Am. Chem. Soc.*, **1996**, 118, 3838. (b) Kresge, A. J.; Tobin, J. B.; *Angew. Chem. Int. Ed.*, **1993**, 32, 5, 721.

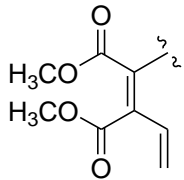
2.4		0.082 ^c	2.8	$t\text{Bu}\text{-}\equiv\text{-Au}(\text{IPr})$	0.81
2.5	CH_3	0.35 ^d	2.9	Ph	1.0
2.6	$t\text{Bu}\text{-}\equiv\text{-}$	0.46	2.10	vinyl	1.5

^a Ratio of R¹H: PhH using ¹H NMR spectroscopy. ^b Measured by competition experiments between **2.3** and **2.4**. ^c Measured by competition experiment between **2.4** and **2.6**. ^d Measured by the ratio of **2.9** and **2.5** due to product volatility.

b) Proposed transition state for proto-deauration

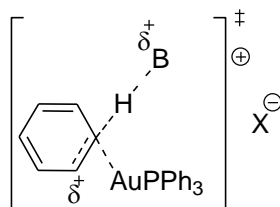

Transition state model for proto deauration, showing partial contribution of the π -system in the protonation event

Table 2.2: **a)** Comparison between reaction rates of selected organogold compounds. **b)** Proposed transition state for protodemetalation step concerned in vinyl and aryl gold species.

One last interesting important feature is the fact when comparing triphenylphosphine and the NHC ligand IPr, the latter showed an increase in the reaction rate by a factor 1.8 (compare compounds **2.6** and **2.8**), suggesting that NHC ligand can expand the substrate scope of gold catalyzed rearrangements which are terminated by proto-demetalation. Conversely, the slower protodemetalation step for phosphine ligands may be seen as useful, if one envisages submitting these intermediates in further reactions, such as cross-coupling transformations¹³².

2.1.5.3 Path B: trapping gold intermediates with electrophiles in a “1,2-fashion” and debate on the nature of the intermediate formed

The “push-pull” sequence represented in pathway B of scheme 2.2 plays a central role on the recognized power of gold catalyzed reactions¹³⁷ because, once well planned, it allows one to form up to two C-C or C-X bonds, where X is an heteroatom (not considering more elaborated cascades reactions) in just one step and thus rapidly access great molecular complexity. A representative example of this “push-pull” sequence is shown below (Scheme 2.5)¹³⁸:

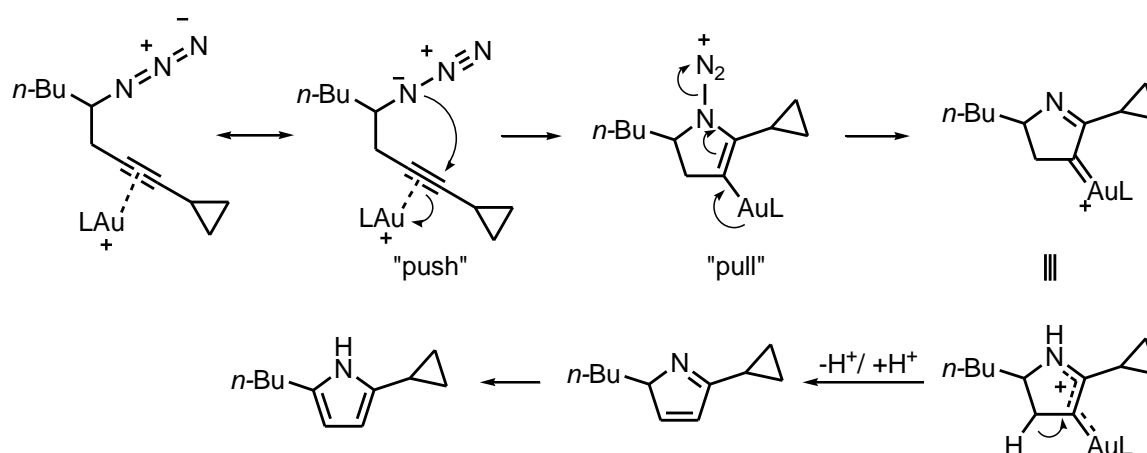

Scheme 2.5: A representative example of the “push-pull” reactivity of gold systems using an acetylenic Schmidt reaction.

One *sine qua non* condition to such a *push-pull* sequence to happen is that the positive charge in the α -position to the gold center is stabilized enough. The resulting intermediate can be described either as a cationic form or a carbenoid species. And here, is where an extensive debate about the nature of these intermediates begins.

Among many examples in the literature¹³⁹ demonstrating the highly cationic nature of intermediates implicated in cycloisomerization processes¹⁴⁰, two of the most

¹³⁷ For an overview of this rich chemistry, see refs. 102a-g.

¹³⁸ For an example using gold (a) Gorin, D. J.; Davis, N. R.; Toste, F. D.; *J. Am. Chem. Soc.*, **2005**, 127, 11260. A similar reactivity is found using Pt: (b) Hiroya, K.; Matsumoto, S.; Ashikawa, M.; Ogiwara, K.; Sakamoto, T.; *Org. Lett.*, **2006**, 8, 5349.

¹³⁹ For a few examples that suggest the intervention of highly charged cation-like species, see: (a) Jiménez-Nuñez, E.; Claverie, C. K.; Bour, C.; Cardens, C. G.; Echavarren, A. M.; *Angew. Chem. Int. Ed.*, **2008**, 47, 7892. (b) Zou, Y.; Garayalde, D.; Wang, Q.; Nevado, C.; Goeke, A.; *Angew. Chem. Int. Ed.*, **2008**, 47, 10110. (c) Böhringer, S.; Gagosz, F.; *Adv. Synth. Catal.*, **2008**, 350, 2617.

¹⁴⁰ Fürstner, A.; Morency, L.; *Angew. Chem. Int. Ed.*; **2008**, 47, 5030.

representative ones were possibly reported by the Fürstner's group. In the first one, an enyne of type **2.11** bearing a substituent R = H was submitted to gold catalysis, there was no regioselectivity on the cyclization and the reaction proceeded with a poor yield (30%, with a 2:1 mixture of regioisomers). When a methyl group was introduced on the double bond (R = Me), the reaction efficiency and selectivity increased considerably (80% of just one regioisomer, scheme 2.6), a result that is difficult to explain using a gold carbene intermediate, such as **2.12**, but which can be beautifully derived from a charge-delocalized and highly-ordered cationic intermediate (or transition state) such as **2.13**.

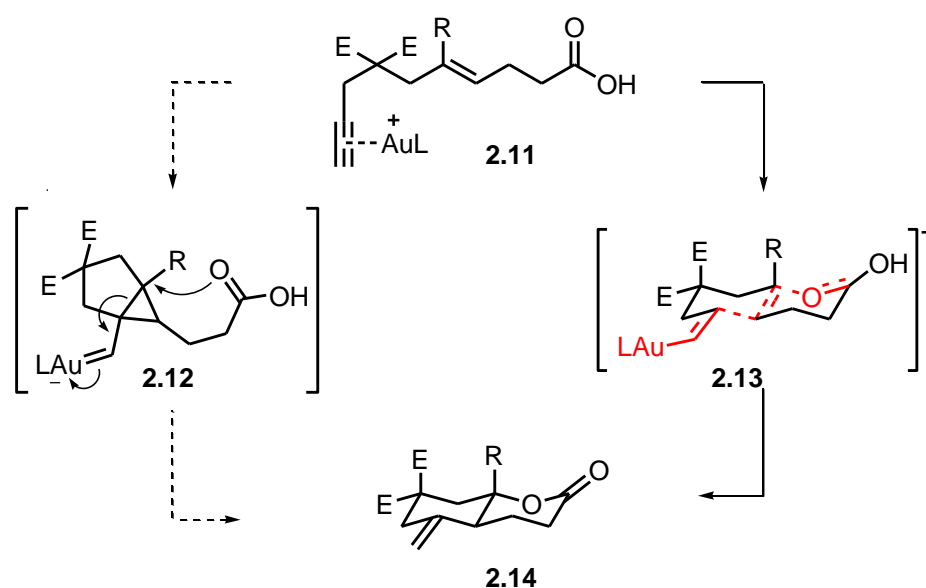

Scheme 2.6: Au(I)-catalyzed cycloisomerization cascade. Conditions: PPh₃PAuCl (5 mol%), AgSbF₆ (5 mol%), CH₂Cl₂, at room temperature. E = CO₂Me. The reaction is regioselective for R = Me, but unselective for R = H. This outcome can be rationalized using a more or less concerted process following the same logic of cationic polyene cyclization reactions (*cf.* “Stork-Eschenmoser postulate”¹⁴¹, Scheme 2.6 was extracted from ref. 140).

A second representative finding, also from Fürstner's group, was uncovered from a tentative experiment to observe a gold carbene complex, but resulted instead in the formation of a highly cationic form, the other mesomeric form of this intermediate (scheme

¹⁴¹ (a) Stork, G.; Burgstahler, A. W.; *J. Am. Chem. Soc.*, **1955**, 77, 5068. (b) Stadler, P. A.; Eschenmoser, A.; Shinz, H.; Stork, G.; *Helv. Chim. Acta*, **1957**, 40, 2191.

2.7)¹⁴². This conclusion was based on the following NMR observations: two -OCH₂- groups of the ketal ring in structure **2.16** give rise to just one signal in both the ¹H and the ¹³C NMR spectra, suggesting there is rapid rotation about the C₂-C₃ bond on the NMR timescale, even at -78°C. Whereas this finding is incompatible with the putative gold carbene structure **2.17**, it is consistent with the presence of an oxocarbenium cation of type **2.16** (Scheme 2.7). Moreover, the analysis of the pertinent coupling constants reveals the (*Z*)-olefin character of the C₁-C₂ bond, $J_{H_1-H_2} = 13.9$ Hz. If the temperature is carefully raised, the solution gradually changes color from yellow to dark red. NMR spectroscopy reveals that (*Z*)-**2.16** rearranges over the course of several hours to a new compound, featuring the distinctive spectroscopic coupling constant $J_{H_1-H_2} = 19.1$ Hz of the corresponding *E* isomer (*E*)-**2.18**. Even in solutions in which both gold species are present, their NMR spectroscopic signals are not significantly broadened by mutual exchange, thus confirming the high barrier of interconversion.

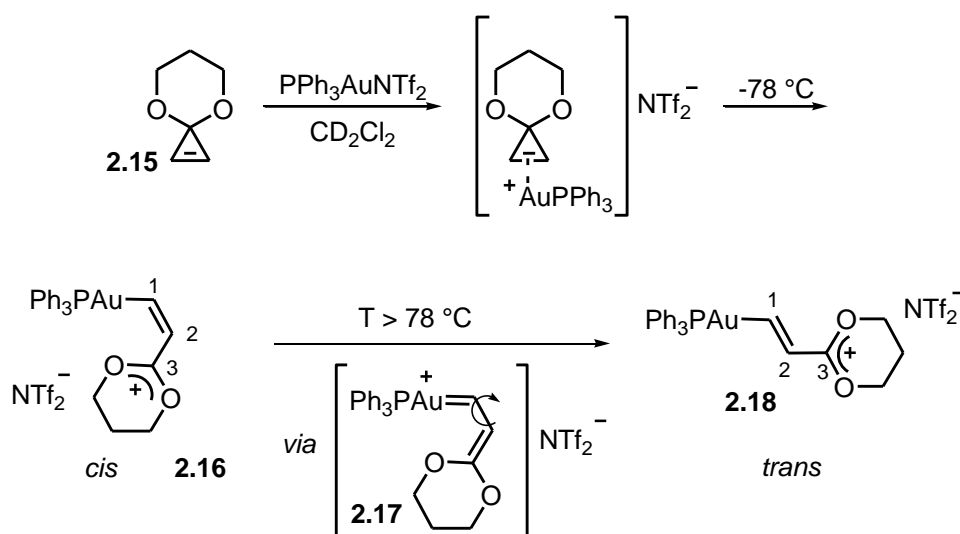

Scheme 2.7: The attempted generation of a gold carbene by rearrangement of cyclopropene **2.15** produced only the corresponding cationic vinyl gold species (Scheme 2.7 was extracted from ref. 142).

As a consequence of these studies, Fürstner argued that even if the intervention of a carbene species cannot be excluded from the gold reactivity scenario, strong evidences have been cumulated to support the view of gold catalyzed processes as falling into the general

¹⁴² Seidel, G.; Mynott, R.; Fürstner, A.; *Angew. Chem. Int. Ed.*; **2009**, 48, 2510.

categories of Friedel-Crafts reactions, Prins-type processes and cationic rearrangements, with any claim of the intervention of gold-carbenoid intermediates having to be carefully weighed against the cationic behavior highlighted above.

Conversely, further calculations performed by Toste's group on cyclopropenes of type **2.15** and other compounds¹⁴³, supported the idea that even if complex **2.18** ($\text{Au}_\text{O}^{\text{PPh}}$), studied by Fürstner was essentially cationic, other analogous vinyl gold complexes, without the cationic stabilizing oxygens, such as $\text{Au}_\text{Me}^{\text{PMe}}$, were better described as carbene-like compounds ($\text{Au}_\text{X}^{\text{L}}$ refers to a notation where L is the ancillary ligand on gold and X is the substituent on C³, see Figure 2.7). In order to test this hypothesis experimentally, both complexes were submitted to cyclopropanation protocols. Any productive cyclopropanation of intermediates resulting from the gold-catalyzed reaction using cyclopropene **2.15** as a precursor to $\text{Au}_\text{O}^{\text{PMe}}$ failed (Figure 2.7a). However, the gold-catalyzed reaction of cyclopropene **2.19** (which was assumed to decompose to an intermediate similar to $\text{Au}_\text{Me}^{\text{PMe}}$) with *cis*-stilbene (**2.20**) afforded the product of stereospecific olefin cyclopropanation (Figure 2.7b).

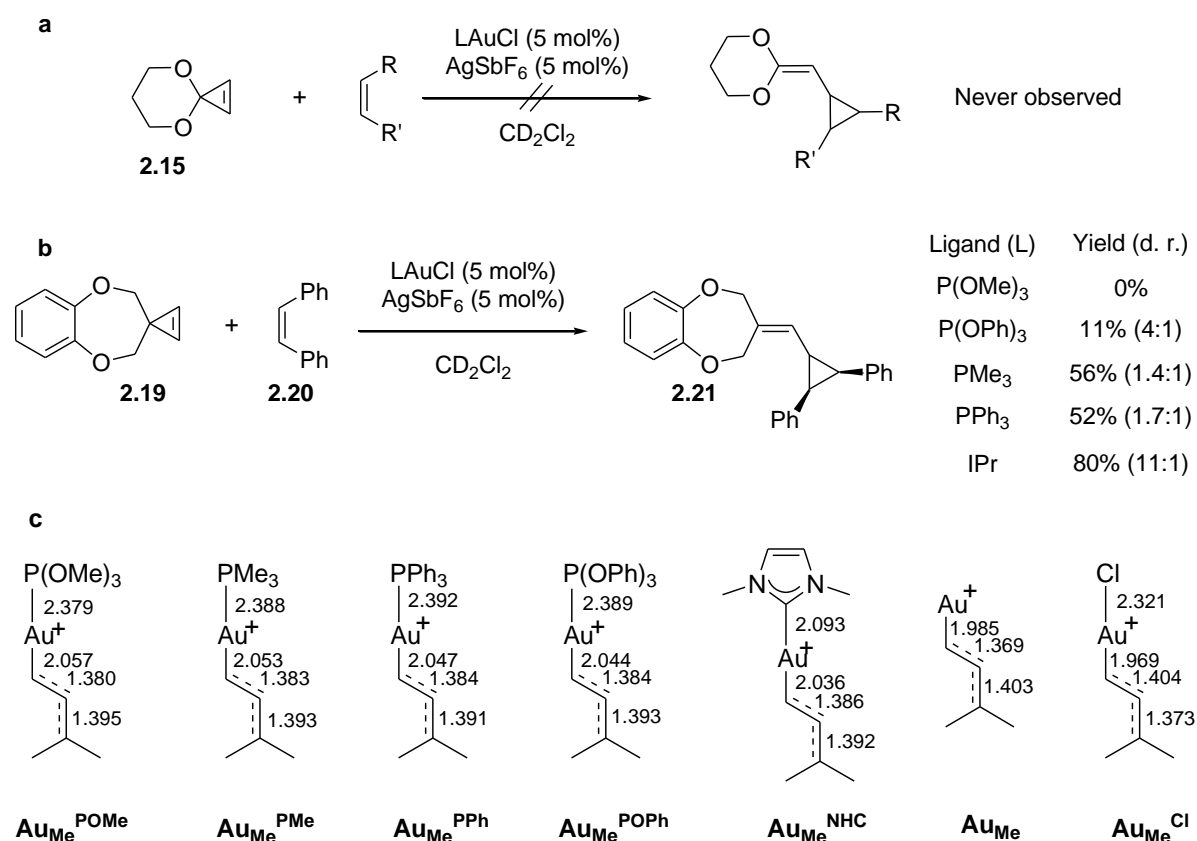

¹⁴³ Benitez, D.; Shapiro, N. D.; Tkatchouk, E.; Wang, Y.; Goddard III, W. A.; Toste, F. D.; *Nature Chem.*, **2009**, 1, 482.

Figure 2.7: **Experimental and theoretical comparison for the carbene reactivity of the substrate with different ancillary ligands.** **a, b**, Attempted (a) and observed (b) carbene-like reactivity, demonstrating the impact of the ancillary ligand on the yield of cyclopropanation product. **c**, Bond distances in $\text{Au}_{\text{Me}}^{\text{L}}$ complexes (Figure 2.7 was extracted from ref. 143).

The difference in the efficiency observed for the cyclopropanation reaction which strongly depends on the ancillary ligand used on gold can be explained in terms of their σ -donor and π -acceptor properties. Because Au(I) complexes have only one valence orbital ($6s$), it results from the Pauli exclusion principle¹⁴³ that the stronger the σ -donor ligand on gold, the smaller will be the LAu-C^1 bond order (which means that this bond, Au-C^1 , is elongated). This is coherent with the view of figure 2.7c, when comparing the Au-C^1 bond lengths between the different phosphine and phosphite ligands (strong σ -donors and strong π -acceptors) and Au_{Me} . Additionally, the metal center is able to form two π -bonds by donation from perpendicular filled d -orbitals into empty π -acceptors on the ancillary ligand and C^1 . Although these two bonds are not mutually exclusive, they compete for electron density from gold (Figure 2.8). As a consequence, strongly π -acidic ligands decrease back-donation to the substrate, resulting in even longer Au-C^1 bonds (2.057 Å for $\text{Au}_{\text{Me}}^{\text{POMe}}$).

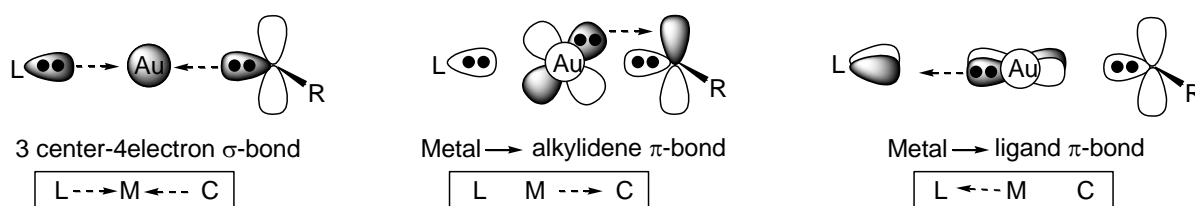

Figure 2.8: The L-Au-C^1 bonding interactions can be partitioned into three components. The first one accounts for the σ -interactions ($6s$ orbital of gold, LUMO), and the other two, implicating two perpendicular and filled $5d$ orbitals (HOMO) of gold are responsible for the π -interactions (Figure 2.8 was extracted from ref. 143).

This bond scenario explains the observed results for the cyclopropanation reaction mentioned earlier. Ancillary ligands which are good π -acceptors tend to favor carbocationic behavior, because they decrease $\text{Au} \rightarrow \text{C}^1$ π -donation. In line with this reasoning, it was

found that strongly π -acidic phosphite ligands provide only traces of the desired product and significant polymerization. Conversely, ligands that increase $\text{Au} \rightarrow \text{C}^1$ π -donation are expected to reduce carbocationic reactivity, while ligands that decrease $\text{C}^1 \rightarrow \text{Au}$ σ -donation should increase carbene reactivity. This was exactly what was observed for the *N*-heterocyclic ligand IPr (1,3-bis(2,6-diisopropylphenyl)imidazol-2-ylidene), which affects both of these parameters (it is strongly σ -donating and only weakly π -acidic). As a result, IPrAu^+ gave the product of stereospecific cyclopropanation with the best yield and diastereoselectivity among all the ligands tried (80% yield, 11:1 cis:trans).

As a consequence of these studies, Toste argued that gold(I)-coordinated carbenes is best accounted for by a continuum ranging from a metal-stabilized singlet carbene to a metal-coordinated carbocation, with the position of a given gold species on this continuum being largely determined by the carbene substituents and the ancillary ligand.

Finally, one may object that these two mesomeric forms are nothing but canonical extremes of the very same intermediate, thus making any discussion pointless. Nevertheless, as it was briefly highlighted here, a growing body of theoretical and experimental information suggests that these mesomeric forms contribute very unevenly to the actual character of Au^+ species, actually making it important to distinguish between them (Figure 2.9).

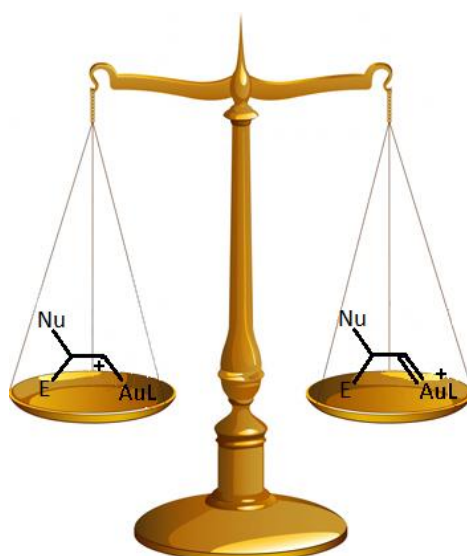

Figure 2.9: Different reaction profiles are accessed by Au^+ catalysis that can be explained by either the carbocationic form (on the left side) or the carbene form (on the right side). The

true nature of these intermediates is still source of debate and further studies should be provided to shed light on this subject.

2.1.5.4 The Dewar-Chatt-Duncanson model

A complex of a transition metal with a π -ligand, such as an alkene or an alkyne is generally described using the model of Dewar-Chatt-Duncanson (DCD)¹⁴⁴. In general lines, this model states that a σ -bond is made by the overlap of the π -orbital of the ligand (alkyne or alkene) with an empty d orbital of suitable symmetry from the metal. In another hand, a π -bond derives from the interaction of a filled d orbital of the metal with the empty antibonding orbital π^* of the ligand (backdonation).

As detailed by A. Fürstner and P. W. Davies^{102f}, there are 4 orbitals of type d of suitable symmetry to interact with an alkyne π -ligand (Figure 2.10).

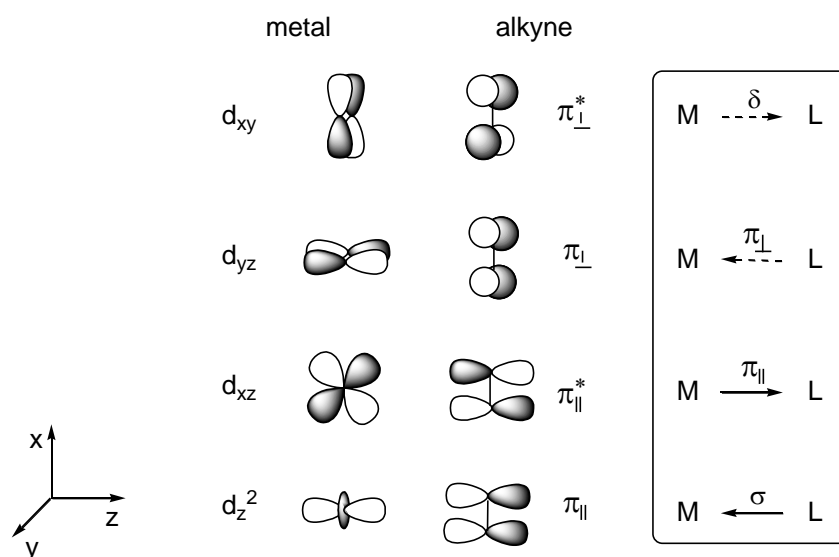

Figure 2.10: Considering possible interactions between d orbitals from the metal and π orbitals from an alkyne ligand, with the model being well applied to d^{10} -Au and d^8 -Pt complexes. (Figure 2.10 was extracted from ref. 102f).

The strongest interactions are the ones coming from the donation $M (d_{z^2}) \leftarrow L (\pi_{\parallel})$ and the back-donation $M (d_{xz}) \rightarrow L (\pi_{\perp}^*)$, which are derived from a better overlap between

¹⁴⁴ Dewar, M. J. S.; *Bull. Soc. Chim. Fr.*, **1951**, 18, C71. (b) Chatt, J.; Duncanson, L. A.; *J. Chem. Soc.*, **1953**, 2939.

parallel orbitals (orbitals drawn in the plane of the paper). Weaker interactions derived from a poorer overlap between orbitals come from the donation $M(d_{yz}) \leftarrow L(\pi_{\perp})$ and back-donation $M(d_{xy}) \rightarrow L(\pi_{\perp}^*)$ (here, the subscripted sign \perp represents orbitals drawn perpendicular to the plane of the paper).

The individual contributions of each orbital interaction have been calculated using high level computational methods. Considering the complex derived from the complexation of gold(I) to ethyne, $[\text{Au}^+(\text{C}_2\text{H}_2)]$, it was found that the Au-alkyne bond is described by *ca.* 65% of the σ -interaction, *ca.* 27% for the in-plane π_{\parallel} back-donation, *ca.* 7% for the orthogonal π_{\perp} , and *ca.* 1% for the δ interaction¹²⁵. In light of these results, one can conclude that alkynes (but this is also true for alkenes) are strong two-electron σ -donors, but fairly poor π -acceptors toward Au(I) (as well as for Pt(II)). Even if back-donation occur to some extent and should not be overlooked^{102f}, comparison to the analogous Cu-ethyne complex shows that in the case of copper, π -backbonding is much more important for copper than for gold. As a general conclusion, gold cannot be considered to participate significantly in Chatt-Dewar-Duncanson-type bonding^{102e}.

In contrast to this energetic situation of π -ligands, are non-bonding p orbitals. Because they are lower in energy than the π^* orbitals of alkenes and alkynes, they are generally more suitable to overlap with the $5d$ filled orbitals of gold. These non-bonding p orbitals are typically found in cationic intermediates (Figure 2.11).

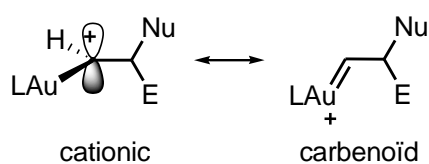
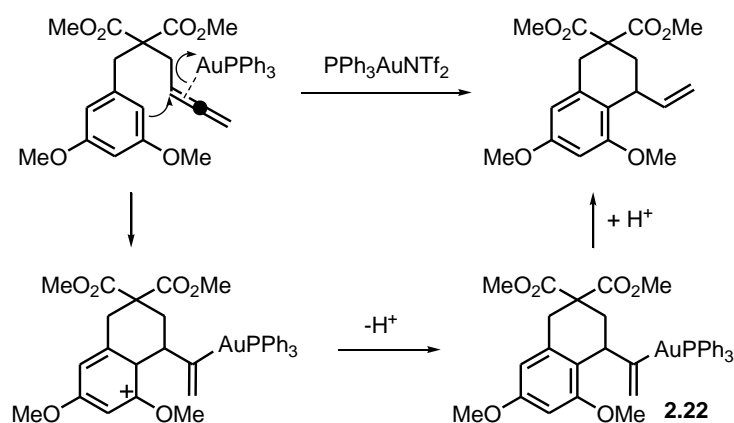

Figure 2.11: Non-ligand p -orbitals are lower in energy than π^* orbitals of π -ligands and thus, more suitable for back-donation from gold. In complexes where strong back-donation is present, the carbenoid mesomeric form should better describe the nature of this intermediate.

2.1.6 Considerations on the nature of vinyl gold species

After a nucleophilic attack on an alkyne or allene activated by gold, a vinyl gold species is generally expected to be formed and then engaged in either a 1,1-trapping or 1,2-trapping processes, as previously discussed in paragraph 2.1.5.2 and 2.1.5.3, respectively. Despite consistent with one's intuition and the product structure observation, this was revealed to be a simplistic view of the whole mechanism.

Gagné *et al.*¹⁴⁵ reported the existence of a diaurated complex **2.23** implicated in the intramolecular Friedel-Crafts reaction on an allene catalyzed by $\text{PPh}_3\text{AuNTf}_2$. This new observed intermediate, which is supposed to engage the vinyl anion in a bridging three-center two-electron mode and being further stabilized by a Au-Au interaction (well established and worth $5\text{-}10\text{ kcal}\cdot\text{mol}^{-1}$ ¹⁴⁶) would account for the greater stability of the more electron deficient and crowded diaurated intermediate **2.23** towards acid when compared to the simpler vinyl gold species **2.22** (scheme 2.9).



Scheme 2.8: Friedel-Crafts reaction on an allene activated by PPh_3Au^+ complex and the generally accepted simplified mechanism¹⁴⁷.

Although it is not clear if **2.23** operates “on” or “off” the cycle under true catalytic conditions or if **2.23** is directly protodeaurated instead of **2.22**, the above results indicate that **2.22** and **2.23** are both viable intermediates in the intramolecular hydroarylation of allenes and an additional structure corresponding to **2.23** should be added to the

¹⁴⁵ Weber, D.; Tarselli, M.A.; Gagné, M. R.; *Angew. Chem. Int. Ed.*, **2009**, 48, 5733.

¹⁴⁶ Schmidbauer, H.; *Chem. Soc. Rev.*, **1995**, 24, 391.

¹⁴⁷ See also: Tarselli, M. A.; Gagné, M. R.; *J. Org. Chem.*, **2008**, 73, 2439.

mechanism of scheme 2.8. This means that the mechanism implicated in this hydroarylation process, as well as it possibly suggests for other gold-mediated mechanisms, is more complex than one could initially “naively” imagine.

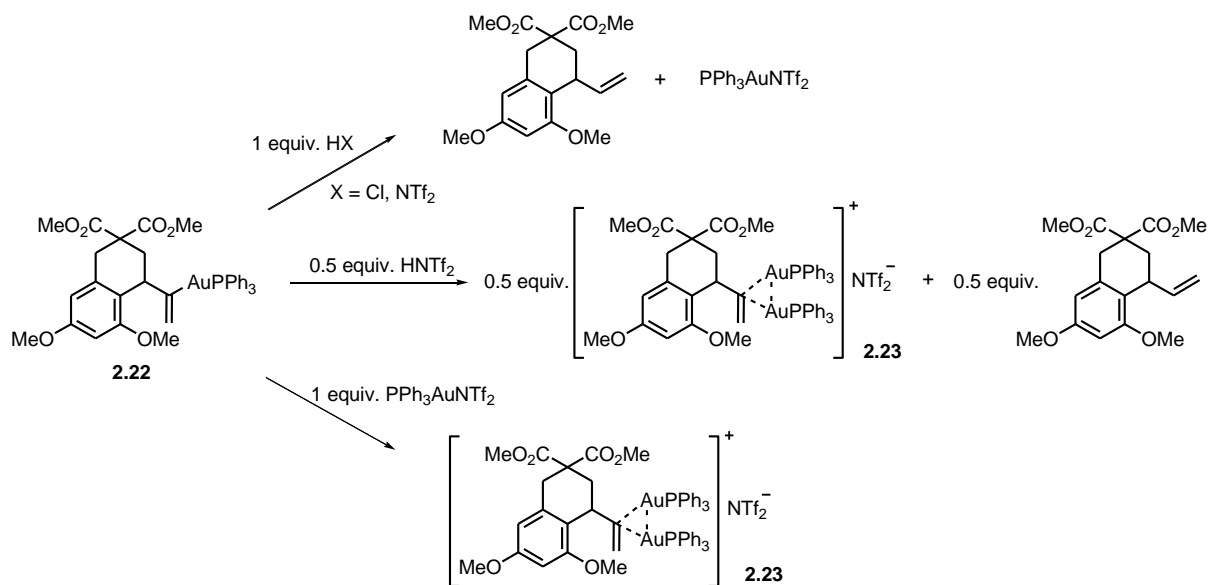

Scheme 2.9: Study of reactivity of intermediate **2.22** (Scheme 2.9 was extracted from ref. 145).

CHAPTER 3: SYNTHESIS OF FUNCTIONALIZED OXAZOLONES BY A SEQUENCE OF Cu(II) AND Au(I)-CATALYZED TRANSFORMATIONS

This work was developed with contributions from the students Andrea K. Buzas, Florin M. Istrate, and Yann Odabachian. Complementary reading can be found in previous reports on this subject¹⁴⁸. With the concern for a clear exposal of the subject, all the experiments performed will be presented herein, nevertheless, the ones done by the author of this thesis will be marked with a red star (*).

Part of the results exhibited here was published in the journal Organic Letters: Istrate, F.; Buzas, A. K.; Jurberg, I. D.; Odabachian, Y.; Gagosz, F.; *Org. Lett.*, **2008**, 10, 5, 925.

¹⁴⁸ (a) Buzas, A. K.; *PhD. Thesis Ecole Polytechnique*, **2009**, Chapter 4, pp. 116-148. (b) Istrate, F. M.; *PhD Thesis Ecole Polytechnique*, **2009**, Chapter 4, pp. 91-112.

3.1 INTRODUCTION:

3.1.1 Importance of 4-Oxazol-2-ones

4-oxazol-2-ones are an important class of heterocycles, whose biological importance has been recognized over the past years. For instance, combretoxazalone derivatives¹⁴⁹, such as **3.1**, are reported to exhibit cytotoxic and antitumor properties; 4-substituted 3-aryl-5-*tert*-butyl-4-oxazol-2-ones¹⁵⁰, such as **3.2**, have been described as powerful herbicides; 3,4-diaryloxazolones¹⁵¹, such as **3.3**, as anti-inflammatory agents; and compound **3.4** as possessing antimicrobial properties¹⁵² (Figure 3.1).

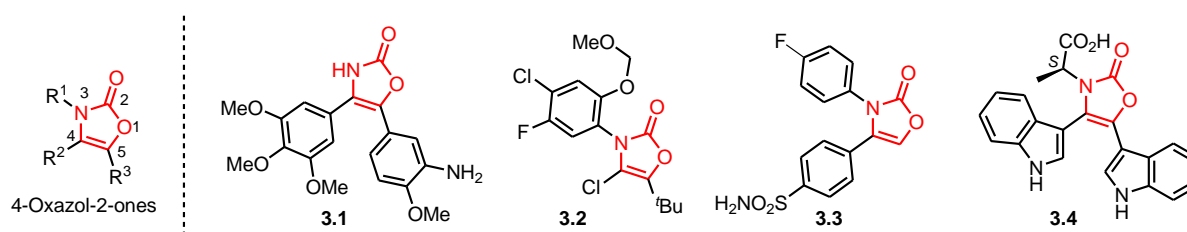

Figure 3.1: Examples of biological active 4-oxazol-2-ones.

3.1.2 Synthesis of 4-Oxazol-2-ones

4-Oxazol-2-ones can be synthesized following a great number of protocols. Moreover, general strategies to assemble such molecules can be reduced to a few common intermediates. Some of these methods, arguably judged of wide generality, will be briefly presented below.

¹⁴⁹ Nam, N. -H.; Kim, Y.; You, Y.-J.; Hong, D.-H.; Kim, H.-M.; Ahn, B.-Z.; *Bioorg. Med. Chem. Lett.*, **2001**, 11, 3073.

¹⁵⁰ Kudo, N.; Tanigushi, M.; Furuta, S.; Sato, K.; Endo, T.; Honma, T.; *J. Agric. Food Chem.*, **1998**, 46, 5305.

¹⁵¹ Puig, C.; Crespo, M. I.; Godessart, N.; Feixas, J.; Ibarzo, J.; Jimenez, J. -M.; Soca, L.; Cardelus, I.; Heredia, A.; Miralpeix, M.; Puig, J.; Beleta, J.; Huerta, J. M.; Lopez, M.; Segarra, V.; Ryder, H.; Palacios, J. M.; *J. Med. Chem.*, **2000**, 43, 214.

¹⁵² Rodrigues Pereira, E.; Sancelme, M.; Voldoire, A.; Prudhomme, M.; *Bioorg. Med. Chem. Lett.*, **1997**, 7, 2503.

Oxazolones can be accessed from (*N*-aryl-*N*-hydroxy)-acetylammides through a thermally¹⁵³ or photolytic induced rearrangement¹⁵⁴, or upon treatment with triethylamine and *p*-nitrobenzenesulphonylchloride¹⁵⁵. In addition, mesylated (*N*-aryl-*N*-hydroxy)-acetylammide under basic conditions and sonication¹⁵⁶ can also be rearranged to the corresponding 4-oxazol-2-one (Scheme 3.1).

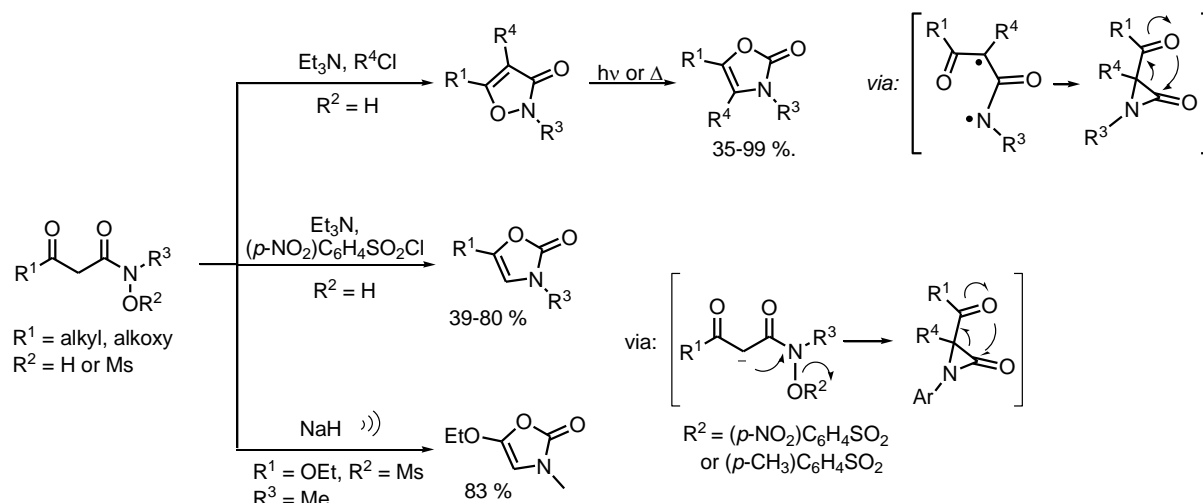

Scheme 3.1: Some examples of oxazolones synthesis starting from (*N*-aryl-*N*-hydroxy)-acetylammides derivatives.

Other straightforward methods to assemble the oxazolone core consist of the treatment of α -hydroxy ketones with isocyanates¹⁵⁷, α -aminoketones with a base and phosgene¹⁵⁸, and from the N-/O-exchange from cyclic carbonates¹⁵⁹ (scheme 3.2).

¹⁵³ Gagneux, A. R.; Goschke, R.; *Tetrahedron Lett.*, **1966**, 7, 45, 5451.

¹⁵⁴ (a) Nakagawa, M.; Nakamura, T.; Tomita, K.; *Agric. Biol. Chem.*, **1974**, 38, 2205. (b) Göth, H.; Gagneux, A. R.; Eugster, C. H.; Schmid, H.; *Helv. Chim. Acta*, **1967**, 50, 19, 137. For the same rearrangement for a close related product, see: (c) Rokach, J.; Hamel, P.; *J. Chem. Soc., Chem. Comm.*, **1979**, 786.

¹⁵⁵ Sato, K.; Kinoto, T.; Sugai, S.; *Chem. Pharm. Bull.*, **1986**, 34, 4, 1553.

¹⁵⁶ Hoffman, R. V.; Reddy, M. M.; Cervantes-Lee, F.; *J. Org. Chem.*, **2000**, 65, 2591.

¹⁵⁷ See refs. 149 and 150.

¹⁵⁸ Hamad, M. O.; Kiptoo P. K.; Stinchcomb, A. L.; Crooks, P.; *Bioorg. Med. Chem.*, **2006**, 14, 20, 7051.

¹⁵⁹ (a) Shehan, J. C.; Guziec, F. S.; *J. Am. Chem. Soc.*, **1972**, 94, 6561. (b) Shehan, J. C.; Guziec, F. S.; *J. Org. Chem.*; **1973**, 38, 3034. (c) Kanaoka, M.; Kurata, Y.; *Chem. Pharm. Bull.*, **1978**, 26, 660.

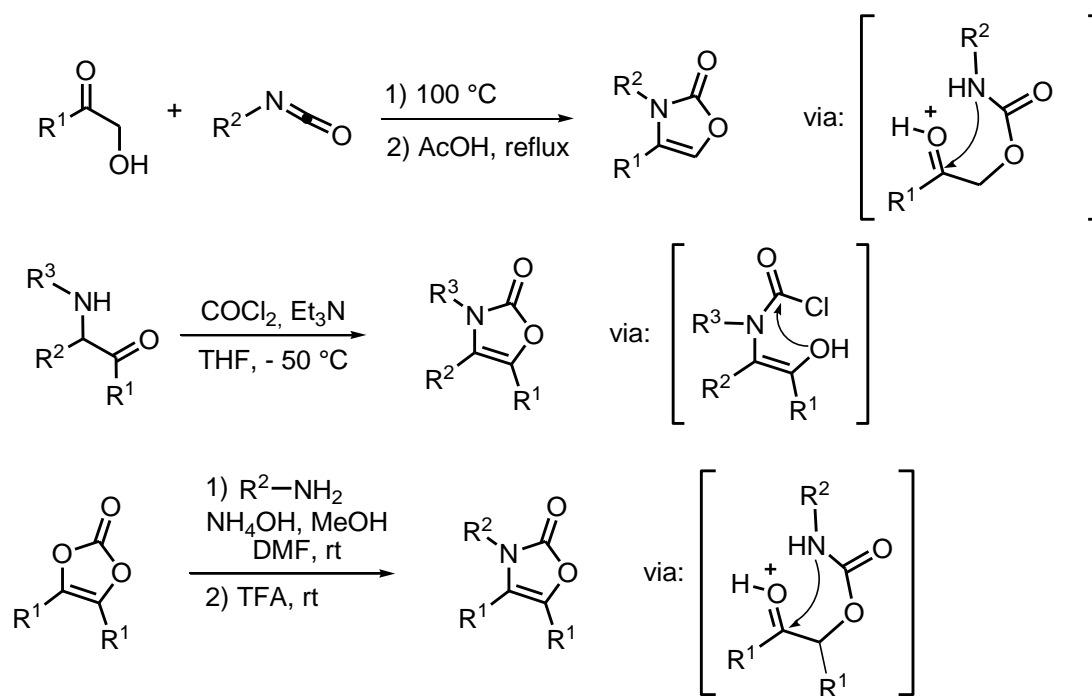

Scheme 3.2: Some of the common strategies to synthesize oxazolones.

3.1.3 Chemistry of Ynamines and Ynamides

Since the first preparation of an ynamine reported in the literature in 1892 by J. Bode¹⁶⁰ and the subsequent developments that culminated with the first general method for ynamine synthesis reported by Viehe in 1963¹⁶¹, reactivity of such alkynes started to be more deeply explored. However, unlike its close relative enamines, their synthetic potential did not consolidate. The reason for that is the fact ynamines are difficult to prepare and to handle, with their sensitivity toward hydrolysis and their reactivity toward electrophiles thus making such molecules generally inaccessible synthetically. A clever way to solve this problem is to attenuate the electron density on the nitrogen atom of ynamines by adding an electron withdrawing group, or through substitutions in the alkyne, thus improving ynamines stability.

Today, the term ynamides is employed to generally refer to electron-deficient ynamines carrying an EWG on the nitrogen atom. Examples of simple ynamines (compounds **3.1-3.5**) and ynamides are shown below (compounds **3.6-3.9**)¹⁶² (figure 3.2).

¹⁶⁰ Bode, J.; *Liebigs Ann. Chem.*, **1892**, 267, 268.

¹⁶¹ Viehe, H. G.; *Angew. Chem. Int. Ed.*, **1963**, 2, 477.

¹⁶² Hsung, R. P.; *Tetrahedron*, **2006**, 62, 3781.

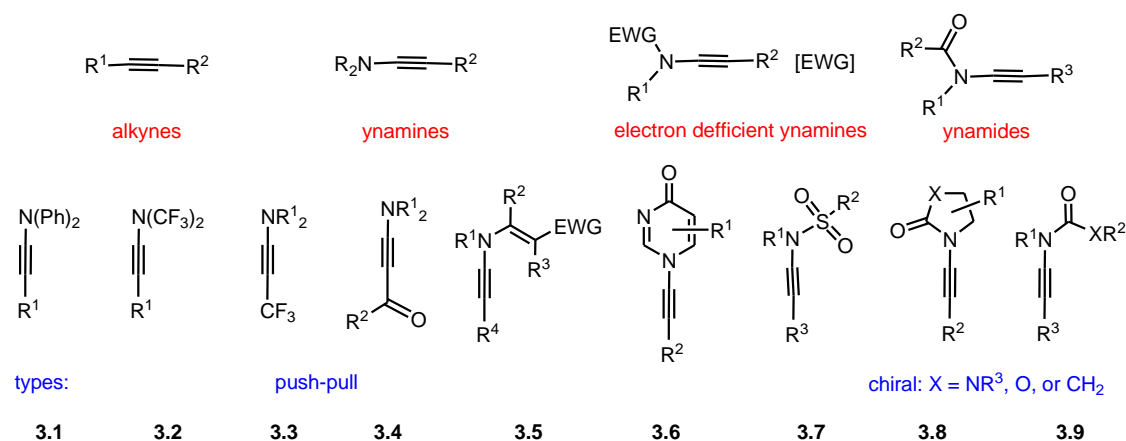

Figure 3.2: Presentation of different classes of ynamines (Figure 3.2 was extracted from ref. 162).

Ultimately, the more stable ynamides¹⁶³ gave birth to the *renaissance* of ynamines chemistry and have been applied to a large variety of processes, ranging from cycloadditions¹⁶⁴, metathesis reactions¹⁶⁵, enamide synthesis¹⁶⁶, α -aminoamidines synthesis¹⁶⁷, indole synthesis¹⁶⁸, radical¹⁶⁹, metal¹⁷⁰ and Brønsted acid¹⁷¹ promoted

¹⁶³ For recent reviews, see: (a) DeKorver, K. A.; Li, H.; Lohse, A. G.; Hayashi, R.; Lu, Z.; Zhang, Y.; Hsung, R. P.; *Chem. Rev.*, **2010**, 110, 9, 5064. (b) Evano, G.; Coste, A.; Jouvin, K.; *Angew. Chem. Int. Ed.*, **2010**, 49, 2840.

¹⁶⁴ For examples of [4+2] additions, see: (a) Dunetz, J. R.; Danheiser, R. D.; *J. Am. Chem. Soc.*, **2005**, 127, 5776. For an example of [2+2] addition, see: (b) Riddell, N.; Villeneuve, K.; Tam, W.; *Org. Lett.*, **2005**, 7, 17, 3681. (c) Kohlén, A. L.; Mak, X. Y.; Lam, T. Y.; Dunetz, J. R.; Danheiser, R. L.; *Tetrahedron*, **2006**, 62, 3815. For an example of [2+2+2] reaction, see: (d) Tanaka, K.; Takeishi, K.; Noguchi, K.; *J. Am. Chem. Soc.*, **2006**, 128, 4586.

¹⁶⁵ (a) Saito, N.; Sato, Y.; Mori, M.; *Org. Lett.*, **2002**, 4, 5, 803. (b) Huang, J.; Xiong, H.; Hsung, R. P.; Rameshkumar, C.; Mulder, J. A.; Grebe, T. P.; *Org. Lett.*, **2002**, 4, 14, 2417.

¹⁶⁶ Gourdet, B.; Lam, H. W.; *J. Am. Chem. Soc.*, **2009**, 131, 3802.

¹⁶⁷ Kim, J. Y.; Kim, S. H.; Chang, S.; *Tetrahedron Lett.*, **2008**, 49, 1745.

¹⁶⁸ (a) Couty, S.; Liégault, B.; Meyer, C.; Cossy, J.; *Org. Lett.*, **2004**, 6, 15, 2511. (b) Dooleweerd, K.; Ruhland, T.; Skrydstrup, T.; *Org. Lett.*; **2009**, 11, 1, 221.

¹⁶⁹ (a) Marion, F.; Courillon, C.; Malacria, M.; *Org. Lett.*, **2003**, 5, 5095. (b) Marion, F.; Coulomb, J.; Servais, A.; Courillon, C.; Fensterbank, L.; Malacria, M.; *Tetrahedron*, **2006**, 62, 3882.

¹⁷⁰ For Au based methods, see: (a) Couty, S.; Meyer, C.; Cossy, J.; *Angew. Chem. Int. Ed.*, **2006**, 45, 6726. (b) Buzas, A. K.; Istrate, F.; Le Goff, X. F.; Odabachian, Y.; Gagosz, F.; *J. Organom. Chem.*, **2009**, 694, 515. For a Pd-based method, see: (c) Zhang, Y.; DeKorver, K. A.; Lohse, A. G.; Zhang, Y.-S.; Huang, J.; Hsung, R. P.; *Org. Lett.*, **2009**, 11, 4, 899. For the use of BF₃·OEt₂ and Zn(OTf)₂, see: (d) Kurtz, K. C. M.; Hsung, R. P.; Zhang, Y.; *Org. Lett.*; **2006**, 8, 2, 231.

¹⁷¹ (a) Zhang, Y.; Hsung, R. P.; Zhang, X.; Huang, J.; Slafer, B. W.; Davis, A.; *Org. Lett.*, **2005**, 7, 6, 1047. (b) Gonzalez-Rodriguez, C.; Escalante, L.; Varela, J. A.; Castedo, L.; Saa, C.; *Org. Lett.*, **2009**, 11, 17, 1531.

(cyclo)isomerizations to their application in natural product synthesis¹⁷². Some examples are shown below (scheme 3.3).

a)

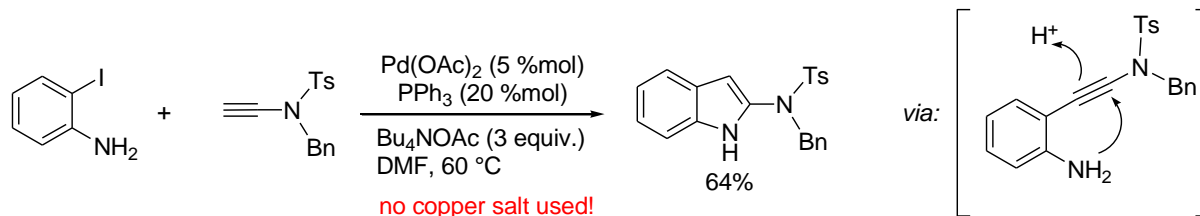

b)

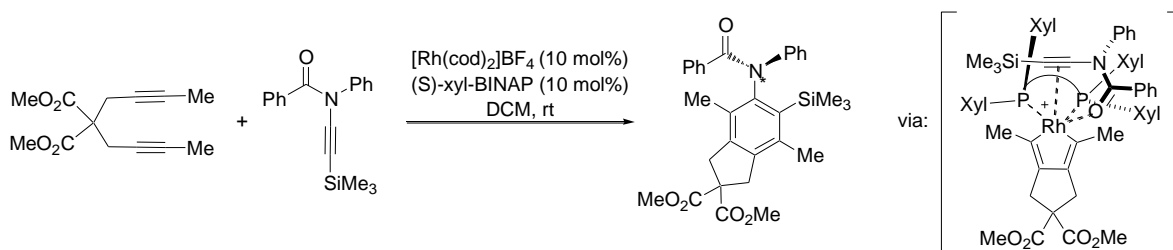

c)

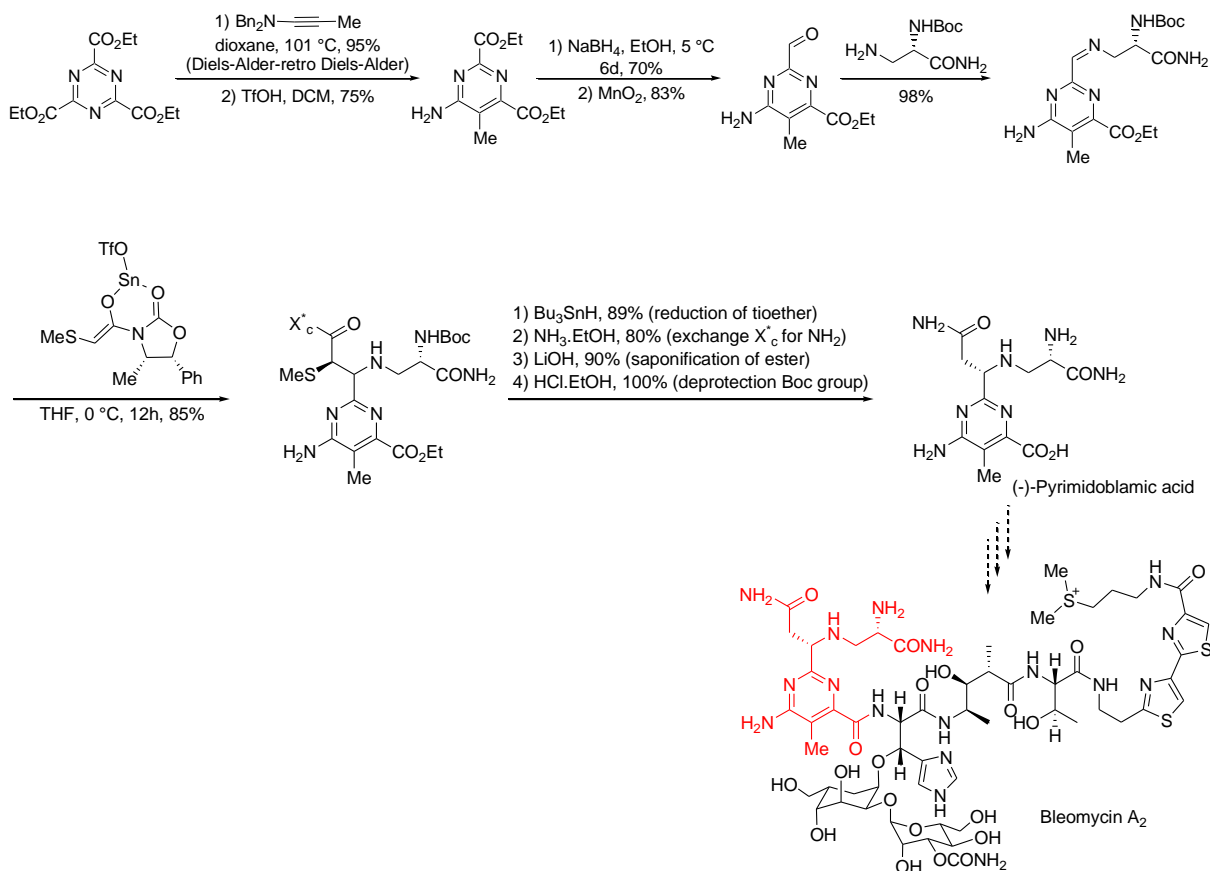

¹⁷²(a) Boger, D. L.; Honda, T.; Dang, Q.; *J. Am. Chem. Soc.*, **1994**, 116, 13, 5619. (b) see ref. 159a (c) Couty, S.; Meyer, C.; Cossy, J.; *Tetrahedron Lett.*, **2006**, 47, 5, 767.

Scheme 3.3: Three examples of ynamines applied in synthesis. **a)** 2-amino-indole synthesis through a Sonogashira coupling followed by spontaneous amino addition to the triple bond. **b)** Enantioselective synthesis of axially chiral anilides through rhodium promoted [2+2+2] cycloaddition. **c)** Synthesis of (-)-Pyridoblamic acid, the pyrimidine metal binding domain of Bleomycin A₂ through a Diels-alder-retro Diels-Alder sequence using 1-(dibenzylamino)propyne.

3.1.3.1 Synthesis of Ynamides

Due to the importance of ynamides as synthetically stable ynamine synthons, growing efforts have been consacrated to the development of new methodologies towards the synthesis of such molecules.

Isomerization of N-propargylated compounds was recognized by Hsung *et al.*¹⁷³ as a fast and practical route to ynamides. Nevertheless, this process proved to be highly sensitive to the electron-withdrawing group on the nitrogen atom. For instance, carbamates were reported to stop at the allene intermediate. On the other hand, amides are fully isomerized to the corresponding ynamides¹⁷³ (scheme 3.4).

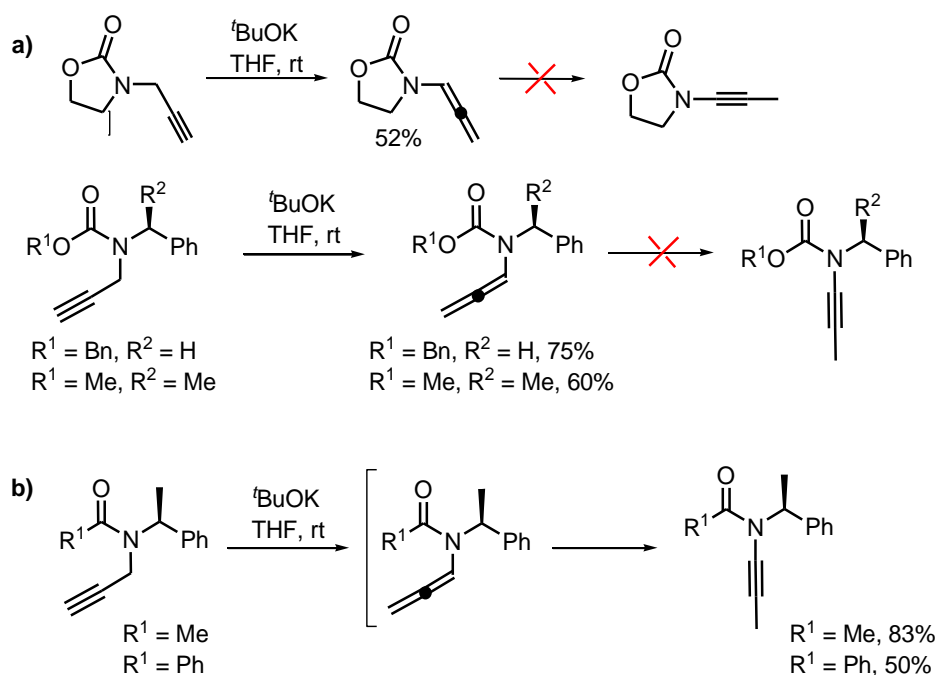

¹⁷³ Wei, L.-L.; Mulder, J. A.; Xiong, H.; Zifcsak, C. A.; Douglas, C. J.; Hsung, R. P.; *Tetrahedron*, **2001**, 57, 459.

Scheme 3.4: Attempts in the isomerization of *N*-propargyl derivatives. **a)** *N*-propargyl carbamates fail to completely isomerize to the corresponding ynamide and stop at the allenamide intermediate. **b)** In contrast, *N*-propargyl amides isomerize under the same conditions to the corresponding ynamides.

Another possible route to ynamides¹⁶² is the elimination reaction from bromoenamides. Although the desired ynamide can be obtained, this process is limited to the elimination of *Z*-bromo enamides, with *E*-enamides generally being recovered (scheme 3.5).

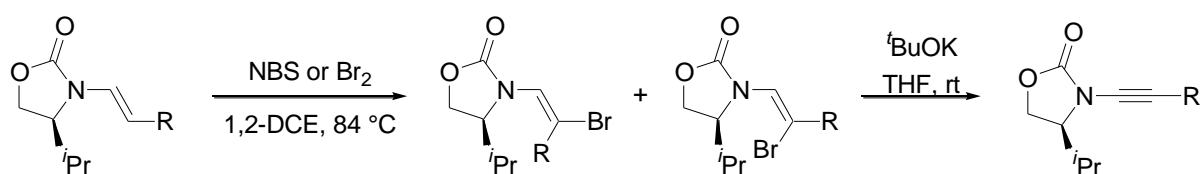

examples:

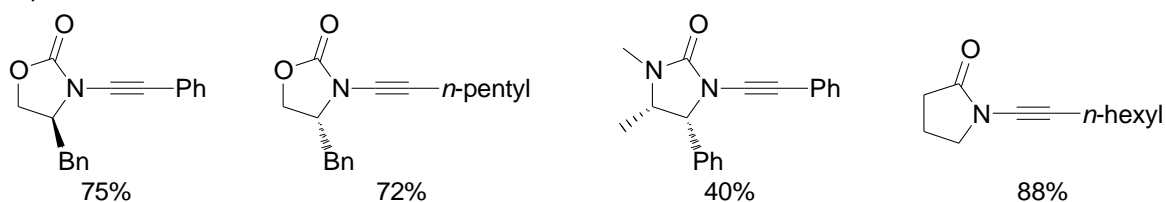

Scheme 3.5: The procedure reported by Hsung *et al.* based on the bromination of enamides followed by elimination, substantially extends the scope of this method first reported by Viehe *et al.*¹⁷⁴, but still presents severe limitations as the elimination step is only possible for *Z*-bromo enamides.

The Corey-Fuchs derived methods from formamides **3.10** are also a possible route to ynamides. These compounds react with triphenylphosphine and tetrachloromethane to produce β,β -dichloroenamides **3.11**, which upon treatment with a strong base, such as *n*-BuLi, at low temperatures, rearrange to furnish the lithium acetylide anion that can be trapped either by a proton (**3.12**)¹⁷⁵ or another electrophile (**3.13**)¹⁷⁶, or can be

¹⁷⁴ This is considered the first report on ynamide synthesis: Janousek, Z.; Collard, J.; Viehe, H. J.; *Angew. Chem. Int. Ed.*, **1972**, 11, 917.

¹⁷⁵ (a) Brückner, D.; *Synlett*, **2000**, 1402. (b) Brückner, D.; *Tetrahedron*, **2006**, 62, 3809.

¹⁷⁶ Rodríguez, D.; Martínez-Esperón, M. F.; Castedo, L.; Saá, C.; *Synlett*, **2007**, 1963.

transmetalated with ZnBr₂ to be directly engaged in a Negishi cross-coupling reaction with aryl iodides (**3.5**)¹⁷⁷. Conversely, dichloro compound **3.11** can be first submitted to a Suzuki cross-coupling reaction and then undergo chlorine elimination upon treatment with a strong base to form the alkyne moiety. Ynamides **3.12** can also be functionalized through a Sonogashira cross-coupling reaction¹⁷⁸ (Scheme 3.6).

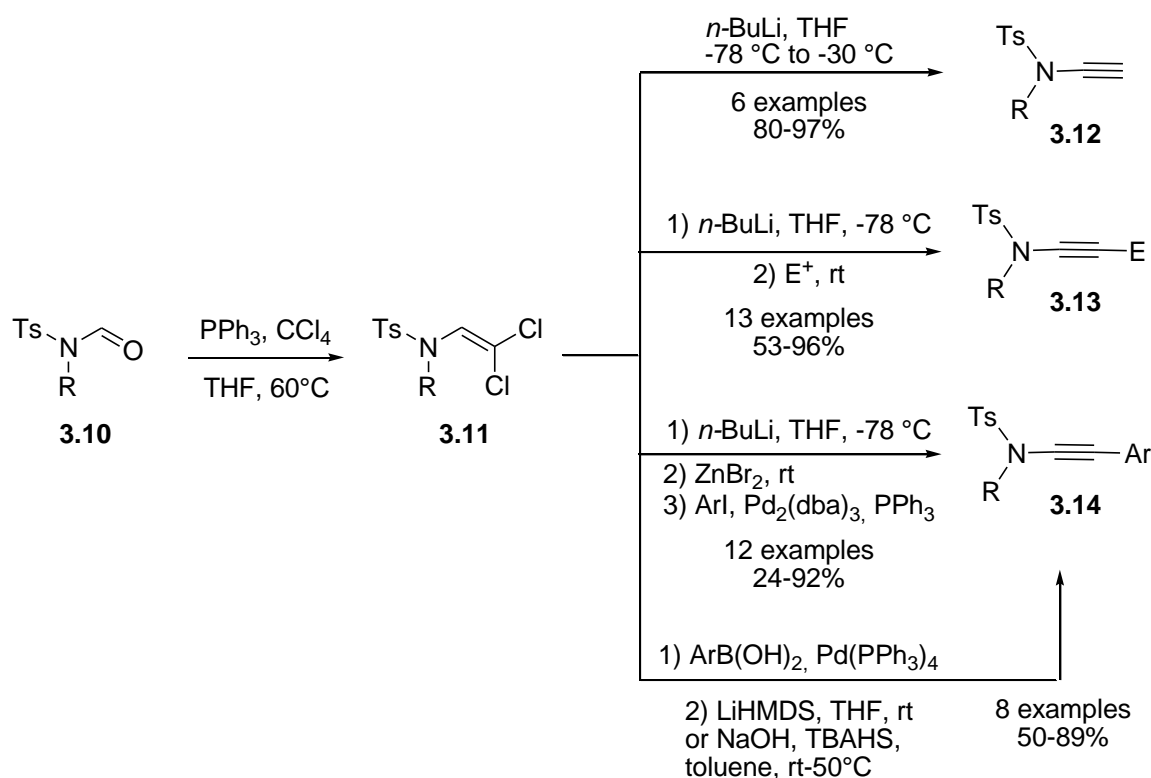

Scheme 3.6: Synthesis of ynamides from formamides. (Scheme 3.6 was extracted from ref. 163b).

Finally, cross-coupling reactions have been found as one of the most efficient routes to ynamides. Today, six main cross-coupling protocols have been established (Figure 3.3).

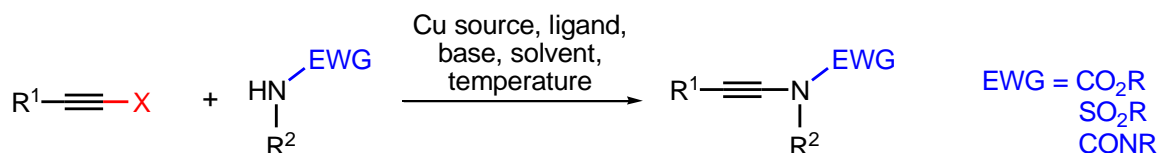

¹⁷⁷ (a) Rodríguez, D.; Castedo, L.; Saá, C.; *Synlett*, **2004**, 783. (b) Martínez-Esperón, M. F.; Rodríguez, D.; Castedo, L.; Saá, C.; *Tetrahedron*, **2006**, 62, 3842.

¹⁷⁸ Tracey, M. R.; Zhang, Y.; Frederick, M. O.; Mulder, J. A.; Hsung, R. P.; *Org. Lett.*, **2004**, 6, 2209.

1) Hsung *et al.*: CuSO₄·5H₂O (5-10 mol%), 1,10-phenantroline (10-20 mol%), K₃PO₄ (2 equiv.) or K₂CO₃ (2 equiv.) toluene, 60 -65 °C, X = Br ref. 179

2) Danheiser *et al.*: CuI (1 equiv.), no ligand KHMDS (1 equiv.), pyridine, rt, X = Br ref. 180

until here: cross-coupling reactions described at the time our work was developed

3) Stahl *et al.*: CuCl₂ (20 mol %), no ligand, O₂ (1 atm) Na₂CO₃ (2 equiv.), pyridine (2 equiv.), toluene, 70 °C, X = H ref. 181

4) Jiao *et al.*: CuCl₂·2H₂O (10 mol %), no ligand, under air Na₂CO₃ (2 equiv.), toluene, 100 °C, X = CO₂H ref. 182

5) Evano *et al.*: CuCl₂·2H₂O (15 mol%), 1,2-dimethylimidazole (40 mol%), O₂ (1 atm) 4A molecular sieves, CH₂Cl₂, rt, X = BF₃K ref. 183

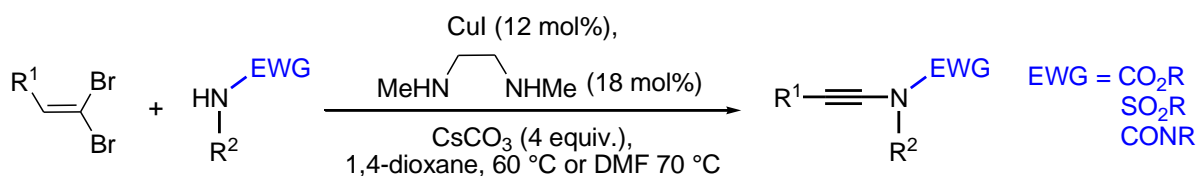

6) Evano *et al.*: ref. 184

Figure 3.3: List of cross-coupling reactions employed to assemble ynamides.

All the aforementioned methods afford the desired ynamides with good yields, notwithstanding some advantages of a few protocols over others. For instance, Danheiser's (Method 2) and Evano's (Method 5) protocols are the only reports on the coupling reaction at room temperature. On one hand, Danheiser's method uses 1 equiv. of amine derivative, 2 equiv. of bromoalkyne and a stoichiometric quantity of copper salt. On the other hand, Evano's method 5 uses catalytic quantity of a copper salt, but 5 equiv. of amine derivatives with 1 equiv. of the alkyne coupling partner (5 equiv. of amine derivative are also needed in Stahl's protocol, method 3).

Among these previous six methods, two of the most interesting ones are Hsung's method 1, which employs almost equal amounts of coupling partners (1.1 equiv. of alkyne

¹⁷⁹ (a) Zhang, Y.; Hsung, R. P.; Tracey, M. R.; Kurtz, K. C. M.; Vera, E. L.; *Org. Lett.*, **2004**, 6, 7, 1151. For a preliminary report, see: (b) Frederick, M. O.; Mulder, J. A.; Tracey, M. R.; Hsung, R. P.; Huang, J.; Kurtz, K. C. M.; Shen, L.; Douglas, C. J.; *J. Am. Chem. Soc.*, **2003**, 125, 2368.

¹⁸⁰ Dunetz, J. R.; Danheiser, R. L.; *Org. Lett.*, **2003**, 5, 21, 4011.

¹⁸¹ Hamada, T.; Ye, X.; Stahl, S. S.; *J. Am. Chem. Soc.*, **2008**, 130, 833.

¹⁸² Jia, W.; Jiao, N.; *Org. Lett.*, **2010**, 12, 9, 2000.

¹⁸³ Jouvin, K.; Couty, F.; Evano, G.; *Org. Lett.*, **2010**, 12, 14, 3272.

¹⁸⁴ Co, A.; Karthikeyan, G.; Couty, F.; Evano, G.; *Angew. Chem. Int. Ed.*; **2009**, 48, 4381.

and 1.0 equiv. of amine derivatives) and Evans's method 6 where the bromo alkyne is formed in the course of the reaction and its vinyl dibromo precursor being easily obtained from the corresponding aldehydes.

Nitrogen containing compounds successfully employed in the aforementioned cross-coupling reactions are shown below (Figure 3.4).

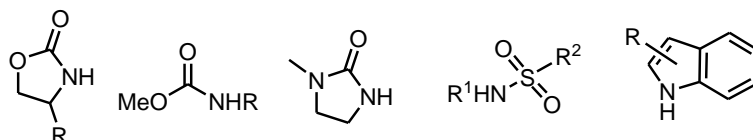
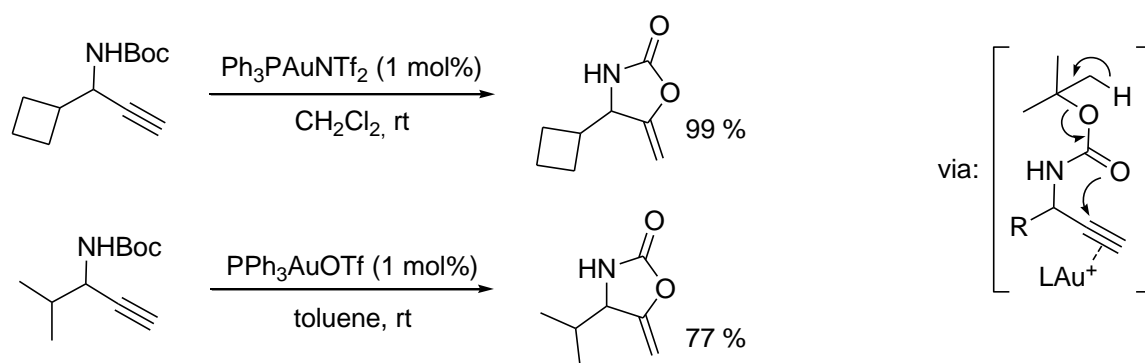

Figure 3.4: List of typical frameworks used in C_{sp} -N cross coupling reactions.

3.2 Boc-CYCLIZATION ON ALKYNES: Literature background and previous work in our laboratory

In previous studies from our group and others, the 5-*exo dig* cyclization of propargyl Boc-carbamates¹⁸⁵ and –carbonates¹⁸⁶ was reported to afford alkylidene cyclic carbamates and carbonates, respectively. A brief overview is shown below (Scheme 3.7).



¹⁸⁵ For Au mediated Boc-cyclization of propargyl carbamates, see: (a) Buzas, A.; Gagosz, F.; *Synlett*, **2006**, 2727. (b) Robles-Machin, R.; Adrio, J.; Carretero, J. C.; *J. Org. Chem.*, **2006**, 71, 5023. (c) Lee, E.-S.; Yeom, H.S.; Hwang, J.-H.; Shin, S.; *Eur. J. Org. Chem.*, **2007**, 3503.

¹⁸⁶ (a) For Boc-cyclization of propargyl carbonates using gold, see: (a) Buzas, A.; Gagosz, F.; *Org. Lett.*, **2006**, 8, 515. (b) Buzas, A. K.; Istrate, F. M.; Gagosz, F.; *Tetrahedron*, **2009**, 65, 1889. (c) Kang, J.-E.; Shin, S.; *Synlett*, **2006**, 717. For the use of mercury, see: (d) Yamamoto, H.; Nishiyama, M.; Imagawa, H.; Nishizawa, M.; *Tetrahedron Lett.*, **2006**, 47, 8369.

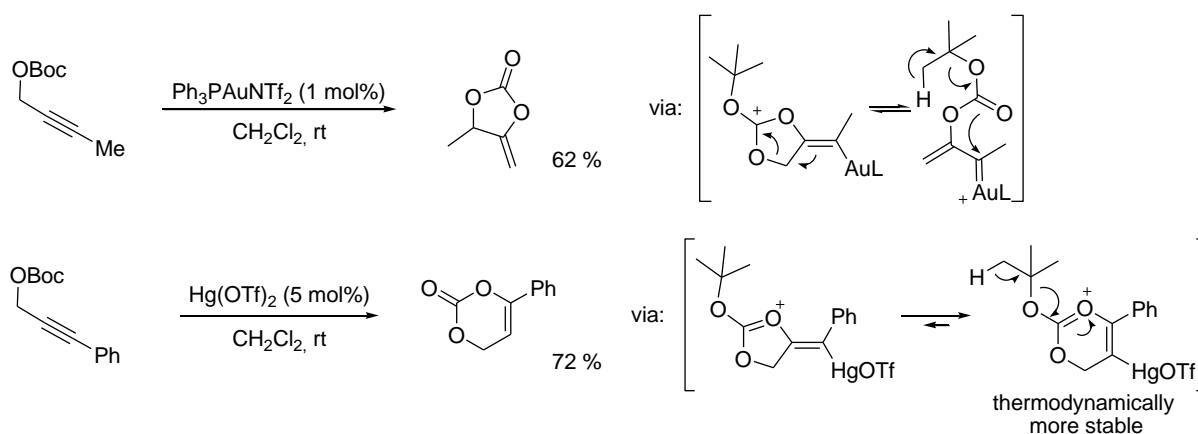

Scheme 3.7: Literature background based on previous work from our group and others.

3.3 RESULTS AND DISCUSSION

3.3.1 The initial idea

Although the alkyldene cyclic carbamates can be isomerized to 4-oxazol-2-ones under acidic conditions¹⁸⁷ (scheme 3.8), our group was interested in a more straightforward route to such molecules.

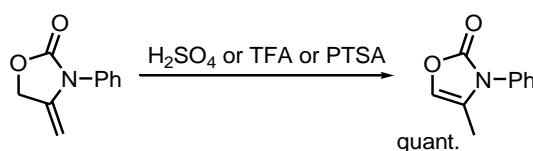

Scheme 3.8: Isomerization of alkyldene carbamates under acidic conditions

Furthermore, we were also interested if the 5-*endo dig* cyclization, equally favorable as the previous 5-*exo* process shown above, as predicted by the empirical Baldwin rules¹⁸⁸, would be accessible through the gold mediated rearrangement of the corresponding ynamides homologues (scheme 3.9). Also an aspect of interest to us was the extension of the reaction scope of ynamide cross-coupling reactions for Boc derivatives, first reported by Hsung *et al.*, which at the time our work was performed, was quite restricted (see figure 3.3).

¹⁸⁷ Stoffel, P. J.; Dixon, W. D.; *J. Org. Chem.*, **1964**, 29, 978.

¹⁸⁸ (a) Baldwin, J. E.; *J. Chem. Soc., Chem. Commun.*, **1976**, 734. (b) Johnson, C. D.; *Acc. Chem. Res.*, **1993**, 26, 476.

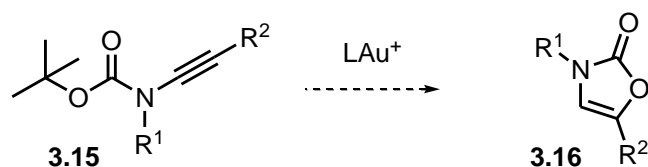

Scheme 3.9: hypothesis concerning the gold-mediated 5-endo dig cyclization process of ynamides tested in this project.

As necessary precursors for the cross-coupling reaction that would afford ynamides **3.15a-v**, *tert*-butyloxy carbamates **3.18a-h** were synthesized using Boc_2O in different solvents¹⁸⁹ (table 3.1).

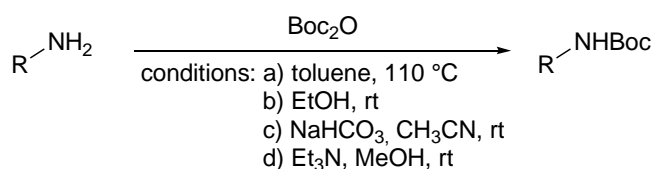

substrate	product	conditions	time	yield
	 3.18a	a	2 h	82 %
	 3.18b	a	1 h	85 %*
	 3.18c	a	2 h	43 %
	 3.18d	a	3 h	70 %
	 3.18e	a	1 h	95 %*
	 3.18f	b	5 min	83 %*

¹⁸⁹ (a) Schlosser, M.; Ginanneschi, A.; Leroux, F.; *Eur. J. Org. Chem.*, **2006**, 2006, 2956. (b) Vilavain, T.; *Tetrahedron Lett.*, **2006**, 47, 6739. (c) Simpson, G. L.; Gordon, A. H.; Lindsay, D. M.; Promsawan, N.; Crump, M. P.; Mulholland, K.; Hayter, B. R.; Gallagher, T.; *J. Am. Chem. Soc.*, **2006**, 128, 10638. (d) Yuste, F.; Ortiz, B.; Carrasco, A.; Peralta, M.; Quintero, L.; Sánchez-Obregón, R.; Walls, F.; Garcia-Ruano, J. L.; *Tetrahedron: Asymmetry*, **2000**, 11, 3079.

substrate	product	conditions	time	yield
	 3.18g	c	24 h	47 %
	 3.18h	d	24 h	90 %
	 3.18i	a	2 h	83 %

Table 3.1: Carbamates synthesized in this project

The synthesis of ynamides was inspired from Hsung's protocol^{179a}, with a slight modification of reagent proportions (our protocol: 1 equiv. of bromoalkyne, 1.2 equiv. of carbamate, 2.4 equiv. of K₃PO₄, 0.2 equiv. of CuSO₄·5H₂O and 0.4 equiv. of 1,10-phenanthroline, toluene, 80 °C). The scope of this method was then more deeply studied, with 22 examples of Boc-ynamides being synthesized, possessing neutral, electron rich and electron poor groups on the aromatic ring **3.18a-3.18e**, esters **3.18g** and **3.18h** for the amine part, and ester **3.17e**, silyl ether **3.17f** and a bulky alkyne partner **3.17i** for the bromo alkyne part, being tolerated (table 3.2).

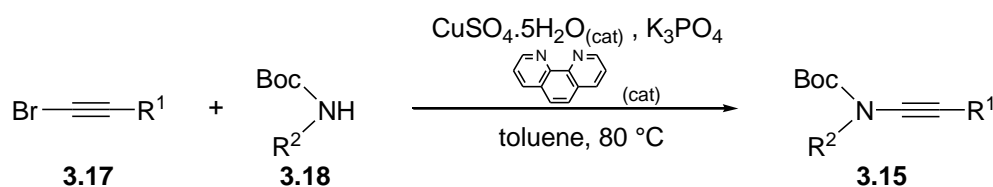

entry	bromoalkyne	carbamate	ynamide	time	yield
1	 3.17a	 3.18a	 3.15a	40 h	80%
2	3.17a	 3.18b	 3.15b	16 h	65%*

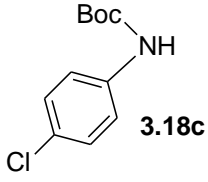
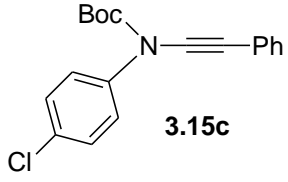
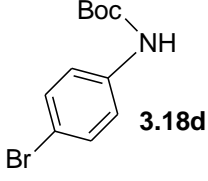
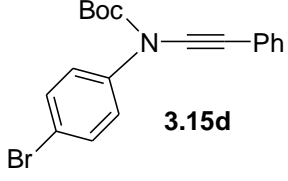
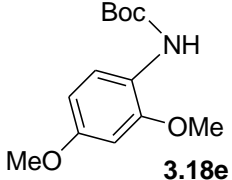
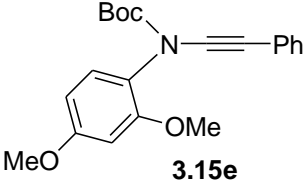
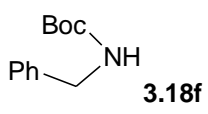
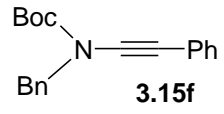
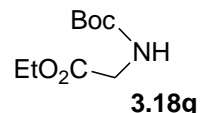
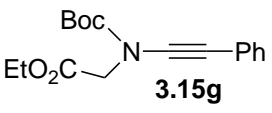
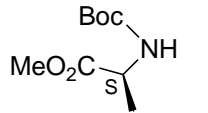
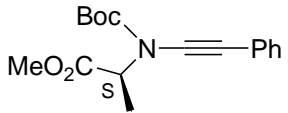
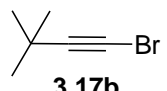
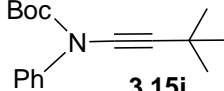
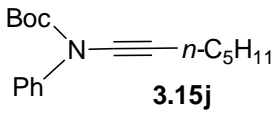
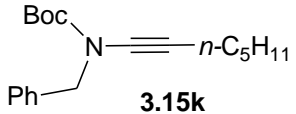
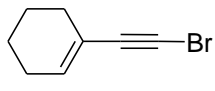
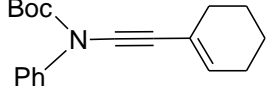
entry	bromoalkyne	carbamate	ynamide	time	yield
3	3.17a	 3.18c	 3.15c	18 h	68%
4	3.17a	 3.18d	 3.15d	16 h	48%
5	3.17a	 3.18e	 3.15e	48 h	22%*
6	3.17a	 3.18f	 3.15f	48 h	62%*
7	3.17a	 3.18g	 3.15g	36 h	70%
8	3.17a	 3.18h	 3.15h	48 h	23%
9	 3.17b	3.18a	 3.15i	38 h	24 %
10	$n\text{-C}_5\text{H}_{11}\text{-C}\equiv\text{C-Br}$ 3.17c	3.18a	 3.15j	52 h	75 %*
11	3.17c	3.18f	 3.15k	48 h	69 %
12	 3.17d	3.18a	 3.15l	67 h	72 %

entry	bromoalkyne	carbamate	ynamide	time	yield
13	3.17d	3.18c	 3.15m	67 h	80 %
14	3.17d	3.18g	 3.15n	67 h	50 %
15	 3.17e	3.18a	 3.15o	65 h	55 %*
16	3.17e	 3.18i	 3.15p	48h	49%
17	3.17e	3.18f	 3.15q	48 h	49 %*
18	3.17e	3.18i	 3.15r	72 h	49 %*
19	 3.17f	3.18a	 3.15s	45 h	88 %
20	3.17f	3.18f	 3.15t	62 h	72 %*
21	 3.17g	3.18a	 3.15u	48 h	74 %
22	3.17g	3.18i	 3.15v	48 h	65 %

Table 3.2: Ynamides synthesized in this project.

Having an efficient route to ynamides in hand, we next focused on the cyclization of Boc-ynamides.

The use of the gold complex $\text{PPh}_3\text{AuNTf}_2$, which was reported to work nicely in the case studied by Hashmi *et al.*¹⁹⁰, afforded the desired cyclized product only in poor yields (entry 1, table 3.3). The more electrophilic cationic gold complex $(p\text{-CF}_3\text{Ph})_3\text{PAuNTf}_2$ increased the product conversion, but provided access to only modest yields (entries 2 and 3, table 3.3). Conversely, employment of a different counter-ion on the gold complex, by using $\text{PPh}_3\text{Au}(\text{NCCH}_3)\text{SbF}_6$ considerably increased the reaction yield, affording the desired oxazolone in good yields (entries 4 and 5, table 3.3). Only degradation was obtained with the use of HNTf_2 (entry 6, table 3.3). Noteworthy, the reaction also worked for AgNTf_2 , but less efficiently (entry 7, table 3.3). Finally, optimal conditions were found to be 1 mol% of $\text{PPh}_3\text{Au}(\text{NCCH}_3)\text{SbF}_6$ in refluxing dichloromethane (entry 5, table 3.3).

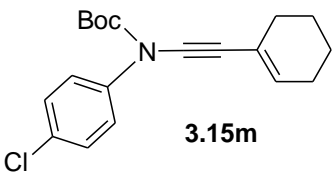
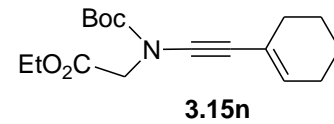
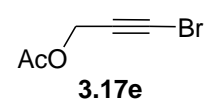
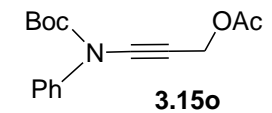
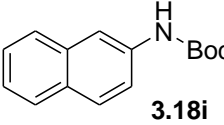
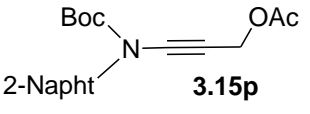
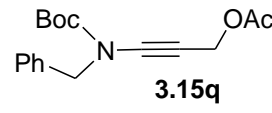
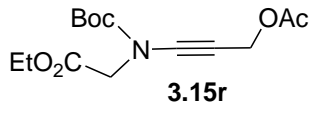
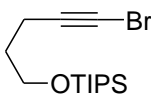
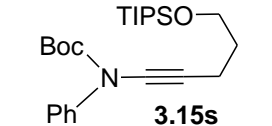
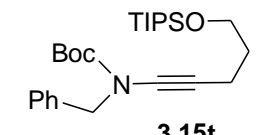
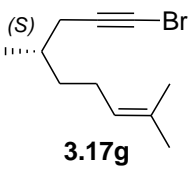
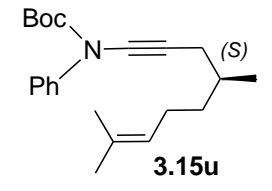
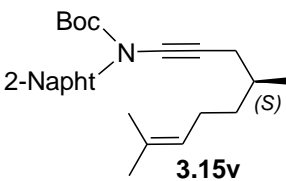
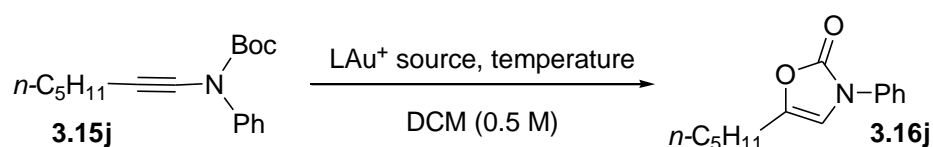

entry	LAu^+ source	temperature	time	conversion ^a	yield
1	$\text{PPh}_3\text{AuNTf}_2$	20 °C	7 h	63 %	28 % ^b
2	$(p\text{-CF}_3\text{Ph})_3\text{PAuNTf}_2$	20 °C	72 h	85 %	52 % ^c
3	$(p\text{-CF}_3\text{Ph})_3\text{PAuNTf}_2$	40 °C	2 h 30 min	100 %	40 % ^c
4	$\text{PPh}_3\text{Au}(\text{NCCH}_3)\text{SbF}_6$	20 °C	4 h 30 min	100 %	69 % ^c
5	$\text{PPh}_3\text{Au}(\text{NCCH}_3)\text{SbF}_6$	40 °C	30 min	100 %	74 % ^b
6	HNTf_2	20 °C	1 h	100 %	degrad.
7	AgNTf_2	20 °C	1h 30 min	100 %	53 %

^a estimated by ¹H NMR. ^b Isolated yield. ^c Estimated by ¹H NMR of the crude reaction mixture

Table 3.3: Catalyst screening for the Au(I)-mediated cyclization of Boc-ynamides.

Accordingly, substrates **3.15a-3.15v** were submitted to the optimal conditions of cyclization. The reaction proved to be compatible with numerous functional groups, aryl,

¹⁹⁰ Hashmi, A. S. K.; Salathé, R. Frey, W.; *Synlett*, **2007**, 1763.

benzyl and acetyl groups on the nitrogen atom, and esters (**3.15o-3.15r**), silyl ethers (**3.15s-3.15t**), aryl (**3.15a-3.15h**), alkyl (**3.15j-3.15n**, **3.15u-3.15v**) and a bulky group (**3.15i**) on the alkyne moiety afforded the desired oxazolones in general good yields (38-94%, table 3.4).

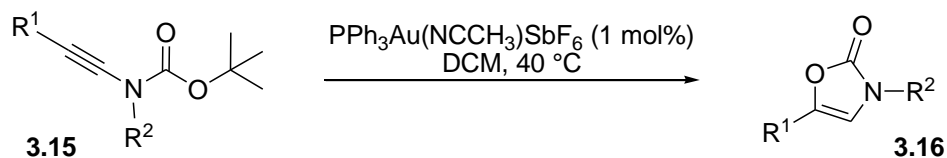

entry	substrate	R ¹	R ²	time	product	yield ^a
1	3.15a		Ph	25 min	3.16a	83%
2	3.15b		<i>p</i> -FPh	10 min	3.16b	88 %
3	3.15c		<i>p</i> -ClPh	10 min	3.16c	88 %
4	3.15d		<i>p</i> -BrPh	10 min	3.16d	83 %
5	3.15e	Ph	2,4-(OMe) ₂ Ph	16 h	3.16e	85 %*
6	3.15f		Bn	16 h	3.16f	78 %
7	3.15g		CH ₂ CO ₂ Et	12 h	3.16g	93 %
8	3.15h		EtO ₂ C- 	8 h	3.16h	94 %
9	3.15i	^t Bu	Ph	2h	3.16i	58 %

10	3.15j	<i>n</i> -C ₅ H ₁₁	Ph	30 min	3.16j	74 %
11	3.15k		Bn	40 min	3.16k	50 % ^b

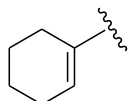
12	3.15l		Ph	30 min	3.16l	78 %
13	3.15m		<i>p</i> -ClPh	10 min	3.16m	94 %
14	3.15n		CH ₂ CO ₂ Et	5 h	3.16n	70 %

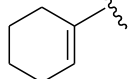
15	3.15o		Ph	40 min	3.16o	71 %
16	3.15p		2-Napht	45 min	3.16p	88 %
17	3.15q	AcO- 	Bn	20 min	3.16q	50 % ^b
18	3.15r		CH ₂ CO ₂ Et	20 min	3.16r	49 %

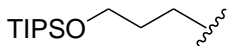
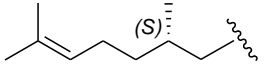
entry	substrate	R ¹	R ²	time	product	yield ^a
19	3.15s		Ph	1 h	3.16s	69 %
20	3.15t		Bn	40 min	3.16t	38 % ^b
21	3.15u		Ph	30 min	3.16u	71 %
22	3.15v		2-Napht	3 h	3.16v	80 %

^aisolated yields. ^bProduct isolation proved difficult due to product instability. Yield determined by ¹H NMR of the crude reaction mixture using 1,3,5-trimethoxybenzene as internal standard.

Table 3.4: Oxazolones synthesized in this project.

For the examples **3.15a-3.15d**, where the reaction time was short, the Ag(I)-mediated cyclization was attempted. In most cases, the desired oxazolones were isolated in good yields (88-96%, scheme 3.11). Nevertheless, this performance was not general, since substrate **3.15o**, for instance, afforded the corresponding oxazolone **3.16o** in poor 36% yield (scheme 3.10).

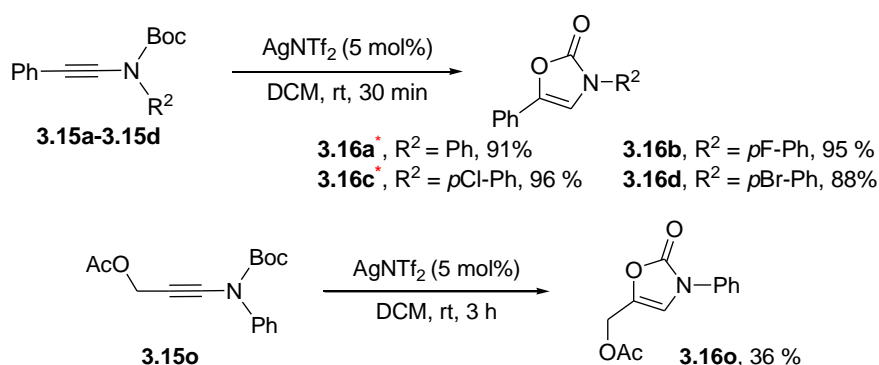

Scheme 3.10: Silver(I)-mediated Boc-cyclization of ynamides proved to work very well in certain cases, although not as general as the gold catalyzed process.

The proposed mechanism is believed to start with the gold activation of the triple bond in the ynamide molecule **3.15** toward cyclization of the nucleophilic oxygen atom of the Boc group, generating the cationic stabilized species **3.19**. Cleavage of the C-O bond from the tert-butyloxy group affords isobutene and furnishes the vinyl gold species **3.20**, which is protodeaurated to give entry to oxazolones **3.16** (Scheme 3.11).

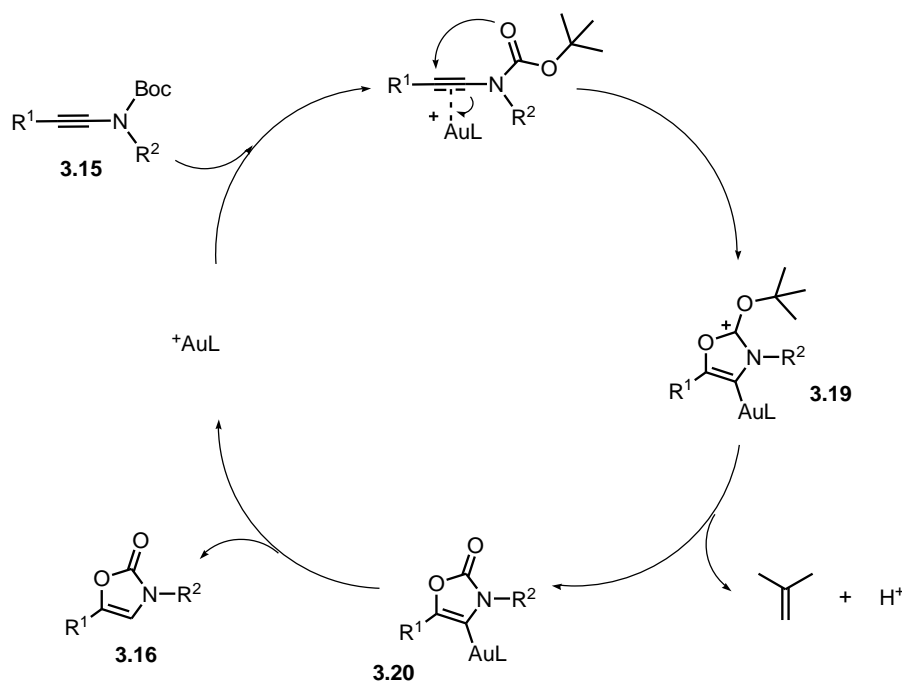

Scheme 3.11: Proposed catalytic cycle for the gold mediated Boc-cyclization of ynamides.

Next, we envisaged a possible domino sequence expecting that the new double bond from the oxazolone ring would be nucleophilic enough to attack a second triple bond in close proximity. Despite all our efforts, this proved difficult, and did not afford in our hands any further cyclized product (scheme 3.12).

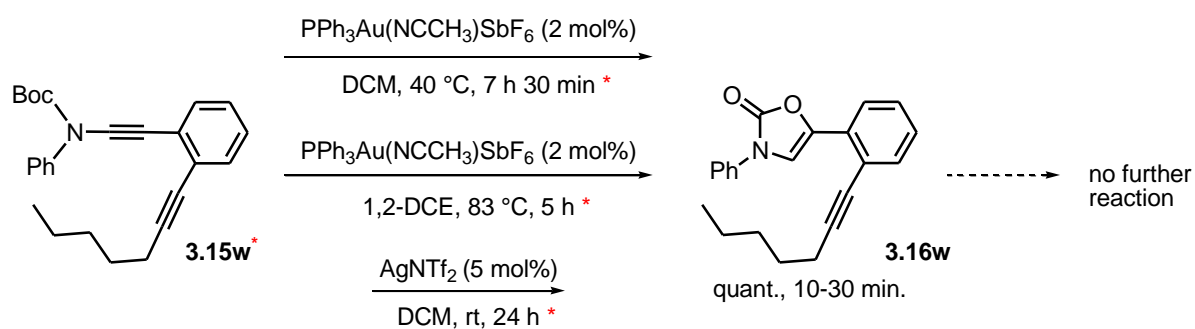

Scheme 3.12: First efforts on the direct conversion of ynamides to a tricyclic structure did not afford the desired compounds, being always stopped after the oxazolone formation.

Even submitting the isolated oxazolone (91% from $\text{PPh}_3\text{Au}(\text{NCCH}_3)\text{SbF}_6$, DCM, 40 °C) to different gold catalysts and a stronger electrophile, such as NIS, did not afford any further cyclized products (as observed from the ^1H NMR of the crude reaction mixture), but only the complete recovery of the starting oxazolone (scheme 3.13).

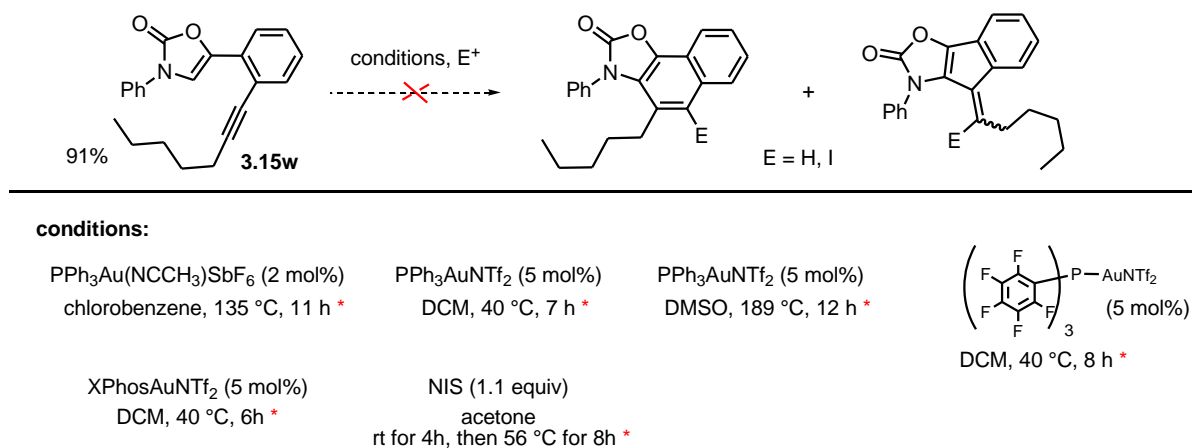

Scheme 3.13: Conditions tested for the cyclization of oxazolone **3.15w** under different electrophilic conditions.

Other cyclization attempts using different ynamides also failed. It seems that the double bonds from 4-oxazol-2-ones are simply not nucleophilic enough to attack the alkyne (Scheme 3.14).

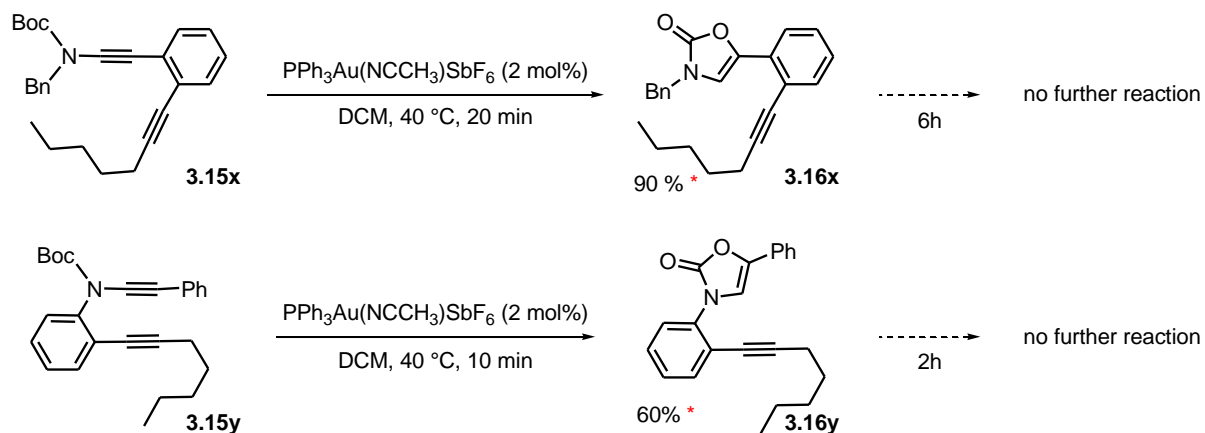

Scheme 3.14: Trials of cascade reaction *via* 4-oxazol-2-ones.

A possible explanation for this inertness is the “push-push” nature exerted both by the oxygen and the nitrogen atoms with competitive antithetic mesomeric modes of action from the enol point of view and the enamine point of view (figure 3.5).

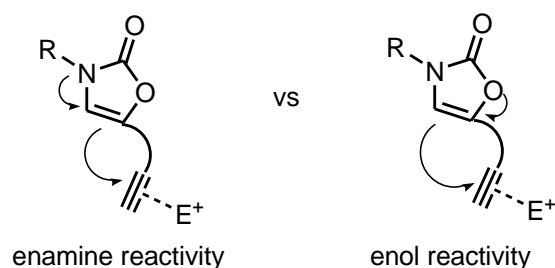

Figure 3.5: The possible reason for the inertness of 4-oxazol-2-ones towards electrophiles can be the low nucleophilicity of the double bond due to the antithetic reactivities accessed by enol against enamine modes of attack (“push-push system”).

3.4 CONCLUSION

In summary, an efficient two-steps sequence to access 4-oxazol-2-ones from bromoalkynes and *tert*-butyloxycarbamates was developed. In one sense we extended the reaction scope of NBoc ynamides synthesis through a Cu(II)-based cross-coupling reaction initially developed by Hsung. In another sense, we have also further extended the feasibility of the Au(I)-promoted cyclization of *tert*-butyloxy carbamates previously studied in our group from the 5-*exo dig* to the 5-*endo dig* cyclization mode.

Preliminary efforts to access a gold(I)-promoted cyclization cascade proved difficult. This can be attributed to the “push-push” nature of 4-oxazol-2-ones, which would account for the low nucleophilicity of the double bond present in the oxazolone ring.

3.5 PERSPECTIVES AND FURTHER DEVELOPMENTS

As discussed previously, the “push-push” nature of 4-oxazol-2-ones seems to hamper the envisioned cascade cyclization process, which stops after the first cyclization. Nevertheless, another important aspect worth mentioning is that, because enamines are more nucleophilic than enols (fact that is commonly used in organocatalysis with proline

derivatives and other amines), all the cyclizations attempted here were sterically favoring the enol nucleophilic attack, and hence, were against the expected double bond polarity. A further way to test if this cascade reaction could be from diyne of type **3.21**, which would give a product coming from an *exo* or/and *endo* cyclization **3.22** or/ and **3.23**, respectively. These cyclized iminium ions could eventually be quenched by a nucleophile to produce **3.24** and/or **3.25** or ring-expand to **3.26** and/or **3.27** (this semi-pinacol-like rearrangement would occur *via* a stabilized carbocation that would be at the same time allylic and α to an oxygen atom, scheme 3.15).

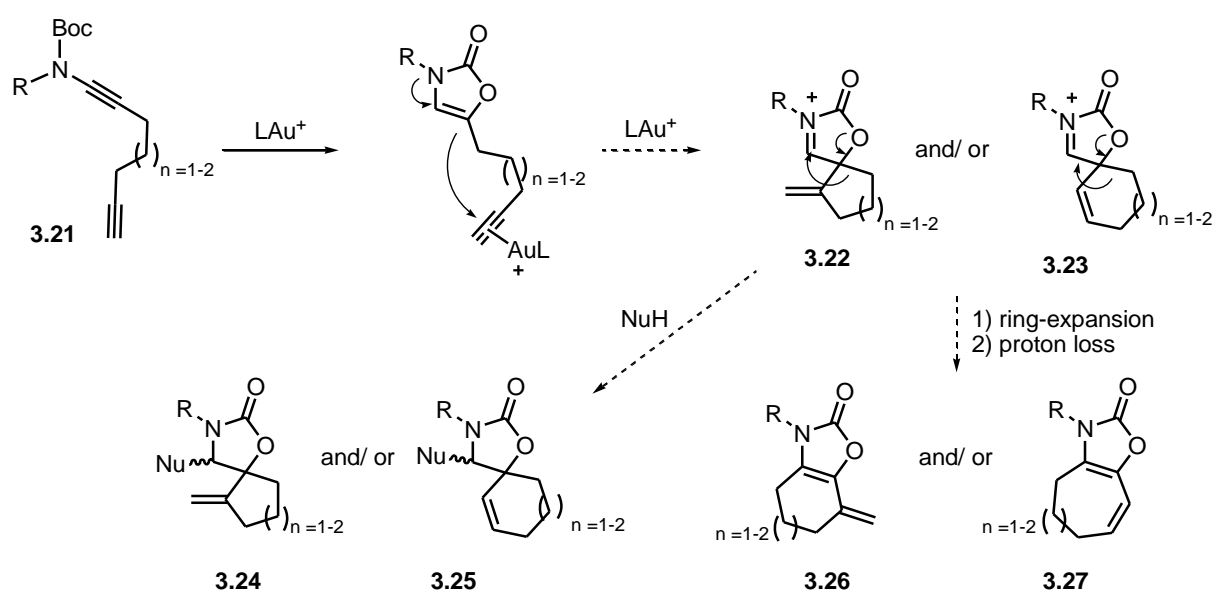

Scheme 3.15: Envisaged reaction pathways exploitable in the gold-mediated cascade reaction with diyne **3.21**.

Another suggestion of cascade reaction involves dienynes **3.28** and **3.31**, which could potentially undergo the Boc rearrangement studied in this chapter to generate compounds **3.29** and **3.32**, respectively, followed by a Diels-Alder reaction with the diene in close proximity to furnish tricyclic structures **3.30** and **3.33**, respectively¹⁹¹ (scheme 3.16).

¹⁹¹ Fearnley, S. P.; Market, E.; *Chem. Comm.*, **2002**, 438.

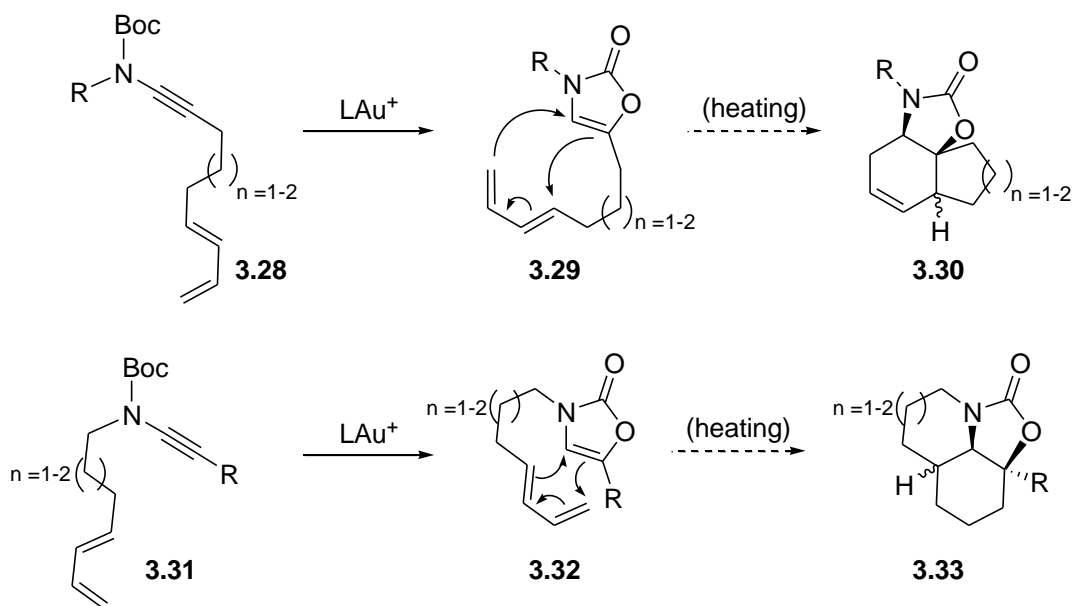

Scheme 3.16 : Boc cyclization/ Diels-Alder sequence to construct bicyclic structures **3.30** and **3.33**.

**CHAPTER 4: GOLD(I)-MEDIATED CYCLOISOMERIZATION OF 1,6-ENYNES – A SHORT
DISGRESSION ON CATALYST COUNTER ION EFFECT AND REMOTE SUBSTITUENT CONTROL**

The work described in this chapter was performed individually and the results were not yet published

CHAPTER 4: GOLD(I)-MEDIATED CYCLOISOMERIZATION OF 1,6-ENYNES – A SHORT DISGRESSION ON CATALYST COUNTER ION EFFECT AND REMOTE SUBSTITUENT CONTROL

4.1 INTRODUCTION: Gold catalyzed 1,6-enyne cycloisomerizations

The attractiveness of metal-enyne cycloisomerization is pinned on the rapid increase in structural complexity starting from considerably simple acyclic substructures. Among many competent metals, such as Pt¹⁹², Pd¹⁹³, Ru¹⁹⁴, In¹⁹⁵, Rh¹⁹⁶, etc., gold is particularly efficient, due to its ability to access a wide range of cyclic products under mild conditions and with high chemoselectivity. For this reason, gold-mediated 1,*n*-enyne (*n* = 3, 4, 5, 6, etc) cycloisomerization¹⁹⁷ has been extensively studied in the past 10 years.

Although today numerous aspects concerning the mechanistic scenario and product selectivity for the gold-mediated cycloisomerization have been settled, others still remain to be elucidated. In the next sections of this introduction, these well established aspects will be discussed in more detail for 1,6-enynes (Scheme 4.1). As other enynes are outside the scope of this chapter, the reader looking for further information is invited to visit the excellent reviews listed in ref. 197.

¹⁹² For leading references, see: (a) Méndez, M.; Muñoz, M. P.; Nevado, C.; Cárdenas, D. J.; Echavarren, A. M.; *J. Am. Chem. Soc.*, **2001**, 123, 10511. (b) Fürstner, A.; Stelzer, F.; Szillat, H.; *J. Am. Chem. Soc.*, **2001**, 123, 11863. (c) Chatani, N.; Furukawa, N.; Sakurai, H.; Murai, S.; *Organometallics*, **1996**, 15, 901.

¹⁹³ For leading references, see: (a) Trost, B. M.; Lee, D. C.; Rise, F.; *Tetrahedron Lett.*, **1989**, 30, 651. (b) Ito, Y.; Goeke, A.; Sawamura, M.; Kuwano, R.; *Angew. Chem. Int. Ed.*, **1996**, 35, 662. (c) Mikami, K.; Terada, M.; Hatano, M.; *Angew. Chem. Int. Ed.*, **2001**, 40, 249.

¹⁹⁴ For leading references, see: (a) Trost, B. M.; Toste, D.; *J. Am. Chem. Soc.*, **1999**, 121, 9728. (b) Trost, B. M.; Surivet, J.-P.; Toste, F. D.; *J. Am. Chem. Soc.*, **2004**, 126, 47, 15592. (c) Trost, B. M.; Gutierrez, A. C.; Ferreira, A. M.; *J. Am. Chem. Soc.*, **2010**, 132, 26, 9206.

¹⁹⁵ For leading references, see: (a) Miyanoana, Y.; Chatani, N.; *Org. Lett.*, **2006**, 8, 10, 2155. (b) Hayashi, N.; Shibata, I.; Baba, A.; *Org. Lett.*, **2004**, 6, 26, 4981. (c) Miura, K.; Fujisawa, N.; Hosomi, A.; *J. Org. Chem.*, **2004**, 69, 7, 2427.

¹⁹⁶ For leading references, see: (a) Ota, K.; Lee, S. I.; Takachi, M.; Nakai, H.; Morimoto, T.; Sakurai, H.; Kataoka, K.; Chatani, N.; *J. Am. Chem. Soc.*, **2009**, 131, 15203. (b) Kim, H.; Lee, C.; *J. Am. Chem. Soc.*, **2005**, 127, 29, 10180. (c) Denmark, S. E.; Liu, J. H.-C.; *J. Am. Chem. Soc.*, **2007**, 129, 12, 3737. (d) Kim, S. Y.; Chung, Y. K.; *J. Org. Chem.*, **2010**, 75, 4, 1281.

¹⁹⁷ For reviews on cycloisomerization of 1,*n*-enynes, using only gold, see: (a) Jiménez-Núñez, E.; Echavarren, A. M.; *Chem. Rev.*, **2008**, 108, 3326. Using platinum and gold, see: (b) Zhang, L.; Sun, J.; Kozmin, S. A.; *Adv. Synth. Cat.*, **2006**, 348, 2271. (c) Soriano, E.; Marco-Contelles, J.; *Acc. Chem. Res.*, **2009**, 42, 8, 1026. Using silver and gold: (d) Belmont, P.; Parker, E.; *Eur. J. Org. Chem.*, **2009**, 35, 6075. Using numerous metals, see: (e) Aubert, C.; Buisine, O.; Malacria, M.; *Chem. Rev.*, **2002**, 102, 813.

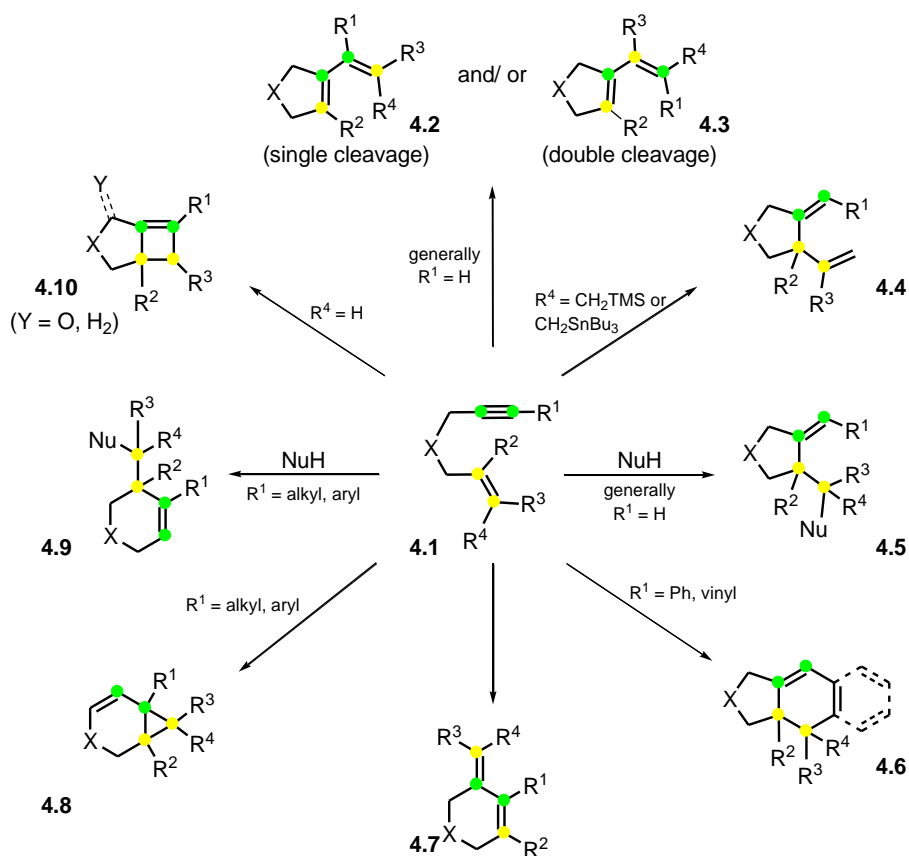

Scheme 4.1: Reaction scope of cycloisomerization of 1,6-enynes and interception of reaction intermediates by a nucleophile.

4.1.1 Synthesis of 1-alkenyl-1-cyclopentenes (4.2 and 4.3)

In 2004, Echavarren *et al.* reported the use of gold catalysts for the cycloisomerization of 1,6-enynes **4.11**¹⁹⁸. The generation of highly cationic Ph_3PAu^+ species from the treatment of PPh_3AuCl with AgSbF_6 was employed to produce dienes **4.12** at room temperature. Previously, only PtCl_2 -promoted cycloisomerizations had been described and they required heating at 80°C ^{192c}. Our group next reported the use of stable, highly active and easy to handle $\text{Ph}_3\text{PAuNTf}_2$ ¹⁹⁹ for the same transformation and many other gold catalysts followed as suitable options for this transformation²⁰⁰. A representative reaction scope is exhibited below (scheme 4.2).

¹⁹⁸ Nieto-Oberhuber, C.; Muñoz, M. P.; Buñuel, E.; Nevado, C.; Cárdenas, D. J.; Echavarren, A. M.; *Angew. Chem. Int. Ed.*, **2004**, 43, 2402.

¹⁹⁹ Mezailles, N.; Ricard, L.; Gagosz, F.; *Org. Lett.*, **2005**, 7, 4133.

²⁰⁰ See reviews in ref 197.

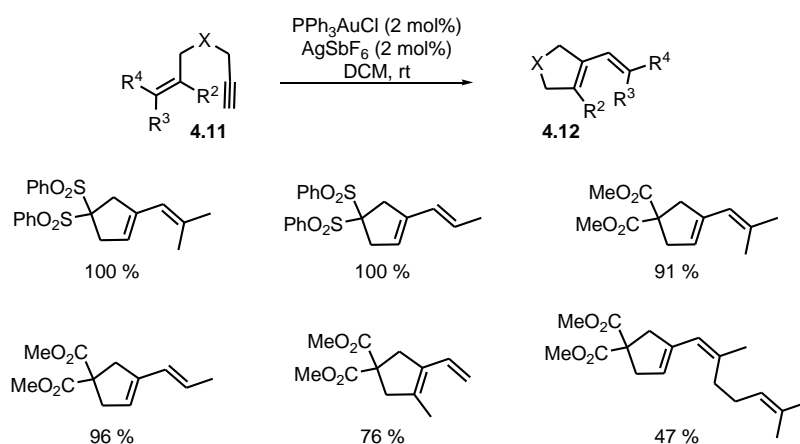

Scheme 4.2: Examples of dienes obtained from gold catalyzed 1,6-enynes cycloisomerizations¹⁹⁸.

The reactivity of the gold-alkyne and gold-alkene complexes can be understood from cationic forms **4.14** and **4.17**, which are resonance structures of **4.13** and **4.16**, respectively. Another important resonance structure of the Au-alkyne complex is the gold carbene **4.15**, which is implicated in cyclopropanation reactions discussed below. Complex **4.17** reveals that the [1,2]-hydride shift would produce the corresponding Au carbene **4.18**. Applying the principle of microscopic reversibility, one can find a common termination step found in gold catalysis: Au carbene **4.18** serves as a precursor for a [1,2]-hydride shift, which upon elimination of LAu^+ fragment from intermediate **4.17**, produces an alkene (formal “ β -hydride elimination”).

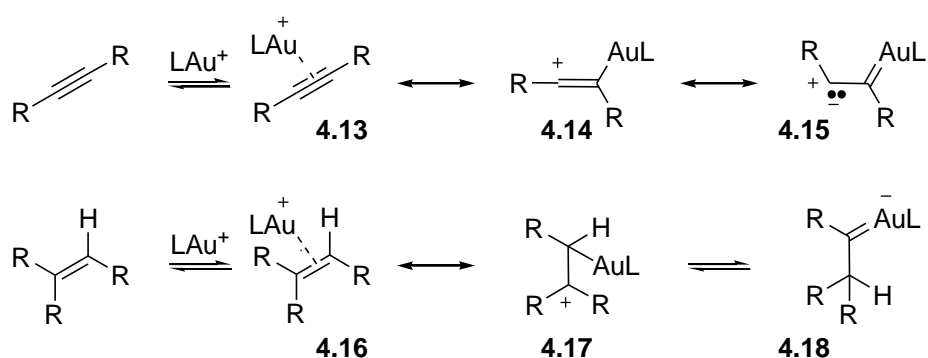

Scheme 4.3: Resonance structures of gold-alkyne and gold alkene complexes.

The reaction mechanism culminating in products **4.2/4.3** is described by the complexation of the gold metal to the alkyne, followed by a 5-*exo* dig cyclization. This step

corresponds to the cyclopropanation of the proximate alkene to produce cyclopropyl metal carbene **4.19**. This initial step can also be explained by invoking the resonance contribution of carbene **4.15**, which results in direct alkyne cyclopropanation. Alternatively, the cyclopropanation can be envisioned to occur step-wise *via* initial reaction of the alkene with the alkenyl cation **4.14**, followed by nucleophilic interception of the resulting carbocation by the alkenyl gold formed (not shown). Echavarren *et al.* performed DFT calculations¹⁹⁸, suggesting that the Au(I)-mediated cyclopropanation to afford intermediate **4.19** occurs directly *via* a single transition state. In the absence of an external nucleophile, highly electron-deficient gold carbene **4.19** undergoes a [1,2]-alkyl shift to produce **4.20**.

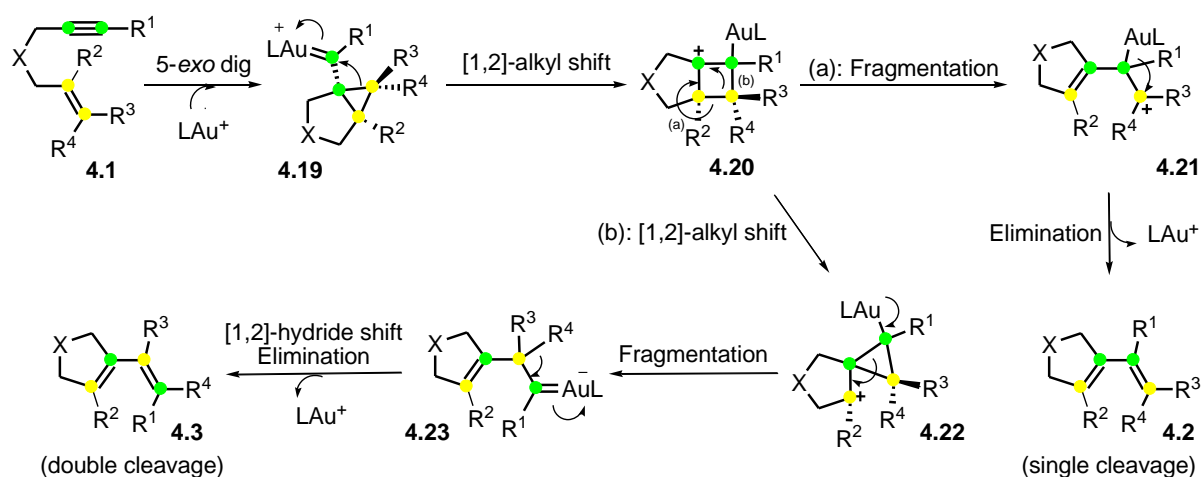

Scheme 4.4: Mechanistic rationale for observed cycloisomerized products **4.2** and **4.3** from carbene **4.19**.

Depending on the nature of the substituents R^2 and R^3 on the alkene, two pathways are possible. Cyclobutane cation **4.20** can either fragment to produce cyclopentene **4.21** (pathway a) or undergo another [1,2]-alkyl shift (dyotropic rearrangement²⁰¹) to give the spirocycle **4.22**, which fragments to produce carbene **4.23** (pathway b). Elimination of the metal fragment from **4.21** and **4.23** affords diene **4.2** (which is originated from the cleavage of one C-C bond), and diene **4.3** (which comes from the cleavage of two C-C bonds), respectively.

²⁰¹ Term defined in 1972 by M. T. Reetz, referring to a new class of pericyclic isomerization reactions, where two σ -bonds simultaneously migrate intramolecularly. For a review on the subject, see: Fernández, I.; Cossío, F. P.; Sierra, M.; *Chem. Rev.*, **2009**, 109, 6687.

Despite the fact that the mechanism in scheme 4.4 is described as proceeding in a step-wise fashion, this is to give the reader a detailed analysis of the bond-breaking and bond-forming steps. DFT calculations showed that the product conversions from **4.19** to either **4.21** or **4.23** are actually direct processes²⁰². In this regard, **4.19** should be seen as a delocalized highly distorted cyclopropylmethyl/cyclobutyl/homoallyl carbocation²⁰³ (often called non-classical carbocation²⁰⁴).

4.1.2 Synthesis of alkenylmethylene-cyclopentanes (4.4)

1,6-enynes containing allylsilanes and allylstannanes moieties can be rearranged upon treatment with gold²⁰⁵ (but also a wide range of other metal transition catalysts²⁰⁶) to afford alkenylmethylene-cyclopentane derivatives (scheme 4.5).

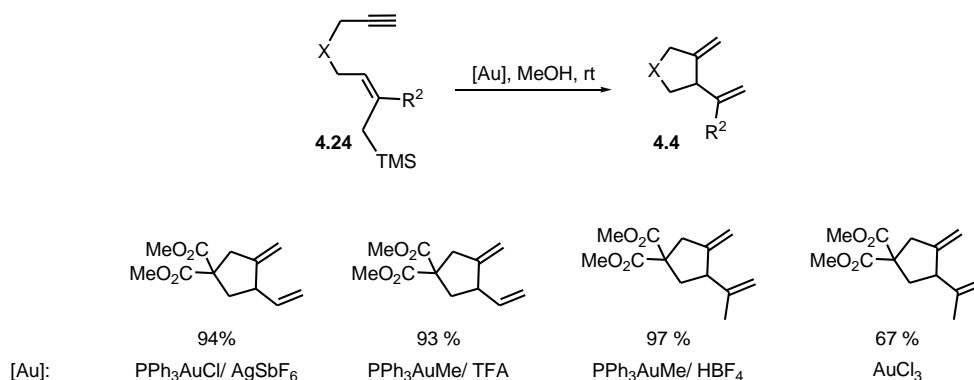

Scheme 4.5: Examples of gold mediated formation of alkenylmethylene-cyclopentanes from allyltrimethylsilane derivatives.

The mechanism of this reaction can be seen as a concerted process that starts with the gold activation of alkyne **4.25**, followed by the formation of a gold stabilized vinyl cation **4.26** and addition of the alkene moiety to generate the carbocationic intermediate **4.28**.

²⁰² Nieto-Oberhuber, C.; Lopez, S.; Muñoz, M. P.; Cárdenas, D. J.; Buñuel, E.; Nevado, C.; Echavarren, A. M.; *Angew. Chem. Int. Ed.*, **2005**, 44, 6146.

²⁰³ Casanova, J.; Kent, D. R.; Goddard, W. A.; Roberts, J. A.; *Proc. Natl. Acad. Sci. U. S. A.*, **2003**, 100, 15.

²⁰⁴ For some mechanistic insights, see: Garayalde, D.; Gómez-Bengoia, E.; Huang, X.; Goeke, A.; Nevado, C.; *J. Am. Chem. Soc.*, **2010**, 132, 4720.

²⁰⁵ (a) Fernandez-Rivas, C.; Mendez, M.; Nieto-Oberhuber, C.; Echavarren, A. M.; *J. Org. Chem.*, **2002**, 67, 5197. (b) Porcel, L.; López-Carrillo, V.; García-Yebra, C.; Echavarren, A. M.; *Angew. Chem. Int. Ed.*, **2008**, 47, 1883.

²⁰⁶ (a) Fernandez-Rivas, C.; Mendez, M.; Echavarren, A. M.; *J. Am. Chem. Soc.*, **2000**, 122, 1221. (b) Mendez, M.; Muñoz, M. P.; Nevado, C.; Cardenas, D. J.; Echavarren, A. M.; *J. Am. Chem. Soc.*, **2001**, 123, 10511. (c) Fernández-Rivas, C.; Méndez, M.; Nieto-Oberhuber, C.; Echavarren, A. M.; *J. Org. Chem.*, **2002**, 67, 5197.

Alternatively, this cyclization might proceed in a stepwise manner involving initial generation of cyclopropyl **4.27**, which undergoes ring opening by the proximal alkene to generate the same intermediate **4.28**. Elimination of either a silyl cation ($G = \text{TMS}$) or a tributyltin cation ($G = \text{Bu}_3\text{Sn}$) affords the vinyl gold complex **4.29**. Protodemetalation takes place to give the observed diene **4.4** and regenerates the active catalyst (scheme 4.6).

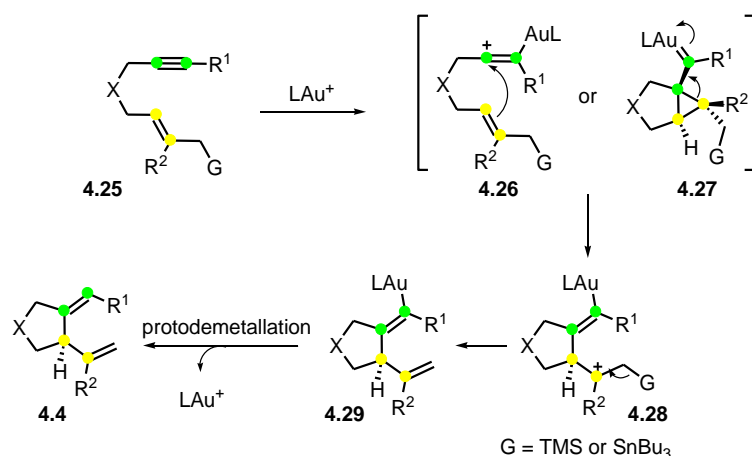

Scheme 4.6: Mechanism of gold-catalyzed cyclization of allylstannanes and allylsilanes derivatives.

Although other metals, such as Pt and Ru, are capable of producing the same products under very similar conditions²⁰⁶, these metals can also react through the intermediacy of metalacycles by simultaneous coordination to the alkyne and alkene moieties. Subsequent β -hydrogen elimination from a proximal alkyl substituent affords a formal alder-ene product, distinct from diene **4.4** by the geometry of the double bond carrying the R^1 group (not shown, metalcycle mechanism proved by deuteration experiments).

4.1.3 Hydroxy-, alkoxy-, amine- and (hetero)aryl- addition/5-*exo* cycloisomerization process with 1,6-enynes (4.5)

1,6-enynes can react with alcohols, hydroxy groups²⁰⁷, amines²⁰⁸ or electron rich (hetero)aromatic rings²⁰⁹ in an inter- or intramolecular fashion, in the presence of Au(I)

²⁰⁷ Nieto-Oberhuber, C.; Muñoz, M. P.; López, S.; Jiménez-Nuñez, E.; Nevado, C.; Herrero-Gómez, E.; Raducan, M.; Echavarren, A. M.; *Chem. Eur. J.*, **2006**, 12, 1677 (corrigendum: *Chem. Eur. J.*, **2008**, 14, 5096).

²⁰⁸ Lesseurre, L.; Toullec, P. Y.; Genêt, J.-P.; Michelet, V.; *Org. Lett.*, **2007**, 9, 20, 4049.

catalysts. While the combination of $\text{PPh}_3\text{AuCl}/\text{AgSbF}_6$ and $\text{AuMe}(\text{PPh}_3)/\text{protic acid}$ affords similar results, gold catalysts carrying bulky biphenyl phosphine ligands have proven to be the catalyst of choice for this transformation. Representative examples of reaction scope are shown below (scheme 4.7). Two of the examples shown, using a phosphite ligand on gold, were performed at -50°C to avoid their fast skeletal rearrangement to dienes of type **4.2/4.3**.

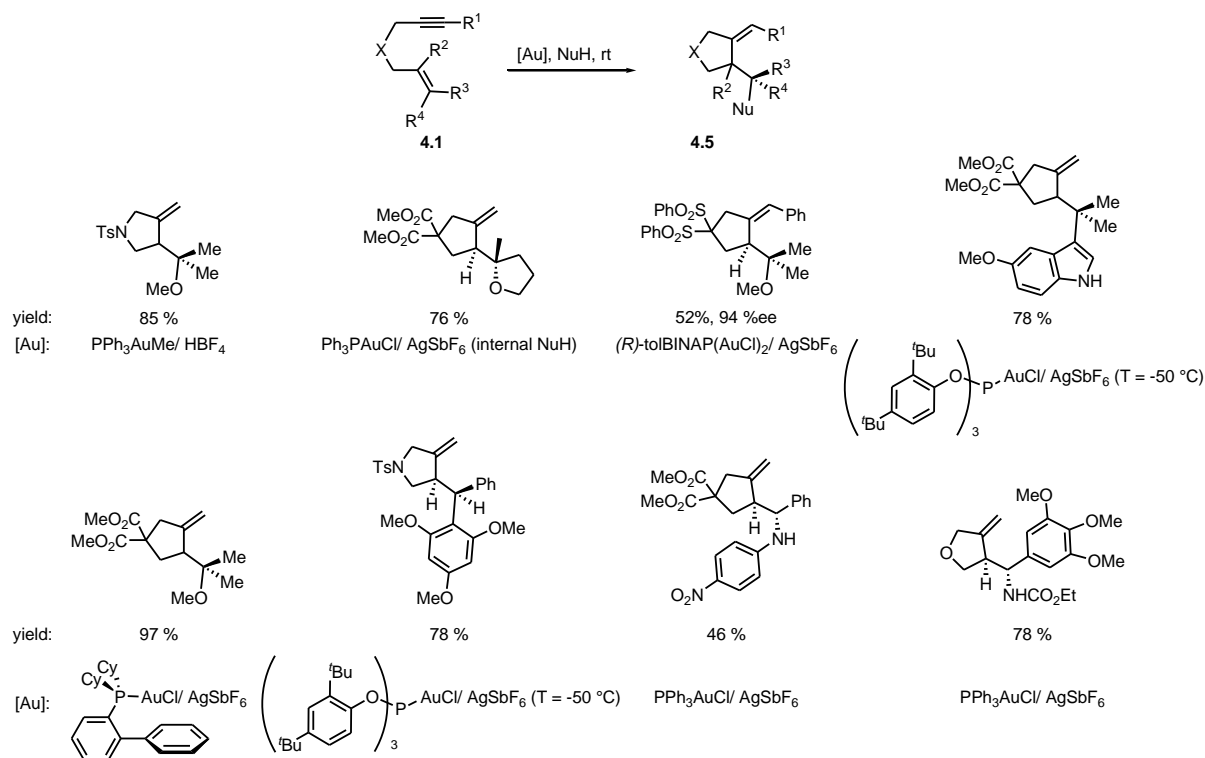

Scheme 4.7: Representative scope of nucleophilic addition/ cyclization of 1,6-enynes using different gold catalysts.

Two possible mechanisms for the nucleophilic addition/cyclization can be imagined. The first proceeds in a highly concerted manner implicating simultaneous attack of the gold-alkyne complex by the alkene with a concomitant addition of the nucleophile, as shown in **4.30** (scheme 4.8). The second one proceeds step-wise with formation of the cyclopropane intermediate **4.19**, followed by addition of the nucleophile. The final step is the protodemetalation of the vinyl gold complex **4.31** (Scheme 4.8).

²⁰⁹ (a) Toullec, P. Y.; Genin, E.; Leseurre, L.; Genêt, J.-P.; Michelet, V.; *Angew. Chem. Int. Ed.*, **2006**, 45, 7427. (b) Amijs, C. H. M.; Ferrer, C.; Echavarren, A. M.; *Chem. Comm.*, **2007**, 698.

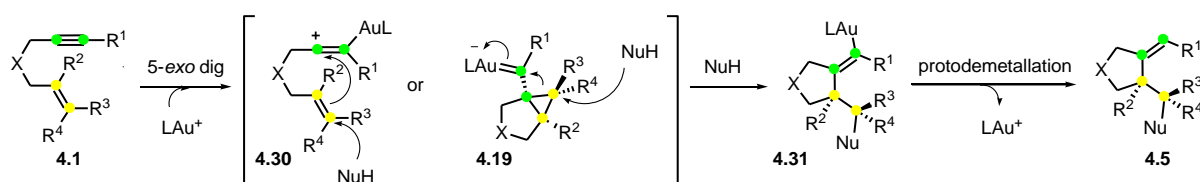

Scheme 4.8: Mechanistic proposal for gold-mediated alkoxy cyclization reactions.

4.1.4 Formal intramolecular [4+2] cycloadditions of alkenes with enynes and arylalkynes (4.6)

For 1,6-enynes **4.1** where R^1 is an aromatic ring derivative or a vinyl moiety, a second reaction takes place besides the expected 5-*exo* cycloisomerization (*cf.* section 4.1.1). This novel process corresponds to a formal [4+2] cycloaddition of alkenes with enynes or aryl alkynes²¹⁰. Such examples are illustrated below (scheme 4.9).

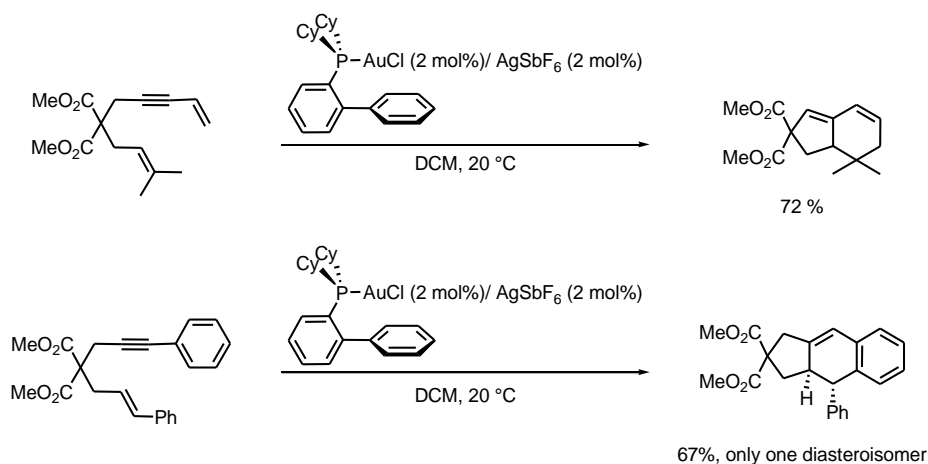

Scheme 4.9: Two examples of the gold-catalyzed intramolecular [4+2]-cycloaddition of 1,6-enynes.

The proposed reaction mechanism follows an intramolecular olefin cyclopropanation from the gold activated enyne **4.1**, thus generating the gold carbene **4.19**, which has the proximal alkene or aryl ring nearby, favoring a subsequent nucleophilic attack and opening of the cyclopropane ring in a reminiscent process of the Nazarov cyclization (or analogously to the previous mechanisms, a concerted alkyl addition/Friedel-Crafts alkylation sequence,

²¹⁰ (a) Nieto-Oberhuber, C.; Lorez, S.; Echavarren, A. M.; *J. Am. Chem. Soc.*, **2005**, 127, 6178. (b) Nieto-Oberhuber, C.; Pérez-Galán, P.; Herrero, Gómez, E.; Lauterbach, T.; Rodríguez C.; Lóez, S.; Bour, C.; Rosellón, A.; Cárdenas, D. J.; Echavarren, A. M.; *J. Am. Chem. Soc.*, **2008**, 130, 269.

as depicted in **4.32**) to give intermediate **4.33**. Subsequent loss of a proton, followed by protodeauration, furnishes tricycle **4.6** and closes the catalytic cycle (scheme 4.10).

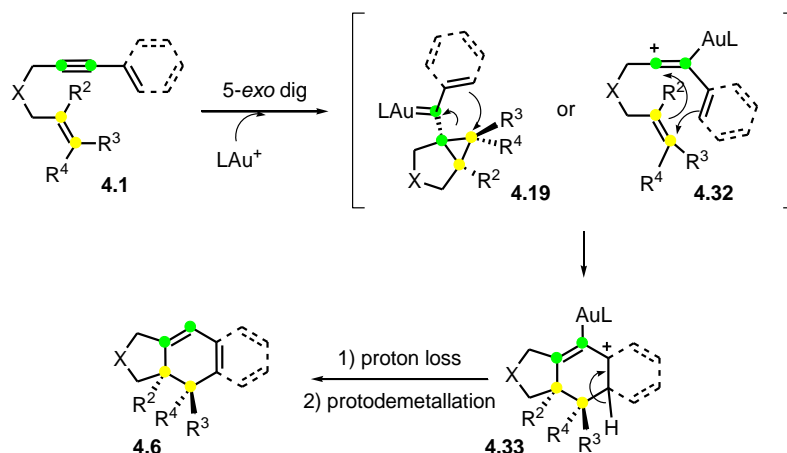

Scheme 4.10: Gold(I)-catalyzed formal [4+2]-cycloaddition of 1,6-enynes.

4.1.5 Synthesis of methylenecyclohexenes (**4.7**)

Further investigation of 1,6-enynes cycloisomerization processes performed by Echavarren *et al.* revealed that certain compounds, such as **4.34**, **4.37** and **4.39**, did not afford only cyclopentenes as it could be initially expected (*cf.* section 4.1.1), but methylenecyclohexenes²¹¹ in different extents (scheme 4.11).

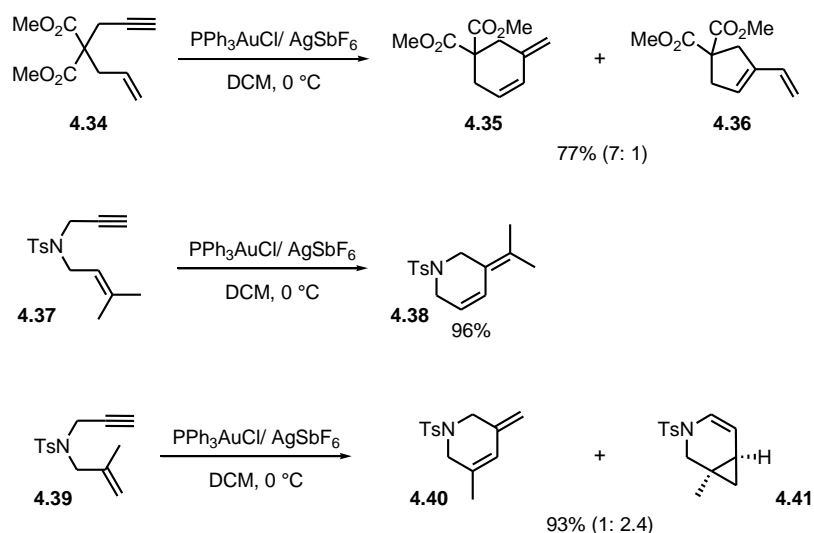

Scheme 4.11: Depending on the substitution pattern of 1,6-enynes, different cycloisomerized products can be obtained. One of the possible outcomes are methylenecyclohexene derivatives.

²¹¹ Cabello, N.; Jiménez-Núñez, E.; Buñuel, E.; Cárdenas, D. J.; Echavarren, A. M.; *Eur. J. Org. Chem.*, **2007**, 4217.

The mechanism for the methylenecyclohexenes synthesis is presented in scheme 4.12. DFT calculations^{211,212} indicate that the pathway the lowest in energy follows a 5-*exo* cyclization to give the gold carbene **4.19** (as in scheme 4.4). Then, a [1,2]-alkyl shift is responsible for the ring expansion to the 6-membered ring, which is accompanied by allylic cation formation to give access to intermediate **4.42**. Subsequent elimination of the gold fragment LAu⁺ generates methylenecyclohexene **4.7** (scheme 4.12b).

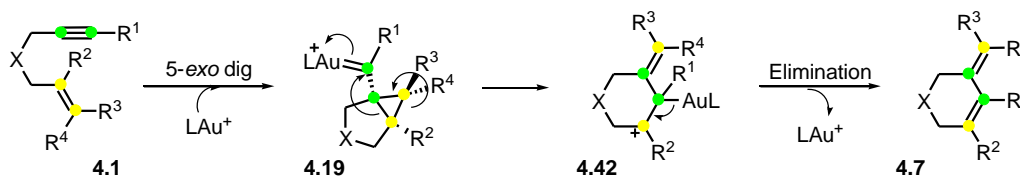

Scheme 4.12: Reaction mechanism based on DFT calculations for the formation of methylenecyclohexene **4.7** from the gold-mediated cycloisomerization of 1,6-enyne **4.1**.

From what can be seen until this point, in comparison to section 4.1.1, the substitution of the 1,6 enynes greatly influences the outcome of the cycloisomerization process. Temperature also plays an important role in product selectivity between 5- and 6-membered rings. For instance, cyclization of enyne **4.34** at -15 °C in the presence of PPh₃Au(NCCH₃)SbF₆ produces a mixture of 10:1 of **4.35**:**4.36**, whereas at 0 °C, this ratio drops to 7:1 (scheme 4.11) and at room temperature (23 °C) a 1:1 mixture of **4.35**:**4.36** is observed. The catalyst is also an important parameter. For instance, PtCl₄, AuCl, JohnPhosAu(NCCH₃)SbF₆, [2,4-(^tBu)₂PhO]₃PAuCl/ AgSbF₆ afforded virtually only the diene **4.36** at room temperature.

4.1.6 Synthesis of bicyclo[4.1.0]heptenes (**4.8**)

The first two examples of synthesis of bicyclo[4.1.0]heptenes promoted by gold catalysis were reported by Echavarren *et al.* in 2004¹⁹⁸ with remarkable efficiency and mild reaction conditions (DCM, 20 °C). Subsequent work from Michelet *et al.*²¹³ reported their

²¹² Curiously, not all authors have considered these calculations and describe an alternative mechanism higher in energy through a 6-*endo* dig cyclization. See: (a) Gorin, D.; Sherry, B. D.; Toste, D.; *Chem. Rev.*, **2008**, 108, 8, 3351 (scheme 22, p 3365). (b) ref. 197b (scheme 34, p. 2283).

²¹³ Chao, C.-M.; Beltrami, D.; Toullec, P. Y.; Michelet, V.; *Chem. Commun.*, **2009**, 6988.

enantioselective synthesis, with low to moderate yields, but excellent enantioselectivity (scheme 4.14).

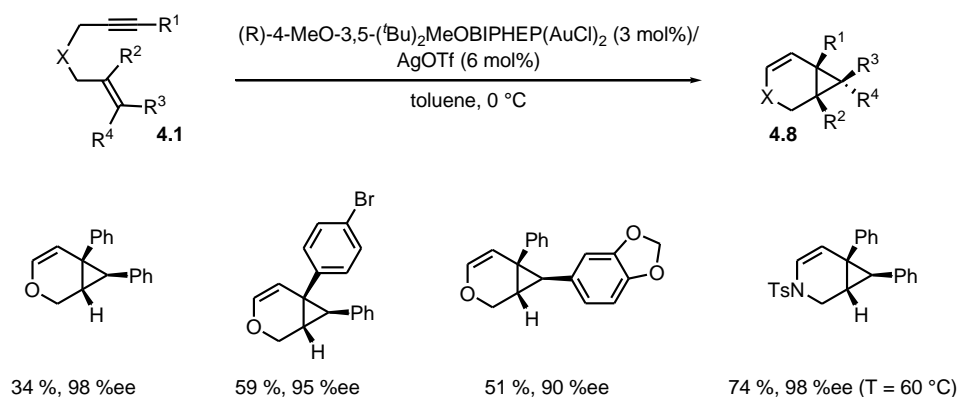

Scheme 4.13: Representative scope of the enantiomeric synthesis of bicyclo[4.1.0]heptenes.

The reaction mechanism is believed to proceed through the 6-*endo* dig cyclization, which generates the highly electrophilic gold carbene **4.43**. Subsequent [1,2]-hydride shift generates intermediate **4.44**, that eliminates the gold fragment LAu⁺ and closes the catalytic cycle with concomitant formation of bicyclo[4.1.0]heptene **4.8**.

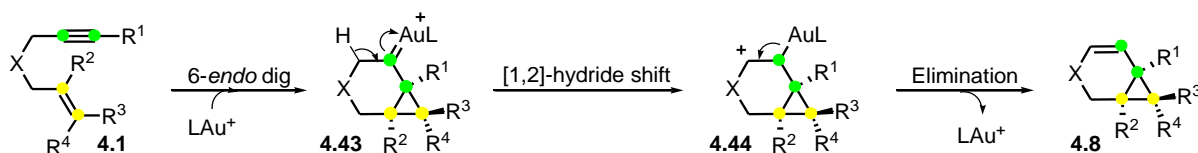

Scheme 4.14: Reaction mechanism for the gold-promoted cycloisomerization of 1,6-enynes generating bicyclo[4.1.0]heptenes **4.8**.

In order to rationalize the ease of 1,6-enyne **4.1** to follow either a 5-*exo* or a 6-*endo* cyclization pathway, DFT calculations on the reaction of (*E*)-6-octen-1-yne and the gold complex [Au(PH₃)]⁺ were performed as a model system. They show the formation of a highly polarized (η^1 -alkyne)gold complex **4.45**, which reacts readily with the alkene in a 5-*exo* cyclization mode with a very small activation energy of 0.1 kcal.mol⁻¹ to afford intermediate **4.46**. The structure of this intermediate can be seen as the canonical form **4.47**, corresponding to a gold(I) stabilized homoallylic carbocation. The activation energy for the 6-*endo*-dig process to give the gold carbene **4.48** is significantly higher, equal to 6.1 kcal.mol⁻¹, which suggests that the *exo* cyclization is favored with gold(I) catalysts of type R₃PAu⁺, at

least for substrates related to (*E*)-6-octen-1-yne. For comparison purposes, the calculated activation energies for the analogous transformation with [Pt(H₂O)Cl₂] are 10.3 and 11.2 kcal.mol⁻¹ for 5-*exo* and 6-*endo* cyclizations, respectively.

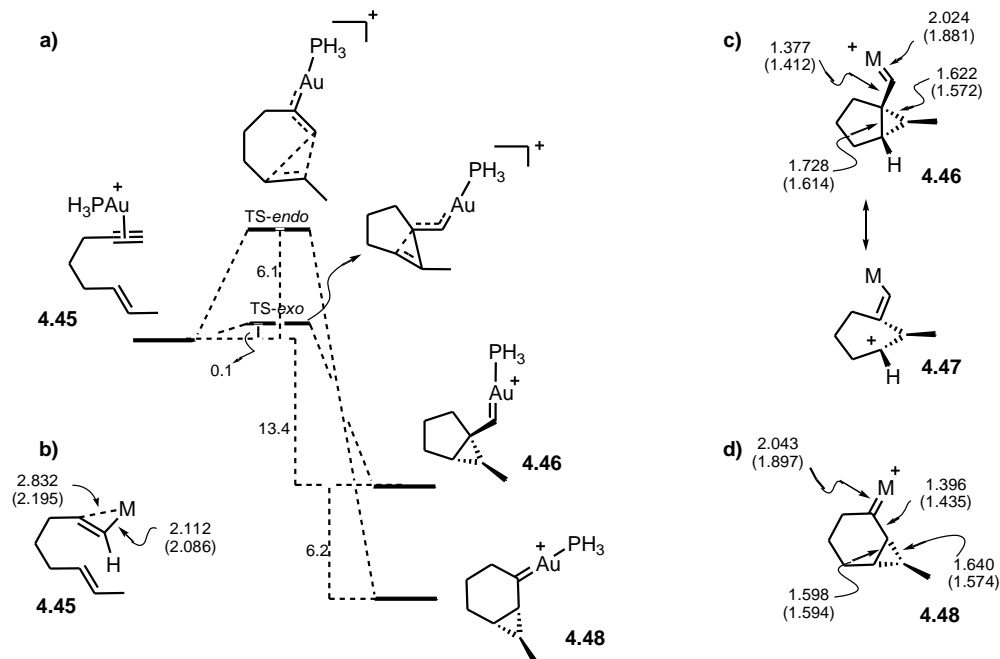

Scheme 4.15: **a)** DFT calculations showing the reaction coordinate for the cyclization of (*E*)-6-octen-1-yne with [AuPH₃]⁺. **b)-d)** Selected bond lengths in Å for **4.45-4.48**. Values in parentheses are for the comparison with the Pt complex *trans*-Pt(H₂O)Cl₂.

4.1.7 Nucleophilic addition/6-*endo* cyclization process with 1,6-enynes (**4.9**)

Following the same pattern of nucleophilic additions to cyclopropyl gold carbenes **4.19**, nucleophiles can add to cyclopropyl gold carbenes **4.43** on the carbon of cyclopropyl carrying R³ and R⁴ groups to afford cyclohexene derivatives **4.9**²¹⁴. The reaction scope is exhibited below (scheme 4.16).

²¹⁴ Amijs, C. H. M.; López-Carrillo, V.; Raducan, M.; Pérez-Galán, P.; Ferrer, C.; Echavarren, A. M.; *J. Org. Chem.*, **2008**, *73*, 7721.

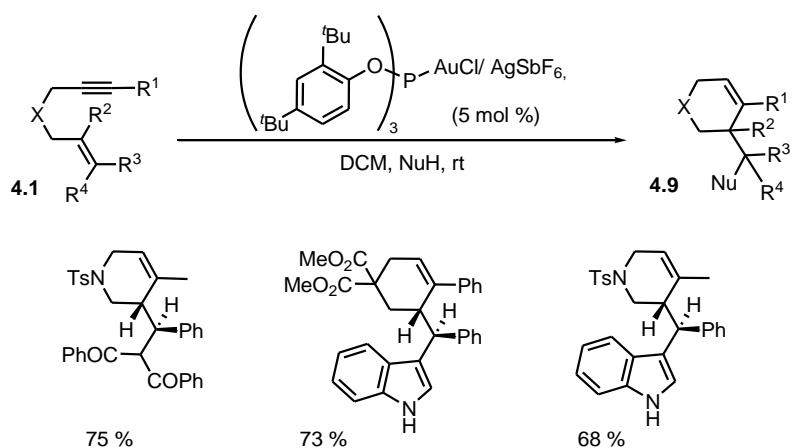

Scheme 4.16 : Reaction scope of nucleophilic attack to 6-*endo* frameworks.

The mechanism starts by the 6-*endo* cyclization of the gold-activated triple bond of the 1,6-enyne **4.1**, thus generating cyclopropyl gold carbene **4.43**. Subsequent nucleophilic addition to intermediate **4.43** produces vinyl-gold **4.50**, which after protodemetalation affords cyclohexene derivative **4.9** (scheme 4.17). In analogy to previous mechanisms, the nucleophilic addition can also be seen as proceeding in a concerted manner through the stabilized vinyl gold cation **4.49**.

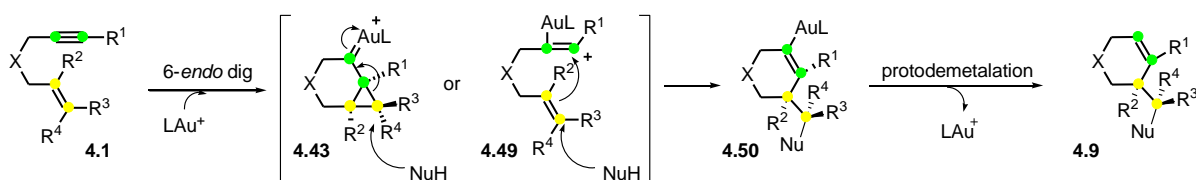

Scheme 4.17: Proposed mechanism for the nucleophilic addition to 6-*endo* frameworks.

The regioselectivity between a 5-*exo* and a 6-*endo* cycle with the nucleophilic attack, furnishing **4.5** and **4.9**, respectively, is mostly dictated by the substitution on the alkyne moiety. Internal alkynes ($R^1 \neq H$) generally afford 6-*endo* cyclization products, although the 5-*exo* cyclization mode is also followed for internal alkynes with alkenes moieties substituted at C-2 ($R^2 \neq H$).

4.1.8 Synthesis of bicyclo[3.2.0]heptenes (4.10)

Although initially postulated as possible intermediates in the formation of dienes **4.2**, cyclobutenes were immediately discarded upon examination of the low energies implicated in the supposed conrotatory ring opening necessary to afford dienes **4.2**. The energy calculated (DFT methods) to ring-open an hypothetical cyclobutene formed during this process would correspond to an extremely fast process even at low temperatures such -63 °C ($\Delta G_{298}^\ddagger = 21.7$ kcal.mol $^{-1}$ for single cleavage mechanism using Cyclohexyl-JohnphosAu(NCCH $_3$)SbF $_6$), thus corresponding to an unrealistic low activation energy when compared to the activation energy for the ring-opening of close-related cyclobutenes ($\Delta G_{298}^\ddagger = 25.6$ kcal.mol $^{-1}$ for the conrotatory ring-opening of bicyclo[3.2.0]hept-5-ene to 1-vinyl-1-cyclopentene)²⁰².

Despite this fact, cyclobutenes are observed in gold cycloisomerization reactions of 1,6-enynes. Indeed, upon consideration of small changes in the substrate structure, through the interplay with the gold catalyst employed, one is capable of modulating the system reactivity and gain entry to cyclobutenes. Examples of such a modulation is the use of ynamide derivatives **4.51**, which generates unstable cyclobutenes **4.52** and have to be immediately hydrolyzed to cyclobutanones **4.53**²¹⁵; and from amide- and ester-tethered 1,6-enynes **4.54** that have the alkyne extremity substituted by an aryl ring (*i.e.*, R 1 = Ph or tolyl)²¹⁶ (scheme 4.16).

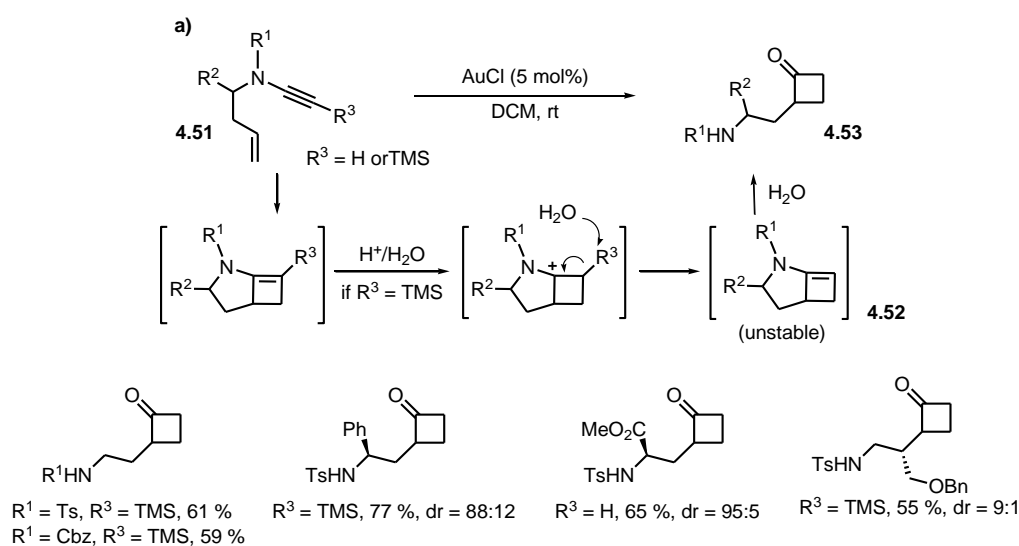

²¹⁵ Couty, S.; Meyer, C.; Cossy, J.; *Angew. Chem. Int. Ed.*, **2006**, 45, 6726.

²¹⁶ Lee, Y. T.; Kang, Y. K.; Chung, Y. K.; *J. Org. Chem.*, **2009**, 74, 7922.

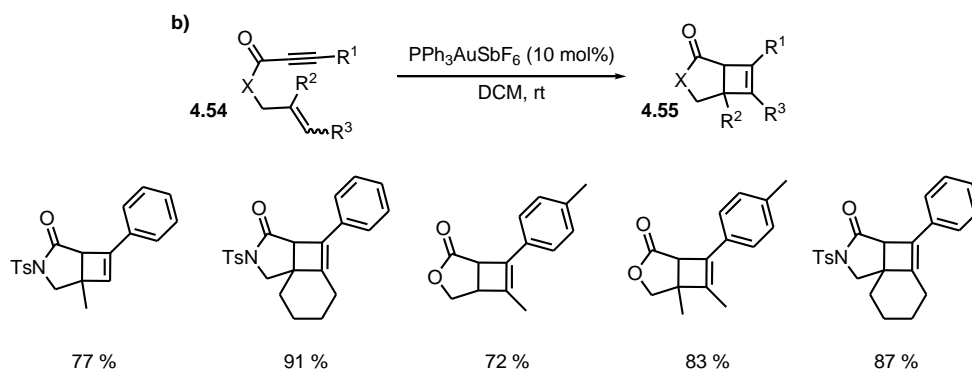

Scheme 4.16: Examples of cyclobutenes accessed by gold catalysis, either as **a)** intermediates or **b)** products.

The mechanism proposed and supported by DFT calculations^{198,214} on the enyne **4.54** is proposed to start with the gold activation of the alkyne, followed by either the 6-*endo* or the 5-*exo-syn* cyclization, which affords intermediates **4.56** (analogous to **4.43**) and **4.58** (analogous to **4.19**), respectively, depending on the substitution pattern on the 1,6-enyne **4.54**. Each intermediate, **4.56** and **4.58**, undergoes a [1,2]-alkyl shift to generate, respectively, carbocations **4.57** and **4.60**, which upon elimination of the LAu^+ fragment produce cyclobutene **4.55**.

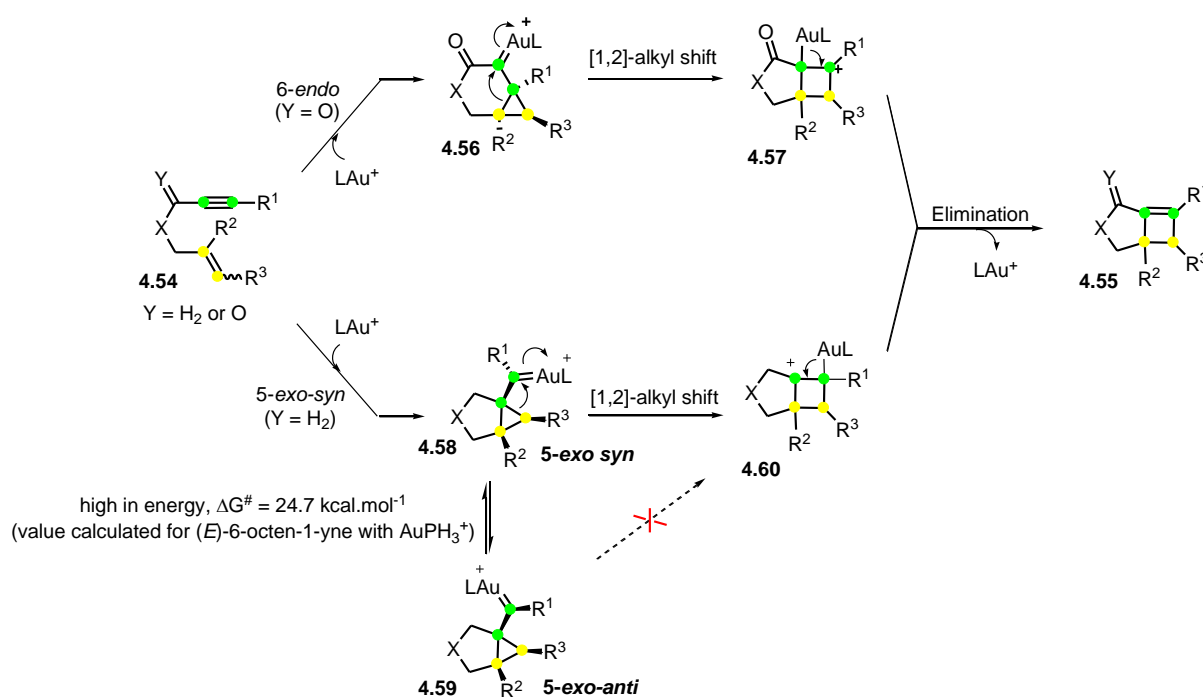

Scheme 4.17: Mechanism of the gold-mediated cyclobutene synthesis from 1,6-enynes. The reaction pathway depends on the enyne substituents.

The reaction mechanism pathway is believed to diverge upon the substituents on the 1,6-enyne. DFT calculations²¹⁴ on enynes having an ester- or amide- tether and an aryl group at the alkyne (*i.e.* R¹ = Ph or tolyl) were found to have a 6-*endo* transition state lower in energy than the two possible transition states for the formation of the 5-*exo-syn* and 5-*exo-anti*²¹⁷ products by 14.0 and 2.4 kcal.mol⁻¹, respectively (values calculated for the amide tethered 7-phenyl-1,6-enyne)²¹⁸, which suggests that the 6-*endo* cyclization is the preferred pathway. On another hand, DFT calculations¹⁹⁸ on enynes **4.54** having no carbonyl (Y = H₂) show that the 6-*endo* transition state is 6.0 kcal.mol⁻¹ higher in energy to that arising from the 5-*exo* cyclization product (see scheme 4.15a), which suggests that, in this case, the 5-*exo* pathway is the preferred one. Also noteworthy is the fact 5-*exo-syn* **4.58** and 5-*exo-anti* **4.59** products tend to not interconvert readily, with a high difference of free energy $\Delta G^\ddagger = 24.7$ kcal.mol⁻¹ (calculated for (*E*)-6-octen-1-yne with AuPH₃⁺) that can be attributed to the loss of conjugation between the gold carbene and the cyclopropane²⁰². Furthermore, the relative orientation of the phosphine gold(I) moiety in the cyclopropyl gold carbene complex largely affects the rearrangement to cyclobutenes. 5-*exo-anti* cyclopropyl gold carbenes afford generally dienes **4.2** and/or **4.3** (*cf.* section 4.1.1) with an $\Delta G^\ddagger = 9.1$ kcal.mol⁻¹ to go from **4.19** to **4.21** (single cleavage, value calculated (*E*)-6-octen-1-yne and H₃PAu⁺) and $\Delta G^\ddagger = 14.2$ kcal.mol⁻¹ to go from **4.19** to **4.23** (double cleavage, value calculated for the same substrate and gold catalyst)²⁰², while 5-*exo-syn* cyclopropyl gold carbene **4.58** has a difference of free energy $\Delta G^\ddagger = 7.8$ kcal.mol⁻¹ to go to **4.60** (again, value for (*E*)-6-octen-1-yne and AuPH₃⁺). In contrast, formation of 5-*exo-anti* **4.59** (or **4.19**) and 5-*exo-syn* **4.58** cyclopropyl gold carbenes from enyne **4.1** have ΔG^\ddagger of 0.1 and 9.4 kcal.mol⁻¹, respectively. These differences of values in free energies are consistent with two common experimental observations: one, that 1,6-enynes generally produce dienes **4.2** and/or **4.3** and not cyclobutenes **4.10**. Two, that nucleophiles usually add in a *trans* fashion to the gold alkyne complex, which generates 5-*exo-anti* cyclopropyl gold carbene and not in a *cis* fashion, which would afford the 5-*exo-syn* cyclopropyl gold carbene, but which is eventually accessible in some cases (either from an hypothetical nucleophilic *cis*-attack in the gold stabilized vinyl cation formed²⁰² or lowering

²¹⁷ *Syn*- and *anti*- product are directly related to the positioning of the nucleophilic double bond relative to the gold fragment, *cis* or *trans*, respectively.

²¹⁸ A possible concurrent pathway corresponding to the direct transformation of the ester or amide-tethered enyne **4.54** to cyclobutene **4.55** might also be operating, since the difference in free energy $\Delta G^\ddagger = 15.3$ kcal.mol⁻¹ is virtually identical to the one of the transformation from enyne **4.54** to the 6-*endo* intermediate **4.56**, being $\Delta G^\ddagger = 15.2$ kcal.mol⁻¹ (values calculated to the amide tethered 7-phenyl-1,6-enyne).

the energy barrier of *anti-to-syn* isomerization). Although formation of the 5-*exo-cis* product is less favorable, it can compete if substitution at the alkene and/ or alkyne disfavors the skeletal rearrangement to **4.2** and/or **4.3**. For example, DFT calculations on 1-phenyl-6-hexen-1-yne show that only 8.6 kcal.mol⁻¹ is required for the *anti-to-syn* isomerization^{210b}. Finally, once the 5-*exo-syn* gold carbene **4.58** has been formed, then the most likely outcome is cyclobutene **4.10**.

Also noteworthy, the formation of isomerized cyclobutenes **4.63**^{210b}, corresponding to the proton elimination of intermediate **4.61** (supposed coming from the same pathway as intermediate **4.57**) followed by protodemetalation has also been observed to internal alkynes substituted with a phenyl ring (scheme 4.18).

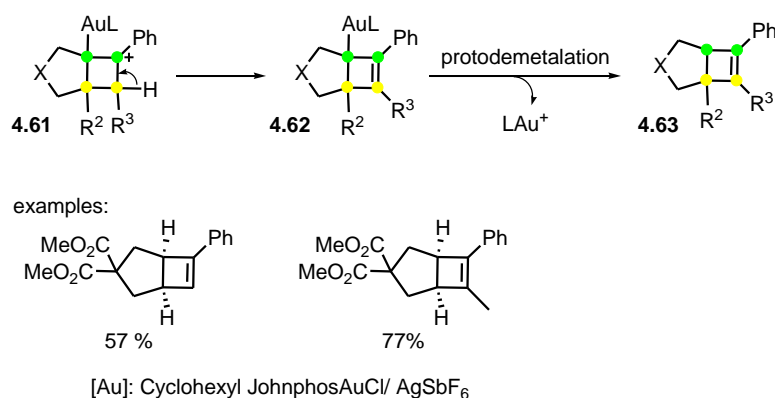

Scheme 4.18: Two examples observed for the corresponding double bond isomerized cyclobutenes **4.63**.

4.2 RESULTS AND DISCUSSION

4.2.1 The Initial idea

At the beginning of this project, we were interested in the potential cascade reaction shown in scheme 4.19, whereby a substituted 1,6-enyne of type **4.64** could afford bicyclic product of type **4.65** and/or **4.66** (scheme 4.19).

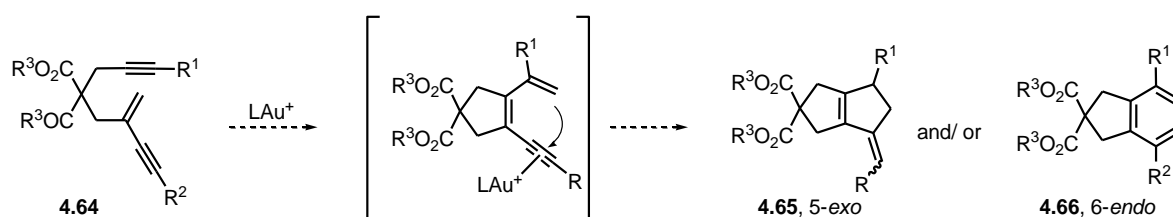

Scheme 4.19: Hypothetical cascade reaction initially envisaged in this project.

To test our initial hypothesis, substrate **4.64a** was synthesized starting from ethyl bromo malonate **4.67** as described below (scheme 4.20)

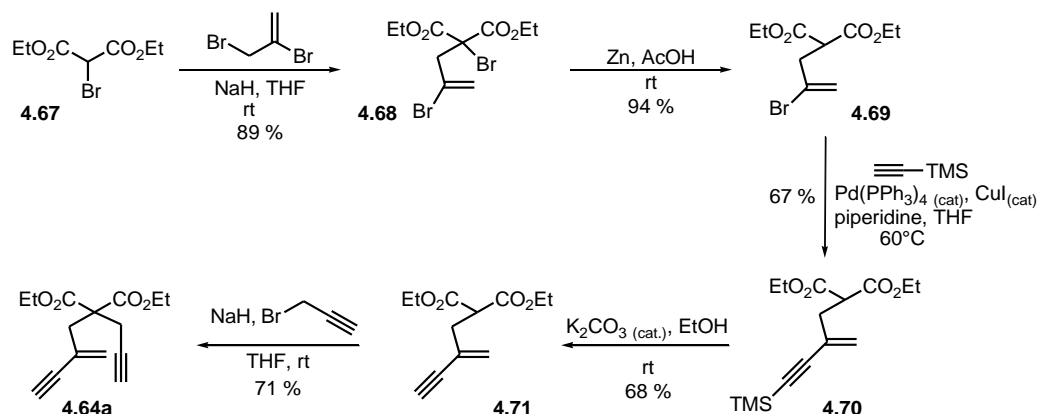

Scheme 4.20: Synthesis of substrate **4.64a**.

Enyne **4.64a** was submitted to the usual metal catalysts employed in enynes cycloisomerization, $\text{PPh}_3\text{Au}(\text{NCCH}_3)\text{SbF}_6$, $\text{PPh}_3\text{AuNTf}_2$ and PtCl_2 (table 4.1). The results obtained were not encouraging. Substrate **4.64a** afforded only cyclopentadiene derivative **4.73a**, as one could expect from either a single or double cleavage (*cf.* section 4.1.1), with very slow kinetics.

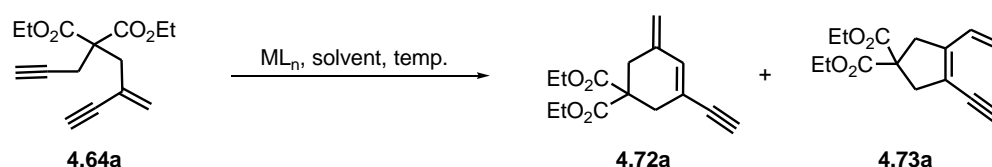

entry	ML_n	conditions	time	conversion	ratio 4.72a:4.73a ^a	yield ^b
1	$\text{PPh}_3\text{Au}(\text{NCCH}_3)\text{SbF}_6$ (4 mol%)	CDCl_3 , rt	7 days	100%	0 : 1	100 %
2	$\text{PPh}_3\text{AuNTf}_2$ (4 mol%)	CDCl_3 , rt	12 days	50%	1 : 10	100 %
3	$\text{PPh}_3\text{AuNTf}_2$ (4 mol%)	CDCl_3 , 60 °C	51 h	81 %	1 : 2	100 %
4	PtCl_2 (10 mol%)	toluene, 80 °C	30 h	50%	0 : 1	< 100% ^c

^a determined by ¹H NMR of the crude reaction mixture. ^b estimated by NMR. ^c unidentified product present at the reaction mixture.

Table 4.1: First trials of the gold-mediated double cyclization on enyne **4.64a**.

The reaction required 7 days at room temperature to reach completion and afford the 5-membered cycle **4.73a** as the only product with the more reactive $\text{PPh}_3\text{Au}(\text{NCCH}_3)\text{SbF}_6$ (entry 1, table 4.1). The use of $\text{PPh}_3\text{AuNTf}_2$ at room temperature gave only 50% conversion after 12 days, in a slightly different 10:1 ratio of **4.72a**: **4.73a** (entry 2, table 4.1) and a 1:2 ratio under reflux of CDCl_3 (entry 3, table 4.1). The use of catalyst PtCl_2 in toluene at 80°C also afforded only 50 % conversion for the formation of compound **4.73a** together with unidentified byproducts (entry 4, table 4.1). No trace of a double cyclized product of type **4.65** or **4.66** was observed.

With the unsubstituted enyne **4.64a** proving to be quite reluctant to react under our reaction conditions, we decided to focus our studies on the internal enyne **4.64b**, anticipating that this substrate would be more reactive than **4.64a** due to the increased electron density imposed by the heptynyl chain.

Substrate **4.64b** was synthesized from vinyl bromo malonate **4.69** through a Sonogashira cross-coupling reaction, which afforded mono-substituted malonate **4.74**. This intermediate was subsequently submitted to standard propargylation conditions to afford **4.64b** (scheme 4.21):

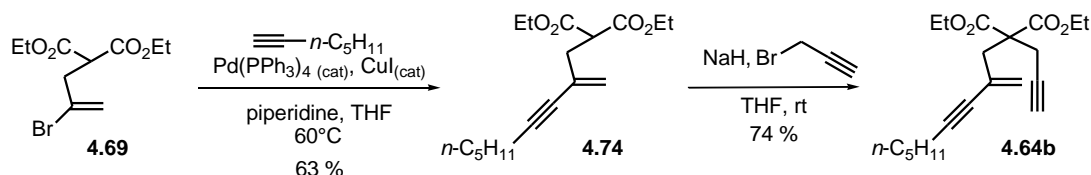

Scheme 4.21: synthesis of substrate **4.64b**.

Again, treatment of enyne **4.64b** with the gold catalysts $\text{PPh}_3\text{AuNTf}_2$ and $\text{PPh}_3\text{Au}(\text{NCCH}_3)\text{SbF}_6$ afforded only a mixture of 5- and 6-membered cyclic products, but the ratio between the 5- and 6-membered cyclic products using these two catalysts were very different (table 4.2). Furthermore, the selectivity towards the 6-membered ring was remarkable, since in the literature, the 5-membered ring is generally by far the most favored one (*cf.* sections 4.1.1 – 4.1.3).

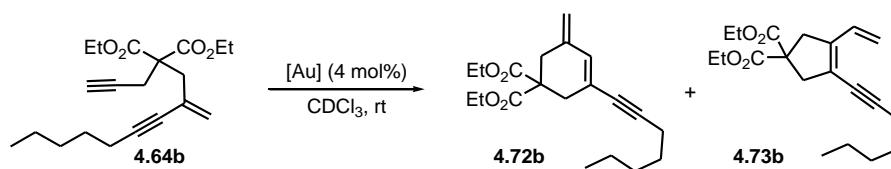

entry	[Au]	time	conversion	ratio 4.72b : 4.73b ^a	isolated yield
1	PPh ₃ Au(NCCH ₃)SbF ₆	3 h	100%	1.9 : 1	58 %
2	PPh ₃ AuNTf ₂	18 h	100%	14.3 : 1	73 %

^a ratio determined by ¹H NMR of the crude reaction mixture

Table 4.2: Second trial on the cascade reaction using 1,6-enynes afforded cycloisomerized products in very different ratios, with a notable preference towards the 6-membered cyclic product in the case of PPh₃AuNTf₂.

From these preliminary studies, we recognized the difficulty of performing our initial idea on the cascade reaction using 1,6-enynes. Nevertheless, from this serendipity, we became very interested on the effects governing the selectivity of the cycloisomerization process of 1,6-enynes towards the ring expanded 6-membered cycles.

In order to observe if the same selectivity difference seen for **4.64b** was present with other substrates, we synthesized enynes **4.64c-g** (scheme 4.22) and submitted them to both catalysts, PPh₃Au(NCCH₃)SbF₆ and PPh₃AuNTf₂.

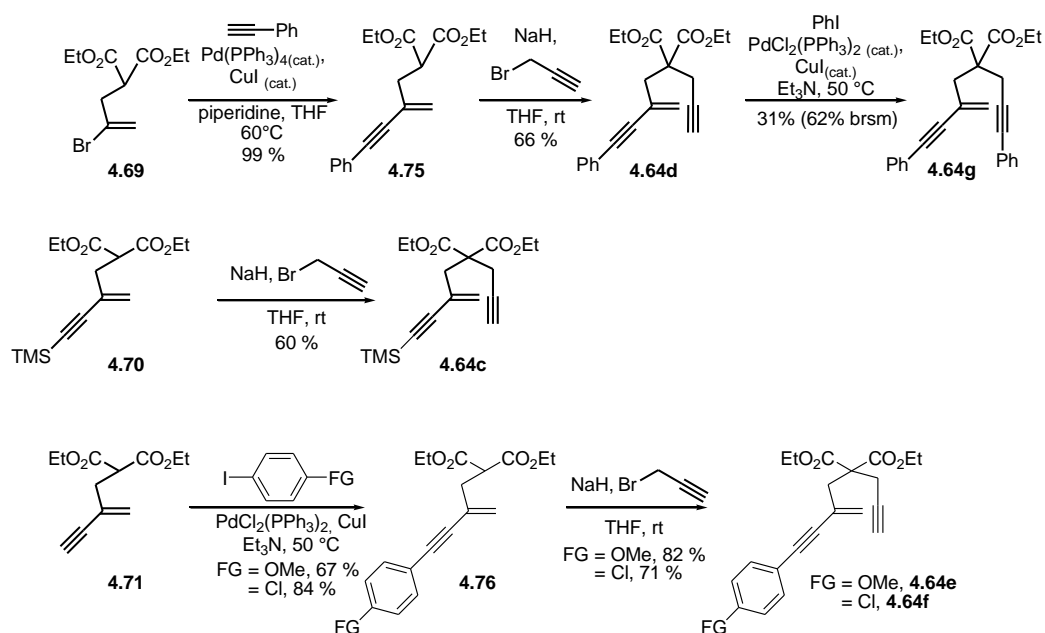

Scheme 4.22: Synthesis of enynes **4.64c-g**.

Despite the small number of molecules tested, the same trend was observed (table 4.3). Accordingly, TMS substituted enyne **4.64c** cyclizes with different ratios and in very long reaction times for each gold catalyst (entries 1 and 2, table 4.2), with NTf₂ counter-ion favoring the 6-membered ring. A substantial increase in the formation of the 6-membered ring using PPh₃AuNTf₂ with substrate **4.64c**, when compared to enyne **4.64a**, suggests that the TMS loss occurs, at least in this case, after cyclization. (entry 2, table 4.3).

Substrate **4.64d** afforded a mixture 2.55:1 of compounds **4.72d**:**4.73d** when treated with the gold catalyst PPh₃Au(NCCH₃)SbF₆ (entry 3, table 4.3) and **4.72d** as the only product when treated with PPh₃AuNTf₂ (entry 4, table 4.3). Other catalysts in the same conditions (4mol%, CDCl₃, rt) were also tried with this substrate: i) [2,4-(^tBu)₂PhO]₃PAuCl/AgSbF₆ afforded a 90% yield of the 6-membered ring **4.72d** in less than 30 min. (estimated by ¹H NMR of the reaction crude, no sign was attributable to the 5-membered ring was detected); ii) XphosAuNTf₂ afforded a 2.5:1 mixture of **4.72d**:**4.73d** and iii) AuCl₃ did not produce any cyclized product, with starting material being recovered after 19h of reaction.

Substrate **4.64e**, possessing a *para*-methoxy group on the phenyl ring, afforded the 6-membered cyclic adduct as the only product using both catalysts (entries 5 and 6, table 4.3) and substrate **4.64f**, possessing a *para*-chloro group on the phenyl ring was insensitive to both catalysts (entries 7 and 8, table 4.3). On another hand, when both alkyne moieties were substituted by a phenyl ring, the reaction proved to be very sluggish using both catalysts. A 2:1 mixture of **4.72g**:**4.73g** was obtained after 6 days for catalyst PPh₃Au(NCCH₃)SbF₆ (entry 9, table 4.3) and was not complete, even at reflux of chloroform for 7 days, for catalyst PPh₃AuNTf₂ (entry 10, table 4.3).

Although more examples are necessary to consolidate the trend observed here, *the previous results suggest that the interplay of the gold catalyst PPh₃AuNTf₂ and a vinyl alkyne appendage on the 1,6-enyne are capable of drastically improving the selectivity of the cycloisomerization process for the 6-membered cyclic adducts.*

To corroborate our suspicions, similar findings were also recently uncovered in the study of 1,6-diynes²¹⁹, where the 6-*endo* cyclization was greatly favored in regard to the 5-*exo* process using Et₃PAuNTf₂, when compared to Et₃PAuSbF₆ (interestingly enough, the substrates prepared in this work can be seen as 1,7-diynes and therefore, are structurally close to 1,6-diynes reported in ref. 219).

²¹⁹ Sperger, C. A.; Fiksdahl, A.; *J. Org. Chem.*, **2010**, 75, 4542.

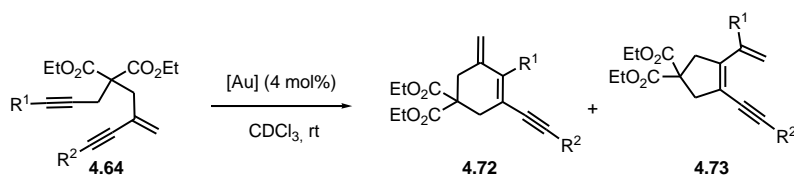

entry	R ¹ , R ²	[Au]	time	conversion	ratio 4.72 : 4.73 ^a	isolated yield
1	H, TMS (4.64c)	PPh ₃ Au(NCCH ₃)SbF ₆	12 days	100 %	1 : 10 (R ² = H, 4.72a : 4.73a)	62 %
2	4.64c	PPh ₃ AuNTf ₂	12 days	68 %	9 : 10 (R ² = H, 4.72a : 4.73a)	- ^b
3	H, Ph (4.64d)	PPh ₃ Au(NCCH ₃)SbF ₆	2 h 20 min	100 %	2.55 : 1 (4.72d : 4.73d)	60 %
4	4.64d	PPh ₃ AuNTf ₂	18 h	100 %	1 : 0 (4.72d : 4.73d)	99 %
5	H, 4-(OMe)-Ph (4.64e)	PPh ₃ Au(NCCH ₃)SbF ₆	2 h	100 %	1:0 (4.72e : 4.73e)	99%
6	4.64e	PPh ₃ AuNTf ₂	7 h	100 %	1:0 (4.72e : 4.73e)	99%
7	H, 4-(Cl)-Ph (4.64f)	PPh ₃ Au(NCCH ₃)SbF ₆	48 h	0 %	only starting material	- ^b
8	4.64f	PPh ₃ AuNTf ₂	48 h	0 %	only starting material	- ^b
9	Ph, Ph (4.64g)	PPh ₃ Au(NCCH ₃)SbF ₆	6 days	100 %	2 : 1 (4.72g : 4.73g)	91 %
10	4.64g	PPh ₃ AuNTf ₂	7 days	30 % ^c	4.3 : 1 (4.72g : 4.73g)	- ^b

^a ratio determined by ¹H NMR of the crude reaction mixture. ^b Not isolated. ^c under reflux (60 °C).

Table 4.3: Results of gold-catalyzed cycloisomerization of 1,6-enynes with branched vinyl-alkyne moieties.

In order to test this hypothesis with some control experiments, we considered compound **4.64h** with an extra carbon between the vinyl alkyne branch and the alkene moiety. This substrate was synthesized from 2-(chloromethyl)-3-chloropropene by a cross coupling reaction with heptyne, followed by the exchange of the chlorine atom by a iodine, following typical Finkelstein reaction conditions and a subsequent secondary alkylation of propargyl malonate, to afford **4.64h** (scheme 4.23).

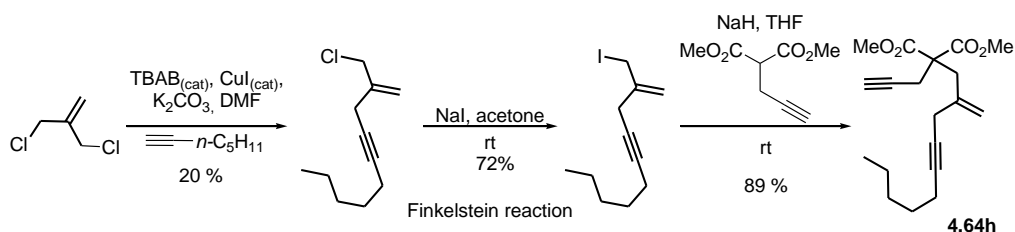

Scheme 4.23: Synthesis of substrate **4.64h**.

The previous large difference in the product distribution observed for **4.64b** disappeared with **4.64h**, which upon treatment with catalysts $\text{PPh}_3\text{Au}(\text{NCCH}_3)\text{SbF}_6$ and $\text{PPh}_3\text{AuNTf}_2$ afforded a 3.3:1 and a 2:1 mixtures of **4.72h**:**4.73h**, respectively (table 4.4).

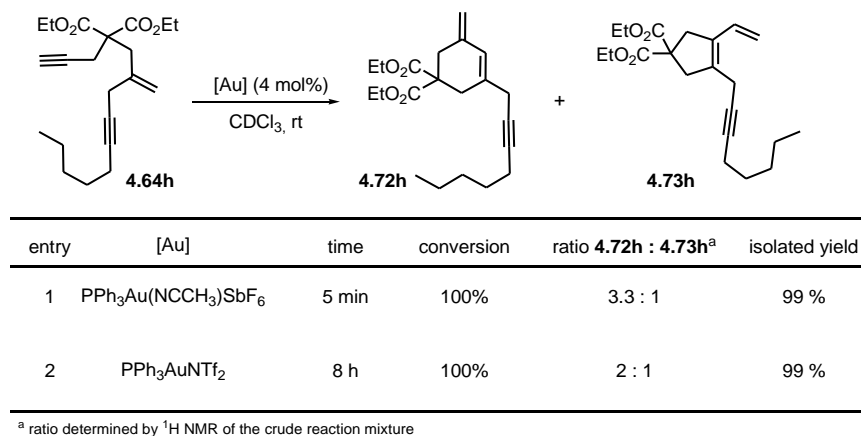
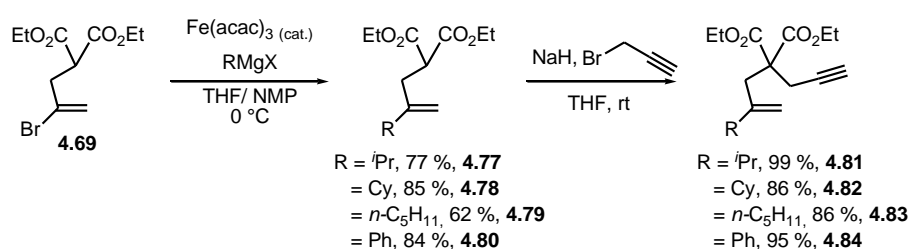

Table 4.4: Control experiment on the influence of a vinyl alkyne moiety.

In other efforts to reassure our suspicions on the need of a vinylalkyne moiety for the regioselectivity control of 1,6-enynes cycloisomerization, substrates **4.81-4.84** (synthesized as depicted in scheme 4.24) were submitted to catalysts $\text{PPh}_3\text{Au}(\text{NCCH}_3)\text{SbF}_6$ and $\text{PPh}_3\text{AuNTf}_2$. Interestingly, not only the difference in selectivity for the 5- and 6-membered cyclic products was not marked, but also extensive amounts of positional isomers of the double bond for the 6-membered cyclic frameworks were found at both 23 °C (room temperature) and at 0 °C for both catalysts (table 4.5).



Scheme 4.24 : Synthesis of substrates **4.81-4.84**.

X = C(CO₂Et)₂

substrate	products	[Au]	T (°C)	products ratio a : b : c : d	time	
4.81		PPh ₃ (NCCH ₃)AuSbF ₆	23	2 : 3.3 : 0 : 1	5 min	
			0	1.7 : 3.3 : 1 : 1	1 h 30 min	
			23	2.3 : 1 : 2.5 : 0	30 min	
			PPh ₃ AuNTf ₂	0	2.7 : 1 : 3.3 : 0	4 h
4.82		PPh ₃ (NCCH ₃)AuSbF ₆	23	1 : 1.4 : 0	5 min	
			0	1 : 0 : 1.2	1 h 30 min	
			PPh ₃ AuNTf ₂	23	2 : 0 : 1	20 min
			0	1 : 0 : 1.5	8 h	
4.83		PPh ₃ (NCCH ₃)AuSbF ₆	23	2 : 1 : 1.2 : 0	10 min	
			0	5 : 1 : 1 : 4.5	1 h 30 min	
			PPh ₃ AuNTf ₂	23	3.3 : 1 : 1 : 2.7	25 min
			0	2 : 1 : 1 : 1.6	6 h	
4.84		PPh ₃ (NCCH ₃)AuSbF ₆	23	2.5 : 1 : 1 : 1	15 min	
			0	3.3 : 1 : 1 : 1	4 h	
			PPh ₃ AuNTf ₂	23	3.3 : 1 : 1 : 1	1 h
			0	4 : 1 : 1 : 1 : 1	9 h	

Table 4.5: Gold(I) mediated cycloisomerization reactions of 1,6-enynes without a stabilizing vinyl alkyne moiety on the alkene.

This confirmed our initial suspicions on the use of substituted vinyl alkyne moieties as directing groups for the regioselectivity of cycloisomerization, but also revealed an extra stabilizing effect from these groups against double bond isomerization (probably due to the conjugation with the alkyne introduced). For instance, substrates **4.64b** and **4.83/ 4.64d** and **4.84**, are pairs of almost the same product, except for the alkyne moiety present in both **4.64b** and **4.64d**. They both afford with the use of $\text{PPh}_3\text{AuNTf}_2$ selective formation of 6-membered rings, whereas their counter parts, **4.83** and **4.84**, respectively, afford mixtures of 5- and 6-membered rings with extensive amounts of double bond isomerization.

Interestingly, similar remote substituent control has also been recently reported on the enyne cross-metathesis/metallotropic [1,3]-shift sequence²²⁰ (scheme 4.25).

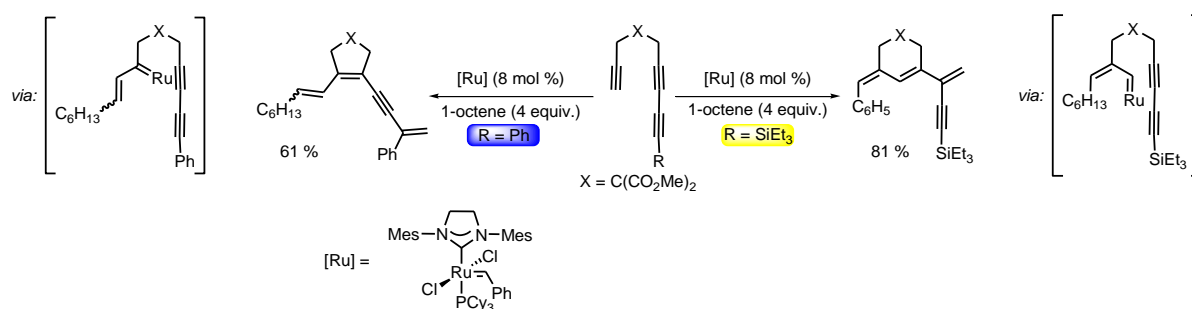

Scheme 4.25: Remote control on enyne cross-metathesis and metallotropic [1,3]-shift using similar remote substituents has also been reported in the literature²²⁰.

It is already an accepted concept that a charged transition-metal catalyst can have its activity, lifetime, stability and product selectivity being significantly influenced by the nature of the counterion. In subsequent efforts to understand the effect of counter ion influence on this cycloisomerization process, simple enyne **4.89** was submitted to gold catalysts $\text{PPh}_3\text{Au}^+ \text{X}^-$, with $\text{X} = \text{OTf}, \text{NTf}_2, \text{BF}_4, \text{and SbF}_6$. Interestingly, the increase in the 6-membered cyclic product followed the inverse order of counter-ion coordinating ability²²¹: SbF_6^- (less-coordinating) $> \text{BF}_4^- > \text{Tf}_2\text{N}^- > \text{TfO}^-$ (more coordinating) (table 4.6), which is contrary to the previous results obtained for enynes **4.64b** and **d**. This means that the counter-ion alone cannot explain the difference in the regioselectivity found for enyne **4.64b** and **d**.

²²⁰ Yun, S. Y.; Wang, K.-P.; Kim, M.; Lee, D.; *J. Am. Chem. Soc.*, **2010**, 132, 26, 8840.

²²¹ (a) Strauss, S. H.; *Chem. Rev.*, **1993**, 93, 927. (b) LaPointe, R. E.; Roof, G. R.; Abboud, K. A.; Klosin, J.; *J. Am. Chem. Soc.*, **2000**, 122, 9560. (c) Reed, C. A.; *Acc. Chem. Res.*, **1998**, 31, 133.

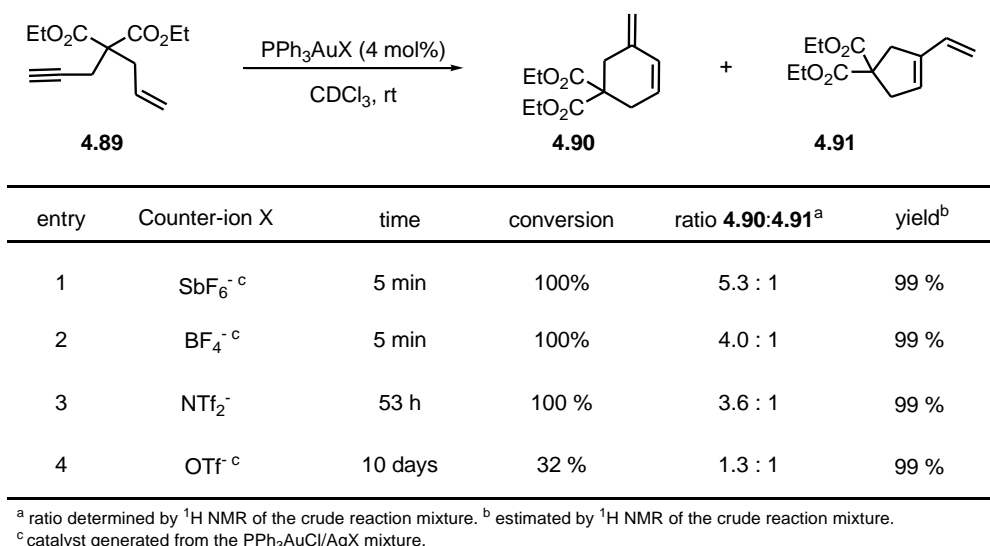

Table 4.6: Investigation on the effect of the counter-ion in the cycloisomerization of 1,6-enynes.

It is also noteworthy to mention results reported by Echavarren *et al.*^{197a}, who found for the cycloisomerization reaction of the methyl malonate **4.34** (analogue to enyne **4.89**) with catalyst PPh₃Au(NCCH₃)SbF₆ (2 mol%) in DCM at room temperature (23 °C), a 2:1 ratio of 6-:5- membered cyclic products, in stark contrast to entry 1 of table 4.6. The explanation for that, also given in one of Echavarren's report²¹¹, was due to degradation of the 6-membered cycle, thus making the relative amount of the 5-membered cycle increase. In our studies, we observed in 5 min, a 5.3:1 ratio for the 6-membered:5-membered cycles; in 15 min, the ratio dropped to 2.8:1 and after 4h, there was no more 6-membered product present in solution, but only the 5-membered cycle and uncharacterizable degradation.

At the same time we were investigating the counter-ion effect on the gold cationic fragment PPh₃Au⁺, we became interested in the possibility of finding a competent catalyst for the selective 6-membered product formation from 1,6-enynes, independent of the appendage on the alkene moiety. Such a catalyst would be of great synthetic value, since 6-membered cycles are rarely obtained alone, but generally with varying amounts of other products^{197a, 197c, 211, 222}.

From our initial screening with the most common catalysts (table 4.7), no suitable complex was identified for the task, but some empirical informations can be interpreted: i) simple gold(I) and gold(III) salts are selective towards the 5-membered cycle (entries 1-3,

²²² Chen, Z.; Zhang, Y.-X.; Wang, Y.-H.; Zhu, L.-L.; Liu, H.; Li, X.-X.; *Org. Lett.*, **2010**, 12, 15, 3468.

table 4.2, the low conversions are probably associated with the fragile catalyst integrity due to high hygroscopicity of these salts). ii) Buchwald biphenyl ligands afford similar results (entries 4-8, table 4.2), but it suggests that product selectivity **4.90/4.91** is insensitive to bulky groups on the phosphorous atom (entries 4 and 6, table 4.2) and it increases with less hindered biphenyl ligands. The best result is obtained for the “extreme case” of just one phenyl ring (entries 4, 5 and 13, table 4.2). Also, no difference in selectivity was marked for biphenyl ligands with different counter-ions (entries 6 and 7, table 4.2). iii) phosphines with electron withdrawing atoms/groups seem to favorise the 6-membered

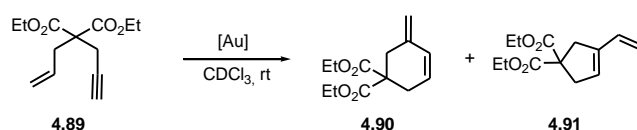

entry	[Au]	ratio 4.90:4.91	time	yield	entry	[Au]	ratio 4.90:4.91	time	yield
1	AuCl	0 : 1	7 days	100 % (30 % conv.)	9		2.3 : 1	1 min	100 %
2	AuCl ₃	0 : 1	56 h	100 %	10		2.1 : 1	11 days	<100% ^b (75% conv.)
3	AuBr ₃	0 : 1	5 days	100 % (25 % conv.)	11		1 : 1	16 h	< 100 % ^b
4		1.1 : 1	20 min	100 %	12		1.7 : 1	30 h	< 100 % ^b
5		1.6 : 1	1 h 45 min	100 %	13	Cy ₂ PhPAuCl/ AgNTf ₂	2 : 1	6 days	< 100 % ^b
6		1.1 : 1	30 min	100 %	14		1.5 : 1	19 h	100 %
7		1.1 : 1	5 min	100 %	15		2.4 : 1	2h 30	100 %
8		1.4 : 1	40 min	100 %	16		1.6 : 1	6 days	< 100% ^b (53 % conv.)

^aestimated by ¹HNMR of the crude reaction mixture. ^bsubproducts present in a minor extent

Table 4.2: Catalyst screening for the regioselective 6-membered cyclic product **4.90**.

ring formation (entries 8, 9 and 10, table 4.2). iv) NHC ligands do not give satisfactory results either. But once again, steric demanding groups increase the reaction selectivity (entries 11 and 12, table 4.2).

Three new catalysts were tried in this project (entries 14, 15 and 16, table 4.2). In entry 14, we supposed that a rigid tricyclic structure would be enough hindered to impart selectivity, but was inefficient²²³. In entries 15 and 16 of table 4.2, phosphino *N*-aryl pyrroles (PAP) ligands reported by Beller *et al.* in palladium cross coupling reactions²²⁴ were for the first time, to the best of our knowledge, employed in gold chemistry. Beller describes these ligands in terms of reactivity to be close to Buchwald biphenyl phosphine ligands, but easier to prepare. Interestingly, in our case, we found the PAP-gold catalyst in entry 15 of table 4.2 to be more selective than any biphenyl phosphine ligand tried and even the most selective of all catalysts tried before (a similar result was obtained with phosphite ligand, entry 9, table 4.2). Here, the same trend of palladium cross-coupling reactions was observed, the more steric-demanding PAP ligand was more effective in catalysis (entries 15 and 16, table 4.2).

4.3 CONCLUSION

Although not closed, we started here two very interesting projects concerning i) the interplay of the counter-ion NTf₂ from triphenyl phosphine gold catalysts with an alkynyl branch on the alkene moiety in 1,6-enynes, which suggests that high regioselectivity towards the 6-membered cycle can be obtained and ii) the use of PAP-ligands in gold catalysis, as efficient and potential selective ligands towards the 6-membered cycle.

Project i) still lacks a larger scope investigation but we believe we have begun a seminal work proving that high differences in regioselectivity for the cyclization of 1,6-enynes can be attained at room temperature, that favors the formation of a 6-membered ring. This is an interesting observation, since these 6-membered rings are rarely formed through gold-mediated cycloisomerization of 1,6-enynes (*cf.* section 4.1.5).

²²³ Blug, M.; Guibert, C.; Le Goff, X.-F.; Mezailles, N.; Le Floch, P.; *Chem. Comm.*, **2009**, 201.

²²⁴ (a) Zapf, A.; Jackstell, R.; Rataboul, F.; Riermeier, T.; Monsees, A.; Fuhrmann, C.; Dingerdissen, U.; Beller, M.; *Chem. Comm.*, **2004**, 38. (b) Rataboul, F.; Zapf, A.; Jackstell, R.; Harkal, S.; Riermeier, T.; Monsees, A.; Dingerdissen, U.; Beller, M.; *Chem Eur. J.*, **2004**, 10, 2983. (c) Harkal, S.; Rataboul, F.; Zapf, A.; Fuhrmann, C.; Riermeier, T.; Monsees, A.; Beller, M.; *Adv. Synth. Catal.*, **2004**, 346, 1742. (d) Schulz, T.; Torborg, C.; Schäffner, B.; Huang, J.; Zapf, A.; Kadyrov, R.; Börner, A.; Beller, M.; *Angew. Chem. Int. Ed.*, **2009**, 48, 918.

Project ii) reports for the first time the use of PAP-ligands in gold catalysis and reveal these ligands as potential sources for the regioselective 6-membered ring formation. The maxima of catalysis fits well here: “Catalysis is all about fine tuning”. In this regard, new substituents on these ligands must be screened, but these preliminary results look promising.

4.4 PERSPECTIVES AND FURTHER DEVELOPMENTS

In order to enlarge the scope of 1,6-enynes **4.92** that cyclize preferentially to a 6-membered ring, we believe that some substrates would be of particular interest to study, notably by changing the enyne tether to O, NTs, C(SO₂Ph)₂ and C(CH₂OAc)₂; and investigating the effect of ester groups on alkyne extremities. As R¹ = *n*-C₅H₁₁ and Ph showed the best selectivities (table 4.2 and entries 3 and 4 of table 4.3), we suggest that these two groups are kept in following studies (scheme 4.21).

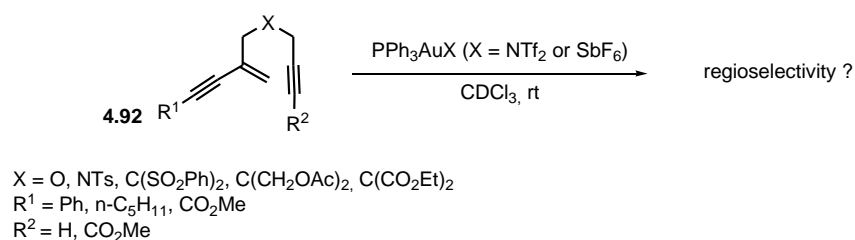

Scheme 4.21: Substrates **4.92** are possibly interesting substrates to investigate the regioselectivity cycloisomerization processes using triphenyl phosphine gold catalysts.

Having in mind the change in reactivity found for 1,6-enynes **4.92**, a further interesting question is about the reaction mechanism. The trapping of reaction intermediates by a nucleophile during the gold mediated cycloisomerization would afford what kind of product? This is a pertinent question because, despite suggested by DFT calculations that formation of methylene cyclohexenes **4.7** occurs through the ring expansion of intermediate **4.19**, as shown in scheme 4.12, slight structure modifications such as the alkyne branch considered in enynes **4.92** can eventually change the reaction pathway. The cyclobutenes synthesis discussed in section 4.1.6 is an example of such a change in reaction mechanism.

Concerning the search for a competent gold catalyst to perform the regioselective 6-membered ring formation from 1,6-enynes, a second catalyst screening can be envisaged. A possible choice regrouping the two main properties observed in table 4.2 regarding selectivity: steric hindrance and the presence of electronwithdrawing groups suggests catalysts following the general structure **4.93**, such as **4.94** and **4.95** (Figure 4.1).

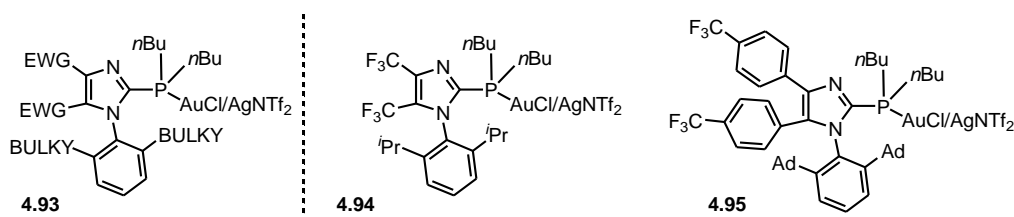

Figure 4.1: Possible new catalysts for the gold regioselective synthesis of 6-membered cycles from 1,6-enynes.

Interestingly, recent mass-spectrometry studies report that gold can participate in metathesis reactions²²⁵. One attempt to detect this reactivity of gold carbenoids in metathesis reactions can be envisaged from the cycloisomerization of 1,6-enynes in the presence of diazo compounds. Such reactivity is already well established for Ru²²⁶, but has also been found in Ni complexes²²⁷. One use of gold carbenoids generated from enynes **4.96** can be envisaged. Using enyne **4.96**, a typical 5-*exo* cyclization would generate a methylcyclopropyl gold carbene that would possibly be trapped by a nucleophilic diazonium compound, as shown in **4.97** (Such 1,2 additions to gold carbenes have already been suggested in the literature²²⁸). Subsequent elimination of nitrogen and the gold catalyst, would produce alkene **4.98**, a product coming from a cycloisomerization/ formal cross-metathesis sequence (scheme 4.22). Under the acidic reaction conditions, it is possible that for the use of the trimethylsilyl diazo methane as shown in scheme 4.22, that the TMS group inserted in the substrate is eliminated at some point *en route* to **4.98**.

²²⁵ Federov, A.; Moret, M.-E.; Chen, P.; *J. Am. Chem. Soc.*, **2008**, 130, 8880.

²²⁶ (a) Monnier, F.; Castillo, D.; Dérien, S.; Toupet, L.; Dixneuf, P. H.; *Angew. Chem. Int. Ed.*, **2003**, 42, 5474. (b) Eckert, M.; Monnier, F.; Shchetnikov, G. T.; Titanyuk, I. D.; Osipov, S. N.; Toupet, L.; Dérien, S.; Dixneuf, P. H.; *Org. Lett.*, **2005**, 7, 17, 3741. (c) Monnier, F.; Le Bray, C. V.; Castillo, D.; Aubert, V.; Dérien, S.; Dixneuf, P. H.; Toupet, L.; Ienco, A.; Mealli, C.; *J. Am. Chem. Soc.*, **2007**, 129, 6037.

²²⁷ (a) Ni, Y.; Montgomery, J.; *J. Am. Chem. Soc.*, **2004**, 126, 11162. (b) Ni, Y.; Montgomery, J.; *J. Am. Chem. Soc.*, **2006**, 128, 2609.

²²⁸ Some examples : (a) Davies, P. W.; Albrecht, S. J.-C.; *Chem. Comm.*, **2008**, 238. (b) see ref 209b (c) see ref 214.

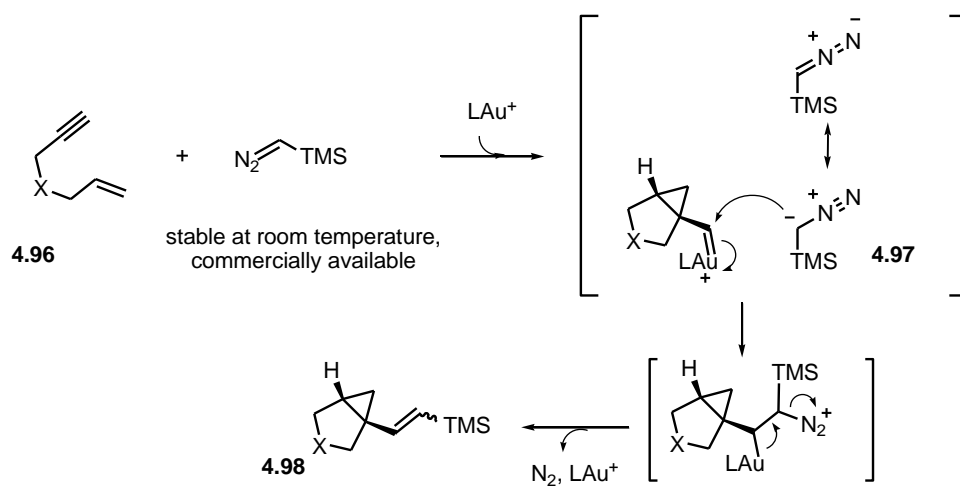

Scheme 4.22: Envisaged route to a cycloisomerization/ formal cross-metathesis sequence.

CHAPTER 5: HYDROALKYLATION OF ALKYNYL ETHERS VIA A GOLD(I)-CATALYZED 1,5-HYDRIDE SHIFT/ CYCLIZATION SEQUENCE

This work was developed with contribution from the student Yann Odabachian. With the concern for a clear exposal of the subject, all the experiments performed will be presented herein, nevertheless, the ones done by the author of this thesis will be marked with a red star (*).

Part of the results exhibited here was published in the Journal of the American Chemical Society: Jurberg, I. D.; Odabachian, Y.; Gagosz, F.; *J. Am. Chem. Soc.*, **2010**, 132, 10, 3543.

CHAPTER 5: HYDROALKYLATION OF ALKYNYL ETHERS VIA A GOLD(I)-CATALYZED 1,5-HYDRIDE SHIFT/ CYCLIZATION SEQUENCE

5.1 INTRODUCTION: C-H activation processes and intramolecular redox reactions.

5.1.1 C-H activation processes

Although intensive research on C-H activation contributed to dramatic advances in this area since the 1980's, the ultimate goal of functionalizing strong C-H bonds still deserves to be named as a Holy Grail in organic chemistry. The importance of this process relies on the ubiquitous presence of these bonds in nature. For instance, considering the energy industry and economical issues, the utilization of methane (the main component of natural gas) from remote locations of many of the world's known natural gas resources is hampered due to the difficulty of accessing these sites. Today's solutions to this difficulty are both costly: one is the gas transportation; the other is the current procedure to convert hydrocarbon gas in a more readily transportable liquid, which consists in a two-steps process: the production of synthesis gas (CO and H₂) and its conversion to the desired products²²⁹. The development of efficient strategies for the direct conversion of methane to methanol or other liquid fuels or chemicals could thus significantly improve methane utilization²³⁰.

Concerning organic synthesis, a practical, predictable and efficient C-H activation process would represent a revolution²³¹ in the logic underpinning the way we build molecules, where functionalization of a certain site is generally based on the proximity of heteroatoms and unsaturations. Viewing C-H bonds as functional groups can notably save functional groups manipulations and allow shortcuts in many steps of tedious procedures²³².

²²⁹ Gradasi, M. J.; Green, N. W.; *Fuel Proc. Technol.*, **1995**, 42, 65.

²³⁰ Three landmarks toward this goal are: (a) Periana, R. A.; Taube, D. J.; Evitt, E. R.; Löffler, D. G.; Wentrcek, P. R.; Voss, G.; Masuda, T.; *Science*, **1993**, 259, 340. (b) Periana, R. A.; Taube, D. J.; Gamble, S.; Taube, H.; Satoh, T.; Fujii, H.; *Science*, **1998**, 280, 560. (c) Periana, R. A.; Mironov, O.; Taube, D.; Bhalla, G.; Jones, C. J.; *Science*, **2003**, 301, 814.

²³¹ For some very interesting studies, see: (a) White, C.; Chen, M. S.; *Science*, **2007**, 318, 783. (b) Chen, M. S.; White, M. C.; *Science*, **2010**, 327, 566. (c) Chen, K.; Eschenmoser, A.; Baran, P. S.; *Angew. Chem. Int. Ed.*, **2009**, 48, 9705. (d) Phipps, R. J.; Gaunt, M. J.; *Science*, **2009**, 323, 1593.

²³² For some examples of such shortcuts in total synthesis, see: (a) Stang, E. M.; White, M. C.; *Nature*, **2009**, 1, 547. (b) Chen, B.; Baran, P.; *Nature*, **2009**, 459, 824. (c) Hinman, A.; Du Bois, J. H.; *J. Am. Chem. Soc.*, **2003**, 125, 11510. (d) Fischer, D. F.; Sarpong, R.; *J. Am. Chem. Soc.*, **2010**, 132, 5926. (e) Beck, E. M.; Hatley, R.; Gaunt, M. J.; *Angew. Chem. Int. Ed.*, **2008**, 120, 3046.

In the context of C-H functionalization, the preceding C-H “activation” step is commonly understood as defined by Shilov and Shulp’in: “when we refer to the activation of a molecule, we mean that the reactivity of this molecule increases due to some action. (...) The main result of the activation of a C-H bond is the replacement of a strong C-H bond with a weaker, more readily functionalized bond”^{233a}.

In this regard, metal complexes²³³ have been extensively employed in the research of viable catalytic systems capable of efficiently activating C-H bonds. The mechanisms implicated in C-H activations are (i) oxidative addition, which involves late transition metals, such as Re, Fe, Ru, Os, Rh, Ir, Pt. The C-H fragment is added to the metal center to generate two new metal-carbon and metal hydride bonds. (ii) σ -Bond metathesis, which involves early-transition metals with d^0 electronic configuration, accounts for the interchange of alkyl groups. (iii) 1,2-Insertion involves the addition of an alkane to a metal-nonmetal double bond. (iv) Metalloradical activation implicates two metal centers, which break and share the C-H bond fragments, forming two new metal-carbon and metal-hydrogen fragments. Finally, (v) electrophilic activation refers to the displacement of the hydrogen atom from the C-H bond by another group, generally a halide or a water molecule (scheme 5.1).²³⁴

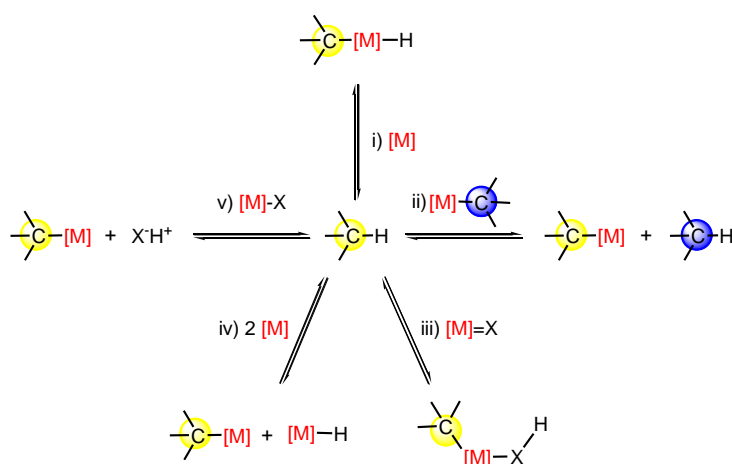

Scheme 5.1: There are five typical metal-promoted C-H activation pathways: i) oxidative addition, ii) σ -bond metathesis, iii) 1,2 insertion, iv) metalloradical activation and v) electrophilic activation.

²³³ For a review using numerous metals, see: (a) Shilov, A. E.; Shulp’in, G. B.; *Chem. Rev.*, **1997**, 97, 2879. (b) Díaz-Requejo, M. M.; Pérez, P. J.; *Chem Rev.*, **2008**, 3379. For reviews using rhodium, see: (c) Davies, H. M. L.; Manning, J. R.; *Nature*, **2008**, 451, 417. (d) Lewis, J. C.; Bergman, R. G. Ellman, J. A.; *Acc. Chem. Res.*, **2008**, 41, 8, 1013. For a review using palladium, see: (e) Lyons, T. W.; Sanford, M. S.; *Chem. Rev.*; **2010**, 110, 1147.

²³⁴ Labinger, J. A.; Bercaw, J. E.; *Nature*, **2002**, 417, 507.

These processes participate to different extents in the few catalytic systems described to date for the activation and subsequent functionalization of C-H bonds using unreactive hydrocarbons. Three of the most successful transformations dealing with alkanes are borylation reported by Hartwig *et al.*²³⁵ and alkane dehydrogenation²³⁶, which both proceed through mechanism i), and Shilov's systems for the activation of methane²³⁰, which generally occurs through the electrophilic activation mechanism v) (scheme 5.2).

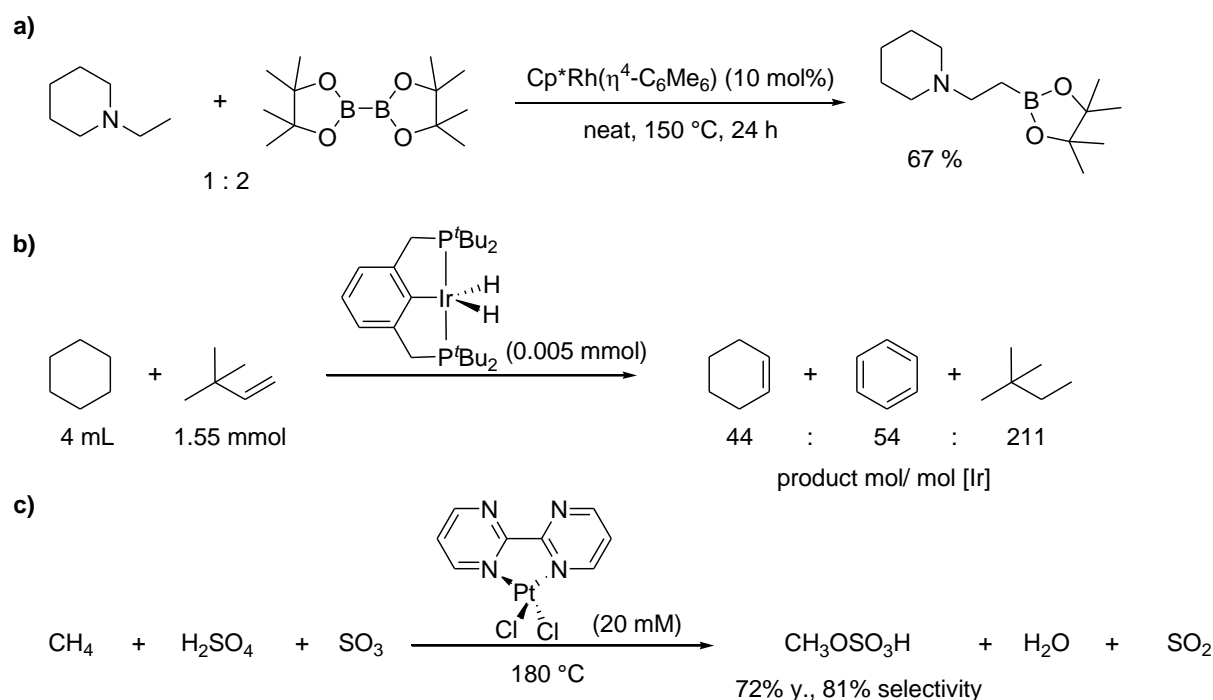

Scheme 5.2: Examples of **a)** Hartwig's borylation and **b)** alkane dehydrogenation, which both proceed through an oxidative addition mechanism, whereas **c)** Pt(II)-based activation of methane to methane bisulphate is believed to occur through an electrophilic activation mechanism.

One significant problem met in these aforementioned C-H activation processes is selectivity. One reason is because the desired functionalized product must not react more

²³⁵ (a) Mkhaliid, I. A. I.; Barnard, J. H.; Marder, T. B.; Murphy, J. M.; Hartwig, J. F.; *Chem. Rev.*, **2010**, 110, 890. (b) Chen, H.; Schlecht, S.; Semple, T. C.; Hartwig, J. F.; *Science*, **2000**, 287, 1995.

²³⁶ (a) Gupta, M.; Hagen, C.; Kaska, W. C.; Flesher, R.; Jensen, C. M.; *Chem. Comm.*, **1996**, 2083. (b) Gupta, M.; Hagen, C.; Kaska, W. C.; Cramer, R. E.; Jensen, C. M.; *J. Am. Chem. Soc.*, **1997**, 119, 840. (c) Liu, F. C.; Pak, E. B.; Singh, B.; Jensen, C. M.; Goldman, A. S.; *J. Am. Chem. Soc.*, **1999**, 121, 4086. (d) Goldman, A. S.; Roy, A. H.; Huang, Z.; Ahuja, R.; Schinski, W.; Brookhart, M.; *Science*, **2006**, 312, 257.

readily with the metal center than the substrate starting material. A second reason is because selectivity among different C-H bonds in the starting substrate is often difficult.

When we consider these selectivity issues in the more general scenario of functionalizing organic molecules, one way to target the activation of a specific C-H bond, is to use the proximity of a heteroatom, such as nitrogen or oxygen, or of an unsaturated multiple bond, to activate the neighboring C-H bond²³⁷. In these cases, the mechanisms of activation are completely different from the C-H metalation processes presented in scheme 5.1.

Indeed, typical approaches to functionalize α -C-H bonds to a heteroatom or an unsaturated bond generally consist of redox processes promoted by a transition metal catalyst that can be performed either in an inter- or intramolecular manner. In order to activate the targeted α -C-H bond through hydrogen abstraction, intermolecular processes use external oxidizing agents (*via* SET processes), such as 2,3-dichloro-5,6-dicyanobenzoquinone (DDQ), ^tBuOOH (TBHP), ^tBuOO^tBu (DTBP), *N*-bromosuccinimide (NBS) or O₂. The process is now termed cross-dehydrogenative coupling (CDC)²³⁸. On another hand, intramolecular processes take advantage of an electrophilic moiety present in the substrate, which serves as a hydride acceptor. This electrophilic moiety receives a hydride, thus being reduced and generates an oxidized stabilized carbocation due to the presence of a α -heteroatom/allylic (or benzylic) double bond. The hydride addition to the electrophilic moiety is generally accompanied by concomitant formation of an internal nucleophile which cyclizes on the cation previously formed (scheme 5.3).

²³⁷ Godula, K.; Sames, D.; *Science*, **2006**, 312, 67.

²³⁸ For reviews, see: (a) Li, C.-J.; *Acc. Chem. Res.*, **2009**, 42, 2, 335. (b) Scheuermann, C. J.; *Chem. Asian J.*, **2010**, 5, 436. For selected publications, see: (c) Li, Z.; Li, C.-J.; *J. Am. Chem. Soc.*, **2005**, 127, 6968. (d) Zhang, Y.; Li, C.-J.; *J. Am. Chem. Soc.*, **2006**, 128, 4242. (e) Yu, B.; Jiang, T.; Li, J.; Su, Y.; Pan, X.; She, X.; *Org. Lett.*, **2009**, 11, 15, 3442. (f) Li, Z.; Li, C.-J.; *J. Am. Chem. Soc.*, **2005**, 127, 3672. (g) Zhang, Y.; Li, C.-J.; *J. Am. Chem. Soc.*, **2006**, *Angew. Chem. Int. Ed.*, **2006**, 45, 1949. (g) Rice, G. T.; White, M. C.; *J. Am. Chem. Soc.*, **2009**, 133, 31, 11707. (h) Reed, S. A.; Mazzotti, A. R.; White, M. C.; *J. Am. Chem. Soc.*, **2009**, 133, 11701. (i) Tu, W.; Liu, L.; Floreacing, P. E.; *Angew. Chem. Int. Ed.*, **2008**, 47, 4184. (j) Li, Z.; Yu, R.; Li, H.; *Angew. Chem. Int. Ed.*, **2008**, 47, 7497.

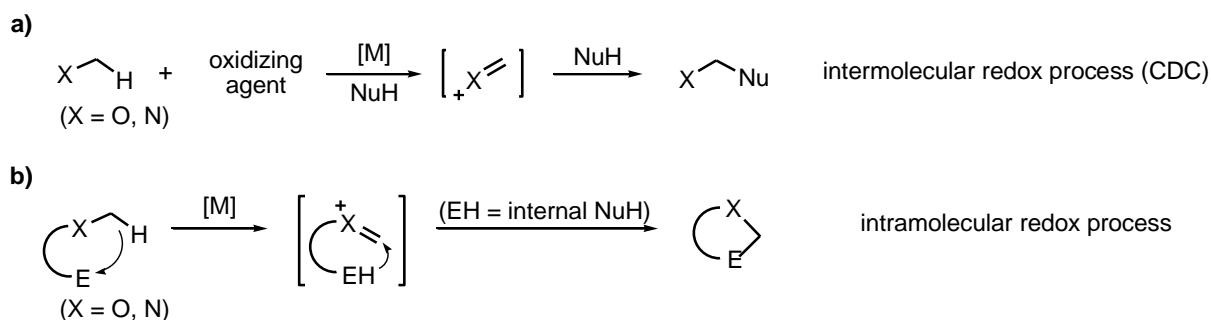

Scheme 5.3: General schemes for the **a)** inter- and **b)** intramolecular redox/cyclization processes, where the directing group is a heteroatom X = O or N.

Since the subject developed in this chapter is essentially an intramolecular redox process (as depicted in scheme 5.3b), literature background concerning this transformation will be more deeply discussed in the next section.

5.1.2 Intramolecular redox reactions: literature background

Literature background concerning 1,5-hydride shift/cyclization sequences is largely dominated by the use of either carbonyl/iminium or Michael acceptors, in a 1,2- or 1,4-hydride additions, respectively, followed by a cyclization step using the nucleophile generated from the 1,5-shift event (scheme 5.4).

a) 1,2-hydride addition

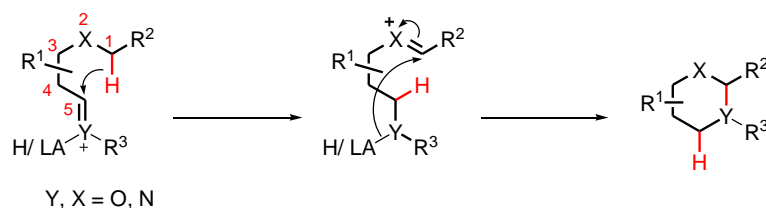

b) 1,4-hydride addition

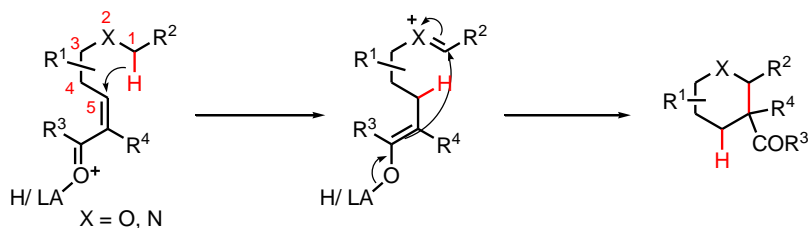

Scheme 5.4: Intramolecular approach towards cyclized products following a [1,5]-hydride shift/cyclization sequence, proceeding either by **a)** 1,2- or **b)** 1,4-hydride addition.

This 1,5-hydride shift/cyclization sequence was originally described to proceed upon heating in temperatures in the range of 100-230 °C and using tertiary amines as hydride donors. This reactivity was named as *tert*-amino effect²³⁹. Later developments extended the generality of this ring closure approach to the use of ethers as *linkers*. Reactions were described to proceed under milder conditions using catalytic amounts of Brønsted acids, such as TfOH²⁴⁰ and TFA²⁴¹, and different Lewis acids, such as Gd(OTf)₂²⁴², Mg(OTf)₂²⁴³, SnCl₄²⁴⁴, BF₃·OEt₂²⁴⁵ and Sc(OTf)₃²⁴⁶. Moreover, the first organocatalytic approach using a pyrrolidine derivative/TFA has also been recently documented²⁴⁷. Selected examples are shown below (scheme 5.5).

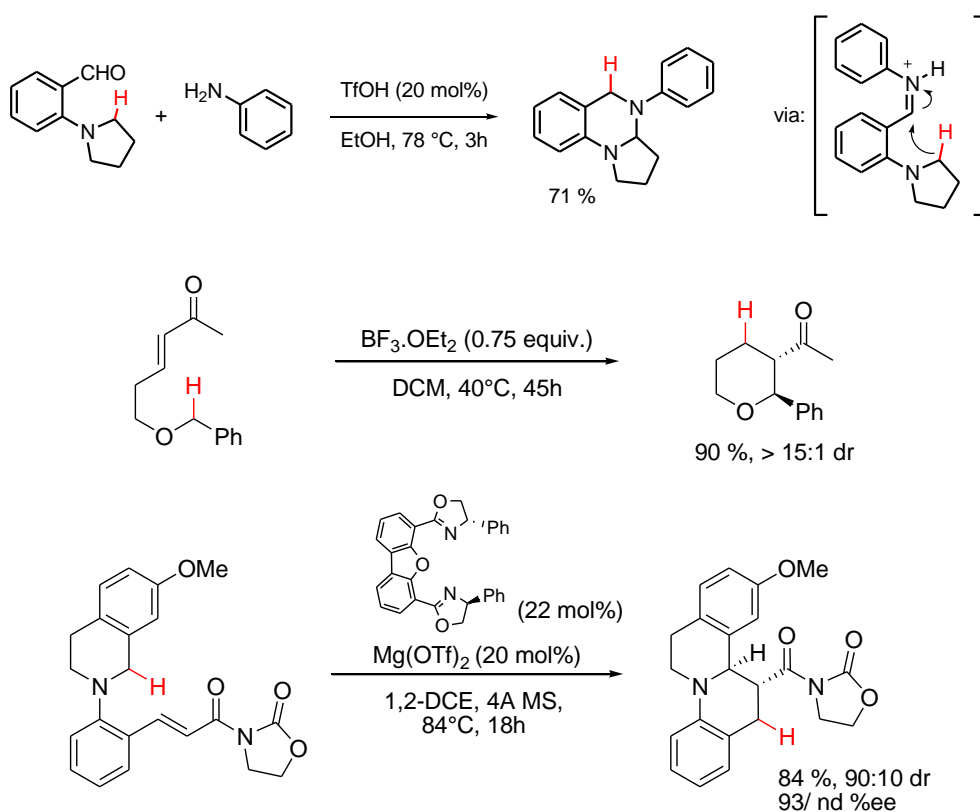

²³⁹ For a review, see: Mátyus, P.; Éliás, O.; Tapolcsányi, P.; Polonka-Bálint, Á.; Halász-Dajka, B.; *Synthesis*, **2006**, 16, 2625.

²⁴⁰ Zhang, C.; Murarka, S.; Seidel, D.; *J. Org. Chem.*, **2009**, 74, 419

²⁴¹ Che, X.; Zheng, L.; Dang, Q.; Bai, X.; *Synlett*, **2008**, 2373.

²⁴² Murarka, S.; Zhang, C.; Konieczynska, M. D.; Seidel, D.; *Org. Lett.*, **2009**, 11, 1, 129.

²⁴³ Murarka, S.; Deb, I.; Zhang, C.; Seidel, D.; *J. Am. Chem. Soc.*, **2009**, 131, 13226.

²⁴⁴ Mori, K.; Kawasaki, T.; Sueoka, S.; Akiyama, T.; *Org. Lett.*, **2010**, 12, 8, 1732.

²⁴⁵ (a) Pastine, S. J.; McQuaid, K. M.; Sames, D.; *J. Am. Chem. Soc.*, **2005**, 127, 12180. (b) Pastine, S. J.; Sames, D.; *Org. Lett.*, **2005**, 7, 24, 5429. (c) McQuaid, K. M.; Sames, D.; *J. Am. Chem. Soc.*, **2009**, 131, 402.

²⁴⁶ McQuaid, K. M.; Long, J. Z.; Sames, D.; *Org. Lett.*, **2009**, 11, 14, 2972.

²⁴⁷ Kang, Y., K.; Kim, S. M.; Kim, D. Y.; *J. Am. Chem. Soc.*, **2010**, ASAP.

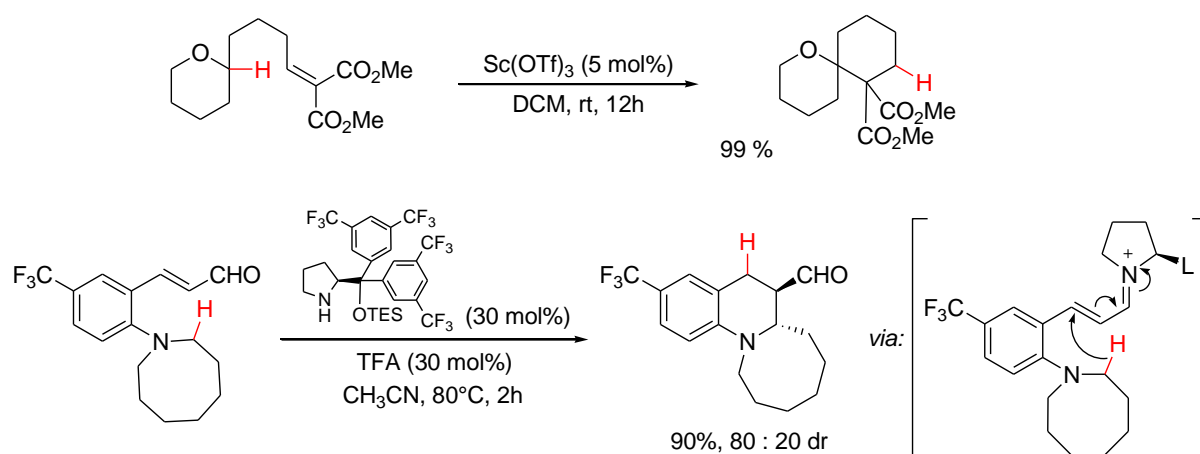

Scheme 5.5: Selected examples from the literature for the 1,5-hydride shift/cyclization sequence using different Brønsted/Lewis acids and 1,2-/1,4-hydride acceptors.

Important features concerning the substrate structure and the nature of the activating species employed (Brønsted acid, Lewis acid, temperature, etc) are determinants in allowing the 1,5-hydride shift to occur. For instance, in thermal-promoted procedures, which are generally described with double Michael-acceptors, the presence of strong electron-withdrawing groups at the terminal vinylic carbon, such as two cyano groups, are considered as a prerequisite for the 1,5-hydride shift to occur efficiently²³⁹. Conversely, carbonyl/Lewis acid complexes, which are highly electrophilic²⁴⁸, allow a broader use of Michael acceptors, such as α,β -enals, -enones, -amide derivatives, -double esters, etc. (cf. scheme 5.5). Additionally, more demanding substrates, such as **5.1**, fail to cyclize thermally, but using $\text{Sc}(\text{OTf})_3$ afford the desired product with excellent yield²⁴⁶ (scheme 5.6).

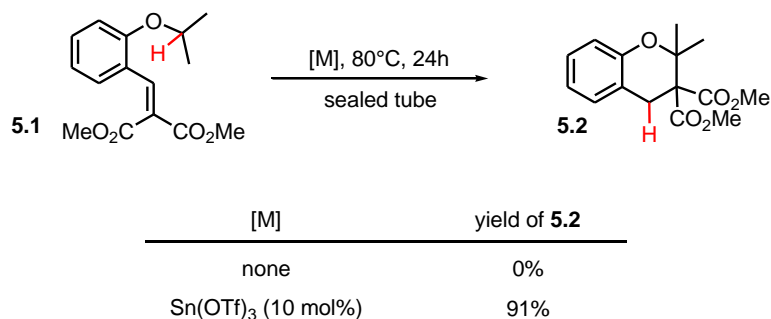

²⁴⁸ Mayr, H.; Kempf, B.; Ofial, A. R.; *Acc. Chem. Res.*, **2003**, 36, 66.

Scheme 5.6: Comparison of a cyclization proceeding *via* a thermal process and a Sc(OTf)₃-catalyzed process using substrate **5.1**.

Importantly, because the initiating interaction between the substrate and the activating species (a Brønsted- or Lewis-acid) occurs far from the targeted C-H bond, functionalization can be attained at sterically hindered positions.

Furthermore, the 1,5-relationship between the hydride donor and acceptor moieties seems to be essential, since other substrates possessing a 1,4- or a 1,6-relationships, such as **5.6** and **5.7**, respectively, failed to cyclize under typical reaction conditions^{246a} (figure 5.1).

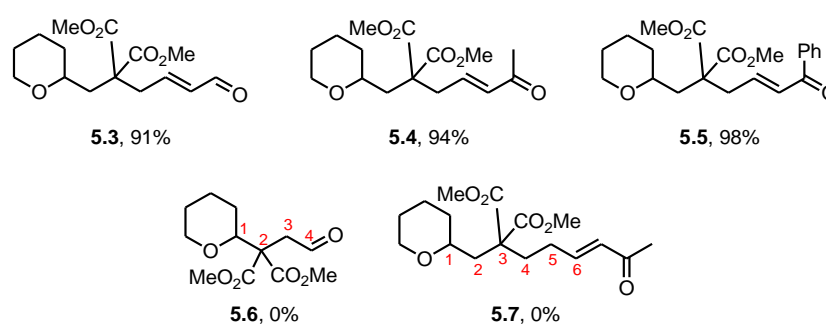
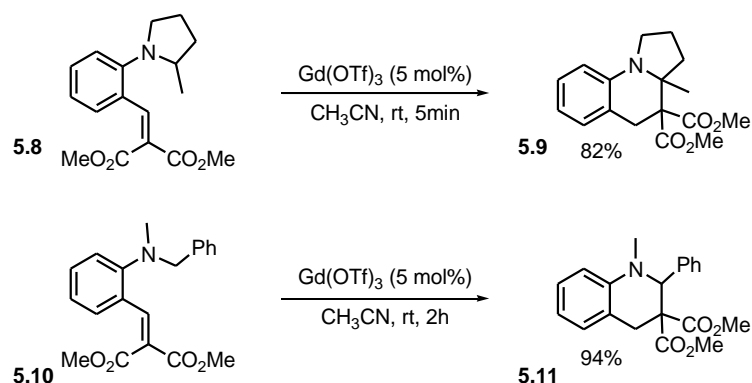

Figure 5.1: Substrates **5.3-5.5** with a 1,5-relationship between hydride donor-acceptor cyclize with excellent yields under treatment with BF₃.OEt₂ (30 mol%), at room temperature, whereas substrates **5.6** and **5.7**, with a 1,4- and 1,6-relationship, respectively, failed to afford any cyclized products.

In agreement with these observations and deuteration experiments²⁴⁶, this process is believed to undergo a cation-induced *through space*²⁴⁹ hydride shift, which should proceed through a six-membered transition state. The ease of the hydride transfer to occur is directly related to the stabilized cation generated, which makes the presence of a heteroatom, such as oxygen or nitrogen, indispensable. Cationic stabilization also explains

²⁴⁹ The term *through space* is suggested by D. Sames, one of the main players in this area, to distinguish between this process and other more common 1,5-sigmatropic hydride shifts, which proceeds *via* a σ - or π -framework. For some examples of such processes, see: (a) Diaz, D.; Martín, V. S.; *Org. Lett.*, **2000**, 2, 335. (b) Wölfling, J.; Frank, E.; Schneider, G.; Tietze, L. F.; *Angew. Chem. Int. Ed.*, **1998**, 38, 200.

regioselective issues with branched substrates, as for example, substrates **5.8** and **5.10**, which both afford only one regioisomer²⁴³ (scheme 5.6).



Scheme 5.6: The regioselectivity observed in 1,5-hydride shift/ cyclization sequences can be explained from the stabilization of cations generated as intermediates.

Another important structural feature is the effect of neighbor substituents on the reaction rates, as it has been noted for pyridazine²³⁹ (scheme 5.7a) and phenyl-ether²⁴⁴ (scheme 5.7b) derivatives. Accordingly, the bulkier the neighboring group, the faster is the reaction rate and lower is the catalyst loading required. This enhancement is attributed to two factors, one is the conformational behavior of the chain bearing the targeted C-H bond, which tends to spend more time in a productive conformation, due to an $A^{1,3}$ -allylic strain-like repulsion, and another is the “buttressing effect” between the two *ortho*-substituents (scheme 5.7).

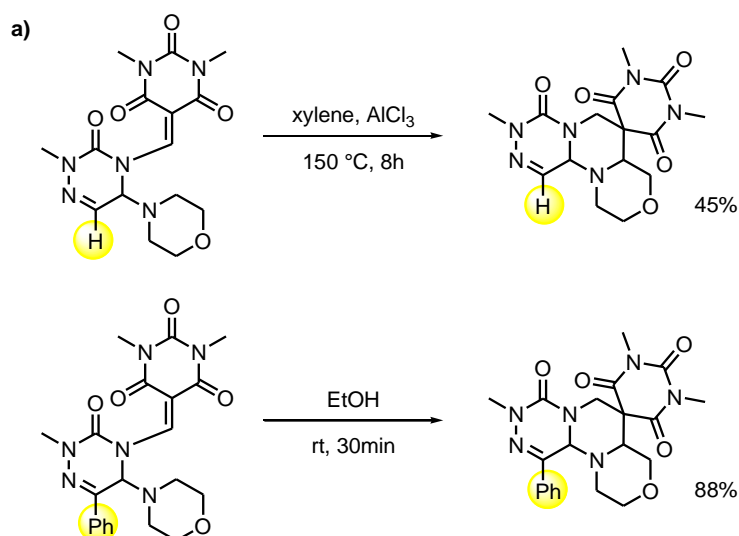

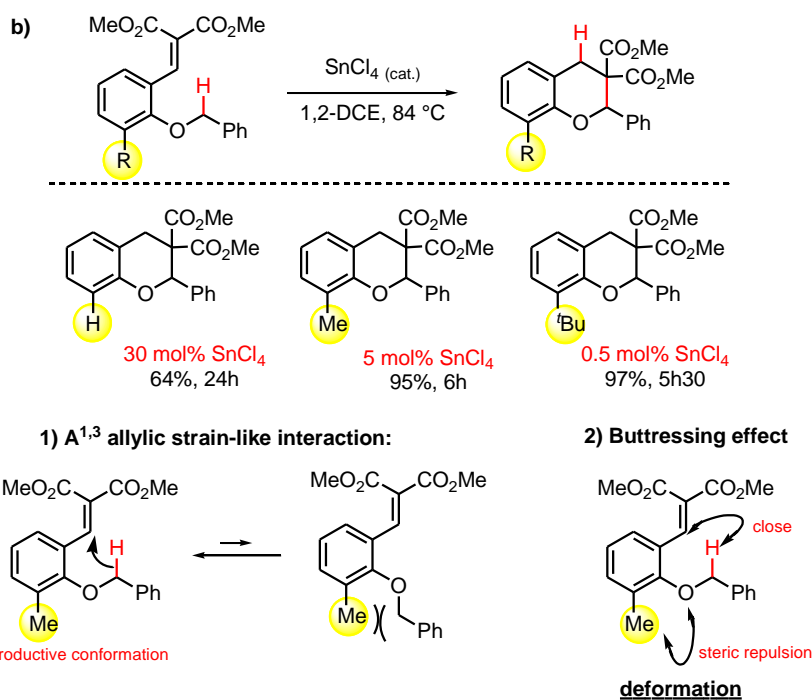

Scheme 5.7: Examples of A^{1,3}-allylic strain-like and buttressing effects on the reaction rates of 1,5-shift/ cyclization sequence.

The reaction scope of this 1,5-hydride shift/ cyclization sequence has also been extended to include alkynes as hydride acceptors. Urabe *et al.*²⁵⁰ reported the use of alkynylsulfones using $\text{Rh}(\text{tfa})_4$ as catalyst in refluxing toluene. Interestingly, the use of sulfones was necessary to activate the alkyne moiety, whereas other substituents, such as hydrogen (terminal alkyne), alkyl, phenyl, trimethylsilyl or ester, all failed to produce the corresponding cyclized products (scheme 5.8).

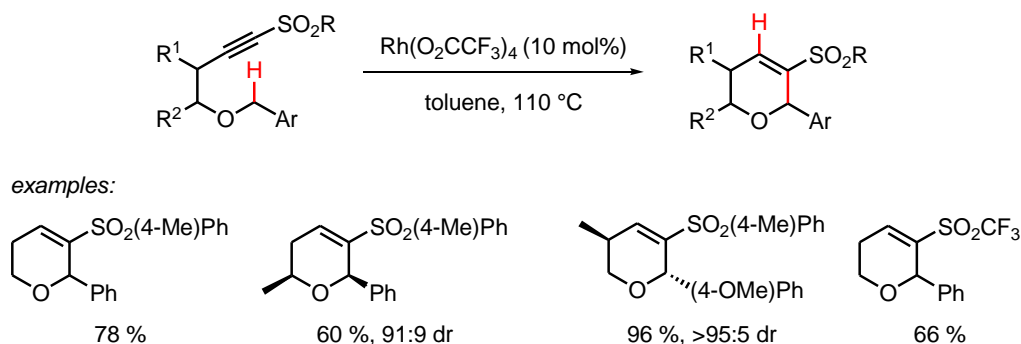

²⁵⁰ Shikanai, D.; Murase, H.; Hata, T.; Urabe, H.; *J. Am. Chem. Soc.*, **2009**, 131, 3166.

Scheme 5.8: Selected examples to demonstrate the reaction scope of alkynyl sulfones in the Rh-catalyzed 1,5-hydride shift/ cyclization sequence.

While the work developed in this chapter was under evaluation for publication in the *Journal of American Chemical Society* in late 2009, a very close report focusing on the use of PtI_4 for the activation of alkynes toward the 1,5-hydride shift/cyclization sequence performed by Vadola and Sames²⁵¹ appeared on the same journal's website as an ASAP publication. In their study, Vadola and Sames showed that unactivated alkynes could undergo a through-space hydride shift, followed by a cyclization event using cyclic ethers and carbamates as hydride sources (scheme 5.9).

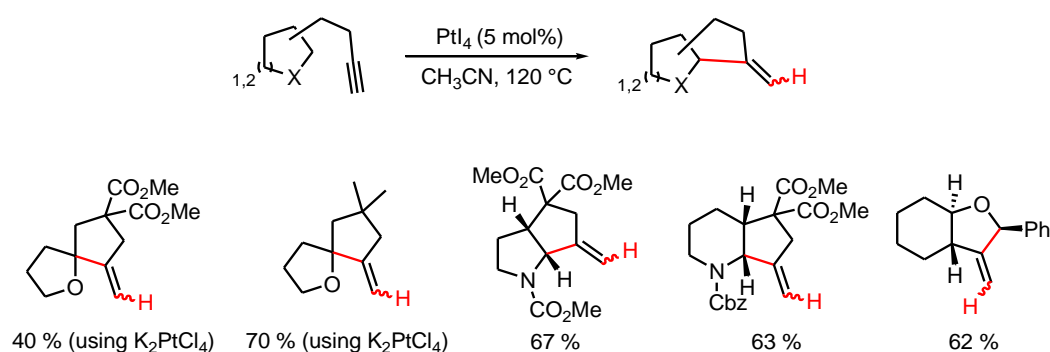

Scheme 5.9: Selected examples to demonstrate the reaction scope on the platinum-catalyzed 1,5-shift/cyclization sequence reported by Vadola and Sames (In red the C-C bond formed and the transferred hydride are highlighted).

Because C(2)-linked substrates have the targeted C-H bond on a tertiary carbon, which ultimately would mean a more stabilized carbocation, they were expected to be more reactive than C(3)-substituted substrates. Indeed, these substrates afforded only degradation upon treatment with the highly electrophilic PtI_4 . In such cases, the less active platinum chloride salt, K_2PtCl_4 , was used (scheme 5.9).

Recognizing the difference in reactivity between different platinum salts depending on the halide on the platinum center, an interesting study with common platinum salts was also carried out. The authors hypothesized that by increasing both the bond length and by

²⁵¹ Vadola, P.; Sames, D.; *J. Am. Chem. Soc.*, **2009**, 131, 16525.

following the trend of spectrochemical series²⁵² when moving from a chloride to an iodide as ligand, platinum iodides would be more electrophilic than other platinum halides, and the platinum metal would be more accessible to the alkyne, thus resulting in a more active catalyst²⁵³. Indeed, this has shown to be the case. In order to confirm if the observed halide effect was due to increased catalyst activity and not catalyst stability, the formation of fused bicycle ring **5.13a** from substrate **5.12a** was investigated using different platinum halides. Interestingly, PtI₂ was shown to be the most active, but reactions catalyzed by this salt failed to proceed to completion due to the instability of this catalyst under the reaction conditions. Overall, the best result was obtained with PtI₄ (scheme 5.10).

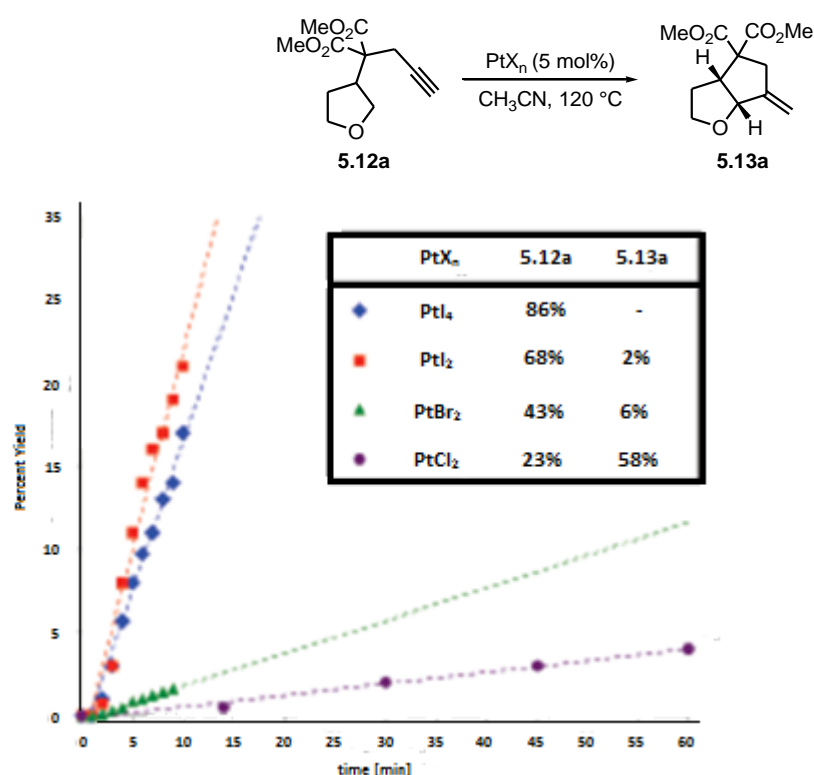

Scheme 5.10: Effect of the halide ligand on the catalyst activity (scheme 5.10 was reproduced from ref. 251).

²⁵² Ligands are capable of modifying the difference energy between the *d* orbitals of the metal center, called the *ligand-field splitting parameter* (Δ). For halides, the order from small Δ to large Δ (spectrochemical series) is: I < Br < Cl < F. For a broader discussion, see: (a) *Les orbitales moléculaires dans les complexes*. Jean, Y.; Editions de l'École Polytechnique, Palaiseau: **2003**. (b) *Chimie Moléculaire des Éléments de Transition*, Mathey, F.; Sevin, A.; Éditions de l'École Polytechnique, Palaiseau: **2000**.

²⁵³ For examples in the literature where platinum iodides and bromides performed better than platinum chlorides, see: (a) Fürstner, A.; Szillat, H.; Gabor, B.; Mynott, R. J.; *J. Am. Chem. Soc.*, **1998**, 120, 8305. (b) Hardin, A. R.; Sarpong, R.; *Org. Lett.*, **2007**, 9, 4547.

5.2 RESULTS AND DISCUSSION

5.2.1 The initial idea

The literature background we had at the time was the 1,5-hydride shift/cyclization sequences reported on Michael acceptors and aldehyde/iminium groups and Urabe's work on alkynyl sulfones (*cf.* section 5.1.2). Recognizing the limiting aspect of Urabe's report of the necessary presence of a sulfone substituent at the alkynyl moiety and knowing the high π -Lewis acidity of gold complexes (*cf.* chapter 2), we were interested in the possibility of using alkynes as 1,5-hydride acceptors²⁵⁴, speculating that they could subsequently follow the same corresponding cyclization process typically observed in *tert*-amino effects (scheme 5.11).

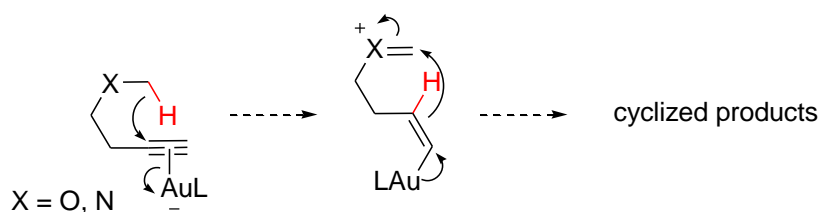

Scheme 5.11: Initial hypothesis concerning the 1,5-hydride shift/ cyclization sequence catalyzed by gold.

Investigation towards the best reaction conditions was performed under the following experimental conditions: treatment of 0.1 mmol of model substrate **5.17a**, with 4 mol% of catalyst and heating to reflux in 500 μ L of solvent. Substrate **5.17a** was synthesized by two straightforward alkylation steps of dimethyl malonate **5.15** (scheme 5.12).

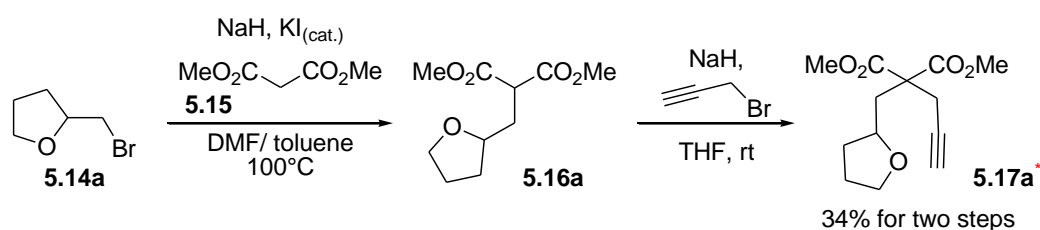

Scheme 5.12: Synthesis of substrate **5.17a**.

²⁵⁴ Hydrides have already been described to add to gold- or platinum-carbene followed by cyclization onto the resulting carbocation. For instance, see: (a) Cui, L.; Peng, Y.; Zhang, L.; *J. Am. Chem. Soc.*, **2009**, 131, 8394. (b) Bhunia, S.; Liu, R.-S.; *J. Am. Chem. Soc.*, **2008**, 130, 16488. (c) Jiménez-Núñez, E.; Raducan, M.; Launterbach, T.; Molawi, K.; Solorio, C. R.; Echavarren, A. M.; *Angew. Chem. Int. Ed.*, **2009**, 48, 6152.

The first trial using PtCl₂, which had already been documented to efficiently catalyze hydride shifts²⁵⁵, failed to provide any expected cyclization product (entry 1, table 5.1). The use of AuBr₃ alone or in combination with the silver salt AgNTf₂ did not afford any productive cyclization either, but only marginal amounts of the hydrated-derived ketone **5.21a**²⁵⁶ (entries 2 and 3, table 5.1). While the use of ligands **L1-L4** on gold metal centers did not produce any efficient catalyst for the desired transformation, affording only trace amounts of the 6-membered cycle **5.18a** and degradation under the reaction conditions (entries 4-7, table 5.1), **L5-L7** performed substantially better. Initial experiments in refluxing CDCl₃ using **L5** and **L6**, with SbF₆ as counter-ion, afforded 45% and 57%, respectively, of the 6-membered cycle **5.18a**. Surprisingly, tricyclic structure **5.20a** which was attributed to a double C-H activation and represents a formal [3+2]-cycloaddition product was also produced in the reaction mixture to minor extents (entries 8 and 9, table 5.1). Changing the counter-ion on the gold center from SbF₆ to NTf₂ decreased the reaction yield of **5.18a** to 41% (entry 10, table 5.1). Ligand **L7** afforded a slightly better yield of **5.18a** than **L6** (entry 11, table 5.1). As undesired hydration products were consistently being formed due to trace amounts of water present in the solvent, we hypothesized that changing the reaction solvent could increase the reaction rate of 1,5-hydride-shift/cyclization sequence over the hydration pathway²⁵⁷. Solvent screening using toluene (entry 12, table 5.1), dioxane (entry 13, table 5.1) and nitromethane (entry 13, table 5.1) revealed the latter as the optimal choice in reducing hydration. Furthermore, by stopping reactions after 2h, allowed us to compare reaction rates using ligands **L7-L10** (entries 15-18, table 5.1), which also pointed to the higher activity of ligand **L7** over **L8**, **L9** and **L10**.

²⁵⁵ (a) Yang, S.; Li, Z.; Jian, X.; He, C.; *Angew. Chem., Int. Ed.*, **2009**, *48*, 3999. (b) Tobisu, M.; Nakai, H.; Chatani, N. *J. Org. Chem.* **2009**, *74*, 5471. (c) Bajracharya, G. B.; Pahadi, N. K.; Gridnev, I. D.; Yamamoto, Y.; *J. Org. Chem.*, **2006**, *71*, 6204.

²⁵⁶ For examples on reports of gold-catalyzed hydration of alkynes, see: (a) Marion, N.; Ramón, R. S.; Nolan, S. P.; *J. Am. Chem. Soc.*, **2009**, *131*, 448. (b) Mizushima, E.; Sato, K.; Hayashi, T.; Tanaka, M.; *Angew. Chem., Int. Ed.*, **2002**, *41*, 4563.

²⁵⁷ It is a well established fact that solvent effects can significantly increase reaction rates/ concertedness of transition states. For some reports on this influence, see: (a) Xie, D.; Zhou, Y.; Xu, D.; Guo, H.; *Org. Lett.*, **2005**, *7*, 11, 2093. (b) Regan, C. K.; Craig, S. L.; Brauman, J. I.; *Science*, **2002**, *295*, 5593, 2245. (c) McCabe, J. R.; Grieger, R. A.; Eckert, C. A.; *Ind. Eng. Chem. Fundamen.*, **1970**, *9*, 1, 156.

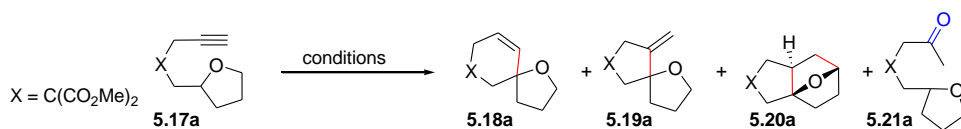

entry	catalyst	solvent, temp.	time					
				5.17a	5.18a	5.19a	5.20a	5.21a
1	PtCl ₂	toluene, 100 °C	7h	100%				
2	AuBr ₃	1,2-DCE, 84 °C	1h			traces of hydration		
3	AuBr ₃ (1)/ AgNTf ₂ (3)	1,2-DCE, 84 °C	12h			traces of hydration		
4	L1 SbF ₆	CDCl ₃ , 60 °C	1h		traces	catalyst degradation		
5	L2 SbF ₆	CDCl ₃ , 60 °C	7h		traces	catalyst degradation		
6	L3 SbF ₆	CDCl ₃ , 60 °C	8h		traces	catalyst degradation		
7	L4 SbF ₆	CH ₂ Cl ₂ , 40 °C	13h		traces	catalyst degradation		
8	L5 SbF ₆	CDCl ₃ , 60 °C	26h	0%	45%	9%	14%	32%
9	L6 SbF ₆	CDCl ₃ , 60 °C	13h	0%	57%	5%	9%	29%
10	L6 NTf ₂	CDCl ₃ , 60 °C	72h	0%	41%	5%	6%	48%
11	L7 SbF ₆	CDCl ₃ , 60 °C	7h	0%	59%	5%	9%	27%
12	L7 SbF ₆	toluene, 100 °C	2h	0%	59%	4%	8%	29%
13	L7 SbF ₆	dioxane, 100 °C	2h	0%	0%	0%	0%	100%
14	L7 SbF ₆	CH ₃ NO ₂ , 100 °C	10h	0%	75%	15%	4%	6%
15	L7 SbF ₆	CH ₃ NO ₂ , 100 °C	2h	54%	36%	2%	8%	0%
16	L8 SbF ₆	CH ₃ NO ₂ , 100 °C	2h	58%	24%	3%	7%	8%
17	L9 SbF ₆	CH ₃ NO ₂ , 100 °C	2h	53%	19%	5%	11%	11%
18	L10 SbF ₆	CH ₃ NO ₂ , 100 °C	2h				catalyst degradation	

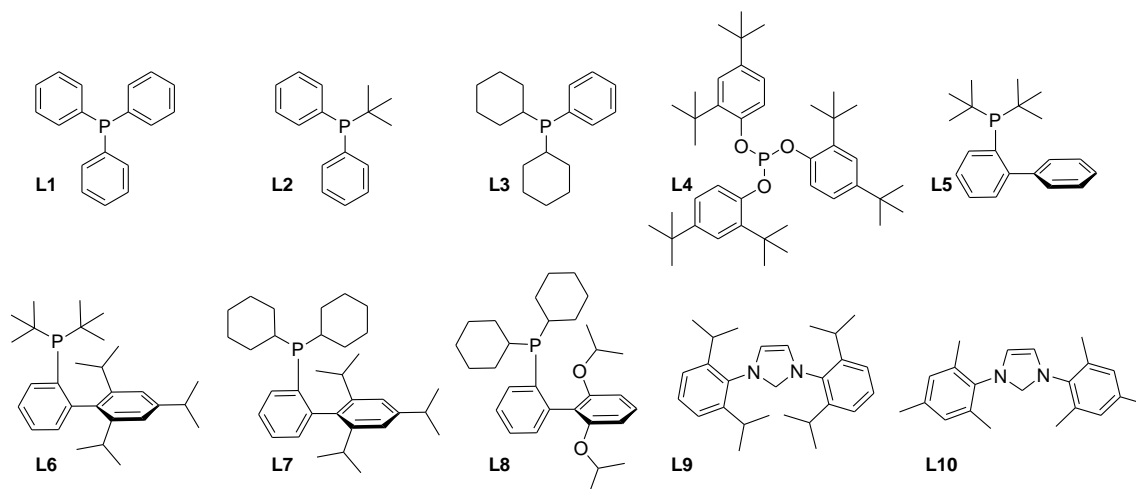
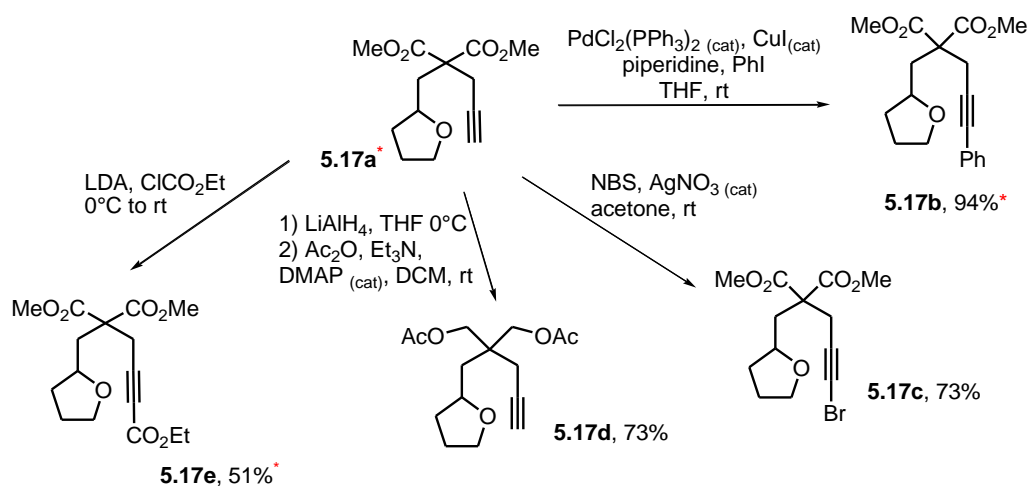

Table 5.1: Catalytic system optimization for the 1,5-hydride shift/cyclization sequence using unactivated alkynes.

With the optimal conditions in hand, we had set the stage to start the investigation on reaction scope and functional group tolerance of this process. Accordingly, alkynes derived from propargyl malonate **5.17a** were synthesized from four different methods: a Sonogashira cross-coupling reaction leading to substrate **5.17b**, a bromination step leading to substrate **5.17c**, reduction with LiAlH₄ /acetylation sequence leading to substrate **5.17d** and treatment with LDA/CICO₂Et leading to substrate **5.17e** (scheme 5.13).



Scheme 5.13: Alkynes synthesized from propargyl malonate **5.17a**.

Other terminal alkynes **5.17f-t** were also synthesized *via* two straightforward alkylation steps. The first alkylation inserted either a THF or a sulfonamide ring from a bromo (**5.14f-j**, **5.14l**, **5.14p**) or a tosylate (**5.14k**)/ mesylate (**5.14q-r**) derivative, respectively. Bromo derivatives **5.14f-j**, **5.14l**, **5.14p** were constructed from a NBS-promoted cyclization process from the corresponding homoallyl alcohol **5.26f-j**, **5.26l**, **5.26p** (ester) or from either a chloro- or an iodo-ether derivative, **5.29** and **5.31**, respectively.

The second alkylation step consisted of the propargylation of the monosubstituted malonate previously prepared. From these double alkylated substrates, compounds **5.17f**, **5.17k-l** were treated with LDA and ethyl chloroformate to afford the corresponding conjugate esters **5.17m-o** (scheme 5.14).

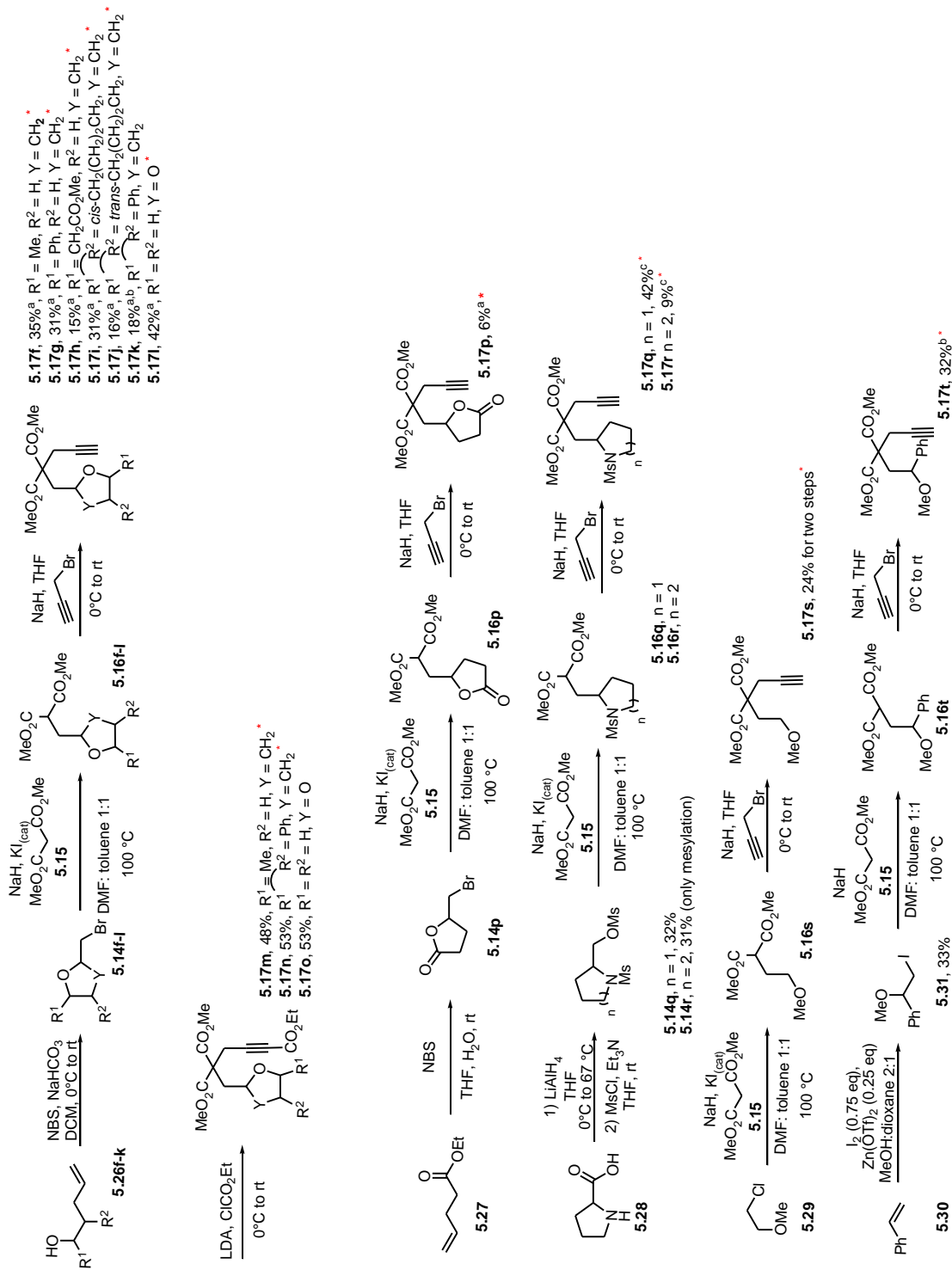

^a, yields for three steps. ^b, tosylate **5.14k** was prepared as the alkylating agent from homotolyl alcohol **5.26k** via 1) *m*-CPBA, DCM, rt 2) *p*-TSA, DCM, rt 3) TsCl, Et₃N, DCM ^c, yields for two last steps

Scheme 5.14: Detailed synthesis of the main C(2)-linked THF/sulfonamides rings in this project.

Other C(2)-linked heterocycles synthesized in the context of this work by analogous alkylation procedures are shown below (figure 5.1).

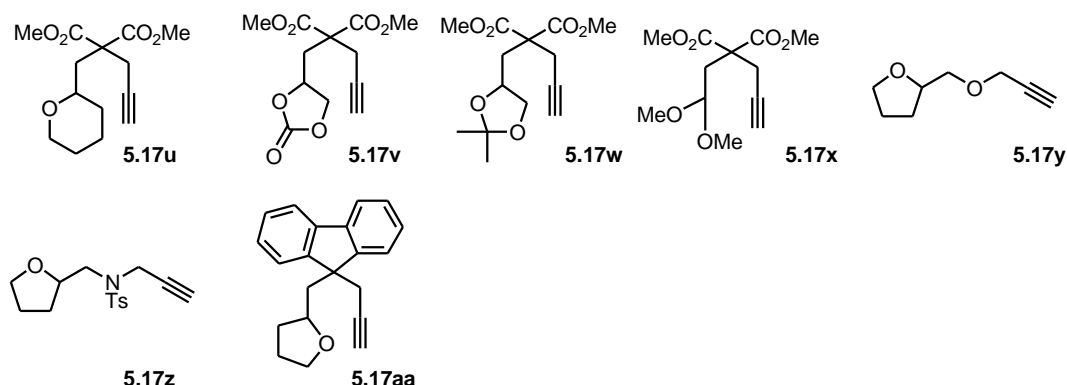

Figure 5.1: Other substrates synthesized in the context of this project.

These C(2)-linked heterocycles (**5.17a-5.17aa**) were submitted to our optimized reaction conditions. In this context, only oxygenated 5-membered rings with either a malonate or a diacetoxymethyl groups as tethers and bearing terminal alkynes or alkynes substituted by an ester group proceeded through the gold-catalyzed 1,5-hydride shift/cyclization sequence.

For instance, internal alkynes **5.17b,c** afforded only starting material after prolonged reaction times (entries 1 and 2, table 5.2). On another hand, the use of a diacetate in the tether of **5.17d** allowed the reaction to proceed smoothly, affording a 3.7:1 mixture of cyclized products **5.18d:5.20d** (entry 3, table 5.2). Conjugate esters **5.17e** and **5.17m-o** were highly selective towards 6-membered cycles **5.18e** and **5.18m-o** (entries 4, 12 and 14, table 5.2), with exception of **5.17n**, where the presence of the aromatic ring destabilizes the carbocation at the α -position to the oxygen due its inductive electron-withdrawing effect (entry 12, table 5.2). Double substituted THF rings at positions 2 and 5, **5.17f-h**, and even triple substituted **5.17i-j**, afforded mixtures of diastereoisomers for spiro compound **5.18** and the formal [3+2]-addition product **5.20** (entries 5-9, table 5.2) in ratios that are difficult to rationalize only on the grounds of carbocation stabilization, but where steric hindrance should also play an important role. For instance, the THF ring bearing an ester branch **5.17h** afforded a richer mixture in formal [3+2]-product **5.20h** (1.5:1 of **5.18h:5.20h**, entry 7, table 5.2) than **5.17g** (2.3:1 of **5.18g:5.20g**, entry 6, table 5.2) that was approximately obtained in the same ratio for compound **5.17i** (2.1:1 of **5.18i:5.20i**, entry 8, table 5.2).

Interestingly, compound **5.17j**, which has a *trans* ring-junction, did not afford any formal [3+2]-addition product (entry 9, table 5.2), whereas **5.17i** with a *cis* ring-junction

entry	substrate	trans:cis ^a	products	isolated yield	5.18:5.20 ^a
1		-	5.17b^b	- [*]	-
2		-	(5.17c + hydration)	-	-
3		-		70%	3.7:1
4		-		91% [*]	-
5		2:1		82% ^d [*]	5.1:1
6		2:1		76% ^d [*]	2.3:1
7		2.5:1		82% ^d [*]	1.5:1
8		1.6:1		74% ^d [*]	2.1:1
9		1:0		50% [*]	-
10		-	(5.17k + hydration)	-	-

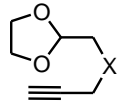
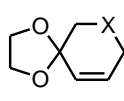
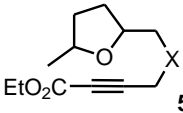
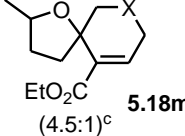
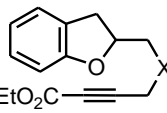
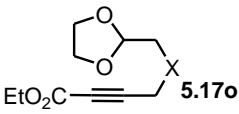
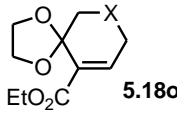
entry	substrate	trans:cis ^a	products	isolated yield	5.18:5.20 ^a
11 ^e	 5.17i	-	 5.18i	73% ^f	-
12	 5.17m	4.5:1	 5.18m (4.5:1) ^c	78% [*]	-
13	 5.17n	-	5.17n^b	- [*]	-
14	 5.17o	-	 5.18o	65%	-

^a determined by ¹H NMR spectroscopy. ^b SM fully recovered. ^c dr determined by ¹H NMR spectroscopy.

^d Global yield corresponding to (5.18 + 5.20). ^e In nitropropane at 130 °C. ^f isolated as the deprotected dioxolane form.

Table 5.2: Main results of the gold-catalyzed 1,5-hydride shift/cyclization sequence using C(2)-substituted heterocycles.

afforded a 2.1:1 mixture of **5.18i:5.20i** (entry 8, table 5.2). This difference can only be rationalized in steric grounds. The formation of a formal [3+2]-addition product in the cyclization of **5.17j** is not observed probably because the conformation necessary to the second hydrogen transfer to occur is hindered by the presence of the fused 6-membered cycle with the *trans* junction (scheme 5.15, see also the reaction mechanism proposition in scheme 5.19).

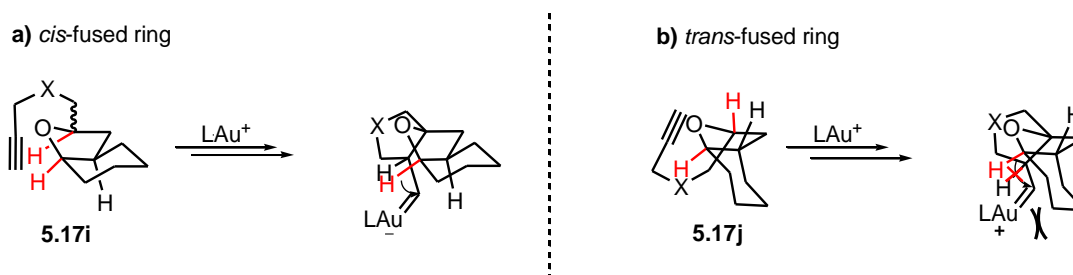

Scheme 5.15: Geometric constraints suffered by the *trans*-fused ring **5.17j** in comparison to the *cis*-fused ring **5.17i** (in red, the hydrogens that will be transferred).

Also noteworthy, the synthesis of substrate **5.17j** in only one diastereoisomer is *at first sight*, of no consequence, as the tertiary center in the α -position to the oxygen proximal to the tether is always destroyed during the reaction process (even if an eventual “chiral memory” can nevertheless be present, see mechanism discussion in scheme 5.19). By the same reason evoked for the conjugate alkyne **5.17n**, terminal alkyne **5.17k** does not undergo cyclization, but rather affords only starting material and the hydration product **5.21k** (entry 10, table 5.2). Finally, dioxolane **5.18l** can also be obtained from **5.17l**. Nevertheless, it should be noted that a poor conversion was obtained for this substrate under reflux of nitromethane (20% after 6h). This reaction was then conducted at 130 °C in nitropropane. Furthermore, even if the dioxolane ring survived our reaction conditions (as indicated by ^1H NMR analysis of the crude reaction mixture) it proved to be rather labile and did not resist the acidic conditions of column chromatography, being isolated as the corresponding deprotected ketone (entry 11, table 5.2).

Other C(2)-linked heterocycles **5.17p-z** and **5.17aa** were also submitted to our optimized reaction conditions, but they afforded only starting material and hydration products of the general structure type **5.21** in different extents. Indeed, sulfonamides and 6-membered heterocycles **5.17q**, **5.17r** and **5.17u**, which were expected to be less reactive^{251,258}, gave only starting material. Lactone **5.17p** and carbonate **5.17v** and acetal **5.17w** were not able to sufficiently stabilize the cation in the α -position of the oxygen and were unreactive. Greater rotation freedom also seems a restricting factor for the occurrence of the 1,5-hydride shift, as no productive cyclization was observed for acetal **5.17x** and for ethers **5.17s** and **5.17t**. Nor are other *linkers* allowed, as only starting material and hydration products (of type **5.21**) in different extents were obtained for these reactions with substrates **5.17y**, **5.17z** and **5.17aa**.

After having learned about the reactivity pattern demonstrated by C(2)-substituted heterocycles, we were interested on the reactivity of C(3)-substituted THF rings, which were expected to be less prone to undergo the 1,5-hydride shift, because of their secondary C-H bonds. In this regard, substrates **5.36a-l** were synthesized using classic straightforward

²⁵⁸ This trend is also observed in reactions proceeding via C-H metal insertion: (a) DeBoeuf, B.; Pastine, S. J.; Dames, D.; *J. Am. Chem. Soc.*, **2004**, 126, 6556. (b) Chatani, N.; Asaumi, T.; Yorimitsu, S.; Ikeda, T.; Kakiuchi, F.; Murai, S.; *J. Am. Chem. Soc.*, **2001**, 123, 10935.

routes. Homoallyl alcohols **5.32b-e**, which are readily obtained from the Barbier reaction²⁵⁹ were submitted to a bromination step²⁶⁰, affording dibromo intermediates **5.33b-e**, which were directly engaged in a S_N2-intramolecular substitution without purification. The C(3)-bromo THF rings thus obtained are submitted to the same propargylation, esterification, bromination and cross-coupling reactions previously employed for C(2)-substituted THFs (scheme 5.15).

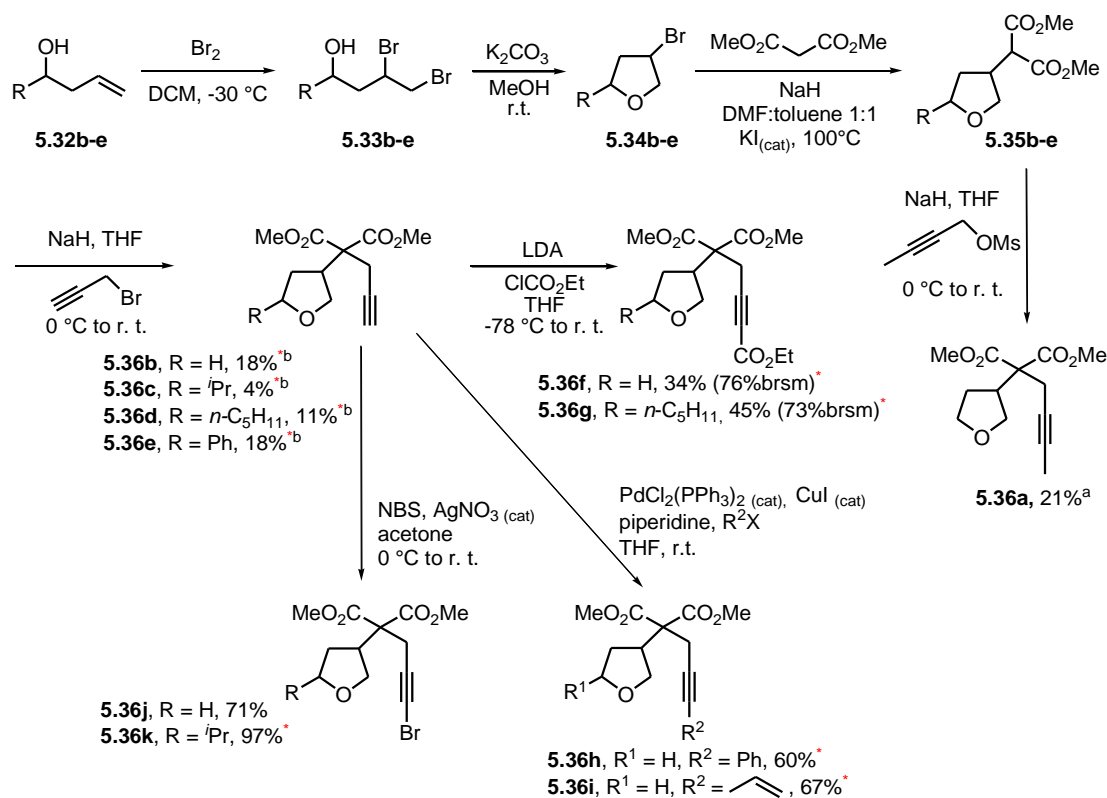

Other related structure synthesized in this project:

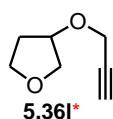

^a: yield for two steps. ^b: Overall yield.

Scheme 5.15: Synthesis of malonates bearing C(3)-substituted THF rings.

Subjection of alkynes **5.36a-l** to our optimized conditions furnished similar results as C(2)-linked substrates. Internal alkynes did not react. Only starting material was recovered when substrates **5.36a**, **5.36h** and **5.36i** were submitted to gold-catalysis (entries 1, 8 and 9,

²⁵⁹ Wilson, S. R.; Guazzaroni, M. E.; *J. Org. Chem.*, **1989**, 54, 3087.

²⁶⁰ Chirskaya, M. V.; Vasil'ev, A. A.; Sergovskaya, N. L.; Shorshnev, S. V.; Sviridov, S. I.; *Tetrahedron Lett.*, **2004**, 45, 8811.

table 5.3).

$$\text{X} = \text{C}(\text{CO}_2\text{Me})_2$$

entry	substrate	trans:cis ^a	products	isolated yield 5.37:5.38^a	
1		-	5.36a^b	-	-
2		-	 5.37b + 5.38b	95% ^c	6:1
3		1:3	 5.37c (1:3)^c	93% ^c	-
4		1:3	 5.37d (1:3)^c	88% ^c	-
5		1:3	 5.37e (1:3)^c	29% ^c	-
6		-	 5.37f + 5.38f	81% ^c	1:1
7		1:3	 5.37g (6.7:1)^c + 5.38g (1.6:1)^c	90% ^c	1.5:1
8		-	5.36h^b	- ^c	-
9		-	5.36i^b	- ^c	-
10 ^d		-	 5.37j (4.3:1)^c	75%	-
11		1:3	5.36k^b	- ^c	-
12		-	(5.36l + hydration)	- ^c	-

a: Determined by ¹H NMR spectroscopy. ^b: SM fully recovered. ^c: dr determined by ¹H NMR spectroscopy. ^d: The conversion of **5.36j** was 85%

Table 5.3: Results of the gold catalyzed 1,5-hydride shift/cyclization sequence using C(3)-linked THF rings.

On another hand, conjugate alkynes **5.36f** and **5.36g** afforded cyclized products, but without any regioselectivity, with 1:1 and 1.5:1 mixtures of 5-:6-membered rings, respectively (entries 6 and 7, table 5.3). Some selectivity was observed using terminal alkyne **5.36b**, which afforded a 6:1 mixture of 5-:6-membered cycles (entry 2, table 5.3). Interestingly, complete regioselectivity was observed with 3,5-substituted THF rings bearing terminal alkynes **5.36c-e**, which afforded only 5-membered ring products (entries 3-5, table 5.3). Curiously, this time, brominated alkyne **5.36j** furnished the corresponding 5-membered product regioselectively, in good 75% yield (entry 10, table 5.3), but this reactivity was not general, as **5.36k** failed to undergo the same reaction process (entry 11, table 5.3). Furthermore, an ethereal linker proved to be prejudicial, as compound **5.36l** also failed to afford any desired cyclization (entry 12, table 5.3). We next attempted this 1,5-hydride shift/cyclization sequence with the oxygen being part of the tether. Results obtained with terminal alkynes **5.40a-d** were highly disappointing, as no trace of cyclized products **5.42** or **5.43** were observed (scheme 5.16).

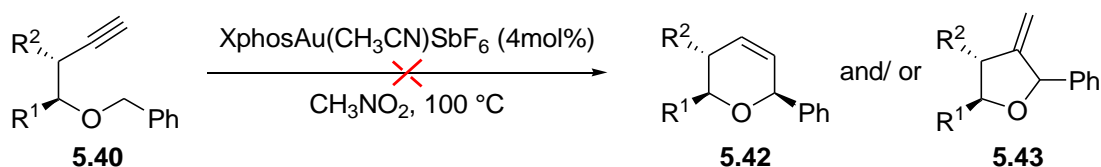

Scheme 5.16: Envisaged products in the gold catalysis with substrate of type **5.40** were not observed, but instead, a complex mixture of products.

We next turned our attention to conjugate esters **5.41a-e**. These esters were synthesized from propargyl alcohols **5.39 a-d** that were alkylated on the oxygen, to furnish terminal alkynes **5.40a-d**, and then treated with *n*-BuLi and quenched with ethyl chloroformate to give access to the desired conjugate esters **5.41a-d**. Alkynyl ester **5.41e** was synthesized from epoxide **5.42**, which was opened with an acetylide anion generated from the treatment of trimethylsilyl ethyne with *n*-BuLi, then methanolysis of the TMS group (K_2CO_3 (cat)/MeOH) and benzylation of the alcohol generated benzyl ether **5.43**. This alkynyl

ether was deprotonated with *n*-BuLi and quenched with ethyl chloroformate to afford alkynyl ester **5.41e** (scheme 5.16).

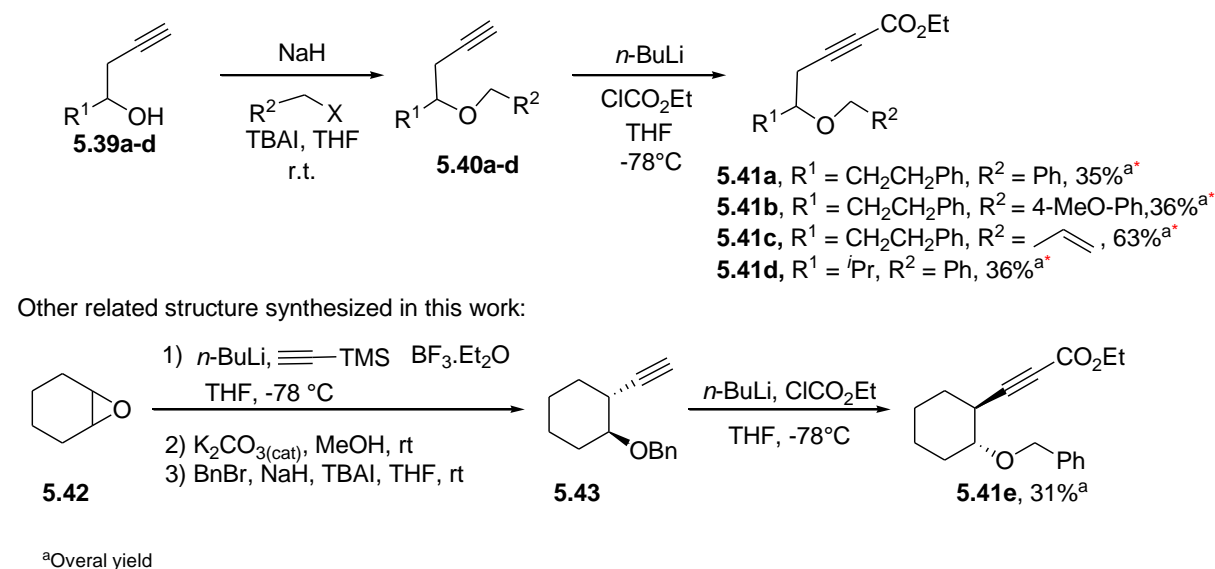

Scheme 5.17: Synthesis of conjugate esters **5.41a-e**.

Subjection of benzyl derivatives **5.41a** and **5.41d-e** to our optimized conditions afforded cyclic ethers **5.44a** and **5.44d-e** with excellent diastereoselectivities (entries 1, 4, 5, table 5.4). In the cases where an allyl or a PMB group were used, only degradation was obtained in both cases (entries 2 and 3, table 5.4).

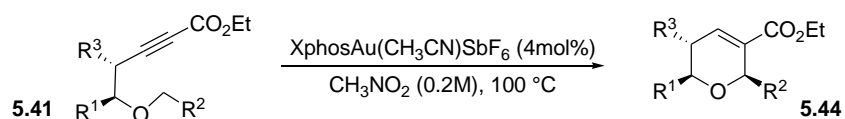

entry	substrate	products	isolated yield	<i>cis:trans</i> ^a (R ¹ , R ²)
1			65%*	16:1
2		degradation	-*	-
3		degradation	-*	-
4			74%*	> 25:1
5			88%	> 25:1

^a Determined by ¹H NMR spectroscopy

Table 5.4: Alkynyl ethers with the oxygen being part of the tether employed in the 1,5-hydride shift/cyclization sequence.

In order to investigate the reaction mechanism of this 1,5-hydride shift/cyclization process, deuterated compounds **5.49** and **5.50** were prepared. The deuteration in **5.49** was obtained from the deprotonation at the α -position of the ester **5.45** and quench with MeOD, which afforded derivative 63%D-**5.46**. Subsequent reduction with lithium aluminium hydride slightly eroded its deuterium content to 50%D. Then, tosylation and the same two alkylation steps used for the synthesis of previous substrates afforded compound **5.49** with 50%D (scheme 5.18a). The deuteration in **5.50** was performed in a more straightforward manner. Substrate **5.17** was deprotonated with LDA and then quenched with D₂O (scheme 5.18b).

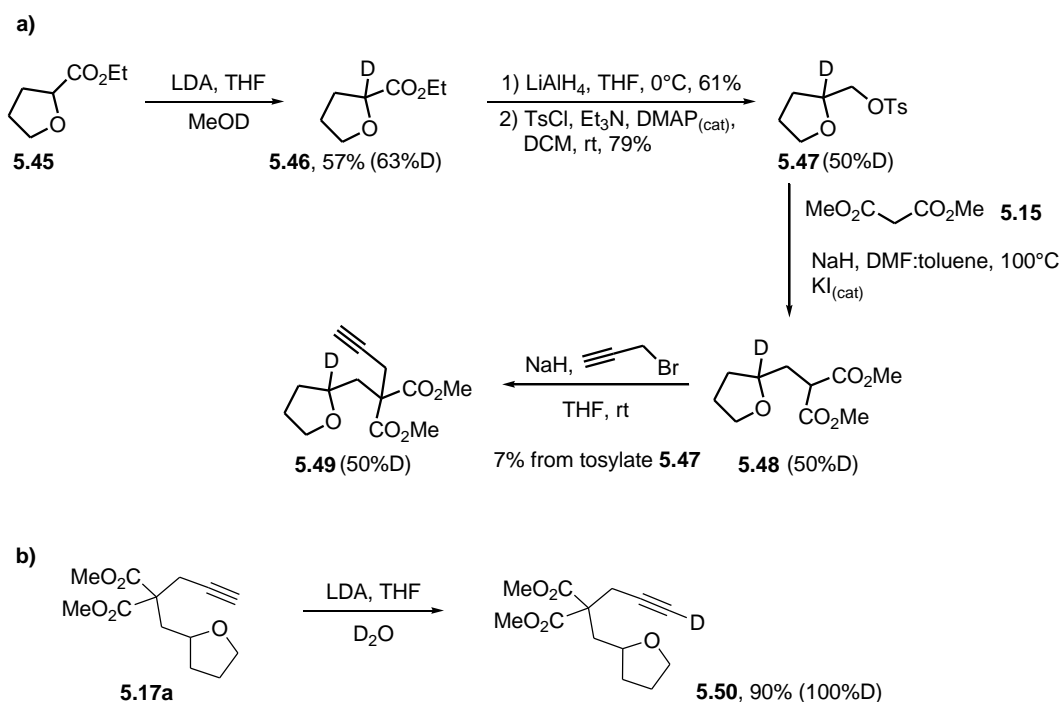

Scheme 5.18: a) Synthesis of deuterated substrate **5.49**. b) Synthesis of deuterated substrate **5.50**.

The cyclization of **5.49** and **5.50** afforded **5.51** and **5.52**, respectively (scheme 5.19a). The observed deuteration pattern suggests that an intramolecular 1,5-hydride shift takes place and generates a stabilized cation in an oxonium form, as the one drawn in **5.53**. This cationic form can be seen as being delocalized on the vinylic gold moiety, as shown in **5.54**. At this stage, two reaction pathways are possible. Either this delocalized carbocation rearranges to a 5-membered cycle **5.55** or to the 6-membered cycle **5.56**, which through a 1,2-alkyl shift ring-expands to give the same 6-membered cycle **5.56**. Finally, the 6-membered cycle **5.56** regenerates the gold fragment and affords the major product **5.18a**. Formation of the by-products **5.19a** and **5.20a** can be explained from the 5-membered ring intermediate **5.55**, which can either undergo a 1,2-hydride shift through the intermediacy of **5.57** and subsequent gold loss to afford compound **5.19a**, or can follow another 1,5-hydride shift to generate oxonium **5.58** that evolves by ring-closure to produce the tricycle **5.20a** (scheme 5.19b).

At this point, important remarks should be made. Although in the previously discussed mechanism for the synthesis of **5.18a**, the direct route from **5.54** to the 6-membered cycle **5.56** cannot be excluded, the passage through the 5-membered cycle **5.55**

is supported by the formation of by-products **5.19a** and **5.20a**, and presumably due to the nucleophilic nature of the β -carbon of vinylgold **5.53**. In contrast to the previous work reported by Vadola and Sames²⁵¹, where 5-membered cycles were reported as major products, we obtained mainly 6-membered rings. A plausible explanation for this difference in regioselectivity is that the ring expansion from **5.55** to **5.56** might be under thermodynamic control using XphosAu(NCCH₃)SbF₆, whereas the use of the stronger Lewis acid PtI₄ would implicate essentially a kinetic control.

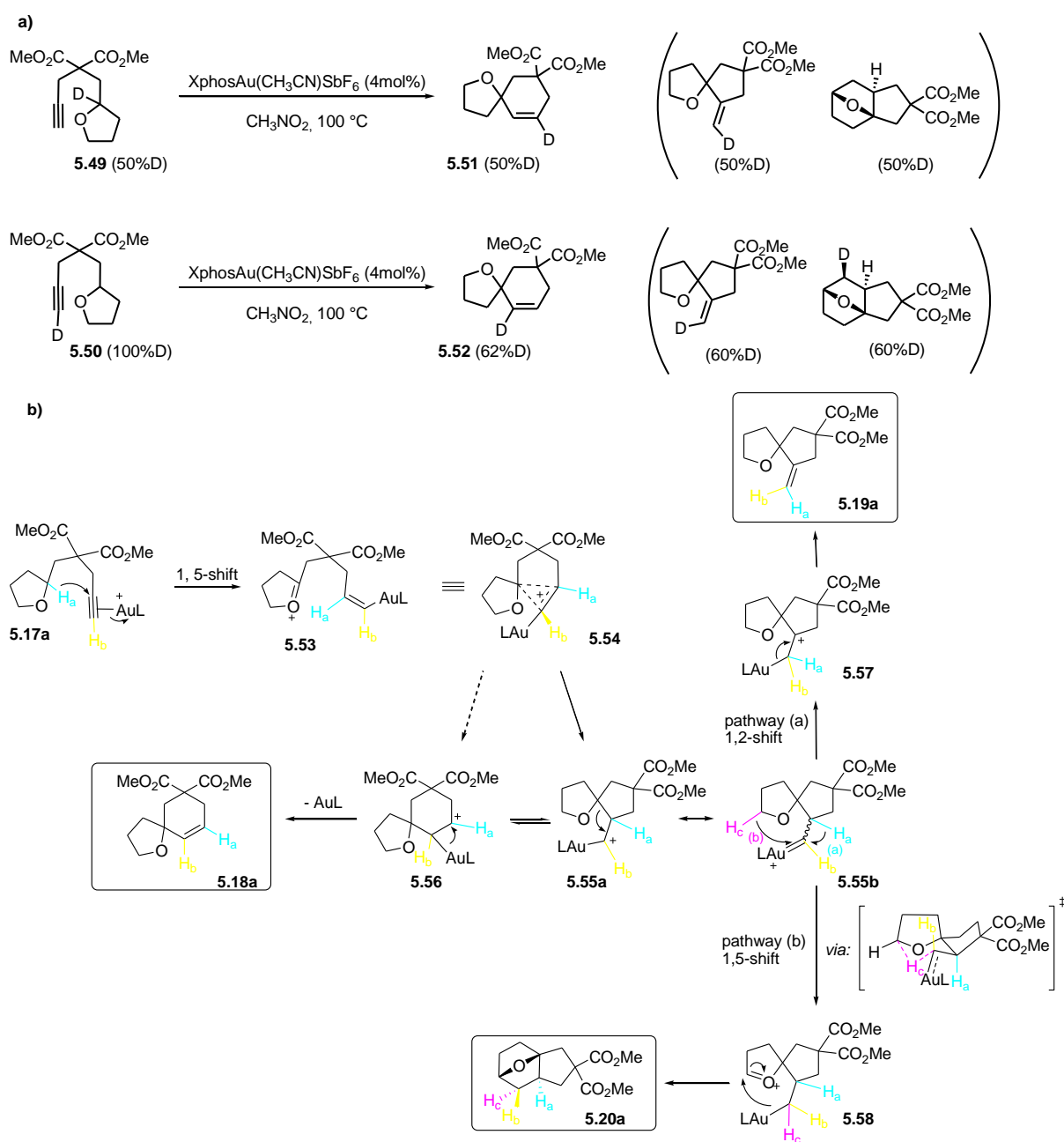

Scheme 5.19: **a)** Results of deuterium experiments using **5.49** and **5.50** suggests that **b)** the mechanism for the formation of main product **5.18a** as starting with a 1,5-hydride shift, followed by ring-closure to produce the 5-membered cycle, which would ultimately ring-expands to a 6-membered ring. Formation of by-products **5.19a** and **5.20a** are also exhibited.

Upon careful examination of the ^1H NMR of the crude reaction mixtures of each of the deuterium-labeled experiments, it is interesting to note that for both of the by-products, **5.19a** and **5.20a**, the deuterium atom was found to be exclusively incorporated at a single vinylic position (scheme 5.20a). This stereoselectivity is believed to derive from the existence of only one productive conformer **5.59**, as the presence of the THF ring hinders the formation of the other conformer **5.60** (scheme 5.20b).

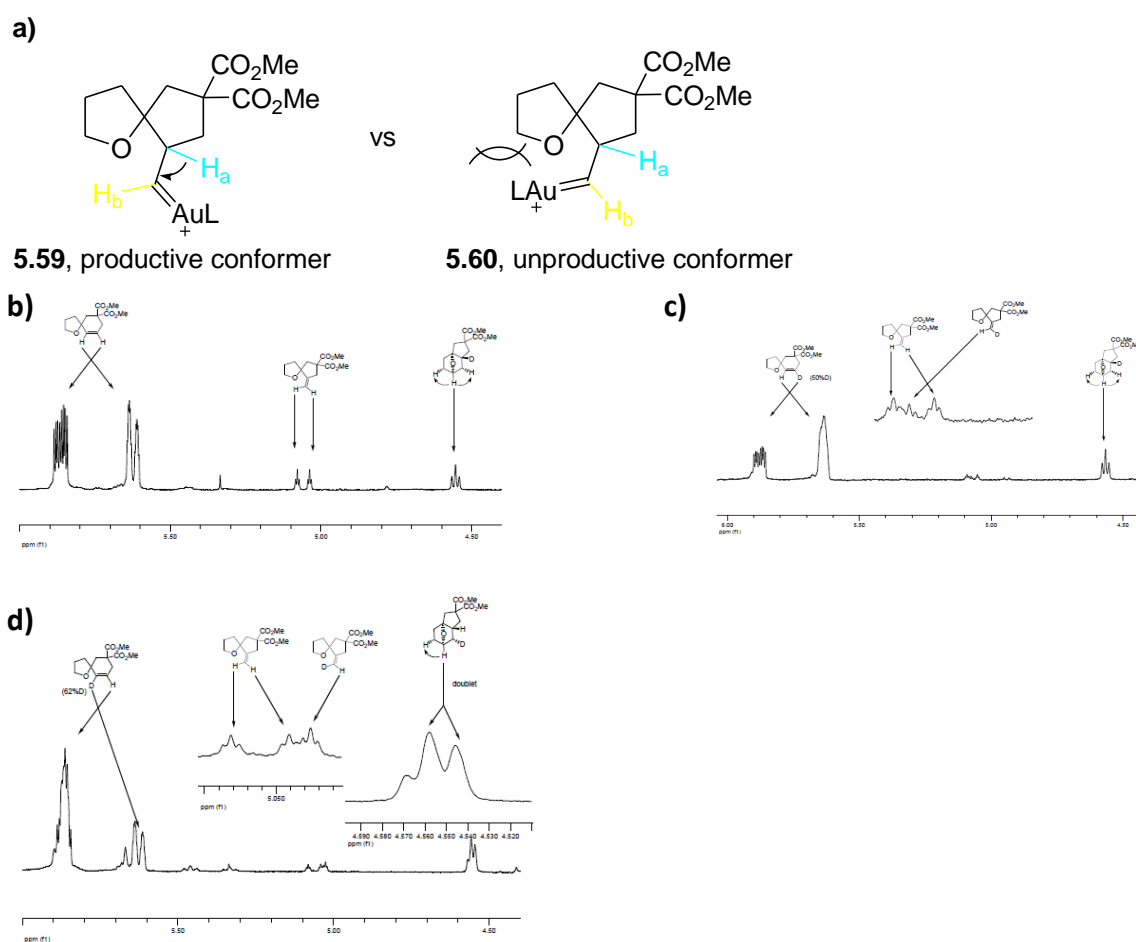

Scheme 5.20 : **a)** Comparison between two possible conformers that culminate with the stereoselective hydride shift in all three observed products **5.18a**, **5.19a** and **5.20a**. **b)** ^1H NMR of representative signals using **5.17a**. **c)** ^1H NMR of representative signals using **5.49**. **d)** ^1H NMR of representative signals using **5.50**.

Concerning the 1,5-shift/cyclization sequence using C(3)-linked THFs, 5-membered rings with an exo methylene were obtained as the major outcome, instead of the 6-membered cycles that were mainly observed when using C(2)-linked THFs. Although both substrates proceed essentially by the same mechanism discussed above in scheme 5.19, the difference in selectivity can be accounted for by the different stabilities of intermediates **5.62** and **5.63**, which lead to products **5.37b** and **5.38b**, respectively. For the cyclization of substrate **5.17a**, the steric constraints in the spiro intermediate **5.55** should favor its rearrangement into cation **5.56** and then the formation of cyclohexene **5.18a** as the major product (scheme 5.19). The steric constraints should be weaker for the fused bicyclic intermediate **5.62**, thus allowing for a rapid 1,2-hydride shift leading to **5.37b**, rather than a 1,2-alkyl shift leading to **5.38b** (scheme 5.21).

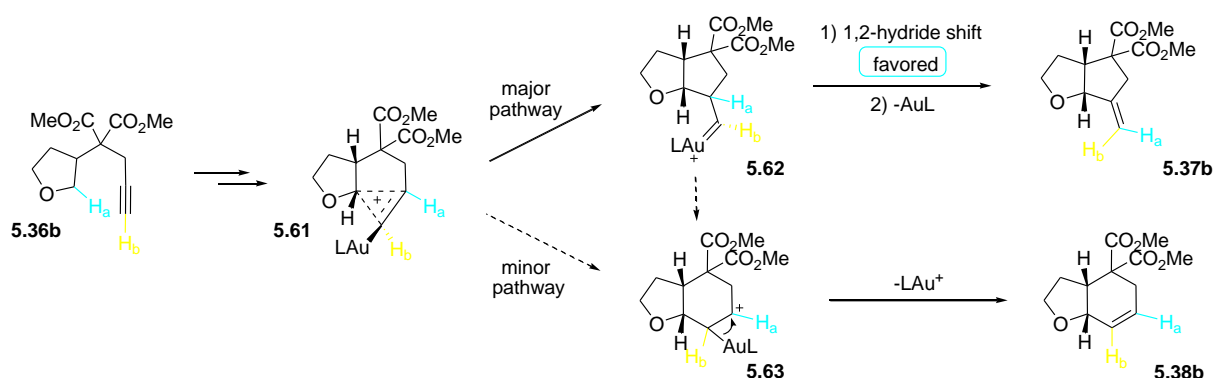

Scheme 5.21: The divergent reaction pathway observed for C(3)-linked THFs, which lead to 5-membered cycles as major products, contrasts with the reaction pathway observed for C(2)-linked THFs, which lead usually to 6-membered cycles. This difference can be explained in terms of different steric hindrance present in intermediates **5.62** and **5.63**.

An alternative reaction mechanism for alkynyl esters, such as **5.41a-e**, could also be imagined to proceed through the cationic gold(I) coordination to the carbonyl²⁶¹ of the ester group, followed by a hydride conjugate addition. This would generate an enolate form that would then attack the cation formed and produce the ring closure (not shown). This hypothesis is considered less likely, because gold(I) complexes are known to preferentially activate alkynes rather than keto functionalities. Furthermore, it would not explain the formation of isomers **5.38f** and **5.38g** from compounds **5.36f** and **5.36g**, respectively (see entries 6 and 7, table 5.3).

The high selectivity towards 6- when compared to 5-membered rings observed in the reaction of conjugate alkynyl esters **5.41a** and **5.41d-e**, might be accounted by the destabilization of gold carbene **5.65** caused by the ester group that is on the same carbon that carries the gold fragment. This destabilization would accelerate the subsequent 1,2-alkyl shift leading to intermediate **5.66** thus explaining why 5-membered cycles are not observed in this case (but also why 6-membered cycles are observed to some extent in the case of substrates **5.36f** and **5.36g**, scheme 5.22). The high diastereoselectivities observed should be considered by the fact that the diastereoselective hydride addition/cyclization sequence, which proceeds *via* a Zimmerman-Traxler transition state that is responsible to set the relative stereochemistry between (R^1 , R^3) and R^2 (Scheme 5.22).

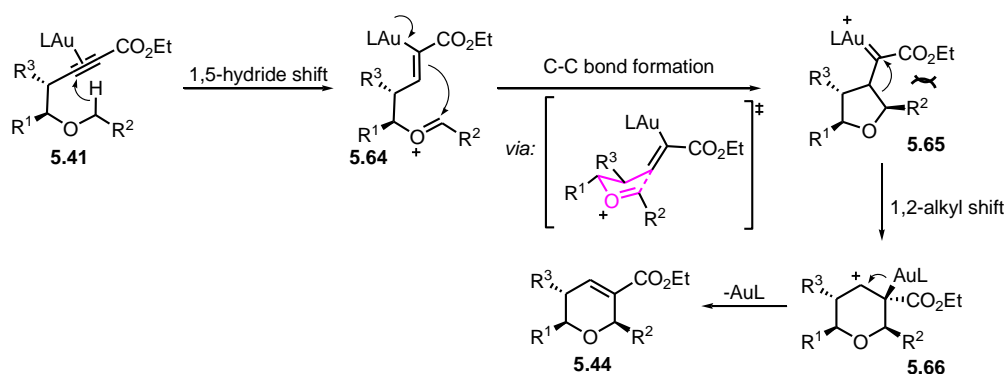

Scheme 5.22 Reaction mechanism for the 1,5-hydride shift/cyclization sequence using alkynyl esters **5.41**.

²⁶¹ Au(I) catalysts were recognized as more carbophilic Lewis acids, while Au(III) more oxophilic. For a more detailed discussion, see: Yamamoto, Y.; *J. Org. Chem.*, **2007**, 72, 7817.

5.3 CONCLUSION

Various fused and spiro tetrahydrofurans and dihydropyrans were obtained *via* a 1,5-hydride shift/cyclization sequence performed on alkynyl ethers by using the gold complex XphosAu(CH₃CN)SbF₆ as the catalyst in refluxing nitromethane. This hydroalkylation process showed good substrate scope and functional group compatibility, being applicable to aliphatic and cyclic ethers possessing either terminal or substituted alkynes. This route, that formally transforms a C(sp³)-H bond into a new C-C bond, represents not only a practical entry to ethers possessing five- or six-membered rings, but is also one of the first reports where an hydrogen atom is intramolecularly transferred as an hydride to an unactivated alkyne.

CHAPTER 6: FORMATION OF CINNOLINE DERIVATIVES BY A GOLD(I)-CATALYZED HYDROARYLATION OF N-PROPARGYL-N'-ARYLHYDRAZINES

The work described in this chapter was performed individually and was reported in the Journal of Organometallic Chemistry: Jurberg, I. D.; Gagosz, F.; *J. Organom. Chem.*, **2011**, 696, 37.

CHAPTER 6: FORMATION OF CINNOLINE DERIVATIVES BY A GOLD(I)-CATALYZED HYDROARYLATION OF *N*-PROPARGYL-*N'*-ARYLHYDRAZINES

6.1 INTRODUCTION: Intramolecular hydroarylation processes and Importance of Cinnoline derivatives

6.1.1 Intramolecular Hydroarylation Processes

Among the large-quantity chemicals manufactured by the chemical industry, arene derivatives, such as benzenes, naphthalenes, phenols and anilines have a great importance as they serve as raw material for a plethora of organic transformations. In this context, conception of catalytic and straightforward processes derived from these compounds, which functionalize aromatic C-H bonds leading to C-C bond formation in more complex structures are very practical and therefore of great interest for the chemical and pharmaceutical community²⁶².

In this regard, an intramolecular hydroarylation procedure, which proceeds by a formal addition of an arene C-H bond across a multiple bond²⁶³ represents a flexible and conceptually simple approach allowing rapid access to valuable annulated compounds. Other advantages using this approach in comparison to other common annulation strategies, such as the Heck reaction for instance²⁶⁴, is that the hydroarylation process not only eliminates the need for a halogen or a triflate group, but allows also multiple mechanistic possibilities, ultimately allowing access to different products (scheme 6.1).

²⁶² See for instance: Rassias, G.; Stevenson, N. G.; Curtis, N. R.; Northall, J. M.; Gray, M.; Prodger, J. C.; Walker, J. W.; *Org. Proc. Res. & Dev.*, **2010**, 14, 92.

²⁶³ For examples of the intermolecular version of hydroarylation processes, see: using metal triflates (a) Tsuchimoto, T.; Maeda, T.; Shirakawa, E.; Kawakami, Y.; *Chem. Comm.*, **2000**, 1573. Using Pd, see: (b) Tsukada, N.; Mitsuboshi, T.; Setgushi, H.; Inoue, Y.; *J. Am. Chem. Soc.*, **2003**, 125, 12102. Using Ru, see: (c) Murai, S.; Kakiuchi, F.; Sekine, S.; Tanaka, Katamani, A.; Sonoda, M.; Chatani, N.; *Nature*, **1993**, 366, 529. Using Fe, see: (d) Li, R.; Wang, S. R.; Lu, W.; *Org. Lett.*, **2007**, 9, 11, 2219.

²⁶⁴ For examples of the 5-*exo* regioselectivity, see: (a) Firmansjah, L.; Fu, G. C.; *J. Am. Chem. Soc.*, **2007**, 129, 11340. (b) Lapierre, A. J. B.; Geib, S. J.; Curran, D. P.; *J. Am. Chem. Soc.*, **2007**, 129, 494. (c) Ashimori, A.; Bachand, B.; Calter, M. A.; Govek, S. P.; Overman, L. E.; Poon, D. J.; *J. Am. Chem. Soc.*, **1998**, 120, 6488.

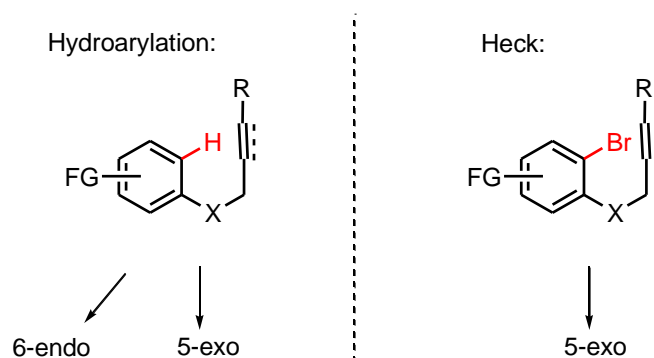

Figure 6.1: Comparison between the hydroarylation *versus* the Heck approach for the ring-closure of propargyl/allyl arene derivatives.

The three main alternative mechanistic routes available from the hydroarylation approach are i) arene metalation-Heck type addition²⁶⁵, ii) multiple bond activation-Friedel-Crafts type substitution²⁶⁶ and iii) metal-promoted Claisen rearrangement-heteroatom addition sequences^{267,268} (scheme 6.1).

²⁶⁵ (a) Kakiuchi, F.; Yamauchi, M.; Chatani, N.; Murai, S.; *Chem. Lett.*, **1996**, 111. (b) Thalji, R. K.; Ahrendt, K. A.; Bergman, R. G.; Ellman, J. A.; *J. Am. Chem. Soc.*, **2001**, 123, 9692. (c) Boele, M. D. K.; van Strijdonck, G. P. F.; de Vries, A. H. M.; Kramer, P. C. J.; de Vries, J. G.; Leeuwen, P. W. N. M.; *J. Am. Chem. Soc.*, **2002**, 124, 1586. (d) Baran, P. S.; Corey, E. J.; *J. Am. Chem. Soc.*, **2002**, 124, 7904.

²⁶⁶ For examples using Ru(II) and Pt(II), see: (a) Chatani, N.; Inoue, H.; Ikeda, T.; Murai, S.; *J. Org. Chem.*, **2000**, 65, 4913. For examples of alkyne arylation processes using "I⁺" sources, see: (b) Yao, T.; Campo, M. A.; Larock, R. C.; *Org. Lett.*, **2004**, 6, 16, 2677. (c) Barluenga, J.; Trincado, M.; Marco-Arias, M.; Ballesteros, A.; Rubio, E.; González, J. M.; *Chem. Comm.*, **2008**, 2005. (d) Barluenga, J.; Rodríguez, M. A.; González, J. M.; Campos, P. J.; *Tetrahedron Lett.*, **1990**, 31, 29, 4207.

²⁶⁷ Koch-Pomeranz, U.; Hansen, H.-J.; Schmid, H.; *Helv. Chim. Acta*, **1973**, 56, 2981.

²⁶⁸ Another possible mechanism is the hydrometalation of the triple carbon-carbon bond, generating an alkenylmetal species, followed by intramolecular substitution of the arene ring. For examples using palladium, see: (a) Trost, B. M.; Toste, F. D.; *J. Am. Chem. Soc.*, **1996**, 118, 6305. (b) Larock, R. C.; Doty, M. J.; Tian, Q.; Zenner, J. M.; *J. Org. Chem.*, **1997**, 62, 7536.

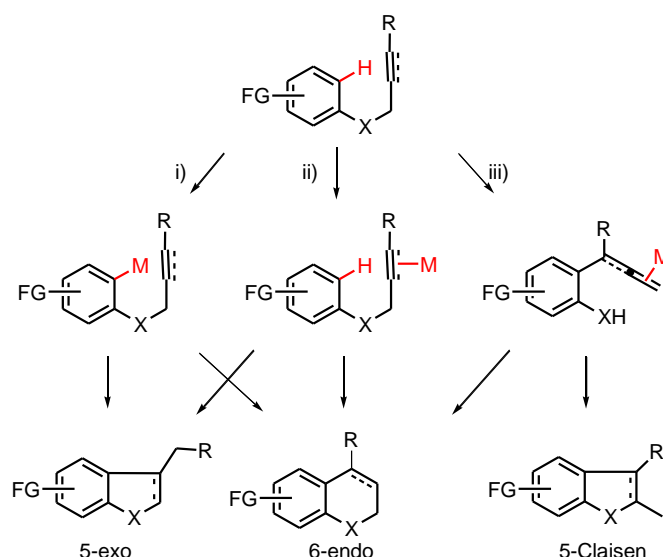

Scheme 6.1: Hydroarylation of alkynes and alkenes can follow three main pathways: i) arene metalation-Heck type addition, ii) multiple bond activation-Friedel-Crafts substitution and iii) metal-promoted Claisen rearrangement-heteroatom addition.

Common metals employed in intramolecular hydroarylation processes with alkenes and alkynes are Pt²⁶⁹, Pd²⁷⁰, Ru²⁷¹, Ga²⁷², Hg²⁷³, Cu²⁷⁴ and Au²⁷⁵. For instance, the synthesis of important biological agents, such as chromenes **6.1**²⁷⁶, coumarins **6.2**²⁷⁷, dihydroquinolines

²⁶⁹ (a) Pastine, S. J.; Youn, S. W.; Sames, D.; *Org Lett.*, **2003**, 5, 7, 1055. (b) Pastine, S. J.; Youn, S. W.; Sames, D.; *Tetrahedron*, **2003**, 59, 8859. (c) Fürstner, A.; Mamane, V.; *J. Org. Chem.*, **2002**, 67, 6264.

²⁷⁰ (a) Jia, C.; Piao, D.; Kitamura, T.; Fujiwara, Y.; *J. Org. Chem.*, **2000**, 65, 7516. (b) Jia, C.; Piao, D.; Oyamada, J.; Lu, W.; Kitamura, T.; Fujiwara; *Science*, **2000**, 287, 1992.

²⁷¹ (a) Youn, S. W.; Pastine, S. J.; Sames, D.; *Org. Lett.*, **2004**, 6, 4, 581. (b) Merlic, C. A.; Pauly, M. E.; *J. Am. Chem. Soc.*, **1996**, 118, 11319.

²⁷² Inoue, H.; Chatani, N.; Murai, S.; *J. Org. Chem.*, **2002**, 67, 1414.

²⁷³ Nishizawa, M.; Takao, H.; Yadav, V. K.; Imagawa, H.; Sugihara, T.; *Org. Lett.*, **2003**, 5, 24, 4563.

²⁷⁴ (a) Williamson, N. M.; March, D. R.; Ward, D.; *Tetrahedron Lett.*, **1995**, 36, 42, 7721. (b) Williamson, N. M.; Ward, A. D.; *Tetrahedron*, **2005**, 61, 155.

²⁷⁵ (a) Reetz, M. T.; Sommer, K.; *Eur. J. Org. Chem.*, **2003**, 3485. (b) Shi, Z.; He, C.; *J. Org. Chem.*, **2004**, 69, 3669. (c) Xiao, F.; Chen, Y.; Liu, Y.; Wang, J.; *Tetrahedron*, **2008**, 64, 2755. (d) Menon, R. S.; Findlay, A. D.; Bissember, A. C.; Banwell, M. G.; *J. Org. Chem.*, **2009**, 74, 22, 8901.

²⁷⁶ Chromenes have been used as potassium channel activating drugs and they have also been found in the framework of a series of tannins, which are becoming increasingly important because of their health-promoting effects found in teas, vegetables, fruits, fruit juices, and red wines. For references, see: (a) Ashwood, V. A.; Buckingham, R. E.; Cassidy, F.; Evans, J. M.; Faruk, E. A.; Hamilton, T. C.; Nash, D. J.; Stemp, G.; Willcocks, K. *J. Med. Chem.* **1986**, 29, 2194. (b) Atwal, K. S.; Grover, G. J.; Ferrara, F. N.; Ahmed, S. Z.; Sleph, P. G.; Dzwonczyk, S.; Normandin, D. E. *J. Med. Chem.* **1995**, 38, 1966. (c) Elomri, A.; Mitaku, S.; Michel, S.; Skaltsounis, A.-L.; Tillequin, F.; Koch, M.; Pierré, A.; Guilbaud, N.; Léonce, S.; Kraus-Berthier, L.; Rolland, Y.; Atassi, G. *J. Med. Chem.* **1996**, 39, 4762.

²⁷⁷ Coumarins are used in the pharmaceutical industry as precursors of a number of synthetic anticoagulant drugs, where a notable one is warfarin. For references, see: (a) Lowenthal, J.; Birnbaum, H.; *Science*, **1969**, 164, 181. (b) O'Reilly, R. A.; Ohms, J. I.; Motley, C. H.; *J. Biol. Chem.*, **1969**, 244, 1303.

6.3²⁷⁸ and quinolinones **6.4**²⁷⁹ have been reported using PtCl₄^{269a-b}, Pd(OAc)₂/ TFA²⁷⁰, Hg(OTf)₂-(TMU)₃ (TMU = tetramethylurea)²⁷³, CuCl²⁷⁴, AuCl₃/AgOTf^{275b} and JohnPhosAu(NCCH₃)SbF₆^{275d} (scheme 6.1).

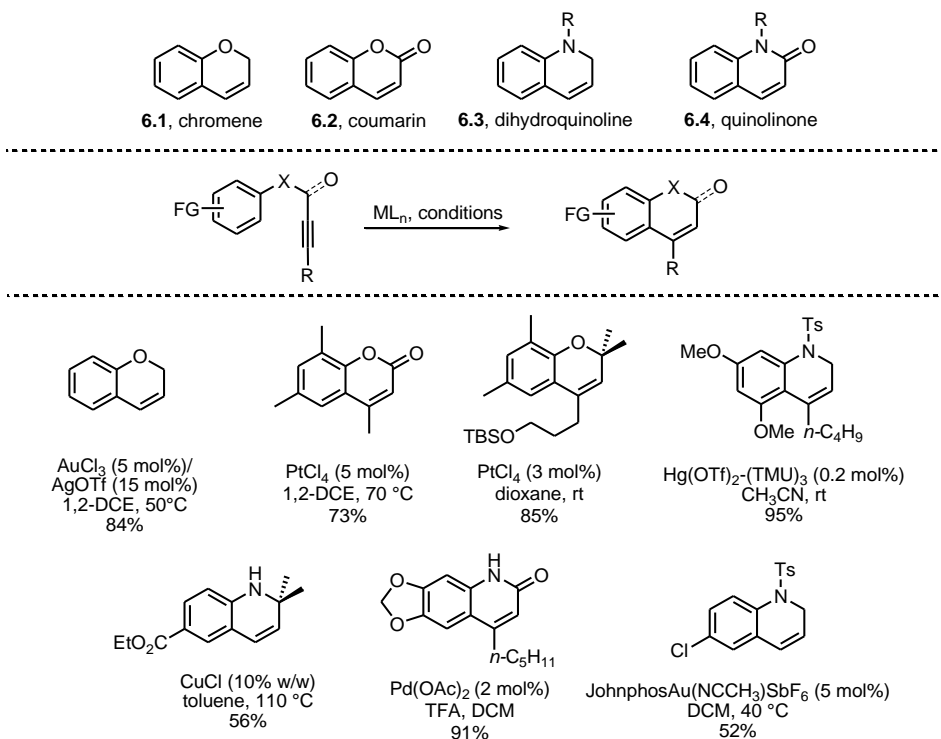

Scheme 6.1: Selected substrate scope of chromenes, coumarins, dihydroquinolines and quinolinones obtained from different transition metal-catalyzed transformations.

6.1.2 Importance of cinnolines

Another important class of benzo-fused compounds is derived from cinnolines, the focus of this project. Because cinnolines exhibit an exceptional spectrum of pharmaceutical activities²⁸⁰, their use in drug design have been investigated and numerous tetrahydrocinnolines²⁸¹ and 1,2-dihydrocinnolines²⁸², such as **6.5** or the commercially

²⁷⁸ Dihydroquinolines have been used in a variety of ways as antioxidants. For references, see: (a) Johnson, J. V.; Rauckman, B. S.; Baccanari, D. P.; Roth, B.; *J. Med. Chem.*, **1989**, 32, 1942. (b) Prohaszka, L.; Rozsnya, T.; *Avian Pathology*, **1990**, 19.

²⁷⁹ Quinolinones were found to have anticancer activity. See: (a) Barbeau, O. R.; Cano-Soumillac, C.; Griffin, R. J.; Hardcastle, I. R.; Smith, C. G. M.; Richardson, C.; Clegg, W.; Harrington, R. W.; Golding, B. T.; *Org. & Biom. Chem.*, **2007**, 5, 2670. (b) Nio, Y.; Ohmori, H.; Hirahara, N.; Sasaki, S.; Takamura, M.; Tamura, K.; *Anticancer Drugs*, **1997**, 8, 7, 686.

²⁸⁰ Lewgowd, W.; Stanczak, A.; *Arch. Pharm. Chem. Sci.*, **2007**, 340, 65.

²⁸¹ Stanczak, A.; Kwapiszewski, W.; Szadowska, A.; Pakulska, W.; *Pharmazie*, **1994**, 49, 406.

²⁸² Siegfried, A. G.; **1965**, Fr Patent 1393596.

available drugs *cinnopentazone* **6.6** and *cinnofuradione* **6.7** have demonstrated important biological activity (scheme 6.2).

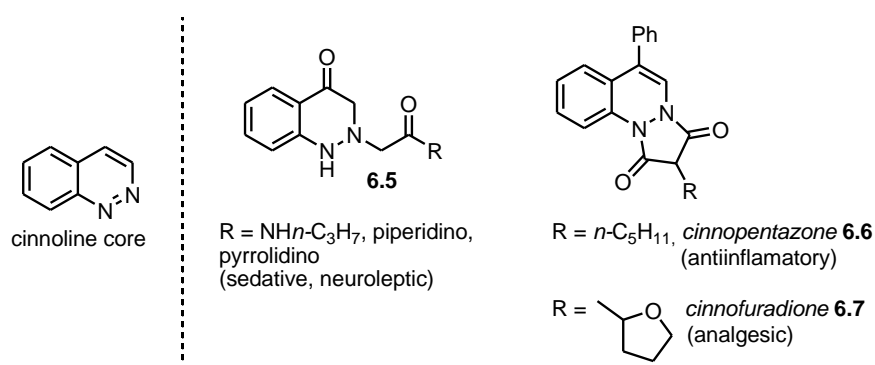

Scheme 6.2: Examples of bioactive 1,2-dihydro- and tetrahydrocinnolines.

6.2 RESULTS AND DISCUSSION

6.2.1 The initial idea

Previous work in our group²⁸³ describes the 6-*exo* dig cyclization of propargyl aniline derivatives **6.7** bearing a malonate as tether upon treatment with XphosAu(NCCH₃)SbF₆ (1 mol%) in refluxing nitromethane to afford mixtures of tetrahydroquinolines **6.8** and dihydroquinolines **6.9**. These mixtures were isomerized by treatment with a catalytic amount of PTSA to obtain dihydroquinoline **6.9** as the sole product. Subsequent exposure of these dihydroquinolines **6.9** to the sun light promoted a 6 π -electrocyclic ring opening-ring closure sequence that afforded indoles **6.10** (scheme 6.3).

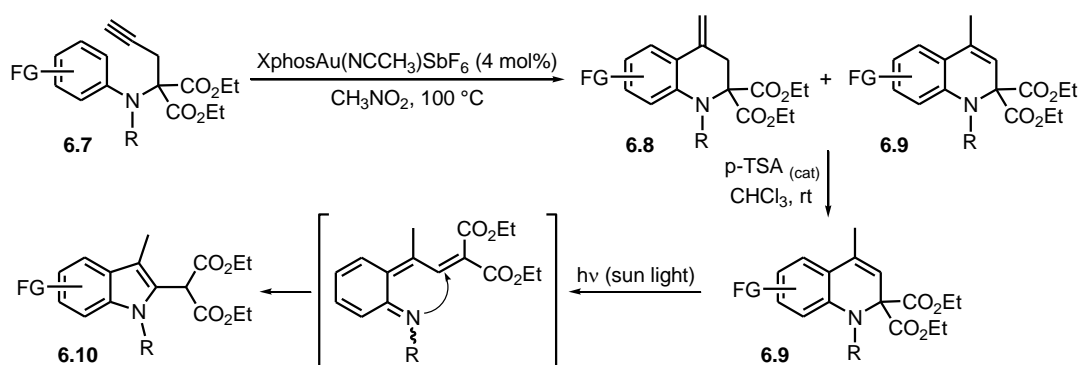

Scheme 6.3: Previous work developed in our group towards the synthesis of dihydroquinolines **6.9** and indoles **6.10**.

²⁸³ Gronnier, C.; Odabachian, Y.; Gagosz, F.; *Chem. Commun.*, **2010**, (doi: 10.1039/C0CC00033G).

Based on these results, we envisaged a similar reaction sequence from *N*-propargyl-*N'*-arylhydrazines **6.11**, which would ultimately afford cinnoline derivatives **6.13** and aminoindoles **6.14** (scheme 6.4).

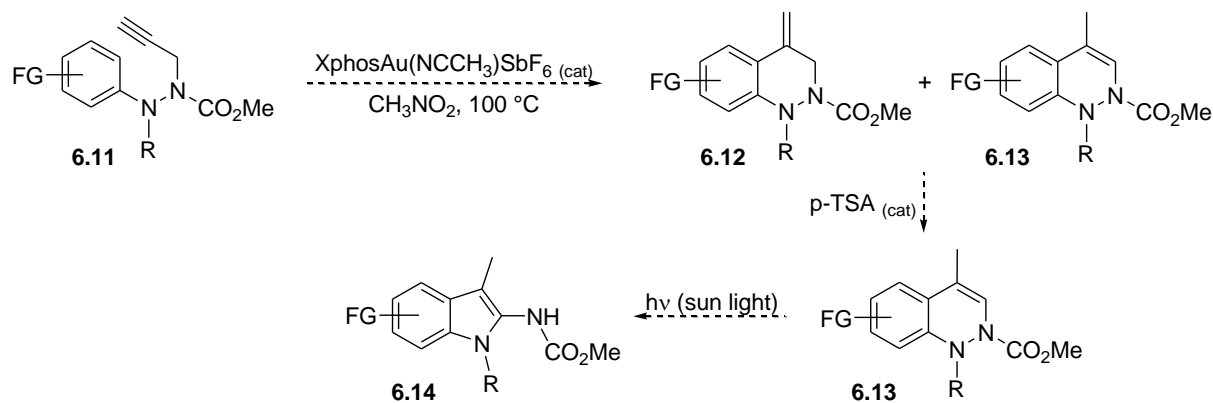

Scheme 6.4: Reaction sequence envisaged to access cinnoline derivatives **6.13** and aminoindoles **6.14**.

In order to start our investigation, *N*-propargyl-*N'*-phenyl hydrazine **6.15** was synthesized from diethyl azodicarboxylate (DEAD) in a two-steps sequence consisting of the conjugate addition of phenyl magnesium bromide²⁸⁴ and standard propargylation. Subsequent gold catalysis using the previously optimized protocol for *N*-aminophenyl propargyl malonates **6.7** (*i.e.* 1 mol% $\text{XphosAu}(\text{NCCH}_3)\text{SbF}_6$ in refluxing CH_3NO_2) did not afford any products, except for the starting substrate. Higher catalyst loadings and different solvents did not change this result. We speculate that the origin of this lack of reactivity comes from the steric constraint between the two ester groups presents in **6.15**²⁸⁵. Other possible reasons are the dipole repulsion between both esters groups and/or the low nucleophilicity of the phenyl ring due to the electron-withdrawing carboxymethyl group on the proximal nitrogen atom (scheme 6.5).

²⁸⁴ Demers, J. P.; Klaubert, D. H.; *Tetrahedron Lett.*, **1987**, 28, 42, 4933

²⁸⁵ In contrast to amide bonds, whose energy barriers of rotation depend on the solvent used, carbamates rotation barriers were reported to be independent of solvent variation. See: Cox, C.; Lectka, T.; *J. Org. Chem.*, **1998**, 63, 2426.

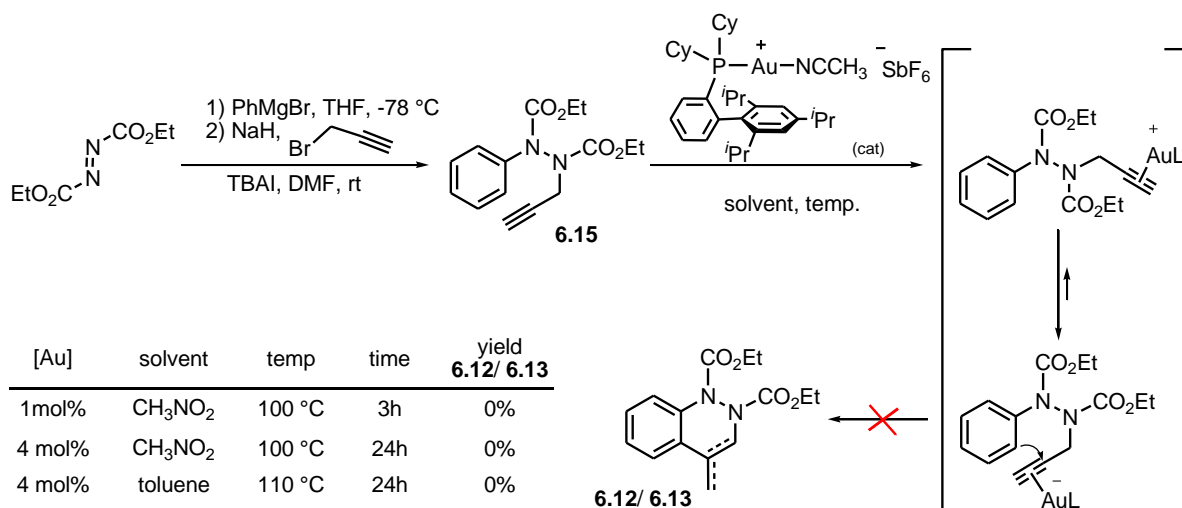

Scheme 6.15: First trials towards the cyclization of *N*-propargyl-*N'*-aryl hydrazines using **6.15**.

As a second attempt, as well as a proof-of-principle experiment, we speculated that hydrazine derivative **6.11a** carrying two phenyl rings on the same nitrogen atom would exhibit a substantially faster cyclization rate, as both aromatic rings are available to attack the alkyne moiety. Substrate **6.11a** was prepared from phenyl hydrazine **6.16** following protection of the primary nitrogen as a carbamate, oxidation, Grignard conjugate addition and propargylation. Only one purification step by column chromatography was necessary at the end of this sequence (scheme 6.16).

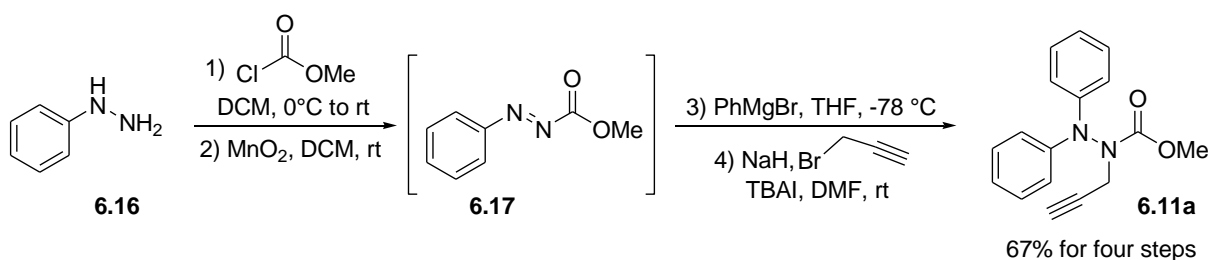

Scheme 6.16: Synthesis of substrate **6.11a**.

Treatment of compound **6.11a** with 1 mol% of XphosAu(NCCH₃)SbF₆ in refluxing nitromethane did not afford any product, but only starting substrate. It was by increasing the amount of gold catalyst to 4 mol% that the desired cyclization was observed, and with an excellent 99% yield for **6.12a** as the only isomer in 1h. No trace of the internal double-bond isomer **6.13a** was observed under these reaction conditions, but the exocyclic double bond

isomer **6.12a** could be isomerized to the internal position isomer **6.13a** upon treatment with a catalytic amount of PTSA in refluxing chloroform (Scheme 6.17).

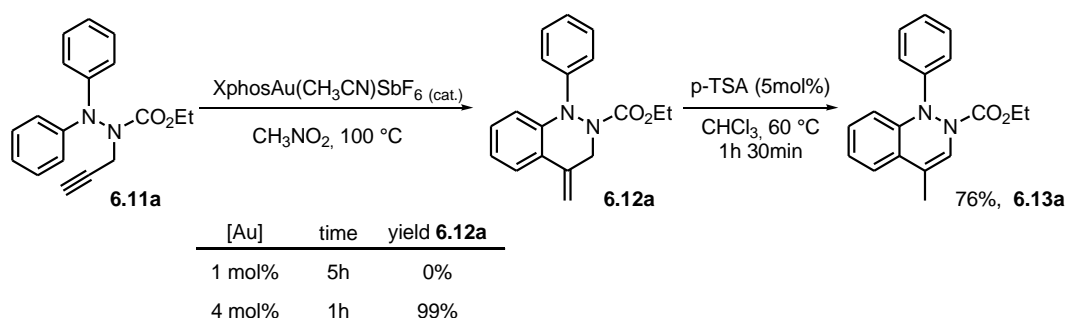

Scheme 6.17: Hydroarylation attempt with **6.11a**.

After being reinvigorated by this positive result, we turned our attention to less-biased substrates. Hydrazine derivatives **6.11b-e** with different substituents on the nitrogen proximal to the aromatic ring were prepared. The synthetic route chosen for substrates **6.11b-c** was identical to that used to prepare **6.11a** (scheme 6.18a). In the case where a benzyl group is used, a double alkylation strategy using *n*-BuLi was employed for substrate **6.11d** (scheme 6.18b)²⁸⁶. Although our attempt to add *tert*-butyl magnesium chloride to the phenyl intermediate **6.17** failed, with only the starting substrate being recovered, the reverse addition, *i.e.*, the addition of phenyl magnesium bromide to the previously prepared *tert*-butyl intermediate **6.20** afforded the desired hydrazine derivative in a good 66% overall yield (scheme 6.18c).

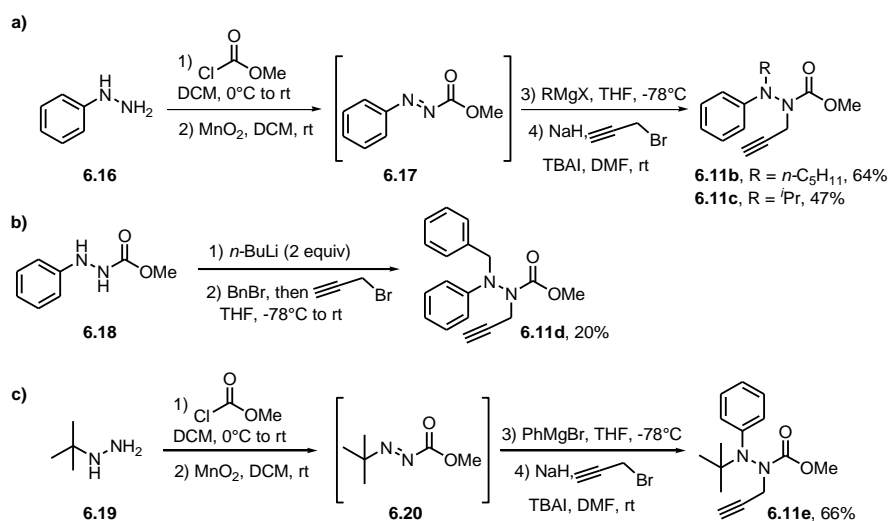

²⁸⁶ Bredihhin, A.; Groth, U. M.; Mäeorg, U.; *Org. Lett.*, **2007**, 9, 6, 1097.

Scheme 6.18: Synthesis of substrates **6.11b-e**.

The subsequent application of our hydroarylation-isomerization protocol to substrates **6.11b-d** furnished the desired cyclic products in 75-99% yields. However not surprisingly, the *tert*-butyl group in substrate **6.11e** did not resist the acidic conditions and only a poor 25% yield was obtained for **6.12e** according to ¹H NMR analysis of the crude reaction mixture, with concomitant formation of an unidentified complex mixture of products (scheme 6.19).

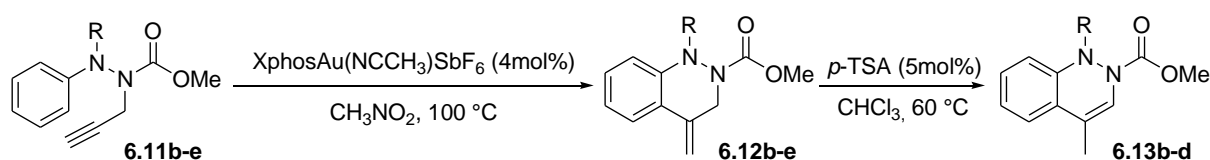

R	product	time	yield	product	time	yield
<i>n</i> -C ₅ H ₁₁	6.12b	2h 30min	99%	6.13b	1h	91%
Bn	6.12c	1h 30min	87%	6.13c	30min	80%
<i>i</i> Pr	6.12d	1h	96%	6.13d	30min	75%
<i>t</i> Bu	6.12e	3h	25% ^a			

^a estimated by ¹H NMR spectroscopy. Not isolated.

Scheme 6.19: Synthesis of tetrahydroquinolines **6.12b-e** and dihydroquinolines **6.13b-d**.

We next turned our attention to aromatic rings possessing different functional groups and the regioselectivity coming from the hydroarylation process when asymmetrically substituted aromatic nuclei (such as those with *meta*-substituents) were employed. Substrates **6.11f-p** were prepared by the same synthetic route as substrates **6.11a-c**, with this time, MeMgBr being systematically added. Gold catalysis with molecules **6.11f-k** and subsequent treatment with a catalytic amount of *p*-TSA afforded products in good 63-85% isolated yields. Substrate **6.11l** bearing the strong electron withdrawing NO₂ group did not react (scheme 6.20a).

Aromatic rings with a methyl and chloro group as *meta*-substituents, **6.11m** and **6.11n**, respectively, afforded 1:1 mixtures of both possible regioisomers **6.12ma** and

6.12mb, and **6.12na** and **6.12nb**, respectively, without any selectivity (scheme 6.20b). Aromatic rings with a methyl and a chloro group as *ortho*-substituents produced very sluggish reactions, affording also 7-*endo* cyclization products, **6.12ob** and **6.12pb**, respectively. We speculate that the steric constraint caused by the necessary alignment of the methyl on the nitrogen atom and the substituent in the *ortho*-position of the aromatic rings renders this step so slow that the 7-membered ring enters as a competing pathway in the process (scheme 6.20c).

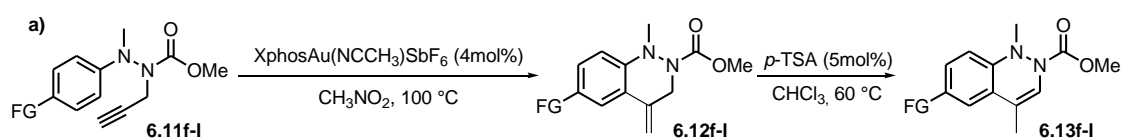

FG	product	yield ^a	product	time	yield ^b	product	time	yield ^b
OMe	6.11f	60%	6.12f	9h	83%	6.13f	1h	88%
Cl	6.11g	71%	6.12g	18h	99%	6.13g	1h	95%
F	6.11h	99%	6.12h	13h	79%	6.13h	1h	75%
CO ₂ Et	6.11i	71%	6.12i	14h	86%	6.13i	1h	81%
CN	6.11j	87%	6.12j	5h	63%	6.13j	4h 30min	73%
CF ₃	6.11k	77%	6.12k	17h	76%	6.13k	1h 30min	67%
NO ₂	6.11l	71%	6.12l	24h	0%	-		

^a: Global yield from the corresponding hydrazine. ^b: Isolated yields

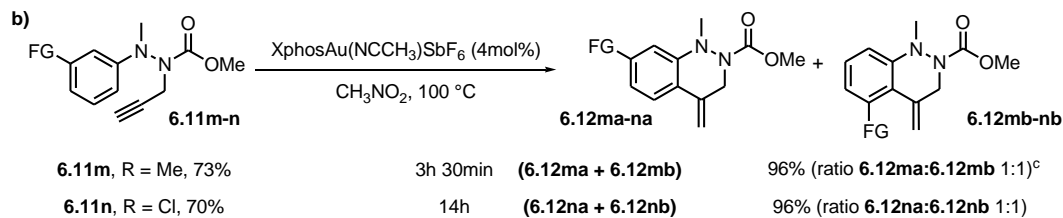

^c: Yield stimulated from ¹H NMR spectroscopy. Although, a 1:1 mixture is observed after 1h by ¹H NMR when the experiment is carried in CDCl₃, prolonged reaction time promotes the degradation of regioisomer **6.12ma**, while regioisomer **6.12mb** can be isolated alone in 48%.

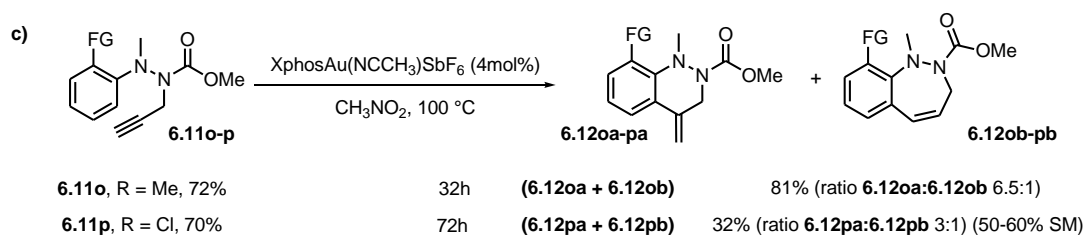

Scheme 6.20: Results obtained for the cyclization of aromatic hydrazines bearing different functional groups **a)** in the *para*-position **6.11f-l**, and **b)** chloro- and methyl-substituted aryl hydrazines in the *meta*-position, **6.11m-n**, and **c)** in the *ortho*-position **6.11o-p**.

Internal alkynes **6.11q-s** with a vinyl, a phenyl or an allyl group, respectively, and other substrates as **6.11t, -u** did not afford any cyclized product, rather only the starting substrate was recovered (scheme 6.21a). Trials toward the rearrangement of dihydroquinolines **6.13** to indoles **6.14** with compounds **6.13a-b** or **6.13f-g** upon heating, acid catalyzed conditions or microwave irradiation gave only the corresponding starting materials. Although the use of a hv lamp (wave length of sun light) afforded a complex mixture of products using compound **6.13b**, the more electron-rich derivative **6.13f** rearranged in a substantially cleaner transformation to indole **6.14f**²⁸⁷ (scheme 6.21b). This represents our first successful lead towards the expected indole derivative of type **6.14** but further experiments are still necessary to confirm the structure obtained and to study the reaction scope (*cf.* previous experiments with malonate derivatives **6.9** and ¹H NMR of the crude reaction mixture. The small scale employed of *ca.* 10 mg precluded product isolation).

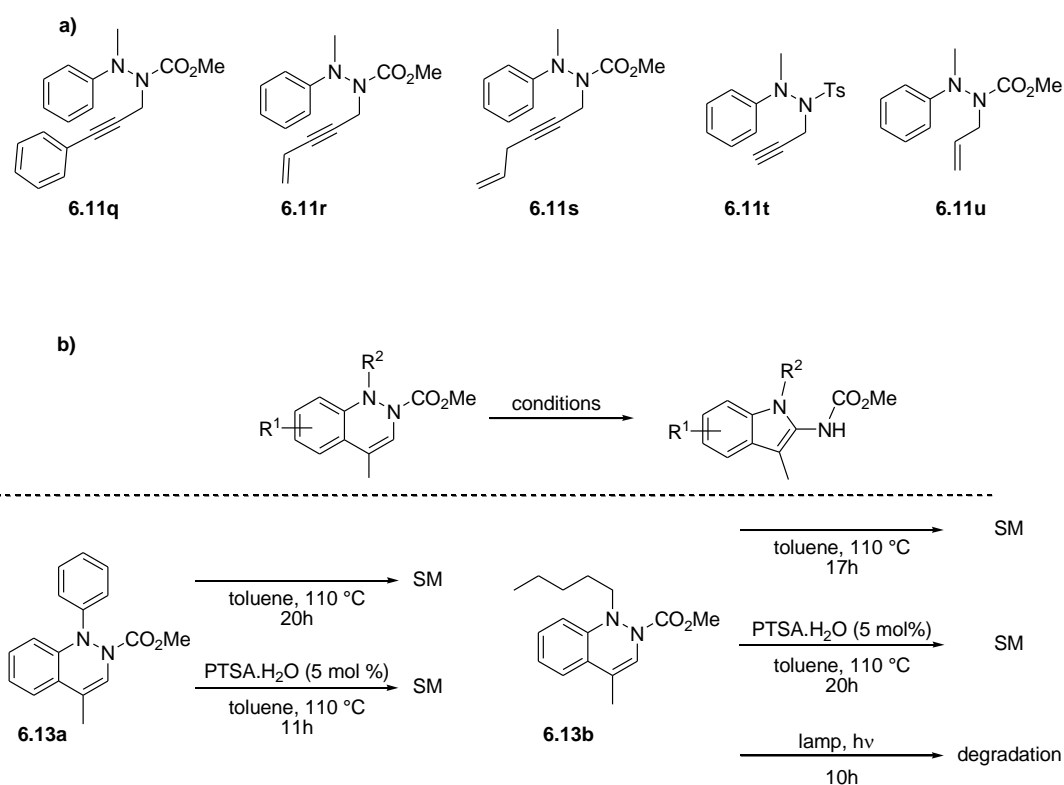

²⁸⁷ Although we could observe the substantially clean formation of a major product from the ¹H NMR of the crude reaction mixture, TLC analysis revealed a series of minor products to be also present in the reaction mixture.

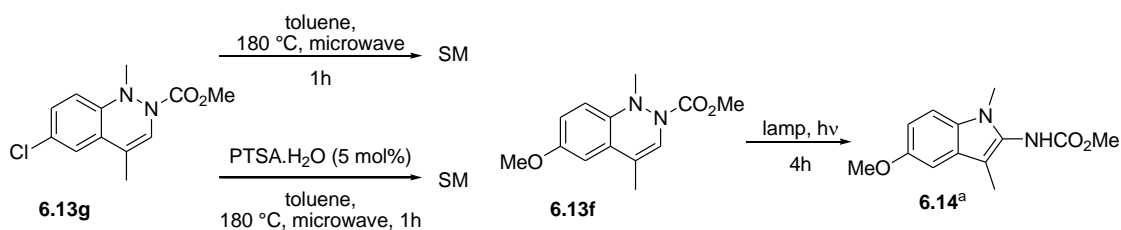

^aobserved by ¹H NMR of the crude reaction mixture. Not isolated.

Scheme 6.21: Trials concerning **a**) internal alkynes **6.11q-s** and other substrates **6.11t,u** also submitted to gold catalysis and **b**) rearrangement of dihydroquinolines **6.13a-b** and **6.13f-g** toward the corresponding indole derivatives.

Concerning the reaction mechanism, a detailed study was not performed and an unambiguous mechanism cannot be determined. Nevertheless, in recent related studies reported in the literature, gold(I)-catalysts have been documented to activate aryl C-H bonds²⁸⁸ and have also been proposed to react through a dual activation mode in the NXS-promoted halogenation of aromatic compounds by activating both the C-H bond and the substrate electrophilic moiety²⁸⁹. Although in our case, we cannot exclude the gold-metallation of the aromatic C-H bond to participate in the process, it seems hard to explain the reactivity pattern previously observed without passing by the activation of the alkyne triple bond in a Friedel-Crafts *type* mechanism. The main reason for this is that electron poor aromatic rings afforded reaction times considerably longer, presumably due to their lower nucleophilicity.

Furthermore, it is worth-mentioning that surprising results were obtained when different aryl groups on the nitrogen atom were employed in competition experiments performed with substrates **6.11v-x**. Little discrimination in product regioselectivities was observed for the cyclization of **6.11v-x**, which gave a 1:2 mixture of **6.12va:6.12vb** and a 1:1.5 mixture of **6.12wa:6.12wb**, respectively. Moreover, the phenyl cyclized product **6.12vb** obtained as the major product was not anticipated, as we were expecting that the more electron-rich 4-(OMe)Ph ring would have a higher cyclization rate (scheme 6.21).

²⁸⁸ Lu, P.; Boorman, T. C.; Slawin, A. M. Z.; Larrosa, I.; *J. Am. Chem. Soc.*, **2010**, 132, 16, 5580.

²⁸⁹ Mo, F.; Yan, J. M.; Qiu, D.; Li, F.; Zhang, Y.; Wang, J.; *Angew. Chem. Int. Ed.*, **2010**, 49, 11, 2028.

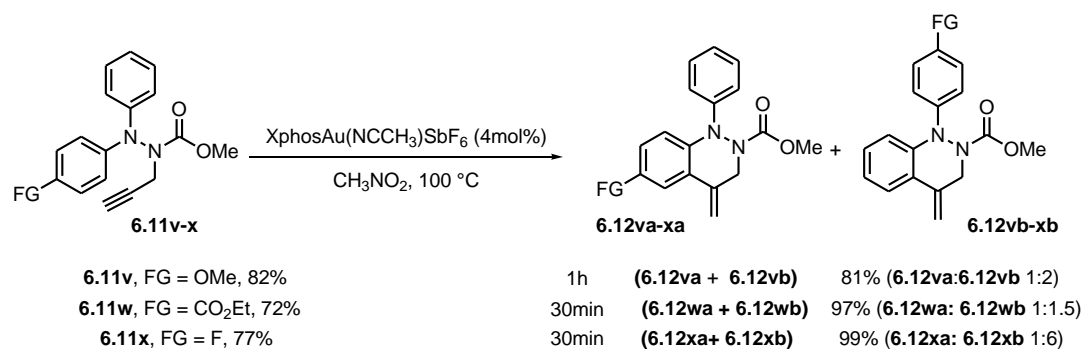

Scheme 6.21: Competition experiments using different substituted aromatic rings.

Although, in light of these results, rationalization of the observed selectivity is a difficult matter and further investigation on the reaction mechanism is still necessary, we speculate that the observed results can be possibly accounted by two effects: i) the electrophilic gold activation of the alkyne triple bond towards nucleophilic addition in a Friedel-Crafts-*type* mechanism and ii) the reversible complexation of the gold complex on the Lewis-basic nitrogen atom carrying both aromatic rings. This complexation would force either one aromatic ring or the other to be in a productive close-proximity position of the alkyne triple bond. This dual action promoted by the gold complex can possibly explain the little discrimination found in the cyclization observed with the methoxy and the ester groups in **6.11v** and **6.11w**, respectively, and also why the more electron poor cycle in **6.11v** furnished the major cyclization product.

6.3 CONCLUSION

In summary, we developed in this chapter a practical and efficient synthetic route for the synthesis of cinnoline derivatives by a gold(I)-catalyzed hydroarylation process. Starting substrates **6.11** can be synthesized in a 4 steps/1 purification process from commercially available arylhydrazines. This procedure was also found to be compatible with the presence of different aryl or alkyl groups on the nitrogen atom proximal to the functionalized aromatic rings.

6.4 PERSPECTIVES AND FURTHER DEVELOPMENTS

Based on cross-dehydrogenative coupling oxidations (*cf.* introduction chapter 5) and the already reported conjugate addition on indole derivatives²⁹⁰, a further functionalization of tetrahydrocinnoline derivatives can be proposed (scheme 6.22)

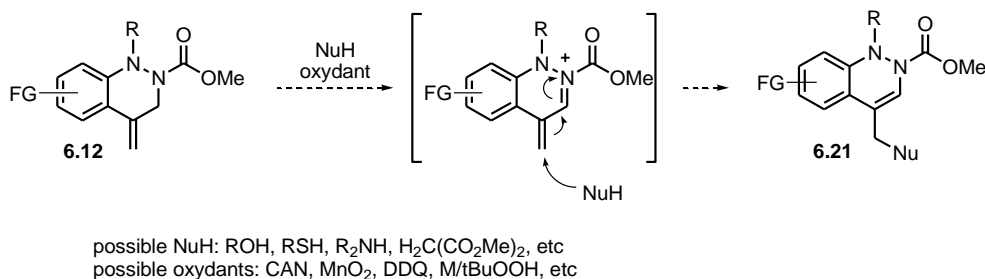

Scheme 6.22: Potential functionalization route from tetrahydro cinnoline derivatives **6.12**.

A possible route to cinnoline rings can also be envisaged from the use of 4-Phenylpyrazole-3,5-dione **6.22**, which upon conjugate addition of an ArMgX derivative and a propargylation step should afford intermediate **6.23** that should cyclize to tetrahydrocinnoline **6.24** upon treatment with a catalytic amount of XphosAu(NCCH₃)SbF₆. Intermediate **6.24** can either be submitted to a functionalization step as the one discussed in scheme 6.22 and further cleavage of the amide bonds by action of a strong base, such as KOH, to give access to cinnolines **6.26** or can be isomerized by a catalytic amount of *p*TSA and then have their amides bond cleaved to produce cinnolines of type **6.25**.

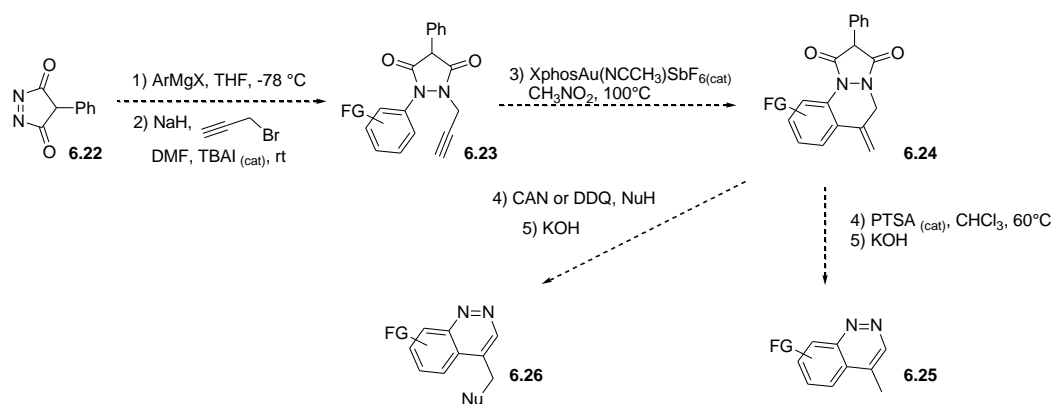

Scheme 6.23: Potential route to functionalized cinnolines **6.25** and **6.26**.

²⁹⁰ Nicolaou, K. C.; Lee, S. H.; Estrada, A. A.; Zak, M.; *Angew. Chem. Int. Ed.*, **2005**, 44, 3736.

APPENDICES A & B: ACRONYMS AND ABBREVIATIONS & EXPERIMENTAL SECTION

APPENDIX A: Acronyms and abbreviations

A.1 Units

°C	Celsius degree
atm	Standard atmosphere
g	Gram
h	Hour
Hz	Hertz
kg	Kilogram
L	Liter
M	Molar concentration
mg	Milligram
MHz	Megahertz
min	Minute
mL	Milliliter
mmol	Millimole
mol	Mole
m/z	Mass unity on elementary charge
N	Normal concentration
ppm	parts per million

A.2 Chemical groups and compounds

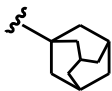
Ac	Acetyl
Ad	Adamantyl
	
Ar	Aryl
Bn	Benzyl
Boc	<i>tert</i> -Butoxycarbonyl
Bu	Butyl
Bz	Benzoyl
Cy	Cyclohexyl
1,2-DCE	1,2-dichloroethane
DCM	Dichloromethane
DMAP	<i>N,N</i> -Dimethyl-4-aminopyridine

DMF	Dimethylformamide
DMSO	Dimethylsulfoxide
dppm	1,1-Bis(diphenylphosphino)methane
Et	Ethyl
IMes	<i>N,N'</i> -bis(2,4,6-trimethylphenyl)imidazol-2-ylidene

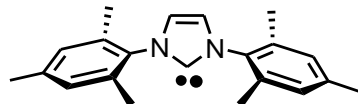

<i>i</i> Pr	Isopropyl
IPr	<i>N,N'</i> -bis(2,6-diisopropylphenyl)imidazol-2-ylidene

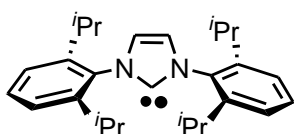

JohnPhos	2-(Di- <i>tert</i> -butylphosphino)biphenyl
----------	---

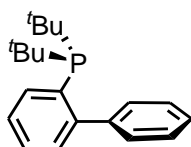

KHMDS	Potassium bis(trimethylsilyl)amide
LDA	Lithiumdiisopropylamide
Me	Methyl
Mes	Mesityl, <i>i.e.</i> , 2,4,6-trimethylphenyl
<i>m</i> -CPBA	<i>meta</i> -chloroperbenzoic acid
Ms	Mesyl, <i>i.e.</i> , Methanesulfonyl
2-Napht	2-Naphtyl
<i>n</i> -Bu	<i>n</i> -Butyl
NBS	<i>N</i> -bromosuccinimide
NHC	<i>N</i> -heterocyclic carbene
NIS	<i>N</i> -iodosuccinimide
<i>n</i> -Pr	<i>n</i> -Propyl
NXS	<i>N</i> -halosuccinimide
PE	Petroleum ether
Ph	Phenyl
phen	1,10-phenanthroline

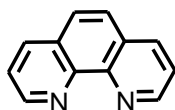

Piv	Pivalyl
PMB	<i>para</i> -methoxy benzyl
<i>p</i> -TSA	<i>para</i> -toluene sulfonic acid
Py	pyridine
TBAF	tetrabutylammonium fluoride
TBS	<i>tert</i> -Butyldimethylsilyl
^t Bu	<i>tert</i> -Butyl
<i>tert</i> -Butyl Xphos	2-Di- <i>tert</i> -butylphosphino-2',4',6'-triisopropylbiphenyl

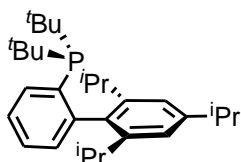

TIPS	triisopropylsilyl
TFA	Trifluoroacetic acid
TMS	Trimethylsilyl
THF	Tetrahydrofuran
Tf	Trifluoromethanesulfonyl
Tol	Tolyl, <i>i.e.</i> , 4-methyl-phenyl
Ts	Tosyl, <i>i.e.</i> , <i>para</i> -toluene sulfonyl
Xphos	2-Dicyclohexylphosphino-2',4',6'-triisopropylbiphenyl

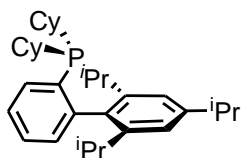

A.3 Other acronyms and abbreviations

aq.	Aqueous
<i>ax</i>	Axial
bs	Broad singlet (in NMR)
cat.	Catalytic
CI ⁺	Positive chemical ionization (in MS)
conc.	Concentrated
conv.	Conversion
d	Doublet (in NMR)
de	Diastereoisomeric excess
degrad.	Degradation
dr	Diastereoisomeric ratio
E	Electrophile
ee	Enantiomeric excess

EI ⁺	Positive electron ionization (in MS)
<i>eq</i>	Equatorial
equiv.	Equivalent
EDG	Electron donating group
EWG	Electron withdrawing group
Hept	Heptuplet (in NMR)
HPLC	High pressure liquid chromatography
HRMS	High resolution mass spectroscopy
IR	Infrared
J	Coupling constant
LG	Leaving group
m	Multiplet (in NMR)
<i>m-</i>	<i>meta-</i>
MF	Molecular formula
MS	Mass spectroscopy
MW	Molecular weight
NMR	Nuclear magnetic resonance
Nu	Nucleophile
<i>o-</i>	<i>ortho-</i>
<i>p-</i>	<i>para-</i>
q	Quadruplet (in NMR)
quant	Quantitative
rt	Room temperature
s	Singlet (in NMR)
SM	Starting material
sol.	Solution
t	Triplet (in NMR)
temp	Temperature
TLC	Thin layer chromatography
TOF	Turnover frequency
TON	Turnover number
UV	Ultraviolet
v/v	Volume to volume (about solutions)
w/w	Weight to weight
δ	Chemical shift
Δ	Heating
ν	Wavenumber (in IR)

Part of the work presented in this manuscript is the result of the collaboration with some members of our research group. In subjects where other students were involved, a red star (^{*}) was previously used to mark the experiments performed by the author of this manuscript. Only these experiments will be described in this section. The contribution of each member was acknowledged at the beginning of each chapter in the Main Sections and will be restated here, together with the reference of the journal in which the results were published.

Chapter 1: Individual work under the guidance of Fabien Gagosz and Samir Zard.

Jurberg, I. D.; Gagosz, F.; Zard, S.; *Org. Lett.*, **2010**, 12, 3, 416.

Chapter 3: Collaboration with Andrea K. Buzas, Florin Istrate and Yann Odabachian under the guidance of Fabien Gagosz.

Istrate, F.; Buzas, A. K.; Jurberg, I. D.; Odabachian, Y.; Gagosz, F.; *Org. Lett.*; **2008**, 10, 5, 925.

Chapter 4: Individual work under the guidance of Fabien Gagosz.

Unpublished results

Chapter 5: Collaboration with Yann Odabachian under the guidance of Fabien Gagosz.

Jurberg, I. D.; Odabachian, Y.; Gagosz, F.; *J. Am. Chem. Soc.*, **2010**, 132, 10, 3543.

Chapter 6: Individual work under the guidance of Fabien Gagosz

Jurberg, I. D.; Gagosz, F.; *J. Organom. Chem.*, **2011**, 696, 37.

Compounds characterized in Chapter 1:

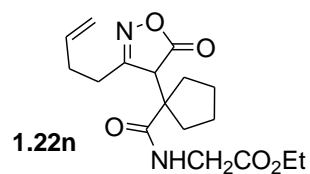
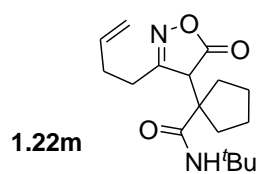
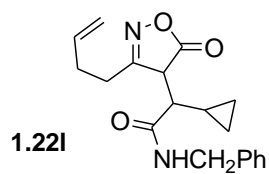
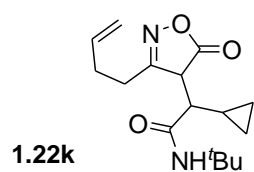
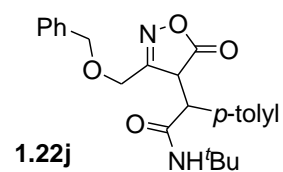
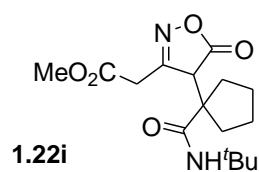
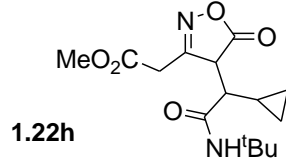
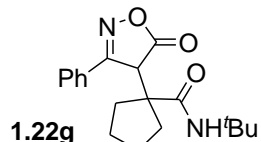
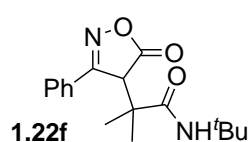
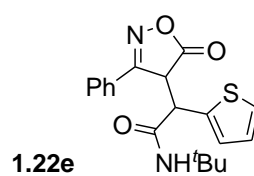
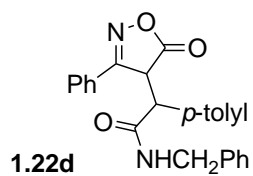
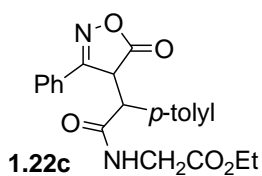
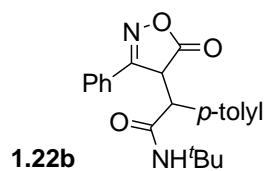
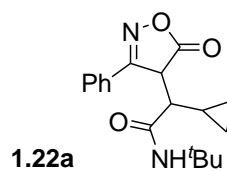
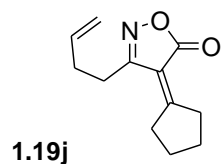
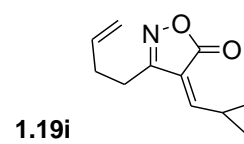
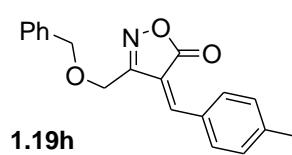
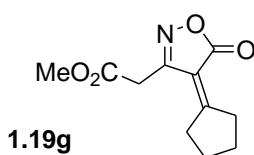
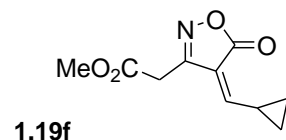
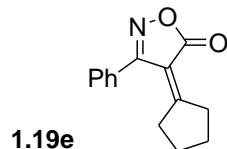
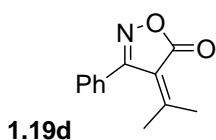
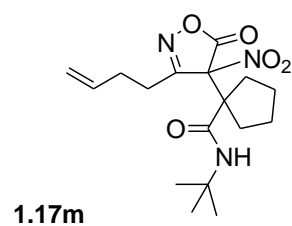
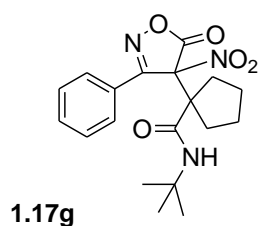
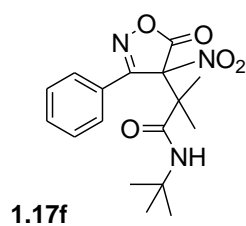

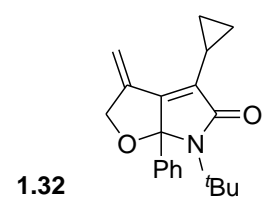
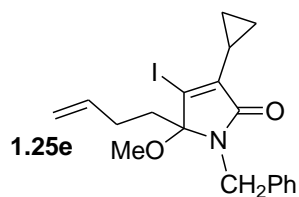
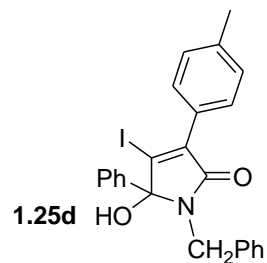
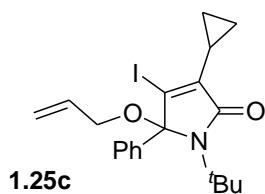
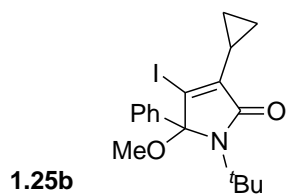
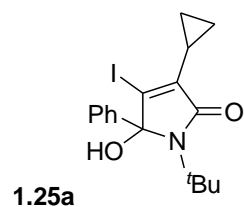
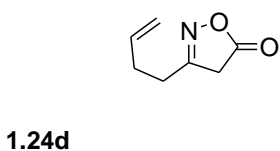
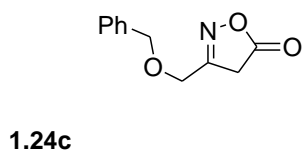
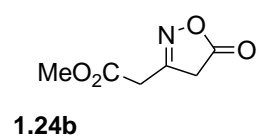
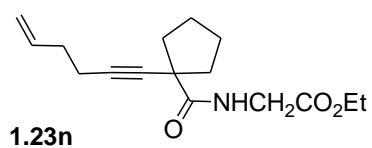
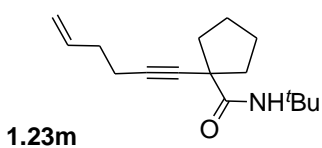
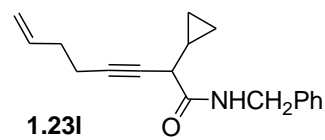
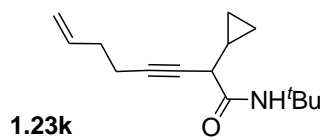
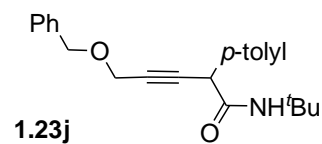
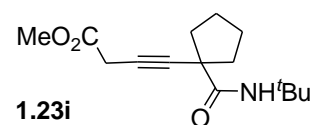
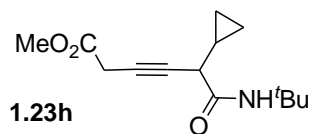
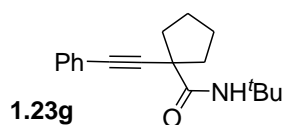
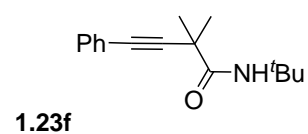
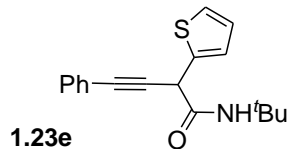
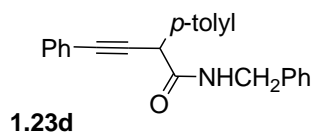
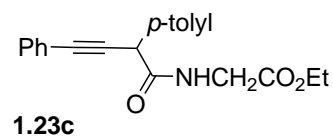
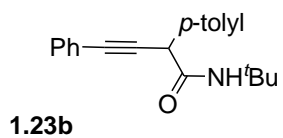
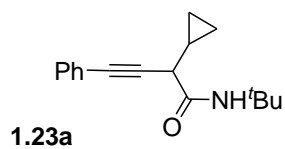

Compounds characterized in Chapter 3:

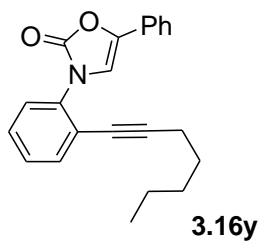
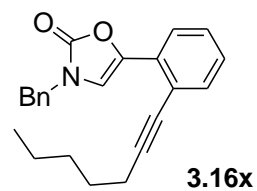
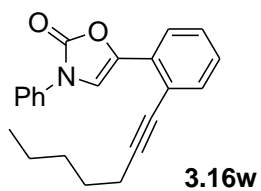
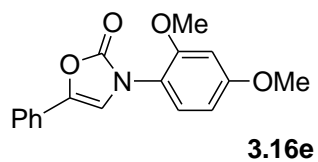
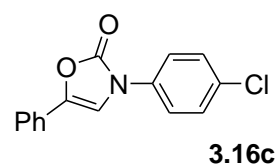
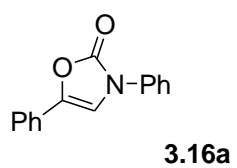
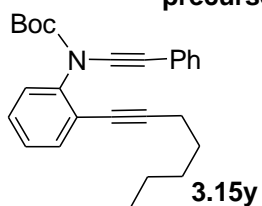
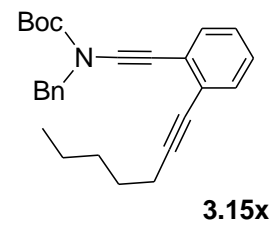
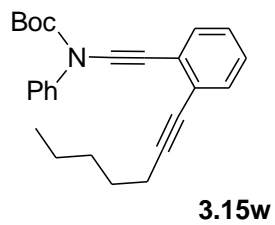
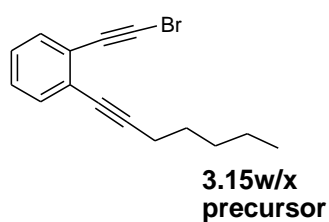
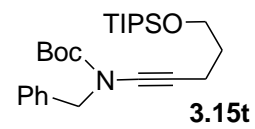
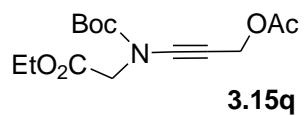
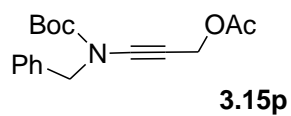
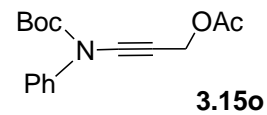
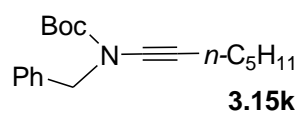
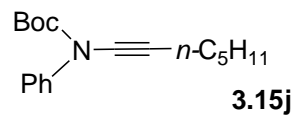
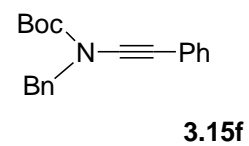
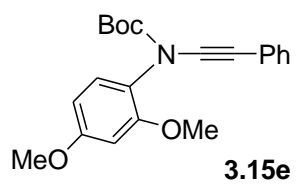
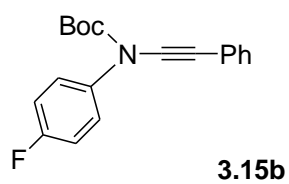

Compounds characterized in Chapter 4:

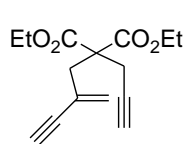

4.64a

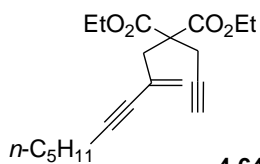

4.64b

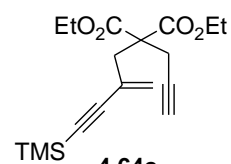

4.64c

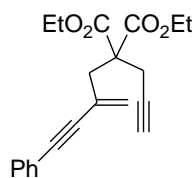

4.64d

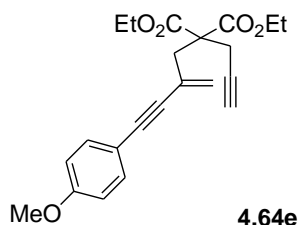

4.64e

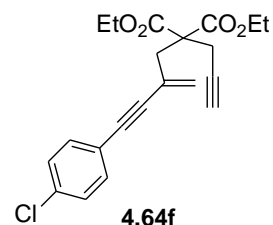

4.64f

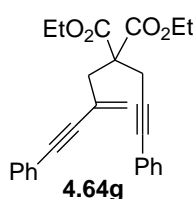

4.64g

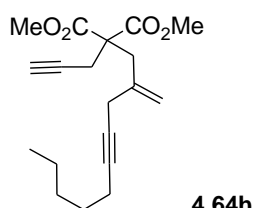

4.64h

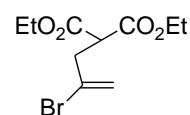

4.69

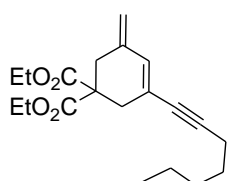

4.72b

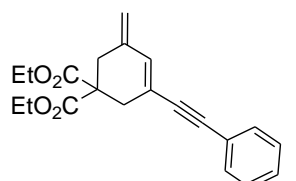

4.72d

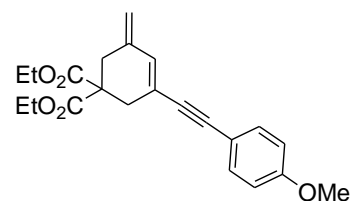

4.72e

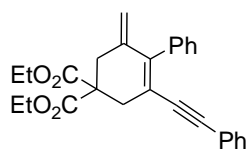

4.72g

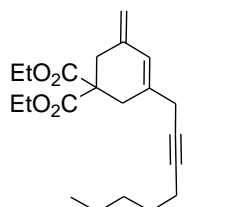

4.72h

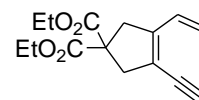

4.73a

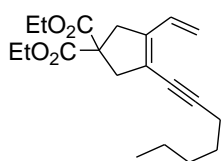

4.73b

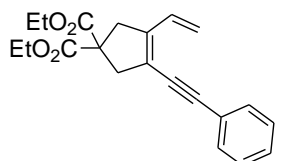

4.73d

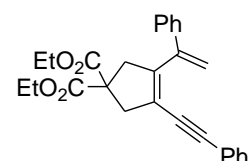

4.73g

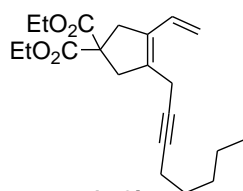

4.73h

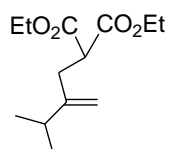

4.77

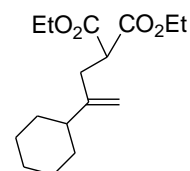

4.78

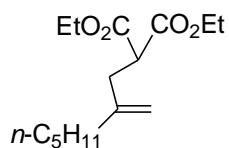

4.79

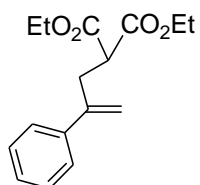

4.80

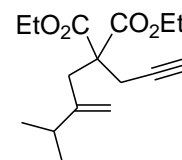

4.81

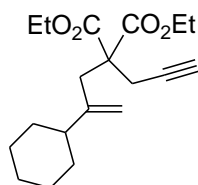

4.82

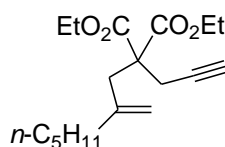

4.83

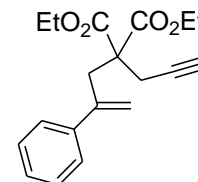

4.84

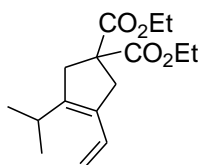

4.85a

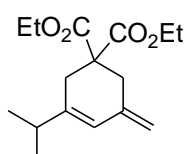

4.85c

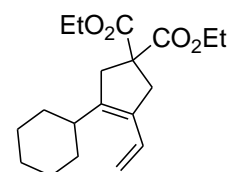

4.86a

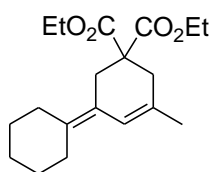

4.86b

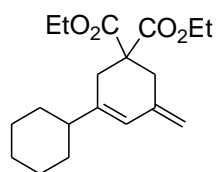

4.86c

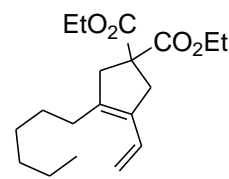

4.87a

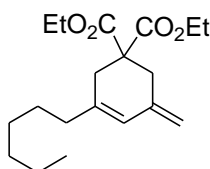

4.87c

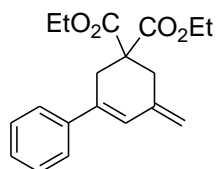

4.88a

Compounds characterized in Chapter 5:

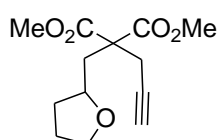

5.17a

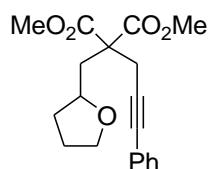

5.17b

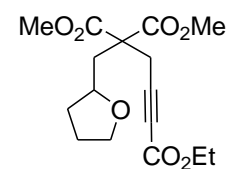

5.17e

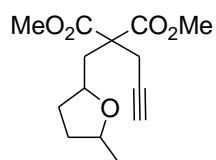

5.17f

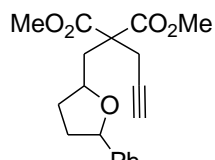

5.17g

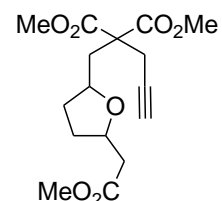

5.17h

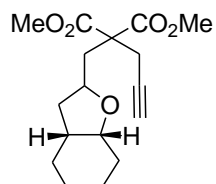

5.17i

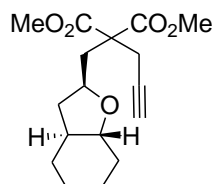

5.17j

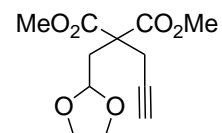

5.17l

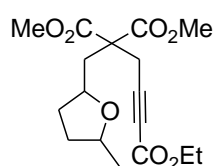

5.17m

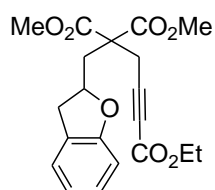

5.17n

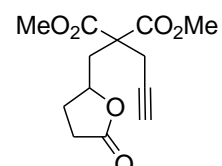

5.17p

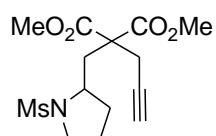

5.17q

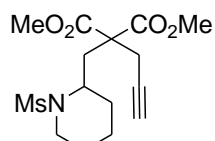

5.17r

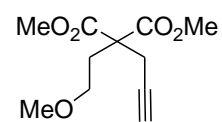

5.17s

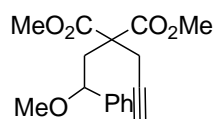

5.17t

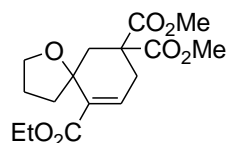

5.18e

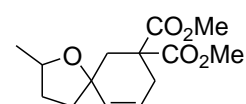

5.18f

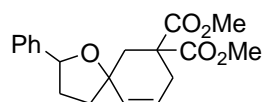

5.18g

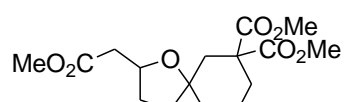

5.18h

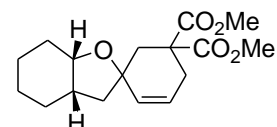

5.18i

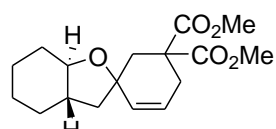

5.18j

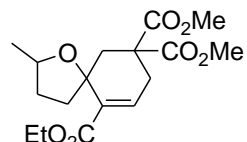

5.18m

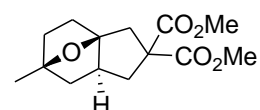

5.20f

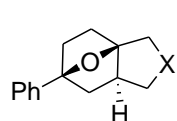

5.20g

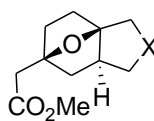

5.20h

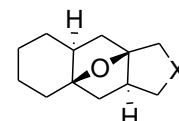

5.20i

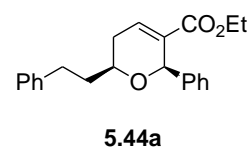
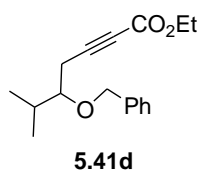
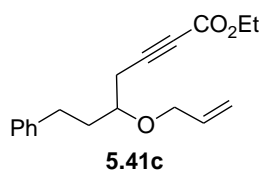
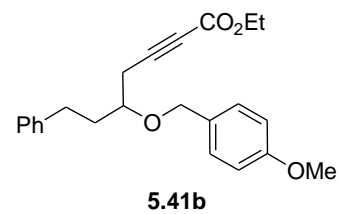
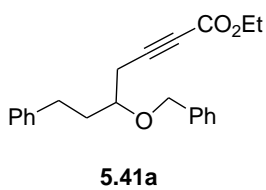
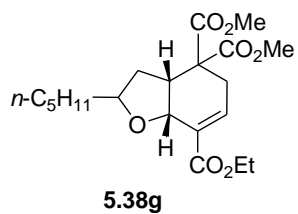
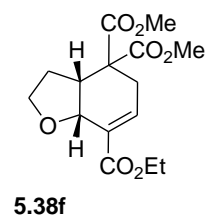
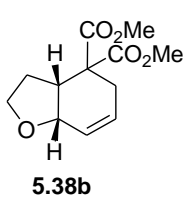
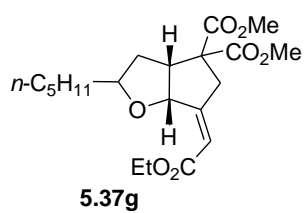
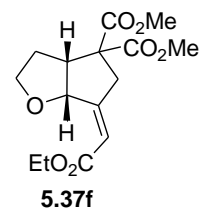
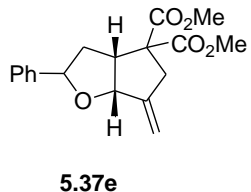
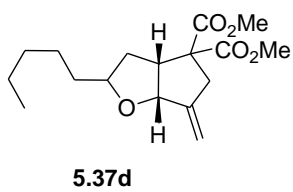
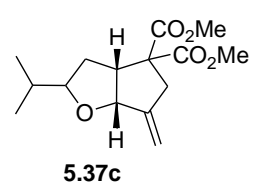
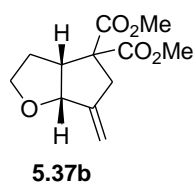
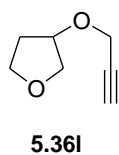
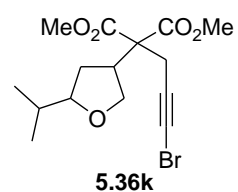
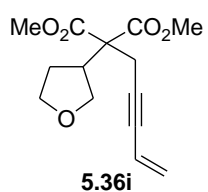
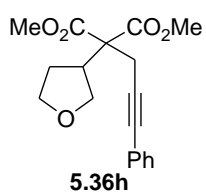
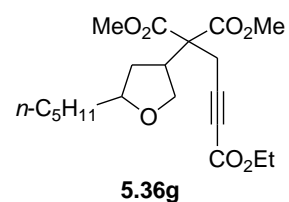
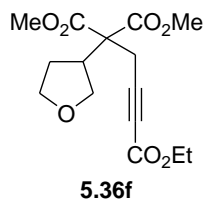
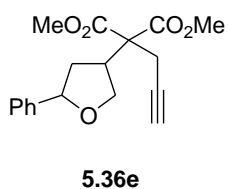
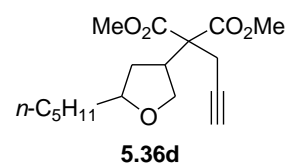
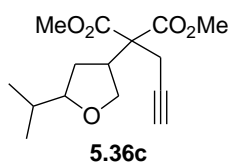
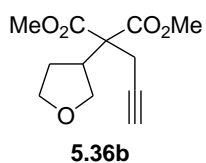

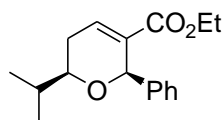

5.44d

Compounds characterized in Chapter 6:

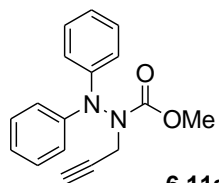

6.11a



6.11b

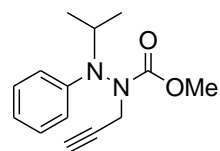

6.11c

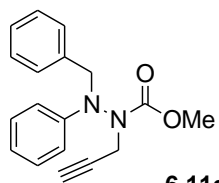

6.11d

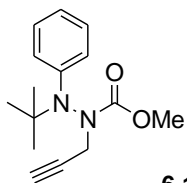

6.11e

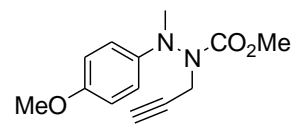

6.11f

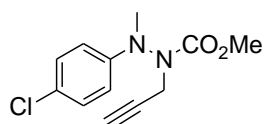

6.11g

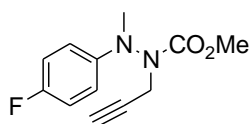

6.11h

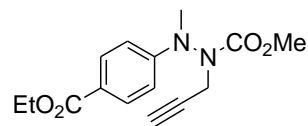

6.11i

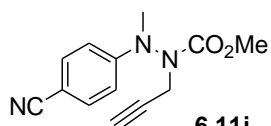

6.11j

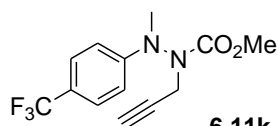

6.11k

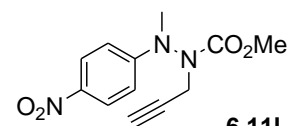

6.11l

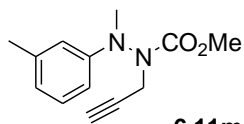

6.11m

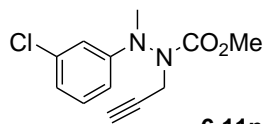

6.11n

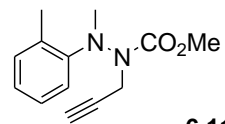

6.11o

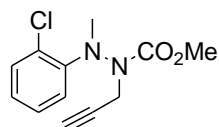

6.11p

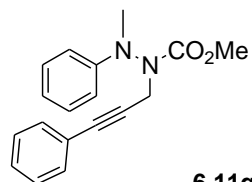

6.11q

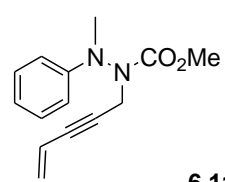

6.11r

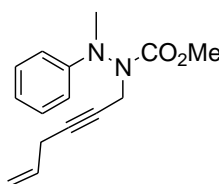

6.11s

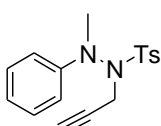

6.11t

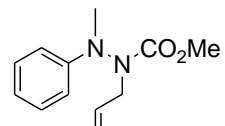

6.11u

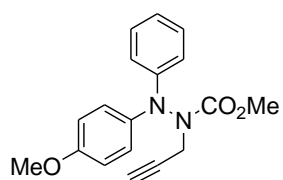

6.11v

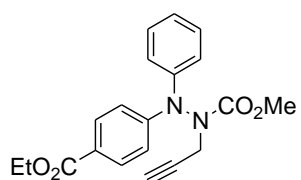

6.11w

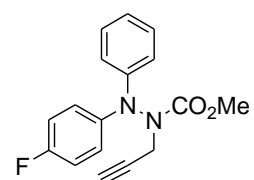

6.11x

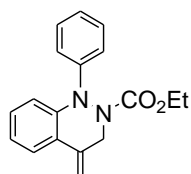

6.12a

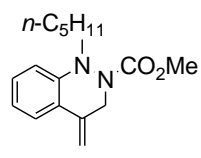

6.12b

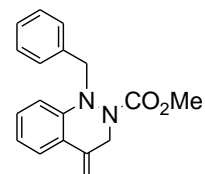

6.12c

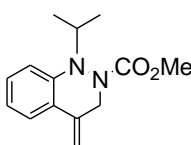

6.12d

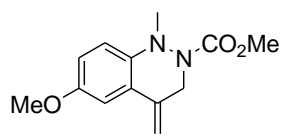

6.12f

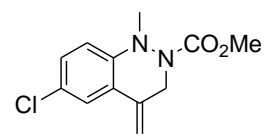

6.12g

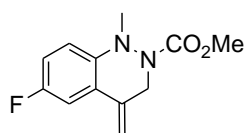

6.12h

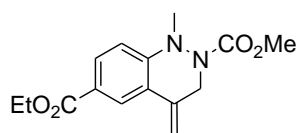

6.12i

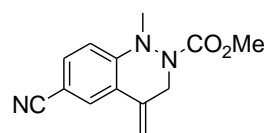

6.12j

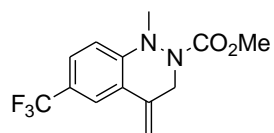

6.12k

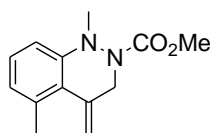

6.12mb

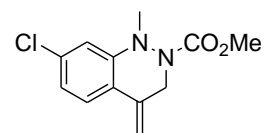

6.12na

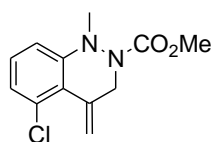

6.12nb

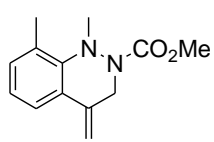

6.12oa

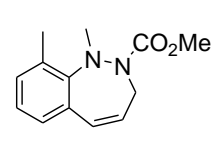

6.12ob

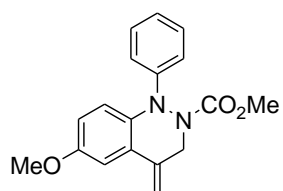

6.12va

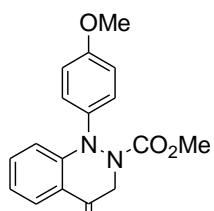

6.12vb

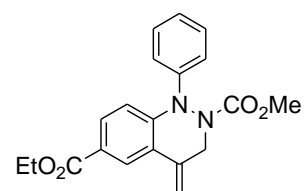

6.12wa

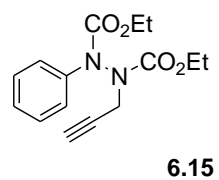
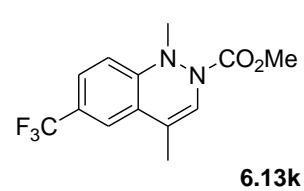
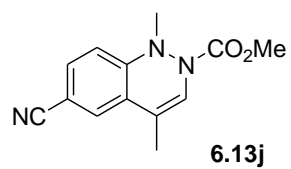
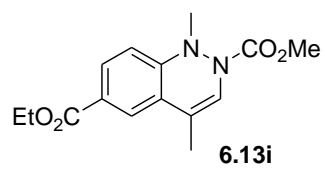
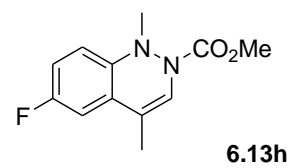
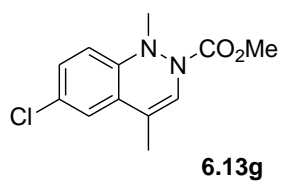
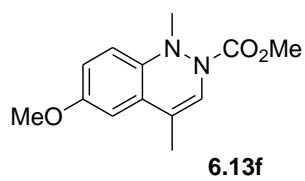
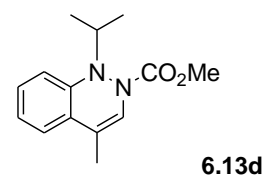
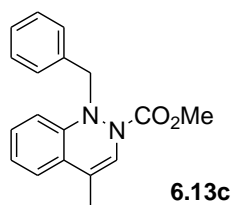
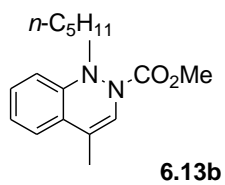
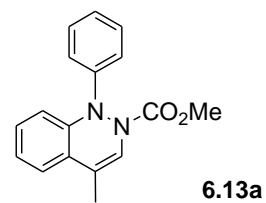
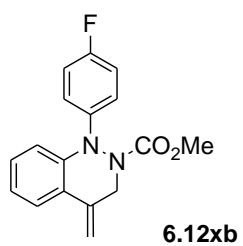
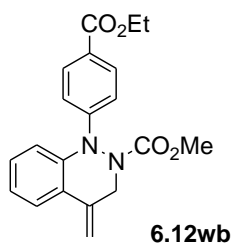

B.1 General Methods

B.1.1 Reagents and Solvents

Commercially available reagents were used as received without further purification.

All **reaction solvents** correspond to SDS “pure for synthesis” solvents and were used as received, with the exception of dry Et₂O and THF, which were obtained by distillation from Na/benzophenone and dry DCM and toluene, which were obtained by distillation from CaH₂.

Solvents for flash column chromatographies correspond to SDS “pure for synthesis” solvents and were used as received.

The same holds for **HPLC solvents**, which correspond to the SDS “HPLC grade”.

B.1.2 Experimental Procedures

All non-aqueous reactions were performed under dry Ar or N₂ atmosphere using standard syringe/cannula/septum techniques, unless specified otherwise.

Concentration under reduced pressure was performed by rotator evaporation at room temperature using a water jet pump.

Purified compounds were further dried on a high vacuum pump.

B.1.3 Chromatography

Thin layer chromatography (TLC) were done on Merck Silica Gel 60 F₂₅₄ plates (aluminium plates coated with silica gel 60). They were visualized under UV light at 254 or 365 nm, then stained using KMnO₄ or anisaldehyde solution. **KMnO₄ solution** was prepared from 600 mL of water, 6g of KMnO₄ 40 g of K₂CO₃ and 0.5mL concentrated acetic acid. **Anisaldehyde solution** was prepared from 26 mL *p*-anisaldehyde, 950 mL ethanol 95%, 35 mL concentrated sulfuric acid and 10.5 mL concentrated acetic acid.

Flash column chromatography were performed on SDS 60 CC 40-63 silica gel (pore-size 60 Å, particle size 40-63 μm) using a forced flow of eluent at 0.1-0.5 bar pressure.

B.1.4 Analytical Methods

NMR spectra were recorded on a Bruker Avance 400 operating at a 400 MHz for ¹H and 100MHz for ¹³C nuclei.

In ^1H NMR chemical shifts (δ) are expressed in ppm using tetramethylsilane ($\delta = 0$ ppm) or the residual peak of chloroform ($\delta = 7.26$ ppm) as an internal reference. Coupling constants J are given in Hertz (Hz).

In ^{13}C NMR, chemical shifts (δ) are expressed in ppm taking the chloroform residual peak ($\delta = 77.0$ ppm) as an internal reference.

IR spectra were recorded with a Perkin Elmer FT-1600 spectrometer. Oil or solid samples were dissolved in carbon tetrachloride and then placed in a sodium chloride cell. The spectra values are reported as absorption maxima and expressed in cm^{-1} .

Mass spectra (MS) were recorded on a Hewlett Packard HP-5890 B using positive electron ionization (EI^+) or positive chemical ionization with ammonia (Cl^+ , NH_3) methods. Fragment signals are given a mass-to-charge ratio (m/z).

All analyses were performed at the DCSO laboratory (Laboratoire de Chimie de Synthèse Organique) of Ecole Polytechnique.

B.1.5 Softwares

The 1D and 2D NMR FID spectral data was processed and visualized using MesctReC 4.7.0.0.

This manuscript was written using Microsoft Word, versions 2002 and 2007. Chemical formulas were edited in Cambridge Soft's Chemdraw Standard 6.0 and 8.0.

The name of the synthesized compounds was determined according to the CAS nomenclature using Beilstein AutoNom 2000, version 4.01.305.

B.2 The catalysts synthesis

B.2.1 Synthesis of phosphine gold(I) bis(trifluoromethanesulfonyl)imidate complexes

The phosphine gold(I) bis(trifluoromethanesulfonyl)imidate complexes used during our work were obtained according to the method developed in our laboratory from the corresponding phosphine gold(I) chloride derivatives upon treatment with AgNTf₂ in DCM at rt.

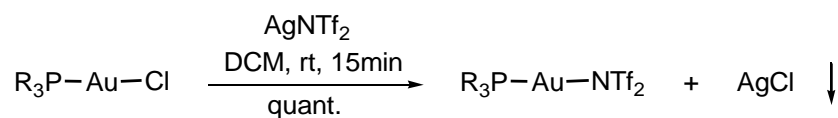

PR₃ = PPh₃, (*p*-CF₃C₆H₄)₃P, Ad₂(*n*-Bu)P, Johnphos, Xphos, etc.

General Procedure B.2.1: The phosphine gold(I) chloride complex (1 equiv.) was dissolved in DCM (0.04M) at rt and AgNTf₂ (1 equiv.) was added resulting in the instantaneous formation of the expected silver chloride precipitate. The mixture was stirred for an additional 15 min and the formation of a single complex was observed in ³¹P NMR of the crude mixture. Filtration over celite to remove the silver chloride salts resulted in a pale colored solution. The expected complex was obtained quantitatively by evaporation to dryness under reduced pressure and drying under vacuum.

B.2.2 Synthesis of phosphine gold chloride complexes

Phosphine gold chloride complexes, such as XPhosAuCl, *tert*-butylXphosAuCl and Ad₂(*n*-Bu)PAuCl can be prepared from Me₂S.AuCl upon treatment with the corresponding phosphine by simple ligand exchange.

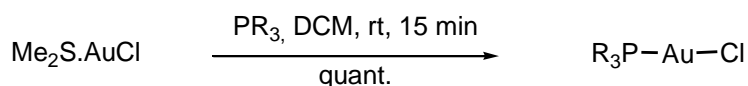

General Procedure B.2.2: Me₂S.AuCl (1 equiv.) and the phosphine (1 equiv.) were weighed in air then placed under nitrogen. DCM (0.04 M) was added, which resulted in the dissolution of the starting material and the formation of a pale yellow solution. The mixture was stirred at rt for 15 min and the complete formation of the desired gold chloride complex was verified by ³¹P NMR. The volume of the solution was reduced to 1 mL and then 5 mL of hexane was added, resulting in the precipitation of the complex. The solid was filtered,

washed with hexane and dried under vacuum, resulting in the quantitative isolation of the title compound.

B.2.3 Synthesis of $\text{PR}_3\text{Au}(\text{NCCH}_3)\text{SbF}_6$

The synthesis of the gold complex $\text{PR}_3\text{Au}(\text{NCCH}_3)\text{SbF}_6$ is performed by treating the phosphine gold complex PR_3AuCl with the silver salt AgSbF_6 in acetonitrile at rt.

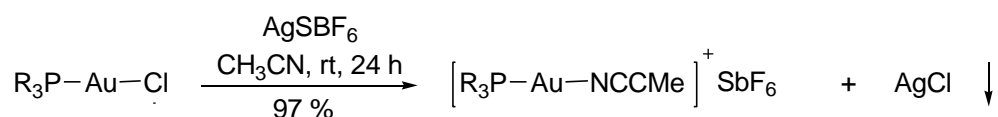

General procedure B.2.3: To a mixture of PR_3AuCl (1 equiv.) and AgSbF_6 (1 equiv.), acetonitrile (0.125 M) was added. The reaction mixture was allowed to stir at rt for 24h and then it was filtered through a pad of celite. The filtrate was evaporated under reduced pressure to give the expected cationic complex.

B.3 Synthesized Molecules

B.3.1. Chapter1: Unusual approach to branched 3-alkynylamides and to 1,5-dihydropyrrol-2-ones

All molecules synthesized for the publication of this work²⁹¹ are described below. This project was developed individually.

B.3.1.1 Synthesis of isoxazolin-5-ones

Isoxazolin-5-ones were synthesized as depicted below:

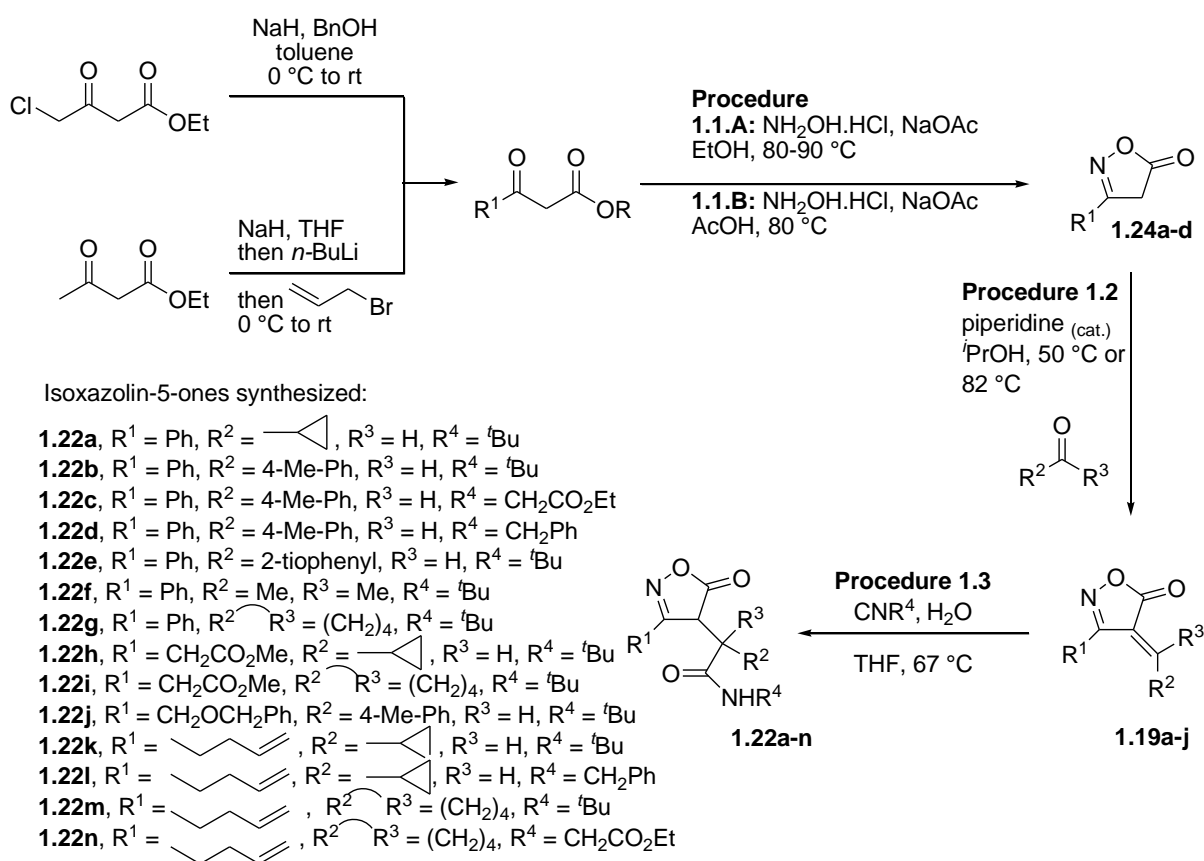

Scheme B.3.1.1: Synthetic route employed for the synthesis of substrates **1.22a-n**.

4-Benzyloxy-3-oxo-butyric acid ethyl ester and 3-oxo-hept-6-enoic acid ethyl ester were synthesized as described in the literature²⁹². All other β -ketoesters were commercially afforded.

²⁹¹ Jurberg, I. D.; Gagosz, F.; Zard, S. Z.; *Org. Lett.*, **2010**, 12, 3, 416.

General procedure 1.1.A²⁹³, *Synthesis of the 5-isoxazolone ring*: A mixture of NH₂OH.HCl (1 equiv.) and NaOAc (1equiv.) in acetic acid (0.5 M) was allowed to stir for 15 min. at room temperature. The β -ketoester (1 equiv.) was slowly added to the reaction mixture and the reaction was allowed to stir for 1h at room temperature until complete consumption of the starting β -ketoester (a mixture of the corresponding oxime and the final product is formed). The mixture was then heated up to 80-90 °C for 30 min, when no more oxime was detected on TLC. The solution was then filtered and concentrated under reduced pressure. H₂O and DCM were added. The organic layers were separated and extracted with DCM (2x). The combined organic extracts were dried (MgSO₄) and concentrated under reduced pressure. In most of the cases, the desired compound can be obtained pure and no purification step is necessary.

General procedure 1.1.B²⁹⁴, *Synthesis of the isoxazolin-5-ones*: A mixture of the β -ketoester (1 equiv.), EtOH (0.5 M), NH₂OH.HCl (1.5 equiv.) and NaOAc (1.5 equiv.) was heated up to reflux (78 °C) until complete consumption of the starting material (TLC). The temperature was allowed to cool to room temperature. At this point, a catalytic amount of HCl 37% (ca. 20 μ L per mmol of β -ketoester) was added and the reaction was heated to reflux (78 °C) until the complete disappearance of the oxime (TLC). The mixture was filtered, extracted with DCM (3x), dried (MgSO₄) and concentrated under reduced pressure. The product was generally obtained pure and no purification step was necessary.

General procedure 1.2, *Knoevenagel condensation of isoxazolin-5-ones with aldehydes/ketones*: To a round bottom flask charged with isoxazolin-5-one (1 equiv.) in isopropanol (0.5 M) was added the aldehyde (1.2 equiv.) or ketone (2.0 equiv.) and a catalytic amount of piperidine (ca. 0.1 mL/ mmol isoxazolin-5-one). The resulting solution was then stirred to 50 °C in the case of aldehydes or to reflux (82 °C) in the case of ketones. Upon completion (TLC), most of the solvent was removed under partial vacuum. In the case of aldehydes, the products generally precipitated and were isolated by filtration followed by washes with petroleum ether. In the other cases, the solution was completely evaporated and purification was accomplished by flash column chromatography (silica gel, PE:AcOEt).

²⁹² (a) Beck, G.; Jendralla, H.; Kessler, K. *Synthesis* **1995**, 1014. (b) Keränen, M. D.; Kot, K.; Hollmann C.; Eilbracht, P.; *Org. Biomol. Chem.* **2004**, 2, 3379.

²⁹³ Thesis Sylvain Huppé. Ecole Polytechnique, **1996**, p. 146.

²⁹⁴ Kim, C. K.; Krasavage, B. A.; Maggiulli, C. A. *J. Het. Chem.* **1985**, 22, 127.

Isocyanides EtO₂CCH₂NC **1.20b** and PhCH₂NC **1.20c** were synthesized from the corresponding amines as described in the literature²⁹⁵. *t*BuNC was commercially afforded.

General Porcedure 1.3, 1,4-addition of isocyanides to alkylidene isoxazolin-5-ones: To a round bottom flask charged with isocyanide (1 equiv.) and THF (0.33 M) was added the alkylidene isoxazolin-5-one (1 equiv.), followed by a small amount of water (50 μL/ mmol isoxazolin-5-one). The temperature was heated up to reflux (67°C) and the reaction mixture was allowed to stir at this temperature. Upon reaction completion (TLC), the solvent was removed under reduced pressure. Purification by flash column chromatography afforded the pure products in the stated yields.

(5-Oxo-4,5-dihydro-isoxazol-3-yl)-acetic acid methyl ester

1.24b

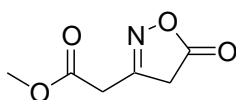

MF: C₆H₇O₄N

MW = 157 g.mol⁻¹

Method : See **general procedure 1.1.B** using (1 equiv., 20 mmol, 3.48 g) of 3-oxo-pentanedioic acid dimethyl ester.

Purification : none/ R_f (1:1 PE:AcOEt): 0.36.

Product : Yellow solid.

Yield : 98%.

¹H NMR (δ, ppm) 3.78 (s, 3H, OCH₃), 3.61 (s, 2H, CH₂), 3.57 (s, 2H, CH₂).

(CDCl₃, 400 MHz)

¹³C NMR (δ, ppm) 174.7 (Cq, C=O), 167.7 (Cq, C=O), 160.7 (Cq, C=N), 52.8 (OCH₃), 35.7 (CH₂), 34.4 (CH₂).

(CDCl₃, 100 MHz)

²⁹⁵ (a) Panella, L.; Alexandre, A. M.; Kruidhof, G. J.; Robertus, J.; Feringa, B. L.; de Vries, J. G.; Minnaard, A. J.; *J. Org. Chem.*, **2006**, 71, 5, 2026. (b) Park, W. K. C.; Auer, M.; Jaksche, H.; Wong, C-H.; *J. Am. Chem. Soc.*; **1996**, 118, 10150.

IR (ν , cm^{-1}) (CCl_4) 3003 (w), 2955 (w), 2848 (w), 1813 (s), 1748 (s), 1611 (w), 1509 (w), 1437 (w), 1407 (w), 1374 (w), 1329 (w), 1293 (w), 1205 (m), 1156 (m), 1003 (w).

HRMS (EI+, m/z) : calculated: 157.0375 found: 157.0372.

3-Benzyloxymethyl-4H-isoxazol-5-one

1.24c

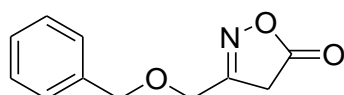

MF: $\text{C}_{11}\text{H}_{11}\text{O}_3\text{N}$

MW = $205 \text{ g}\cdot\text{mol}^{-1}$

Method : See **general procedure 1.1.A** using (1 equiv., 5 mmol, 1.18 g) of 4-benzyloxy-3-oxo-butyrac acid ethyl ester.

Purification : Flash column chromatography (silica gel, 8:2 PE: AcOEt)/ R_f (7:3 PE: AcOEt): 0.42.

Product : Dark orange oil.

Yield : 68%.

$^1\text{H NMR}$ (δ , ppm) 7.40-7.32 (m, 5H, CH-Ph), 4.58 (s, 2H, OCH_2), 4.32 (s, 2H, OCH_2), 3.44 (s, 2H, CH_2).
(CDCl_3 , 400 MHz)

$^{13}\text{C NMR}$ (δ , ppm) 174.7 (Cq, C=O), 164.5 (Cq, C=N), 136.4 (Cq, Ph), 128.6 (CH-Ph), 128.3 (CH-Ph), 128.0 (CH-Ph), 73.4 (OCH_2), 64.8 (OCH_2), 34.4 (CH_2).
(CDCl_3 , 100 MHz)

IR (ν , cm^{-1}) (CCl_4) 3067 (w), 3033 (w), 2927 (m), 2863 (m), 1889 (w), 1810 (s), 1739 (s), 1611 (w), 1498 (w), 1453 (s), 1377 (s), 1337 (s), 1246 (w), 1185 (s), 1154 (s), 1096 (s), 1023 (s), 1003 (w).

HRMS (EI+, m/z) : Calculated: 205.0739 found: 205.0737.

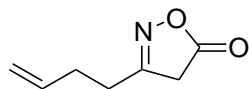
MF: C₇H₉O₂NMW = C₇H₉O₂N

- Method :** See **general procedure 1.1.A** using (1 equiv., 5 mmol, 850 mg) of 3-oxo-hept-6-enoic acid ethyl ester.
- Purification :** none/ R_f (9:1 PE:AcOEt): 0.38.
- Product :** Dark orange oil.
- Isolated yield :** 95%.
- ¹H NMR** (δ, ppm) (CDCl₃, 400 MHz) 5.81 (ddt, 1H, *J* = 6.6Hz, *J* = 10.2Hz, *J* = 15.3Hz, 1H, CH=CH₂), 5.13 (ddt, *J* = 1.5 Hz, *J* = 1.6Hz, *J* = 15.3Hz, 1H, CH=CH₂), 5.09 (ddt, *J* = 1.5Hz, *J* = 1.6Hz, *J* = 6.6Hz, 1H, CH=CH₂), 3.38 (s, 2H, CH₂CO₂), 2.59 (t, *J* = 7.4 Hz, 2H, CH₂-homo allyl chain), 2.42-2.37 (m, 2H, CH₂-homo allyl chain).
- ¹³C NMR** (δ, ppm) (CDCl₃, 100 MHz) 175.1 (C_q, OC=O), 166.2 (C_q, C=N), 135.6 (CH=CH₂), 116.9 (CH=CH₂), 35.9 (CH₂CO₂), 29.7 (CH₂-homo allyl chain), 28.4 (CH₂-homo allyl chain).
- IR** (ν, cm⁻¹) (CCl₄) 3082 (w), 2980 (w), 2924 (w), 1807 (s), 1692 (w), 1641 (w), 1611 (w), 1441 (w), 1380 (w), 1320 (w), 1260 (w), 1160 (m).
- HRMS** (EI+, m/z) : Calculated: 139.0633 found: 139.0629.

{4-[1-Cyclopropyl-methylidene]-5-oxo-4,5-dihydro-isoxazol-3-yl}-acetic acid methyl ester (E and Z) 1.19f

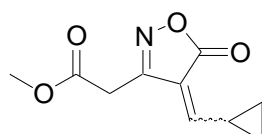
MF: C₁₀H₁₁O₄NMW = 209 g.mol⁻¹

Method :	See general procedure 1.2 using (1 equiv., 10 mmol, 1.57 g) of (5-oxo-4,5-dihydro-isoxazol-3-yl)-acetic acid methyl ester.
Purification :	Flash column chromatography (silica gel, 6:4 PE:AcOEt)/ R_f (1:1 PE: AcOEt): 0.40.
Product :	Pale yellow solid.
Yield :	48% (inseparable mixture, ratio isomers 5:1).
$^1\text{H NMR}$ (δ, ppm) (CDCl₃, 400 MHz)	Major isomer: 6.49 (d, J = 11.6 Hz, 1H, =CH), 3.59 (s, 3H, OCH ₃), 3.50 (s, 2H, COCH ₂), 3.06-2.97 (m, 1H, CH-cyclopropane), 1.36-1.31 (m, 2H, CH ₂ -cyclopropane), 1.02-0.97 (m, 2H, CH ₂ -cyclopropane). Minor isomer: 6.43 (d, J = 12.4Hz, 1H, =CH), 3.72 (s, 2H, COCH ₂), 3.63 (s, 3H, OCH ₃), 1.91-1.82 (m, 1H, CH-cyclopropane), 1.36-1.31 (m, 2H, CH ₂ -cyclopropane), 1.02-0.97 (m, 2H, CH ₂ -cyclopropane).
$^{13}\text{C NMR}$ (δ, ppm) (CDCl₃, 100 MHz)	Major isomer: 169.1 (Cq, C=O), 167.5 (Cq, C=O), 166.1 (=CH), 156.2 (Cq, C=N), 117.7 (Cq, =C=O ₂ N), 52.3 (OCH ₃), 31.6 (CH ₂ CO ₂ Me), 14.6 (CH-cyclopropane), 13.4 (CH ₂ -cyclopropane), Minor isomer: 169.1 (Cq, C=O), 167.5 (Cq, C=O), , 163.5 (=CH), 155.7 (Cq, C=N), 117.7 (Cq, =C=O ₂ N), 52.4 (OCH ₃), 33.9 (CH ₂ CO ₂ Me), 15.4 (CH-cyclopropane), 13.3 (CH ₂ -cyclopropane).
IR (ν, cm⁻¹) (CCl₄)	3075 (w), 3010 (w), 2955 (w), 2848 (w), 1770 (s), 1750 (s), 1646 (s), 1436 (w), 1330 (w), 1297 (w), 1256 (w), 1203 (w), 1171 (w), 1109 (w), 1057 (w), 1019 (w)
HRMS (EI+, m/z) :	Calculated: 209.0688 found: 209.0689.

(4-Cyclopentylidene-5-oxo-4,5-dihydro-isoxazol-3-yl)-acetic acid methyl ester 1.19g

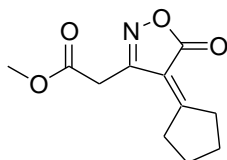

MF: C₁₁H₂₃O₄N

MW = 223 g.mol⁻¹

Method :	See general procedure 1.2 using (1 equiv., 10 mmol, 1.57 g) of (5-oxo-4,5-dihydro-isoxazol-3-yl)-acetic acid methyl ester.
Purification :	Flash column chromatography (silica gel, 8:2 PE:AcOEt)/ R_f (7:3 PE: AcOEt): 0.58.
Product :	Brown oil.

Isolated yield :	74%.
¹H NMR (δ, ppm) (CDCl ₃ , 400 MHz)	3.77 (s, 3H, OCH ₃), 3.73 (s, 2H, CH ₂ CO ₂), 3.12 (t, <i>J</i> = 7.4 Hz, 2H, CH ₂ -cyclopentane), 2.75 (t, <i>J</i> = 6.2Hz, 2H, CH ₂ -cyclopentane), 1.90-1.85 (m, 4H, CH ₂ -cyclopentane).
¹³C NMR (δ, ppm) (CDCl ₃ , 100 MHz)	182.8 (Cq, C=O), 169.0 (Cq, C=O), 168.3 (Cq, C=N), 155.7 (Cq), 114.2 (Cq, =C-CO ₂ N), 52.8 (OCH ₃), 35.6 (CH ₂ -cyclopentane), 35.0 (CH ₂ -cyclopentane), 34.4 (CH ₂ CO ₂), 25.9 (CH ₂ -cyclopentane), 25.2 (CH ₂ -cyclopentane).
IR (ν, cm ⁻¹) (CCl ₄)	3509 (w), 2965 (s), 2881 (s), 1750 (s), 1649 (s), 1555 (w), 1438 (m), 1409 (s), 1330 (s), 1295 (m), 1260 (s), 1202 (s), 1175 (s), 1134 (s), 1017(s), 993 (m).
HRMS (EI+, <i>m/z</i>) :	Calculated: 223.0845 found: 223.0845.

3-Benzyloxymethyl-4-[1-*p*-tolyl-methylidene]-4*H*-isoxazol-5-one

1.19h

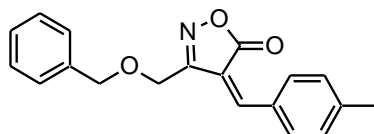

MF: C₁₉H₁₇O₃N

MW = 307 g.mol⁻¹

Method :	See general procedure 1.2 using (1 equiv., 5 mmol, 1.03 g) of 3-benzyloxymethyl-4 <i>H</i> -isoxazol-5-one.
Purification :	Flash column chromatography (silica gel, 9:1 PE: AcOEt)/ <i>R_f</i> (7:3 PE: AcOEt): 0.61.
Product :	Yellow solid.
Isolated yield :	52% (for two steps).
¹H NMR (δ, ppm) (CDCl ₃ , 400 MHz)	8.26 (d, <i>J</i> = 8.4 Hz, 2H, CH-tolyl), 7.83 (s, 1H, =CH), 7.38-7.32 (m, 7H, CH-Ph + CH-tolyl), 4.60 (s, 2H, OCH ₂), 4.60 (s, 2H, OCH ₂), 2.46 (s, 3H, CH ₃).
¹³C NMR (δ, ppm) (CDCl ₃ , 100 MHz)	161.1 (Cq, C=O), 152.1 (=CH), 146.1 (Cq, C=N), 136.7 (Cq, Ar), 134.4 (CH-Ar), 130.2 (Cq, Ar), 129.9 (CH-Ar), 128.7 (CH-Ar), 128.5 (Cq, Ar), 128.3 (CH-Ar), 128.3 (CH-Ar), 116.3 (Cq, =C-CO ₂ N), 72.8 (OCH ₂), 63.7 (OCH ₂), 22.1 (CH ₃).
IR (ν, cm ⁻¹) (CCl ₄)	3067 (w), 3032 (w), 2923 (w), 2865 (w), 1761 (s), 1696 (s), 1622 (s), 1597 (s), 1559 (s), 1499 (w), 1452 (w), 1419 (w), 1372 (w), 1349 (w), 1318 (w), 1287 (w),

1241 (w), 1216 (w), 1188 (w), 1102 (s), 1021 (w)

HRMS (EI+, m/z) : Calculated: 307.1208 found: 307.1203.

3-But-3-enyl-4-[1-cyclopropyl-meth-(Z)-ylidene]-4H-isoxazol-5-one (E and Z) 1.19i

MF: C₁₁H₁₃O₂N

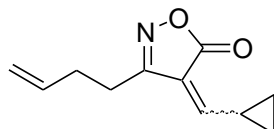

MW = 191 g.mol⁻¹

Method : See **general procedure 1.2** using (1 equiv., 10 mmol, 1.39 g) of 3-but-3-enyl-4H-isoxazol-5-one.

Purification : Flash column chromatography (silica gel, 9:1 PE:AcOEt)/ R_f (9:1 PE:AcOEt): 0.45.

Product : Pale green solid.

Isolated yield : 70% (inseparable mixture, ratio isomers 10: 1).

¹H NMR (δ, ppm) (CDCl₃, 400 MHz) **Major isomer:** 6.30 (d, *J* = 11.2 Hz, 1H, =CH), 5.89-5.79 (m, 1H, CH=CH₂), 5.12-5.03 (m, 2H, CH=CH₂), 3.25-3.16 (m, 1H, CH-cyclopropane), 2.58 (dd, *J* = 6.6 Hz, *J* = 8.6 Hz, 2H, CH₂-homo allyl chain), 2.45-2.39 (m, 2H, CH₂-homo allyl chain), 1.45-1.40 (m, 2H, CH₂-cyclopropane), 1.01-0.97 (m, 2H, CH₂-cyclopropane).

Minor isomer: 6.26 (d, *J* = 12.0 Hz, 1H, =CH), 5.89-5.79 (m, 1H, CH=CH₂), 5.12-5.03 (m, 2H, CH=CH₂), 2.85 (dd, *J* = 6.6Hz, *J* = 8.6Hz, 2H, CH₂-homo allyl chain), 2.54-2.49 (m, 2H, CH₂-homo allyl chain), 2.12-2.03 (m, 1H, CH-cyclopropane), 1.45-1.40 (m, 2H, CH₂-cyclopropane), 1.10-1.07 (m, 2H, CH₂-cyclopropane).

¹³C NMR (δ, ppm) (CDCl₃, 100 MHz) **Major isomer:** 169.8 (Cq, C=O), 162.9 (=CH), 161.1 (Cq, C=N), 136.2 (CH=CH₂), 119.5 (Cq, CCO₂), 116.3 (CH=CH₂), 30.0 (CH₂-homo allyl chain), 25.2 (CH₂-homo allyl chain), 14.1 (CH-cyclopropane), 13.2 (CH₂-cyclopropane). **Minor isomer:** 170.0 (Cq, C=O), 161.7 (=CH), 161.1 (Cq, C=N), 136.1 (CH=CH₂), 119.2 (Cq, CCO₂), 116.3 (CH=CH₂), 29.8 (CH₂-homo allyl chain), 28.3 (CH₂-homo allyl chain), 15.0 (CH-cyclopropane), 13.1 (CH₂-cyclopropane).

IR (ν, cm⁻¹) (CCl₄) 3512 (w), 3080 (w), 3009 (w), 2985 (w), 2926 (w), 2858 (w), 1767 (s), 1647 (s), 1564 (w), 1446 (w), 1288 (w), 1180 (w), 1120 (w)

HRMS (EI+, m/z) : calculated: 191.0946 found: 191.0950.

3-But-3-enyl-4-cyclopentylidene-4H-isoxazol-5-one

1.19j

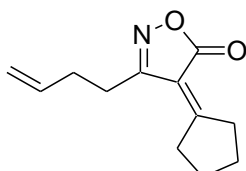

MF: C₁₂H₁₅O₂N

MW = 205 g. mol⁻¹

- Method :** See **general procedure 1.2** using (1 equiv., 10 mmol, 1.39 g) of 3-but-3-enyl-4H-isoxazol-5-one.
- Purification :** Flash column chromatography (silica gel, 9:1 PE:AcOEt)/ **R_f** (9:1 PE:AcOEt): 0.30.
- Product :** Orange pale solid.
- Isolated yield :** 61%.
- ¹H NMR** (δ, ppm) (CDCl₃, 400 MHz) 5.90 (ddt, *J* = 6.5Hz, *J* = 10.2Hz, *J* = 17.0Hz, 1H, CH=CH₂), 5.12 (ddd, *J* = 1.5Hz, *J* = 3.2Hz, *J* = 17.0Hz, 1H, CH=CH₂), 5.07 (ddd, *J* = 1.5Hz, *J* = 2.7Hz, *J* = 10.2Hz, 1H, CH=CH₂), 3.11 (t, *J* = 6.8 Hz, 2H, CH₂-cyclopentane), 2.85 (t, *J* = 6.4 Hz, 2H, CH₂-cyclopentane), 2.73 (m, 2H, CH₂-cyclopentane), 2.51-2.45 (m, 2H, CH₂-cyclopentane), 1.93-1.83 (m, 4H, CH₂-homo allyl chain).
- ¹³C NMR** (δ, ppm) (CDCl₃, 100 MHz) 181.2 (Cq, C=O), 169.6 (Cq, C=N), 161.0 (Cq), 136.3 (CH=CH₂), 116.1 (CH=CH₂), 114.9 (Cq, =CCO₂N), 25.4 (CH₂-cyclopentane), 35.2 (CH₂-cyclopentane), 29.7 (CH₂-cyclopentane), 28.5 (CH₂-cyclopentane), 25.9 (CH₂-homo allyl chain), 25.2 (CH₂-homo allyl chain).
- IR** (ν, cm⁻¹) (CCl₄) 3080 (w), 2969 (m), 2880 (m), 1761 (s), 1648 (s), 1449 (w), 1409 (w), 1316 (w), 1295 (w), 1179 (m), 1138 (m), 1025 (w), 993.3 (w).
- HRMS** (EI+, m/z) : Calculated: 205.1103 found: 205.1100.

***N*-tert-Butyl-2-cyclopropyl-2-(5-oxo-3-phenyl-4,5-dihydro-isoxazol-4-yl)-acetamide and *N*-tert-Butyl-2-cyclopropyl-2-(5-oxo-3-phenyl-2,5-dihydro-isoxazol-4-yl)-acetamide** 1.22a

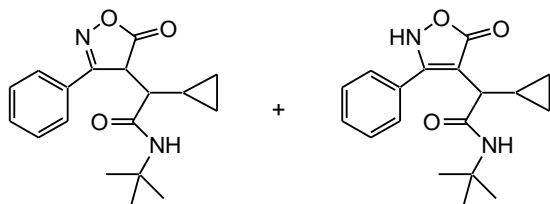

MF: C₁₈H₂₂O₃N₂

MW = 314 g.mol⁻¹

Method : See **general procedure 1.3** using (1 equiv. 2 mmol, 426 mg) of 4-[1-cyclopropyl-methylidene]-3-phenyl-4H-isoxazol-5-one and (1 equiv, 2 mmol, 166 mg) of *tert* butyl isocyanide.

Purification : none/ R_f (6:4 PE:Et₂O): 0.29.

Product : Pale pink solid.

Isolated Yield : ~100% (inseparable mixture, ratio maj. dia. : min. dia. : NHform 1: 0.76 : 0.40).

¹H NMR (δ, ppm) (CDCl₃, 400 MHz) **Major diastereomer:** 7.69-7.67 (m, 2H, CH-Ph), 7.52-7.40 (m, 3H, CH-Ph), 6.10 (br s, 1H, NHCO), 4.85 (d, *J* = 1.9 Hz, 1H, CHCO₂), 2.15 (dd, *J* = 1.9 Hz, *J* = 10.6 Hz, 1H, CHCON), 1.39-1.37 (m, 1H, CH-cyclopropane), 1.39 (s, 9H, CH₃-^tBu), 0.68-0.63 (m, 2H, CH₂-cyclopropane), 0.43-0.39 (m, 1H, CH₂-cyclopropane), 0.34-0.30 (m, 1H, CH₂-cyclopropane).

Minor diastereomer: 7.69-7.67 (m, 2H, CH-Ph), 7.52-7.40 (m, 3H, CH-Ph), 6.32 (br s, 1H, NHCO), 4.83 (d, *J* = 2.4 Hz, 1H, CHCO₂), 2.01 (dd, *J* = 2.4 Hz, *J* = 10.8 Hz, 1H, CHCON) 1.28 (s, 9H, CH₃-^tBu), 0.89-0.83 (m, 1H, CH-cyclopropane), 0.74-0.70 (m, 1H, CH₂-cyclopropane), 0.68-0.63 (m, 1H, CH₂-cyclopropane), 0.60-0.54 (m, 1H, CH₂-cyclopropane), -0.07- -0.16 (m, 1H, CH₂-cyclopropane).

NH form: 7.61-7.60 (m, 2H, CH-Ph), 7.52-7.40 (m, 3H, CH-Ph), 6.43 (br s, 1H, NHCO), 2.55 (d, *J* = 10.4 Hz, 1H, CHCON), 1.39-1.37 (m, 1H, CH-cyclopropane), 1.37 (s, 9H, CH₃-^tBu), 0.68-0.63 (m, 1H, CH₂-cyclopropane), 0.28-0.23 (m, 1H, CH₂-cyclopropane), 0.18-0.13 (m, 1H, CH₂-cyclopropane), 0.04- -0.06 (m, 1H CH₂-cyclopropane).

¹³C NMR (δ, ppm) (CDCl₃, 100 MHz) **Major diastereomer:** 179.05 (Cq, C=O), 168.9 (Cq, C=O), 166.3 (Cq, C=N), 131.5 (CH-Ph), 129.1 (CH-Ph), 128.1 (Cq, Ph), 127.5 (CH-Ph), 52.5 (CHCON), 51.8 (Cq, ^tBu), 46.5 (CHCO₂), 28.5 (CH₃-^tBu), 9.7 (CH-cyclopropane), 5.1 (CH₂-cyclopropane), 4.0 (CH₂-cyclopropane).

Minor diastereomer: 176.6 (Cq, C=O), 168.7 (Cq, C=O), 166.7 (Cq, C=N), 131.8 (CH-Ph), 129.4 (CH-Ph), 128.4 (Cq, Ph), 127.1 (CH-Ph), 51.8 (Cq, ^tBu), 51.6 (CHCON), 47.3 (CHCO₂), 28.6 (CH₃-^tBu), 8.9 (CH-cyclopropane), 4.4 (CH₂-cyclopropane), 4.3 (CH₂-cyclopropane).

NHform: no visible pics.

IR (ν , cm^{-1}) (CCl_4) 3314 (w), 3047 (w), 3003 (w), 2966 (w), 2927 (w), 2856 (w), 2802 (w), 1716 (s), 1619 (s), 1545 (m), 1453 (m), 1366 (w), 1299 (w), 1255 (w), 1220 (w), 1141 (w), 1039 (w).

HRMS (EI+, m/z) : Calculated: 314.1631 found: 314.1630.

***N*-tert-Butyl-2-(5-oxo-3-phenyl-4,5-dihydro-isoxazol-4-yl)-2-*p*-tolyl-acetamide and *N*-tert-Butyl-2-(5-oxo-3-phenyl-2,5-dihydro-isoxazol-4-yl)-2-*p*-tolyl-acetamide** **1.22b**

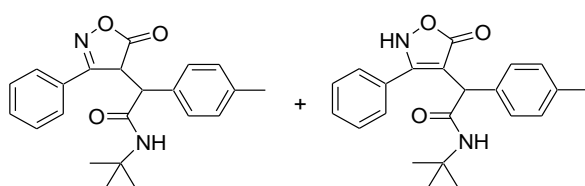

MF: $\text{C}_{22}\text{H}_{24}\text{O}_3\text{N}_2$

MW = $364 \text{ g}\cdot\text{mol}^{-1}$

Method : See **general procedure 1.3** using (1 equiv. 2 mmol, 526 mg) of 3-phenyl-4-[1-*p*-tolyl-methylidene]-4H-isoxazol-5-one and (1 equiv, 2 mmol, 166 mg) of *tert* butyl isocyanide.

Purification : Filtration/ R_f (7:3 PE: AcOEt): 0.76.

Product : Yellow solid.

Isolated Yield : 58% (inseparable mixture, ratio maj. dia. : min. dia: NHform 0.60 : 0.44 : 1).

^1H NMR (δ , ppm) **Major diastereoisomer:** 7.54-7.37 (m, 3H, CH-Ph), 7.18-7.13 (m, 2H, CH-Ph), 7.10 (d, $J = 8.0$ Hz, 2H, CH-tol), 6.99 (d, $J = 8.0$ Hz, 2H, CH-tol), 5.20 (br s, 1H, NHCO), 4.75 (d, $J = 2.4$ Hz, 1H, CHCO_2), 4.15 (d, $J = 2.4$ Hz, 1H, NCOCH) 2.33 (s, 3H, CH_3), 1.19 (s, 9H, CH_3 - ^tBu).

(CDCl_3 , 400 MHz)

Minor diastereoisomer: 7.54-7.37 (m, 3H, CH-Ph), 7.18-7.13 (m, 2H, CH-Ph), 7.04 (d, $J = 8.0$ Hz, 2H, CH-tol), 6.79 (d, $J = 8.0$ Hz, 2H, CH-tol), 5.60 (br s, 1H, NHCO), 5.00 (d, $J = 3.6$ Hz, 1H, CHCO), 4.04 (d, $J = 3.6$ Hz, 1H, NCOCH), 2.30 (s, 3H, CH_3), 1.32 (s, 9H, CH_3 - ^tBu),

NH form: 7.68 (d, $J = 7.8$ Hz, 2H, CH-tol), 7.54-7.37 (m, 3H, CH-Ph) 7.47 (d, $J = 7.8$ Hz, 2H, CH-tol), 7.18-7.13 (m, 2H, CH-Ph), 6.21 (br s, 1H, NHCO), , 4.41 (s, 1H, NCOCH), 2.33 (s, 3H, CH_3), 1.30 (s, 9H, CH_3 - ^tBu).

^{13}C NMR (δ , ppm) **Major diastereoisomer, minor diastereoisomer and NH form (three Cq carbons can not be unambiguously assigned):** 177.9 (Cq, C=O), 176.3 (Cq, C=O), 172.3 (Cq, C=O), 168.4 (Cq, C=O), 167.8 (Cq, C=O), 166.3 (Cq, C=O), 166.0 (Cq, $\underline{\text{C}}\text{-N}$), 164.2 (Cq, $\underline{\text{C}}\text{-N}$), 139.0 (Cq), 138.9 (Cq), 137.5 (Cq), 135.2 (Cq), 131.6 (CH-Ar), 131.4 (CH-Ar), 131.2 (CH-Ar), 131.1 (Cq), 130.1 (CH-Ar),

(CDCl_3 , 100 MHz)

130.0 (CH-Ar), 130.0 (CH-Ar), 129.8 (Cq), 129.4 (CH-Ar), 129.2 (CH-Ar), 129.1(CH-Ar), 129.0 (CH-Ar), 128.8 (CH-Ar), 128.3 (CH-Ar), 128.2 (Cq), 127.8 (CH-Ar), 127.4 (Cq), 127.2 (CH-Ar), 127.1 (CH-Ar), 53.9 (CH), 52.7 (CH), 52.5 (Cq, ^tBu), 52.1 (Cq, ^tBu), 51.8 (Cq, ^tBu), 48.4 (CH), 48.0 (CH), 47.9 (CH), 28.5 (CH₃-^tBu), 28.4 (CH₃-^tBu), 28.3 (CH₃-^tBu), 21.1 (CH₃), 21.1 (CH₃), 21.0 (CH₃).

IR (ν , cm⁻¹) (CCl₄) 3425 (w), 3275 (w), 3064 (w), 3028(w), 2971 (m), 2925 (w), 1796 (s), 1738 (w), 1676 (s), 1644 (s), 1557 (w), 1515 (s), 1475 (s), 1450 (s), 1394 (s), 1366 (s), 1311 (w), 1268 (w), 1219 (m), 1150 (w), 1118 (w), 1029 (w).

HRMS (EI+, m/z) : Calculated: 364.1787 found: 364.1791.

[2-(5-Oxo-3-phenyl-4,5-dihydro-isoxazol-4-yl)-2-*p*-tolyl-acetylamino]-acetic acid ethyl ester and [2-(5-Oxo-3-phenyl-2,5-dihydro-isoxazol-4-yl)-2-*p*-tolyl-acetylamino]-acetic acid ethyl ester 1.22c

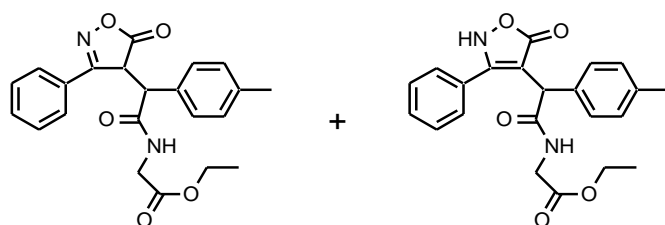

MF: C₂₂H₂₂O₅N₂

MW = 394 g.mol⁻¹

Method : See **general procedure 1.3** using (1 equiv., 2 mmol, 526 mg) of 3-phenyl-4-[1-*p*-tolyl-methylidene]-4H-isoxazol-5-one and (1 equiv., 2 mmol, 226 mg) of methyleneamino-acetic acid methyl ester.

Purification : Flash column chromatography (silica gel, 1:1 PE: AcOEt)/ **R_f** (7:3 PE: AcOEt): 0.20.

Product : Pale green solid.

Isolated yield : 38% (inseparable mixture, ratio dia. 1 : dia. 2 : NHform 1: 1: 2).

¹H NMR (δ , ppm) **Diastereoisomer 1:** 7.64 (d, J = 7.2 Hz, 2H, CH-tolyl), .54-7.39 (m, 7H, CH-Ph + CH-tolyl), 15.90 (br t, J = 5.2 Hz, 1H, NHCO), 4.66-4.65 (m, 1H, CHCON) 4.18-4.10 (m, 3H, OCH₂CH₃ + CHCO₂N), 3.90 (t, J = 5.2 Hz, 2H, CH₂CO₂Et), 2.33 (s, 3H, CH₃), 1.28-1.19 (m, 3H, OCH₂CH₃).

Diastereoisomer 2: 7.54-7.39 (m, 5H, CH-Ph), 7.05 (d, J = 7.8Hz, 2H, CH-tolyl) 6.83 (d, J = 7.8Hz, 2H, CH-tolyl), 6.29 (br t, J = 4.8Hz, 1H, NHCO), 5.04 (d, J = 3.6Hz, 1H, CHCON), 4.27 (d, J = 2.0 Hz, 1H, CHCO₂N), 4.18-4.10 (m, 2H, OCH₂CH₃ dia. 2) 4.06 (dd, J = 3.0 Hz, J = 5.0 Hz, 2H, CH₂CO₂Et), 2.30 (s, 3H, CH₃), 1.28-1.19 (m, 3H, OCH₂CH₃).

NH form: 7.54-7.39 (m, 3H, CH-Ph), 7.24 (d, J = 7.6Hz, 2H, CH-tolyl), 7.15-7.11 (m, 5H, CH-Ph + CH-tolyl + NHCO), , 4.66-4.65 (m, 1H, CHCON), 4.18-

4.10 (m, 2H, OCH₂CH₃), 3.96 (dd, *J* = 5.2 Hz, *J* = 7.2 Hz, 2H, CH₂CO₂Et), 2.32 (s, 3H, CH₃), 1.28-1.19 (m, 3H, OCH₂CH₃).

¹³C NMR (δ, ppm) **Diastereoisomer 1, diastereoisomer 2, NHform** (two Cq carbons and one CH-Ar can not be unambiguously assigned). 177.5 (Cq, C=O), 176.1 (Cq, C=O), 172.2 (Cq, C=O), 169.8 (Cq, C=O), 169.3 (Cq, C=O), 169.2 (Cq, C=O), 169.1 (Cq, C=O), 169.1 (Cq, C=O), 169.0 (Cq, C=O), 165.9 (Cq, C-N), 165.8 (Cq, C-N), 164.3 (Cq, C-N), 139.3 (Cq, Ar), 139.1 (Cq, Ar), 137.7 (Cq, Ar), 134.3 (Cq, Ar), 131.7 (CH-Ar), 131.5 (CH-Ar), 130.6 (Cq, Ar), 130.1 (CH-Ar), 130.1 (CH-Ar), 129.8 (CH-Ar), 129.5 (CH-Ar), 129.3 (CH-Ar), 129.2 (CH-Ar), 129.1 (CH-Ar), 129.0 (CH-Ar), 128.2 (CH-Ar), 128.0 (Cq, Ar), 127.6 (CH-Ar), 127.5 (CH-Ar), 127.2 (Cq, Ar), 127.1 (CH-Ar), 95.8 (Cq, C=CCO₂N, NHform), 61.6 (OCH₂CH₃ x2), 61.6 (OCH₂CH₃), 52.8 (CH), 51.6 (CH), 47.9 (CH), 47.8 (CH), 47.3 (CH), 41.9 (CH₂CO₂Et), 41.8 (CH₂CO₂Et), 41.7 (CH₂CO₂Et), 21.1 (CH₃-tolyl), 21.1 (CH₃-tolyl), 21.0 (CH₃-tolyl), 14.1 (OCH₂CH₃), 14.0 (OCH₂CH₃ x2).

IR (ν, cm⁻¹) (CCl₄) 3419 (w), 3311(w), 3060 (w), 2984 (w), 2927 (w), 2868 (w), 1797 (m), 1747 (s), 1679 (s), 1620 (m), 1516 (m), 1477 (m), 1444 (m), 1378 (m), 1205 (s), 1115 (w), 1025 (w).

HRMS (EI+, m/z) : Calculated: 394.1529 found: 394.1531.

***N*-Benzyl-2-(5-oxo-3-phenyl-4,5-dihydro-isoxazol-4-yl)-2-*p*-tolyl-acetamide and *N*-Benzyl-2-(5-oxo-3-phenyl-2,5-dihydro-isoxazol-4-yl)-2-*p*-tolyl-acetamide 1.22d**

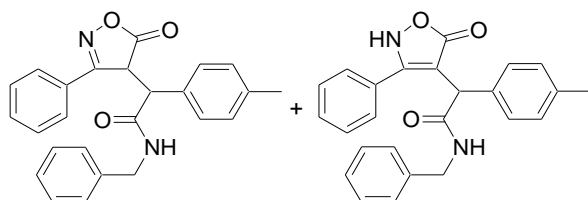

MF: C₂₅H₂₂O₃N₂

MW = 398 g.mol⁻¹

Method : See **general procedure 1.3** using (1 equiv., 2 mmol, 526 mg) of 3-phenyl-4-[1-*p*-tolyl-methylidene]-4H-isoxazol-5-one and (1 equiv., 2 mmol, 234 mg) of benzyl isocyanide.

Purification : Flash column chromatography (silica gel, 8:2 PE: AcOEt)/ R_f (7:3 PE: AcOEt): 0.35.

Product : Brown solid in a foam form.

Yield : 57% (inseparable mixture, ratio dia. 1 : dia. 2 : NHform 1 : 1 : 2).

¹H NMR (δ, ppm) **Diastereoisomer 1:** 7.66 (d, *J* = 7.6 Hz, 2H, CH-tolyl), 7.55-7.00 (m, 12H, CH-Ph + CH-tolyl), 5.74 (br s, 1H, CONH), 4.70 (d, *J* = 2.4Hz, 1H, CHCON), 4.53 (dd, *J* = 5.7 Hz, *J* = 15.0 Hz, 1H, CH₂NH), 4.42-4.35 (m, 1H, CH₂NH), 4.25 (d, *J*

= 2.4 Hz, 1H, CHCO₂), 2.30 (s, 3H, CH₃).

Diastereomer 2: 7.55-7.00 (m, 12H, CH-Ph + CH-tolyl), 6.79 (d, *J* = 8.0 Hz, 2H, CH-tolyl), 6.07 (br s, 1H, CONH), 5.02 (d, *J* = 3.2Hz, 1H, CHCON), 4.42-4.35 (m, 2H, CH₂NH), 4.13 (d, *J* = 3.2 Hz, 1H, CHCO₂), 2.27 (s, 3H, CH₃).

NH form: 7.55-7.00 (m, 15H, CH-Ph + 2x CH-tolyl + CONH) 4.62 (s, 1H, CHCON), 4.42-4.35 (m, 2H, CH₂NH), 2.32 (s, 3H, CH₃).

¹³ C NMR (δ, ppm) (CDCl ₃ , 100 MHz)	Diastereomer 1, diastereomer 2 and NH form (seven carbons CH-Ar and one Cq carbon can not be unambiguously assigned): 177.7 (Cq, C=O), 176.3 (Cq, C=O), 172.4 (Cq, C=O), 169.5 (Cq, C=O), 168.8 (Cq, C=O), 166.0 (Cq, C=O), 166.0 (Cq, C-N), 164.2 (Cq, C-N), 139.2 (Cq, Ar), 139.0 (Cq, Ar), 137.6 (Cq, Ar), 137.4 (Cq, Ar), 137.3 (Cq, Ar), 137.1 (Cq, Ar), 134.8 (Cq, Ar), 131.7 (CH-Ar), 131.5 (CH-Ar), 130.7 (Cq, Ar), 130.5 (Cq, Ar), 130.4 (Cq, Ar), 130.1 (Cq, Ar), 129.8 (CH-Ar), 129.4 (CH-Ar), 129.2 (CH-Ar), 129.1 (CH-Ar), 129.0 (CH-Ar), 128.9 (CH-Ar), 128.7 (CH-Ar), 128.6 (CH-Ar), 128.6 (CH-Ar), 128.5 (Cq, Ar), 128.2 (CH-Ar), 128.1 (Cq, Ar), 127.7 (CH-Ar), 127.6 (CH-Ar), 127.5 (CH-Ar) 127.3 (CH-Ar), 127.1 (CH-Ar), 53.1 (CH), 51.9 (CH), 48.0 (CH), 47.9 (CH), 47.6 (CH), 44.2 (CH ₂), 44.0 (CH ₂), 43.9 (CH ₂), 21.0 (CH ₃), 21.0 (CH ₃ x2).
IR (ν, cm ⁻¹) (CCl ₄)	3434 (w), 3276 (w), 3064 (w), 3032 (w), 2925 (w), 1797 (s), 1676 (s), 1644 (s), 1566 (m), 1515 (s), 1475 (s), 1449 (s), 1396 (s), 1363 (s), 1310 (w), 1254 (w), 1118 (w), 1074 (w), 1026 (w).
HRMS (EI+, m/z) :	Calculated: 398.1631 found: 398.1621.

***N*-tert-Butyl-2-(5-oxo-3-phenyl-4,5-dihydro-isoxazol-4-yl)-2-thiophen-2-yl-acetamide and *N*-tert-Butyl-2-(5-oxo-3-phenyl-2,5-dihydro-isoxazol-4-yl)-2-thiophen-2-yl-acetamide** **1.22e**

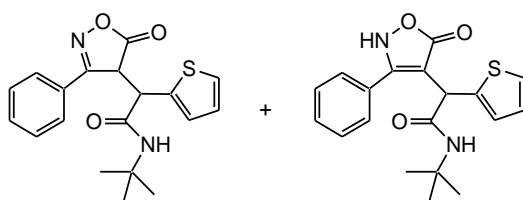

MF: C₁₉H₂₀O₃N₂S

MW = 356g.mol⁻¹

Method :	See general procedure 1.3 using (1 equiv., 2 mmol, 510 mg) of 3-phenyl-4-[1-thiophen-2-yl-methylidene]-4H-isoxazol-5-one and (1 equiv, 2 mmol, 166 mg) of <i>tert</i> butyl isocyanide.
Purification :	Flash column chromatography (silica gel, 7:3 PE: AcOEt)/ R _f (1:1 PE: EtOAc): 0.42.
Product :	Brown solid.
Isolated Yield :	24% (inseparable mixture, ratio dia. 1: dia. 2: NH form 0.42 : 0.42 : 1).

¹ H NMR (δ, ppm) (CDCl ₃ , 400 MHz)	<p>Diastereoisomer 1: 7.72-7.70 (m, 2H, CH-Ph), 7.53-7.38 (m, 3H, CH-Ph), 7.28 (dd, <i>J</i> = 0.8 Hz, <i>J</i> = 5.2 Hz, 1H, CH-tiophene), 6.96-6.93 (m, 1H, CH-tiophene), 6.84 (d, <i>J</i> = 2.8 Hz, 1H, CH-tiophene), 5.50 (br s, 1H, NHCO), 4.88 (d, <i>J</i> = 2.4 Hz, 1H, CHCO₂), 4.49 (d, <i>J</i> = 2.4 Hz, 1H, CHCON), 1.20 (s, 9H, CH₃-^tBu).</p> <p>Diastereoisomer 2: 7.53-7.38 (m, 5H, CH-Ph), 7.24-7.21 (m, 1H, CH-tiophene), 6.96-6.93 (m, 1H, CH-tiophene), 6.78 (d, <i>J</i> = 3.6 Hz, 1H, CH-tiophene), 5.95 (br s, 1H, NHCO), 5.03 (d, <i>J</i> = 3.6 Hz, 1H, CHCO₂), 4.33 (d, <i>J</i> = 3.6 Hz, 1H, CHCON), 1.34 (s, 9H, CH₃-^tBu).</p> <p>NH form: 7.53-7.38 (m, 5H, CH-Ph), 7.24-7.21 (m, 1H, CH-tiophene), 6.96-6.93 (m, 2H, CH-tiophene), 6.58 (br s, 1H, NHCO), 4.69 (s, 1H, CHCON), 1.32 (s, 9H, CH₃-^tBu).</p>
¹³ C NMR (δ, ppm) (CDCl ₃ , 100 MHz)	<p>Diastereoisomer 1, diastereoisomer 2 and NHform (one Cq carbon can not be unambiguously assigned): 177.4 (Cq, C=O), 176.1 (Cq, C=O), 172.2 (Cq, C=O), 167.2 (Cq, C=O), 166.6 (Cq, C=O), 166.0 (Cq, C=O), 165.7 (Cq, C-N), 163.7 (Cq, C-N), 141.2 (Cq), 134.9 (Cq), 134.2 (Cq), 131.8 (CH-Ar), 131.6 (CH-Ar), 130.5 (CH-Ar), 129.3 (CH-Ar), 129.2 (Cq), 129.1 (CH-Ar), 129.1 (CH-Ar), 129.0 (CH-Ar), 128.2 (CH-Ar), 128.0 (CH-Ar), 127.9 (CH-Ar), 127.9 (Cq), 127.8 (CH-Ar), 127.7 (CH-Ar), 127.7 (Cq), 127.4 (CH-Ar), 127.3 (CH-Ar), 127.1 (CH-Ar), 127.0 (Cq), 126.9 (CH-Ar), 125.8 (CH-Ar), 125.3 (CH-Ar), 52.4 (Cq, ^tBu), 52.2 (Cq, ^tBu), 52.0 (Cq, ^tBu), 48.8 (CH), 48.5 (CH), 48.2 (CH), 47.7 (CH), 44.2 (CH), 29.6 (CH₃-^tBu), 28.4 (CH₃-^tBu), 28.3 (CH₃-^tBu).</p>
IR (ν, cm ⁻¹) (CCl ₄)	3417 (w), 3282.9 (w), 3069(w), 2969 (m), 2928 (m), 2870 (w), 1797 (m), 1680 (s), 1647 (s), 1563 (m), 1517 (s), 1475 (s), 1452 (s), 1394 (s), 1366 (s), 1280 (s), 1222 (s), 1072 (w), 1043 (w), 1027 (w).
HRMS (EI+, m/z) :	Calculated: 356.1195 found: 356.1183.

***N*-tert-Butyl-2-(5-oxo-3-phenyl-4,5-dihydro-isoxazol-4-yl)-isobutyramide**

1.22f

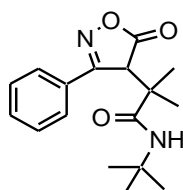

MF: C₁₇H₂₂O₃N₂

MW = 302 g.mol⁻¹

Method :	See general procedure 1.3 using (1 equiv., 2 mmol, 402 mg) of 4-isopropylidene-3-phenyl-4H-isoxazol-5-one and (1 equiv., 2 mmol, 166 mg) of <i>tert</i> butyl isocyanide.
Purification :	filtration/ R _f (7:3 PE: AcOEt): 0.31.
Product :	White solid.

Isolated Yield : 58% (CH form only).

¹H NMR (δ, ppm) 7.59-7.58 (m, 2H, CH-Ph), 7.50-7.41 (m, 3H, CH-Ph), 5.25 (br s, 1H, NH), 4.55 (s, 1H, CHCO₂), 1.59 (s, 3H, CH₃), 1.17 (s, 9H, CH₃-^tBu), 1.12 (s, 3H, CH₃).
(CDCl₃, 400 MHz)

¹³C NMR (δ, ppm) 176.49 (Cq, C=O), 172.4 (Cq, C=O), 167.3 (Cq, C=N), 131.2 (CH-Ph), 128.9 (CH-Ph), 128.7 (Cq, Ph), 128.1 (CH-Ph), 51.4 (Cq), 50.9 (CHCO₂), 45.9 (Cq), 28.4 (CH₃-^tBu), 23.7 (CH₃), 22.6 (CH₃).
(CDCl₃, 100 MHz)

IR (ν, cm⁻¹) (CCl₄) 3313 (w), 2973 (s), 2863 (s), 1811 (w), 1706 (s), 1626 (m), 1535 (m), 1451 (m), 1384 (w), 1363 (m), 1341 (m), 1303 (w), 1258 (w), 1213 (w), 1156 (w), 1069 (s), 1001 (w).

HRMS (EI+, m/z) : Calculated: 302.1631 found: 302.1633.

1-(5-Oxo-3-phenyl-4,5-dihydro-isoxazol-4-yl)-cyclopentanecarboxylic acid *tert*-butylamide and 1-(5-Oxo-3-phenyl-2,5-dihydro-isoxazol-4-yl)-cyclopentanecarboxylic acid *tert*-butylamide 1.22g

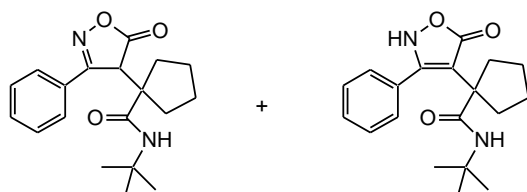

MF: C₁₉H₂₄O₃N₂

MW = 328 g.mol⁻¹

Method : See **general procedure 1.3** using (1 equiv., 2 mmol, 454 mg) of 4-cyclopentylidene-3-phenyl-4H-isoxazol-5-one and (1 equiv, 2 mmol, 166 mg) of *tert* butyl isocyanide..

Purification : Flash column chromatography (silica gel, 8:2 PE: AcOEt) / R_f(7:3 PE: AcOEt): 0.30.

Product : White solid.

Isolated Yield : 51% (inseparable mixture, ratio CHform: NHform 1:1).

¹H NMR (δ, ppm) **CH form and NH form:** 7.52-7.41 (m, 10H, CH-Ph), 6.76 (br s, 1H, NH), 5.29 (br s, 1H, NH), 4.16 (s, 1H, CHCO₂ CHform), 2.38-2.35 (m, 2H, CH₂-cyclopentane), 2.00-1.96 (m, 1H, CH₂-cyclopentane), 1.89-1.40 (m, 13H, CH₂-cyclopentane), 1.24 (s, 9H, CH₃-^tBu), 1.20 (s, 9H, CH₃-^tBu).
(CDCl₃, 400 MHz)

¹³C NMR (δ, ppm) (CDCl₃, 100 MHz) **CH form and NH form:** 176.8 (Cq, C=O), 174.0 (Cq, C=O), 173.6 (Cq, C=O), 171.5 (Cq, C=O), 167.4 (Cq, C-N), 163.2 (Cq, C-N), 131.1 (CH-Ph), 131.0 (CH-Ph), 128.9 (CH-Ph), 128.9 (Cq, Ph), 128.7 (CH-Ph), 128.6 (CH-Ph), 128.0 (CH-Ph), 127.9 (Cq, Ph), 104.1 (Cq, C=CCO₂N NHform), 57.0 (CHCO₂ CHform), 52.1 (Cq), 51.5 (Cq), 50.9 (Cq), 50.7 (Cq), 35.5 (CH₂-cyclopentane x2), 34.6 (CH₂-cyclopentane), 33.7(CH₂-cyclopentane), 28.4 (CH₃, ^tBu), 28.3 (CH₃-^tBu), 23.7 (CH₂-cyclopentane), 23.6 (CH₂-cyclopentane), 23.3 (CH₂-cyclopentane x2).

IR (ν, cm⁻¹) (CCl₄) 3434 (w), 3339 (w), 3061 (m), 2962 (s), 2869 (m), 2788 (w), 1797 (m), 1710 (s), 1675 (s), 1643 (s), 1606 (s), 1535 (s), 1451 (s), 1391 (m), 1362 (s), 1292 (m), 1268 (m), 1216 (m), 1176 (m), 1109 (w), 1020 (m).

HRMS (EI+, m/z) : Calculated: 328.1787 found: 328.1777.

[4-(*tert*-Butylcarbamoyl-cyclopropyl-methyl)-5-oxo-4,5-dihydro-isoxazol-3-yl]-acetic acid methyl ester and [4-(*tert*-Butylcarbamoyl-cyclopropyl-methyl)-5-oxo-2,5-dihydro-isoxazol-3-yl]-acetic acid methyl ester **1.22h**

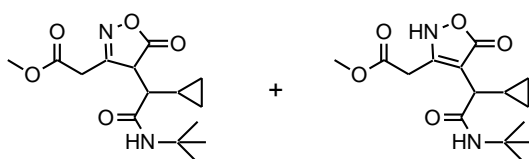

MF: C₁₅H₂₂O₅N₂

MW = 310 g.mol⁻¹

Method : See **general procedure 1.3** using (1 equiv., 2 mmol, 418 mg) of {4-[1-cyclopropyl-methylidene]-5-oxo-4,5-dihydro-isoxazol-3-yl}-acetic acid methyl ester and (1 equiv., 2 mmol, 166 mg) of *tert* butyl isocyanide.

Purification : None/ R_f (1:1 PE:AcOEt): 0.43.

Product : Orange solid.

Isolated Yield : ~100% (inseparable mixture, ratio maj.: dia.:min. dia.:NH form 2:1:4).

¹H NMR (δppm) (CDCl₃, 400 MHz) **Major diastereoisomer:** 6.14 (br s, 1H, NH), 4.15 (d, *J* = 2.4 Hz, 1H, CHCO₂N), 3.73 (s, 3H, OCH₃), 3.61 (s, 2H, CH₂CO₂Me), 2.08-2.04 (m, 1H, CHCON), 1.32 (s, 9H, CH₃-^tBu), 1.20-1.44 (m, 1H, CH-cyclopropane), 0.80-0.72 (m, 1H, CH₂-cyclopropane), 0.71-0.63 (m, 1H, CH₂-cyclopropane), 0.44-0.32 (m, 2H, CH₂-cyclopropane).

Minor diastereoisomer: 5.87 (br s, 1H, NH), 3.97 (d, *J* = 1.6 Hz, 1H, CHCO₂N), 3.70 (s, 3H, OCH₃), 3.57 (s, 2H, CH₂CO₂Me), 2.08-2.04 (m, 1H, CHCON), 1.30 (s, 9H, ^tBu), 1.20-1.44 (m, 1H, CH-cyclopropane), 0.80-0.72 (m, 1H, CH₂-cyclopropane), 0.71-0.63 (m, 1H, CH₂-cyclopropane), 0.44-0.32 (m, 2H, CH₂-cyclopropane).

CH₂-cyclopropane).

NH form: 6.31 (br s, 1H, NH), 3.73-3.65 (m, 5H, OCH₃ + CH₂CO₂Me) 2.55 (d, *J* = 9.2 Hz, CHCON), 1.36-1.30 (m, 1H, CH-cyclopropane), 1.33 (s, 9H, ^tBu), 0.60-0.54 (m, 1H, CH₂-cyclopropane), 0.53-0.46 (m, 1H, CH₂-cyclopropane), 0.30-0.22 (m, 1H, CH₂-cyclopropane), 0.21-0.12 (m, 1H, CH₂-cyclopropane).

¹³C NMR (δ, ppm)

(CDCl₃, 100 MHz)

Major diastereoisomer, minor diastereoisomer, NHform: 177.7 (Cq, C=O), 177.3 (Cq, C=O), 173.7 (Cq, C=O), 172.3 (Cq, C=O), 169.3 (Cq, C=O), 169.2 (Cq, C=O), 168.8 (Cq, C=O), 168.1 (Cq, C=O), 168.0 (Cq, C=O), 163.3 (Cq, C-N), 163.3 (Cq, C-N), 157.6 (Cq, C-N), 92.3 (Cq, C=CCO₂, NHform), 52.6 (OCH₃), 52.6 (OCH₃ x2), 52.1 (CH), 52.0 (Cq, ^tBu), 51.8 (Cq, ^tBu), 51.6 (Cq, ^tBu), 51.0 (CH), 48.6 (CH), 48.1 (CH), 46.4 (CH), 34.6 (CH₂CO₂Me), 34.0 (CH₂CO₂Me), 31.6 (CH₂CO₂Me), 28.6 (CH₃-^tBu), 28.5 (CH₃-^tBu), 28.5 (CH₃-^tBu), 13.9 (CH-cyclopropane), 11.7 (CH-cyclopropane), 10.4 (CH-cyclopropane), 6.6 (CH₂-cyclopropane), 5.3 (CH₂-cyclopropane), 4.5 (CH₂-cyclopropane), 4.3 (CH₂-cyclopropane), 3.9 (CH₂-cyclopropane), 3.8 (CH₂-cyclopropane).

IR (ν, cm⁻¹) (CCl₄)

3433 (w), 3081 (w), 2967 (m), 1793 (s), 1741 (s), 1678 (s), 1647 (s), 1514 (s), 1457 (m), 1400 (m), 1366 (m), 1331 (m), 1212 (s), 1168 (m), 1016 (w).

HRMS (EI+, m/z) :

Calculated: 310.1529 found: 310.1524.

[4-(1-*tert*-Butylcarbamoyl-cyclopentyl)-5-oxo-4,5-dihydro-isoxazol-3-yl]-acetic acid methyl ester

1.22i

MF: C₁₆H₂₄O₅N₂

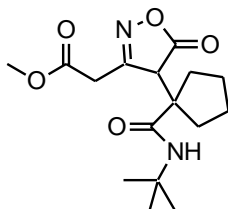

MW = 324 g.mol⁻¹

Method :

See **general procedure 1.3** using (1 equiv., 2 mmol, 446 mg) of (4-cyclopentylidene-5-oxo-4,5-dihydro-isoxazol-3-yl)-acetic acid methyl ester and (1 equiv., 2 mmol, 166 mg) of *tert* butyl isocyanide.

Purification :

Flash column chromatography (silica gel, 7:3 PE:AcOEt)/ R_f (1:1 PE: AcOEt): 0.50.

Product :

Brown oil.

Isolated yield :

56% (CHform only).

¹H NMR (δ, ppm) (CDCl ₃ , 400 MHz)	5.49 (br, 1H, NH), 3.81-3.62 (m, 6H, CH ₂ CO ₂ + OCH ₃ + CHCO ₂ N), 2.34-2.28 (m, 1H, CH ₂ -cyclopentane), 2.21-1.42 (m, 1H, CH ₂ -cyclopentane), 2.01-1.93 (m, 1H, CH ₂ -cyclopentane), 1.88-1.77 (m, 2H, CH ₂ -cyclopentane), 1.75-1.59 (m, 3H, CH ₂ -cyclopentane), 1.28 (s, 9H, CH ₃ - ^t Bu)
¹³C NMR (δ, ppm) (CDCl ₃ , 100 MHz)	176.9 (Cq, C=O), 171.6 (Cq, C=O), 168.8 (Cq, C=O), 163.4 (Cq, C=N), 52.3 (Cq), 52.7 (CHCO ₂ N), 52.1 (OCH ₃), 51.8 (Cq), 34.9 (CH ₂ -cyclopentane), 34.9 (CH ₂ -cyclopentane), 33.6 (CH ₂ CO ₂), 28.5 (CH ₃ - ^t Bu), 24.0 (CH ₂ -cyclopentane), 23.9 (CH ₂ -cyclopentane)
IR (ν, cm ⁻¹) (CCl ₄)	3438 (w), 2962 (s), 2877 (m), 1795 (s), 1743 (s), 1673 (s), 1513 (s), 1453 (s), 1406 (m), 1365 (s), 1324 (m), 1208 (s), 1176 (s), 1006 (w)
HRMS (EI+, m/z) :	Calculated: 324.1685 found: 324.1681.

2-(3-Benzyloxymethyl-5-oxo-2,5-dihydro-isoxazol-4-yl)-N-tert-butyl-2-p-tolyl-acetamide

1.22j

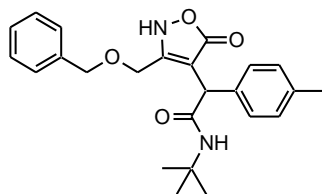

MF: C₂₄H₂₈O₄N₂

MW = 408 g.mol⁻¹

Method :	See general procedure 1.3 using (1 equiv., 1.5 mmol, 464 mg) of 3-benzyloxymethyl-4-[1-p-tolyl-methylidene]-4H-isoxazol-5-one and (1 equiv., 1.5 mmol, 126 mg) of <i>tert</i> butyl isocyanide.
Purification :	Flash column chromatography (silica gel, 7:3 PE: AcOEt) / R _f (7:3 PE: AcOEt): 0.55.
Product :	Brown solid.
Yield :	72% (ratio CH forms: NHform traces : 1).
¹H NMR (δ, ppm) (CDCl ₃ , 400 MHz)	NH form: 7.35-7.30 (m, 3H, CH-Ph), 7.21-7.19 (m, 2H, CH-Ph), 7.12 (d, J = 8.2 Hz, 2H, CH-tolyl), 7.08 (d, J = 8.2Hz, 2H, CH-tolyl), 6.02 (br s, 1H, NH), 4.58 (s, 1H, CHCON), 4.43 (d, J = 13.1Hz, 1H, CH ₂), 4.42 (d, J = 11.5Hz, 1H, CH ₂), 4.34 (d, J = 11.5Hz, 1H, CH ₂), 4.30 (d, J = 13.1Hz, 1H, CH ₂), 2.31 (s, 3H, CH ₃), 1.29 (s, 9H, CH ₃ - ^t Bu).
¹³C NMR (δ, ppm)	NH form: 174.0 (Cq, C=O), 171.8 (Cq, C=O), 161.3 (Cq, =CNH), 137.4 (Cq, Ar), 137.2 (Cq, Ar), 135.6 (Cq, Ar), 129.6 (CH-Ar), 128.4 (CH-Ar), 128.0 (CH-Ar), 128.0 (CH-Ar), 126.9 (CH-Ar), 95.2 (Cq, =COCO ₂ N), 72.2 (OCH ₂), 63.5

(CDCl₃, 100 MHz) (OCH₂), 52.5 (Cq), 47.2 (CH), 28.3 (CH₃-^tBu), 21.0 (CH₃).

IR (ν, cm⁻¹) (CCl₄) 3430 (w), 3286 (w), 3029 (w), 2970 (w), 2923 (w), 2870 (w), 1707 (m), 1646 (s), 1549 (m), 1502 (m), 1454 (w), 1396 (w), 1364 (w), 1311 (w), 1217 (w), 1089 (w).

HRMS (EI+, m/z) : Calculated: 408.2049 found: 408.2038.

2-(3-But-3-enyl-5-oxo-4,5-dihydro-isoxazol-4-yl)-N-tert-butyl-2-cyclopropyl-acetamide

1.22k

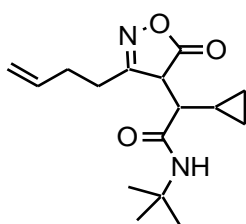

MF: C₁₆H₂₄O₃N₂

MW = 292 g.mol⁻¹

Method : See **general procedure 1.3** using (1 equiv., 2 mmol, 382 mg) of 3-but-3-enyl-4-[1-cyclopropyl-methylidene]-4*H*-isoxazol-5-one and (1 equiv., 2 mmol, 166 mg) of *tert* butyl isocyanide.

Purification : Flash column chromatography (silica gel, 8:2 PE: AcOEt)/ **R_f** (8:2 PE: AcOEt): 0.23.

Product : White solid.

Isolated yield : 89% (ratio maj. dia. : min. dia.: NHform 2: 1: traces).

¹H NMR (δ, ppm) (CDCl₃, 400 MHz) **Major diastereoisomer:** 6.29 (br s, 1H, CONH), 5.89-5.76 (m, 1H, CH=CH₂), 5.13-5.03 (m, 2H, CH=CH₂), 4.19 (d, *J* = 3.2 Hz, 1H, CHCO₂), 2.72-2.34 (m, 4H, CH₂-homo allyl chain), 2.10 (dd, *J* = 2.8 Hz, *J* = 10.8 Hz, 1H, CHCON) 1.38 (s, 9H, CH₃-^tBu), 0.90-0.66 (m, 5H, CH₂-cyclopropane + CH-cyclopropane).

Minor diastereoisomer: 6.04 (br s, 1H, CONH), 5.89-5.76 (m, 1H, CH=CH₂), 5.13-5.03 (m, 2H, CH=CH₂), 3.79 (d, *J* = 3.2 Hz, 1H, CHCO₂), 2.72-2.34 (m, 4H, CH₂-homo allyl chain), 1.99 (dd, *J* = 3.2 Hz, *J* = 10.8 Hz, 1H, CHCON), 1.35 (s, 9H, CH₃-^tBu), 1.14-1.05 (m, 1H, CH-cyclopropane), 0.49-0.42 (m, 2H, CH₂-cyclopropane), 0.41-0.34 (m, 2H, CH₂-cyclopropane).

¹³C NMR (δ, ppm) (CDCl₃, 100 MHz) **Major diastereoisomer:** 178.5 (Cq, C=O), 168.9 (Cq, C=O), 168.1 (Cq, C=N), 136.0 (CH=CH₂), 116.3 (CH=CH₂), 51.6 (Cq, ^tBu), 50.9 (CHCON), 48.1 (CHCO₂), 29.2 (CH₂-homo allyl chain), 28.6 (CH₃-^tBu) 28.2 (CH₂-homo allyl chain), 9.8 (CH-cyclo propane), 4.7 (CH₂-cyclo propane), 4.3 (CH₂-cyclo

propane).

Minor diastereoisomer: 177.4 (Cq, C=O), 168.7 (Cq, C=O), 168.3 (Cq, C=N), 135.9 (CH=CH₂), 116.5 (CH=CH₂), 51.8 (CHCON), 51.7 (Cq, ^tBu), 49.1 (CHCO₂), 29.4 (CH₂-homo allyl chain), 28.6 (CH₃-^tBu) 28.3 (CH₂-homo allyl chain), 11.0 (CH-cyclo propane), 5.9 (CH₂-cyclo propane), 4.6 (CH₂-cyclo propane).

IR (ν, cm⁻¹) (CCl₄) 3434 (w), 3296 (w), 3074 (w), 2969 (w), 2922 (w), 1791 (m), 1681 (s), 1643 (s), 1605 (s), 1515 (s), 1453 (m), 1392 (m), 1364 (m), 1298 (m), 1220 (m), 1104 (m), 1028 (m), 995 (m), 965 (m).

HRMS (EI+, m/z) : Calculated: 292.1787 found: 292.1780.

***N*-Benzyl-2-(3-but-3-enyl-5-oxo-4,5-dihydro-isoxazol-4-yl)-2-cyclopropyl-acetamide and *N*-Benzyl-2-(3-but-3-enyl-5-oxo-2,5-dihydro-isoxazol-4-yl)-2-cyclopropyl-acetamide 1.22I**

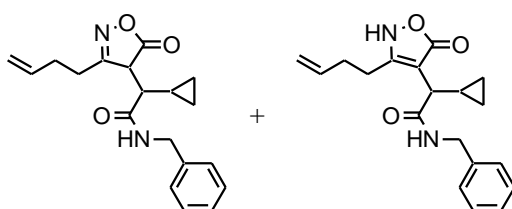

MF: C₁₉H₂₂O₃N₂

MW = 326 g.mol⁻¹

Method : See **general procedure 1.3** using (1 equiv., 2 mmol, 382 mg) of 3-but-3-enyl-4-[1-cyclopropyl-methylidene]-4*H*-isoxazol-5-one and (1 equiv., 2 mmol, 234 mg) of benzyl isocyanide.

Purification : Flash column chromatography 7:3 PE: AcOEt/ R_f (7:3 PE: AcOEt): 0.24.

Product : Brown oil.

Isolated yield : 30% (ratio maj. dia.: min. dia. NHform 2:1:2).

¹H NMR (δ, ppm) (CDCl₃, 400 MHz) **Major diastereoisomer:** 7.36-7.23 (m, 5H, CH-Ph), 6.74 (br s, 1H, CONH), 5.86-5.72 (m, 1H, CH=CH₂), 5.13-5.00 (m, 2H, CH=CH₂), 4.58-4.41 (m, 2H, CH₂NH), 4.12 (d, *J* = 2.4Hz, 1H, CHCO₂), 2.71-2.12 (m, 4H, CH₂-homo allyl chain), 2.20 (dd, *J* = 2.8Hz, *J* = 10.8Hz, 1H, CHCON), 1.01-0.93 (m, 1H, CH-cyclo propane), 0.83-0.61 (m, 2H, CH₂-cyclo propane), 0.48-0.36 (m, 2H, CH₂-cyclo propane).

Minor diastereoisomer: 7.36-7.23 (m, 5H, CH-Ph), 6.67 (br s, 1H, CONH), 5.86-5.72 (m, 1H, CH=CH₂), 5.13-5.00 (m, 2H, CH=CH₂), 4.58-4.41 (m, 2H, CH₂NH) 3.86 (d, *J* = 2.8Hz, 1H, CHCO₂), 2.71-2.12 (m, 4H, CH₂-homo allyl chain), 2.13 (dd, *J* = 2.8Hz, *J* = 11.2 Hz, 1H, CHCON), 1.14-1.06 (m, 1H, CH-cyclo propane), 0.83-0.61 (m, 2H, CH₂-cyclo propane), 0.48-0.36 (m, 1H, CH₂-cyclo propane).

cyclo propane), 0.33-0.27 (m, 1H, CH₂-cyclo propane).

NHform: 7.36-7.23 (m, 6H, CH-Ph + CONH), 5.86-5.72 (m, 1H, CH=CH₂), 5.13-5.00 (m, 2H, CH=CH₂), 4.58-4.41 (m, 2H, CH₂NH), 2.71-2.12 (m, 5H, CH₂-homo allyl chain + CHCON), 1.55-1.47 (m, 1H, CH-cyclo propane), 0.58-0.51 (m, 1H, CH₂-cyclo propane), 0.48-0.36 (m, 2H, CH₂-cyclo propane), 0.22-0.15 (m, 1H, CH₂-cyclo propane).

¹³C NMR (δ, ppm) (CDCl₃, 100 MHz) **Major diastereoisomer, minor diastereoisomer and NHform:** 178.3 (Cq, C=O), 177.2 (Cq, C=O), 173.4 (Cq, C=O), 172.7 (Cq, C=O), 170.0 (Cq, C=O), 169.7 (Cq, C=O), 168.1 (Cq, C-N), 167.9 (Cq, C-N), 164.6 (Cq, C-N), 137.8 (Cq, Ar), 137.6 (Cq, Ar), 137.6 (Cq, Ar), 136.1 (CH=CH₂), 136.0 (CH=CH₂), 135.8 (CH=CH₂), 128.9 (CH-Ar), 128.8 (CH-Ar), 128.6 (CH-Ar), 127.7 (CH-Ar), 127.6 (CH-Ar x2), 127.5 (CH-Ar), 127.5 (CH-Ar), 127.4 (CH-Ar), 116.6 (CH=CH₂), 116.5 (CH=CH₂), 116.4 (CH=CH₂), 99.5 (Cq), 50.8 (CH), 50.7 (CH), 50.3 (CH), 49.0 (CH), 48.3 (CH), 44.0 (CH₂N), 43.9 (CH₂N), 43.7 (CH₂N), 31.5 (CH₂-homo allyl chain), 29.3 (CH₂-homo allyl chain), 29.1 (CH₂-homo allyl chain), 28.3 (CH₂-homo allyl chain), 28.2 (CH₂-homo allyl chain), 24.9 (CH₂-homo allyl chain), 13.1 (CH-cyclopropane), 10.6 (CH-cyclopropane), 9.7 (CH-cyclopropane), 5.9 (CH₂-cyclopropane), 5.2 (CH₂-cyclopropane), 5.1 (CH₂-cyclopropane), 4.7 (CH₂-cyclopropane), 4.6 (CH₂-cyclopropane), 4.3 (CH₂-cyclopropane).

IR (ν, cm⁻¹) (CCl₄) 3443 (w), 3079 (w), 3032 (w), 3007 (w), 2926 (w), 2856 (w), 1794 (m), 1712 (s), 1680 (m), 1648 (m), 1550 (w), 1516 (m), 1430 (w), 1356 (w), 1288 (w), 1258 (w), 1175 (w), 1099 (w), 1024 (w).

HRMS (EI+, m/z) : Calculated: 326.1631 found: 326.1622.

1-(3-But-3-enyl-5-oxo-4,5-dihydro-isoxazol-4-yl)-cyclopentanecarboxylic acid *tert*-butylamide and 1-(3-But-3-enyl-5-oxo-2,5-dihydro-isoxazol-4-yl)-cyclopentanecarboxylic acid *tert*-butylamide **1.22m**

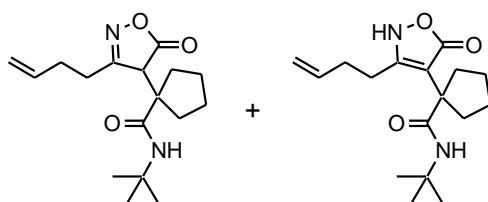

MF: C₁₇H₂₆O₃N₂

MW = 306 g.mol⁻¹

Method : See **general procedure 1.3** using (1 equiv., 2 mmol, 410 mg) of 3-but-3-enyl-4-cyclopentylidene-4*H*-isoxazol-5-one and (1 equiv., 2 mmol, 166 mg) of *tert* butyl isocyanide.

Purification : Flash column chromatography (silica gel, 8:2 PE: AcOEt)/ R_f (8:2 PE: AcOEt): 0.32.

Product : Orange solid.

Isolated yield : 60% (ratio CHform: NHform 1:0.6).

¹H NMR (δ, ppm) (CDCl₃, 400 MHz) **CHform:** .83-5.71 (m, 1H, CH=CH₂), 5.47 (br s, 1H, CONH), 5.06-4.98 (m, 2H, CH=CH₂), 3.60 (s, 1H, CHCO₂), 2.61-2.53 (m, 2H, CH₂-homo allyl chain), 2.47-2.33 (m, 2H, CH₂-homo allyl chain), 2.22-2.01 (m, 2H, CH₂-cyclopentane), 1.83-1.58 (m, 6H, CH₂-cyclopentane) 1.29 (s, 9H, CH₃-^tBu).

NH form: 6.50 (br s, 1H, CONH), 5.83-5.71 (m, 1H, CH=CH₂), 5.06-4.98 (m, 2H, CH=CH₂), 2.70 (t, *J* = 7.7Hz, 2H, CH₂-homo allyl chain), 2.47-2.33 (m, 2H, CH₂-homo allyl chain), 2.22-2.01 (m, 2H, CH₂-cyclopentane), 1.83-1.58 (m, 6H, CH₂-cyclopentane), 1.24 (s, 9H, CH₃-^tBu).

¹³C NMR (δ, ppm) (CDCl₃, 100 MHz) **CHform:** 177.2 (Cq, C=O), 172.1 (Cq, C=O), 168.1 (Cq, C=N), 136.1 (CH=CH₂), 116.1 (CH=CH₂), 55.8 (Cq), 52.2 (Cq), 52.0 (CHCO₂N), 35.3 (CH₂), 35.1 (CH₂), 29.2 (CH₂), 28.4 (CH₂), 28.3 (CH₂), 24.6 (CH₂), 24.3 (CH₃-^tBu).

NHform: 174.2 (Cq, C=O), 173.2 (Cq, C=O), 163.8 (Cq, C-N), 135.8 (CH=CH₂), 116.6 (CH=CH₂), 101.4 (Cq, C=CO₂N), 51.6 (Cq), 50.9 (Cq), 33.2 (CH₂), 31.4 (CH₂), 28.8 (CH₂), 28.5 (CH₂), 28.4 (CH₂), 25.8 (CH₂), 23.1 (CH₃-^tBu).

IR (ν, cm⁻¹) (CCl₄) 3438 (w), 3080 (w), 2965 (m), 2876 (w), 1787 (s), 1733 (w), 1675 (s), 1608 (w), 1512 (s), 1453 (m), 1392 (w), 1366 (w), 1327 (w), 1217 (w), 1161 (w), 1094 (w).

HRMS (EI+, m/z) : Calculated: 306.1944 found: 306.1955.

{[1-(3-But-3-enyl-5-oxo-4,5-dihydro-isoxazol-4-yl)-cyclopentanecarbonyl]-amino}-acetic acid ethyl ester and {[1-(3-But-3-enyl-5-oxo-2,5-dihydro-isoxazol-4-yl)-cyclopentanecarbonyl]-amino}-acetic acid ethyl ester 1.22n

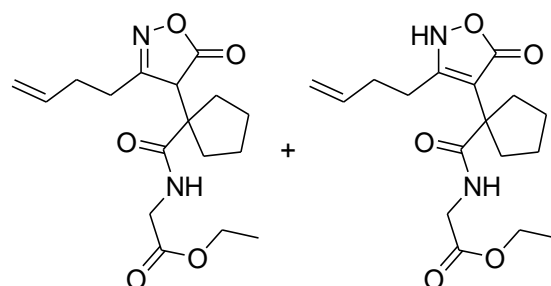

MF: C₁₇H₂₄O₅N₂

MW = 336 g.mol⁻¹

Method : See **general procedure 1.3** using (1 equiv., 2 mmol, 410 mg) of 3-but-3-enyl-4-cyclopentylidene-4*H*-isoxazol-5-one and (1 equiv., 2 mmol, 226 mg) of methyleneamino-acetic acid methyl ester.

Purification : Flash column chromatography (silica gel, 7:3 PE: AcOEt)/ R_f (7:3 PE: AcOEt):

0.20.

Product : Pale brown solid.

Isolated yield : 49% (ratio CH form: NH form 1: 0.88).

¹H NMR (δ , ppm) (CDCl₃, 400 MHz) **CH form:** 6.35 (br s, 1H, CONH), 5.90-5.78 (m, 1H, H₂C=CH), 5.14-5.04 (m, 2H, H₂C=CH) 4.24 (q, J = 7.2 Hz, 2H, OCH₂CH₃), 4.03 (dd, J = 5.2 Hz, J = 12.4 Hz, 2H, CH₂NH), 3.70 (s, 1H, CHCO₂), 2.89-2.18 (m, 7H, CH₂ cyclopentane + homoallyl chain), 1.98-1.69 (m, 5H, CH₂-cyclopentane), 1.32 (t, J = 7.2 Hz, 3H, OCH₂CH₃).

NHform: 7.10 (t, J = 5.5 Hz, 1H, CONH), 5.90-5.78 (m, 1H, H₂C=CH), 5.14-5.04 (m, 2H, H₂C=CH), 4.18 (q, J = 7.2 Hz, 2H, OCH₂CH₃), 3.97 (d, J = 5.5 Hz, 2H, CH₂NH), 2.89-2.18 (m, 7H, CH₂ cyclopentane + homoallyl chain), 1.98-1.69 (m, 5H, CH₂-cyclopentane), 1.28 (t, J = 7.2 Hz, 3H, OCH₂CH₃).

¹³C NMR (δ , ppm) (CDCl₃, 100 MHz) **CH form and NH form:** 176.8 (Cq, C=O), 175.5 (Cq, C=O), 174.1 (Cq, C=O), 173.0 (Cq, C=O), 169.8 (Cq, C=O), 169.6 (Cq, C=O), 167.8 (Cq, C-N), 164.6 (Cq, C-N), 136.2 (CH=CH₂), 136.0 (CH=CH₂), 116.7 (CH=CH₂), 116.1 (CH=CH₂), 102.5 (Cq, NHform), 61.7 (OCH₂CH₃), 61.2 (OCH₂CH₃), 55.4 (Cq), 55.2 (Cq), 51.6 (CHCO₂, CHform), 41.6 (CH₂), 37.8 (CH₂), 35.3 (CH₂), 35.3 (CH₂), 34.6 (CH₂), 33.2 (CH₂), 31.2 (CH₂), 29.1 (CH₂), 28.8 (CH₂), 25.9 (CH₂), 24.9 (CH₂), 24.8 (CH₂), 23.7 (CH₂), 23.2 (CH₂), 14.1 (OCH₂CH₃), 14.1 (OCH₂CH₃).

IR (ν , cm⁻¹) (CCl₄) 3253 (w), 3081 (w), 2943 (m), 2864 (w), 2750 (w), 1748 (s), 1703 (s), 1630 (s), 1550 (m), 1516 (m), 1447 (w), 1398 (w), 1374 (w), 1349 (w), 1285 (w), 1256 (w), 1204 (s), 1114 (w), 1019 (m).

HRMS (EI+, m/z) : Calculated: 336.1685 found: 336.1696.

B.3.1.2 Synthesis of β -branched alkynes and dihydropyrrolones

Alkynes and dihydro pyrrolones were synthesized as described below:

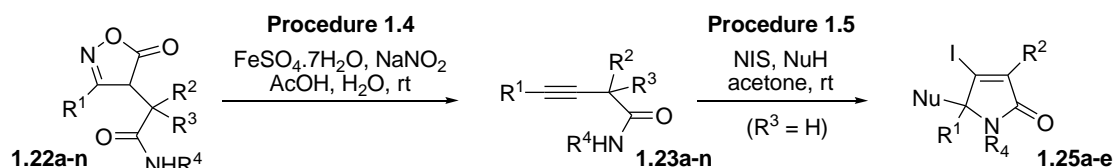

Alkynes synthesized:

- 1.23a**, $R^1 = \text{Ph}$, $R^2 = \text{cyclopropyl}$, $R^3 = \text{H}$, $R^4 = \text{tBu}$
1.23b, $R^1 = \text{Ph}$, $R^2 = 4\text{-Me-Ph}$, $R^3 = \text{H}$, $R^4 = \text{tBu}$
1.23c, $R^1 = \text{Ph}$, $R^2 = 4\text{-Me-Ph}$, $R^3 = \text{H}$, $R^4 = \text{CH}_2\text{CO}_2\text{Et}$
1.23d, $R^1 = \text{Ph}$, $R^2 = 4\text{-Me-Ph}$, $R^3 = \text{H}$, $R^4 = \text{CH}_2\text{Ph}$
1.23e, $R^1 = \text{Ph}$, $R^2 = 2\text{-tiophenyl}$, $R^3 = \text{H}$, $R^4 = \text{tBu}$
1.23f, $R^1 = \text{Ph}$, $R^2 = \text{Me}$, $R^3 = \text{Me}$, $R^4 = \text{tBu}$
1.23g, $R^1 = \text{Ph}$, $R^2 = \text{cyclopropyl}$, $R^3 = (\text{CH}_2)_4$, $R^4 = \text{tBu}$
1.23h, $R^1 = \text{CH}_2\text{CO}_2\text{Me}$, $R^2 = \text{cyclopropyl}$, $R^3 = \text{H}$, $R^4 = \text{tBu}$
1.23i, $R^1 = \text{CH}_2\text{CO}_2\text{Me}$, $R^2 = \text{cyclopropyl}$, $R^3 = (\text{CH}_2)_4$, $R^4 = \text{tBu}$
1.23j, $R^1 = \text{CH}_2\text{OCH}_2\text{Ph}$, $R^2 = 4\text{-Me-Ph}$, $R^3 = \text{H}$, $R^4 = \text{tBu}$
1.23k, $R^1 = \text{cyclopropyl}$, $R^2 = \text{cyclopropyl}$, $R^3 = \text{H}$, $R^4 = \text{tBu}$
1.23l, $R^1 = \text{cyclopropyl}$, $R^2 = \text{cyclopropyl}$, $R^3 = \text{H}$, $R^4 = \text{CH}_2\text{Ph}$
1.23m, $R^1 = \text{cyclopropyl}$, $R^2 = \text{cyclopropyl}$, $R^3 = (\text{CH}_2)_4$, $R^4 = \text{tBu}$
1.23n, $R^1 = \text{cyclopropyl}$, $R^2 = \text{cyclopropyl}$, $R^3 = (\text{CH}_2)_4$, $R^4 = \text{CH}_2\text{CO}_2\text{Et}$

Dihydro pyrrolones synthesized:

- 1.25a**, $R^1 = \text{Ph}$, $R^3 = \text{cyclopropyl}$, $R^4 = \text{tBu}$, Nu = OH
1.25b, $R^1 = \text{Ph}$, $R^3 = \text{cyclopropyl}$, $R^4 = \text{tBu}$, Nu = OMe
1.25c, $R^1 = \text{Ph}$, $R^3 = \text{cyclopropyl}$, $R^4 = \text{tBu}$, Nu = OCH₂CH=CH₂
1.25d, $R^1 = \text{Ph}$, $R^3 = 4\text{-Me-Ph}$, $R^4 = \text{CH}_2\text{Ph}$, Nu = OH
1.25e, $R^1 = \text{cyclopropyl}$, $R^3 = \text{cyclopropyl}$, $R^4 = \text{CH}_2\text{Ph}$, Nu = OMe

Scheme B.3.1.2: Synthesis of alkynes **1.23a-n** and dihydropyrrolones **1.25a-e**.

General Procedure 1.4, Nitrosative cleavage of the 5-isoxazolinone ring: All the solutions must be thoroughly degased beforehand. To a three neck flask under an argon atmosphere charged with $\text{FeSO}_4 \cdot 7\text{H}_2\text{O}$ (5.5 equiv.) and AcOH (0.25 M to isoxazolinone), equipped with two addition funnels, one charged with a solution of NaNO_2 (10 equiv.) in H_2O (0.25 M to isoxazolinone) and the other with isoxazolinone (1 equiv.) in AcOH (0.25 M to isoxazolinone) was added half of a solution of sodium nitrite in water. The remainder was added slowly simultaneously with a solution of isoxazolinone in acetic acid at room temperature. The reaction was allowed to stir at rt until completion (TLC). The set-up was then flushed with nitrogen for 30 minutes, water was added and the reaction extracted with DCM (3x). The organic extracts were treated with NaHCO_3 (with stirring) for 40 min and dried (MgSO_4). Concentration under reduced pressure and purification by flash column chromatography of the residue provided alkynes in the stated yields.

General Procedure 1.5: To a round bottom flask charged with alkyne (1 equiv.), wet acetone (0.2 M) and the corresponding alcohol used as nucleophile (10 equiv.) was added *N*-iodosuccinimide (2.1 equiv.) dissolved in wet acetone (0.2 M). In the case where water is inserted, no nucleophile is added (water comes from acetone). The reaction was allowed to stir at room temperature. After complete consumption of the starting material (TLC), a

solution of $\text{Na}_2\text{S}_2\text{O}_3$ in water was added. The mixture was extracted with Et_2O (3x), dried (MgSO_4) and concentrated under reduced pressure. Purification by flash column chromatography (silica, PE:AcOEt) afforded the pure product in the stated yields.

2-Cyclopropyl-4-phenyl-but-3-ynoic acid *tert*-butylamide

1.23a

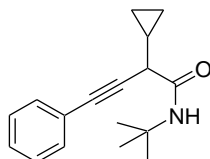

MF: $\text{C}_{17}\text{H}_{21}\text{ON}$

MW = $255 \text{ g}\cdot\text{mol}^{-1}$

Method :	See general procedure 1.4 using (1 equiv., 1.6 mmol, 510 mg) of the corresponding isoxazolin-5-one.
Purification :	Flash column chromatography (silica gel, 6:4 PE:Et ₂ O)/ R_f (6:4 PE:Et ₂ O): 0.88.
Product :	Pale pink solid.
Yield :	92%.
¹H NMR (δ, ppm) (CDCl ₃ , 400 MHz)	7.42-7.39 (m, 2H, CH-Ph), 7.33-7.30 (m, 3H, CH-Ph), 6.32 (br s, 1H, NH), 3.39 (d, <i>J</i> = 5.6 Hz, CHCON), 1.41-1.36 (m, 1H, CH-cyclopropane), 1.39 (s, 9H, CH ₃ - ^t Bu), 0.63-0.54 (m, 2H, CH ₂ -cyclopropane), 0.53-0.43 (m, 2H, CH ₂ -cyclopropane).
¹³C NMR (δ, ppm) (CDCl ₃ , 100 MHz)	168.9 (Cq, C=O), 131.6 (CH-Ph), 128.5 (CH-Ph), 128.4 (CH-Ph), 122.4 (Cq, Ph), 86.4 (Cq, C≡C), 84.8 (Cq, C≡C), 51.3 (Cq, ^t Bu), 43.5 (CHCON), 28.6 (CH ₃ - ^t Bu), 12.5 (CH-cyclopropane), 3.1 (CH ₂ -cyclopropane), 1.6 (CH ₂ cyclopropane).
IR (ν, cm ⁻¹) (CCl ₄)	3410 (m), 3082 (w), 3001 (w), 2968 (m), 2928 (w), 2873 (w), 1685 (s), 1513 (s), 1453 (m), 1391 (w), 1364 (m), 1274 (m), 1222 (m), 1021 (w).
HRMS (EI+, <i>m/z</i>) :	Calculated: 255.1623 found: 255.1622.

4-Phenyl-2-*p*-tolyl-but-3-ynoic acid *tert*-butylamide

1.23b

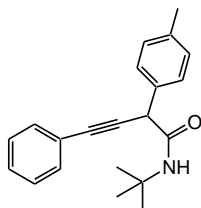
MF: C₂₁H₂₃ONMW = 305 g.mol⁻¹

- Method :** See **general procedure 1.4** using (1 equiv., 1.15 mmol, 420 mg) of the corresponding isoxazolin-5-one.
- Purification :** Flash column chromatography (silica gel, 1:1 PE: Et₂O) / R_f(1:1 PE: Et₂O): 0.50.
- Product :** Pale yellow solid.
- Isolated Yield :** 87%.
- ¹H NMR** (δ, ppm) (CDCl₃, 400 MHz) 7.52-7.49 (m, 2H, CH-Ph), 7.48 (d, *J* = 8.0 Hz, 2H, CH-tolyl), 7.42-7.40 (m, 3H, CH-Ph), 7.20 (d, *J* = 8.0 Hz, 2H, CH-tolyl), 6.50 (br s, 1H, NH), 4.61 (s, 1H, CHCON), 2.37 (s, 3H, CH₃), 1.39 (s, 9H, CH₃-^tBu).
- ¹³C NMR** (δ, ppm) (CDCl₃, 100 MHz) 167.7 (Cq, C=O), 137.1(Cq, Ar), 133.6 (Cq, Ar) , 131.4 (CH-Ph), 129.3 (CH-tolyl), 128.4 (CH-Ph), 128.3 (CH-Ph), 127.5 (CH-tolyl), 122.3 (Cq, Ar), 87.0 (Cq, C≡C), 86.3 (Cq, C≡C), 51.3 (Cq, ^tBu), 46.5 (CHCON), 28.4 (CH₃-^tBu), 21.0 (CH₃)
- IR** (ν, cm⁻¹) (CCl₄) 3410 (w), 3056 (w), 3028 (w), 2969 (m), 2926 (w), 2871, 1689 (s), 1512 (s), 1452 (w), 1391 (w), 1366 (w), 1271 (w), 1224 (w), 1045 (w), 1026 (w).
- HRMS** (EI+, *m/z*) : Calculated: 305.1780 found: 305.1777.

(4-Phenyl-2-*p*-tolyl-but-3-ynoylamino)-acetic acid ethyl ester

1.23c

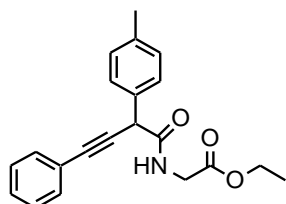
MF: C₂₁H₂₁O₃NMW = 335 g. mol⁻¹

Method :	See general procedure 1.4 using (1 equiv., 0.20 mmol, 65 mg) of the corresponding isoxazolin-5-one.
Purification :	Flash column chromatography (silica gel, 6:4 Et ₂ O: PE) / R _f (7:3 PE:EtOAc): 0.50.
Product :	Brown solid.
Isolated yield :	81%.
¹H NMR (δ, ppm) (CDCl ₃ , 400 MHz)	7.54-7.52 (m, 2H, CH-Ph), 7.46 (d, <i>J</i> = 8.2 Hz, 2H, CH-tolyl), 7.35-7.34 (m, 3H, CH-Ph), 7.19 (d, <i>J</i> = 8.2 Hz, 2H, CH-tolyl), 7.01 (br t, <i>J</i> = 5.2 Hz, 1H, NH), 4.73 (s, 1H, CHCON), 4.21 (q, <i>J</i> = 7.1 Hz, 2H, OCH ₂ CH ₃), 4.08 (dd, <i>J</i> = 5.2 Hz, <i>J</i> = 18.5 Hz, 1H, CH ₂ NH), 4.00 (dd, <i>J</i> = 5.2, <i>J</i> = 18.5 Hz, 1H, CH ₂ NH), 2.35 (s, 3H, CH ₃), 1.26 (t, <i>J</i> = 7.1 Hz, 3H, OCH ₂ CH ₃)
¹³C NMR (δ, ppm) (CDCl ₃ , 100 MHz)	169.5 (Cq, C=O), 168.8 (Cq, C=O), 137.7 (Cq, Ar), 133.1 (Cq, Ar), 131.8 (CH-Ph), 129.5 (CH-tolyl), 128.6 (CH-Ph), 128.4 (CH-Ph), 127.8 (CH-tolyl), 122.3 (Cq, Ar), 87.5 (Cq, C≡C), 85.3 (Cq, C≡C), 61.6 (OCH ₂ CH ₃), 45.7 (CHCON), 41.8 (CH ₂ NH), 21.1 (CH ₃), 14.1 (OCH ₂ CH ₃)
IR (ν, cm ⁻¹) (CCl ₄)	3406 (w), 3028 (w), 2984 (w), 2926 (w), 2864 (w), 1745 (s), 1690 (s), 1512 (s), 1443 (w), 1376 (w), 1351 (w), 1205 (s), 1023 (w).
HRMS (EI+, <i>m/z</i>) :	Calculated: 335.1521 found: 335.1529.

4-Phenyl-2-*p*-tolyl-but-3-ynoic acid benzylamide

1.23d

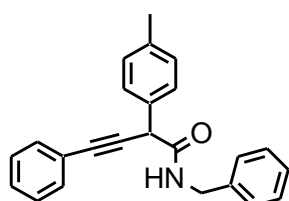

MF: C₂₄H₂₁ON

MW = 339g.mol⁻¹

Method :	See general procedure 1.4 using (1 equiv., 0.25 mmol, 100 mg) of the corresponding isoxazolin-5-one.
Purification :	Flash column chromatography (silica gel, 6:4 Et ₂ O: PE)/ R _f (8:2 PE:EtOAc): 0.39.
Product :	Yellow solid.

Isolated yield :	90%.
¹H NMR (δ, ppm) (CDCl ₃ , 400 MHz)	7.52-7.48 (m, 4H, CH-Ar), 7.39-7.24 (m, 10H, CH-Ar), 6.81 (br t, <i>J</i> = 5.8Hz, 1H, NH), 4.83 (s, 1H, CHCON), 4.56 (dd, <i>J</i> = 5.8Hz, <i>J</i> = 15.0 Hz, 1H, CH ₂ NH), 4.48 (dd, <i>J</i> = 5.8Hz, <i>J</i> = 15.0 Hz, 1H, CH ₂ NH), 2.42 (s, 3H, CH ₃)
¹³C NMR (δ, ppm) (CDCl ₃ , 100 MHz)	168.8 (Cq, C=O), 137.9 (Cq, Ar), 137.6 (Cq, Ar), 133.2 (Cq, Ar), 131.7 (CH-Ar), 129.5 (CH-Ar), 128.7 (CH-Ar), 128.6 (CH-Ar), 128.3 (CH-Ar), 127.7 (CH-Ar), 127.5 (CH-Ar), 127.4 (CH-Ar), 122.3 (Cq, Ar), 87.3 (Cq, C≡C), 85.7 (Cq, C≡C), 46.0 (CHCON), 43.8 (CH ₂ NH), 21.1 (CH ₃).
IR (ν, cm ⁻¹) (CCl ₄)	3424 (w), 3062 (w), 3031 (w), 2925 (w), 1690 (s), 1512 (s), 1451 (w), 1253 (w), 1196 (w), 1025 (w).
HRMS (EI+, <i>m/z</i>) :	Calculated: 339.1623 found: 339.1620.

4-Phenyl-2-thiophen-2-yl-but-3-ynoic acid *tert*-butylamide

1.23e

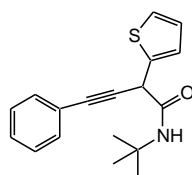

MF: C₁₈H₁₉ONS

MW = 297 g.mol⁻¹

Method :	See general procedure 1.4 using (1 equiv., 0.36 mmol, 130 mg) of the corresponding isoxazolin-5-one.
Purification :	Flash column chromatography (silica gel, 6:4 Et ₂ O: PE) / R_f (6:4 Et ₂ O: PE): 0.66.
Product :	Brown solid.
Isolated Yield :	92%.
¹H NMR (δ, ppm) (CDCl ₃ , 400 MHz)	7.51-7.48 (m, 2H, CH-Ph), 7.38-7.35 (m, 3H, CH-Ph), 7.25 (dd, <i>J</i> = 1.2 Hz, <i>J</i> = 4.8 Hz, 1H, CH thiophene), 7.19 (dt, <i>J</i> = 1.2 Hz, <i>J</i> = 3.6 Hz, 1H, CH-thiophene), 6.98 (dd, <i>J</i> = 3.6 Hz, <i>J</i> = 4.8 Hz, 1H, CH-thiophene), 6.45 (br s, 1H, NH), 4.85 (s, 1H, CHCON), 1.37 (s, 9H, CH ₃ - ^t Bu).
¹³C NMR (δ, ppm) (CDCl ₃ , 100 MHz)	166.5 (Cq, C=O), 138.9 (Cq, Ar), 131.6 (CH-Ph), 128.8 (CH-Ph), 128.5 (CH-Ph), 126.6 (CH-thiophene), 125.9 (CH-thiophene), 125.4 (CH-thiophene), 122.1 (Cq, Ar), 87.3 (Cq, C≡C), 85.3 (Cq, C≡C), 51.6 (Cq, ^t Bu), 42.5 (CHCON), 28.4 (CH ₃ - ^t Bu).

IR (ν , cm^{-1}) (CCl_4) 3410 (w), 2968 (w), 2928 (w), 2870 (w), 1806 (w), 1692(s), 1566 (s), 1513 (w), 1453 (w), 1392 (w), 1366 (w), 1273 (w), 1223 (w).

HRMS (EI+, m/z) : Calculated: 297.1187 found: 297.1183.

2,2-Dimethyl-4-phenyl-but-3-ynoic acid *tert*-butylamide

1.23f

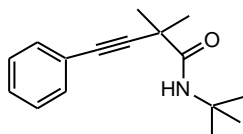

MF: $\text{C}_{16}\text{H}_{21}\text{ON}$

MW = 243 g. mol^{-1}

Method : See **general procedure 1.4** using (1 equiv., 1.14 mmol, 344 mg) of the corresponding isoxazolin-5-one.

Purification : Flash column chromatography (silica gel, 9:1 PE: AcOEt)/ R_f (7:3 PE: AcOEt): 0.92.

Product : White solid.

Yield : 76%.

$^1\text{H NMR}$ (δ , ppm) 7.42-7.40 (m, 2H, CH-Ph), 7.33-7.32 (m, 3H, CH-Ph), 6.67 (br s, 1H, NH), 1.50 (s, 6H, CH_3), 1.37 (s, 9H, CH_3 - ^tBu).
(CDCl_3 , 400 MHz)

$^{13}\text{C NMR}$ (δ , ppm) 172.7 (Cq, C=O), 131.4 (CH-Ph), 128.4 (CH-Ph), 128.4 (CH-Ph), 122.6 (Cq, Ph), 92.8 (Cq, $\text{C}\equiv\text{C}$), 84.8 (Cq, $\text{C}\equiv\text{C}$), 51.0 (Cq), 39.8 (Cq), 28.5 (CH_3 - ^tBu), 27.5 (CH_3).
(CDCl_3 , 100 MHz)

IR (ν , cm^{-1}) (CCl_4) 3410 (w), 3062 (w), 2973 (w), 2973 (w), 2933 (w), 2871 (w), 1812 (w), 1683 (s), 1511 (s), 1455 (w), 1391 (w), 1365 (w), 1271 (w), 1223 (w), 1178 (w), 1178(w).

HRMS (EI+, m/z) : Calculated: 243.1623 found: 243.1617.

***N*-tert-Butyl-2-(4-nitro-5-oxo-3-phenyl-4,5-dihydro-isoxazol-4-yl)-isobutyramide**

1.17f

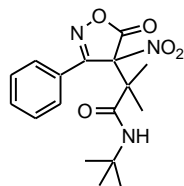

MF: C₁₇H₂₁O₅N₃

MW = 347.g.mol⁻¹

- Method :** See **general procedure 1.4** using (1 equiv., 1.14 mmol, 344 mg) of the corresponding isoxazolin-5-one.
- Purification :** Flash column chromatography (silica gel, 9:1 PE: AcOEt) / **R_f** (9:1 PE: AcOEt): 0.31.
- Product :** White solid.
- Isolated yield :** 20%.
- ¹H NMR** (δ, ppm) 7.57-7.51 (m, 3H, CH-Ph), 7.47-7.43 (m, 2H, CH-Ph), 5.31 (br s, 1H, NH) 1.71 (s, 3H, CH₃), 1.26 (s, 9H, CH₃-^tBu), 1.21 (s, 3H, CH₃).
(CDCl₃, 400 MHz)
- ¹³C NMR** (δ, ppm) 171.3 (Cq, C=O), 167.3 (Cq, C=O), 161.8 (Cq, C=N), 131.7 (CH-Ph), 129.3 (CH-Ph), 128.9 (CH-Ph), 128.1 (Cq, Ph), 94.3 (Cq), 52.1 (Cq), 51.8 (Cq), 28.3 (CH₃-^tBu), 22.1 (CH₃), 21.7 (CH₃).
(CDCl₃, 100 MHz)
- IR** (ν, cm⁻¹) (CCl₄) 3583 (w), 3456 (w), 3064 (w), 2971 (w), 2932 (w), 2873 (w), 1809 (s), 1706 (s), 1676 (s), 1562 (s), 1513 (s), 1454 (m), 1392 (w), 1366 (w), 1340 (m), 1272 (w), 1219 (m), 1179 (w), 1145 (w), 1096 (w).
- HRMS** (EI+, m/z) : Calculated: 347.1481 found: 347.1496.

1-Phenylethynyl-cyclopentanecarboxylic acid *tert*-butylamide

1.23g

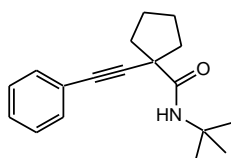

MF: C₁₈H₂₃ON

MW = 269.g.mol⁻¹

Method :	See general procedure 1.4 using (1 equiv., 0.40 mmol, 130 mg) of the corresponding isoxazolin-5-one.	
Purification :	Flash column chromatography (silica gel, 9:1 PE: AcOEt)/ R_f (7:3 PE: AcOEt): 0.69.	
Product :	White solid.	
Isolated Yield :	71%.	
$^1\text{H NMR}$ (δ, ppm) (CDCl_3 , 400 MHz)	7.41-7.39 (m, 2H, CH-Ph), 7.33-7.31 (m, 3H, CH-Ph), 6.70 (br s, 1H, NH), 2.28-2.21 (m, 2H, CH_2 -cyclopentane), 2.03-1.97 (m, 2H, CH_2 -cyclopentane), 1.87-1.83 (m, 4H, CH_2 -cyclopentane), 1.38 (s, 9H, CH_3 - ^tBu).	
$^{13}\text{C NMR}$ (δ, ppm) (CDCl_3 , 100 MHz)	172.4 (Cq, C=O), 131.4 (CH-Ph), 128.4 (CH-Ph), 128.2 (CH-Ph), 122.9 (Cq, Ph), 93.0 (Cq, $\text{C}\equiv\text{C}$), 85.0 (Cq, $\text{C}\equiv\text{C}$), 51.1 (Cq), 50.0 (Cq), 39.8 (CH_2 -cyclopentane), 28.6 (CH_3 - ^tBu), 25.7 (CH_2 -cyclopentane).	
IR (ν , cm^{-1}) (CCl_4)	3409 (w), 3060 (w), 2966 (s), 2871 (w), 1680 (s), 151 (s), 1452 (w), 1391 (w), 1365 (w), 1322 (w), 1267 (w), 1222 (w).	
HRMS (EI+, m/z) :	Calculated: 269.1780	found: 269.1778.

1-(4-Nitro-5-oxo-3-phenyl-4,5-dihydro-isoxazol-4-yl)-cyclopentanecarboxylic acid *tert*-butylamide **1.17g**

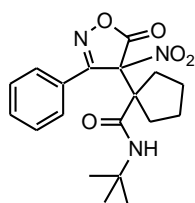

MF: $\text{C}_{19}\text{H}_{23}\text{O}_5\text{N}_3$

MW = $373 \text{ g}\cdot\text{mol}^{-1}$

Method :	See general procedure 1.4 using (1 equiv., 0.40 mmol, 130 mg) of the corresponding isoxazolin-5-one.	
Purification :	Flash column chromatography (silica gel, 9:1 PE: AcOEt)/ R_f (7:3 PE: AcOEt): 0.53.	
Product :	dark red solid.	

Isolated yield : 18%.

¹H NMR (δ, ppm) 7.57-7.41 (m, 5H, CH-Ph), 5.19 (br s, 1H, NH), 2.98-2.91 (m, 1H, CH₂-cyclopentane), 2.15-2.08 (m, 1H, CH₂-cyclopentane), 2.04-1.95 (m, 1H, CH₂-cyclopentane), 1.87-1.75 (m, 2H, CH₂-cyclopentane), 1.71-1.61 (m, 1H, CH₂-cyclopentane), 1.53-1.43 (m, 2H, CH₂-cyclopentane), 1.25 (s, 9H, CH₃-^tBu).

¹³C NMR (δ, ppm) 171.3 (Cq, C=O), 167.6 (Cq, C=O), 162.4 (Cq, C=N) 131.8 (CH-Ph), 129.4 (CH-Ph), 128.7 (CH-Ph), 127.3 (Cq, Ph), 94.4 (Cq), 61.5 (Cq), 52.1 (Cq), 33.1 (CH₂-cyclopentane), 32.7 (CH₂-cyclopentane), 28.3 (CH₃-^tBu), 25.9 (CH₂-cyclopentane), 24.7 (CH₂-cyclopentane).

IR (ν, cm⁻¹) (CCl₄) 3455 (w), 3063 (w), 2966 (s), 2874 (w), 1804 (s), 1720 (s), 1676 (s), 1562 (s), 1513 (s), 1453 (s), 1392 (w), 1365 (m), 1338 (s), 1263 (m), 1219 (m), 1127 (w), 1072 (w).

HRMS (EI+, m/z) : Calculated: 373.1648 found: 373.1638.

X-ray structure for **1.17g**

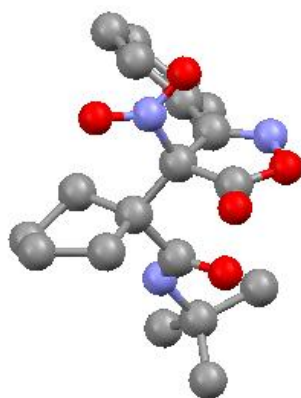

Table 1. Crystal data for **1.17g**

Compound	1.17g
Molecular formula	C ₁₉ H ₂₃ N ₃ O ₅
Molecular weight	373.40
Crystal habit	Colorless Plate
Crystal dimensions(mm)	0.34x0.32x0.04

Crystal system	monoclinic
Space group	P2 ₁ /c
a(Å)	7.507(1)
b(Å)	18.276(1)
c(Å)	14.379(1)
α(°)	90.00
β(°)	112.491(1)
γ(°)	90.00
V(Å ³)	1822.7(3)
Z	4
d(g·cm ⁻³)	1.361
F(000)	792
λ(cm ⁻¹)	0.100
Absorption corrections	multi-scan , 0.9669 min, 0.9960 max
Diffractometer	KappaCCD
X-ray source	MoKα
μ(Å)	0.71069
Monochromator	graphite
T (K)	150.0(1)
Scan mode	phi and omega scans
Maximum θ	27.48
HKL ranges	-9 9 , -21 23 , -14 18
Reflections measured	10476
Unique data	4171
Rint	0.0307
Reflections used	2721
Criterion	I > 2σ(I)
Refinement type	Fsqd
Hydrogen atoms	mixed
Parameters refined	247
Reflections / parameter	11
wR2	0.1069
R1	0.0412
Weights a, b	0.0506 , 0.0000
GoF	1.021
difference peak / hole (e Å ⁻³)	0.230(0.042) / -0.239(0.042)

Table 2. Atomic Coordinates (A x 10⁴) and equivalent isotropic displacement parameters (Å² x 10³) for **1.17g**

atom	x	y	z	U(eq)
O(1)	8614(2)	2939(1)	2543(1)	40(1)
O(6)	10673(1)	3143(1)	4128(1)	39(1)
O(8)	8765(2)	4654(1)	3075(1)	54(1)

O(9)	8072(1)	4790(1)	4394(1)	43(1)
O(22)	7294(1)	2193(1)	3852(1)	32(1)
N(2)	6696(2)	3157(1)	1923(1)	39(1)
N(7)	8127(2)	4434(1)	3691(1)	35(1)
N(23)	4321(2)	2299(1)	3883(1)	24(1)
C(3)	6008(2)	3562(1)	2436(1)	28(1)
C(4)	7355(2)	3647(1)	3523(1)	25(1)
C(5)	9094(2)	3203(1)	3495(1)	31(1)
C(10)	4033(2)	3860(1)	1964(1)	28(1)
C(11)	2541(2)	3418(1)	1344(1)	36(1)
C(12)	695(2)	3697(1)	905(1)	42(1)
C(13)	319(2)	4412(1)	1072(1)	39(1)
C(14)	1800(2)	4857(1)	1671(1)	37(1)
C(15)	3643(2)	4581(1)	2119(1)	32(1)
C(16)	6531(2)	3372(1)	4300(1)	23(1)
C(17)	4831(2)	3830(1)	4349(1)	25(1)
C(18)	4986(2)	3734(1)	5433(1)	32(1)
C(19)	7143(2)	3797(1)	6038(1)	36(1)
C(20)	8060(2)	3374(1)	5411(1)	32(1)
C(21)	6043(2)	2565(1)	3989(1)	23(1)
C(24)	3676(2)	1533(1)	3562(1)	26(1)
C(25)	4955(2)	993(1)	4333(1)	36(1)
C(26)	3712(2)	1398(1)	2525(1)	38(1)
C(27)	1609(2)	1474(1)	3496(2)	47(1)

U(eq) is defined as 1/3 the trace of the Uij tensor.

Table 3. Bond lengths (Å) and angles (deg) for **1.17g**

O(1)-C(5)	1.364(2)	O(1)-N(2)	1.430(2)
O(6)-C(5)	1.192(2)	O(8)-N(7)	1.225(2)
O(9)-N(7)	1.216(2)	O(22)-C(21)	1.235(2)
N(2)-C(3)	1.285(2)	N(7)-C(4)	1.535(2)
N(23)-C(21)	1.334(2)	N(23)-C(24)	1.495(2)
N(23)-H(23N)	0.8741	C(3)-C(10)	1.478(2)
C(3)-C(4)	1.509(2)	C(4)-C(5)	1.551(2)
C(4)-C(16)	1.554(2)	C(10)-C(15)	1.388(2)
C(10)-C(11)	1.391(2)	C(11)-C(12)	1.382(2)
C(11)-H(11)	0.9500	C(12)-C(13)	1.376(2)
C(12)-H(12)	0.9500	C(13)-C(14)	1.382(2)
C(13)-H(13)	0.9500	C(14)-C(15)	1.379(2)
C(14)-H(14)	0.9500	C(15)-H(15)	0.9500
C(16)-C(21)	1.545(2)	C(16)-C(17)	1.550(2)
C(16)-C(20)	1.571(2)	C(17)-C(18)	1.527(2)
C(17)-H(17A)	0.9900	C(17)-H(17B)	0.9900
C(18)-C(19)	1.521(2)	C(18)-H(18A)	0.9900
C(18)-H(18B)	0.9900	C(19)-C(20)	1.535(2)
C(19)-H(19A)	0.9900	C(19)-H(19B)	0.9900
C(20)-H(20A)	0.9900	C(20)-H(20B)	0.9900
C(24)-C(25)	1.520(2)	C(24)-C(26)	1.522(2)

C(24)-C(27)	1.522(2)	C(25)-H(25A)	0.9800
C(25)-H(25B)	0.9800	C(25)-H(25C)	0.9800
C(26)-H(26A)	0.9800	C(26)-H(26B)	0.9800
C(26)-H(26C)	0.9800	C(27)-H(27A)	0.9800
C(27)-H(27B)	0.9800	C(27)-H(27C)	0.9800
C(5)-O(1)-N(2)	110.1(1)	C(3)-N(2)-O(1)	109.5(1)
O(9)-N(7)-O(8)	125.0(1)	O(9)-N(7)-C(4)	120.1(1)
O(8)-N(7)-C(4)	114.9(1)	C(21)-N(23)-C(24)	124.2(1)
C(21)-N(23)-H(23N)	124.2	C(24)-N(23)-H(23N)	111.4
N(2)-C(3)-C(10)	120.0(1)	N(2)-C(3)-C(4)	113.3(1)
C(10)-C(3)-C(4)	126.5(1)	C(3)-C(4)-N(7)	108.8(1)
C(3)-C(4)-C(5)	99.0(1)	N(7)-C(4)-C(5)	102.9(1)
C(3)-C(4)-C(16)	114.7(1)	N(7)-C(4)-C(16)	114.8(1)
C(5)-C(4)-C(16)	114.8(1)	O(6)-C(5)-O(1)	122.5(1)
O(6)-C(5)-C(4)	129.1(2)	O(1)-C(5)-C(4)	108.0(1)
C(15)-C(10)-C(11)	119.1(1)	C(15)-C(10)-C(3)	120.8(1)
C(11)-C(10)-C(3)	120.1(1)	C(12)-C(11)-C(10)	120.0(2)
C(12)-C(11)-H(11)	120.0	C(10)-C(11)-H(11)	120.0
C(13)-C(12)-C(11)	120.5(2)	C(13)-C(12)-H(12)	119.8
C(11)-C(12)-H(12)	119.8	C(12)-C(13)-C(14)	119.9(2)
C(12)-C(13)-H(13)	120.1	C(14)-C(13)-H(13)	120.1
C(15)-C(14)-C(13)	120.0(2)	C(15)-C(14)-H(14)	120.0
C(13)-C(14)-H(14)	120.0	C(14)-C(15)-C(10)	120.6(2)
C(14)-C(15)-H(15)	119.7	C(10)-C(15)-H(15)	119.7
C(21)-C(16)-C(17)	114.9(1)	C(21)-C(16)-C(4)	102.4(1)
C(17)-C(16)-C(4)	114.8(1)	C(21)-C(16)-C(20)	107.3(1)
C(17)-C(16)-C(20)	104.3(1)	C(4)-C(16)-C(20)	113.2(1)
C(18)-C(17)-C(16)	104.0(1)	C(18)-C(17)-H(17A)	111.0
C(16)-C(17)-H(17A)	111.0	C(18)-C(17)-H(17B)	111.0
C(16)-C(17)-H(17B)	111.0	H(17A)-C(17)-H(17B)	109.0
C(19)-C(18)-C(17)	102.9(1)	C(19)-C(18)-H(18A)	111.2
C(17)-C(18)-H(18A)	111.2	C(19)-C(18)-H(18B)	111.2
C(17)-C(18)-H(18B)	111.2	H(18A)-C(18)-H(18B)	109.1
C(18)-C(19)-C(20)	104.2(1)	C(18)-C(19)-H(19A)	110.9
C(20)-C(19)-H(19A)	110.9	C(18)-C(19)-H(19B)	110.9
C(20)-C(19)-H(19B)	110.9	H(19A)-C(19)-H(19B)	108.9
C(19)-C(20)-C(16)	106.3(1)	C(19)-C(20)-H(20A)	110.5
C(16)-C(20)-H(20A)	110.5	C(19)-C(20)-H(20B)	110.5
C(16)-C(20)-H(20B)	110.5	H(20A)-C(20)-H(20B)	108.7
O(22)-C(21)-N(23)	122.9(1)	O(22)-C(21)-C(16)	117.6(1)
N(23)-C(21)-C(16)	119.6(1)	N(23)-C(24)-C(25)	110.1(1)
N(23)-C(24)-C(26)	109.2(1)	C(25)-C(24)-C(26)	111.4(1)
N(23)-C(24)-C(27)	106.7(1)	C(25)-C(24)-C(27)	110.1(1)
C(26)-C(24)-C(27)	109.1(1)	C(24)-C(25)-H(25A)	109.5
C(24)-C(25)-H(25B)	109.5	H(25A)-C(25)-H(25B)	109.5
C(24)-C(25)-H(25C)	109.5	H(25A)-C(25)-H(25C)	109.5
H(25B)-C(25)-H(25C)	109.5	C(24)-C(26)-H(26A)	109.5
C(24)-C(26)-H(26B)	109.5	H(26A)-C(26)-H(26B)	109.5
C(24)-C(26)-H(26C)	109.5	H(26A)-C(26)-H(26C)	109.5
H(26B)-C(26)-H(26C)	109.5	C(24)-C(27)-H(27A)	109.5
C(24)-C(27)-H(27B)	109.5	H(27A)-C(27)-H(27B)	109.5
C(24)-C(27)-H(27C)	109.5	H(27A)-C(27)-H(27C)	109.5
H(27B)-C(27)-H(27C)	109.5		

Table 4. Anisotropic displacement parameters ($\text{Å}^2 \times 10^3$) for **1.17g**

atom	U11	U22	U33	U23	U13	U12
O(1)	40(1)	45(1)	41(1)	5(1)	24(1)	16(1)
O(6)	21(1)	38(1)	59(1)	0(1)	16(1)	2(1)
O(8)	59(1)	38(1)	84(1)	9(1)	48(1)	-7(1)
O(9)	34(1)	33(1)	58(1)	-11(1)	14(1)	-6(1)
O(22)	26(1)	27(1)	45(1)	-1(1)	17(1)	4(1)
N(2)	42(1)	42(1)	34(1)	8(1)	18(1)	14(1)
N(7)	24(1)	27(1)	54(1)	1(1)	16(1)	1(1)
N(23)	20(1)	25(1)	28(1)	-2(1)	11(1)	0(1)
C(3)	32(1)	27(1)	29(1)	4(1)	16(1)	3(1)
C(4)	21(1)	22(1)	33(1)	0(1)	11(1)	-1(1)
C(5)	26(1)	26(1)	45(1)	3(1)	20(1)	0(1)
C(10)	29(1)	30(1)	25(1)	6(1)	13(1)	3(1)
C(11)	41(1)	30(1)	34(1)	2(1)	10(1)	-2(1)
C(12)	34(1)	45(1)	37(1)	2(1)	3(1)	-8(1)
C(13)	28(1)	49(1)	35(1)	5(1)	6(1)	3(1)
C(14)	33(1)	36(1)	38(1)	0(1)	9(1)	8(1)
C(15)	27(1)	32(1)	34(1)	0(1)	7(1)	1(1)
C(16)	20(1)	25(1)	24(1)	0(1)	8(1)	0(1)
C(17)	21(1)	25(1)	28(1)	-1(1)	9(1)	1(1)
C(18)	32(1)	35(1)	30(1)	-3(1)	14(1)	4(1)
C(19)	36(1)	42(1)	25(1)	-6(1)	6(1)	3(1)
C(20)	25(1)	36(1)	27(1)	-3(1)	3(1)	4(1)
C(21)	21(1)	25(1)	21(1)	3(1)	7(1)	3(1)
C(24)	26(1)	23(1)	29(1)	-2(1)	10(1)	-4(1)
C(25)	45(1)	28(1)	33(1)	2(1)	13(1)	-2(1)
C(26)	51(1)	30(1)	30(1)	-4(1)	11(1)	-4(1)
C(27)	34(1)	34(1)	75(1)	-9(1)	23(1)	-10(1)

The anisotropic displacement factor exponent takes the form
 $2\pi^2 [h^2a^2U(11) + \dots + 2hka^*b^*U(12)]$

Table 5. Hydrogen Coordinates ($\text{Å} \times 10^4$) and equivalent isotropic displacement parameters ($\text{Å}^2 \times 10^3$) for **1.17g**

atom	x	y	z	U(eq)
H(23N)	3394	2560	3940	29
H(11)	2791	2925	1222	44
H(12)	-322	3394	485	50
H(13)	-957.0001	4598	776	47
H(14)	1549	5353	1775	45
H(15)	4655	4888	2537	39
H(17A)	4962	4352	4199	29
H(17B)	3581	3644	3865	29

H(18A)	4268	4122	5622	38
H(18B)	4491	3250	5531	38
H(19A)	7495	3574	6713	43
H(19B)	7558	4315	6117	43
H(20A)	8370	2867	5665	38
H(20B)	9263	3617	5446	38
H(25A)	6276	1028	4359	54
H(25B)	4470	495	4139	54
H(25C)	4944	1107	4996	54
H(26A)	2967	1779	2060	57
H(26B)	3145	917	2278	57
H(26C)	5048	1409	2570	57
H(27A)	1571	1579	4157	70
H(27B)	1126	978	3287	70
H(27C)	800	1828		

5-tert-Butylcarbamoyl-5-cyclopropyl-pent-3-ynoic acid methyl ester

1.23h

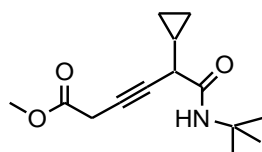

MF: C₁₄H₂₁O₃N

MW = 251 g.mol⁻¹

Method :	See general procedure 1.4 using (1 equiv., 1.64 mmol, 508 mg) of the corresponding isoxazolin-5-one.
Purification :	Flash column chromatography (silica gel, 7:2:1 tol: DCM: AcOEt)/ R _f (1:1 PE: AcOEt): 0.67.
Product :	Yellow oil.
Isolated yield :	9% (difficult to isolate).
¹H NMR (δ, ppm) (CDCl ₃ , 400 MHz)	6.66 (br s, 1H, NH), 3.74 (s, 3H, OCH ₃), 3.30 (d, J = 2.4Hz, CH ₂ CO ₂), 3.18-3.16 (m, 1H, CHCON), 1.37 (s, 9H, CH ₃ - ^t Bu), 1.30-1.24 (m, 1H, CH-cyclopropane), 0.54-0.33 (m, 4H, CH ₂ -cyclopropane).
¹³C NMR (δ, ppm) (CDCl ₃ , 100 MHz)	169.5 (Cq, OC=O), 168.9 (Cq, NC=O), 79.5 (Cq, C≡C), 78.5 (Cq, C≡C), 52.6 (OCH ₃), 51.4 (Cq, ^t Bu), 42.8 (CHCON), 28.6 (CH ₃ - ^t Bu), 25.7 (CH ₂ CO ₂), 12.3 (CH-cyclopropane), 3.1 (CH ₂ -cyclopropane), 1.4 (CH ₂ -cyclopropane).
IR (ν, cm ⁻¹) (CCl ₄)	3382 (w), 2968 (m), 1748 (s), 1721 (s), 1680 (s), 1609 (w), 1562 (m), 1519 (s), 1454 (m), 1398 (w), 1365 (m), 1338 (m), 1267 (m), 1209 (s), 1177 (s), 1021

(w).

HRMS (EI+, m/z) : Calculated: 251.1521 found: 251.1513.

4-(1-*tert*-Butylcarbamoyl-cyclopentyl)-but-3-ynoic acid methyl ester

1.23i

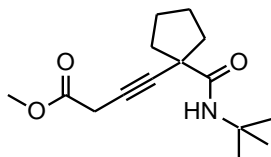

MF: C₁₅H₂₃O₃N

MW = 265g.mol⁻¹

Method : See **general procedure 1.4** using (1 equiv., 1.13 mmol, 366 mg) of the corresponding isoxazolin-5-one.

Purification : Flash column chromatography (silica gel, 2x, 95:5 toluene:AcOEt, then 9:1 PE:AcOEt)/ **R_f** (9:1 PE:AcOEt): 0.38.

Product : Transparent oil.

Isolated yield : 15%.

¹H NMR (δ, ppm) (CDCl₃, 400 MHz) 6.96 (br s, 1H, NH), 3.73 (s, 3H, OCH₃), 3.30 (s, 2H, CH₂CO₂), 2.15-2.10 (m, 2H, CH₂-cyclopentane), 1.88-1.83 (m, 2H, CH₂-cyclopentane), 1.79-1.73 (m, 4H, CH₂-cyclopentane), 1.36 (s, 9H, CH₃-^tBu).

¹³C NMR (δ, ppm) (CDCl₃, 100 MHz) 172.5 (Cq, C=O), 169.0 (Cq, C=O), 87.7 (Cq, C≡C), 76.5 (Cq, C≡C), 52.5 (OCH₃), 51.1 (Cq), 49.3 (Cq), 39.6 (CH₂), 28.6 (CH₃-^tBu), 25.8 (CH₂), 25.5 (CH₂).

IR (ν, cm⁻¹) (CCl₄) 3384 (m), 2963 (s), 2871 (m), 1750 (s), 1677 (s), 1515 (s), 1451 (s), 1396 (w), 1364 (w), 1341 (w), 1319 (w), 1265 (s), 1204 (s), 1173 (s).

HRMS (EI+, m/z) : MS (HRMS EI): calculated: 265.1678 found: 265.1665.

5-Benzyloxy-2-*p*-tolyl-pent-3-ynoic acid *tert*-butylamide

1.23j

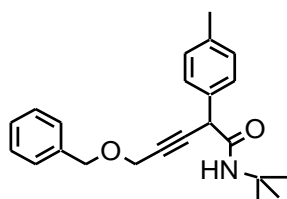
MF: C₂₃H₂₇O₂NMW = 349 g.mol⁻¹

Method : See **general procedure 1.4** using (1 equiv., 0.25 mmol, 100 mg) of the corresponding isoxazolin-5-one.

Purification : Flash column chromatography (silica gel, 95:5 toluene: AcOEt)/ **R_f** (95:5 toluene: AcOEt): 0.29.

Product : White solid.

Yield : 47%.

¹H NMR (δ, ppm) 7.36-7.32 (m, 7H, CH-Ph + CH-tolyl), 7.16 (d, *J* = 8.0 Hz, 2H, CH-tolyl), 6.24 (br s, 1H, NH), 4.62 (s, 2H, OCH₂Ph), 4.42 (t, *J* = 2.0 Hz, CHCON), 4.29 (d, *J* = 2.0 Hz, 2H, CH₂O), 2.34 (s, 3H, CH₃), 1.32 (s, 9H, CH₃-^tBu)

¹³C NMR (δ, ppm) 167.5 (Cq, C=O), 137.4 (Cq, Ar), 137.2 (Cq, Ar), 133.6 (Cq, Ar), 129.4 (CH-Ar), 128.5 (CH-Ar), 128.0 (CH-Ar), 128.0 (CH-Ar), 127.6 (CH-Ar), 83.9 (Cq, C≡C), 83.0 (Cq, C≡C), 71.7 (OCH₂Ph), 57.5 (OCH₂), 51.5 (Cq, ^tBu), 46.3 (CHCON), 28.5 (CH₃-^tBu), 21.1 (CH₃)

IR (ν, cm⁻¹) (CCl₄) 3412 (w), 3031 (w), 2968 (w), 2926 (w), 2862 (w), 1689 (s), 1512 (s), 1454 (w), 1389 (w), 1363 (w), 1270 (w), 1222 (w), 1077 (w), 1023 (w).

HRMS (EI+, *m/z*) : Calculated: 349.2042 found: 349.2049

2-Cyclopropyl-oct-7-en-3-ynoic acid *tert*-butylamide

1.23k

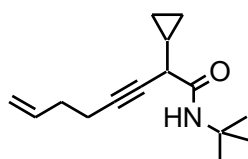
MF: C₁₅H₂₃ONMW = 233g.mol⁻¹

Method : See **general procedure 1.4** using (1 equiv., 0.30 mmol, 100mg) of the corresponding isoxazolin-5-one.

Purification :	Flash column chromatography (silica gel, 8:2 PE: AcOEt)/ R_f (8:2 PE:AcOEt): 0.68.
Product :	Pale yellow oil.
Isolated yield :	94%.
$^1\text{H NMR}$ (δ, ppm) (CDCl_3 , 400 MHz)	6.31 (br, 1H, NH), 5.87-5.77 (m, 1H, $\text{CH}=\text{CH}_2$), 5.10-5.02 (m, 2H, $\text{CH}=\text{CH}_2$), 3.16-3.14 (m, 1H, CHCON), 2.31-2.21 (m, 4H, CH_2 -homo allyl chain), 1.34 (s, 9H, CH_3 - t Bu), 1.26-1.22 (m, 1H, CH-cyclo propane), 0.52-0.31 (m, 4H, CH_2 -cyclo propane).
$^{13}\text{C NMR}$ (δ, ppm) (CDCl_3 , 100 MHz)	169.7 (Cq, C=O), 136.6 ($\text{CH}=\text{CH}_2$), 115.9 ($\text{CH}=\text{CH}_2$), 86.1 (Cq, $\text{C}\equiv\text{C}$), 76.0 (Cq, $\text{C}\equiv\text{C}$), 51.1 (Cq, t Bu), 42.9 (CHCON), 32.8 (CH_2 -homo allyl chain), 28.6 (CH_2 -homo allyl chain), 18.4 (CH_3 - t Bu), 12.3 (CH-cyclo propane), 2.8 (CH_2 -cyclo propane), 1.2 (CH_2 -cyclo propane).
IR (ν , cm^{-1}) (CCl_4)	3406 (w), 3082 (w), 2970 (w), 2926 (m), 2873 (w), 1807 (w), 1683 (s), 1565 (s), 1514 (s), 1454 (w), 1391 (w), 1365 (w), 1332 (w), 1274 (w), 1222 (w).
HRMS (EI+, m/z) :	Calculated: 233.1780 found: 233.1777.

2-Cyclopropyl-oct-7-en-3-ynoic acid benzylamide

1.23I

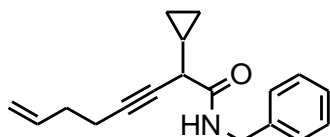

MF: $\text{C}_{18}\text{H}_{21}\text{ON}$

MW = $267\text{g}\cdot\text{mol}^{-1}$

Method :	See general procedure 1.4 using (1 equiv., 0.55 mmol, 190 mg) of the corresponding isoxazolin-5-one.
Purification :	Flash column chromatography (silica gel, 95:5 toluene: AcOEt)/ R_f (7:3 PE: AcOEt): 0.55.
Product :	Pale yellow solid.
Isolated yield :	60%.
$^1\text{H NMR}$ (δ, ppm) (CDCl_3 , 400 MHz)	7.36-7.33 (m, 2H, CH-Ph), 7.29-7.27 (m, 3H, CH-Ph), 6.82 (br t, $J = 4.8$ Hz, 1H, NH), 5.74 (ddt, 1H, $J = 6.4\text{Hz}$, $J = 10.2\text{Hz}$, $J = 16.9\text{Hz}$, 1H, $\text{CH}=\text{CH}_2$), 4.95 (ddt, $J = 1.5\text{Hz}$, $J = 1.6$ Hz, $J = 16.9$ Hz, 1H, $\text{CH}=\text{CH}_2$), 4.91 (ddt, $J = 1.0\text{Hz}$, $J = 1.6\text{Hz}$, $J = 10.2$ Hz, 1H, $\text{CH}=\text{CH}_2$), 4.50 (dd, $J = 4.8\text{Hz}$, $J = 14.0\text{Hz}$, 1H, CH_2NH), 4.45 (dd, $J = 4.8\text{Hz}$, $J = 14.0\text{Hz}$, 1H, CH_2NH), 3.37-3.35 (m, 1H,

CHCON), 2.30-2.26 (m, 2H, CH₂-homo allyl chain), 2.22-2.17 (m, 2H, CH₂-homo allyl chain), 1.39-1.31 (m, 1H, CH-cyclo propane), 0.55-0.37 (m, 4H, CH₂-cyclo propane).

¹³C NMR (δ, ppm) 170.5 (Cq, C=O), 138.2 (Cq, Ph), 136.8 (CH=CH₂), 128.6 (CH-Ph), 127.5 (CH-Ph), 127.4 (CH-Ph), 115.9 (CH=CH₂), 86.4 (Cq, C≡C), 75.4 (Cq, C≡C), 43.6 (CH₂NH), 42.2 (CHCON), 32.8 (CH₂-homo allyl chain), 18.3 (CH₂-homo allyl chain), 12.4 (CH-cyclo propane), 2.8 (CH₂-cyclo propane), 1.4 (CH₂-cyclo propane).

IR (ν, cm⁻¹) (CCl₄) 3418 (w), 3081 (w), 3030 (w), 3007 (w), 2925 (w), 2851 (w), 1682 (s), 1514 (s), 1454 (w), 1398 (w), 1356 (w), 1333 (w), 1252 (w), 1022 (w).

HRMS (EI+, m/z) : Calculated: 267.1623 found: 267.1622.

1-Hex-5-en-1-ynyl-cyclopentanecarboxylic acid *tert*-butylamide

1.23m

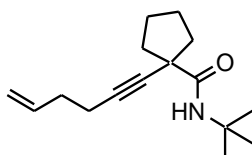

MF: C₁₆H₂₅ON

MW = 247g.mol⁻¹

Method : See **general procedure 1.4** using (1 equiv., 0.33 mmol, 100 mg) of the corresponding isoxazolin-5-one.

Purification : Flash column chromatography (silica gel, 95:5 PE:AcOEt)/ **R_f** (8:2 PE:AcOEt): 0.72.

Product : Transparent oil.

Isolated yield : 68%.

¹H NMR (δ, ppm) 6.69 (br s, 1H, NH), 5.84 (ddt, *J* = 6.3Hz, *J* = 10.2Hz, *J* = 16.9Hz, 1H, CH=CH₂), 5.10 (ddt, *J* = 1.4Hz, *J* = 1.5Hz, *J* = 16.9Hz, 1H, CH=CH₂), 5.04 (ddm, *J* = 1.4, *J* = 10.2, 1H, CH=CH₂), 2.34-2.30 (m, 2H, CH₂-cyclo pentane), 2.28-2.23 (m, 2H, CH₂-homo allyl chain), 2.15-2.08 (m, 2H, CH₂-cyclo pentane) 1.85-1.75 (m, 6H, CH₂-cyclo pentane + homo allyl chain), 1.34 (s, 9H, CH₃-^tBu).

¹³C NMR (δ, ppm) 173.0 (Cq, C=O), 136.8 (CH=CH₂), 115.9 (CH=CH₂), 84.6 (Cq, C≡C), 84.4 (Cq, C≡C), 50.9 (Cq), 50.0 (Cq), 39.8 (CH₂-homo allyl chain), 32.8 (CH₂-cyclo pentane), 28.6(CH₃-^tBu) , 25.4 (CH₂-homo allyl chain), 18.5 (CH₂-cyclo pentane).

IR (ν, cm⁻¹) (CCl₄) 3405 (w), 3080 (w), 2965 (w), 2871 (w), 1678 (s), 1512 (s), 1452 (w), 1391 (w), 1364 (w), 1334 (w), 1267 (w), 1223 (w).

HRMS (EI+, m/z) : Calculated: 247.1936 found: 247.1946.

1-(3-But-3-enyl-4-nitro-5-oxo-4,5-dihydro-isoxazol-4-yl)-
cyclopentanecarboxylic acid *tert*-butylamide

1.17m

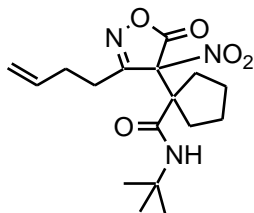

MF: C₁₇H₂₅O₅N₃

MW = 351 g.mol⁻¹

Method : See **general procedure 1.4** using (1 equiv., 0.33 mmol, 100 mg) of the corresponding isoxazolin-5-one.

Purification : Flash column chromatography (silica gel, 8:2 PE: AcOEt)/ R_f (8:2 PE:AcOEt): 0.25.

Product : White solid.

Isolated yield : 26%.

¹H NMR (δ, ppm) 5.86 (ddt, *J* = 6.4Hz, *J* = 10.2Hz, *J* = 17.0Hz, 1H, CH=CH₂), 5.48 (br s, 1H, NH), 5.11 (ddt, *J* = 1.4Hz, *J* = 1.6Hz, *J* = 17.0Hz, 1H, CH=CH₂), 5.05 (ddt, *J* = 1.3Hz, *J* = 1.4Hz, *J* = 10.2Hz, 1H, CH=CH₂), 2.79-2.60 (m, 2H, CH₂-homo allyl chain), 2.54-2.45 (m, 3H, CH₂-homo allyl chain+ CH₂-cyclo pentane), 2.33-2.24 (m, 2H, CH₂-cyclo pentane), 2.19-2.13 (m, 1H, CH₂-cyclo pentane), 1.86-1.74 (m, 2H, CH₂-cyclo pentane), 1.73-1.62 (m, 2H, CH₂-cyclo pentane), 1.30 (s, 9H, CH₃-^tBu).

¹³C NMR (δ, ppm) 170.3 (Cq, C=O), 167.4 (Cq, C=O), 163.8 (Cq, C=N), 136.0 (CH=CH₂), 116.2 (CH=CH₂), 93.6 (Cq), 60.4 (Cq), 52.3 (Cq), 32.6 (CH₂), 32.2 (CH₂), 28.6 (CH₂), 28.3 (CH₃-^tBu), 27.6 (CH₂), 25.4 (CH₂), 24.7 (CH₂).

IR (ν, cm⁻¹) (CCl₄) 3580 (w), 3436 (w), 3389 (w), 3079 (w), 2963 (s), 2930 (s), 2874 (s), 1802 (s), 1720 (s), 1679 (s), 1648 (s), 1562 (s), 1513 (s), 1454 (s), 1392 (w), 1365 (s), 1334 (s), 1263 (s), 1221 (s), 1163 (s), 1096 (s), 1020 (s).

HRMS (EI+, m/z) : Calculated: 351.1802 found: 351.1794.

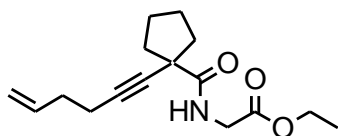

MF: C₁₆H₂₃O₃N

MW = 277 g.mol⁻¹

Method :	See general procedure 1.4 using (1 equiv., 0.30 mmol, 100 mg) of the corresponding isoxazolin-5-one.
Purification :	Flash column chromatography (silica gel, 6:4 Et ₂ O: PE)/ R _f (7:3 PE:AcOEt): 0.59.
Product :	Transparent oil.
Isolated yield :	70%.
¹H NMR (δ, ppm) (CDCl ₃ , 400 MHz)	7.35 (br s, 1H, NH), 5.85 (ddt, <i>J</i> = 6.3Hz, <i>J</i> = 10.3Hz, <i>J</i> = 16.4Hz, 1H, CH=CH ₂), 5.08 (ddt, 1H, <i>J</i> = 1.5 Hz, <i>J</i> = 1.6 Hz, <i>J</i> = 17.2Hz, 1H, CH=CH ₂), 5.03 (ddm, <i>J</i> = 1.0 Hz, <i>J</i> = 10.2Hz, 1H, CH=CH ₂), 4.21 (q, <i>J</i> = 7.2Hz, 1H, OCH ₂ CH ₃), 4.00 (d, <i>J</i> = 5.3Hz, 2H, CH ₂ NH), 2.35-2.25 (m, 4H, CH ₂ -homo allyl chain), 2.17-2.10 (m, 2H, CH ₂ -cyclo pentane), 1.92-1.86 (m, 2H, CH ₂ -cyclo pentane), 1.82-1.76 (m, 4H, CH ₂ -cyclo pentane), 1.28 (t, <i>J</i> = 7.2Hz, 3H, OCH ₂ CH ₃).
¹³C NMR (δ, ppm) (CDCl ₃ , 100 MHz)	174.2 (Cq, C=O), 169.8 (Cq, C=O), 137.1 (CH=CH ₂), 115.7 (CH=CH ₂), 84.9 (Cq, C≡C), 83.5 (Cq, C≡C), 61.4 (OCH ₂ CH ₃), 49.0 (Cq-cyclo pentane), 41.8 (CH ₂ NH), 39.9 (CH ₂ -cyclo pentane), 33.0 (CH ₂ -homo allyl chain), 25.2 (CH ₂ -cyclo pentane), 18.5 (CH ₂ -homo allyl chain), 14.1 (OCH ₂ CH ₃).
IR (ν, cm ⁻¹) (CCl ₄)	3402 (w), 3079 (w), 2954 (w), 2870 (w), 1747 (s), 1679 (s), 1512 (m), 1444 (w), 1375 (w), 1350 (w), 1206 (s), 1023 (w).
HRMS (EI+, m/z) :	Calculated: 277.1678 found: 277.1677.

1-tert-Butyl-3-cyclopropyl-5-hydroxy-4-iodo-5-phenyl-1,5-dihydro-pyrrol-2-one

1.25a

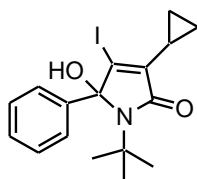

MF: C₁₇H₂₀O₂NI

MW = 397 g.mol⁻¹

- Method :** See **general procedure 1.5** using (1 equiv., 0.10 mmol, 25 mg) of the corresponding alkyne. No nucleophile added.
- Purification :** Flash column chromatography (silica gel, 8:2 PE: AcOEt)/ R_f (8:2 PE:AcOEt): 0.55.
- Product :** White solid.
- Isolated yield :** 72%.
- ¹H NMR** (δ, ppm) (CDCl₃, 400 MHz) 7.77 (br s, 1H, CH-Ph), 7.40 (br s, 1H, CH-Ph), 7.32 (t, J = 5.1Hz, 2H, CH-Ph), 7.02 (br s, 1H, CH-Ph), 2.63 (s, 1H, OH), 1.64-1.59 (m, 1H, CH₂-cyclo propane), 1.50-1.45 (m, 1H, CH-cyclo propane), 1.42-1.37 (m, 1H, CH₂-cyclo propane), 1.32 (s, 9H, CH₃-^tBu), 0.90-0.81 (m, 2H, CH₂-cyclo propane).
- ¹³C NMR** (δ, ppm) (CDCl₃, 100 MHz) 167.2 (Cq, C=O), 141.9 (Cq), 139.1 (Cq), 128.2 (CH-Ph), 127.4 (CH-Ph), 125.4 (CH-Ph), 118.9 (Cq), 93.4 (Cq), 57.2 (Cq-^tBu), 28.8 (CH₃-^tBu), 12.3 (CH-cyclo propane), 6.7 (CH₂-cyclo propane), 6.2 (CH₂-cyclo propane).
- IR** (ν, cm⁻¹) (CCl₄) 3.584 (w), 3065 (w), 3009 (w), 2965 (w), 2928 (w), 1695 (s), 1642 (w), 1451 (w), 1346 (m), 1270 (w), 1209 (w), 1170 (w), 1130 (w), 1014 (w).
- HRMS** (EI+, m/z) : Calculated: 397.0539 found: 397.0540.

X-ray structure for **1.25a**

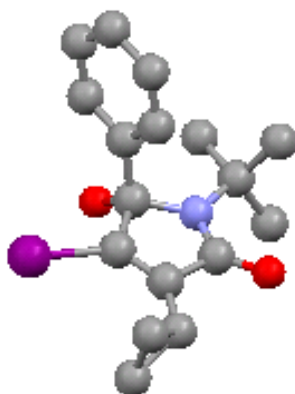

Table 1. Crystal data for **1.25a**

Compound	1.25a
Molecular formula	$C_{17}H_{20}INO_2 + CHCl_3$
Molecular weight	516.61
Crystal habit	Colorless Needle
Crystal dimensions(mm)	0.40x0.06x0.04
Crystal system	monoclinic
Space group	$P2_1/a$
a(Å)	10.4160(10)
b(Å)	20.0190(10)
c(Å)	10.0610(10)
α (°)	90.00
β (°)	97.8860(10)
γ (°)	90.00
V(Å ³)	2078.1(3)
Z	4
d(g·cm ⁻³)	1.651
F(000)	1024
μ (cm ⁻¹)	1.938
Absorption corrections	multi-scan , 0.5111 min, 0.9265 max
Diffractometer	KappaCCD
X-ray source	MoK α
λ (Å)	0.71069
Monochromator	graphite
T (K)	150.0(1)
Scan mode	phi and omega scans
Maximum θ	28.69
HKL ranges	-9 14 , -25 26 , -13 13
Reflections measured	19156
Unique data	5351
Rint	0.0445
Reflections used	3595
Criterion	$I > 2\sigma(I)$

Refinement type	Fsqd
Hydrogen atoms	mixed
Parameters refined	193
Reflections / parameter	18
wR2	0.0932
R1	0.0373
Weights a, b	0.0421 , 0.0000
GoF	0.983
difference peak / hole (e Å ⁻³)	0.699(0.093) / -0.664

Table 2. Atomic Coordinates (A x 10⁴) and equivalent isotropic displacement parameters (Å² x 10³) for **1.25a**

atom	x	y	z	U(eq)
I(1)	5317(1)	-1040(1)	4559(1)	36(1)
O(1)	2014(2)	-2433(1)	877(2)	30(1)
O(2)	2194(2)	-1345(1)	4853(2)	28(1)
N(1)	1623(2)	-1728(1)	2587(2)	22(1)
C(1)	2395(3)	-2064(2)	1833(3)	24(1)
C(2)	3787(3)	-1928(2)	2346(3)	29(1)
C(3)	3785(3)	-1483(2)	3333(3)	25(1)
C(4)	2433(3)	-1266(2)	3528(3)	23(1)
C(5)	4772(3)	-2278(2)	1707(4)	41(1)
C(6)	6102(4)	-2452(2)	2422(5)	60(1)
C(7)	5989(4)	-1921(3)	1393(4)	59(1)
C(8)	179(3)	-1759(2)	2320(3)	27(1)
C(9)	-235(4)	-2500(2)	2354(4)	42(1)
C(10)	-434(3)	-1384(2)	3424(4)	39(1)
C(11)	2198(3)	-540(2)	3124(3)	23(1)
C(12)	2351(3)	-337(2)	1840(3)	32(1)
C(13)	2151(4)	315(2)	1437(3)	41(1)
C(14)	1805(3)	794(2)	2330(3)	37(1)
C(15)	1665(3)	600(2)	3617(3)	34(1)
C(16)	1852(3)	-58(2)	4013(3)	28(1)
C(30)	-290(3)	-1441(2)	970(3)	37(1)

U(eq) is defined as 1/3 the trace of the U_{ij} tensor.

Table 3. Bond lengths (Å) and angles (deg) for **1.25a**

I(1)-C(3)	2.077(3)	O(1)-C(1)	1.234(3)
O(2)-C(4)	1.398(3)	O(2)-H(2)	0.8400
N(1)-C(1)	1.357(4)	N(1)-C(8)	1.492(4)
N(1)-C(4)	1.499(4)	C(1)-C(2)	1.496(4)
C(2)-C(3)	1.335(4)	C(2)-C(5)	1.461(5)
C(3)-C(4)	1.512(4)	C(4)-C(11)	1.521(4)
C(5)-C(6)	1.512(5)	C(5)-C(7)	1.526(6)
C(5)-H(5)	1.0000	C(6)-C(7)	1.477(7)
C(6)-H(6A)	0.9900	C(6)-H(6B)	0.9900
C(7)-H(7A)	0.9900	C(7)-H(7B)	0.9900
C(8)-C(30)	1.519(4)	C(8)-C(9)	1.546(5)

C(8)-C(10)	1.548(5)	C(9)-H(9A)	0.9800
C(9)-H(9B)	0.9800	C(9)-H(9C)	0.9800
C(10)-H(10A)	0.9800	C(10)-H(10B)	0.9800
C(10)-H(10C)	0.9800	C(11)-C(12)	1.384(4)
C(11)-C(16)	1.396(4)	C(12)-C(13)	1.374(5)
C(12)-H(12)	0.9500	C(13)-C(14)	1.395(5)
C(13)-H(13)	0.9500	C(14)-C(15)	1.378(5)
C(14)-H(14)	0.9500	C(15)-C(16)	1.383(4)
C(15)-H(15)	0.9500	C(16)-H(16)	0.9500
C(30)-H(30A)	0.9800	C(30)-H(30B)	0.9800
C(30)-H(30C)	0.9800		

C(4)-O(2)-H(2)	109.5	C(1)-N(1)-C(8)	122.6(2)
C(1)-N(1)-C(4)	109.5(2)	C(8)-N(1)-C(4)	127.3(2)
O(1)-C(1)-N(1)	125.5(3)	O(1)-C(1)-C(2)	124.8(3)
N(1)-C(1)-C(2)	109.7(2)	C(3)-C(2)-C(5)	136.1(3)
C(3)-C(2)-C(1)	106.1(3)	C(5)-C(2)-C(1)	117.8(3)
C(2)-C(3)-C(4)	112.7(2)	C(2)-C(3)-I(1)	130.3(2)
C(4)-C(3)-I(1)	117.0(2)	O(2)-C(4)-N(1)	112.0(2)
O(2)-C(4)-C(3)	112.5(2)	N(1)-C(4)-C(3)	101.2(2)
O(2)-C(4)-C(11)	108.6(2)	N(1)-C(4)-C(11)	111.4(2)
C(3)-C(4)-C(11)	111.0(3)	C(2)-C(5)-C(6)	123.6(3)
C(2)-C(5)-C(7)	121.4(3)	C(6)-C(5)-C(7)	58.2(3)
C(2)-C(5)-H(5)	114.1	C(6)-C(5)-H(5)	114.1
C(7)-C(5)-H(5)	114.1	C(7)-C(6)-C(5)	61.4(3)
C(7)-C(6)-H(6A)	117.6	C(5)-C(6)-H(6A)	117.6
C(7)-C(6)-H(6B)	117.6	C(5)-C(6)-H(6B)	117.6
H(6A)-C(6)-H(6B)	114.7	C(6)-C(7)-C(5)	60.4(3)
C(6)-C(7)-H(7A)	117.7	C(5)-C(7)-H(7A)	117.7
C(6)-C(7)-H(7B)	117.7	C(5)-C(7)-H(7B)	117.7
H(7A)-C(7)-H(7B)	114.8	N(1)-C(8)-C(30)	109.6(3)
N(1)-C(8)-C(9)	108.2(3)	C(30)-C(8)-C(9)	111.4(3)
N(1)-C(8)-C(10)	110.8(2)	C(30)-C(8)-C(10)	109.0(3)
C(9)-C(8)-C(10)	107.8(3)	C(8)-C(9)-H(9A)	109.5
C(8)-C(9)-H(9B)	109.5	H(9A)-C(9)-H(9B)	109.5
C(8)-C(9)-H(9C)	109.5	H(9A)-C(9)-H(9C)	109.5
H(9B)-C(9)-H(9C)	109.5	C(8)-C(10)-H(10A)	109.5
C(8)-C(10)-H(10B)	109.5	H(10A)-C(10)-H(10B)	109.5
C(8)-C(10)-H(10C)	109.5	H(10A)-C(10)-H(10C)	109.5
H(10B)-C(10)-H(10C)	109.5	C(12)-C(11)-C(16)	117.9(3)
C(12)-C(11)-C(4)	119.7(3)	C(16)-C(11)-C(4)	122.4(3)
C(13)-C(12)-C(11)	121.4(3)	C(13)-C(12)-H(12)	119.3
C(11)-C(12)-H(12)	119.3	C(12)-C(13)-C(14)	120.4(3)
C(12)-C(13)-H(13)	119.8	C(14)-C(13)-H(13)	119.8
C(15)-C(14)-C(13)	118.8(3)	C(15)-C(14)-H(14)	120.6
C(13)-C(14)-H(14)	120.6	C(14)-C(15)-C(16)	120.7(3)
C(14)-C(15)-H(15)	119.7	C(16)-C(15)-H(15)	119.7
C(15)-C(16)-C(11)	120.8(3)	C(15)-C(16)-H(16)	119.6
C(11)-C(16)-H(16)	119.6	C(8)-C(30)-H(30A)	109.5
C(8)-C(30)-H(30B)	109.5	H(30A)-C(30)-H(30B)	109.5
C(8)-C(30)-H(30C)	109.5	H(30A)-C(30)-H(30C)	109.5
H(30B)-C(30)-H(30C)	109.5		

Table 4. Anisotropic displacement parameters ($\text{\AA}^2 \times 10^3$) for **1.25a**

atom	U11	U22	U33	U23	U13	U12
I(1)	31(1)	33(1)	40(1)	-5(1)	-5(1)	-6(1)
O(1)	32(1)	29(1)	30(1)	-10(1)	3(1)	1(1)
O(2)	42(1)	22(1)	19(1)	3(1)	5(1)	0(1)
N(1)	22(1)	17(1)	27(1)	-5(1)	1(1)	0(1)
C(1)	27(2)	20(2)	27(2)	-2(1)	5(1)	0(1)
C(2)	21(2)	28(2)	36(2)	-2(1)	1(1)	2(1)
C(3)	22(2)	22(2)	30(2)	-1(1)	-2(1)	-2(1)
C(4)	28(2)	20(2)	19(1)	-3(1)	3(1)	-2(1)
C(5)	26(2)	46(2)	49(2)	-18(2)	1(2)	6(2)
C(6)	31(2)	71(3)	73(3)	-20(2)	-5(2)	22(2)
C(7)	31(2)	92(4)	57(2)	-16(2)	17(2)	-1(2)
C(8)	23(2)	30(2)	29(2)	-3(1)	4(1)	-2(1)
C(9)	31(2)	33(2)	61(2)	7(2)	7(2)	-5(2)
C(10)	21(2)	45(2)	52(2)	-12(2)	12(2)	3(2)
C(11)	24(2)	19(2)	26(1)	-4(1)	3(1)	-2(1)
C(12)	48(2)	22(2)	27(2)	-2(1)	10(1)	-1(2)
C(13)	60(2)	30(2)	33(2)	3(2)	8(2)	6(2)
C(14)	48(2)	19(2)	42(2)	2(1)	-2(2)	-1(2)
C(15)	47(2)	19(2)	35(2)	-8(1)	0(2)	7(2)
C(16)	36(2)	27(2)	21(1)	-1(1)	4(1)	3(1)
C(30)	26(2)	47(2)	38(2)	4(2)	-1(1)	7(2)

The anisotropic displacement factor exponent takes the form
 $2\pi^2 [h^2 a^{*2} U(11) + \dots + 2hka^* b^* U(12)]$

Table 5. Hydrogen Coordinates ($\text{\AA} \times 10^4$) and equivalent isotropic displacement parameters ($\text{\AA}^2 \times 10^3$) for **1.25a**

atom	x	y	z	U(eq)
H(2)	2306	-1746	5083	41
H(5)	4413	-2610	1013	49
H(6A)	6314	-2315	3373	71
H(6B)	6484	-2884	2198	71
H(7A)	6297	-2022	527	71
H(7B)	6127	-1454	1703	71
H(9A)	49	-2685	3248	63
H(9B)	165	-2752	1684	63
H(9C)	-1180	-2532	2153	63
H(10A)	-178	-1604	4291	58
H(10B)	-1380	-1392	3207	58
H(10C)	-131	-920	3473	58
H(12)	2600	-656	1224	38
H(13)	2248	440	546	49
H(14)	1668	1245	2056	44
H(15)	1437	922	4238	41
H(16)	1743	-184	4901	34
H(30A)	-44	-969	991	56
H(30B)	-1235	-1480	778	56
H(30C)	108	-1670		

1-tert-Butyl-3-cyclopropyl-4-iodo-5-methoxy-5-phenyl-1,5-dihydro-pyrrol-2-one

1.25b

MF: C₁₈H₂₂O₂NI

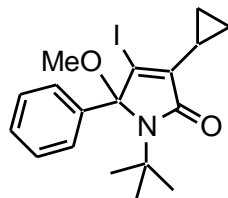

MW = 411 g.mol⁻¹

- Method :** See **general procedure 1.5** using (1 equiv., 0.10 mmol, 26 mg) of the corresponding alkyne and (10 equiv., 1 mmol, 41 μ L) of MeOH.
- Purification :** Flash column chromatography (silica gel, 8:2 PE: AcOEt)/ **R_f** (8:2 PE:AcOEt): 0.86.
- Product :** Yellow solid.
- Isolated yield :** 76%.
- ¹H NMR** (δ , ppm) (CDCl₃, 400 MHz) 7.78 (d, *J* = 7.4Hz, 1H, CH-Ph), 7.39 (t, *J* = 7.2Hz, 1H, CH-Ph), 7.30 (dt, *J* = 7.4Hz, *J* = 7.2Hz, 2H, CH-Ph), 6.96 (d, *J* = 7.2Hz, 1H, CH-Ph), 3.25 (s, 3H, OCH₃), 1.67 (tt, *J* = 5.3Hz, *J* = 8.7Hz, 1H, CH-cyclo propane), 1.50-1.40 (m, 2H, CH₂-cyclo propane), 1.28 (s, 9H, CH₃-^tBu), 0.89-0.84 (m, 2H, CH₂-cyclo propane).
- ¹³C NMR** (δ , ppm) (CDCl₃, 100 MHz) 167.8 (Cq, C=O), 143.6 (Cq), 139.0 (Cq), 128.3 (CH-Ph), 128.2 (CH-Ph), 127.8 (CH-Ph), 127.7 (CH-Ph), 125.7 (CH-Ph), 115.8 (Cq), 97.5 (Cq), 56.9 (Cq, ^tBu), 49.8 (OCH₃), 28.1 (CH₃-^tBu), 12.2 (CH-cyclo propane), 6.7 (CH₂-cyclo propane), 6.3(CH₂-cyclo propane)
- IR** (ν , cm⁻¹) (CCl₄) 3064 (w), 3004 (w), 2965 (w), 2935 (w), 2833 (w), 1693 (s), 1643 (w), 1488 (w), 1394 (w), 1362 (w), 1337 (m), 1272 (w), 1247 (w), 1210 (w), 1117 (w), 1075 (w).
- HRMS** (EI+, m/z) : calculated: 411.0696 found: 411.0702.

5-Allyloxy-1-*tert*-butyl-3-cyclopropyl-4-iodo-5-phenyl-1,5-dihydro-pyrrol-2-one

1.25c

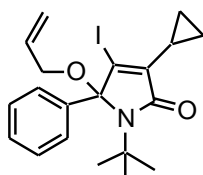

MF: C₂₀H₂₄O₂Ni

MW = 437 g.mol⁻¹

- Method :** See **general procedure 1.5** using (1 equiv., 0.10 mmol, 26 mg) of the corresponding alkyne and (10 equiv., 1 mmol, 70 μ L) of allyl alcohol.
- Purification :** Flash column chromatography (silica gel, 9:1 PE:AcOEt)/ R_f (9:1 PE:AcOEt): 0.74.
- Product :** Yellow solid.
- Isolated yield :** 72%.
- ¹H NMR** (δ , ppm) (CDCl₃, 400 MHz) 7.86 (d, *J* = 7.8Hz, 1H, CH-Ph), 7.40 (t, *J* = 7.4Hz, 1H, CH-Ph), 7.34-7.28 (m, 2H, CH-Ph), 6.96 (d, *J* = 7.4Hz, 1H, CH-Ph), 6.04 (ddt, *J* = 5.1Hz, *J* = 10.4Hz, *J* = 17.2Hz, 1H, CH=CH₂), 5.46 (ddt, 1H, *J* = 1.5Hz, *J* = 1.7Hz, *J* = 17.2Hz, 1H, CH=CH₂), 5.26 (ddt, *J* = 1.5Hz, *J* = 1.7Hz, *J* = 10.4Hz, 1H, CH=CH₂), 3.93 (ddt, *J* = 1.7 Hz, *J* = 5.2 Hz, *J* = 12.4 Hz, 1H, OCH₂), 3.88 (ddt, *J* = 1.7 Hz, *J* = 5.2 Hz, *J* = 12.4 Hz, 1H, OCH₂), 1.67 (tt, *J* = 5.3Hz, *J* = 8.6Hz, 1H, CH-cyclo propane), 1.50-1.41 (m, 2H, CH₂-cyclo propane), 1.28 (s, 9H, CH₃-^tBu), 0.91-0.82 (m, 2H, CH₂-cyclo propane).
- ¹³C NMR** (δ , ppm) (CDCl₃, 100 MHz) 167.7 (Cq, C=O), 143.4 (Cq), 139.0 (Cq), 133.6 (CH=CH₂), 128.4 (CH-Ph), 128.2 (CH-Ph), 127.8 (CH-Ph), 127.8 (CH-Ph), 125.7 (CH-Ph), 116.8 (CH=CH₂), 115.9 (Cq), 96.9 (Cq), 63.1 (OCH₂), 57.0 (Cq, ^tBu), 28.1 (CH₃-^tBu), 12.2 (CH-cyclopropane), 6.7 (CH₂-cyclo propane), 6.3 (CH₂-cyclo propane).
- IR** (ν , cm⁻¹) (CCl₄) 3081 (w), 3008 (w), 2967 (w), 2927 (w), 1693 (s), 1643 (w), 1551 (w), 1451 (w), 1395 (w), 1363 (w), 1337 (m), 1272 (w), 1248 (w), 1212 (w), 1125 (w), 1062 (w), 1023 (w) .
- HRMS** (EI+, m/z) : Calculated: 437.0852 found: 437.0837.

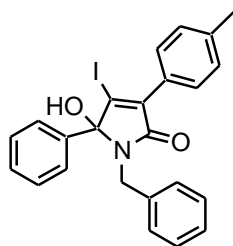
MF: C₂₄H₂₀O₂NIMW = 481 g.mol⁻¹

Method :	See general procedure 1.5 using (1 equiv., 0.10 mmol, 36 mg) of the corresponding alkyne. No nucleophile added.
Purification :	Flash column chromatography (silica gel, 95:5 PE:AcOEt)/ R _f (8:2 PE: AcOEt): 0.54.
Product :	Yellow solid.
Isolated yield :	68%.
¹H NMR (δ, ppm) (CDCl ₃ , 400 MHz)	7.68 (d, <i>J</i> = 8.2Hz, 2H, CH-tolyl), 7.39-7.37 (m, 5H, CH-Ph), 7.27-7.26 (m, 5H, CH-Ph), 7.22 (d, <i>J</i> = 8.2Hz, 2H, CH-tolyl), 4.82 (d, <i>J</i> = 15.0Hz, 1H, <u>CH</u> ₂ N), 4.01 (d, <i>J</i> = 15.0Hz, 1H, <u>CH</u> ₂ N), 2.42 (s, 1H, OH), 2.39 (s, 3H, CH ₃).
¹³C NMR (δ, ppm) (CDCl ₃ , 100 MHz)	166.8 (Cq, C=O), 140.6 (Cq), 139.5 (Cq), 137.9 (Cq), 136.4 (Cq), 129.0 (CH-Ar), 128.9 (CH-Ar), 128.9 (CH-Ar), 128.9 (CH-Ar), 128.7 (CH-Ar), 128.4 (CH-Ar), 127.5 (Cq), 127.3 (CH-Ar), 126.6 (CH-Ar), 120.0 (Cq), 93.2 (Cq), 44.6 (CH ₂ N), 21.5 (CH ₃).
IR (ν, cm ⁻¹) (CCl ₄)	3577 (w), 3065 (w), 3033 (w), 2926 (w), 2859 (w), 1708 (s), 1622 (w), 1551 (w), 1498 (w), 1450 (w), 1385 (w), 1335 (w), 1280 (w), 1166 (w), 1073 (w), 1047 (w).
HRMS (EI+, <i>m/z</i>) :	calculated: 481.0539 found: 481.0527.

1-Benzyl-5-but-3-enyl-3-cyclopropyl-4-iodo-5-methoxy-1,5-dihydro-pyrrol-2-one

1.25e

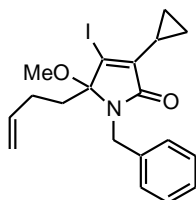
MF: C₁₉H₂₂O₂NIMW = 423 g.mol⁻¹

Method :	See general procedure 1.5 using (1 equiv., 0.10 mmol, 27 mg) of the corresponding alkyne and (10 equiv., 1 mmol, 41 μ L) of MeOH.
Purification :	Flash column chromatography (silica gel, 95:5 PE:AcOEt)/ R_f (95:5 PE:AcOEt): 0.54.
Product :	Yellow oil.
Isolated yield :	70%.
¹H NMR (δ , ppm) (CDCl ₃ , 400 MHz)	7.36-7.30 (m, 4H, CH-Ph), 7.24-7.20 (m, 1H, CH-Ph), 5.77 (ddt, $J = 6.2\text{Hz}$, $J = 10.2\text{Hz}$, $J = 16.9\text{Hz}$, 1H, <u>CH</u> =CH ₂), 4.99 (ddm, $J = 1.2\text{Hz}$, $J = 16.9\text{Hz}$, 1H, CH= <u>CH</u> ₂), 4.94 (ddm, $J = 1.2\text{Hz}$, $J = 10.2\text{ Hz}$, 1H, CH= <u>CH</u> ₂), 4.58 (d, $J = 16.2\text{Hz}$, 1H, CH ₂ N), 4.53 (d, $J = 16.2\text{Hz}$, 1H, CH ₂ N), 3.09 (s, 3H, OCH ₃), 2.06-1.90 (m, 4H, CH ₂ -homo allyl chain), 1.78-1.71 (m, 1H, CH-cyclo propane), 1.60-1.54 (m, 2H, CH ₂ -cyclo propane), 0.90-0.83 (m, 2H, CH ₂ -cyclo propane).
¹³C NMR (δ , ppm) (CDCl ₃ , 100 MHz)	156.5 (Cq, C=O), 144.4 (Cq), 140.5 (Cq), 137.4 (<u>CH</u> =CH ₂), 128.2 (CH-Ph), 127.4 (CH-Ph), 126.3 (CH-Ph), 114.9(CH= <u>CH</u> ₂), 111.2 (Cq), 106.2 (Cq), 50.5 (CH ₂ N), 49.5 (OCH ₃), 36.1 (CH ₂ -homo allyl chain), 27.0 (CH ₂ -homo allyl chain), 12.3 (CH-cyclo propane), 7.1 (CH ₂ -cyclo propane), 6.5 (CH ₂ -cyclo propane).
IR (ν , cm ⁻¹) (CCl ₄)	3069 (w), 3012 (w), 2958 (w), 2933 (w), 2360 (w), 2337 (w), 1688 (s), 1642 (w), 1618 (w), 1496 (w), 1451 (w), 1354 (w), 1327 (w), 1327 (w), 1299 (w), 1268 (w), 1170 (w), 1130 (w), 1037 (w), 987 (w).
HRMS (EI+, m/z) :	calculated: 423.696 found: 423.0677.

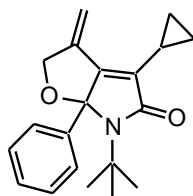
MF: C₂₀H₂₃O₂NMW = 309 g.mol⁻¹

- Method :** To a round bottom flask at room temperature under an argon atmosphere charged with 5-allyloxy-1-*tert*-butyl-3-cyclopropyl-4-iodo-5-phenyl-1,5-dihydro-pyrrol-2-one (1 equiv., 0.07 mmol, 31 mg), CH₃CN (850 μL) and THF (280 μL) was added Et₃N (1.5 equiv., 0.11 mmol, 15 μL) and then Pd(PPh₃)₄ (0.10 equiv., 0.007 mmol, 8 mg). The reaction was allowed to heat up to reflux (T < 82 °C) and to stir at this temperature overnight. Upon completion (TLC), the volatiles were evaporated. Purification by flash column chromatography afforded the title compound in the stated yield.
- Reference:** Morice, C.; Domostoj, M.; Briner, K.; Mann, A.; Suffert, J.; Wermuth, C-G.; *Tetrahedron Letters*, 42, **2001**, 6499.
- Purification :** Flash column chromatography (silica gel, 95:5 PE AcOEt)/ R_f (9:1 PE:AcOEt): 0.38.
- Product :** White solid.
- Isolated yield :** 51%.
- ¹H NMR** (δ, ppm) (CDCl₃, 400 MHz) 7.35-7.27 (m, 5H, CH-Ph), 5.36 (t, *J* = 2.2Hz, 1H, C=CH₂), 5.10 (t, *J* = 2.2Hz, 1H, C=CH₂), 4.92 (dt, *J* = 2.2Hz, *J* = 13.1Hz, 1H, OCH₂), 4.78 (dt, *J* = 2.2Hz, *J* = 13.1Hz, 1H, OCH₂), 1.81-1.74 (m, 1H, CH-cyclo propane), 1.53-1.48 (m, 1H, CH₂-cyclo propane), 1.26-1.22 (m, 1H, CH₂-cyclo propane), 1.24 (s, 9H, CH₃-^tBu), 0.93-0.86 (m, 2H, CH₂-cyclo propane).
- ¹³C NMR** (δ, ppm) (CDCl₃, 100 MHz) 171.9 (Cq, C=O), 153.3 (Cq), 137.5 (Cq), 136.1 (Cq), 132.0 (Cq), 128.3 (CH-Ph), 127.9 (CH-Ph), 126.8 (CH-Ph), 109.2 (C=CH₂), 100.3 (Cq), 75.8 (OCH₂), 56.0 (Cq, ^tBu), 28.2 (CH₃-^tBu), 8.4 (CH-cyclo propane), 7.6 (CH₂-cyclo propane), 5.3 (CH₂-cyclo propane).
- IR** (ν, cm⁻¹) (CCl₄) 3064 (w), 2964 (w), 2928 (w), 2869 (w), 1694 (s), 1597 (w), 1485 (w), 1451 (w), 1392 (w), 1363 (w), 1333 (w), 1293 (w), 1263 (w), 1215 (w), 1142 (w), 1025 (w).
- HRMS** (EI+, m/z) : Calculated: 309.1729 found: 309.1742.

B.3.2 Chapter 3: Synthesis of functionalized oxazolones by a sequence of copper (II) and gold (I)-catalyzed transformations

Only experiments performed by this author are presented in this section. The substrates reported in this section are marked with a red star (*).

B.3.2.1 Synthesis of ynamides *via* a Cu-mediated coupling reaction:

The synthetic route employed for the synthesis of ynamides is depicted in the scheme below:

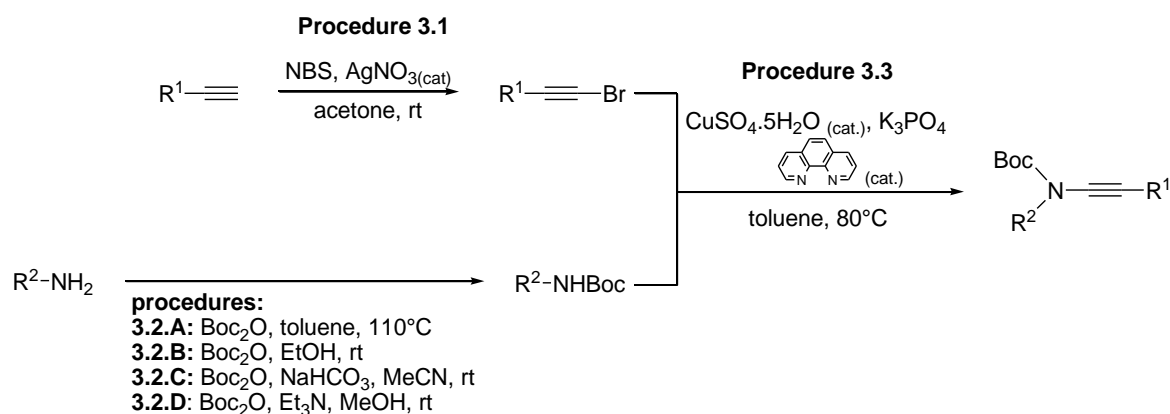

Ynamides synthesized:

3.15a, R¹ = Ph, R² = Ph

3.15b^{*}, R¹ = Ph, R² = 4-F-Ph

3.15c, R¹ = Ph, R² = 4-Cl-Ph

3.15d, R¹ = Ph, R² = 4-Br-Ph

3.15e^{*}, R¹ = Ph, R² = 2-OMe-4-OMe-Ph

3.15f^{*}, R¹ = Ph, R² = Bn

3.15g, R¹ = Ph, R² = CH₂CO₂Et

3.15h, R¹ = Ph, R² = CH(S)-Me-CO₂Me

3.15i, R¹ = ^tBu, R² = Ph

3.15j^{*}, R¹ = *n*-C₅H₁₁, R² = Ph

3.15k^{*}, R¹ = *n*-C₅H₁₁, R² = Bn

3.15l, R¹ = , R² = Ph

3.15m, R¹ = , R² = 4-Cl-Ph

3.15n, R¹ = , R² = CH₂CO₂Et

3.15o^{*}, R¹ = CH₂OAc, R² = Ph

3.15p, R¹ = CH₂OAc, R² = 2-Napht

3.15q^{*}, R¹ = CH₂OAc, R² = Bn

3.15r^{*}, R¹ = CH₂OAc, R² = CH₂CO₂Et

3.15s, R¹ = CH₂CH₂CH₂OTIPS, R² = Ph

3.15t^{*}, R¹ = CH₂CH₂CH₂OTIPS, R² = Bn

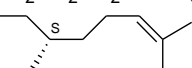
3.15u, R¹ = , R² = Ph

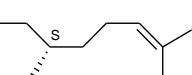
3.15v, R¹ = , R² = Bn

3.15w^{*}, R¹ = , R² = Ph
n-C₅H₁₁-≡

3.15x^{*}, R¹ = , R² = Bn
n-C₅H₁₁-≡

3.15y^{*}, R¹ = Ph, R² = 
n-C₅H₁₁-≡

Scheme B.3.2.1: Synthesis of ynamides.

General Procedure 3.1., *NBS promoted bromination of terminal alkynes*: To a round bottom flask charged with the alkyne (1 equiv.) and acetone (0.15 M) at 0 °C. was added *N*-bromo succinimide (1.2 equiv) and AgNO₃ (0.1 equiv.). The reaction mixture was allowed to warm up to room temperature, the flask was covered with an aluminium foil to avoid light exposure and the reaction was allowed to stir at room temperature until completion (TLC). The reaction mixture was then diluted in H₂O, extracted with Et₂O (3x), dried (MgSO₄) and concentrated under reduced pressure. Purification of the crude mixture by flash column chromatography afforded the bromoalkynes in the stated yields.

Synthesis of ^tBu-carbamates (Boc protection of amines):

General Procedure 3.2.A²⁹⁶: To a round bottom flask charged with aniline (1 equiv.) and toluene (1M) at room temperature was added Boc₂O (1.5 equiv.). The resulting mixture was heated up to reflux (110 °C) and allowed to stir at this temperature until completion (TLC). The reaction usually takes one to two hours. The mixture is then concentrated under reduced pressure and the solid obtained recrystallized from an adequate solvent mixture.

General Procedure 3.2.B²⁹⁷: To a round bottom flask charged with amine (1 equiv.) and EtOH (1M) at room temperature was added Boc₂O (1.1 equiv) and allowed to stir at this temperature. Upon completion (TLC), the reaction mixture is concentrated under reduced pressure and the resulting solid recrystallized from an adequate solvent mixture. The reaction usually takes about 10 min.

General Procedure 3.2.C²⁹⁸: To a round bottom flask charged with amine (1 equiv.) and MeCN (0.2 M) at 0 °C was added NaHCO₃ (3 equiv.) and Boc₂O (1 equiv.). The reaction was allowed to warm up and to stir at room temperature until completion (TLC). The reaction was generally left for 24h. The solution is then concentrated under reduced pressure. The residue is then diluted in water, extracted with DCM (3x), washed with brine (1x), dried (MgSO₄) and concentrated under reduced pressure. Purification by flash column chromatography afforded the expected pure product.

²⁹⁶ Schlosser, M.; Ginanneschi, A.; Leroux, F.; *Eur. J. Org. Chem*, **2006**, 2006, 2956.

²⁹⁷ Vilaivan, T.; *Tetrahedron Lett.*, **2006**, 47, 6739.

²⁹⁸ Simpson, G. L.; Gordon, A. H.; Lindsay, D. M. Promsawan, N.; Crump, M. P.; Mulholand, K.; Hayter, B. R.; Gallagher, T.; *J. Am. Chem. Soc.*, **2006**, 128, 10638.

General Procedure 3.2.D²⁹⁹: To a round bottom flask charged with amine (1 equiv.) and MeOH (0.75 M) were added Et₃N (1.5 equiv.) and Boc₂O (1.05 equiv.). The reaction mixture was allowed to stir at room temperature until completion (TLC). The reaction was generally left for 24h. The solution is then concentrated under reduced pressure. The residue is then diluted in water, extracted with DCM (3x), washed with brine (1x), dried (MgSO₄) and concentrated under reduced pressure. The expected product is generally pure and used directly in the following step.

General Procedure 3.3³⁰⁰, *Cu-mediated coupling reaction between carbamates and bromoalkynes*: To a round bottom flask at room temperature, under an argon flow and closed with a rubber septum were sequentially added: bromoalkyne (1 equiv.), anhydrous toluene (0.33 M), carbamate (1.2 equiv.) K₃PO₄ (2.4 equiv.), CuSO₄·5H₂O (0.2 equiv.) and 1,10-phenanthroline (0.4 equiv.). The argon flow was removed and the flask was heated up to 80 °C for 16 to 72 h, while being periodically monitored by TLC. Upon completion, the reaction was left to cool down to room temperature, diluted in AcOEt, filtered through a short pad of celite and concentrated under reduced pressure. Purification of the crude mixture by flash column chromatography afforded the title compounds in the stated yields.

(4-Fluoro-phenyl)-phenylethynyl-carbamic acid *tert*-butyl ester

3.15b

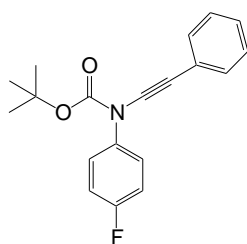

MF: C₁₁H₁₄O₂NF

MW = 311 g.mol⁻¹

Method : See **general procedure 3.3** using (1 equiv., 2 mmol, 362 mg) of bromoethynylbenzene and (1.2 equiv., 2.4 mmol, 506 mg) of (4-fluoro-phenyl)-carbamic acid *tert*-butyl ester.

²⁹⁹ Yuste, F.; Ortiz, B.; Carrasco, A.; Peralta, M.; Quintero, L.; Sánchez-Obregón, R.; Walls, F.; Garcia Ruano, J. L.; *Tetrahedron: Asymmetry*, **2000**, 11, 3079.

³⁰⁰ The protocol for the synthesis of ynamides consists on a slight modification of a procedure previously reported by Hsung *et al*: (a) Zhang, Y.; Hsung, R. P.; Tracey, M. R.; Kurtz, K. C. M.; Vera, E. L. *Org. Lett.* **2004**, 6, 1151. (b) Zhang, X.; Zhang, Y.; Huang, J.; Hsung, R. P.; Kurtz, K. C. M.; Oppenheimer, J.; Peterson, M. E.; Sagamanova, I. K.; Shen, L.; Tracey, M. R.; *J. Org. Chem.* **2006**, 71, 4170.

Purification :	Flash column chromatography (silica gel, 95:5 PE:Et ₂ O).
Product :	Yellow oil that crystallizes in the fridge to give a transparent solid.
Conversion:	100%.
Isolated yield:	65%.
¹H NMR (δ, ppm) (CDCl ₃ , 400 MHz)	7.49 (dd, <i>J</i> _{H-H} = 8.9Hz, <i>J</i> _{H-F} = 4.8Hz, 2H, CH-Ar), 7.39 (dd, <i>J</i> _{H-H} = 1.6Hz, <i>J</i> _{H-H} = 8.0Hz, 2H, CH-Ph), 7.32-7.26 (m, 3H, CH-Ph), 7.08 (t, <i>J</i> _{H-H/H-F} = 8.9Hz, 2H, CH-Ar), 1.57 (s, 9H, CH ₃ - ^t Bu).
¹³C NMR (δ, ppm) (CDCl ₃ , 100 MHz)	161.0 (d, <i>J</i> _{C-F} = 244.9Hz, Cq, Ar), 152.9 (Cq, NC=O), 135.6 (d, <i>J</i> _{C-F} = 3.1Hz, Cq, Ar), 130.9 (CH-Ph), 128.3 (CH-Ph), 127.5 (CH-Ph), 126.6 (d, <i>J</i> _{C-F} = 8.4Hz, CH-Ar), 123.2 (Cq, Ph), 115.6 (d, <i>J</i> _{C-F} = 22.8Hz, CH-Ar), 83.7 (Cq, ^t Bu), 83.5 (Cq, C≡C), 70.1 (Cq, C≡C), 28.0 (CH ₃ - ^t Bu).
IR (ν, cm ⁻¹) (CCl ₄)	3058 (w), 2980 (m), 2933 (w), 2252 (s), 1875 (w), 1737 (s), 1599 (m), 1508 (s), 1453 (w), 1391 (w), 1364 (s), 1290 (s), 1238 (s), 1158 (s), 1096 (w), 1068 (w), 1009 (m).
HRMS (EI+, m/z) :	Calculated: 311.1322 found: 311.1312.

(2,4-Dimethoxy-phenyl)-phenylethynyl-carbamic acid *tert*-butyl ester

3.15e

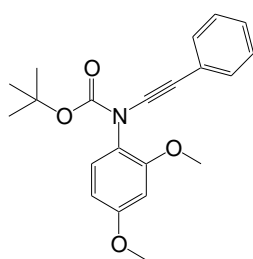

MF: C₂₁H₂₃O₄N

MW = 353 g.mol⁻¹

Method :	See general procedure 3.3 using (1 equiv., 2 mmol, 362 mg) of bromoethynylbenzene and (1.2 equiv., 2.4 mmol, 607 mg) of (2,4-dimethoxy-phenyl)-carbamic acid <i>tert</i> -butyl ester.
Purification :	Flash column chromatography (silica gel, 9:1 PE:AcOEt).
Product :	Brown solid in foam form.
Conversion:	33%.

Isolated Yield :	22%.
¹H NMR (δ, ppm) (CDCl ₃ , 400 MHz)	7.37-7.35 (m, 2H, CH-Ph), 7.29-7.21 (m, 4H, CH-Ph + CH-Ar), 6.52-6.48 (m, 2H, CH-Ar), 3.86 (s, 3H, OCH ₃), 3.82 (s, 3H, OCH ₃), 1.51 (s, 9H, CH ₃ - ^t Bu).
¹³C NMR (δ, ppm) (CDCl ₃ , 100 MHz)	160.5 (Cq, NC=O), 155.4 (Cq, Ar), 153.4 (Cq, Ar), 130.7 (CH-Ph), 128.6 (CH-Ar), 128.0 (CH-Ph), 126.9 (CH-Ph), 123.7 (Cq, Ph), 121.8 (Cq, Ar), 104.2 (CH-Ar), 99.5 (CH-Ar), 84.7 (Cq, ^t Bu), 82.5 (Cq, C≡C), 67.9 (Cq, C≡C), 55.7 (OCH ₃), 55.4 (OCH ₃), 27.8 (CH ₃ - ^t Bu).
IR (ν, cm ⁻¹) (CCl ₄)	3079 (w), 2977 (s), 2936 (s), 2838 (s), 2251 (s), 1734 (s), 1607 (s), 1513 (s), 1462 (s), 1420 (w), 1367 (s), 1321 (s), 1295 (s), 1254 (s), 1213 (s), 1162 (s), 1130 (s), 1041 (s), 1005 (m), 972 (w).
HRMS (EI+, m/z) :	calculated: 353.1627 found: 353.1626.

Benzyl-phenylethynyl-carbamic acid *tert*-butyl ester

3.15f

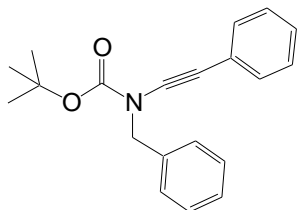

MF: C₂₀H₂₁O₂N

MW = 307 g.mol⁻¹

Method :	See general procedure 3.3 , using (1 equiv., 2 mmol, 362 mg) of bromoethynyl-benzene and (1.2 equiv., 2.4 mmol, 497 mg) of benzyl-carbamic acid <i>tert</i> -butyl ester.
Purification :	Flash column chromatography (silica gel, 95:5 PE:Et ₂ O)/ R _f (95:5 PE: Et ₂ O): 0.56.
Product :	Yellow oil that crystallizes in the fridge to give a white solid.
Conversion	< 100% (difficult to estimate).
Isolated Yield :	62%.
¹H NMR (δ, ppm) (CDCl ₃ , 400 MHz)	7.40-7.24 (m, 10H, CH-Ph), 4.67 (s, 2H, CH ₂ N), 1.53 (s, 9H, CH ₃ - ^t Bu).

¹³C NMR (δ, ppm) (CDCl ₃ , 100 MHz)	153.7 (Cq, NC=O), 136.3 (Cq, Ph), 130.5 (CH-Ph), 128.4 (CH-Ph), 128.2 (CH-Ph), 128.0 (CH-Ph), 127.8 (CH-Ph), 127.0 (CH-Ph), 123.5 (Cq, Ph), 84.0 (Cq, C≡C), 82.5 (Cq, ^t Bu), 70.9 (Cq, C≡C), 53.0 (CH ₂ N), 27.9 (CH ₃ - ^t Bu).
IR (ν, cm ⁻¹) (CCl ₄)	3063 (w), 3033 (w), 2979 (w), 2934 (w), 2243 (m), 1722 (s), 1496 (w), 1447 (w), 1393 (m), 1366 (m), 1302 (s), 1244 (m), 1159 (s), 1072 (w), 1026 (w), 995 (w).
HRMS (EI+, m/z) :	calculated: 307.1572 found: 307.1579.

Hept-1-ynyl-phenyl-carbamic acid *tert*-butyl ester

3.15j

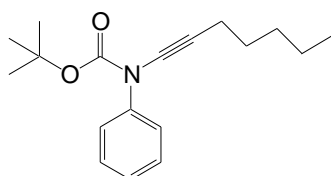

MF: C₁₆H₂₅O₂N

MW = 287 g.mol⁻¹

Method :	See general procedure 3.3 , using (1 equiv., 2 mmol, 350 mg) of 1-bromohept-1-yne and (1.2 equiv., 2.4 mmol, 464 mg) of phenyl-carbamic acid <i>tert</i> -butyl ester.
Purification :	Flash column chromatography (silica gel, 95:5 PE: Et ₂ O).
Product :	Yellow oil.
Conversion:	76%.
Isolated Yield :	69%.
¹H NMR (δ, ppm) (CDCl ₃ , 400 MHz)	7.48 (d, <i>J</i> = 7.7Hz, 2H, CH-Ph), 7.35 (t, <i>J</i> = 7.7Hz, 2H, CH-Ph), 7.20 (t, <i>J</i> = 7.7Hz, 1H, CH-Ph), 2.33 (t, <i>J</i> = 7.0Hz, 2H, CH ₂ -pentyl chain), 1.59-1.54 (m, 2H, CH ₂ -pentyl chain), 1.63 (s, 9H, CH ₃ - ^t Bu), 1.45-1.28 (m, 4H, CH ₂ -pentyl chain), 0.91 (t, <i>J</i> = 7.2Hz, 3H, CH ₃ -pentyl chain),
¹³C NMR (δ, ppm) (CDCl ₃ , 100 MHz)	153.5 (Cq, NC=O), 140.2 (Cq, Ph), 128.5 (CH-Ph), 126.0 (CH-Ph), 124.4 (CH-Ph), 82.7 (Cq, ^t Bu), 74.2 (Cq, C≡C), 69.2 (Cq, C≡C), 30.9 (CH ₂ -pentyl chain), 28.5 (CH ₂ -pentyl chain), 27.9 (CH ₃ - ^t Bu), 22.1 (CH ₂ -pentyl chain), 18.4 (CH ₂ -pentyl chain), 13.9 (CH ₃ -pentyl chain).
IR (ν, cm ⁻¹) (CCl ₄)	3068 (w), 3039 (w), 2959 (s), 2932 (s), 2862 (m), 2267 (m), 1731 (s), 1594 (m), 1495 (m), 1460 (m), 1389 (w), 1366 (m), 1296 (s), 1256 (s), 1215 (m), 1161 (s), 1073 (w), 1049 (w), 1019 (w).

HRMS (EI+, m/z) : calculated: 287.1885 found: 287.1889.

Benzyl-hept-1-ynyl-carbamic acid *tert*-butyl ester

3.15k

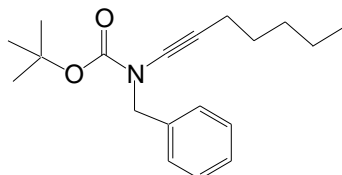

MF: C₁₉H₂₇O₂N

MW = 301 g.mol⁻¹

Method : See **general procedure 3.3** using (1 equiv, 2 mmol, 350 mg) of 1-bromo-hept-1-yne and (1.2 equiv., 2.4 mmol, 497 mg) of benzyl-carbamic acid *tert*-butyl ester.

Purification : Flash column chromatography (silica gel, PE:Et₂O)/ R_f (95:5 PE:Et₂O): 0.63.

Product : Transparent oil.

Conversion < 100% (difficult to estimate).

Isolated Yield : 69%.

¹H NMR (δ, ppm) 7.39-7.31 (m, 5H, CH-Ph), 4.60 (s, 2H, CH₂N), 2.29 (t, *J* = 6.4Hz, 2H, CH₂-pentyl chain), 1.54 (s, 9H, CH₃-^tBu), 1.57-1.46 (m, 2H, CH₂-pentyl chain), 1.41-1.32 (m, 4H, CH₂-pentyl chain), 0.94 (t, *J* = 7.1Hz, 3H, CH₃-pentyl chain).
(CDCl₃, 400 MHz)

¹³C NMR (δ, ppm) 154.5 (Cq, NC=O), 136.8 (Cq, Ph), 128.3 (CH-Ph), 128.0 (CH-Ph), 127.5 (CH-Ph), 81.9 (Cq, ^tBu), 74.5 (Cq, C≡C), 69.6 (Cq, C≡C), 52.9 (CH₂N), 30.8 (CH₂-pentyl chain), 28.6 (CH₂-pentyl chain), 28.0 (CH₃-^tBu), 22.1 (CH₂-pentyl chain), 18.3 (CH₂-pentyl chain), 13.9 (CH₃-pentyl chain).
(CDCl₃, 100 MHz)

IR (ν, cm⁻¹) (CCl₄) 3066 (w), 3032 (w), 2958 (s), 2932 (s), 2862 (m), 2260 (m), 1718 (s), 1455 (m), 1389 (s), 1367 (s), 1295 (s), 1256 (s), 1230 (s), 1164 (s), 1077 (w), 1028 (w), 1009 (w), 996 (w).

HRMS (EI+, m/z) : calculated: 301.2042 found: 301.2033.

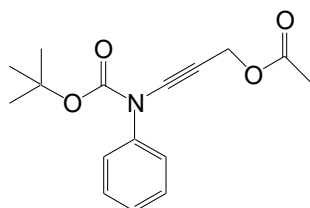
MF: C₁₆H₁₉O₄NMW = 289 g.mol⁻¹

Method :	See general procedure 3.3 using (1 equiv., 2 mmol, 354 mg) of 4-bromo-but-3-ynoic acid methyl ester and (1.2 equiv., 2.4 mmol, 464 mg) of phenyl-carbamic acid <i>tert</i> -butyl ester.
Purification :	Flash column chromatography (silica gel, 9:1 PE:Et ₂ O)/ R _f (9:1 PE:Et ₂ O): 0.34.
Product :	Transparent oil that crystallizes in the fridge to give a white solid.
Conversion:	91%.
Isolated Yield :	52%.
¹H NMR (δ, ppm) (CDCl ₃ , 400 MHz)	7.45 (d, <i>J</i> = 7.7Hz, 2H, CH-Ph), 7.39 (t, <i>J</i> = 7.7Hz, 2H, CH-Ph), 7.26 (t, <i>J</i> = 7.7Hz, CH-Ph), 4.88 (s, 2H, OCH ₂), 2.10 (s, 3H, COCH ₃), 1.55 (s, 9H, CH ₃ - ^t Bu).
¹³C NMR (δ, ppm) (CDCl ₃ , 100 MHz)	170.1 (Cq, C=O), 152.7 (Cq, C=O), 139.2 (Cq, Ph), 128.6 (CH-Ph), 126.7 (CH-Ph), 124.6 (CH-Ph), 83.5 (Cq, ^t Bu), 80.8 (Cq, C≡C), 64.4 (Cq, C≡C), 52.6 (OCH ₂), 27.7 (CH ₃ - ^t Bu), 20.6 (C-CH ₃ CO ₂).
IR (ν, cm ⁻¹) (CCl ₄)	3068 (w), 3039 (w), 2980 (m), 2936 (m), 2262 (m), 1742 (s), 1595 (w), 1496 (m), 1454 (m), 1437 (m), 1369 (m), 1287 (s), 1224 (s), 1158 (s), 1075 (w), 1048 (m), 1020 (s).
HRMS (EI+, <i>m/z</i>) :	calculated: 289.1314 found: 289.1322.

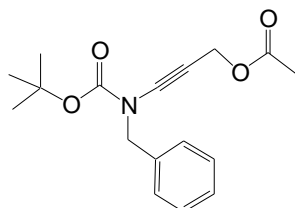
MF: C₁₇H₂₁O₄NMW = 303 g.mol⁻¹

Method :	See general procedure 3.3 using (1 equiv., 2 mmol, 354 mg) of 4-bromo-but-3-ynoic acid methyl ester and (1.2 equiv., 2.4 mmol, 497 mg) of benzyl-carbamic acid <i>tert</i> -butyl ester.
Purification :	Flash column chromatography (silica gel, 95:5 toluene: Et ₂ O)/ R _f (95:5 toluene: Et ₂ O): 0.40.
Product :	Transparent oil.
Conversion:	95%.
Isolated Yield :	14% (difficult to isolate).
¹H NMR (δ, ppm) (CDCl ₃ , 400 MHz)	7.39-7.31 (m, 5H, CH-Ph), 4.83 (s, 2H, CH ₂ O), 4.61 (s, 2H, CH ₂ N), 2.11 (s, 3H, CH ₃ CO), 1.53 (s, 9H, CH ₃ - ^t Bu).
¹³C NMR (δ, ppm) (CDCl ₃ , 100 MHz)	170.3 (Cq, C=O), 153.8 (Cq, C=O), 136.2 (Cq, Ph), 128.4 (CH-Ph), 128.1 (CH-Ph), 127.8 (CH-Ph), 82.9 (Cq, ^t Bu), 81.4 (Cq, C≡C), 65.2 (Cq, C≡C), 53.1 (CH ₂ N), 52.8 (OCH ₂), 27.9 (CH ₃ - ^t Bu), 20.8 (CH ₃ C=O).
IR (ν, cm ⁻¹) (CCl ₄)	3459 (w), 3066 (w), 3033 (m), 2980 (s), 2938 (s), 2259 (s), 1845 (w), 1726 (s), 1608 (w), 1497 (m), 1477 (m), 1436 (s), 1400 (s), 1365 (s), 1294 (s), 1224 (s), 1161 (s), 1076 (w), 1020 (s), 957 (s), 903 (w).
HRMS (EI+, m/z) :	Calculated: 303.1421 found: 303.1469.

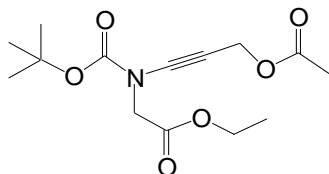

MF: C₁₄H₂₁O₆N

MW = 299 g.mol⁻¹

- Method :** See **general procedure 3.3** using (1 equiv., 2 mmol, 354 mg) of 4-bromo-but-3-ynoic acid methyl ester and (1.2 equiv., 2.4 mmol, 488 mg) of *tert*-butoxycarbonylamino-acetic acid ethyl ester.
- Purification :** Flash column chromatography (silica gel, 9:1 toluene:Et₂O)/ R_f (9:1 toluene:Et₂O): 0.30.
- Product :** Yellow oil that crystallizes in the fridge to give a transparent solid.
- Conversion:** 95%.
- Isolated Yield :** 48%.
- ¹H NMR** (δ, ppm) (CDCl₃, 400 MHz) 4.73 (s, 2H, CH₂O), 4.16 (q, *J* = 7.0Hz, 2H, OCH₂CH₃), 4.00 (s, 2H, CH₂N), 2.00 (s, 3H, CH₃C=O), 1.43 (s, 9H, CH₃-^{*t*}Bu), 1.21 (t, *J* = 7.0Hz, 3H, OCH₂CH₃).
- ¹³C NMR** (δ, ppm) (CDCl₃, 100 MHz) 170.1 (Cq, C=O), 167.6 (Cq, C=O), 153.5 (Cq, C=O), 152.9 (Cq, C=O *rotamer*), 83.2 (Cq, ^{*t*}Bu), 81.4 (Cq, C≡C *rotamer*), 80.7 (Cq, C≡C), 64.3 (Cq, C≡C), 63.7 (Cq, C≡C *rotamer*), 61.3 (OCH₂CH₃), 52.7 (OCH₂), 50.6 (CH₂N), 27.7 (CH₃-^{*t*}Bu), 20.6 (C=OCH₃), 14.0 (OCH₂CH₃).
- IR** (ν, cm⁻¹) (CCl₄) 2982 (m), 2939 (m), 2263 (m), 1738 (s), 1473 (w), 1404.8 (m), 1370 (m), 1349 (s), 1318 (s), 1220 (s), 1158 (s), 1099 (w), 1026.8 (s), 960 (m).
- HRMS** (EI+, *m/z*) : Calculated: 299.1369 found: 299.1374.

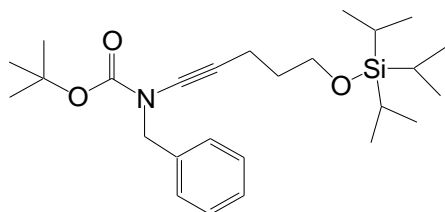
MF: C₂₆H₄₃O₃NSiMW = 445 g.mol⁻¹

Method :	See general procedure 3.3 using (1 equiv., 1.95mmol, 624 mg) of (5-bromo-pent-4-ynyloxy)-triisopropyl-silane and (1.2 equiv., 2.34 mmol, 485 mg) of benzyl-carbamic acid <i>tert</i> -butyl ester.
Purification :	Flash column chromatography (silica gel, 95:5 toluene:Et ₂ O)/ R_f (toluene:Et ₂ O): 0.55.
Product :	Pale yellow oil.
Conversion:	77%.
Isolated Yield :	72%.
¹H NMR (δ, ppm) (CDCl ₃ , 400 MHz)	7.38-7.31 (m, 5H, CH-Ph), 4.59 (s, 2H, CH ₂ N), 3.77 (t, <i>J</i> = 6.0Hz, 2H, CH ₂ O), 2.42 (t, <i>J</i> = 6.0Hz, 2H, CH ₂), 1.75 (t, <i>J</i> = 6.0Hz, 2H, CH ₂), 1.54 (s, 9H, CH ₃ - ^t Bu), 1.12-1.10 (d, <i>J</i> = 3.7Hz, 3H, CH- ⁱ Pr), 1.11 (d, <i>J</i> = 3.7Hz, 18H, CH ₃ - ⁱ Pr).
¹³C NMR (δ, ppm) (CDCl ₃ , 100 MHz)	154.5 (Cq, NC=O), 136.8 (Cq, Ph), 128.3 (CH-Ph), 127.9 (CH-Ph), 127.5 (CH-Ph), 81.9 (Cq, ^t Bu), 74.6 (Cq, C≡C), 69.2 (Cq, C≡C), 61.8 (CH ₂ O), 53.0 (CH ₂ N), 32.3 (CH ₂), 27.9 (CH ₃ - ^t Bu), 17.9 (CH ₃ - ⁱ Pr), 14.8 (CH ₂), 11.9 (CH- ⁱ Pr).
IR (ν, cm ⁻¹) (CCl ₄)	3066 (w), 3032 (w), 2943 (s), 2895 (s), 2866 (s), 2751 (w), 2723 (w), 2262 (m), 1719 (s), 1461 (s), 1388 (s), 1295 (s), 1251 (s), 1164 (s), 1108 (s), 1069 (s), 996 (m), 964 (w), 934 (w), 918 (w), 901 (w).
HRMS (EI+, m/z) :	calculated: 445.3012 found: 445.3023.

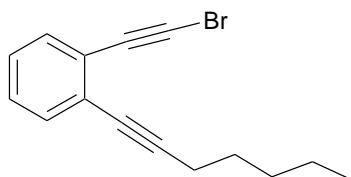
1-Bromoethynyl-2-hept-1-ynyl-benzene**3.15x/w
precursor**MF: C₁₅H₁₅BrMW = 275g.mol⁻¹**Method :**

To a round bottom flask under an argon atmosphere at room temperature charged with 2-bromo-benzaldehyde (1 equiv., 5 mmol, 583 μ L), 1-heptyne (1.2 equiv, 6.0 mmol, 786 μ L) and Et₃N (0.25 M, 20 mL) was added PdCl₂(PPh₃)₂ (0.02 equiv, 0.1 mmol, 70 mg). The mixture was allowed to stir at this temperature for 5 min, then CuI (0.01 equiv., 0.05 equiv., 10 mg) was added and the resulting mixture was heated up to 50 °C and allowed to stir at this temperature overnight. Upon completion (TLC), the reaction was filtered through a short pad of celite and the volatiles evaporated under reduced pressure. Purification of the crude mixture by flash column chromatography (silica gel, 95:5 PE:Et₂O) afforded 2-heptynyl benzaldehyde (959 mg, 96 %).

Next, a solution of 2-heptynylbenzaldehyde (1 equiv., 4.4 mmol, 880 mg) dissolved in anhydrous DCM (3.5 mL) was slowly added to a previously prepared solution of PPh₃ (4 equiv, 17.6 mmol, 4.61 g) and CBr₄ (2 equiv., 8.8 mmol, 2.92 g) in anhydrous DCM (12.5 mL) at 0°C. The reaction was allowed to stir at 0°C. Upon completion (TLC), the reaction was quenched with a saturated solution of NaHCO₃, extracted with DCM (3x), washed with brine (1x), dried (MgSO₄) and concentrated under reduced pressure. To the white solid obtained was added petrol ether and the solid was carefully triturated and left to stir for some minutes to ensure the best extraction of the dibromo vinyl compound from the insoluble triphenyl phosphine. The solution was then filtered and concentrated under reduced pressure again. Purification by flash column chromatography (silica gel, PE) of the crude, afforded the corresponding vinyldibromide (1.22 g, 78 %) as a yellow oil.

Next, to a solution of 1-(2,2-dibromo-vinyl)-2-hept-1-ynyl-benzene (1 equiv., 3.34 mmol, 1.19 g) in distilled THF (0.1M, 35mL) under an argon atmosphere at -78°C was added LiHMDS (2 equiv., 1M solution in hexanes, 6.7 mmol, 6.7 mL) dropwise. The reaction was allowed to stir at -78°C. After the complete consumption of the starting material, the reaction was quenched with a saturated solution of NH₄Cl at -78°C and allowed to warm up to room temperature. The reaction was extracted with Et₂O (3x), washed with brine (1x), dried (MgSO₄) and concentrated under reduced pressure. Filtration through a pad of silica gel (PE) afforded the title compound (903 mg, 98%)

Purification :	See above/ R_f (PE): 0.48.
Product :	Yellow oil.
Isolated yield :	73 % for three steps.
$^1\text{H NMR}$ (δ, ppm) (CDCl_3 , 400 MHz)	7.42 (d, $J = 6.8$ Hz, 1H, CH-Ar), 7.38 (d, $J = 7.6$ Hz, 1H, CH-Ar), 7.26-7.18 (m, 2H, CH-Ar), 2.47 (t, $J = 6.8$ Hz, 2H, CH_2 -pentyl chain), 1.68-1.61 (m, 2H, CH_2 -pentyl chain), 1.54-1.46 (m, 2H, CH_2 -pentyl chain), 1.43-1.34 (m, 2H, CH_2 -pentyl chain). 0.941 (t, $J = 7.2$ Hz, 3H, CH_3 -pentyl chain).
$^{13}\text{C NMR}$ (δ, ppm) (CDCl_3 , 100 MHz)	132.2 (CH-Ar), 131.7 (CH-Ar), 128.3 (CH-Ar), 127.3 (Cq, Ar), 127.1 (CH-Ar), 125.1 (Cq, Ar), 95.2 (Cq, $\text{C}\equiv\text{C}$), 79.1 (Cq, $\text{C}\equiv\text{C}$), 79.0 (Cq, $\text{C}\equiv\text{C}$), 53.0 (Cq, $\text{C}\equiv\text{C}$ -Br), 31.0 (CH_2 -pentyl chain), 28.4 (CH_2 -pentyl chain), 22.3 (CH_2 -pentyl chain), 19.6 (CH_2 -pentyl chain), 14.0 (CH_3 -pentyl chain).
IR (ν , cm^{-1}) (CCl_4)	3063 (w), 2955 (s), 2931 (s), 2862 (s), 2232 (m), 2200 (m), 1476 (s), 1444 (s), 1376 (w), 1332 (w), 1298 (w), 1105 (w), 1036 (w).
HRMS (EI+, m/z) :	Calculated: 274.0357 found: 274.0348.

(2-Hept-1-ynyl-phenylethynyl)-phenyl-carbamic acid *tert*-butyl ester

3.15w

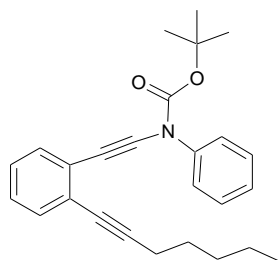

MF: $\text{C}_{26}\text{H}_{29}\text{O}_2\text{N}$

MW = $387 \text{ g}\cdot\text{mol}^{-1}$

Method :	See general procedure 3.3 using (1 equiv., 2 mmol, 550 mg) of 1-bromoethynyl-2-hept-1-ynyl-benzene and (1.2 equiv., 2.4 mmol, 464 mg) of phenyl-carbamic acid <i>tert</i> -butyl ester.
Purification :	Flash column chromatography (silica gel, 98:2 PE: AcOEt)/ R_f (95:5 PE:AcOEt): 0.31.
Product :	Yellow oil.
Isolated yield :	78%.

¹H NMR (δ, ppm) (CDCl ₃ , 400 MHz)	7.63 (d, <i>J</i> = 7.6Hz, 2H, CH-Ar), 7.38 (m, 4H, CH-Ar), 7.26-7.16 (m, 3H, CH-Ar), 2.30 (t, <i>J</i> = 7.2Hz, 2H, CH ₂ -pentyl chain), 1.58 (s, 9H, CH ₃ - ^t Bu), 1.53-1.45 (m, 2H, CH ₂ -pentyl chain), 1.38-1.24 (m, 4H, CH ₂ -pentyl chain), 0.89 (t, <i>J</i> = 7.2Hz, 3H, CH ₃ -pentyl chain).
¹³C NMR (δ, ppm) (CDCl ₃ , 100 MHz)	152.8 (Cq, NC=O), 139.7 (Cq, Ar), 131.9 (CH-Ar), 130.7 (CH-Ar), 128.6 (CH-Ar), 127.1 (CH-Ar), 126.9 (CH-Ar), 126.4 (CH-Ar), 125.9 (Cq, Ar), 125.4 (Cq, Ar), 124.4 (CH-Ar), 94.3 (Cq, C≡C), 86.9 (Cq, C≡C), 83.5 (Cq, ^t Bu), 79.4 (Cq, C≡C), 69.9 (Cq, C≡C), 31.2 (CH ₂ -pentyl chain), 28.4 (CH ₂ -pentyl chain), 28.0 (CH ₃ - ^t Bu), 22.2 (CH ₂ -pentyl chain), 19.6 (CH ₂ -pentyl chain), 14.0 (CH ₃ -pentyl chain).
IR (ν, cm ⁻¹) (CCl ₄)	3064 (w), 2959 (m), 2932 (m), 2864 (w), 2251 (m), 1737 (s), 1490 (w), 1458 (w), 1365 (s), 1285 (s), 1254 (m), 1157 (s), 1008 (w).
HRMS (EI+, m/z) :	Calculated: 387.2198 found: 387.2198.

Benzyl-(2-hept-1-ynyl-phenylethynyl)-carbamic acid *tert*-butyl ester

3.15x

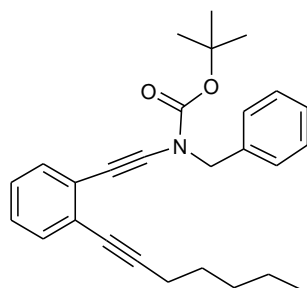

MF: C₂₇H₃₁O₂N

MW = 401g.mol⁻¹

Method :	See general procedure 3.3 using (1 equiv., 1.2 mmol, 330 mg) of 1-bromoethynyl-2-hept-1-ynyl-benzene and (1.2 equiv., 1.44 mmol, 298 mg) of benzyl-carbamic acid <i>tert</i> -butyl ester.
Purification :	Flash column chromatography (silica gel, 98:2 PE:AcOEt)/ R_f (95:5 PE:AcOEt): 0.56.
Product :	Orange oil.
Isolated yield :	81%.
¹H NMR (δ, ppm)	7.51 (d, <i>J</i> = 7.2Hz, 2H, CH-Ar), 7.41-7.30 (m, 5H, CH-Ar), 7.20-7.13 (m, 2H, CH-Ar), 4.73 (s, 2H, CH ₂ N), 2.40 (t, <i>J</i> = 7.2Hz, 2H, CH ₂ -pentyl chain), 1.64-1.54 (m, 2H, CH ₂ -pentyl chain), 1.57 (s, 9H, CH ₃ - ^t Bu), 1.46-1.38 (m, 2H, CH ₂ -pentyl)

(CDCl ₃ , 400 MHz)	chain), 1.39-1.29 (m, 2H, CH ₂ -pentyl chain), 0.92 (t, <i>J</i> = 7.2Hz, 3H, CH ₃ -pentyl chain).
¹³ C NMR (δ, ppm)	153.5 (Cq, NC=O), 136.6 (Cq, Ar), 131.9 (CH-Ar), 130.6 (CH-Ar), 128.4 (CH-Ar), 128.1 (Cq, Ar), 127.7 (CH-Ar), 127.0 (CH-Ar), 126.5 (CH-Ar), 125.9 (CH-Ar), 125.0 (Cq, Ar), 93.8 (Cq, C≡C), 87.9 (Cq, C≡C), 82.6 (Cq, C≡C), 79.6 (Cq, ^t Bu), 70.1 (Cq, C≡C), 53.5 (CH ₂ N), 31.1 (CH ₂ -pentyl chain), 28.5 (CH ₂ -pentyl chain), 27.9 (CH ₃ - ^t Bu), 22.1 (CH ₂ -pentyl chain), 19.6 (CH ₂ -pentyl chain), 13.9 (CH ₃ -pentyl chain).
(CDCl ₃ , 100 MHz)	
IR (ν, cm ⁻¹) (CCl ₄)	3064 (w), 2958 (w), 2933 (m), 2863 (w), 2242 (m), 1723 (s), 1452 (w), 1390 (m), 1366 (m), 1303 (m), 1246 (m), 1159 (m).
HRMS (EI+, m/z) :	Calculated: 401.2355 found: 401.2346.

(2-Hept-1-ynyl-phenyl)-phenylethynyl-carbamic acid *tert*-butyl ester

3.15y

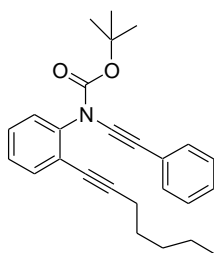

MF: C₂₆H₂₉O₂N

MW = 387 g.mol⁻¹

Method : To a round bottom flask charged with 2-iodo aniline (1 equiv., 2.28 mmol, 500 mg) and triethylamine (9 mL) under an argon atmosphere was added 1-heptyne (1.2 equiv., 2.74 mmol, 360 μL) and PdCl₂(PPh₃)₂ (0.02 equiv., 0.045 mmol, 32 mg). The reaction mixture was allowed to stir for 5 minutes at room temperature. CuI (0.01 equiv., 0.023 mmol, 4.4 mg) was then added and the reaction mixture heated up to 30°C and allowed to stir at this temperature overnight. Upon completion (TLC), the mixture was then cooled to room temperature, filtered through a short pad of celite and concentrated under reduced pressure. Purification by flash column chromatography (silica gel, 95:5 PE:AcOEt) afforded the coupled product (414 mg, 97 %) as a light red/brown oil

Next, to a round bottom flask charged with this coupled aniline (1 equiv., 412 mg, 2.20 mmol) and anhydrous THF (1M, 2.20 mL) at room temperature was added Boc₂O (1.10 equiv., 2.43 mmol, 545 mg) and the reaction mixture was then heated to reflux. After complete consumption of the starting amine (TLC), the mixture was concentrated under reduced pressure. Purification by flash column chromatography (silica gel, 98:2 PE:AcOEt) afforded the Boc protected

aniline (500 mg, 79 %) as a yellow oil.

Next, **general procedure 3.3** using this previously prepared carbamate (1.2 equiv., 1.67 mmol, 480 mg) and bromoethynyl-benzene. (1.0 equiv. 1.39 mmol, 252 mg) afforded after purification by flash column chromatography (silica gel, 95:5 PE:AcOEt) the title compound (110 mg, 20 %).

Purification : See above/ R_f (95:5 PE:AcOEt): 0.38.

Product : Orange/brown oil.

Isolated yield : 16% for three steps.

$^1\text{H NMR}$ (δ , ppm) (CDCl₃, 400 MHz) 7.53 (d, $J = 6.4\text{Hz}$, 1H, CH-Ar), 7.46-7.27 (m, 8H, CH-Ar), 2.47 (t, $J = 7.2\text{Hz}$, 2H, CH₂-pentyl chain), 1.69-1.62 (m, 2H, CH₂-pentyl chain), 1.57 (br s, 9H, CH₃-^tBu), 1.53-1.45 (m, 2H, CH₂-pentyl chain), 1.39-1.32 (m, 2H, CH₂-pentyl chain), 0.93 (t, $J = 7.2\text{Hz}$, 3H, CH₃-pentyl chain).

$^{13}\text{C NMR}$ (δ , ppm) (CDCl₃, 100 MHz) 153.0 (Cq, NC=O), 132.9 (CH-Ar), 130.9 (CH-Ar), 128.3 (CH-Ar), 128.0 (CH-Ar), 127.9 (CH-Ar), 127.8 (Cq, Ar), 127.3 (CH-Ar), 127.1 (CH-Ar), 123.7 (Cq, Ar), 122.9 (Cq, Ar), 96.3 (Cq, C \equiv C), 82.9 (Cq, C \equiv C), 83.9 (Cq, C \equiv C), 82.9 (Cq, C \equiv C), 31.0 (CH₂-pentyl chain), 28.3 (CH₂-pentyl chain), 27.9 (CH₃-^tBu), 22.2 (CH₂-pentyl chain), 19.7 (CH₂-pentyl chain), 13.9 (CH₃-pentyl chain).

IR (ν , cm⁻¹) (CCl₄) 2959 (w), 2932 (m), 2863 (w), 2253 (m), 1737 (s), 1489 (w), 1452 (w), 1367 (m), 1298 (s), 1251 (s), 1160 (s).

HRMS (EI+, m/z) : calculated: 387.2198 found: 387.2194.

B.3.2.2 Synthesis of 4-oxazolin-2-ones *via* a Au/ Ag-mediated rearrangement of *t*Bu-ynamides

N-alkynyl *tert*-butyloxycarbamates in the presence of the gold catalyst $\text{PPh}_3\text{Au}(\text{NCCH}_3)\text{SbF}_6$ or the silver catalyst AgNTf_2 rearrange to afford 4-oxazolin-2-ones (Scheme B.3.2).

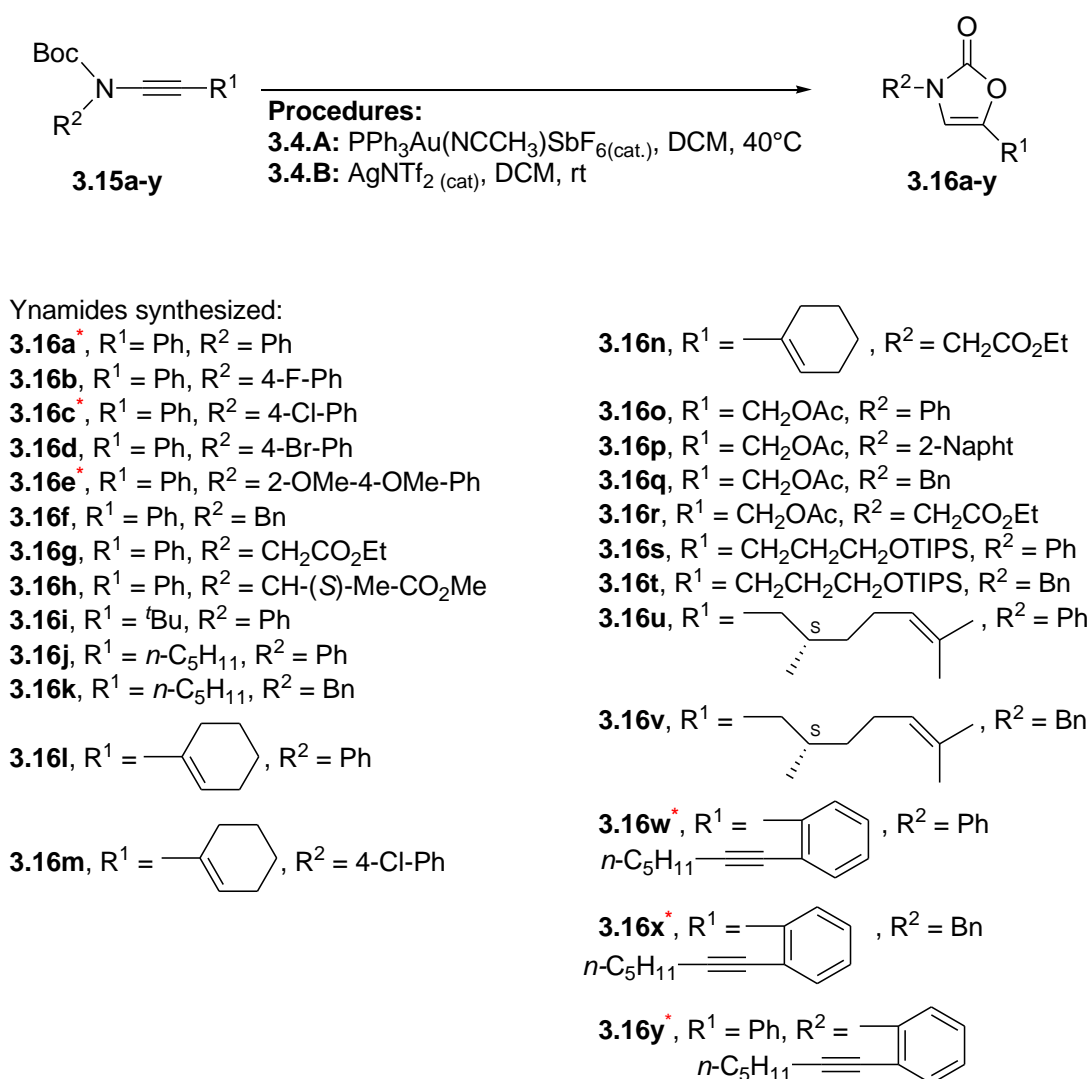

Scheme B.3.2.2: 4-Oxal-2-ones synthesized in this project

General Procedure 3.4.A, *Au*-mediated rearrangement of *t*Bu-ynamides to oxazolinones: To a round bottom flask charged with ynamide (1 equiv.) and anhydrous DCM (0.5 M) at room temperature and under an argon atmosphere was added $\text{PPh}_3\text{Au}(\text{CH}_3\text{CN})\text{SbF}_6$ (0.01 equiv). The reaction mixture was heated to reflux (40 °C) and allowed to stir at this temperature. Upon completion (TLC), the solution was concentrated

under reduced pressure and purified either by flash column chromatography or by recrystallization from a suitable solvent mixture to afford the title compound .

In the case of oxazolones remarked instable, which made isolation impossible, the reaction was performed again, changing the previous solvent for CDCl_2 . Upon completion (NMR), 1,3,5-trimethoxybenzene (1 equiv.) was added as an internal standard and the yield was determined by ^1H NMR analysis of the crude reaction mixture.

General Procedure 3.4.B, Ag-mediated rearrangement of ^tBu -ynamides: To a round bottom flask charged with ynamide (1 equiv.) and anhydrous DCM (0.5 M) at room temperature and under an argon atmosphere was added AgNTf_2 (0.05 equiv). The reaction mixture was allowed to stir at this temperature (rt). Upon completion (TLC), the solution was concentrated under reduced pressure and the yield of the rearranged oxazolone was determined through ^1H NMR analysis of the crude reaction mixture using 1,3,5-trimethoxybenzene (1 equiv.) as an internal standard.

3,5-Diphenyl-3H-oxazol-2-one

3.16a

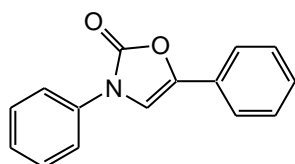

MF: $\text{C}_{15}\text{H}_{11}\text{NO}_2$

MW = $237 \text{ g}\cdot\text{mol}^{-1}$

Method :	See general procedure 3.4.B using (1 equiv., 0.25 mmol, 74 mg) of phenyl-phenylethynyl-carbamic acid <i>tert</i> -butyl ester.
Purification :	Recrystallization from petrol ether.
Product :	White solid.
Isolated Yield :	83%.
^1H NMR (δ , ppm)	7.63 (d, $J = 7.6\text{Hz}$, 2H, CH-Ph), 7.56 (d, $J = 7.3 \text{ Hz}$, 2H, CH-Ph), 7.48 (t, $J = 7.6 \text{ Hz}$, 2H, CH-Ph), 7.42 (t, $J = 7.3 \text{ Hz}$, 2H, CH-Ph), 7.34 (t, $J = 7.3 \text{ Hz}$, 1H, CH-

(CDCl₃, 400 MHz) Ph), 7.31 (t, *J* = 7.6 Hz, 1H, CH-Ph), 7.18 (s, 1H, NCH=).

¹³C NMR (δ, ppm) 152.5 (Cq, NC=O), 139.8 (Cq, OC=CHN), 135.4 (Cq, Ph), 129.4 (CH-Ph), 128.8 (CH-Ph), 128.5 (CH-Ph), 126.8 (Cq, Ph), 126.5 (CH-Ph), 123.1 (CH-Ph), 120.9 (CH-Ph), 108.4 (OC=CHN).

IR (ν, cm⁻¹) (CCl₄) 3153 (w), 3055 (w), 2958 (m), 2927 (w), 2860 (w), 1773 (s), 1595 (m), 1503 (s), 1450 (m), 1393 (s), 1212 (w), 1114 (m).

HRMS (EI+, *m/z*) : Calculated: 237.0790 found: 237.0793.

3-(4-Chloro-phenyl)-5-phenyl-3H-oxazol-2-one

3.16c

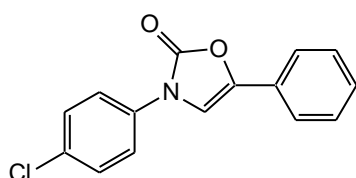

MF: C₁₅H₁₀NO₂Cl

MW = 271 g.mol⁻¹

Method : See **general procedure 3.4.B** using (1 equiv., 0.25 mmol, 82 mg) of (4-chlorophenyl)-phenylethynyl-carbamic acid *tert*-butyl ester.

Purification : Recrystallization from petrol ether.

Product : White solid.

Isolated Yield : 88%.

¹H NMR (δ, ppm) 7.62-7.55 (m, 4H, CH-Ar), 7.47-7.41 (m, 4H, CH-Ar), 7.36 (t, *J* = 7.4Hz, 1H, CH-Ar), 7.16 (s, 1H, NCH=).

(CDCl₃, 400 MHz)

¹³C NMR (δ, ppm) 152.3 (Cq, NC=O), 140.1 (OC=CHN), 134.0 (Cq, Ar), 132.0 (Cq, Ar), 129.6 (CH-Ar), 128.9 (CH-Ar), 128.7 (CH-Ar), 126.6 (Cq, Ar), 123.2 (CH-Ar), 122.0 (CH-Ar), 107.9 (OC=CHN).

(CDCl₃, 100 MHz)

IR (ν, cm⁻¹) (CCl₄) 3177 (w), 3062 (w), 2975 (m), 2928 (w), 1731 (s), 1654 (s), 1498 (m), 1449 (m), 1393 (s), 1279 (s), 1203 (m), 1095 (m), 1052 (w), 1016 (m).

HRMS (EI+, *m/z*) : Calculated: 271.0400 found: 271.0403.

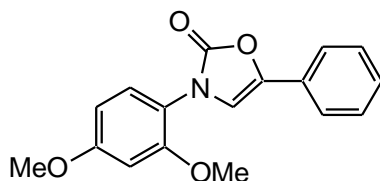
MF: C₁₇H₁₅NO₄MW = 297 g.mol⁻¹

- Method :** See **general procedure 3.4.A** using (1 equiv., 0.10 mmol, 32 mg) of (2,4-dimethoxyphenyl)-phenylethynyl-carbamic acid tert-butyl ester.
- Purification :** Recrystallization from petrol ether.
- Product :** Orange solid.
- Isolated Yield :** 78%.
- ¹H NMR** (δ, ppm) (CDCl₃, 400 MHz) 7.53 (d, *J* = 7.2 Hz, 2H, CH-Ar), 7.41-7.36 (m, 3H, CH-Ar), 7.30 (t, *J* = 7.4 Hz, 1H, CH-Ar), 6.96 (s, 1H, NCH=), 6.57 (s, 1H, CH-Ar), 6.56 (dd, *J* = 2.6 Hz, *J* = 10.8 Hz, 1H, CH-Ar), 3.84 (s, 3H, OCH₃), 3.83 (s, 3H, OCH₃).
- ¹³C NMR** (δ, ppm) (CDCl₃, 100 MHz) 160.7 (Cq, Ar), 154.9 (Cq, Ar), 153.9 (Cq, NC=O), 138.5 (OC=CHN), 128.7 (CH-Ar), 128.0 (CH-Ar), 127.9 (CH-Ar), 127.4 (Cq, Ar), 122.8 (CH-Ar), 116.6 (Cq, Ar), 112.0 (OC=CHN), 104.5 (CH-Ar), 99.6 (CH-Ar), 55.7 (OCH₃), 55.5 (OCH₃).
- IR** (ν, cm⁻¹) (CCl₄) 3061 (w), 2927 (w), 2854 (m), 2360 (w), 1768 (s), 1611 (s), 1518 (m), 1460 (s), 1287 (s), 1212 (m), 1162 (m), 1109 (s), 1039 (s).
- HRMS** (EI+, *m/z*) : Calculated: 397.1001 found: 297.0998.

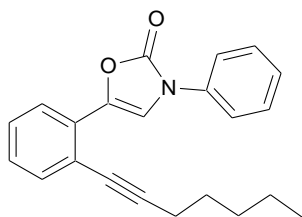
MF: C₂₂H₂₁O₂NMW = 331 g. mol⁻¹

- Method :** See **general procedure 3.4.A** using (1 equiv., 0.52 mmol, 200 mg) of (2-hept-1-ynyl-phenylethynyl)-phenyl-carbamic acid *tert*-butyl ester.
- Purification :** Flash column chromatography (silica gel, 98:2 PE: AcOEt)/ **R_f** (9:1 PE:AcOEt): 0.42.
- Product :** Yellow solid.
- Isolated yield :** 91%.
- ¹H NMR** (δ, ppm) (CDCl₃, 400 MHz) 7.94 (s, 1H, NCH=), 7.73 (d, *J* = 8.0Hz, 1H, CH-Ar), 7.63 (dd, *J* = 0.9Hz, *J* = 8.0Hz, 2H, CH-Ar), 7.48 (t, *J* = 8.0Hz, 3H, CH-Ar), 7.38-7.30 (m, 2H, CH-Ar), 7.26-7.22 (m, 1H, CH-Ar), 2.53 (t, *J* = 7.2Hz, 2H, CH₂-pentyl chain), 1.71-1.64 (m, 2H, CH₂-pentyl chain), 1.49-1.41 (m, 2H, CH₂-pentyl chain), 1.38-1.29 (m, 2H, CH₂-pentyl chain), 0.88 (t, *J* = 7.4Hz, 3H, CH₃-pentyl chain).
- ¹³C NMR** (δ, ppm) (CDCl₃, 100 MHz) 152.1 (Cq, NC=O), 138.2 (Cq), 135.6 (Cq), 133.8 (CH-Ar), 129.5 (CH-Ar), 128.1 (CH-Ar), 127.5 (CH-Ar), 127.4 (CH-Ar), 126.6 (Cq), 124.5 (CH-Ar), 121.0 (CH-Ar), 118.4 (Cq), 112.6 (NCH=), 97.2 (Cq, C≡C), 80.2 (Cq, C≡C), 31.3 (CH₂-pentyl chain), 28.3 (CH₂-pentyl chain), 22.2 (CH₂-pentyl chain), 19.8 (CH₂-pentyl chain), 13.9 (CH₃-pentyl chain).
- IR** (ν, cm⁻¹) (CCl₄) 3066 (w), 2958 (s), 2932 (s), 2863 (s), 1772 (s), 1719 (s), 1639 (w), 1596 (s), 1503 (s), 1460 (s), 1389 (s), 1308 (s), 1272(m), 1223 (m), 1158 (s), 1114 (s), 1027 (s), 978 (s).
- HRMS** (EI+, *m/z*) : Calculated: 331.1572 found: 331.1581.

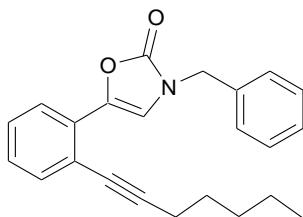
MF: C₂₃H₂₃O₂NMW = 345g.mol⁻¹

- Method :** See **general procedure 3.4.A** using (1 equiv. 0.10 mmol, 40 mg) of benzyl-(2-hept-1-ynyl-phenylethynyl)-carbamic acid *tert*-butyl ester.
- Purification :** Flash column chromatography (silica gel, 9:1 PE:AcOEt)/ R_f (9:1 PE:AcOEt): 0.29.
- Product :** White solid.
- Isolated yield :** 90%.
- ¹H NMR** (δ, ppm) (CDCl₃, 400 MHz) 7.65 (d, *J* = 8.0Hz, 1H, CH-Ar), 7.41-7.29 (m, 8H, NCH= + CH-Ar), 7.17 (dt, *J* = 1.3Hz, *J* = 7.6Hz, 1H, CH, CH-Ar), 4.80 (s, 2H, CH₂N), 2.28 (t, *J* = 7.2Hz, CH₂-pentyl chain), 1.49-1.42 (m, 2H, CH₂-pentyl chain), 1.38-1.30 (m, 4H, CH₂-pentyl chain), 0.90 (t, *J* = 7.2Hz, 3H, CH₃-pentyl chain).
- ¹³C NMR** (δ, ppm) (CDCl₃, 100 MHz) 154.4 (Cq, NC=O), 137.6 (Cq), 135.1 (Cq), 133.5 (CH-Ar), 129.0 (CH-Ar), 128.4 (CH-Ar), 128.0 (CH-Ar), 127.9 (CH-Ar), 127.0 (Cq), 124.2 (CH-Ar), 124.2 (CH-Ar), 118.1 (Cq), 113.0 (NCH=), 96.8 (Cq, C≡C), 80.0 (Cq, C≡C), 47.9 (CH₂N), 31.1 (CH₂-pentyl chain), 28.1 (CH₂-pentyl chain), 22.1 (CH₂-pentyl chain), 19.5 (CH₂-pentyl chain), 13.9 (CH₃-pentyl chain).
- IR** (ν, cm⁻¹) (CCl₄) 3066 (w), 3033 (w), 2930 (s), 2862 (s), 1757 (s), 1701 (s), 1630 (s), 1601 (s), 1562 (s), 1490 (s), 1453 (s), 1392 (s), 1364 (s), 1312 (s), 1265 (s), 1173 (s), 1113 (s), 1085 (s), 1022 (s).
- HRMS** (EI+, m/z) : Calculated: 345.1729 found: 345.1727.

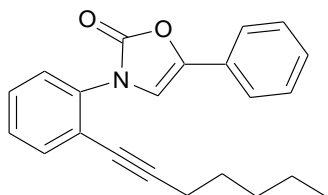
MF: C₂₂H₂₁O₂NMW = 331g. mol⁻¹

- Method :** See **general procedure 3.4.A** using (1 equiv. 0.10 mmol, 39 mg) of (2-hept-1-ynyl-phenyl)-phenylethyne-carbamic acid *tert*-butyl ester.
- Purification :** Flash column chromatography (silica gel, 9:1 PE:AcOEt)/ R_f(9:1 PE:AcOEt): 0.27.
- Product :** Yellow oil.
- Isolated yield :** 57%.
- ¹H NMR** (δ, ppm) (CDCl₃, 400 MHz) 7.57-7.51 (m, 4H, CH-Ar), 7.42-7.37 (m, 3H, CH-Ar), 7.34-7.30 (m, 2H, CH-Ar), 7.24 (s, 1H, NCH=), 2.37 (t, *J* = 7.0Hz, 2H, CH₂-pentyl chain), 1.54-1.47 (m, 2H, CH₂-pentyl chain), 1.34-1.26 (m, 2H, CH₂-pentyl chain), 1.24-1.15 (m, 2H, CH₂-pentyl chain), 0.79 (t, *J* = 7.3Hz, 3H, CH₃-pentyl chain).
- ¹³C NMR** (δ, ppm) (CDCl₃, 100 MHz) 153.3 (Cq, C=O), 138.6 (Cq), 136.0 (Cq), 133.5 (CH-Ar), 128.9 (CH-Ar), 128.6 (CH-Ar), 128.2 (CH-Ar), 128.1 (CH-Ar), 127.4 (Cq), 126.2 (CH-Ar), 122.9 (CH-Ar), 120.5 (Cq), 111.2 (NCH=), 97.7 (Cq, C≡C), 76.4 (Cq, C≡C), 31.0 (CH₂-pentyl chain), 28.1 (CH₂-pentyl chain), 22.1 (CH₂-pentyl chain), 19.6 (CH₂-pentyl chain), 13.8 (CH₃-pentyl chain).
- IR** (ν, cm⁻¹) (CCl₄) 2957 (w), 2931(w), 2861(w), 1776 (s), 1497 (w), 1453 (w), 1391 (w), 1293 (w), 1214 (w), 1125 (w), 1101 (w), 1051 (w).
- HRMS** (EI+, *m/z*) : calculated: 331.1572 found: 331.1581.

B.3.3 Chapter 4: Gold(I) mediated cycloisomerization of 1,6-enynes – a short digression on catalyst counter ion effect and remote substituent control

All molecules synthesized for this work are described here. This project was developed individually.

B.3.3.1 Synthesis of 1,6-enynes

1,6-enynes were synthesized as depicted in the scheme below:

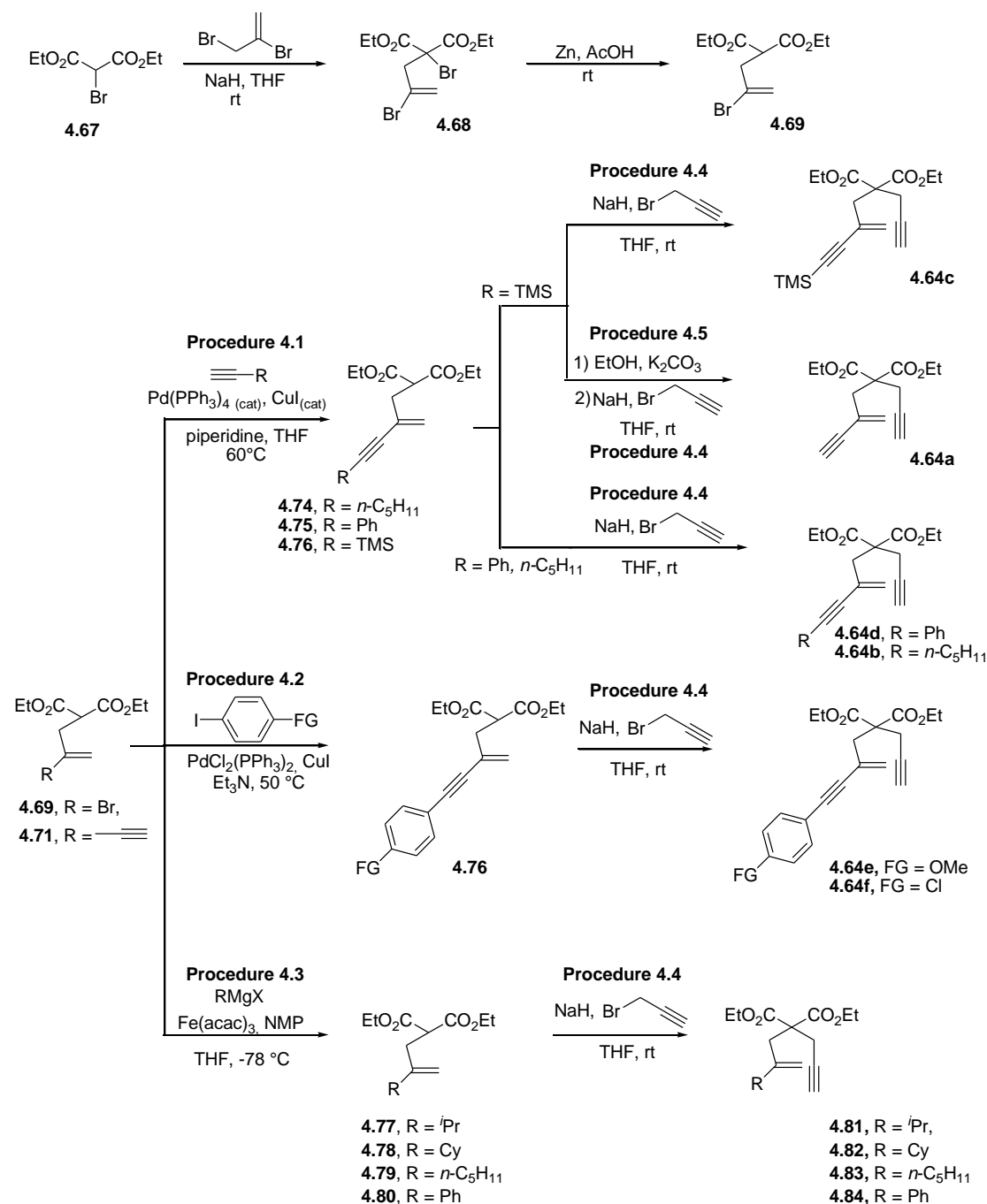

Scheme B.3.3.1 Synthesis of 1,6-enynes.

General Procedure 4.1³⁰¹, *Sonogashira coupling reaction with vinyl bromides*: To a round bottom flask charged with vinyl bromide (1 equiv.) and Pd(PPh₃)₄ (0.01 equiv.) under an argon atmosphere was sequentially added CuI (0.01 equiv.), piperidine (1 equiv.), THF (0.10 M) and alkyne (2 equiv.). The reaction mixture was heated up to 60 °C and allowed to stir at this temperature upon completion (TLC). The reaction was generally left overnight. The mixture was then quenched with a saturated solution of NH₄Cl, extracted with Et₂O (3x), dried (MgSO₄) and concentrated under reduced pressure. Purification by flash column chromatography afforded the title compounds in the stated yields.

General Procedure 4.2³⁰², *Sonogashira coupling reaction with aryl iodides*: To a round bottom flask charged with alkyne (1 equiv.), aryl iodide (1.1 equiv.) and Et₃N (0.10 M) was added PdCl₂(PPh₃)₄ (0.02 equiv.) and CuI (0.02 equiv.). The mixture was heated up to 50 °C and allowed to stir at this temperature upon completion (TLC). The reaction was usually left overnight. Then a saturated solution of NH₄Cl was added, the reaction was extracted with AcOEt (3x), dried (MgSO₄) and concentrated under reduced pressure. Purification by flash column chromatography afforded the title alkynes in the stated yields.

General Procedure 4.3³⁰³, *Iron-mediated coupling reaction*: To a round bottom flask charged with vinyl bromide (1 equiv.) and Fe(acac)₃ (0.02 equiv.) flushed with argon for 15 min was added THF (0.70 M to vinyl bromide) and NMP (0.80 M to vinyl bromide). The temperature was cooled to 0 °C and the Grignard reagent (3 equiv.) was added. The reaction was allowed to stir at 0 °C upon completion (TLC). The reaction usually takes not more than 1h. The reaction was then quenched with a saturated solution of NH₄Cl, extracted with Et₂O (3x), dried (MgSO₄) and concentrated under reduced pressure. Purification by flash column chromatography afforded the title compounds in the stated yields.

General procedure 4.4, *Propargylation of monosubstituted malonates*: To a round bottom flask charged with monosubstituted malonate (1equiv.) and THF (0.125 M) was sequentially added NaH (60% in mineral oil, 1.5 equiv.) and propargyl bromide (1.5 equiv., 80% w/w solution in toluene). The reaction was allowed to stir at room temperature upon completion (TLC). The reaction was usually left overnight. Then, the reaction was quenched with a saturated solution of NH₄Cl, extracted with AcOEt (3x), dried (MgSO₄) and concentrated

³⁰¹ Organ, M. G.; Cooper, J. T.; Rogers, L. R.; Soleymanzadeh, F.; Paul T.; *J. Org. Chem.* **2000**, 65, 23, 7959.

³⁰² Fürstner A.; Davies P. W.; Gress T.; *J. Am. Chem. Soc.*, **2005**, 127, 23, 8244.

³⁰³ Fürstner, A.; Leitner, A.; Mendez, M.; Krause, H.; *J. Am. Chem. Soc.*, **2002**, 124, 46, 13856.

under reduced pressure. Purification by flash column chromatography afforded the title compounds in the stated yields.

General Procedure 4.5³⁰⁴, *Deprotection of TMS-alkynes*: To a round bottom flask charged with TMS-protected alkyne (1equiv.) and EtOH (0.50 M) at room temperature was added K₂CO₃ (0.20 equiv.). The reaction was allowed to stir at this temperature upon completion (TLC). The mixture was then diluted in H₂O, extracted with DCM (3x), washed with brine (1x), dried (MgSO₄) and concentrated under reduced pressure. Purification by flash column chromatography afforded the terminal alkyne.

2-(2-Bromo-allyl)-malonic acid diethyl ester

4.69

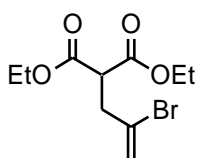

MF: C₁₀H₁₅O₄Br

MW = 279 g.mol⁻¹

Method :

To a round bottom flask charged with 2-bromo-malonic acid diethyl ester (1 equiv., 20 mmol, 3.42 mL), 2,3-dibromo-propene (1.2 equiv., 24 mmol, 3.10 mL) and DMF (1M, 20 mL) at 0 °C was added K₂CO₃ (2 equiv., 40 mmol, 5.52 g). The temperature was allowed to warm up and to stir at room temperature. Upon completion (TLC), the reaction was diluted in water, extracted with Et₂O (3x), washed with brine (1x), dried (MgSO₄) and concentrated under reduced pressure. Purification by flash column chromatography afforded 2-bromo-2-(2-bromo-allyl)-malonic acid diethyl ester (6.36 g, 89 %).

This compound (1 equiv., 16.8 mmol, 6.0 g) was then diluted in AcOH (1M, 17 mL). To this solution at room temperature was added Zn dust (2 equiv. 33.6 mmol, 2.20 g) and the reaction was allowed to stir at room temperature upon completion (TLC). The reaction was then filtered through a small pad of celite, washed with a saturated solution of Na₂CO₃ with stirring (in a erlenmeyer), then the solution was extracted with Et₂O (3x), washed with brine (1x), dried (MgSO₄) and concentrated under reduced pressure. Filtration through silica gel

³⁰⁴ Allevi, P.; Ciuffreda P.; Anastasia M.; *Tetrahedron: Asymmetry*; **1997**, 8, 1, 93.

(8:2 PE:AcOEt) afforded the title compound (4.4 g, 94%).

Purification : See above.

Product : Transparent oil.

Isolated yield : 84% (for two steps)

¹H NMR (δ , ppm) (CDCl₃, 400 MHz) 5.69 (s, 1H, C=CH₂), 5.47 (s, 1H, C=CH₂), 4.21 (q, J = 7.1Hz, 4H, OCH₂CH₃), 3.78 (t, J = 7.6Hz, 1H, CH), 3.01 (d, J = 7.6 Hz, 2H, CH₂), 1.27 (t, J = 7.1Hz, 6H, OCH₂CH₃).

¹³C NMR (δ , ppm) (CDCl₃, 100 MHz) 168.1 (Cq x2, C=O), 129.4 (Cq, C=CH₂), 119.7 (C=CH₂), 61.7 (OCH₂CH₃ x2), 50.6 (CH), 40.4 (CH₂), 14.0 (OCH₂CH₃ x2).

IR (ν , cm⁻¹) (CCl₄) 3467(w), 2984 (s), 2939 (s), 2908 (s), 2874 (m), 1737 (s), 1632 (s), 1465 (s), 1445 (s), 1428 (s), 1392 (s), 1369 (s), 1176 (s), 1038 (s).

MS (CI, NH₃, m/z) : M + H⁺: 280, M + NH₄⁺: 297.

2-(2-Methylene-but-3-ynyl)-2-prop-2-ynyl-malonic acid diethyl ester

4.64a

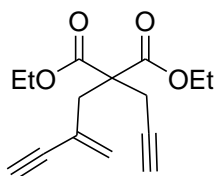

MF: C₁₅H₁₈O₄

MW = 262 g. mol⁻¹

Method : See **general procedure 3.1** with (1 equiv., 1.0 mmol, 280 mg) of 2-(2-bromo-allyl)-malonic acid diethyl ester and ethynyl-trimethyl-silane (2 equiv., 2.0 mmol, 277 μ L), followed by **general procedure 3.5** with (1 equiv., 0.95 mmol, 282 mg) of the previously prepared coupled product, followed by **general procedure 3.4** using (1 equiv., 0.54 mmol, 120 mg) of the previously prepared terminal alkyne.

Purification : Flash column chromatography (silica gel 9:1 PE AcOEt)/ R_f (95:5 PE:AcOEt): 0.30.

Product : Transparent oil.

Isolated yield : 38 % for three steps.

¹H NMR (δ, ppm) (CDCl₃, 400 MHz) 5.59 (s, 1H, C=CH₂), 5.51 (s, 1H, C=CH₂), 4.23-4.13 (m, 4H, OCH₂CH₃), 2.97 (s, 2H, CH₂), 2.89 (d, *J* = 2.8Hz, 2H, CH₂-propargyl chain), 2.86 (s, 1H, ≡CH), 2.02 (t, *J* = 2.7Hz, 1H, ≡CH), 1.24 (t, *J* = 7.2 Hz, 6H, OCH₂CH₃).

¹³C NMR (δ, ppm) (CDCl₃, 100 MHz) 169.3 (Cq x2, C=O), 128.5 (C=C₂), 124.5 (Cq, C=C₂), 83.2 (Cq, C≡C), 79.0 (Cq, C≡C), 77.8 (≡CH), 71.7 (≡CH), 61.7 (OCH₂CH₃), 56.2 (Cq), 38.2 (CH₂), 22.2 (CH₂), 13.9 (OCH₂CH₃).

IR (ν, cm⁻¹) (CCl₄) 3313 (s), 2954 (w), 2842 (w), 1744 (s), 1610 (w), 1437 (m), 1324 (w), 1296 (m), 1274 (m), 1237 (s), 1209 (s), 1199 (s), 1182 (s), 1075 (w), 1053 (w), 982 (w).

HRMS (EI+, *m/z*) : Calculated: 262.1205 found: 262.1210.

2-(2-Methylene-non-3-ynyl)-2-prop-2-ynyl-malonic acid diethyl ester

4.64b

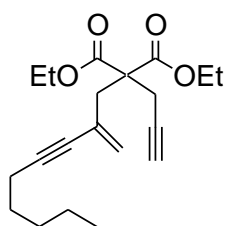

MF: C₂₀H₂₈O₄

MW = 332 g.mol⁻¹

Method : See **general procedure 4.1** using (1 equiv., 0.9 mmol, 250 mg) of 2-(2-bromoallyl)-malonic acid diethyl ester and hept-1-yne (3 equiv., 2.7 mmol, 360 μL), followed by **general procedure 4.4** using (1 equiv., 0.41 mmol, 120 mg) of the previously prepared compound.

Purification : Flash column chromatography (silica gel 95:5 PE: AcOEt)/ **R_f** (9:1 PE:AcOEt): 0.38.

Product : Orange oil.

Isolated yield : 47% for two steps.

¹H NMR (δ, ppm) (CDCl₃, 400 MHz) 5.40 (s, 1H, C=CH₂), 5.39 (s, 1H, C=CH₂), 4.27-4.12 (m, 4H, OCH₂CH₃), 2.94 (m, 4H, CH₂), 2.24 (t, *J* = 7.2Hz, 2H, CH₂-pentylchain), 2.00 (t, *J* = 2.6Hz, 1H, C≡CH), 1.53-1.48 (m, 2H, CH₂-pentylchain), 1.37-1.30 (m, 4H, CH₂-pentylchain), 1.26 (t, *J* = 7.2Hz, 6H, OCH₂CH₃), 0.90 (t, *J* = 7.0 Hz, 3H, CH₃-

pentylchain).

¹³C NMR (δ, ppm) (CDCl ₃ , 100 MHz)	169.5 (Cq x2, C=O), 126.0 (Cq, <u>C</u> =CH ₂), 125.2 (C=C <u>H</u> ₂), 91.3 (Cq, C≡C), 80.3 (Cq, C≡C), 79.3 (Cq, C≡C), 71.5 (C≡C <u>H</u>), 61.6 (O <u>C</u> H ₂ CH ₃ x2), 56.5 (Cq), 38.7 (CH ₂), 31.1 (CH ₂), 28.3 (CH ₂), 22.3 (CH ₂), 22.2 (CH ₂), 19.4 (CH ₂), 14.0 (CH ₃), 13.9 (CH ₃).
IR (ν, cm ⁻¹) (CCl ₄)	3314 (m), 3295 (w), 2982 (m), 2961 (m), 2935 (m), 2910 (m), 2874 (w), 2862 (w), 2838 (w), 2224 (w), 1740 (s), 1606 (w), 1466 (w), 1458 (w), 1446 (w), 1437 (w), 1390 (w), 1367 (w), 1323 (w), 1300 (m), 1280 (m), 1241 (m), 1206 (s), 1184 (s), 1097 (m), 1054 (m), 1018 (m), 1011 (m).
HRMS (EI+, m/z):	Calculated: 332.1988 found: 332.1979.

2-(2-Methylene-4-trimethylsilyl-but-3-ynyl)-2-prop-2-ynyl-malonic acid diethyl ester **acid** **4.64c**

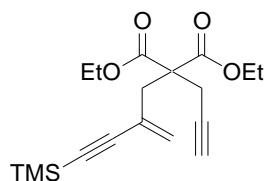

MF: C₁₈H₂₆O₄Si

MW = 334 g.mol⁻¹

Method :	See general procedure 4.1 with (1 equiv., 3.6 mmol, 1.0 g) of 2-(2-bromoallyl)-malonic acid diethyl ester followed by general procedure 4.4 using (1 equiv., 0.14 mmol, 40 mg) of the previously prepared monosubstituted malonate.
Purification :	Flash column chromatography (silica gel 95:5 PE:AcOEt)/ R_f (95:5 PE:AcOEt): 0.23.
Product :	Yellow pale oil.
Isolated yield :	37% for two steps.
¹H NMR (δ, ppm) (CDCl ₃ , 400 MHz)	5.55 (s, 1H, C=CH ₂), 5.43 (s, 1H, C=CH ₂), 4.27-4.12 (m, 4H, O <u>C</u> H ₂ CH ₃), 2.96 (d, <i>J</i> = 2.6Hz, 2H, CH ₂ -propargyl chain), 2.95 (s, 2H, CH ₂), 2.02 (t, <i>J</i> = 2.6Hz, 1H, ≡CH), 1.26 (t, <i>J</i> = 7.2Hz, 6H, OCH ₂ <u>C</u> H ₃), 0.19 (s, 9H, CH ₃ -TMS).
¹³C NMR (δ, ppm) (CDCl ₃ , 100 MHz)	169.3 (Cq x2, C=O), 127.6 (C=C <u>H</u> ₂), 125.8 (Cq, <u>C</u> =CH ₂), 104.9 (Cq, C≡C), 94.9 (Cq, C≡C), 79.3 (Cq, C≡C), 71.6 (≡C <u>H</u>), 61.6 (O <u>C</u> H ₂ CH ₃ x2), 56.7 (Cq), 38.2 (CH ₂), 22.3 (CH ₂), 14.0 (OCH ₂ <u>C</u> H ₃ x2), -0.20 (CH ₃ -TMS).
IR (ν, cm ⁻¹) (CCl ₄)	3314 (m), 2982 (m), 2963 (m), 2938 (w), 2902 (w), 2873 (w), 2145 (w), 1740 (s), 1604 (w), 1464 (w), 1445 (w), 1391 (w), 1367 (w), 1323 (w), 1297 (m), 1275 (m), 1251 (s), 1204 (s), 1184 (s), 1096 (w), 1072 (w), 1053 (w)

HRMS (EI+, m/z) : Calculated: 334.1600 found: 334.1589.

2-(2-Methylene-4-phenyl-but-3-ynyl)-2-prop-2-ynyl-malonic acid diethyl ester 4.64d

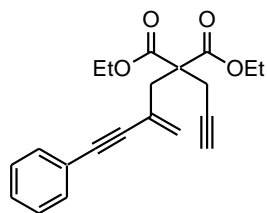

MF: C₂₁H₂₂O₄

MW = 338 g.mol⁻¹

Method : See **general procedure 4.1** with (1 equiv., 0.9 mmol, 250 mg) of 2-(2-bromoallyl)-malonic acid diethyl ester and ethynyl-benzene (2 equiv., 1.8 mmol, 197 μ L), followed by **general procedure 4.4** using (1 equiv., 0.9 mmol, 270 mg) of the previously prepared coupled product.

Purification : Flash column chromatography (silica gel 95:5 PE AcOEt)/ **R_f** (95:5 PE:AcOEt): 0.24.

Product : Orange oil.

Isolated yield : 66% (for two steps).

¹H NMR (δ , ppm) (CDCl₃, 400 MHz) 7.44-7.42 (m, 2H, CH-Ph), 7.31-7.29 (m, 3H, CH-Ph), 5.59 (s, 1H, C=CH₂), 5.49 (s, 1H, C=CH₂), 4.26-4.10 (m, 4H, OCH₂CH₃), 3.07 (s, 2H, CH₂), 3.00 (d, *J* = 2.7Hz, 2H, CH₂-propargyl chain), 2.06 (t, *J* = 2.7Hz, 1H, \equiv CH), 1.23 (t, *J* = 7.2Hz, 6H, OCH₂CH₃).

¹³C NMR (δ , ppm) (CDCl₃, 100 MHz) 169.4 (Cq x2, C=O), 131.5 (CH-Ph), 128.3 (CH-Ph), 128.3 (CH-Ph), 126.6 (C=CH₂), 125.5 (Cq), 123.0 (Cq), 89.9 (Cq, C \equiv C), 89.0 (Cq, C \equiv C), 79.2 (Cq, C \equiv C), 71.7 (\equiv CH), 61.8 (OCH₂CH₃ x2), 56.6 (Cq), 38.6 (CH₂), 22.3 (CH₂), 14.0 (OCH₂CH₃ x2).

IR (ν , cm⁻¹) (CCl₄) 3312 (w), 2983 (w), 2939 (w), 2908 (w), 1740 (s), 1687 (w), 1599 (w), 1491 (w), 1465 (w), 1444 (w), 1368 (w), 1285 (w), 1247 (w), 1215 (m), 1193 (m), 1097 (w).

HRMS (EI+, m/z) : Calculated: 338.1518 found: 338.1532.

2-[4-(4-Methoxy-phenyl)-2-methylene-but-3-ynyl]-2-prop-2-ynyl-malonic acid diethyl ester **4.64e**

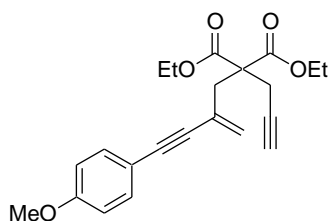

MF: C₂₂H₂₄O₅

MW = 368 g.mol⁻¹

- Method :** See **general procedure 4.1** with (1 equiv., 3.6 mmol, 1.0 g) of 2-(2-bromoallyl)-malonic acid diethyl ester and ethynyltrimethyl silane, followed by **general procedure 4.5** using (1 equiv., 2.0 mmol, 580 mg) of the previously prepared coupled product in EtOH, followed by **general procedure 4.2** using (1 equiv., 0.63 mmol, 140 mg) of the previously prepared terminal alkyne and (1.1 equiv., 0.69 mmol, 161 mg) of 1-iodo-4-methoxy-benzene, followed by **general procedure 4.4** using (1 equiv., 0.42 mmol, 140 mg) of the previously prepared monosubstituted malonate.
- Purification :** Flash column chromatography (silica gel 95:5 PE: AcOEt)/ **R_f** (9:1 PE:AcOEt): 0.33.
- Product :** White solid.
- Isolated yield :** 25% for four steps.
- ¹H NMR** (δ, ppm) (CDCl₃, 400 MHz) 7.37 (d, *J* = 8.6Hz, 2H, CH-Ar), 6.83 (d, *J* = 8.6Hz, 2H, CH-Ar), 5.54 (s, 1H, C=CH₂), 5.45 (s, 1H, C=CH₂), 4.23-4.12 (m, 4H, OCH₂CH₃), 3.81 (s, 3H, OCH₃), 3.06 (s, 2H, CH₂), 3.00 (d, *J* = 2.8Hz, 2H, CH₂-propargyl chain), 2.05 (t, *J* = 2.8Hz, 1H, ≡CH), 1.23 (t, *J* = 7.0Hz, 6H, OCH₂CH₃).
- ¹³C NMR** (δ, ppm) (CDCl₃, 100 MHz) 169.5 (Cq x2, C=O), 159.7 (Cq), 133.0 (CH-Ar), 125.8 (C=C₂), 125.8 (Cq), 115.2 (Cq), 114.0 (CH-Ar), 90.0 (Cq, C≡C), 87.9 (Cq, C≡C), 79.4 (Cq, C≡C), 71.6 (≡CH), 61.7 (OCH₂CH₃ x2), 56.7 (Cq), 55.3 (OCH₃), 38.7 (CH₂), 22.4 (CH₂), 14.0 (OCH₂CH₃ x2).
- IR** (ν, cm⁻¹) (CCl₄) 3314 (m), 2983 (m), 2937 (m), 2908 (w), 2838 (w), 1739 (s), 1601 (m), 1571 (w), 1509 (s), 1465 (w), 1442 (w), 1390 (w), 1367 (w), 1289 (s), 1249 (s), 1215 (s), 1193 (s), 1181 (s), 1170 (s), 1096 (w), 1071 (w).
- HRMS** (EI+, m/z) : Calculated: 368.1624 found: 368.1623.

2-[4-(4-Chloro-phenyl)-2-methylene-but-3-ynyl]-2-prop-2-ynyl-malonic acid diethyl ester 4.64f

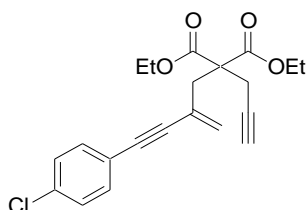

MF: C₂₁H₂₁O₄Cl

MW = 372.5 g.mol⁻¹

- Method :** See **general procedure 4.1** with (1 equiv., 3.6 mmol, 1.0 g) of 2-(2-bromo-allyl)-malonic acid diethyl ester, followed by **general procedure 4.5** using (1 equiv., 2.0 mmol, 580 mg) of the previously prepared coupled product in EtOH, followed by **general procedure 4.2** using (1 equiv., 0.63 mmol, 140 mg) of the previously prepared terminal alkyne and (1.1 equiv., 0.69 mmol, 161 mg) of 1-chloro-4-iodo-benzene, followed by **general procedure 4.4** using (1 equiv., 0.53 mmol, 151 mg) of the previously prepared monosubstituted malonate.
- Purification :** Flash column chromatography (silica gel 95:5 PE:AcOEt)/ **R_f** (9:1 PE:AcOEt): 0.50.
- Product :** White solid.
- Isolated yield :** 27% for four steps.
- ¹H NMR** (δ, ppm) (CDCl₃, 400 MHz) 7.36 (d, *J* = 8.6Hz, 2H, CH-Ar), 7.28 (d, *J* = 8.6Hz, 2H, CH-Ar), 5.59 (s, 1H, C=CH₂), 5.50 (s, 1H, C=CH₂), 4.25-4.09 (m, 4H, OCH₂CH₃), 3.06 (s, 2H, CH₂), 2.98 (d, *J* = 2.8Hz, 2H, CH₂-propargyl chain), 2.06 (t, *J* = 2.8Hz, 1H, ≡CH), 1.23 (t, *J* = 7.2Hz, 6H, OCH₂CH₃).
- ¹³C NMR** (δ, ppm) (CDCl₃, 100 MHz) 169.4 (Cq x2, C=O), 134.4 (Cq), 132.7 (CH-Ar), 128.7 (CH-Ar), 126.9 (C=CH₂), 125.4 (Cq), 121.5 (Cq), 90.1 (Cq, C≡C), 88.8 (Cq, C≡C), 79.2 (Cq, C≡C), 71.7 (≡CH), 61.8 (OCH₂CH₃ x2), 56.7 (Cq), 38.5 (CH₂), 22.4 (CH₂), 14.0 (OCH₂CH₃ x2).
- IR** (ν, cm⁻¹) (CCl₄) 3313 (s), 3100 (w), 2983 (s), 2939 (m), 2907 (w), 2873 (w), 1739 (s), 1606 (w), 1591 (w), 1490 (s), 1465 (m), 1445 (m), 1397 (m), 1367 (m), 1321 (m), 1285 (s), 1247 (s), 1215 (s), 1193 (s), 1093 (s), 1071 (s).
- HRMS** (EI+, m/z) : Calculated: 372.1128 found: 372.1121.

2-(2-Methylene-4-phenyl-but-3-ynyl)-2-(3-phenyl-prop-2-ynyl)-malonic acid diethyl ester IDJ 4.64g

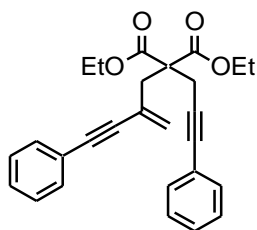

MF: C₂₇H₂₆O₄

MW = 414 g.mol⁻¹

- Method :** To a round bottom flask under an argon atmosphere charged with 2-(2-methylene-4-phenyl-but-3-ynyl)-2-prop-2-ynyl-malonic acid diethyl ester (1 equiv., 0.30 mmol, 100 mg) and Et₃N (0.1 M, 3 mL) was sequentially added PhI (1.20 equiv., 0.36 mmol, 40 μL) and PdCl₂(PPh₃)₂ (0.02 equiv., 0.006 mmol, 4.2 mg). The reaction was allowed to stir at room temperature for 5 min., the CuI (0.02 equiv, 0.006 mmol, 1.2 mg) was then added and the reaction was allowed to stir at room temperature overnight. Upon completion (TLC), the reaction was filtered through celite, concentrated under reduced pressure and purified by flash column chromatography.
- Reference:** Thorand, S.; Krause N.; *J. Org. Chem.* **1998**, 63, 8551.
- Purification :** Flash column chromatography (silica gel, toluene)/ R_f (toluene): 0.34.
- Product :** White solid.
- Isolated yield :** 31% isolated/ 62% (brsm).
- ¹H NMR** (δ, ppm) (CDCl₃, 400 MHz) 7.45- 7.43 (m, 2H, CH-Ph), 7.38-7.36 (m, 3H, CH-Ph), 7.30-7.27 (m, 5H, CH-Ph), 5.61 (s, 1H, C=CH₂), 5.52 (s, 1H, C=CH₂), 4.28-4.12 (m, 4H, OCH₂CH₃), 3.22 (s, 2H, CH₂), 3.13 (s, 2H, CH₂), 1.24 (t, J = 7.0Hz, 6H, OCH₂CH₃).
- ¹³C NMR** (δ, ppm) (CDCl₃, 100 MHz) 169.6 (Cq x2, C=O), 131.6 (CH-Ph), 131.5 (CH-Ph), 128.3 (CH-Ph), 128.2 (CH-Ph), 128.2 (CH-Ph), 127.9 (CH-Ph), 126.5 (C=C₂H₂), 125.7 (Cq), 123.3 (Cq), 123.0 (Cq), 89.9 (Cq, C≡C), 89.2 (Cq, C≡C), 84.8 (Cq, C≡C), 83.9 (Cq, C≡C), 61.7 (OCH₂CH₃ x2), 57.0 (Cq), 38.9 (CH₂), 23.3 (CH₂), 14.0 (OCH₂CH₃ x2).
- IR** (ν, cm⁻¹) (CCl₄) 3059 (w), 2983 (m), 2939 (w), 2907 (w), 1739 (s), 1599 (w), 1491 (m), 1477 (w), 1465 (w), 1444 (m), 1426 (w), 1390 (w), 1367 (w), 1286 (w), 1260 (w), 1215 (m), 1193 (m), 1181 (m), 1097 (w), 1070 (w), 1052 (w), 1030 (w).
- HRMS** (EI+, m/z) : Calculated: 414.1831 found: 414.1843.

Compound **4.64h** was synthesized as described in the scheme below:

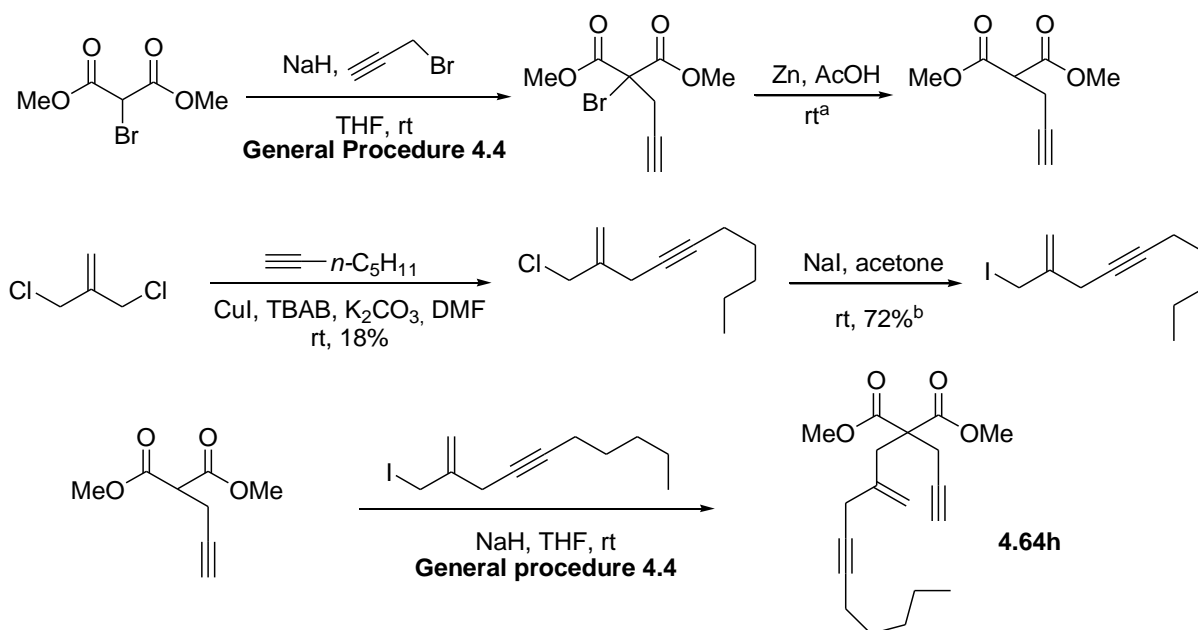

Scheme B.3.3.2: Synthesis of substrate **4.64h**. ^a Synthesized by Fabien Gagosz, yields unknown. ^b Following references.³⁰⁵

2-(2-Methylene-dec-4-ynyl)-2-prop-2-ynyl-malonic acid dimethyl ester

4.64h

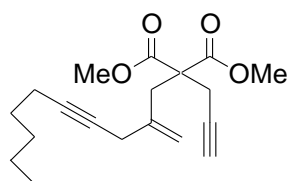

MF: C₁₉H₂₆O₄

MW = 318 g.mol⁻¹

Method : See **general procedure 4.4** using (1 equiv., 0.33 mmol, 55 mg) of previously prepared 2-prop-2-ynyl-malonic acid dimethyl ester and previously prepared 1-iodo-dec-4-yn-2-one (1.2 equiv., 0.39 mmol, 108 mg) in the place of propargyl bromide.

Purification : Flash column chromatography (silica gel, 9:1 PE AcOEt) / **R_f** (9:1 PE:AcOEt): 0.37.

³⁰⁵ (a) Buzas, A.; Gagosz, F.; *J. Am. Chem. Soc.*, 128, **2006**, 12614. (b) D'Aniello, F.; Mann, A.; Mattii, D.; Taddei, M.; *J. Org. Chem.* **1994**, 59, 14, 3762.

Product :	yellow oil.
Isolated yield :	89%.
¹H NMR (δ, ppm) (CDCl ₃ , 400 MHz)	7.32 (s, 1H, C=CH ₂), 5.00 (s, 1H, C=CH ₂), 3.76 (s, 6H, OCH ₃), 2.93 (s, 2H, CH ₂), 2.84 (d, <i>J</i> = 2.8Hz, 2H, CH ₂ -propargyl chain), 2.82 (s, 2H, CH ₂), 2.20-2.16 (m, 2H, CH ₂ -pentylchain), 2.05 (t, <i>J</i> = 2.8 Hz, 1H, ≡CH), 1.53-1.46 (m, 2H, CH ₂ -pentylchain), 1.38-1.28 (m, 4H, CH ₂ -pentylchain), 0.90 (t, <i>J</i> = 7.0Hz, 3H, CH ₃ -pentylchain).
¹³C NMR (δ, ppm) (CDCl ₃ , 100 MHz)	170.4 (Cq x2, C=O), 139.4 (Cq, C=CH ₂), 116.5 (C=C=CH ₂), 83.5 (Cq, C≡C), 79.0 (Cq, C≡C), 76.3 (Cq, C≡C), 71.9 (C≡CH), 56.5 (Cq), 52.8 (OCH ₃ x2), 37.2 (CH ₂), 31.1 (CH ₂), 28.7 (CH ₂), 26.8 (CH ₂), 22.8 (CH ₂), 22.2 (CH ₂), 18.7 (CH ₂), 14.0 (CH ₃).
IR (ν, cm ⁻¹) (CCl ₄)	3314 (m), 2955 (m), 2934 (m), 2861 (w), 2843 (w), 1742 (s), 1647 (w), 1436 (m), 1327 (w), 1292 (m), 1235 (m), 1201 (m), 1179 (m), 1072 (m), 1053 (m).
HRMS (EI+, <i>m/z</i>) :	Calculated: 318.1831 found: 318.1844.

2-(3-Methyl-2-methylene-butyl)-malonic acid diethyl ester

4.77

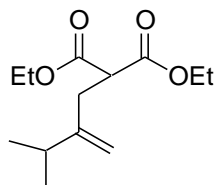

MF: C₁₃H₂₂O₄

MW = 242 g.mol⁻¹

Method :	See general procedure 4.3 using (1 equiv., 0.54 mmol, 150 mg) of 2-(2-bromo-allyl)-malonic acid diethyl ester and (4 equiv., solution 2 M in THF, 1.08 mL) of ⁱ PrMgCl.
Purification :	Flash column chromatography (silica gel 9:1 PE: AcOEt)/ R_f (9:1 PE:AcOEt): 0.52.
Product :	Transparent oil.
Isolated yield :	77%.
¹H NMR (δ, ppm)	4.81 (s, 1H, C=CH ₂), 4.70 (s, 1H, C=CH ₂), 4.19 (q, <i>J</i> = 7.2Hz, 4H, OCH ₂ CH ₃), 3.60 (t, <i>J</i> = 8.0Hz, 1H, CH), 2.64 (d, <i>J</i> = 8.0Hz, 2H, CH ₂), 2.25 (hept, <i>J</i> = 6.8Hz,

(CDCl₃, 400 MHz) 1H, CH-ⁱPr), 1.26 (t, *J* = 7.2Hz, 6H, OCH₂CH₃), 1.04 (d, *J* = 6.8Hz, 6H, CH₃-ⁱPr).

¹³C NMR (δ, ppm) 169.2 (Cq x2, C=O), 152.0 (Cq, C=CH₂), 108.1 (C=CH₂), 61.3 (OCH₂CH₃ x2), 50.8 (CH), 33.9 (CH), 33.1 (CH₂), 21.7 (CH₃-ⁱPr x2), 14.1 (OCH₂CH₃ x2).

(CDCl₃, 100 MHz)

IR (ν, cm⁻¹) (CCl₄) 3086 (w), 2965 (s), 2938 (m), 2908 (m), 2873 (m), 1737 (s), 1645 (m), 1465 (m), 1446 (m), 1391 (m), 1369 (m), 1334 (m), 1300 (m), 1247 (m), 1177 (m), 1151 (m), 1097 (m), 1037 (m).

HRMS (EI+, m/z) : Calculated: 242.1518 found: 242.1522.

2-(2-Cyclohexyl-allyl)-malonic acid diethyl ester

4.78

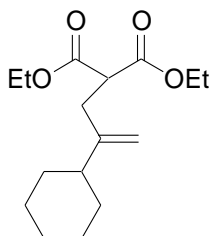

MF: C₁₆H₂₆O₄

MW =282 g.mol⁻¹

Method : See **general procedure 4.3** using (1 equiv., 0.54 mmol, 150 mg) of 2-(2-bromo-allyl)-malonic acid diethyl ester and (4 equiv., solution 1.3 M in THF/toluene, 1.66 mL) of CyMgCl.

Purification : Flash column chromatography (silica gel 95:5 PE:AcOEt)/ R_f (9:1 PE:AcOEt): 0.53.

Product : Transparent oil.

Isolated yield : 85%.

¹H NMR (δ, ppm) 4.78 (s, 1H, C=CH₂), 4.71 (s, 1H, C=CH₂), 4.18 (q, *J* = 7.1Hz, 4H, OCH₂CH₃), 3.58 (t, *J* = 7.7Hz, 1H, CH), 2.63 (d, *J* = 7.7Hz, 2H, CH₂), 1.87-1.66 (m, 6H, CH- + CH₂-Cy), 1.28-1.1 (m, 5H, CH₂-Cy), 1.26 (t, *J* = 7.1Hz, 6H, OCH₂CH₃).

(CDCl₃, 400 MHz)

¹³C NMR (δ, ppm) 169.2 (Cq x2, C=O), 151.2 (Cq, C=CH₂), 108.7 (C=CH₂), 61.3 (OCH₂CH₃ x2), 50.9 (CH), 44.2 (CH), 33.7 (CH₂), 32.4 (CH₂), 26.7 (CH₂), 26.3 (CH₂), 14.1 (OCH₂CH₃ x2).

(CDCl₃, 100 MHz)

IR (ν, cm⁻¹) (CCl₄) 3086 (w), 2983 (m), 2929 (s), 2854 (s), 1753 (s), 1735 (s), 1643 (w), 1477 (w), 1464 (w), 1448 (m), 1391 (w), 1369 (m), 1333 (m), 1299 (m), 1235 (m), 1177 (m), 1151 (s), 1114 (w), 1097 (m), 1037 (m).

HRMS (EI+, m/z) : Calculated: 282.1831 found: 282.1831.

2-(2-Methylene-heptyl)-malonic acid diethyl ester

4.79

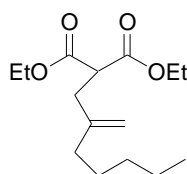

MF: C₁₅H₂₆O₄

MW = 270g.mol⁻¹

Method : See **general procedure 4.3** using (1 equiv., 0.54 mmol, 150 mg) of 2-(2-bromo-allyl)-malonic acid diethyl ester and (3 equiv., solution 2M in Et₂O, 810 μL) of *n*-C₅H₁₁MgBr.

Purification : Flash column chromatography (silica gel 95:5 PE: AcOEt)/ R_f (9:1 PE:AcOEt): 0.56.

Product : Transparent oil.

Isolated yield : 62%.

¹H NMR (δ, ppm) (CDCl₃, 400 MHz) 4.78 (s, 1H, C=CH₂), 4.74 (s, 1H, C=CH₂), 4.18 (q, *J* = 7.2Hz, 4H, OCH₂CH₃), 3.57 (t, *J* = 7.7Hz, 1H, CH), 2.61 (d, *J* = 7.7Hz, 2H, CH₂), 2.02 (t, *J* = 7.6Hz, 2H, CH₂-pentylchain), 1.47-1.39 (m, 2H, CH₂-pentylchain), 1.35-1.28 (m, 4H, CH₂-pentylchain), 1.26 (t, *J* = 7.2Hz, 6H, OCH₂CH₃), 0.89 (t, *J* = 7.0Hz, 3H, CH₃-pentylchain).

¹³C NMR (δ, ppm) (CDCl₃, 100 MHz) 169.2 (Cq x2, C=O), 146.0 (Cq, C=CH₂), 110.8 (C=CH₂), 61.4 (OCH₂CH₃ x2), 50.7 (CH), 36.0 (CH₂), 34.8 (CH₂), 31.5 (CH₂), 27.3 (CH₂), 22.5 (CH₂), 14.1 (CH₃), 14.0 (CH₃).

IR (ν, cm⁻¹) (CCl₄) 3080 (w), 2983 (m), 2960 (m), 2932 (m), 2873 (m), 2860 (m), 1753 (s), 1736 (s), 1647 (w), 1465 (m), 1445 (m), 1391 (m), 1369 (m), 1334 (m), 1234 (m), 1176 (m), 1150 (m), 1097 (m), 1037 (m).

HRMS (EI+, m/z) : Calculated: 270.1831 found: 270.1827.

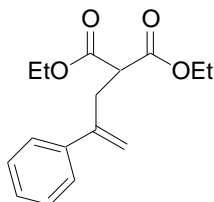
MF: C₁₆H₂₀O₄MW = 276g.mol⁻¹

Method :	See general procedure 4.3 using (1 equiv., 0.54 mmol, 150 mg) of 2-(2-bromo-allyl)-malonic acid diethyl ester and (4 equiv., solution 1 M in THF, 2.2 mL) of PhMgBr.
Purification :	Flash column chromatography (silica gel 9:1 PE: AcOEt)/ R_f (9:1 PE:AcOEt): 0.33.
Product :	Transparent oil.
Isolated yield :	84%.
¹H NMR (δ, ppm) (CDCl ₃ , 400 MHz)	7.39-7.28 (m, 5H, CH-Ph), 5.30 (s, 1H, C=CH ₂), 5.13 (s, 1H, C=CH ₂), 4.15 (q, <i>J</i> = 7.2Hz, 4H, OCH ₂ CH ₃), 3.50 (t, <i>J</i> = 7.6Hz, 1H, CH), 3.12 (d, <i>J</i> = 7.6Hz, 2H, CH ₂), 1.24 (t, <i>J</i> = 7.2 Hz, 6H, OCH ₂ CH ₃).
¹³C NMR (δ, ppm) (CDCl ₃ , 100 MHz)	168.9 (Cq x2, C=O), 144.9 (Cq), 140.1 (Cq), 128.4 (CH-Ph), 127.7 (CH-Ph), 126.3 (CH-Ph), 114.7 (C=CH ₂), 61.4 (OCH ₂ CH ₃ x2), 51.0 (CH), 34.5 (CH ₂), 14.0 (OCH ₂ CH ₃ x2).
IR (ν, cm ⁻¹) (CCl ₄)	3467 (w), 3085 (w), 3060 (w), 3025 (w), 2983 (m), 2939 (w), 2907 (w), 2873 (w), 1736 (s), 1631 (w), 1600 (w), 1575 (w), 1495 (m), 1476 (m), 1465 (m), 1446 (m), 1391 (m), 1369 (s), 1331 (s), 1301 (s), 1264 (s), 1230 (s), 1152 (s), 1110 (s), 1097 (s), 1064 (s), 1037 (s).
HRMS (EI+, m/z) :	Calculated: 276.1362 found: 276.1371.

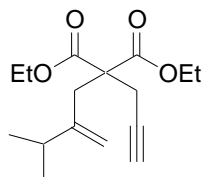
MF: C₁₆H₂₄O₄MW = 280g.mol⁻¹

- Method :** See **general procedure 4.4** using (1 equiv., 0.4 mmol, 96 mg) of 2-(3-methyl-2-methylene-butyl)-malonic acid diethyl ester.
- Purification :** Flash column chromatography (silica gel 9:1 PE: AcOEt)/ **R_f** (9:1 PE:AcOEt): 0.38.
- Product :** Transparent oil.
- Isolated yield :** 99%.
- ¹H NMR** (δ, ppm) (CDCl₃, 400 MHz) 4.93 (s, 1H, C=CH₂), 4.83 (s, 1H, C=CH₂), 4.24-4.15 (m, 4H, OCH₂CH₃), 2.88 (s, 2H, CH₂), 2.82 (d, *J* = 2.8Hz, 2H, CH₂-propargyl chain), 2.07-1.98 (m, 2H, CH-^{*i*}Pr + ≡CH), 1.25 (t, *J* = 7.2Hz, 6H, OCH₂CH₃), 1.01 (d, *J* = 6.8Hz, 6H, CH₃-^{*i*}Pr).
- ¹³C NMR** (δ, ppm) (CDCl₃, 100 MHz) 170.2 (Cq x2, C=O), 150.6 (Cq, C=CH₂), 111.3 (C=C=CH₂), 79.5 (Cq, C≡C), 71.6 (C≡CH), 61.6 (OCH₂CH₃ x2), 56.7 (Cq), 36.6 (CH₂), 33.6 (CH-^{*i*}Pr), 22.5 (CH₂), 22.0 (CH₃-^{*i*}Pr), 14.0 (OCH₂CH₃ x2).
- IR** (□, cm⁻¹) (CCl₄) 3314 (s), 2964 (s), 2931 (s), 2872 (m), 1737 (s), 1641 (w), 1465 (m), 1367 (m), 1325 (m), 1288 (s), 1203 (s), 1097 (s), 1049 (s), 1018 (s).
- HRMS** (EI+, *m/z*) : Calculated: 280.1675 found: 280.1680.

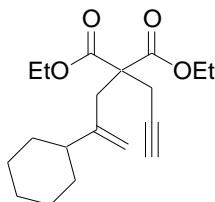
MF: C₁₉H₂₈O₄MW = 320 g.mol⁻¹

Method :	See general procedure 4.4 using (1 equiv., 0.46 mmol, 129 mg) of 2-(2-cyclohexyl-allyl)-malonic acid diethyl ester.
Purification :	Flash column chromatography (silica gel 95:5 PE: AcOEt)/ R _f (95:5 PE:AcOEt): 0.34.
Product :	Transparent oil.
Isolated yield :	86%.
¹H NMR (δ, ppm) (CDCl ₃ , 400 MHz)	4.89 (s, 1H, C=CH ₂), 4.85 (s, 1H, C=CH ₂), 4.26-4.13 (m, 4H, OCH ₂ CH ₃), 2.86 (s, 2H, CH ₂), 2.82 (d, <i>J</i> = 2.5Hz, 2H, CH ₂ -propargyl chain), 2.02 (t, <i>J</i> = 2.5Hz, 1H, ≡CH), 1.81-1.74 (m, 3H, CH- + CH ₂ -Cy), 1.67-1.56 (m, 3H, CH ₂ -Cy), 1.26 (t, <i>J</i> = 7.0Hz, 6H, OCH ₂ CH ₃), 1.22-1.02 (m, 5H, CH-Cy).
¹³C NMR (δ, ppm) (CDCl ₃ , 100 MHz)	170.2 (Cq x2, C=O), 149.7 (Cq, C=CH ₂), 112.1 (C=C ₂ H ₂), 79.5 (Cq, C≡C), 71.6 (≡CH), 61.6 (OCH ₂ CH ₃ x2), 56.7 (Cq), 43.9 (CH-Cy), 36.9 (CH ₂), 32.8 (CH ₂), 26.9 (CH ₂), 26.4 (CH ₂), 22.5 (CH ₂), 14.0 (OCH ₂ CH ₃ x2).
IR (ν, cm ⁻¹) (CCl ₄)	3314 (s), 3086 (w), 2983 (s), 2929 (s), 2853 (s), 1737 (s), 1639 (w), 1477 (w), 1464 (w), 1447 (m), 1389 (w), 1367 (w), 1323 (m), 1287 (s), 1259 (s), 1241 (s), 1222 (s), 1201 (s), 1184 (s), 1133 (m), 1096 (m), 1068 (s), 1053 (s), 1017 (s).
HRMS (EI+, <i>m/z</i>) :	Calculated: 320.1988 found: 320.1992.

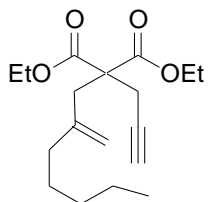
MF: C₁₈H₂₈O₄MW = 308 g.mol⁻¹

- Method :** See **general procedure 4.4** using (1 equiv., 0.30 mmol, 80 mg) of 2-(2-methylene-heptyl)-malonic acid diethyl ester.
- Purification :** Flash column chromatography (silica gel 95:5 PE:AcOEt)/ **R_f** (9:1 PE:AcOEt): 0.61.
- Product :** Transparent oil.
- Isolated yield :** 86%.
- ¹H NMR** (δ, ppm) (CDCl₃, 400 MHz) 4.91 (s, 1H, C=CH₂), 4.91 (s, 1H, C=CH₂), 4.27-4.13 (m, 4H, OCH₂CH₃), 2.83 (s, 2H, CH₂), 2.82 (d, *J* = 2.7Hz, 2H, CH₂-propargyl chain), 2.02 (t, *J* = 2.7Hz, 1H, ≡CH), 1.90 (t, *J* = 7.6Hz, 2H, CH₂-pentyl chain), 1.45-1.38 (m, 2H, CH₂-pentyl chain), 1.31-1.21 (m, 4H, CH₂-pentyl chain), 1.26 (t, *J* = 7.2Hz, 6H, OCH₂CH₃), 0.88 (t, *J* = 7.2 Hz, 3H, CH₃-pentyl chain).
- ¹³C NMR** (δ, ppm) (CDCl₃, 100 MHz) 170.2 (Cq x2, C=O), 144.3 (Cq, C=CH₂), 114.7 (C=CH₂), 79.4 (Cq, C≡C), 71.6 (≡CH), 61.6 (OCH₂CH₃ x2), 56.6 (Cq), 37.2 (CH₂), 36.6 (CH₂), 31.5 (CH₂), 27.7 (CH₂), 22.6 (CH₂), 22.5 (CH₂), 14.0 (CH₃ x2), 13.9 (CH₃).
- IR** (ν, cm⁻¹) (CCl₄) 3314 (m), 3078 (w), 2982 (m), 2960 (m), 2932 (m), 2873 (m), 2860 (m), 1737 (s), 1641 (w), 1465 (w), 1445 (w), 1389 (w), 1367 (w), 1323 (w), 1287 (m), 1260 (m), 1204 (s), 1183 (s), 1097 (m), 1069 (m), 1050 (m), 1017(m).
- HRMS** (EI+, *m/z*) : Calculated: 308.1988 found: 308.1996.

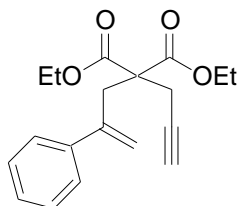
MF: C₁₉H₂₂O₄MW = 314 g.mol⁻¹

- Method :** See **general procedure 3.4** using (1 equiv., 0.41 mmol, 114 mg) of 2-(2-phenyl-allyl)-malonic acid diethyl ester.
- Purification :** Flash column chromatography (silica gel 9:1 PE: AcOEt)/ **R_f** (9:1 PE:AcOEt): 0.30.
- Product :** White solid.
- Isolated yield :** 95%.
- ¹H NMR** (δ, ppm) (CDCl₃, 400 MHz) 7.34-7.23 (m, 5H, CH-Ph), 5.30 (s, 1H, C=CH₂), 5.29 (s, 1H, C=CH₂), 3.98-3.90 (m, 2H, OCH₂CH₃), 3.80-3.72 (m, 2H, OCH₂CH₃), 3.32 (s, 2H, CH₂), 2.75 (d, *J* = 2.6Hz, 2H, CH₂-propargyl chain), 2.04 (t, *J* = 2.6Hz, 1H, ≡CH), 1.13 (t, *J* = 7.2Hz, 6H, OCH₂CH₃).
- ¹³C NMR** (δ, ppm) (CDCl₃, 100 MHz) 169.5 (Cq x2, C=O), 144.0 (Cq), 141.2 (Cq), 128.0 (CH-Ph), 127.6 (CH-Ph), 126.9 (CH-Ph), 118.8 (C=C₂), 79.4 (Cq, C≡C), 71.6 (≡CH), 61.4 (OCH₂CH₃ x2), 56.4 (Cq), 36.7 (CH₂), 22.3 (CH₂), 13.8 (OCH₂CH₃ x2).
- IR** (ν, cm⁻¹) (CCl₄) 3314 (m), 3084 (w), 3059 (w), 2983 (m), 2938 (w), 2907 (w), 2873 (w), 1738 (s), 1627 (w), 1600 (w), 1575 (w), 1493 (w), 1475 (w), 1464 (w), 1445 (w), 1425 (w), 1390 (w), 1367 (w), 1322 (w), 1300 (m), 1287 (m), 1241 (m), 1207 (s), 1187 (s), 1096 (w).
- HRMS** (EI+, m/z) : Calculated: 314.1518 found: 314.1512.

B.3.3.2 Cycloisomerization reaction of 1,6-enynes

The previously prepared 1,6-enynes were submitted to gold catalysis using PPh_3 as ancillary ligand and two different counter ions, SbF_6^- and NTf_2^- .

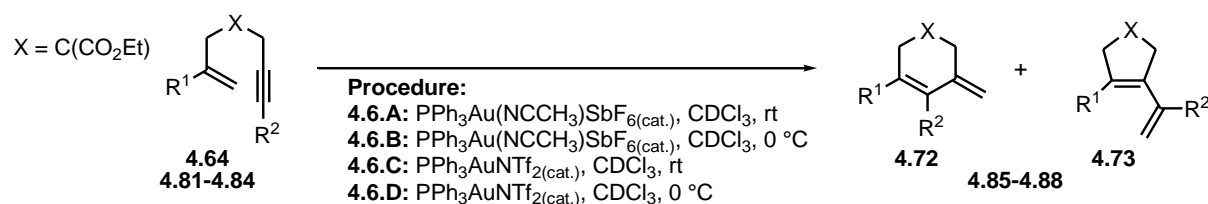

Scheme B.3.3.2: Gold catalyzed transformations of enynes **4.64** and **4.81-4.84**.

General procedure 4.6.A: To a NMR tube charged with 1,6-enyne (1 equiv.) and CDCl_3 (0.5 mL) was added the catalyst $\text{PPh}_3\text{Au}(\text{NCCH}_3)\text{SbF}_6$ (0.04 equiv.). The NMR tube was allowed to stand at room temperature while constantly monitored by ^1H NMR. Upon completion, the content of the NMR tube was transferred to a round bottom flask, concentrated under reduced pressure and purified by flash column chromatography.

General procedure 4.6.B: To a NMR tube charged with 1,6-enyne (1 equiv.) and CDCl_3 (0.5 mL) at 0 °C was added the catalyst $\text{PPh}_3\text{Au}(\text{NCCH}_3)\text{SbF}_6$ (0.04 equiv.). The NMR tube was allowed to stand at 0 °C for an estimated duration of time, after which, the reaction mixture was quenched with Et_3N at 0 °C before removal the NMR tube from the ice bath. When reaction completion was observed, the content of the NMR tube was transferred to a flask, concentrated under reduced pressure and purified by flash column chromatography.

General procedure 4.6.C: To a NMR tube charged with 1,6-enyne (1 equiv.) and CDCl_3 (0.5 mL) was added the catalyst $\text{PPh}_3\text{AuNTf}_2$ (0.04 equiv.). The NMR tube was allowed to stand at room temperature while constantly monitored by ^1H NMR. Upon completion, the content of the NMR tube was transferred to a round bottom flask, concentrated under reduced pressure and purified by flash column chromatography.

General procedure 4.6.D: To a NMR tube charged with 1,6-enyne (1 equiv.) and CDCl_3 (0.5 mL) at 0 °C was added the catalyst $\text{PPh}_3\text{AuNTf}_2$ (0.04 equiv.). The NMR tube was allowed to stand at 0 °C for an estimated duration of time, after which, the reaction mixture was

quenched with Et₃N at 0°C before removal the NMR tube from the ice bath. When reaction completion was observed, the content of the NMR tube was transferred to a flask, concentrated under reduced pressure and purified by flash column chromatography.

3-Ethynyl-4-vinyl-cyclopent-3-ene-1,1-dicarboxylic acid diethyl ester

4.73a

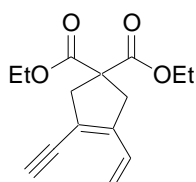

MF: C₁₅H₁₈O₄

MW = 262 g.mol⁻¹

Method :	See general procedure 4.6.A using (1 equiv., 0.02 mmol, 6.6 mg) of 2-(2-methylene-4-trimethylsilyl-but-3-ynyl)-2-prop-2-ynyl-malonic acid diethyl ester
Purification :	Flash column chromatography (silica gel 9:1 PE: AcOEt)/ R_f (9:1 PE:AcOEt): 0.35.
Product :	Transparent oil.
Isolated yield :	62%.
¹H NMR (δ, ppm) (CDCl ₃ , 400 MHz)	6.77 (dd, <i>J</i> = 11.0Hz, <i>J</i> = 17.4Hz, 1H, CH=CH₂), 5.29 (d, <i>J</i> = 11.0Hz, 1H, CH=CH₂), 5.24 (d, <i>J</i> = 17.4Hz, 1H, CH=CH₂), 4.21 (q, <i>J</i> = 7.2Hz, 4H, OCH₂CH₃), 3.27 (s, 1H, ≡CH), 3.23 (s, 2H, CH₂), 3.22 (s, 2H, CH₂), 1.26 (t, <i>J</i> = 7.2 Hz, 6H, OCH₂CH₃).
¹³C NMR (δ, ppm) (CDCl ₃ , 100 MHz)	171.3 (Cq x2, C=O), 145.7 (Cq), 130.8 (CH=CH₂), 117.9 (Cq), 117.6 (CH=CH₂), 83.7 (Cq, C≡C), 78.7 (≡CH), 61.8 (OCH₂CH₃ x2), 57.6 (Cq), 43.8 (CH₂), 39.5 (CH₂), 14.0 (OCH₂CH₃ x2).
IR (ν, cm ⁻¹) (CCl ₄)	3311 (m), 2982 (m), 2962 (m), 2929 (m), 2856 (w), 1736 (s), 1681 (w), 1465 (w), 1446 (w), 1389 (w), 1367 (w), 1259 (s), 1185 (m), 1096 (m), 1072 (m), 1017 (m).
HRMS (EI+, m/z) :	Calculated: 262.1205 found: 262.1213.

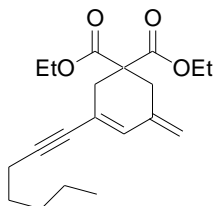
MF: C₂₀H₂₈O₄MW = 332 g.mol⁻¹

- Method :** See **general procedure 4.6.C** using (1 equiv., 0.02 mmol, 6.6 mg) of 2-(2-methylene-non-3-ynyl)-2-prop-2-ynyl-malonic acid diethyl ester.
- Purification :** Flash column chromatography (silica gel 9:1 PE: AcOEt) / **R_f** (9:1 PE:AcOEt): 0.29.
- Product :** Transparent oil.
- Isolated yield :** 73%.
- ¹H NMR** (δ, ppm) (CDCl₃, 400 MHz) 6.35 (s, 1H, C=CH), 4.95 (s, 1H, C=CH₂), 4.92 (s, 1H, C=CH₂), 4.17 (q, *J* = 7.2Hz, 4H, OCH₂CH₃), 2.82 (s, 2H, CH₂), 2.74 (s, 2H, CH₂), 2.32 (t, *J* = 7.2 Hz, 2H, CH₂-pentylchain), 1.57-1.50 (m, 2H, CH₂-pentylchain), 1.43-1.30 (m, 4H, CH₂-pentylchain),, 1.23 (t, *J* = 7.2Hz, 6H, OCH₂CH₃), 0.90 (t, *J* = 7.0Hz, 3H, CH₃-pentylchain).
- ¹³C NMR** (δ, ppm) (CDCl₃, 100 MHz) 170.4 (Cq x2, C=O), 138.9 (Cq), 132.7 (=CH), 120.4 (Cq), 114.4 (=CH₂), 92.9 (Cq, C≡C), 81.1 (Cq, C≡C), 61.6 (OCH₂CH₃ x2), 53.8 (Cq), 35.0 (CH₂), 35.0 (CH₂), 31.1 (CH₂), 28.4 (CH₂), 22.2 (CH₂), 19.5 (CH₂), 14.1 (CH₃ x2), 14.0 (CH₃).
- IR** (ν, cm⁻¹) (CCl₄) 2960 (m), 2933 (m), 2874 (m), 2861 (m), 1738 (s), 1701 (w), 1639 (w), 1466 (w), 1458 (w), 1446 (w), 1419 (w), 1368 (w), 1300 (w), 1253 (m), 1193 (m), 1159 (w), 1098 (w), 1053 (w).
- HRMS** (EI+, *m/z*) : Calculated: 332.1988 found: 332.1997.

3-Hept-1-ynyl-5-methylene-cyclohex-3-ene-1,1-dicarboxylic acid diethyl ester **4.72b** +
and 3-Hept-1-ynyl-4-vinyl-cyclopent-3-ene-1,1-dicarboxylic acid diethyl ester **4.73b**

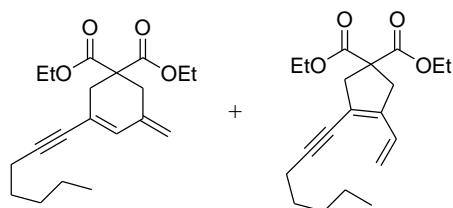

MF: C₂₀H₂₈O₄

MW = 332 g.mol⁻¹

Method : See **general procedure 4.6.A** using (1 equiv., 0.03 mmol, 9 mg) of 2-(2-methylene-non-3-ynyl)-2-prop-2-ynyl-malonic acid diethyl ester.

Purification : Flash column chromatography (silica gel 9:1 PE AcOEt)/ **R_f** (9:1 PE:AcOEt): 0.29.

Product : Transparent oil.

Isolated yield : 58% (ratio 1.9:1).

¹H NMR (δ, ppm) (CDCl₃, 400 MHz) **5 membered ring:** 6.74 (dd, *J* = 11.0Hz, *J* = 17.0Hz, 1H, CH=CH₂), 5.19 (d, *J* = 11.0Hz, 1H, CH=CH₂), 5.18 (d, *J* = 17.0Hz, 1H, CH=CH₂), 4.23-4.15 (m, 4H, OCH₂CH₃), 3.17 (s, 4H, CH₂), 2.37 (t, *J* = 7.0Hz, 2H, CH₂-pentylchain), 1.57-1.50 (m, 2H, CH₂-pentylchain), 1.43-1.30 (m, 4H, CH₂-pentylchain), 1.25 (t, *J* = 7.2 Hz, 6H, OCH₂CH₃), 0.90 (t, *J* = 7.0Hz, 3H, CH₃-pentylchain).

6-membered ring: 6.35 (s, 1H, C=CH), 4.95 (s, 1H, C=CH₂), 4.92 (s, 1H, C=CH₂), 4.23-4.15 (m, 4H, OCH₂CH₃), 2.82 (s, 2H, CH₂), 2.74 (s, 2H, CH₂), 2.32 (t, *J* = 7.2 Hz, 2H, CH₂-pentylchain), 1.57-1.50 (m, 2H, CH₂-pentylchain), 1.43-1.30 (m, 4H, CH₂-pentylchain), 1.23 (t, *J* = 7.2Hz, 6H, OCH₂CH₃), 0.90 (t, *J* = 7.0Hz, 3H, CH₃-pentylchain).

¹³C NMR (δ, ppm) (CDCl₃, 100 MHz) **5 and 6 membered rings:** 171.6 (Cq x2, C=O), 170.4 (Cq x2, C=O), 142.1 (Cq), 138.9 (Cq), 132.7 (CH=), 131.2 (CH=), 120.5 (Cq), 119.9 (Cq), 116.1 (=CH₂), 114.4 (=CH₂), 97.6 (Cq, C≡C), 92.9 (Cq, C≡C), 81.2 (Cq, C≡C), 75.6 (Cq, C≡C), 61.7 (OCH₂CH₃ x2), 61.6 (OCH₂CH₃ x2), 57.5 (Cq), 53.8 (Cq), 44.3 (CH₂), 39.4 (CH₂), 35.0 (CH₂), 35.0 (CH₂), 31.1 (CH₂ x2), 28.5 (CH₂), 28.4 (CH₂), 22.2 (CH₂ x2), 19.7 (CH₂), 19.5 (CH₂), 14.1 (CH₃ x4), 14.0 (CH₃ x2).

IR (□, cm⁻¹) (CCl₄) 2961 (w), 2933 (w), 2874 (w), 2861 (w), 1737 (s), 1625 (w), 1467 (w), 1458 (w), 1445 (w), 1424 (w), 1367 (w), 1299 (w), 1252 (m), 1163 (m), 1097 (m), 1075 (m), 1045 (m), 1017 (m).

HRMS (EI+, m/z) : Calculated: 332.1988 found: 332.1976.

5-Methylene-3-phenylethynyl-cyclohex-3-ene-1,1-dicarboxylic acid diethyl ester 4.72d

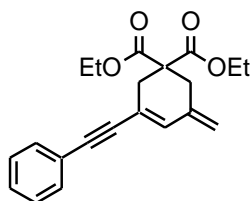

MF: C₂₁H₂₂O₄

MW = 338g.mol⁻¹

- Method :** See **general procedure 4.6.C** using (1 equiv., 0.02 mmol, 6.8 mg) of 2-(2-methylene-4-phenyl-but-3-ynyl)-2-prop-2-ynyl-malonic acid diethyl ester.
- Purification :** Flash column chromatography (silica gel 9:1 PE AcOEt)/ **R_f** (95:5 PE:AcOEt): 0.24.
- Product :** Transparent oil.
- Isolated yield :** 100%.
- ¹H NMR** (δ, ppm) (CDCl₃, 400 MHz) 7.45-7.43 (m, 2H, CH-Ph), 7.31-7.30 (m, 3H, CH-Ph), 6.53 (s, 1H, C=CH), 5.04 (s, 1H, C=CH₂), 5.02 (s, 1H, C=CH₂), 4.20 (q, *J* = 7.2Hz, 4H, OCH₂CH₃), 2.87 (s, 4H, CH₂), 1.24 (t, *J* = 7.2Hz, 6H, OCH₂CH₃).
- ¹³C NMR** (δ, ppm) (CDCl₃, 100 MHz) 170.3 (Cq x2, C=O), 138.8 (Cq), 134.1 (CH), 131.6 (CH), 128.3 (CH), 128.2 (CH), 123.2 (Cq), 119.7 (Cq), 115.6 (C=C₂H₂), 91.5 (Cq, C≡C), 90.0 (Cq, C≡C), 61.7 (OCH₂CH₃ x2), 53.8 (Cq), 35.0 (CH₂), 34.6 (CH₂), 14.0 (OCH₂CH₃ x2).
- IR** (ν, cm⁻¹) (CCl₄) 3312 (w), 3059 (w), 2981 (m), 2937 (m), 2908 (m), 1737 (s), 1597 (w), 1487 (m), 1443 (m), 1388 (m), 1366 (m), 1300 (m), 1248 (s), 1188 (s), 1097 (s), 1057 (s), 1016 (s).
- HRMS** (EI+, m/z) : Calculated: 338.1518 found: 338.1523.

5-Methylene-3-phenylethynyl-cyclohex-3-ene-1,1-dicarboxylic acid diethyl ester **4.72d** +
3-Phenylethynyl-4-vinyl-cyclopent-3-ene-1,1-dicarboxylic acid diethyl ester **4.73d**

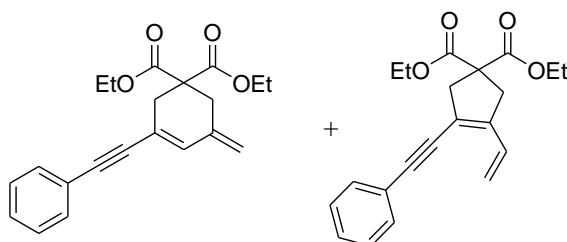

MF: C₂₁H₂₂O₄

MW = 338 g.mol⁻¹

- Method :** See **general procedure 4.6.A** using (1 equiv., 0.02 mmol, 6.8 mg) of 2-(2-methylene-4-phenyl-but-3-ynyl)-2-prop-2-ynyl-malonic acid diethyl ester.
- Purification :** Flash column chromatography (silica gel 9:1 PE AcOEt)/ R_f (9:1 PE:AcOEt): 0.32.
- Product :** Yellow oil.
- Isolated yield :** 57% (ratio 2.55:1).
- ¹H NMR** (δ, ppm) (CDCl₃, 400 MHz) **5 membered ring:** 7.47-7.42 (m, 2H, CH-Ph), 7.33-7.30 (m, 3H, CH-Ph), 6.86 (dd, *J* = 10.8Hz, *J* = 17.6Hz, CH=CH₂), 5.29 (d, *J* = 10.8Hz, 1H, CH=CH₂), 5.25 (d, *J* = 17.6Hz, 1H, CH=CH₂), 4.25- 4.17 (m, 4H, OCH₂CH₃), 3.31 (s, 2H, CH₂), 3.25 (s, 2H, CH₂), 1.27-1.23 (m, 6H, OCH₂CH₃).
- 6 membered ring:** 7.47-7.42 (m, 2H, CH-Ph), 7.33-7.30 (m, 3H, CH-Ph), 6.54 (s, 1H, C=CH), 5.05 (s, 1H, C=CH₂), 5.02 (s, 1H, C=CH₂), 4.25- 4.17 (m, 4H, OCH₂CH₃), 2.87 (s, 4H, CH₂), 1.27-1.23 (m, 6H, OCH₂CH₃).
- ¹³C NMR** (δ, ppm) (CDCl₃, 100 MHz) **5 and 6 membered rings:** 171.4 (Cq x2, C=O), 170.3 (Cq x2, C=O), 143.9 (Cq), 138.8 (Cq), 134.1 (CH), 131.9 (CH), 131.5 (CH), 131.5 (CH), 131.3 (CH), 131.1 (Cq), 128.3 (CH), 128.3 (CH), 128.2 (CH), 123.2 (Cq), 119.7 (Cq), 119.0 (Cq), 117.1 (=CH₂), 115.6 (=CH₂), 96.1 (Cq, C≡C), 91.5 (Cq, C≡C), 89.9 (Cq, C≡C), 84.4 (Cq, C≡C), 61.8 (OCH₂CH₃ x2), 61.7 (OCH₂CH₃ x2), 57.6 (Cq), 53.8 (Cq), 44.0 (CH₂), 39.6 (CH₂), 35.0 (CH₂), 34.6 (CH₂), 14.0 (OCH₂CH₃ x4).
- IR** (ν, cm⁻¹) (CCl₄) 2983 (w), 2963 (w), 2930 (w), 2909 (w), 2856 (w), 1737 (s), 1685 (w), 1599 (w), 1491 (w), 1465 (w), 1444 (w), 1423 (w), 1389 (w), 1368 (w), 1300 (w), 1249 (s), 1186 (m), 1161 (m), 1097 (m).
- HRMS** (EI+, *m/z*) : Calculated: 338.1518 found: 338.1524.

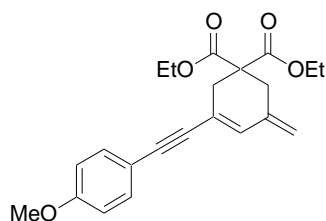
3-(4-Methoxy-phenylethynyl)-5-methylene-cyclohex-3-ene-1,1-dicarboxylic acid diethyl ester**4.72e**MF: C₂₂H₂₄O₅MW = 368 g.mol⁻¹

- Method :** See **general procedure 4.6.A or C** using (1 equiv., 0.02 mmol, 7.4 mg) of 2-[4-(4-methoxy-phenyl)-2-methylene-but-3-ynyl]-2-prop-2-ynyl-malonic acid diethyl ester.
- Purification :** Flash column chromatography (silica gel 8:2 PE AcOEt) / R_f (9:1 PE:AcOEt): 0.21.
- Product :** White solid.
- Isolated yield :** 100%.
- ¹H NMR** (δ, ppm) (CDCl₃, 400 MHz) 7.37 (d, *J* = 8.8Hz, 2H, CH-Ar), 6.84 (d, *J* = 8.8Hz, 2H, CH-Ar), 6.50 (s, 1H, C=CH), 5.02 (s, 1H, C=CH₂), 4.99 (s, 1H, C=CH₂), 4.19 (q, *J* = 7.2Hz, 4H, OCH₂CH₃), 3.81 (s, 3H, OCH₃), 2.86 (s, 4H, CH₂), 1.24 (t, *J* = 7.2Hz, 6H, OCH₂CH₃).
- ¹³C NMR** (δ, ppm) (CDCl₃, 100 MHz) 170.3 (Cq x2, C=O), 159.6 (Cq), 139.0 (Cq), 133.4 (C=C_≡CH), 133.0 (CH-Ar), 120.0 (Cq), 115.4 (Cq), 115.0 (C=C_≡CH₂), 114.0 (CH-Ar), 91.6 (Cq, C≡C), 88.8 (Cq, C≡C), 61.6 (OCH₂CH₃ x2), 55.3 (OCH₃), 53.9 (Cq), 35.1 (CH₂), 34.8 (CH₂), 14.0 (OCH₂CH₃ x2).
- IR** (ν, cm⁻¹) (CCl₄) 3472 (w), 2982 (m), 2960 (m), 2932 (m), 2855 (w), 2839 (w), 2198 (w), 1730 (s), 1682 (m), 1604 (m), 1510 (s), 1465 (m), 1443 (w), 1423 (w), 1390 (w), 1367 (w), 1292 (m), 1250 (s), 1182 (s), 1172 (s), 1097 (m), 1036 (s).
- HRMS** (EI+, m/z) : Calculated: 368.1624 found: 368.1633.

5-Methylene-4-phenyl-3-phenylethynyl-cyclohex-3-ene-1,1-dicarboxylic acid diethyl ester and 3-Phenylethynyl-4-(1-phenyl-vinyl)-cyclopent-3-ene-1,1-dicarboxylic acid diethyl ester	4.72g	+
	4.73g	

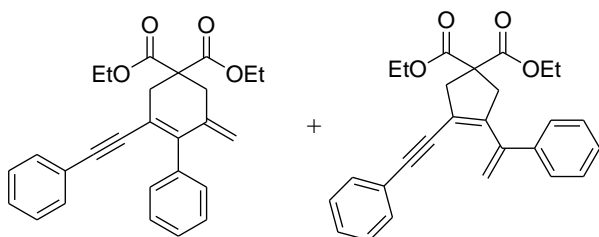

MF: C₂₇H₂₆O₄

MW = 414 g.mol⁻¹

- Method :** See **general procedure 4.6.A** using (1 equiv., 0.03 mmol, 12.2 mg) of 2-(2-methylene-4-phenyl-but-3-ynyl)-2-(3-phenyl-prop-2-ynyl)-malonic acid diethyl ester.
- Purification :** Flash column chromatography (silica gel 9:1 PE: AcOEt)/ **R_f** (9:1 PE:AcOEt): 0.29.
- Product :** Yellow oil.
- Isolated yield :** 91% (ratio 2:1).
- ¹H NMR** (δ, ppm) (CDCl₃, 400 MHz) **5 membered ring:** 7.47-7.42 (m, 2H, CH-Ph), 7.38-7.27 (m, 8H, CH-Ph), 6.62 (s, 1H, C=CH₂), 6.51 (s, 1H, C=CH₂), 4.28-4.13 (m, 4H, OCH₂CH₃), 3.18 (s, 4H, CH₂), 1.18 (t, *J* = 7.2Hz, 6H, OCH₂CH₃).
- 6 membered ring :** 7.47-7.42 (m, 2H, CH-Ph), 7.38-7.27 (m, 8H, CH-Ph), 6.98 (s, 1H, C=CH₂), 6.44 (s, 1H, C=CH₂), 4.28-4.13 (m, 4H, OCH₂CH₃), 2.97 (s, 2H, CH₂), 2.95 (s, 2H, CH₂), 1.25 (t, *J* = 7.2Hz, 6H, OCH₂CH₃).
- ¹³C NMR** (δ, ppm) (CDCl₃, 100 MHz) **5 and 6 membered rings:** 170.4 (Cq x2, C=O), 170.3 (Cq x2, C=O), 141.4 (Cq), 136.8 (Cq), 136.5 (Cq), 131.7 (CH), 131.5 (Cq), 131.4 (Cq), 131.0 (Cq), 130.3 (Cq), 129.4 (CH), 129.3 (CH), 129.1 (CH), 128.3 (CH x2), 128.2 (CH x2), 128.2 (CH), 128.1 (CH), 127.0 (Cq), 124.4 (Cq), 123.2 (Cq), 121.4 (CH), 121.3 (CH), 120.0 (C=CH₂), 119.5 (C=CH₂), 96.1 (Cq, C≡C), 92.2 (Cq, C≡C), 91.8 (Cq, C≡C), 90.5 (Cq, C≡C), 61.7 (OCH₂CH₃ x4), 54.0 (Cq), 54.0 (Cq), 36.8 (CH₂), 35.5 (CH₂), 34.9 (CH₂), 31.0 (CH₂), 14.1 (OCH₂CH₃ x2), 14.0 (OCH₂CH₃), 13.9 (OCH₂CH₃).
- IR** (ν, cm⁻¹) (CCl₄) 3060 (w), 2982 (w), 2964 (w), 2930 (w), 2910 (w), 2856 (w), 1737 (s), 1598 (w), 1573 (w), 1492 (w), 1478 (w), 1465 (w), 1444 (w), 1424 (w), 1389 (w), 1367 (w), 1301 (w), 1246 (m), 1183 (m), 1097 (w), 1071 (w), 1052 (w).
- HRMS** (EI+, m/z) : Calculated:414.1831 found: 414.1842.

5-Methylene-3-oct-2-ynyl-cyclohex-3-ene-1,1-dicarboxylic acid dimethyl ester
and 3-Oct-2-ynyl-4-vinyl-cyclopent-3-ene-1,1-dicarboxylic acid dimethyl ester

4.72h +
4.73h

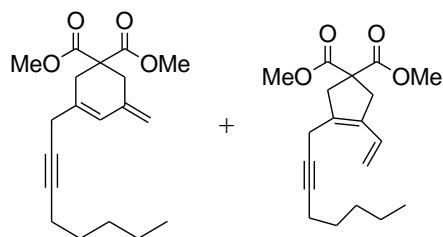

MF: C₁₉H₂₆O₄

MW = 318 g.mol⁻¹

- Method :** See **general procedure 4.6.A** using (1 equiv., 0.02 mmol, 6.4 mg) of 2-(2-methylene-dec-4-ynyl)-2-prop-2-ynyl-malonic acid dimethyl ester.
- Purification :** Flash column chromatography (silica gel 9:1 PE AcOEt)/ R_f (9:1 PE:AcOEt): 0.35.
- Product :** Yellow oil.
- Isolated yield :** 100% (ratio 3.33:1).
- ¹H NMR** (δ, ppm) (CDCl₃, 400 MHz) **5 membered ring:** 6.56 (dd, *J* = 11.0Hz, *J* = 17.0Hz, 1H, CH=CH₂), 5.13 (d, *J* = 11.0 Hz, 1H, CH=CH₂), 5.09 (d, *J* = 17.0Hz, 1H, CH=CH₂), 3.74 (s, 6H, OCH₃), 3.23 (s, 2H, CH₂), 3.18 (s, 2H, CH₂), 3.09 (s, 2H, CH₂), 2.15-2.11 (m, 2H, CH₂-pentylchain), 1.54-1.46 (m, 2H, CH₂-pentylchain) 1.41-1.25 (m, 4H, CH₂-pentylchain), 0.89 (t, *J* = 7.0 Hz, 3H, CH₃-pentyl chain).
- 6 membered ring:** 6.19 (s, 1H, C=CH), 4.95 (s 1H, C=CH₂), 4.93 (s 1H, C=CH₂), 3.71 (s, 6H, OCH₃), 2.97 (s, 2H, CH₂), 2.84 (s, 2H, CH₂), 2.64 (s, 2H, CH₂), 2.21-2.16 (m, 2H, CH₂-pentylchain), 1.54-1.46 (m, 2H, CH₂-pentylchain), 1.41-1.25 (m, 4H, CH₂-pentylchain), 0.90 (t, *J* = 6.8Hz, 3H, CH₃-pentylchain).
- ¹³C NMR** (δ, ppm) (CDCl₃, 100 MHz) **Only 6 membered ring described:** 171.2 (Cq x2, C=O), 139.0 (Cq), 134.5 (Cq), 124.5 (C=CH), 112.5 (C=CH₂), 83.3 (Cq, C≡C), 75.5 (Cq, C≡C), 54.4 (Cq), 52.7 (OCH₃ x2), 35.7 (CH₂), 34.1 (CH₂), 31.1 (CH₂), 28.6 (CH₂), 26.8 (CH₂), 22.2 (CH₂), 18.7 (CH₂), 13.9 (CH₃).
- IR** (ν, cm⁻¹) (CCl₄) 2956 (m), 2933 (m), 2874 (w), 2861 (w), 1741 (s), 1700 (w), 1436 (m), 1256 (m), 1206 (m), 1179 (m), 1102 (w), 1051 (w).
- HRMS** (EI+, m/z) : Calculated: 318.1831 found: 318.1830.

**3-Isopropyl-4-vinyl-cyclopent-3-ene-1,1-dicarboxylic acid diethyl ester and
3-Isopropyl-5-methylene-cyclohex-3-ene-1,1-dicarboxylic acid diethyl ester**

**4.85a +
4.85c**

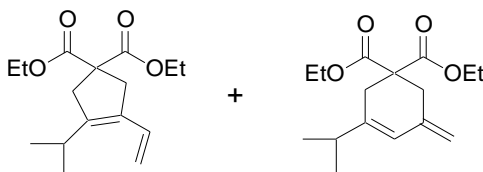

MF: C₁₆H₂₄O₄

MW = 280 g.mol⁻¹

- Method :** See **general procedure 4.6.C** using (1 equiv., 0.02 mmol, 5.6 mg) of 2-(3-methyl-2-methylene-butyl)-2-prop-2-ynyl-malonic acid diethyl ester.
- Purification :** Flash column chromatography (silica gel 95:5 PE: AcOEt)/ **R_f** (9:1 PE:AcOEt): 0.40.
- Product :** Transparent oil.
- Isolated yield :** 100% (ratio 1:0.9 : other minor isomers neglected).
- ¹H NMR** (δ, ppm) (CDCl₃, 400 MHz) **5 membered ring:** 6.61 (dd, *J* = 10.8Hz, *J* = 17.3Hz, 1H, CH=CH₂), 5.08 (d, *J* = 10.8Hz, 1H, CH=CH₂), 5.04 (d, *J* = 17.3Hz, 1H, CH=CH₂), 4.23-4.13 (m, 4H, OCH₂CH₃), 3.13 (s, 2H, CH₂), 3.05 (s, 2H, CH₂), 2.94-2.88 (m, 1H, CH-^{*i*}Pr), 1.27-1.21 (m, 6H, OCH₂CH₃), 1.06 (d, *J* = 6.8Hz, 6H, CH₃-^{*i*}Pr).
- 6 membered ring:** 5.93 (s, 1H, C=CH), 4.84 (s, 1H, C=CH₂), 4.83 (s, 1H, C=CH₂), 4.23-4.13 (m, 4H, OCH₂CH₃), 2.82 (s, 2H, CH₂), 2.61 (s, 2H, CH₂), 2.35-2.30 (m, 1H, CH-^{*i*}Pr), 1.27-1.21 (m, 6H, OCH₂CH₃), , 1.02 (d, *J* = 6.9Hz, 6H, CH₃-^{*i*}Pr).
- ¹³C NMR** (δ, ppm) (CDCl₃, 100 MHz) **5 and 6 membered rings:** 171.2 (Cq x2, C=O), 171.0 (Cq x2, C=O), 144.8 (Cq), 144.6 (Cq), 139.9 (Cq), 129.8 (=CH), 129.6 (Cq), 121.8 (=CH), 113.6 (=CH₂), 111.3 (=CH₂), 61.5 (OCH₂CH₃ x2), 61.4 (OCH₂CH₃ x2), 57.1 (Cq), 54.4 (Cq), 40.4 (CH₂), 39.9 (CH₂), 36.0 (CH₂), 35.0 (CH-^{*i*}Pr), 32.1 (CH₂), 26.6 (CH-^{*i*}Pr), 21.0 (CH₃-^{*i*}Pr x2), 20.8 (CH₃-^{*i*}Pr x2), 14.1 (CH₃ x2), 14.0 (CH₃ x2).
- IR** (ν, cm⁻¹) (CCl₄) 2964 (m), 2932 (m), 2872 (w), 1735 (s), 1645 (w), 1465 (w), 1446 (w), 1387 (w), 1366 (w), 1299 (m), 1251 (s), 1186 (m), 1097 (m), 1071 (m), 1052 (m), 1018 (m).
- HRMS** (EI+, *m/z*) : Calculated: 280.1675 found: 280.1667.

**3-Cyclohexyl-4-vinyl-cyclopent-3-ene-1,1-dicarboxylic acid diethyl ester and
5-Methyl-bicyclohexyliden-5-ene-3,3-dicarboxylic acid diethyl ester**

**4.86a +
4.86b**

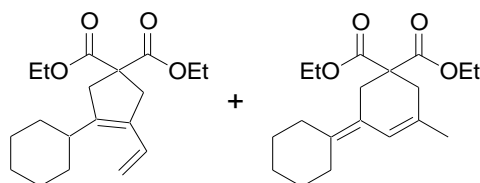

MF: C₁₉H₂₈O₄

MW = 320 g.mol⁻¹

- Method :** See **general procedure 4.6.A** using (1 equiv., 0.02 mmol, 6.4 mg) of 2-(2-cyclohexyl-allyl)-2-prop-2-ynyl-malonic acid diethyl ester.
- Purification :** Flash column chromatography (silica gel 9:1 PE:AcOEt)/ R_f (PE:AcOEt): 0.27.
- Product :** Transparent oil.
- Isolated yield :** 89% (ratio 1:1.4).
- ¹H NMR** (δ, ppm) (CDCl₃, 400 MHz) **5 membered ring:** 6.62 (dd, *J* = 10.4Hz, *J* = 17.2Hz, 1H, CH=CH₂), 5.07 (d, *J* = 10.4Hz, 1H, CH=CH₂), 5.03 (d, *J* = 17.2Hz, 1H, CH=CH₂), 4.22-4.13 (m, 4H, OCH₂CH₃), 3.13 (s, 2H, CH₂), 3.05 (s, 2H, CH₂), 1.76-1.50 (m, 11H, CH- + CH₂-Cy), 1.27-1.22 (m, 6H, OCH₂CH₃).
- 6 membered ring:** 6.25 (s, 1H, C=CH), 4.22-4.13 (m, 4H, OCH₂CH₃), 2.82 (s, 2H, CH₂), 2.55 (s, 2H, CH₂), 2.26 (t, *J* = 5.2Hz, 4H, CH₂-Cy), 1.82 (s, 3H, CH₃), 1.76-1.50 (m, 6H, CH₂-Cy), 1.27-1.22 (m, 6H, OCH₂CH₃).
- ¹³C NMR** (δ, ppm) (CDCl₃, 100 MHz) **5 and 6 membered rings:** 172.2 (Cq x2, C=O), 171.4 (Cq x2, C=O), 144.1 (Cq), 135.8 (Cq), 132.1 (Cq), 130.0 (Cq), 129.8 (CH=CH₂), 121.0 (Cq), 120.8 (C=CH), 113.4 (CH=CH₂), 61.5 (OCH₂CH₃ x2), 61.3 (OCH₂CH₃ x2), 57.3 (Cq), 54.6 (Cq), 41.1 (CH₂), 40.4 (CH₂), 37.4 (CH), 35.9 (CH₂), 33.6 (CH₂), 31.3 (CH₂), 31.1 (CH₂), 30.7 (CH₂), 29.9 (CH₂), 28.3 (CH₂), 28.2 (CH₂), 27.0 (CH₂), 26.4 (CH₂), 26.1 (CH₂), 26.0 (CH₂), 23.9 (CH₃), 14.0 (OCH₂CH₃ x4).
- IR** (ν, cm⁻¹) (CCl₄) 3498 (w), 2930 (s), 2855 (m), 1734 (s), 1464 (w), 1447 (w), 1367 (w), 1259 (s), 1188 (m), 1097 (m), 1071 (m), 1018 (m).
- HRMS** (EI+, m/z) : Calculated: 320.1988 found: 320.1984.

**3-Cyclohexyl-4-vinyl-cyclopent-3-ene-1,1-dicarboxylic acid diethyl ester 4.86a + 4.86c
and 5-Methylene-bicyclohexyl-6-ene-3,3-dicarboxylic acid diethyl ester**

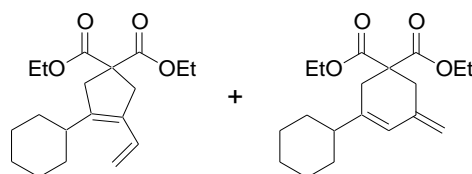

MF: C₁₉H₂₈O₄

MW = 320 g.mol⁻¹

Method : See **general procedure 4.6.B** using (1 equiv., 0.02 mmol, 6.4 mg) of 2-(2-cyclohexyl-allyl)-2-prop-2-ynyl-malonic acid diethyl ester.

Purification : Flash column chromatography (silica gel, 9:1 PE :AcOEt)/ R_f (PE: AcOEt): 0.27.

Product : Transparent oil.

Isolated yield : 88% (ratio 1:1.2).

¹H NMR (δ, ppm) (CDCl₃, 400 MHz) **5 membered ring:** 6.62 (dd, *J* = 10.8Hz, *J* = 17.2Hz, 1H, CH=CH₂), 5.07 (d, *J* = 10.0Hz, 1H, CH=CH₂), 5.03 (d, *J* = 17.2Hz, 1H, CH=CH₂), 4.22-4.13 (m, 4H, OCH₂CH₃), 3.13 (s, 2H, CH₂), 3.05 (s, 2H, CH₂), 1.83-1.64 (m, 11H, CH- + CH₂-Cy), 1.27-1.22 (m, 6H, OCH₂CH₃).

6 membered ring: 5.91 (s, 1H, C=CH), 4.83 (s, 1H, C=CH₂), 4.81 (s, 1H, C=CH₂), 4.22-4.13 (m, 4H, OCH₂CH₃), 2.82 (s, 2H, CH₂), 2.61 (s, 2H, CH₂), 1.83-1.64 (m, 11H, CH- + CH₂-Cy), 1.27-1.22 (m, 6H, OCH₂CH₃).

¹³C NMR (δ, ppm) (CDCl₃, 100 MHz) **5 and 6 membered rings:** 172.2 (Cq x2, C=O), 171.0 (Cq x2, C=O), 144.2 (Cq), 144.1 (Cq), 140.0 (Cq), 130.0 (=CH), 129.8 (Cq), 122.1 (=CH), 113.4 (=CH₂), 111.1 (=CH₂), 61.5 (OCH₂CH₃ x2), 61.4 (OCH₂CH₃ x2), 57.3 (Cq), 54.4 (Cq), 45.4 (CH), 41.1(CH₂), 40.4 (CH₂), 37.4 (CH), 36.0 (CH₂), 32.9 (CH₂), 31.3 (CH₂), 29.7 (CH₂), 26.6 (CH₂), 26.4 (CH₂), 26.3 (CH₂), 26.1 (CH₂), 14.0 (OCH₂CH₃ x2), 13.9 (OCH₂CH₃ x2).

IR (ν, cm⁻¹) (CCl₄) 3498 (w), 2930 (s), 2855 (m), 1734 (s), 1464 (w), 1447 (w), 1367 (w), 1259 (s), 1188 (m), 1097 (m), 1071 (m), 1018 (m).

HRMS (EI+, m/z) : Calculated: 320.1988 found: 320.1984.

3-Pentyl-4-vinyl-cyclopent-3-ene-1,1-dicarboxylic acid diethyl ester and 5-Methylene-3-pentyl-cyclohex-3-ene-1,1-dicarboxylic acid diethyl ester

**4.87a +
4.87c**

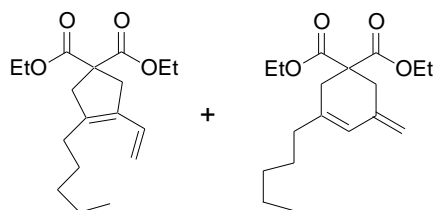

MF: C₁₈H₂₈O₄

MW = 308g.mol⁻¹

- Method :** See **general procedure 4.6.B or D** using (1 equiv., 0.02 mmol, 5.4 mg) of 2-(2-methylene-heptyl)-2-prop-2-ynyl-malonic acid diethyl ester.
- Purification :** Flash column chromatography (silica gel 9:1 PE :AcOEt)/ **R_f** (9:1 PE:AcOEt): 0.36.
- Product :** Transparent oil.
- Isolated yield :** 93% (ratio 1:0.84: other minor isomers neglected).
- ¹H NMR** (δ, ppm) (CDCl₃, 400 MHz) **5 membered ring:** 6.57 (dd, 1H, *J* = 11.0Hz, *J* = 17.0Hz, CH=CH₂), 5.07 (d, *J* = 11.0Hz, 1H, CH=CH₂), 5.04 (d, *J* = 17.0 Hz, 1H, CH=CH₂), 4.22-4.15 (m, 4H, OCH₂CH₃), 3.15 (s, 2H, CH₂), 3.06 (s, 2H, CH₂), 2.18 (t, *J* = 7.6Hz, 2H, CH₂-pentylchain) 1.48-1.37 (m, 2H, CH₂-pentyl chain), 1.33-1.20 (m, 10H, CH₂-pentylchain and OCH₂CH₃ x2) 0.91-0.86 (m, 3H, CH₃-pentylchain).
- 6 membered ring:** 5.92 (s, 1H, C=CH), 4.82 (s, 1H, C=CH₂), 4.80 (s, 1H, C=CH₂), 4.22-4.15 (m, 4H, OCH₂CH₃), 2.81 (s, 2H, CH₂), 2.58 (s, 2H, CH₂), 2.07 (t, *J* = 7.6Hz, 2H, CH₂-pentylchain), 1.48-1.37 (m, 2H, CH₂-pentyl chain), 1.33-1.20 (m, 10H, CH₂-pentylchain and OCH₂CH₃ x2), 0.91-0.86 (m, 3H, CH₃-pentylchain).
- ¹³C NMR** (δ, ppm) (CDCl₃, 100 MHz) **5 and 6 membered rings:** 172.2 (Cq x2, C=O), 171.0 (Cq x2, C=O), 139.7 (Cq), 139.7 (Cq), 139.4 (Cq), 131.3 (Cq), 130.1 (CH=CH₂), 123.8 (=CH), 113.6 (CH=CH₂), 111.0 (=CH₂), 61.5 (OCH₂CH₃ x2), 61.4 (OCH₂CH₃ x2), 57.2 (Cq), 54.4 (Cq), 44.2 (CH₂), 40.5 (CH₂), 37.4 (CH₂), 35.8 (CH₂), 34.3 (CH₂), 31.6 (CH₂), 31.6 (CH₂), 27.9 (CH₂), 27.6 (CH₂), 27.0 (CH₂), 22.5 (CH₂), 22.5 (CH₂), 14.0 (CH₃ x4), 14.0 (CH₃ x2).
- IR** (ν, cm⁻¹) (CCl₄) 3314 (w), 2960 (m), 2931 (s), 2873 (m), 2860 (m), 1735 (s), 1465 (w), 1445 (w), 1367 (w), 1251 (s), 1186 (m), 1097 (m), 1071 (m), 1017 (m).
- HRMS** (EI+, m/z) : Calculated: 308.1988 found: 308.1985.

5-Methylene-3-phenyl-cyclohex-3-ene-1,1-dicarboxylic acid diethyl ester, 5-Methyl-3-phenyl-cyclohexa-2,4-diene-1,1-dicarboxylic acid diethyl ester, 3-Methyl-5-phenyl-cyclohexa-2,4-diene-1,1-dicarboxylic acid diethyl ester and 3-Methyl-5-phenyl-cyclohexa-2,5-diene-1,1-dicarboxylic acid diethyl ester

4.88a-d

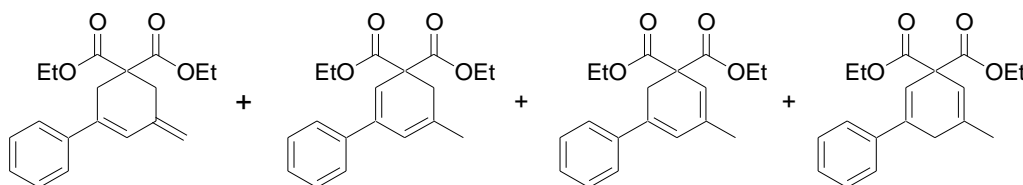

MF: C₁₉H₂₂O₄

MW = 314
g.mol⁻¹

- Method :** See **general procedure 4.6.A or B or C or D** using (1 equiv., 0.02 mmol, 6.3 mg) of 2-(2-phenyl-allyl)-2-prop-2-ynyl-malonic acid diethyl ester.
- Purification :** Flash column chromatography (silica gel 9:1 PE: AcOEt)/ **R_f** (9:1 PE:AcOEt): 0.29.
- Product :** Transparent oil.
- Isolated yield :** 79% (ratio 1: 0.3: 0.3: 0.3).
- ¹H NMR** (δ, ppm) (CDCl₃, 400 MHz) **Mixture of four isomers:** 7.52-7.43 (m, 8H, CH-Ph), 7.36-7.33 (m, 8H, CH-Ph), 7.31-7.27 (m, 4H, CH-Ph), 6.50 (s, 1H, C=CH first isomer), 6.13 (s, 1H, C=CH), 6.13 (s, 1H, C=CH), 6.04 (s, 2H, C=CH), 5.71 (s, 1H, C=CH), 5.71 (s, 1H, C=CH), 5.06 (s, 1H, C=CH₂ first isomer), 5.02 (s, 1H, C=CH₂ first isomer), 4.24-4.16 (m, 16H, OCH₂CH₃ all isomers), 3.19 (s, 2H, CH₂), 3.18 (s, 2H, CH₂), 3.08 (s, 2H, CH₂ first isomer), 2.94 (s, 2H, CH₂ first isomer), 2.80 (s, 2H, CH₂), 1.94 (s, 3H, CH₃), 1.92 (s, 3H, CH₃), 1.92 (s, 3H, CH₃), 1.28-1.21 (m, 24H, OCH₂CH₃).
- ¹³C NMR** (δ, ppm) (CDCl₃, 100 MHz) **Mixture of four isomers (eight CH, four Cq, one CH₃ and one CH₂ carbons can not be unambiguously assigned):** 170.9 (Cq x2, C=O), 170.8 (Cq x2, C=O), 170.7 (Cq x4, C=O), 140.6 (Cq), 139.9 (Cq), 139.8 (Cq), 138.0 (Cq), 136.7 (Cq), 136.3 (Cq), 135.9 (Cq), 134.9 (Cq), 128.4 (CH), 128.4 (CH), 128.4 (CH), 127.6 (CH), 126.0 (CH), 125.9 (CH), 125.7 (CH), 125.7 (CH), 123.2 (CH), 119.6 (Cq), 117.1(CH), 116.5 (CH), 114.2 (CH₂), 61.7 (OCH₂CH₃ x4), 61.6 (OCH₂CH₃ x4), 55.8 (Cq), 55.6 (Cq), 54.5 (Cq), 35.5 (CH₂), 34.4 (CH₂), 33.4 (CH₂), 32.1 (CH₂), 23.2 (CH₃), 21.5 (CH₃), 14.0 (OCH₂CH₃ x8).
- IR** (ν, cm⁻¹) (CCl₄) 3474 (w), 3061 (w), 2982 (m), 2931 (m), 2873 (w), 1735 (s), 1600 (w), 1494 (w), 1464 (w), 1446 (m), 1367 (m), 1243 (s), 1186 (s), 1096 (m), 1071 (m), 1054 (m), 1023 (m).
- HRMS** (EI+, m/z) : Calculated: 314.1518 found: 314.1530.

B.3.4. Chapter 5: Hydroalkylation of Alkynyl Ethers *via* a Gold(I)-Catalyzed 1,5-Hydride Shift/Cyclization Sequence

Only experiments performed by this author are presented in this section. These experiments are marked with a red star (*).

B.3.4.1 Synthesis of substrates bearing C(2)-THF and 1,3-dioxolane rings

Most representative alkynes synthesized in this work having C(2)-substituted THF and dioxolane rings were synthesized as depicted in the scheme B.3.4.1. Similar structures corresponding to direct modifications from these previous substrates were synthesized in an analogous manner and are summarized below:

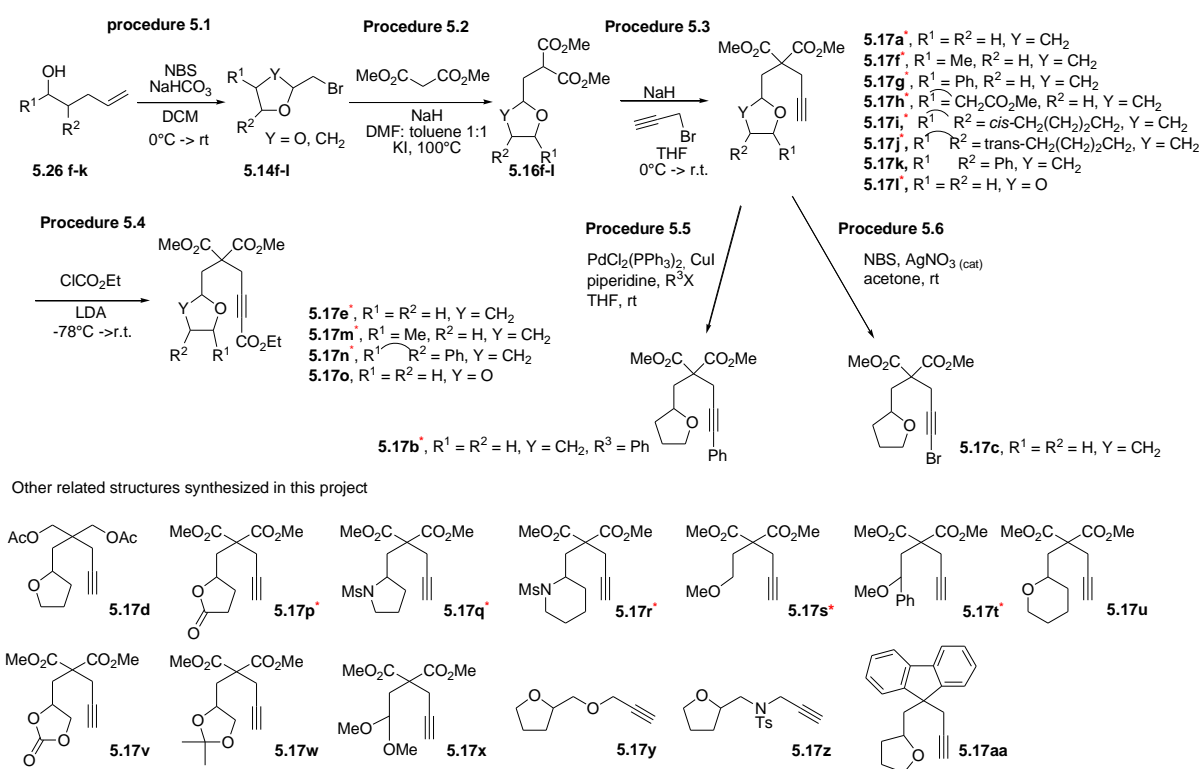

Scheme B.3.4.1: synthesis of C(2)-linked THF rings **5.17a-aa**.

General procedure 5.1³⁰⁶, *NBS promoted cyclisation of secondary homoallylic alcohols*:

To a round bottom flask, charged with homoallyl alcohol (1 equiv.) and DCM (0.2 M) at 0°C, was added *N*-bromosuccinimide (1.5 equiv.) followed by NaHCO₃ (1.5 equiv.). The reaction

³⁰⁶ Based on the work of Lee, A S.-Y.; Tsao, K.-W.; Chang, Y.-T.; Chu, S. F. *Tetrahedron Lett.* 48, 38, 2007, 6790.

mixture was allowed to stir at 0°C, with the temperature being slowly raised to room temperature. Such reactions were normally left overnight. After complete consumption of the starting homoallylic alcohol (TLC), water was added to the mixture, followed by extraction with Et₂O (3x), washed with brine (1x), dried (MgSO₄), and concentrated under reduced pressure. Purification by flash column chromatography afforded pure bromo C(2)-branched THFs in the stated yields.

General procedure 5.2³⁰⁷, monoalkylation of dimethyl malonate:

To a round bottom flask, charged with NaH (1.2 equiv.) in toluene (1M to the alkylating agent) was slowly added dimethyl malonate (2 equiv.) at 0°C. The temperature was allowed to warm to room temperature, when the alkylating agent (1 equiv.), dissolved in DMF (1M to the alkylating agent) was introduced, followed by the addition of KI (0.5 equiv. to the alkylating agent). The reaction was then heated up to 100 °C overnight. After the complete consumption of the alkylating agent (TLC), the reaction mixture was cooled to room temperature, quenched with a saturated solution of NH₄Cl, extracted with AcOEt (3x); washed with small amounts of water (5x); dried (MgSO₄) and concentrated under reduced pressure. Purification by flash column chromatography generally afforded the pure monoalkylated malonate.

General Procedure 5.3, propargylation of monoalkylated dimethyl malonates:

To a round bottom flask, charged with NaH (1.5 equiv.) and THF (0.125 M) at 0°C, was added the monoalkylated dimethylmalonate (1 equiv.). The reaction mixture was allowed to warm to room temperature. Propargyl bromide (1.2 equiv.) was then added and the reaction mixture allowed to stir at room temperature. After complete consumption of the monoalkylated malonate (TLC), the reaction was quenched with a saturated solution of NH₄Cl, extracted with AcOEt (3x), dried (MgSO₄) and concentrated under reduced pressure. Purification by flash column chromatography afforded dialkylated dimethyl malonates.

³⁰⁷ Pastine, S; J.; McQuaid, K. M.; Sames, D. *J. Am. Chem. Soc.* 127, 12180.

General Procedure 5.4, Synthesis of ethyl butynoates derivatives:

To a round bottom flask, charged with diisopropylamine (2 equiv.) and THF (0.250 M) at 0°C was added *n*-BuLi (1.6M in hexanes, 2 equiv.) and allowed to stir for 15 min. at 0°C. The temperature was then cooled to -78 °C and the alkyne (1 equiv.) dissolved in THF (0.250 M) was added. The reaction mixture was allowed to stir at -78 °C for 1h. The anion was then quenched with ethyl chloroformate (2 equiv.). The reaction mixture was allowed to warm to room temperature, water was added and the reaction mixture extracted with AcOEt (3x), dried (MgSO₄) and concentrated under reduced pressure. Purification by flash column chromatography afforded the desired compounds.

General Procedure 5.5³⁰⁸, *Sonogashira coupling reaction with propargylated malonates:*

To a round bottom flask under an argon atmosphere was sequentially added: alkyne (1 equiv.), piperidine (0.7 M with respect to alkyne), PdCl₂(PPh₃)₂ (35 mg, 0.05 equiv.), CuI (19 mg, 0.1 equiv.), halide (1.2 equiv.) and THF (0.7 M with respect to the alkyne). The reaction mixture was allowed to stir overnight at room temperature. Upon completion (TLC), the reaction was diluted with a saturated solution of NH₄Cl, extracted with Et₂O (3x), dried (MgSO₄), concentrated under reduced pressure and purified by flash column chromatography to afford the title compounds.

General Procedure 5.6 (same as general procedure 1.1): NBS promoted bromination of terminal alkynes: To a round bottom flask charged with the alkyne (1 equiv.) and acetone (1.2 equiv.) at 0 °C. was added *N*-bromo succinimide (1.2 equiv) and AgNO₃ (0.1 equiv.). The reaction mixture was allowed to warm up to room temperature. The flask was covered with an aluminium foil to avoid light exposure and the reaction was allowed to stir at room temperature until completion (TLC). The reaction was then diluted with H₂O, extracted with Et₂O (3x), dried (MgSO₄) and concentrated under reduced pressure. Purification of the crude mixture by flash column chromatography afforded the bromoalkynes in the given yields.

³⁰⁸ Tenaglia, A.; Gaillard, S.; *Org. Lett.*, **2007**, 9, 18, 3607.

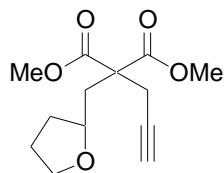
MF: C₁₃H₁₈O₅MW = 254 g.mol⁻¹

- Method :** See **general procedure 5.2** using (1 equiv., 12 mmol, 1.98 g) of 2-bromomethyl-tetrahydro-furan followed by **general procedure 5.3** using (1 equiv., 4.6 mmol, 1.0 g) of the previously prepared monoalkylated malonate.
- Purification :** Flash column chromatography (silica gel, 85: 15 PE: AcOEt)/ **R_f** (7:3 PE:AcOEt): 0.45.
- Product :** Transparent oil.
- Isolated yield :** 34% for two steps.
- ¹H NMR** (δ, ppm) (CDCl₃, 400 MHz) 3.98-3.92 (m, 1H, OCH-THF ring), 3.74 (s, 3H, OCH₃), 3.72 (s, 3H, OCH₃), 3.70-3.64 (m, 2H, OCH₂-THF ring), 3.05 (dd, *J* = 2.7Hz, *J* = 17.3Hz, 1H, CH₂-propargyl chain), 2.92 (dd, *J* = 2.7Hz, *J* = 17.3Hz, 1H, CH₂-propargyl chain), 2.31 (dd, *J* = 3.5Hz, *J* = 14.6Hz, 1H, CH₂CHO), 2.25 (dd, *J* = 9.6Hz, *J* = 14.6Hz, 1H, CH₂CHO), 2.07-2.02 (m, 1H, CH₂-THF ring), 2.00 (t, *J* = 2.7Hz, 1H, ≡CH), 1.94-1.76 (m, 2H, CH₂-THF ring), 1.59-1.50 (m, 1H, CH₂-THF ring).
- ¹³C NMR** (δ, ppm) (CDCl₃, 100 MHz) 170.8 (Cq, C=O), 170.7 (Cq, C=O), 79.3 (Cq, C≡CH), 74.8 (OCH-THF ring), 71.3 (≡CH), 67.8 (OCH₂), 55.7 (Cq), 52.8 (OCH₃), 52.7 (OCH₃), 37.9 (CH₂), 32.2 (CH₂), 25.4 (CH₂), 23.0 (CH₂).
- IR** (ν, cm⁻¹) (CCl₄) 3314 (s), 2974 (m), 2953 (s), 2872 (w), 2843(w), 1743 (s), 1457 (m), 1436 (s), 1360 (w), 1323 (w), 1287 (s), 1220 (s), 1200 (s), 1183 (s), 1121 (w), 1086 (s), 1052 (w), 1015 (w).
- HRMS** (EI+, *m/z*) : Calculated: 254.1154 found: 254.1163.

2-(3-Phenyl-prop-2-ynyl)-2-(tetrahydro-furan-2-ylmethyl)-malonic dimethyl ester

acid 5.17b

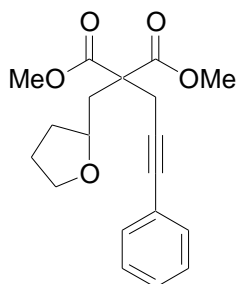

MF: C₁₉H₂₂O₅

MW = 330 g.mol⁻¹

- Method :** See **general procedure 5.5** using (1 equiv., 0.5 mmol, 125 mg) of 2-prop-2-ynyl-2-(tetrahydro-furan-2-ylmethyl)-malonic acid dimethyl ester and (1.1 equiv., 0.55 mmol, 60 μ L) of iodo-benzene.
- Purification :** Flash column chromatography (silica gel, 8:2 PE:AcOEt)/ **R_f** (7:3 PE:AcOEt): 0.44.
- Product :** Orange oil.
- Isolated yield :** 94%.
- ¹H NMR** (δ , ppm) (CDCl₃, 400 MHz) 7.37-7.34 (m, 2H, CH-Ph), 7.29-7.26 (m, 3H, CH-Ph), 4.05-3.99 (m, 1H, OCH-THF ring), 3.76 (s, 3H, OCH₃), 3.74 (s, 3H, OCH₃), 3.76-3.66 (m, 2H, OCH₂-THF ring), 3.26 (d, $J = 17.4$ Hz, 1H, CH₂-propargyl chain), 3.13 (d, $J = 17.4$ Hz, 1H, CH₂-propargyl chain), 2.38 (dd, $J = 3.3$ Hz, $J = 14.6$ Hz, 1H, **CH₂**CHO), 2.30 (dd, $J = 9.8$ Hz, $J = 14.6$ Hz, 1H, **CH₂**CHO), 2.09-2.01 (m, 1H, CH₂-THFring), 1.95-1.77 (m, 2H, CH₂-THFring), 1.60-1.52 (m, 1H, CH₂-THFring).
- ¹³C NMR** (δ , ppm) (CDCl₃, 100 MHz) 171.0 (Cq, C=O), 170.8 (Cq, C=O), 131.6 (CH-Ph), 128.2 (CH-Ph), 127.9 (CH-Ph), 123.3 (Cq-Ph), 84.8 (Cq, C \equiv C), 83.5 (Cq, C \equiv C), 74.8 (OCH-THF ring), 67.7 (OCH₂-THF ring), 56.1 (Cq), 52.8 (OCH₃), 52.6 (OCH₃), 38.2 (CH₂), 32.3 (CH₂), 25.5 (CH₂), 23.9 (CH₂).
- IR** (ν , cm⁻¹) (CCl₄) 3024 (w), 2974 (w), 2952 (m), 2872 (w), 1757 (m), 1742 (s), 1491 (w), 1436 (m), 1326 (w), 1289 (w), 1260 (w), 1218 (s), 1200 (s), 1182 (s), 1120 (w), 1087 (s), 1051 (w), 1030 (w).
- HRMS** (EI+, m/z) : calculated: 330.1467 found: 330.1468.

5-Methoxycarbonyl-5-(tetrahydro-furan-2-ylmethyl)-hex-2-ynedioic acid 1-ethyl ester 6-methyl ester 5.17e

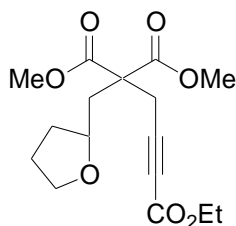

MF: C₁₆H₂₂O₇

MW = 326 g.mol⁻¹

- Method :** See **general procedure 5.4** using (1 equiv., 1 mmol, 240 mg) of 2-prop-2-ynyl-2-(tetrahydro-furan-2-ylmethyl)-malonic acid dimethyl ester.
- Purification :** Flash column chromatography (silica gel, 8:2 PE:AcOEt)/ **R_f** (7:3 PE AcOEt): 0.29.
- Product :** Yellow pale oil.
- Isolated yield :** 51%.
- ¹H NMR** (δ, ppm) (CDCl₃, 400 MHz) 4.19 (q, *J* = 7.1Hz, 2H, OCH₂CH₃), 3.96-3.89 (m, 1H, OCH-THF ring), 3.75 (s, 3H, OCH₃), 3.73 (s, 3H, OCH₃), 3.73-3.64 (m, 2H, OCH₂-THF ring), 3.23 (d, *J* = 17.6Hz, 1H, CH₂-propargyl chain), 3.07 (d, *J* = 17.6Hz, 1H, CH₂-propargyl chain), 2.30-2.22 (m, 2H, CH₂CHO), 2.08-2.00 (m, 1H, CH₂-THF ring), 1.94-1.76 (m, 2H, CH₂-THF ring), 1.58-1.51 (m, 1H, CH₂-THF ring), 1.28 (t, *J* = 7.1Hz, 3H, OCH₂CH₃).
- ¹³C NMR** (δ, ppm) (CDCl₃, 100 MHz) 170.2 (Cq, C=O), 170.1 (Cq, C=O), 153.3 (Cq, C=O), 83.8 (Cq, C≡C), 75.5 (Cq, C≡C), 74.7 (OCH-THFring), 67.8 (OCH₂-THF ring), 61.8 (OCH₂CH₃), 55.6 (Cq), 52.9 (OCH₃), 52.8 (OCH₃), 38.1 (CH₂), 32.2 (CH₂), 25.3 (CH₂), 23.2 (CH₂), 13.9 (OCH₂CH₃).
- IR** (ν, cm⁻¹) (CCl₄) 2979 (m), 2954 (m), 2906 (w), 2873 (w), 2240 (m), 1744 (s), 1716 (s), 1458 (w), 1436 (m), 1366 (w), 1322 (w), 1253 (s), 1220 (s), 1201 (s), 1182 (s), 1120 (w), 1086 (s), 1015 (w).
- HRMS** (EI+, m/z) : calculated: 326.1366. found: 326.1375.

2-(5-Methyl-tetrahydro-furan-2-ylmethyl)-2-prop-2-ynyl-malonic acid dimethyl ester 5.17f

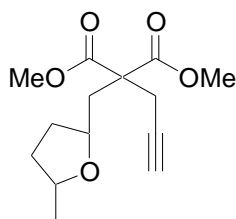

MF: C₁₄H₂₀O₅

MW = 268 g.mol⁻¹

Method :	See general procedure 5.1 using (1 equiv., 19 mmol, 1.90 g) of hex-5-en-2-ol followed by general procedure 5.2 using (1 equiv., 13.5 mmol, 2.42 g) of 2-bromomethyl-5-methyl-tetrahydro-furan, followed by general procedure 5.3 using (1 equiv., 4.10 mmol, 944 mg) of the previously monoalkylated malonate.
Purification :	Flash column chromatography (silica gel, 9:1 PE:AcOEt)/ R_f : (9:1 PE: AcOEt): 0.20.
Product :	Transparent oil.
Isolated yield :	35% for three steps (ratio <i>cis</i> : <i>trans</i> 1:2)
¹H NMR (δ, ppm) (CDCl ₃ , 400 MHz)	Major diastereoisomer (trans): 4.16-4.10 (m, 1H, OCH-THF ring), 3.98-3.87 (m, 1H, OCH-THF ring), 3.73 (s, 3H, OCH ₃), 3.72 (s, 3H, OCH ₃), 3.06 (dd, <i>J</i> = 2.7Hz, <i>J</i> = 17.3Hz, 1H, CH ₂ -propargyl chain), 2.93 (dd, <i>J</i> = 2.7Hz, <i>J</i> = 17.3Hz, 1H, CH ₂ -propargyl chain), 2.38-2.20 (m, 2H, CH ₂ CHO), 2.16-2.08 (m, 1H, CH ₂ -THF ring), 2.05-1.97 (m, 1H, CH ₂ -THF ring), 1.99 (t, <i>J</i> = 2.7Hz, 1H, ≡CH), 1.62-1.53 (m, 1H, CH ₂ -THF ring), 1.46-1.35 (m, 1H, CH ₂ -THF ring), 1.13 (d, <i>J</i> = 6.1Hz, 3H, CH ₃). Minor diastereoisomer (cis): 3.98-3.87 (m, 2H, OCH-THF ring x2), 3.73 (s, 3H, OCH ₃), 3.71 (s, 3H, OCH ₃), 3.05 (dd, <i>J</i> = 2.7Hz, <i>J</i> = 17.3Hz, 1H, CH ₂ -propargyl chain), 2.92 (dd, <i>J</i> = 2.7Hz, <i>J</i> = 17.3Hz, 1H, CH ₂ -propargyl chain), 2.38-2.20 (m, 2H, CH ₂ CHO), 1.99 (t, <i>J</i> = 2.7Hz, 1H, ≡CH), 1.95-1.87 (m, 1H, CH ₂ -THF ring), 1.62-1.53 (m, 2H, CH ₂ -THF ring), 1.46-1.35 (m, 1H, CH ₂ -THF ring), 1.15 (d, <i>J</i> = 6.1Hz, 3H, CH ₃).
¹³C NMR (δ, ppm) (CDCl ₃ , 100 MHz)	Major diastereoisomer (trans): 170.7 (Cq, C=O), 170.7 (Cq, C=O), 79.4 (Cq, C≡CH), 74.2 (OCH), 74.2 (OCH), 71.2 (≡CH), 55.7 (Cq), 52.8 (OCH ₃), 52.6 (OCH ₃), 38.3 (CH ₂), 33.5 (CH ₂), 32.7 (CH ₂), 23.0 (CH ₂), 21.0 (CH ₃). Minor diastereoisomer (cis): 170.8 (Cq, C=O), 170.7 (Cq, C=O), 77.2 (Cq, C≡CH), 75.9 (OCH), 74.8 (OCH), 71.3 (≡CH), 55.7 (Cq), 52.8 (OCH ₃), 52.6 (OCH ₃), 38.9 (CH ₂), 32.6 (CH ₂), 32.3 (CH ₂), 22.9 (CH ₂), 21.3 (CH ₃).
IR (ν, cm ⁻¹) (CCl ₄)	3314 (s), 2971 (s), 2953 (s), 2931 (s), 2871 (m), 1758 (s), 1743 (s), 1457 (m), 1437 (s), 1377 (m), 1344 (w), 1323 (m), 1285 (s), 1253 (s), 1222 (s), 1200 (s), 1183 (s), 1151(m), 1120 (m), 1095 (s).

HRMS (EI+, m/z) : Calculated 268.1311 found: 268.1309.

2-(5-Phenyl-tetrahydro-furan-2-ylmethyl)-2-prop-2-ynyl-malonic acid dimethyl ester 5.17g

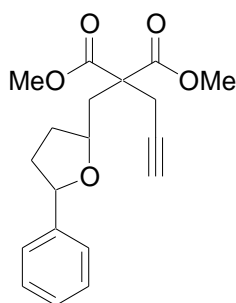

MF: C₁₉H₂₁O₅

MW = 329 g.mol⁻¹

Method : See **general procedure 5.1** using (1 equiv., 8.6 mmol, 1.40 g) of 1-phenyl-pent-4-en-1-ol followed by **general procedure 5.2** using (1 equiv., 7.5 mmol, 1.80 g) of 2-bromomethyl-5-phenyl-tetrahydro-furan followed by **general procedure 5.3** using (1 equiv, 2.3 mmol, 680 mg) of the previously prepared monoalkylated malonate.

Purification : Flash column chromatography (silica gel, 8:2 PE:AcOEt)/ R_f. (8:2 PE:AcOEt): 0.44.

Product : Transparent oil.

Isolated yield : 31% for three steps (ratio *cis* : *trans* 1:2).

¹H NMR (δ, ppm) (CDCl₃, 400 MHz) **Major diastereoisomer (trans):** 7.32-7.20 (m, 5H, CH-Ph), 4.91 (dd, *J* = 6.4Hz, *J* = 7.6, 1H, OCH-THF ring), 4.34-4.26 (m, 1H, OCH-THF ring), 3.73 (s, 3H, OCH₃), 3.64 (s, 3H, OCH₃), 3.11 (dd, *J* = 2.7Hz, *J* = 17.3Hz, 1H, CH₂-propargyl chain), 2.99 (dd, *J* = 2.7Hz, *J* = 17.3Hz, 1H, CH₂-propargyl chain), 2.40-2.37 (m, 2H, CH₂CHO), 2.36-2.34 (m, 1H, CH₂-THF ring), 2.29-2.17 (m, 1H, CH₂-THF ring), 2.02 (t, *J* = 2.7Hz, 1H, ≡CH), 1.84-1.67 (m, 2H, CH₂-THF ring). **Minor diastereoisomer (cis):** 7.32-7.20 (m, 5H, CH-Ph), 4.84 (t, *J* = 7.2Hz, 1H, OCH-THF ring), 4.10-4.03 (m, 1H, OCH-THF ring), 3.74 (s, 3H, OCH₃), 3.59 (s, 3H, OCH₃), 3.09 (dd, *J* = 2.7Hz, *J* = 17.2Hz, 1H, CH₂-propargyl chain), 2.97 (dd, *J* = 2.7Hz, *J* = 17.2Hz, 1H, CH₂-propargyl chain), 2.55-2.43 (m, 2H, CH₂CHO), 2.29-2.17 (m, 1H, CH₂-THF ring), 2.15-2.07 (m, 1H, CH₂-THF ring), 2.03 (t, *J* = 2.7Hz, 1H, ≡CH), 1.84-1.67 (m, 2H, CH₂-THF ring).

¹³C NMR (δ, ppm) (CDCl₃, 100 MHz) **Major diastereoisomer (trans):** 170.6 (Cq x2, C=O), 143.4 (Cq, Ph), 128.2 (CH-Ph), 125.3 (CH-Ph), 127.0 (CH-Ph), 79.8 (OCH-THF ring), 79.4 (Cq, C≡CH), 75.1 (OCH-THF ring), 71.3 (≡CH), 55.8 (Cq), 52.8 (OCH₃), 52.7 (OCH₃), 38.4 (CH₂), 34.7 (CH₂), 32.9 (CH₂), 23.1 (CH₂). **Minor diastereoisomer**

(cis): 170.6 (Cq x2, C=O), 143.1 (Cq, Ph), 128.0 (CH-Ph), 126.9 (CH-Ph), 125.8 (CH-Ph), 81.3 (OCH-THF ring), 79.3 (Cq, $\underline{\text{C}}\equiv\text{CH}$), 75.5 (OCH-THF ring), 71.4 ($\equiv\text{CH}$), 55.8 (Cq), 52.8 (OCH₃), 52.6 (OCH₃), 38.3 (CH₂), 34.0 (CH₂), 32.1 (CH₂), 23.0 (CH₂).

IR (ν , cm⁻¹) (CCl₄) 3433 (w), 3313 (m), 3065 (w), 3031 (w), 2953 (m), 2875 (w), 2843 (w), 1758 (s), 1742 (s), 1692 (w), 1493 (w), 1449 (m), 1437 (m), 1321 (m), 1284 (m), 1251 (m), 1222 (s), 1200 (s), 1183 (s), 1087 (s), 1038 (m), 1027 (m).

HRMS (EI+, m/z) : Calculated: 329.1389 found: 329.1395.

2-(5-Methoxycarbonylmethyl-tetrahydro-furan-2-ylmethyl)-2-prop-2-ynyl-malonic acid dimethyl ester

5.17h

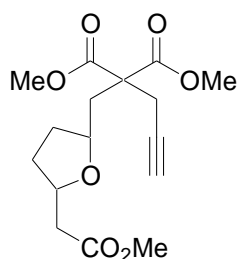

MF: C₁₆H₂₂O₇

MW = 326 g.mol⁻¹

Method : See **general procedure 5.1** using (1 equiv., 16.3 mmol, 2.58 g) of 3-hydroxyhept-6-enoic acid methyl ester followed by **general procedure 5.2** using (1 equiv., 4.22 mmol, 1.0 g) of (5-bromomethyl-tetrahydro-furan-2-yl)-acetic acid methyl ester followed by **general procedure 5.3** using (1 equiv., 0.92 mmol, 265 mg) of the previously prepared monoalkylated malonate.

Purification : Flash column chromatography (silica gel, 7:3 PE:AcOEt)/ R_f (7:3 PE:AcOEt) : 0.34.

Product : Transparent oil.

Isolated yield : 15% for three steps (ratio *cis:trans*: 1:3)

¹H NMR (δ , ppm) (CDCl₃, 400 MHz) **Major diastereomer (trans):** 4.30-4.23 (m, 1H, OCH-THFring), 4.13-4.07 (m, 1H, OCH-THFring), 3.72 (s, 3H, OCH₃), 3.71 (s, 3H, OCH₃), 3.67 (s, 3H, OCH₃), 3.02 (dd, *J* = 2.7Hz, *J* = 17.3Hz, 1H, CH₂-propargyl chain), 2.90 (dd, *J* = 2.7Hz, *J* = 17.3Hz, 1H, CH₂-propargyl chain), 2.51 (dd, *J* = 7.1Hz, *J* = 14.9Hz, 1H, CH₂), 2.38 (dd, *J* = 6.2Hz, *J* = 14.9Hz, 1H, CH₂), 2.31-2.19 (m, 2H, CH₂), 2.16-2.07 (m, 2H, CH₂-THFring), 1.99 (t, *J* = 2.7Hz, 1H, $\equiv\text{CH}$), 1.66-1.49 (m, 2H, CH₂-THFring). **Minor diastereomer: (cis):** 4.22-4.15 (m, 1H, OCH-THFring), 3.95-3.88 (m, 1H, OCH-THFring), 3.72 (s, 3H, OCH₃), 3.70 (s, 3H, OCH₃), 3.66 (s, 3H, OCH₃), 3.01 (dd, *J* = 2.7Hz, *J* = 17.3Hz, 1H, CH₂-propargyl chain), 2.89 (dd, *J* = 2.7Hz, *J* = 17.3Hz, 1H, CH₂-propargyl chain), 2.55 (dd, *J* = 6.8Hz, *J* = 15.0Hz, 1H, CH₂), 2.41 (dd, *J* = 6.2Hz, *J* = 15.0Hz, 1H, CH₂), 2.31-

2.19 (m, 2H, CH₂), 2.05-2.02 (m, 2H, CH₂-THFring), 1.99 (t, *J* = 2.7Hz, 1H, ≡CH), 1.66-1.49 (m, 2H, CH₂-THFring).

¹³C NMR (δ, ppm) (CDCl₃, 100 MHz) **Major diastereoisomer (trans):** 171.5 (Cq, C=O), 170.5 (Cq x2, C=O), 79.3 (Cq, C≡CH), 74.9 (OCH-THF ring), 74.6 (OCH-THF ring), 71.2 (≡CH), 55.7 (Cq), 52.8 (OCH₃), 52.6 (OCH₃), 51.5 (OCH₃), 40.7 (CH₂), 38.0 (CH₂), 32.4 (CH₂), 31.4 (CH₂), 23.0 (CH₂). **Minor diastereoisomer (cis):** 171.4 (Cq, C=O), 170.5 (Cq, C=O), 170.4 (Cq, C=O), 79.2 (Cq, C≡CH), 75.8 (OCH-THF ring), 75.2 (OCH-THF ring), 71.3 (≡CH), 55.6 (Cq), 52.8 (OCH₃), 52.6 (OCH₃), 51.5 (OCH₃), 40.6 (CH₂), 38.5 (CH₂), 31.9 (CH₂), 30.7 (CH₂), 22.9 (CH₂).

IR (ν, cm⁻¹) (CCl₄) 3314 (m), 2953 (m), 2879 (w), 2843 (w), 1743 (s), 1458 (m), 1437 (s), 1377 (w), 1351 (w), 1321 (m), 1285 (s), 1253 (s), 1223 (s), 1200 (s), 1182 (s), 1084 (s), 1050 (m).

HRMS (EI+, *m/z*) : Calculated: 326.1366 found: 326.1368.

2-(Octahydro-benzofuran-2-ylmethyl)-2-prop-2-ynyl-malonic acid dimethyl ester 5.17i

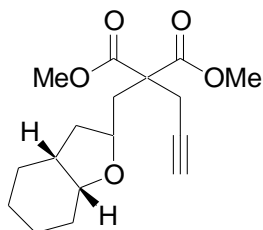

MF: C₁₇H₂₄O₅

MW = 308 g.mol⁻¹

Method : See **general procedure 5.1** using (1 equiv., 7.1 mmol, 1.0 g) of *syn*-2-allyl-cyclohexanol followed by **general procedure 5.2** using (1 equiv., 5.75 mmol, 1.26 g) of 2-bromomethyl-octahydro-benzofuran, followed by **general procedure 5.3** using (1 equiv., 3.1 mmol, 823 mg) of the previously prepared monoalkylated malonate.

Purification : Flash column chromatography (silica gel, 95:5 toluene: AcOEt)/ *R_f*. (8: 2 PE: AcOEt): 0.36.

Product : Pale yellow oil.

Isolated yield : 32% for three steps (ratio diastereoisomers *cis* : *trans* 1:1.7)

¹H NMR (δ, ppm) (CDCl₃, 400 MHz) **Major diastereoisomer (trans):** 4.24-4.18 (m, 1H, OCH-THF ring), 3.80 (dd, *J* = 3.5Hz, *J* = 8.6Hz, 1H, OCH-THF ring), 3.73 (s, 3H, OCH₃), 3.71 (s, 3H, OCH₃), 3.06 (dd, *J* = 2.7Hz, *J* = 17.3Hz, 1H, CH₂-propargyl chain), 2.93 (dd, *J* = 2.7Hz,

$J = 17.3\text{Hz}$, 1H, CH_2 -propargyl chain), 2.30 (dd, $J = 8.5\text{Hz}$, $J = 14.5\text{Hz}$, 1H, CH_2CHO), 2.24 (dd, $J = 3.5\text{Hz}$, $J = 14.5\text{Hz}$, 1H, CH_2CHO), 2.04-1.96 (m, 1H, CH-octahydro-benzofuran ring), 1.99 (t, $J = 2.7\text{Hz}$, 1H, $\equiv\text{CH}$), 1.84 (ddd, $J = 1.8\text{Hz}$, $J = 7.0\text{Hz}$, $J = 12.4\text{Hz}$, 1H, CH_2 -octahydro-benzofuran ring), 1.65 (td, $J = 7.0\text{Hz}$, $J = 12.4\text{Hz}$, 1H, CH_2 -octahydro-benzofuran ring), 1.56-1.31 (m, 7H, CH_2 -octahydro-benzofuran ring), 1.22-1.12 (m, 1H, octahydro-benzofuran ring).
Minor diastereoisomer (cis): 3.96-3.89 (m, 1H, OCH-THF ring), 3.75-3.73 (m, 1H, OCH-THF ring), 3.74 (s, 3H, OCH_3), 3.71 (s, 3H, OCH_3), 3.08 (dd, $J = 2.7\text{Hz}$, $J = 17.3\text{Hz}$, 1H, CH_2 -propargyl chain) 2.92 (dd, $J = 2.7\text{Hz}$, $J = 17.3\text{Hz}$, 1H, CH_2 -propargyl chain), 2.40 (d, $J = 6.7\text{Hz}$, 2H, CH_2CHO), 2.17-2.10 (m, 1H, CH-octahydro-benzofuran ring), 1.99 (t, $J = 2.6\text{Hz}$, 1H, $\equiv\text{CH}$), 1.79-1.70 (m, 2H, CH_2 -octahydro-benzofuran ring), 1.56-1.31 (m, 7H, CH_2 -octahydro-benzofuran ring), 1.22-1.12 (m, 1H, CH_2 -octahydro-benzofuran ring).

^{13}C NMR (δ , ppm)
 (CDCl_3 , 100 MHz)

Major diastereoisomer (trans): 170.8 (Cq, C=O), 170.8 (Cq, C=O), 77.8 ($\equiv\text{CH}$), 75.8 (OCH-THF ring), 72.5 (OCH-THF ring), 71.1 (Cq, $\underline{\text{C}}\equiv\text{CH}$), 55.8 (Cq), 52.8 (OCH_3), 52.5 (OCH_3), 39.7 (CH_2), 39.3 (CH_2), 38.3 (CH, octahydro-benzofuran ring), 28.1 (CH_2), 27.8 (CH_2), 24.3 (CH_2), 23.0 (CH_2), 20.4 (CH_2).

Minor diastereoisomer (cis): 170.8 (Cq, C=O), 170.7 (Cq, C=O), 79.5 ($\equiv\text{CH}$), 75.8 (OCH-THF ring), 73.6 (OCH-THF ring), 71.2 (Cq, $\underline{\text{C}}\equiv\text{CH}$), , 55.9 (Cq), 52.8 (OCH_3), 52.6 (OCH_3), 39.8 (CH_2), 38.4 (CH_2), 37.6 (CH), 28.8 (CH_2), 28.7 (CH_2), 23.8 (CH_2), 22.8 (CH_2), 21.3 (CH_2).

IR (ν , cm^{-1}) (CCl_4)

3314 (s); 3000 (w); 2936 (s); 2856 (m); 1743 (s); 1457 (m); 1436 (s); 1322 (m); 1286 (s); 1252 (s); 1219 (s); 1200 (s); 1183 (s); 1156 (s); 1118 (m); 1091 (s); 1067 (m); 1009 (w).

HRMS (EI+, m/z) :

Calculated. for 308.1624 found: 308.1634.

2-(Octahydro-benzofuran-2-ylmethyl)-2-prop-2-ynyl-malonic acid dimethyl ester 5.17j

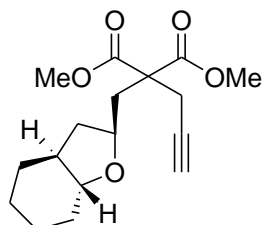

MF: $\text{C}_{17}\text{H}_{24}\text{O}_5$

MW = 308 $\text{g}\cdot\text{mol}^{-1}$

Method :

See **general procedure 5.1** using (1 equiv., 7.14 mmol, 1.0 g) of *anti*-2-allyl-cyclohexanol followed by **general procedure 5.2** using (1 equiv., 3.9 mmol, 850 mg) of 2-bromomethyl-octahydro-benzofuran followed by **general procedure 5.3** using (1 equiv., 1.11 mmol, 300 mg) of the previously prepared monoalkylated malonate.

Purification :	Flash column chromatography (silica gel, 95:5 toluene:AcOEt)/ R_f (95:5 toluene: AcOEt): 0.30.
Product :	Transparent oil.
Isolated yield :	16% for three steps (ratio 93:7 in favor of drawn diastereoisomer).
$^1\text{H NMR}$ (δ, ppm) (CDCl₃, 400 MHz)	Only major diastereoisomer described: 4.18-4.11 (m, 1H, OCH-THF ring), 3.73 (s, 3H, OCH ₃), 3.70 (s, 3H, OCH ₃), 3.06 (dd, $J = 2.7\text{Hz}$, $J = 17.3\text{Hz}$, 1H, CH ₂ -propargyl chain), 3.05-2.95 (m, 1H, CHO-THF ring), 2.93 (dd, $J = 2.7\text{Hz}$, $J = 17.3\text{Hz}$, 1H, CH ₂ -propargyl chain), 2.36 (dd, $J = 10.2\text{Hz}$, $J = 14.7\text{Hz}$, 1H, CH ₂ CHO), 2.31-2.63 (m, 1H, CH ₂ CHO), 2.20 (td, $J = 6.6\text{Hz}$, $J = 11.6\text{Hz}$, 1H, CH), 1.99 (t, $J = 2.7\text{Hz}$, 1H, $\equiv\text{CH}$), 1.94-1.89 (m, 2H, CH ₂ -octahydro-benzofuran ring), 1.79-1.74 (m, 1H, CH ₂ - octahydro-benzofuran ring), 1.72-1.67 (m, 1H, CH ₂ -octahydro-benzofuran ring), 1.39-1.30 (m, 1H, CH ₂ -octahydro-benzofuran ring), 1.27-1.02 (m, 5H, CH ₂ -octahydro-benzofuran ring).
$^{13}\text{C NMR}$ (δ, ppm) (CDCl₃, 100 MHz)	Only major diastereoisomer described: 170.8 (Cq, C=O), 170.7 (Cq, C=O), 81.5 (OCH-THF ring), 79.3 (Cq, $\text{C}\equiv\text{CH}$), 73.5 (OCH-THF ring), 71.2 ($\equiv\text{CH}$), 55.8 (Cq), 52.8 (OCH ₃), 52.6 (OCH ₃), 46.0 (CH), 39.1 (CH ₂), 38.7 (CH ₂), 31.2 (CH ₂), 29.0 (CH ₂), 25.7 (CH ₂), 24.3 (CH ₂), 22.8 (CH ₂).
IR (ν, cm⁻¹) (CCl₄)	3314 (m), 2999 (w), 2937 (m), 2858 (m), 1758 (s), 1743 (s), 1456 (m), 1436 (m), 1377 (w), 1353 (w), 1284 (m), 1250 (m), 1221 (s), 1200 (s), 1183 (s), 1143 (m), 1109 (w), 1068 (s), 1049 (w)
HRMS (EI+, m/z) :	Calculated: 308.1624 Found: 308.1613.

2-[1,3]Dioxolan-2-ylmethyl-2-prop-2-ynyl-malonic acid dimethyl ester

5.17I

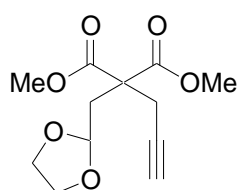

MF: C₁₂H₁₆O₆

MW = 254 g.mol⁻¹

Method :	See general procedure 5.2 using (1 equiv., 10 mmol, 1.67 g) of 2-bromomethyl-[1,3]dioxolane followed by general procedure 5.3 using (1 equiv., 5 mmol, 1.10 g) of the previously monoalkylated malonate.
Purification :	Flash column chromatography (silica gel, 8:2 PE:AcOEt) / R_f (7:3 PE:AcOEt): 0.26.
Product :	Transparent solid.

Isolated yield : 42% for two steps.

¹H NMR (δ, ppm) 4.99 (t, *J* = 4.8Hz, 1H, OCHO-dioxolane ring), 3.93-3.90 (m, 2H, OCH₂-dioxolane ring), 3.82-3.79 (m, 2H, OCH₂-dioxolane ring), 3.73 (s, 6H, OCH₃), 2.98 (d, *J* = 2.7Hz, 2H, CH₂-propargyl chain), 2.49 (d, *J* = 4.8Hz, 2H, CH₂CHO₂), 2.03 (t, *J* = 2.7Hz, 1H, ≡CH).

¹³C NMR (δ, ppm) 170.2 (Cq x2, C=O), 101.6 (OCHO-dioxolane ring), 79.0 (Cq, C≡CH), 71.5 (≡CH), 64.8 (OCH₂-dioxolane ring), 54.6 (Cq), 52.8 (OCH₃ x2), 35.6 (CH₂), 23.6 (CH₂).

IR (ν, cm⁻¹) (CCl₄) 3314 (w), 2954 (w), 2336 (w), 1743 (s), 1436 (w), 1200 (w).

HRMS (EI+, *m/z*) : Calculated: 256.0947 found: 256.0940.

5-Methoxycarbonyl-5-(5-methyl-tetrahydro-furan-2-ylmethyl)-hex-2-ynedioic acid 1-ethyl ester 6-methyl ester

5.17m

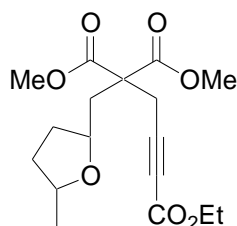

MF: C₁₇H₂₄O₇

MW = 340 g.mol⁻¹

Method : See **general procedure 5.4** using (1 equiv., 0.82 mmol, 220 mg) of 2-(5-methyl-tetrahydro-furan-2-ylmethyl)-2-prop-2-ynyl-malonic acid dimethyl ester.

Purification : Flash column chromatography (silica gel, 85:15 PE:AcOEt)/ **R_f**. (8:2 EP:AcOEt): 0.31.

Product : Yellow pale oil.

Isolated yield : 48% (ratio *cis*: *trans* 1:2).

¹H NMR (δ, ppm) **Major diastereoisomer (trans):** 4.19 (q, *J* = 7.1Hz, 2H, OCH₂CH₃), 4.13-4.07 (m, 1H, OCH-THF ring), 3.99-3.85 (m, 1H, OCH-THF ring), 3.75 (s, 3H, OCH₃), 3.73 (s, 3H, OCH₃), 3.24 (d, *J* = 17.6Hz, 1H, CH₂-propargyl chain), 3.08 (d, *J* = 17.6Hz, 1H, CH₂-propargyl chain), 2.36-2.18 (m, 2H, CH₂CHO), 2.16-2.09 (m, 1H, CH₂-THF ring), 2.07-1.97 (m, 1H, CH₂-THF ring), 1.63-1.53 (m, 1H, CH₂-THF ring), 1.44-1.34 (m, 1H, CH₂-THF ring), 1.29 (t, *J* = 7.1Hz, 3H, OCH₂CH₃), 1.13 (d, *J* = 6.1Hz, 3H, CH₃). **Minor diastereoisomer (cis):** 4.19 (q, *J* = 7.1Hz,

2H, OCH₂CH₃), 4.13-4.07 (m, 1H, OCH-THF ring), 3.99-3.85 (m, 1H, OCH-THF ring), 3.75 (s, 3H, OCH₃), 3.72 (s, 3H, OCH₃), 3.23 (d, *J* = 17.6Hz, 1H, CH₂-propargyl chain), 3.07 (d, *J* = 17.6Hz, 1H, CH₂-propargyl chain), 2.36-2.18 (m, 2H, CH₂CHO), 2.07-1.97 (m, 1H, CH₂-THF ring), 1.95-1.87 (m, 1H, CH₂-THF ring), 1.63-1.53 (m, 1H, CH₂-THF ring), 1.44-1.34 (m, 1H, CH₂-THF ring), 1.29 (t, *J* = 7.1Hz, 3H, OCH₂CH₃), 1.15 (d, *J* = 6.2Hz, 3H, CH₃).

¹³C NMR (δ, ppm) (CDCl₃, 100 MHz) **Major diastereoisomer (trans):** 170.2 (Cq x2, C=O), 153.3 (Cq, C=O), 83.9 (Cq, C≡C), 74.4 (OCH-THF ring), 74.1 (OCH-THF ring), 75.6 (Cq, C≡C), 61.8 (OCH₂CH₃), 55.6 (Cq), 53.0 (OCH₃), 52.7 (OCH₃), 38.4 (CH₂), 33.4 (CH₂), 32.8 (CH₂), 23.2 (CH₂), 20.9 (CH₃), 13.9 (OCH₂CH₃). **Minor diastereoisomer (cis):** 170.3 (Cq x2, C=O), 153.3 (Cq, C=O), 84.0 (Cq, C≡C), 76.0 (OCH-THF ring), 75.5 (Cq, C≡C), 74.7 (OCH-THF ring), 61.8 (OCH₂CH₃), 55.6 (Cq), 52.9 (OCH₃), 52.7 (OCH₃), 39.1 (CH₂), 32.5 (CH₂), 32.3 (CH₂), 23.2 (CH₂), 21.2 (CH₃), 13.9 (OCH₂CH₃).

IR (ν, cm⁻¹) (CCl₄) 2954 (m), 2906 (w), 2873 (w), 2843 (w), 2240 (m), 1744 (s), 1716 (s), 1457 (m), 1436 (s), 1376 (m), 1367 (m), 1321 (m), 1253 (s), 1223 (s), 1201 (s), 1183 (s), 1152 (s), 1094 (s), 1016 (m).

HRMS (EI+, m/z) : Calculated.: 340.1522 found: 340.1520.

5-(2,3-Dihydro-benzofuran-2-ylmethyl)-5-methoxycarbonyl-hex-2-ynedioic acid 1-ethyl ester

5.17n

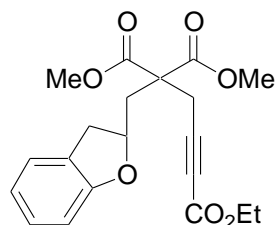

MF: C₂₀H₂₂O₇

MW = 374 g.mol⁻¹

Method : See **general procedure 5.4** using (1 equiv., 0.71 mmol, 215 mg) of 2-(2,3-dihydro-benzofuran-2-ylmethyl)-2-prop-2-ynyl-malonic acid dimethyl ester.

Purification : Flash column chromatography (silica gel, 9:1 PE:AcOEt)/ **R_f** (9:1 PE:AcOEt): 0.25

Product : Transparent oil.

Isolated yield : 53%.

¹H NMR (δ, ppm) (CDCl₃, 400 MHz) 7.16 (d, *J* = 7.5Hz, 1H, CH-Ar), 7.08 (t, *J* = 7.5Hz, 1H, CH-Ar), 6.83 (t, *J* = 7.5Hz, 1H, CH-Ar), 6.66 (d, *J* = 7.5Hz, 1H, CH-Ar), 4.87 (dddd, *J* = 2.8Hz, *J* = 6.4Hz, *J* = 9.1Hz, *J* = 10.7Hz, 1H, OCH-THF ring), 4.19 (q, *J* = 7.2Hz, 2H, OCH₂CH₃), 3.79 (s, 3H, OCH₃), 3.75 (s, 3H, OCH₃), 3.40 (dd, *J* = 9.0Hz, *J* =

15.6Hz, 1H, $\underline{\text{C}}\text{H}_2\text{CHO}$), 3.27 (d, $J = 17.8\text{Hz}$, 1H, CH_2 -propargyl chain), 3.16 (d, $J = 17.8\text{Hz}$, 1H, CH_2 -propargyl chain), 2.90 (dd, $J = 6.4\text{Hz}$, $J = 15.6\text{Hz}$, 1H, $\underline{\text{C}}\text{H}_2\text{CHO}$), 2.57 (dd, $J = 10.7\text{Hz}$, $J = 15.0\text{Hz}$, 1H, CH_2 -THF ring), 2.45 (dd, $J = 2.8\text{Hz}$, $J = 15.0\text{Hz}$, 1H, CH_2 -THF ring), 1.29 (t, $J = 7.1\text{Hz}$, 3H, $\text{OCH}_2\underline{\text{C}}\text{H}_3$).

^{13}C NMR (δ , ppm) 169.9 (Cq, C=O), 169.8 (Cq, C=O), 158.8 (Cq, C=O), 153.2 (Cq, Ar), 128.0 (CH-Ar), 126.0 (Cq, Ar), 124.9 (CH-Ar), 120.6 (CH-Ar), 109.5 (CH-Ar), 83.1 (Cq, $\text{C}\equiv\text{C}$), 78.6 (OCH-THFring), 75.9 (Cq, $\text{C}\equiv\text{C}$), 62.0 ($\underline{\text{O}}\text{CH}_2\text{CH}_3$), 55.2 (Cq), 53.2 (OCH₃), 53.0 (OCH₃), 38.8 (CH₂), 36.4 (CH₂), 23.4 (CH₂), 14.0 (OCH₂ $\underline{\text{C}}\text{H}_3$)

IR (ν , cm^{-1}) (CCl₄) 3035 (w), 2984 (w), 2954 (m), 2907 (w), 2843 (w), 2241 (m), 1745 (s), 1717 (s), 1614 (w), 1599 (w), 1480 (m), 1463 (m), 1436 (m), 1389 (w), 1367 (w), 1323 (w), 1286 (w), 1254 (s), 1230 (s), 1201 (m), 1182 (m), 1094 (m), 1075 (m), 1015 (w).

HRMS (EI+, m/z) : Calculated: 374.1366 Found: 374.1369.

2-(5-Oxo-tetrahydro-furan-2-ylmethyl)-2-prop-2-ynyl-malonic acid dimethyl ester 5.17p

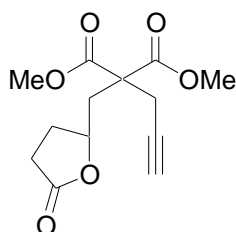

MF: C₁₃H₁₆O₆

MW = 268 g.mol⁻¹

Method : See **general procedure 4.1** using (1 equiv., 10 mmol, 1.28 g) of pent-4-enoic acid ethyl ester followed by **general procedure 5.2** using (1 equiv., 3.5 mmol, 630 mg) of 5-bromomethyl-dihydro-furan-2-one, followed by **general procedure 5.3** using the previously prepared monoalkylate malonate.

Purification : Flash column chromatography (silica gel, 1:1 PE: AcOEt)/ **R_f** (1:1 PE:AcOEt): 0.38.

Product : Transparent oil, cristallizes a white solid in the fridge.

Isolated yield : 6 % for three steps.

^1H NMR (δ , ppm) 4.66-4.59 (m, 1H, OCH-lactone ring), 3.77 (s, 6H, OCH₃), 3.02 (dd, $J = 2.7\text{Hz}$, $J = 17.5\text{Hz}$, 1H, CH_2 -propargyl chain), 2.92 (dd, $J = 2.7\text{Hz}$, $J = 17.5\text{Hz}$, 1H, CH_2 -propargyl chain), 2.54-2.48 (m, 3H, CH_2 -lactone ring + $\underline{\text{C}}\text{H}_2\text{CHO}$), 2.46-2.34 (m, 2H, CH_2 -lactone ring), 2.04 (t, $J = 2.7\text{Hz}$, 1H, $\equiv\text{CH}$), 1.97-1.88 (m, 1H, CH_2 -lactone ring).

¹³C NMR (δ, ppm) 176.0 (Cq, C=O), 170.0 (Cq, C=O), 169.9 (Cq, C=O), 78.4 (Cq, **C**≡CH), 76.4 (OCH-lactone ring), 72.0 (≡CH), 55.2 (Cq), 53.1 (OCH₃), 53.1 (OCH₃), 38.5 (CH₂), 28.6 (CH₂), 28.2 (CH₂), 23.4 (CH₂).

IR (ν, cm⁻¹) (CCl₄) 3313 (m), 2954 (m), 2844 (w), 1788 (s), 1743 (s), 1458 (m), 1437 (m), 1354 (w), 1322 (w), 1288 (m), 1263 (m), 1251 (m), 1227 (s), 1203 (s), 1181 (s), 1158 (s), 1075 (s), 1020 (w).

HRMS (EI+, m/z) : Calculated: 268.0947 found: 268.0948.

2-(1-Methanesulfonyl-pyrrolidin-2-ylmethyl)-2-prop-2-ynyl-malonic acid dimethyl ester **acid** **5.17q**

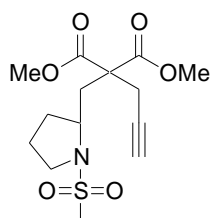

MF: C₁₄H₂₁O₆NS

MW = 331 g.mol⁻¹

Method : See **general procedure 5.2** using (1 equiv., 6.5 mmol, 1.66 g) of methanesulfonic acid 1-methanesulfonyl-pyrrolidin-2-ylmethyl ester followed by **general procedure 5.3** using (1 equiv., 0.6 mmol, 176 mg) of the previously prepared monoalkylated malonate.

Purification : Flash column chromatography (silica gel, 1:1 PE:AcOEt)/ **R_f** (1:1 PE:AcOEt): 0.36.

Product : White solid.

Isolated yield : 9% for two steps.

¹H NMR (δ, ppm) 3.99-3.94 (m, 1H, CHN), 3.75 (s, 6H, OCH₃), 3.41-3.34 (m, 1H, CH₂N), 3.32-3.26 (m, 1H, CH₂N), 3.05 (dd, *J* = 2.7Hz, *J* = 17.5Hz, 1H, CH₂-propargyl chain), 2.98 (dd, *J* = 2.7Hz, *J* = 17.5Hz, 1H, CH₂-propargyl chain), 2.80 (s, 3H, SO₂CH₃), 2.47 (dd, *J* = 6.5Hz, *J* = 14.8Hz, 1H, **CH₂**CHN), 2.26 (dd, *J* = 7.4Hz, *J* = 14.8Hz, 1H, **CH₂**CHN), 2.04 (t, *J* = 2.7Hz, 1H, ≡CH), 2.00-1.92 (m, 3H, CH₂), 1.79-1.73 (m, 1H, CH₂).

¹³C NMR (δ, ppm) 170.3 (Cq x2, C=O), 78.9 (Cq, C≡C), 71.9 (≡CH), 56.4 (SO₂CH₃), 55.7 (Cq), 52.9 (OCH₃), 52.8 (OCH₃), 47.4 (CH₂N), 37.4 (CH₂), 36.6 (CHN), 32.0 (CH₂), 24.1 (CH₂), 22.7 (CH₂).

IR (ν, cm⁻¹) (CCl₄) 3313 (m), 2954 (m), 1741 (s), 1438 (w), 1350 (s), 1286 (m), 1202 (s), 1151 (s), 1061 (s).

HRMS (EI+, m/z) : Calculated: 331.1090 found: 331.1076.

2-(1-Methanesulfonyl-piperidin-2-ylmethyl)-2-prop-2-ynyl-malonic dimethyl ester

acid 5.17r

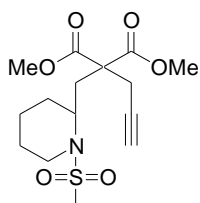

MF: C₁₅H₂₃O₆NS

MW = 345 g.mol⁻¹

Method : See **general procedure 5.2** using (1 equiv., 6.3 mmol, 1.61 g) of methanesulfonic acid 1-methanesulfonyl-piperidin-2-ylmethyl ester followed by **general procedure 5.3** using (1 equiv., 0.6 mmol, 184 mg) of the previously prepared monoalkylated malonate.

Purification : Flash column chromatography (silica gel 1:1 PE:AcOEt)/ R_f (7:3 PE:AcOEt): 0.15.

Product : White solid.

Isolated yield : 42% for two steps.

¹H NMR (δ, ppm) (CDCl₃, 400 MHz) 4.18-4.15 (m, 1H, CHN-piperidine ring), 3.75 (s, 3H, OCH₃), 3.74 (s, 3H, OCH₃), 3.57 (dd, *J* = 3.6Hz, *J* = 14.6Hz, 1H, CH₂N-piperidine ring), 3.16 (dd, *J* = 2.6Hz, *J* = 17.6Hz, 1H, CH₂-propargyl chain), 3.13 (dd, *J* = 3.6Hz, *J* = 14.6Hz, 1H, CH₂N-piperidine ring), 3.01 (dd, *J* = 2.6Hz, *J* = 17.6Hz, 1H, CH₂-propargyl chain), 2.89 (s, 3H, SO₂CH₃), 2.79 (dd, *J* = 10.4Hz, *J* = 15.1Hz, 1H, CH₂CHN), 2.22 (dd, *J* = 4.0Hz, *J* = 15.1Hz, 1H, CH₂CHN), 2.01 (t, *J* = 2.6Hz, 1H, ≡CH), 1.77-1.69 (m, 2H, CH₂-piperidine ring), 1.62-1.50 (m, 4H, CH₂-piperidine ring).

¹³C NMR (δ, ppm) (CDCl₃, 100 MHz) 170.4 (Cq, C=O), 170.0 (Cq, C=O), 79.0 (Cq, C≡C), 71.6 (≡CH), 55.5 (Cq), 53.0 (OCH₃), 52.9 (OCH₃), 48.6 (SO₂CH₃), 40.7 (CH₂N), 40.6 (CHN), 32.0 (CH₂), 29.7 (CH₂), 24.2 (CH₂), 21.9 (CH₂), 18.6 (CH₂).

IR (ν, cm⁻¹) (CCl₄) 3313 (m), 2953 (m), 1742 (s), 1438 (m), 1340 (s), 1289 (m), 1202 (s), 1148 (s).

HRMS (EI+, m/z) : Calculated: 345.1246 found: 345.1234.

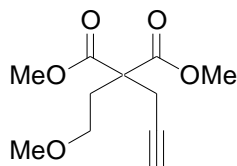
MF: C₁₁H₁₆O₅MW = 228 g.mol⁻¹

- Method :** See **general procedure 5.2** using (1 equiv., 10.6 mmol, 970 μ L) of 1-chloro-2-methoxy-ethane followed by **general procedure 5.3** using (1 equiv., 1.6 mmol, 300 mg) of the previously prepared monoalkylated malonate.
- Purification :** Flash column chromatography (silica gel, 8:2 PE:AcOEt)/ R_f (8:2 PE:AcOEt): 0.28.
- Product :** Transparent oil.
- Isolated yield :** 24% for two steps.
- ¹H NMR** (δ , ppm) (CDCl₃, 400 MHz) 3.73 (s, 6H, OCH₃), 3.44 (t, J = 6.1Hz, 2H, OCH₂), 3.25 (s, 3H, OCH₃), 2.89 (d, J = 2.7Hz, 2H, CH₂-propargyl chain), 2.37 (t, J = 6.1Hz, 2H, CH₂), 2.00 (t, J = 2.7Hz, 1H, \equiv CH).
- ¹³C NMR** (δ , ppm) (CDCl₃, 100 MHz) 170.6 (Cq x2, C=O), 78.9 (Cq, $\underline{\text{C}}\equiv\text{CH}$), 71.4 ($\equiv\text{CH}$), 68.2 (OCH₂), 58.7 (OCH₃), 55.2 (Cq), 52.7 (OCH₃ x2), 32.0 (CH₂), 23.2 (CH₂).
- IR** (ν , cm⁻¹) (CCl₄) 3314 (s), 3028 (w), 2985 (w), 2953 (m), 2928 (m), 2896 (m), 2876 (m), 2833 (m), 2812 (w), 1741 (s), 1481 (w), 1458 (m), 1436 (s), 1389 (w), 1351 (w), 1323 (m), 1289 (s), 1226 (s), 1198 (s), 1184 (s), 1160 (m), 1123 (s), 1102 (s), 1063 (m), 1035 (s), 1004 (w).
- HRMS** (EI+, m/z) : Calculated: 228.0998 found: 228.1000.

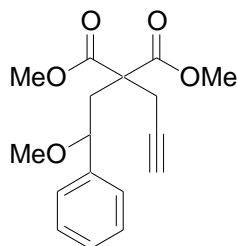
MF: C₁₇H₂₀O₅MW = 304 g.mol⁻¹

- Method :** See **general procedure 5.2** using (1 equiv., 3.21 mmol, 840 mg) of (2-iodo-2-methoxy-ethyl)-benzene followed by **general procedure 5.3** using (1 equiv., 1.69 mmol, 450 mg) of the previously prepared monoalkylated malonate.
- Purification :** Flash column chromatography (silica gel, 9:1 PE:AcOEt). / **R_f** (8:2 PE:AcOEt): 0.35.
- Product :** Transparent oil.
- Isolated yield :** 32% for two steps.
- ¹H NMR** (δ, ppm) (CDCl₃, 400 MHz) 7.37-7.28 (m, 5H, CH-Ph), 4.24 (dd, *J* = 4.9Hz, *J* = 8.2Hz, 1H, CHOCH₃), 3.76 (s, 3H, OCH₃), 3.73 (s, 3H, OCH₃), 3.09 (s, 3H, OCH₃), 3.03 (dd, *J* = 2.6Hz, *J* = 17.3Hz, 1H CH₂-propargyl chain), 2.96 (dd, *J* = 2.7Hz, *J* = 17.3Hz, 1H, CH₂-propargyl chain), 2.46-2.43 (m, 2H, CH₂), 2.02 (t, *J* = 2.7Hz, 1H, ≡CH).
- ¹³C NMR** (δ, ppm) (CDCl₃, 100 MHz) 170.5 (Cq x2, C=O), 141.7 (Cq, Ph), 128.5 (CH-Ph), 127.7 (CH-Ph), 126.4 (CH-Ph), 79.9 (OCH), 79.0 (Cq, C≡CH), 71.6 (≡CH), 56.7 (OCH₃), 55.4 (Cq), 52.7 (OCH₃), 52.6 (OCH₃), 41.2 (CH₂), 23.5 (CH₂).
- IR** (ν, cm⁻¹) (CCl₄) 3314 (s), 3088 (w), 3066 (w), 3029 (w), 2999 (w), 2952 (m), 2904 (w), 2888 (w), 2842 (w), 2825 (w), 1741 (s), 1494 (w), 1455 (m), 1436 (s), 1355 (w), 1323 (m), 1289 (s), 1231 (s), 1199 (s), 1182 (s), 1105 (s), 1094 (s), 1065 (s), 1038 (s).
- HRMS** (EI+, *m/z*) : Calculated: 304.1311 found: 304.1319.

B.3.4.2 Synthesis of substrates bearing C(3)-THF rings

Alkynes synthesized in this work having C(3)-substituted THF rings were obtained as depicted in the scheme below:

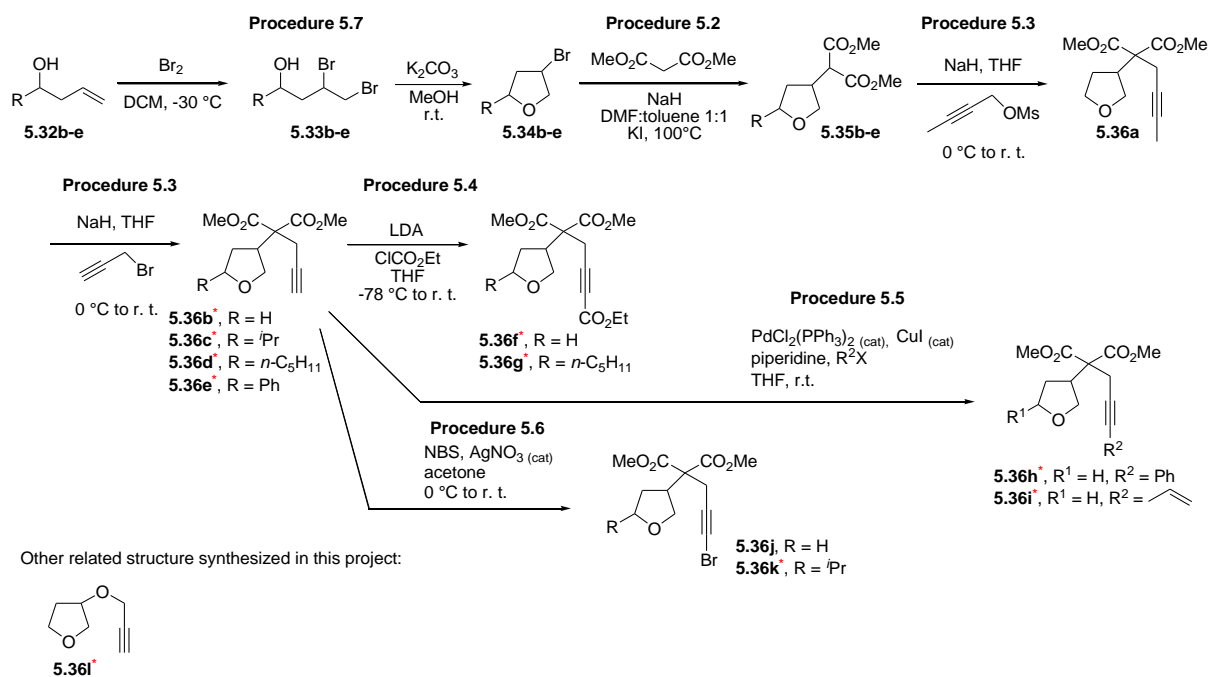

Scheme B.3.4.2: C(3)-linked THF rings synthesized in this project

General procedure 5.7³⁰⁹, Br_2 promoted cyclisation of allylic alcohols:

To a round bottom flask, charged with allylic alcohol (1 equiv.) and DCM (1M) at -30°C , was added Br_2 (1.2 equiv.) dissolved in DCM (4 M). The addition of Br_2 is stopped when the orange color persists, which normally means the reaction is over (TLC). The solution is treated with a solution of $\text{Na}_2\text{S}_2\text{O}_3$ in water, extracted with DCM (3x); dried (MgSO_4), and concentrated under reduced pressure. The dibromo compound is then diluted in MeOH (0.4M), followed by the addition of K_2CO_3 (3 equiv.) and the reaction mixture is allowed to stir overnight at room temperature. Upon completion (TLC), the reaction is filtered, concentrated under reduced pressure and purified by flash column chromatography.

³⁰⁹ Chirskaya, M. V.; Vasil'ev, A. A.; Sergovskaya, N. L.; Shorshnev, S. V.; Sviridov, S. I., *Tetrahedron Lett.*, **2004**, 45, 48, 8811.

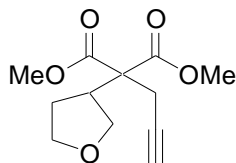
MF: C₁₂H₁₆O₅MW = 240 g.mol⁻¹

- Method :** See **general procedure 5.2** using (1 equiv., 6 mmol, 1.45 g) of toluene-4-sulfonic acid tetrahydro-furan-3-yl ester followed by **general procedure 5.3** using (1 equiv., 1.36 mmol, 275 mg) of the previously prepared monoalkylated malonate.
- Purification :** Flash column chromatography (silica gel, 8:2 PE:AcOEt)/ **R_f** (7:3 PE:AcOEt): 0.43.
- Product :** White solid.
- Isolated yield :** 17% for two steps.
- ¹H NMR** (δ, ppm) (CDCl₃, 400 MHz) 3.95 (dd, *J* = 8.1Hz, *J* = 9.3Hz, 1H, OCH₂-THF ring), 3.86-3.78 (m, 2H, OCH₂-THF ring), 3.76 (s, 3H, OCH₃), 3.75 (s, 3H, OCH₃), 3.66 (dd, *J* = 8.4Hz, *J* = 15.5Hz, 1H, OCH₂-THF ring), 3.17-3.09 (m, 1H, CH-THF ring), 2.85 (d, *J* = 2.7Hz, 2H, CH₂-propargyl chain), 2.12-2.05 (m, 1H, CH₂-THF ring), 2.03 (t, *J* = 2.7Hz, 1H, ≡CH), 1.86-1.77 (m, 1H, CH₂-THF ring).
- ¹³C NMR** (δ, ppm) (CDCl₃, 100 MHz) 170.2 (Cq, C=O), 169.9 (Cq, C=O), 78.7 (Cq, C≡CH), 71.6 (≡CH), 69.4 (OCH₂-THF ring), 67.9 (OCH₂-THF ring), 58.8 (Cq), 52.8 (OCH₃), 52.7 (OCH₃), 41.9 (CH-THF ring), 27.8 (CH₂), 24.4 (CH₂).
- IR** (ν, cm⁻¹) (CCl₄) 3313 (m), 2954 (m), 2858 (w), 1758 (m), 1736 (s), 1436 (m), 1355 (w), 1276 (m), 1232 (s), 1201 (s), 1182 (m), 1118 (w), 1075 (m), 1054 (w), 1026 (w).
- HRMS** (EI+, *m/z*) : Calculated: 240.0998 found: 240.0999.

2-(5-Isopropyl-tetrahydro-furan-3-yl)-2-prop-2-ynyl-malonic acid dimethyl ester 5.36c

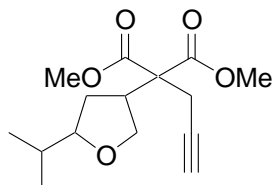

MF: C₁₅H₂₂O₅

MW = 282 g.mol⁻¹

- Method :** See **general procedure 5.7** using (1equiv., 26.3 mmol, 3.0 g) of 2-methyl-hex-5-en-3-ol followed by **general procedure 5.2** using (1 equiv., 3 mmol, 587 mg) of 4-bromo-2-isopropyl-tetrahydro-furan followed by **general procedure 5.3** using (1 equiv., 1.45 mmol, 355 mg) of the previously prepared monoalkylated malonate.
- Purification :** Flash column chromatography (silica gel, 95:5 toluene:AcOEt)/ R_f. (8:2 PE:AcOEt) : 0.48.
- Product :** Transparent oil.
- Isolated yield :** 4% for three steps (inseparable mixture, ratio diastereoisomers 1:3)
- ¹H NMR** (δ, ppm) (CDCl₃, 400 MHz) **Major diastereomer (cis):** 3.94 (d, *J* = 7.2Hz, 2H, OCH- + OCH₂- THF ring), 3.75 (s, 3H, OCH₃), 3.74 (s, 3H, OCH₃), 3.47-3.40 (m, 1H, OCH₂-THF ring), 3.21-3.13 (m, 1H, CH-THF ring), 2.99-2.77 (m, 2H, CH₂-propargyl chain), 2.08-2.04 (m, 1H-CH-ⁱPr), 2.03 (t, *J* = 2.7Hz, 1H, ≡CH), 1.71-1.61 (m, 1H, CH₂-THF ring), 1.42-1.34 (m, 1H, CH₂-THF ring), 0.94 (d, *J* = 6.7Hz, 3H, CH₃-ⁱPr), 0.85 (d, *J* = 6.7Hz, 3H, CH₃-ⁱPr). **Minor diastereomer (trans):** 4.14 (dd, *J* = 9.2Hz, *J* = 7.7Hz, 1H, OCH-THF ring), 3.76 (s, 3H, OCH₃), 3.75 (s, 3H, OCH₃), 3.65 (dd, *J* = 9.2Hz, *J* = 8.4Hz, 1H, OCH₂-THF ring), 3.47-3.40 (m, 1H, OCH₂-THF ring), 3.11-3.05 (m, 1H, CH-THF ring), 2.99-2.77 (m, 2H, CH₂-propargyl chain), 2.08-2.04 (m, 1H, CH-ⁱPr), 2.04 (t, *J* = 2.7Hz, 1H, ≡CH), 1.94-1.86 (m, 1H, CH₂-THF ring), 1.85-1.76 (m, 1H, CH₂-THF ring), 0.93 (d, *J* = 6.7Hz, 3H, CH₃-ⁱPr), 0.86 (d, *J* = 6.7Hz, 3H, CH₃-ⁱPr).
- ¹³C NMR** (δ, ppm) (CDCl₃, 100 MHz) **Major diastereoisomer (cis):** 170.2 (Cq, C=O), 169.8 (Cq, C=O), 84.9 (OCH-THF ring), 78.7 (Cq, C≡CH), 71.6 (≡CH), 69.1 (OCH₂-THF ring), 58.9 (Cq), 52.8 (OCH₃), 52.7 (OCH₃), 42.0 (CH), 32.7 (CH), 31.2 (CH₂), 24.2 (CH₂), 19.3 (CH₃), 18.4 (CH₃). **Minor diastereoisomer (trans):** 170.0 (Cq, C=O), 170.0 (Cq, C=O), 84.3 (OCH-THF ring), 78.6 (Cq, C≡CH), 71.5 (≡CH), 69.1 (OCH₂-THF ring), 58.5 (Cq), 52.8 (OCH₃), 52.7 (OCH₃), 41.7 (CH), 32.8 (CH), 30.8 (CH₂), 24.4 (CH₂), 18.9 (CH₃), 18.4 (CH₃).
- IR** (ν, cm⁻¹) (CCl₄) 3313 (s); 2955 (s); 2873 (s); 2844 (m); 1758 (s); 1736 (s); 1469 (m); 1458 (m); 1448 (m); 1436 (s); 1389 (w); 1366 (w); 1352 (w); 1312 (m); 1282 (s); 1227 (s);

1201 (s); 1185 (s); 1139 (m); 1118 (m); 1078 (s); 1036 (m).

HRMS (EI+, m/z) : Calculated: 282.1467. Found: 282.1459.

2-(5-Pentyl-tetrahydro-furan-3-yl)-2-prop-2-ynyl-malonic acid dimethyl ester

5.36d

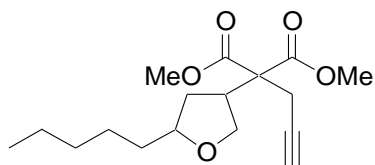

MF: C₁₇H₂₆O₅

MW = 310 g.mol⁻¹

Method : See **general procedure 5.7** using (1 equiv., 21.1 mmol, 3.0 g) of non-1-en-4-ol followed by **general procedure 5.2** using (1 equiv., 9.3 mmol, 2.05 g) of 4-bromo-2-pentyl-tetrahydro-furan followed by **general procedure 5.3** using (1 equiv., 3.5 mmol, 963 mg) of the previously prepared monoalkylated malonate.

Purification : Flash column chromatography (silica gel, 9:1 PE:AcOEt)/ **R_f** (8:2 PE:AcOEt): 0.37.

Product : Transparent oil.

Isolated yield : 11% for three steps (inseparable mixture of diastereoisomers, ratio cis: trans 3:1).

¹H NMR (δ, ppm) (CDCl₃, 400 MHz) **Major diastereoisomer (cis):** 3.97 (dd, *J* = 9.7Hz, *J* = 5.9Hz, 1H, OCH-THF ring), 3.91 (dd, *J* = 9.7 Hz, *J* = 8.2Hz, 1H, OCH₂-THF ring), 3.75 (s, 3H, OCH₃), 3.74 (s, 3H, OCH₃), 3.72-3.65 (m, 1H, OCH₂-THF ring), 3.21-3.11 (m, 1H, CH), 2.85 (dd, *J* = 2.7Hz, *J* = 17.2Hz, 1H, CH₂-propargyl chain), 2.80 (dd, *J* = 2.7Hz, *J* = 17.2Hz, 1H, CH₂-propargyl chain), 2.15-2.09 (m, 1H, CH₂-THFring), 2.02 (t, *J* = 2.7Hz, 1H, ≡CH), 1.62-1.52 (m, 1H, CH₂-THF ring), 1.46-1.28 (m, 8H, CH₂-pentyl chain), 0.88 (t, *J* = 6.7Hz, 3H, CH₃-pentyl chain). **Minor diastereoisomer (trans):** 4.14 (dd, *J* = 9.1Hz, *J* = 7.8Hz, 1H, OCH-THF ring), 3.75 (s, 3H, OCH₃), 3.74 (s, 3H, OCH₃), 3.72-3.65 (m, 2H, OCH₂-THF ring), 3.21-3.11 (m, 1H, CH), 2.88-2.77 (m, 2H, CH₂-propargyl chain), 2.03 (t, *J* = 2.7Hz, 1H, ≡CH), 1.99-1.94 (m, 1H, CH₂-THF ring), 1.75-1.68 (m, 1H, CH₂-THF ring), 1.46-1.28 (m, 8H, CH₂-pentyl chain), 0.88 (t, *J* = 6.7Hz, 3H, CH₃-pentyl chain).

¹³C NMR (δ, ppm) (CDCl₃, 100 MHz) **Major diastereoisomer (cis):** 170.2 (Cq, C=O), 169.8 (Cq, C=O), 79.6 (OCH-THF ring), 78.8 (≡CH), 71.6 (Cq, **C**≡CH), 68.9 (OCH₂-THF ring), 59.0 (Cq), 52.7 (OCH₃), 52.6 (OCH₃), 42.1 (CH), 35.0 (CH₂), 33.7 (CH₂), 31.9 (CH₂), 25.9 (CH₂), 24.2 (CH₂), 22.5 (CH₂), 13.9 (CH₃, pentyl chain). **Minor diastereoisomer (trans):** 170.1 (Cq, C=O), 170.0 (Cq, C=O), 79.0 (OCH-THF ring), 78.7 (≡CH), 71.5 (Cq, **C**≡CH), 68.8 (OCH₂-THF ring), 58.6 (Cq), 52.7 (OCH₃), 52.6 (OCH₃), 41.6 (CH), 35.5 (CH₂), 33.2 (CH₂), 31.8 (CH₂), 25.7 (CH₂), 24.4 (CH₂), 22.5 (CH₂), 13.9 (CH₃-pentyl chain).

IR (ν , cm^{-1}) (CCl_4) 3313 (m), 3001 (w), 2954 (m), 2932 (m), 2860 (m), 1758 (s), 1736 (s), 1456 (m), 1435 (m), 1379 (w), 1355 (w), 1312 (w), 1284 (m), 1230 (s), 1200 (s), 1137 (w), 1117 (w), 1092 (w), 1073 (w), 1051 (w).

HRMS (EI^+ , m/z) : Calculated: 310.1780 found: 310.1765.

2-(5-Phenyl-tetrahydro-furan-3-yl)-2-prop-2-ynyl-malonic acid dimethyl ester 5.36e

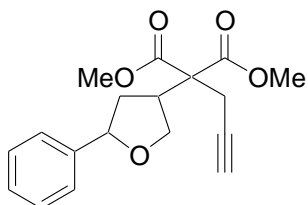

MF: $\text{C}_{18}\text{H}_{20}\text{O}_5$

MW = $316 \text{ g}\cdot\text{mol}^{-1}$

Method : See **general procedure 5.7** using (1 equiv., 20 mmol, 3.0 g) of 1-phenyl-but-3-en-1-ol followed by **general procedure 5.2** using (1 equiv., 11.9 mmol, 2.7 g) of 4-bromo-2-phenyl-tetrahydro-furan followed by **general procedure 5.3** using (1 equiv., 5.03 mmol, 1.4 g) of previously prepared monosubstituted malonate.

Purification : Flash column chromatography (silica gel, 8:2 PE AcOEt)/ R_f (8:2 PE:AcOEt): 0.29.

Product : Yellow pale oil.

Isolated yield : 18% for three steps. (ratio cis: trans 3: 1).

$^1\text{H NMR}$ (δ , ppm) (CDCl₃, 400 MHz) **Major diastereoisomer (cis):** 7.35-7.24 (m, 5H, CH-Ph), 4.79 (dd, $J = 5.6\text{Hz}$, $J = 10.2\text{Hz}$, 1H, OCH-THF ring), 4.19 (dd, $J = 6.4\text{Hz}$, $J = 9.4\text{Hz}$, 1H, OCH₂-THF ring), 4.14 (dd, $J = 8.5\text{Hz}$, $J = 9.4\text{Hz}$, 1H, OCH₂-THF ring), 3.76 (s, CH₃, OCH₃), 3.75 (s, CH₃, OCH₃), 3.40-3.31 (m, 1H, CH), 2.91-2.78 (m, 2H, CH₂-propargyl chain), 2.46 (ddd, $J = 5.6\text{Hz}$, $J = 8.2\text{Hz}$, $J = 12.6\text{Hz}$, 1H, CH₂-THF ring), 2.05 (t, $J = 2.7\text{Hz}$, 1H, $\equiv\text{CH}$), 1.72 (td, $J = 10.0\text{Hz}$, $J = 12.6\text{Hz}$, 1H, CH₂-THF ring).

Minor diastereoisomer (trans): 7.35-7.24 (m, 5H, CH-Ph), 4.86 (dd, $J = 6.6\text{Hz}$, $J = 7.7\text{Hz}$, 1H, OCH-THF ring), 4.34 (dd, $J = 7.7\text{Hz}$, $J = 9.2\text{Hz}$, 1H, OCH₂-THF ring), 3.89 (dd, $J = 8.0\text{Hz}$, $J = 9.2\text{Hz}$, 1H, OCH₂-THF ring), 3.78 (s, 3H, OCH₃), 3.77 (s, 3H, OCH₃), 3.24 (dd, $J = 7.7\text{Hz}$, $J = 9.2\text{Hz}$, 1H, CH), 2.91-2.78 (m, 2H, CH₂-propargyl chain), 2.41-2.34 (m, 1H, CH₂-THF ring), 2.12 (ddd, $J = 6.6\text{Hz}$, $J = 9.7\text{Hz}$, $J = 13.0\text{Hz}$, 1H, CH₂-THF ring), 2.03 (t, $J = 2.7\text{Hz}$, 1H, $\equiv\text{CH}$).

$^{13}\text{C NMR}$ (δ , ppm) (CDCl₃, 100 MHz) **Major diastereoisomer (cis):** 170.1 (Cq, C=O), 169.7 (Cq, C=O), 141.5 (Cq, Ph), 128.3 (CH-Ph), 127.5 (CH-Ph), 125.8 (CH-Ph), 81.0 (OCH-THF ring), 78.6 (Cq, $\underline{\text{C}}\equiv\text{CH}$), 71.7 ($\equiv\text{CH}$), 69.6 (OCH₂-THF ring), 58.9 (Cq), 52.8 (OCH₃), 52.7 (OCH₃), 42.5 (CH), 36.7 (CH₂), 24.3 (CH₂). **Minor diastereoisomer (trans):** 170.0 (Cq, C=O), 169.9 (Cq, C=O), 142.7 (Cq, Ph), 128.3 (CH-Ph), 127.3 (CH-Ph), 125.5 (CH-Ph), 80.0 (OCH-THF ring), 78.5 (Cq, $\underline{\text{C}}\equiv\text{CH}$), 71.8 ($\equiv\text{CH}$), 69.6 (OCH₂-THF ring), 58.5 (Cq), 52.8 (OCH₃), 52.7 (OCH₃), 41.8 (CH), 35.8 (CH₂), 24.5 (CH₂).

IR (ν , cm^{-1}) (CCl_4) 3313 (m), 3089 (w), 3066 (w), 3032 (w), 3003 (w), 2954 (m), 2869 (w), 2844 (w), 1757 (s), 1736 (s), 1495 (w), 1450 (m), 1436 (s), 1348 (m), 1312 (m), 1280 (s), 1226 (s), 1201 (s), 1115 (s), 1086 (s), 1065 (s), 1029 (s).

HRMS (EI+, m/z) : Calculated: 316.1311 found: 316.1309.

**5-Methoxycarbonyl-5-(tetrahydro-furan-3-yl)-hex-2-ynedioic acid 1-ethyl ester
6-methyl ester 5.36f**

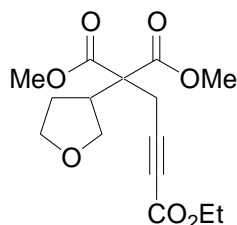

MF: $\text{C}_{19}\text{H}_{22}\text{O}_5$

MW = 330 $\text{g}\cdot\text{mol}^{-1}$

Method : See **general procedure 5.4** using (1 equiv., 1 mmol, 240 mmol) of 2-prop-2-ynyl-2-(tetrahydro-furan-2-ylmethyl)-malonic acid dimethyl ester.

Purification : Flash column chromatography (silica gel, 7:3 PE:AcOEt) / R_f (8:2 PE:AcOEt): 0.33.

Product : Yellow pale oil.

Isolated yield : 34 % (76%, brsm).

$^1\text{H NMR}$ (δ , ppm) 4.20 (q, $J = 7.1\text{Hz}$, 2H, OCH_2CH_3), 3.93 (dd, $J = 8.0\text{Hz}$, $J = 9.4\text{Hz}$, 1H, OCH_2 -THF ring), 3.86-3.80 (m, 2H, OCH_2 -THF ring), 3.78 (s, 3H, OCH_3), 3.76 (m, 3H, OCH_3), 3.66 (dd, $J = 8.4\text{Hz}$, $J = 15.6\text{Hz}$, 1H, OCH_2 -THF ring), 3.12-3.04 (m, 1H, CH), 3.00 (s, 2H, CH_2 -propargyl chain), 2.13-2.05 (m, 1H, CH_2 -THFring), 1.86-1.77 (m, 1H, CH_2 -THFring), 1.29 (t, $J = 7.1\text{Hz}$, 3H, OCH_2CH_3).

$^{13}\text{C NMR}$ (δ , ppm) 169.6 (Cq, C=O), 169.4 (Cq, C=O), 153.1 (Cq, C=O), 82.8 (Cq, $\text{C}\equiv\text{C}$), 75.8 (Cq, $\text{C}\equiv\text{C}$), 69.3 (OCH_2 -THF ring), 67.8 (OCH_2 -THF ring), 61.9 (OCH_2CH_3), 58.5 (Cq), 53.0 (OCH_3), 52.9 (OCH_3), 42.2 (CH), 27.7 (CH_2), 24.4 (CH_2), 14.0 (OCH_2CH_3).

IR (ν , cm^{-1}) (CCl_4) 3024 (w), 2974 (w), 2952 (m), 2872 (w), 1757 (m), 1742 (s), 1491 (w), 1436 (m), 1326 (w), 1289 (w), 1260 (w), 1218 (s), 1200 (s), 1182 (s), 1120 (w), 1087 (s), 1051 (w), 1030 (w).

HRMS (EI+, m/z) : calculated: 330.1467 found: 330.1468.

5-Methoxycarbonyl-5-(5-pentyl-tetrahydro-furan-3-yl)-hex-2-ynedioic acid 1-ethyl ester 6-methyl ester 5.36g

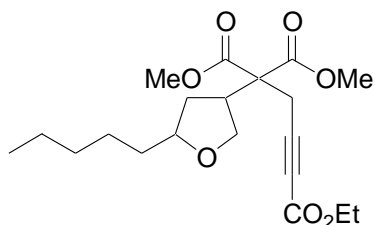

MF: C₂₀H₃₀O₇

MW = 382 g.mol⁻¹

- Method :** See **general procedure 5.4** using (1 equiv., 1 mmol, 310 mg) of 2-(5-pentyl-tetrahydro-furan-3-yl)-2-prop-2-ynyl-malonic acid dimethyl ester
- Purification :** Flash column chromatography (silica gel, 9:1 PE:AcOEt)/ R_f (8:2 PE:AcOEt): 0.38.
- Product :** Transparent/ pale green oil.
- Isolated yield :** 45% (73%, brsm, inseparable mixture of diastereoisomers, ratio cis:trans: 3:1)

¹H NMR (δ, ppm) (CDCl₃, 400 MHz) **Major diastereoisomer (cis):** 4.20 (q, *J* = 7.0Hz, 2H, OCH₂CH₃), 3.97 (dd, *J* = 5.5Hz, *J* = 9.6Hz, 1H, OCH₂-THF ring), 3.90 (dd, *J* = 8.2Hz, *J* = 9.6Hz, 1H, OCH₂-THF ring), 3.77 (s, 3H, OCH₃), 3.75 (s, 3H, OCH₃), 3.74-3.64 (m, 1H, OCH-THF ring), 3.16-3.07 (m, 1H, CH-THF ring), 3.02-2.92 (m, 2H, CH₂-propargyl chain), 2.12 (ddd, *J* = 5.5Hz, *J* = 8.6Hz, *J* = 12.5Hz, 1H, CH₂-THF ring), 1.57-1.52 (m, 1H, CH₂-THF ring), 1.47-1.21 (m, 11H, CH₂- + CH₃- pentyl chain), 0.88 (t, *J* = 7.0Hz, 3H, OCH₂CH₃).

Minor diastereoisomer (trans): 4.20 (q, *J* = 7.0Hz, 2H, OCH₂CH₃), 4.13 (dd, *J* = 7.7Hz, *J* = 9.2Hz, 1H, OCH-THF ring), 3.77 (s, 3H, OCH₃), 3.76 (s, 3H, OCH₃), 3.74-3.64 (m, 2H, OCH₂-THF ring), 3.16-3.07 (m, 1H, CH-THF ring), 3.02-2.92 (m, 2H, CH₂-propargyl chain), 2.01-1.94 (m, 1H, CH₂-THF ring), 1.76-1.68 (m, 1H, CH₂-THF ring), 1.47-1.21 (m, 11H, CH₂- + CH₃- pentyl chain), 0.88 (t, *J* = 7.0Hz, 3H, OCH₂CH₃).

¹³C NMR (δ, ppm) (CDCl₃, 100 MHz) **Major diastereoisomer (cis):** 169.8 (Cq, C=O), 169.4 (Cq, C=O), 153.2 (Cq, C=O), 83.0 (Cq, C≡C), 79.6 (OCH-THF ring), 75.8 (Cq, C≡C), 69.0 (OCH₂-THF ring), 62.0 (OCH₂CH₃), 58.8 (Cq), 53.1 (OCH₃), 53.0 (OCH₃), 42.5 (CH), 35.0 (CH₂), 33.7 (CH₂), 31.9 (CH₂), 25.9 (CH₂), 24.3 (CH₂), 22.6 (CH₂), 14.0 (CH₃x2, pentyl chain + OCH₂CH₃).

Minor diastereoisomer (trans): 169.7 (Cq, C=O), 169.6 (Cq, C=O), 153.2 (Cq, C=O), 82.9 (Cq, C≡C), 79.1 (OCH-THF ring), 75.8 (Cq, C≡C), 68.8 (OCH₂-THF ring), 62.0 (OCH₂CH₃), 58.4 (Cq), 53.1 (OCH₃), 53.0 (OCH₃), 42.1

(CH), 35.5 (CH₂), 33.4 (CH₂), 31.9 (CH₂), 25.8 (CH₂), 24.6 (CH₂), 22.6 (CH₂), 14.0 (CH₃x2 pentyl chain + OCH₂CH₃).

IR (ν, cm⁻¹) (CCl₄) 2955 (m), 2933 (m), 2873 (w), 2861 (w), 2242 (w), 1737 (s), 1717 (s), 1456 (w), 1435 (m), 1367 (w), 1254 (s), 1231 (s), 1115 (m), 1075 (m).

HRMS (EI+, m/z) : Calculated: 382.1992 found: 382.1998.

2-(3-Phenyl-prop-2-ynyl)-2-(tetrahydro-furan-3-yl)-malonic acid dimethyl ester 5.36h

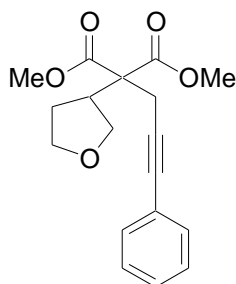

MF: C₁₈H₂₀O₅

MW = 316 g.mol⁻¹

Method : See **general procedure 5.5** using (1 equiv., 1 mmol, 240 mg) of 2-prop-2-ynyl-2-(tetrahydro-furan-3-yl)-malonic acid dimethyl ester and (1.1 equiv., 1.10 mmol, 120 μL) of iodo-benzene.

Purification : Flash column chromatography (silica gel, 8:2 PE:AcOEt)/ **R_f** (8:2 PE:AcOEt): 0.41.

Product : Yellow oil.

Isolated yield : 60%.

¹H NMR (δ, ppm) 7.37-7.35 (m, 2H, CH-Ph), 7.29-7.27 (m, 3H, CH-Ph), 3.99 (dd, *J* = 8.0Hz, *J* = 9.2Hz, 1H, OCH₂-THF ring), 3.88 (dd, *J* = 6.6Hz, *J* = 9.2Hz, 1H, OCH₂-THF ring), 3.83 (dt, *J* = 3.9Hz, *J* = 8.4Hz, 1H, OCH₂-THF ring), 3.78 (s, 3H, OCH₃), 3.77 (s, 3H, OCH₃), 3.71-3.65 (m, 1H, OCH₂-THF ring), 3.19 (td, *J* = 8.0Hz, *J* = 15.6Hz, 1H, CH-THFring), 3.07 (s, 2H, CH₂-propargyl chain), 2.17-2.08 (m, 1H, CH₂-THF ring), 1.92-1.83 (m, 1H, CH₂-THF-ring).

¹³C NMR (δ, ppm) 170.3 (Cq, C=O), 170.1 (Cq, C=O), 131.6 (Cq, Ph), 128.2 (CH-Ph), 128.1 (CH-Ph), 123.0 (CH-Ph), 84.1 (Cq, C≡C), 83.8 (Cq, C≡C), 69.5 (OCH₂-THF ring), 67.9 (OCH₂-THF ring), 59.2 (Cq), 52.8 (OCH₃), 52.7 (OCH₃), 42.1 (CH), 27.8 (CH₂), 25.3 (CH₂).

IR (ν, cm⁻¹) (CCl₄) 3060 (w), 2954 (m), 2860 (w), 1736 (s), 1599 (w), 1573 (w), 1491 (w), 1435 (m), 1354 (w), 1316 (w), 1275 (s), 1231 (s), 1201 (s), 1181 (s), 1116 (s), 1073 (s), 1054 (s), 1027 (m).

HRMS (EI+, m/z) : Calculated: 316.1311 found: 316.1305.

2-Pent-4-en-2-ynyl-2-(tetrahydro-furan-3-yl)-malonic acid dimethyl ester

5.36i

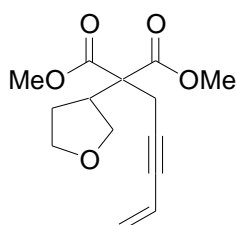

MF: C₁₄H₁₈O₅

MW = 266 g.mol⁻¹

Method : See **general procedure 5.5** using (1 equiv., 1 mmol, 240 mg) of 2-prop-2-ynyl-2-(tetrahydro-furan-3-yl)-malonic acid dimethyl ester and (1.2 equiv., 1.20 mmol, solution 1M in THF, 1.2 mL) of iodo-benzene.

Purification : Flash column chromatography (silica gel, 8:2 PE:AcOEt)/ R_f (8:2 PE:AcOEt): 0.31.

Product : Orange oil.

Isolated yield : 67%.

¹H NMR (δ, ppm) (CDCl₃, 400 MHz) 5.72 (tdd, *J* = 2.0Hz, *J* = 11.0Hz, *J* = 17.5Hz, 1H, CH=CH₂), 5.56 (dd, 2.2Hz, *J* = 17.5Hz, 1H, CH=CH₂), 5.42 (dd, *J* = 2.2Hz, *J* = 11.0Hz, 1H, CH=CH₂), 3.96 (dd, *J* = 8.2Hz, *J* = 9.3Hz, 1H, OCH₂-THF ring), 3.83 (dd, *J* = 6.7Hz, *J* = 9.3Hz, 1H, OCH₂-THF ring), 3.80 (dd, *J* = 4.1Hz, *J* = 8.2Hz, 1H, OCH₂-THF ring), 3.76 (s, 3H, OCH₃), 3.75 (s, 3H, OCH₃), 3.72-3.64 (m, 1H, OCH₂-THF ring), 3.11 (td, *J* = 8.0Hz, *J* = 15.7Hz, 1H, CH-THF ring), 2.97 (d, *J* = 2.0Hz, 2H, CH₂-propargyl chain), 2.12-2.04 (m, 1H, CH₂-THF ring), 1.87-1.78 (m, 1H, CH₂-THF ring).

¹³C NMR (δ, ppm) (CDCl₃, 100 MHz) 170.3 (Cq, C=O), 170.0 (Cq, C=O), 126.9 (CH=CH₂), 116.9 (CH=CH₂), 84.7 (Cq, C≡C), 82.4 (Cq, C≡C), 69.4 (OCH₂-THF ring), 67.9 (OCH₂-THF ring), 59.0 (Cq), 52.7 (OCH₃ x2), 42.0 (CH), 27.8 (CH₂), 25.2 (CH₂).

IR (ν, cm⁻¹) (CCl₄) 2954 (w), 2859 (w), 1737 (s), 1435 (w), 1275 (w), 1232 (m), 1202 (w), 1075 (w)

HRMS (EI+, m/z) : Calculated: 266.1154 found: 266.1145.

2-(3-Bromo-prop-2-ynyl)-2-(5-isopropyl-tetrahydro-furan-3-yl)-malonic acid dimethyl ester 5.36k

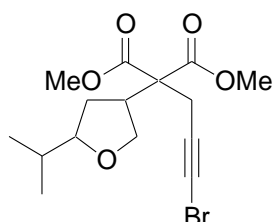

MF: C₁₆H₂₃O₅Br

MW = 374 g.mol⁻¹

- Method :** See **general procedure 5.6** using (1 equiv., 0.35 mmol, 100 mg) of 2-(5-isopropyl-tetrahydro-furan-3-yl)-2-prop-2-ynyl-malonic acid dimethyl ester.
- Purification :** Flash column chromatography (silica gel, 8:E PE:AcOEt)/ R_f (8:2 PE:AcOEt): 0.58.
- Product :** Transparent oil.
- Isolated yield :** 97% (inseparable mixture, ratio diastereoisomers cis:trans 3:1).
- ¹H NMR** (δ, ppm) (CDCl₃, 400 MHz) **Major diastereoisomer (cis):** 3.93 (d, *J* = 7.0Hz, 2H, OCH-+ OCH₂-THF ring), 3.76 (s, 3H, OCH₃), 3.74 (s, 3H, OCH₃), 3.48-3.38 (m, 1H, OCH₂-THF ring), 3.16-3.08 (m, 1H, CH-THF ring), 2.90-2.80 (m, 2H, CH₂-propargyl chain), 2.08-2.01 (m, 1H, CH₂-THF ring), 1.69-1.61 (m, 1H, CH-^{*i*}Pr), 1.42-1.34 (m, 1H, CH₂-THF ring), 0.94 (d, *J* = 6.6Hz, 3H, CH₃-^{*i*}Pr), 0.85 (d, *J* = 6.6Hz, 3H, CH₃-^{*i*}Pr). **Minor diastereoisomer (trans):** 4.13 (t, *J* = 8.6Hz, 1H, OCH-THF ring), 3.76 (s, 3H, OCH₃), 3.74 (s, 3H, OCH₃), 3.63 (t, *J* = 8.7Hz, 1H, OCH₂-THF ring), 3.48-3.38 (m, 1H, OCH₂-THF ring), 3.06-3.00 (m, 1H, CH-THF ring), 2.90-2.80 (m, 2H, CH₂-propargyl chain), 1.93-1.85 (m, 1H, CH₂-THF ring), 1.84-1.75 (m, 1H, CH₂-THF ring), 1.69-1.61 (m, 1H, CH-^{*i*}Pr), 0.94 (d, *J* = 6.6Hz, 3H, CH₃-^{*i*}Pr), 0.85 (d, *J* = 6.6Hz, 3H, CH₃-^{*i*}Pr).
- ¹³C NMR** (δ, ppm) (CDCl₃, 100 MHz) **Major diastereoisomer (cis):** 170.1 (Cq, C=O), 169.7 (Cq, C=O), 85.0 (OCH-THF ring), 74.8 (Cq, C≡CBr), 69.1 (OCH₂-THF ring), 58.9 (Cq), 52.8 (OCH₃), 52.7 (OCH₃), 42.2 (CH), 41.7 (Cq, C≡CBr), 32.7 (CH), 31.2 (CH₂), 25.4 (CH₂), 19.4 (CH₃-^{*i*}Pr), 18.4 (CH₃-^{*i*}Pr). **Minor diastereoisomer (trans):** 170.0 (Cq, C=O), 169.9 (Cq, C=O), 84.4 (OCH-THF ring), 74.8 (Cq, C≡CBr), 69.1 (OCH₂-THF ring), 58.5 (Cq), 52.8 (OCH₃), 52.7 (OCH₃), 42.0 (CH), 41.9 (Cq, C≡CBr), 32.8 (CH), 31.0 (CH₂), 25.6 (CH₂), 19.0 (CH₃-^{*i*}Pr), 18.4 (CH₃-^{*i*}Pr).
- IR** (ν, cm⁻¹) (CCl₄) 2956 (s), 2873 (s), 2772 (w), 2737 (w), 2696 (w), 2222 (w), 1744 (s), 1469 (s), 1436 (s), 1389 (s), 1366 (s), 1352 (s), 1313 (s), 1279 (s), 1222 (s), 1138 (s), 1118 (s), 1078 (s).

HRMS (EI+, m/z) : Calculated: 374.0729 found: 374.0716.

3-Prop-2-ynyloxy-tetrahydro-furan

5.361

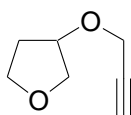

MF: C₇H₁₀O₂

MW = 126 g.mol⁻¹

- Method :** See **general procedure 5.3** using (1 equiv., 5.6 mmol, 500 mg) of tetrahydrofuran-3-ol. Besides what described in the general procedure, it was added (0.2 equiv., 1.13 mmol, 420 mg) of tetrabutyl ammonium iodide.
- Purification :** Flash column chromatography (silica gel, 8:2 PE:AcOEt)/ R_f (8:2 PE:AcOEt): 0.39.
- Product :** Orange oil.
- Isolated yield :** 78%.
- ¹H NMR** (δ, ppm) (CDCl₃, 400 MHz) 4.37-4.33 (m, 1H, OCH-THF ring), 4.15 (d, *J* = 2.4Hz, 2H, CH₂-propargyl chain), 3.98-3.72 (m, 4H, OCH₂-THF ring), 2.42 (t, *J* = 2.4Hz, 1H, ≡CH), 2.03-2.00 (m, 2H, CH₂.THF ring).
- ¹³C NMR** (δ, ppm) (CDCl₃, 100 MHz) 79.7 (Cq, C≡C), 78.7 (OCH), 74.3 (≡CH), 72.6 (OCH₂), 67.0 (OCH₂), 56.3 (OCH₂), 32.4 (CH₂-THF ring).
- IR** (ν, cm⁻¹) (CCl₄) 3312 (s), 2977 (m), 2950 (m), 2858 (m), 1441 (w), 1348 (w), 1269 (w), 1120 (s), 1074 (s), 1010 (w).
- MS** (CI, NH₃, m/z): M+H⁺: 127; M+NH₄⁺: 144.

B.3.4.3 Synthesis of benzyl butynyl ether derivatives

Benzyl butynyl ether derivatives were synthesized as it follows:

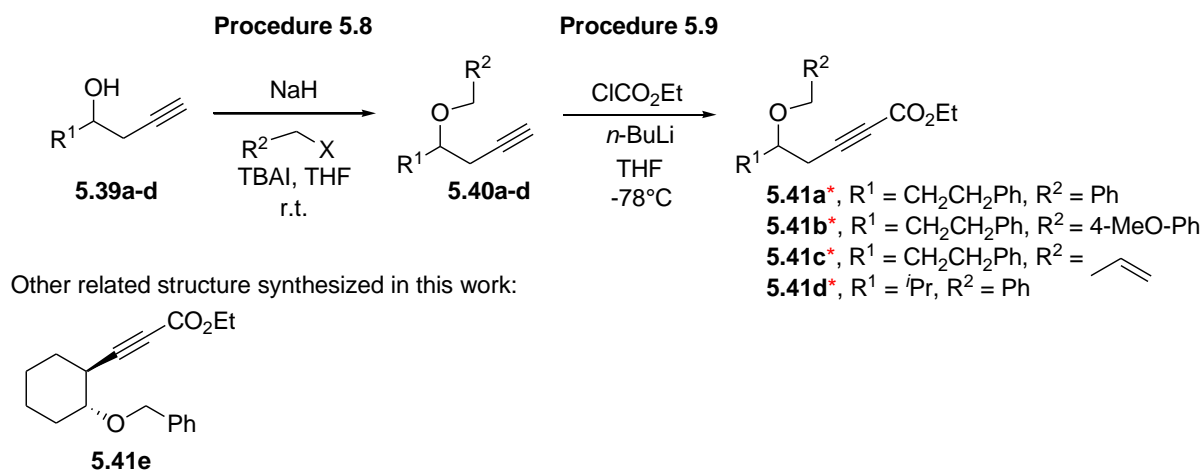

Scheme B.3.4.3: Synthesis of alkynyl ethers with the oxygen atom being part of the 1,5-framework.

General Procedure 5.8, *Benylation of alkynyl alcohols*:

To a round bottom flask, charged with alkynyl alcohol (1 equiv.) and THF (0.125 M) at 0 °C, was slowly added NaH (1.5 equiv.). The reaction mixture was allowed to warm up to room temperature. Benzyl bromide (1.2 equiv.) was then added, followed by the addition of tetrabutyl ammonium iodide (0.1 equiv.). The reaction mixture was then allowed to stir at room temperature overnight. After the complete consumption of the starting alcohol (TLC), the reaction was quenched with a saturated solution of NH₄Cl, extracted with AcOEt (3x); dried (MgSO₄), and concentrated under reduced pressure. Purification by flash column chromatography afforded the desired product.

General procedure 5.9, *Synthesis of ethyl pentynoates derivatives*:

To a round bottom flask, charged with alkynyl ether (1 equiv.) and THF (0.125M) at -78°C was added *n*-BuLi (solution 1.6M in hexanes, 1.5 equiv.) and allowed to stir for 1h at -78°C. The anion was then quenched with ethyl chloroformate (1.5 equiv.). The reaction mixture was allowed to warm up to room temperature, water was added and the reaction mixture

extracted with AcOEt (3x), dried (MgSO₄) and concentrated under reduced pressure. Purification by flash column chromatography afforded the desired compounds.

5-Benzyloxy-7-phenyl-hept-2-ynoic acid ethyl ester

5.41a

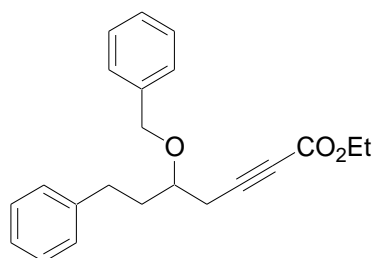

MF: C₂₂H₂₄O₃

MW = 336 g.mol⁻¹

- Method :** See **general procedure 5.8** using (1 equiv., 3 mmol, 522 mg) of 1-phenyl-hex-5-yn-3-ol and (1.2 equiv., 3.6 mmol, 430 μL) of benzyl bromide followed by **general procedure 5.9** using (1 equiv. 1 mmol, 264 mg) of 4-benzyloxy-6-phenyl-hex-1-yne.
- Purification :** Flash column chromatography (silica gel, 95:5 PE:AcOEt)/ **R_f** (8:2 PE:AcOEt): 0.55.
- Product :** Pale yellow oil.
- Isolated yield :** 35% for two steps.
- ¹H NMR** (δ, ppm) (CDCl₃, 400 MHz) 7.39-7.28 (m, 7H, CH-Ph), 7.21-7.16 (m, 3H, CH-Ph), 4.66 (d, *J* = 11.6Hz, 1H, OCH₂), 4.51 (d, *J* = 11.6Hz, 1H, OCH₂), 4.22 (q, *J* = 7.1Hz, 2H, OCH₂CH₃), 3.66-3.60 (m, 1H, OCH), 2.84-2.77 (m, 1H, CH₂), 2.70-2.62 (m, 2H, CH₂), 2.58 (dd, *J* = 6.4Hz, *J* = 17.2Hz, 1H, CH₂), 2.05-1.92 (m, 2H, CH₂), 1.31 (t, *J* = 7.1Hz, 3H, OCH₂CH₃).
- ¹³C NMR** (δ, ppm) (CDCl₃, 100 MHz) 153.5 (Cq, C=O), 141.5 (Cq, Ph), 138.0 (Cq, Ph), 128.5 (CH-Ph), 128.4 (CH-Ph x2), 127.8 (CH-Ph), 127.7 (CH-Ph), 125.9 (CH-Ph), 85.7 (Cq, C≡C), 75.8 (OCH), 74.7 (Cq, C≡C), 71.6 (OCH₂Ph), 61.8 (OCH₂CH₃), 35.9 (CH₂), 31.4 (CH₂), 24.2 (CH₂), 14.0 (OCH₂CH₃).
- IR** (ν, cm⁻¹) (CCl₄) 3088 (w), 3066 (w), 3030 (w), 2984 (w), 2939 (w), 2865 (w), 2238 (m), 1715 (s), 1604 (w), 1496 (w), 1455 (w), 1366 (w), 1350 (w), 1300 (w), 1251 (s), 1072 (s), 1028 (m).
- HRMS** (EI+, m/z) : Calculated: 336.1726 Found: 336.1714.

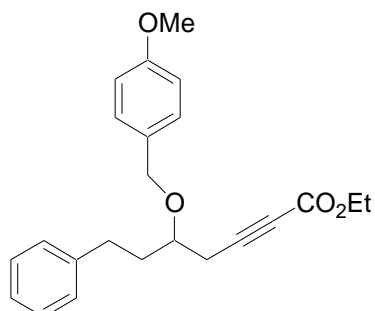
MF: C₂₃H₂₆O₄MW = 366 g.mol⁻¹

- Method :** See **general procedure 5.8** using (1 equiv., 5 mmol, 870 mg) of 1-phenyl-hex-5-yn-3-ol and (1.2 equiv., 6 mmol, 820 μ L) of *p*-methoxybenzyl chloride followed by **general procedure 5.9** using (1 equiv., 1 mmol, 294 mg) of 1-methoxy-4-(1-phenethyl-but-3-ynyloxymethyl)-benzene.
- Purification :** Flash column chromatography (silica gel, 9:1 PE:AcOEt)/ **R_f** (8:2 PE:AcOEt): 0.50.
- Product :** Transparent oil.
- Isolated yield :** 36% for two steps.
- ¹H NMR** (δ , ppm) (CDCl₃, 400 MHz) 7.30-7.26 (m, 4H, CH-Ph + CH-Ar), 7.21-7.15 (m, 3H, CH-Ph), 6.89 (d, *J* = 8.7Hz, 2H, CH-Ar), 4.58 (d, *J* = 11.2Hz, 1H, OCH₂Ph), 4.44 (d, *J* = 11.2Hz, 1H, OCH₂Ph), 4.22 (q, *J* = 7.1Hz, 2H, OCH₂CH₃), 3.81 (s, 3H, OCH₃), 3.64-3.58 (m, 1H, OCH), 2.83-2.76 (m, 1H, CH₂), 2.67-2.60 (m, 2H, CH₂), 2.55 (dd, *J* = 6.4Hz, *J* = 17.2Hz, 1H, CH₂), 1.99-1.93 (m, 2H, CH₂), 1.31 (t, *J* = 7.1Hz, 3H, OCH₂CH₃).
- ¹³C NMR** (δ , ppm) (CDCl₃, 100 MHz) 159.4 (Cq, C=O), 153.6 (Cq, Ar), 141.6 (Cq, Ar), 130.2 (Cq, Ar), 129.5 (CH-Ar), 128.4 (CH-Ar x2), 125.9 (CH-Ar), 113.9 (CH-Ar), 85.8 (Cq, C \equiv C), 75.4 (OCH), 74.7 (Cq, C \equiv C), 71.3 (OCH₂Ph), 61.8 (OCH₂CH₃), 55.3 (OCH₃), 36.0 (CH₂), 31.4 (CH₂), 24.3 (CH₂), 14.0 (OCH₂CH₃).
- IR** (ν , cm⁻¹) (CCl₄) 3066 (w), 3029 (w), 2984 (w), 2936 (m), 2864 (w), 2837 (w), 2238 (w), 1715 (s), 1613 (w), 1587 (w), 1514 (m), 1497 (w), 1464 (w), 1455 (w), 1366 (w), 1349 (w), 1302 (w), 1250 (s), 1172 (w), 1072 (m), 1040 (w).
- HRMS** (EI+, *m/z*) : Calculated: 366.1831 Found: 366.1831.

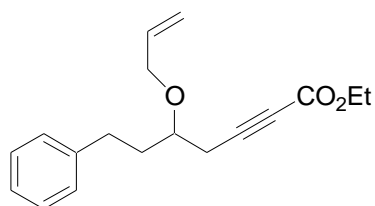
MF: C₁₈H₂₂O₃MW = 286 g.mol⁻¹

- Method :** See **general procedure 5.8** using (1 equiv., 2.6 mmol, 455 mg) of 1-phenyl-hex-5-yn-3-ol and (1.2 equiv., 3 mmol, 260 μ L) of allyl bromide followed by **general procedure 5.9** using (1 equiv., 1mmol, 214 mg) of (3-allyloxy-hex-5-ynyl)-benzene.
- Purification :** Flash column chromatography (silica gel, 95:5 PE:AcOEt)/ **R_f** (8:2 PE:AcOEt): 0.66.
- Product :** Transparent oil.
- Isolated yield :** 63% for two steps.
- ¹H NMR** (δ , ppm) (CDCl₃, 400 MHz) 7.31-7.26 (m, 2H, CH-Ph), 7.21-7.17 (m, 3H, CH-Ph), 5.93 (tdd, $J = 5.7\text{Hz}$, $J = 10.4\text{Hz}$, $J = 17.2\text{Hz}$, 1H, CH=CH₂), 5.30 (ddd, $J = 1.4\text{Hz}$, $J = 3.0\text{Hz}$, $J = 17.2\text{Hz}$, 1H, CH=CH₂), 5.19 (ddd, $J = 1.4\text{Hz}$, $J = 3.0\text{Hz}$, $J = 10.4\text{Hz}$, 1H, CH=CH₂), 4.22 (q, $J = 7.2\text{Hz}$, 2H, OCH₂CH₃), 4.12 (tdd, $J = 1.4\text{Hz}$, $J = 5.7\text{Hz}$, $J = 12.6\text{Hz}$, 1H, OCH₂), 3.98 (tdd, $J = 1.4\text{Hz}$, $J = 5.7\text{Hz}$, $J = 12.6\text{Hz}$, 1H, OCH₂), 3.55 (quin, $J = 6.2\text{Hz}$, 1H, OCH), 2.83-2.76 (m, 1H, CH₂), 2.71-2.62 (m, 1H, CH₂), 2.61 (dd, $J = 6.2\text{Hz}$, $J = 17.2\text{Hz}$, 1H, CH₂), 2.53 (dd, $J = 6.2\text{Hz}$, $J = 17.2\text{Hz}$, 1H, CH₂), 1.95 (dt, $J = 6.2\text{Hz}$, $J = 8.0\text{Hz}$, 2H, CH₂), 1.30 (t, $J = 7.2\text{Hz}$, 3H, OCH₂CH₃).
- ¹³C NMR** (δ , ppm) (CDCl₃, 100 MHz) 153.6 (Cq, C=O), 141.6 (Cq, Ph), 134.7 (CH), 128.4 (CH x2), 125.9 (CH), 117.2 (CH=CH₂), 85.7 (Cq, C \equiv C), 75.9 (OCH), 74.7 (Cq, C \equiv C), 70.7 (OCH₂Ph), 61.8 (OCH₂CH₃), 36.0 (CH₂), 31.4 (CH₂), 24.3 (CH₂), 14.0 (OCH₂CH₃).
- IR** (ν , cm⁻¹) (CCl₄) 3086 (w), 3066 (w), 3029 (w), 2985 (w), 2938 (w), 2862 (w), 2239 (m), 1715 (s), 1604 (w), 1496 (w), 1455 (w), 1424 (w), 1367 (w), 1342 (w), 1251 (s), 1172 (w), 1135 (w), 1073 (s), 1030 (w).
- HRMS** (EI+, m/z) : Calculated: 286.1569 Found: 286.1575.

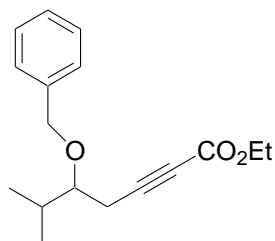
MF: C₁₇H₂₂O₃MW = 274 g.mol⁻¹

Method :	See general procedure 5.8 using (1 equiv., 3.6 mmol, 400 mg) of 2-methylhex-5-yn-3-ol followed and (1.2 equiv., 4.30 mmol, 510 μL) of benzyl bromide followed by general procedure 5.9 using (1 equiv, 1 mmol, 202 mg) of (1-isopropyl-but-3-ynylloxymethyl)-benzene.
Purification :	Flash column chromatography (silica gel, 95:5 PE:AcOEt)/ R_f (8:2 PE:AcOEt): 0.66.
Product :	Transparent oil.
Isolated yield :	36 % for two steps.
¹H NMR (δ, ppm) (CDCl ₃ , 400 MHz)	7.39-7.27 (m, 5H, CH-Ph), 4.69 (d, <i>J</i> = 11.5Hz, 1H, OCH ₂ Ph), 4.53 (d, <i>J</i> = 11.5Hz, 1H, OCH ₂ Ph), 4.22 (q, <i>J</i> = 7.1Hz, 2H, OCH ₂ CH ₃), 3.40 (q, <i>J</i> = 5.8Hz, 1H, OCH), 2.57 (d, <i>J</i> = 6.0Hz, 2H, CH ₂ CHO), 1.98 (hept, <i>J</i> = 6.2Hz, 1H, CH- ^{<i>i</i>} Pr), 1.31 (t, <i>J</i> = 7.1Hz, 3H, OCH ₂ CH ₃), 0.96 (d, <i>J</i> = 6.2Hz, 3H, CH ₃ - ^{<i>i</i>} Pr), 0.95 (d, <i>J</i> = 6.2Hz, 3H, CH ₃ - ^{<i>i</i>} Pr).
¹³C NMR (δ, ppm) (CDCl ₃ , 100 MHz)	153.7 (Cq, C=O), 138.3 (Cq, Ar), 128.3 (CH-Ph), 127.8 (CH-Ph), 127.6 (CH-Ph), 86.8 (Cq, C≡C), 81.7 (OCH), 74.3 (Cq, C≡C), 72.5 (OCH ₂ Ph), 61.8 (OCH ₂ CH ₃), 31.7 (CH- ^{<i>i</i>} Pr), 21.7 (CH ₂), 18.6 (CH ₃ - ^{<i>i</i>} Pr), 17.5 (CH ₃ - ^{<i>i</i>} Pr), 14.0 (OCH ₂ CH ₃).
IR (ν, cm ⁻¹) (CCl ₄)	3091 (w), 3067 (w), 3033 (w), 2964 (m), 2938 (m), 2908 (m), 2875 (m), 2236 (m), 1747 (m), 1713 (s), 1497 (w), 1466 (m), 1455 (m), 1423 (w), 1387 (m), 1366 (m), 1300 (m), 1250 (s), 1205 (w), 1175 (w), 1073 (s), 1028 (m), 1013 (m).
HRMS (EI+, <i>m/z</i>) :	Calculated: 274.1569 found: 274.1579.

B.3.4.4 Au(I)-Catalyzed transformations

The previously prepared compounds were submitted to gold catalysis as depicted in the scheme below.

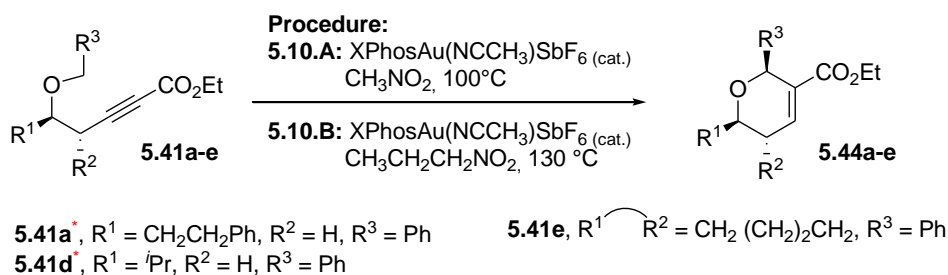
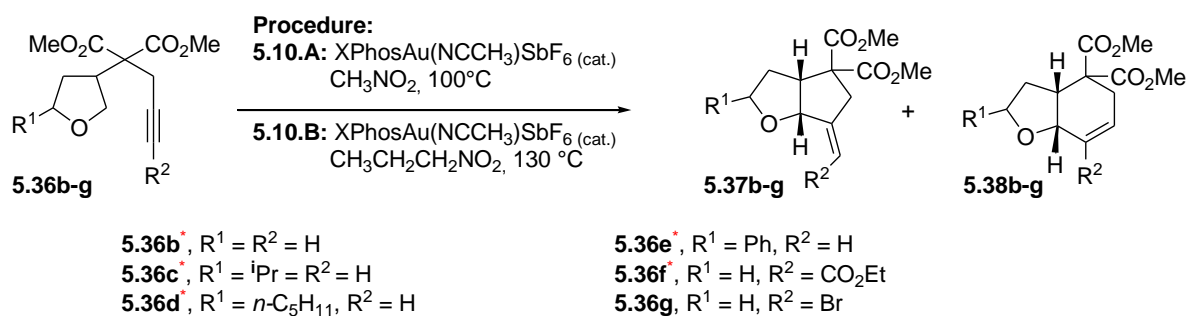
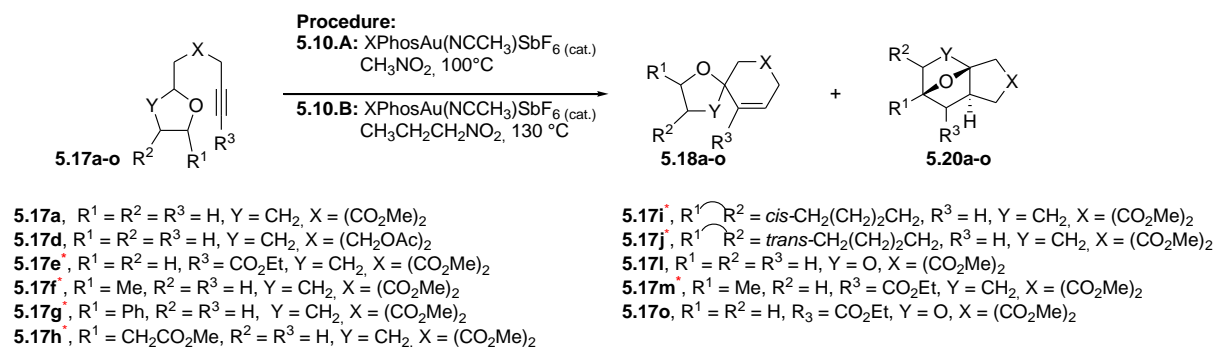

Scheme B.3.4.4: Gold(I) catalysis of alkynes **5.17a-o**, **5.36b-g** and **5.41a-e**.

Procedure 5.10.A: To a solution of alkyne (0.1 mmol, 1 equiv.) in dry nitromethane (500 μ L) was added XphosAu(NCCH₃)SbF₆ (3.8 mg, 0.04 equiv.) The reaction mixture was heated up to reflux (100 °C) being periodically monitored (TLC). Upon completion, the mixture was evaporated and purified by flash column chromatography.

Procedure 5.10.B: To a solution of alkyne (0.1 mmol, 1 equiv.) in dry nitropropane (250 μ L) was added XphosAu(NCCH₃)SbF₆ (3.8 mg, 0.04 equiv.) The reaction mixture was heated to reflux (130 °C) being periodically monitored (TLC). Upon completion, the mixture was evaporated and purified by flash column chromatography.

1-Oxa-spiro[4.5]dec-6-ene-6,9,9-tricarboxylic acid 6-ethyl ester 9,9-dimethyl ester 5.18e

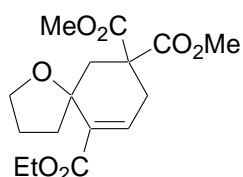

MF: C₁₆H₂₂O₇

MW = 326 g.mol⁻¹

Method :	See general procedure 5.10.A using (1 equiv., 0.1 mmol, 33 mg) of 5-methoxycarbonyl-5-(tetrahydro-furan-2-ylmethyl)-hex-2-ynedioic acid 1-ethyl ester 6-methyl ester.
Purification :	Flash column chromatography (silica gel, 8:2 PE:AcOEt) / R _f (7:3 PE AcOEt): 0.43.
Product :	Transparent oil.
Isolated yield :	91%.
¹H NMR (δ , ppm) (CDCl ₃ , 400 MHz)	7.09 (dd, $J = 2.9\text{Hz}$, $J = 5.1\text{Hz}$, 1H, CH=); 4.20-4.10 (m, 2H, OCH ₂ CH ₃); 3.98 (dt, $J = 5.4\text{Hz}$, $J = 7.7\text{Hz}$, 1H, OCH ₂ -THFring); 3.74-3.67 (m, 1H, OCH ₂ -THFring); 3.73 (s, 3H, OCH ₃); 3.69 (s, 3H, OCH ₃); 3.03 (ddd, $J = 1.3\text{Hz}$, $J = 5.1\text{Hz}$, $J = 19.1\text{Hz}$, 1H, CH ₂ CH=); 2.61 (dd, $J = 1.3\text{Hz}$, $J = 14.2\text{Hz}$, 1H, CH ₂); 2.47 (ddd, $J = 6.2\text{Hz}$, $J = 9.5\text{Hz}$, $J = 12.4\text{Hz}$, 1H, CH ₂ -THFring); 2.35 (dd, $J = 2.9\text{Hz}$, $J = 19.1\text{Hz}$, 1H, CH ₂ CH=); 2.23-2.12 (m, 1H, CH ₂ -THFring); 2.02 (d, $J = 14.2\text{Hz}$, 1H, CH ₂); 2.01-1.93 (m, 1H, CH ₂ -THFring); 1.64 (ddd, $J = 6.2\text{Hz}$, $J = 8.5\text{Hz}$, $J = 12.4\text{Hz}$, 1H, CH ₂ -THFring); 1.28 (t, $J = 7.2\text{Hz}$, 3H, OCH ₂ CH ₃).
¹³C NMR (δ , ppm) (CDCl ₃ , 100 MHz)	171.7 (Cq, C=O); 170.6 (Cq, C=O); 165.3 (Cq, C=O); 139.6 (C=CH); 132.6 (Cq, C=CH); 78.4 (Cq, C-O-THF ring); 67.8 (OCH ₂ -THF ring); 60.2 (OCH ₂ CH ₃); 52.7 (OCH ₃); 52.3 (OCH ₃); 51.2 (Cq); 40.6 (CH ₂); 35.9 (CH ₂); 31.2 (CH ₂); 26.8 (CH ₂); 14.1 (OCH ₂ CH ₃).
IR (ν , cm ⁻¹) (CCl ₄)	2981 (s), 2953 (s), 2905 (m), 2885 (m), 2843 (m), 1740 (s), 1645 (w), 1478 (w), 1457 (m), 1437 (s), 1414 (m), 1378 (m), 1357 (m), 1324 (m), 1296 (s), 1254 (s), 1205 (s), 1184 (s), 1171 (s), 1114 (s), 1097 (s), 1074 (s), 1053 (s).
HRMS (EI+, m/z) :	Calculated: 326.1366 Found: 326.1368.

2-Methyl-1-oxa-spiro[4.5]dec-9-ene-7,7-dicarboxylic acid dimethyl ester	5.18f	+
7-Methyl-10-oxa-tricyclo[5.2.1.0^{1,5}]decane-3,3-dicarboxylic acid dimethyl ester	5.20f	

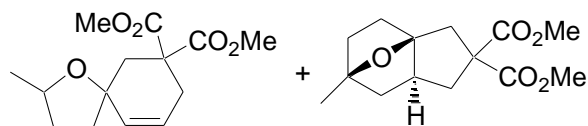

MF: C₁₄H₂₀O₅

MW = 268 g.mol⁻¹

Method : See **general procedure 5.10 A** using (1 equiv., 0.1 mmol, 27 mg) of 2-(5-methyl-tetrahydro-furan-2-ylmethyl)-2-prop-2-ynyl-malonic acid dimethyl ester.

Purification : Flash column chromatography (silica gel, 9:1 PE:AcOEt)/ R_f (7:3 PE:AcOEt): 0.51.

Product : Transparent oil.

Isolated yield : 82% (inseparable mixture, ratio isomers 5.1: 1).

¹H NMR (δ, ppm) (CDCl₃, 400 MHz) **Major diastereoisomer:** 5.81 (ddd, *J* = 2.7Hz, *J* = 4.7Hz, *J* = 9.9Hz, 1H, CH=), 5.58 (tdd, *J* = 1.5Hz, *J* = 2.7Hz, *J* = 9.9Hz, 1H, CH=), 4.00-3.92 (m, 1H, OCH-THFring), 3.71 (s, 3H, OCH₃), 3.69 (s, 3H, OCH₃), 2.86 (tdd, *J* = 1.5Hz, *J* = 4.7Hz, *J* = 17.8Hz, 1H, CH₂CH=), 2.61 (d, *J* = 13.9Hz, 1H, CH₂), 2.16 (td, *J* = 2.7Hz, *J* = 17.8Hz, 1H, CH₂CH=), 2.10-2.03 (m, 1H, CH₂), 1.99 (d, *J* = 13.9Hz, 1H, CH₂), 1.88-1.75 (m, 2H, CH₂), 1.56-1.47 (m, 1H, CH₂), 1.18 (d, *J* = 6.1Hz, 3H, CH₃).

Minor diastereoisomer: 5.81 (ddd, *J* = 2.8Hz, *J* = 4.6Hz, *J* = 9.9 Hz, 1H, CH=), 5.62 (tdd, *J* = 1.0Hz, *J* = 1.8Hz, *J* = 9.9, 1H, CH=), 4.16-4.08 (m, 1H, OCH-THFring), 3.72 (s, 3H, OCH₃), 3.69 (s, 3H, OCH₃), 2.80 (tdd, *J* = 1.5Hz, *J* = 4.6Hz, *J* = 17.8Hz, 1H, CH₂CH=), 2.52 (td, *J* = 1.0Hz, *J* = 13.8Hz, 1H, CH₂), 2.18 (td, *J* = 2.8Hz, *J* = 17.8Hz, 1H, CH₂CH=), 2.16 (d, *J* = 13.8Hz, 1H, CH₂), 2.08-2.01 (m, 1H, CH₂), 1.89-1.79 (m, 2H, CH₂), 1.67-1.60 (m, 1H, CH₂), 1.18 (d, *J* = 6.1Hz, 3H, CH₃).

Formal [3+2] product: 3.71 (s, 6H, OCH₃ x2), 2.66 (d, *J* = 15.0Hz, 1H, CH₂), 2.53 (d, *J* = 15.0Hz, 1H, CH₂), 2.35 (dd, *J* = 12.4Hz, *J* = 7.7Hz, 1H, CH₂), 2.21-2.13 (m, 1H, CH₂), 2.10-2.01 (m, 3H, CH+CH₂), 1.90 -1.75 (m, 3H, CH₂), 1.57-1.46 (m, 1H, CH₂), 1.17 (d, *J* = 6.1Hz, 3H, CH₃).

¹³C NMR (δ, ppm) (CDCl₃, 100 MHz) **Major diastereoisomer:** 172.4 (Cq, C=O), 171.2 (Cq, C=O), 131.3 (CH=), 126.1 (CH=), 78.0 (Cq, C-O THFring), 73.9 (CHO-THFring), 52.6 (OCH₃), 52.3 (OCH₃), 51.8 (Cq), 38.5 (CH₂), 38.4 (CH₂), 33.5 (CH₂), 30.4 (CH₂), 21.4 (CH₃). **Minor diastereoisomer:** 172.3 (Cq, C=O), 171.3 (Cq, C=O), 131.1 (CH=), 125.7 (CH=), 78.1 (Cq, C-O THFring), 75.6 (CHO-THFring), 52.6 (OCH₃), 52.4 (OCH₃), 51.8 (Cq), 40.9 (CH₂), 38.9 (CH₂), 33.5 (CH₂), 30.5 (CH₂), 21.9 (CH₃). **Formal [3+2] product:** 173.0 (Cq, C=O), 171.7 (Cq, C=O), 94.3 (Cq, C-O), 85.4 (Cq, C-O), 62.4 (Cq), 52.7 (OCH₃), 52.6 (OCH₃), 48.3 (CH), 45.9 (CH₂).

41.0 (CH₂), 37.6 (CH₂), 36.4 (CH₂), 32.9 (CH₂), 21.2 (CH₃).

IR (ν, cm⁻¹) (CCl₄) 3031 (m), 2970 (s), 2952 (s), 2870 (m), 2842 (w), 1740 (s), 1436 (s), 1395 (w), 1381 (w), 1353 (w), 1301 (m), 1250 (s), 1211 (s), 1198 (s), 1174 (s), 1148 (m), 1097 (s), 1048 (m), 1008 (w).

HRMS (EI+, m/z) : Calculated: 268.1311 Found: 268.1298.

2-Phenyl-1-oxa-spiro[4.5]dec-9-ene-7,7-dicarboxylic acid dimethyl ester and 7-Phenyl-10-oxa-tricyclo[5.2.1.0^{1,5}]decane-3,3-dicarboxylic acid dimethyl ester	5.18g	+	5.20g
---	--------------	----------	--------------

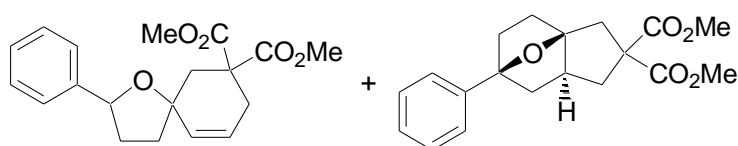

MF: C₁₉H₂₂O₅

MW = 330 g.mol⁻¹

Method : See **general procedure 5.10.A** using (1 equiv., 0.1 mmol, 33 mg) of 2-(5-phenyl-tetrahydro-furan-2-ylmethyl)-2-prop-2-ynyl-malonic acid dimethyl ester.

Purification : Flash column chromatography (silica gel, 8:2 PE:AcOEt) / R_f (8:2 PE: AcOEt): 0.29.

Product : Transparent oil.

Isolated yield : 76% (inseparable mixture, ratio isomers 2.3:1).

¹H NMR (δ, ppm) (CDCl₃, 400 MHz) **Major diastereoisomer:** 7.37-7.19 (m, 5H, CH-Ph), 5.86 (ddd, *J* = 2.6Hz, *J* = 4.8Hz, *J* = 10.0Hz, 1H, CH=), 5.70 (d, *J* = 10.0Hz, 1H, CH=), 4.90 (dd, *J* = 6.8Hz, *J* = 7.6Hz, 1H, OCH-THFring), 3.73 (s, 3H, OCH₃), 3.55 (s, 3H, OCH₃), 2.91 (dd, *J* = 4.8Hz, *J* = 17.9Hz, 1H, CH₂CH=), 2.74 (d, *J* = 14.0Hz, 1H, CH₂), 2.44-2.35 (m, 1H, CH₂-THF ring), 2.21 (td, *J* = 2.6Hz, *J* = 17.9Hz, 1H, CH₂CH=), 2.13 (d, *J* = 14.0Hz, 1H, CH₂), 1.97-1.92 (m, 2H, CH₂-THFring), 1.90-1.81 (m, 1H, CH₂-THFring).

Minor diastereoisomer: 7.35-7.19 (m, 5H, CH-Ph), 5.86 (ddd, *J* = 2.8Hz, *J* = 4.6Hz, *J* = 10.0Hz, 1H, CH=), 5.76 (d, *J* = 10.0Hz, 1H, CH=), 5.02 (t, *J* = 6.8Hz, 1H, OCH-THFring), 3.73 (s, 3H, OCH₃), 3.49 (s, 3H, OCH₃), 2.81 (dd, *J* = 4.6Hz, *J* = 17.7Hz, 1H, CH₂CH=), 2.76 (d, *J* = 14.0Hz, 1H, CH₂), 2.40-2.33 (m, 1H, CH₂-THFring), 2.34 (d, *J* = 14.0Hz, 1H, CH₂), 2.26 (td, *J* = 2.8Hz, *J* = 17.7Hz, 1H, CH₂CH=), 2.04-1.92 (m, 3H, CH₂-THFring).

Formal [3+2] product: 7.37-7.19 (m, 5H, CH-Ph), 3.76 (s, 3H, OCH₃), 3.74 (s, 3H, OCH₃), 2.83 (d, *J* = 14.9Hz, 1H, CH₂), 2.62 (d, *J* = 14.9Hz, 1H, CH₂), 2.44-2.35 (m, 2H, CH+CH₂), 2.32-2.25 (m, 2H, CH₂), 1.97-1.92 (m, 2H, CH₂), 1.90-

1.81 (m, 2H, CH₂), 1.71 (m, 1H, CH₂).

¹³C NMR (δ, ppm) (CDCl₃, 100 MHz) **Major diastereoisomer:** 172.3 (Cq, C=O), 171.0 (Cq, C=O), 143.0 (Cq, Ph), 130.7 (CH), 128.1 (CH), 127.0 (CH), 126.2 (CH), 125.6 (CH), 79.5 (OCH-THFring), 78.5 (Cq, C-O THFring), 52.6 (OCH₃), 52.4 (OCH₃), 52.0 (Cq), 38.8 (CH₂), 38.5 (CH₂), 34.9 (CH₂), 30.5 (CH₂).
Minor diastereoisomer: 172.2 (Cq, C=O), 171.1 (Cq, C=O), 142.9 (Cq, Ph), 130.6 (CH-Ph), 128.0 (CH=), 127.2 (CH-Ph), 126.1 (CH=), 125.7 (CH-Ph), 81.2 (OCH-THFring), 78.9 (Cq, C-O-THFring), 52.6 (OCH₃), 52.5 (OCH₃), 52.0 (Cq), 40.3 (CH₂), 38.4(CH₂), 34.6 (CH₂), 30.5 (CH₂).
Formal 3+2 product: 172.9 (Cq, C=O), 171.7 (Cq, C=O), 142.5 (Cq, Ph), 128.1 (CH-Ph), 126.9 (CH-Ph), 125.0 (CH-Ph), 94.5 (Cq), 88.7 (Cq), 62.5 (Cq), 52.8 (OCH₃), 52.6 (OCH₃), 48.1 (CH), 47.6 (CH₂), 41.0 (CH₂), 37.8 (CH₂), 36.8 (CH₂), 32.4 (CH₂).

IR (ν, cm⁻¹) (CCl₄) 3066 (w), 3031 (w), 2952 (m), 2871 (w), 1740 (s), 1494 (w), 1448 (m), 1435 (w), 1299 (w), 1252 (m), 1217 (w), 1198 (w), 1180 (w), 1095 (w), 1050 (w), 1027 (w).

HRMS (EI+, m/z) : Calculated: 330.1467 Found: 330.1463.

2-Methoxycarbonylmethyl-1-oxa-spiro[4.5]dec-9-ene-7,7-dicarboxylic acid dimethyl ester and 7-Methoxycarbonylmethyl-10-oxatricyclo[5.2.1.0^{1,5}]decane-3,3-dicarboxylic acid dimethyl ester	5.18h + 5.20h
--	----------------------

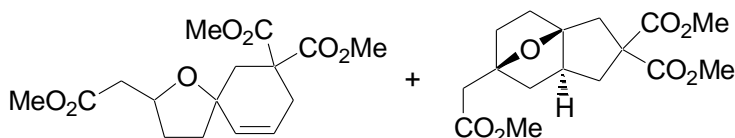

MF: C₁₆H₂₂O₇

MW = 326 g.mol⁻¹

Method : See **general procedure 5.10.A** using (1 equiv., 0.1 mmol, 33 mg) of 2-(5-methoxycarbonylmethyl-tetrahydro-furan-2-ylmethyl)-2-prop-2-ynyl-malonic acid dimethyl ester

Purification : Flash column chromatography (silica gel, 7:3 PE:AcOEt)/ **R_f** (7:3 PE:AcOEt): 0.30.

Product : Transparent oil.

Isolated yield : 82% (inseparable mixture, ratio isomers 1.5: 1).

¹H NMR (δ, ppm) (CDCl₃, 400 MHz) **Major diastereoisomer:** 5.82 (ddd, *J* = 2.5Hz, *J* = 4.7Hz, *J* = 9.9Hz, 1H, CH=), 5.54 (d, *J* = 9.9Hz, 1H, CH=), 4.30-4.23 (m, 1H, OCH-THFring), 3.71 (s, 3H, OCH₃), 3.69 (s, 3H, OCH₃), 3.66 (s, 3H, OCH₃), 2.85 (dd, *J* = 4.7Hz, *J* = 17.9Hz, 1H, CH₂CH=), 2.60 (d, *J* = 14.5Hz, 1H, CH₂), 2.58 (d, *J* = 15.4Hz, 1H, CH₂), 2.41 (dd, *J* = 7.2Hz, *J* = 15.4Hz, 1H, CH₂), 2.23-2.13 (m, 1H, CH₂-THFring), 2.16 (dt, *J* = 2.5Hz, *J* = 17.9Hz, 1H, CH₂CH=), 2.03 (d, *J* = 14.5Hz,

1H, CH₂), 1.83 (t, *J* = 7.2Hz, 2H, CH₂-THFring), 1.71-1.62 (m, 1H, CH₂-THFring).

Minor diastereoisomer: 5.81 (ddd, *J* = 3.0Hz, *J* = 4.4Hz, *J* = 10.0Hz, 1H, CH=), 5.62 (d, *J* = 10.0Hz, 1H, CH=), 4.41-4.34 (m, 1H, OCH-THFring), 3.72 (s, 3H, OCH₃), 3.68 (s, 3H, OCH₃), 3.66 (s, 3H, OCH₃), 2.76 (dd, *J* = 4.4Hz, *J* = 17.8Hz, 1H, CH₂CH=), 2.62 (dd, *J* = 6.1Hz, *J* = 15.3Hz, 1H, CH₂), 2.49 (d, *J* = 14.1Hz, 1H, CH₂), 2.41 (dd, *J* = 7.4Hz, *J* = 15.3Hz, 1H, CH₂), 2.24-2.17 (m, 3H, CH₂-THF ring + CH₂+CH₂CH=), 1.88-1.82 (m, 2H, CH₂-THF ring), 1.80-1.69 (m, 1H, CH₂-THF ring).

Formal [3+2] product: 3.70 (s, 3H, OCH₃), 3.67 (s, 3H, OCH₃), 3.65 (s, 3H, OCH₃), 2.63-2.55 (m, 1H, CH₂), 2.43-2.32 (m, 1H, CH₂), 2.23-2.12 (m, 5H, CH+CH₂), 1.86-1.63 (m, 6H, CH₂).

¹³C NMR (δ, ppm)
(CDCl₃, 100 MHz)

Major diastereoisomer: 172.3 (Cq, C=O), 171.5 (Cq, C=O), 171.1 (Cq, C=O), 130.7 (CH=), 126.5 (CH=), 78.5 (Cq, C-O THF ring), 74.2 (OCH-THF ring), 52.7 (OCH₃), 52.4 (OCH₃), 51.7 (Cq), 51.5 (OCH₃), 40.9 (CH₂), 38.5 (CH₂), 38.1 (CH₂), 31.5 (CH₂), 30.4 (CH₂).

Minor diastereoisomer: 172.2 (Cq, C=O), 171.4 (Cq, C=O), 171.2 (Cq, C=O), 130.4 (CH=), 125.9 (CH=), 78.7 (Cq, C-O THFring), 75.4 (OCH-THF ring), 52.6 (OCH₃), 52.5 (OCH₃), 51.9 (Cq), 51.5 (OCH₃), 41.2 (CH₂), 40.5 (CH₂), 38.1(CH₂), 31.4 (CH₂), 30.4 (CH₂).

Formal [3+2] product: 172.8 (Cq, C=O), 171.4 (Cq, C=O), 170.7 (Cq, C=O), 94.3 (Cq), 84.6 (Cq), 62.3 (Cq), 52.3 (OCH₃), 51.5 (OCH₃), 51.5 (OCH₃), 47.7 (CH), 44.1 (CH₂), 40.7 (CH₂), 37.4 (CH₂), 35.1 (CH₂), 32.3 (CH₂), 29.6 (CH₂).

IR (ν, cm⁻¹) (CCl₄)

3031 (w), 2953 (m), 2843 (w), 1741 (s, C=O), 1436 (m), 1382 (w), 1328 (w), 1302 (w), 1251 (s), 1200 (s), 1175 (s), 1146 (w), 1097 (m), 1052 (m).

HRMS (EI+, m/z) :

Calculated: 326.1366 Found: 326.1357.

Name not found (Beilstein)

5.18i +
5.20i

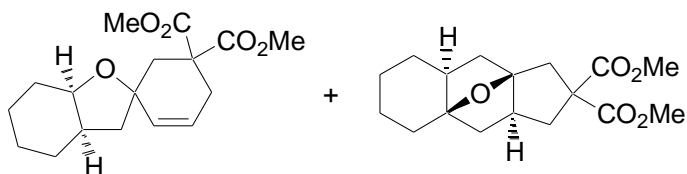

MF: C₁₇H₂₄O₅

MW = 308 g.mol⁻¹

Method :

See **general procedure 5.10.A** using (1 equiv., 0.1 mmol, 31 mg) of 2-(octahydro-benzofuran-2-ylmethyl)-2-prop-2-ynyl-malonic acid dimethyl ester.

Purification :

Flash column chromatography (silica gel, 9:1 PE:AcOEt)/ R_f (8:2 PE:AcOEt): 0.40.

Product :

Transparent oil.

Isolated yield :	74% (inseparable mixture, ratio isomers 2.1: 1).
¹H NMR (δ, ppm) (CDCl ₃ , 400 MHz)	<p>Major diastereoisomer : 5.79 (ddd, $J = 2.6\text{Hz}$, $J = 4.6\text{Hz}$, $J = 9.9\text{Hz}$, 1H, CH=), 5.70 (d, $J = 10.0\text{Hz}$, 1H, CH=), 3.84 (q, $J = 3.7\text{Hz}$, 1H, OCH-THFring), 3.70 (s, 3H, OCH₃), 3.68 (s, 3H, OCH₃), 2.86 (dd, $J = 4.6\text{Hz}$, $J = 17.9\text{Hz}$, 1H, CH₂CH=), 2.63 (d, $J = 14.0\text{Hz}$, 1H, CH₂), 2.14 (td, $J = 2.5\text{Hz}$, $J = 17.9\text{Hz}$, 1H, CH₂CH=), 2.09-2.02 (m, 1H, CH-octahydro-benzofuran ring), 1.97 (d, $J = 14.0\text{Hz}$, 1H, CH₂), 1.92-1.85 (m, 2H, CH₂-octahydro-benzofuran ring), 1.77-1.41 (m, 8H, CH₂-octahydro-benzofuran ring).</p> <p>Minor diastereoisomer: 5.73 (ddd, $J = 2.0\text{Hz}$, $J = 4.0\text{Hz}$, $J = 10.0\text{Hz}$, 1H, CH=), 5.68 (d, $J = 10.0\text{Hz}$, 1H, CH=), 3.95 (dd, $J = 5.2\text{Hz}$, $J = 10.6\text{Hz}$, 1H, OCH-THF ring), 3.72 (s, 3H, OCH₃), 3.70 (s, 3H, OCH₃), 2.78 (td, $J = 4.0\text{Hz}$, $J = 17.7\text{Hz}$, 1H, CH₂CH=), 2.65 (d, $J = 13.8\text{Hz}$, 1H, CH₂), 2.29 (d, $J = 13.8\text{Hz}$, 1H, CH₂), 2.24-2.17 (m, 1H, CH-octahydro-benzofuran ring), 2.17 (td, $J = 2.0\text{Hz}$, $J = 17.7\text{Hz}$, 1H, CH₂CH=), 1.88 (dd, $J = 7.2\text{Hz}$, $J = 12.8\text{Hz}$, 1H, CH₂-octahydro-benzofuran ring), 1.76 (dd, $J = 6.3\text{Hz}$, $J = 12.8\text{Hz}$, 1H, CH₂-octahydro-benzofuran ring), 1.66-1.44 (m, 8H, CH₂-octahydro-benzofuran ring).</p> <p>Formal [3+2] product: 3.71 (s, 3H, OCH₃), 3.70 (s, 3H, OCH₃), 2.64 (d, $J = 15.3\text{Hz}$, 1H, CH₂), 2.55 (d, $J = 15.3\text{Hz}$, 1H, CH₂), 2.32 (q, $J = 4.1\text{Hz}$, 1H, CH), 2.09-2.02 (m, 2H, CH+CH₂), 1.77-1.41 (m, 4H, CH₂), 1.38-1.28 (m, 5H, CH₂), 1.20-1.03 (m, 4H, CH₂).</p>
¹³C NMR (δ, ppm) (CDCl ₃ , 100 MHz)	<p>Major diastereoisomer: 172.4 (Cq, C=O), 171.3 (Cq, C=O), 132.3 (CH=), 125.6 (CH=), 76.5 (Cq, C-O THF ring), 75.4 (OCH-THF ring), 52.5 (OCH₃), 52.3 (OCH₃), 51.9 (Cq), 45.2 (CH₂), 39.3 (CH₂), 38.9 (CH), 30.1 (CH₂), 28.5 (CH₂), 28.2 (CH₂), 24.2 (CH₂), 20.5 (CH₂).</p> <p>Minor diastereoisomer: 172.3 (Cq, C=O), 171.4 (Cq, C=O), 131.7 (CH=), 124.0 (CH=), 77.2 (Cq, C-O THF ring), 76.9 (OCH-THF ring), 52.6 (OCH₃), 52.3 (OCH₃), 52.1 (Cq), 43.5 (CH₂), 41.8 (CH₂), 37.9 (CH), 30.2 (CH₂), 29.2 (CH₂), 27.8 (CH₂), 23.1 (CH₂), 21.7 (CH₂).</p> <p>Formal [3+2] product : 173.2 (Cq, C=O), 171.8 (Cq, C=O), 94.6 (Cq, C-O), 85.7 (Cq, C-O), 62.4 (Cq), 52.8 (OCH₃), 52.6 (OCH₃), 48.2 (CH), 45.4 (CH₂), 41.8 (CH), 41.4 (CH₂), 41.0 (CH₂), 37.6 (CH₂), 33.5 (CH₂), 31.3 (CH₂), 24.9 (CH₂), 23.0 (CH₂).</p>
IR (ν, cm ⁻¹) (CCl ₄)	3031 (w), 2935 (m), 2855 (m), 1740 (s), 1435 (m), 1395 (w), 1380 (w), 1364 (w), 1322 (w), 1300 (w), 1249 (s), 1201 (m), 1178 (m), 1156 (w), 1144 (w), 1097 (w), 1081 (w), 1047 (w), 1017 (w).
HRMS (EI+, m/z) :	Calculated: 308.1624 Found: 308.1620.

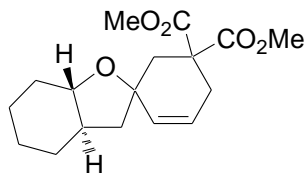
MF: C₁₇H₂₄O₅MW = 308 g.mol⁻¹

- Method :** See **general procedure 5.10.A** using (1 equiv. 0.1 mmol, 31 mg) of 2-(octahydro-benzofuran-2-ylmethyl)-2-prop-2-ynyl-malonic acid dimethyl ester.
- Purification :** Flash column chromatography (silica gel, 9:1 PE:AcOEt)/ R_f (8:2 PE: AcOEt): 0.34.
- Product :** Transparent oil.
- Isolated yield :** 50% (only two diastereoisomers, ratio 2:1).
- ¹H NMR** (δ, ppm) (CDCl₃, 400 MHz) **Major diastereoisomer:** 5.76 (ddd, *J* = 2.5Hz, *J* = 4.8Hz, *J* = 10.0Hz, 1H, CH=), 5.59 (d, *J* = 10.0Hz, 1H, CH=), 3.78-3.07 (m, 1H, OCH-THFring), 3.71 (s, 3H, OCH₃), 3.68 (s, 3H, OCH₃), 3.04 (td, *J* = 3.4Hz, *J* = 10.0Hz, 1H, CH), 2.88 (dd, *J* = 4.8Hz, *J* = 17.8Hz, 1H, CH₂CH=), 2.60 (d, *J* = 14.0Hz, 1H, CH₂), 2.17 (dt, *J* = 2.5Hz, *J* = 17.8Hz, CH₂CH=), 2.14 (d, *J* = 14.0Hz, 1H, CH₂) 1.93-1.02 (m, 10H, CH₂-octahydro-benzofuran ring).
- Minor diastereoisomer:** 5.82 (ddd, *J* = 3.2Hz, *J* = 4.0Hz, *J* = 9.8Hz, 1H, CH=), 5.66 (d, *J* = 9.8Hz, 1H, CH=), 3.78-3.07 (m, 1H, CHO-THFring), 3.71 (s, 3H, OCH₃), 3.67 (s, 3H, OCH₃), 3.18 (td, *J* = 3.8Hz, *J* = 10.0Hz, 1H, CH), 2.77 (dd, *J* = 4.4Hz, *J* = 17.8Hz, 1H, CH₂CH=), 2.53 (d, *J* = 13.8Hz, 1H, CH₂), 2.24 (dt, *J* = 2.6Hz, *J* = 17.8Hz, CH₂CH=), 2.15 (d, *J* = 13.8Hz, 1H, CH₂), 1.93-1.02 (m, 10H, CH₂-octahydro-benzofuran ring).
- ¹³C NMR** (δ, ppm) (CDCl₃, 100 MHz) **Major diastereoisomer:** 172.4 (Cq, C=O), 171.3 (Cq, C=O), 131.2 (CH=), 124.9 (CH=), 81.8 (OCH-THF ring), 76.6 (Cq, C-O-THF ring), 52.6 (OCH₃), 52.3 (OCH₃), 52.0 (Cq), 45.5 (CH), 44.4 (CH₂), 40.0 (CH₂), 31.3 (CH₂), 30.3 (CH₂), 29.1 (CH₂), 25.7 (CH₂), 24.3 (CH₂).
- Minor diastereoisomer:** 172.2 (Cq, C=O), 171.3 (Cq, C=O), 131.9 (CH=), 125.8 (CH=), 83.3 (OCH-THF ring), 72.2 (Cq, C-O-THF ring), 52.5 (OCH₃), 52.3 (OCH₃), 51.9 (Cq), 45.3 (CH), 44.5 (CH₂), 41.2 (CH₂), 31.9 (CH₂), 30.4 (CH₂), 29.0 (CH₂), 25.8 (CH₂), 24.3 (CH₂).
- IR** (ν, cm⁻¹) (CCl₄) 3030 (w), 2935 (m), 2858 (w), 1741 (s), 1436 (m), 1384 (w), 1351 (w), 1325 (w), 1299 (w), 1247 (m), 1202 (w), 1181 (w), 1141 (w), 1110 (w), 1081 (w), 1060 (w).
- HRMS** (EI+, m/z) : Calculated: 308.1624 Found: 308.1629.

2-Methyl-1-oxa-spiro[4.5]dec-6-ene-6,9,9-tricarboxylic acid 6-ethyl ester 9,9-dimethyl ester 5.18m

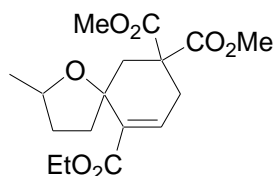

MF: C₁₇H₂₄O₇

MW = 340 g.mol⁻¹

- Method :** See **general procedure 5.10.A** using (1 equiv., 0.1 mmol, 34 mg) of 5-methoxycarbonyl-5-(5-methyl-tetrahydro-furan-2-ylmethyl)-hex-2-ynedioic acid 1-ethyl ester 6-methyl ester.
- Purification :** Flash column chromatography (silica gel, 8:2 PE:AcOEt)/ **R_f** (7:3PE:AcOEt): 0.39.
- Product :** Transparent oil.
- Isolated yield :** 78%.
- ¹H NMR** (δ, ppm) (CDCl₃, 400 MHz) **Major diastereoisomer:** 7.10 (dd, *J* = 3.2Hz, *J* = 4.9Hz, 1H, CH=), 4.47-4.39 (m, 1H, OCH-THF ring), 4.27-4.14 (m, 2H, OCH₂CH₃), 3.77 (s, 3H, OCH₃), 3.74 (s, 3H, OCH₃), 2.99 (ddd, *J* = 1.3Hz, *J* = 4.9Hz, *J* = 19.0Hz, 1H, CH₂CH=), 2.78-2.66 (m, 1H, CH₂-THF ring), 2.61 (dd, *J* = 1.3Hz, *J* = 14.0Hz, 1H, CH₂), 2.43 (dd, *J* = 3.1Hz, *J* = 19.0Hz, 1H, CH₂CH=), 2.21 (d, *J* = 14.0Hz, 1H, CH₂), 2.20-2.14 (m, 1H, CH₂-THFring), 1.77-1.65 (m, 2H, CH₂-THF ring), 1.33 (t, *J* = 7.1Hz, 3H, OCH₂CH₃), 1.24 (d, *J* = 6.1Hz, 3H, CH₃).
- Minor diastereoisomer:** 7.13-7.09 (m, 1H, CH=), 4.27-4.14 (m, 2H, OCH₂CH₃), 4.02-3.95 (m, 1H, OCH-THF ring), 3.77 (s, 3H, OCH₃), 3.74 (s, 3H, OCH₃), 3.16 (ddd, *J* = 1.7Hz, *J* = 5.3Hz, *J* = 19.1Hz, 1H, CH₂CH=), 2.76 (d, *J* = 14.1Hz, 1H, CH₂), 2.33 (dd, *J* = 2.7Hz, *J* = 19.2Hz, 1H, CH₂CH=), 2.06-2.02 (m, 1H, CH₂-THFring), 2.01 (d, *J* = 14.1Hz, 1H, CH₂), 1.93-1.85 (m, 1H, CH₂-THF ring), 1.77-1.65 (m, 2H, CH₂-THF ring), 1.33 (t, *J* = 7.1Hz, 3H, OCH₂CH₃), 1.27 (d, *J* = 6.0Hz, 3H, CH₃).
- ¹³C NMR** (δ, ppm) (CDCl₃, 100 MHz) **Major diastereoisomer:** 171.8 (Cq, C=O), 170.7 (Cq, C=O), 165.5 (Cq, C=O), 139.0 (C=C_H), 133.3 (Cq, C=CH), 78.8 (Cq, C-O-THFring), 77.1 (OCH-THFring), 60.2 (OCH₂CH₃), 52.6 (OCH₃), 52.5 (OCH₃), 51.1 (Cq), 43.1 (CH₂), 36.5 (CH₂), 34.4 (CH₂), 31.3 (CH₂), 21.8 (CH₃), 14.1 (OCH₂CH₃).
- Minor diastereoisomer:** 171.9 (Cq, C=O), 170.5 (Cq, C=O), 165.3 (Cq, C=O), 139.6 (C=C_H), 132.8 (Cq, C=CH), 78.2 (Cq, C-O-THFring), 74.4 (OCH-THFring), 67.6 (OCH₂CH₃), 52.7 (OCH₃), 52.3 (OCH₃), 51.1 (Cq), 45.9 (CH₂), 40.5 (CH₂), 37.4(CH₂), 34.6 (CH₂), 20.3 (CH₃), 14.1 (OCH₂CH₃).
- IR** (ν, cm⁻¹) (CCl₄) 2971 (s), 2954 (s), 2931 (s), 2905 (m), 2870 (m), 2842 (w), 1740 (s), 1644 (w), 1477 (w), 1458 (s), 1436 (s), 1414 (m), 1375 (m), 1357 (m), 1324 (m), 1299 (s),

1258 (s), 1211 (s), 1174 (s), 1140 (m), 1096 (s), 1070 (s), 1038 (s), 1009 (m).

HRMS (EI+, m/z) : Calculated: 340.1522 Found: 340.1515.

4-Methylene-hexahydro-cyclopenta[<i>b</i>]furan-6,6-dicarboxylic acid dimethyl ester and 2,3,3a,7a-Tetrahydro-6<i>H</i>-benzofuran-7,7-dicarboxylic acid dimethyl ester	5.37b + 5.38b
--	----------------------

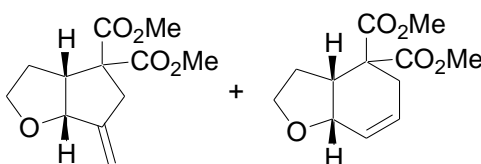

MF: C₁₂H₁₆O₅

MW = 240 g.mol⁻¹

Method : See **general procedure 5.10.A** using (1 equiv., 0.1 mmol, 24 mg) of 2-prop-2-ynyl-2-(tetrahydro-furan-3-yl)-malonic acid dimethyl ester

Purification : Flash column chromatography (silica gel, 8:2 PE: AcOEt)/ R_f. (7:3 PE:AcOEt): 0.39.

Product : Transparent oil.

Isolated yield : 95 % (ratio 6:1).

¹H NMR (δ, ppm) (CDCl₃, 400 MHz) **5-exo product:** 5.19 (d, *J* = 2.6Hz, 1H, C=CH₂), 5.11 (s, 1H, C=CH₂), 4.71 (d, *J* = 7.2Hz, 1H, OCH-THF ring), 3.91 (td, *J* = 8.0Hz, *J* = 3.3Hz, 1H, OCH₂-THF ring), 3.74 (s, 3H, OCH₃), 3.71 (s, 3H, OCH₃), 3.65 (td, *J* = 8.0Hz, *J* = 5.8Hz, 1H, OCH₂-THF ring), 3.45 (dd, *J* = 16.5Hz, *J* = 8.5Hz, 1H, CH), 3.20 (dq, *J* = 16.2Hz, *J* = 1.0Hz, 1H, CH₂), 2.64 (d, *J* = 16.2Hz, 1H, CH₂), 2.03-1.95 (m, 1H, CH₂-THF ring), 1.57-1.48 (m, 1H, CH₂-THF ring).

6-endo product: 5.69 (ddd, *J* = 10.3Hz, *J* = 5.3Hz, *J* = 2.3Hz, 1H, =CH), 5.58 (dt, *J* = 10.3Hz, *J* = 3.2Hz, 1H, =CH), 4.78-4.76 (m, 1H, OCH-THF ring), 3.90-3.72 (m, 2H, OCH₂-THF ring), 3.74 (s, 3H, OCH₃), 3.72 (s, 3H, OCH₃), 3.12 (dd, *J* = 17.5Hz, *J* = 8.8Hz, 1H, CH), 2.696-2.59 (m, 2H, CH₂), 1.89-1.87 (m, 1H, CH₂), 1.80-1.68 (m, 1H, CH₂).

¹³C NMR (δ, ppm) (CDCl₃, 100 MHz) **5-exo product:** 171.8 (Cq, C=O), 170.0 (Cq, C=O), 147.0 (Cq, C=CH₂), 113.1 (C=CH₂), 84.6 (OCH-THF ring), 68.5 (OCH₂-THF ring), 61.9 (Cq), 52.9 (OCH₃), 52.8 (OCH₃), 48.0 (CH), 38.0 (CH₂), 29.8 (CH₂). **6-endo-product:** 171.3 (Cq, C=O), 170.8 (Cq, C=O), 127.9 (CH=), 125.9 (CH=), 74.4 (OCH-THF ring), 65.8 (OCH₂-THF ring), 56.2 (Cq), 52.6 (OCH₃), 52.3 (OCH₃), 40.4 (CH), 26.8 (CH₂), 25.9 (CH₂).

IR (ν , cm^{-1}) (CCl_4) 2981 (w), 2953 (m), 2855 (w), 1736 (s), 1435 (s), 1242 (m), 1160 (s), 1063 (s).

HRMS (EI^+ , m/z): Calculated: 240.0998 Found: 240.0994.

2-Isopropyl-6-methylene-hexahydro-cyclopenta[*b*]furan-4,4-dicarboxylic acid dimethyl ester 5.37c

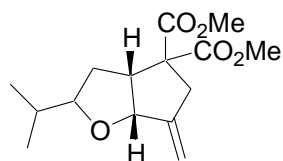

MF: $\text{C}_{15}\text{H}_{22}\text{O}_5$

MW = 282 $\text{g}\cdot\text{mol}^{-1}$

Method : See **general procedure 5.10.A** using (1 equiv., 0.1 mmol, 28 mg) of 2-(5-isopropyl-tetrahydro-furan-3-yl)-2-prop-2-ynyl-malonic acid dimethyl ester.

Purification : Flash column chromatography (silica gel, 8:2 PE:AcOEt)/ R_f : (8:2 PE: AcOEt): 0.58.

Product : Transparent oil.

Isolated yield : 93% (inseparable mixture, ratio diastereoisomers 1:5).

$^1\text{H NMR}$ (δ , ppm) (CDCl₃, 400 MHz) **Major diastereoisomer** 5.17 (s, 1H, C=CH₂), 5.07 (s, 1H, C=CH₂), 4.65 (d, J = 7.3Hz, 1H, OCH-THF ring), 3.73 (s, 3H, OCH₃), 3.69 (s, 3H, OCH₃), 3.50-3.44 (m, 2H, OCH-THF ring + CH), 3.20 (d, J = 15.8Hz, 1H, CH₂), 2.58 (d, J = 15.8Hz, 1H, CH₂), 1.95-1.89 (m, 1H, CH₂-THF ring), 1.73-1.66 (m, 1H, CH-^{*i*}Pr), 1.15 (q, J = 11.2Hz, 1H, CH₂-THF ring), 0.95 (d, J = 6.7Hz, 3H, CH₃-^{*i*}Pr), 0.84 (d, J = 6.7Hz, 3H, CH₃-^{*i*}Pr). **Minor diastereoisomer:** 5.17 (s, 1H, C=CH₂), 5.09 (s, 1H, C=CH₂), 4.83 (d, J = 6.9Hz, 1H, OCH-THF ring), 3.73 (s, 3H, OCH₃), 3.69 (s, 3H, OCH₃), 3.50-3.44 (m, 2H, OCH-THF ring+ CH), 3.18 (d, J = 16.0Hz, 1H, CH₂), 2.66 (d, J = 16.0Hz, 1H, CH₂), 1.81-1.75 (m, 1H, CH₂-THF ring), 1.73-1.66 (m, 1H, CH-^{*i*}Pr), 1.54-1.48 (m, 1H, CH₂-THF ring), 0.92 (d, J = 6.7Hz, 3H, CH₃-^{*i*}Pr), 0.82 (d, J = 6.7Hz, 3H, CH₃-^{*i*}Pr).

$^{13}\text{C NMR}$ (δ , ppm) (CDCl₃, 100 MHz) **Major diastereoisomer:** 171.7 (Cq, C=O), 170.0 (Cq, C=O), 146.8 (Cq, C=CH₂), 113.0 (C=CH₂), 86.0 (OCH-THF ring), 84.0 (OCH-THF ring), 61.7 (Cq), 52.8 (OCH₃), 52.5 (OCH₃), 48.1 (CH), 37.3 (CH₂), 33.0 (CH₂), 32.4 (CH-^{*i*}Pr), 19.6 (CH₃-^{*i*}Pr), 18.4 (CH₃-^{*i*}Pr). **Minor diastereoisomer:** 171.8 (Cq, C=O), 170.2 (Cq, C=O), 147.8 (Cq, C=CH₂), 112.5 (C=CH₂), 84.7 (OCH-THF ring), 84.3 (OCH-THF ring), 62.1 (Cq), 52.7 (OCH₃), 52.5 (OCH₃), 47.5 (CH), 38.7 (CH₂), 32.3 (CH-^{*i*}Pr), 31.7 (CH₂), 19.1 (CH₃-^{*i*}Pr), 18.2 (CH₃-^{*i*}Pr).

IR (ν , cm^{-1}) (CCl_4) 3082 (w), 3030 (w), 2956 (s), 2909 (s), 2873 (s), 2843 (s), 1744 (s), 1673 (w), 1469 (s), 1435 (s), 1450 (s), 1406 (w), 1389 (m), 1366 (m), 1331 (w), 1271 (s), 1238 (s), 1193 (s), 1161(s), 1113 (s), 1079 (s), 1032 (s).

HRMS (EI+, m/z) : Calculated: 282.1467 Found: 282.1462.

6-Methylene-2-pentyl-hexahydro-cyclopenta[*b*]furan-4,4-dicarboxylic acid dimethyl ester 5.37d

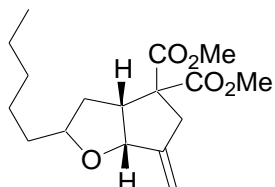

MF: C₁₇H₂₆O₅

MW = 310 g.mol⁻¹

Method : See **general procedure 5.10.A** using (1 equiv., 0.1 mmol, 31 mg) of 2-(5-pentyl-tetrahydro-furan-3-yl)-2-prop-2-ynyl-malonic acid dimethyl ester.

Purification : Flash column chromatography (silica gel, 9:1 PE:AcOEt)/ **R_f** (8:2 PE:AcOEt): 0.53.

Product : Transparent oil.

Isolated yield : 88% (inseparable mixture, ratio diastereoisomers 1:5).

¹H NMR (δ, ppm) (CDCl₃, 400 MHz) **Major diastereoisomer:** 5.17 (s, 1H, C=CH₂), 5.07 (s, 1H, C=CH₂), 4.63 (d, *J* = 7.3Hz, 1H, OCH-THF ring), 3.76-3.66 (m, 1H, OCH-THF ring), 3.73 (s, 3H, OCH₃), 3.69 (s, 3H, OCH₃), 3.51-3.45 (m, 1H, CH-THF ring), 3.21 (d, *J* = 15.7Hz, 1H, CH₂), 2.58 (d, *J* = 15.7Hz, 1H, CH₂), 2.01-1.95 (m, 1H, CH₂-THF ring), 1.71-1.20 (m, 8H, CH₂-pentyl chain), 1.09 (q, *J* = 11.2, 1H, CH₂-THF ring), 0.86 (t, *J* = 6.8Hz, 3H, CH₃-pentyl chain). **Minor diastereoisomer:** 5.17 (s, 1H, C=CH₂), 5.09 (s, 1H, C=CH₂), 4.82 (d, *J* = 6.8Hz, 1H, OCH-THF ring), 3.76-3.66 (m, 1H, OCH-THF ring), 3.73 (s, 3H, OCH₃), 3.70 (s, 3H, OCH₃), 3.51-3.45 (m, 1H, CH), 3.17 (d, *J* = 16.0Hz, 1H, CH₂), 2.65 (d, *J* = 16.0Hz, 1H, CH₂), 1.71-1.20 (m, 8H, CH₂-pentyl chain), 1.68-1.57 (m, 1H, CH₂-THF ring), 1.14-1.05 (q, *J* = 11.2, 1H, CH₂-THF ring). 0.88 (m, 3H, CH₃-pentyl chain).

¹³C NMR (δ, ppm) (CDCl₃, 100 MHz) **Major diastereoisomer:** 171.7 (Cq, C=O), 170.0 (Cq, C=O), 146.7 (Cq, C=CH₂), 113.1 (C=CH₂), 84.1 (OCH-THF ring), 80.7 (OCH-THF ring), 61.8 (Cq), 52.8 (OCH₃), 52.5 (OCH₃), 48.3 (CH), 37.4 (CH₂), 35.7 (CH₂), 34.6 (CH₂), 31.9 (CH₂), 25.9 (CH₂), 22.5 (CH₂), 13.9 (CH₃). **Minor diastereoisomer:** 171.8 (Cq, C=O), 170.1 (Cq, C=O), 147.7 (Cq, C=CH₂), 112.6 (C=CH₂), 84.1 (OCH-THF ring), 79.5 (OCH-THF ring), 62.1 (Cq), 52.8 (OCH₃), 52.4 (OCH₃), 47.4 (CH), 38.7 (CH₂), 34.9 (CH₂), 34.4 (CH₂), 31.8 (CH₂), 25.7 (CH₂), 22.5 (CH₂), 13.9 (CH₃).

IR (ν, cm⁻¹) (CCl₄) 3082 (w), 3029 (w), 2955 (s), 2932 (s), 2860 (s), 1736 (s), 1673 (w), 1455 (s), 1435 (s), 1379 (w), 1339 (w), 1273 (s), 1238 (s), 1194 (s), 1160 (s), 1092 (s), 1078 (s), 1031 (s).

HRMS (EI+, m/z) : Calculated: 310.1780 Found: 310.1767.

6-Methylene-2-phenyl-hexahydro-cyclopenta[*b*]furan-4,4-dicarboxylic acid dimethyl ester 5.37e

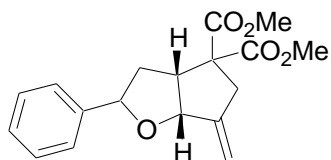

MF: C₁₈H₂₀O₅

MW = 316 g.mol⁻¹

Method : See **general procedure 5.10.A** using (1 equiv., 0.1 mmol, 32 mg) of 2-(5-phenyl-tetrahydro-furan-3-yl)-2-prop-2-ynyl-malonic acid dimethyl ester.

Purification : Flash column chromatography (silica gel, 85:15 PE:AcOEt)/ **R_f** (8:2 PE:AcOEt): 0.56.

Product : Transparent oil.

Isolated yield : 29% (inseparable mixture, ratio diastereoisomers 1:3).

¹H NMR (δ, ppm) **Only major diastereoisomer described:** 7.34-7.28 (m, 5H, CH-Ph), 5.27 (s, 1H, C=CH₂), 5.16 (s, 1H, C=CH₂), 4.85 (d, *J* = 7.5Hz, 1H, OCH-THF ring), 4.82 (dd, *J* = 4.6Hz, *J* = 11.1Hz, 1H, OCH-THF ring), 3.73 (s, 3H, OCH₃), 3.70 (s, 3H, OCH₃), 3.69-3.63 (m, 1H, CH), 3.35 (d, *J* = 16.0Hz, 1H, CH₂), 2.69 (d, *J* = 16.0Hz, 1H, CH₂), 2.30 (ddd, *J* = 4.5Hz, *J* = 8.5Hz, *J* = 11.9Hz, 1H, CH₂-THF ring), 1.49 (q, *J* = 11.9Hz, 1H, CH₂-THF ring).

¹³C NMR δ, ppm) **Only major diastereoisomer described:** 171.7 (Cq, C=O), 169.9 (Cq, C=O), 146.5 (Cq), 140.3 (Cq), 128.4 (CH-Ph), 127.8 (CH-Ph), 126.0 (CH-Ph), 113.6 (C=CH₂), 84.6 (OCH-THF ring), 82.2 (OCH-THF ring), 61.8 (Cq), 52.9 (OCH₃), 52.6 (OCH₃), 48.8 (CH), 38.8 (CH₂), 37.4 (CH₂).

IR (ν, cm⁻¹) (CCl₄) 3067 (w), 3032 (w), 2954 (w), 2929 (w), 2855 (w), 1789 (w), 1739 (s), 1459 (w), 1450 (w), 1435 (m), 1367 (s), 1273 (s), 1237 (s), 1218 (m), 1193 (w), 1159 (m), 1092 (w), 1057 (w), 1029 (w).

HRMS (EI+, m/z) : Calculated: 316.1311 Found: 316.1308.

4-[1-Ethoxycarbonyl-meth-(Z)-ylidene]-hexahydro-cyclopenta[<i>b</i>]furan-6,6-dicarboxylic acid dimethyl ester and 2,3,3a,7a-Tetrahydro-6 <i>H</i> -benzofuran-4,7,7-tricarboxylic acid 4-ethyl ester 7,7-dimethyl ester	5.37f	+
	5.38f	

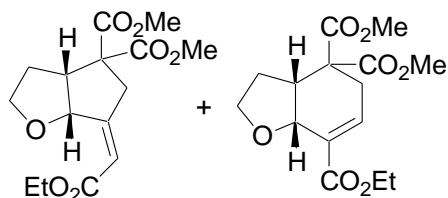

MF: C₁₅H₂₀O₇

MW = 312 g.mol⁻¹

Method : See **general procedure 5.10.A** using (1 equiv., 0.11 mmol, 34 mg) of 5-methoxycarbonyl-5-(tetrahydro-furan-3-yl)-hex-2-ynedioic acid 1-ethyl ester 6-methyl ester.

Purification : Flash column chromatography (silica gel, 6:4 PE:AcOEt)/ R_f (7:3 PE:AcOEt): 0.21.

Product : Transparent oil.

Isolated yield : 81% (inseparable mixture of regioisomers, ratio 1:1).

¹H NMR (δ, ppm) (CDCl₃, 400 MHz) **5-*exo* product:** 5.84 (s, 1H, CH=), 5.50 (d, *J* = 7.5Hz, 1H, OCH-THFring), 4.25-4.13 (m, 2H, OCH₂CH₃), 3.95-3.90 (m, 1H, OCH₂-THF ring), 3.75 (s, 3H, OCH₃), 3.70 (s, 3H, OCH₃), 3.70-3.66 (m, 1H, OCH₂-THFring), 3.49 (q, *J* = 8.4Hz, 1H, CH-THF ring), 3.34 (d, *J* = 17.0Hz, 1H, CH₂), 2.72 (d, *J* = 17.0Hz, 1H, CH₂), 2.07-1.99 (m, 1H, CH₂-THF ring), 1.58-1.49 (m, 1H, CH₂-THF ring), 1.30-1.24 (m, 3H, OCH₂CH₃).

6-*endo* products: 6.85 (dd, *J* = 4.9Hz, *J* = 3.8Hz, 1H, CH=), 5.11 (d, *J* = 7.8Hz, 1H, OCH-THFring), 4.25-4.13 (m, 2H, OCH₂CH₃), 3.83-3.77 (m, 2H, OCH₂-THFring), 3.74 (s, 3H, OCH₃), 3.70 (s, 3H, OCH₃), 3.26 (q, *J* = 9.0Hz, 1H, CH-THF ring), 2.82-2.81 (m, 2H, CH₂), 1.90-1.83 (m, 1H, CH₂-THF ring), 1.74-1.64 (m, 1H, CH₂-THF ring), 1.30-1.24 (m, 3H, OCH₂CH₃).

¹³C NMR (δ, ppm) (CDCl₃, 100 MHz) **5-*exo* and 6-*endo*products:** 171.3 (Cq, C=O), 170.6 (Cq, C=O), 170.2 (Cq, C=O), 169.6 (Cq, C=O), 165.8 (Cq, C=O), 164.9 (Cq, C=O), 157.4 (Cq, C=CH), 135.6 (C=CH), 131.5 (Cq, C=CH), 117.7 (C=CH), 80.7 (OCH-THF ring), 73.2 (OCH-THF ring), 69.0 (OCH₂-THF ring), 66.1 (OCH₂-THF ring), 60.7 (OCH₂CH₃), 60.6 (Cq), 60.2 (OCH₂CH₃), 56.2 (Cq), 53.0 (OCH₃), 52.9 (OCH₃), 52.8 (OCH₃), 52.7 (OCH₃), 48.1 (CH-THF ring), 40.8 (CH-THF ring), 39.4 (CH₂), 30.2 (CH₂), 27.4 (CH₂), 26.7 (CH₂), 14.2 (OCH₂CH₃), 14.1 (OCH₂CH₃).

IR (ν, cm⁻¹) (CCl₄) 2981 (s), 2954 (s), 2905 (m), 2858 (m), 1740 (s), 1676 (m), 1661 (m), 1477 (w), 1436 (s), 1372 (m), 1350 (w), 1254 (s), 1213 (s), 1182 (s), 1161 (s), 1132 (s), 1079 (s), 1065 (s), 1040 (s).

HRMS (EI+, *m/z*) : Calculated: 312.1209 Found: 312.1221.

2-Pentyl-3,3a,5,7a-tetrahydro-2H-benzofuran-4,4,7-tricarboxylic acid 7-ethyl ester 4,4-dimethyl ester 5.37g +
 and 6-[1-Ethoxycarbonyl-methylidene]-2-pentyl-hexahydro-cyclopenta[b]furan-4,4-dicarboxylic acid dimethyl ester 5.38g

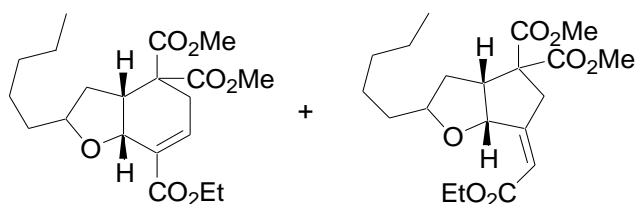

MF: C₂₀H₃₀O₇

MW = 382 g.mol⁻¹

Method : See **general procedure 5.10.A** using (1 equiv., 0.1 mmol, 38 mg) of 5-methoxycarbonyl-5-(5-pentyl-tetrahydro-furan-3-yl)-hex-2-ynedioic acid 1-ethyl ester 6-methyl ester

Purification : Flash column chromatography (silica gel, 8:2 PE:AcOEt)/ R_f (8:2 PE:AcOEt): 0.36.

Product : Transparent oil.

Isolated yield : 90 % (inseparable mixture, ratio isomers major 6-*endo*: minor 6-*endo*: major 5-*exo*: minor 5-*exo*: 0.5: 0.3:1: 0.15).

¹H NMR (δ, ppm) (CDCl₃, 400 MHz) **Major 6-*endo*:** 6.75 (dd, *J* = 1.8Hz, *J* = 5.0Hz, 1H, C=CH), 5.05 (d, *J* = 8.0Hz, 1H, OCH-THF ring), 4.24-4.13 (m, 2H, OCH₂CH₃), 3.83-3.77 (m, 1H, OCH-THF ring), 3.75 (s, 3H, OCH₃), 3.70 (s, 3H, OCH₃), 3.36-3.27 (m, 1H, CH-THF ring), 2.81 (d, *J* = 1.8Hz, 2H, CH₂), 1.84 (ddd, *J* = 5.0Hz, *J* = 7.0Hz, *J* = 11.9Hz, 1H, CH₂-THF ring), 1.62-1.53 (m, 1H, CH₂-THF ring), 1.46-1.20 (m, 11H, CH₂-pentyl chain + OCH₂CH₃), 0.87-0.83 (m, 3H, CH₃-pentyl chain).

Minor 6-*endo*: 6.87 (dd, *J* = 3.7Hz, *J* = 4.8Hz, 1H, C=CH), 5.17 (d, *J* = 7.4Hz, 1H, OCH-THF ring), 4.24-4.13 (m, 2H, OCH₂CH₃), 3.83-3.77 (m, 1H, OCH-THF ring), 3.75 (s, 3H, OCH₃), 3.70 (s, 3H, OCH₃), 3.36-3.27 (m, 1H, CH-THF ring), 2.81 (d, *J* = 1.8Hz, 2H, CH₂), 1.76-1.53 (m, 2H, CH₂-THF), 1.46-1.20 (m, 11H, CH₂-pentyl chain + OCH₂CH₃), 0.87-0.83 (m, 3H, CH₃-pentyl chain).

Major 5-*exo*: 5.81 (s, 1H, C=CH), 5.44 (d, *J* = 7.8Hz, 1H, OCH-THF ring), 4.24-4.13 (m, 2H, OCH₂CH₃), 3.99-3.89 (m, 1H, OCH-THF ring), 3.75 (s, 3H, OCH₃), 3.70 (s, 3H, OCH₃), 3.50 (dd, *J* = 7.8Hz, *J* = 18.1Hz, 1H, CH-THF ring), 3.36 (d, *J* = 16.7Hz, 1H, CH₂), 2.67 (d, *J* = 16.7Hz, 1H, CH₂), 2.04 (ddd, *J* = 4.0Hz, *J* = 8.6Hz, *J* = 12.3Hz, 1H, CH₂-THF ring), 1.46-1.20 (m, 11H, CH₂-pentyl chain + OCH₂CH₃), 1.09 (dd, *J* = 10.8Hz, *J* = 18.1Hz, 1H, CH₂-THF ring), 0.87-0.83 (m, 3H, CH₃-pentyl chain).

Minor 5-*exo*: neglected, many pics are not distinguishable in the mixture

¹³C NMR (δ, ppm) (CDCl₃, 100 MHz) **Major/ minor 6-endo and major 5-exo diastereoisomers:** 171.3 (Cq, C=O), 170.6 (Cq, C=O), 170.5 (Cq, C=O), 170.3 (Cq, C=O), 170.2 (Cq, C=O), 169.7 (Cq, C=O), 166.0 (Cq, C=O), 164.9 (Cq, C=O), 157.9 (Cq), 157.1 (Cq, C=O), 136.2 (CH), 133.9 (CH), 132.7 (Cq), 131.7 (Cq), 117.7 (CH), 80.8 (OCH), 80.0 (OCH), 78.5 (OCH), 76.7 (OCH), 73.5 (OCH), 72.7 (OCH), 60.5 (OCH₂CH₃), 60.4 (OCH₂CH₃), 60.1 (OCH₂CH₃), 56.4 (Cq), 56.3 (Cq), 56.1 (Cq), 53.0 (OCH₃ x2), 52.9 (OCH₃ x2), 52.7 (OCH₃ x2), 48.4 (CH), 41.4 (CH), 40.2 (CH₂), 40.0 (CH), 38.8 (CH₂), 36.0 (CH₂), 35.5 (CH₂), 34.7 (CH₂), 34.4 (CH₂), 33.4 (CH₂), 32.3 (CH₂), 31.9 (CH₂), 31.8 (CH₂), 31.7 (CH₂), 26.7 (CH₂), 26.4 (CH₂), 25.7 (CH₂), 25.6 (CH₂), 25.5 (CH₂), 22.6 (CH₂), 22.5 (CH₂), 14.1 (CH₃ x2), 14.0 (CH₃ x2), 13.9 (CH₃ x2).

IR (ν, cm⁻¹) (CCl₄) 2955 (s), 2932 (s), 2861 (s), 1736 (s), 1677 (m), 1661 (m), 1456 (s), 1436 (s), 1372 (s), 1355 (m), 1330 (m), 1254 (s), 1213 (s), 1160 (s), 1133 (s), 1079 (s), 1039 (s).

HRMS (EI+, m/z) : Calculated: 382.1992 found: 382.1996.

6-Phenethyl-2-phenyl-5,6-dihydro-2H-pyran-3-carboxylic acid ethyl ester

5.44a

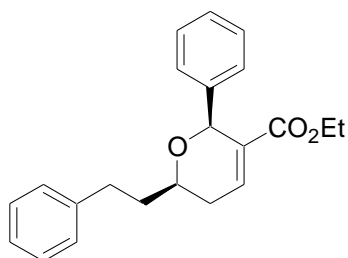

MF: C₂₂H₂₄O₃

MW = 336 g.mol⁻¹

Method : See **general procedure 5.10.A** using (1 equiv., 0.1 mmol, 34 mg) of 5-benzyloxy-7-phenyl-hept-2-ynoic acid ethyl ester.

Purification : Flash column chromatography (silica gel, 95:5 PE:AcOEt)/ R_f (9:1 PE:AcOEt): 0.39.

Product : Transparent oil.

Isolated yield : 65% (ratio of diastereoisomers 16:1 in favor of the drawn molecule).

¹H NMR (δ, ppm) (CDCl₃, 400 MHz) 7.37-7.18 (m, 10H, CH-Ph), 7.12 (d, J = 6.1Hz, 1H, CH=), 5.39 (s, 1H, OCH), 4.05-3.96 (m, 1H, OCH₂CH₃), 3.95-3.87 (m, 1H, OCH₂CH₃), 3.60-3.54 (m, 1H, OCH), 2.83-2.69 (m, 2H, CH₂), 2.36-2.20 (m, 2H, CH₂), 2.02-1.93 (m, 1H, CH₂), 1.86-1.78 (m, 1H, CH₂), 1.00 (t, J = 7.1Hz, 3H, OCH₂CH₃).

¹³C NMR (δ, ppm) 165.6 (Cq, C=O), 141.7 (Cq), 140.6 (Cq), 137.2 (CH=), 133.8 (Cq), 128.4 (CH-Ph), 128.3 (CH-Ph), 128.2 (CH-Ph), 128.2 (CH-Ph), 127.9 (CH-Ph), 125.7 (CH-Ph), 78.0 (OCH), 72.3 (OCH), 60.0 (OCH₂CH₃), 36.8 (CH₂), 31.5 (CH₂), 31.4 (CH₂), 13.8 (OCH₂CH₃).

(CDCl₃, 100 MHz)

IR (ν , cm⁻¹) (CCl₄) 3088 (m), 3066 (m), 3031 (s), 2982 (s), 2930 (s), 2859 (s), 1721 (s), 1653 (m), 1617 (m), 1604 (m), 1496 (m), 1477 (w), 1455 (s), 1432 (w), 1420 (w), 1370 (s), 1353 (s), 1337 (s), 1322 (m), 1290 (s), 1254 (s), 1172 (m), 1161 (m), 1137 (m), 1103 (s), 1066 (s), 1045 (s).

HRMS (EI+, m/z) : Calculated: 336.1726 Found: 336.1734.

6-Isopropyl-2-phenyl-5,6-dihydro-2H-pyran-3-carboxylic acid ethyl ester

5.44d

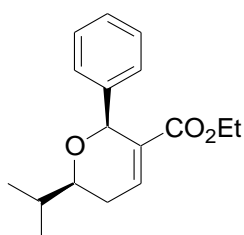

MF: C₁₇H₂₂O₃

MW = 274 g.mol⁻¹

Method : See **general procedure 5.10.A** using (1 equiv., 0.1 mmol, 27 mg) of 5-benzyloxy-6-methyl-hept-2-ynoic acid ethyl ester.

Purification : Flash column chromatography (silica gel, 9:1 PE:AcOEt)/ R_f (8:2 PE:AcOEt): 0.54.

Product : Transparent oil.

Isolated yield : 74 % (ratio diastereoisomers > 25:1 in favor of the drawn structure)

¹H NMR (δ , ppm) 7.39-7.30 (m, 5H, CH-Ph), 7.19-7.17 (m, 1H, C=CH), 5.44 (dd, $J = 3.7$ Hz, $J = 4.7$ Hz, 1H, OCH), 4.05 (qd, $J = 7.1$ Hz, $J = 10.8$ Hz, 1H, OCH₂CH₃), 3.96 (qd, $J = 7.1$ Hz, $J = 10.8$ Hz, 1H, OCH₂CH₃), 3.36 (ddd, $J = 4.0$ Hz, $J = 6.9$ Hz, $J = 9.3$ Hz, 1H, OCH), 2.40-2.26 (m, 2H, CH₂), 1.89-1.77 (m, 1H, CH-^{*i*}Pr), 1.06 (t, $J = 7.1$ Hz, 3H, OCH₂CH₃), 1.02 (d, $J = 6.7$ Hz, 3H, CH₃-^{*i*}Pr), 0.97 (d, $J = 6.8$ Hz, 3H, CH₃-^{*i*}Pr).

¹³C NMR (δ , ppm) 165.7 (Cq, C=O), 140.9 (Cq), 137.5 (C=CH), 133.9 (Cq), 128.2 (CH-Ph), 128.1 (CH-Ph), 127.8 (CH-Ph), 78.4 (OCH), 78.2 (OCH), 60.1 (OCH₂CH₃), 32.5 (CH-^{*i*}Pr), 28.4 (CH₂), 18.8 (CH₃-^{*i*}Pr), 17.9 (CH₃-^{*i*}Pr), 13.8 (OCH₂CH₃).

IR (ν , cm⁻¹) (CCl₄) 3090 (w), 3067 (w), 3035 (w), 2962 (s), 2932 (s), 2907 (s), 2874 (s), 2847 (s), 1746 (s), 1721 (s), 1655 (s), 1616 (w), 1496 (m), 1470 (s), 1455 (s), 1421 (m), 1388 (s), 1369 (s), 1353 (s), 1322 (s), 1292 (s), 1246 (s), 1206 (m), 1173 (m), 1145 (m), 1129 (s), 1101 (s), 1055 (s), 1030 (s).

HRMS (EI+, m/z) : Calculated: 274.1569 Found: 274.1573.

B.3.5 Chapter 6: Formation of cinnoline derivatives by a gold(I) mediated synthesis of cinnoline derivatives

All molecules synthesized for in this work are described below. This project was developed individually.

B.3.5.1 Synthesis of hydrazine derivatives

Hydrazines derivatives were synthesized as it follows:

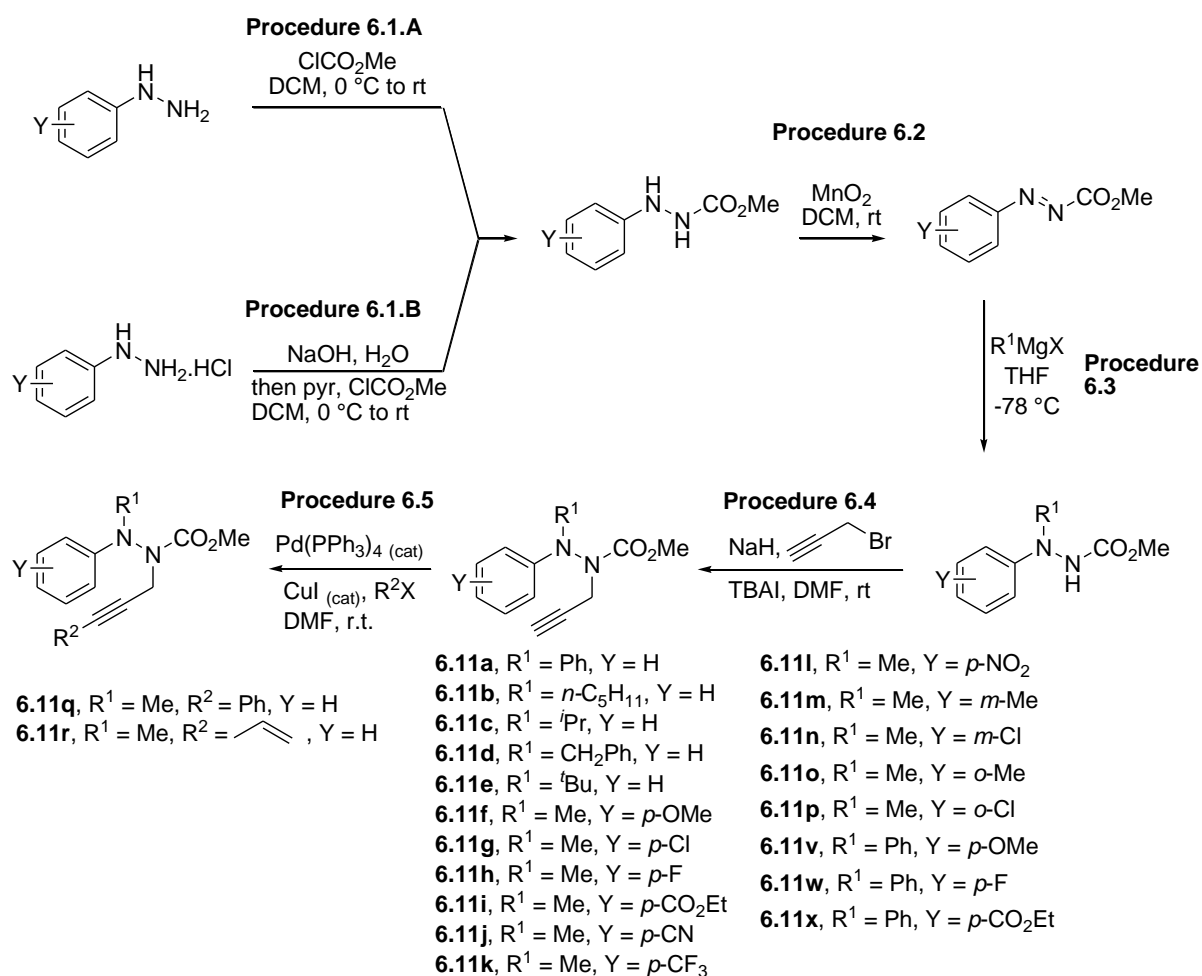

Other structures synthesized in this project:

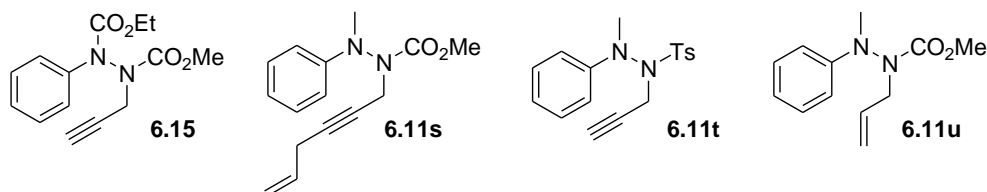

Scheme B.3.5.1: Synthesis of hydrazine derivatives **6.11a-u**.

General Procedure 6.1.A³¹⁰, *Protection of hydrazines in free form*: To a solution of free hydrazine (1 equiv.) and pyridine (1 equiv.) in DCM (0.6 M) in a round bottom flask at 0 °C was slowly added methyl chloroformate (1 equiv.). The reaction was allowed to warm up and to stir at room temperature until complete consumption of the starting hydrazine (TLC, reaction usually takes 30 min.). The solution was then concentrated under reduced pressure (usually left long time to evaporate pyridine) and used in the next step without purification.

General Procedure 6.1.B³¹¹, *Protection of hydrazine.HCl*: To a solution of the salt hydrazine.HCl (1 equiv.) in H₂O (0.6 M) in a round bottom flask at room temperature was added NaOH (1 equiv.). To the resulting mixture was added pyridine (4 equiv.) and the temperature was cooled to 0 °C, followed by the slowly addition of methyl chloroformate (1 equiv.). The reaction was allowed to warm up and to stir at room temperature until the complete consumption of the starting hydrazine (TLC, reaction usually takes 30 min.). The reaction was extracted with AcOEt (3x), dried (MgSO₄) and concentrated under reduced pressure (usually left long time to evaporate pyridine). The protected hydrazine was used in the next step without purification.

General Procedure 6.2³¹², *Oxidation of hydrazides*: To a solution of the hydrazide previously prepared (1 equiv.) in DCM (0.85 M) in a round bottom flask at room temperature was added MnO₂ (5 equiv.). The solution was allowed to stir at room temperature until the complete consumption of the starting hydrazide (TLC, reaction usually takes 30 min.). The solution was then filtered through a short pad of celite and concentrated under reduced pressure. The oxidation products were used in the next step without purification.

³¹⁰ Bausch, M. J.; David, B.; Dobrowolski, P.; Guadalupe-Fasano C.; Gostowski, R.; Selmarten, D.; Prasad, V.; Vaughn, A.; Wang L. H.; *J. Org. Chem.*, **1991**, 19, 5643.

³¹¹ Chaco, M. C.; Rabjohn, N.; *J. Org. Chem.*, **1962**, 27, 2765.

³¹² Kisseljova, K.; Tšubrik, O.; Sillard, R.; Mäeorg, S.; Mäeorg, U.; *Org Lett.*, **2006**, 8, 1, 43.

General Procedure 6.3³¹³, *1,4-Addition of Grignard reagents*: To a solution of the oxidized hydrazide previously prepared (1 equiv.) in THF (0.25 M) in a round bottom flask under an argon atmosphere at -78 °C was added the Grignard reagent (1.5 equiv.) and the reaction was allowed to stir at -78 °C until the complete consumption of the starting hydrazide (TLC, reaction usually takes 30 min.). The reaction was then quenched with H₂O at -78 °C and allowed to warm up to room temperature. The solution was extracted with AcOEt (3x), dried (MgSO₄) and concentrated under reduced pressure. The alkylated hydrazine was used in the next step without purification.

General Procedure 6.4, *N-Alkylation with propargyl bromide*. To a solution of an alkylated hydrazine (1 equiv.) in DMF (0.125 M) in a round bottom flask at room temperature was added NaH (1.5 equiv.) followed by the addition of propargyl bromide (1.5 equiv., 80 % w/w solution in toluene) and tetrabutyl ammonium iodide (0.1 equiv.). The reaction was allowed to stir at room temperature until the complete consumption of the starting hydrazine (TLC, reaction usually left overnight). The reaction was then quenched with a saturated solution of NH₄Cl, extracted with AcOEt (3x), washed with water (5x), dried (MgSO₄) and concentrated under reduced pressure. Purification of the crude mixture by flash column chromatography furnished the fully substituted hydrazine in the stated yields.

General Procedure 6.5, *Sonogashira coupling reaction of propargylated hydrazines*³¹⁴: To a solution of propargylated hydrazine (1 equiv.) and halide (1.5 equiv.) in DMF (0.10 M) in a round bottom flask under an argon atmosphere at room temperature was added piperidine (10 equiv.), CuI (0.1 equiv.) and Pd(PPh₃)₄ (0.05 equiv.). The reaction was allowed to stir at room temperature overnight. Upon reaction completion (TLC), the reaction was quenched with a saturated solution of NH₄Cl, extracted with AcOEt (3x), washed with H₂O (5x), dried (MgSO₄) and concentrated under reduced pressure. Purification by flash column chromatography afforded the desired products in the stated yields.

³¹³ Demers, J. P.; Klaubert, D. H.; *Tetrahedron. Lett.* **1987**, 28, 42, 4933.

³¹⁴ Bongers, K., M.; van den Berg, R. J. B. H. N.; Knijnenburg, A. D.; Heitman, L. H.; Ijzerman, Ad P.; Oosterom, J.; Timmers, C. M.; Overkleeft, H. S.; van der Marel, G. A.; *Bioorg. Med. Chem.*, **2008**, 16, 3744.

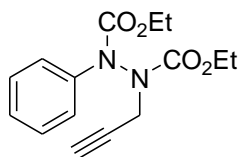
MF: C₁₅H₁₈O₄N₂MW = 290 g.mol⁻¹

- Method :** See **general procedure 6.3** using (1 equiv., 3 mmol, 470 μ L) of diethyl azodicarboxylate and (1 equiv., 3 mmol, 1.0 M solution THF, 3.0 mL) of PhMgBr followed by **general procedure 6.4** (1 equiv., 3 mmol, 750 mg) of the previously prepared compound.
- Purification :** Flash column chromatography (silica gel, 9:1 PE: AcOEt).
- Product :** Pale yellow oil.
- Isolated yield :** 80% for two steps.
- ¹H NMR** (δ , ppm) (CDCl₃, 400 MHz) 7.50 (d, J = 7.9Hz, 1H, CH-Ph), 7.45 (d, J = 7.9Hz, 1H, CH-Ph), 7.33 (t, J = 7.9Hz, 2H, CH-Ph), 7.19 (t, J = 7.9Hz, 1H, CH-Ph), 4.46-4.16 (m, 6H, CH₂-propargyl chain + OCH₂CH₃), 2.22 (t, J = 2.4Hz, 0.3H, \equiv CH rotamere), 2.19 (t, J = 2.4Hz, 0.7H, \equiv CH), 1.34-1.22 (m, 6H, OCH₂CH₃).
- ¹³C NMR** (δ , ppm) (CDCl₃, 100 MHz) 155.6 (Cq, C=O), 155.2 (Cq, C=O rotamere), 154.3 (Cq, C=O rotamere), 153.9 (Cq, C=O), 140.8 (Cq, Ph rotamere), 140.5 (Cq, Ph), 128.5 (CH-Ph), 126.4 (CH-Ph), 126.0 (CH-Ph rotamere), 123.4 (CH-Ph), 73.5 (C \equiv CH), 73.3 (Cq, C \equiv CH), 63.1 (OCH₂CH₃ rotamere), 62.9 (OCH₂CH₃), 62.8 (OCH₂CH₃), 40.2 (CH₂-propargyl chain rotamere), 39.3 (CH₂-propargyl chain), 14.4 (OCH₂CH₃), 14.3 (OCH₂CH₃).
- IR** (ν , cm⁻¹) (CCl₄) 3314 (m), 3068 (w), 3046 (w), 2983 (m), 2935 (w), 2913 (w), 2872 (w), 1725 (s), 1598 (m), 1492 (m), 1482 (m), 1465 (m), 1444 (m), 1403 (s), 1373 (s), 1305 (s), 1275 (s), 1238 (s), 1200 (s), 1174 (s), 1133 (s), 1096 (s), 1061 (s), 1030 (s).
- HRMS** (EI+, m/z) : Calculated: 290.1267 Found 290.1270.

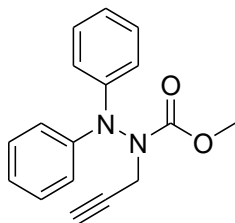
MF: C₁₇H₁₆N₂O₂MW = 280 g.mol⁻¹

- Method :** See **general procedure 6.2** using (1 equiv., 3 mmol, 500 mg) of *N*-phenyl-hydrazinecarboxylic acid methyl ester followed by **general procedure 6.3** using (1 equiv., 3 mmol, 492 mg) of the previously prepared compound and (1.5 equiv., 4.5 mmol, 1M solution in THF, 4.5 mL) of PhMgBr followed by **general procedure 6.4** using (1 equiv., 3 mmol, 721 mg) of *N,N*-diphenyl-hydrazinecarboxylic acid methyl ester.
- Purification :** Flash column chromatography (silica gel, 9:1 PE:AcOEt).
- Product :** Yellow oil.
- Isolated yield :** 67% for three steps.
- ¹H NMR** (δ, ppm) (CDCl₃, 400 MHz) 7.31-7.27 (m, 4H, CH-Ph), 7.16-7.14 (m, 4H, CH-Ph), 7.03 (t, *J* = 7.3Hz, 2H, CH-Ph), 4.40 (br s, 2H, CH₂-propargyl chain), 3.82 (br s, 0.8H, OCH₃ rotamere), 3.69 (br s, 2.2H, OCH₃), 2.26 (br s, 1H, ≡CH).
- ¹³C NMR** (δ, ppm) (CDCl₃, 100 MHz) 156.9 (Cq, C=O), 144.2 (Cq, Ph), 129.1 (CH-Ph), 122.9 (CH-Ph), 119.8 (CH-Ph rotamere), 119.4 (CH-Ph), 78.2 (Cq, C≡CH), 73.3 (C≡CH), 53.6 (OCH₃), 38.9 (CH₂).
- IR** (ν, cm⁻¹) (CCl₄) 3313 (m), 3070 (w), 3042 (w), 2956 (w), 1718 (s), 1592 (s), 1497 (s), 1446 (s), 1377 (m), 1330 (m), 1314 (m), 1275 (m), 1239 (m), 1196 (w), 1178 (w), 1127 (w), 1079 (w), 1031 (w).
- HRMS** (EI+, *m/z*) : Calculated: 280.1212 Found: 280.1225.

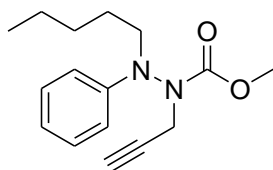
MF: C₁₆H₂₂N₂O₂MW = 274 g. mol⁻¹

- Method :** See **general procedure 6.2** using (1 equiv., 3.4 mmol, 570 mg) of *N*-phenyl-hydrazinecarboxylic acid methyl ester followed by **general procedure 6.3** using (1 equiv., 1.7 mmol, 280 mg) of the previously prepared compound and (1.5 equiv., 4.5 mmol, 1M solution in THF, 2.6 mL) of *n*-C₅H₁₁MgBr followed by **general procedure 6.4** using (1 equiv., 1.31 mmol, 310 mg) of *N*-pentyl-*N*-phenyl-hydrazinecarboxylic acid methyl ester.
- Purification :** Flash column chromatography (silica gel, 9:1 PE:AcOEt).
- Product :** Pale yellow oil.
- Isolated yield :** 64% for three steps.
- ¹H NMR** (δ, ppm) (CDCl₃, 400 MHz) 7.27-7.23 (m, 2H, CH-Ph), 6.84 (t, *J* = 7.3Hz, 1H, CH-Ph), 6.74-6.68 (m, 2H, CH-Ph), 4.55 (br d, *J* = 17.5Hz, 0.7H, NCH₂-propargyl chain), 4.45 (br d, *J* = 17.5Hz, 0.3H, NCH₂-propargyl chain *rotamere*), 4.01 (br d, *J* = 17.5Hz, 1H, NCH₂-propargyl chain), 3.81 (br s, 0.8H, OCH₃ *rotamere*), 3.70 (br s, 2.2H, OCH₃), 3.60-3.53 (m, 1H, NCH₂-pentyl chain), 3.44-3.37 (m, 1H, NCH₂-pentyl chain), 2.29 (br s, 1H, ≡CH), 1.77 (br s, 2H, CH₂-pentyl chain), 1.39-1.36 (m, 4H, CH₂-pentyl chain), 0.93 (t, *J* = 6.7Hz, 3H, CH₃-pentyl chain).
- ¹³C NMR** (δ, ppm) (CDCl₃, 100 MHz) 157.1 (Cq, C=O), 147.2 (Cq, Ph), 129.2 (CH-Ph), 119.2 (CH-Ph), 112.4 (CH-Ph), 78.9 (Cq, C≡CH), 72.5 (C≡CH), 53.4 (OCH₃), 52.8 (NCH₂), 40.4 (NCH₂ *rotamere*), 39.0 (NCH₂), 29.3 (CH₂-pentyl chain), 27.2 (CH₂-pentyl chain), 22.5 (CH₂-pentyl chain), 14.1 (CH₃-pentyl chain)
- IR** (ν, cm⁻¹) (CCl₄) 3313 (m), 3095 (w), 3068 (w), 3030 (w), 2957 (m), 2932 (m), 2873 (w), 1716 (s), 1599 (s), 1499 (s), 1446 (s), 1415 (w), 1378 (s), 1337 (m), 1273 (s), 1238 (s), 1194 (m), 1130 (m), 1091 (w), 1070 (w), 1034 (w).
- HRMS** (EI+, *m/z*) : Calculated: 274.1681 Found: 274.1694.

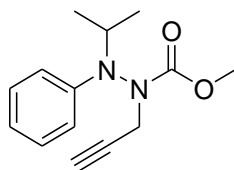
MF: C₁₄H₁₈O₂N₂MW = 246 g.mol⁻¹

- Method :** See **general procedure 6.2** using (1 equiv., 2 mmol, 332 mg) of *N*-phenyl-hydrazinecarboxylic acid methyl ester followed by **general procedure 6.3** using (1 equiv., 2 mmol, 328 mg) of the previously prepared compound and (1.5 equiv., 3 mmol, solution 2M in THF, 1.5 mL) of ¹PrCl followed by **general procedure 6.3** using (1 equiv., 2 mmol, 450 mg) of *N*-isopropyl-*N*-phenyl-hydrazinecarboxylic acid methyl ester.
- Purification :** Flash column chromatography (silica gel, 9:1 PE:AcOEt).
- Product :** Yellow oil.
- Isolated yield :** 47% for three steps.
- ¹H NMR** (δ, ppm) (CDCl₃, 400 MHz) 7.26 (dd, *J* = 7.3Hz, *J* = 8.5Hz, 2H, CH-Ph), 6.82 (t, *J* = 7.3Hz, 1H, CH-Ph), 6.70 (d, *J* = 8.5Hz, 0.5H, CH-Ph_{rotamere}), 6.65 (d, *J* = 8.5Hz, 1.5H, CH-Ph), 4.61 (dd, *J* = 2.4Hz, *J* = 17.4Hz, 0.7H, NCH₂), 4.50 (br d, *J* = 17.4Hz, 0.3H, NCH₂_{rotamere}), 4.23-4.11 (m, 1H, CH-^{*i*}Pr), 3.90 (br d, *J* = 17.4Hz, 0.3H, NCH₂_{rotamere}), 3.83 (dd, *J* = 2.4Hz, *J* = 17.4Hz, 0.7H, NCH₂), 3.84 (s, 0.7H, OCH₃_{rotamere}), 3.71 (s, 2.3H, OCH₃), 2.38 (t, *J* = 2.4Hz, 1H, ≡CH), 1.36 (d, *J* = 6.6Hz, 3H, CH₃-^{*i*}Pr), 1.34 (d, *J* = 6.6Hz, 3H, CH₃-^{*i*}Pr).
- ¹³C NMR** (δ, ppm) (CDCl₃, 100 MHz) 157.8 (Cq, C=O), 156.5 (Cq, C=O_{rotamere}), 145.5 (Cq, Ph), 129.3 (CH-Ph), 129.2 (CH-Ph_{rotamere}), 118.7 (CH-Ph_{rotamere}), 118.6 (CH-Ph), 112.7 (CH-Ph_{rotamere}), 112.2 (CH-Ph), 79.0 (Cq, C≡CH_{rotamere}), 78.7 (Cq, C≡CH), 73.2 (C≡CH), 73.1 (C≡CH_{rotamere}), 53.4 (OCH₃_{rotamere}), 53.3 (OCH₃), 50.4 (CH-^{*i*}Pr_{rotamere}), 50.1 (CH-^{*i*}Pr), 42.1 (NCH₂_{rotamere}), 41.2 (NCH₂), 20.2 (CH₃-^{*i*}Pr_{rotamere}), 19.8 (CH₃-^{*i*}Pr), 19.0 (CH₃-^{*i*}Pr_{rotamere}), 18.8 (CH₃-^{*i*}Pr).
- IR** (ν, cm⁻¹) (CCl₄) 3313 (m), 3096 (w), 3068 (w), 3028 (w), 2978 (w), 2955 (w), 2876 (w), 1737 (s), 1716 (s), 1596 (s), 1498 (s), 1447 (s), 1413 (w), 1381 (s), 1369 (s), 1333 (m), 1295 (s), 1274 (s), 1238 (s), 1194 (m), 1171 (w), 1141 (m), 1116 (s), 1039 (w).
- HRMS** (EI+, m/z) : Calculated: 246.1368 Found: 246.1359.

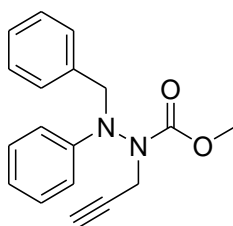
MF: C₁₈H₁₈O₂N₂MW = 294 g.mol⁻¹

Method : To a round bottom flask under an argon atmosphere at -78 °C charged with *N*-phenyl-hydrazinecarboxylic acid methyl ester (1 equiv., 3 mmol, 498 mg) and THF (0.2 M, 15 mL) was added *n*-BuLi (2.5 equiv., 7.5 mmol, 2.5 M in hexanes, 3 mL) and the reaction was allowed to stir at -78 °C for 20 min. Then benzyl bromide (1 equiv., 3 mmol, 360 μL) was added. The temperature was allowed to warm up and to stir at room temperature for 2h. Then propargyl bromide (1.1 equiv., 3.3 mmol, solution 80% w/w in toluene, 360 μL) was added. The reaction was allowed to stir at room temperature overnight. Upon completion (TLC), the reaction was quenched with H₂O, extracted with AcOEt (3x), dried (MgSO₄) and concentrated under reduced pressure. Purification by flash column chromatography afforded the pure product.

Reference: Bredihhin, A.; Groth, U. M.; Mäeorg, U.; *Org. Lett.*, **2007**, 9, 6, 1097.

Purification : Flash column chromatography (silica gel, 9:1 PE:AcOEt).

Product : Orange solid.

Isolated yield : 20%.

¹H NMR (δ, ppm) (CDCl₃, 400 MHz) 7.43 (br d, *J* = 5.9Hz, 2H, CH-Ph), 7.34 (t, *J* = 7.4Hz, 2H, CH-Ph), 7.27 (t, *J* = 7.4Hz, 2H, CH-Ph), 7.21 (dd, *J* = 7.4Hz, *J* = 8.8Hz, 2H, CH-Ph), 6.85 (t, *J* = 7.3Hz, 1H, CH-Ph), 6.80-6.73 (m, 1H, CH-Ph), 4.86 (br d, *J* = 15.5Hz, 1H, NCH₂), 4.64 (br d, *J* = 15.5Hz, 1H, NCH₂), 4.37 (br d, *J* = 16.7Hz, 1H, NCH₂), 4.19 (d, *J* = 16.7Hz, 1H, NCH₂), 3.81 (br s, 0.8H, OCH₃ rotamere), 3.70 (br s, 2.2H, OCH₃), 2.20 (br s, 1H, ≡CH).

¹³C NMR (δ, ppm) (CDCl₃, 100 MHz) 156.7 (Cq, C=O), 155.2 (Cq, C=O rotamere), 147.6 (Cq, Ph), 137.5 (Cq, Ph), 129.0 (CH-Ph), 128.5 (CH-Ph), 127.4 (CH-Ph), 127.2 (CH-Ph), 119.7 (CH-Ph), 112.9 (CH-Ph), 78.6 (Cq, C≡CH), 72.8 (C≡CH), 58.1 (NCH₂), 53.4 (OCH₃), 40.9 (NCH₂ rotamere), 39.4 (NCH₂).

IR (ν, cm⁻¹) (CCl₄) 3313 (m), 3091 (w), 3067 (w), 3031 (w), 2956 (w), 2855 (w), 1718 (s), 1600 (s), 1499 (s), 1446 (s), 1376 (s), 1335 (m), 1268 (m), 1237 (s), 1194 (m), 1137 (m), 1110 (w), 1089 (w), 1062 (w), 1030 (w).

HRMS (EI+, m/z) : Calculated: 294.1368 Found: 294.1372.

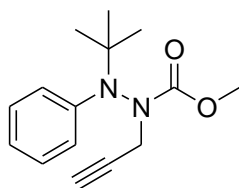
N*-phenyl-*N*-*tert*-butyl-*N*-prop-2-ynyl-hydrazinecarboxylic acid methyl ester*6.11e**MF: C₁₅H₂₀O₂N₂MW = g.mol⁻¹

Method : See **general procedure 6.2** using (1 equiv., 1,71 mmol, 250 mg) of *N*-*tert*-butyl-hydrazinecarboxylic acid methyl ester followed by **general procedure 6.3** using (1 equiv., 1.7 mmol, 246 mg) of the previously prepared compound and (1.5 equiv., 2.56 mmol, solution 1.0 M in THF, 2.6 mL) of PhMgBr followed by **general procedure 6.4** using (1 equiv., 1.1 mmol, 244 mg) of *N*-phenyl-*N*-*tert*-butyl-hydrazinecarboxylic acid methyl ester.

Purification : Flash column chromatography (silica gel, 9:1 PE:AcOEt).

Product : Yellow pale oil.

Isolated yield : 66% for three steps.

¹H NMR (δ, ppm) 7.24-7.20 (m, 2H, CH-Ar), 6.90-6.84 (br s, 3H, CH-Ar), 4.52 (br d, *J* = 17.4Hz, 1H, NCH₂), 3.87 (br d, *J* = 17.4Hz, 1H, NCH₂), 3.75 (br s, 3H, OCH₃), 2.33 (br s, 1H, ≡CH), 1.53 (s, 9H, CH₃-^tBu).
(CDCl₃, 400 MHz)

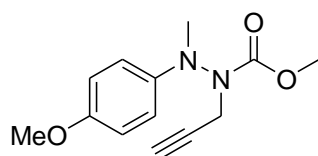
N*-(4-Methoxy-phenyl)-*N*-methyl-*N*-prop-2-ynyl-hydrazinecarboxylic acid methyl ester*6.11f**MF: C₁₃H₁₆O₂N₂MW = 248 g.mol⁻¹

Method : See **general procedure 6.2** using (1 equiv., 1.5 mmol, 300 mg) of *N*-(4-methoxy-phenyl)-hydrazinecarboxylic acid methyl ester followed by **general procedure 6.3** using (1 equiv., 1.5 mmol, 297 mg) of the previously prepared compound and (1.5 equiv., 2.25 mmol, solution 1.4 M in 3:1 toluene:THF, 1.6 mL) of MeMgBr followed by **general procedure 6.4** using (1 equiv., 1.36 mmol, 285 mg) of *N*-(4-methoxy-phenyl)-*N*-methyl-hydrazinecarboxylic acid methyl

ester.

Purification : Flash column chromatography (silica gel, 8:2 PE:AcOEt).

Product : Orange oil.

Isolated yield : 60% for three steps.

¹H NMR (δ , ppm) (CDCl₃, 400 MHz) 6.83 (br d, J = 9.1Hz, 2H, CH-Ar), 6.68 (br s, 2H, CH-Ar), 4.54 (br d, J = 17.0Hz, 1H, NCH₂), 4.03 (br d, J = 17.0Hz, 1H, NCH₂), 3.76 (br s, 3H, OCH₃), 3.72 (br s, 3H, OCH₃), 3.21 (br s, 3H, NCH₃), 2.28 (br s, 1H, \equiv CH).

¹³C NMR (δ , ppm) (CDCl₃, 100 MHz) 157.0 (Cq, C=O), 153.4 (Cq, Ar), 142.1 (Cq, Ar), 114.7 (CH-Ar), 113.5 (CH-Ar), 79.2 (Cq, $\underline{\text{C}}\equiv\text{CH}$), 72.3 (C $\equiv\text{C}\underline{\text{H}}$), 55.6 (OCH₃), 53.4 (OCH₃), 39.6 (NCH₃), 37.9 (NCH₂).

IR (ν , cm⁻¹) (CCl₄) 3313 (m), 2999 (w), 2955 (m), 2906 (w), 2833 (w), 1716 (s), 1510 (w), 1464 (m), 1446 (s), 1374 (s), 1273 (m), 1246 (s), 1194 (m), 1181 (m), 1156 (m), 1119 (m), 1071 (m), 1042 (m).

HRMS (EI+, m/z) : Calculated: 248.1161 Found: 248.1157.

***N*-(4-Chloro-phenyl)-*N*'-methyl-*N*-prop-2-ynyl-hydrazinecarboxylic acid methyl ester** **acid** **6.11g**

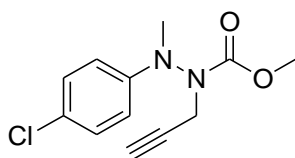

MF: C₁₂H₁₃O₂N₂Cl

MW = 252.5 g.mol⁻¹

Method : See **general procedure 6.2** using (1 equiv., 1.5 mmol, 300 mg) of *N*-(4-chloro-phenyl)-hydrazinecarboxylic acid methyl ester followed by **general procedure 6.3** using (1 equiv., 1.5 mmol, 298 mg) of the previously prepared compound and (1.5 equiv., 2.25 mmol, solution 1.4 M in 3:1 toluene:THF, 1.6 mL) of MeMgBr followed by **general procedure 6.4** using (1 equiv., 1.5 mmol, 330 mg) of *N*-(4-chloro-phenyl)-*N*'-methyl-hydrazinecarboxylic acid methyl ester.

Purification : Flash column chromatography (silica gel, 8:2 PE:AcOEt).

Product : Orange oil.

Isolated yield : 71% for three steps.

¹H NMR (δ, ppm) (CDCl ₃ , 400 MHz)	7.19 (br d, <i>J</i> = 8.7Hz, 2H, CH-Ar), 6.64 (br s, 2H, CH-Ar), 4.54 (br d, <i>J</i> = 15.6Hz, 1H, NCH ₂), 4.09 (br d, <i>J</i> = 15.6Hz, 1H, NCH ₂), 3.70 (br s, 3H, OCH ₃), 3.22 (br s, 3H, NCH ₃), 2.29 (br s, 1H, ≡CH).
¹³C NMR (δ, ppm) (CDCl ₃ , 100 MHz)	156.4 (Cq, C=O), 146.8 (Cq, Ar), 129.1 (CH-Ar), 124.2 (Cq, Ar), 113.2 (CH-Ar), 78.6 (Cq, <u>C</u> ≡CH), 72.8 (C≡ <u>C</u> H), 53.5 (OCH ₃), 39.3 (NCH ₃), 38.2 (NCH ₂).
IR (ν, cm ⁻¹) (CCl ₄)	3312 (m), 3095 (w), 3003 (w), 2957 (m), 2903 (w), 2818 (w), 1721 (s), 1599 (s), 1495 (s), 1446 (s), 1419 (m), 1375 (s), 1347 (m), 1324 (s), 1270 (s), 1237 (s), 1194 (s), 1184 (s), 1156 (s), 1119 (s), 1099 (m), 1069 (m).
HRMS (EI+, <i>m/z</i>) :	Calculated: 252.0666 Found: 252.0657.

***N*-(4-Fluoro-phenyl)-*N*-methyl-*N*-prop-2-ynyl-hydrazinecarboxylic acid methyl ester 6.11h**

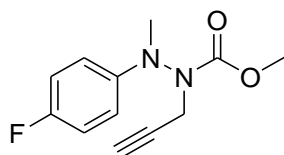

MF: C₁₂H₁₃O₂N₂F

MW = 236 g.mol⁻¹

Method :	See general procedure 6.2 using (1 equiv., 2 mmol, 368 mg) of <i>N</i> -(4-fluorophenyl)-hydrazinecarboxylic acid methyl ester followed by general procedure 6.3 using (1 equiv., 2 mmol, 364 mg) of the previously prepared compound and (1.5 equiv., 3 mmol, solution 1.4 M in 3:1 toluene:THF, 2.14 mL) of MeMgBr followed by general procedure 6.4 using (1 equiv., 2 mmol, 396 mg) of <i>N</i> -(4-fluorophenyl)- <i>N</i> -methyl-hydrazinecarboxylic acid methyl ester
Purification :	Flash column chromatography (silica gel, 8:2 PE: AcOEt).
Product :	Orange oil.
Isolated yield :	99% for three steps.
¹H NMR (δ, ppm) (CDCl ₃ , 400 MHz)	6.98 (t, <i>J</i> = 8.7Hz, 2H, CH-Ar), 6.70 (br s, 2H, CH-Ar), 4.57 (br d, <i>J</i> = 16.8Hz, 1H, NCH ₂), 4.12 (br d, <i>J</i> = 16.8Hz, 1H, NCH ₂), 3.73 (br s, 3H, OCH ₃), 3.25 (s, 3H, NCH ₃), 2.34 (br s, 1H, ≡CH).
¹³C NMR (δ, ppm) (CDCl ₃ , 100 MHz)	156.7 (d, <i>J</i> _{C-F} = 237.5Hz, Cq, Ar), 156.5 (Cq, C=O), 144.4 (Cq, Ar), 115.50 (d, <i>J</i> _{C-F} = 22.5Hz, CH-Ar), 113.0 (br s, CH-Ar), 78.7 (Cq, <u>C</u> ≡CH), 72.6 (C≡ <u>C</u> H), 53.3 (OCH ₃), 39.4 (NCH ₃), 38.0 (NCH ₂).

IR (ν , cm^{-1}) (CCl_4) 3312 (m), 3058 (w), 3003 (w), 2957 (w), 2901 (w), 2816 (w), 1720 (s), 1614 (w), 1509 (s), 1446 (s), 1418 (w), 1375 (s), 1322 (m), 1272 (m), 1231 (s), 1195 (m), 1158 (m), 1118 (s), 1069 (m).

HRMS (EI+, m/z) : Calculated: 236.0961 Found: 236.0969.

4-(*N*-Methoxycarbonyl-*N*-methyl-*N*-prop-2-ynyl-hydrazino)-benzoic acid ethyl ester 6.11i

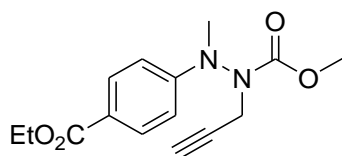

MF: $\text{C}_{15}\text{H}_{18}\text{O}_4\text{N}_2$

MW = $290 \text{ g}\cdot\text{mol}^{-1}$

Method : See **general procedure 6.2** using (1 equiv., 1.26 mmol, 300 mg) of 4-(*N*-methoxycarbonyl-hydrazino)-benzoic acid ethyl ester followed by **general procedure 6.3** using (1 equiv., 1.26 mmol, 297 mg) of the previously prepared compound and (1.2 equiv., 1.89 mmol, solution 1.4M in 3:1 toluene:THF, 1.10 mL) of MeMgBr followed by **general procedure 6.4** using (1 equiv., 1.26 mmol, 318 mg) of 4-(*N*-methoxycarbonyl-*N*-methyl-hydrazino)-benzoic acid ethyl ester.

Purification : Flash column chromatography (silica gel, 7:3 PE: AcOEt).

Product : Orange/yellow oil.

Isolated yield : 71% for three steps.

^1H NMR (δ , ppm) (CDCl₃, 400 MHz) 7.94 (d, $J = 8.4\text{Hz}$, 2H, CH-Ar), 6.68 (br d, $J = 8.4\text{Hz}$, 2H, CH-Ar), 4.61 (br d, $J = 17.1\text{Hz}$, 1H, NCH₂), 4.33 (q, $J = 7.1\text{Hz}$, 2H, OCH₂CH₃), 4.11 (d, $J = 17.1\text{Hz}$, 1H, NCH₂), 3.70 (br s, 3H, OCH₃), 3.31 (s, 3H, NCH₃), 2.29 (br s, 1H, $\equiv\text{CH}$), 1.36 (t, $J = 7.1\text{Hz}$, 3H, OCH₂CH₃).

^{13}C NMR (δ , ppm) (CDCl₃, 100 MHz) 166.5 (Cq, C=O), 156.3 (Cq, C=O), 151.5 (Cq, Ar), 131.4 (CH-Ar), , 120.9 (Cq, Ar), 110.9 (CH-Ar), 78.3 (Cq, $\underline{\text{C}}\equiv\text{CH}$), 73.0 ($\text{C}\equiv\text{CH}$), 60.4 (OCH₂CH₃), 53.7 (OCH₃), 39.3 (NCH₃), 38.1 (NCH₂), 14.4 (OCH₂CH₃).

IR (ν , cm^{-1}) (CCl_4) 3312 (m), 2982 (m), 2957 (m), 2906 (w), 1713 (s), 1608 (s), 1558 (w), 1555 (w), 1550 (m), 1547 (m), 1543 (m), 1535 (w), 1464 (m), 1446 (s), 1428 (w), 1368 (s), 1333 (s), 1313 (s), 1276 (s), 1236 (s), 1182 (s), 1156 (m), 1108 (s), 1071 (m), 1021 (m).

HRMS (EI+, m/z) : Calculated: 290.1267 Found: 290.1259.

***N*-(4-Cyano-phenyl)-*N*-methyl-*N*-prop-2-ynyl-hydrazinecarboxylic methyl ester**

acid 6.11j

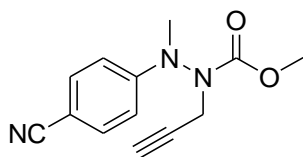

MF: C₁₃H₁₃O₂N₃

MW = 243 g.mol⁻¹

- Method :** See **general procedure 6.2** using (1 equiv., 1.6 mmol, 300 mg) of *N*-(4-cyano-phenyl)-hydrazinecarboxylic acid methyl ester followed by **general procedure 6.3** using (1 equiv., 1.6 mmol, 328 mg) of the previously prepared compound and (1.5 equiv., 2.4 mmol, solution 1.4 M in 3:1 toluene:THF, 1.7 mL) of MeMgBr followed by **general procedure 6.4** using (1 equiv., 1.6 mmol, 325 mg) of *N*-(4-cyano-phenyl)-*N*-methyl-hydrazinecarboxylic acid methyl ester.
- Purification :** Flash column chromatography (silica gel, 7:3 PE:AcOEt).
- Product :** Orange oil.
- Isolated yield :** 87% for three steps.
- ¹H NMR** (δ, ppm) (CDCl₃, 400 MHz) 7.52 (d, *J* = 8.5Hz, 2H, CH-Ar), 6.72 (br d, *J* = 8.5Hz, 2H, CH-Ar), 4.56 (br d, *J* = 17.2Hz, 1H, NCH₂), 4.14 (d, *J* = 17.2Hz, 1H, NCH₂), 3.72 (br s, 3H, OCH₃), 3.30 (s, 3H, NCH₃), 2.30 (br s, 1H, ≡CH).
- ¹³C NMR** (δ, ppm) (CDCl₃, 100 MHz) 155.9 (Cq, C=O), 151.2 (Cq, Ar), 133.6 (CH-Ar), 119.8 (Cq, Ar), 111.7 (CH-Ar), 101.4 (Cq, CN), 77.9 (Cq, C≡CH), 73.3 (C≡CH), 53.8 (OCH₃), 39.0 (NCH₃), 38.1 (NCH₂).
- IR** (ν, cm⁻¹) (CCl₄) 3311 (m), 3005 (w), 2957 (w), 2908 (w), 2825 (w), 2225 (m), 1727 (s), 1609 (s), 1514 (s), 1446 (s), 1376 (s), 1345 (s), 1300 (m), 1275 (m), 1238 (s), 1195 (w), 1179 (w), 1159 (w), 1119 (w), 1070 (w).
- HRMS** (EI+, m/z) : Calculated: 243.1008 Found: 243.1008.

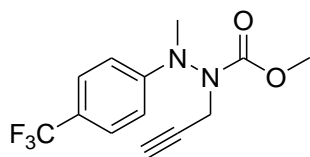

MF: C₁₃H₁₃O₂N₂F₃

MW = 286 g.mol⁻¹

- Method :** See **general procedure 6.2** using (1 equiv., 1.28 mmol, 300 mg) of *N*-(4-trifluoromethyl-phenyl)-hydrazinecarboxylic acid methyl ester followed by **general procedure 6.3** using (1 equiv., 1.28 mmol, 297 mg) of the previously prepared compound and (1.5 equiv., 1.92, solution 1.4M in 3:1 toluene:THF, 1.3 mL) of MeMgBr followed by **general procedure 6.4** using (1 equiv., 1.28 mmol, 317 mg) of *N*-methyl-*N*-(4-trifluoromethyl-phenyl)-hydrazinecarboxylic acid methyl ester.
- Purification :** Flash column chromatography (silica gel, 8:2 PE:AcOEt).
- Product :** Orange oil.
- Isolated yield :** 77% for three steps.
- ¹H NMR** (δ, ppm) (CDCl₃, 400 MHz) 7.45 (d, *J* = 8.8Hz, 2H, CH-Ar), 6.75 (br s, 2H, CH-Ar), 4.46 (br d, *J* = 17.8Hz, 1H, NCH₂), 4.13 (d, *J* = 17.8Hz, 1H, NCH₂), 3.71 (br s, 3H, OCH₃), 3.29 (s, 3H, NCH₃), 2.30 (br s, 1H, ≡CH).
- ¹³C NMR** (δ, ppm) (CDCl₃, 100 MHz) 156.2 (Cq, C=O), 150.4 (q, *J*_{C-F} = 21.0Hz, Cq, Ar), 126.7 (q, *J*_{C-F} = 270.6 Hz, Cq, CF₃), 126.0 (q, *J* = 3.8Hz, CH-Ar), 121.1 (Cq, Ar), 111.2 (CH-Ar), 78.3 (Cq, C≡CH), 73.0 (C≡CH), 53.7 (OCH₃), 39.2 (NCH₃), 38.2 (NCH₂).
- IR** (ν, cm⁻¹) (CCl₄) 3312 (s), 3004 (w), 2957 (m), 2907 (w), 2823 (w), 1724 (s), 1619 (s), 1585 (w), 1523 (s), 1446 (s), 1377 (s), 1327 (s), 1276 (s), 1237 (s), 1194 (s), 1166 (s), 1123 (s), 1076 (s), 1065 (s), 1005 (s).
- HRMS** (EI+, *m/z*) : Calculated: 286.0929 Found: 286.0925.

***N*-Methyl-*N*-(4-nitro-phenyl)-*N*-prop-2-ynyl-hydrazinecarboxylic acid methyl ester 6.111**

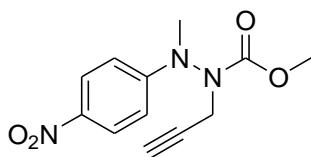

MF: C₁₂H₁₃N₃O₄

MW = 263 g.mol⁻¹

- Method :** See **general procedure 6.2** using (1 equiv., 1.18 mmol, 250 mg) of *N*-(4-nitro-phenyl)-hydrazinecarboxylic acid methyl ester followed by **general procedure 6.3** using (1 equiv., 1.18 mmol, 246 mg) of the previously prepared compound and (1.5 equiv., 1.77 mmol, solution 1.4 M in 3:1 toluene:THF, 1.3 mL) of MeMgBr followed by **general procedure 6.4** using (1 equiv., 1.0 mmol, 230 mg) of *N*-methyl-*N*-(4-nitro-phenyl)-hydrazinecarboxylic acid methyl ester.
- Purification :** Flash column chromatography (silica gel, 8:2 PE:AcOEt).
- Product :** Orange oil.
- Isolated yield :** 71% for three steps.
- ¹H NMR** (δ, ppm) (CDCl₃, 400 MHz) 8.12 (d, *J* = 9.0Hz, 2H, CH-Ar), 6.70 (d, *J* = 9.0Hz, 2H, CH-Ar), 4.54 (br d, *J* = 17.3Hz, 1H, NCH₂), 4.18 (d, *J* = 17.3Hz, 1H, NCH₂), 3.72 (br s, 3H, OCH₃), 3.33 (s, 3H, NCH₃), 2.31 (br s, 1H, ≡CH).
- ¹³C NMR** (δ, ppm) (CDCl₃, 100 MHz) 155.5 (Cq, C=O), 153.0 (Cq, Ar), 139.8 (Cq, Ar), 125.8 (CH-Ar), 110.8 (CH-Ar), 77.7 (Cq, C≡CH), 73.5 (C≡CH), 53.8 (OCH₃), 39.1 (NCH₃), 38.2 (NCH₂).
- IR** (ν, cm⁻¹) (CCl₄) 3313 (m), 3090 (w), 3004 (w), 2958 (m), 2934 (w), 2910(w), 2855 (w), 2827 (w), 2662 (w), 1725 (s), 1599 (s), 1511 (s), 1446 (s), 1421 (m), 1376 (s), 1335 (s), 1276 (s), 1238 (s), 1193 (s), 1158 (m), 1110 (s), 1070 (m).
- HRMS** (EI+, m/z) : Calculated: 263.0906 Found: 263.0912.

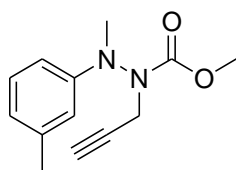
MF: C₁₃H₁₆N₂O₂MW = 232 g.mol⁻¹

- Method :** See **general procedure 6.2** using (1 equiv., 1.56 mmol, 280 mg) of *N*-*m*-tolyl-hydrazinecarboxylic acid methyl ester followed by **general procedure 6.3** using (1 equiv., 1.56 mmol, 278 mg) of the previously prepared compound with (1.5 equiv., 2.34 mmol, solution 1.4 M in 3:1 toluene:THF, 1.7 mL) of MeMgBr followed by **general procedure 6.4** using (1 equiv., 1.53 mmol, 296 mg) of *N*-methyl-*N*-*m*-tolyl-hydrazinecarboxylic acid methyl ester.
- Purification :** Flash column chromatography (silica gel, 9:1 PE:AcOEt).
- Product :** Yellow oil.
- Isolated yield :** 73% for three steps.
- ¹H NMR** (δ, ppm) (CDCl₃, 400 MHz) 7.14 (t, *J* = 7.9Hz, 1H, CH-Ar), 6.67 (d, *J* = 7.9Hz, 1H, CH-Ar), 6.50 (br s, 2H, CH-Ar), 4.62 (br d, *J* = 16.8Hz, 1H, NCH₂), 4.02 (br d, *J* = 16.8Hz, 1H, NCH₂), 3.71 (br s, 3H, OCH₃), 3.25 (s, 3H, NCH₃), 2.32 (s, 3H, Ph-CH₃), 2.28 (br s, 1H, ≡CH).
- ¹³C NMR** (δ, ppm) (CDCl₃, 100 MHz) 156.8 (Cq, C=O), 147.8 (Cq, Ar), 139.1 (Cq, Ar), 129.1 (CH-Ar), 120.1 (CH-Ar), 112.5 (CH-Ar), 109.1 (CH-Ar), 79.0 (Cq, C≡CH), 72.4 (C≡CH), 53.5 (OCH₃), 39.4 (NCH₃), 38.0 (NCH₂), 21.8 (Ph-CH₃).
- IR** (ν, cm⁻¹) (CCl₄) 3313 (m), 3043 (w), 3001 (w), 2956 (m), 2922 (w), 2826 (w), 1717 (s), 1605 (s), 1587 (s), 1493 (s), 1447 (s), 1376 (s), 1321 (m), 1275 (m), 1237 (s), 1194 (m), 1173 (w), 1154 (w), 1120 (m), 1097 (w), 1083 (w), 1068 (w).
- HRMS** (EI+, m/z) : Calculated: 232.1212 Found: 232.1213.

***N*-(3-Chloro-phenyl)-*N*-methyl-*N*-prop-2-ynyl-hydrazinecarboxylic methyl ester**

acid 6.11n

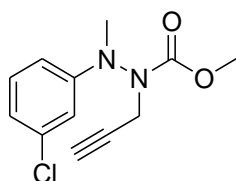

MF: C₁₂H₁₃O₂N₂Cl

MW = 252.5 g.mol⁻¹

- Method :** See **general procedure 6.2** using (1 equiv., 5.6 mmol, 1 g) of *N*-(3-chloro-phenyl)-hydrazinecarboxylic acid methyl ester followed by **general procedure 6.3** using (1 equiv., 2 mmol, 397 mg) of the previously prepared compound and (1.5 equiv., 3 mmol, solution 1.4 M in 3:1 toluene:THF, 2.14mL) of MeMgBr followed by **general procedure 6.4** using (1 equiv., 2 mmol, 450 mg) of *N*-(3-chloro-phenyl)-*N*-methyl-hydrazinecarboxylic acid methyl ester.
- Purification :** Flash column chromatography (silica gel, 8:2 PE:AcOEt).
- Product :** Orange oil.
- Isolated yield :** 70% for three steps.
- ¹H NMR** (δ, ppm) (CDCl₃, 400 MHz) 7.16 (t, *J* = 8.1Hz, 1H, CH-Ar), (dd, *J* = 1.0Hz, *J* = 7.8Hz, 1H, CH-Ar), 6.69 (br s, 1H, CH-Ar), 6.58 (br s, 1H, CH-Ar), 4.59 (d, *J* = 16.6Hz, 1H, NCH₂), 4.08 (d, *J* = 16.6Hz, 1H, NCH₂), 3.71 (br s, 3H, OCH₃), 3.24 (s, 3H, NCH₃), 2.30 (br s, 1H, ≡CH).
- ¹³C NMR** (δ, ppm) (CDCl₃, 100 MHz) 156.4 (Cq, C=O), 149.2 (Cq, Ar), 135.2 (Cq, Ar), 130.2 (CH-Ar), 119.1 (CH-Ar), 112.0 (CH-Ar), 110.1 (CH-Ar), 78.5 (Cq, C≡CH), 72.8 (C≡CH), 53.6 (OCH₃), 39.3 (NCH₃), 38.2 (NCH₂).
- IR** (ν, cm⁻¹) (CCl₄) 3312 (m), 3077 (w), 3004 (w), 2957 (m), 2908 (w), 2818 (w), 1721 (s), 1596 (s), 1573 (m), 1487 (s), 1446 (s), 1419 (m), 1375 (s), 1347 (m), 1296 (m), 1266 (s), 1237 (s), 1195 (m), 1157 (m), 1123 (s), 1106 (s), 1083 (s).
- HRMS** (EI+, m/z) : Calculated: 252.0666 found: 252.0656.

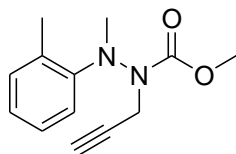
MF: C₁₃H₁₆N₂O₂MW = 232 g.mol⁻¹

- Method :** See **general procedure 6.2** using (1 equiv., 1.56 mmol, 280 mg) of *N*-*o*-tolyl-hydrazinecarboxylic acid methyl ester followed by **general procedure 6.3** using (1 equiv., 1.56 mmol, 278 mg) of the previously prepared compound and (1.5 equiv., 2.34 mmol, solution 1.4 M in 3:1 toluene:THF, 1.7 mL) of MeMgBr followed by **general procedure 6.4** using (1 equiv., 1.56 mmol, 304 mg) of *N*-methyl-*N'*-*o*-tolyl-hydrazinecarboxylic acid methyl ester.
- Purification :** Flash column chromatography (silica gel, 9:1 PE:AcOEt).
- Product :** Yellow oil.
- Isolated yield :** 72% for three steps.
- ¹H NMR** (δ, ppm) (CDCl₃, 400 MHz) 7.19-7.12 (m, 2H, CH-Ar), 7.06 (br s, 1H, CH-Ar), 6.99 (t, *J* = 7.4Hz, 1H, CH-Ar), 4.00 (br s, 2H, NCH₂), 3.84 (s, 3H, OCH₃), 3.22 (s, 3H, NCH₃), 2.21 (br s, 1H, ≡CH), 2.19 (s, 3H, Ph-CH₃).
- ¹³C NMR** (δ, ppm) (CDCl₃, 100 MHz) 155.7 (Cq, C=O), 145.8 (Cq, Ar), 131.8 (CH-Ar), 131.3 (Cq, Ar), 126.3 (CH-Ar), 123.7 (CH-Ar), 118.4 (CH-Ar), 79.8 (Cq, C≡CH), 71.8 (C≡CH), 53.3 (OCH₃), 40.3 (NCH₃), 35.0 (NCH₂), 18.9 (Ph-CH₃).
- IR** (ν, cm⁻¹) (CCl₄) 3313 (m), 3072 (w), 3025 (w), 2996 (w), 2956 (m), 2897 (w), 2806 (w), 1713 (s), 1600, 1495 (w), 1449 (s), 1417 (m), 1384 (s), 1337 (m), 1304 (m), 1270 (s), 1238 (s), 1193 (m), 1146 (m), 1130 (m), 1111 (s), 1071 (w), 1056 (w), 1036 (w).
- HRMS** (EI+, m/z) : Calculated: 232.1212 Found: 232.1215.

***N*-(2-Chloro-phenyl)-*N*'-methyl-*N*-prop-2-ynyl-hydrazinecarboxylic methyl ester**

acid 6.11p

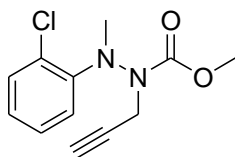

MF: C₁₂H₁₃O₂N₂Cl

MW = 252.5 g.mol⁻¹

- Method :** See **general procedure 6.2** using (1 equiv., 2 mmol, 400 mg) of *N*-(2-chloro-phenyl)-hydrazinecarboxylic acid methyl ester followed by **general procedure 6.3** using (1 equiv., 2 mmol, 397 mg) of the previously prepared compound and (1.5 equiv., 3 mmol, solution 1.4 M in 3:1 toluene:THF, 2.15 mL) of MeMgBr followed by **general procedure 6.4** using (1 equiv., 0.84 mmol, 180 mg) of *N*-(2-chloro-phenyl)-*N*'-methyl-hydrazinecarboxylic acid methyl ester.
- Purification :** Flash column chromatography (silica gel, 9:1 PE, AcOEt).
- Product :** Orange oil.
- Isolated yield :** 72% for three steps.
- ¹H NMR** (δ, ppm) (CDCl₃, 400 MHz) 7.30 (d, *J* = 7.7Hz, 1H, CH-Ph), 7.20 (t, *J* = 7.7Hz, 1H, CH-Ph), 7.07 (br s, 1H, CH-Ph), 6.95 (t, *J* = 7.7Hz, 1H, CH-Ph), 4.50 (br s, 1H, NCH₂), 4.31 (br s, 1H, NCH₂), 3.75 (s, 3H, OCH₃), 3.29 (br s, 3H, NCH₃), 2.26 (br s, 1H, ≡CH).
- ¹³C NMR** (δ, ppm) (CDCl₃, 100 MHz) 156.4 (Cq, C=O), 155.0 (Cq, C=O_{rotamere}), 145.5 (Cq, Ar), 144.2 (Cq, Ar_{rotamere}), 131.2 (CH-Ar), 130.8 (CH-Ar_{rotamere}), 127.0 (CH-Ar), 126.2 (Cq, Ar), 125.8 (Cq, Ar_{rotamere}), 123.8 (CH-Ar), 120.5 (CH-Ar), 119.6 (CH-Ar_{rotamere}), 79.8 (Cq, C≡CH), 79.5 (Cq, C≡CH_{rotamere}), 72.1 (C≡CH), 53.1 (OCH₃), 40.7 (NCH₃), 40.1 (NCH₂), 39.5 (NCH₃_{rotamere}), 37.3 (NCH₂_{rotamere}).
- IR** (ν, cm⁻¹) (CCl₄) 3312 (m), 3068 (w), 3000 (w), 2956 (w), 2899 (w), 2809 (w), 1721 (s), 2590 (w), 1482 (s), 1445 (s), 1417 (w), 1368 (s), 1336 (w), 1302 (w), 1239 (s), 1194 (w), 1155 (w), 1119 (s), 1071 (s), 1043 (m).
- HRMS** (EI+, m/z) : Calculated: 252.0666 Found: 252.0669.

***N*-Methyl-*N*-phenyl-*N*-(3-phenyl-prop-2-ynyl)-hydrazinecarboxylic methyl ester**

acid 6.11q

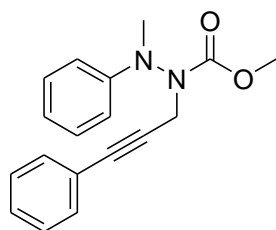

MF: C₁₈H₁₈O₂N₂

MW = 294 g.mol⁻¹

- Method :** See **general procedure 6.2** using (1 equiv., 10 mmol, 1.66 g) of *N*-phenyl-hydrazinecarboxylic acid methyl ester followed by **general procedure 6.3** using (1 equiv., 10 mmol, 1.64 mmol) of the previously prepared compound and (1.5 equiv., 15 mmol, solution 1.4 M in 3:1 toluene:THF, 10.7 mL) of MeMgBr followed by **general procedure 6.4** using (1 equiv., 10 mmol, 1.8 g) of *N*-methyl-*N*-phenyl-hydrazinecarboxylic acid methyl ester followed by **general procedure 6.5** using (1 equiv., 1 mmol, 218 mg) of *N*-methyl-*N*-phenyl-prop-2-ynyl-hydrazinecarboxylic acid methyl ester and (1.5 equiv., 1.5 mmol, 170 μ L) of iodo benzene.
- Purification :** Flash column chromatography (silica gel, 9:1 PE:AcOEt).
- Product :** Orange oil.
- Isolated yield :** 65% for four steps.
- ¹H NMR** (δ , ppm) (CDCl₃, 400 MHz) 7.38-7.36 (m, 2H, CH-Ph), 7.31-7.28 (m, 5H, CH-Ph), 6.86 (t, $J = 7.3$ Hz, 1H, CH-Ph), 6.76 (br s, 2H, CH-Ph), 4.83 (d, $J = 17.3$ Hz, 1H, NCH₂), 4.33 (d, $J = 17.3$ Hz, 1H, NCH₂), 3.81 (br s, 0.7H, OCH₃ rotamere), 3.72 (br s, 2.3H, OCH₃), 3.31 (s, 3H, NCH₃).
- ¹³C NMR** (δ , ppm) (CDCl₃, 100 MHz) 156.9 (Cq, C=O), 147.9 (Cq, Ph), 131.6 (CH-Ph), 129.2 (CH-Ph), 128.3 (CH-Ph), 128.2 (CH-Ph), 122.6 (Cq, Ph), 119.0 (CH-Ph), 111.8 (CH-Ph), 84.2 (Cq, C \equiv C), 77.2 (Cq, C \equiv C), 53.5 (OCH₃), 39.4 (NCH₃), 38.6 (NCH₂).
- IR** (ν , cm⁻¹) (CCl₄) 3066 (w), 3033 (w), 3002 (w), 2956 (m), 2899 (w), 2817 (w), 1716 (s), 1600 (s), 1500 (s), 1491 (s), 1446 (s), 1416 (w), 1376 (s), 1349 (m), 1323 (m), 1269 (s), 1235 (s), 1194 (m), 1157 (m), 1119 (s), 1089 (m), 1066 (m), 1030 (m), 1005 (m).
- HRMS** (EI+, m/z) : Calculated: 294.1368 Found: 294.1370.

***N*-Methyl-*N*-pent-4-en-2-ynyl-*N*-phenyl-hydrazinecarboxylic acid methyl ester 6.11r**

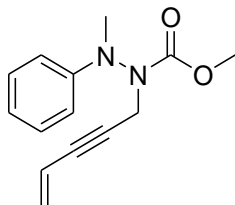

MF: C₁₄H₁₆O₂N₂

MW = 244 g.mol⁻¹

- Method :** See **general procedure 6.2** using (1 equiv, 10 mmol, 1.66 g) of *N*-phenyl-hydrazinecarboxylic acid methyl ester followed by **general procedure 6.3** using (1 equiv., 10 mmol, 1.64 mmol) of the previously prepared compound and (1.5 equiv., 15 mmol, solution 1.4 M in 3:1 toluene:THF, 10.7 mL) of MeMgBr followed by **general procedure 6.4** using (1 equiv., 10 mmol, 1.8 g) of *N*-methyl-*N*-phenyl-hydrazinecarboxylic acid methyl ester followed by **general procedure 6.5** using (1 equiv., 1 mmol, 218 mg) of *N*-methyl-*N*-phenyl-prop-2-ynyl-hydrazinecarboxylic acid methyl ester and (2 equiv., 2 mmol, solution 1M in THF, 2 mL) of vinyl bromide.
- Purification :** Flash column chromatography (silica gel, 9:1 PE:AcOEt).
- Product :** Orange oil.
- Isolated yield :** 61% for four steps.
- ¹H NMR** (δ, ppm) (CDCl₃, 400 MHz) 7.26 (t, *J* = 8.0Hz, 2H, CH-Ph), 6.84 (t, *J* = 7.3Hz, 1H, CH-Ph), 6.71 (br s, 2H, CH-Ph), 5.77 (dd, *J* = 11.0Hz, *J* = 17.3Hz, 1H, CH=CH₂), 5.59 (d, *J* = 17.3Hz, 1H, CH=CH₂), 5.47 (d, *J* = 11.0Hz, 1H, CH=CH₂), 4.72 (br d, *J* = 17.6Hz, 1H, NCH₂), 4.19 (d, *J* = 17.6Hz, 1H, NCH₂), 3.70 (br s, 3H, OCH₃), 3.26 (s, 3H, NCH₃).
- ¹³C NMR** (δ, ppm) (CDCl₃, 100 MHz) 156.8 (Cq, C=O), 147.8 (Cq, Ph), 129.2 (CH), 127.4 (CH=CH₂), 119.0 (CH), 116.6 (CH), 111.8 (CH), 84.9 (Cq, C≡C), 82.9 (Cq, C≡C), 53.5 (OCH₃), 39.3 (NCH₃), 38.5 (NCH₂).
- IR** (ν, cm⁻¹) (CCl₄) 3097 (w), 3031 (w), 2956 (w), 2817 (w), 1716 (s), 1600 (s), 1500 (s), 1446 (s), 1414 (w), 1376 (s), 1348 (m), 1323 (m), 1272 (m), 1236 (m), 1194 (w), 1148 (w), 1118 (m), 1089 (w), 1065 (w), 1031 (w).
- HRMS** (EI+, m/z) : Calculated: 244.1212 Found: 244.1212.

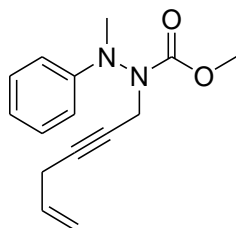
MF: C₁₅H₁₈O₂N₂MW = 258 g.mol⁻¹

Method : See **general procedure 6.2** using (1 equiv., 10 mmol, 1.66 g) of *N*-phenyl-hydrazinecarboxylic acid methyl ester followed by **general procedure 6.3** using (1 equiv., 10 mmol, 1.64 mmol) of the previously prepared compound and (1.5 equiv., 15 mmol, solution 1.4 M in 3:1 toluene:THF, 10.7 mL) of MeMgBr followed by **general procedure 6.4** using (1 equiv., 10 mmol, 1.8 g) of *N*-methyl-*N*-phenyl-hydrazinecarboxylic acid methyl ester.

Next, to a solution of propargylated hydrazine (1 equiv., 1 mmol, 218 mg) in DMF (1 M, 1 mL) under an argon atmosphere at room temperature was added K₂CO₃ (2.8 equiv., 2.8 mmol, 386 mg), tetrabutylammonium bromide (0.15 equiv., 0.15 mmol, 48 mg) and CuI (0.1 equiv., 0.1 mmol, 19 mg). The reaction was allowed to stir at room temperature for 30 min, allyl bromide (5 equiv., 5 mmol, 430 μL) and NaI (0.8 equiv., 0.8 mmol, 120 mg) were added and the reaction was allowed to stir at room temperature for 60 h. The reaction was then diluted with a saturated solution of NH₄Cl, extracted with AcOEt (3x), washed with H₂O (5x), dried (MgSO₄) and purified by flash column chromatography.

Purification : Flash column chromatography (silica gel, 9:1 PE: AcOEt).

Product : Yellow oil.

Isolated yield : 33% for four steps.

¹H NMR (δ, ppm) (CDCl₃, 400 MHz) 7.27-7.23 (m, 2H, CH-Ph), 6.83 (t, *J* = 7.3Hz, 1H, CH-Ph), 6.71 (br s, 2H, CH-Ph), 5.77 (ddd, *J* = 5.2Hz, *J* = 10.2Hz, *J* = 16.3Hz, 1H, CH=CH₂), 5.27 (dd, *J* = 1.0Hz, *J* = 16.3Hz, 1H, CH=CH₂), 5.09 (dd, *J* = 1.0Hz, *J* = 10.2Hz, 1H, CH=CH₂), 4.61 (br d, *J* = 17.4Hz, 1H, NCH₂), 4.09 (d, *J* = 17.4Hz, 1H, NCH₂), 3.69 (br s, 3H, OCH₃), 3.25 (s, 3H, NCH₃), 3.00 (br d, *J* = 5.2Hz, 2H, CH₂-allyl chain).

¹³C NMR (δ, ppm) (CDCl₃, 100 MHz) 156.9 (Cq, C=O), 148.0 (Cq, Ph), 132.2 (CH), 129.2 (CH), 118.9 (CH), 116.2 (CH=CH₂), 111.8 (CH), 81.2 (Cq, C≡C), 77.2 (Cq, C≡C), 53.4 (OCH₃), 39.3 (NCH₃), 38.3 (NCH₂), 23.0 (CH₂-allyl chain).

IR (ν, cm⁻¹) (CCl₄) 3093 (w), 3068 (w), 3031 (w), 2986 (w), 2956 (w), 2897 (w), 2816 (w), 1717 (s), 1643 (w), 1600 (s), 1500 (s), 1446 (s), 1419 (m), 1377 (s), 1349 (s), 1324 (s), 1274 (s), 1237 (s), 1194 (s), 1158 (m), 1117 (s), 1089 (m), 1065 (m), 1031 (m).

HRMS (EI+, m/z) : Calculated: 258.1368 Found: 258.1369.

***N*' methyl-*N*'-phenyl-*N*-prop-2-ynyl-[(4-methylphenyl)sulfonyl]hydrazine**

6.11t

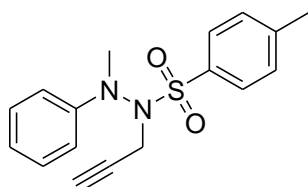

MF: C₁₇H₁₈O₂N₂S

MW = 314 g.mol⁻¹

- Method :** See **general procedure 6.2** using (1 equiv., 1 mmol, 262 mg) of *N*-phenyl-*N*'-tosyl hydrazine followed by **general procedure 6.3** using (1 equiv., 1 mmol, 260 mg) of the previously prepared compound and (1.5 equiv., 1.5 mmol, solution 1.4 M in 3:1 toluene:THF, 1.10 mL) of MeMgBr followed by **general procedure 6.4** using (1 equiv., 1 mmol, 276 mg) of the previously methylated compound.
- Purification :** Flash column chromatography (silica gel, 9:1 PE:AcOEt).
- Product :** Orange oil.
- Isolated yield :** 32% for three steps (last compound is not stable on SiO₂, it decomposes losing Ts group).
- ¹H NMR** (δ, ppm) (CDCl₃, 400 MHz) 7.85 (d, *J* = 8.2Hz, 2H, CH-Ts), 7.29 (d, *J* = 8.2Hz, 2H, CH-Ts), 7.19 (dd, *J* = 7.4Hz, *J* = 8.7Hz, 2H, CH-Ph), 6.87-6.82 (m, 3H, CH-Ph), 4.51 (br d, *J* = 17.5Hz, 1H, NCH₂), 4.08 (br d, *J* = 17.5Hz, NCH₂), 3.00 (s, 3H, NCH₃), 2.42 (s, 3H, Ph-CH₃), 2.23 (t, *J* = 2.5Hz, 1H, ≡CH).
- ¹³C NMR** (δ, ppm) (CDCl₃, 100 MHz) 147.9 (Cq, Ar), 144.2 (Cq, Ar), 135.6 (Cq, Ar), 129.5 (CH-Ar), 128.9 (CH-Ar), 128.4 (CH-Ar), 120.3 (CH-Ar), 113.6 (CH-Ar), 78.2 (Cq, C≡CH), 73.9 (C≡CH), 37.8 (NCH₃), 36.0 (NCH₂), 21.6 (Ph-CH₃).
- IR** (ν, cm⁻¹) (CCl₄) 3312 (m), 3068 (w), 3032 (w), 2925 (w), 2816 (w), 1600 (s), 1498 (s), 1470 (w), 1455 (w), 1417 (w), 1362 (s), 1305 (w), 1292 (w), 1264 (w), 1185 (m), 1168 (s), 1118 (m), 1096 (s), 1034 (w) 1019 (w)
- HRMS** (EI+, m/z) : Calculated: 314.1089 Found: 314.1080.

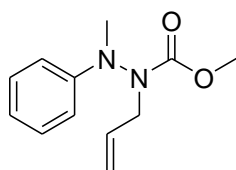
MF: C₁₂H₁₆O₂N₂MW = 220 g.mol⁻¹

- Method :** See **general procedure 6.2** using (1 equiv., 1.9 mmol, 315 mg) of *N*-phenylhydrazinecarboxylic acid methyl ester followed by **general procedure 6.3** using (1 equiv., 1.9 mmol, 312 mg) of the previously prepared compound and (1.5 equiv., 2.85 mmol, solution 1.4 M in 3:1 toluene: THF, 2.0 mL) of MeMgBr followed by **general procedure 6.4** using (1 equiv., 1.9 mmol, 350 mg) of *N*-methyl-*N*-phenylhydrazinecarboxylic acid methyl ester and allyl bromide (1.5 equiv., 2.85 mmol, 250 μ L) instead of propargyl bromide.
- Purification :** Flash column chromatography (silica gel, 9:1 PE:AcOEt).
- Product :** Orange oil.
- Isolated yield :** 70% for three steps.
- ¹H NMR** (δ , ppm) (CDCl₃, 400 MHz) 7.27-7.23 (m, 2H, CH-Ph), 6.82 (t, J = 7.3Hz, 1H, CH-Ph), 6.66 (br d, J = 7.3Hz, 2H, CH-Ph), 6.03-5.93 (m, 1H, CH=CH₂), 5.24 (dd, J = 1.2Hz, J = 17.1Hz, 1H, CH=CH₂), 5.17 (dd, J = 1.2Hz, J = 10.1Hz, 1H, CH=CH₂), 4.39 (br s, 1H, NCH₂), 3.88 (dd, J = 7.4Hz, J = 14.9Hz, 1H, NCH₂), 3.68 (br s, 3H, OCH₃), 3.15 (s, 3H, NCH₃).
- ¹³C NMR** (δ , ppm) (CDCl₃, 100 MHz) 162.7 (Cq, C=O), 157.2 (Cq, Ph), 148.1 (CH), 133.3 (CH), 129.2 (CH), 118.8 (CH=C_H), 111.7 (CH), 53.2 (OCH₃), 51.8 (NCH₂), 39.7 (NCH₃).
- IR** (ν , cm⁻¹) (CCl₄) 3070 (w), 3031 (w), 2997 (w), 2955 (m), 2899 (w), 2816 (w), 1713 (s), 1644 (w), 1600 (s), 1500 (s), 1447 (s), 1418 (w), 1378 (s), 1323 (s), 1277 (s), 1240 (s), 1194 (s), 1157 (s), 1113 (s), 1084 (m), 1056 (m), 1031 (m).
- HRMS** (EI+, m/z) : Calculated: 220.1212 Found: 220.1210.

***N*-(4-Methoxy-phenyl)-*N*-phenyl-*N*-prop-2-ynyl-hydrazinecarboxylic acid methyl ester 6.11v**

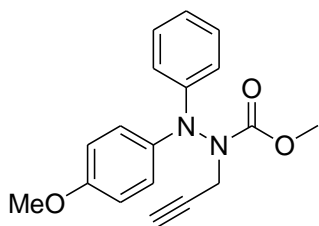

MF: C₁₈H₁₈O₃N₂

MW = 310 g.mol⁻¹

- Method :** See **general procedure 6.2** using (1 equiv., 1.5 mmol, 300 mg) of *N*-(4-methoxy-phenyl)-hydrazinecarboxylic acid methyl ester followed by **general procedure 6.3** using (1 equiv., 1.5 mmol, 291 mg) of the previously prepared compound and (1.5 equiv., 2.25 mmol, solution 1M in THF, 2.25 mL) of PhMgBr followed by **general procedure 6.4** using (1 equiv., 1.5 mmol, 416 mg) of *N*-(4-methoxy-phenyl)-*N*-phenyl-hydrazinecarboxylic acid methyl ester.
- Purification :** Flash column chromatography (silica gel, 85:15 PE: AcOEt).
- Product :** Orange oil.
- Isolated yield :** 82% for three steps.
- ¹H NMR** (δ, ppm) (CDCl₃, 400 MHz) 7.36-7.29 (br s, 2H, CH-Ar), 7.22 (t, *J* = 7.9Hz, 2H, CH-Ar), 6.90-6.85 (m, 5H, CH-Ar), 4.38 (br s, 2H, NCH₂), 3.82 (br s, 3H, OCH₃), 3.72 (br s, 3H, OCH₃), 2.25 (br s, ≡CH).
- ¹³C NMR** (δ, ppm) (CDCl₃, 100 MHz) 157.2 (Cq, C=O), 156.9 (Cq, C=O_{rotamere}), 145.7 (Cq, Ar), 136.3 (Cq, Ar), 133.30 (Cq, Ar), 128.9 (CH-Ar), 126.4 (CH-Ar_{rotamere}), 125.6 (CH-Ar), 120.4 (CH-Ar), 115.1 (CH-Ar), 114.5 (CH-Ar), 78.4 (Cq, C≡CH), 73.1 (≡CH), 55.5 (OCH₃), 53.6 (OCH₃), 39.8 (NCH₂_{rotamere}), 38.7 (NCH₂).
- IR** (ν, cm⁻¹) (CCl₄) 3313 (m), 3092 (w), 3066 (w), 3042 (w), 3003 (m), 2955 (m), 2934 (m), 2909 (w), 2836 (w), 1725 (s), 1599 (s), 1494 (s), 1445 (s), 1416 (m), 1378 (s), 1275 (s), 1196 (s), 1181 (s), 1126 (s), 1082 (m), 1040 (s).
- HRMS** (EI+, *m/z*) : Calculated: 310.1318 Found: 310.1317.

***N*-(4-Fluoro-phenyl)-*N*'-phenyl-*N*-prop-2-ynyl-hydrazinecarboxylic methyl ester**

acid 6.11w

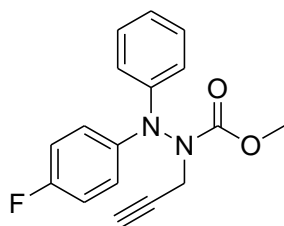

MF: C₁₇H₁₅O₂N₂F

MW = 298 g.mol⁻¹

- Method :** See **general procedure 6.2** using (1equiv., 1.6 mmol, 300 mg) of *N*-(4-fluorophenyl)-hydrazinecarboxylic acid methyl ester followed by **general procedure 6.3** using (1 equiv., 1.6 mmol, 297 mg) and (1.5 equiv., 2.45 mmol, solution 1M in THF, 2.5 mL) of PhMgBr followed by **general procedure 6.4** using (1 equiv., 1.6 mmol, 423 mg) of *N*-(4-fluorophenyl)-*N*'-phenyl-hydrazinecarboxylic acid methyl ester.
- Purification :** Flash column chromatography (silica gel, 9:1 PE: AcOEt).
- Product :** Yellow oil.
- Isolated yield :** 77% for three steps.
- ¹H NMR** (δ, ppm) (CDCl₃, 400 MHz) 7.32-7.25 (m, 4H, CH-Ar), 7.07-7.00 (m, 5H, CH-Ar), 4.49 (br d, *J* = 17.5Hz, 1H, NCH₂), 4.36 (br d, *J* = 17.5Hz, 1H, NCH₂), 3.85 (br s, 0.9H, CH₃ rotamere), 3.74 (br s, 2.1 H, OCH₃), 2.30 (br s, 1H, ≡CH).
- ¹³C NMR** (δ, ppm) (CDCl₃, 100 MHz) 160.6 (Cq, C=O), 157.49 (d, *J*_{C-F} = 141.0Hz, Cq, CF-Ar), 144.5 (Cq, Ar), 140.1 (Cq, Ar), 129.1 (CH-Ar), 124.1 (CH-Ar), 123.3 (CH-Ar rotamere), 122.0 (CH-Ar), 117.2 (CH-Ar), 115.9 (d, *J*_{C-F} = 22.6Hz, CH-Ar), 78.2 (Cq, C≡CH), 73.4 (C≡CH), 53.7 (OCH₃), 39.8 (NCH₂ rotamere), 38.7 (NCH₂).
- IR** (ν, cm⁻¹) (CCl₄) 3312 (m), 3043 (w), 2956 (w), 1720 (s), 1597 (m), 1506 (s), 1496 (s), 1446 (s), 1376 (m), 1317 (m), 1272 (m), 1232 (s), 1197 (m), 1174 (m), 1156 (m), 1126 (m), 1032 (w).
- HRMS** (EI+, *m/z*) : Calculated: 298.1118 Found: 298.1118.

4-(*N*-Methoxycarbonyl-*N*-phenyl-*N*-prop-2-ynyl-hydrazino)-benzoic acid ethyl ester 6.11x

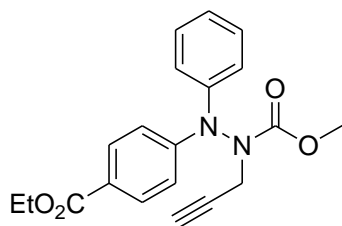

MF: C₂₀H₂₀O₄N₂

MW = 352 g.mol⁻¹

Method : See **general procedure 6.2** using (1 equiv., 1.26 mmol, 300 mg) of 4-(*N*-methoxycarbonyl-hydrazino)-benzoic acid ethyl ester followed by **general procedure 6.3** using (1 equiv., 1.26 mmol, 297 mg) of the previously prepared compound and (1.5 equiv., 1.89 mmol, solution 1M in THF, 1.9 mL) of PhMgBr followed by **general procedure 6.4** using (1 equiv., 1.26 mmol, 406 mg) of 4-(*N*-methoxycarbonyl-*N*-phenyl-hydrazino)-benzoic acid ethyl ester.

Purification : Flash column chromatography (silica gel, 8:2 PE:AcOEt).

Product : Orange oil.

Isolated yield : 72% for three steps.

¹H NMR (δ, ppm) (CDCl₃, 400 MHz) 7.91 (d, *J* = 8.8Hz, 2H, CH-Ar), 7.40-7.30 (m, 4H, CH-Ph), 7.22 (t, *J* = 7.3Hz, 1H, CH-Ph), 6.97 (d, *J* = 8.8Hz, 2H, CH-Ar), 4.54 (br d, *J* = 17.8Hz, 0.7H, NCH₂), 4.45 (br d, *J* = 17.8Hz, 0.3H_{rotamere}, NCH₂), 4.33 (q, *J* = 7.2Hz, 2H, OCH₂CH₃), 4.28 (d, *J* = 17.8Hz, 1H, NCH₂), 3.83 (br s, 1H, OCH₃ rotamere), 3.71 (br s, 2H, OCH₃), 2.25 (br s, 1H, ≡CH), 1.36 (t, *J* = 7.2Hz, 3H, OCH₂CH₃).

¹³C NMR (δ, ppm) (CDCl₃, 100 MHz) 166.3 (Cq, C=O), 156.4 (Cq, C=O), 149.2 (Cq, Ar), 142.0 (Cq, Ar), 130.9 (CH-Ar), 129.5 (CH-Ar), 125.9 (CH-Ar), 124.4 (CH-Ar rotamere), 123.6 (CH-Ar), 122.7 (Cq, Ar), 114.6 (CH-Ar), 77.7 (Cq, C≡CH), 73.7 (C≡CH), 60.5 (OCH₂CH₃), 53.8 (OCH₃), 39.6 (NCH₂ rotamere), 38.5 (NCH₂), 14.4 (OCH₂CH₃).

IR (ν, cm⁻¹) (CCl₄) 3312 (m), 2982 (w), 2957 (w), 2907 (w), 1716 (s), 1608 (s), 1594 (m), 1509 (m), 1492 (m), 1446 (m), 1425 (w), 1367 (m), 1313 (m), 1273 (s), 1238 (m), 1177 (s), 1107 (s), 1026 (s).

HRMS (EI+, m/z) : Calculated: 352.1423 Found: 352.1423.

B.3.5.2 Au(I)-catalyzed Friedel-Crafts reaction

Previous synthesized substrates were submitted to gold catalysis as it is shown in the scheme below.

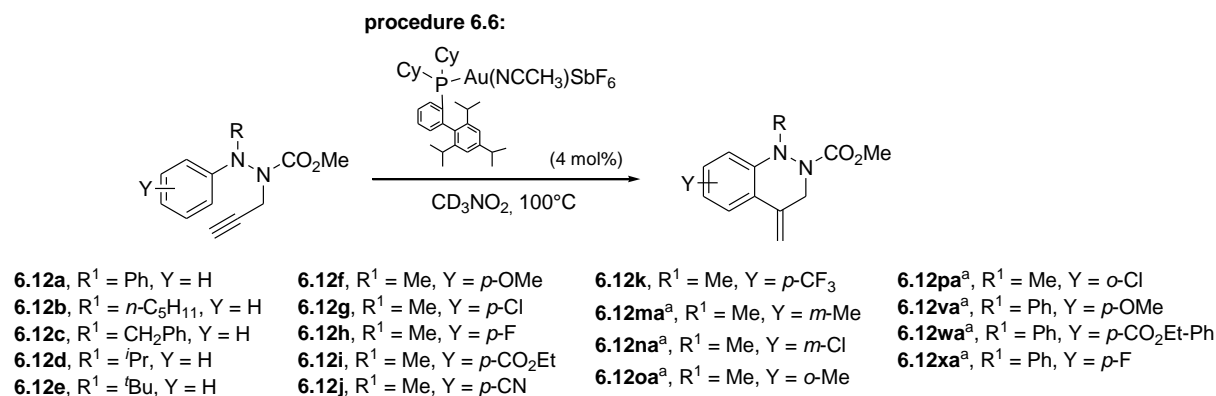

^a: Other regioisomers found

Scheme B.3.5.2: Gold catalyzed transformation towards tetrahydrocinnolines **6.12a-x**.

General Procedure 6.6, Gold catalyzed Friedel-Crafts reaction: To a reaction vessel (a NMR tube in our case) was added the hydrazine derivative (1 equiv.), the gold catalyst XphosAu(NCCH₃)SbF₆ (0.04 equiv.) and CD₃NO₂ (0.2 M). The reaction was heated up to reflux (100 °C). Upon completion (NMR), the reaction mixture was transferred to a round bottom flask and concentrated under reduced pressure. Flash column chromatography afforded the hydroarylated product in the stated yields.

4-Methylene-1-phenyl-3,4-dihydro-1H-cinnoline-2-carboxylic acid methyl ester **6.12a**

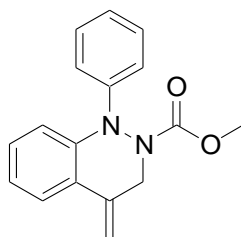

MF: C₁₇H₁₆O₂N₂

MW = 280 g.mol⁻¹

Method :	See general procedure 6.6 using (1 equiv., 0.1 mmol, 28 mg) of <i>N,N</i> -diphenyl- <i>N</i> -prop-2-ynyl-hydrazinecarboxylic acid methyl ester.
Purification :	Flash column chromatography (silica gel, 8:2 PE:AcOEt).
Product :	White solid.
Isolated yield :	100%.
¹H NMR (δ, ppm) (CDCl ₃ , 400 MHz)	7.80 (d, <i>J</i> = 7.9Hz, 1H, CH-Ar), 7.33-7.28 (m, 4H, CH-Ar), 7.20-7.14 (m, 3H, CH-Ar), 7.07 (t, <i>J</i> = 7.3Hz, 1H, CH-Ar), 5.74 (s, 1H, C=CH ₂), 5.11 (s, 1H, C=CH ₂), 4.84 (br s, 1H, NCH ₂), 4.07 (br s, 1H, NCH ₂), 3.83 (s, 3H, OCH ₃).
¹³C NMR (δ, ppm) (CDCl ₃ , 100 MHz)	158.0 (Cq, C=O), 146.6 (Cq), 140.2 (Cq), 134.8 (Cq), 129.0 (CH-Ar), 128.3 (CH-Ar), 125.3 (Cq), 124.8 (CH-Ar), 124.0 (CH-Ar), 123.1 (CH-Ar), 122.9 (CH-Ar), 118.1 (CH-Ar), 108.3 (C=C ₂ H ₂), 53.6 (OCH ₃), 47.3 (NCH ₂).
IR (ν, cm ⁻¹) (CCl ₄)	3069 (w), 3025 (w), 2945 (w), 2848 (w), 1740 (s), 1644(w), 1590 (w), 1572 (w), 1490 (s), 1400 (s), 1440 (s), 1384 (m), 1363 (s), 1350 (s), 1245 (s), 1200 (m), 1130 (m), 1100 (w).
HRMS (EI+, <i>m/z</i>) :	Calculated: 280.1212 Found: 280.1215.

4-Methylene-1-pentyl-3,4-dihydro-1*H*-cinnoline-2-carboxylic acid methyl ester 6.12b

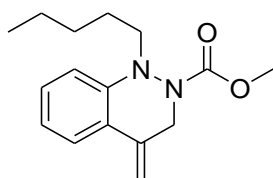

MF: C₁₆H₂₂O₂N₂

MW = 274 g.mol⁻¹

Method :	See general procedure 6.6 using (1 equiv., 0.1 mmol, 27 mg) of <i>N</i> -pentyl- <i>N</i> -phenyl- <i>N</i> -prop-2-ynyl-hydrazinecarboxylic acid methyl ester.
Purification :	Flash column chromatography (silica gel, 8:2 PE:AcOEt).
Product :	Yellow oil.
Isolated yield :	100%.

¹H NMR (δ, ppm) (CDCl ₃ , 400 MHz)	7.58 (dd, <i>J</i> = 1.1Hz, <i>J</i> = 7.9Hz, 1H, CH-Ar), 7.23-7.18 (m, 1H, CH-Ar), 6.92-6.82 (m, 2H, CH-Ar), 5.56 (s, 1H, C=CH ₂), 4.98 (s, 1H, C=CH ₂), 4.69 (br s, 1H, NCH ₂), 3.80 (br s, 1H, NCH ₂), 3.70 (s, 3H, OCH ₃), 3.44 (br s, 1H, NCH ₂), 3.32 (br s, 1H, NCH ₂), 1.68-1.58 (m, 2H, CH ₂ -pentyl chain), 1.38-1.36 (m, 4H, CH ₂ -pentyl chain), 0.94-0.91 (m, 3H, CH ₃ -pentyl chain).
¹³C NMR (δ, ppm) (CDCl ₃ , 100 MHz)	158.0 (Cq, C=O), 145.1 (Cq), 135.3 (Cq), 129.0 (CH-Ar), 124.5 (CH-Ar), 121.9 (Cq), 120.6 (CH-Ar), 117.5 (CH-Ar), 107.1 (C=C ₂ H ₂), 55.6 (NCH ₂), 53.2 (OCH ₃), 45.3 (NCH ₂), 29.3 (CH ₂ -pentyl chain), 27.3 (CH ₂ -pentyl chain), 22.6 (CH ₂ -pentyl chain), 14.1 (CH ₃ -pentyl chain).
IR (ν, cm ⁻¹) (CCl ₄)	3072 (w), 2957 (m), 2931 (m), 2873 (w), 2860 (w), 1730 (s), 1636 (w), 1601 (w), 1570 (w), 1499 (w), 1483 (m), 1448 (s), 1378 (m), 1331 (m), 1302 (m), 1268 (m), 1245 (m), 1213 (m), 1136 (w), 1122 (w), 1096 (w), 998 (w).
HRMS (EI+, m/z) :	Calculated: 274.1681 Found: 274.1690.

1-Benzyl-4-methylene-3,4-dihydro-1*H*-cinnoline-2-carboxylic acid methyl ester 6.12c

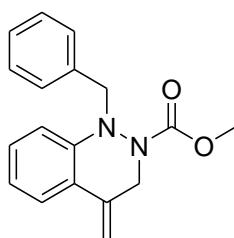

MF: C₁₈H₁₈N₂O₂

MW = 294 g.mol⁻¹

Method :	See general procedure 6.6 using (1 equiv., 0.1 mmol, 29 mg) of <i>N</i> -benzyl- <i>N</i> -phenyl- <i>N</i> -prop-2-ynyl-hydrazinecarboxylic acid methyl ester.
Purification :	Flash column chromatography (silica gel, 9:1 PE:AcOEt).
Product :	Yellow oil.
Isolated yield :	87%.
¹H NMR (δ, ppm) (CDCl ₃ , 400 MHz)	7.59 (d, <i>J</i> = 7.7Hz, 1H, CH-Ph), 7.37-7.21 (m, 6H, CH-Ph), 7.02 (d, <i>J</i> = 7.7Hz, 1H, CH-Ph), 6.91 (t, <i>J</i> = 7.7Hz, 1H, CH-Ph), 5.54 (s, 1H, C=CH ₂), 4.92 (s, 1H, C=CH ₂), 4.74 (br s, 1H, NCH ₂), 4.56 (br s, 2H, NCH ₂), 3.64 (s, 3H, OCH ₃), 3.51 (br s, 1H, NCH ₂).
¹³C NMR (δ, ppm) (CDCl ₃ , 100 MHz)	157.6 (Cq, C=O), 144.2 (Cq, Ar), 136.9 (Cq, Ar), 135.2 (Cq, Ar), 129.0 (CH-Ph), 128.7 (CH-Ph), 128.3 (CH-Ph), 127.6 (CH-Ph), 124.7 (CH-Ph), 122.0 (Cq, C=CH ₂), 120.7 (CH-Ph), 117.0 (CH-Ph), 107.2 (C=C ₂ H ₂), 59.2 (NCH ₂), 53.1 (OCH ₃), 46.4 (NCH ₂).

IR (ν , cm^{-1}) (CCl_4) 3067 (w), 3033 (w), 2955 (w), 2929 (w), 2855 (w), 1716 (s), 1637 (w), 1603 (w), 1569 (w), 1542 (w), 1484 (m), 1454 (s), 1377 (m), 1356 (m), 1329 (m), 1314 (m), 1246 (s), 1206 (s), 1164 (w), 1140 (w), 1119 (w), 1098 (w), 1080 (w), 1063 (w), 1044 (w), 1029 (w).

HRMS (EI+, m/z) : Calculated: 294.1368 Found: 294.1379.

1-Isopropyl-4-methylene-3,4-dihydro-1H-cinnoline-2-carboxylic acid methyl ester 6.12d ester

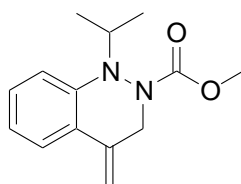

MF: $\text{C}_{14}\text{H}_{18}\text{N}_2\text{O}_2$

MW = 246 $\text{g}\cdot\text{mol}^{-1}$

Method : See **general procedure 6.6** (1 equiv., 0.1 mmol, 25 mg) of *N*-isopropyl-*N*-phenyl-*N*-prop-2-ynyl-hydrazinecarboxylic acid methyl ester.

Purification : Flash column chromatography (silica gel, 8:2 PE:AcOEt).

Product : Yellow pale oil.

Isolated yield : 96%.

^1H NMR (δ , ppm) 7.58 (dd, $J = 8.0$ Hz, 1H, CH-Ph), 7.20 (ddd, $J = 8.0$ Hz, 1H, CH-Ph), 6.99 (d, $J = 8.0$ Hz, 1H, CH-Ph), 6.87 (t, $J = 8.0$ Hz, 1H, CH-Ph), 5.54 (s, 1H, C=CH₂), 4.95 (s, 1H, C=CH₂), 4.80 (br d, $J = 15.0$ Hz, 1H, NCH₂), 4.09 (hept, $J = 6.6$ Hz, 1H, CH-^{*i*}Pr), 3.75 (d, $J = 15.0$ Hz, 1H, NCH₂), 3.69 (s, 3H, OCH₃), 1.32 (d, $J = 6.6$ Hz, 3H, CH₃-^{*i*}Pr), 1.15 (d, $J = 6.6$ Hz, 3H, CH₃-^{*i*}Pr).

^{13}C NMR (δ , ppm) 159.0 (Cq, C=O), 143.9 (Cq), 135.4 (Cq), 128.9 (CH-Ph), 124.6 (CH-Ph), 122.4 (Cq), 120.4 (CH-Ph), 118.0 (CH-Ph), 107.1 (C=CH₂), 56.0 (CH-^{*i*}Pr), 53.2 (OCH₃), 48.3 (NCH₂), 20.7 (CH₃-^{*i*}Pr), 19.8 (CH₃-^{*i*}Pr).

IR (ν , cm^{-1}) (CCl_4) 3072 (w), 2976 (m), 2955 (m), 1712 (s), 1636 (w), 1604 (w), 1568 (w), 1481 (m), 1456 (m), 1446 (s), 1384 (m), 1362 (m), 1313 (w), 1300 (w), 1280 (w), 1238 (m), 1204 (m), 1172 (w), 1132 (m), 1091 (w), 1043 (w).

HRMS (EI+, m/z) : Calculated: 246.1368 Found: 246.1374.

6-Methoxy-1-methyl-4-methylene-3,4-dihydro-1H-cinnoline-2-carboxylic acid methyl ester 6.12f

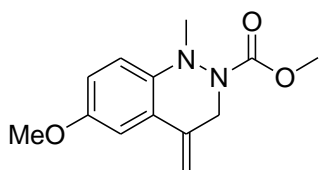

MF: C₁₃H₁₆N₂O₃

MW = 248 g.mol⁻¹

- Method :** See **general procedure 6.6** using (1 equiv., 0.11 mmol, 27 mg) of *N*-(4-methoxy-phenyl)-*N*-methyl-*N*-prop-2-ynyl-hydrazinecarboxylic acid methyl ester.
- Purification :** Flash column chromatography (silica gel, 8:2 PE:AcOEt).
- Product :** Yellow solid.
- Isolated yield :** 83 %.
- ¹H NMR** (δ, ppm) (CDCl₃, 400 MHz) 7.08 (d, *J* = 2.8Hz, 1H, CH-Ar), 6.91 (d, *J* = 8.9Hz, 1H, CH-Ar), 6.83 (dd, *J* = 2.8Hz, *J* = 8.9Hz, 1H, CH-Ar), 5.55 (s, 1H, C=CH₂), 5.03 (s, 1H, C=CH₂), 4.61 (br s, 1H, NCH₂), 3.98 (br s, 1H, NCH₂), 3.78 (s, 3H, OCH₃), 3.72 (s, 3H, OCH₃), 3.10 (s, 3H, NCH₃).
- ¹³C NMR** (δ, ppm) (CDCl₃, 100 MHz) 156.7 (Cq, C=O), 154.4 (Cq, Ar), 139.8 (Cq, Ar), 135.2 (Cq, Ar), 123.3 (Cq, Ar), 120.0 (CH-Ar), 116.1 (CH-Ar), 108.3 (CH-Ar), 107.8 (C=C₂H₂), 55.6 (OCH₃), 55.5 (NCH₂), 53.2 (OCH₃), 43.4 (NCH₃).
- IR** (ν, cm⁻¹) (CCl₄) 3001 (w), 2955 (w), 1711 (s), 1613 (w), 1571 (w), 1558 (w), 1542 (w), 1493 (s), 1454 (s), 1388 (w), 1295 (w), 1234 (s), 1118 (m), 1048 (w).
- HRMS** (EI+, *m/z*) : Calculated: 248.1161 Found: 248.1162 .

6-Chloro-1-methyl-4-methylene-3,4-dihydro-1H-cinnoline-2-carboxylic acid methyl ester 6.12g

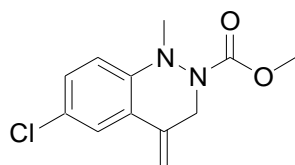

MF: C₁₂H₁₃N₂O₂Cl

MW = 252 g.mol⁻¹

Method :	See general procedure 6.6 using (1 equiv., 0.08 mmol, 20 mg) of <i>N</i> -(4-chlorophenyl)- <i>N</i> -methyl- <i>N</i> -prop-2-ynyl-hydrazinecarboxylic acid methyl ester.
Purification :	Flash column chromatography (silica gel, 7:3 PE:AcOEt).
Product :	White solid.
Isolated yield :	100%.
¹H NMR (δ, ppm) (CDCl ₃ , 400 MHz)	7.52 (d, <i>J</i> = 2.1Hz, 1H, CH-Ar), 7.16 (dd, <i>J</i> = 2.1Hz, <i>J</i> = 8.8Hz, 1H, CH-Ar), 6.81 (d, <i>J</i> = 8.8Hz, 1H, CH-Ar), 5.55 (s, 1H, C=CH ₂), 5.03 (s, 1H, C=CH ₂), 4.63 (br s, 1H, NCH ₂), 3.78 (br s, 1H, NCH ₂), 3.72 (s, 3H, OCH ₃), 3.18 (NCH ₃).
¹³C NMR (δ, ppm) (CDCl ₃ , 100 MHz)	157.0 (Cq, C=O), 143.5 (Cq), 134.3 (Cq), 128.9 (CH-Ar), 125.8 (Cq), 124.3 (CH-Ar), 123.0 (Cq), 117.9 (CH-Ar), 108.4 (C=CH ₂), 53.4 (OCH ₃), 45.5 (NCH ₂), 42.2 (NCH ₃).
IR (ν, cm ⁻¹) (CCl ₄)	2956 (w), 1720 (s), 1484 (s), 1448 (s), 1375 (s), 1308 (w), 1244 (m), 1212 (s), 1150 (w), 1119 (w).
HRMS (EI+, m/z) :	Calculated: 252.0666 Found: 252.0667.

6-Fluoro-1-methyl-4-methylene-3,4-dihydro-1*H*-cinnoline-2-carboxylic acid methyl ester 6.12h

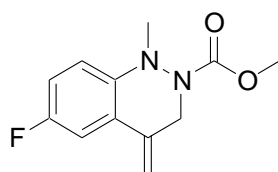

MF: C₁₂H₁₃O₂N₂F

MW = 236 g.mol⁻¹

Method :	See general procedure 6.6 using (1 equiv., 0.1 mmol, 24 mg) of <i>N</i> -(4-fluorophenyl)- <i>N</i> -methyl- <i>N</i> -prop-2-ynyl-hydrazinecarboxylic acid methyl ester.
Purification :	Flash column chromatography (silica gel, 8:2 PE:AcOEt).
Product :	Yellow pale solid.
Isolated yield :	79%.
¹H NMR (δ, ppm)	7.25 (dd, <i>J</i> _{H-H} = 2.6Hz, <i>J</i> _{H-F} = 9.0Hz, 1H, CH-Ar), 6.94 (ddd, <i>J</i> _{H-H} = 2.6Hz, <i>J</i> _{H-F} = 7.8Hz, <i>J</i> _{H-H} = 9.0Hz, 1H, CH-Ar), 6.88 (dd, <i>J</i> _{H-F} = 5.0Hz, <i>J</i> _{H-H} = 9.0Hz, 1H, CH-Ar), 5.54 (s, 1H, C=CH ₂), 5.06 (s, 1H, C=CH ₂), 4.64 (br s, 1H, NCH ₂), 3.88 (br

(CDCl₃, 400 MHz) s, 1H, NCH₂), 3.73 (s, 3H, OCH₃), 3.14 (s, 3H, NCH₃).

¹³C NMR (δ, ppm) 157.6 (d, J_{C-F} = 239.7Hz, Cq, C-F), 156.8 (Cq, C=O), 141.71 (d, J = 1.7Hz, Cq, Ar), 134.6 (Cq), 123.5 (Cq), 119.32 (d, J_{C-F} = 8.0Hz, CH-Ar), 116.20 (d, J_{C-F} = 23.2Hz, CH-Ar), 110.36 (d, J_{C-F} = 23.2Hz, CH-Ar), 108.6 (C=CH₂), 53.3 (OCH₃), 47.7 (NCH₂), 43.0 (NCH₃).

IR (ν, cm⁻¹) (CCl₄) 2956 (w), 1724 (s), 1635 (w), 1581 (w), 1509 (w), 1491 (s), 1452 (s), 1383 (w), 1292 (w), 1243 (m), 1212 (s), 1133 (w), 1114 (w), 1080 (w).

HRMS (EI+, m/z) : Calculated: 236.0961 Found: 236.0962.

1-Methyl-4-methylene-3,4-dihydro-1H-cinnoline-2,6-dicarboxylic acid 6-ethyl ester 2-methyl ester 6.12i

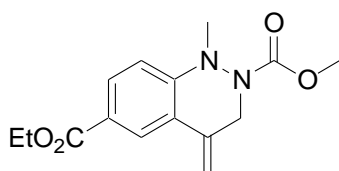

MF: C₁₅H₁₈N₂O₄

MW = 290 g.mol⁻¹

Method : See **general procedure 6.6** using (1 equiv., 0.1 mmol, 29 mg) of 4-(*N*-methoxycarbonyl-*N*-methyl-*N*-prop-2-ynyl-hydrazino)-benzoic acid ethyl ester

Purification : Flash column chromatography (silica gel, 7:3 PE:AcOEt).

Product : Yellow oil.

Isolated yield : 86% (with ~17% inseparable impurity based on ¹H NMR).

¹H NMR (δ, ppm) 8.24 (d, J = 1.8Hz, 1H, CH-Ar), 7.87 (dd, J = 1.8Hz, J = 8.7Hz, 1H, CH-Ar), 6.76 (d, J = 8.7Hz, 1H, CH-Ar), 5.66 (s, 1H, C=CH₂), 5.00 (s, 1H, C=CH₂), 4.69 (br s, 1H, NCH₂), 4.34 (q, J = 7.1Hz, 2H, OCH₂CH₃), 3.80 (br s, 1H, NCH₂), 3.72 (s, 3H, OCH₃), 3.30 (s, 3H, NCH₃), 1.37 (t, J = 7.1Hz, 3H, OCH₂CH₃).

¹³C NMR (δ, ppm) 166.5 (Cq, C=O), 157.5 (Cq, C=O), 147.4 (Cq), 130.4 (CH-Ar), 126.7 (CH-Ar), 121.0 (Cq), 119.9 (Cq), 113.4 (CH-Ph), 110.8 (Cq), 108.1 (C=CH₂), 60.6 (OCH₂CH₃), 53.5 (OCH₃), 41.0 (NCH₂), 38.1 (NCH₃), 14.4 (OCH₂CH₃).

IR (ν, cm⁻¹) (CCl₄) 2982 (w), 2957 (w), 1715 (s), 1608 (m), 1559 (w), 1499 (w), 1446 (m), 1367 (w), 1308 (m), 1276 (m), 1258 (s), 1216 (s), 1175 (w), 1154 (m), 1110 (m), 1025 (w).

HRMS (EI+, m/z) : Calculated: 290.1267 Found: 290.1265.

6-Cyano-1-methyl-4-methylene-3,4-dihydro-1H-cinnoline-2-carboxylic acid methyl ester 6.12j

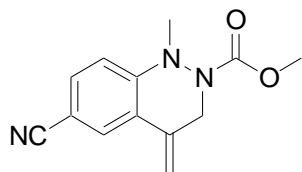

MF: C₁₃H₁₃N₃O₂

MW = 243 g.mol⁻¹

- Method :** See **general procedure 6.6** using (1 equiv., 0.1 mmol, 24 mg) of *N*-(4-cyano-phenyl)-*N*-methyl-*N*-prop-2-ynyl-hydrazinecarboxylic acid methyl ester.
- Purification :** Flash column chromatography (silica gel, 7:3 PE:AcOEt).
- Product :** Yellow solid.
- Isolated yield :** 63%.
- ¹H NMR** (δ, ppm) (CDCl₃, 400 MHz) 7.79 (d, *J* = 1.8Hz, 1H, CH-Ar), 7.44 (dd, *J* = 1.8Hz, *J* = 8.6Hz, 1H, CH-Ar), 6.75 (d, *J* = 8.6Hz, 1H, CH-Ar), 5.57 (s, 1H, C=CH₂), 5.03 (s, 1H, C=CH₂), 4.65 (br s, 1H, NCH₂), 3.79 (br s, 1H, NCH₂), 3.73 (s, 3H, OCH₃), 3.31 (s, 3H, NCH₃).
- ¹³C NMR** (δ, ppm) (CDCl₃, 100 MHz) 157.5 (Cq, C=O), 146.6 (Cq), 132.4 (CH-Ar), 129.1 (CH-Ar), 120.5 (Cq), 119.6 (Cq), 113.5 (CH-Ar), 111.6 (Cq), 109.0 (C=CH₂), 101.5 (Cq, CN), 53.6 (OCH₃), 47.7 (NCH₂), 40.6 (NCH₃).
- IR** (ν, cm⁻¹) (CCl₄) 2957 (w), 2929 (w), 2226 (m, CN), 1732 (s, C=O), 1635 (w), 1608 (m), 1497 (m), 1446 (m), 1371 (w), 1325 (m), 1279 (w), 1243 (m), 1217 (m), 1194 (w), 1159 (w), 1117 (w), 1085 (w), 1064 (w).
- HRMS** (EI+, m/z) : Calculated: 243.1008 Found: 243.1002.

1-Methyl-4-methylene-6-trifluoromethyl-3,4-dihydro-1H-cinnoline-2-carboxylic acid methyl ester 6.12k

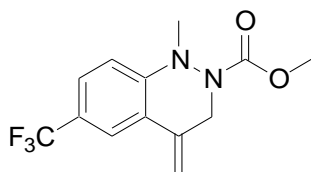

MF: C₁₃H₁₃O₂N₂F₃

MW = 286 g.mol⁻¹

Method :	See general procedure 6.6 using (1 equiv., 0.1 mmol, 29 mg) of <i>N</i> -methyl- <i>N</i> -prop-2-ynyl- <i>N</i> -(4-trifluoromethyl-phenyl)-hydrazinecarboxylic acid methyl ester
Purification :	Flash column chromatography (silica gel, 8:2 PE:AcOEt).
Product :	White solid.
Isolated yield :	76%.
¹H NMR (δ, ppm) (CDCl ₃ , 400 MHz)	7.78 (d, <i>J</i> _{H-H} = 1.6Hz, 1H, CH-Ar), 7.43 (dd, <i>J</i> _{H-H} = 1.6Hz, <i>J</i> _{H-H} = 8.6Hz, 1H, CH-Ar), 6.84 (d, <i>J</i> _{H-H} = 8.6Hz, 1H, CH-Ar), 5.61 (s, 1H, C=CH ₂), 5.04 (s, 1H, C=CH ₂), 4.66 (br s, 1H, NCH ₂), 3.80 (br s, 1H, NCH ₂), 3.73 (s, 3H, OCH ₃), 3.28 (s, 3H, NCH ₃).
¹³C NMR (δ, ppm) (CDCl ₃ , 100 MHz)	157.5 (Cq, C=O), 152.0 (q, <i>J</i> _{C-F} = 21.0Hz, Cq, Ar), 146.5 (Cq), 134.4 (Cq), 125.8 (q, <i>J</i> _{C-F} = 2.8Hz, CH-Ar), 122.0 (q, <i>J</i> _{C-F} = 3.7Hz, CH-Ar), 120.5 (Cq), 114.2 (q, <i>J</i> _{C-F} = 256.0 Hz, Cq, CF ₃), 114.5 (CH-Ar), 108.5 (C=C ₂ H ₂), 53.5 (OCH ₃), 46.7 (NCH ₂), 41.3 (NCH ₃).
IR (ν, cm ⁻¹) (CCl ₄)	3003 (w), 2957 (m), 2930 (m), 2856 (w), 1728 (s), 1622 (s), 1576 (w), 1542 (s), 1509 (m), 1445 (s), 1334 (s), 1284 (s), 1213 (s), 1171 (s), 1150 (s), 1126 (s), 1085 (s), 1008 (m).
HRMS (EI+, m/z) :	Calculated: 286.0934 Found: 286.0934.

1,5-Dimethyl-4-methylene-3,4-dihydro-1*H*-cinnoline-2-carboxylic acid methyl ester **6.12mb**

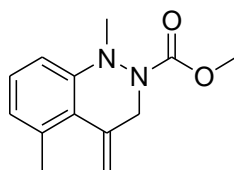

MF: C₁₃H₁₆N₂O₂

MW = 232 g.mol⁻¹

Method :	See general procedure 6.6 using (1 equiv., 0.1 mmol, 23 mg) of <i>N</i> -methyl- <i>N</i> -prop-2-ynyl- <i>N</i> - <i>m</i> -tolyl-hydrazinecarboxylic acid methyl ester.
Purification :	Flash column chromatography (silica gel, 9:1 PE:AcOEt).
Product :	Transparent oil.
Isolated yield :	48%.

¹H NMR (δ, ppm) 7.11 (t, *J* = 8.0Hz, 1H, CH-Ar), 6.78 (d, *J* = 8.0Hz, 2H, CH-Ar), 5.41 (s, 1H, C=CH₂), 5.31 (br s, 1H, C=CH₂), 4.52 (br s, 1H, NCH₂), 3.83 (br s, 1H, NCH₂), 3.74 (s, 3H, OCH₃), 3.19 (s, 3H, NCH₃), 2.47 (s, 3H, CH₃).
(CDCl₃, 400 MHz)

¹³C NMR (δ, ppm) 157.0 (Cq, C=O), 146.1 (Cq), 136.8 (Cq), 135.0 (Cq), 127.7 (CH-Ar), 124.0 (CH-Ar), 121.8 (Cq), 114.9 (C=CH₂), 114.5 (CH-Ar), 53.2 (OCH₃), 46.7 (NCH₂), 43.5 (NCH₃), 23.2 (CH₃).
(CDCl₃, 100 MHz)

IR (ν, cm⁻¹) (CCl₄) 3068 (w), 2956 (s), 2857 (s), 2810 (w), 1716 (s), 1633 (m), 1593 (m), 1574 (m), 1468 (s), 1445 (s), 1378 (s), 1330 (s), 1310 (s), 1260 (s), 1234 (s), 1210 (s), 1132 (s), 1083 (s), 1032 (w).

HRMS (EI+, *m/z*) : Calculated: 232.1212 Found: 232.1208.

7-Chloro-1-methyl-4-methylene-3,4-dihydro-1*H*-cinnoline-2-carboxylic acid methyl ester and 5-Chloro-1-methyl-4-methylene-3,4-dihydro-1*H*-cinnoline-2-carboxylic acid methyl ester **6.12na + 6.12nb**

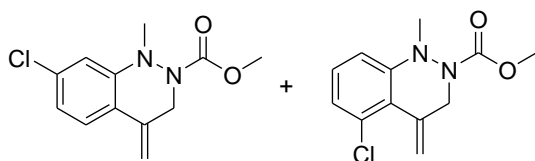

MF: C₁₂H₁₃O₂N₂Cl

MW = 252 g.mol⁻¹

Method : See **general procedure 6.6** using (1 equiv., 0.1 mmol, 25 mg) of *N*-(3-chloro-phenyl)-*N*-methyl-*N*-prop-2-ynyl-hydrazinecarboxylic acid methyl ester.

Purification : Flash column chromatography (silica gel, 8:2 PE:AcOEt).

Product : Yellow oil.

Isolated yield : 96% (mixture inseparable of regioisomers 1:1).

¹H NMR (δ, ppm) **Mixture of regioisomers:** 7.47 (d, *J* = 8.9Hz, 1H, CH-Ar), 7.09 (t, *J* = 8.1Hz, 1H, CH-Ar), 6.94 (d, *J* = 7.8Hz, 1H, CH-Ar), 6.83-6.81 (m, 2H, CH-Ar), 6.77 (d, *J* = 8.3Hz, 1H, CH-Ar), 6.18 (s, 1H, C=CH₂), 5.52 (s, 1H, C=CH₂), 5.39 (br s, 1H, C=CH₂), 4.98 (br s, 1H, C=CH₂), 4.55 (br s, 2H, NCH₂), 3.74 (s, 3H, OCH₃), 3.72 (s, 3H, OCH₃), 3.66 (br s, 2H, NCH₂), 3.22 (s, 3H, NCH₃), 3.20 (s, 3H, NCH₃).
(CDCl₃, 400 MHz)

¹³C NMR (δ, ppm) **Mixture of regioisomers:** 157.3 (Cq, C=O), 157.0 (Cq, C=O), 146.6 (Cq), 145.5 (Cq), 134.6 (Cq), 134.5 (Cq), 132.7 (Cq), 132.2 (Cq), 128.3 (CH-Ar), 125.8 (CH-Ar x2), 122.7 (CH-Ar), 120.2 (CH-Ar), 119.7 (CH-Ar), 117.2 (C=CH₂), 115.6 (Cq), 114.2 (Cq), 107.5 (C=CH₂), 53.4 (OCH₃), 53.3 (OCH₃),
(CDCl₃, 100 MHz)

43.2 (NCH₂), 41.7 (NCH₂), 39.2 (NCH₃), 38.5 (NCH₃).

IR (ν , cm⁻¹) (CCl₄) 3001 (w), 2956 (m), 2928 (w), 2813 (w), 1721 (s), 1634 (w), 1595 (s), 1561 (m), 1486 (s), 1447 (s), 1374 (s), 1312 (s), 1214 (s), 1156 (s), 1118 (s), 1103 (s), 1076 (s), 1062 (s).

HRMS (EI+, m/z) : Calculated: 252.0666 Found: 252.0653.

1,8-Dimethyl-4-methylene-3,4-dihydro-1<i>H</i>-cinnoline-2-carboxylic acid methyl ester and 1,9-Dimethyl-1,3-dihydro-benzo[<i>c</i>][1,2]diazepine-2-carboxylic acid methyl ester	6.12oa + 6.12ob
--	------------------------

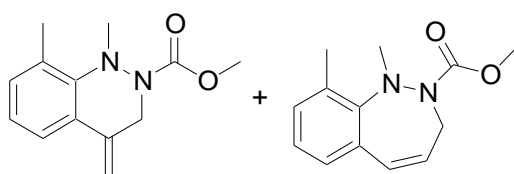

MF: C₁₃H₁₆N₂O₂

MW = 232 g.mol⁻¹

Method : See **general procedure 6.6** using (1 equiv., 0.11 mmol, 25 mg) of *N*-methyl-*N*-prop-2-ynyl-*N*-*o*-tolyl-hydrazinecarboxylic acid methyl ester.

Purification : Flash column chromatography (silica gel, 8:2 PE:AcOEt).

Product : Yellow oil.

Isolated yield : 81% (mixture inseparable of regioisomers, ratio 6.5:1).

¹H NMR (δ , ppm) (CDCl₃, 400 MHz) **6-*exo* product:** 7.51 (d, $J = 7.6$ Hz, 1H, CH-Ar), 7.10 (d, $J = 7.6$ Hz, 1H, CH-Ar), 7.03-6.97 (m, 1H, CH-Ar), 5.62 (s, 1H, C=CH₂), 5.07 (s, 1H, C=CH₂), 4.78 (br d, $J = 14.8$ Hz, 1H, NCH₂), 4.33 (br d, $J = 14.8$ Hz, 1H, NCH₂), 3.71 (s, 3H, OCH₃), 2.93 (s, 3H, NCH₃), 2.37 (s, 3H, CH₃).

7-*endo* product: 7.08-7.07 (m, 1H, CH-Ar), 7.03-6.96 (m, 2H, CH-Ar), 6.39 (d, $J = 12.4$ Hz, 1H, CH=), 5.85 (ddd, $J = 2.1$ Hz, $J = 4.8$ Hz, $J = 12.4$ Hz, 1H, CH=), 5.00 (br d, $J = 14.8$ Hz, 1H, NCH₂), 4.26 (br d, $J = 14.8$ Hz, 1H, NCH₂), 3.65 (s, 3H, OCH₃), 2.93 (s, 3H, NCH₃), 2.49 (CH₃).

¹³C NMR (δ , ppm) (CDCl₃, 100 MHz) **6-*exo* product:** 156.3 (Cq, C=O), 145.4 (Cq), 135.4 (Cq), 131.0 (CH-Ar), 130.5 (Cq), 125.4 (Cq), 123.9 (CH-Ar), 121.8 (CH-Ar), 108.1 (C=C₂H₂), 53.1 (OCH₃), 42.2 (NCH₂), 41.7 (NCH₃), 17.9 (CH₃).

7-*endo* product: 157.0 (Cq, C=O), 147.0 (Cq, Ar), 133.9 (Cq, Ar), 130.5 (Cq, Ar), 130.4 (CH), 130.4 (CH), 128.9 (CH), 127.7 (CH), 125.0 (CH), 53.0 (OCH₃), 45.1 (NCH₂), 38.7 (NCH₃), 18.4 (CH₃).

IR (ν , cm⁻¹) (CCl₄) 2956 (w), 2924 (w), 2857 (w), 1707 (s), 1630 (w), 1593 (w), 1558 (m), 1542 (m), 1452 (s), 1390 (m), 1313 (w), 1279 (w), 1263 (w), 1250 (m), 1228 (w), 1197 (w), 1139 (w), 1110 (w), 1089 (w), 1035 (w).

HRMS (EI+, m/z) : Calculated: 232.1208 Found: 232.1208.

6-Methoxy-4-methylene-1-phenyl-3,4-dihydro-1*H*-cinnoline-2-carboxylic acid methyl ester and 1-(4-Methoxy-phenyl)-4-methylene-3,4-dihydro-1*H*-cinnoline-2-carboxylic acid methyl ester 6.12va + 6.12vb

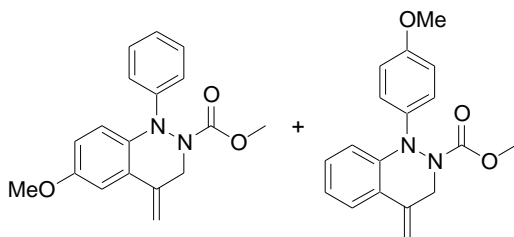

MF: C₁₈H₁₈O₃N₂

MW = 310 g.mol⁻¹

Method : See **general procedure 6.6** using (1 equiv., 0.1 mmol, 31 mg) of *N*-(4-methoxy-phenyl)-*N*-phenyl-*N*-prop-2-ynyl-hydrazinecarboxylic acid methyl ester.

Purification : Flash column chromatography (silica gel, 85:15 PE:AcOEt).

Product : Dark green oil.

Isolated yield : 84% (inseparable mixture of regioisomers, ratio: 1: 2).

¹H NMR (δ, ppm) (CDCl₃, 400 MHz) **Major regioisomer:** 7.72 (d, *J* = 7.7Hz, 1H, CH-Ar), 7.24-6.96 (m, 5H, CH-Ar), 6.82 (d, *J* = 9.0Hz, 2H, CH-Ar), 5.67 (s, 1H, C=CH₂), 5.05 (s, 1H, C=CH₂), 4.69 (br s, 2H, NCH₂), 3.78 (s, 6H, OCH₃).

Minor regioisomer: 7.24-6.96 (m, 8H, CH-Ar), 5.65 (s, 1H, C=CH₂), 5.10 (s, 1H, C=CH₂), 4.69 (br s, 2H, NCH₂), 3.84 (s, 3H, OCH₃), 3.77 (s, 3H, OCH₃).

¹³C NMR (δ, ppm) (CDCl₃, 100 MHz) **Major and minor regioisomers:** 157.9 (Cq), 157.8 (Cq), 156.4 (Cq), 156.3 (Cq), 147.0 (Cq), 141.2 (Cq), 140.6 (Cq), 137.7 (Cq), 134.8 (Cq), 134.7 (Cq), 133.7 (Cq), 132.8 (Cq), 129.0 (CH-Ar), 128.4 (CH-Ar), 125.0 (CH-Ar), 124.6 (CH-Ar), 123.1 (CH-Ar), 122.3 (CH-Ar), 122.2 (CH-Ar), 121.9 (CH-Ar), 117.2 (CH-Ar), 115.1 (CH-Ar), 114.2 (CH-Ar), 109.2 (C=CH₂), 108.7 (CH-Ar), 108.1 (C=CH₂), 55.5 (OCH₃), 55.4 (OCH₃), 53.6 (OCH₃), 53.5 (OCH₃), 46.6 (NCH₂), 46.3 (NCH₂).

IR (ν, cm⁻¹) (CCl₄) 3072 (w), 3001 (m), 2955 (m), 2934 (m), 2910 (m), 2855 (w), 2836 (m), 1717 (s), 1632 (w), 1598 (m), 1571 (w), 1558 (s), 1555 (s), 1551 (s), 1547 (s), 1543 (s), 1508 (s), 1492 (s), 1450 (s), 1378 (s), 1297 (s), 1246 (s), 1181 (s), 1131 (s), 1041 (s).

HRMS (EI+, m/z) : Calculated: 310.1318 Found: 310.1309.

4-Methylene-1-phenyl-3,4-dihydro-1*H*-cinnoline-2,6-dicarboxylic acid 6-ethyl ester 2-methyl ester and 1-(4-Ethoxycarbonyl-phenyl)-4-methylene-3,4-dihydro-1*H*-cinnoline-2-carboxylic acid methyl ester **6.12wa + 6.12 wb**

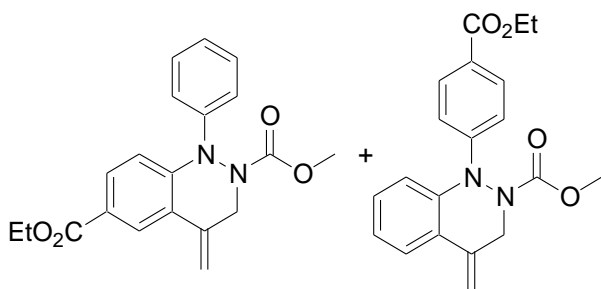

MF: C₂₀H₂₀N₂O₄

MW = 352 g.mol⁻¹

- Method :** See **general procedure 6.6** using (1 equiv., 0.1 mmol, 35 mg) of 4-(*N*-methoxycarbonyl-*N*-phenyl-*N*-prop-2-ynyl-hydrazino)-benzoic acid ethyl ester.
- Purification :** Flash column chromatography (silica gel, 8:2 PE: AcOEt).
- Product :** Yellow pale oil.
- Isolated yield :** 97% (inseparable mixture of regioisomers, ratio 1:1.5).
- ¹H NMR** (δ, ppm) (CDCl₃, 400 MHz)
Minor product: 8.43 (d, *J* = 1.8Hz, 1H, CH-Ar), 7.85 (dd, *J* = 1.8Hz, *J* = 8.6Hz, 1H, CH-Ar), 7.32-7.08 (m, 6H, CH-Ar), 5.81 (s, 1H, C=CH₂), 5.13 (s, 1H, C=CH₂), 4.87 (br s, 1H, NCH₂), 4.38 (q, *J* = 7.2Hz, 2H, OCH₂CH₃), 4.37 (br s, 1H, NCH₂), 3.76 (s, 3H, OCH₃), 1.39 (t, *J* = 7.2Hz, 3H, OCH₂CH₃).
- Major product:** 7.93 (d, *J* = 9.0Hz, 2H, CH-Ar), 7.76 (d, *J* = 7.9Hz, 1H, CH-Ar), 7.32-7.08 (m, 5H, CH-Ar), 5.70 (s, 1H, C=CH₂), 5.08 (s, 1H, C=CH₂), 4.34 (q, *J* = 7.2Hz, 2H, OCH₂CH₃), 4.06 (br d, *J* = 14.9Hz, 1H, NCH₂), 3.76 (s, 3H, OCH₃), 3.73 (br s, 1H, NCH₂), 1.37 (t, *J* = 7.1Hz, 3H, OCH₂CH₃).
- ¹³C NMR** (δ, ppm) (CDCl₃, 100 MHz)
Major and minor products: 166.2 (Cq, C=O), 166.0 (Cq, C=O), 158.1 (Cq, C=O), 157.8 (Cq, C=O), 149.6 (Cq), 145.5 (Cq), 143.9 (Cq), 138.9 (Cq), 134.3 (Cq), 133.9 (Cq), 130.9 (CH-Ar), 129.2 (CH-Ar), 129.1 (CH-Ar), 128.4 (CH-Ar), 126.8 (CH-Ar), 126.2 (Cq), 126.0 (Cq), 125.0 (CH-Ar), 124.1 (CH-Ar), 123.9 (CH-Ar), 123.2 (CH-Ar), 121.1 (CH-Ar), 119.8 (CH-Ar), 115.5 (CH-Ar), 113.2 (Cq), 112.7 (Cq), 109.4 (C=CH₂), 109.0 (C=CH₂), 60.9 (OCH₂CH₃), 60.6 (OCH₂CH₃), 53.8 (OCH₃), 53.7 (OCH₃), 48.5 (NCH₂), 47.9 (NCH₂), 14.4 (OCH₂CH₃), 14.3 (OCH₂CH₃).
- IR** (ν, cm⁻¹) (CCl₄) 3070 (w), 3031 (w), 2982 (m), 2957 (m), 2932 (m), 2873 (w), 2855 (w), 1717 (s), 1631 (m), 1599 (s), 1509 (s), 1494 (s), 1482 (s), 1448 (s), 1367 (s), 1311 (s), 1271 (s), 1215 (s), 1175 (s), 1109 (s), 1024 (s).
- HRMS** (EI+, *m/z*) : Calculated: 352.1423 Found: 352.1438.

6-Fluoro-4-methylene-1-phenyl-3,4-dihydro-1*H*-cinnoline-2-carboxylic acid methyl ester and 1-(4-Fluoro-phenyl)-4-methylene-3,4-dihydro-1*H*-cinnoline-2-carboxylic acid methyl ester 6.12xa + 6.12 xb

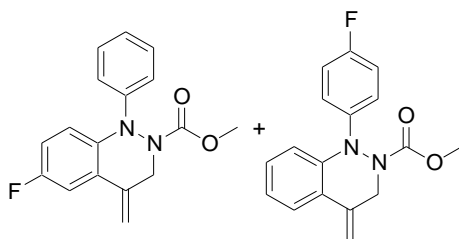

MF: C₁₇H₁₅O₂N₂F

MW = 298 g.mol⁻¹

- Method :** See **general procedure 6.6** using (1 equiv., 0.1 mmol, 30 mg) of *N*-(4-fluoro-phenyl)-*N*-phenyl-*N*-prop-2-ynyl-hydrazinecarboxylic acid methyl ester.
- Purification :** Flash column chromatography (silica gel, 9:1 PE:AcOEt).
- Product :** White solid.
- Isolated yield :** 100% (inseparable mixture of regioisomers, ratio 1: 6.5).
- ¹H NMR** (δ, ppm) (CDCl₃, 400 MHz) **Only major regioisomer described:** 7.79 (d, *J*_{H-H} = 7.9Hz, 1H, CH-Ar), 7.27 (t, *J*_{H-H} = 8.4Hz, 1H, CH-Ar), 7.19-7.11 (m, 4H, CH-Ar), 7.00 (dd, *J*_{H-H} = 8.3Hz, *J*_{H-F} = 9.0Hz, 1H, CH-Ar), 5.74 (s, 1H, C=CH₂), 5.11 (s, 1H, C=CH₂), 4.78 (br s, 1H, NCH₂), 4.05 (br s, 1H, NCH₂), 3.83 (s, 3H, OCH₃).
- ¹³C NMR** (δ, ppm) (CDCl₃, 100 MHz) **Only major regioisomer described:** 159.1 (d, *J*_{C-F} = 242.4Hz, Cq, C-F), 157.9 (Cq, C=O), 143.1 (Cq), 143.0 (Cq), 140.3 (Cq), 134.5 (Cq), 129.1 (CH-Ar), 128.5 (CH-Ar), 124.8 (CH-Ar), 123.9 (CH-Ar), 122.5 (CH-Ar), 115.6 (d, *J*_{C-F} = 22.6Hz, CH-Ar), 108.5 (C=CH₂), 53.6 (OCH₃), 46.7 (NCH₂).
- IR** (ν, cm⁻¹) (CCl₄) 3074 (w), 3033 (w), 3000 (w), 2957 (m), 2930 (m), 2856 (w), 1721 (s, C=O), 1633 (m), 1599 (m), 1572 (m), 1505 (s), 1484 (s), 1449 (s), 1376 (s), 1328 (s), 1308 (s), 1265 (s), 1231 (s), 1158 (s), 1130 (s), 1106 (m), 1036 (w).
- HRMS** (EI+, m/z) : Calculated: 298.1118 Found: 298.1108.

B.3.5.3 Synthesis of cinnoline derivatives via Au(I) catalysis

The external double bond from the hydroarylated products can be isomerized to the internal position to produce substituted cinnoline derivatives (Scheme B.3.5.3).

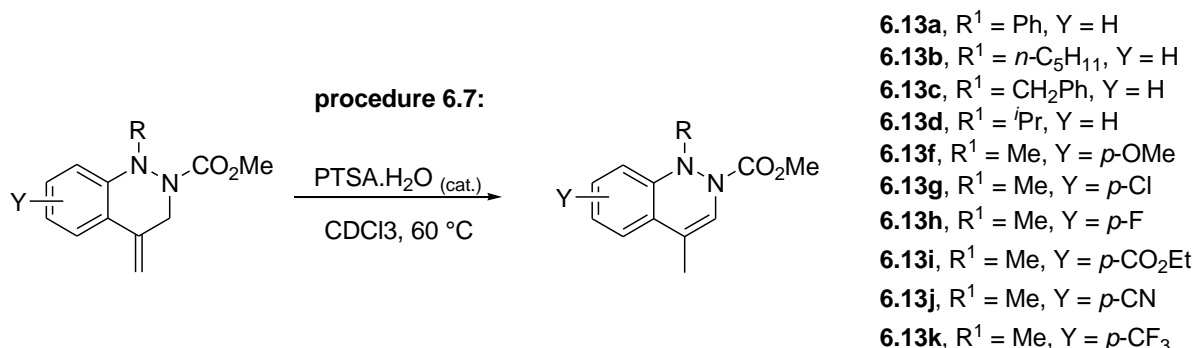

Scheme B.3.5.3: Isomerization to dihydrocinnolines **6.13a-k**.

General Procedure 6.7, Isomerization of the double bond: To a reaction vessel (a NMR tube in our case) was added the hydroarylated derivative (1 equiv.), PTSA.H₂O (0.05 equiv.) and CDCl₃ (0.2 M). The reaction was heated up to reflux (60 °C). Upon completion (NMR), the reaction mixture was diluted in DCM, transferred to a separating funnel, washed with a saturated solution of NaHCO₃, extracted with DCM (3x), dried (MgSO₄), concentrated under reduced pressure and purified by flash column chromatography to afford the desired isomerized products in the stated yields.

4-Methyl-1-phenyl-1*H*-cinnoline-2-carboxylic acid methyl ester

6.13a

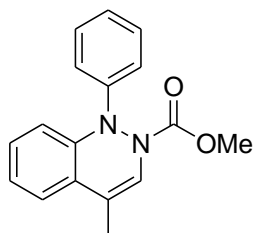

MF: C₁₇H₁₆O₂N₂

MW = 280 g.mol⁻¹

Method :	See general procedure 6.7 using (1 equiv., 0.1 mmol, 28 mg) of 4-methylene-1-phenyl-3,4-dihydro-1 <i>H</i> -cinnoline-2-carboxylic acid methyl ester.
Purification :	Flash column chromatography (silica gel, 95:5 PE:AcOEt).
Product :	White solid.
Isolated yield :	76%.
¹H NMR (δ, ppm) (CDCl ₃ , 400 MHz)	7.40-7.30 (m, 4H, Ar), 7.19 (dd, <i>J</i> = 7.4Hz, <i>J</i> = 8.4Hz, 2H, CH-Ar), 6.98 (t, <i>J</i> = 7.4Hz, 1H, CH-Ar), 6.89 (d, <i>J</i> = 8.4Hz, 2H, CH-Ar), 6.77 (br s, 1H, =CHN), 3.88 (s, 3H, OCH ₃), 2.04 (d, <i>J</i> = 1.4Hz, 1H, CH ₃).
¹³C NMR (δ, ppm) (CDCl ₃ , 100 MHz)	155.0 (Cq, C=O), 148.8 (Cq), 138.9 (Cq), 128.6 (CH), 127.7 (CH), 126.4 (CH), 125.2 (CH), 124.0 (Cq), 123.3 (CH), 122.6 (CH), 120.1 (Cq), 116.2 (CH), 114.2 (CH), 53.6 (OCH ₃), 14.7 (CH ₃).
IR (ν, cm ⁻¹) (CCl ₄)	3072 (w), 3030 (w), 2955 (w), 2923 (w), 2859 (w), 1747 (m), 1718 (s), 1646 (w), 1594 (w), 1568 (w), 1492 (s), 1450 (s), 1443 (s), 1386 (m), 1361 (s), 1351 (s), 1242 (s), 1197 (m), 1177 (w), 1159 (w), 1138 (m), 1110 (w), 1073 (w), 1032 (w).
HRMS (EI+, <i>m/z</i>) :	Calculated: 280.1212 Found: 280.1216.

4-Methyl-1-pentyl-1*H*-cinnoline-2-carboxylic acid methyl ester

6.13b

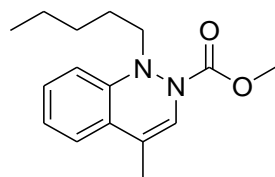

MF: C₁₆H₂₂O₂N₂

MW = 274 g.mol⁻¹

Method :	See general procedure 6.7 using (1 equiv., 0.1 mmol, 27 mg) of 4-methylene-1-pentyl-3,4-dihydro-1 <i>H</i> -cinnoline-2-carboxylic acid methyl ester.
Purification :	Flash column chromatography (silica gel, 7:3 PE:AcOEt).
Product :	Yellow oil.
Isolated yield :	91%.

¹H NMR (δ, ppm) (CDCl ₃ , 400 MHz)	7.25-7.21 (m, 2H, CH-Ar), 7.19-7.09 (m, 2H, CH-Ar), 6.62 (br s, 1H, NCH=), 3.80 (s, 3H, OCH ₃), 3.09 (br s, 1H, NCH ₂), 2.82 (br s, 1H, NCH ₂), 2.07 (d, <i>J</i> = 1.2Hz, 3H, CH ₃), 1.38-1.26 (m, 6H, CH ₂ -pentyl chain), 0.88 (t, <i>J</i> = 6.9Hz, 3H, CH ₃ -pentyl chain).
¹³C NMR (δ, ppm) (CDCl ₃ , 100 MHz)	154.7 (Cq, C=O), 144.2 (Cq), 128.0 (CH), 127.2 (Cq), 125.3 (CH), 122.7 (CH), 122.4 (CH), 121.2 (CH), 118.2 (Cq), 58.2 (NCH ₂ -pentyl chain), 53.1 (OCH ₃), 29.2 (CH ₂ -pentyl chain), 26.8 (CH ₂ -pentyl chain), 22.5 (CH ₂ -pentyl chain), 14.8 (CH ₃), 14.0 (CH ₃).
IR (ν, cm ⁻¹) (CCl ₄)	3032 (w), 2957 (m), 2929 (m), 2858 (w), 1744 (s), 1711 (s), 1649 (w), 1600 (w), 1499 (w), 1484 (w), 1455 (s), 1443 (s), 1387 (w), 1363 (s), 1334 (m), 1263 (s), 1245 (m), 1194 (w), 1135 (w), 1109 (w), 1016 (w).
HRMS (EI+, <i>m/z</i>) :	Calculated: 274.1681 Found: 274.1684.

1-Benzyl-4-methyl-1*H*-cinnoline-2-carboxylic acid methyl ester

6.13c

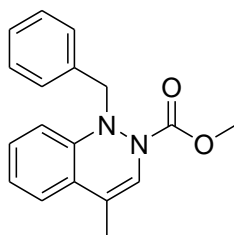

MF: C₁₈H₁₈N₂O₂

MW = 294 g.mol⁻¹

Method :	See general procedure 6.7 using (1 equiv., 0.08 mmol, 23 mg) of 1-benzyl-4-methylene-3,4-dihydro-1 <i>H</i> -cinnoline-2-carboxylic acid methyl ester.
Purification :	Flash column chromatography (silica gel, 9:1 PE:AcOEt).
Product :	Transparent oil.
Isolated yield :	81%.
¹H NMR (δ, ppm) (CDCl ₃ , 400 MHz)	7.27-7.22 (m, 6H, CH-Ph), 7.16-7.14 (m, 2H, CH-Ph), 6.96-6.94 (m, 1H, CH-Ph), 6.66 (br s, 1H, NCH=), 4.14 (br s, 1H, NCH ₂), 3.99 (br s, 1H, NCH ₂), 3.59 (br s, 3H, OCH ₃), 2.01 (s, 3H, CH ₃).
¹³C NMR (δ, ppm) (CDCl ₃ , 100 MHz)	154.4 (Cq, C=O), 143.9 (Cq), 135.9 (Cq), 130.2 (CH-Ar), 128.4 (Cq), 127.9 (CH-Ar), 127.8 (CH-Ar), 127.7 (CH-Ar), 125.7 (CH -Ar), 123.0 (CH -Ar), 122.4 (CH-Ar), 121.6 (NCH=), 117.8 (Cq), 62.3 (NCH ₂), 53.0 (OCH ₃), 14.8 (CH ₃).
IR (ν, cm ⁻¹) (CCl ₄)	3068 (w), 3033 (w), 2954 (w), 2923 (w), 2856 (w), 1712 (s), 1650 (w), 1603 (w), 1496 (w), 1484 (w), 1455 (s), 1442 (s), 1387 (s), 1365 (s), 1351 (s), 1258 (m), 1246 (m), 1195 (m), 1158 (w), 1137 (m), 1114 (w), 1080 (w), 1019 (w).

HRMS (EI+, m/z) : Calculated: 294.1368 Found: 294.1378.

1-Isopropyl-4-methyl-1*H*-cinnoline-2-carboxylic acid methyl ester

6.13d

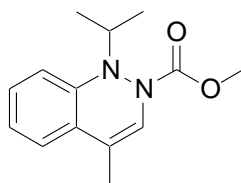

MF: C₁₄H₁₈N₂O₂

MW = 246 g.mol⁻¹

Method : See **general procedure 6.7** using (1 equiv., 0.1 mmol, 25 mg) of 1-isopropyl-4-methylene-3,4-dihydro-1*H*-cinnoline-2-carboxylic acid methyl ester.

Purification : Flash column chromatography (silica gel, 9:1 PE:AcOEt).

Product : Yellow pale oil.

Isolated yield : 75%.

¹H NMR (δ, ppm) 7.24-7.11 (m, 4H, CH-Ph), 6.68 (br s, 1H, NCH=), 3.78 (s, 3H, OCH₃), 3.31 (hept, *J* = 6.4Hz, 1H, CH-^{*i*}Pr), 2.06 (s, 3H, CH₃), 1.07 (d, *J* = 6.4Hz, 3H, CH₃-^{*i*}Pr), 1.04 (d, *J* = 6.4Hz, 3H, CH₃-^{*i*}Pr).
(CDCl₃, 400 MHz)

¹³C NMR (δ, ppm) 155.5 (Cq, C=O), 142.6 (Cq), 128.7 (Cq), 127.4 (CH), 125.3 (CH), 124.3 (CH), 122.8 (CH), 122.2 (CH), 118.9 (Cq), 57.0 (CH-^{*i*}Pr), 53.1 (OCH₃), 20.6 (CH₃-^{*i*}Pr), 19.8 (CH₃-^{*i*}Pr), 14.8 (CH₃).
(CDCl₃, 100 MHz)

IR (ν, cm⁻¹) (CCl₄) 3070 (w), 3032 (w), 2974 (s), 2954 (s), 2925 (s), 2859 (m), 1746 (s), 1708 (s), 1650 (m), 1601 (w), 1482 (m), 1455 (s), 1442 (s), 1386 (s), 1350 (s), 1327 (s), 1257 (s), 1244 (s), 1234 (s), 1193 (m), 1173 (m), 1159 (m), 1133 (s), 1104 (m), 1072 (w), 1034 (w), 1016 (s).

HRMS (EI+, m/z) : Calculated: 246.1368 Found: 246.1373.

6-Methoxy-1,4-dimethyl-1*H*-cinnoline-2-carboxylic acid methyl ester

6.13f

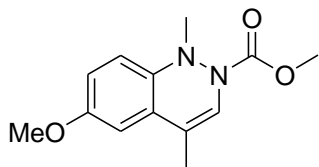
MF: C₁₃H₁₆N₂O₃MW = 248 g.mol⁻¹

- Method :** See **general procedure 6.7** using (1 equiv., 0.08 mmol, 21 mg) of 6-methoxy-1-methyl-4-methylene-3,4-dihydro-1*H*-cinnoline-2-carboxylic acid methyl ester.
- Purification :** Flash column chromatography (silica gel, 1:1 PE: AcOEt).
- Product :** White solid.
- Isolated yield :** 88%.
- ¹H NMR** (δ, ppm) (CDCl₃, 400 MHz) 7.05 (br s, 1H, CH-Ar), 6.74-6.72 (m, 2H, CH-Ar), 6.67 (br s, 1H, NCH=), 3.83 (br s, 3H, OCH₃), 3.79 (s, 3H, OCH₃), 2.76 (s, 3H, NCH₃), 2.06 (s, 3H, CH₃).
- ¹³C NMR** (δ, ppm) (CDCl₃, 100 MHz) 157.4 (Cq, Ar), 153.8 (Cq, C=O), 138.5 (Cq, Ar), 128.7 (Cq, Ar), 123.2 (CH), 120.9 (CH), 116.8 (Cq), 112.8 (CH), 108.2 (CH), 55.5 (OCH₃), 53.4 (OCH₃), 45.5 (NCH₃), 14.9 (CH₃).
- IR** (ν, cm⁻¹) (CCl₄) 3076 (w), 2998 (w), 2955 (m), 2922 (w), 2861 (w), 2835 (w), 2783 (w), 1737 (s), 1712 (s), 1649 (m), 1607 (m), 1573 (m), 1487 (s), 1444 (s), 1404 (m), 1388 (s), 1361 (s), 1311 (m), 1265 (s), 1246 (s), 1209 (m), 1193 (m), 1179 (m), 1146 (m), 1125 (s), 1113 (s), 1064 (m), 1048 (s), 1012 (m).
- HRMS** (EI+, m/z) : Calculated: 248.1161 Found: 248.1156.

6-Chloro-1,4-dimethyl-1*H*-cinnoline-2-carboxylic acid methyl ester

6.13g

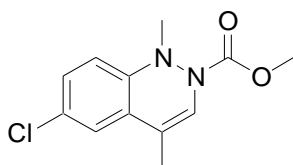
MF: C₁₂H₁₃O₂N₂ClMW = 252 g.mol⁻¹

Method : See **general procedure 6.7** using (1 equiv., 0.07 mmol, 19 mg) of 6-chloro-1-methyl-4-methylene-3,4-dihydro-1*H*-cinnoline-2-carboxylic acid methyl ester.

Purification : Flash column chromatography (silica gel, 7:3 PE: AcOEt).

Product : White solid.

Isolated yield : 95%.

¹H NMR (δ, ppm) (CDCl₃, 400 MHz) 7.16-7.14 (m, 2H, CH-Ar), 7.03 (br s, 1H, CH-Ar), 6.68 (br s, 1H, NCH=), 3.84 (s, 3H, OCH₃), 2.79 (s, 3H, NCH₃), 2.04 (s, 3H, CH₃).

¹³C NMR (δ, ppm) (CDCl₃, 100 MHz) 153.5 (Cq, C=O), 143.7 (Cq), 131.0 (Cq), 129.2 (Cq), 127.9 (CH), 123.6 (CH), 122.4 (CH), 121.7 (CH), 116.0 (Cq), 53.4 (OCH₃), 45.5 (NCH₃), 14.8 (CH₃).

IR (ν, cm⁻¹) (CCl₄) 2956 (w), 1741 (m), 1716 (s), 1558 (w), 1477 (m), 1444 (s), 1416 (w), 1403 (w), 1388 (w), 1358 (s), 1262 (m), 1243 (m), 1194 (w), 1123 (m), 1092 (m).

HRMS (EI+, m/z) : Calculated: 252.0666 Found: 252.0663.

6-Fluoro-1,4-dimethyl-1*H*-cinnoline-2-carboxylic acid methyl ester

6.13h

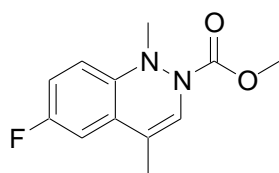

MF: C₁₂H₁₃O₂N₂F

MW = 236 g.mol⁻¹

Method : See **general procedure 6.7** using (1 equiv., 0.07 mmol, 16 mg) of 6-fluoro-1-methyl-4-methylene-3,4-dihydro-1*H*-cinnoline-2-carboxylic acid methyl ester.

Purification : Flash column chromatography (silica gel, 6:4 PE:AcOEt).

Product : White solid.

Isolated yield : 75%.

¹H NMR (δ, ppm) (CDCl₃, 400 MHz) 7.07 (br s; 1H, CH-Ar), 6.90-6.85 (m, 2H, CH-Ar), 6.70 (br s, 1H, NCH=), 3.84 (s, 3H, OCH₃), 2.78 (s, 3H, NCH₃), 2.05 (s, 3H, CH₃).

¹³C NMR (δ, ppm) 160.49 (d, $J_{C-F} = 242.9\text{Hz}$, Cq, C-F), 153.0 (Cq, C=O), 141.0 (Cq), 129.5 (Cq), 123.8 (CH), 121.5 (CH), 115.8 (Cq), 114.5 (d, $J_{C-F} = 24.0\text{Hz}$, CH-Ar), 109.1 (d, $J_{C-F} = 24.0\text{Hz}$, CH-Ar), 53.5 (OCH₃), 45.5 (NCH₃), 14.8 (CH₃).
(CDCl₃, 100 MHz)

IR (ν, cm⁻¹) (CCl₄) 3073 (w), 2997 (w), 2956 (w), 2923 (w), 2861 (w), 1744 (s), 1714 (s), 1650 (w), 1610 (w), 1581 (w), 1509 (w), 1496 (m), 1483 (s), 1445 (s), 1405 (w), 1388 (m), 1359 (s), 1337 (s), 1265 (s), 1244 (s), 1194 (m), 1183 (m), 1143 (w), 1122 (s), 1111 (s), 1143 (w), 1030 (w), 1013 (w).

HRMS (EI+, m/z) : Calculated: 236.0961 Found: 236.0959.

1,4-Dimethyl-1*H*-cinnoline-2,6-dicarboxylic acid 6-ethyl ester 2-methyl ester

6.13i

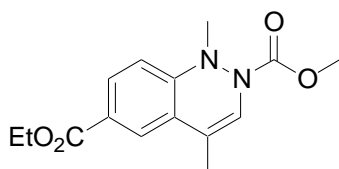

MF: C₁₅H₁₈N₂O₄

MW = 290 g.mol⁻¹

Method : See **general procedure 6.7** using (1 equiv., 0.07 mmol, 16 mg) of 1-methyl-4-methylene-3,4-dihydro-1*H*-cinnoline-2,6-dicarboxylic acid 6-ethyl ester 2-methyl ester.

Purification : Flash column chromatography (silica gel, 8:2 PE:AcOEt).

Product : White solid.

Isolated yield : 81%.

¹H NMR (δ, ppm) 7.89-7.85 (m, 2H, CH-Ar), 7.10 (d, $J = 8.0\text{Hz}$, 1H, CH-Ar), 6.65 (br s, 1H, NCH=), 4.37 (q, $J = 7.1\text{Hz}$, 2H, OCH₂CH₃), 3.84 (s, 3H, OCH₃), 2.89 (s, 3H, NCH₃), 2.10 (s, 3H, CH₃), 1.39 (t, $J = 7.1\text{Hz}$, 3H, OCH₂CH₃).
(CDCl₃, 400 MHz)

¹³C NMR (δ, ppm) 166.1 (Cq, C=O), 149.6 (Cq, C=O), 131.3 (CH), 129.7 (CH), 129.1 (Cq), 127.3 (Cq), 123.8 (CH), 121.6 (CH), 116.9 (Cq), 110.8 (Cq), 61.0 (OCH₂CH₃), 53.4 (OCH₃), 45.4 (NCH₃), 15.0 (OCH₂CH₃), 14.3 (CH₃).
(CDCl₃, 100 MHz)

IR (ν, cm⁻¹) (CCl₄) 3073 (w), 2980 (m), 2956 (m), 2926 (m), 2859 (m), 1717 (s), 1654 (w), 1607 (m), 1572 (w), 1488 (m), 1444 (s), 1389 (s), 1358 (s), 1279 (s), 1249 (s), 1226 (s), 1194 (m), 1181 (m), 1149 (m), 1106 (s), 1068 (m), 1028 (m).

HRMS (EI+, m/z) : Calculated: 290.1267 Found: 290.1261.

6-Cyano-1,4-dimethyl-1*H*-cinnoline-2-carboxylic acid methyl ester

6.13j

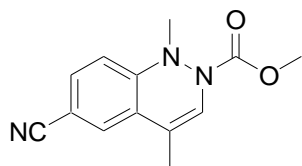
MF: C₁₃H₁₃N₃O₂MW = 243 g.mol⁻¹

- Method :** See **general procedure 6.7** using (1 equiv., 0.06 mmol, 15 mg) of 6-cyano-1-methyl-4-methylene-3,4-dihydro-1*H*-cinnoline-2-carboxylic acid methyl ester.
- Purification :** Flash column chromatography (silica gel, 7:3 PE:AcOEt).
- Product :** White solid.
- Isolated yield :** 73%.
- ¹H NMR** (δ, ppm) 7.48-7.42 (m, 2H, CH-Ar), 7.10 (d, *J* = 8.2Hz, 1H, CH-Ar), 6.68 (br s, 1H, NCH=), 3.84 (s, 3H, OCH₃), 2.91 (s, 3H, NCH₃), 2.05 (s, 3H, CH₃).
(CDCl₃, 400 MHz)
- ¹³C NMR** (δ, ppm) 153.5 (Cq, C=O), 149.4 (Cq), 132.0 (CH), 128.3 (Cq), 126.2 (CH), 123.0 (CH), 122.3 (CH), 118.8 (Cq), 115.7 (Cq), 108.6 (Cq, CN), 53.6 (OCH₃), 45.5 (NCH₃), 14.7 (CH₃).
(CDCl₃, 100 MHz)
- IR** (ν, cm⁻¹) (CCl₄) 3000 (w), 2956 (m), 2925 (m), 2230 (m), 1742 (s), 1718 (s), 1648 (m), 1608 (m), 1488 (s), 1444 (s), 1419 (m), 1406 (m), 1389 (m), 1359 (s), 1286 (s), 1263 (s), 1248 (s), 1195 (s), 1120 (s), 1070 (m), 1032 (m), 1013 (m).
- HRMS** (EI+, *m/z*) : Calculated: 243.1008 Found: 243.1013.

1,4-Dimethyl-6-trifluoromethyl-1*H*-cinnoline-2-carboxylic acid methyl ester

6.13k

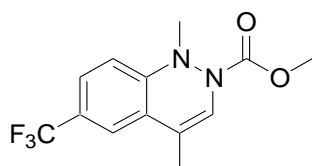
MF: C₁₃H₁₃O₂N₂F₃MW = 286 g.mol⁻¹

Method : See **general procedure 6.7** using (1 equiv., 0.05 mmol, 15 mg) of 1-methyl-4-methylene-6-trifluoromethyl-3,4-dihydro-1*H*-cinnoline-2-carboxylic acid methyl ester.

Purification : Flash column chromatography (silica gel, 8:2 PE:AcOEt).

Product : White solid.

Isolated yield : 67%.

¹H NMR (δ, ppm) (CDCl₃, 400 MHz) 7.46-7.40 (m, 2H, CH-Ar), 7.17 (d, *J* = 7.7Hz, 1H, CH-Ar), 6.70 (br s, 1H, NCH=), 3.84 (s, 3H, OCH₃), 2.87 (s, 3H, NCH₃), 2.09 (s, 3H, CH₃).

¹³C NMR (δ, ppm) (CDCl₃, 100 MHz) 155.3 (q, *J* = 21.4Hz, Cq, C-CF₃), 153.3 (Cq, C=O), 148.3 (Cq), 125.1 (q, *J*_{C-F} = 3.5Hz, CH-Ar), 124.0 (q, *J*_{C-F} = 272.0Hz, Cq, CF₃), 122.4 (CH-Ar), 122.2 (NCH=), 119.4 (CH-Ar, q, *J*_{C-F} = 3.3Hz), 116.1 (Cq), 111.2 (Cq), 53.5 (OCH₃), 45.5 (NCH₃), 14.8 (CH₃).

IR (ν, cm⁻¹) (CCl₄) 3421 (w), 2957 (m), 2926 (m), 2856 (m), 2716 (s), 1648 (w), 1620 (s), 1579 (w), 1494 (w), 1444 (s), 1389 (s), 1357 (s), 1318 (s), 1284 (s), 1235 (s), 1194 (s), 1169 (s), 1130 (s), 1077 (s).

HRMS (EI+, *m/z*) : Calculated: 286.0929 Found: 286.0928.