



HAL
open science

Decision support systems for sustainable renewable energy systems and hydrogen logistics: modelling, control and risk analysis

Hanane Dagdougui

► **To cite this version:**

Hanane Dagdougui. Decision support systems for sustainable renewable energy systems and hydrogen logistics: modelling, control and risk analysis. Business administration. École Nationale Supérieure des Mines de Paris; Università degli studi di Genova - Italie, 2011. English. NNT : 2011ENMP0072 . pastel-00679421

HAL Id: pastel-00679421

<https://pastel.hal.science/pastel-00679421>

Submitted on 15 Mar 2012

HAL is a multi-disciplinary open access archive for the deposit and dissemination of scientific research documents, whether they are published or not. The documents may come from teaching and research institutions in France or abroad, or from public or private research centers.

L'archive ouverte pluridisciplinaire **HAL**, est destinée au dépôt et à la diffusion de documents scientifiques de niveau recherche, publiés ou non, émanant des établissements d'enseignement et de recherche français ou étrangers, des laboratoires publics ou privés.

École doctorale n° 356: SMI-Sciences des métiers de l'ingénieur

Doctorat ParisTech
T H È S E

pour obtenir le grade de docteur délivré par

l'École Nationale Supérieure des Mines de Paris
Spécialité " Science et Génie des Activités à Risques "

présentée et soutenue publiquement par

Hanane Dagdougui

15 Décembre 2011

**Systeme d'aide à la décision pour la durabilité des
systèmes énergétiques renouvelables et des infrastructures
d'hydrogène: modélisation, contrôle et analyse de risques**

1^{er} Directeur de thèse : Roberto Sacile
2^{ème} Directeur de thèse: Emmanuel Garbolino

Jury

Président du jury

Mme Paola GIRDINIO, Professor, DINAEL, Faculty of Engineering, University of Genoa, Italy

Examineurs

M. Jérôme Tixier, Docteur, Sécurité industrielle et environnement, Ecole des Mines d'Alès, Alès

M. Thierry RANCHIN, Docteur HDR, Centre Énergétique et Procédés, Ecole des Mines de Paris

M. Riccardo MINCIARDI, Professeur, DIST, Faculty of Engineering, University of Genoa, Italy

Rapporteurs

M. Laurent PERRIN, Professor, LRGP, Ecole Nationale des Industries Chimiques, Nancy, France

M. Gabriele Landucci, Professor, DICCISM, Faculty of Engineering, University of Pisa, Italy

Directeurs de thèse

M. Emmanuel Garbolino, Docteur HDR, Centre for Risks and Crisis, Ecole des Mines de Paris

M. Roberto Sacile, Professeur, DIST, Faculty of Engineering, University of Genoa, Italy



“Science and Information Technology for System Monitoring and Environmental Risk Management” – XXII Cycle – DIST – UNIGE - Italy

“Science and Engineering of risk activities” – CRC – MINES ParisTech-France

Thesis in Cotutoring

for the degree of

DOCTOR OF PHILOSOPHY

presented and publicly defended by

Hanane Dagdougui

Decision support systems for sustainable renewable energy systems and hydrogen logistics: modelling, control and risk analysis

Thesis Supervisor 1: Prof. Roberto Sacile

Thesis Supervisor 2: Dr. Emmanuel Garbolino

Résumé

Compte tenu du caractère épuisable des ressources énergétiques actuels, il est nécessaire de chercher une ou des alternatives meilleures fondées sur les ressources d'énergies renouvelables. L'hydrogène produit à partir des énergies renouvelables offre une solution prometteuse pour satisfaire les objectifs mondiaux de réduction des émissions de gaz à effet de serre et assurer une sécurité énergétique d'approvisionnement.

L'utilisation d'un vecteur énergétique tel que l'hydrogène couplé aux ressources renouvelables offre une variété d'avantages sur plusieurs échelles. L'hydrogène facilite l'exploitation des ressources renouvelables dans le secteur de transport. En effet, il permet de remplacer les carburants fossiles, assurant ainsi une réduction des émissions polluantes. L'hydrogène peut être alors une solution pour les défis énergétiques actuels, or, cela ne pourra se réaliser qu'en surmontant des obstacles tels que ceux liés aux caractères intermittents des ressources renouvelables. Une attention particulière doit être accordée à la faisabilité technique de la chaîne d'approvisionnement en hydrogène, qui est principalement entourée par le caractère intermittent des ressources renouvelables.

Par ailleurs, l'infrastructure d'hydrogène présente de nombreuses difficultés qui doivent être traitées pour une transition réussie vers une économie dépendante de l'hydrogène. Ces difficultés sont principalement dues à des problèmes purement économiques, ainsi qu'à l'existence de nombreuses options technologiques pour la production, le stockage, le transport et l'utilisation d'hydrogène. Pour cette raison principale, il est primordial de comprendre et d'analyser la chaîne logistique d'hydrogène à l'avance, afin de détecter les facteurs importants qui peuvent jouer un rôle imminent dans l'élaboration d'une configuration optimale. Dans notre recherche, on analysera essentiellement la question suivante: Comment mettre en place un futur énergétique durable intégrant les énergies renouvelables et l'hydrogène?

Cette question est abordée par le biais du développement de nouveaux systèmes énergétiques fondés sur des innovations radicales. Ainsi, dans quel contexte l'infrastructure de l'hydrogène doit être développée en intégrant les critères liés aux risques de l'hydrogène?

Ce travail est étudié en deux grandes parties. La première partie est consacrée à l'état de l'art lié à l'hydrogène et aux énergies renouvelables. Quant à la deuxième, elle décrit les différentes

études et contributions scientifiques accomplies au cours du développement de ce travail de recherche.

Le *chapitre 1* présente les principales motivations du choix de cette problématique. Il développe le contexte de la recherche, l'étendue des travaux et la méthodologie déployée dans cette thèse. Le *chapitre 2* aborde la notion de développement durable des énergies renouvelables. Ce chapitre introduit l'hydrogène comme futur vecteur énergétique, son rôle et ses avantages dans la résolution des problèmes liés à la sécurité d'approvisionnement et à l'environnement. Le *chapitre 3* est divisé en deux parties. En premier lieu, on présente certains concepts préliminaires qui concernent la chaîne d'approvisionnement d'hydrogène, et ce selon une approche organisationnelle où les différents nœuds de la chaîne logistique sont décrits. En deuxième lieu, le chapitre 3 se poursuit par une analyse bibliographique détaillée sur les différentes approches et méthodes disponibles pour la planification et la modélisation de l'infrastructure d'hydrogène. Ce chapitre met en évidence les différentes classes d'approches, menant ainsi à une classification des méthodes. Il souligne également les défis majeurs qu'il faut surmonter pour l'introduction de l'hydrogène. Le *chapitre 4* aborde les questions liées aux risques d'utilisation de l'hydrogène dans les différentes composantes de sa chaîne logistique. Il analyse les problématiques de sécurité de la "filiale hydrogène". Ce chapitre se poursuit par la revue des approches méthodologiques publiées par les communautés scientifiques et techniques, et qui servent à évaluer les risques d'une partie ou de la globalité de la chaîne logistique d'hydrogène.

La deuxième partie s'intéresse essentiellement aux contributions apportées par cette thèse, ces contributions étant liées à l'exploitation des énergies renouvelables et de l'hydrogène, ainsi qu'à l'étude des risques de l'hydrogène dans sa chaîne logistique. Cette partie vise à présenter les travaux scientifiques dont la majorité a été publiée dans la littérature.

Le *chapitre 5* englobe trois parties. Il étudie essentiellement l'exploitation des énergies renouvelables comme matières premières pour la production de l'hydrogène.

La *partie A* traite les ressources renouvelables selon diverses perspectives, notamment à partir d'une évaluation des ressources éoliennes et solaires disponibles. La *partie B* introduit une méthode pour améliorer celle présentée dans la partie A : cette partie présente des moyens spécifiques pour une meilleure analyse du potentiel des énergies renouvelables. Ce chapitre contient également un système d'aide à la décision pour l'exploitation des ressources renouvelables pour la production d'hydrogène. L'approche globale, à la fois pour les parties A et B est appliquée à un cas d'étude dans la région Ligure, au nord de l'Italie.

La *partie C*, quant à elle, présente une nouvelle configuration de la chaîne logistique de l'hydrogène, entièrement fondée sur l'utilisation des ressources renouvelables comme matière

première de production. Il s'agit d'un réseau "vert" de stations d'hydrogène et de plusieurs usines de production centralisées. Dans ce cadre, un problème d'optimisation a été proposé, où les principales décisions sont la sélection des stations services à hydrogène qui seront alimentées par les productions centralisées et le contrôle de flux d'énergie et d'hydrogène échangées entre les composants du système. Les critères de sélection sont fondés sur la distance qui sépare les nœuds de production et de consommation, ainsi que sur d'autres critères strictement liés à la minimisation des risques. Les configurations optimales sont rapportées en tenant compte de la présence d'une demande supplémentaire dédiée au marché industriel d'hydrogène et de la connexion avec le réseau électrique.

Au *chapitre 6*, deux systèmes d'aide à la décision sont proposés. Ces derniers peuvent être considérés comme des outils pour la sélection des infrastructures liées à l'hydrogène. La *Partie A* étudie une approche intégrée considérée comme un système d'aide à la décision pour la sélection des stations services en hydrogène. La méthode combine deux approches différentes: une analyse détaillée des données spatiales utilisant un système d'information géographique (SIG) avec un modèle d'optimisation mathématique. Concernant le SIG, les critères relatifs à la demande en hydrogène et la sécurité sont considérés pour la sélection des stations d'hydrogène, tandis que dans le modèle mathématique d'autres critères sont abordés, tels que le coût d'installation. En général, le système d'aide à la décision permet d'identifier les sites appropriés fournissant des informations sur une échelle multicritères pour la localisation de l'infrastructure d'hydrogène. La *partie B*, quant à elle, propose une approche empirique afin d'évaluer le risque d'un scénario accidentel dans les canalisations haute pression à hydrogène. L'approche vise à étudier les effets des conditions d'opération de l'hydrogène et à analyser les différents scénarios d'échec. Cette partie présente un outil d'ingénierie utile destiné à établir les exigences de sécurité liées à définir des zones adéquates de sécurité pour les canalisations d'hydrogène, assurant ainsi la sécurité des personnes et de l'environnement.

A la lumière du développement durable et de la large diffusion des technologies des énergies renouvelables, le *chapitre 7* présente deux types de systèmes énergétiques durables innovants. La *partie A* présente un modèle dynamique innovant d'un système hybride intégrant des sous-systèmes tels qu'un électrolyseur, une centrale hydroélectrique, des stations de pompage, des éoliennes, des piles à combustible et un système de stockage à hydrogène. Ce modèle est testé sur une installation dans la province d'Azilal, Maroc. En effet, en se basant sur ce modèle dynamique, un problème d'optimisation sous contraintes est formulé afin de satisfaire en temps réel à différentes demandes d'énergie électrique "fluctuantes" au cours de la journée. Le modèle d'optimisation développé est défini comme un problème de programmation mathématique non linéaire, qui est résolu en utilisant

un outil commercial d'optimisation Lingo-Lindo. Le cas d'étude démontre qu'une approche énergétique durable pourrait être tout à fait commune dans un proche avenir.

Toujours, dans le but de promouvoir les systèmes hybrides à base des sources d'énergies renouvelables, un modèle d'aide à la décision optimale dans un réseau de micro-réseaux est proposé à la *partie B* du chapitre 7. Le modèle est formalisé comme étant un problème d'origine discrète et centralisé, défini comme un réseau de coopération entre réseaux électriques intelligents. Les variables de contrôle sont les flux de puissances instantanées échangées entre les micro-réseaux, et qui peuvent être obtenus à partir de la solution d'un problème linéaire quadratique gaussien sur un horizon temporel fixe. L'état du système est représenté par l'énergie stockée dans chaque micro-réseau. L'objectif est de minimiser les variations de l'énergie stockée dans chaque dispositif de stockage à partir d'une valeur de référence, ainsi que de minimiser l'échange d'énergie.

Les conclusions scientifiques et techniques de notre étude feront l'objet de la conclusion générale au *Chapitre 8*. Les apports ainsi que les limites du modèle et de l'outil développé sont abordés. Enfin, les perspectives de nos travaux de recherche sont proposées.

Abstract

A transition to a renewable based energy system is crucial. Hydrogen produced from renewable energy sources (RES) offers the promise of a clean, sustainable energy carrier that can be produced from domestic energy resources around the globe. The production of hydrogen from renewable energy resources is not well understood. This complexity that exists comes from many facts such that related to the intermittent behaviour of renewable energy resources. The alternative fuels and energy carriers that are produced from the RES are challenging for the sustainable development of renewable energy. These systems need to be better investigated to first manage the flux of renewable energy and hence produce alternative fuel and energy. In addition, attention must be given to the technical feasibility of the hydrogen supply chain, which is mainly driven by uncertain, but clean solar and wind energy resources.

Furthermore, the infrastructure of hydrogen presents many challenges and defies that need to be overcome for a successful transition to a future hydrogen economy. These challenges are mainly due to the existence of many technological options for the production, storage, transportation and end users. Given this main reason, it is essential to understand and analyse the hydrogen supply chain (HSC) in advance, in order to detect the important factors that may play increasing role in obtaining the optimal configuration.

Acknowledgments

Foremost, I would like to express my deepest respect and gratitude to my Supervisor Prof. Roberto Sacile for his guidance, support and advices. His continual support and constructive criticism in numerous research work have always inspired me in my technical and personal development. Professor Roberto Sacile is not only as a supervisor for my thesis, but also as fatherly friend. He supports me and helps me during my stay in Italy. I would like to thanks my co-supervisor, Doctor HDR Emmanuel Garbolino from The MINES ParisTech for sharing his valuable experience, and providing help, guidance and assistance during my thesis.

I would like to express my thanks to the Dean of the Faculty of Engineering, M. Paola Girdinio who has made me the honour to be a part of my thesis committe. Thanks go also to Prof. Riccardo Minciardi, the head of the Department of Communication and System Science, for being kindly agreeing to be referee for this dissertation, and his important advices, honest insights, which improved the quality of this work.

I would like to express his gratitude to Dr. Domenico Pizzorni, Eni HSE Oil Company manager for sharing his valuable experience, and providing help, guidance and assistance.

Furthermore, I would like to extend my most sincere thanks to Prof. Gabriele Landucci, Prof. Laurent Perrin, Doctor Thierry Ranchin, Jérôme Tixier, for been kindly agreeing to be referee for this thesis.

My personal sincere thank goes to all my colleagues at the University of Genoa and at the Department of Communication and System Science for inspiring discussions, and, above all, for the pleasing work environment which I really enjoyed. I would like to thank other researchers, PhD students and technicians of the centre for Risks and Crisis, at the MINES ParisTech for their kindness and hospitality during my stay in Sophia Antipolis.

A very important part of this work goes to my mother, I am, as ever, especially indebted to her for the love, help and support throughout my life. Also, I thank my sister Lamia and my brothers Rachid and Younes for their support and understanding during my stay in Italy. I thank them for allowing me to go through with this adventure, and the pride they testy to me.

My sincere and deep thanks go to Prof. Ahmed Ouammi for his invaluable support and useful suggestions.

<i>Chapitre 1 : Introduction</i>	20
1. Context of research	22
2. Objective and scope of thesis	22
3. Structure of the dissertation	25
<i>Chapitre 2 : Sustainability of renewable energy resources</i>	28
1. Sustainability concept	28
2. Renewable energy resources and sustainability	30
3. Renewable hydrogen energy	31
3.1 Renewable hydrogen: as a future fuel	32
3.2 Renewable hydrogen: as an electric bridge	33
4. Conclusion	34
<i>Chapitre 3 : The need for a sustainable planning of hydrogen energetic vector</i>	35
<i>A- Hydrogen as an energy alternative</i>	37
1. Introduction	37
2. Hydrogen production methods	37
2.1 Hydrogen from Fossil fuels	37
2.2 Hydrogen from Biomass	38
2.3 Hydrogen from Nuclear	38
2.4 Hydrogen from renewable energy resources	39
3. Comparisons of hydrogen production routes	40
3.1 Scales of production	40
3.2 Environmental benefits & challenges	41
3.3 Costs and economy of hydrogen production	42
4. Hydrogen storage and distribution	45
4.1 Hydrogen storage	45
4.2 Hydrogen transportation	46
5. Conclusion	49
<i>B- Planning and design of the future hydrogen supply chain: A state-of-art</i>	50
1. Introduction	50
2. Background: Hydrogen supply chain	51
3. Roadmaps deployment	52
4. Build-up Scenarios	53
5. Approaches for the planning and design of hydrogen infrastructure	53
5.1 Optimization Methods	54
5.2 Geographical information system (GIS) based approaches	58
5.3 Assessment plans towards the transition to Hydrogen infrastructure	59

6. Challenges for the design of the future hydrogen supply chain.....	61
7. Conclusion and main contributions.....	62
<i>Chapitre 4 : Hydrogen risks & safety issues: assessment and analysis</i>	63
1. Introduction.....	63
2. Hydrogen Safety Properties	64
2.1 Physicochemical properties.....	64
2.2 Hydrogen safety issues.....	65
3. Risk of hydrogen supply chain.....	67
3.1 Risks in hydrogen systems.....	68
3.2 Risks in hydrogen refueling stations.....	69
4. Methodology for hydrogen risks analysis.....	71
4.1 Risk definition.....	71
4.2 Risk analysis	72
4.3 Quantitative risk assessment technique.....	72
4.4 Hazard identification.....	74
4.5 Historical analysis of hydrogen accidents.....	74
4.6 Event tree analysis	77
4.7 Consequence calculation.....	79
4.8 Risk acceptance criteria	81
4.9 Hydrogen infrastructure regulations	83
5. Conclusion	85
<i>Chapitre 5 : Models and methods dedicated to formalized a regional decision support system based on renewable hydrogen energy systems</i>	86
<i>A-Renewable energy sources: clean feedstocks for hydrogen production</i>	86
1. Introduction.....	88
2. Wind speed and solar irradiation data.....	89
3. Wind analysis model.....	90
3.1 Extrapolation of data at hub height	91
3.2 Wind power density	91
3.3 Classes of wind power density.....	92
4. Modelling the wind power plant and its performance	92
5. Results and discussion	93
6. Conclusion	109
<i>B- A regional decision support system for onsite renewable hydrogen production from solar and wind energy sources</i>	110
1. Introduction.....	110
2. Potential of renewable hydrogen production	111
2.1 Wind and solar data collection.....	112

2.2 Assessment of the available wind/solar energy potential	112
2.3 Assessment of the available hydrogen potential	115
3. Criteria for site selection	115
4. Modelling hydrogen refuelling station.....	116
4.1 Photovoltaic module	117
4.2 Wind turbine model	117
4.3 Hydrogen electrolysis production	118
5. Method application	119
5.1 Study area.....	119
5.2 Meteorological data.....	120
5.3 Geographic model and interpolation method.....	120
6. Conclusion and future developments.....	133
<i>C- Modelling and control of hydrogen and energy flows in a network of Green Hydrogen Refuelling Stations powered by wind and solar resources</i>	<i>135</i>
1. Introduction.....	135
2. The methodological approach.....	137
2.1 Model structure and components	137
2.2 Planning horizon: plants and technologies.....	138
2.3 Modelling the mixed renewable energy system.....	140
3. Optimization problem	142
3.1 Objective function.....	143
3.2 Constraints	144
4. Results and discussion	147
5. Conclusion	158
<i>Chapitre 6 : Decision support system based on risk criteria for the hydrogen infrastructure implementation.....</i>	<i>159</i>
<i>A-Novel approach to develop alternative transition toward the implementation of green hydrogen infrastructure</i>	<i>160</i>
1. Introduction.....	160
2. Method description	160
2.1 GIS based approachdecision	160
2.2 Mathematical optimization: model description.....	161
2.3 Model characteristics	162
3. Hydrogen refuelling station components	166
4. Consequence of worst scenario: Explosion	166
5. Harm criteria for explosion.....	167
5.1 Harm to people.....	167
5.2 Harm to structures	169

6. GIS based on safety distance criteria	170
7. Case study	171
7.1 Hydrogen demand data	171
7.2 Locations of hydrogen refuelling stations.....	173
7.3 Eligible hydrogen refueling stations	174
8. Conclusion and future work.....	176
<i>B-Hazard and risk evaluation in hydrogen pipeline</i>	<i>177</i>
1. Introduction.....	177
2. Release model	178
3. Jet flame length	179
4. Thermal effect from jet fire.....	180
5. Risk evaluation.....	181
6. Results and discussions.....	182
7. Conclusion	186
<i>Chapitre 7 : Smart renewable systems and hydrogen as storage medium</i>	<i>187</i>
<i>A- A dynamic decision model for the real time control of hybrid hydrogen renewable energy production systems</i>	<i>189</i>
1. Introduction.....	189
2. Energy storage systems and optimization of RES: State of the art.....	191
3. The wind model	192
4. The Integrated System Model	193
4.1 State and control variables	194
4.2 Data and forecasts	196
4.3 Model parameters.....	196
4.4 State equations and other equations of the model.....	197
5. The Optimization problem	198
6. Case Study.....	200
7. Conclusion	207
<i>B-Optimal control of power flows and energy local storages in a network of microgrids modelled as a system of systems</i>	<i>209</i>
1. Introduction.....	209
2. The Microgrid system model	211
2.1 Household consumption.....	211
2.2 Wind power generation.....	212
2.3 Hydrogen energy storage device.....	213
2.4 Internal and external power flows.....	215
2.5 Information and control flows.....	215
2.6 The Controller	215

3. The Network of power Microgrids as a system of systems model	216
3.1 The microgrid network.....	216
3.2 The system of systems controller.....	217
4. Example: A network of four Microgrids.....	221
4.1 Case study: Liguria Region.....	221
4.2 Electricity demand for the households.....	222
4.3 Wind energy	223
4.4 Energy balance in the four microgrids on a given time interval.....	224
4.5 Optimal control strategy.....	225
5. Results & discussion	225
5.1 System of systems optimal strategy	227
5.2 Weak control optimal strategy	229
6. Conclusion	230
<i>Chapitre 8 : General conclusion.....</i>	<i>231</i>
1. Main contributions	231
2. Discussions and future perspectives	233
References.....	235

List of figures

Figure 1.1 Thesis structure.....	23
Figure 2.1 Criteria for the Energy sustainability.....	29
Figure 2.2 Renewable energy-possible uses with electricity and Hydrogen	32
Figure 3.1 Hydrogen production process	40
Figure 3.2 CO ₂ emissions of various hydrogen production technologies (Pilavachi <i>et al.</i> , 2009)	42
Figure 3.3 Capital costs of various hydrogen production technologies in [US\$/kg H ₂ /day] (Pilavachi <i>et al.</i> , 2009)	43
Figure 3.4 Feedstocks costs of various hydrogen production technologies in [US\$/kg H ₂ /day] (Pilavachi <i>et al.</i> , 2009)	43
Figure 3.5 Operating & maintenance costs of various hydrogen production technologies in [US\$/kg H ₂ /day] (Pilavachi <i>et al.</i> , 2009)	44
Figure 3.6 European Hydrogen pipeline percentages by country [www.roads2hy.com]	48
Figure 3.7 U.S Hydrogen pipeline percentages by state [Energy Information Administration, 2008]	48
Figure 3.8 Structure of the mathematical optimization of the HSC.....	55
Figure 4.1 Parts of the supply chain related to safety aspects.....	68
Figure 4.2 Separation distances required for an exposure to a radiant heat flux of 1.6 kW/m ² generated by a jet fire (Sandia Lab)	71
Figure 4.3 Risk analysis approaches and methodologies.....	72
Figure 4.4 Quantitative risk assessments (Frantzitch, 1998, Kikukawa et al., 2009)	73
Figure 4.5 Risk map in case of liquid hydrogen refueling station (Kikukawa et al., 2009)	74
Figure 4.6 H ₂ incident reporting and lessons learned (www.h2incidents.org/)	75
Figure 4.7 Histograms of the incidents causes (equipment failure, human errors, failure to follow the standards operation process (SOP), vehicles collision and others) in the case of hydrogen delivery (www.h2incidents.org/)	76
Figure 4.8 Shares of total possible causes for accidents involving hydrogen.....	77
Figure 4.9 Event tree for pipeline hydrogen transmission (Jo and Ahn, 2006)	78
Figure 4.10 Hydrogen gas storage leakage/rupture event tree (Rigas and Sklavounos, 2005).....	79
Figure 4.11 Societal risk curve, FN curve with ALARP region	82
Figure 4.12 Zero Regio hydrogen refuelling unit in Mantova Source: http://www.admin.zeroregio.de/CDROM/englisch/10openingeni/opening/index.html	85
Figure 5.1 The geographical locations of wind meteorological stations	89
Figure 5.2 The geographical locations of solar meteorological stations.....	90
Figure 5.3 Available wind energy in Liguria region.....	96
Figure 5.4 Annual wind direction frequencies at the four locations.....	101
Figure 5.5 Monthly variation of wind power density for the four locations.....	102
Figure 5.6 Seasonal histograms of the wind speed	105
Figure 5.7 Histograms of the monthly of the mean wind energy produced by the wind power plant versus the available wind energy in the swept rotor area for the four locations.....	106
Figure 5.8 Seasonal assessment of the available and produced wind energy for the four locations	106
Figure 5.9 Solar energy production map.....	109
Figure 5.10 Configuration of the ANN with three layers	114
Figure 5.11 CO ₂ emissions from fossil fuel combustion by sector in Liguria region.....	120
Figure 5.12 Map of the annual mean available wind energy of Liguria region as obtained by the ANN kriging technique.	124
Figure 5.13 Map of the annual mean available solar energy of Liguria region as obtained by the ANN kriging technique.....	125

Figure 5.14 Map of the annual mean available hydrogen potential from wind and solar of Liguria region as obtained by the ANN kriging technique.....	128
Figure 5.15 Electrical network map of Liguria region.....	129
Figure 5.16 Inhabited area map of Liguria region	129
Figure 5.17 Railways map of Liguria region	130
Figure 5.18 Roads map of Liguria region	130
Figure 5.19 Rivers map of Liguria region.....	131
Figure 5.20 The spatial information regarding the eligible areas	131
Figure 5.21 Monthly solar irradiation and wind speed data in Capo Vado	132
Figure 5.22 Monthly hydrogen productions in Capo Vado	133
Figure 5.23 System description.....	138
Figure 5.24 Energy and hydrogen flows exchanged among system components	141
Figure 5.25 Wind speed and solar radiation data in the test site.....	149
Figure 5.26 Manufacturer power curve of the considered wind turbine.....	149
Figure 5.27 Hydrogen demand of the network of GHRS	150
Figure 5.28 Electrical energy demand of the network of GHRS	151
Figure 5.29 Energy produced by the mixed energy system.....	152
Figure 5.30 Electrical energy sent to the electrolyser plant.....	152
Figure 5.31 Electrical energy sold to the network	153
Figure 5.32 Electrical energy consumed by GHRS	153
Figure 5.33 Hydrogen storage level of the main tank.....	154
Figure 5.34 Hydrogen storage level of GHRS1	155
Figure 5.35 Hydrogen storage level of GHRS2.....	155
Figure 5.36 Hydrogen storage level of GHRS3.....	156
Figure 5.37 Hydrogen storage level of GHRS4.....	156
Figure 5.38 Hydrogen storage level of GHRS5.....	157
Figure 5.39 Hydrogen storage level of GHRS6.....	157
Figure 5.40 Hydrogen storage level of GHRS7	158
Figure 6.1 Model components displaying both modules considered.....	162
Figure 6.2 Configurations of hydrogen refueling stations driven by renewable energy.....	163
Figure 6.3 Electrolysis onsite hydrogen refueling station.....	164
Figure 6.4 Offsite hydrogen refueling station	164
Figure 6.5 General components of hydrogen refueling station.....	166
Figure 6.6 GIS based study on risk based decision support.....	170
Figure 6.7 Percentage of hydrogen demand in most populated areas in Liguria.....	172
Figure 6.8 Snapshot of hydrogen demand for different scenario.....	173
Figure 6.9 Offsite hydrogen refueling station sites	174
Figure 6.10 Onsite hydrogen sites.....	174
Figure 6.11 Onsite buffer location versus population.....	175
Figure 6.12 Offsite locations versus population	175
Figure 6.13 System under study.....	177
Figure 6.14 Diagram of hydrogen accidental scenarios.....	179
Figure 6.15 Pie bars of the damages and injuries due to the hydrogen failure in the delivery mode	181
Figure 6.16 The variation of the release flow rate of hydrogen versus the pressure at the supply point for different values of λ	182
Figure 6.17 Relationship between the hole diameter and release rate	183
Figure 6.18 The jet flame length as function of the pressure at the supply point.....	184
Figure 6.19 Comparison of the current model and experiments by T, Mogi and S, Horiguchi	184
Figure 6.20 The heat flux from the hydrogen jet flame as a function of the radial distance	185
Figure 7.1 The integrated renewable energy system.....	194

Figure 7.2 The considered case study in Morocco.....	201
Figure 7.3 Lower water reservoir.....	201
Figure 7.4 Higher water reservoir	202
Figure 7.5 Wind speed on 1st November 2007 of Essaouira site	204
Figure 7.6 The energy demand per residential unit.	205
Figure 7.7 Hourly energy from the wind farm vs used wind energy	205
Figure 7.8 Optimal use of hourly wind energy potential	205
Figure 7.9 Hourly electrical energy production that is used to satisfy the electrical energy demand	206
Figure 7.10 Total hourly energy production vs hourly energy demand.....	207
Figure 7.11 Hourly wind energy production vs hourly energy demand	207
Figure 7.12 Microgrid components.....	209
Figure 7.13 The conceptual model of a microgrid system.....	211
Figure 7.14 The conceptual model of the network of microgrids, and of the related controller	216
Figure 7.15 Savona district and the locations of the four microgrid.....	222
Figure 7.16 The deterministic energy demand versus the predicted electric demand in Savona site	223
Figure 7.17 Histograms of wind speed frequencies of the four sites	224
Figure 7.18 Wind speed data.....	224
Figure 7.19 Directed connections planned among the microgrids.....	225
Figure 7.20 (a, b, c, d). The prediction of μ_{ti} , and the a posteriori true power balance e_{ti} for the microgrid $i = 1, \dots, 4$ (in top down order).	227
Figure 7.21 Trends of the optimal values for the $u_{t,i}^*$, $i=1, \dots, 4$ elements of the control variables under a cooperative strategy (u_{1coop} , u_{2coop} , u_{3coop} and u_{4coop} in the legend).	228
Figure 7.22 Trends of the optimal values for the state variables z^* under a cooperative strategy (respectively for microgrids 1,..4 referred to in the legend as z_{1coop} , z_{2coop} , z_{3coop} and z_{4coop})	229
Figure 7.23 Weak control hypothesis: Trends of the optimal values for the $u_{t,i}^*$, $i=1, \dots, 4$ elements of the control variables under a cooperative strategy (u_{1-weak} , u_{2-weak} , u_{3-weak} and u_{4-weak} in the legend).....	230

List of tables

Table 3.1 Cost of hydrogen from various technologies	44
Table 3.2 Types and properties of hydrogen storage media (Lymberopoulos, 2008)	46
Table 4.1 Properties of hydrogen that are particularly relevant to safety	65
Table 4.2 Leak frequency estimate for hydrogen pipes (LaChance et al., 2009)	66
Table 4.3 Probability of a major accident causing one or more fatalities among customers (Zhiyong et al., 2011).....	69
Table 5.1 The average wind speed on the whole measurements period for each site.	94
Table 5.2 Available wind energy for each site.....	95
Table 5.3 Annual average wind speed (a), annual power density (b) and annual available energy for the four sites with highest wind speed (c).....	96
Table 5.4 Monthly variations of the mean wind speed and Weibull parameters in Capo Vado site.	98
Table 5.5 Monthly variations of the mean wind speed and Weibull parameters in Casoni site.....	98
Table 5.6 Monthly variations of the mean wind speed and Weibull parameters in Fontana Fresca site	99
Table 5.7 Monthly variations of the mean wind speed and Weibull parameters in Monte Settepani site	Erreur ! Signet non défini.
Table 5.8 The seasonal wind characteristics	103
Table 5.9 Solar energy production	108
Table 5.10 Objective and proposed selection criteria	116
Table 5.11 Italian hydrogen refuelling stations	117
Table 5.12 Predictions of the annual mean available wind energy obtained by the ANN kriging method learning on 25 sites and testing on the same data	122
Table 5.13 Predictions of the annual mean available solar energy obtained by the ANN kriging method learning on 16 sites and testing on the same data	123
Table 5.14 Wind energy and its equivalent in hydrogen mass	126
Table 5.15 Solar energy and its equivalent in hydrogen mass.....	127
Table 5.16 Characteristics of a network of GHRS.....	148
Table 6.1 Accidents leading to explosion for onsite and offsite station (CEC, 2005; http://www.h2incidents.org)	167
Table 6.2 Direct and indirect on people damage due to overpressure (Jeffries 1997),.....	168
Table 6.3 Damage to structures and equipment due to overpressure (Guidelines, 1998).....	169
Table 6.4 Threshold between effect distances for "no harm"	170
Table 6.5 Thermal radiation and damages as function of the radial distance from the failure point, for large; medium and small population	186
Table 7.1 Optimization problem parameters.....	203

*"We can't solve problems by using the same kind of
thinking we used
when we created them"*

Albert Einstein

Chapitre 1 : Introduction

Pour répondre aux préoccupations mondiales concernant la réduction des émissions des gaz à effet de serre ainsi qu'aux problèmes liés à la sécurité énergétique, l'hydrogène semble être une alternative intéressante aux énergies fossiles conventionnelles. D'une part, l'utilisation de l'hydrogène comme carburant nécessite la conception d'une infrastructure ainsi qu'à un déploiement progressif d'une solution à long terme ayant un caractère économiquement, socialement et écologiquement durable. D'autre part, l'utilisation de l'hydrogène pour la production d'énergie nécessite des stratégies solides et efficaces pour contrôler le flux d'énergie entre différents composants du système. Le développement des infrastructures, en réponse aux changements climatiques, représente dans ce cas un problème d'optimisation pour lequel cette thèse cherche à apporter des éléments méthodologiques. Dans cette thèse, nous nous sommes concentrés sur le déploiement des modèles et approches pour les systèmes d'aide à la décision pour le développement durable des systèmes énergétiques à hydrogène. La thèse est particulièrement orientée vers le développement d'une nouvelle configuration de la chaîne d'approvisionnement d'hydrogène, essentiellement fondée sur l'utilisation des ressources énergétiques renouvelables dans le but de réduire les émissions de gaz à effet de serre et se libérer de la dépendance aux ressources énergétiques fossiles.

Preamble

In this thesis, we have focused on the deployment of an innovative models and approaches for the decision support system of sustainable renewable hydrogen energy systems. The thesis is particularly devoted to develop new frame of the hydrogen supply chain mainly based on the use of clean and sustainable energy resources to generate hydrogen as both: a fuel for vehicles or for power generation.

In order to meet the global concerns to reduce the greenhouse gases emissions and ensure the security of supply, hydrogen appears to be an interesting alternative to fossil fuels. From one hand, the use of hydrogen as a fuel needs the design of a future infrastructure and a gradual deployment of a long term solutions that must be economically and environmentally sustainable. From the other hand, the use of hydrogen for power generation necessitates robust and efficient strategies to control the power flows between the system components. The development of such infrastructure, in response to climate changes, is an optimization problem in which we provide some contributions in

this thesis. In this chapter, we present the general context, the selected issues and our major goals, and then we will conclude by giving the structure of this dissertation.

1. Context of research

Global concern over environmental climate change linked to fossil fuel consumption has increased pressure to generate new clean energies. The exploitation of fossil fuels creates pollution on local, regional, and global scales. Most countries around the world are now convinced that the increase of carbon dioxide and other so called greenhouse gases in the atmosphere lead to threatening consequences such as global climate change and sea level rise (Pearce, 2006) and (McCarthy, 2001). As reported at the international energy agency (IEA, 2009), the energy generation accounts for over 80% of the anthropogenic greenhouse gases with emissions resulting from the production, transformation, handling and consumption of all kinds of energy commodities.

Growing evidence of environmental problems is also due to the conventional transportation systems powered by hydrocarbons are the responsible for many greenhouse gases, such as nitrogen oxides, volatile organic compounds and carbon monoxide (Granovskii *et al.*, 2006); (Doll and Wietschel, 2008). Currently, the level of CO_2 emissions per capita for developing nations is 20% of that for the major industrial nations. By 2030, CO_2 emissions from developing nations could account for more than half the world CO_2 emissions. Another problem that is faced is the one related to the declining of crude oil supplied and political instability in the regions with large oil reserves. This dependency has developed the “energy security” concept and even deeper, the concept of “security of supply”. Energy security generally refers to ensuring adequate and reliable energy supplies at reasonable prices in order to sustain economic growth (Hogan *et al.*, 2007). Worldwide energy consumption has been increasing rapidly and almost exponentially since the industrial revolution; and this increasing trend of energy consumption has been accelerated by the improvement of the quality of life, that almost directly relates to the amount of energy consumption; by the industrialization of the developing nations; and by the increase of population in the world (Li, 2005). As a matter of fact, strict emission regulations are the subject of the worldwide discussion on the sustainability of the present fossil fuel based energy systems. Also, they are triggering the need to develop new energy systems driven by alternative fuels. There is an increasing need for new and greater sources of energy for future global energy and transportation applications. An alternative fuel must be environmentally acceptable, economically competitive, technically feasible, and readily available.

2. Objective and scope of thesis

A transition to renewable based energy systems is crucial. Hydrogen produced from RES offers the promise of a clean and sustainable energy carrier that can be produced from the available energy resources around the globe. The production of hydrogen from RES is not well understood. This complexity that exists comes from many facts such that related to the intermittent behaviour of

RES. The alternative fuels and energy carriers that are produced from the RES are challenging for the sustainable development of renewable energy. These systems need to be better investigated to first manage the flux of renewable energy and hence produce alternative fuel and energy. In addition, attention must be given to the technical feasibility of the hydrogen supply chain, which is mainly driven by the uncertain, but clean solar and wind energy resources.

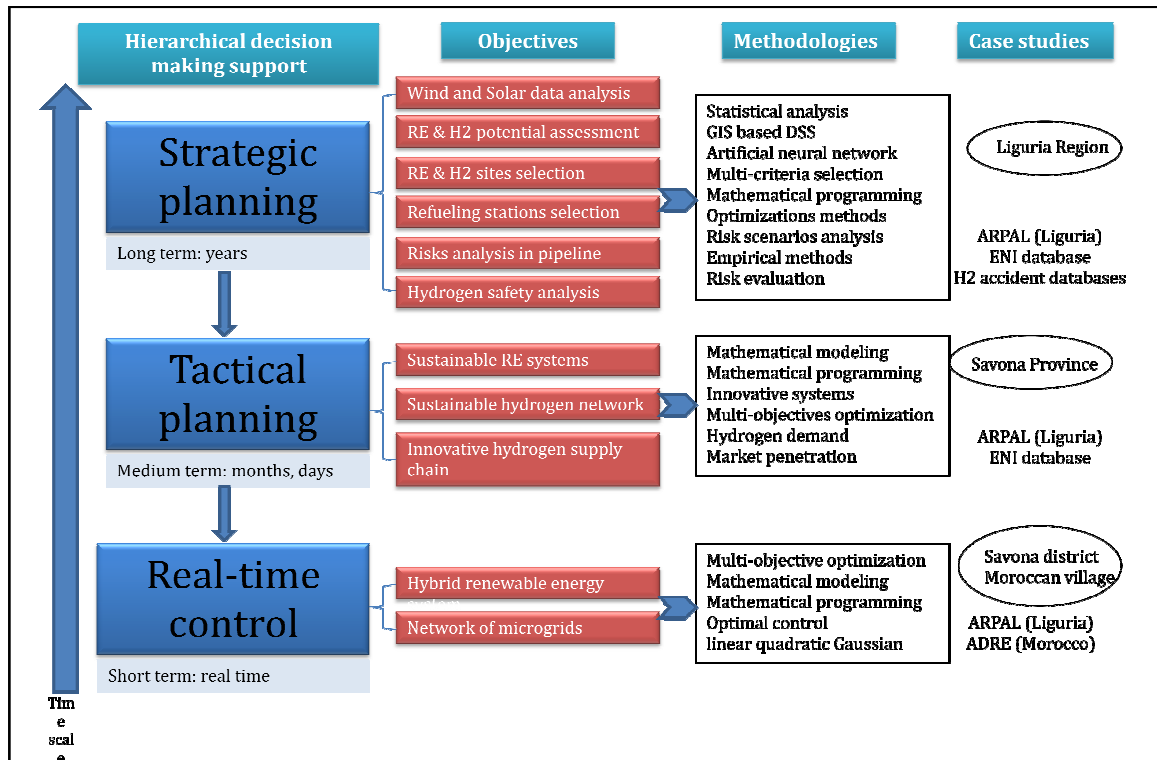

Figure 1.1 Thesis structure

The objective of this thesis is devoted to the RES integrated with hydrogen systems. The problem presented within the thesis is treated following three hierarchical decision making support levels as shown in Figure 1.1: strategic, tactical and real time planning. Each planning level evolves a given decision time horizon and implement various methodologies.

In each category of decision (strategic, tactical, real time), the decision support making for the sustainable renewable energy systems and hydrogen logistics are given following various time horizon. The strategic plans are a type of decision making process that is quiet difficult to gather because they cover a relatively long period of time. The tactical planning are a medium term decision making process which emphasizes analysing the everyday functioning of the renewable hydrogen systems, while the real time controls are a short term DSS which has the responsibility to reach a real time decisions. Despite their differences, tactical, strategic, real-time planning are

integrally related. Decision makers need all planning procedure, and these latter must be closely related to be successful.

For instance, the strategic planning has the aim to propose the large frame of the renewable hydrogen supply chain, and hence to focus on the parts which have a long-term effects, such as plant location, feedstocks availability. The output of the strategic planning will serve for the second of decision (tactical one) in order to better analyse the consequences of strategic plans once operating. From the methodologies application perspectives, different case studies have been implemented which are mainly based in Italy and Morocco.

The general objective is to develop methodologies, new models and innovative strategies for the optimization and the optimal control of the sustainable energy systems. The thesis deals also with the hydrogen logistic chain, giving focus on a network of integrated facilities, sources of production, storage systems, infrastructures, and delivery process to the end users in terms of hydrogen refuelling stations, industrial and commercial market.

In addition, when hydrogen infrastructure design strategies are established, safety and risk considerations are of paramount importance for the sustainable hydrogen economy. So that, it is reasonable to determine safety, technological conditions and associated operating procedures for the realization of such systems. Different motivations are behind the choice of this hydrogen research theme. In addition to the environmental and energy security issues that motivate to thinking about new energy alternatives, especially hydrogen. There are other motivations that drive our investigations in the domain, namely:

- The introduction of hydrogen would largely require new dedicated infrastructures, so the best configuration of hydrogen infrastructure must be found taking into account especially the current environmental conditions.
- The role of infrastructure to build the hydrogen economy, through understanding and managing all components of the logistic chain.

One other additional value of this research work is the implementation of safety issues in the hydrogen logistic chain. In particular, in order to achieve the goals notated in previous paragraph and make hydrogen supply chain acceptable by public and other entities, a specific interest is dedicated to the configuration of the hydrogen pathway that minimizes the total risk.

The frame of the risk that is treated in the context of this thesis can be divided following three viewpoints:

- The first one which is a deterministic analysis that focuses on describing the hazards in terms of the consequences that may occur in some parts of hydrogen infrastructure, namely, pipeline, storage tank, where no consideration is taken of the frequency of the occurrence.

The aim of this part is to demonstrate the consequence of hydrogen accident in case of a future infrastructure operation.

- Second viewpoint focuses on the frequency analysis, thus basing on different worldwide available databases and other published results of the frequency of occurrence of a hydrogen accident into some parts of the supply chain.
- The third and last part will integrate the risk into the whole supply chain, thus looking for integration of a hydrogen infrastructure that minimizes the global risk as regard the risks to population and environment.

In establishing a hydrogen infrastructure design strategy, attention will be given to the design of a configuration of hydrogen pathway that take into account the trade-off between centralized (large scale production at renewable energy promising sites) and decentralized (small-scale production at local refuelling stations or small plants) supply chain.

3. Structure of the dissertation

The thesis is divided into two tomes. In tome 1, a review of the current state-of-art related to the hydrogen and renewable energy resources is done. While, Tome II describes different studies and scientific contributions accomplished during my thesis, where each chapter is composed by publications that appear in international journals.

Chapter 1 provides main motivations behind thinking about hydrogen as an energy carrier or future fuel alternative. It presents the context of the research, scope of work and the methodology deployed within the thesis. The *chapter 2* review the sustainable development of renewable energy. It represents the substance hydrogen, its role and advantages in solving the worldwide environmental and energy security issues. In *Chapter 3*, some preliminary concepts on hydrogen supply chain following an organisational approach, utilisations, as well as a description of the infrastructures components are presented. The same chapter describes in detail the current state of the available approaches for the planning and modelling of the hydrogen infrastructure. A classification of models and approaches is done. The chapter also highlights future challenges for the introduction of hydrogen. *Chapter 4* discusses the risks of using the hydrogen in different components of its logistic chain as well as it discusses about the safety issues related to hydrogen. A detailed literature review is summarized which contains the state of art of hydrogen risks and the methodological approach followed by the worldwide scientific and technical communities to evaluate risks that results from hydrogen accident.

Tome II constitutes the core of my research. It is composed by 6 research studies. They represent various scientific research related to hydrogen exploitation as both, future fuel or/and for power

generation. *Chapter 5* is divided into three main parts. The chapter deals with the use of renewable energy sources as clean feedstocks for hydrogen production. *The first part* analyses deeply the renewable energy sources from different perspectives, it shows an assessment of wind and solar resources available, focus is specially dedicated to the energy that can be extracted from these resources. *The second part* presents further enhancement of the previous chapter. It implements specific methods for a better analysis of the potential of renewable energy sources. In addition, it presents a decision support system for the hydrogen energy exploitation, focusing on some specific planning aspects. In particular, the planning aspects regard the selection of locations with high hydrogen production mainly based on the use of solar and wind energies. The overall approach for both chapter 6 and 7 is applied to a specific case study in Liguria region, in the north of Italy. An innovative design of hydrogen network is proposed in the *third part of chapter 5*. It consists of a network of Green Hydrogen Refuelling Stations (GHRS) and several production nodes. The proposed model is formulated as a mathematical programming, where the main decisions are the selection of GHRS that are powered by the production nodes based on distance and risk criteria, as well as the energy and hydrogen flows exchanged among the system components from the production nodes to the demand points. Optimal configurations are reported taking into account the presence of an additional industrial market demand of hydrogen and a connection with the electrical network.

Chapter 6 presents two decision support systems that may be implemented in the selection of hydrogen infrastructure locations. In *a first part*, an integrated approach considered as a decision support system for the selection of hydrogen refueling stations is given. The method combines two different approaches: a detailed spatial data analysis using a geographic information system with a mathematical optimization model. Regarding GIS component, criteria related to the demand and safety are considered for the selection of the hydrogen stations, while in the mathematical model, criteria that regard costs minimization are considered. In general, the DSS will identify the suitable sites providing information on multi-criterion level evaluation of locating the hydrogen infrastructure.

Chapter 6 is pursued by *the second section* that seeks to propose a mathematical model that has been proposed in order to assess the hazard and consequences of an accident scenario of hydrogen in pipelines. The study aims to investigate the effects of different hydrogen operations conditions and to tackle with different release or failure scenarios. The study presents a helpful engineering tool, to establish the safety requirements that are related to define adequate safety buffer zones for the hydrogen pipeline in order to ensure safety to people, as well the environment.

Chapter 7 presents two innovative types of sustainable energy systems. *In first section of Chapter 7*, a hybrid renewable energy system is shown, integrating several subsystems, i.e., wind turbine, water storage, hydrogen storage, electrolyzer, fuel cell, and hydroelectric plant. Beside the electric energy satisfaction, the objective function also aims to satisfy the hydrogen and water demands. Unlike most contributions available in the literature, in this chapter an overall optimization problem is defined in connection with a dynamic system model, with the aim to define optimal real time control strategies. *The second section of Chapter 7* presents a mathematical formalization to support optimal decisions in a regional network of power microgrids, where each microgrid has a local energy storage, can produce energy from wind, and must feed the consumption of a certain number of households. In the model, the control variables are the instantaneous power flows among the microgrids and with the main power grid. The objective is to minimize the power exchanges among the grids, and to make each local storage work around a proper optimal value.

Chapitre 2 : Sustainability of renewable energy resources

Les impacts environnementaux à l'égard du réchauffement climatique sont devenus une priorité mondiale pour éliminer progressivement l'utilisation de combustibles fossiles pour les activités de transport en faveur du vecteur énergétique hydrogène. Les carburants alternatifs qui sont produites à partir des systèmes d'énergie renouvelables sont un défi pour le développement durable de la production d'énergie renouvelable. Un aspect important qui mérite d'être étudié est la faisabilité de tels systèmes, et quelles sont les limites pour considérer les énergies renouvelables comme source de carburant et source pour la production d'électricité. Ces aspects sont étudiés dans le détail au cours de cette thèse. Notre recherche analyse, dans le même temps, les aspects liés à la faisabilité des modes de production verte et le développement d'une chaîne d'approvisionnement qui fonctionne en s'appuyant sur ses propres ressources énergétiques renouvelables.

1. Sustainability concept

The current trend of rising fossil fuel environmental related problems and others energy security issues make the exploration for more sustainable ways to use energy more persuasive than ever. Sustainability is now a core concept in major policy-making processes, in the environmental aspects of population growth, and in the redevelopment of existing facilities and infrastructure. Sustainable development can be considered to be a higher form of environmental policy. Due to the broad implications of resource management, sustainability is functionally dependent on energy use, on the ways energy is transformed, and the types of energy selected for a given task [Roosa, 2008]. The sustainability is defined as the ability of physical development and environmental impacts to sustain long term habitation on the plane Earth by human and other indigenous species. Four keys are defined according to the Brundtland Commission's Report (Jefferson, 2006) which are considered as the key elements of sustainable energy:

- 1) Sufficient energy supplies to meet human needs,
- 2) Energy efficiency and conservation measures minimizing waste of primary resources,
- 3) Safety issues and public health arising using energy resources,
- 4) Protection of the biosphere and prevention of more localised forms of pollution.

The sustainability of energy is an important factor to be considered. Energy is one of the principal driving forces in the economical development of a country. It is the fundamental input for the production of goods and services, apart from increasing the well-being of the population, through the provision of thermal comfort, light and leisure, among other benefits (Pereira *et al.*, 2008). Providing affordable, reliable, environmentally sustainable energy to the world's population presents a major challenge for the first half of this century and beyond. The sustainable development of energy resources requires a supply of energy resources that are sustainably available at a reasonable cost, without causing any environmental damages. It is well recognized that energy resources such as fossil fuels are finite and lack sustainability, while renewable energy sources (RES) are sustainable over a relatively longer term (Mustafa Omer, 2008). The concept of sustainability is widely accepted as having three dimensions or pillars – economic, social and environmental. (see Figure 2.1):

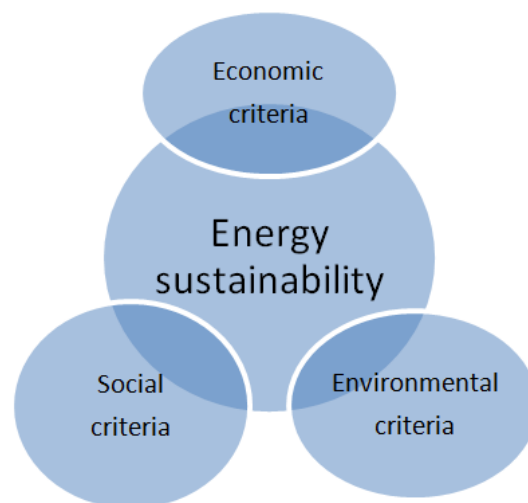

Figure 2.1 Criteria for the Energy sustainability

According to Lund (Lund, 2007), the sustainable energy development strategies may involve three main technological changes: energy savings on the demand side, efficiency improvements in the energy production, and replacement of fossil fuels by various sources of renewable energy. For sustainable development, green energy can play an important role for meeting energy requirements in both industrial and local applications. Therefore, development and utilization of green energy strategies and technologies should be given a high priority for sustainable development in a country (Pereira *et al.*, 2008). In general, energy generation and use are strongly linked to all elements of sustainable development: economic, social, and environmental. Achieving sustainable development on global scale will require the judicious use of resources, technology, appropriate economic

incentives and strategic planning at the local and national levels (Streimikiene *et al.*, 2007). Implementing sustainable solutions that involve energy conservation, energy efficiency, and alternative energy production can reduce energy use, improve urban sustainability, and begin to address environmental problems.

2. Renewable energy resources and sustainability

The use of RES and the rational use of energy, in general, are the fundamental inputs for any responsible energy policy. RES supply 14% of the total world energy demand (Demirbas, 2005). RES can include biomass, hydropower, geothermal, solar, wind and marine energies, and are also often called green alternative sources of energy. The renewable are the primary, domestic and clean or inexhaustible energy resources. Many authors from the academic and industrial worldwide communities agreed that RES are the pivot for sustainable development. For instance, the European Union has officially recognized the need of promoting RES as a priority measure both for reduction of energetic dependence and for environmental protection (Franco and Salza, 2011). Achieving sustainable development on global scale will require the judicious use of resources, technology, appropriate economic incentives and strategic planning at the local and national levels (Streimikiene *et al.*, 2007).

A transition to a renewable based energy system is crucial. Obstacles with renewable electric energy conversion systems are often referred to the intermittency of the energy sources. Their variability poses problems for applications that require a continuous supply of energy. Thus, the variability related to the inherent temporal mismatch between resource availability (sun shining, wind blowing etc.) and the load poses a serious technical issue for the deployment of renewable energy (Bergen, 2008). To summarize, the main critical elements related to the intermittent RES can be categorized as follow (Franco and Salza, 2011):

- Variability and stochastic behaviour of renewable energy system due to fluctuation of renewable sources through weather conditions
- Direct applications of energy from renewable can satisfy the electric loads, but cannot be considered as an alternative fuel for transportation purposes, which means that electricity from RES cannot be useful in mobile applications.
- Constraint related to the flow of electricity sent from renewable energy systems through power grid lines.
- Mismatch between the supply and demand side, which make high pressure on servicing the demand side

- Excess of electricity production risk, caused both by high level of installed renewable power plants capacity and by the intrinsic poor flexibility of thermal power plants

3. Renewable hydrogen energy

In order to overcome the above RES drawbacks, one of the alternatives is the adoption of RES-Hydrogen systems. In fact, hydrogen is an energy carrier, so it needs to be produced from others sources of energy. A renewable based hydrogen economy is one of the possible implementations of such systems. Using RES as basis of hydrogen production could lead to many environmental advantages. In addition, in contrast to RES alone, RES coupled with hydrogen production plants can solve many problems and can even increase the penetration of RES. This penetration could be reached through creating a bridge to the use of RES in the transportation sector and through the use of hydrogen as a storage medium for electricity generation. Hence, hydrogen can play double role: as a fuel for the transportation sector and as a storage medium for the intermittent RES. The main question now is why hydrogen and not another material. In fact, hydrogen is the most abundant element in the world, it is not toxic and its combustion does not create any pollution or greenhouse gases. It has the highest specific energy content of all conventional fuels. Hydrogen may be used as fuel in almost any application where fossil fuels are used today, in particular in transportation sector, where it would offer immediate benefits in terms of the pollution reduction and cleaner environment (Barbir, 2009). Hydrogen, in contrast to RES, can be utilized in different applications and in all parts of the economy (e.g., generate electricity and as an automobile fuel). Recent studies suggest that renewable hydrogen will have a small price premium compared to hydrogen from traditional fossil sources (such as steam reforming of natural gas) if hydrogen is to become a competitive, environmentally-friendly alternative to gasoline (NAS 2004). In a long term, hydrogen from renewable energy can contribute significantly as a bridge to the implementation of RES in transportation sector. In addition, hydrogen could be more used as a storage medium for electricity from intermittent renewable energies such as wind power and photovoltaic systems, contributing then significantly to the widespread use of renewable energy technologies. Figure 2.2 displays the possible uses of RES. It appears clearly how the perspective of further increase of RES can lead to satisfy transportation and electricity demand.

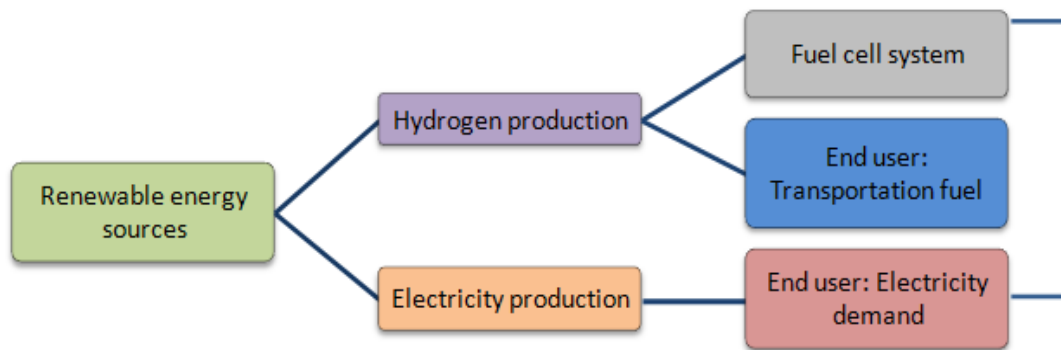

Figure 2.2 Renewable energy-possible uses with electricity and Hydrogen

3.1 Renewable hydrogen: as a future fuel

Hydrogen is currently gaining much attention as a possible future substitute for fossil fuel in the transport sector (Lee *et al.*, 2010). As transport fuel, hydrogen can both be combusted like kerosene and gasoline, or used in fuel cells. Fuel cells convert hydrogen into electricity, which is used to power the electric motors that are used to make the wheels turn and propel the vehicles. The use of hydrogen in fuel cell vehicles offers a number of advantages over existing fuels (Hugo, 2005). The fuel cell vehicles (FCV) can be a long-term solution to the persisted environmental problems associated with transportation. FCV are less complex, have better fuel economy, lower GHG emissions, greater oil import reductions and would lead to a sustainable transportation system once renewable energy was used to produce hydrogen (Thomas *et al.*, 1998). The internal combustion engine can operate in a bivalent mode with gasoline and hydrogen from RES, which might be of significant importance for the transition period to a hydrogen economy in the early phase of market introduction (Ajanovic, 2008). According to Wei and Chihlin (Wei and Lin, 2009), six issues must be addressed in order to implement the hydrogen as an alternative fuel, namely: limited number of refuelling station, high cost of installation of refuelling stations, limited on-board fuel storage, safety and liability concerns, improvements in the competition, and high initial cost for consumers. There are a few ways to supply renewable energy to drive vehicles. One is to use electricity from a grid, which will be supplied by wind power or PV (photovoltaics). In this case electricity will be used by plug-in electricity or by hydrogen production through water electrolysis (Tsuchiya, 2008). The option of producing hydrogen from RES as a transportation fuel is also receiving increased attention. Many studies have been published which investigate the technical and economic issues of hydrogen as a future fuel. Linnemann and Steinberger-Wilckens (Linnemann and Steinberger-Wilckens, 2007) have presented a model that calculates realistic costs of wind-hydrogen vehicle

fuel production. Authors found that, if hydrogen is to represent a practical fuel alternative, it has to compete with conventional energy carriers. Joffe *et al.* (2004) presented a technical modelling of hydrogen infrastructure technologies and how they could be deployed to provide an initial facility for the refuelling of hydrogen fuel-cell buses in London. The results suggest that the choice of H₂ production technology can have significant effects on when the infrastructure would be installed, and the timing of hydrogen production, and bus refuelling. In (Vidueira and Contreras, 2003), a feasibility study of an autonomous solar-H₂ system connected to a filling station for fuel cell buses is presented. Greiner *et al.* (2007) gave a method for assessment of wind–hydrogen (H₂) energy systems. Authors evaluate two possibilities with connection and no connection with the grid. The produced hydrogen will be supplied to a filling station where local vehicles can fill at demand. From the practical side, many projects and demonstrator case studies have been implemented for example: the CUTE project will use renewable energy from wind, solar and hydropower for refuelling stations in four European cities (Jones, 2002).

3.2 Renewable hydrogen: as an electric bridge

Hydrogen is proposed as a convenient energy carrier due to its versatility in use and as an energy storage medium. Hydrogen produced from RES offers the promise of a clean, sustainable energy carrier that can be produced from domestic energy resources around the globe. Energy storage is a potential solution to the integration issues that are described above. Appropriate operation of energy storage could increase the value of wind and solar power in the power system through ensuring the matching between renewable power generation and electric demand. Hydrogen is now in the same position than electricity a little over century ago, when it replaced the direct use of the power from a steam engine (Scott, 2004). However, hydrogen does not replace electricity in the future, but they will work together in some kind of synergy. Electricity will be converted to hydrogen when energy storage is needed and hydrogen will be converted back to electricity when e.g. a fuel cell vehicle needs power to its traction motor (Sperling & Cannon, 2004). The implementation of hydrogen will help to overcome the storage difficulty of renewable energy. A renewable hydrogen system with electrolyzer, storage and fuel cell can be used to provide households with a reliable power supply. In fact, hydrogen has been regarded by many as a popular carrier of renewable energy in remote locations (Barbir, 2009), (Salgi *et al.*, 2008), (Wietschel and Seydel, 2007). Hydrogen can be expected to allow the integration of some RES, of an intermittent character, in the current energy system (Zoulias *et al.*, 2006). Several authors have proposed the use of hydrogen for the management of the energy generated ((Agustin and Lopez, 2008), (Taljan *et al.*, 2008), (Shakyaa *et al.*, 2005), (Korpas and Holen, 2006), (Zhou *et al.*, 2008)). In fact, the electricity generated from

renewable sources such as wind, solar, and hydro can be turned into hydrogen using the electrolysis process, hydrogen can then be stored until it can be transferred into electricity and fed into the electrical grid. Hydrogen is the suitable energy carrier to store solar and wind energy and transforms them to most convenient energy form - electricity. Electricity made from RES is an inexhaustible, environmentally friendly energy carrier. International interest in hydrogen as an energy carrier is high. Several projects have considered the feasibility of a renewable hydrogen economy, and others have begun to plan renewable hydrogen systems.

4. Conclusion

The increasingly environmental impacts of global warming have made a worldwide priority to phase out the use of fossil fuels as transportation and energy fuels in favour of hydrogen. The alternative fuels and energy carriers that are produced from the RES are challenging for the sustainable development of renewable energy. These systems need a lot of investigations to first manage the flux of renewable energy and then to produce the alternative fuel and energy. In addition, one important aspect that worth to be studied is the feasibility of such systems, and what are the limits of considering renewable energy as a source of fuel and electricity production. During the further development of the thesis, these aspects will be deeply studied, analysing in the same time the aspects related to the feasibility of the green production routes and developing a supply chain that operates basing on such clean renewable energy resources.

Chapitre 3 : The need for a sustainable planning of hydrogen energetic vector

Dans cette section, nous présenterons et détaillerons certains concepts préliminaires qui concernent la chaîne d'approvisionnement d'hydrogène et ce, selon une approche organisationnelle où les différents nœuds de la chaîne logistique sont décrits. Cette présentation commence par exposer les différents moyens disponibles pour produire l'hydrogène, en expliquant leurs avantages et limites. Le chapitre se poursuit par une comparaison entre ces moyens de production, cette dernière ayant d'ailleurs démontré que de considérables avantages environnementaux pourraient être obtenus en exploitant les énergies renouvelables, particulièrement le solaire, l'éolien et hydrologie pour production d'hydrogène. Ce chapitre détaille ensuite les différents moyens de stockage et de transport disponibles pour l'infrastructure de l'hydrogène.

Le chapitre 3 se poursuit par une analyse bibliographique détaillée sur les différentes approches et méthodes disponibles pour la planification et la modélisation de l'infrastructure d'hydrogène. Une classification de la littérature liée à la CAH (chaîne d'approvisionnement d'hydrogène) a été réalisée et distingue trois catégories principales de contributions, à savoir: les méthodes mathématiques pour l'optimisation de l'infrastructure d'hydrogène, les approches fondées sur l'information spatiale à l'aide de l'utilisation de SIG (systèmes d'information géographiques) et la planification de la chaîne d'approvisionnement d'hydrogène. Sur la base de cette étude bibliographique, il a été constaté que nombreux sont les auteurs qui mettent l'accent sur la conception d'une chaîne logistique de l'hydrogène moyennant des méthodes d'optimisation. Ces dernières sont plus efficaces pour mieux répondre à la question liée à l'optimisation des coûts de l'infrastructure de l'hydrogène. Il a été remarqué aussi qu'il existe peu d'études qui abordent l'optimisation de la chaîne en intégrant les questions liées aux risques induits par ces technologies.

Preamble

From the previous chapter, we understood the need for sustainable energy systems mainly driven by the use of hydrogen. Hence, in this Chapter, we will discuss about the hydrogen infrastructure following an organisational approach. In the first section of this chapter "Hydrogen as an energy alternative", an introduction to different hydrogen supply chain nodes is presented. In particular, a comparison of different hydrogen production routes is shown, where economic and environmental aspects have been investigated.

In the second section of Chapter 3, "Planning and design of the future hydrogen supply chain", a literature review of the current available approaches for the planning of the future hydrogen infrastructure is presented. This section will provide the elements for developing a decision support model for the hydrogen supply chain. It will allow us to characterize the tool to the decision that we need to develop and highlight the contributions of our approach.

A- Hydrogen as an energy alternative

1. Introduction

The development of clean, sustainable, and cost-competitive hydrogen production processes is essential to the market success of hydrogen technologies. Hydrogen has the highest specific energy content of all conventional fuels, it is the most abundant element in the universe; it is not pollutant and can offer great potential in enhancing the current air quality and decrease noise resulting in using the usual transportation means. Hydrogen can be produced from a wide variety of primary sources. Such diversity obviously contributes significantly to the security of fuel supply. It is possible to produce it from water, both by conventional electrolysis and advanced high temperature processes; nuclear or solar energy (solar energy and wind energy) can be used as heat source for H₂ producing processes, biomass and coal can be gasified to obtain hydrogen, as well as fossil fuels (Conte *et al.*, 2001).

2. Hydrogen production methods

2.1 Hydrogen from Fossil fuels

Hydrogen can be manufactured from fossil fuels through a variety of technologies (coal, natural gas, etc.). The production technologies are: steam reforming (SMR), partial oxidation, and gasification. Nowadays, most hydrogen produced worldwide (approximately 99%; (Hart *et al.*, 1999)) which is about 700 billion Nm³ (Ball and Wietschel, 2009) per year is derived from fossil fuels; roughly half on natural gas and close to one third on crude oil fractions in refineries. At the world scale, global hydrogen production today is enough to fuel approximately more than Nm³ 600 million fuel cell cars and is based almost exclusively on fossil fuels. Currently, the largest use of hydrogen is as a reactant in the chemical and petroleum industries: ammonia production has a share of around 50%, followed by crude oil processing with slightly less than 40%. In Europe, 80% of the total hydrogen was consumed by mainly two industrial sectors: the refinery (50%) and the ammonia industry (32%), which are both captive users. If one adds hydrogen consumption by methanol and metal industries, those four sectors cover 90% of the total. The hydrogen production from fossil fuels is a well established technology in the world, for instance, in Europe, there are seven high producer's capacities in Germany, United Kingdom, Netherlands, Spain, France, Belgium and Italy.

2.2 Hydrogen from Biomass

Hydrogen produced from non-intermittent such as the biomass offers the possibility of renewable hydrogen. It enables a sustainable route for the production (Balat and Kirtay, 2010). The use of biomass instead of fossil fuels reduces the net amount of CO₂ released to the atmosphere. Biomass gasification can offer great potential through utilizing renewable feedstocks derived from agricultural waste, energy crops and/or forestry residues (Guoxin and Hao, 2009). The gasification of biomass currently represents a global capacity of production of over 430 million Nm³ of hydrogen per day (Shoko *et al.*, 2006) and (Balat, 2008). Many countries around the world have allocated the research and development towards the hydrogen production from biomass. For instance, Austria has several demonstration plants and pilot projects for the gasification of biomass for hydrogen production. In U.S, a target objective is to lead to hydrogen from biomass competitive with gasoline by 2015. Despite the advantages of hydrogen from renewable biomass, biomass has several limitations, among them, the processes of hydrogen production from biomass are still in the development and require a strong effort in terms of R&D and demonstration activities (Balat and Balat, 2009). In addition, another limitation illustrated in term of the low content of hydrogen available in the biomass (6 to 6.5 %). Also, the characteristics of biomass are very important since they can vary greatly from location to location, seasonally and yearly (Fowler *et al.*, 2009). So that the hydrogen production via biomass route may not be competitive with the hydrogen production with fossil fuels. From others production points, the costs of hydrogen production from biomass become higher due to the additional costs of the logistics of the crops to the centralized production facilities (Landry, 2006).

2.3 Hydrogen from Nuclear

Nuclear power could produce hydrogen by either electrolysis of water, or by direct thermal decomposition of water using heat from high temperature reactors (Moriarty and Honnery, 2007). Nuclear power plants produce heat that can be used directly or converted to electricity for the production of hydrogen. Hydrogen generation from water using nuclear energy has been examined in Japan. It is found that the high temperature gas cooled reactor (HTGR) has a possibility to generate hydrogen economically compared with other types of nuclear reactors. Four countries in the world are leaders in the production of hydrogen from nuclear: Japan, France, Korea and U.S. for instance, France is carrying out R&D program on massive hydrogen production with innovative high temperature processes. Collaboration in the literature appears also in the paper published by Yildiz *et al.* (2006), who presented nuclear energy as major source for clean production of large amounts of hydrogen which will be essential for solving the problem of fast growing energy

demand in all sectors in the world, including the transportation. Nevertheless, despite the R&D carried out in the world, the nuclear hydrogen production cannot be considered at any case as a sustainable route, especially after the explosion in the Fukushima Nuclear Power Plant triggered by the Tsunami in Japan 2011, thus nuclear faces many government and public acceptance.

2.4 Hydrogen from renewable energy resources

Many authors agreed that neither fossil fuel, biomass, or nuclear cannot satisfy the existing electricity demands and cannot provide sufficient climate-neutral energy to be probable routes for long-term hydrogen future production. Biomass, hydro and geothermal even their feedstock can be estimated by accuracy, but they have limited potential and they are not always climate –neutral (Moriarty and Honnery, 2007). The only remaining way to produce hydrogen is then the intermittent RES, especially solar and wind energies. In contrast to those production methods, renewable energies are a desired energy source for hydrogen production due their diversity, regionality, abundance, and potential for sustainability. Renewable hydrogen is mainly an economic option in countries with a large renewable resource base and/ or a lack of fossil resources, for remote and sparsely populated areas (such as islands) or for storing surplus electricity from intermittent renewable energies. Hydrogen coupled with renewable energy resources provides an energy storage medium which enables the more towards greater use of the intermittent renewable energy resources in the transportation sector, enabling then new interactions between the electric and transportations sector. Renewable hydrogen production offers the potential for a distributed hydrogen supply network model, which would be based on on-site or off-site hydrogen production. The electricity generated from renewable sources can be turned into hydrogen using the electrolysis process. In fact, about 55 kWh of electricity are needed to liberate 1 kg of hydrogen from 9 kg of water by electrolysis (Bossel, 2006). Hydrogen can then be stored until it is needed as fuel for either transportation applications or local stationary power generation sources, or it can be transferred into electricity and fed into the electrical (Martin and Grasman, 2009). Electrolysis driven by renewable energy may be an option for a sustainable hydrogen production. In fact, the electricity generated by the renewable energy systems is transferred to the electrolyzers system for the production of the hydrogen via electrolysis by passing electricity through two electrodes in water. One advantage of electrolysis of water is that nowadays; it is compatible with large variety of available renewable energy technologies namely, solar, hydro, wind, wave, geothermal, etc. In addition, water electrolysis benefits of some additional advantages (Clarke *et al.*, 2009), among them the use of different scales (on-site and off-site), its greater maturity, compactness and high current density and small footprint. General interest in a wind-hydrogen system has increased partly

because the price of wind power has become competitive with traditional power generating sources in certain areas. Due to the characteristics of a wind-hydrogen system it has the potential to play a complementary role during the mass introduction of hydrogen (Elam *et al.*, 2003). It seems likely that intermittent RES, chiefly wind and solar will have to supply most non-fossil energy in 2050 and beyond (Moriarty and Honnery, 2009). The technical potential for these sources is undoubtedly very large (de Vries *et al.*, 2007). In the long term, strong hydrogen markets and a growing hydrogen infrastructure will create opportunities for renewable hydrogen systems. To be successful, many challenges face the wind and solar energies, among them costs issues and the need for improvement in energy ratio (Moriarty and Honnery, 2007). Figure 3.1 displays different technologies available for hydrogen production.

Hydrogen from fossil fuel	Hydrogen from nuclear	Hydrogen from biomass	Hydrogen from renewable
<ul style="list-style-type: none"> • Steam reforming • Coal gasification • Partial oxidation 	<ul style="list-style-type: none"> • Electrolysis • Thermo-chemical 	<ul style="list-style-type: none"> • Gasification of biomass • Thermo-chemical 	<ul style="list-style-type: none"> • Solar-Electrolysis • Wind-electrolysis • Photo-chemical • Photo-biological • Photo-electrolytical

Figure 3.1 Hydrogen production process

3. Comparisons of hydrogen production routes

3.1 Scales of production

The cost of hydrogen is highly influenced by the scale of the installation. In fact, in addition to the various production routes available for the generation of hydrogen, more pathways could be developed namely distributed and centralized production pathway. Centralized production is usually a large scale production of hydrogen, where hydrogen is needed to be transported to the demand points. For instance, the hydrogen production cost from natural gas via steam reforming of methane varies from about 1.25 US\$/kg for large systems to about 3.50 US\$/kg for small systems with a natural gas price of 0.3 US\$/kg. Distributed production is considered by many authors to be the most likely pathway during the market development of energy systems. In this case, hydrogen must be used close to the production point (Levin and Chahine). The distributed production infrastructure could consist of natural gas reformers or electrolyzers located at the point of use, for example refueling station or stationary power generation. This pathway does not require substantial hydrogen delivery infrastructure. The cost of decentralized H₂ production may exceed US\$6/kg

today (Hydrogen production and distribution). The centralized production benefits from large economies of scale, but to be commercially viable there is a need to develop distribution technologies.

3.2 Environmental benefits & challenges

The environmental benefits of the hydrogen production need to be well investigated in order to study the effects of different production means on the environment. The long-term hydrogen production must ensure an environmental sustainability so to be successful and to not lead to the same problems of today conventional fossil fuels. Many papers have studied the environmental impacts of various hydrogen production routes, including those based on non-renewable and renewable energy resources (Kothari *et al.*, 2008), (Afgan and Carvalho, 2004), (Williams, 2004), (Afgan and Carvalho, 2002). These impacts are always evaluated in terms of the carbon dioxide emitted for the production of one kilogram of hydrogen, since CO₂ is the most important greenhouse gas and is the largest emission from the systems (Kothari *et al.*, 2004). In particular, steam reforming of methane (natural gas) requires only 4.5 kg of water for each kilogram of hydrogen, but 5.5 kg of CO₂ emerge from the process (Bossel, 2006). Figure 3.2 displays the CO₂ emissions for different hydrogen production technologies:

SMR: steam methane reforming

CG: coal gasification

PV-EL: photovoltaic & Electrolyser

H-EL: Hydropower and Electrolyser

POX: partial oxidation of hydrocarbons

BG: biomass gasification

W-EL: wind power and Electrolyser

Hydrogen production from fossil fuels is a major source of CO₂ emissions. It appears that the main disadvantages of hydrogen production via methane steam reforming (SMR), coal gasification (CG), and partial oxidation of hydrocarbons (POH) are the emissions of the CO₂. Among H₂ production routes, coal gasification is the one that lead to high emissions (equal o 29.33 kg CO₂/kg H₂). The electrolysis is the one considered as the only process that does not accompanied with the CO₂ emissions. It is considered so only when power plants use renewable energy resources to generate the needed electricity.

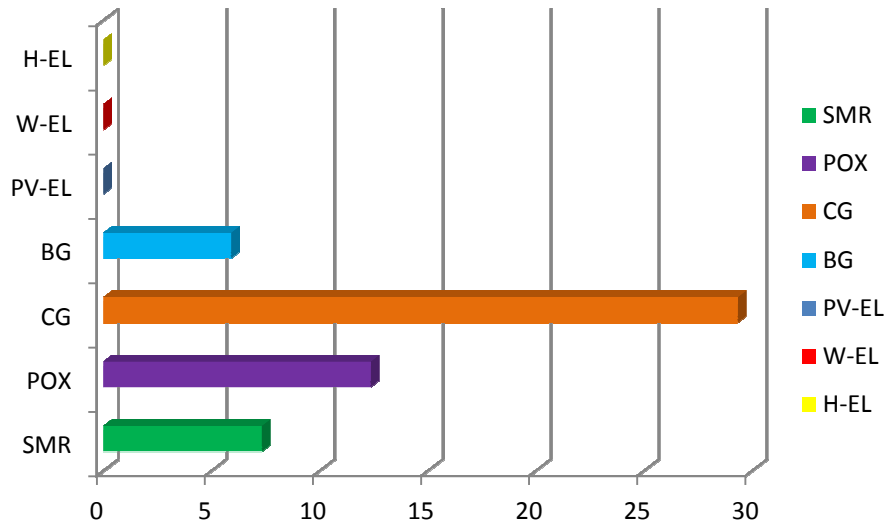

Figure 3.2 CO₂ emissions of various hydrogen production technologies (Pilavachi *et al.*, 2009)

Some solutions are proposed to reduce the emissions of CO₂ such as the separation and the sequestration of carbon dioxide produced in the hydrogen production process capture. Nevertheless, the CO₂ sequestration is not yet technically and commercially proven; and the additional cost of the logistics of the CO₂ capture; storage and transport could increase the total cost of hydrogen production from fossil fuel. As reported by Ball and Wietschel (2000), the total hydrogen production costs increase by about 3–5% in the case of natural gas reforming and 10–15% in the case of coal gasification.

3.3 Costs and economy of hydrogen production

To complete the comparison among the different processes, the cost analysis is important to determine whether a certain hydrogen production route can be used. The cost of producing hydrogen depends on the capital, operation, maintenance and feedstock costs (Kothari *et al.*, 2008). For instance, from a feedstocks viewpoint, cost of hydrogen from fossil fuels is highly dependent on the price of natural gas and others conventional fuels, while the cost of hydrogen produced from renewable energy resources, depend on the level of advancement of renewable energy technologies, and whether the system is connected or not to the electric grid. Figures 3.3, 3.4 and 3.5 show the previous costs for various production routes as analysed by Pilavachi *et al.* (2009), while Table 2.2 displays the cost of hydrogen in \$/kg.

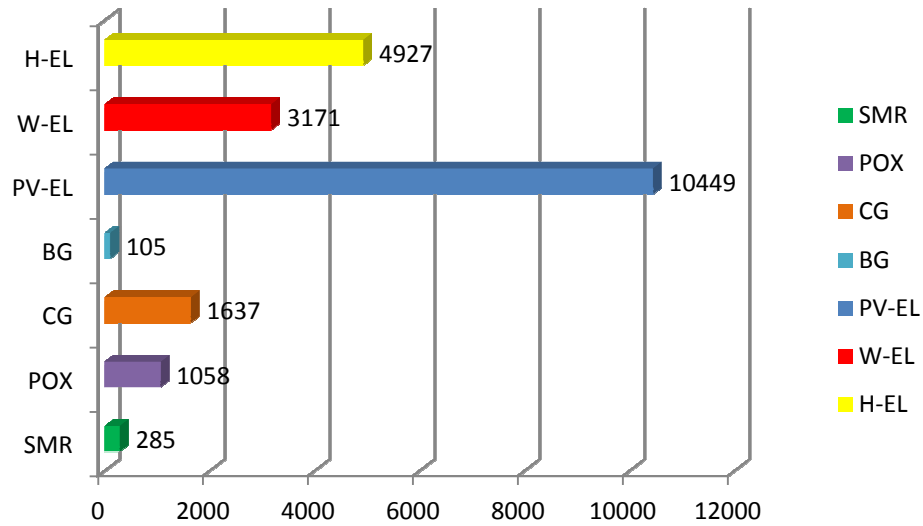

Figure 3.3 Capital costs of various hydrogen production technologies in [US\$/kg H₂/day] (Pilavachi *et al.*, 2009)

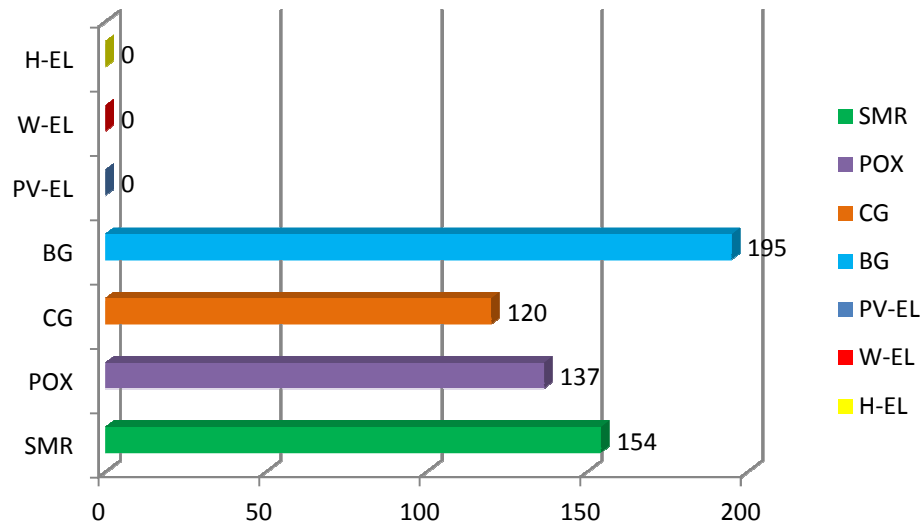

Figure 3.4 Feedstocks costs of various hydrogen production technologies in [US\$/kg H₂/day] (Pilavachi *et al.*, 2009)

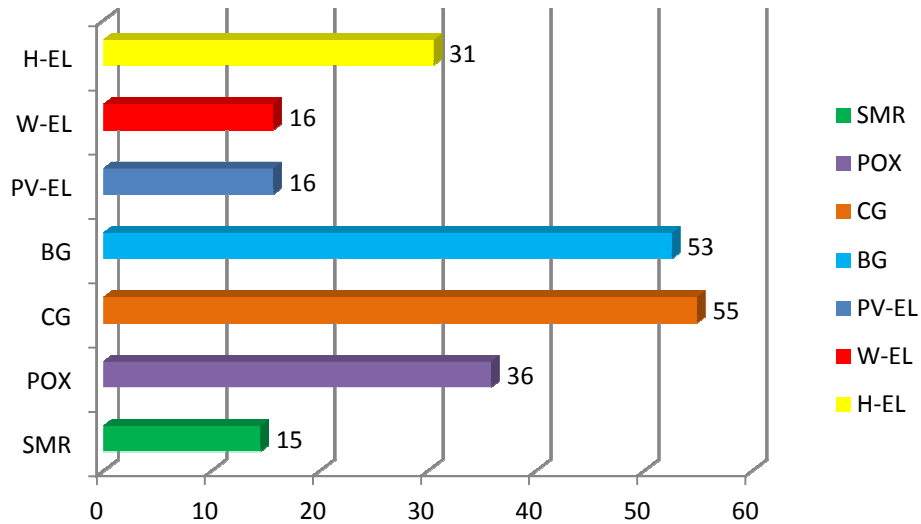

Figure 3.5 Operating & maintenance costs of various hydrogen production technologies in [US\$/kg H₂/day] (Pilavachi *et al.*, 2009)

Figure 3.4 displays that the biomass gasification technology is the one that have higher feedstock costs (followed by the steam methane reforming (SMR) technology). No feedstocks cost is been added to the cost of hydrogen from renewable energy resources. In Table 3.1, the hydrogen production from renewable energy resources has higher capital cost, where a higher value (10449 \$ /kgH₂/day) is observed for the electrolysis process with photovoltaic technology (PV-E).

Resources	Cost of hydrogen production [\$/kg]
Methane steam reforming	0.828 (Mueller-Langer <i>et al.</i> , 2007), (Lagorse <i>et al.</i> , 2008)
Nuclear	1.44-5.40 (FY, 2008), (Elder and Allen, 2009)
Biomass	5.28-9.84 (Lemus and Duarte, 2010), (biomass California)
Hydropower	5.4-7.92 (Mueller-Langer <i>et al.</i> , 2007)
Geothermal	9 (Ewan and Allen, 2008)
Wind-electrolysis	4-9 (Greiner <i>et al.</i> , 2007)
PV-electrolysis	5-20 (Lemus and Duarte, 2010)

Table 3.1 Cost of hydrogen from various technologies

From the last section, it appears that there are many trade-offs that exists among the production routes of hydrogen. From an environmental perspective, it is evident that hydrogen production from renewable energy resources, in particular, wind, hydro and PV will have significant effect on the reduction of the carbon dioxide emissions. From an economic perspective, by comparing the

different costs of hydrogen production methods, it appears that the same previous resources have no costs related to feedstocks since these resources are free and available. The operating and maintenance costs still low using the wind for hydrogen production, but once it comes to the capital costs, photovoltaic has higher capital costs, followed by wind turbines, and hydro. In our thesis, we have based our study using the RES giving special attention to wind and solar. These production sources will be implemented in the thesis as main feedstocks for the hydrogen supply chain. We believe that these resources could lead to high environmental benefits, as regarding the costs, they may go down as more technologies will be developed.

4. Hydrogen storage and distribution

4.1 Hydrogen storage

Hydrogen contains a lot of energy per unit of weight while the content of energy per unit of volume is quite low. This poses a potential problem in terms of storing large amounts of hydrogen. The traditional means of storage such as pressure tanks and cryogenic tanks have improved dramatically, and a number of new storage technologies are currently under development. The least complex method of storing pure hydrogen is as a compressed gas in a high-pressure cylinder. Compressed hydrogen is considered to be a solution for hydrogen storage on motor vehicles due to the relative simplicity of gaseous hydrogen, rapid refuelling capability, excellent dormancy characteristics, and low infrastructure impact. One downside of the methods is a significant energy penalty-up to 20% of the energy content of hydrogen is required to compress the gas. For instance, the storage of 6 kg would require a volume of 255 L (67.5 gallons) for the gas alone. A key enabler factor to use this route of storage is the public's awareness on safety issues associated with high-pressure hydrogen tanks. Another storage type is the one based on storing hydrogen in liquid form. Hydrogen can be stored in liquid form at extremely low temperature for both stationary and onboard vehicle applications. To be liquefied, up to 40% of energy content of hydrogen is required. Hydrogen liquefaction and use of liquid hydrogen is usually practiced only when high storage density is required, for example, in aerospace applications. Some prototype hydrogen-powered automobiles as well as commercially-available automobiles also use specially developed liquid hydrogen tanks (Braess and Strobl, 1996). An alternative to the traditional storage methods (liquid and gas) is proposed through the use of advanced solid materials. Certain materials absorb hydrogen under moderate pressure at low temperatures, forming reversible hydrogen compounds called hydrides. This type of hydrogen storage is often called "solid" hydrogen storage since hydrogen becomes part of the solid material through some physicochemical bonding.

The hydrogen storage capacity for various storage technologies under specific temperature and pressure conditions is summarized in:

Type of storage media	Volume (g/l)	Mass (%)	Pressure (MPa)	Temperature
Compressed gas	Max 33	13	80	298
Liquid hydrogen	71	100	0.1	21
Metal hydrides	Max 150	2	0.1	298

Table 3.2 Types and properties of hydrogen storage media (Lymberopoulos, 2008)

An issue that confronts the use of high-pressure and cryogenic storage centres is public perception and acceptability associated with the use of pressurised gas and liquid hydrogen containment (Dunn, 2002). In fact, large studies have been devoted to investigate the issues related to risks of using gaseous and liquid hydrogen. Hydrogen storage is regarded as one of the most critical issues, which must be solved before a technically and economically viable hydrogen infrastructure implementation. In fact, without effective storage systems, a hydrogen economy will be difficult to achieve. In term of automobile, there is a general agreement that the on-board storage of hydrogen is one of the critical issues for the implementation of the hydrogen vehicles.

4.2 Hydrogen transportation

The emergence of transport systems of the hydrogen energy is one primordial part of successful hydrogen economy. The transportation part will play the driven role in building an hydrogen market in different territories. It will facilitate the transport of hydrogen in territorial basis and between different territories. Yang and Ogden (2007) stated that the choice of the lowest-cost delivery mode (compressed gas trucks, cryogenic liquid trucks or gas pipelines) will depend upon specific geographic and market characteristics (e.g. city population and radius, population density, size and number of refuelling stations and market penetration of fuel cell vehicles). According to many authors (Yang and Ogden,2007), (Qadrdan *et al.*, 2008), the main factors affecting the choice of hydrogen transport mode are the application, quantity to be transported, density of demand, and distance from the production site to the delivery points.

- *Application*: this factor means the type of hydrogen that is needed to be transported to the point in question. For instance, if liquid hydrogen is needed for the application (liquid hydrogen refuelling station), it should be delivered as liquid hydrogen (similarly in case of gaseous application where the choice will limit to gaseous transportation modes), so that, in this case, the type of the application dictates the mode of transport.

- *Quantity*: for large quantities, pipelines are the preferred option, especially in case of long distance, because in this case, pipeline delivery is cheaper than all other methods except in the case of transport over an ocean, in which liquid hydrogen transport would be the cheapest one. While, in case of small quantities, compressed gaseous hydrogen trailers are suitable for over short distances. Distance is also the deciding factor between liquid and gaseous trailers. Hydrogen transport costs are typically in the range of 1–4 ct/kWh (equivalent to 0.3–1.3 \$/kg) depending on the type of transportation and the form of hydrogen (Ball, Wietschel, 2009).
- *Distance*: As mentioned earlier, distance is an important factor. For a short distance a pipeline can be very economical because the capital expense of a short pipeline may be close to the capital cost of tube trucks or tankers, and there are no transportation or liquefaction costs. As the distance increases, the capital cost of a pipeline increases rapidly, and the economics will depend on the quantity of hydrogen pipelines will be favoured for larger quantities of hydrogen (Amos, 1998).
- *Density of demand*: The criterion related to the density of the hydrogen demand is also key factor since the concentration or not of the hydrogen demand will contribute to the choice of the hydrogen transportation mode. This concentration may depend on the future opened hydrogen market and on the density of population.

4.2.1 Mode 1: Pipeline transportation

Similar to the natural gas, you can think of a network of pipelines with transport functions and distribution. In fact, the gaseous hydrogen transport and distribution system might look like current natural gas pipelines with significant technological innovations: new materials for the ducts, and different working pressures and flows to overcome the reduced energy content of gaseous hydrogen (Conte *et al.*, 2001).

Pipelines have been used to transport hydrogen for more than 50 years, and today, there are about 16,000 km of hydrogen pipelines around the world that supply hydrogen to refineries and chemical plants in several industrial areas of USA, Canada and Europe. Dense networks exist for example between Belgium, France and the Netherlands, in the Ruhr area in Germany or along the Gulf coast in the United States (Ball and Wietschel, 2009). Typical operating pressures are 1-3 MPa (145-435 psig) with flows of 310-8,900 kg/h. The longest hydrogen pipeline in the world is owned by Air Liquide and runs 400 km from Northern France to Belgium (Hart 1997). The United States has more than 720 km (447 mi) of hydrogen pipelines concentrated along the Gulf Coast and Great Lakes (Hart 1997; Report to Congress 1995). The cheapest option of transporting hydrogen is by high capacity pipeline, which can cost less than 0.1 US\$/kg over 100 km (Wilckens, 2003). The estimation of the capital cost of hydrogen transmission pipelines range from 200,000 to 1,000,000

US\$/km (Smit *et al.*, 2007). Figure 3.6 and 3.7 display respectively the European and US pipeline hydrogen network available.

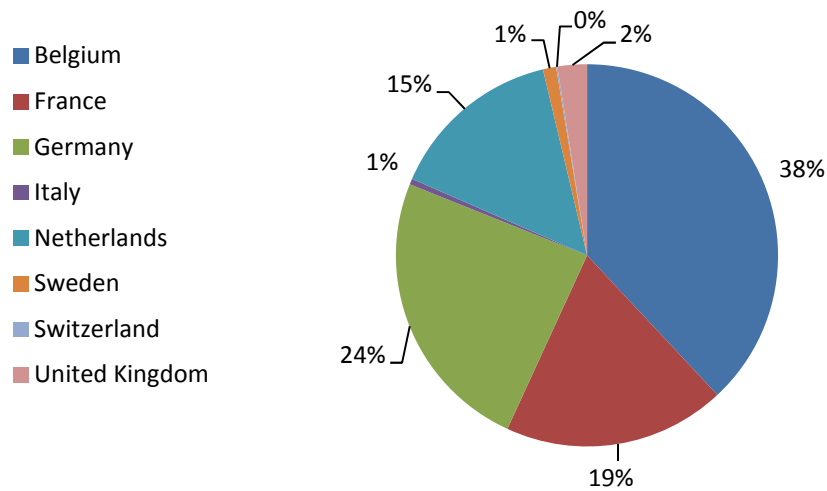

Figure 3.6 European Hydrogen pipeline percentages by country [www.roads2hy.com]

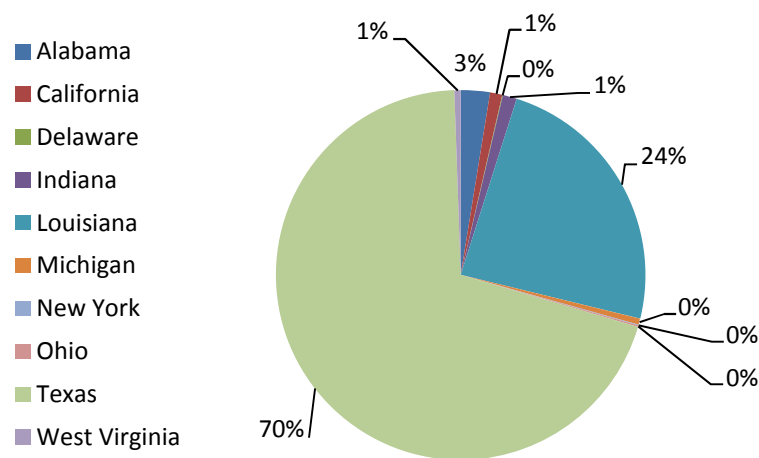

Figure 3.7 U.S. Hydrogen pipeline percentages by state [Energy Information Administration, 2008]

4.2.2 Mode 2: Liquid truck

Liquid hydrogen has a high operating cost due to the electricity needed for liquefaction, but lower capital costs depending on the quantity of hydrogen and the delivery distance (the future of hydrogen-opportunities and challenges). Delivery by cryogenic liquid hydrogen tankers is the most economical pathway for medium market penetration. They could transport relatively large amounts

of hydrogen and reach markets located throughout large geographic areas (NREL report). Although pipeline transport is preferred for gases, hydrogen transport by trucks will play a role in a hydrogen economy. Liquid hydrogen delivery is used today to deliver moderate quantities of hydrogen medium to long distances (Simbeck and Chang, 2002). Forty ton trucks can carry 3500 kg in the liquid state. So that, the transport of liquid hydrogen is limited by volume, not by weight (Bossel, 2006).

4.2.3 Mode 3: tube trailer

Generally, transporting compressed hydrogen gas over the road in high-pressure tube trailers is expensive and used primarily for short distances; it becomes cost-prohibitive when transporting farther than about 321 km from the point of production.

In the United States, commercial tube trailers are well established, they are made up of 12–20 long steel cylinders mounted on a truck trailer bed and are regulated by the US Department of Transportation (DOT). Current DOT regulations and industry standards have limited gas pressures on trucks to 160 atm or less, although higher-pressure trailers have been received special certification especially for risk and security reasons.

5. Conclusion

This section presented a review of different hydrogen technologies that can be used in developing a future infrastructure. The review has started by presenting various available hydrogen production routes, explaining their advantages. we pursued by a comparison between these production means, and which has shown that significant environmental benefits could be obtained using renewable energy - in particular solar, wind and hydro- sources for hydrogen production. From this main outcome, RES specially wind, solar and hydro will constitute the main source of production in developing the approach of the thesis. The section continues by reviewing various storage medium and transportation modes available for the hydrogen infrastructure. In the next section, we will discuss about different existing methods for the planning and design aspect of hydrogen supply chain.

B- Planning and design of the future hydrogen supply chain: A state-of-art

1. Introduction

Hydrogen can be considered as an attractive alternative to succeed the current carbon-based energy system ((Ogden, 1999), (Blanchette, 2008)). Hydrogen is a secondary form of energy that has to be produced like electricity. Its benefits are even substantially considering since hydrogen can be manufactured from a wide number of primary energy sources, such as natural gas, nuclear, coal, biomass, wind and solar energies. From one hand, the development of a hydrogen infrastructure for producing and delivering hydrogen is primordial to reach the hydrogen transition and its development. From other hand, the infrastructure of hydrogen presents many challenges and defies that need to be overcome for a successful transition to a future hydrogen economy. These challenges are mainly due to the existence of many technological options for the production, storage, transportation and end users. Given this main reason, it is essential to understand and analyse the hydrogen supply chain (HSC) in advance, in order to detect the important factors that may play increasing role in obtaining the optimal configuration. However, despite previous cited hydrogen advantages and benefits, the design of an upcoming hydrogen economy is a hard task. A hydrogen infrastructure with production facilities, distribution chains, and refilling stations is very expensive to construct. The difficulties rise also from the presence of many uncertainties in the hydrogen economy as a whole. Also, from a demand perspective, the big obstacle in the adoption of hydrogen-fuelled vehicles is the lack in delivery infrastructures. Real difficulties to hydrogen economy are the ones related to the need of significant investment costs with the no assurance of profitable demand, usually untitled as the “Chicken and Eggs” enigma ((Waegel *et al.*, 2006) and (Ogden *et al.*, 2005). These problems motivate many scientific communities to study, understand and analyse the hydrogen supply chain (HSC) in advance, in order to detect the important factors that play major role in designing the optimal configuration.

The objective of this chapter is to review the current state of art of the available approaches for the planning and modelling of the hydrogen infrastructure. The decision support systems for the HSC may vary from paper to paper. A classification of models and approaches have been done, and which include mathematical optimization methods, geographic information system (GIS) based decision support system and assessment plans to a better transition. Studies related to HSC can be categorized into two types: 1) those related to a component of the supply chain, such as production, storage, distribution, market analysis, and 2) those studies related to the complete analysis of the HSC including simultaneously all parts of the chain. The main objectives within this chapter is: (i)

to review the studies conducted on the HSC (ii) to classify many approaches proposed to find the optimal configuration of the chain, including the review of different mathematical models developed to date to find the optimal configuration of the hydrogen supply chain and iii) to present the future trends and challenges for the design of HSC. Based on this literature review, we will state the characteristics of the tool that will be adopted for the decision support of the future hydrogen supply chain that we propose.

2. Background: Hydrogen supply chain

The design of a HSC has as an objective to find the optimal configuration, including location, production feedstocks, storage, and distribution. This design has to support efficient operations of the whole supply chain. Generally, the modelling of hydrogen infrastructures is a complex task, the main complexities come from the significant uncertainties in demand, supply, economic and environmental impacts, and the diversity of technologies available for production, storage and transportation. In this regard, it is necessary to develop appropriate tools and models to study the transition to a hydrogen economy.

One of the key issues that have to be resolved is how to determine the optimal structure of the network capable of fulfilling the growing hydrogen demand in the existing markets. This optimal structure must usually minimize the cost of development and installation of hydrogen infrastructure. However, one must think that minimizing the total cost may lead to solutions that are inappropriate to some others aspects such as environmental ones. Thus, to find a better compromise, the planning and design of the HSC must take into account multi-criteria decisions that allow in addition to cost criteria, the involvement of other particularities. Hydrogen can be produced from a variety of primary energy feedstocks and distributed in a variety of forms using different technologies. The first dimension rise from the first node of the supply chain is the production.

For example, steam reforming process is exclusively the mature technology that is widely used nowadays. In addition, renewable energy, nuclear, biomass could also play an increasing role in the hydrogen production phase. Unlike conventional fuel infrastructure, hydrogen can be produced using two scales namely centralized or decentralized productions. In fact, these additional aspects may increase the complexity to find the optimal pathway for future hydrogen economy. In fact, centralized production is beneficial. It enables the production at large scales, but one must think that demand of hydrogen will not at high level, plus the additional costs for the distribution must be added. Whereas, decentralized hydrogen can be exploited on site demand with small scale production, thus leading to significant reduction in transportation costs. In this respect, many

authors claimed that centralized systems are often not considered facilities in the near future (Lemus and Duarte, 2010) for producing hydrogen to be used as energy carrier.

From the hydrogen state viewpoint, it can be used in two forms liquid and gas. Liquefied hydrogen can be transported in tankers via rails, roads, or ship, while gaseous hydrogen can be transported via high pressurized pipeline or via tube trailers. These diversities in transportation must be addressed meaning the finding of the most cost effective transportation modes to connect the production to demand centers.

3. Roadmaps deployment

Roadmaps for the hydrogen economy are widely deployed by many countries around the world. They adapted to enable forecasting of future hydrogen infrastructure. The hydrogen economy will be influenced by interactions of complex technological, political, economic and social aspects. Roadmaps are intended to help identifying the strategic objectives and key activities needed to evaluate the costs and benefits of a hydrogen infrastructure. According to (US department of Energy, 2002), roadmap provides a blueprint for the coordinated, long-term, public and private efforts required for hydrogen energy development. In EU, the prospects of hydrogen economy plays a major role, specially because of two main conditions namely the aggregation of many countries that have various specific institutional, opportunities, conditions and territorial and socio-economic barriers. As reported in European HyWays project (project developed to set the European hydrogen roadmap) ((HyWays, 2008), (Seymour *et al.*, 2008)), in addition to the role of hydrogen in improving the security of supply, it may strength the European competitiveness through taking frontrunner position in the worldwide market for hydrogen technologies. According to European roadmap, if hydrogen is introduced into the European energy system, the cost to reduce one unit of CO₂ decreases by 4% in 2030 and 15% in 2050. This outcome implies that hydrogen is a cost effective option for the reduction of CO₂. As a part of the roadmap establishment, Stiller *et al.* (2008) have investigated the early hydrogen user centres and corridors in Europe. Their paper aims to find the realistic starting points for hydrogen use, also to facilitate the modelling of further deployment of supply infrastructure. Same group of authors studied in another work (Christoph *et al.*, 2007) the assessment of the regional hydrogen demand and infrastructure build-up for 10 European countries. In United States (US), an energy economy based on hydrogen could resolve growing concerns about the energy supply security, air pollution and GHG emissions. The United States Department of Energy (DOE) reports that there is a strength need to lower the overall cost of hydrogen proceeding by the reduction of the carbon sequestration costs. From the delivery perspective, attention needs to be given to the components enhancement of the existing delivery

systems, such pipeline materials, compressors and safety sensors. In (US-DOE, 2002), (Workshop DOE, 2005), researchers have claimed the need to test the feasibility of delivery methods from centralized and distributed hydrogen production plants as well as compressors, storage systems. In addition to the European and U.S roadmaps, many others countries have developed national or/and regional roadmaps. See for instance references ((Salgado and Martínez, 2004), (Cherigui and Belhamel, 2005),(Agator and Avril, 2006),(Minnesota report, 2010),(New York Roadmap, 2005), (Texas Roadmap, 2009)).

4. Build-up Scenarios

The planning of scenarios can be considered as a systematic tool that supports designing the HSC. The main objective of scenarios is to think about what will be the decisions making process under a certain situation that usually cannot be determined with accuracy. The use of scenarios can also serve as guidance for the implementation of certain policies and measures to obtaining a desirable future position (Wietschel *et al.*, 2006). In the literature, in developing the future hydrogen pathways, almost all authors have referred to scenarios in their studies. These scenarios vary from paper to paper and from case study to the other. A scenario that is widely used in practically all published papers in the literature is the one related to hydrogen market penetration. The objective of this scenario is to response to the question related to how hydrogen demand can be estimated. In particular, this scenario could simplify and support the design procedure of HSC through resolving hypothetically the “chicken and eggs” enigma related to hydrogen demand and infrastructure availability. Others scenarios can be categorized into time and space. The space based scenario is mainly related to those scenarios that assume the development of HSC in a place rather than other. The time based scenario relates the design of the HSC related to a certain type horizon, this type of scenario is usually involved in a multi-period HSC design. In this respect, the annual fuel cell vehicles and the hydrogen demand can be estimated assuming the fuel cell vehicle will be introduced up to a certain time (Gronich, 2006). Others scenario may be developed on a country basis, such us scenario based on some environmental policies, like thus related to the regulations of the CO₂ emissions, penetration of a feedstocks, costs of the fossil fuels. More scenarios could be found in (Dickson *et al.* , 2006) and (Ogden *et al.*, 2004).

5. Approaches for the planning and design of hydrogen infrastructure

The transition to a hydrogen economy has been studied in various locations and reported in many research studies. Each of these plans treats particular aspects related to the transition to hydrogen economy. This may vary according to national or regional plans/roadmaps, specific policies

(Hajimiragha, 2009) or specific environmental targets. The published research studies that analyze the hydrogen infrastructure can be categorized following three methodological approaches. In the first one, researchers focus on design of the hydrogen supply using the mathematical optimization methods, usually the architecture of these studies consist of presenting the general mathematical formalization, then an application of the model is performed for a national or regional case study. The second approach is related to studies that explained spatially models and frameworks for the design of hydrogen infrastructure. These approaches usually are related to country or region specific. The third approach that can be implemented in the design phase of HSC is the use of transition scenario and plans. These studies may aggregate future hydrogen scenario evaluation and cost estimation.

5.1 Optimization Methods

A literature review shows that the most common approach in designing and modelling a HSC is optimization methods. Various optimization techniques such as linear programming, dynamic programming, multi-objective programming, stochastic programming, and multi-period were used by researchers to design the HSC in a most effective way. The aim of such method is to find out the optimal configuration that response to some criteria (economic, safety, environmental). The input of those models consider a set of options for the production, storage and transportation, while the output is to determine the type, numbers, location and capacity of the production, storage, transportation and etc (Figure 3.8).

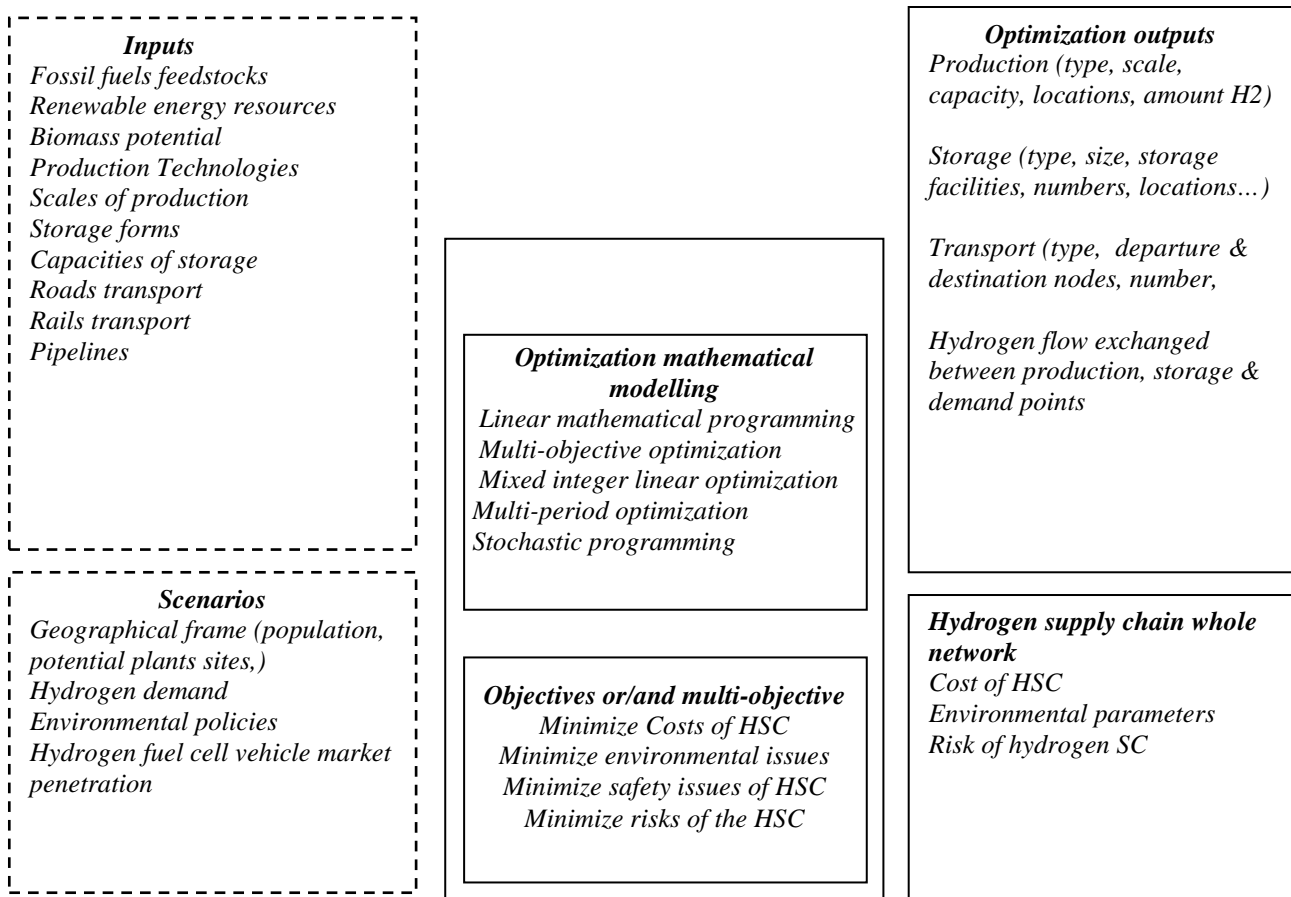

Figure 3.8 Structure of the mathematical optimization of the HSC

Almansoori and Shah (Almansoori and Shah, 2006) have proposed a highly contribution to the design and planning of HSC network. Their models have been previously adopted by many authors all around the world. Their model consists of a multi-period model for optimizing the operation of a future HSC. In their paper, the authors have enhanced and gave more detail to their previous work (Almansoori and Shah, 2009) which does not take into account many aspects, such as, the primary energy source and the evolution of the network for the planning horizon. Ingason *et al.* (2008) have presented a mixed integer linear programming (MILP) approach to locate the most economical site for hydrogen production technologies in Iceland. Authors' approach includes a feasibility study of exporting renewable energy in the form of hydrogen, from Iceland to Europe. The article discusses also how the total cost of hydrogen production can be minimized, basing on costs of electricity production and transportation and hydrogen production. The results may provide ideas on which power plants to use, where to locate and how to design the electrical transportation network in between. Brey *et al.* (2006) have focused on the hydrogen economy and its development for Spain. The objective is to plan a gradual transition to a hydrogen economy solely based on the use of RES available within the territory having as target the satisfaction of hydrogen demand in a period of

three years. Results have demonstrated that by the adoption of gradual transition, the GHG could drop by an amount of 4.54% by the target year. Also, from the security of supply perspective, authors have found that Spain region are self-sufficient for supplying hydrogen demand. Hugo *et al.* (2005) have developed a generic model for the optimal planning of future HSC for fuel cell vehicles. They used a mixed integer optimization techniques to find out optimal integrated investment strategies across a variety of supply chain decision-making stages. A concluding remark of the authors stated that to reach high GHG reduction target, the optimal supply chain design and investment strategy should starts with on-site generation through small-scale reforming using natural gas from the grid. Kamarudin *et al.* (2009) have developed a method to determine the optimum hydrogen delivery network employing truck transportation. Their method was based on the use of mixed integer linear programming to optimize a future hydrogen infrastructure in Malaysia. Authors have solved their model for two hydrogen demand calculation methods. Kim et al (2008) have developed MILP model for the optimization of a hydrogen infrastructure under demand uncertainty. Authors proposed a stochastic method to take into account the effect of the uncertainty in the HSC. Comparing the two models with and without uncertainties, the main differences consist of the cost function, where various values can be obtained for each hydrogen demand value (source of uncertainty). Kim and Moon (Kim and Moon, 2008) have dealt with a multi-objective optimization approach considering cost and safety of HSC . The mathematical formulation of this model is an extension of the work by (Kim et al, 2008). The safety objective is here treated in term of risk index, aiming essentially the minimization of the population risk in the operation of the HSC. In a very recent paper, Konda *et al.* (2011) have presented a multi-period optimization that is based on a techno-economic analysis. Before introducing their model, authors have mentioned the hydrogen supply pathways through an overview of various parts of the hydrogen infrastructure. Then, the model formulated basing on a MILP, it has been solved in the General Algebraic Modelling System Environment (GAMS). The approach was applied on a large scale Dutch case study. The application of the model to the case-study reveals that the transition towards a large-scale H₂-based transport is economically feasible, for any given demand scenario. Gosálbez *et al.* (2009) have studies bi-criteria mixed integer linear programming that aims to design an hydrogen network considering cost and environmental impact. In this work, authors focused on the analysis of the environmental impact from a life-cycle analysis viewpoint. The authors have extended the model presented by (Almansoori and Shah, 2009) in order to take into account the evolution of the network over time, especially considering time-variant demand. Sabio *et al.* (2010) have formulated a multi-objective problem to allow the control of variation of the economic performance of the hydrogen network. The author's approach is an extension of some previous

published works ((Sabio *et al.*, 2010), (Kim *et al.*, 2008), (Almansoori and Shah, 2009), (Kim and Moon, 2008)). The design problem addressed in this work has as objective to determine the optimal configuration of a three-echelon HSC namely production, storage and market, thus minimizing the expected total discounted cost and the associated financial risk associated to market changes. Li *et al.* (2008) have extended the previous work by (Hugo *et al.*, 2005) where the case study of China was specifically analyzed under a multi-period framework to provide optimal integrated investment strategies across a variety of supply chain decision-making stages. Significant contributions appeared from the California state where hydrogen has started to be seen as an important alternative fuel and energy carrier. Parker et al (2010) have constructed a model for finding the most efficient and economical configuration of the green energy pathway mainly based on agricultural residues. Their approach was based on an integrated model that aims to evaluate the economic potential and the infrastructure requirements of the bio-hydrogen production from agricultural residues. The approach has been essentially applied to the northern California, where results have demonstrated that agricultural waste can be cost similar to the natural gas for the hydrogen production.

Wei and Chihlin (2009) have developed a set covering for locating refueling station using an integer programming method. The work was based on the vehicle range for determining the location and the number of refueling station.

Another approach has been applied this time to the southern California, where (Lin *et al.*, 2008) have investigated a model to determine the least cost hydrogen infrastructure design considering different technological alternatives. Same authors (Lin *et al.*, 2008) have developed a MILP model to optimize a hydrogen station sitting in Southern California by minimizing the fuel-travel-back time. Bersani *et al.* (2009) have investigated the planning of a network of service stations of a given company within a competitive framework. They proposed a decision support system that can be considered to determine the optimal placement of services stations within a hydrogen economy. Heever and Grossmann (Heever and Grossmann, 2003) have defined a mathematical model for a HSC. Study developed by (Kim and Moon, 2008) have focused on a specific case related to the impact of introduction of hydrogen as fuel in the road transportation sector in Korea. The modelling has been done meaning the LEAP software which is an accounting and scenario based modelling tool enabling the assessment of energy consumptions, required costs and GHGs emissions. Nicholas et al (2004) have presented a model for locating hydrogen fuel stations assuming that the existing petrol infrastructure will be strongly related to the hydrogen infrastructure in the future. Joffe *et al.* (2004) have studies a technical modelling of a hydrogen infrastructure. They investigated the operation of the system to provide initial facility for refueling hydrogen fuel cell buses in London city. Their results have demonstrated that the choice of the hydrogen production technology can

have significant effects on when the infrastructure would be installed, timing of hydrogen production and bus refueling. Melaina (Melaina, 2003) has discussed three approaches to estimate the number of hydrogen fueling stations that might be required to have convenient access to hydrogen fueling. These approaches were based upon the existing populations of gasoline stations, the metropolitan land areas, and the lengths of principal arterial roads. It has been demonstrated by the author that the arterial roads approach appears to provide the most consistent analysis for both rural interstate and metropolitan area stations. Brey *et al.* (2006) have described a multi-objective optimization model, where the main aim is to satisfy around a certain percentage of energy demand for the transport in Spain by a certain time horizon. The main assumption of the study is the use of RES. The results permit to find out for each region, what is the RES used to obtain hydrogen and hydrogen transport requirements between the regions.

5.2 Geographical information system (GIS) based approaches

It is important to underline that by contrast to the mathematical optimization approaches, the spatial or GIS approach cannot be considered as a general methodology for the finding of the optimal HSC configuration. In fact, the results of the approach are country/region specific conditions, depending strongly on the local territorial condition, such as transportation network, population, available resources, local policies and others. Fewer studies have focused on this framework, Stiller *et al.* (2009) have developed a GIS-based regional hydrogen demand scenarios and fuelling station networks for the design of the pathways of hydrogen fuel in Norways. The author's method considers growth of regional hydrogen coverage and the increase in the density hydrogen users over time. Kuby *et al.* (2009) have presented a model that locates the hydrogen stations to fuel the maximum volume of vehicle flows. Their model includes a spatial decision support system using GIS coupled with a heuristic algorithm, which is used as a support tool to analyze different scenarios, evaluate tradeoffs and map the results. Johnson *et al.* (2008) have proposed a model for the optimization of a regional hydrogen infrastructure, thus combining two modules, namely the special data in GIS and a techno-economic model of hydrogen infrastructure. Their results have demonstrated that by the aggregation of infrastructure at the regional-scale yields lower levelized costs of hydrogen than at the city-level at a given market penetration level. Also, they concluded that the centralized production with pipeline distribution is the favored pathway even at low market penetration. From the US national renewable energy Laboratory (NREL), Melendez and Milbrandt (2008) have developed a GIS based study for the identification of the minimum hydrogen infrastructure to gain consumer buy-in for purchasing hydrogen vehicles in United States. Authors have also presented a GIS method for sitting hydrogen stations, thus basing on the demand

characteristics of select urban areas. The above cited studies mainly deal with papers that have implemented solely the geographical information system to design the hydrogen infrastructure. However, additional enhancements could be projected by coupling the GIS based module to additional mathematical models which lead to an integrated approach. This coupling could favor the exploitation of two different decision support systems. For instance, Strachan *et al.* (2009) have described an integrated approach linking spatial GIS modelling of hydrogen supply, demands and infrastructures, anchored within a economy-wide energy systems model (MARKAL). The study was specifically applied to the United Kingdom (UK). Ball *et al.* (2007) have proposed a plan for the integration of the hydrogen economy into the German energy system. The objective of the modelling approach is to optimize -for an exogenously given, regionally distributed hydrogen demand-the build-up of a hydrogen infrastructure over space and time, and to assess the corresponding economic and environmental effects. A model was developed as a novel tool to assess the introduction of hydrogen as vehicle fuel by means of an energy system analysis.

5.3 Assessment plans towards the transition to Hydrogen infrastructure

While some authors have developed mathematical and GIS based approaches, others have presented transition models to the future HSC. The objective here is not to model the hydrogen infrastructure, but to understand the behavior of the chain in certain area assuming specific scenarios. Usually, these kinds of studies are accompanied with the cost estimation of the hydrogen pathways. These transition models are implemented on a country or region basis, aggregating simultaneously territorial information and data specific (such local policies and regulations). Lee *et al.* (2009) have studied the environmental aspects of hydrogen pathways in Korea. The objective of this paper is to evaluate the environmental aspects of hydrogen pathways according to hydrogen production methods, production capacities and distribution options. The methodology applied to reach the target is the life cycle assessment (LCA). Results of the LCA applied to the Korean case study show that wind is superior regarding its potential in the reduction of global warming. In fact, authors have demonstrated that the substitution of gasoline with wind energy can reduce the global warming and fossil fuel consumption by 99%. Farrell *et al.* (2003) have reviewed different strategies for the introduction of hydrogen as a transportation fuel. Authors claimed that the cost of introducing hydrogen can be reduced through the selection of a mode that uses a small number of relatively large vehicles that operate along a limited number of point-to-point routes or within a small geographic area. From an environmental point of view, the authors suggested that the environmental benefits of hydrogen uses as a fuel can be reached through the introduction in the modes that have little or no pollution regulations that is applied to them. At the European scale, an

estimation based on hydrogen penetration scenarios in Europe has been carried out by (Tzimas *et al.*, 2007). The authors have evaluated the evolution in the size and the cost of the hydrogen delivery infrastructure in Europe. The estimation study has showed that between 1 and 4 million km of pipelines distribution may be needed. While, a cumulative capital between 700 and 2200 thousand million euros is necessary to build the infrastructure by 2050. In a similar study, (Wietschel *et al.*, 2006) have presented a European hydrogen infrastructure in Europe by 2030. The study was based on the hydrogen penetration level in Europe, where two scenarios have been considered. The decisions related to the selection of HSC were mainly based on both the energy chain calculation costs, emissions, and the expert judgments among others. It can be shown that under economic and CO₂-reduction objectives, the steam reforming of gas is the primary most promising hydrogen production options in this first phase for developing a hydrogen infrastructure. In (Ogden, 1999), Ogden has examined the techno-economical feasibility of developing an infrastructure for the hydrogen with zero emissions vehicles. The modelling has been applied to the Southern of California. Different possibilities for producing and delivering gaseous hydrogen transportation have been analysed. Shane and Samuelson (Shane and Samuelson, 2009) have discussed a novel tool entitled Preferred Combination Assessment (PCA) that enables the analysis of the impacts of an integrated HSC. This latter tool will allow the search for a HSC that respects the criteria pollutant emissions, GHG emissions and energy utilization. The inputs of PCA are among others the total hydrogen demand in a region, number of hydrogen refuelling stations, production facilities and the distances over which it must be delivered, whereas the outputs are the criteria pollutant emissions, GHG emissions, energy consumption, and water consumption. Hake *et al.* (2006) have reviewed the prospects of hydrogen in the energy system considering various scenarios. Authors have firstly reviewed the hydrogen experiences¹ available in Germany, such those related to the infrastructure for the transport of hydrogen (pipeline, railways and roads trailers). Then, they have considered the prospects of three applications of hydrogen namely stationary, mobile and portable power supply. They claimed that the role of hydrogen will be small in the coming decades mainly due to the high investment costs. One solution that might be advantageous for the hydrogen introduction is through its development under constrained conditions. (Smit *et al.*, 2007) have presented an excel simulation for the study of the transition to hydrogen energy. In particular, the main objective is to quantify the Dutch hydrogen transition evaluating, for example, the prospects of hydrogen on-site production and its role for the developing of the hydrogen demand. Authors have found that the use of locally produced hydrogen from natural gas in stationary and mobile applications can yield an economic advantage when compared to the conventional system, and can hence generate hydrogen demand. Contaldi *et al.* (2008) have

analyzed the hydrogen market in Italy that need to be established in order to meet climate change, environmental and energy security issues. The study was done following an Italy-Markal model. Different hydrogen technologies were considered, while the transportation was the only end users. Kruger *et al.* (2003) have explored the potential in New Zealand for the use of hydrogen as a transportation fuel. Their study was based on the use of some historical data on vehicle transport, population and electric energy to make the estimations regarding the requirements of hydrogen fuel for a certain projected horizon.

6. Challenges for the design of the future hydrogen supply chain

The studies published in the literature range from a complete design of the global HSC to a focus on specific nodes. Strategies for designing the hydrogen economy are established based on careful analysis that takes into account critical issues such as cost, environment and safety. It is recognized according to the literature review that models, methods and approaches for the planning of future HSC are mainly focusing on the mathematical optimization. These research studies have tried to find the optimal configuration of HSC optimizing a unique criterion or multi-criteria. One common point between papers based on mathematical optimization lies in the cost minimization of HSC. Some authors have focused on the minimization of various costs related to the node of the HSC, others have focused on the minimization of the environmental impacts of the HSC. Fewer studies have addressed the optimization of the HSC from the risks viewpoint. These criteria may be of highly interest taking into account the particularity of hydrogen. Also, from the production viewpoint, there is a need to investigate HSC that operates on clean feedstock, such those based on renewable energy resources. Future research papers are also needed to cover the technical aspect related to the operation of the HSC. Focus must be dedicated to the evaluation of the technical feasibility and the performance of renewable HSC. In addition, to encourage the widespread use of hydrogen economy, comparison of HSC with the conventional network of petrol products should be done, which could help in decreasing some uncertainties along the future HSC and succeed to the commercialization of the hydrogen as a fuel. Even though the greatest numbers of research studies accomplished worldwide, it must be beer in mind that a successful transition to a hydrogen economy cannot be guaranteed that easy. The development of new models, equipments and others technical standards represent serious challenges for the commercialization of hydrogen. Cost reduction of hydrogen production and cost-competitive transportation are considered ones of the major defies to the success of hydrogen infrastructures. More attention should be given to hydrogen production and delivery challenges like lowering cost of hydrogen production from RES, offering secure production that can be considered as sustainable. The adoption of new strategies and

initiatives, policies, government hydrogen research subventions and specific hydrogen programs will promote and advance the use and acceptance of hydrogen as a fuel. In fact, more support is needed from the national governments. In turn, government preferences must be included in the modelling and the design phase of HSC. New perceptions of hydrogen demand market are needed to better understand the future hydrogen infrastructure. This can be done through including new estimation methods of hydrogen demand that will mainly come from real market.

7. Conclusion and main contributions

A classification of literature related to the HSC has been done, and which has distinguished three main classes of paper, namely: mathematical optimization methods, GIS based approaches and assessment plans for the planning of HSC. Based on the review, it is observed that many authors have focused on design/planning of HSC using mathematical optimization methods. These methods are the most effective ones to best address the question of future hydrogen infrastructure design. Main objectives to be minimized within the optimization of HSC are related to cost and environment. Fewer studies have addressed the optimization of the HSC from the hydrogen risks viewpoint. Considering the HSC state-of-the art, it is also identified that more researches are needed in addressing HSC that operate on clean feedstocks, such those based on RES. For this main reason, the aim within this thesis is to investigate a hydrogen supply chain based on the use of renewable energy sources. The design of such a Green Hydrogen Supply Chain will be based on the use of the optimization methods which have the potential to design a general network of hydrogen infrastructure that can be applied to a variety of case studies. In the optimization of such infrastructure, we will focus also on the risk side aiming to select an infrastructure that minimizes the risks on the population and environment. In this frame, the focus will be dedicated to the evaluation of the technical feasibility and the performance of renewable HSC. From the literature review, a GIS based methodology will be applied basing on a specific case study. The GIS methodology -in contrast to which is published- will be considered to analyze the clean feedstock for hydrogen production and further the tool will support in designing a decision support system to select better sites for hydrogen production. One additional component that will be considered in this thesis is the risk criteria which were not enough considered in the design of a future hydrogen infrastructure, so a design implementing the risk criteria will be studied and considered.

Chapitre 4 : Hydrogen risks & safety issues: assessment and analysis

L'hydrogène a été souvent reconnu comme un vecteur énergétique par excellence susceptible d'alimenter de futurs systèmes énergétiques, car il représente une alternative universelle pour la résolution des préoccupations croissantes liées à l'épuisement des ressources fossiles, au réchauffement climatique et à la pollution atmosphérique. Les avantages de l'hydrogène s'accroissent en tenant compte du grand nombre de sources d'énergies primaires qui peuvent être utilisées pour sa production, telles que le gaz naturel, le charbon, la biomasse et l'électrolyse de l'eau. Cette diversité de production contribue largement à la sécurité énergétique (Hugo, 2005). Généralement, l'hydrogène est produit, stocké puis transporté vers l'utilisateur. Il doit donc être transporté à partir des usines de production vers les points de stockage ou de demandes, ce processus de livraison apporte de nouveaux risques, notamment en considérant la particularité physico-chimique de l'hydrogène. Cependant, une transition sûre et durable vers l'économie d'hydrogène exige l'étude et la compréhension des questions associées à la sécurité (Venetsanos, 2003). Les pratiques de sécurité dans la production, le stockage, la distribution et l'utilisation de l'hydrogène sont essentielles pour l'acceptabilité des technologies de l'hydrogène. Toute défaillance dans les systèmes à hydrogène pourrait endommager la perception du public et diminuer la capacité d'approbation de l'économie d'hydrogène. Cependant, une bonne connaissance de ces dangers ainsi que leurs conséquences est destinée à mettre en œuvre une conception sûre de systèmes utilisant de l'hydrogène. Le *chapitre 4* aborde les questions liées aux risques d'utilisation de l'hydrogène dans les différentes composantes de sa chaîne logistique. Il analyse les problématiques de sécurité de la "filiale hydrogène". Ce chapitre aborde ainsi la revue des approches méthodologiques, publiées par les communautés scientifiques et techniques, qui servent à évaluer les risques d'une partie ou de la globalité de la chaîne logistique d'hydrogène.

1. Introduction

Hydrogen has been often recognized as the likely energy carrier for the future energy systems because it would represent the universal remedy for the growing concerns in accordance with fossil-resource depletion, global warming, and increased air pollution. The benefits are motivated given the great number of primary energy sources used for its production, such as natural gas, coal, biomass and water, contributing towards greater energy safety and flexibility (Hugo, 2005). Generally, hydrogen is produced, stored and then transported to the end-users; in general, it must be

transported from production plants to the storage or demand points. So that, the delivery process of its supply chain brings new hazards exposures. Hence, a safe and sustainable transition to the use of hydrogen requires that the safety issues associated with the hydrogen have to be investigated and fully understood (Venetsanos, 2003). For planning and installing on a large-scale production and distribution infrastructure in urban areas, good standards and best practices are indispensable (Pasman, 2010). Safe practices in the production, storage, distribution, and use of hydrogen are essential for the widespread acceptance of hydrogen technologies. Any failure in hydrogen systems could damage the public perception and decrease the ability of hydrogen to gain the worldwide approval. However, a good knowledge of these dangers and their consequences is intended to implement a safe design of systems using hydrogen. In these circumstances, it is possible to envisage the development of hydrogen as an energy carrier or fuel alternative with a low level of risk, enough to be individually and socially acceptable. It is important to investigate the risks of various parts of the distribution chain before any real implementation. So, the development of preventive and protective measures will require a reliable risk assessment methodology, which has to rely on awareness base of the hydrogen compartment in the logistics chain.

2. Hydrogen Safety Properties

2.1 Physicochemical properties

The concept of hydrogen as a primary energy vector has received considerable attention, due to the environmental and energy security benefits compared to the conventional fossil fuels in terms of emissions and availability of supply. Hydrogen is the most abundant element in the earth. It has been recognized by many researchers as an excellent future energy alternative, playing both the role of a future fuel and the role of an energy carrier for electricity. In addition, the hydrogen as a material has many advantages such as being the most elements that has high energy content per mass. Besides being a good burning properties and high energy output per unit of mass, hydrogen has some drawbacks that may affect directly its safety and acceptability by the public. Hydrogen has physicochemical properties that are drastically different from traditional fuels. The key concerns are related to its low ignition energy, high flame speed, low flame visibility, colorless and odorless and wide flammability range. Table 4.1 displays the properties of hydrogen that are particularly relevant to safety.

	Hydrogen	Methane	Gasoline
Flammability limits (vol (%))	4.0-75	5.3-15	1.0-7.6
Auto-ignition temperature (°C)	572	632	440
Ignition energy (mJ)	0.018	0.280	0.25
Deflagration index (Bar m/s)	550	55	100–150
Limits of detonation in the air (vol (%))	13-65	6.3-13.5	1.1-3.3
Coefficient of diffusion in the air (cm/s)	0.61	0.16	0.05
Max flame speed in the air (cm/s)	3.06	0.39	-

Table 4.1 Properties of hydrogen that are particularly relevant to safety ((Crowl and Jo, 2007), (<http://www.nrel.gov>))

There is a great interest in hydrogen flammability limits and its implications on fire safety and prevention in many applications including hydrogen applications and logistics. For all fuels, the hazard is due to the physical properties of the fuel-in this case due to the flammable and explosive nature of the fuel. In addition, hydrogen is a gas lighter than air, which means that it has the tendency to rise and diffuse rapidly when released into the atmosphere, dependant on the direction, rate and pressure of the release. In addition, due to the low density, hydrogen can also diffuse rapidly through certain porous materials or systems that would normally be gas tight with respect to air or other gases. Hydrogen is highly flammable and very easily ignition.

2.2 Hydrogen safety issues

A hazard is defined as a “chemical or physical condition that has the potential for causing damage to people, property, or the environment” (AIChE/CCPS, 2000). The primary hazard associated with any form of hydrogen is inadvertently producing a flammable or detonable mixture, leading to a fire or detonation. In general, a released quantity of hydrogen may be ignited immediately at the point of release, or it may be ignited after the cloud has been dispersed for a certain time, or it may not ignite at all. Release of hydrogen can be both instantaneous (for instance, the rupture of a compressor or buffer cylinder) or continuous (for instance, a leak in a pipe). In the event of a release of hydrogen, there are a number of potential risk scenarios such as: 1) Dispersion of hydrogen (followed by ignition), 2) Explosion of hydrogen (followed by a jet flame), 3) Instant ignition with resultant jet flame.

2.2.1. Hydrogen leak

The hydrogen gas contains the smallest molecule, which may increase the probability of leak through small holes and materials. In other words, due to its low viscosity, hydrogen is much more prone to leak from piping connections than others hydrocarbons. Hydrogen would leak approximately three times faster than natural gas and five times faster than propane on a volumetric basis (Rosyid, 2006). From other side, hydrogen benefits of lower density comparing with others fuels, which in turn gives it a higher buoyant behaviour in case of a failure in opening environment. Table 4.2 expresses the leak frequency occurrence for the case of hydrogen pipes as estimated by (LaChance *et al.*, 2009). The hydrogen leak sizes were expressed in percent fractional flow area and grouped into 5 classes: <0.01%, <0.1%, <1%, <10%, and 100%. For instance, 0.1% means that the leak size is 0.1% of the cross sectional area of pipe. The generic leaks frequencies apply to an average of all equipment of the type in question (in this case: pipe), in the table 4.2, the generic leak defines all leaks that have occurred coming in particular from chemical, oil, compressed gas, and nuclear industries.

Leak area	Generic leak frequencies	Hydrogen leak frequencies
0.01	7.8E-04	8.6E-06
0.1	1.0E-05	4.5E-06
1	4.0E-05	1.7E-06
10	5.4E-06	8.9E-07
100	5.3E-06	5.6E-07

Table 4.2 Leak frequency estimate for hydrogen pipes (LaChance et al., 2009)

2.2.2 Hydrogen ignition

Fires and explosions have occurred in various components of hydrogen systems as a result of a variety of ignition sources. Ignition sources have included mechanical sparks from rapidly closing valves, electrostatic discharges in ungrounded particulate filters, sparks from electrical equipment, welding and cutting operations, catalyst particles, and lightning strikes near the vent stack. For instance, in case of an instant ignition of hydrogen, a jet flame can be produced.

2.2.3 Hydrogen flash fire

Depending on the pressure of release, weather conditions and the size of the smallest internal diameter of pipe work, hydrogen will disperse within its flammable range for several metres from the release. Flash fires can occur when a cloud of hydrogen in open air finds an ignition source. The flame is traveling back to the leak. It must be noted that a flash fire is a non-explosive combustion of vapour cloud resulting from a release of hydrogen gas into the open air (Pasman and Rogers, 2010).

2.2.4 Jet fire

The analysis of fires is particularly important because they have been found by many researchers as the most frequent accidents. Although jet fires are often smaller than pool fires (in liquid hydrogen) or flash fires, they can also be very large, depending on the fuel discharge rate. Although jet fires have been studied by a number of authors, some of them can be found in (Schefer *et al.*, 2006, Schefer *et al.*, 2006, Houf and Shefer, 2007). Jet fire is a turbulent diffusion of flame that results from the combustion of a flammable fuel continuously released, flame originating from a leak are almost unidirectional.

2.2.5 Explosion of hydrogen

Hydrogen explosion represent a considerable hazard. Hydrogen gas forms combustible or explosive mixtures with the atmospheric oxygen over a wide range of concentrations in the range 4.0–75% and 18–59%, respectively. Vapour cloud explosions involve a large release of hydrogen outdoors that mixes with air to form a large flammable cloud before ignition occurs (Pasman and Rogers, 2010). The strength of the explosion depends on the magnitude of confinement which in turn depends on the degree of confinement, and could generate blast wave that can produce damages to the surrounding buildings and people (Baraldi *et al.*, 2009). Many of the studies on hydrogen stations have dealt with explosion, deflagration or detonation of hydrogen (Yamanaka *et al.*, 2004, Fukuda *et al.*, 2004, Xu *et al.*, 2006).

3. Risk of hydrogen supply chain

It is important to investigate the risks of various parts of the supply chain, especially given the fact that hydrogen presents many peculiarities from the safety and risk viewpoint. The hydrogen system chain was assessed considering production, large scale storage on the production site, refuelling stations, and final utilization for automotive purposes (Landucci *et al.*, 2010). The peculiarities of such infrastructure are mainly related to the spread of hydrogen storage installations in vulnerable areas, like populated areas, commercial and critical infrastructures. The installations might also be

so close to customers such as hydrogen vehicles. Due to these facts, the widespread use of hydrogen requires the safety level to be at least not larger than those of existing fossil fuel technologies.

3.1 Risks in hydrogen systems

Like hydrocarbons, hydrogen as an activity related to energy generation have some safety implications that may starts from the production side to the end uses (final service) going through the feedstock's uses, conversion to energy, transportation between different nodes of the chains. The European Integrated Hydrogen project (EIHP) group claimed that the many ways in which hydrogen differs from conventional fuels make it necessary to perform detailed risk assessment for every stage in the hydrogen supply chain (Alcock *et al.*, 2001).

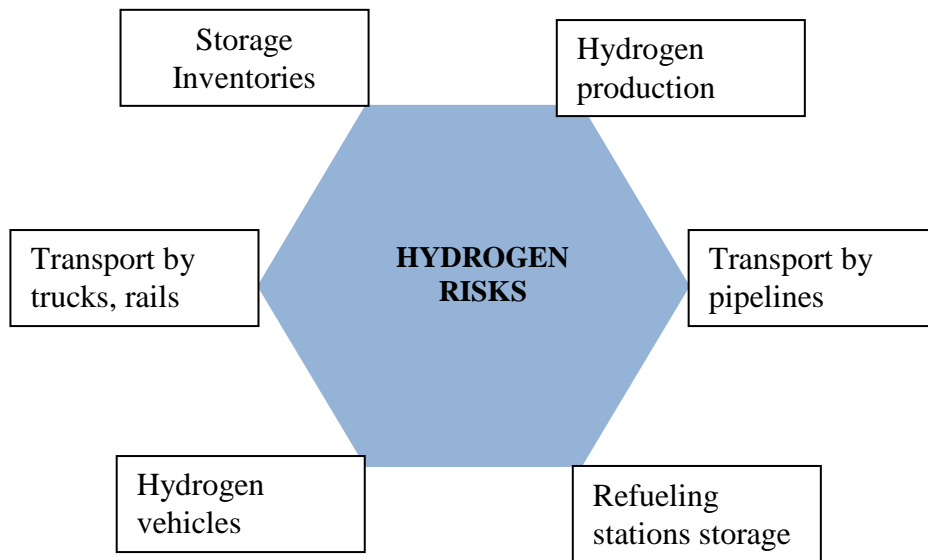

Figure 4.1 Parts of the supply chain related to safety aspects

The use of hydrogen vehicles will require appropriate infrastructures for production, storage and refuelling stages. In particular, the storage problems can be considered as the most part involved in the supply chain where risks may arise. This is firstly due to the large amounts of hydrogen that are accumulated within the storage device, and secondly due to low hydrogen density, its low ignition temperature and flammability, over a wide range of concentrations, which makes leaks a significant hazard for fire, especially in confined spaces (Casamirra *et al.*, 2009). Figure 5.1 shows different part of the hydrogen infrastructure involving risks. A common point can be illustrated from the figure is the involvement of hydrogen storage in different parts of the chain, for instance, hydrogen must be stored in transportation systems, at the refuelling station, and onboard vehicles. Hence, great interest should be given to the storage side.

3.2 Risks in hydrogen refueling stations

Hydrogen refuelling stations must be as safe as gasoline stations. The facility of hydrogen fuelling stations must be safe. As well we may know, the storage of hydrogen is an important aspect of fuelling station design and construction. In fact, the storage system accomplishes two major roles in hydrogen delivery: increase of storage working capacity and regulation of delivery flow rate (Casamirra *et al.*, 2009). The main safety aspects at the user interface are related to the risk associated with a potential ignition of a hydrogen leakage at the station or at the vehicle. Hydrogen refuelling station may be a complex architecture since, it must include additional devices that are essential to deliver the hydrogen to customers, such as compressor unit that is required to compress hydrogen to a required pressure, production facility (in case onsite refuelling station). This complexity in addition to fuels properties may also give rise to the risk compared to the conventional RES. For these reasons, risk of hydrogen in the service station must be well evaluated and the code and standards for safety must be updated in order to take into account this hydrogen peculiarity. These safety issues and specifics may affect the public perception of installing a hydrogen refuelling station, especially those that live close to the facility. Lindell and Earle (1983) examined public perceptions of risk associated with different industrial facilities, and found that the higher the perceived risk, the higher the minimum acceptable distance respondents would live from a facility. Zhiyong *et al.* (2011) presented a quantitative risk assessment study on gaseous hydrogen refuelling station of 2010 World Expo. The Expo hydrogen station, located in the vicinity of the Expo site, is mainly used to fill fuel cell vehicles for 2010 World Expo. The main aim is to evaluate the risk of the station to personnel, refuelling customers and to third parties. The results have shown that the leaks from compressors and dispensers are the main risk contributors to first party and second party risks. This outcome leads to the conclusion that mitigation measures should be implemented in the first place on compressors and dispensers. Table 4.3 shows the probability of a major accident that can cause one or more fatalities.

	Probability of accidents
Leak from Compressors	1.20×10^{-3}
Leak from Dispensers	1.17×10^{-3}
Pipe work-2 Rupture	1.76×10^{-6}
Leak from vehicles Fittings	9.52×10^{-6}
Others	$<10^{-6}$

Table 4.3 Probability of a major accident causing one or more fatalities among customers (Zhiyong *et al.*, 2011)

Kikukawa *et al.* (2008) undertook a risk assessment of hydrogen fuelling stations for 70 MPa fuel cell vehicles using data on hydrogen behaviour at 70 MPa which was extrapolated from existing 35 MPa hydrogen stations data. The study results enable the identification of the safety issues that must be resolved to maintain safety of the hydrogen refuelling station that operates on high pressure such 70 MPa. Results of the study suggested that the safety distance could be maintained to 6 m, which is the same as for 35 MPa hydrogen stations, was sufficient for 70 MPa hydrogen stations.

Same authors, in (Kikukawa *et al.*, 2009), studied risk on liquid hydrogen refuelling stations. They assumed two forms of explosion that might be happened at liquid hydrogen fuelling stations. One is a diffusion explosion where leaked liquid hydrogen vaporizes and mixes with the air and ignites resulting in a diffusion explosion, and the other is a premixed explosion where leaked liquid hydrogen remains on the residual area and mixes with the air and ignites resulting in a premixed explosion. In addition, same authors have highlighted two consequences levels namely, blast pressure and flame. As regard the first kind of consequences, they are resulted from a boiling liquid expanding vapour explosion (BLEVE) or vapour confined explosion (VCE). As regard the jet flame, results have shown that 14mm wide hole produced a 10-m long jet flame, a 1.0-mm wide hole produced a 1.7-m long jet flame and a 0.2-mm wide hole produced no jet flame. Work presented by Houf and Schefer (2007) describes an application of quantitative risk assessment methods to help establish one key code requirement: the minimum separation distances between a hydrogen refuelling station and other facilities and the public at large. The separation distances were calculated using a Sandia developed model for predicting the radiant heat fluxes and flammability envelopes from high pressure releases of hydrogen (Houf and Schefer, 2007). Figure 4.2 provides an example of deterministic separation distances based on one possible consequence of a hydrogen leakage event: the radiant heat flux from an ignited hydrogen jet. It shows the separation distances required to limit the exposure of a person to a radiant heat flux of 1.6 kW/m² which is generally accepted as a level that will not result in harm to an individual even for long exposures (this heat flux level is currently specified in the IFC (IFC, 2003) as a ‘no harm’ criterion for designing hydrogen vent systems).

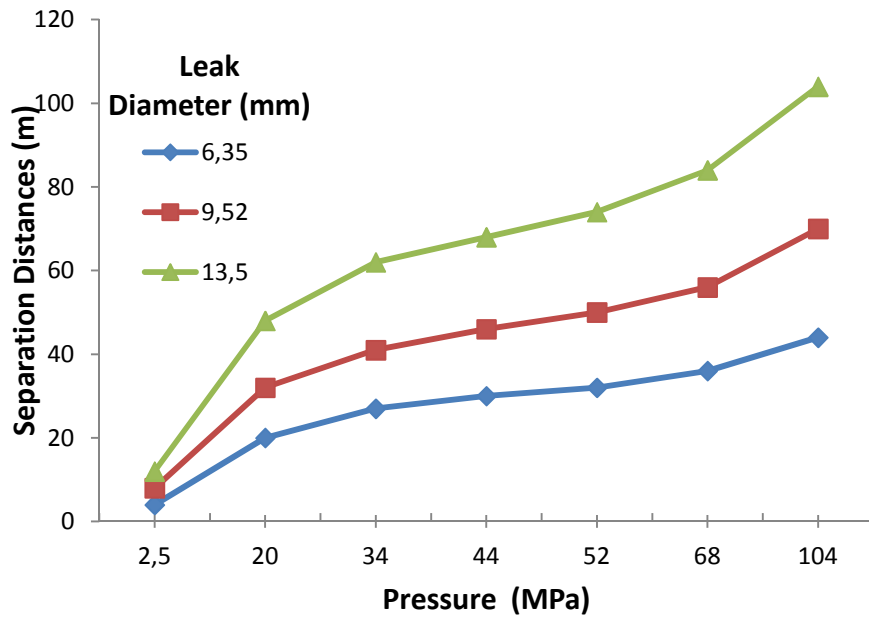

Figure 4.2 Separation distances required for an exposure to a radiant heat flux of 1.6 kW/m² generated by a jet fire (LaChance, 2009)

These results claimed that the gas storage pressure is an important parameter that should be considered when specifying separation distances. Casamirra *et al.* (2009) realized a preliminary safety studies in hazard identifications, and which are intended to if the examined refuelling station design is safe enough, as far as the occurrence frequency point of view, as well to constitute a basis for further more refined studies, which also consider the consequences aspects, allowing the plant risk assessment. These analyses concerned with the high-pressure storage equipment in a hydrogen refuelling station.

4. Methodology for hydrogen risks analysis

4.1 Risk definition

Risk is “a measure of human injury, environmental damage or economic loss in terms of both the incident likelihood and the magnitude of the loss or injury” (AIChE/CCPS, 2000). Also, according to the same reference (AIChE/CCPS, 2000), risk assessment is "the process by which the results of a risk analysis are used to make decisions".

Risk has been considered as the chance that someone or something that is valued will be adversely affected by the hazard (Woodruff, 2005) while “hazard” is any unsafe condition or potential source of an undesirable event with potential for harm or damage (Reniers *et al.*, 2005). Moreover, risk has been defined as a measure under uncertainty of the severity of a hazard (Høj & Kröger, 2002), or a measure of the probability and severity of adverse effects (Haines, 2009). Risk uncertainty has always been a problem in risk assessment studies.

4.2 Risk analysis

Risk analysis is defined as “the development of a quantitative estimate of risk based on engineering valuation and mathematical techniques for combining estimates of incident consequences and frequencies” (AIChE/CCPS, 2000). Proceeding by risk analysis approach, two values of risk have to be measured, namely, the magnitude of the hazard and the probability that the hazard will occur. It is a very crucial phase of risk management since its knowledge provides the first stage of handling hydrogen risks. Figure 4.3 displays different risk analysis approaches available.

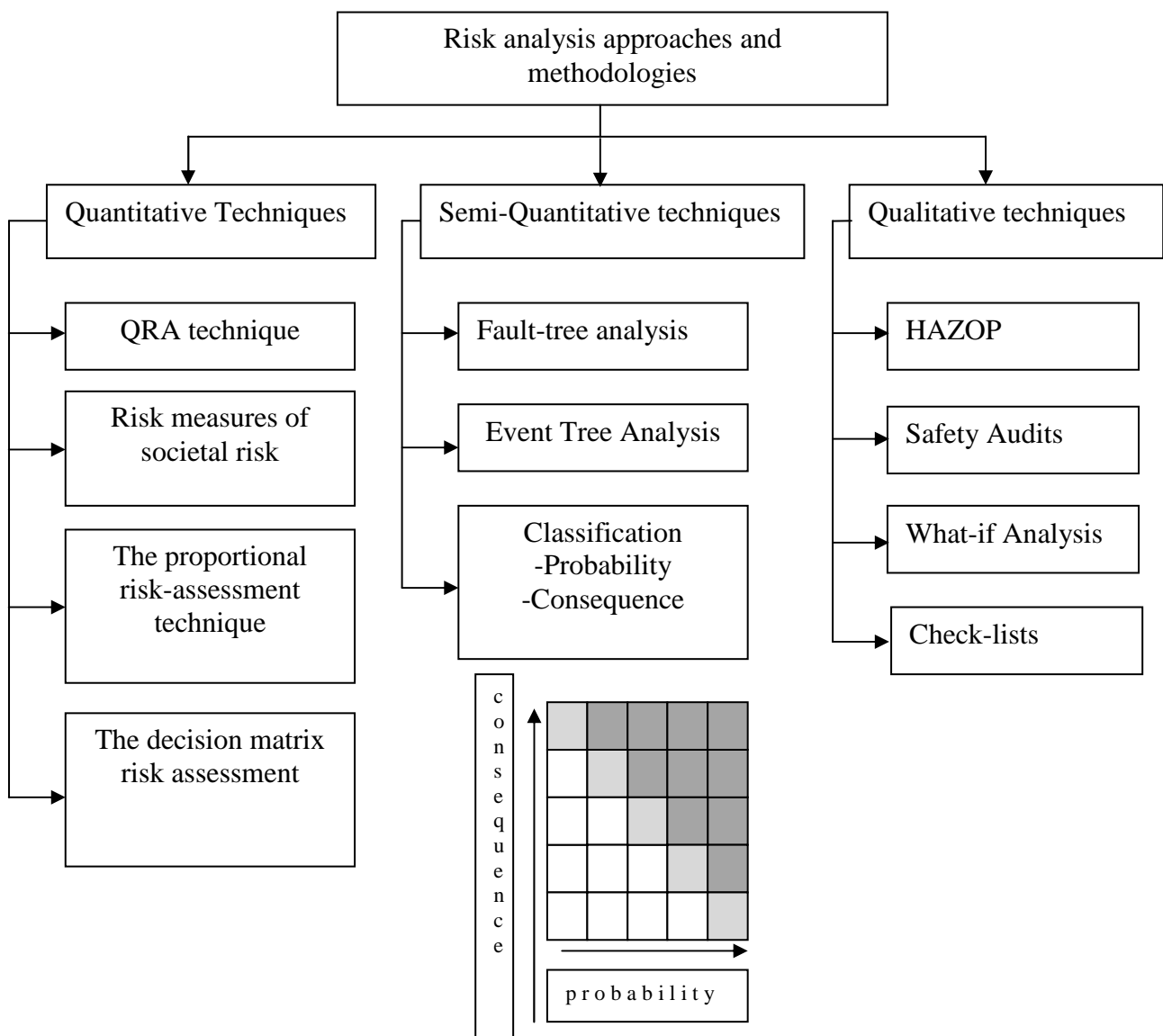

Figure 4.3 Risk analysis approaches and methodologies

4.3 Quantitative risk assessment technique

The QRA requires the evaluation of the hazard and its consequences for each hydrogen release scenario that may occur in different nodes of the hydrogen supply chain as can be seen from Figure 5.4. It is often used to quantify the risk around hydrogen facilities and support the communication with authorities during the permitting process. According to Marhavidas *et al.* (2011), this tool offers the possibility to define four types of objects: unprotected people, cars, residential and buildings. Based on the findings from the QRA, potential measures to control and/or reduce the risk can be suggested, and the effect of the measures evaluated (Haugom and Friis-Hansen, 2011).

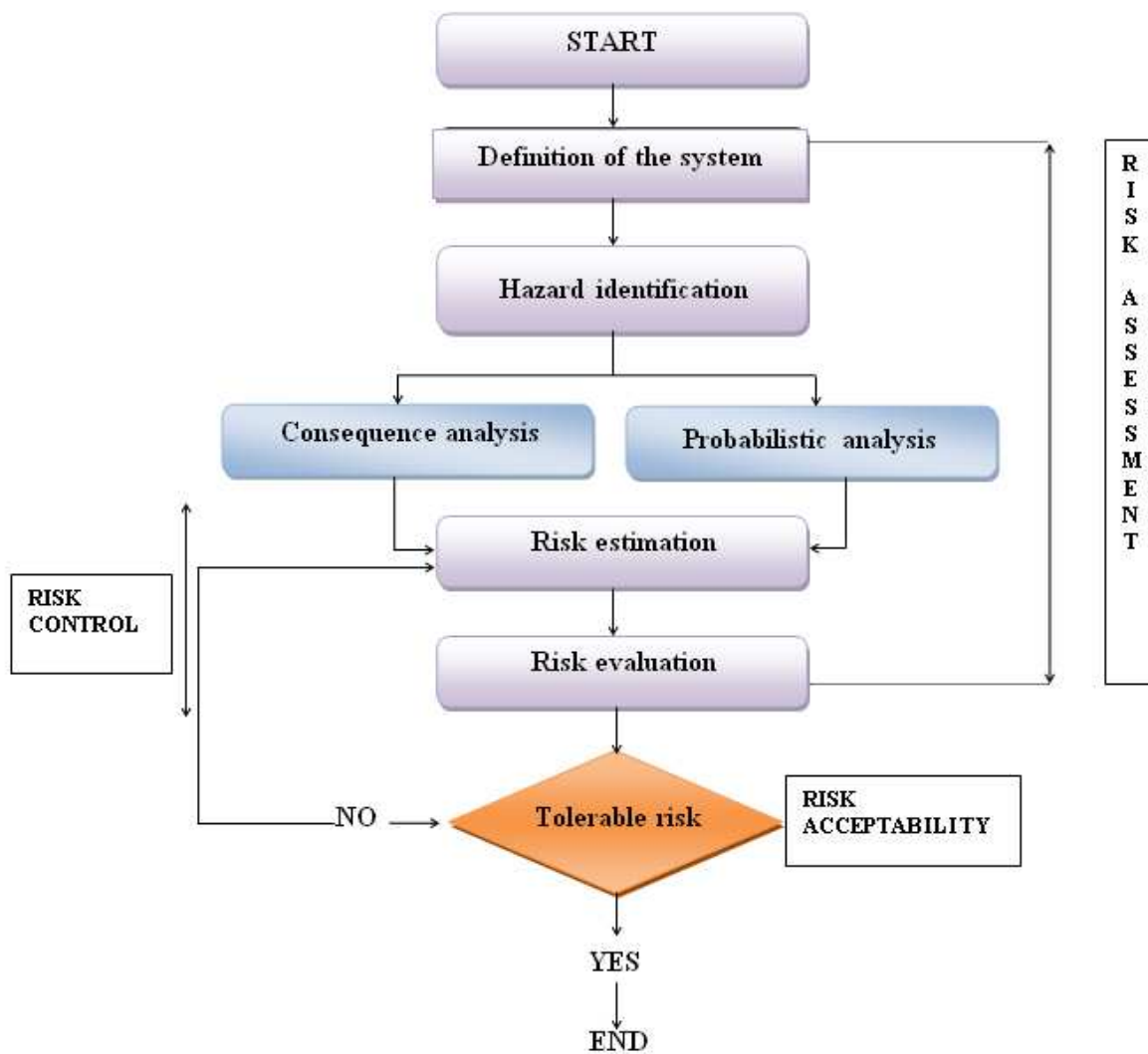

Figure 4.4 Quantitative risk assessments (Frantzitch, 1998, Kikukawa et al., 2009)

Quantitative risk analysis can be also performed following the use of decision matrix risk-assessment. Actually, this method consists of the estimation of risk based on the probability and the consequence of an event (Ayyub, 2003, Marhavidas and Koulouriotis, 2008). The product of

consequence/severity and likelihood of a given impact measures the risk. Then, the risk of such an impact is quantified (Figure 5.5). The risk is then compiled to a format so that it can be compared with the risk acceptance criteria applicable for each the specific hydrogen infrastructure.

		Probability level			
		A	B	C	D
Consequence Severity level	I	8	1	12	29
	II	0	0	0	6
	III	8	1	10	8
	IV	2	0	4	14
	V	00	1	5	13

Figure 4.5 Risk map in case of liquid hydrogen refueling station (Kikukawa et al., 2009)

4.4 Hazard identification

Identifying hazards is fundamental for ensuring the safe design and operation of a system in process plants and others facilities (Dunjó, 2010). Among hazard identification techniques, HAZOP (Hazard and Operability Studies) is one of the methods that are widely considered to be effective to identify the source of a risk, also it performs well for safety assessment in the process industry. In fact, HAZOP identify how a complex system can fail and to determine qualitatively whether the process design is robust and whether the existing safeguards are adequate (HyApproval WP2, 2008). In the context of hydrogen, analysing the literature, it is worth to notate that one main knowledge gap in the hazard identification stage is the current lack of clarity about the main components of a hydrogen delivery and storage infrastructure and their detailed design. This lack of data makes the operation of hazard identification quite complex.

4.5 Historical analysis of hydrogen accidents

Historical analysis of the accidents occurring in the past is required, which may be helpful to determine and focus on the ones that are occurs, the most probable and the ones that lead to high consequences. Many databases have begun to gather data related to hydrogen accidents, the most famous one dedicated specifically to hydrogen entitled "Hydrogen Incident Reporting and Lessons Learned". The American database is being developed by the US Department of Energy and is fully and freely available at www.h2incidents.org/ and can be completed from personal experiences. It is

a database-driven website, intended to facilitate the sharing of lessons learned and other relevant information gained from actual experiences using and working with hydrogen.



Figure 4.6 H2 incident reporting and lessons learned (www.h2incidents.org/)

The h2incidents database is organised enabling the access to different reported hydrogen incidents, thus regarding different viewpoints, namely, the probable causes of incidents, their contributing factors, the damages and injuries that result and equipments involved in the accidents (Figure 4.6). In addition, the h2incidents database reports the incidents depending on its location (laboratory, production, vehicles and so on), which may give fruitful information regarding the level of risks in hydrogen infrastructures. Figure 4.7 shows the results of statistical analysis done on the h2incidents database, and which displays the frequency of occurrence of the causes responsible for the hydrogen failure in the delivery infrastructure, it demonstrates that among the reported incidents that happen during the delivery of hydrogen, the occurrence of equipment failure is the one that has the higher frequency.

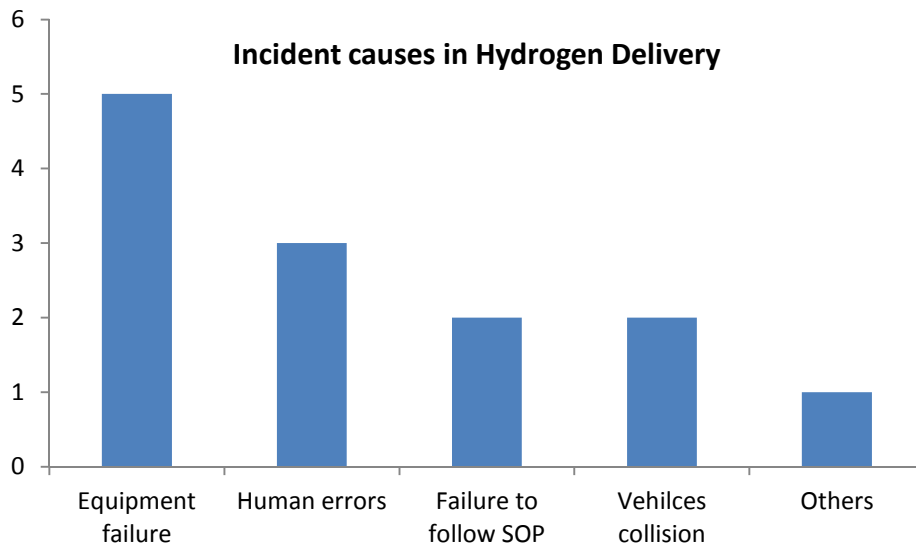

Figure 4.7 Histograms of the incidents causes (equipment failure, human errors, failure to follow the standards operation process (SOP), vehicles collision and others) in the case of hydrogen delivery (www.h2incidents.org/)

Another database which contains a database of historical analysis of hydrogen is the MHIDAS (major hazard incident accident data service) (MHIDAS, 2008). It is a database which includes all accidents involving hazardous materials that have off-site impact, and also those which only have the potential to lead to an off-site impact. Such impacts include human casualties or damage to plant, property or the natural environment. The analysis allowed us to determine the historically most diffused causes and related consequences that might happen when hydrogen is used in any kind of process (transport, industrial, process, etc.).

According to (Gerboni and Salvador, 2009), over a total of 118 records related to accidents involving hydrogen.

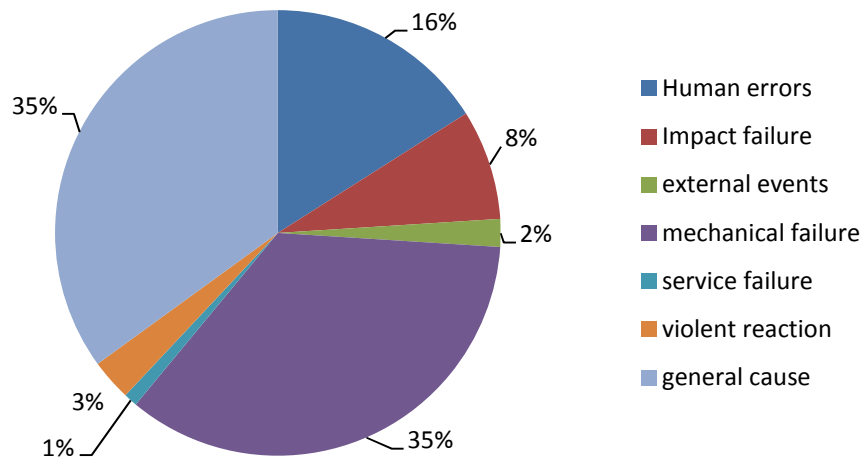

Figure 4.8 Shares of total possible causes for accidents involving hydrogen
(Gerboni and Salvador, 2009)

According to Figure 4.8 published by the same authors, the most frequent cause for an accident was identified as the mechanical failure, although an equivalent share of events had not their cause explicitly determined.

From the hydrogen accidents view point, major knowledge gaps exists in analysing the accidents, thus specially is firstly due to, the lack of handling hydrogen since it is a new energy for future, not yet used by public and others entities and secondly to the insufficient of historical data, since no mature sufficient experience is reached yet.

4.6 Event tree analysis

Event trees are commonly used to keep track of cause–effect relationships, and system and material behaviour characteristics (Gerboni and Salvador, 2009). Event tree analysis (ETA) is a graphic technique that uses decision trees and logically develops visual models of the possible outcomes of an initiating event (Marhavidas *et al.*, 2011). The ETA technique may be applicable to the design, construction, and operation stages of a hydrogen related system.

ETA for hydrogen release: Pipeline

The failure rate of a pipeline has units of the number of failures per year per unit length of the pipeline, 1/yr km, assuming uniform conditions along the pipeline section of interest. It is somewhat different from the case of a point source of failure in which the rate is defined as the number of failures per year (Jo and Crowl, 2008). Crowl and Jo (2007) showed that accidents originate from incidents; an incident can be defined as the loss of control of a material or energy. Figure 4.9

presents the event tree for hydrogen pipeline transmission. Initiation can be realized with a very-low-energy ignition source, i.e. 0.02 MJ (Steven and John, 1990). It is worth to notate from the Figure 4.9 that the possibility of a significant flash fire or vapor cloud explosion resulting from far delayed remote ignition is extremely low due to the buoyant nature of the hydrogen. But within few seconds after the start of the release, a large flammable gas cloud could be formed due to the turbulent mixing between hydrogen and ambient air. This cloud has the potential to produce an explosion due to the nature of hydrogen gas. If the released gas ignited immediately with the rupture of pipeline, it makes a jet fire just after a short-lived fireball.

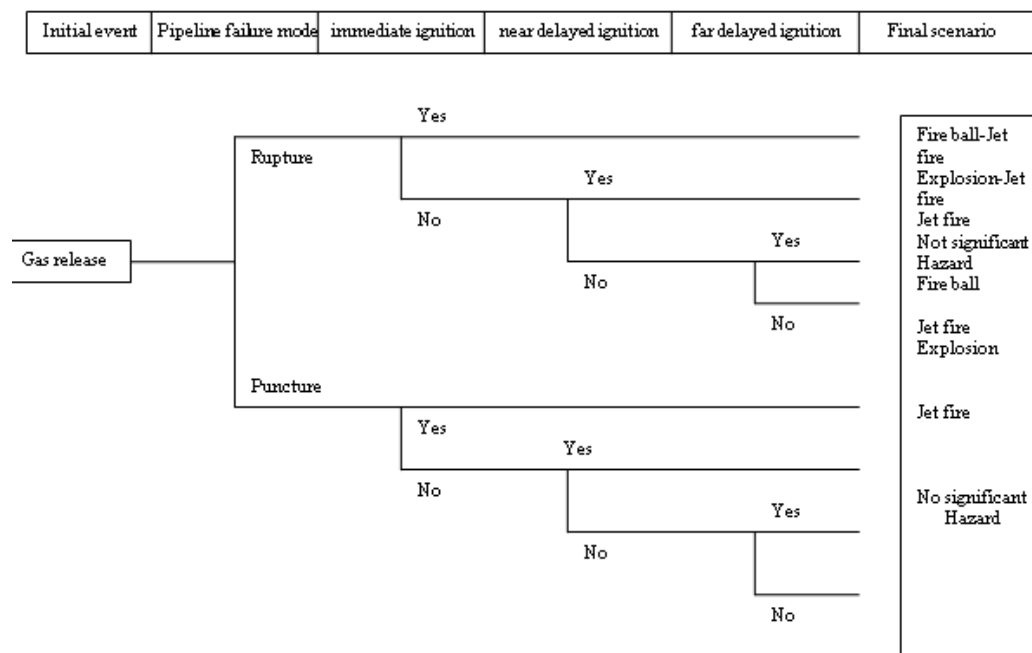

Figure 4.9 Event tree for pipeline hydrogen transmission (Jo and Ahn, 2006)

ETA for hydrogen release: storage tank

The event tree analysis regarding accidental hydrogen release is displayed in Figure 4.10. It appears that the critical factors that may affect substantially the final outcome are two: the time of ignition of the resulting cloud and the confinement where the failure occurs.

It is obvious that, unless an immediate ignition takes place, there is some time of dispersion that intervenes between release and ignition. if real time hydrogen flammability zones were known, it would be possible for preventive measures to be taken and emergency response planning to be prepared against fires and explosions (Rigas and Sklavounos, 2005). Consequently, major issue arises regarding the computation of the dispersion succeeding an accidental hydrogen release.

Hydrogen dispersion may be considered "safe" only when no ignition occurs and no space confinement exists or well ventilation exists.

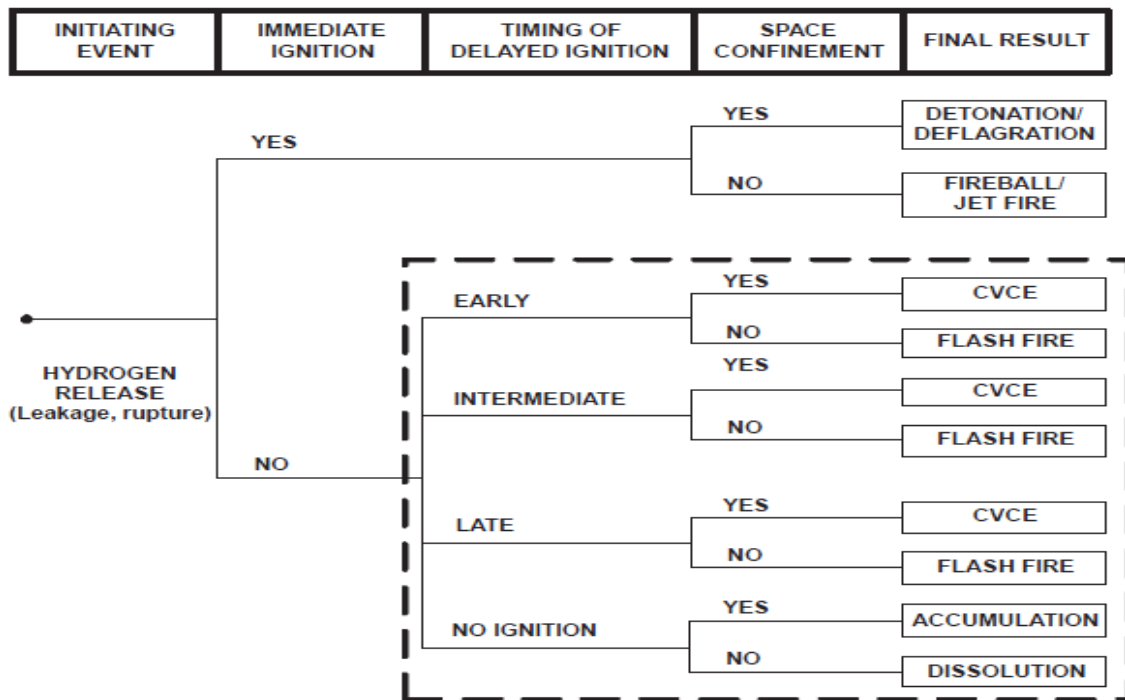

Figure 4.10 Event Tree Analysis adapted to accidental hydrogen releases (Rigas and Sklavounos,

4.7 Consequence calculation

According to the literature view point, different methods and tools have been used to study the consequences of a hydrogen accidents related to specific hydrogen economy infrastructure. These methods could be divided in three approaches:

1. The use of mathematical modelling:
2. The use of experimental studies
3. The use of Software and computational fluid dynamic (CFD)

We notate that the three methods introduced above have their own advantages and drawbacks, and they may provide a variety of knowledge as regard the compartment and how it behaves the hydrogen substance once it releases from facility, thus, under different circumstances.

Mathematical modelling

This method is based upon analytical method that describes the release of hydrogen. The paper presented by William Houf and Robert Schefer (Houf and Schefer, 2007) presented results from models for the radiative heat transfer from hydrogen jet flames and the concentration decay of unignited hydrogen jets for unintended release events involving high-pressure gas storage systems and fuel dispensers. The models are based on a combination of empirical correlations and analytical

models, as well as a numerical model of the temporal blow-down of a hydrogen storage tank. In another investigation, M.F. El-Amin and H. Kanayama (2009) studied a small scale hydrogen leakage in air.

Experimental studies

Many experimental studies have been done to highlight the hazards related to hydrogen. The aims of these works were to:

- Test the usefulness of correlations for predicting flame length & radiant heat flux
- Measurement of the dimensional and radiative properties of large scale, vertical hydrogen jet
- Study the parameters that influences the hazard, namely, leak diameter, pressure;

Measurements done by (Schefer *et al.*, 2007) were performed to characterize the dimensional and radiative properties of large-scale, vertical hydrogen-jet flames. Thus, measurements were obtained at storage pressures up to 413 bar (6000 psi) in this study. It was found that the flame length results show that lower-pressure engineering correlations based on the Froude number and a nondimensional flame length also apply to releases from storage vessels at pressures up to 413 bar (6000 psi). Similarly, radiative heat flux characteristics of these high-pressure jet flames obey scaling laws developed for low-pressure, smaller-scale flames and a wide variety of fuels. The same authors have performed in large-scale, vertical flames to characterize the dimensional, thermal, and radiative properties of an ignited hydrogen jet. These data are relevant to the safety scenario of a sudden leak in a high-pressure hydrogen containment vessel. These data are relevant to the safety scenario of a sudden leak in a high-pressure hydrogen containment vessel. The results show that flame length increases with total jet mass flow rate and jet nozzle diameter (Schefer and Houf, 2006).

Software and computational fluid dynamic (CFD)

It is well known that it is quite expensive to undertake experimental real hydrogen release and combustion in real-scale configurations, the use of computational fluid dynamics (CFD) modelling for safety purposes is increasing in this field. The CFD modelling also permits the investigation of releases in real world environments incorporating the environment conditions and using specific structures of infrastructures. Wilkening and Baraldi (2007) have studied an accidental releases from a large pipelines for methane and hydrogen under similar conditions in a numerical view point, thus for the aim to compare hydrogen pipelines to natural gas pipelines whose use is well established today. Within their paper, they compared safety implications in accidental situations. As a tool of

consequence modelling, the CFD tool has been used to investigate different properties such as density, deflagrability, and flammability limits of hydrogen and methane on dispersion process. Since, it is an accidental release of the substance; release is simulated through assimilating a hole between the high pressure pipeline and its environment. The numerical simulation has been made in the presence and the absence of the wind so to include its effect as regard the dispersion of the gases.

In the design of hydrogen supply chain, besides taking into account the economic and environmental aspects, the risk management is also an important side that must be given careful attention. There are two different perspectives to evaluate the hydrogen risk: (1) risk of hydrogen facilities to the population and environment, and (2) risk of hydrogen developing hydrogen projects. In the first definition, risk is presented previous sections of this chapter taking into account the physical properties of hydrogen. The second definition of risk is in turn related to the financial risks of developing related hydrogen projects.

In fact, hydrogen projects are surrounded by many uncertainties which may lead to failures to complete the project or in meeting its financial goals. Hence it is important to identify the most economic routes, and evaluate impacts of various scenarios of developing a supply infrastructure. The project developers may have many attitudes towards the financial risk associated with the investment on a project under uncertainty, for instance, risk adverse aims to avoid the unfavorable conditions focusing on solutions with lower variability for a certain budget.

Many solutions are proposed to avoid the financial risks of hydrogen projects using:

- The financial tools, which may include insurance and reinsurance policies, alternative risk transfer instruments, contingent capital, and credit enhancement products.
- Understand and prioritize the financial risk
- Identify and understand scenarios that may lead to High risks

In the literature, the component of financial risk is not well studied, there is a lack of research studies that investigate the risk associated hydrogen projects. Sabio et al. (2010) provided a mathematical programming for long-term design and planning of hydrogen supply chains for vehicle use under uncertainty in their economic performance with the ability to handle the financial risk associated to market changes. In their paper, authors have explicitly measured the financial risks via the worst case, which is associated to the objective function as an additional criterion to be optimized.

4.8 Risk acceptance criteria

It was accepted by the IEA hydrogen safety group that is paramount to determine appropriate risk acceptance criteria that ensure acceptable safety levels for the emerging hydrogen fueling infrastructure (<http://www.ieah2safety.com/>).

According to EIHP (Haugom, DNV), there are several alternative strategies for developing risk acceptance criteria, such that:

- Comparing with statistics from existing petrol stations, giving an historical average risk level
- Comparing with estimated risk levels from risk analyses
- Comparing with general risks in society.

For instance, the risk acceptance criteria can be that to ensure that the risk level associated with hydrogen systems are similar to or smaller than the risks associated with comparable existing non hydrogen systems that are generally worldwide accepted in society.

Another tool used for risk acceptance criteria is the "ALARP" proposed by the integrated Hydrogen project phase 2 (EIHP2). The ALARP (As Low As Reasonable Practicable" tool was developed by the UK authority which is based on general risk for society. Figure 4.11 shows the societal risk curve based on the ALARP principle.

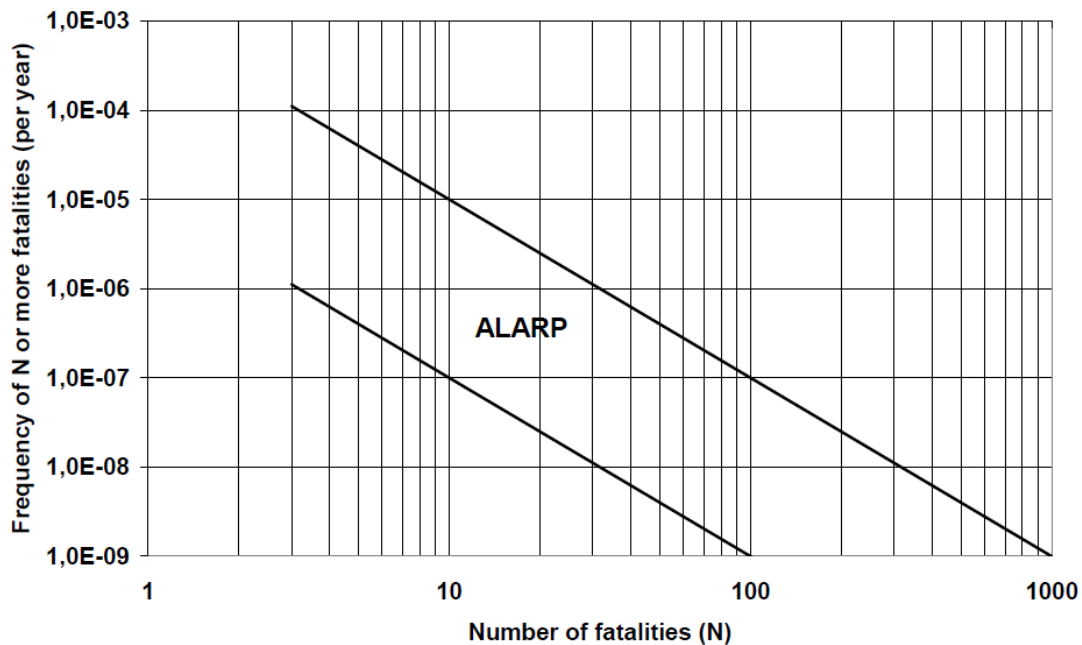

Figure 4.11 Societal risk curve, FN curve with ALARP region

The upper line in Figure 4.11 represents the risk acceptance curve. The region between this line and the lower line denotes the ALARP area (As Low As Reasonable Practical). For scenarios with risk levels (that lie) between these lines the risk should be reduced if practical, typically subject to cost

benefit analysis. For scenarios with risk levels above the upper curve, measures to reduce the risk must be implemented.

According to risk accepted adopted by the EIHP (European integrated hydrogen platform), three main acceptable level of risk could be attributed to the infrastructure related to hydrogen refueling stations. These levels differ according to type of party that is exposed EIHP categorized three parties namely first party risk, second party risk and third party risk. For the first party risks, the individual probability of fatality caused by hydrogen-process related events on the refueling station should not exceed 10^{-4} per year. For the second party risks, the probability of a major accident causing one or more fatalities among customers shall not exceed 10^{-4} per year. For the third party risks, both individual and societal risk measures should be considered (e.g. risk contours and FN curves) (EIHP2, Zhiyong et al, 2010).

4.9 Hydrogen infrastructure regulations

Hydrogen has unique physical and chemical properties which present benefits and challenges to its successful widespread as a fuel. Hydrogen can be used as safely as other common fuels we use today when guidelines are observed and users understand its behavior. The goal that must be ensured is to build new infrastructures providing at least the same or better societal and individual safety compared to the conventional situation (Dujim and Markert, 2009). For this purpose, hydrogen regulations must be developed to provide the information needed to build, maintain, and operate hydrogen facilities including hydrogen fuel cell vehicles. A catastrophic failure in any hydrogen involved project could damage the public's perception of hydrogen and fuel cells. The safety hydrogen regulations should be developed including the production, storage, distribution, and the final use of hydrogen. They are essential for the widespread acceptance of hydrogen by government and public.

In United States, Sandia National laboratories with the department of Energy are the leader in developing technical, research papers regarding the safety issues of hydrogen. They developed a technical basis for assessing the safety of hydrogen-based systems for use in the development/modification of relevant codes and standards. Two database have been made available for public to share information related to hydrogen incidents and lessons learned (<http://www.h2incidents.org>) and safety practices, design and operation (<http://h2bestpractices.org>). In Italy, the Ministerial Decree, in August 2006 approved a technical regulation for the prevention of incidents in planning, build and operation of hydrogen service stations (G.U.n.213 del 13.09.2006). In particular, specific safety distances for hydrogen refuelling stations included in DM 31/8/2006 are used (based on previous experience with CNG).

Generally, a QRA is performed on the first hydrogen refuelling station in Italy, had shown these to be adequate. In particular, if the HRS complies with DM 31 August 2006 then a QRA is required only for the in-situ hydrogen production section of the HRS. If the safety distances of the HRS do not comply with DM 31 August 2006 then a QRA is required on the whole HRS to convince the authorities that the safety characteristics of the non-compliant HRS are equivalent to those of a compliant HRS.

The regulations aim to guaranty the following objectives:

- minimize the cause of hydrogen release, fire and explosion
- limit, in case of incident event, damage to person
- limit, in case of incident event, damage to buildings and adjacent structures
- allow to rescuers to operate in security conditions

The Italian Working Group on the hydrogen fire prevention safety issues (Grasso et al, 2005) has considered that three main topics related to hydrogen infrastructure need to be regulated (Italian ministry of the interior):

- a. the hydrogen refuelling stations
- b. the hydrogen vehicle components
- c. the hydrogen transport in pipelines

In (Grasso et al, 2009), the same Italian Working Group presented theoretical and experimental results that are carried out on the hydrogen fire prevention safety issues the field of the hydrogen transport in pipelines. According to the Group, the published current work is concluded to be considered as a document to begin discussions with the Italian stakeholders that are involved in hydrogen applications. In particular, from one hand, the theoretical framework developed aims at issuing a draft document that is based on Italian regulations in force on the natural gas pipelines. In fact, these latter have been reviewed, corrected and integrated with instructions suitable to the use of hydrogen gas in pipelines. From another hand, the experimental component has designed and installed at the University of Pisa an apparatus which will be considered as the simulation platform of hydrogen releases from pipelines. Another project entitled "The Zero Regio" project includes two demonstration projects, one in Germany (Frankfurt, region of Rhein-Main) and one in Italy (Mantova-Valdaro, region of Lombardy) (see Figure 4.12 .). The demonstrator projects are related to hydrogen refueling stations. In Italy, one refueling unit for compressed hydrogen at 350 bar was built. The regulation requires safety distances of 50% larger than those mentioned in the draft 'technical rule' which was applied in the design of the ENI (Italian biggest oil company) station. A 3x2 m concrete wall became safety requirements (J. Backhaus and I.G. Bunzeck, 2010).



Figure 4.12 Zero Regio hydrogen refuelling unit in Mantova Source:

<http://www.admin.zeroregio.de/CDROM/englisch/10openingeni/opening/index.html>.

5. Conclusion

Hydrogen has a long history of safety use in the chemical, manufacturing and utility industries, however, as a large and widespread scale where general public can handle hydrogen infrastructure, it may create safety issues. For this main reason, the safety technological conditions for the use of hydrogen as an energy carrier must be well known and deeply studied in order to deliver appropriate safety codes and standard to minimize risks on public. The chapter discusses the risks of using the hydrogen in different components of its logistic chain as well as it discusses about the safety issues related to hydrogen. A detailed literature review is summarized which contains the state of art of hydrogen risks and the methodological approach followed by the worldwide scientific and technical communities to evaluate risks that results from hydrogen accident.

Chapitre 5 : Models and methods dedicated to formalized a regional decision support system based on renewable hydrogen energy systems

Dans la 1^{ère} et 2^{ème} partie du chapitre 5, les données du vent et du solaire de la région de Ligurie (Italie) ont été analysées. En effet, l'évaluation du potentiel du vent a porté sur 25 stations réparties sur quatre provinces de la région de la Ligurie à savoir La Spezia, Gênes, Savone et Imperia. L'évaluation du potentiel du solaire a porté sur 16 stations réparties sur les mêmes provinces.

Une analyse statistique a été réalisée, suivie par une méthode d'interpolation de Kriging appropriée, donnant lieu à des cartes de vent de la région Ligurie à différentes hauteurs. Comme résultat, il a été reconnu que certains territoires internes situés dans des régions montagneuses, ainsi que certaines parties de la cote Ligure sont plus prometteuses que d'autres, vis-à-vis d'une exploitation pour la production d'énergie. En outre, ce potentiel semble assez stable au cours des années d'étude. D'après les données obtenues sur les 25 stations, seulement 4 d'entre elles semblent être satisfaisantes pour la production d'énergie.

Afin de détailler ces résultats, une étude approfondie a été menée pour une meilleure évaluation des ressources éoliennes dans ces quatre sites. La distribution mensuelle et saisonnière de la vitesse du vent, la densité de l'énergie éolienne et la direction du vent ont été déterminées pour les quatre sites pour fournir de plus amples informations sur la nature de ces ressources éoliennes. Les résultats montrent que Capo Vado est le meilleur site avec une valeur moyenne mensuelle de vitesse du vent entre 2.80 et 9.98 m/s à une hauteur de 10 m et une densité mensuelle de puissance entre 90.7 et 1177.9 W/m², tandis que la plus haute énergie produite par une éolienne spécifique de 1500 kW a été atteinte en décembre avec une valeur de 3800 MWh.

Cette étude pourrait fournir des informations à propos de la sélection des sites et sur la planification économique des capacités éoliennes pour la production d'électricité dans la région. La classification Battelle-PNL a été utilisée pour classer les sites préalablement analysés vis-à-vis de la pertinence de l'énergie éolienne. Il en résulte que les quatre sites sont considérés comme satisfaisants pour la plupart des applications de l'énergie éoliennes. La variation saisonnière de la vitesse du vent de ces sites doit refléter la nécessité d'adopter des stratégies appropriées pour adapter l'énergie éolienne exploitable à la demande. Ceci pourra être accompli en fonction de deux stratégies principales: la promotion des systèmes hybrides et le stockage d'énergie pour alimenter la demande future dans le but d'éviter une pénurie d'énergie. A propos de la première option, pour les sites étudiés dans ce travail, l'énergie solaire présente une option prometteuse, puisque le rayonnement solaire est

disponible et atteint des valeurs élevées dans les mois ou les saisons où le vent semble avoir un potentiel réduit.

La 2^{ème} partie introduit une méthode pour améliorer celle présentée dans la partie 1 : il s'agit de moyens spécifiques pour une meilleure analyse du potentiel des énergies renouvelables. Ce chapitre contient également la description d'un système d'aide à la décision pour l'exploitation des ressources renouvelables pour la production d'hydrogène. L'approche globale, à la fois pour les parties A et B est appliquée à un cas d'étude dans la région Ligure.

Dans le cadre de l'infrastructure d'hydrogène, une question clé qui doit être abordée est la capacité des systèmes d'énergie renouvelable pour répondre aux exigences de carburant d'hydrogène (en quantité et en temps). La troisième partie du chapitre 5 présente une nouvelle configuration de la chaîne logistique de l'hydrogène, complètement fondée sur l'utilisation des ressources renouvelables comme matière première de production. Il s'agit d'un réseau "vert" de stations d'hydrogène et de plusieurs usines de production centralisées. Dans ce cadre, un problème d'optimisation a été proposé, où les principales décisions sont la sélection des stations services à hydrogène qui seront alimentées par des productions centralisées et le contrôle des flux d'énergie et d'hydrogène échangés entre les composants du système. Les critères de sélection sont fondés sur la distance qui sépare les nœuds de production et de consommation, ainsi que d'autres critères strictement liés à la minimisation des risques. Les configurations optimales sont étudiées en tenant compte de la présence d'une demande supplémentaire dédiée au marché industriel d'hydrogène et de la connexion avec le réseau électrique.

A-Renewable energy sources: clean feedstocks for hydrogen production

1. Introduction

Renewable energy is an environmental friendly option which may be economically competitive with conventional power generation, where good resources are available. It represents an opportunity to enhance sustainable development in both countries which traditionally lacks fossil fuels and those who are constrained by some environmental policies and regulations. Renewable energy can play increasing role in countries that have an important environmental wealth and great renewable energy potential. Quality and accessibility of resource data will enable private investors and public policy-makers to access the technical, economical and environmental potential for large-scale investments in green technologies. For more accurate resource assessment, detailed site-specific micro-sitting analysis should be done considering existing transmission grid, accessibility, land availability, altitudes and topography (Akpınar and Akpınar, 2005), (Mabel and Fernandez, 2008).

Renewable power generation has known a remarkably rapid growth in the past twenty years, and now it is a mature, reliable and efficient technology for electricity production (Fyrıppis et al, 2010). In addition, in regions with proper resource characteristics, renewable energy may already be competitive with coal or nuclear power, especially when the cost of pollution is taken into account in the overall economic evaluation (Kaygusuz, 2002).

Any choice of renewable energy sources exploitation site must be based on the preliminary investigation of the average wind velocity, solar irradiation and potential, so that the accuracy of the resources data analysis is a crucial factor to be undertaken.

In the literature, many studies have been focused on providing a forecasting tool to predict and assess renewable energy sources and power production with good accuracy. From the wind speed assessment viewpoint, several authors (Rehaman, 2004, Shata and Hanitsch, 2008, Himri et al, 2009; Celik, 2006, Ucar and Balo, 2009, Cote et al, 1998) have used many approaches to evaluate wind speed and wind energy production. The aim of this chapter is to investigate the wind speed and solar irradiation characteristics of the Liguria region. The study is performed following two steps. In the first step, the study is based on the analysis and modelling of the statistical data, in this step, attention is given also to a deeply analysis of wind sites that have shown promising potential for future exploitation. In a second step, a GIS tool, more specifically, an ArcGIS Spatial Analyst is used to produce maps of wind and solar energy.

2. Wind speed and solar irradiation data

The estimation of a potential is based on the knowledge of wind and solar regimes on the considered territory. In this chapter, the assessment of the Liguria Region wind and solar potential has been carried out using data gathered by the Agenzia Regionale della Protezione Ambientale Liguria (ARPAL). In total, data from 25 stations for wind and 16 stations for solar distributed over the four provinces of Liguria (Figure 5.1 and Figure 5.2) (i.e., La Spezia, Genoa, Savona and Imperia) have been analyzed. It should be pointed out that different periods of monitoring are available for different sites, these data were the only ones that are available and which have been gathered on-site by the regional agency for environmental protection in the Liguria region.

The wind data used in this current study were observed in the following locations:

- Casoni (2002-June/2008),
- Borgonuovo, Castellari, Cavi di Lavagna, Cenesi, Imperia, Levanto-s Gottardo, Monte Rocchetta and Polanesi (2003-June/2008)
- Genova villa Cambiaso (2002-2006)
- Diano Castello (2003-2007)
- Monte Settepani, Fontana Fresca, Monte Maure and Ranzo (2004-June/2008),
- Vernazza (2004-2007)
- Giacopiane Lago and Pornassio (2005-June/2008)
- Romito Magra (2004-2006)
- Capo Vado (2006-June/2008)
- Genova, ARPAL functional center (2007-June/2008)
- Savona (April/2007-June/2008), Poggio Fearza (2007)
- Corniolo and La Spezia (2008-June/2008).



Figure 5.1 The geographical locations of wind meteorological stations

The solar data used in this current study were observed in the following locations:

- Castellari (2008 Jan/ 2009 Dec)
- Polanesi (2006-Jan/2009-Dec)
- Corniolo (2009-Jan/ 2009-Dec)
- Capo Vado (2008-Jan/2009-Dec)
- Levanto\S.Gottardo
- Sanremo (2008-Jan/ 2009-Dec)
- Ranzo (2006-Jan/ 2009-Dec)
- Giacopiane Lago
- Genova (2005-Jan/ 2009-Dec)
- Monterocchetta
- Buorgonuovo (2005-Jan/ 2009-Dec)
- Cavi di Lavagna (2005-Jan/ 2009-Dec)
- Allasio (2007-Jan/ 2009-Dec)
- Romito Magra (2006-Jan/ 2009-Dec)
- Pornassio (2006-Jan/ 2009-Dec)
- Poggio Fearza (2009-Jan/ 2009-Dec)

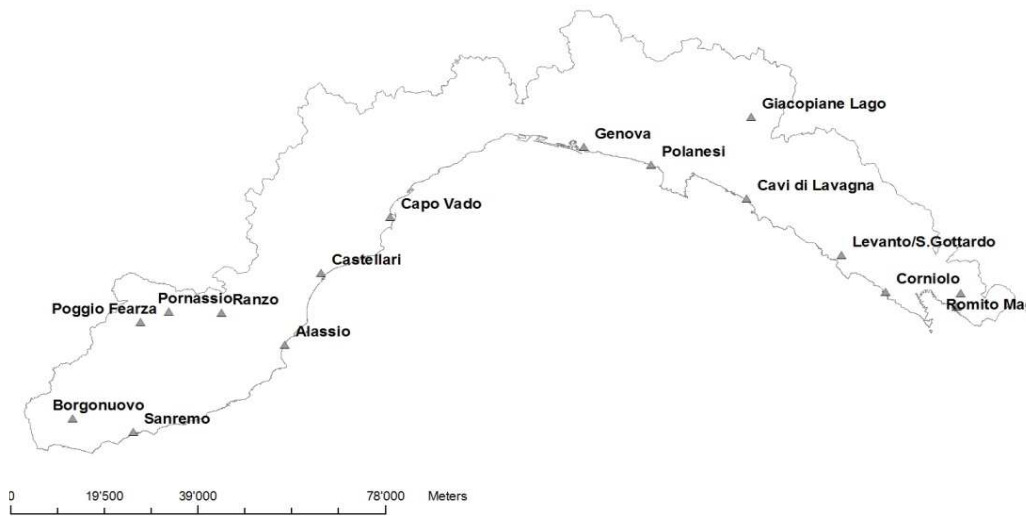

Figure 5.2 The geographical locations of solar meteorological stations

The data have been used to evaluate the annual frequency of wind speed, the monthly and annual variations as regards average speed, the vertical profile of the wind speed, and the assessment of wind and solar power potential.

3. Wind analysis model

The computation of the wind speed probability distribution function (PDF) constitutes the first fundamental step to assess the wind energy potential, since it can effectively determine the performance of wind energy systems for a given location and time (Kantar and Usta, 2008; Carta et al, 2009). Several PDFs have been proposed in the literature to represent the frequencies of the wind speed. The Weibull with its two characteristic parameters is the most commonly used and different estimation methods can be used for its identification (Carta et al, 2009).

The general form of the Weibull PDF is:

$$f(v) = \left(\frac{k}{c}\right)\left(\frac{v}{c}\right)^{k-1} \exp\left(-\left(\frac{v}{c}\right)^k\right) \quad (5.1)$$

where $f(v)$ is the probability of observing wind speed v , k is the dimensionless Weibull shape parameter, and c is the Weibull scale parameter.

According to the measurements of wind speed at a specific site, it is necessary to use estimation methods to derive parameters k and c on the basis of the known data v . Common estimation methods can be applied: the standard deviation method (SD), the maximum likelihood method (MLM), or the least squares method (LSM). In this study, the SD method has been used, so that the two parameters of Weibull PDF, k and c can be related to the mean speed V_m and standard deviation σ by (Pavia and Brien, 1986; Perez et al, 2004):

$$V_m = \int_0^{\infty} v f(v) dv = \int_0^{\infty} v \frac{k}{c} \left(\frac{v}{c}\right)^{k-1} e^{-\left(\frac{v}{c}\right)^k} dv = c \Gamma\left(1 + \frac{1}{k}\right) \quad (5.2)$$

where,

$$\Gamma(y) = \int_0^{\infty} e^{-x} x^{y-1} dx \quad (5.3)$$

$$k = \left(\frac{\sigma}{V_m}\right)^{-1.086} \quad (5.4)$$

$$c = \frac{V_m}{\Gamma\left(1 + \frac{1}{k}\right)} \quad (5.5)$$

3.1 Extrapolation of data at hub height

The wind speed data are collected at a height H_{data} [m] that is different from the height of the hub. So, it is necessary to represent the relation among wind speed v_{hub} [m/s] at hub height H_{hub} [m], the wind speed v_{data} [m/s] at H_{data} , and the surface roughness length z_0 [m]. In this work, a relation proposed in (Dufo-Lopez and Bernal-Agustin, 2008; Damon and Patrick, 2009), is used, namely,

$$v_{hub} = v_{data} \frac{\ln(H_{hub}/z_0)}{\ln(H_{data}/z_0)} \quad (5.6)$$

3.2 Wind power density

The power of the wind that flows at speed v through the blade sweep area A [m^2] increases as the cubic of its velocity and is given by (Eskin et al, 2008):

$$P(v) = \frac{1}{2} \rho A v^3 \quad (5.7)$$

where ρ [kg/m^3] is the density of air.

The wind power density of a site based on Weibull's probability density function can be expressed as follows (Eskin et al, 2008):

$$P = \int_0^{\infty} P(v) f(v) dv = \frac{1}{2} A \rho c^3 \Gamma\left(\frac{k+3}{k}\right) \quad (5.8)$$

3.3 Classes of wind power density

The Battelle-Pacific Northwest Laboratory (PNL) developed a wind power density classification scheme to classify the wind resources. The Battelle-PNL classification is a numerical one which includes rankings from Wind Power Class 1 (lowest) to Wind Power Class 7 (highest). Each class represents a range of wind power density (W/m^2) or a range of equivalent mean wind speeds at specified heights above ground level (Ilinca et al, 2003). Class 4 or greater are considered to be suitable for most wind turbine applications. Class 3 areas are suitable for wind energy development using taller wind turbine towers. Class 2 areas are considered marginal for wind power development and Class 1 areas are unsuitable (Ilinca et al, 2003). More description of the Battelle-PNL classification can be found in (Ilinca et al, 2003).

As determined by Ouammi et al (2010), taking into account a statistical analysis on the whole year, the wind power densities of Capo Vado, Casoni, Fontana Fresca and Monte Settepani are equal respectively to 487.7, 332.5, 206.5 and 203 W/m^2 . Consequently, Capo Vado appears to have potential wind resources as Class 7, Casoni is classified as Class 6 and both Fontana Fresca and Monte Settepani are classified as wind power Class 4.

4. Modelling the wind power plant and its performance

The estimation of the exploitable energy requires the definition of the performances of the wind power plant (WPP) system. The WPP simplified model which is taken into account in this work is related to a horizontal axis wind turbine equipped with a gearbox. So, the WPP is supposed to consist of three main components: the rotor R, the gearbox GB, and the generator G.

The site will be characterized by a wind speed v [m/s] with a statistical distribution function $f(v)$, equipped with a WPP whose efficiency is C_{WPP} and with a rotor sweeping a surface A [m^2],

working in a range of wind speed $v \in [v_i, v_f]$, where v_i [m/s] is the cut-in wind speed, and v_f [m/s] is the cut-off wind speed.

Under the above mentioned hypothesis, the electric energy E_{wt} [kWh] which can be produced per time period T is given by (Diveux et al, 2001):

$$E_{wt} = \frac{T}{1000} \frac{\rho}{2} A \int_{v_i}^{v_f} v^3 f(v)_{hub} C_{WPP}(v) dv \quad (5.9)$$

where T is the number of hours, ρ [kg/m³] is the air density, $f(v)_{hub}$ is the Weibull PDF at the height of the hub and A [m²] is the area swept by the WPP blades.

The WPP performance coefficient of the plant system, $C_{WPP}(v)$, is made by three related components, which are also dependent on the wind speed v (Diveux et al, 2001):

$$C_{WPP}(v) = c_p(v) \eta_{GB}(v) \eta_G(v) \quad (5.10)$$

with c_p the power coefficient, η_{GB} the gearbox efficiency, η_G the generator efficiency.

5. Results and discussion

The obtained results from the available meteorological data used in this study show that in some sites the wind energy potential is low, while in other sites wind potential is considerably high. With the aim of covering all four provinces of Liguria, we used data from all the available stations, even if most of them are not located in the windiest parts of the territory. The average wind speed (on the whole measurement period) has been evaluated for each site and shown in Table 5.1.

The results show that Capo Vado (6.52 m/s), Casoni (5.74 m/s), Monte Settepani (5.45 m/s) and Fontana Fresca (5 m/s), have the highest wind speed at 10 m. Unlike other sites, among these four sites (Table 5.2) Capo Vado is considered the most promising site for the Liguria Region with an available energy of 4271.7 kWh/m².yr.

Sites	Wind speed [m/s] 10 [m]	Wind speed [m/s] 40 [m]	K (SD)	C (m/s) (SD)
Borgonuovo	1.15	1.86	2.3	1.3
Capo Vado	6.52	8.56	1.43	7.18
Castellari	1.28	2.06	1.10	1.32
Cavi di Lavagna	1.25	2.03	0.98	1.24
Cenesi	1.55	2.42	1.43	1.70
Corniolo	2.76	4.05	1.09	2.85
Fontana Fresca	5.00	6.76	1.48	5.51
Genova Centro	3.64	5.14	1.29	3.94
Genova Villa Cambiaso	1.90	2.89	1.63	2.12
Giacopiane Lago	3.73	5.28	1.06	3.82
La Spezia	3.15	4.51	1.43	3.47
Levanto-S Gottardo	1.48	2.32	1.46	1.63
Monte Maure	3.86	5.38	1.69	4.32
Monte Rocchetta	3.80	5.33	1.48	4.21
Monte Settepani	5.45	7.29	1.84	6.13
Poggio Fearza	4.72	6.44	1.51	5.23
Polanesi	1.21	1.95	2.31	1.37
Pornassio	1.24	1.98	1.92	1.39
Ranzo	2.35	3.48	2.23	2.65
Romito Magra	1.01	1.66	1.38	1.10
Savona Istituto Nautico	3.47	4.90	2.44	3.91
Vernazza	1.65	2.55	1.84	1.85
Casoni	5.74	7.30	1.43	6.34
Diano Castello	0.69	1.20	0.99	0.69
Imperia	3.35	4.77	1.54	3.72

Table 5.1 The average wind speed on the whole measurements period for each site.

Sites	K	C [m/s]	Power density [W/m ²]	Available energy [kWh/m ² .yr]	Altitude [m]	Latitude N	Longitude E
Borgonuovo	2.3	1.3	1.54	13.6	100	43.8463	7.6208
Capo Vado	1.43	7.18	487.7	4271.7	170	44.2583	8.4425
Castellari	1.10	1.32	6.04	52.9	100	44.1456	8.2625
Cavi di Lavagna	0.98	1.24	7.5	65.7	100	44.2961	9.3739
Cenesi	1.43	1.70	6.47	56.7	110	44.0750	8.1347
Corniolo	1.09	2.85	62	543.5	258	44.1063	9.7348
Fontana Fresca	1.48	5.51	206.5	1809.3	743	44.4022	9.0936
Genova Centro	1.29	3.94	100	874.3	20	44.4017	8.9472
Genova Villa	1.63	2.12	9.90	86.7	40	44.3986	8.9633
Giacopiane Lago	1.06	3.82	161.75	1417	1016	44.4608	9.3875
La Spezia	1.43	3.47	54.47	477.2	5	44.1045	9.8075
Levanto-S Gottardo	1.46	1.63	5.5	48	100	44.1811	9.6211
Monte Maure	1.69	4.32	80	694.5	210	43.7922	7.6192
Monte Rocchetta	1.48	4.21	92	805.2	412	44.0755	9.9197

Monte Settepani	1.84	6.13	203	1776.5	1375	44.2430	8.1966
Poggio Fearza	1.51	5.23	170	1483.5	1833	44.0420	7.7935
Polanesi	2.31	1.37	1.8	15.8	50	44.3658	9.1247
Pornassio	1.92	1.39	2.3	19.8	500	44.0639	7.8664
Ranzo	2.23	2.65	13.5	118	310	44.0632	8.0049
Romito Magra	1.38	1.10	2	16.9	100	44.1033	9.9303
Savona Istituto Nautico	2.44	3.91	40.23	352.4	38	44.3056	8.4855
Vernazza	1.84	1.85	5.61	49.2	160	44.1361	9.6833
Casoni	1.43	6.34	332.5	2908.8	800	44.5272	9.3086
Diano Castello	0.99	0.69	1.20	10.5	135	43.9232	8.0669
Imperia	1.54	3.72	59	516.7	10	43.8882	8.0416

Table 5.2 Available wind energy for each site

Table 5.3 shows the annual variation of average wind speed of each of these sites. For Capo Vado, a minimum average speed of 6.12 m/s in 2006 and a maximum of 6.87 m/s in 2008, have been monitored, which show that the average wind speed of the site has not undergone considerable changes and has kept the same order of magnitude. The same conclusion can be drawn for Casoni with a minimum of 5.73 m/s in 2008 and a maximum of 6.12 m/s in 2006, and for Monte Settepani with a minimum of 5.16 in 2008 and a maximum of 5.79 m/s in 2007. Similar results are obtained for Fontana Fresca with a minimum of 4.94 m/s in 2004 and a maximum of 5.04 m/s in 2008.

	Capo Vado	Casoni	Fontana Fresca	Monte Settepani
	Annual average wind speed [m/s]			
2004	–	5.82	4.94	5.30
2005	–	5.73	4.94	5.60
2006	6.12	6.12	5.03	5.40
2007	6.56	5.84	4.99	5.79
2008	6.87	5.97	5.04	5.16

(a)

	Capo Vado	Casoni	Fontana fresca	Monte Settepani
	Power density [W/m ²]			
2004	–	355.98	183.80	194.02
2005	–	366.41	200.16	197.92
2006	367.58	367.59	211.40	192.09
2007	483.58	329.03	202.04	222.72
2008	620.71	374.64	237.08	207.54

(b)

	Capo Vado	Casoni	Fontana fresca	Monte Settepani
	Available wind energy [MWh/m ² .yr]			
2004	–	3.12	1.61	1.70
2005	–	3.21	1.75	1.73
2006	3.22	3.22	1.85	1.68
2007	4.24	2.88	1.77	1.95
2008	5.44	3.28	2.08	1.82

(c)

Table 5.3 Annual average wind speed (a), annual power density (b) and annual available energy for the four sites with highest wind speed (c).

ArcGIS Spatial Analyst has been implemented to display the distribution of the wind and solar in the region. The ArcGis tool includes specific interpolation methods to estimate spatially continuous phenomena, here it is related to solar and wind. The aim of the interpolation methods is to create a surface grid in ArcGIS in order to assess the values of cells at locations that lack sampled points. Among interpolation tools, there are spline, kriging methods and inverse distance weighted (IDW). the most appropriate method depends on the distribution of the sampled points as the set of points is dense enough to capture the extend of surface variation. For this reason, this method has been excluded for the case of Liguria region. we should mention that different methods have been tested to evaluate the phenomena and create surface grid, the kriging method is the one that gave the most appropriate results. The data from all the sites have been given as input to a Kriging algorithm in order to produce available wind energy at 10 m.

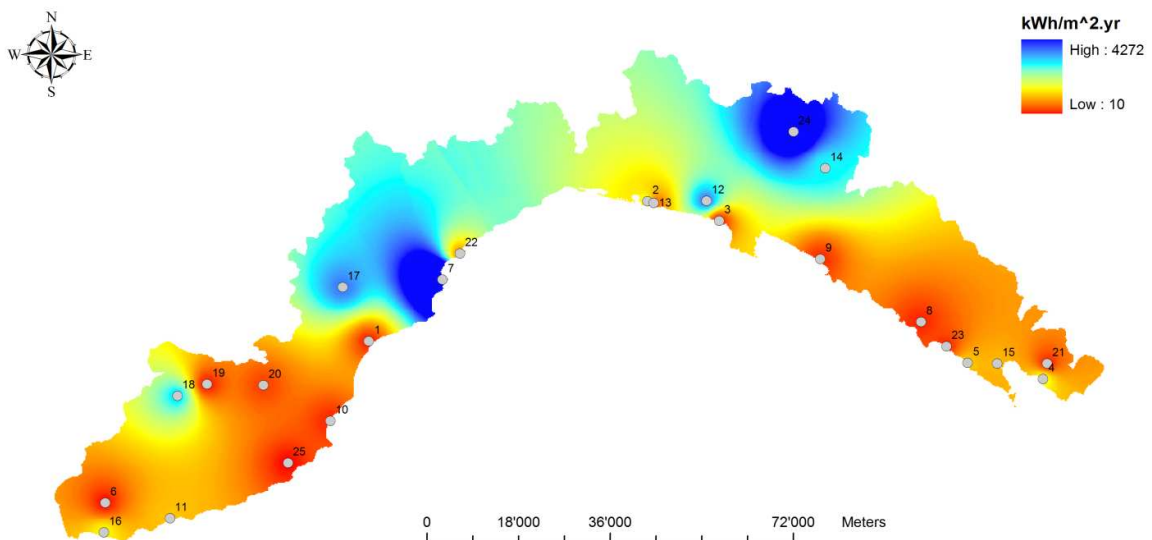

Figure 5.3 Available wind energy in Liguria region

From Figure.5.3, it is quite evident that different sites of Liguria region have very different wind potential characteristics. It seems that some internal territories on the mountains as well as some part of the coast in the western side are more promising than others for the exploitation of the wind resource for energy production. In addition, this potential seems quite stable in the years. However, as usual in these cases, also due to the complex orography of Liguria region, a monitoring campaign on the field should be performed on the site. From the data obtained on the 25 stations, only 4 of them seem to be eligible for energy production.

The WPP with the following geometric and technical characteristics has been considered to assess the energy output: rated power 1500 [kW]; cut-in wind speed of 4 [m/s], rated wind speed of 14 [m/s], cut-off wind speed of 20 [m/s], survival wind speed of 52.5[m/s]; 3 blades; diameter 82 [m]; hub height 76 [m]; and swept area of 5281 [m²]. Furthermore the power coefficient, gearbox efficiency and generator efficiency have been supposed equal respectively to 0.45, 0.96 and 0.96.

The wind speed data of the four locations (Capo Vado, Casoni, Fontana Fresca and Monte Settepani) have been analysed taking into account the monthly and seasonal variations. The monthly variation of Weibull parameters (k and c) and the mean monthly wind speed at 10 and 76 m above the ground level are listed in Tables 5.4, 5.5, 5.6 and 5.7

For Capo Vado site (Table 5.5), it can be observed that the maximum value of the monthly mean wind speed at 10 m is 9.98 m/s in December and a minimum value of 2.80 m/s occurs in April, while at the hub height the monthly wind speed varies between 3.73 and 13.46 m/s. Furthermore, Weibull shape parameter k varies between 0.95 and 1.94, while scale parameter c between 2.73 and 11.25 m/s.

Month	c [m/s]	k	Mean wind speed [m/s] 10 [m]	Mean wind speed [m/s] 76 [m]	Power density [W/m ²]
January	7.50	1.36	6.87	9.27	620.14
February	7.15	1.63	6.40	8.63	381.04
March	7.05	1.46	6.38	8.61	441.65
April	6.21	1.30	5.73	7.73	384.75
May	5.42	2.03	4.80	6.48	125.21
June	5.53	1.89	4.91	6.62	143.73
July	5.13	1.86	4.56	6.15	117.11
August	4.97	1.83	4.41	5.95	108.32
September	5.61	1.54	5.05	6.81	202.53
October	6.51	1.48	5.88	7.94	339.62
November	7.04	1.44	6.39	8.62	452.95
December	8.62	1.39	7.86	10.61	894.86

Table 5.4 Monthly variations of the mean wind speed and Weibull parameters in Capo Vado site.

Capo Vado					
Month	c [m/s]	k	Mean wind speed [m/s] 10 [m]	Mean wind speed [m/s] 76 [m]	Power density [W/m ²]
January	5.91	1.45	5.36	7.24	265.52
February	7.60	1.64	6.80	9.17	453.93
March	7.80	1.53	7.02	9.47	550.20
April	2.73	0.95	2.80	3.78	90.71
May	5.06	1.36	4.63	6.24	187.71
June	5.29	1.58	4.75	6.41	162.55
July	4.95	1.53	4.46	6.01	140.21
August	5.78	1.82	5.14	6.93	172.04
September	6.42	1.49	5.80	7.83	321.06
October	9.22	1.89	8.19	11.05	666.03
November	9.06	1.62	8.11	10.95	783.07
December	11.25	1.94	9.98	13.46	1177.97

Table 5.5 Monthly variations of the mean wind speed and Weibull parameters in Casoni site

Results of Fontana Fresca location (Table 5.6) reveals that at 10 m, a value of 6.78 m/s is observed as a maximum monthly wind speed in December and a minimum value of 3.69 m/s in June, furthermore at the hub height, the monthly wind speed is ranging between 4.98 and 9.15 m/s. The

shape parameter k varies between 1.36 and 1.92 while the scale parameter c between 4.15 and 7.46 m/s.

Fontana Fresca					
Month	c [m/s]	k	Mean wind speed [m/s] 10 [m]	Mean wind speed [m/s] 76 [m]	Power density [W/m²]
January	6.65	1.73	5.93	7.99	279.36
February	5.92	1.47	5.36	7.22	257.13
March	6.61	1.68	5.90	7.96	286.11
April	4.52	1.53	4.07	5.49	107.03
May	5.10	1.82	4.53	6.12	117.81
June	5.15	1.92	4.57	6.17	114.48
July	4.15	1.76	3.69	4.98	66.13
August	4.86	1.68	4.34	5.86	113.80
September	4.52	1.41	4.11	5.55	124.44
October	5.64	1.36	5.17	6.97	261.95
November	6.13	1.50	5.53	7.46	275.45
December	7.46	1.43	6.78	9.15	547.46

Table 5.6 Monthly variations of the mean wind speed and Weibull parameters in Fontana Fresca site

Monte Settepani					
Month	c [m/s]	k	Mean wind speed [m/s] 10 [m]	Mean wind speed [m/s] 76 [m]	Power density [W/m²]
January	7.04	2.26	6.24	8.41	248.60
February	7.58	2.16	6.72	9.06	322.22
March	6.30	1.90	5.59	7.55	212.04
April	6.28	2.45	5.57	7.51	166.26
May	5.81	2.34	5.15	6.95	136.11
June	5.61	2.43	4.97	6.71	118.76
July	5.30	2.25	4.69	6.33	106.21
August	5.70	2.11	5.05	6.81	140.18
September	5.88	2.07	5.21	7.03	157.08
October	7.12	1.95	6.32	8.52	296.46
November	7.07	1.95	6.27	8.46	289.53
December	7.83	2.32	6.94	9.36	334.71

Table 5.7 Monthly variations of the mean wind speed and Weibull parameters in Monte Settepani site

As concern Monte Settepani (Table 5.7), it appears that December is still the month that gives the maximum value of the wind speed, and which attains 6.94 m/s at 10 m. On the other hand, the wind speed reaches its minimum limit in July (4.69 m/s). At the hub height, the monthly wind speeds range between 6.33 and 9.36 m/s. The shape parameter k takes a value between 1.90 and 2.45, while the scale parameter c between 5.30 and 7.83 m/s.

To sum up, a maximum value of the mean wind speed at 10 m is obtained at Capo Vado as 9.98 m/s in December. Furthermore, the Weibull parameter k varies between 0.95 and 2.45 with a minimum at Capo Vado in April and a maximum at Monte Settepani also in April. The parameter c varies between 2.73 and 11.25 m/s, thus for a maximum and minimum values observed at Capo Vado in December and April respectively.

In addition to the wind speed analysis, the knowledge of the wind direction is an essential task to carry out in order to make a better understanding regarding the planning of the wind turbine installations. The wind direction frequencies for the four locations are displayed in Figure 5.4. The wind directions show a quiet similar behaviour. But for Fontana Fresca, all the other locations (Capo Vado, Casoni and Monte Settepani) exhibit a distribution between NNE to NNW pattern. For Capo Vado, the predominant wind direction is the North with a value of 37%, while for Casoni and Monte Settepani; it is respectively NNE and NNW with 31% and 41%. An opposite tendency is observed at Fontana Fresca site, where the predominant direction is the South with

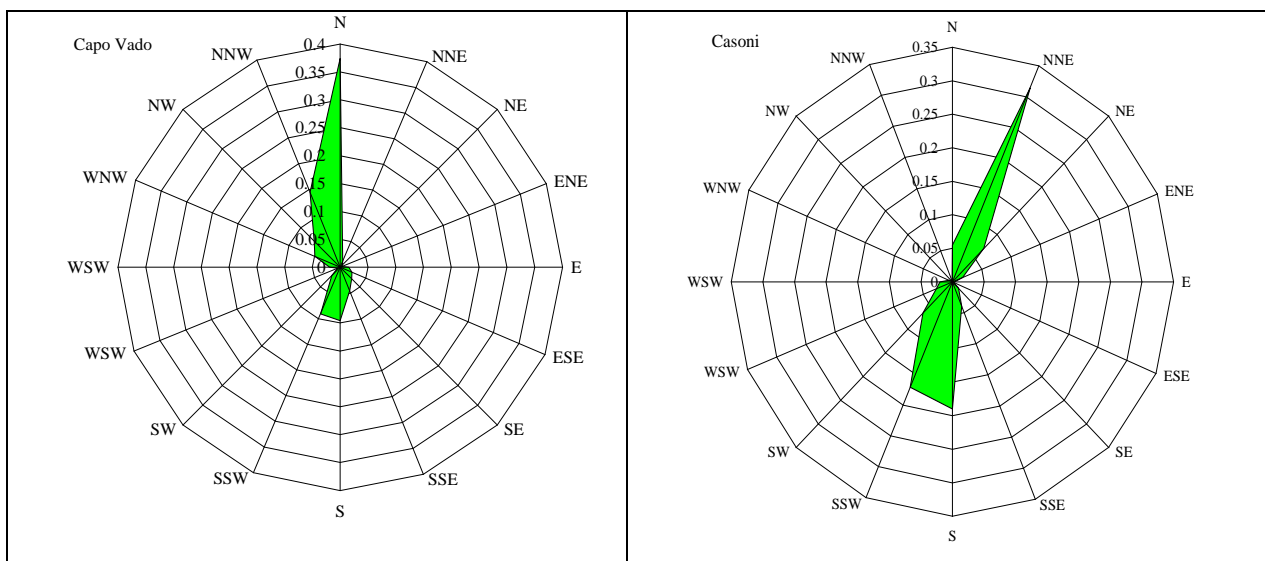

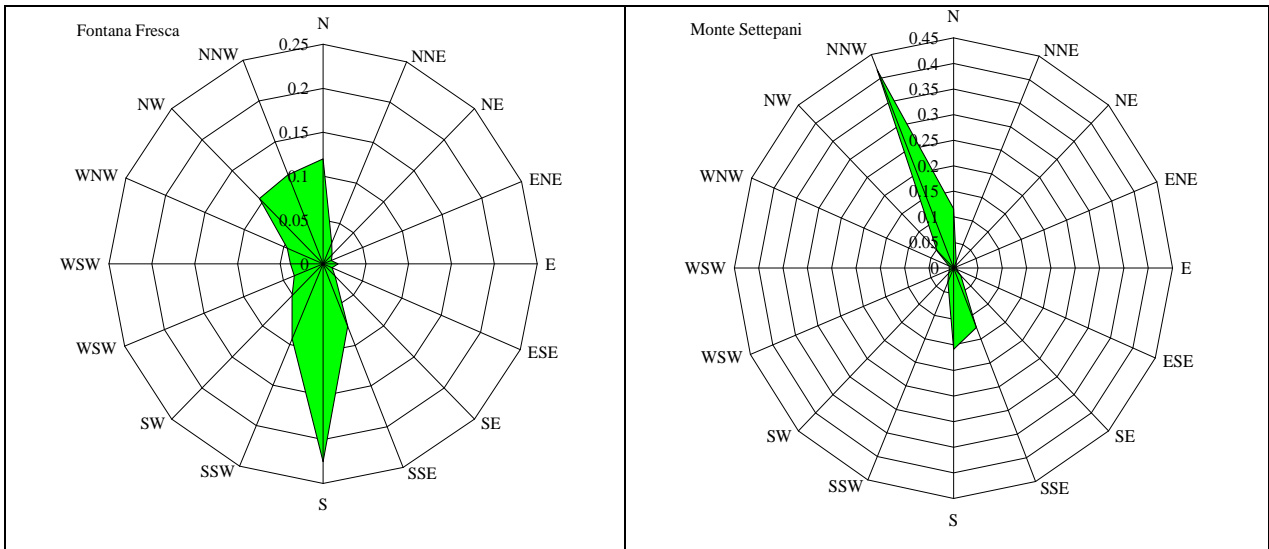

Figure 5.4 Annual wind direction frequencies at the four locations

The estimation of the mean wind speed over a site is not a final step to assess the available wind potential in the considered site. Moreover, the value of the power density is an important parameter that can provide complementary information regarding the choice of suitable site, as well as an immediate classification of the site. For this main reason, the wind power density available at the four locations has been computed. Figure 5.5 reveals the monthly variation of mean wind power density at different heights for the four selected stations. It can be recognized that all the four stations (Capo Vado, Casoni, Fontana Fresca and Monte Settepani) exhibit the same tendency as regards the highest monthly mean wind power density and which occurs in December. Whereas, once it comes to the minimum wind power density, the rate of variation is not the same; the occurrence of the minimum differs from one site to the other. At 10 m elevation, this minimum is reached in August at Casoni site with a value of 108.32 W/m^2 , and for Capo Vado in April with a value of 90.71 W/m^2 , while for the two other sites Fontana Fresca and Monte Settepani, their minimum values occur in July with values equal respectively to 66.13 W/m^2 and 106.21 W/m^2 . Comparing the trend of the four wind power density in Figure 5.5, the wind power density has its maximum value in December for Capo Vado with 1177.97 W/m^2 at 10 m and 2411 W/m^2 at the hub height (76m).

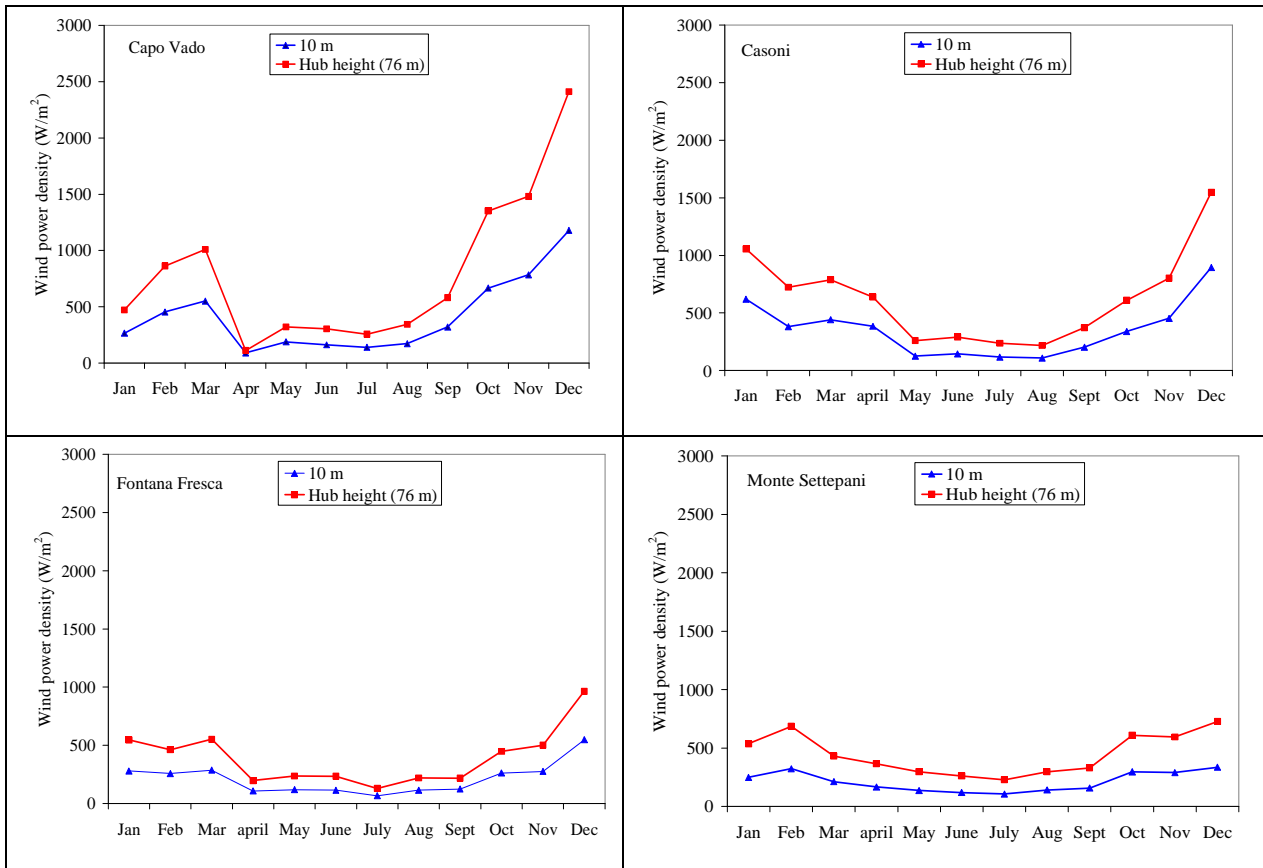

Figure 5.5 Monthly variation of wind power density for the four locations

The seasonal wind characteristics for all the stations are shown in Table 5.8. It is observed that the highest value of the mean wind speed and the mean wind power density for all locations are observed in the Autumn season which coincides with the increased demand of energy. It is also apparent from the same table that Capo Vado location is the windy site, at which the maximum seasonal mean wind speed is about 8.76 m/s (at height of 10 m) observed in the Autumn season, while the minimum of 4.06 m/s in Spring, whereas the seasonal mean power density varies between 134.64 and 872.87 W/m² reached respectively in Spring and Autumn seasons. At the hub height (76 m), the seasonal mean wind speed occurred between 5.48 and 11.81 m/s. The obtained results for the other locations are reported in details in Table 5.8.

Season	c [m/s]	k	Mean wind speed [m/s] 10 [m]	Mean wind speed [m/s] 76 [m]	Power density [W/m ²]
<i>Capo Vado</i>					
Winter	7.09	1.51	6.39	8.63	422.47
Spring	4.41	1.32	4.06	5.48	134.64

Summer	5.71	1.56	5.13	6.92	208.45
Autumn	9.84	1.78	8.76	11.81	872.87
<i>Casoni</i>					
Winter	7.23	1.46	6.55	8.84	477.06
Spring	5.73	1.58	5.15	6.94	207.00
Summer	5.24	1.69	4.67	6.30	140.88
Autumn	7.36	1.39	6.71	9.06	555.13
<i>Fontana Fresca</i>					
Winter	6.40	1.62	5.73	7.73	274.30
Spring	4.93	1.74	4.39	5.93	113.15
Summer	4.51	1.58	4.05	5.46	100.46
Autumn	6.39	1.40	5.83	7.86	359.11
<i>Monte Settepani</i>					
Winter	6.98	2.08	6.18	8.34	260.94
Spring	5.90	2.39	5.23	7.06	140.25
Summer	5.63	2.12	4.98	6.72	134.16
Autumn	7.35	2.06	6.51	8.78	307.17

Table 5.8 The seasonal wind characteristics

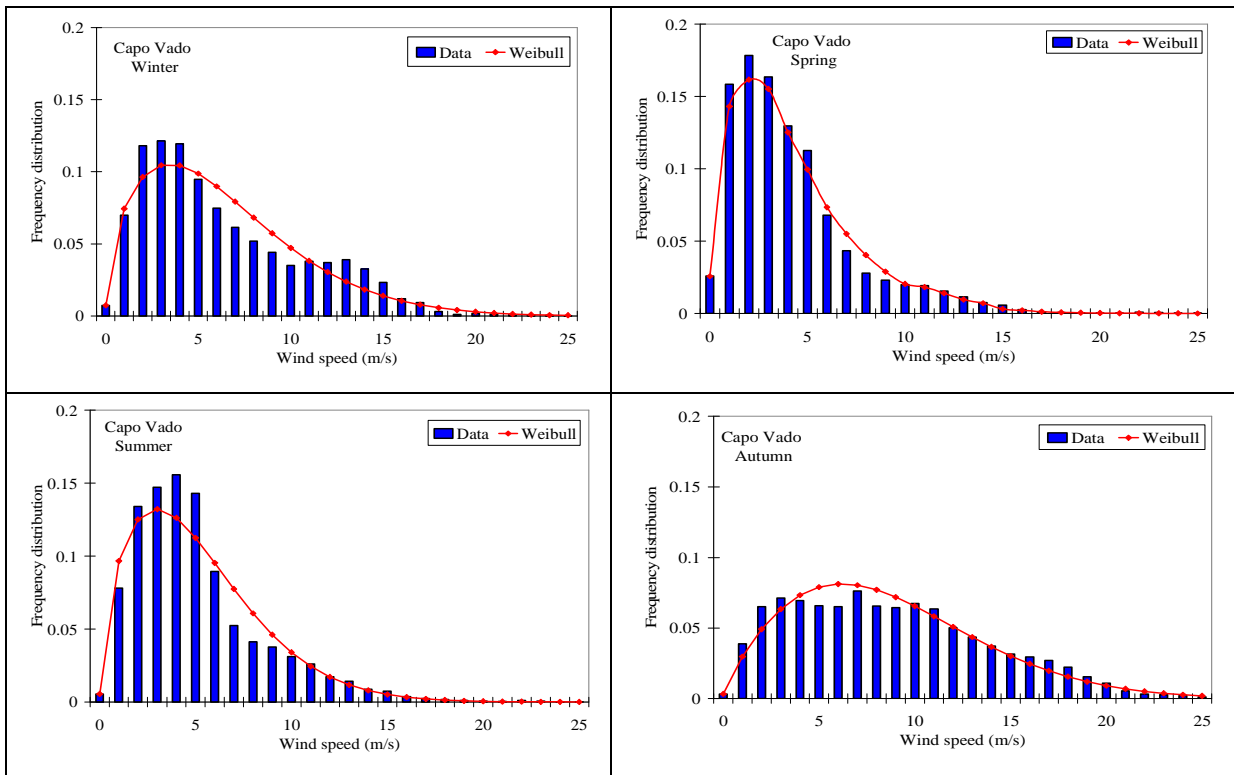

(a)

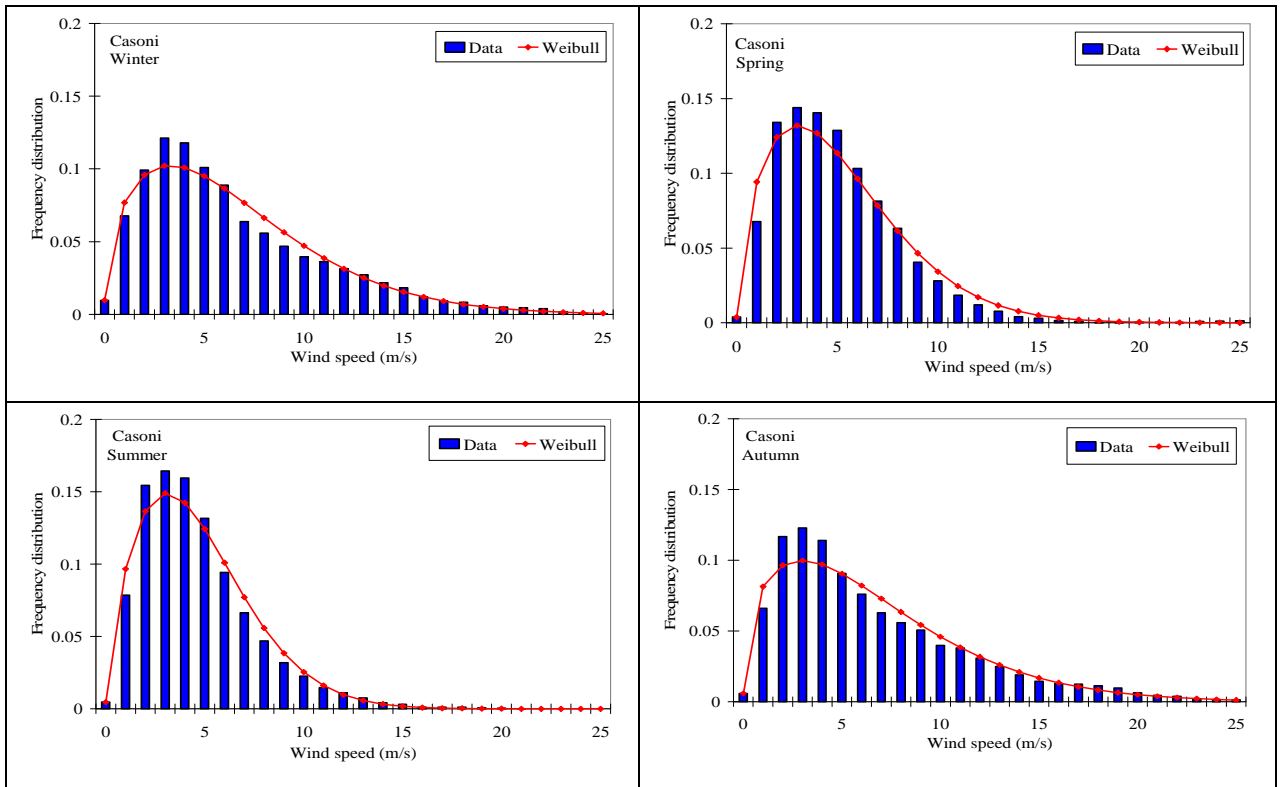

(b)

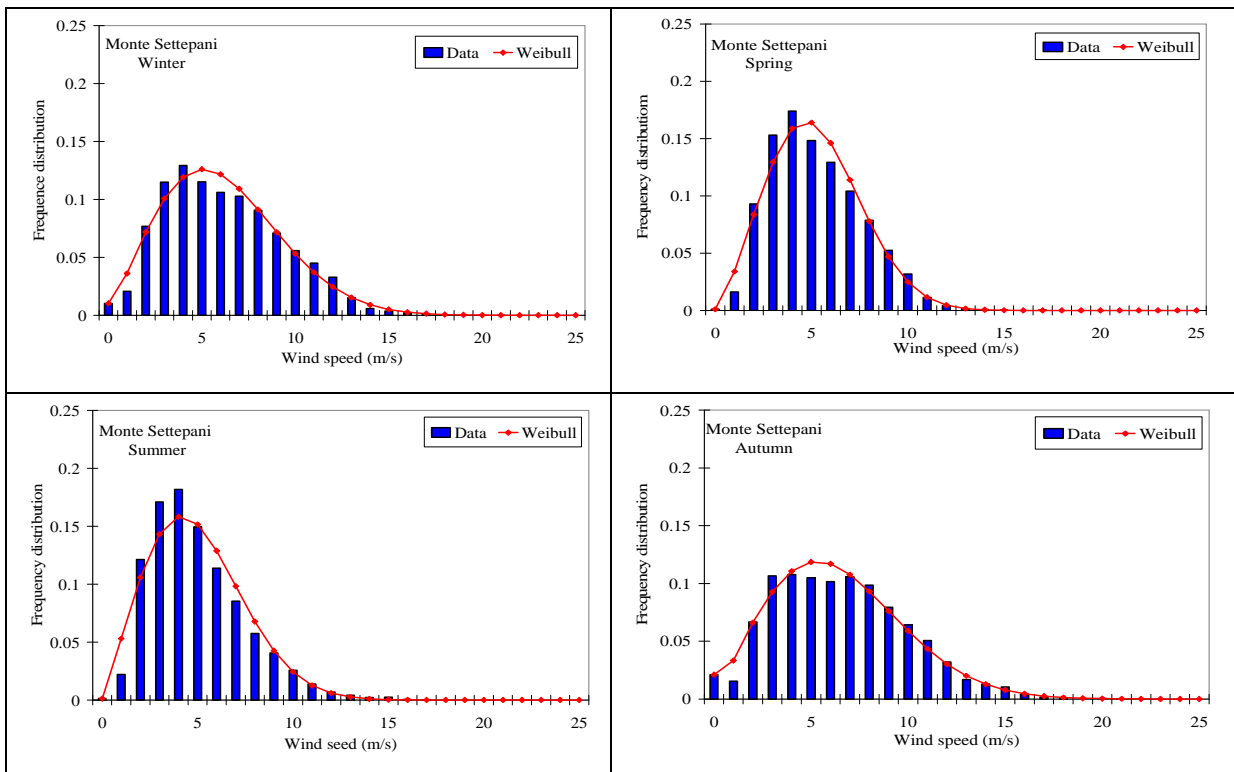

(c)

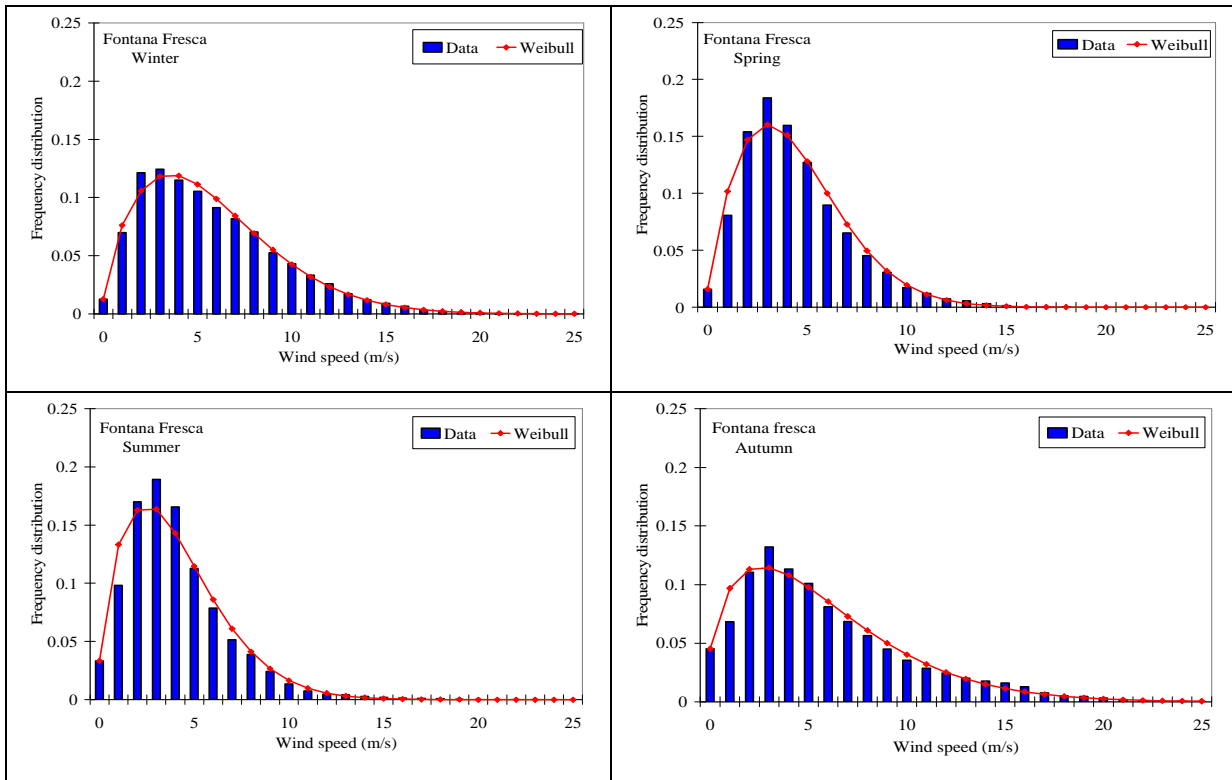

(d)

Figure 5.6 Seasonal histograms of the wind speed

The seasonal variation of the wind speed can help in forecasting the future trend of wind projects. Due to the randomly behaviour of the wind speed and also its variation over the time, it is more practical to represent its behaviour using a probability function. The comparison between the actual seasonal data and the estimated seasonal Weibull frequency distributions of wind speed of the four locations are shown in Figure 5.6. It can be seen that the Weibull distribution demonstrate a good fit. Furthermore, it is observed for Capo Vado and Casoni, that the wind speed covers the large range of variation in Winter and Autumn seasons, and which reach [0-20 m/s], whereas in Spring and Summer the higher range limit does not exceed 15 m/s. For Fontana Fresca and Monte Settepani, the wind speed covers the large range of variation in Winter and Autumn which equal to [0-15 m/s]. In Spring and Summer the higher range limit does not exceed 10 m/s. Results of wind availability in Capo Vado site show that the wind speed is above 3 m/s respectively in Autumn, Winter, Spring and Summer with 82, 68, 49 and 63% of the time, so the wind power plant can produce energy for 82, 68, 49 and 63% of the times respectively in Autumn, Winter, Spring and Summer. The higher percentage of wind availability in Winter occurs at Casoni and Fontana Fresca respectively with 70 and 67%, and at Monte Settepani in Autumn with 79%.

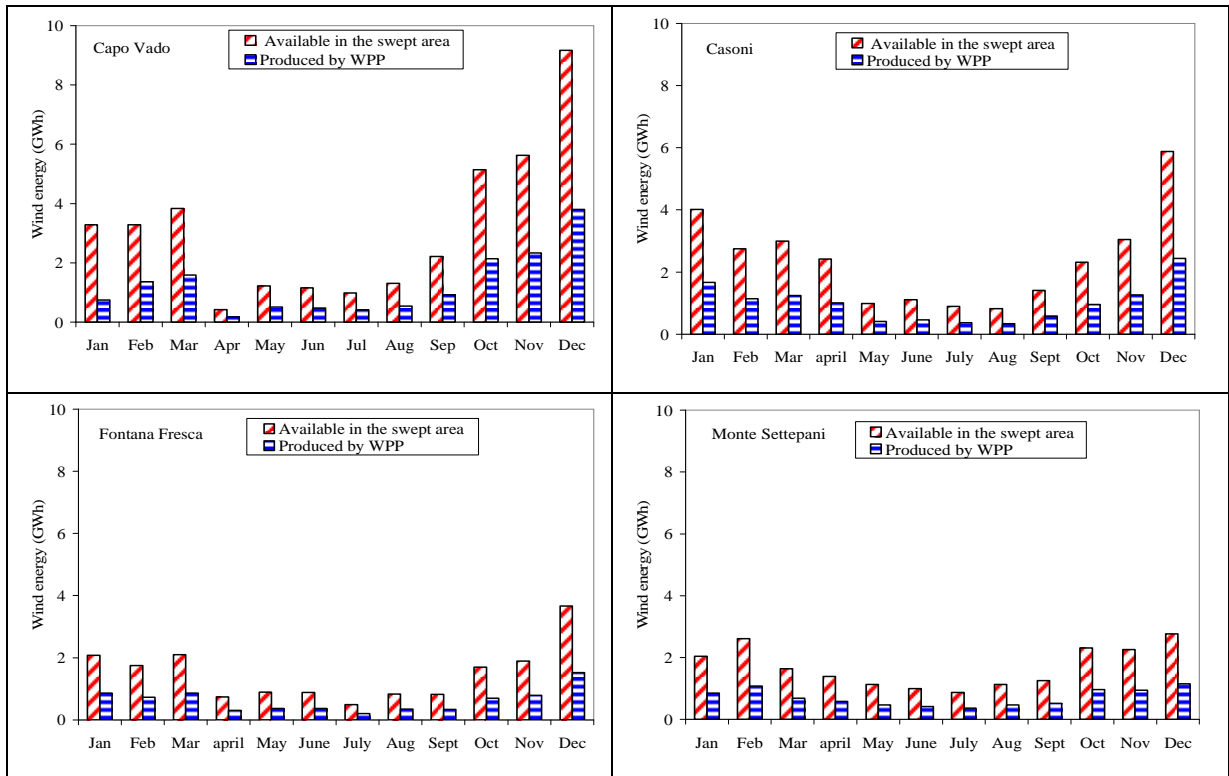

Figure 5.7 Histograms of the monthly of the mean wind energy produced by the wind power plant versus the available wind energy in the swept rotor area for the four locations

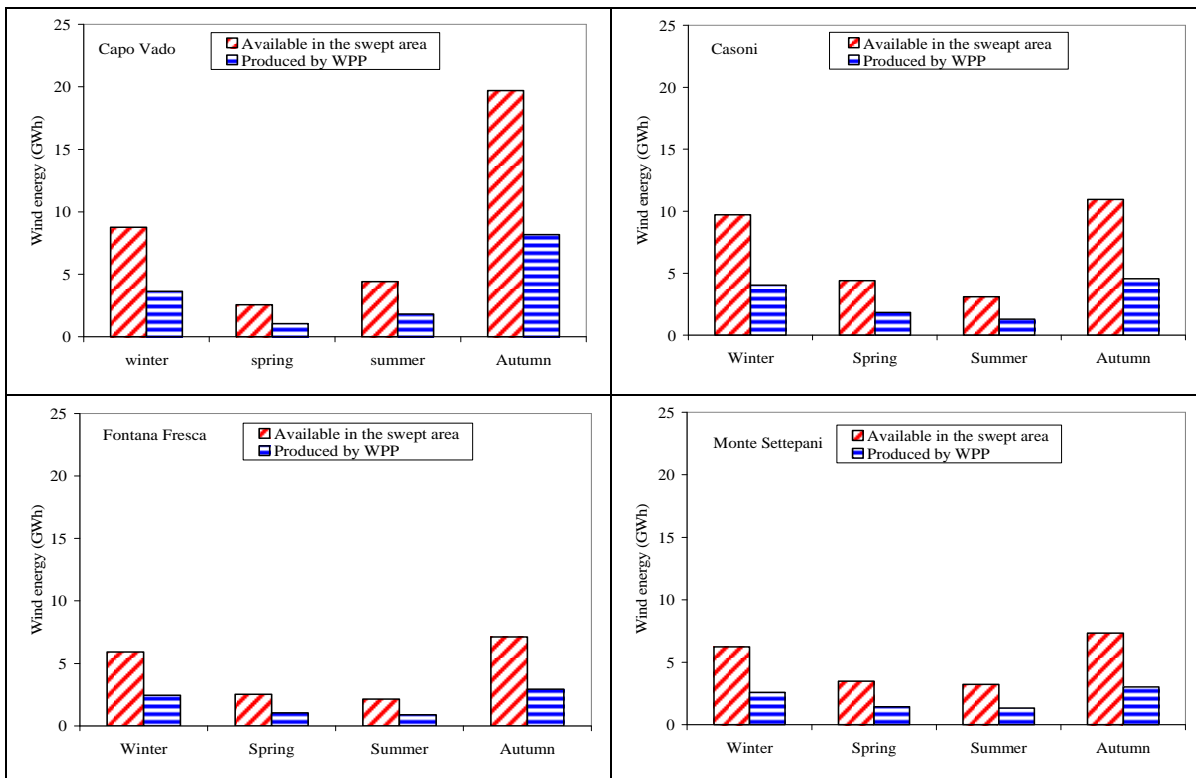

Figure 5.8 Seasonal assessment of the available and produced wind energy for the four locations

The histograms of the monthly variation of the mean wind energy produced by the WPP and the available wind energy in the swept rotor area for the four locations are shown in Figure 5.7. It is important to underline that, for the whole four locations, the highest energy produced by WPP can be reached in December respectively with 3800, 2439, 1519, 1146 MWh. Further seasonal assessments of the available and produced energy are reported in Fig. 6. For all sites, the produced energy by the WPP shows a large variation from season to season, in addition, the highest production values for all stations occur in Autumn season with 8164, 4544, 2951 and 3039 MWh respectively at Capo Vado, Casoni, Fontana Fresca and Monte Settepani.

The monthly and seasonal wind data analysis has been carried out to investigate wind characteristics and WPP production during the periods of 2002-2008, 2006-2008 and 2004-2008 for respectively Casoni, Capo Vado and Monte Settepani and Fontana fresca. The monthly and seasonal wind speed distribution, wind power densities and wind direction are determined for the four locations in order to provide information of wind resources, further assessment of the monthly and seasonal wind energy available in each site and the energy output of the WPP have been done. It is believed that Capo Vado is the best site with a monthly mean wind speed determined between 2.80 and 9.98 m/s in December at a height of 10 m and a monthly wind power density between 90.71 and 1177.97 W/m² while the highest energy produced by WPP was reached in December with 3800 MWh.

As a result of the Battelle-PNL classification made in section above - Capo Vado Class 7, Casoni Class 6, Fontana Fresca and Monte Settepani Class 4 – all the four sites are considered to be suitable for most wind turbine applications taking into account data on the whole year. On the other hand, for example, Capo Vado dramatically falls in Class 1 if data limited to the month of April are taken into account and in Class 7 if limited to the months February, March, October, November and December. This fact should reflect the inadequacy of Battelle-PNL classification on regions with a complex orography and variable wind characteristics as Liguria region, and, in general, as many others Mediterranean countries.

The seasonal variation of these sites should reflect the need of adopting proper strategies to adapt the wind exploitable energy to the demand. These could be done according to two main – not alternative – strategies: hybridizing the production with the contribution of some other renewable energies; storing energy to feed future demand with the aim to avoid shortage. As regards the former option, for the sites investigated in this work, solar energy should be a promising option, since sun irradiation reaches high values just in the months and seasons where wind seems to have lower energy exploitation. As regards the latter option, hydrogen might be a challenging way to

store energy, specifically if coupled with automotive hydrogen fuel future demand. For example, as a rough estimation, for the site of Capo Vado, the estimated hydrogen gas mass that can be produced using an electrolyser characterised by an efficiency of 0.9 is about 65 tones in December (2166 kg/day) which is equivalent to 2558 MWh of hydrogen energy production and 3 tones in April which is equivalent to 117 MWh of hydrogen energy production. In this respect, proper strategies should be studied to couple the storage of hydrogen for household and industrial energy consumption and as a fuel for transport vehicles. From an automotive perspective, as a kilogram of hydrogen is roughly equivalent to a gallon of gasoline in energy content, assuming a 6 kg/fill average per day for a car, the 2166 kg/day would fill approximately 360 cars per day, For a hydrogen vehicle with internal combustion engine fuel consumption is about 0.60 kWh/km as reported by (Ajanovic, 2008), thus, the hydrogen energy production in December for Capo Vado site is more than $4 \cdot 10^6$ km. Table 5.9 shows the solar energy available as computed by statistical analysis and the geographical coordinates of the 16 meteorological stations. It can be seen that the obtained solar energy shows a quiet similar values which is mainly due to the similar orography and climate. The results shown in Table 5.9 have been used to map the solar potential of Liguria region using an Arcgis tool.

N°	Sites	E_{solar} [kWh/m ² .yr]	Latitude N	Longitude E	Altitude [m]
1	Castellari	1239.79	44.1456	8.2625	100
2	genova	1384.34	44.4017	8.9472	20
3	Polanesi	1356.08	44.3658	9.1247	50
4	Monterocchetta	1497.05	44.0755	9.9197	412
5	Corniolo	1512.00	44.1063	9.7348	338
6	Buorgonuovo	1144.60	43.8463	7.6208	100
7	Capo Vado	1456.27	44.2583	8.4425	170
8	Cavi di Lavagna	1365.75	44.2961	9.3739	100
9	Levanto\S.Gottardo	1421.11	44.1811	9.6211	100
10	Allassio	1449.24	44.0000	8.1700	10
11	Sanremo	1556.32	43.8200	7.7800	45
12	Romito Magra	1345.26	44.1033	9.9303	100
13	Ranzo	1380.08	44.0632	8.0049	310
14	Pornassio	1273.39	44.0639	7.8664	500
15	Giacopiane Lago	1375.59	44.4608	9.3875	1016
16	Poggio Fearza	1331.90	44.0420	7.7935	1833

Table 5.9 Solar energy production

The theoretical solar potential of Liguria region that can be exploited for energy production is reported in Figure 5.9. As it can be seen, the total annual solar energy is ranged between 1128 and 1534 kWh/m².yr, which are reached respectively in Buorgonuovo (code 6) and Sanremo (code 11).

In fact, the estimated solar energy over the region does not present important differences between all locations of the territory.

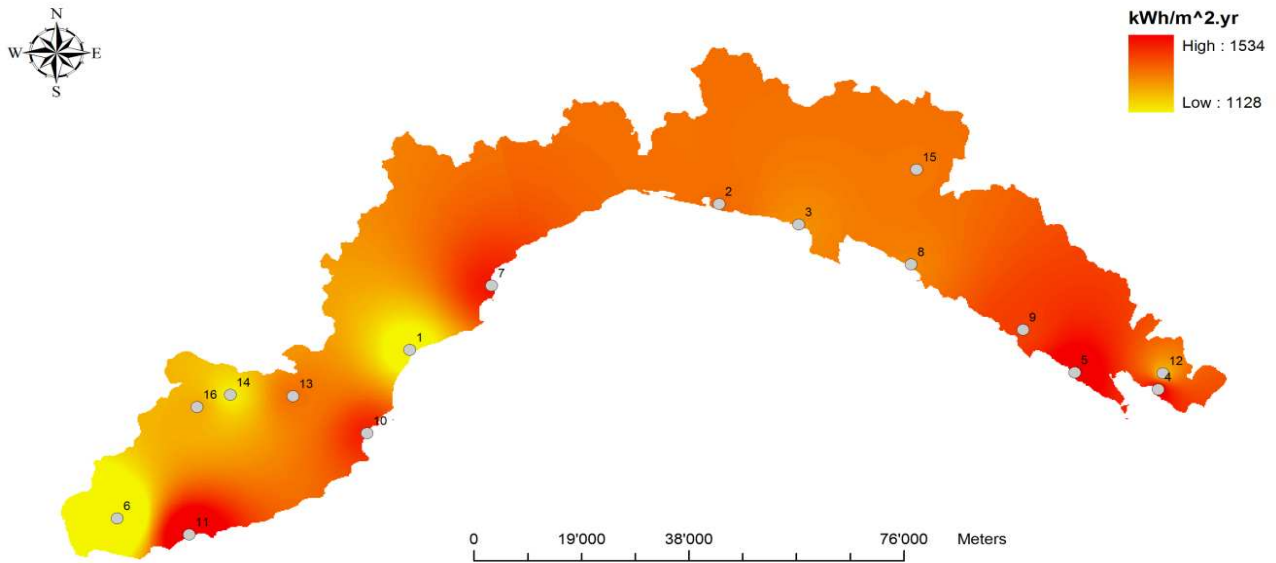

Figure 5.9 Solar energy production map

6. Conclusion

This chapter presented an evaluation of the potential of wind and solar energy available within the territory of Liguria. The study focused on a deeply analysis of wind sites, with special reference to available locations that have shown high wind potential. In this respect, a deeply monthly and seasonal assessment of wind variation characteristics has been performed on those sites. Spatial maps have been generated using the ArcMap tool embedded in the ArcGIS Software. As a future development, I wish to evaluate the potential of renewable energy taking into account the orography of the region. In this way, special interpolation methods will be implemented. Another interesting and challenging research direction is to focus on optimal strategies to storage energy from wind exploitation using the hydrogen as energy vector.

B- A regional decision support system for onsite renewable hydrogen production from solar and wind energy sources

1. Introduction

Among numerous techniques for the hydrogen production without harmful emissions, especially avoiding the carbon dioxide emissions (IUPAP, Shane and Samuelsen, 2009, Barton and Gammon, 2010, Woodrow and Rifkin, 2006), hydrogen technologies driven by renewable energy sources (RES) represent an attractive solution (Little et al., 2007), firstly due to their diversity and abundance, and secondly, because of their environmental sustainability potential. According to (Moriarty and Honnery, 2009), intermittent RES, chiefly wind and solar energy, will have to supply most non-fossil energy in 2050 and beyond, and by contrast to others forms of renewable energy such as hydraulic and biomass, they may play an integral role in the future (Janke, 2010) and they will more and more have a strict synergy with hydrogen production, as it is starting to have in the form of the several wind/hydrogen plants spread all over the world. The main challenges of hydrogen production via intermittent RES are related to storage. In fact, hydrogen can be stored until it is needed as fuel for either transportation applications or local stationary power generation sources, or it can be transferred into electricity and fed into the electrical network (Martin and Grasman, 2009). As a result, hydrogen can be used to assist the penetration of renewable energy systems exploiting its main two features: storage medium to balance the intermittency of many RES and energy carrier for electricity generation in cases of failure of renewable energy production systems.

In the regional and national decision process of the forthcoming hydrogen economy, one key issue that will be more and more required in the adoption of a RES based hydrogen production system is their potentiality to produce and satisfy the hydrogen demand within a specific location. A deep analysis will be more and more required to assist the decision makers for designing and sizing a new future hydrogen plants in a specific territory, with suitable technologies of production. Moreover, the assessment of the hydrogen production availability within the region will contribute to provide information regarding the adequate sites and scales of production plants (small, medium or large).

Rodriguez et al. (2010) have analysed the availability of wind resource and the energy requirement and the potential of hydrogen production from wind resources in the province of Cordoba in Argentina. It results that using the wind power generated by one of the best sites (Rio Cuarto), hydrogen could be generated ten times higher than the amount of hydrogen required for transportation in the province of Cordoba.

Honnery and Moriarty (2009) estimated the global hydrogen production from wind, thus implementing 2 MW turbines per km² over the earth surface. It results that 116 EJ as a technical potential of hydrogen could be generated. In another paper, Ni et al. (2006) have assessed the potential of renewable hydrogen production for energy supply purposes in Hong Kong. Authors have reviewed the technologies for hydrogen production followed by an overview of renewable energy deployment in Hong Kong. As results, they agreed that because of the mismatch between solar and wind energies, as a hybrid systems, they are recommended to increase the availability of renewable energy supply. Levene et al. (2007) have analysed the potential of hydrogen production from renewable electricity. Their analysis has been applied to the whole territory of United states. The results indicate that ample resources exist to produce hydrogen from wind and solar power to serve the transportation sector.

Despite the published results in the literature for the assessment of the hydrogen production from RES, limited attention has been dedicated to the combined role of wind and solar energies in the production of hydrogen. In this work, a GIS-based decision making methodology is proposed for the selection of the most promising location for installing renewable hydrogen systems. In particular, focus is been dedicated to sites where wind and solar energies can play important role in the production process of hydrogen. The proposed methodology aggregates different studies and approaches. The method is analysed in detail in the following section. In section 2, a methodology for the assessment of the renewable hydrogen potential is proposed. It is based on three main modules namely: detailed statistical analysis, an interpolation method using an artificial neural network model and the calculation of the hydrogen production potential from RES. The aim of this section is to highlight suitable sites that have high annual hydrogen production. A multi-criteria decision support method is been presented in section 3, the objective is to provide some support to decision makers for the planning of future hydrogen plants. In section 4, an integrated RES-hydrogen based refuelling station was modelled to test the feasibility of hydrogen plant that is based on solely the hybrid renewable energy resources. The proposed approach is general and can be used for various territories under regional and local considerations. Here, the method is applied to Liguria region in Northern Italy.

2. Potential of renewable hydrogen production

Here, the steps for the determination of hydrogen potential from renewable energy resources are deeply analysed. This section comprises three main sections, namely wind and solar data collection, the assessment of the available wind/solar energy potential and the assessment of the available hydrogen potential.

2.1 Wind and solar data collection

In general, the solar energy production varies with the location, orientation and mechanical devices utilised to convert the sunlight to electricity. However, as reported by (Chiabrando et al., 2009), solar radiation requires a deeply analysis to better evaluate the suitability of a certain area for solar technology installation. The computation of the available solar energy potential is the first step that is needed to be accomplished before the evaluation of the technical solar potential. Solar radiation is here analysed as the amount of energy received by a unit area over a stated. The solar insolation data can be derived from variety of database such as satellite data and situ data that represent the local meteorological stations spread on the territory.

The estimation of the wind potential is based on the knowledge of wind regimes of the considered territory. The wind resources assessment phase is crucial as the provided power is proportional to the cube of wind speed. The behaviour of wind speed is different from that of solar radiation, mainly because high wind speed may be available specifically in some areas rather than other as compared to solar radiation which is usually available for all sites of the territory

For this main reason, special emphasis should be given to the anemological recorded data. The wind speed data are recorded on different heights depending on the wind resources locations. Generally, for accuracy reasons, wind data of long years measurement are needed. These gathered data must be then processed and treated statistically in order to provide the theoretical wind energy. In this paper, the assessment of wind potential has been considered implementing and enhancing previous works developed by (Ouammi et al., 2010) and (Ouammi et al., 2010). The enhancement is done taking into account the orography of the territory in the assessment of the available wind energy resources, as described in the following subsection.

2.2 Assessment of the available wind/solar energy potential

The meteorological measurements stations are usually insufficient to determine the potential of wind and solar energy available in the whole territory. However, appropriate assessment methods are needed to estimate the wind and solar energy in others locations where no measurements stations are available.

Indeed, in order to predict the renewable energy potential that can be assigned to each special points of the region, an interpolation method is required to find out the potential accessible anywhere in the territory in question. Numbers of methods are available to construct an interpolated surface between available point's data measurement. Kriging method is one of the interpolation methods referring to a family of least-square linear regression algorithms that attempt to predict values of a variable at locations where data are not available based on the spatial pattern of the available data

(Alsamanra et al., 2009). Kriging is an interpolation technique that estimates unknown values from known sample values and semi-variograms.

The key tool of this method is the variogram, which relates half of the average squared difference between paired data values to the distance between them (Shad et al, 2009). In recent years, the method has been widely applied in different research fields, among which the application in GIS in order to interpolate data. According to Bargaoui and Chebbi (2009), the most classical method in the Kriging of environmental data is to operate with spatial lags by using spatial coordinates (x,y) of data locations.

In this respect, the Kriging techniques have been adopted for the interpolation of renewable resources using a digital elevation model, among these Kriging techniques, good results have recently been obtained by the use ANNs techniques. It is one of the more frequently used methods for data interpolation in the literature. Data have been inferred using an ANN algorithm to establish a forward/reverse correspondence between the longitude, latitude, elevation and the mean annual wind speed/solar irradiation. Specifically, for the ANN model, a three-layered, back-propagation standard ANN classifier has been used consisting of three layers: input, hidden and output layer. Generally the best way to determine the wind conditions at a given site is by measuring the wind speed at least one year. The Kriging techniques have been adopted for the renewable energy and hydrogen mass assessment, among these Kriging techniques, good results have recently been obtained by the use of artificial neural network (ANN) techniques (Rumelhart, 1986), (Cellura et al., 2008). In this study, data have been inferred using an ANN algorithm (Figure 5.10) to establish a forward/reverse correspondence between the longitude, latitude, elevation and the mean annual renewable energy and the hydrogen mass. Specifically, for the ANN model, a three-layered, back-propagation standard ANN classifier has been used consisting of three layers: input, hidden and output layer. The ANN input layer consists of 3 units which are associated to the longitude, the latitude and the elevation (linearly normalised between 0 and 1, taking into account, respectively, the maximum and minimum longitude, latitude and elevation of the territory) of a specific location.

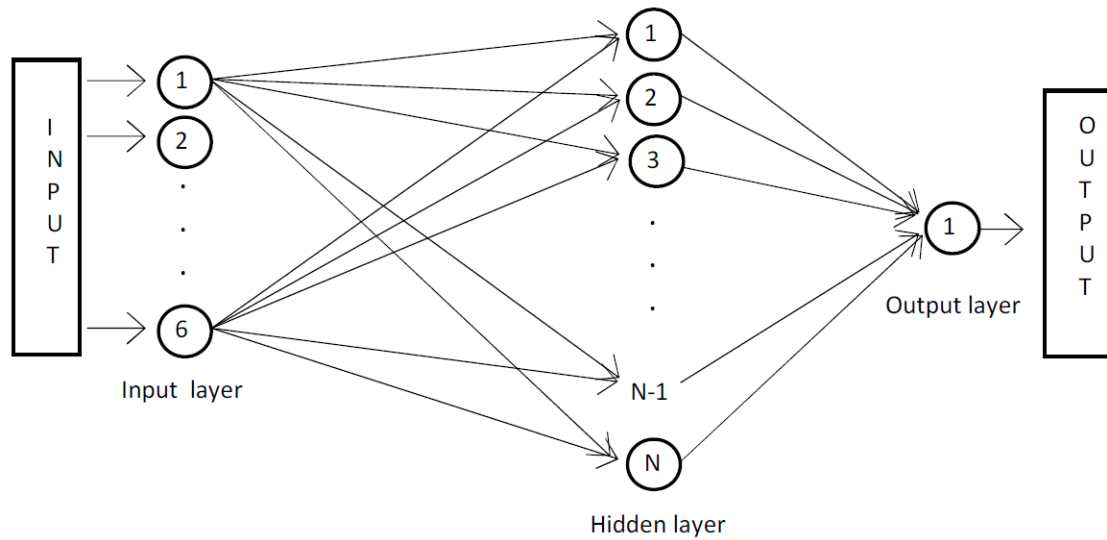

Figure 5.10 Configuration of the ANN with three layers

The ANN output layer consists of 1 unit which is associated to the average annual solar/wind energy available in the location, linearly normalised between 0 (correspondent to the minimum energy available) and 1 (correspondent to the maximum energy available). As regards the hidden layer, the choice of the number of units may be subjective since the prediction accuracy on the learning set increases by adding units, but causing a loss of prediction accuracy on new patterns not belonging to the learning set. In this paper, after some testing, a reasonable choice for the hidden layer is 20 units.

In a back-propagation standard ANN learning phase, the characterising “weights” are defined on a given set of patterns. Specifically, the output y_i of each unit i in the network is determined by:

$$y_i = \frac{1}{1 + e^{-x_i}} \quad (5.11)$$

This output has a real value between 0 and 1; x_i is the total input to unit i given by:

$$x_i = \sum_j w_{i,j} y_j + b_i \quad (5.12)$$

where $w_{i,j}$ is a real number, called weight, representing the strength of the connection from unit j to unit i ; the weighted sum of the inputs is adjusted by the bias characteristic of the unit i , b_i . Network weights are initially assigned random values uniformly distributed in $[-0.3, 0.3]$; in each back-propagation cycle, the weights are adjusted in the total output error. The learning ends either after a user-defined number of steps or when the total output error becomes asymptotic, where this error is defined as:

$$E = \sum_p \sum_j (O_{p,j} - D_{p,j})^2 \quad (5.13)$$

where $O_{p,j}$ is the observed output on unit j for learning pattern p and $D_{p,j}$ is the desired output.

The ANN learning procedure is performed on learning set of patterns, where, in our model, each learning pattern p is represented by 3 parameters (input layer) and by 1 output parameter (output layer).

2.3 Assessment of the available hydrogen potential

Once the potentials of wind and solar energies were assessed, the estimation of the hydrogen production potential can be done. The evaluation of the potential is based on the use of energy generated by the renewable energy driven the operating of an electrolyser plant. The quantification of the hydrogen mass could be performed from the knowledge of the RES available within the specific location. In this analysis, an electrolyser with power capacity of 52.5 kWh/kg is considered (which is equivalent to about 75% in efficiency) (www.h2fc.com). As regards the system losses of the electrolysis, they are assumed to be equal to 90%. The computation of the hydrogen mass produced from both wind and solar energy is described as follow:

$$M_{H_2} = \frac{E_{H_2}}{LHV_{H_2}} = \frac{\eta_1 \cdot \eta_2 \cdot E_{RE}}{LHV_{H_2}} \quad (5.14)$$

where M_{H_2} [kg] is the hydrogen gas mass produced, E_{RE} [kWh] is the renewable energy production, LHV_{H_2} [kWh/kg] is the hydrogen higher heating value, E_{H_2} [kWh] is the hydrogen energy produced, η_1 is the efficiency of the electrolysis system and η_2 is an additional efficiency coefficient included to take into account the energy losses in the electrolyser.

3. Criteria for site selection

According to regional and territorial regulations, environmental as well as work constraints (Aydin et al., 2010), some restrictions to green hydrogen production plants settling may be adopted, discarding areas with features that are not adequate to the exploitation of hydrogen potential. In addition, the spatial information regarding the eligible areas from a regulation viewpoint should be intersected with areas where renewable energy resources can be effectively exploited from an energy viewpoint for hydrogen production. The integration of spatial multi-criteria decision making with the geographical information system enables the implementation of the geographical data with the decision makers' preferences in order to provide overall assessment of multiple, conflicting, and incommensurate criteria (Malczewski, 1999). Table 5.10 displays the assumed objectives and their associated criteria.

Commonly, the following spatial information should be used:

- provincial and municipal boundaries;
- slopes;
- airports, port areas, the urban and industrialized areas;
- sites of interest, the special protection areas and protected areas;
- high and medium voltage electric supply network;
- network traffic main road.

Objectives	Criteria
Acceptable in terms of safety	500 [m] away from inhabitants areas
Acceptable in terms of natural reserves	250 [m] away from water bodies, rivers and environmental protected areas
Acceptable in terms of infrastructures	250 [m] away from the road network 250 [m] away from the electric network 500 [m] away from the railways

Table 5.10 Objective and proposed selection criteria

4. Modelling hydrogen refuelling station

Many hydrogen refuelling stations have been opened and are currently in operation worldwide. To date, more than 140 hydrogen refuelling stations have been opened (Kruse et al, <http://www.bellona.no>). In Italy, around 5 hydrogen refuelling stations are in operation (Table 5.11). An integrated system has been developed. The proposed model is referred to on-site production and it includes a wind turbine, a photovoltaic (PV) module, an electrolyser unit, and a hydrogen storage tank. The aim is to assess the feasibility of the implementation of a green refuelling station in a site with high hydrogen production potential from wind and solar energy.

Location	Italian region	Opening year
Collesalvetti	Tuscany	July 2006
Mantova	Tuscany	September 2007
Milan	Lombardy	September 2004
Pontedera	Tuscany	2003
Turin	Piedmont	-
Assago	Lombardy	February 2010

Table 5.11 Italian hydrogen refuelling stations

4.1 Photovoltaic module

The power output of a photovoltaic (PV) module unit [W] can be calculated as follow (Gastli and Charabi, 2010):

$$P_{pv} = A_{pv} \cdot \eta_{pv} \cdot \eta_{pc} \cdot P_f \cdot G \quad (5.15)$$

where G is the perpendicular radiation at array's surface [W/m^2] received by the PV module, A_{pv} is the PV module area, η_{pv} is the module reference efficiency, p_f is the packing factor and η_{pc} is the power conditioning efficiency.

The energy produced by the PV module [kWh] during the time period T can be expressed as follow:

$$E_{pv} = \frac{\Delta T}{1000} P_{pv} \quad (5.16)$$

4.2 Wind turbine model

The output energy generated by the wind power plant is mostly dependent on the mean wind speed at the location. The knowledge of the probability distribution function of the wind speed is crucial to evaluate the wind energy potential. In this study, the commonly Weibull probability distribution function has been used to represent the frequencies of the wind speed, its general form is represented by:

$$f(v) = \left(\frac{k}{c}\right) \left(\frac{v}{c}\right)^{k-1} \exp\left(-\left(\frac{v}{c}\right)^k\right) \quad (5.17)$$

where $f(v)$ is the probability of occurrence of wind speed v [m/s], k is the dimensionless Weibull shape parameter, and c [m/s] is the Weibull scale parameter. The two Weibull parameters are identified for each site.

The wind speed data are generally collected at the height h_{data} which is different from the wind speed at the hub height. The computation of the Weibull distribution at the hub height is necessary to represent the wind characteristics at the h_{hub} , the following relation is adopted (Ouammi et al., 2010):

$$c_{hub} = c_{data} \frac{\ln(h_{hub}/z_0)}{\ln(h_{data}/z_0)} \quad (5.18)$$

$$k_{hub} = \frac{k}{(1 - 0.088 \times \log(h_{hub}/h_{data}))} \quad (5.19)$$

The wind power density of a site based on Weibull's probability density function is expressed by:

$$P = \int_0^{\infty} P(v)f(v)dv = \frac{1}{2} A\rho c^3 \Gamma\left(\frac{k+3}{k}\right) \quad (5.20)$$

where A is the blade sweep area [m^2] and ρ is the air density [kg/m^3].

Thus the wind power density at the hub height is given by:

$$P_{hub} = \frac{1}{2} A\rho c_{hub}^3 \Gamma\left(\frac{k_{hub}+3}{k_{hub}}\right) \quad (5.21)$$

where gamma function is described by the following equation:

$$\Gamma(y) = \int_0^{\infty} e^{-x} x^{y-1} dx \quad (5.22)$$

The electric energy E_w [Wh] produced per time period T is given by:

$$E_w = C_{wpp} \cdot T \cdot P_{hub} \quad (5.23)$$

The wind power plant performance coefficient C_{wpp} , is composed by three components: c_p the power coefficient, η_{gb} the gearbox performance and η_g the generator performance.

$$C_{wpp} = c_p \cdot \eta_{gb} \cdot \eta_g \quad (5.24)$$

4.3 Hydrogen electrolysis production

The generated power by the hybrid energy system will be sent to the electrolyser to drive the electrolysis process of water for hydrogen production. Different kinds of water electrolyser exist, with different advancements levels, here a proton exchange membrane (PEM) electrolyser has been used. It benefits of high efficiency factor, higher life cycle and a good suitability with renewable energy systems where the amount of electricity varies randomly according to the wind and solar intermittenicies (Kruse et al, <http://www.bellona.no>). Furthermore, PEM becomes an attractive option especially in the case where hydrogen needs to be stored (Barbir, 2005). The output pressures of hydrogen within a PEM are around 1.2 bar (Thanaa et al., 2006), enough to not necessitate the use of a compressor. As a result, electrolyser's output is directly injected to a hydrogen tank or a pipeline network. A power consumption of 52.5 kWh/kg is used by the PEM. As a result, the energy transferred to the hydrogen tank in [kWh] is defined as:

$$E_{hyd}^T = \eta_1 \cdot \eta_2 \cdot E_{hyb}^T \quad (5.25)$$

where η_1 and η_2 are respectively the electrolyser operation efficiency and the electrolyser losses. The hydrogen mass [kg] can be calculated as follow:

$$M_{hyd}^T = E_{hyd}^T / LHV_{H_2} \quad (5.26)$$

where LHV_{H_2} [kWh/kg] is the lower heating value of hydrogen.

5. Method application

5.1 Study area

Liguria Region, situated in the North of Italy between the following geographical coordinates, latitudes 43°47' and 44°10' and longitudes 7°36' and 9°80'. It is a coastal region of the north western Italy, bordered by the Tuscany region in the east, France to the west and Piedmont to the north. As territorial Italian area, Liguria benefits of a Mediterranean climate with an average air temperature equals to 8.75°C January and 23.95 °C in July.

The total production of Liguria region is based on thermo-electric energy. The annual energy produced reaches a value of 13000 GWh/yr, where 6000 GWh is used to satisfy the local demand of the Liguria communities while the surplus (about 50%) is exported outside the region (Regione Liguria, 2009). In addition, due to its local geographical position, been a border region and a land for passage of fuel as a result of port activities, this will contribute significantly to increase the amount of CO₂ gas emitted by the region which is equal to 20.42 MteqCO₂ and will fix the gas on the large woody area available on the region (Regione Liguria, 2009). Due to those special local peculiarities, the need for renewable and sustainable energy seems an obligation to diversify the energy production of the region and even to reduce its total CO₂ gas emissions. Figure 5.11 displays the CO₂ emissions from fossil fuel combustion by sector.

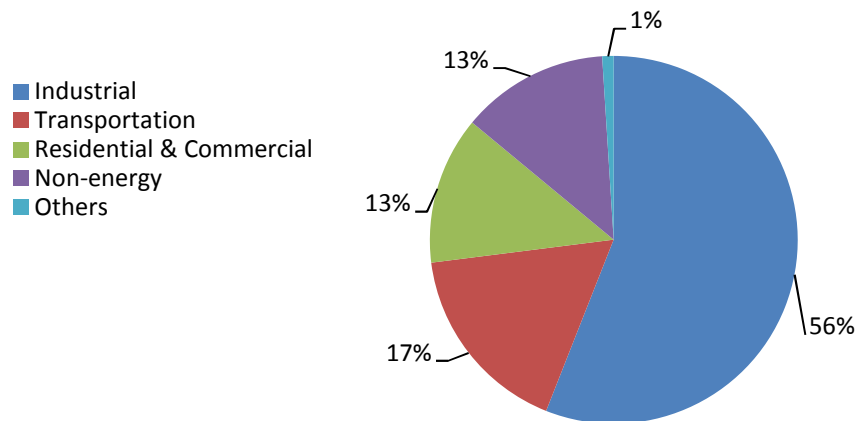

Figure 5.11 CO₂ emissions from fossil fuel combustion by sector in Liguria region

5.2 Meteorological data

5.2.1 Solar irradiance data

In this paper, solar data from 16 stations distributed over Liguria region have been analyzed. The solar irradiation data have been monitored from 2005 to 2009. These data have been used to compute, the monthly and annual solar potential.

5.2.2 Wind data

As regards wind energy, 25 stations distributed over the four provinces of Liguria region (i.e., La Spezia, Genoa, Savona and Imperia) have been considered. The data have been used to evaluate the annual frequency of wind speed and annual variations as regards average wind speed, the vertical profile of the wind speed, and the assessment of the wind power potential.

5.3 Geographic model and interpolation method

A GIS supported methodology has been used to highlight the potential of RES and hence the hydrogen potential from renewable energies. The GIS provides a spatial support to visualize the solar, wind and hydrogen potential in Liguria region. The GIS computer tool requires as an input the results of the artificial neural network model and the geographical coordinates of the meteorological stations that are distributed over the region. An ArcGIS version 9.2 with spatial analyst tool has been used with a cell size equals to 200mx200m. Four parts will be discussed in this section:

- Interpolation by ANN
- Mapping the renewable energy potential
- Mapping the hydrogen production potential

- Criteria for site selection
- Application of a hybrid on-site hydrogen production system

5.3.1 Interpolation by ANN

In the proposed approach, the results of the ANN, in particular the learning set consists of the normalized longitude, latitude and elevation and on the normalised average annual wind energy and its relative hydrogen mass for 25 sites of Liguria region, and on the normalised average annual solar energy and its relative hydrogen mass for 16 Italian sites.

On the other hand, the testing set consists of patterns just represented by the input component (normalised longitude, latitude and elevation), while, according to a classic jackknife procedure, the output component is left unknown and its value results from the ANN algorithm for that specific input. In the adopted approach, the testing set consists of the same 25 and 16 sites quoted above. Finally, in order to obtain a map of the overall average hydrogen mass on the whole Liguria territory, interpolations have also been obtained on the whole Liguria territory, on areas of 200mx200 m. As regards wind energy, in the ANN training process (Table 5.12), the available wind energy predictions have shown an average absolute error of 40 kWh/m².yr. The higher error is equal to 264 kWh/m².yr which is quite low taking into account that the interpolation has been performed on only 25 sites. In addition the sites where the error was higher (Fontana Fresca, Poggio Fearza, Monte Maure, Savona and Casoni) are characterised by a quite complex local orography which obviously requires further local investigations with direct monitoring.

Sites	Available wind energy [kWh/m ² .yr]	ANN predictions [kWh/m ² .yr]	Relative Error
Castellari	52.91	48.86	0.07636
Genova/Centro funzionale	876	948.09	0.08229
Polanesi	15.77	16.05	0.01776
Monterocchetta	805.92	798.93	0.00867
Corniolo	543.12	513.39	0.05472
Buorgonuovo	13.49	10.51	0.22090
Capo Vado	4272.25	4229.63	0.00998
Levanto	48.18	49.29	0.02304
Cavi di Lavagna	65.7	95.74	0.45723
Cenesi	56.68	61.65	0.08769
Imperia	516.84	564.53	0.09229
Fontana Fresca	1808.94	1544.73	0.14605
Genova villa cambiaso	86.72	82.95	0.04336
Giacopiane Lago	1416.93	1374.26	0.03011
Laspezia	477.16	466.51	0.02230
Monte Maure	700.8	607.15	0.13363
Monte Settepani	1778.28	1736.51	0.02349
Poggio Fearza	1489.2	1374.26	0.07718
Pornassio	20.15	23.29	0.15633
Ranzo	118.26	120.88	0.02224
Romito magra	17.52	18.18	0.03767
Savona Istituto Nautico	352.41	436.68	0.23912
Vernazza	49.14	43.75	0.10969
Casoni	2912.7	2823.25	0.03071
Diano Castello	10.51	10.81	0.02854

Table 5.12 Predictions of the annual mean available wind energy obtained by the ANN kriging method learning on 25 sites and testing on the same data

Sites	Available solar energy [kWh/m ² .yr]	ANN predictions [kWh/m ² .yr]	Relative Error
Castellari	1239.79	1292.82	0.04277
Genova	1384.34	1396.30	0.00864
Polanesi	1356.08	1349.32	0.00498
Monterocchetta	1497.05	1518.41	0.01427
Corniolo	1512.00	1473.55	0.02543
Buorgonuovo	1144.60	1147.95	0.00293
Capo Vado	1456.27	1374.10	0.05642
Cavi di Lavagna	1365.75	1358.36	0.00541
Levanto\S.Gottardo	1421.11	1419.59	0.00107
Allassio	1449.24	1481.10	0.02198
Sanremo	1556.32	1531.62	0.01587
Romito Magra	1345.26	1385.04	0.02957
Ranzo	1380.08	1351.49	0.02072
Pornassio	1273.39	1288.92	0.01220
Giacopiane Lago	1375.59	1385.14	0.00694
Poggio Fearza	1331.90	1290.61	0.03100

Table 5.13 Predictions of the annual mean available solar energy obtained by the ANN kriging method learning on 16 sites and testing on the same data

As regards solar energy, in the ANN training process (Table 5.13), the available solar energy predictions have shown an average absolute error of 26 kWh/m².yr on the same sites. The higher error is 82 kWh/m².yr observed in Capo Vado site.

From these tests, it seemed so worthwhile to produce maps of wind and solar energies and hydrogen mass of the whole Liguria region starting from a digital elevation model (DEM).

5.3.2 Mapping renewable energy potential

The mapping of wind potential is an important step to carry out in order to evaluate sites with good wind potential. As can be shown in Figure 5.12, the available wind energy differs in the Liguria region. The map displays the distribution of the available wind energy per square meter at the height of measurement (10 m).

From the recorded wind data as well as from their ANN map, it seems that some internal territories on the mountains as well as some part of the coast in the western side are more promising than others for the exploitation of wind resources for energy production. In particular, two locations (codes 7 and 24) encompass high wind energy potential, which correspond respectively to Capo Vado and Casoni with a wind energy production values equal respectively to 4272 and 2912 kWh/m².yr. In addition, locations 18, 17 and 12 that correspond to Poggio Fearza, Monte Settepani

and Fontana Fresca with annual wind energy production equal to 1489, 1778 and 1808 kWh/m².yr demonstrate good wind potential and seem to be suitable for wind energy exploitation.

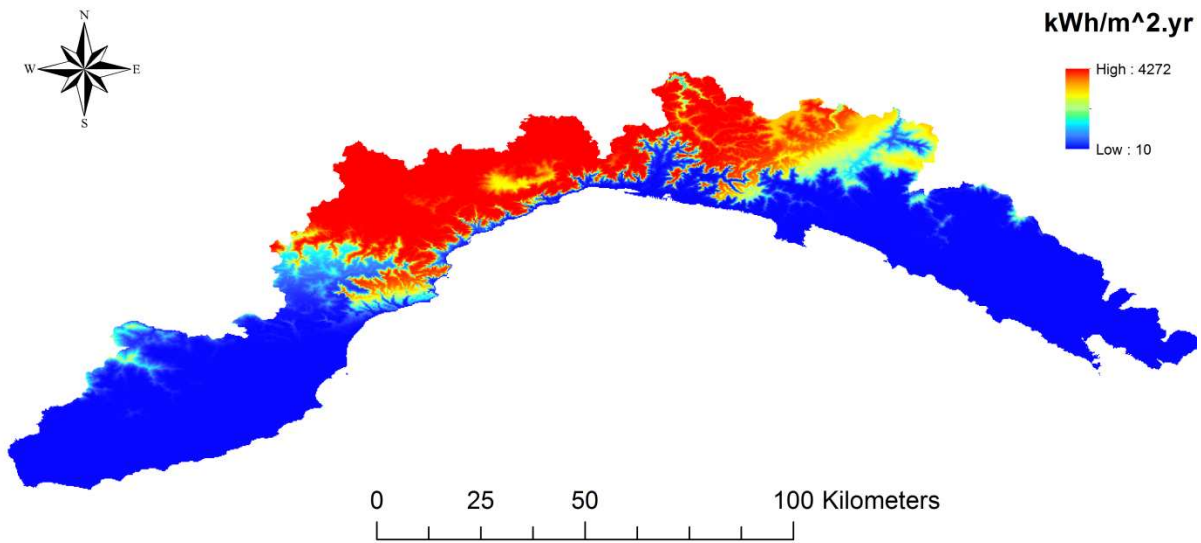

Figure 5.12 Map of the annual mean available wind energy of Liguria region as obtained by the ANN kriging technique.

The theoretical solar potential of Liguria region that can be exploited for energy production is reported in Figure 5.13. As it can be seen, the total annual solar energy is ranged between 1144 and 1556 kWh/m².yr, which are reached respectively in Buorgonuovo (code 6) and Sanremo (code 11). In fact, the estimated solar energy over the region does not present important differences between all locations of the territory. This behaviour is due in particular to the small area of the region, its Mediterranean climate and its similarity regarding the orography. Generally, the ANN solar map obtained shows a high potential in the whole territory, which can be interesting to install various solar energy technologies, which may be thermal, and or photovoltaic.

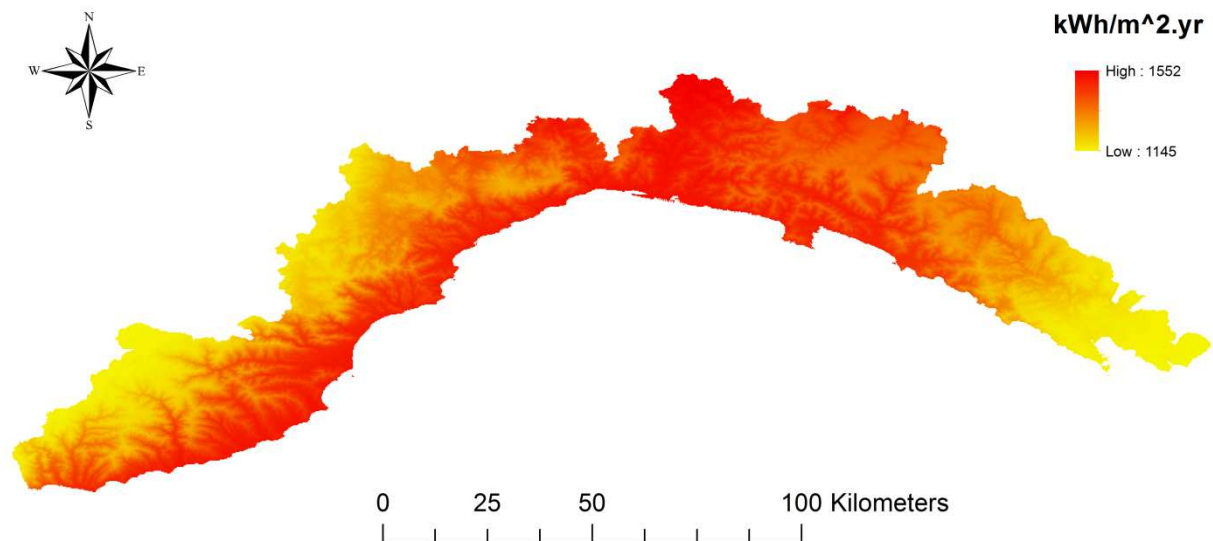

Figure 5.13 Map of the annual mean available solar energy of Liguria region as obtained by the ANN kriging technique

5.3.3 Mapping the hydrogen production potential

Table 5.14 displays the data related to the wind energy production, hydrogen production and the geographical coordinates of different locations of the meteorological stations. By analysing the results depicted in Table 5.14, it appears that hydrogen mass produced from wind energy could reach higher value in some parts of the region such as Capo Vado, Casoni, Monte Settepani and Fontana Fresca with a percentage of hydrogen production in the region respectively equal to 23%, 18%, 9.6%, and 9.7% of the whole produced amount of hydrogen. Two locations of Liguria region have a higher hydrogen potential production from wind energy, namely Capo Vado and Casoni. The maximum amount of the hydrogen mass available reached in those sites is about 73 kg/m².yr.

N°	Sites	E_{wind} [kWh/m ² .yr]	$M_{h2-wind}$ [kg/ m ² .yr]	Latitude N	Longitude E	Altitude [m]
1	Castellari	52.91	0.906	44.1456	8.2625	100
2	Genova/Centro funzionale	876.00	15.008	44.4017	8.9472	20
3	Polanesi	15.77	0.270	44.3658	9.1247	50
4	Monterocchetta	805.92	13.807	44.0755	9.9197	412
5	Corniolo	543.12	9.305	44.1063	9.7348	338
6	Buorgonuovo	13.49	0.231	43.8463	7.6208	100
7	Capo Vado	4272.25	73.192	44.2583	8.4425	170
8	Levanto	48.18	0.825	44.1811	9.6211	100
9	Cavi di Lavagna	65.70	1.126	44.2961	9.3739	100
10	Cenesi	56.68	0.971	44.0000	8.1700	10
11	Imperia	516.84	8.854	43.8200	7.7800	45
12	Fontana fresca	1808.94	30.99	44.4022	9.0936	743
13	Genova villa cambiaso	86.72	1.486	44.3986	8.9633	40
14	Giacopiane lago	1416.93	24.275	44.4608	9.3875	1016
15	La specia	477.16	8.175	44.1045	9.8075	5
16	Monte Maure	700.80	12.006	43.7922	7.6192	210
17	Monte settepani	1778.28	30.465	44.2430	8.1966	1375
18	Poggio Fearza	1489.20	25.513	44.0420	7.7935	1833
19	Pornassio	20.15	0.345	44.0639	7.8664	500
20	Ranzo	118.26	2.026	44.0632	8.0049	310
21	Romito magra	17.52	0.300	44.1033	9.9303	100
22	Savona Istituto Nautico	352.41	6.038	44.3056	8.4855	38
23	Vernazza	49.14	0.842	44.1361	9.6833	160
24	Casoni	2912.70	49.900	44.5272	9.3086	800
25	Diano Castello	10.51	0.180	43.9232	8.0669	135

Table 5.14 Wind energy and its equivalent in hydrogen mass

The hydrogen mass produced from solar energy shows a quite different behaviour than the one observed for the wind. For instance, for Capo Vado site, the maximum amount of hydrogen reached from the available solar energy is lower approximately three times than those produced in the case of wind. High hydrogen mass production from solar energy is observed in the coastal line that is ranged between 26 and 19 kg/m².yr. Table 5.15 shows in detail the results of hydrogen production from the 16 locations distributed over the Liguria region.

N°	Sites	E_{solar} [kWh/m ² .yr]	$M_{\text{h2-solar}}$ [kWh/m ² .yr]	Latitude N	Longitude E	Altitude [m]
1	Castellari	1239.79	21.240	44.1456	8.2625	100
2	genova	1384.34	23.717	44.4017	8.9472	20
3	Polanesi	1356.08	23.232	44.3658	9.1247	50
4	Monterocchetta	1497.05	25.647	44.0755	9.9197	412
5	Corniolo	1512.00	25.904	44.1063	9.7348	338
6	Buorgonuovo	1144.60	19.609	43.8463	7.6208	100
7	Capo Vado	1456.27	24.949	44.2583	8.4425	170
8	Cavi di Lavagna	1365.75	23.398	44.2961	9.3739	100
9	Levanto\S.Gottardo	1421.11	24.346	44.1811	9.6211	100
10	Allassio	1449.24	24.828	44.0000	8.1700	10
11	Sanremo	1556.32	26.663	43.8200	7.7800	45
12	Romito Magra	1345.26	23.047	44.1033	9.9303	100
13	Ranzo	1380.08	23.643	44.0632	8.0049	310
14	Pornassio	1273.39	21.816	44.0639	7.8664	500
15	Giacopiane Lago	1375.59	23.567	44.4608	9.3875	1016
16	Poggio Fearza	1331.90	22.818	44.0420	7.7935	1833

Table 5.15 Solar energy and its equivalent in hydrogen mass

RES utilisation is considered as a promising way to cope with the limitations of current patterns of energy generation and consumption, to complement existing energy production systems, and to contribute to the further modernization of the energy sector. Wind and solar energies provide an indigenous, environmental friendly option that can reduce dependence on energy imports, ensure the sustainable security of energy supply and contribute to an overall strategy for the sustainable development.

However, due to their intermittent behaviour, most RES do not follow the energy demand. The main problem of the RES is that electricity generation cannot be fully forecasted and does not usually match the demand pattern overtime. This is the case, for example, of a wind farm where, in relation to a certain (future) time horizon, the energy produced depends on the wind speed, whose prediction is clearly affected by uncertainties. This fact causes a certain degree of uncertainty even on the satisfaction of the energy demand (also when the demand pattern is assumed to be known) over the considered time horizon. The adoption of a hybrid system can be taken into account as a reasonable solution, which can support energy demands for different applications of both stand-alone and grid-connected users.

The stochastic behaviour of RES should reflect the need of adopting proper strategies to adapt the exploitable renewable energy to the demand. These could be done according to two main – not alternative – strategies: hybridizing the production with the contribution of some other renewable

energies or storing energy to feed future demand with the aim to avoid shortage. As regards hybridizing the production, for the territory investigated in this work, wind and solar energies should be a promising option, since sun irradiation reaches high values just in the months and seasons where wind seems to have lower energy exploitation.

For this main reason, the approach adopted hereafter is based on the combination of solar and wind resources in order to provide information to decision makers related to the selection of appropriate sites for mixed wind and solar hybrid systems for hydrogen production. Figure 5.14 shows the hydrogen map produced using both wind and solar resources available within the Liguria region. It is obtained by making an overlapping process between the wind and solar hydrogen potential maps as obtained by the ANN kriging technique.

The overlapping process consists of making the mean between the hydrogen mass produced from the solar and the one that comes from the wind. It can be seen that the extremities of east and west parts of Liguria dispose of poor hydrogen potential by contrast to the internal part which dispose of a considerable potential.

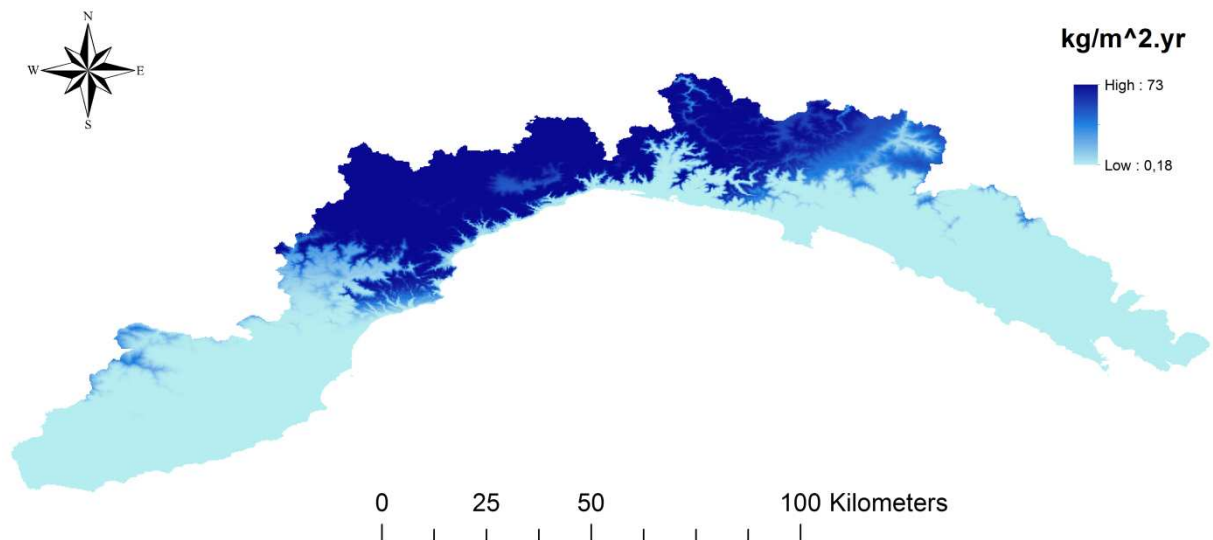

Figure 5.14 Map of the annual mean available hydrogen potential from wind and solar of Liguria region as obtained by the ANN kriging technique

5.3.4 Criteria sites selection

The GIS environment has been used to select the appropriate sites for the implementation of green hydrogen refuelling stations in potential areas on the basis of several criteria. For site selection,

different map layers are collected. These layers include study area, potential locations for hydrogen production from wind and solar energies, populated areas, roads, railways, electrical network, natural reserves, etc.

Figure 5.15 shows the electrical network over the Liguria region. Figures 5.16, 5.17, 5.18 and 5.19 show respectively inhabited areas, railways, roads, and rivers of Liguria region. A detail of the resulting eligible areas for the implementation of green hydrogen refuelling stations for the Liguria region are shown in Figure 5.20.

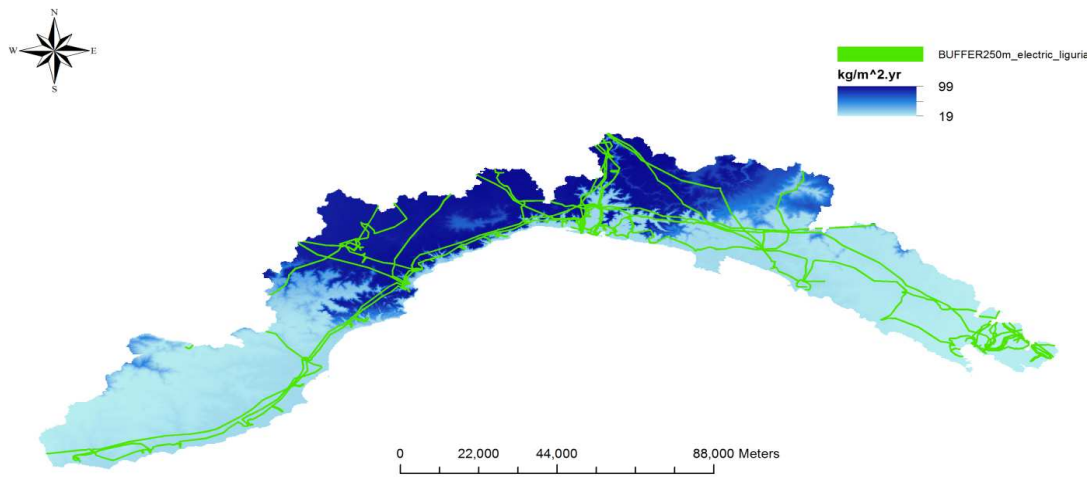

Figure 5.15 Electrical network map of Liguria region

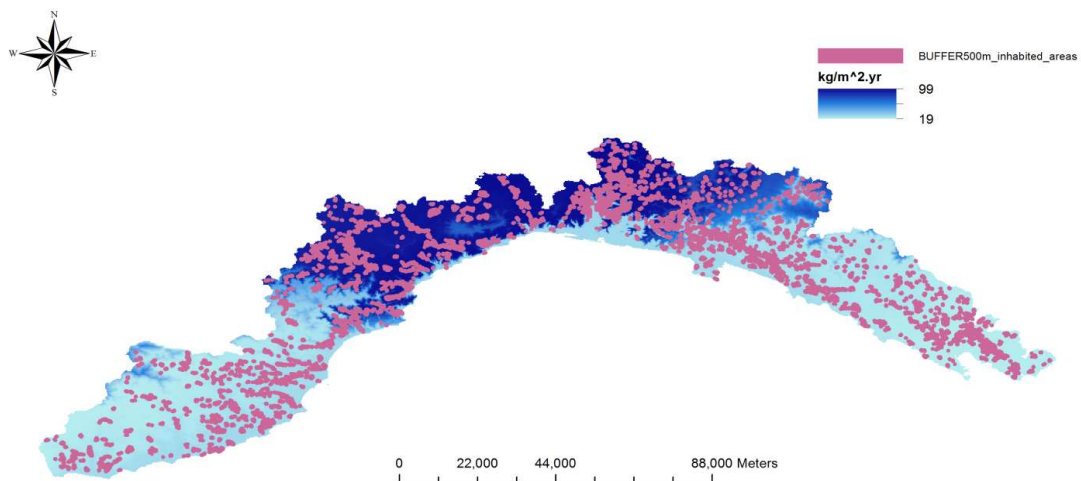

Figure 5.16 Inhabited area map of Liguria region

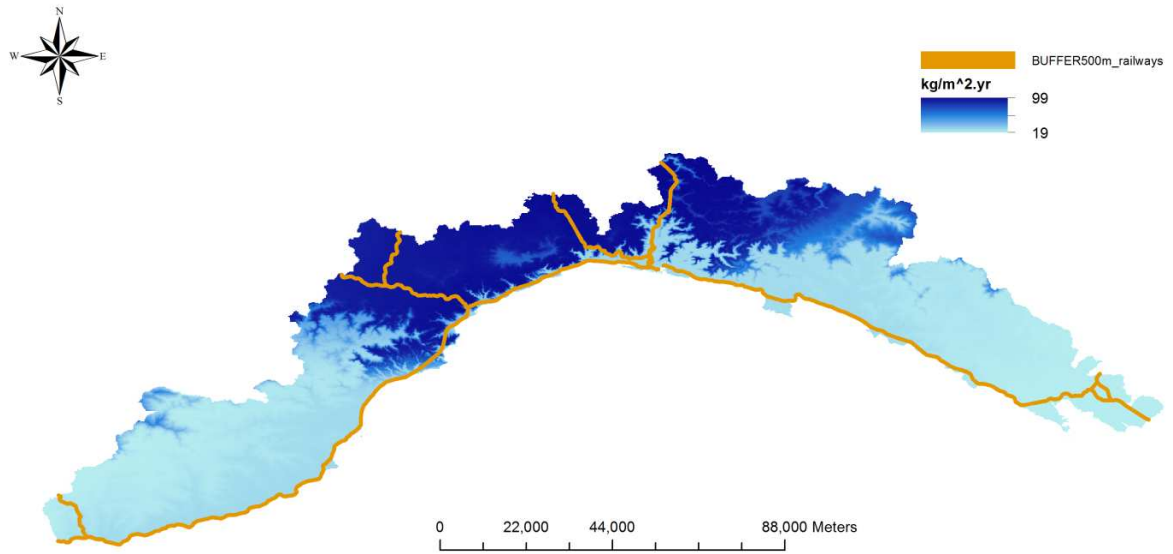

Figure 5.17 Railways map of Liguria region

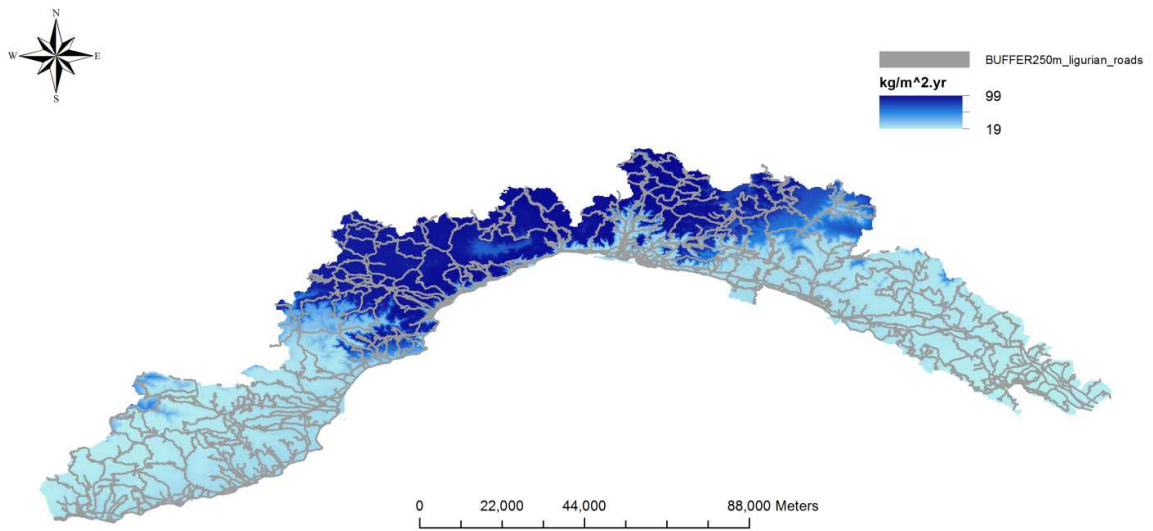

Figure 5.18 Roads map of Liguria region

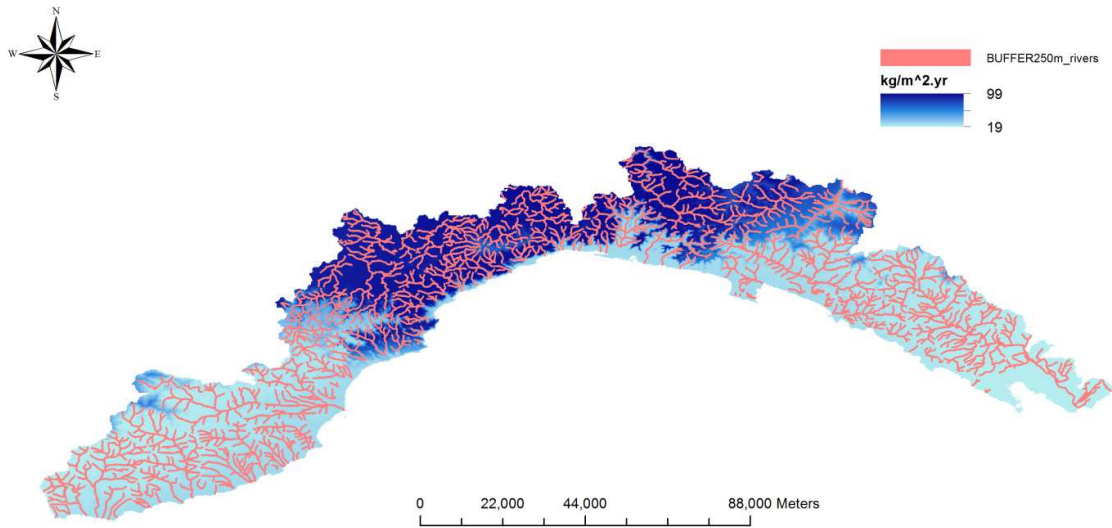

Figure 5.19 Rivers map of Liguria region

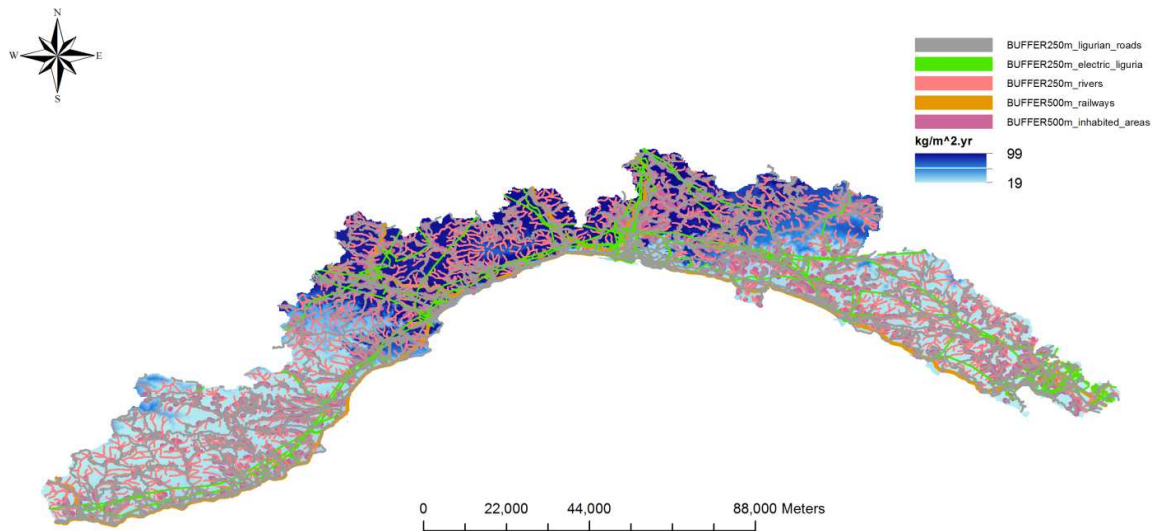

Figure 5.20 The spatial information regarding the eligible areas

5.3.5 Onsite hydrogen refuelling station: Capo Vado site

Given the promising hydrogen potential of Capo Vado, it has been selected for a case study. A renewable energy-hydrogen system was modelled to test the feasibility of hydrogen system that is based on solely the hybrid renewable energy resources. The system to be modelled is a hydrogen refuelling station driven by a mixed hybrid system. The system is composed by a wind turbine, PV modules, electrolyser system and a hydrogen storage unit. The proposed model has been tested using results obtained from Capo Vado site. The monthly wind and solar irradiation data have been used (see Figure 5.21).

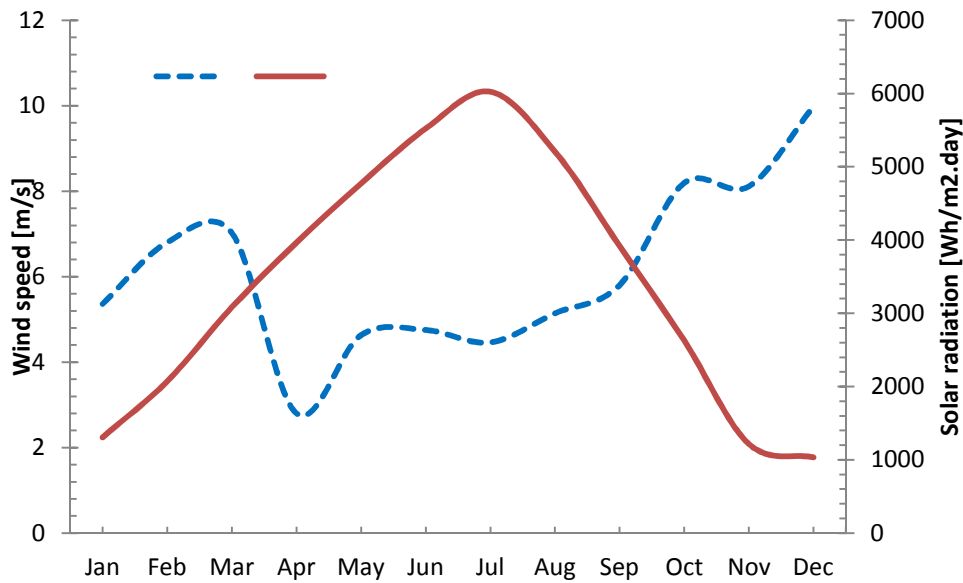

Figure 5.21 Monthly solar irradiation and wind speed data in Capo Vado

The model described by equations (5.15)-(5.26) has been applied to the specific case study. The system to be modeled is a hydrogen refueling station that operates on renewable energy resources. A hybrid renewable energy system is used, which is composed by a wind turbine, with the following technical parameters: cut-in wind speed of 3.5 [m/s], cut-off wind speed of 25 [m/s], hub high (h_{hub}) of 30.5 [m]. As regards the PV module, it is assumed that the PV module area is of 200 m^2 , which might be installed on the roof of the hydrogen refuelling station. A packing factor of 0.9 and a power conditioning efficiency of 0.86 are used. As concern the electrolyser, it is assumed an electrolyser operation efficiency of 75% and electrolyser losses of 0.9. The technologies used for wind and solar are assumed taking into account the hydrogen refuelling station installed in Colleslvati in Italy (<http://www.h2it.org/>), that operates using renewable energy resources for the hydrogen production. The aim behind this last step is to demonstrate the feasibility of a onsite hydrogen refuelling station in the region of Liguria that is based on the use of clean energy (from

mixed renewable energy system). Figure 5.22 displays the monthly hydrogen produced from the proposed hybrid system. It can be seen that the maximum production is reached in December with a value of 2669 kg and a minimum of 216 kg in March, from an automotive perspective, as a kilogram of hydrogen is roughly equivalent to a gallon of gasoline in energy content, assuming a 6 kg/fill average per day for a car, the 2669 kg/day would fill approximately 445 cars per day. On an annual basing, the onsite production of hydrogen in the Capo Vado site can satisfy the demand of about 1920 cars in a period of one year.

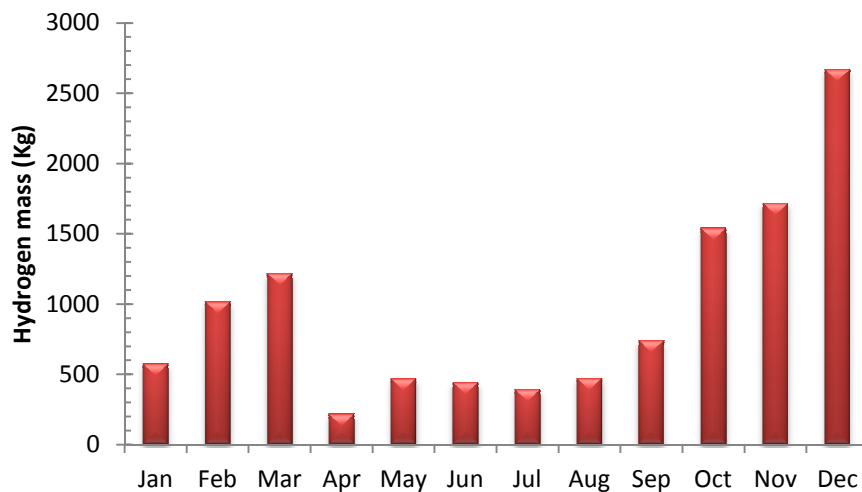

Figure 5.22 Monthly hydrogen productions in Capo Vado

6. Conclusion and future developments

High challenges rise from the production of hydrogen from renewable energy resources. From one hand, hydrogen can be exploited as a bridge to electricity generation through been a storage medium which balance the intermittency of many RES. From the other hand, hydrogen can be considered as an alternative fuel for the future that leads to many environmental advantages. In this chapter, a decision support system is proposed for the selection of the most promising location for installing renewable hydrogen systems. In particular, the focus is been dedicated to sites where wind and solar energies can play important role in the production process of hydrogen. The proposed methodology aggregates different studies and approaches. In this paper four modules were considered: the evaluation of the wind and solar potentials, the analysis of the hydrogen potential, development of a regional decision support module and a last module that regards modelling of an hybrid on-site hydrogen production system. The aim of this latter is to assess the feasibility of hydrogen on-site refuelling station that is based on solely the hybrid renewable energy resources. The proposed methodology has been applied to a region in Northern Italy. The results obtained

showed very high potential of hydrogen in the Capo Vado region, where the application for the hybrid on-site hydrogen refuelling station is been considered. It results that aggregating the wind and solar energies for the hydrogen production could leads to many advantages, among them solving the dispatch problems between the two RES. Future research will be directed to the study of tradeoffs that exists between the on-site and off-site hydrogen production The study will concern the development of optimal configuration that may satisfy not only criteria related to the availability of renewable hydrogen potential, but also criteria that seem particular from a logistic viewpoint.

C- Modelling and control of hydrogen and energy flows in a network of Green Hydrogen Refuelling Stations powered by wind and solar resources

1. Introduction

The global awareness concerning greenhouse gas (GHG) emissions, air pollution, fossil fuel depletion and others energy security issues (Li et al., 2009, Demirbas, 2008) have led many governments and researchers around the world to develop secure and environmental friendly fuel. The current fossil fuel systems must be switched gradually to clean, affordable and reliable energy systems, thus to reach the global drivers for a sustainable vision of our future energy market. Among many alternative energy sources, hydrogen can be considered as an attractive solution to succeed the current carbon-based energy system. The main benefits of hydrogen are even substantially considered by the fact that hydrogen can be manufactured from a number of primary energy sources, such as natural gas, nuclear, coal, biomass, wind and solar energies. Such diversity in production, obviously, contributes significantly to diversifying the energy supply system and ensuring security of fuel supply. For transport applications, there will be an increasing requirement to use clean and low or zero emission fuels such as hydrogen (Clarke et al., 2009). In addition, hydrogen is the most abundant element on the earth, clean and has the highest specific energy content of all conventional fuels (Campen et al., 2008). Hydrogen can contribute to a diversification of automotive fuel sources and supplies and offers the long term possibility of being solely produced from renewable energies. The development of a hydrogen infrastructure for producing and delivering hydrogen appears as a key factor to achieve the hydrogen transition and its development. In fact, the modelling of hydrogen infrastructure is still a complex task, the main complexities rise from the significant uncertainties in demand, supply, economic and environmental impacts, and the diversity of technologies available for production, storage and transportation. The key question is from which source hydrogen can be produced in a sustainable manner (Ingason et al., 2008). The extent to which the hydrogen benefits will occur has a great dependency on the technologies involved. Many authors have agreed that renewable energy sources (RES), such as wind and solar are central for better transition to long-term hydrogen economy.

In order to reach that goal, it is advantageous and crucial to use renewable energy for hydrogen generation. In fact, the resources for the operation of renewable energy systems are inexhaustible and practically free making. In addition, sustainable hydrogen production from electrolysis yields several advantages from a system point of view (Jørgensen and Ropenus, 2008). For instance, wind-powered water electrolysis ranks high in terms of technical and economical feasibility, having a great potential to become the first competitive technology to produce large amounts of renewable

hydrogen in the future (Sherif et al, 2005, Bokris and Veziroglu, 2007, Greiner et al., 2008, Segura et al., 2007, Prince-Richard et al., 2005).

From the end users perspective, the use of hydrogen in fuel cell applications offers a number of advantages over existing fuels and other emerging competitors, especially in the transportation sector (Hugo et al., 2005). The fuel cell vehicles can be a long-term solution to the highly persisted environmental problems associated with transportation. The fuel cell vehicles would be less complex, have better fuel economy, lower GHG, greater oil import reductions and would lead to a sustainable transportation system once renewable energy was used to produce hydrogen (Thomas et al., 1998). According to Doll and Wietschel (2008), the introduction of hydrogen coupled with the fuel cell vehicles could reduce significantly the emissions of CO₂, NO_x and SO_x.

The transition to a sustainable hydrogen economy faces paramount economic and technological barriers that must be overcome in order to ensure a successful transition. It is essential to study and analyse the interactions between different hydrogen infrastructure components in advance, in order to set and build variety of options for the incorporation of this new economy. This will facilitate the management of hydrogen supply chain, and help decisions-makers to define adequate roadmap for the hydrogen implementation.

Many authors have detailed many approaches and models for the development of the future hydrogen infrastructures. The approaches range from the examination of the supply chain as a whole (Almansoori and Shah, 2009, Almansoori and Shah, 2006, Kim et al., 2008) to the focus on a node of the infrastructure such as, production, storage or transportation (Parker et al., 2009, Joffe et al., 2004, Joffe et al., 2004, Dagdougui et al, 2010, Martin and Grasman, 2009, Sherif et al, 2005). In (Kuby et al., 2009), authors have developed a model able to locate the hydrogen stations that refuel maximum volume of vehicle fuel, this latter is measured both using the number of trips and vehicles miles travelled. Bersani et al. (2009) have investigated the planning of a network of service stations of a given company within a competitive framework. They proposed a decision support system that can be considered to determine the optimal placement of services stations within a hydrogen economy. Nicholas et al. (2004) have provided an analytical framework for locating hydrogen fuel stations assuming that the existing petrol infrastructure is strongly related to needed hydrogen infrastructure of the future. In another study, Parker et al. (2009) have assessed the economic and infrastructure requirements of the production of hydrogen from agricultural wastes, they concluded that the delivery price of bio-hydrogen is similar to the hydrogen produced from the natural gas. Joffe et al. (2004) have developed a technical modelling of a hydrogen infrastructure. They investigated the operation of the system so to provide initial facility for refuelling hydrogen fuel cell buses in London city. Greiner et al. (2008) have presented a simulation study of combined

wind-H₂ plant on a small Norwegian island. They include chronological simulations and economic calculations enabling the optimization of the component size. Their simulations include a grid-connected system and an isolated system with backup power generator. Dagdougui et al. (2010) have introduced a dynamic decision model for the real time control of hybrid renewable energy production systems, which can be particularly suitable for autonomous systems.

General interest in a wind-hydrogen system has increased partly because the price of wind power has become competitive with traditional power generating sources in certain areas (Martin and Grasman, 2009). Wind-powered water electrolysis ranks high in terms of technical and economical feasibility, having a great potential to become the first competitive technology to produce large amounts of renewable hydrogen in the future (Sherif et al., 2005). Worldwide installations of wind turbine power reach a value of 194.5 GW (Le journal de l'éolien, 2011). Studies carried out by Honnery and Moriarty (2009) have evaluated the global potential of a coupled wind/hydrogen system, thus in order to estimate the future hydrogen production.

A challenging task that is worth to be deeply studied regards the feasibility to feed hydrogen demand points by an uncertain renewable supply, such as the case of hydrogen production from intermittent RES. The key question that needs to be addressed is the ability of the renewable energy systems to meet the hydrogen fuel requirements (in amount and time).

In this paper, an attempt has been made to plan an innovative design of a hydrogen infrastructure. It consists of a network of GHRS and several production nodes. The proposed model has been formulated as a mathematical programming, where the main decisions are the selection of GHRS that will be powered by each point of production based on distance and population density criteria, as well as the energy and hydrogen flows exchanged among the system components from the production nodes to the demand points. The approaches and methodologies developed can be taken as a support to decision makers, stakeholders and local authorities in the implementation of future hydrogen infrastructures.

2. The methodological approach

2.1 Model structure and components

Wind/solar energy production systems are designated to supply electric and hydrogen needs to a network of GHRS. From the demand viewpoint, the system to be modelled consists of a network of GHRS, each one having a local hydrogen storage tank, and needs to procure hydrogen to costumers (in terms of fuel cell vehicles). From the supply viewpoint, production systems for hydrogen consist of many mixed energy production plants. Each one includes a large scale hybrid wind/solar system, electrolyser unit, fuel cell, and a main hydrogen storage tank. Moreover, each production plant is

connected to the electrical network, giving the system the possibility to sell excess of energy generated by the production nodes. Figure 5.23 displays the proposed hydrogen infrastructure that forms the basis of the hydrogen global system.

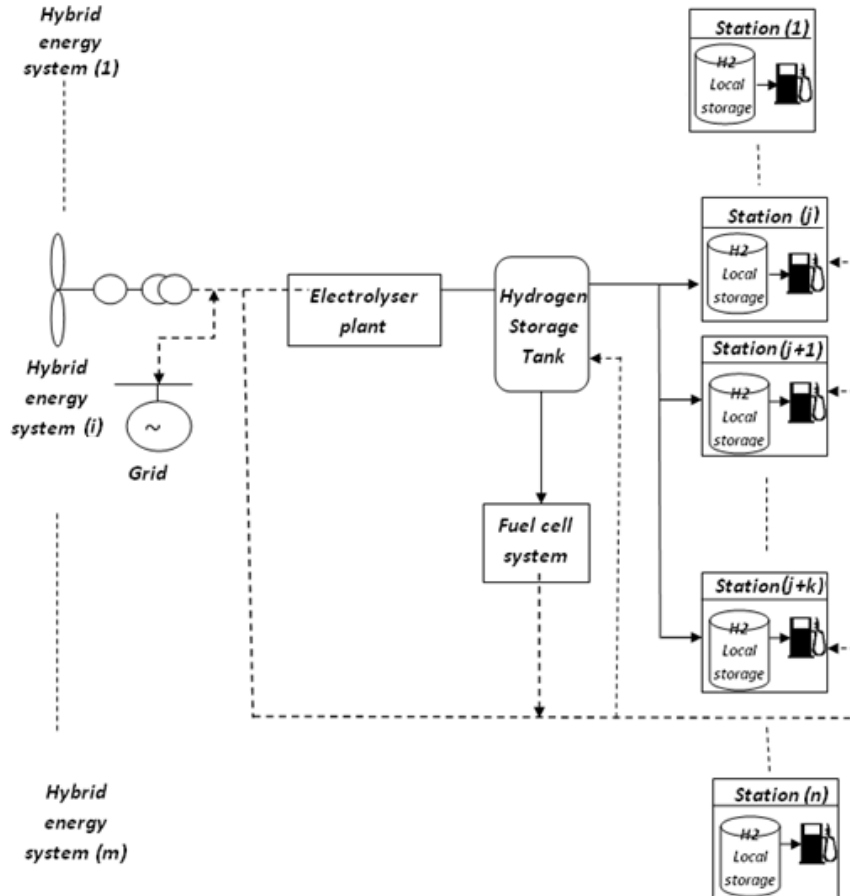

Figure 5.23 System description

2.2 Planning horizon: plants and technologies

The implementation of planning phase is important for the formulation of the optimization model, because it will provide the knowledge about the possibility of making use of the renewable resources for hydrogen production. Furthermore, due to the absence of large hydrogen market, the development of the hydrogen infrastructure will initiate by the introduction of small hydrogen decentralized systems. Hence, the operation of these systems as a whole will depend, in addition to the available renewable resources, to the design of the system that will generate and fulfil specific requirements. In fact, the system must be adapted accurately in order to fit the mass of hydrogen for the GHRS. Nevertheless, economically speaking, the configuration of the best design will strongly depend on the considered scenario. In other words, on the renewable resources condition as well as

the cost of the different components and the final selling prices of the energy generated by each type of renewable source (López et al., 2009). The main idea of using mixed renewable energy systems for hydrogen production is based on generating electrical energy by the wind turbines and the photovoltaic modules, and then using that energy for hydrogen generation using electrolyser systems. Owing to the low energy density by volume of the hydrogen, the effective use of the logistics chain to transport hydrogen to the refuelling stations requires the reduction of the hydrogen volume, thus by means of liquefaction or compression. In this paper, liquefaction or compression of the hydrogen substance will not be considered, neither the distributing chain of hydrogen to the refuelling stations.

2.2.1 Mixed renewable energy system

The selection of the suitable renewable energy technologies has been made on the basis of several considerations: meteorological conditions, renewable energy potential, load factor and amount of hydrogen required by the refuelling stations. The problem needs much more attention, especially because of the use of the intermittent RES, which is mainly the case of solar and wind. Due to these issues, the mixed renewable energy system must be well designed in order to better exploit the potential of RES, hence fulfil specific requirements.

2.2.2 Electrolyser unit

The hydrogen generation process becomes more beneficial if used in conjunction with electricity generated by the RE. Different kinds of water electrolysers exist, with various levels of technological advancements. Water electrolysers can be divided into two categories, alkaline and proton exchange membrane (PEM) electrolysers. PEM electrolysis is a viable alternative for generating hydrogen from RES. Despite its higher cost compared, the PEM benefits of high efficiency factor, higher life cycle (approximately ten years) (Benchirifa et al., 2007), adaptability with renewable energy systems (Kruse et al., 2002). In addition, a PEM electrolyser can deliver hydrogen at high pressure, which will in turn be attractive for the application where hydrogen needs to be stored (Barbir, 2005). In this study, a PEM electrolyser will be adopted, this choice is justified by two main reasons namely, the exploitation of wind/solar potentials and the need of high pressure hydrogen to refuelling stations.

2.2.3 Fuel cell system

Among all kinds of fuel cell available, fuel cell Proton exchange membrane PEM will be the most suitable for the system configuration, this choice is dictated by the PEM electrolysis. The operation

of PEM fuel cell needs only hydrogen, oxygen from the air and water to operate and do not require corrosive fluids like some fuel cells. The driven goal of using a fuel cell system at the centralized plant is to ensure another option for the provision of electricity (in case of low power generation from mixed renewable energy system).

2.2.4 Hydrogen storage system

A hydrogen storage system is available in each hydrogen production plant. Since, the plant is supposed to provide hydrogen for a network of hydrogen refueling station, there is a need to assume the availability of a large scale hydrogen storage system. The storage system assumes the aggregation of both a compressor and storage system. The hydrogen storage device has to be able to meet the requirements of the hydrogen demand at the specific hydrogen refuelling station in each type (taking into consideration the delivery schedule). Because lack of data in particular those related to large scale hydrogen storage. In this paper, the hydrogen storage systems have been sized by analysing the real amount of gasoline delivered by several service stations which is transformed in equivalent amount of hydrogen.

2.2.5 Hydrogen demand

Due to the absence to date of a widespread hydrogen market, the computation of the hydrogen demand cannot be estimated by accuracy. The operation of these markets will depend initially on the hydrogen demand in the available infrastructure, in particular, the number of hydrogen fuel cell vehicles and hydrogen refuelling infrastructure. In addition, due to many uncertainties, the planning of scenario can be considered as the only systematic tool that helps designing the hydrogen supply chain. The configuration of the optimal design will strongly depend on the scenario considered. In this study, the estimation of hydrogen demand of the hydrogen refuelling stations is performed basing on the current supply of the petrol products to the conventional petrol stations. The information related to the petrol stations may be helpful in determining the capacity, the consumption of the future hydrogen refuelling stations. Then, according to these estimations, multiple scenarios are explored including varying hydrogen fuel cell penetrations.

2.3 Modelling the mixed renewable energy system

As presented previously, the electrolysis hydrogen production plant is mainly driven by power generated from the renewable energy system. The overall hydrogen production plant is linked to the network of GHRS. It is composed by the following subsystems: photovoltaic modules, wind turbines, electrolyser unit, fuel cell unit, main hydrogen storage system. Among these subsystems

and from/to the external electrical network, the power and hydrogen flows can be exchanged as shown in Figure 5.24. The energy produced by the renewable energy system can be sent to the electrolyser to produce hydrogen that will be stored in main tank, and/or used to feed electrical energy of GHRS. The quantity of hydrogen can be used for different purposes: to satisfy the hydrogen fuel demand by the refuelling stations, or/and used by the fuel cell to ensure the electricity demand of the refuelling stations in the case of a deficit of energy production, or/and delivered to the industrial markets.

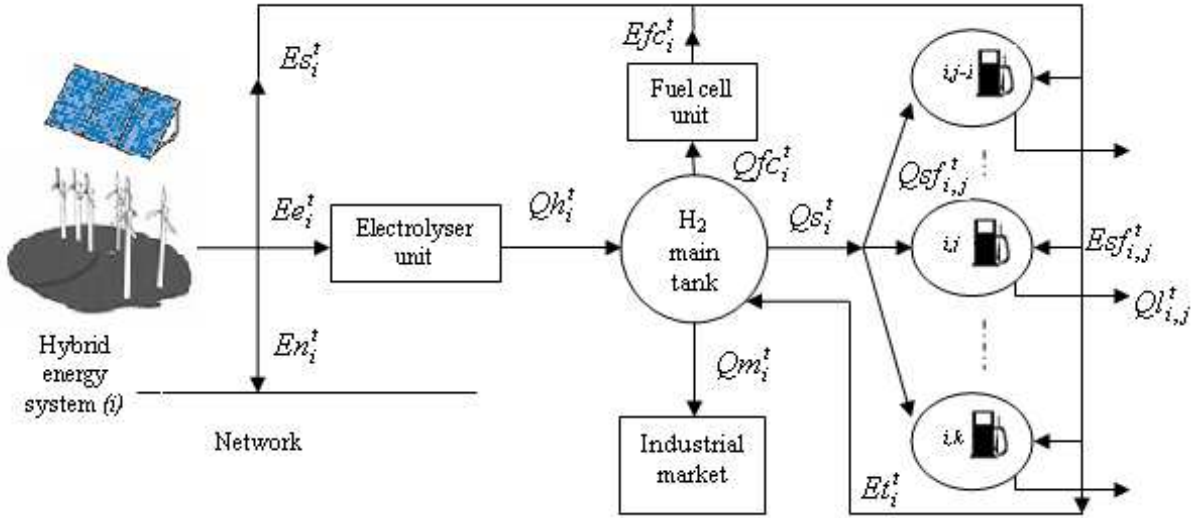

Figure 5.24 Energy and hydrogen flows exchanged among system components

2.3.1 The wind turbine subsystem model

The energy produced by a wind turbine in a point of production i is given by:

$$E_{w,i}^t = \frac{T}{1000} \frac{\rho A}{2} \int_{v_i}^{v_p} c_p \eta_{gb} \eta_g f(v_i^t) v_i^{t3} dv \quad t=1, \dots, T \quad (5.27)$$

where $f(v_i^t)$ is the probability of occurrence of wind speed v_i^t [m/s] in a point of production i , A [m²] is the blade sweep area, ρ is the air density [kg/m³], c_p [-] the power coefficient, η_{gb} [-] the gearbox performance and η_g [-] the generator performance.

where v_i^t corresponds to the wind speed at the wind turbine hub height. It is assumed that the wind speed can be predicted by some reliable meteorological models. In general, the wind speed measurements are given at a height different than the hub height of the wind turbine. So, the following equation is used to evaluate the wind speed at the desired height:

$$v_i^t = v_{data,i}^t \frac{\ln(H_{hub}/z_0)}{\ln(H_{data,i}/z_0)} \quad t=1, \dots, T \quad (5.28)$$

where $H_{data,i}$ [m] is the height of the measurement, H_{hub} [m] is the hub height and z_0 is the surface roughness length and $v_{data,i}^t$ is the wind speed at the height of the measurements.

2.3.2 The PV module subsystem model

Hybrid energy systems are often taken into account as a viable approach to face the RES intermittent character. The use of different RES (such as wind and solar) can enhance the effectiveness to face the load energy demands. The electrical energy generated from a photovoltaic module can be calculated using the following formula:

$$E_{pv,i}^t = S_{pv} \eta_{PV} p_f \eta_{pc} G_i^t \quad t=1, \dots, T \quad (5.29)$$

where S_{pv} [m²] is the solar cell array area, η_{PV} [-] is the module reference efficiency, p_f [-] is the packing factor, η_{pc} [-] is the power conditioning efficiency and G_i^t [kWh/m²] is the forecasted hourly irradiation, that is predicted by some reliable meteorological model.

3. Optimization problem

The decision variables of the optimization problem are:

Ee_i^t , En_i^t and Es_i^t [kWh] are the electrical energy components in time period [t,t+1) respectively given by the mixed renewable energy system i to electrolyser unit, electrical network and to feed the electrical demand of the GHRS.

Efc_i^t , Et_i^t and $Esf_{i,j}^t$ [kWh] are the electrical energy components in time period [t,t+1) respectively given by the fuel cell, consumed by the main hydrogen storage tank in point of production i and consumed by the GHRS j and its local hydrogen tank.

Qh_i^t , $Qsf_{i,j}^t$, $Ql_{i,j}^t$, Qm_i^t [kg] represent in time interval [t,t+1) respectively the amount of hydrogen produced by the electrolyser unit at production node i , the amount of hydrogen sent from the i^{th} production node to the j^{th} GHRS, the amount of hydrogen delivered by the j^{th} GHRS and the amount of hydrogen sent to the industrial market from the i^{th} production node.

where $\rho_{i,j}$ is a binary variable, equals to 1 if the i^{th} production point will be connected to the j^{th} GHRS, 0 otherwise. μ_j is a binary variable, equals to 1 if the j^{th} refueling station is selected, 0 otherwise.

The state variables of the optimization problem are:

M_i^t , $Msf_{i,j}^t$ are respectively the amount of hydrogen stored in time period $[t,t+1)$ in the main tank of i^{th} production point and the amount of hydrogen stored in the local tank of the j^{th} GHRS at instant t .

The following parameters are used in the model

- N_w : number of wind turbines;
- N_{pv} : number photovoltaic modules;
- HHV_{H_2} : hydrogen higher heating value [kWh/kg]
- LHV_{H_2} : hydrogen lower heating value [kWh/kg]
- LHV_{ff} : fossil fuel lower heating value [MJ/kg]
- η_1, η_2 : parameters of the electrolyser plant: the first one represents the efficiency of the electrolysis system, while the second one is an additional efficiency coefficient included to take into account the (energy) losses in the electrolyser.
- η_{ff} : efficiency of the fossil fuelled engine
- η_{H_2} : efficiency of the H_2 engine/fuel cell [-]
- η_{FC} : fuel cell efficiency [-]
- $Qff_{i,j}^t$: demand of fossil fuel in time interval $[t,t+1)$ at the j^{th} refuelling station [kg]
- $\tilde{Q}m_i^t$: hydrogen market demand in time interval $[t,t+1)$ requested from the i^{th} production point [kg]
- $\tilde{Q}l_{i,j}^t$: hydrogen demand in time interval $[t,t+1)$ of the j^{th} GHRS supplied by i^{th} production point [kg]
- $\tilde{E}e_{i,j}^t$: electrical demand in time interval $[t,t+1)$ of the j^{th} GHRS connected to the i^{th} production point [kWh]
- $D_{i,j}$: distance from the i^{th} production point to the j^{th} GHRS [m]
- N_j : population density around a circle of unit diameter of distance of j^{th} GHRS [inhabitant/km²]
- δ_i : binary variable that is implemented to take into account the exchange in power between the hydrogen production plant and the electric network. It is equal to 1 when the market penetration of hydrogen is less enough to allow power exchange with the electrical network.

3.1 Objective function

The objective function to be minimized is the sum of seven terms: two first terms reflect the satisfaction of different hydrogen demands, namely the hydrogen fuel demands of the GHRS and

the industrial market demand. Third term is related to ensure the electrical demands of GHRS, the fourth term is related to the energy sold to the electrical network to be maximized/minimized according to the market penetration, it means, for low hydrogen demand the energy sold to the electrical network will be maximized, otherwise it will be minimized, this assuming that the renewable energy systems are well sized. Fifth term to be maximized is related to the amount of hydrogen stored in the main hydrogen tank. The two last terms are added to select the suitable GHRS to be powered by the appropriate point of productions.

$$Z = \sum_{t=1}^{T-1} \sum_{j=1}^J (Ql_{i,j}^t - \tilde{Q}l_{i,j}^t)^2 + \sum_{t=1}^{T-1} \sum_{i=1}^I \alpha (Qm_i^t - \tilde{Q}m_i^t)^2 + \gamma \sum_{t=1}^{T-1} \sum_{j=1}^J \sum_{i=1}^I (E_{i,j} + \phi Msf_{i,j}^t - \tilde{E}e_{i,j}^t)^2 + \zeta \sum_{t=1}^{T-1} \sum_{i=1}^I \delta_i En_i^t - \lambda \sum_{i=1}^I M_i^{T-1} + \beta \sum_{j=1}^J \sum_{i=1}^I \rho_{i,j} D_{i,j}^2 + \chi \sum_{j=1}^J \mu_j N_j$$

$$t=1, \dots, T-1; i=1, \dots, I; j=1, \dots, J \quad (5.30)$$

$\alpha, \gamma, \zeta, \lambda, \beta, \chi$ are weight factors.

3.2 Constraints

3.2.1 Flow conservation

The overall energy produced $E_{tot,i}^t$ [kWh] by each mixed renewable energy system in time interval [t,t+1) is given by:

$$E_{tot,i}^t = N_w \cdot E_{w,i}^t + N_{pv} \cdot E_{pv,i}^t \quad t=1, \dots, T-1; i=1, \dots, I \quad (5.31)$$

The total energy $E_{tot,i}^t$ [kWh] can be used for three different purposes in the same time interval: direct for the hydrogen production (Ee_i^t), satisfy the electricity demand of the refuelling stations (Es_i^t), and a part sent directly to the electrical network (En_i^t). Thus

$$E_{tot,i}^t = Ee_i^t + En_i^t + Es_i^t \quad t=1, \dots, T-1; i=1, \dots, I \quad (5.32)$$

$$Es_i^t + Efc_i^t - Ees_i^t - Et_i^t = 0 \quad t=1, \dots, T-1; i=1, \dots, I \quad (5.33)$$

The electrical energy Ees_i^t [kWh] consumed in time interval [t,t+1) by k^{th} GHRSs will be equal to the sum of electrical energy consumed by each one, and it is given by:

$$Ees_i^t = \sum_{j=1}^{k < J} Esf_{i,j}^t \quad t=1, \dots, T-1; i=1, \dots, I; j=1, \dots, J \quad (5.34)$$

$$Esf_{i,j}^t = E_{i,j} + \phi Msf_{i,j}^t \quad t=1,\dots,T-1; i=1,\dots,I; j=1,\dots,J \quad (5.35)$$

where $Esf_{i,j}^t$ [kWh] is the electrical energy consumed in time interval by the j^{th} GHRS that is composed by a constant term $E_{i,j}$ and a variable one $\phi Msf_{i,j}^t$, with ϕ the unitary demand of electric energy for a unit of hydrogen stocked reservoir, and $Msf_{i,j}^t$ the amounts of hydrogen available in the j^{th} local tank of the GHRS in time interval $[t,t+1)$.

The electrical energy Et_i^t [kWh] consumed in time interval by the main hydrogen storage reservoir in the point of production i is given by:

$$Et_i^t = \phi M_i^t \quad t=1,\dots,T-1; i=1,\dots,I \quad (5.36)$$

where M_i^t is the amounts of hydrogen available in the main storage reservoir in time interval $[t,t+1)$.

The electrical energy Efc_i^t [kWh] delivered by the fuel cell in time interval $[t,t+1)$ is calculated by:

$$Efc_i^t = LHV_{H_2} \cdot Qfc_i^t \cdot \eta_{fc} \quad t=1,\dots,T-1; i=1,\dots,I \quad (5.37)$$

The amount of hydrogen Qh_i^t [kg] delivered in time interval $[t,t+1)$ by the electrolyser plant is equal to:

$$Qh_i^t = \frac{\eta_1 \eta_2 Ee_i^t}{HHV_{H_2}} \quad t=1,\dots,T-1; i=1,\dots,I \quad (5.38)$$

The amount of hydrogen Qs_i^t consumed in time interval $[t,t+1)$ by the k^{th} GHRS is equal to the sum of hydrogen that is consumed by each one, and it is given by:

$$Qs_i^t = \sum_{j=1}^{k < J} Qsf_{i,j}^t \quad t=1,\dots,T-1; i=1,\dots,I; j=1,\dots,J \quad (5.39)$$

The hydrogen demand $\tilde{Q}l_{i,j}^t$ [kg] of the j^{th} GHRS in time interval $[t,t+1)$ is given by:

$$\tilde{Q}l_{i,j}^t = \frac{Qff_{i,j}^t \cdot LHV_{ff} \cdot \eta_{ff}}{LHV_{H_2} \cdot \eta_{H_2}} \quad t=1,\dots,T-1; i=1,\dots,I; j=1,\dots,J \quad (5.40)$$

3.2.2 Storage system state equations

The state equations of the main hydrogen storage tank of each point of production and the local hydrogen storage tank of each GHRS in time interval $[t,t+1)$ are given by:

$$M_i^{t+1} = M_i^t + Qh_i^t - Qs_i^t - Qm_i^t - Qfc_i^t \quad t=1,\dots,T-1; i=1,\dots,I \quad (5.41)$$

$$Msf_{i,j}^{t+1} = Msf_{i,j}^t + Qsf_{i,j}^t - Ql_{i,j}^t \quad t=1,\dots,T-1; j=1,\dots,J \quad (5.42)$$

$$M_i^1 = M_{i,1} \quad i=1,\dots,I \quad (5.43)$$

$$Msf_{i,j}^1 = Msf_{i,j,1} \quad i=1,\dots,I; j=1,\dots,J \quad (5.44)$$

where $M_{i,1}, Msf_{i,j,1}$ [kg] are respectively the storage system level at the initial time for each main hydrogen storage tank and each local one.

3.2.3 Other constraints

Selection GHRS

Constraint (19) is introduced in order to impose that if the link between the i^{th} production point and the j^{th} GHRS is established. So, the j^{th} GHRS must be selected following the safety viewpoint.

$$If \exists \rho_{i,j} = 1 \rightarrow \gamma_j = 1$$

$$\rho_{i,j} = \begin{cases} 1 & \text{if the link } (i, j) \text{ is established} \\ 0 & \text{otherwise} \end{cases} \quad (5.45)$$

Equation (5.45) can be also written as:

$$\rho_{i,j} - R\gamma_j \leq 0 \quad (5.46)$$

where R is a big number

Hydrogen storage systems

The main hydrogen storage tanks are limited in upper and lower bands:

$$M_{i,\min} \leq M_i^t \leq M_{i,\max} \quad t=1,\dots,T-1; i=1,\dots,I \quad (5.47)$$

The local hydrogen storage tanks are limited in upper and lower bands:

$$Msf_{i,j,\min} \leq Msf_{i,j}^t \leq Msf_{i,j,\max} \quad t=1,\dots,T-1; j=1,\dots,J \quad (5.48)$$

Activation of transport

The hydrogen flows sent from a supply point i to the j^{th} GHRS are limited in upper and lower bands:

$$\rho_{i,j}Qsf_{j,\min} \leq Qsf_{i,j}^t \leq \rho_{i,j}Qsf_{j,\max} \quad t=1,\dots,T-1; i=1,\dots,I; j=1,\dots,J \quad (5.49)$$

Electrolyser

The energy flows sent to the electrolyser unit at each production point i are limited in upper and lower bands:

$$\delta_e^t Ee_{i,\min} \leq Ee_i^t \leq \delta_e^t Ee_{i,\max} \quad t=1,\dots,T-1; i=1,\dots,I \quad (5.50)$$

$$\delta_e^t = \begin{cases} 0 & \text{if } Ee_i^t < Ee_{i,\min} \\ 1 & \text{if } Ee_i^t \geq Ee_{i,\min} \end{cases} \quad (5.51)$$

Fuel cell

The hydrogen flows sent the fuel cell are limited in upper and lower bands:

$$\delta_{fc}^t Qfc_{i,\min} \leq Qfc_i^t \leq \delta_{fc}^t Qfc_{i,\max} \quad t=1,\dots,T-1; i=1,\dots,I \quad (5.52)$$

$$\delta_e^t = \begin{cases} 0 & \text{if } Qfc_i^t < Qfc_{i,\min} \\ 1 & \text{if } Qfc_i^t \geq Qfc_{i,\min} \end{cases} \quad (5.53)$$

Electrical network

The energy sold to the electrical network could be maximized or minimized according to the market penetration (MP).

$$\delta_i = \begin{cases} -1 & \text{if } MP < MP_{threshold} \\ 1 & \text{otherwise} \end{cases} \quad (5.54)$$

4. Results and discussion

The problem is here solved using mathematical programming techniques through a commercial optimization package (Lingo, www.lindosystems.org). In particular, the optimization problem is solved for a case study in Capo Vado site (Savona district) for a time period of one month (April 2009), which consists of a network of seven real refuelling stations. Due to the lack of data that regard fossil fuel and electrical energy consumptions as well as some territorial characteristics (distance, population density, ...), in addition to the meteorological measurements of wind speed and solar radiation, we applied the model to one point of production and seven existing refuelling stations which we have their related data. In this section we assumed that this network of GHRS is the suitable one for the considered point of production. Table 5.16 reports the characteristics of the network of GHRS.

GHR	Code	Longitude	Latitude	Distance [Km]	Density of population Inha/km²
Refuelling station 1	PV 01363	44.4286	8.7587	52	7708
Refuelling station 2	PV 01398	44.2682	8.4344	22	1750
Refuelling station 3	PV 11348	44.3419	8.5438	33	1454
Refuelling station 4	PV 01334	44.1688	8.3413	27	2160
Refuelling station 5	PV 01377	44.0884	8.2072	45	1553
Refuelling station 6	PV 01371	44.3211	8.4654	21	6168
Refuelling station 7	PV 01351	44.1294	8.259	45	2277
Production point	-	44.3984	8.2193	0	-

Table 5.16 Characteristics of a network of GHR

The developed approach supposes that the energy generated from the mixed renewable energy systems is used to ensure electrical energy and hydrogen fuel demands of the GHR as well as a hydrogen market demand. The last is assumed to be constant and equals to 10 kg in time period. The hydrogen market could reflect different users that may buy hydrogen from the production plant. The energy surplus is sold to the electrical network. It is assumed in this case study that the forecasted data from which the optimization problem must be solved are exactly equal to the historical data recorded in the Capo Vado site, and which consist of the daily wind speed and solar radiation, recorded at the height of 10 m. Figure 5.25 shows the daily variation of the wind speed and solar radiation of Capo Vado site, it can be seen that the wind speeds range between 4.8 and 9.5 m/s. Generally, the wind speed takes an average value equal approximately to 7.54 m/s at 10 m of height. Whereas, solar radiation ranges between 0.46 and 7.3 kWh/m²/day, with an average value of 4.8 kWh/m²/day.

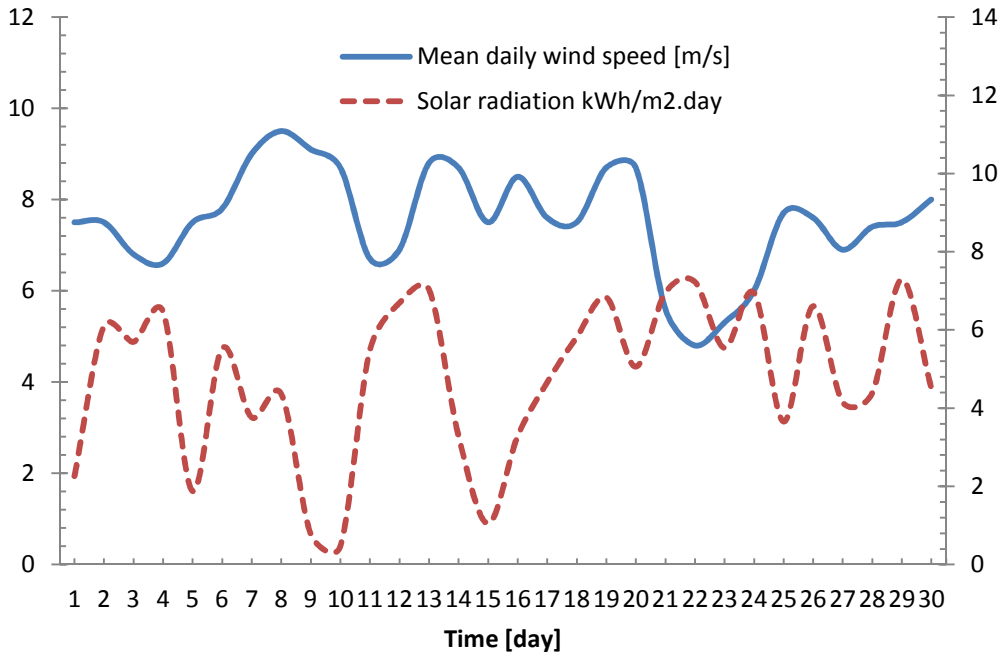

Figure 5.25 Wind speed and solar radiation data in the test site

In this paper, ten wind turbines (ENERCON E-53) (www.enercon.de), with the following geometric and technical characteristics have been considered: $v_c = 2$ [m/s], $v_r = 13$ [m/s], $v_f = 25$ [m/s], $P_r = 800$ [kW], $H_{hub} = 75$ [m]. The power curve of the considered wind turbine supplied by the manufacturer is shown in Figure 5.26. For the photovoltaic modules, it is assumed $S_{pv} = 10000$ [m²], $\eta_{pv} = 0.11$, $\eta_{pc} = 0.86$, and $P_f = 0.9$.

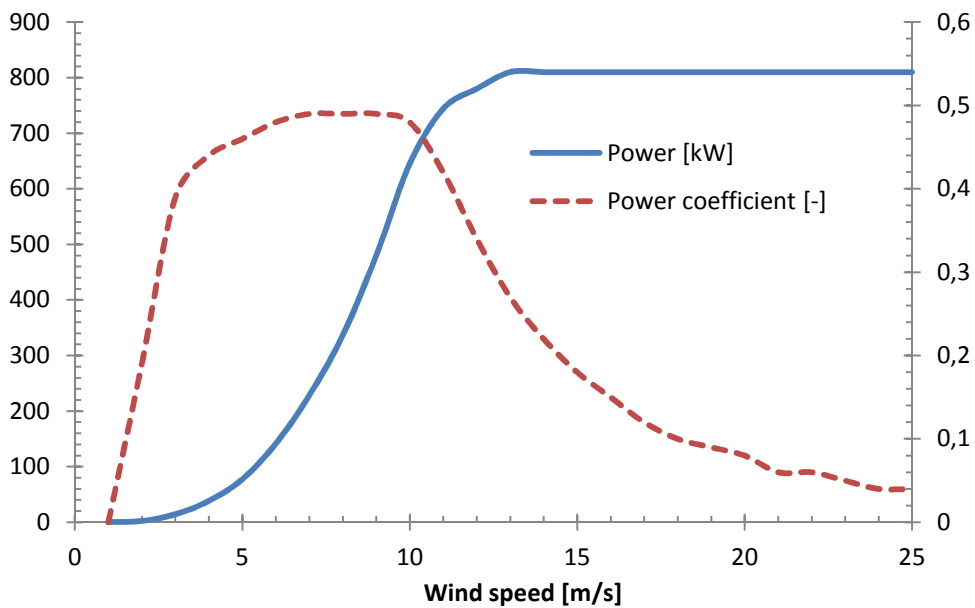

Figure 5.26 Manufacturer power curve of the considered wind turbine

In this work, the hydrogen demands are assumed to be known, and they are estimated using the real existing demands of the petrol stations available in the province. These real data are recorded from petrol stations of an Italian Petrol Company. The demand of hydrogen used in this paper is calculated according to several scenarios of market penetration (5%, 15%, 25%). This hypothesis seems reasonable since in a short term scenario, the demand of hydrogen cannot be equal to the one of petrol products consumed by vehicles. Figure 5.27 displays the hydrogen demands of the network of the GHRs considered. It can be seen that the consumption behaviors of the considered stations in April month are different from each other, and it ranges between 54 and 3500 kg.

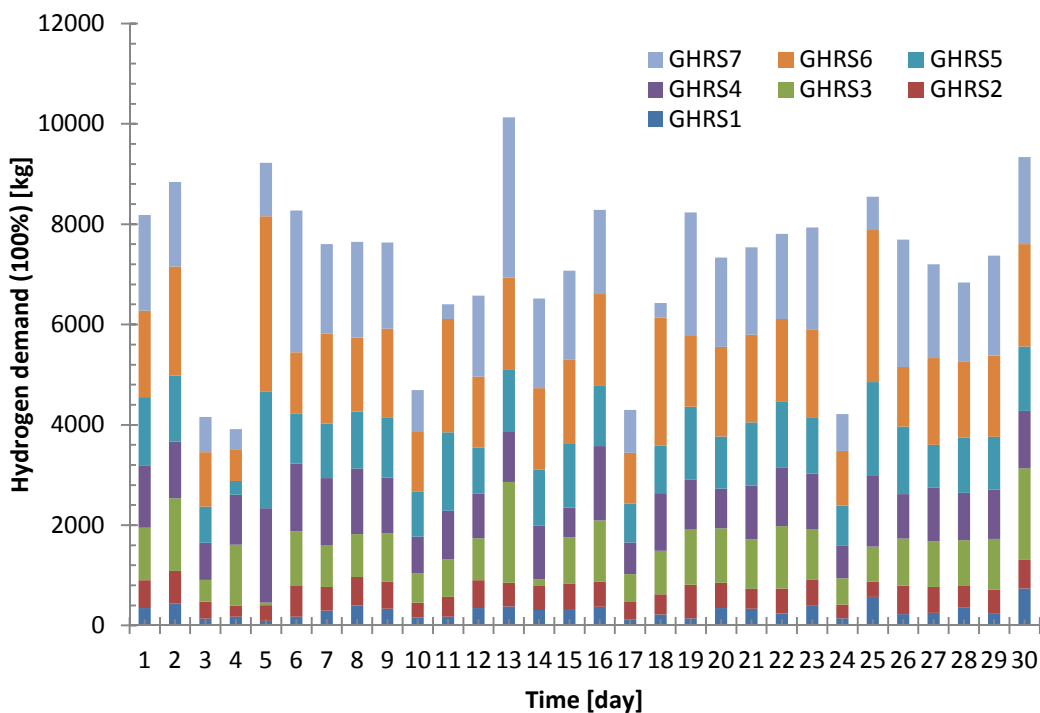

Figure 5.27 Hydrogen demand of the network of GHRs

Figure 5.28 shows the daily electrical energy needs of the GHRs, they range between 1.7 and 318 kWh. These demands are related to the real consumption recorded at petrol stations available in the province of Savona. These demands are almost coming from the electric network, but, since in this study, the GHRs is mentioned, this means that electricity consumption needs to be satisfied by the energy produced by renewable energy system. These demands are mainly coming from lighting, pumps, vehicles machine washes and others. The difference in electricity consumption among refueling stations is mainly due to the availability or not of special services (for instance, car washes machine) and to the demand of hydrogen for vehicles at each time instant that is directly linked to

the pumps consumption. The electrical energy demands used in this case study are calculated according to the scenarios of the market penetration.

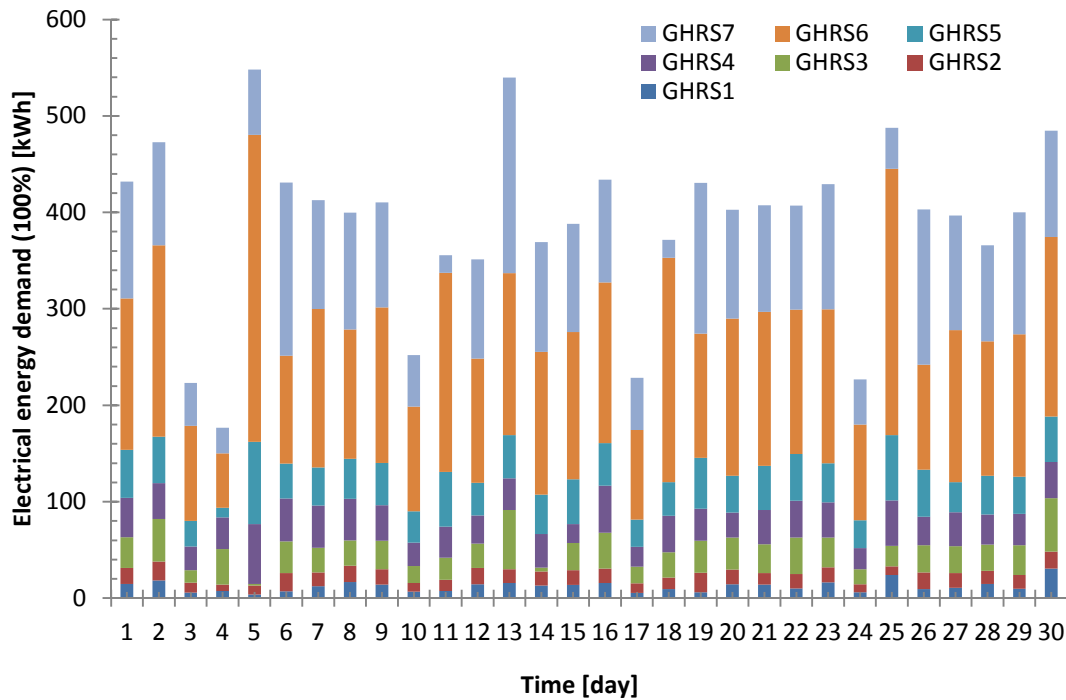

Figure 5.28 Electrical energy demand of the network of GHR5

Figure 5.29 displays the daily energy produced by the mixed renewable energy system, we should notate that no distinction is been considered between the energy produced by wind turbines and photovoltaic modules, It is assumed that it is a clean energy produced by a renewable energy system, since the economical aspect is not taken into account in this study. The daily produced energy ranges between 31 and 188 MWh. Figure 5.30 shows the daily energy sent to the electrolyser plant according to the three scenarios of market penetration in order to produce hydrogen. Figure 5.31 reports the daily electrical energy surplus sold to the electrical network according to each scenario, it can be seen that the most part of electrical energy has been sold in scenarios where the market penetration equals to 5% followed by 15%, while in the third scenario (25%) the system did not exchange energy with the electrical network. This is due to the low demand of hydrogen with a high energy production in the two first scenarios and a high hydrogen demand in the third one. Figure 5.31 displays the daily electrical energy supplied to the network of GHR5 to satisfy their electrical energy needs including the energy consumed by the local hydrogen storage tanks.

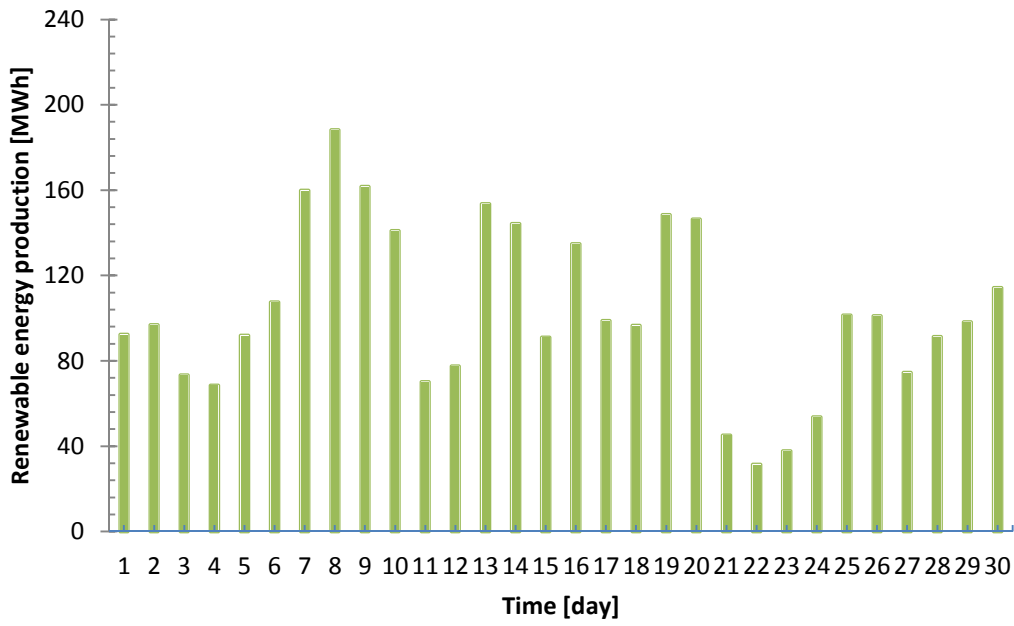

Figure 5.29 Energy produced by the mixed energy system

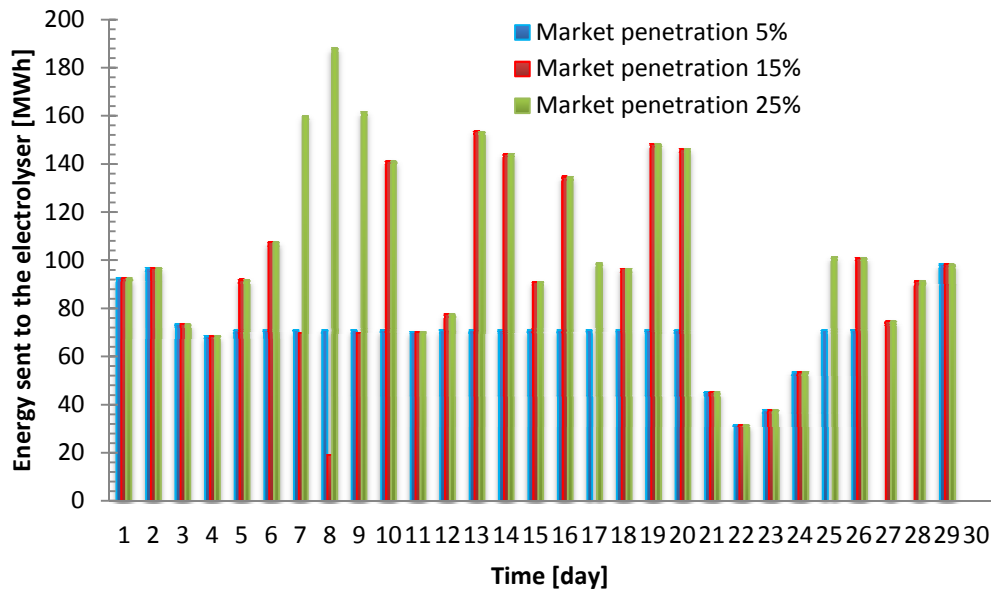

Figure 5.30 Electrical energy sent to the electrolyser plant

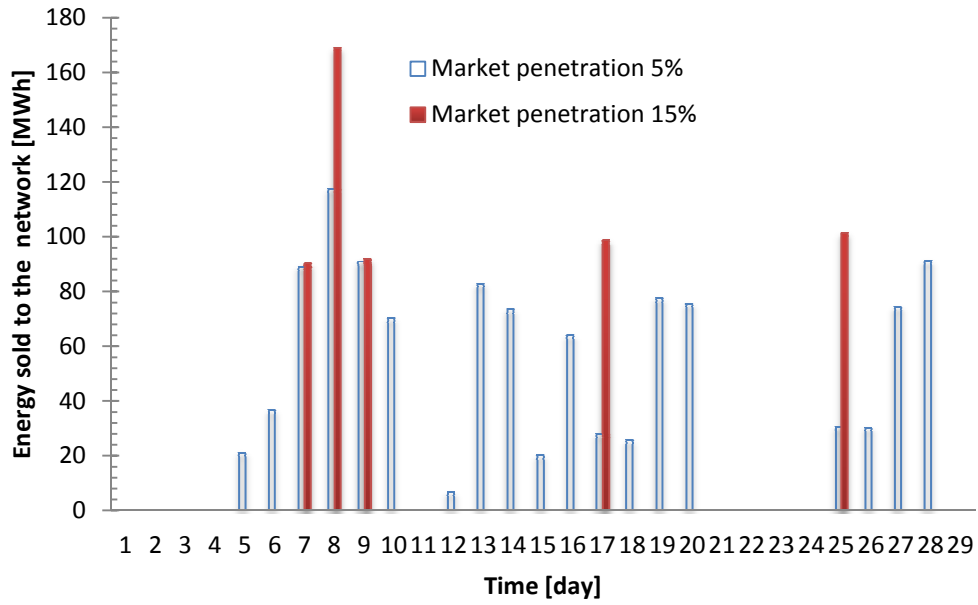

Figure 5.31 Electrical energy sold to the network

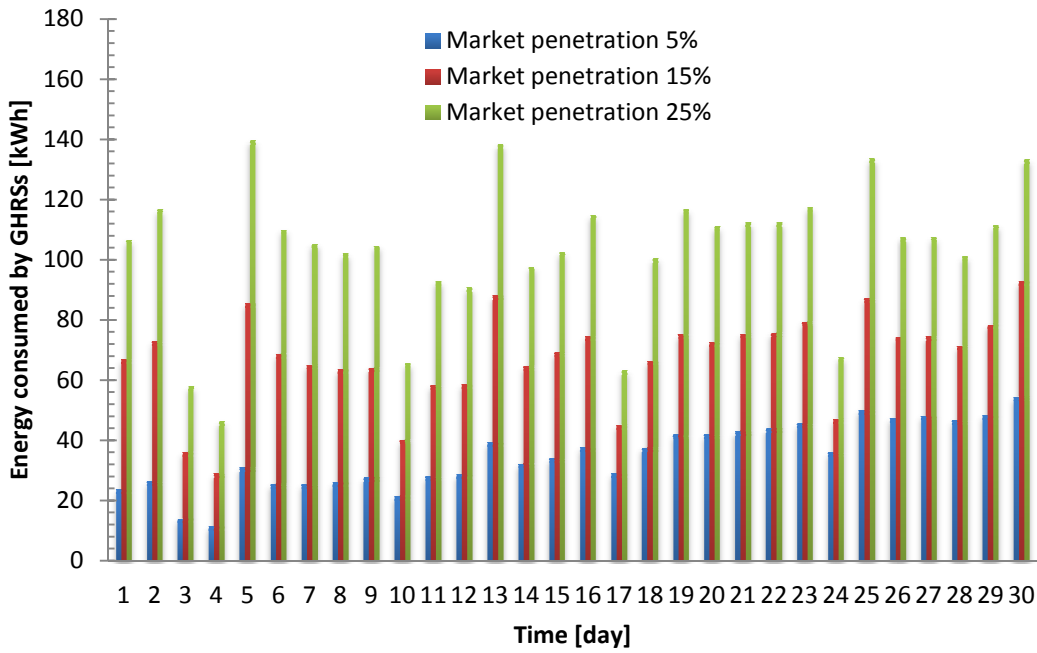

Figure 5.32 Electrical energy consumed by GHRs

Figure 5.33 shows the trend of the energy stored along the month in the main hydrogen storage tank according to the scenarios of the market penetration. It appears that the higher amount of hydrogen stored is reached for a market penetration equals to 5% which is due to the low hydrogen demand.

Figures 5.34, 5.35, 5.36, 5.37, 5.38, 5.39 and 5.40 show the level of hydrogen in each local storage system according to the three scenarios of the market penetration. It is observed that each GHRS exhibit a various storage tendency than the other which is mainly due to the difference in hydrogen demands. It appears from the figures that once the market penetration level of hydrogen increases the level of hydrogen stored in the hydrogen refuelling stations as well as in the main storage system is increasing dramatically. This remark is mainly due to the augmentation of the hydrogen vehicles which necessitates more hydrogen demand. For the same market scenario, the change in the storage level is also dependent on the time of the week and on the size of the refuelling station that serve hydrogen.

P153-156 : Il faut mieux expliquer pourquoi quand la pénétration sur le marché augmente, le stockage augmente (changement de répartition du stockage ?).

In general, all demands are always satisfied in each time period and for each scenario.

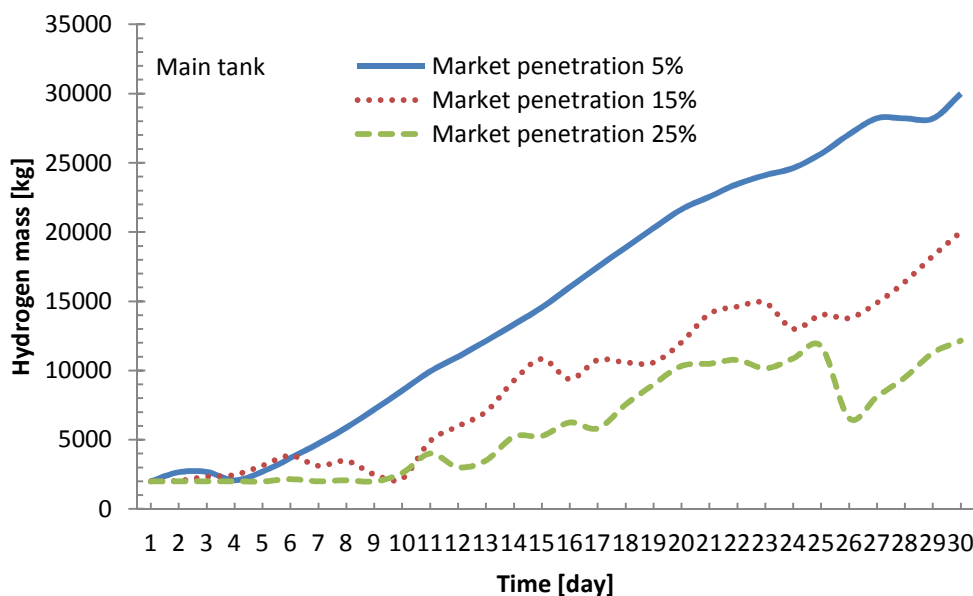

Figure 5.33 Hydrogen storage level of the main tank

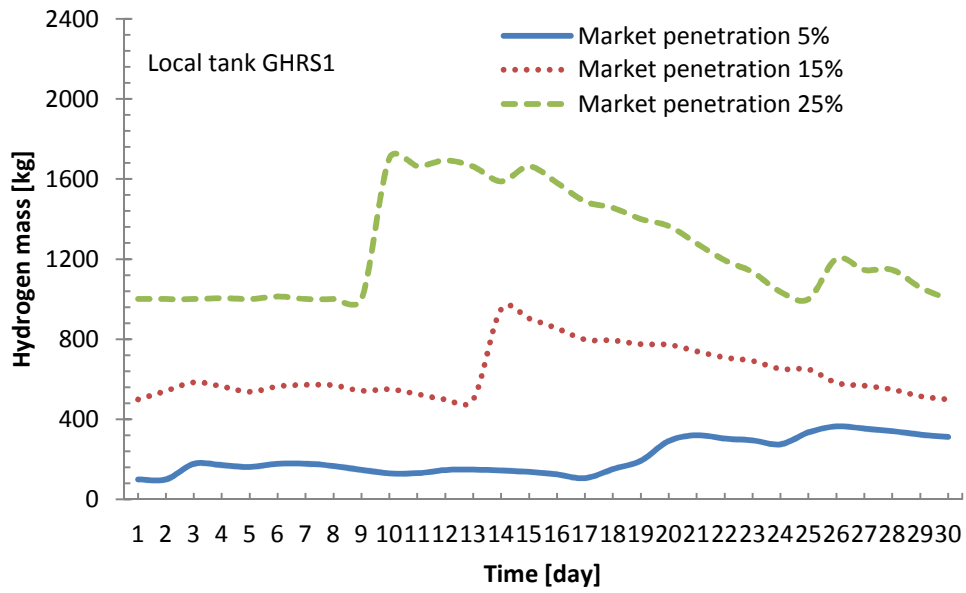

Figure 5.34 Hydrogen storage level of GHRS1

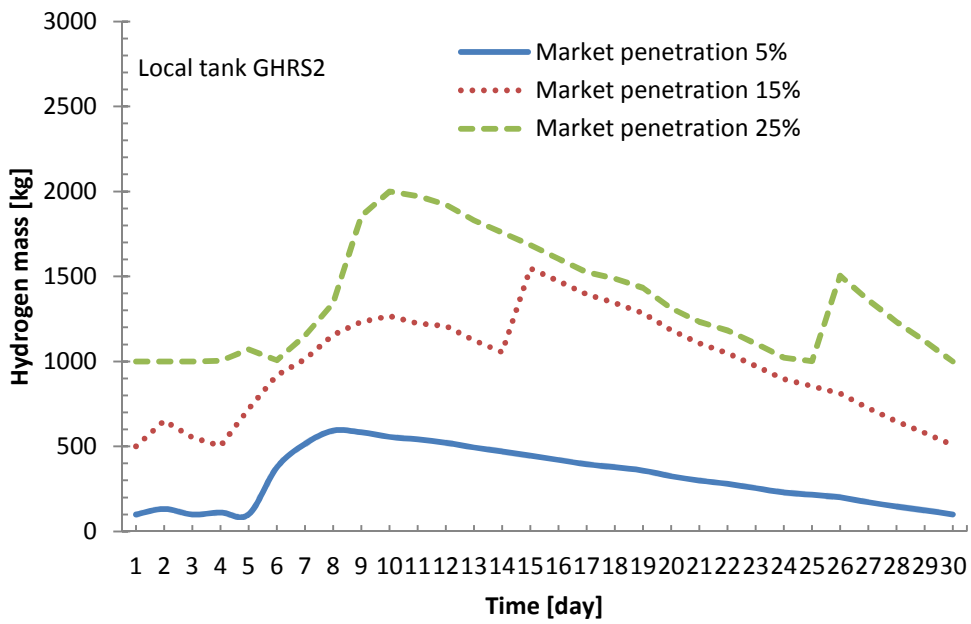

Figure 5.35 Hydrogen storage level of GHRS2

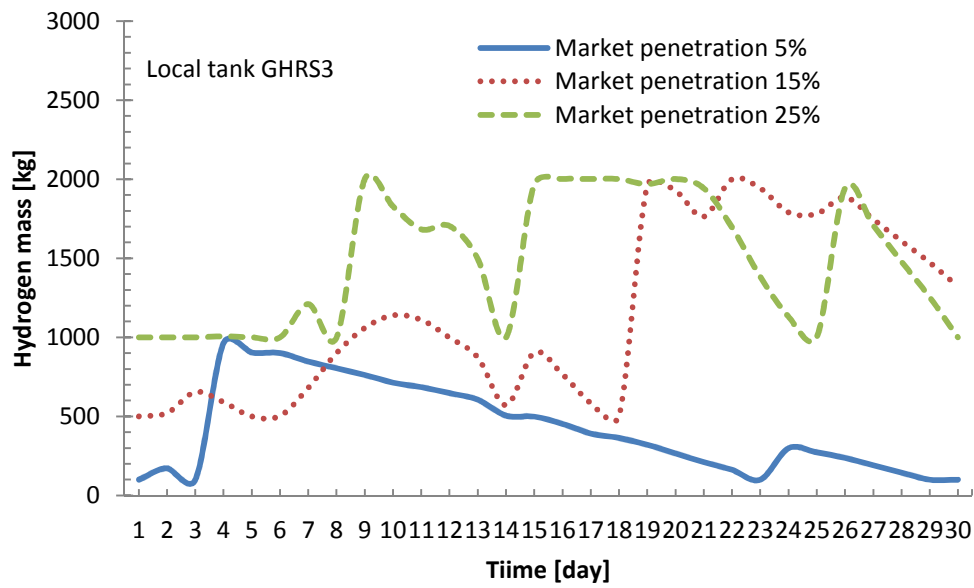

Figure 5.36 Hydrogen storage level of GHRS3

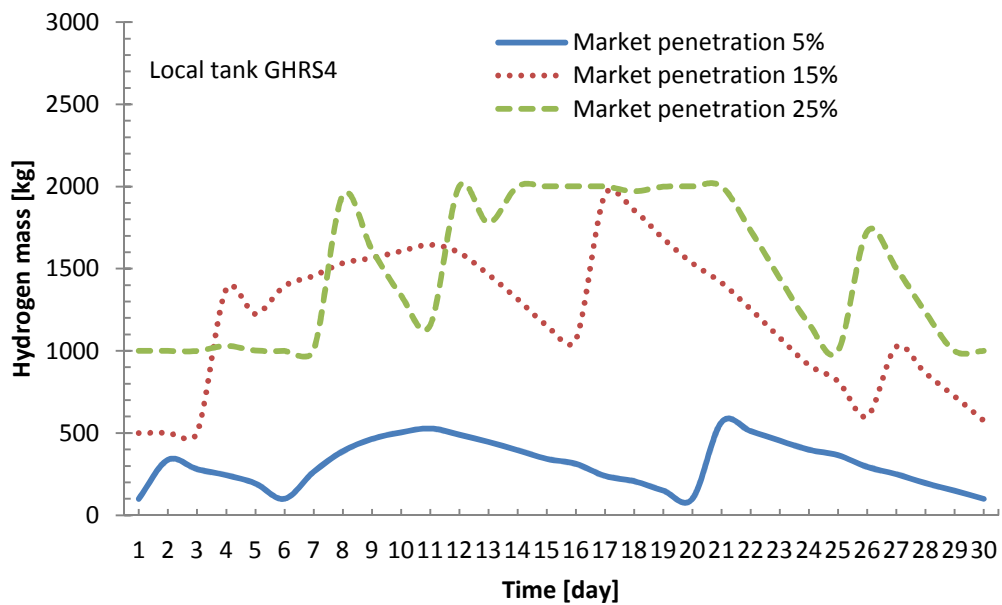

Figure 5.37 Hydrogen storage level of GHRS4

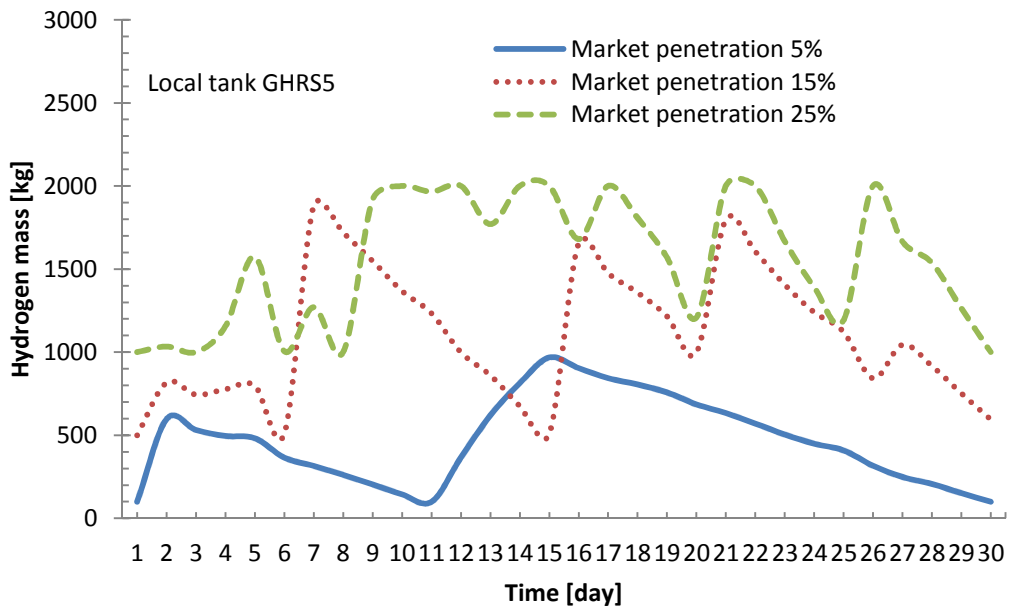

Figure 5.38 Hydrogen storage level of GHRS5

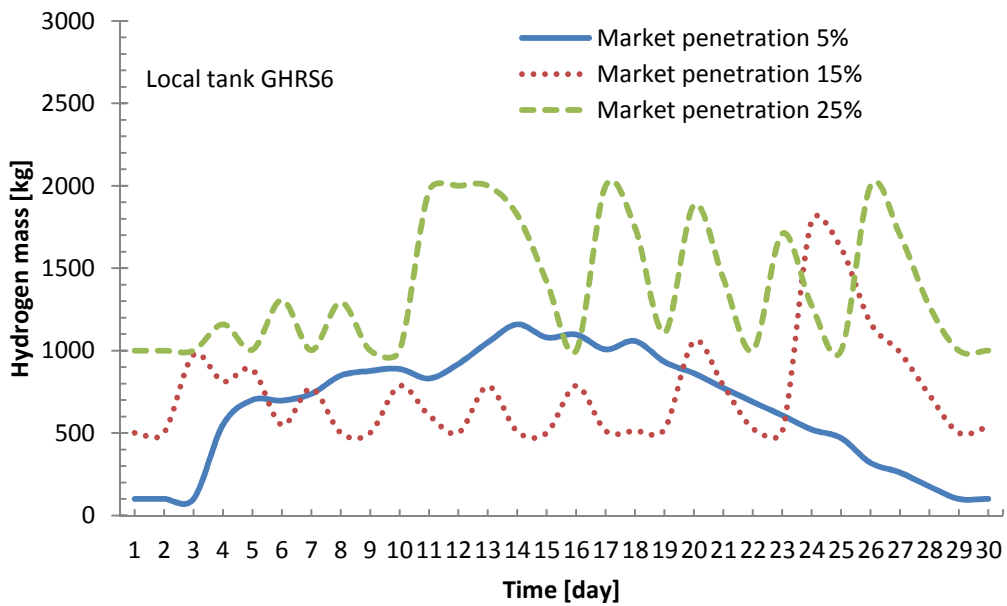

Figure 5.39 Hydrogen storage level of GHRS6

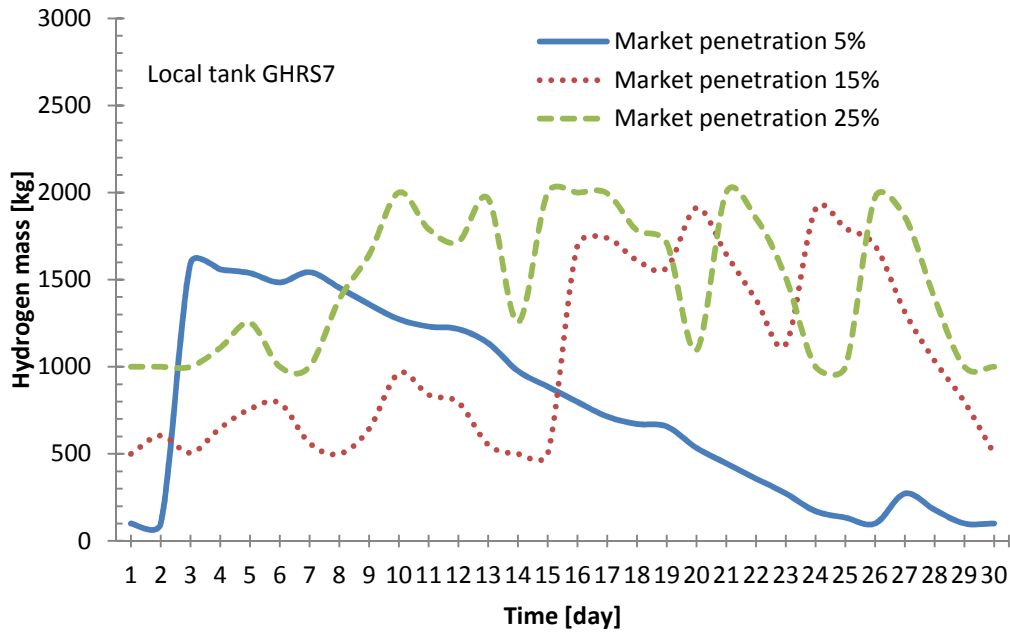

Figure 5.40 Hydrogen storage level of GHR7

5. Conclusion

An optimization model of a network of GHRs is presented. The network of GHRs is completely powered by mixed renewable energy systems. The main decisions within the problem can be categorized into two types: First one related to optimal selection of the network of GHRs following roads network distance and population density criteria, while the second is the control and management of the hydrogen and electric flows that are sent to the GHRs. The optimization model has been simplified, and then applied on one month basis to a case study in the province of Savona, Italy. Optimal results are reported taking into account the presence of an additional hydrogen industrial market and a connection with the electrical network. Results show that the demands are satisfied for each time period and for all market penetration scenarios. Future developments of the present work regard the possibility of introducing stochastic issues both in demand and resource predictions. In this case, in order to reduce the overall complexity of the problem, dynamic programming could be used. Then, the model could be detailed from the electrical and technological point of view. Moreover, an objective function based on hydrogen costs could also be adopted. Finally, the inclusion of the developed dynamic decision model in a decision support system could be helpful since it can allow to the user to interact with the mathematical models.

Chapitre 6 : Decision support system based on risk criteria for the hydrogen infrastructure implementation

De nombreuses études ont affirmé que les infrastructures des stations de services sont l'un des obstacles les plus significatifs pour une transition réussie vers un système de transport routier à base d'hydrogène (DOE, 2002; Melendez, 2006; Ogden, 1999). De nos jours, la majorité des travaux de recherche publiés dans ce domaine traite le problème d'un point de vue lié à la demande d'hydrogène, aux coûts associés, à la pénétration sur le marché et à la distance pour alimenter les véhicules à hydrogène. A notre avis, l'accent doit être donné en amont, en particulier par rapport aux critères de sélection liés à la localisation de ces stations par rapport aux ressources de production. L'objectif de cette partie est de présenter une approche intégrée considérée comme un système d'aide à la décision pour la sélection des stations services en hydrogène. La méthode combine deux approches différentes: une analyse détaillée des données spatiales utilisant un système d'information géographique (SIG) avec un modèle d'optimisation mathématique. Concernant le SIG, les critères relatifs à la demande en hydrogène et à la sécurité sont considérés pour la sélection des stations d'hydrogène, tandis que dans le modèle mathématique d'autres critères sont abordés, tel que le coût d'installation. En général, le système d'aide à la décision permet d'identifier les sites appropriés fournissant des informations sur une échelle multicritères pour la localisation de l'infrastructure d'hydrogène. La composante SIG sera appliquée à la région Ligurie, au nord de l'Italie, tandis que l'application du modèle mathématique est projetée comme un travail futur, car le modèle est encore en phase de développement.

Dans cette étude, une approche empirique est proposée pour évaluer le risque d'un scénario accidentel dans les canalisations à haute pression d'hydrogène. L'approche vise à étudier les effets des conditions d'opération de l'hydrogène, ainsi qu'à analyser les différents scénarios d'échec. L'étude comprend également une analyse des risques pour l'évaluation des zones endommagées, tenant compte de la densité de la population qui vit dans le voisinage. A cet égard, un développement futur peut être inclus pour le modèle global résultant comme un complément spécifique sur les logiciels classiques des systèmes d'information géographique pour l'évaluation des risques dans la planification de pipelines d'hydrogène. Cette partie présente un outil d'ingénierie utile, afin d'établir les exigences de sécurité liées à la définition des zones adéquates de sécurité pour les canalisations d'hydrogène, assurant ainsi la sécurité des personnes ainsi que l'environnement.

A-Novel approach to develop alternative transition toward the implementation of green hydrogen infrastructure

1. Introduction

Many studies have claimed that refueling infrastructures are one of the most formidable barriers to a successful transition to a hydrogen-based road transportation system (DOE, 2002; Melendez, 2006; Ogden, 1999). To the author's knowledge, to date, papers have treated the problem from the point view of hydrogen demand, costs, market penetration, and distance to fuel hydrogen vehicles and areas of interest. More emphasis must be given upstream the hydrogen refueling stations network, in particular to criteria of selection related to the locations of resources of production. The overall objective of this chapter is to present an integrated approach considered as a decision support system for the selection of hydrogen refueling stations. The method combines two different approaches: a detailed spatial data analysis using a geographic information system with a mathematical optimization model of set covering. Regarding GIS component, criteria related to the demand and safety are considered for the selection of the hydrogen stations, while in the mathematical model, criteria that regard costs minimization are considered. In general, the DSS will identify the suitable sites providing information on multi-criterion level evaluation of locating the hydrogen infrastructure. The GIS component of the integrated approach will be applied to the region of Liguria, North of Italy, while the application of mathematical model is projected as a future work since the model still in the development phase.

2. Method description

2.1 GIS based approachdecision

The GIS based modelling is implemented as a first stage of decision support system (DSS) in order to find whether a location is convenient to be a future hydrogen refueling station or not.

The geographic information system is employed to study the spatial relationships that exist between the hydrogen demand, future location, primary resources and existing petrol infrastructure that could be considered as a potential site for hydrogen exploitation. This tool requires the use and integration into one component sources of spatial data from national organizations, local authorities or private companies for the characterization of the area. It help to now the nature and location issues such as population, personal property, the public buildings, the water system, transport infrastructure, areas of nature conservation etc (Garbolino, 2009).

This section of GIS-based modelling is developed at regional scale considering various market hydrogen penetration levels. The analysis was done basing on previous works of (Johnson et al, 2008; Johnson et al 2005).

Even though, it is important to highlight that decision support systems based on GIS, but alone, it is not ideal for the planning of future infrastructure, in particular, hydrogen refueling stations. In a problem of location, the decision makers usually need to perform a selection study, and to choose among a combination of a large set of candidate sites which satisfy some predefined criteria. The GIS module can be considered as preliminary step to select the eligible hydrogen sites. As a result, the GIS tool could lead to a significant reduction of the number of locations that need to be implemented in the mathematical optimization problem, which may reduce significantly the computational time.

2.2 Mathematical optimization: model description

The second component of the approach deals with the mathematical optimization, where eligible hydrogen refueling stations locations, found by the GIS component are implemented as an input to find the optimal set of hydrogen refueling stations that satisfy optimization objectives.

The mathematical optimization is a cost driven where main objectives are to minimize the cost of installation of new onsite hydrogen refueling stations, the cost of conversion of existing gasoline to hydrogen stations and the cost of transporting hydrogen fuel to offsite stations. The model takes into account the cost minimization in order to select those hydrogen refueling stations, a priori - previously selected- by the first model based on the geographical information system.

The novelty of such study is to develop a decision support system for the localization of hydrogen refueling stations taking into account the potential of production within a specific boundary region. Figure 6.1 represents the general model components and architecture.

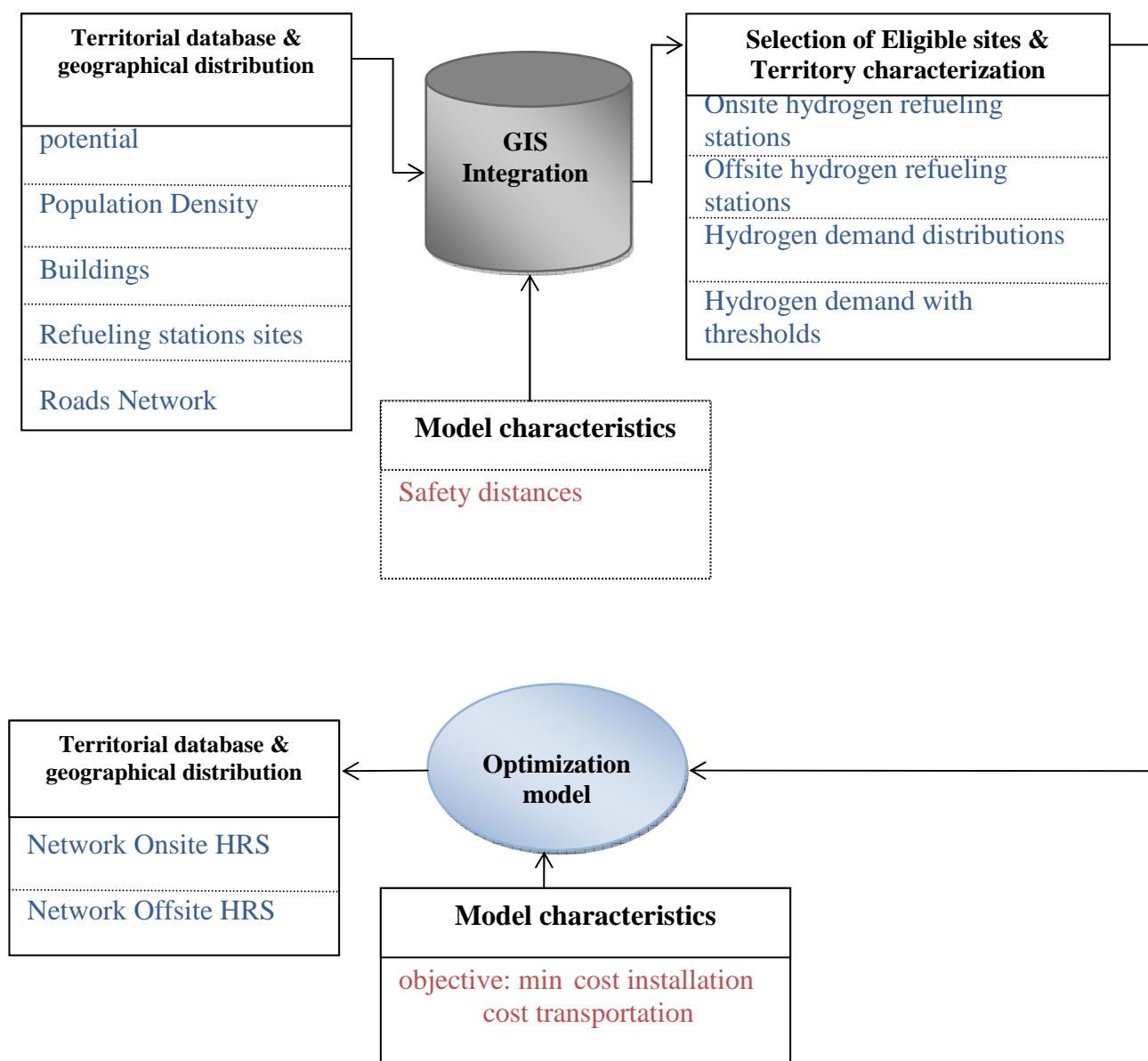

Figure 6.1 Model components displaying both modules considered

2.3 Model characteristics

2.3.1 Hydrogen refuelling stations: type and scale

It is important to understand the function of the service station, which may be simply be a dispensing station (off-site hydrogen refueling station), having hydrogen stored in reservoir or both a production and dispensing station (on-site hydrogen refueling station). Figure 6.2 display different configurations of renewable hydrogen refueling stations that may exist.

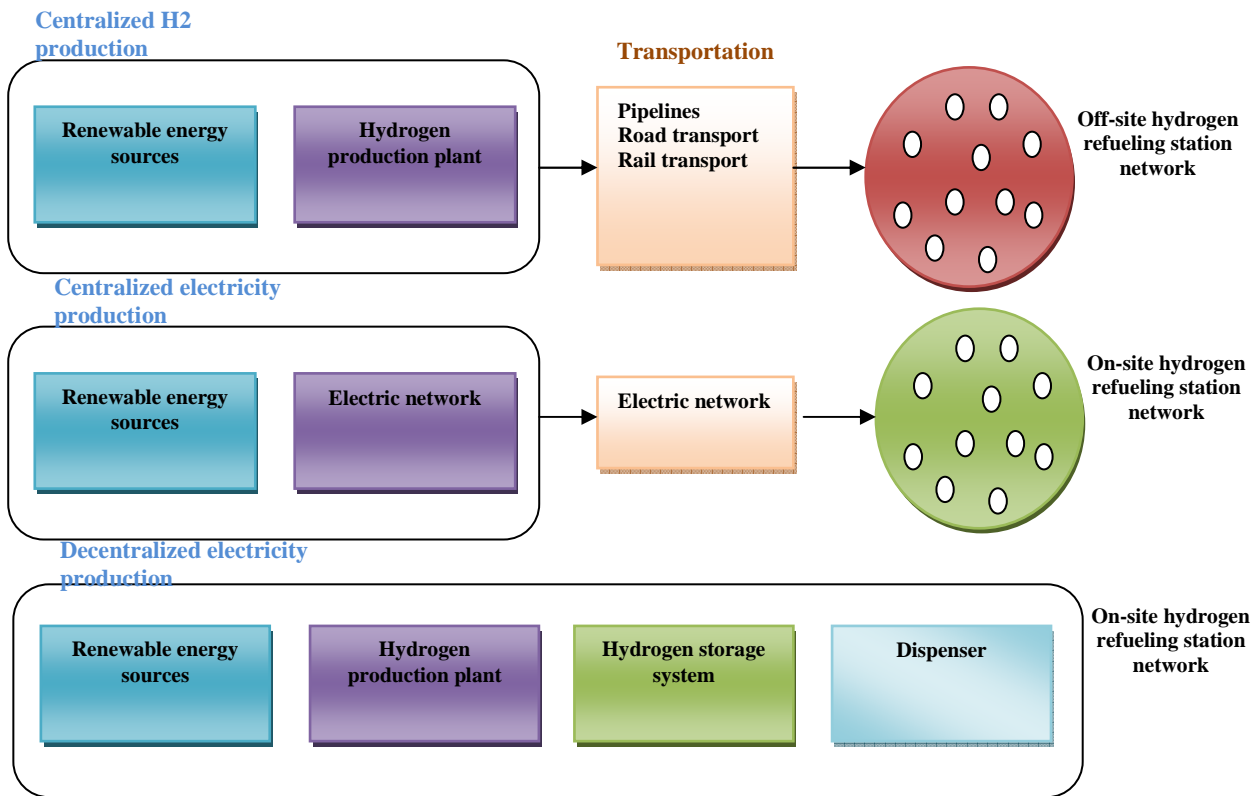

Figure 6.2 Configurations of hydrogen refueling stations driven by renewable energy

One particularity of the proposed approach is the adoption of a combination of onsite and offsite hydrogen refueling stations that are considered as an input for the model.

During the current study, two configurations are considered:

- The onsite hydrogen refueling stations (Figure 6.3)
- The offsite hydrogen refueling stations (Figure 6.4)

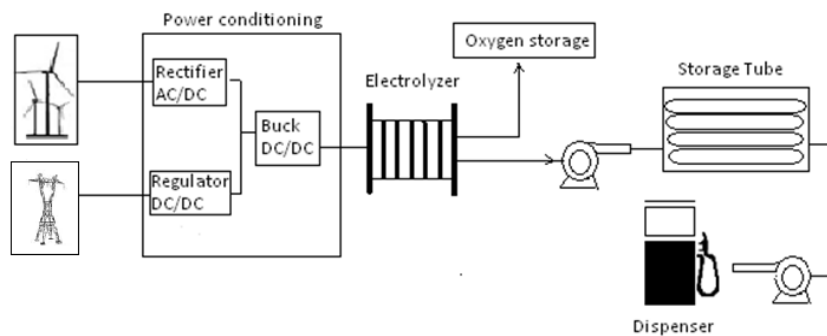

Figure 6.3 Electrolysis onsite hydrogen refueling station

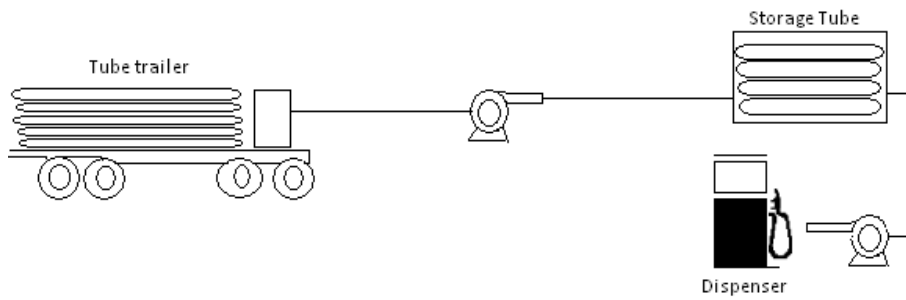

Figure 6.4 Offsite hydrogen refueling station

However, the main goal is to determine the optimal placement for the two types of hydrogen refueling stations noted above. The problem has been solved assuming two scenarios for hydrogen refueling stations:

- Scenario 1: conversion of petrol stations to hydrogen stations. This scenario is been implemented assuming that Petrol companies will then represent one of the major categories of hydrogen producer. This analysis also can be undertaken to avoid in somehow the most haphazard placement of hydrogen station.
- Scenario 2: installation of new hydrogen stations. The scenario is been implemented to take into account the onsite hydrogen station, because, a priori scenario 1, alone may not cover the demand due to the geographical location and hydrogen production potential within the station.

2.3.2 GIS Selection criteria

- **Hydrogen demand**

The hydrogen demand is one of the important criteria that must be taken into account for the localization of the station. From a demand viewpoint, the selection will depend on the spatial distribution of the hydrogen demand basing on the specific market and population data.

Methodology proposed by Ni et al (2005) is adopted and adapted according the proposed case study. The calculation method is based on the population, a multiplier of for the number of vehicles per person, another multiplier for the fraction of hydrogen that use hydrogen fuel, and a multiplier related to fuel economy of hydrogen vehicles as given in equation (6.1):

$$\text{Hydrogen Demand Density [kg H}_2\text{/day/km}^2\text{]} = \text{Population Density [people/km}^2\text{]} \times \text{Vehicle Ownership [0.7 LDV/person]} \times \text{Market Penetration Rate (5\%, 10\%, 40\%, 60\%, 80\%, and 100\%)} \times \text{Fuel Use (0.6 kg H}_2\text{/day/vehicle)} \quad (6.1)$$

Basing on the GIS, the hydrogen demand is calculated on a spatial basis, where various thresholds values are used to identify demand density areas, since only those areas with sufficient hydrogen demand can be assumed to be viable locations for refueling stations opening.

It is important to underline that the hydrogen demand also depends strongly on the market penetration of the hydrogen vehicles. However, the accurate knowledge of the hydrogen market penetration is a hard task, especially because of the uncertainty in supply and demand (related to the chicken and eggs dilemma). Consequently, the current model adopts steady scenario assuming various values for the hydrogen market penetration. Six scenarios for hydrogen market were implemented here (6%, 10%, 40%, 60%, 80%, and 100%). For instance, at 6% market penetration, it is assumed that 6% of the vehicles in the entire region are hydrogen fuel cell vehicles that are in operation within these areas.

- **Safety criteria**

Another criterion that may play increasing role in the selection process of hydrogen refueling stations is related to the safety issues. In fact, refueling station must be adequately located in order to better serve demand of a specific category of hydrogen fuel vehicle users, but, in the same time, they must avoid high risk that can bring to populations and environment.

Two methods could be used to evaluate whether a location can be considered as eligible one or not. These methods are: risk assessment (quantitative & qualitative) and analysis of safety distances. The latter is adopted to justify the permitting process of hydrogen refueling station. The choice of such approach is related to lack of complete data to complete the quantitative risk assessment. The current work will estimate the safety distance from a refueling stations basing on an approach by consequence, where consequence of worst possible scenario is considered to set adequate safety distances. In this context, explosion represents the worst scenario, as stated by (Zhiyong et al, 2010), the explosion produces the longest harm effect distances, both to people and to equipment. The main attention to the introduction of hydrogen refueling station presented will be a macro-scale level, which reflects the outside risk to people and environment nearby. This method is recognized by many authors to be an effective method, which must be used primary in the approval process of hydrogen refueling stations.

3. Hydrogen refuelling station components

The safety distance from a hydrogen refueling station will be determined assuming gaseous fuel stations. These station type may include equipment for the supply, compression, storage, and dispensing of fuel. The failure may occur in any part leading to a scenario of high consequence. The distance required to mitigate the exposure of the target would differ depending on what is the source of the release or kind of failure. Figure 6.5 presents the general components of onsite and offsite HRS that will be considered.

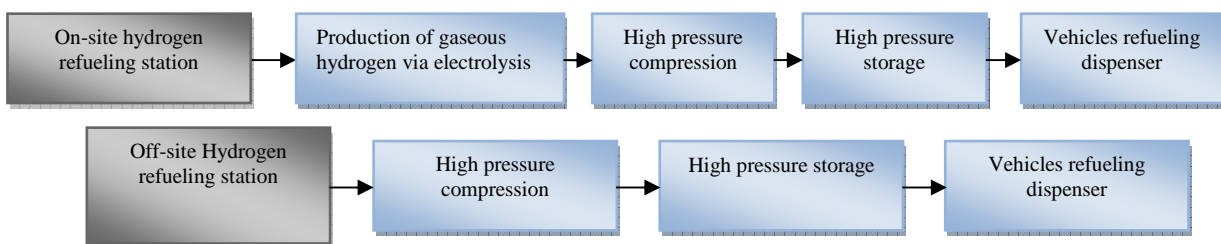

Figure 6.5 General components of hydrogen refueling station

Hydrogen production system: hydrogen is produced onsite by electrolysis process driven by wind turbine or electricity coming from different sources, namely, wind, solar and electric network. The electrolysis process is driven by an alkaline type, which is the most mature electrolysis technology used today. It is assumed that one unit electrolyser is installed. It operates at a rate of 10 Nm³/h, with a consumption of water equals to a value of 7.8 lt/h. Hydrogen is produced at a pressure of 4bar. **Hydrogen compressor system:** the compressor is an essential element of the refueling station, whenever the type of this latter (onsite or offsite). Here, the compressor allows a compression of hydrogen from 4 bar to 200 bar. The compressor is installed with the electrolyser in the same enclosure. **Hydrogen storage system:** The hydrogen station is equipped with hydrogen cylinders for the storage of hydrogen, where the capacity of each is between 30 to 300 kg. The main difference between the stations storage capacities lead into their capacities to refueling cars (how many cars are refueled daily), and the quantity of hydrogen storage in the inventory of each one.

4. Consequence of worst scenario: Explosion

- **Scenario of failure at the hydrogen refueling station**

The hazard source within a hydrogen refueling station can be any object (installation, equipment, construction, machinery, etc) that handle hydrogen and which may create a hazard to its

surroundings. Gaseous hydrogen refueling stations either onsite or offsite mainly consists of compressor, storage tank, piping system which link different components to each other. Owing to this architecture, the hazard may arise from component failure, operational mistake from various sources and in a number of ways (leak, full bore...). The distance required to mitigate the exposure of the target would differ depending on what is the source of the release or kind of failure. Table 6.1 reports different accidents that may derive from different components of the stations which may result of potential explosion of gaseous hydrogen, two databases have been used (CEC, 2005; <http://www.h2incidents.org>). These accidents can lead to a potential of exposing the third party (outside the station), which are of our interest in this study:

Components involved	Scenarios	Failure
Offsite hydrogen refueling station	Tube trailer	accident, compressed trailer Leak, failure of pressure relief device, failure of tube on trailer
	compressor	valve on discharge of compressor fails closed, high pressure hydrogen supply, line to station failure, leak from compressor
	Storage tank	Relief device failure (on cylinders) fails Open, storage tank failure, piping leak
	Dispenser	Piping failure,drive away while connected to dispenser, hose failure, vehicle pressure relief device leaks, vehicle tank backflows through, dispenser vent
Onsite hydrogen refueling station	Electrolyser system	exposed electrical circuit, rectifier startup, hydrogen gas leak or full rupture of pipe, electrolysis gas vent valve leaks
	Compressor	compressor line failure, compressor seal failure, failure compressor valve, hydrogen supply line failure
	Storage tank	overpressure and fail storage tank, storage tank failure, relief device failure fails open
	Dispenser	Piping failure, drive away while connected to dispenser, hose failure, vehicle pressure relief device leaks, vehicle tank backflows through dispenser vent

Table 6.1 Accidents leading to explosion for onsite and offsite station (CEC, 2005; <http://www.h2incidents.org>)

5. Harm criteria for explosion

5.1 Harm to people

The possible effect of overpressure on humans includes direct and indirect effects. The main direct effect is the sudden increase in pressure that can cause damage to pressure-sensitive organs such as the lungs and ears. Indirect effects include the impact from fragments and debris generated by the overpressure event, collapse of structure, and heat radiation (from fireball generated from by vapor cloud explosion) (Jeffries 1997). For people, harm criteria can be expressed in terms of death or injury. The level of person harm is dependent upon factors such as the age of the person, the exposure time. Table 5.2 represents the damage caused by an overpressure to people.

Effect type	Overpressure	Damage description
Direct effect	0.138	Threshold for eardrum rupture
	0.345-0.483	50 % probability of eardrum rupture
	0.689-1.03	90 % probability of eardrum rupture
	0.82-1.03	Threshold for lung hemorrhage
	1.38-1.72	50% probability of fatality from lung hemorrhage
	2.07-2.41	90% probability of fatality from lung hemorrhage
	0.48 4.83-13.8	Threshold of internal injuries by blast Immediate blast fatalities
Indirect effect	0.10-0.20	People knocked down by pressure wave
	0.14	Possible fatality by being projected against obstacles
	0.55-1.10	People standing up will be thrown a distance
	0.069-0.13.8	Threshold of skin lacerations by missiles
	0.28-0.34	50% probability of fatality from missile wounds
	0.48-0.69	100% probability of fatality from missile wounds

Table 6.2 Direct and indirect on people damage due to overpressure (Jeffries 1997), (LaChance et al, 2010)

It can be shown from table 6.2 that the threshold overpressure for no "direct" harm is 0.138 bar, while no "indirect" harm is equal to an overpressure of 0.069 bar.

A mathematical parameter that can join the people harm caused by the overpressure to the peak overpressure is named probit function. The probit function that estimates the fatality level for explosion due to overpressure is expressed in percentage and is given by (Eisenberg et al, 1975):

$$Pr = -77.1 + 6.91 \ln(P_s) \quad (6.2)$$

where P_s is the overpressure

5.2 Harm to structures

According to Table 6.3, the overpressure caused by the explosion has a minimum threshold equals to 0.01 bar and which correspond to the threshold for glass breakage.

Overpressure (bar)	Damage description
0.01	Threshold for glass breakage
0.15-0.20	Collapse of unreinforced concrete or cinderblock walls
0.2-0.3	
0.35-0.4	Collapse of industrial steel frame structure
0.7	Displacement of pipe bridge, breakage of piping
0.5-1	Total destruction of buildings; heavy machinery damaged
	50e100 Displacement of cylindrical storage tank, failure of pipes

Table 6.3 Damage to structures and equipment due to overpressure (Guidelines, 1998)

Similarly to harm to people, Einsenbergs has introduced a mathematical formula that enables the calculation of the probit function due to harm to structure and others equipment. The formula calculates the total damage that results from an overpressure.

$$Pr = -23.8 + 2.92 \ln(P_s) \quad (6.3)$$

where P_s is the overpressure

An estimation done by LI. Zhiyong et al (2011), have assumed that 100% lethality is obtained for an overpressure of 0.3 bar and 0% lethality for lower overpressure levels for people outdoors (outside boundary of the station). Results published by Rosyid are used. In its thesis model, Rosyid concludes that the effect zone due to an explosion could be represented by a circle or ellipse centered at the release point of hydrogen. In their results, the effects zone due to the explosion caused by a liquid release are much more higher than those reached for the case of gaseous hydrogen release by about 3 times. This remark could enhance the safety by using gaseous HRS. Table 6.4 displays the safety distance assumed in this study, for the two types of hydrogen refueling stations, and for different capacities of inventories available at the station. It can be shown that the capacity of inventory has a major role to define the radius of the effect zone around the station.

Type	Station size	Storage capacity (kg)	Safety distance (m)
Onsite Electrolysis hydrogen refueling station	<i>Small</i>	30	150
	<i>Large</i>	420	334.4 (<i>early explosion</i>) 341.2 (<i>late explosion</i>)
Offsite compressed hydrogen refueling station	<i>Small</i>	30	100
	<i>Medium</i>	100	125
	<i>Large</i>	300	300

Table 6.4 Threshold between effect distances for "no harm"

6. GIS based on safety distance criteria

Through the definition of the harm distances or distance with high risks, GIS is deployed to create an overlapping map between the hydrogen refueling station to be installed on the specific territory and the harm distance observed in case of explosion around the station. This procedure is entitled hazard mapping. In our approach, once developing the hazard mapping, another overlapping will be created by combining this latter with the density of population of the region and land use of the region. Refueling stations that have part of the territory that collapse presence of population and harm distance will be not considered for the conversion or installation.

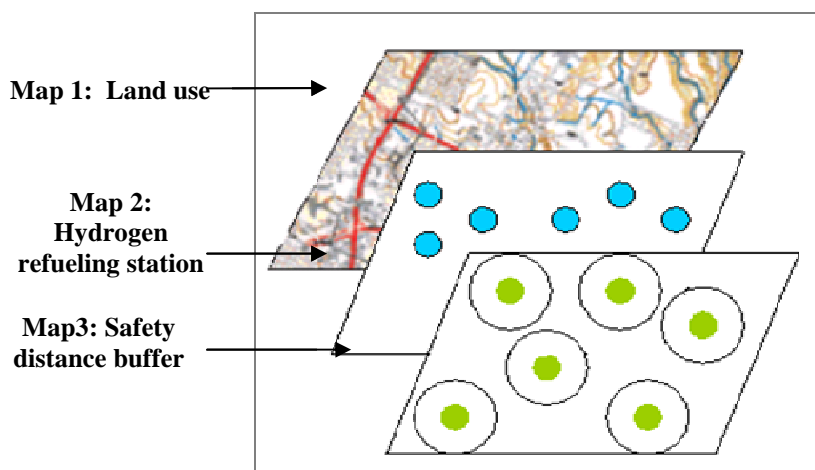

Figure 6.6 GIS based study on risk based decision support

The GIS based decision support system is performed. It consists of four modules that are described hereafter:

Module 1: Buffer layer: The aim is to draw a buffer around all stations implemented in the study. The dimension of the buffer will reflect the safety distance associated with each type of hydrogen

refueling station to be implemented. The buffer regards the existing petrol stations that have the potential to be converted to hydrogen refueling station, and also the new onsite station that are set depending on the hydrogen production potential available within the territory.

Module 2: Population Intersect layer: During this phase, an intersection has been made between the buffers of all stations and the population of the region. The aim was to examine the location of the stations according to different levels of population. Three levels were made regarding the population. When the population is up to 50 thousands, the region can be categorized as Level I. Level II corresponds to region with population between 5 and 50 thousands and Level III for population under 5 thousands.

Module 3: Buildings Intersect layer: the same analysis was made to assess the distribution of station according to the spread and levels of buildings available within the Liguria region. Similarly, three levels were made to classify the density of presence buildings around the hydrogen station. Level I, buildings number up to 20 thousands, Level II for presence of buildings between 7000 and 50000 and finally Level III with a buildings number under 7000.

Module 4: This module aim to create a risk ranking matrix for both levels related to the population as well as the buildings. The aim of this module is not to make a detailed qualitative risk management, but just to exclude those station that have a higher rank regarding population as well as buildings number. We claimed that station within Level I for both population and buildings number are excluded.

7. Case study

The approach presented above is applied at a regional scale to a case study in the north of Italy. Various data are gathered and presented such as the availability of primary energy sources and their distribution, the hydrogen demand over the planning horizon and the future possible scenarios of hydrogen infrastructure. In this case study, hydrogen is assumed to be produced from renewable based electricity generation with the possible combination with the electrical network. The "clean feedstocks" in terms of renewable energy resources, mainly driven by solar and wind energy.

7.1 Hydrogen demand data

A GIS based method to model the magnitude and the spatial distribution of hydrogen demand is developed. the data used to perform the estimation of hydrogen demand maps is mainly articulated around the population data of the region, the area of the region to be studied, beside some others technical parameters. Steps used are described hereafter:

1. The population density of the region [people/km²].

2. An estimation of the hydrogen market penetration [%]
3. An estimation of the total vehicle available: [vehicles/km²] vehicle (or auto) ownership multiplied by the population density. For Italy, the ownership is assumed to be equals to 0.571 vehicles/persons.
4. An estimation of the hydrogen vehicle density [H₂ vehicles/km²]: obtained by multiplying the market penetration by the total vehicle available
5. An estimation of hydrogen demand density [H₂ kg/km²]: obtained by multiplying the hydrogen vehicle density by an average vehicle fuel use of 220 H₂/year/vehicle. This last amount is estimated basing on the fact that an average vehicle travel 25000 km/year and has fuel economy of 105 km/kg (equal to the one of gasoline by gallon)

Figure 6.7 displays the percentage of hydrogen demand covered by the main populated areas (Genoa, Savona, La Spezia, Albenga, Ventimiglia, Sanremo, Imperia, Chiavari and Rappallo). The histograms show the hydrogen demand in each area as a percentage of the total hydrogen demand in the region, for the specific scenario. It can be seen that Genoa city need around 54% of the whole demand of the region. Maps of hydrogen demand for the six different scenarios are given in Figure 6.8. It can be shown that hydrogen demand will begin with area with high population (up to 20000) for small hydrogen market scenario (6, 10%) with a value between 60000 and 600000 kg/year. This remark seems obvious since population density centers will be the ones that will implement the hydrogen fuel cell vehicles.

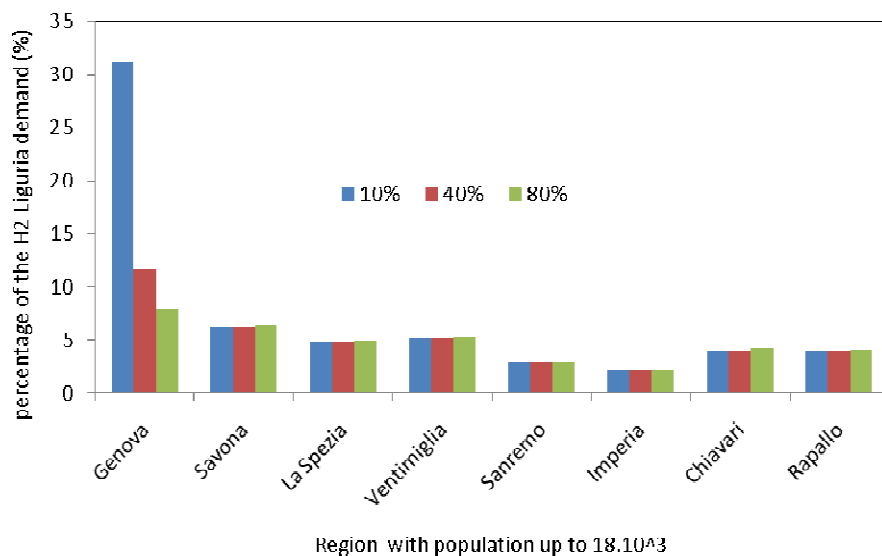

Figure 6.7 Percentage of hydrogen demand in most populated areas in Liguria

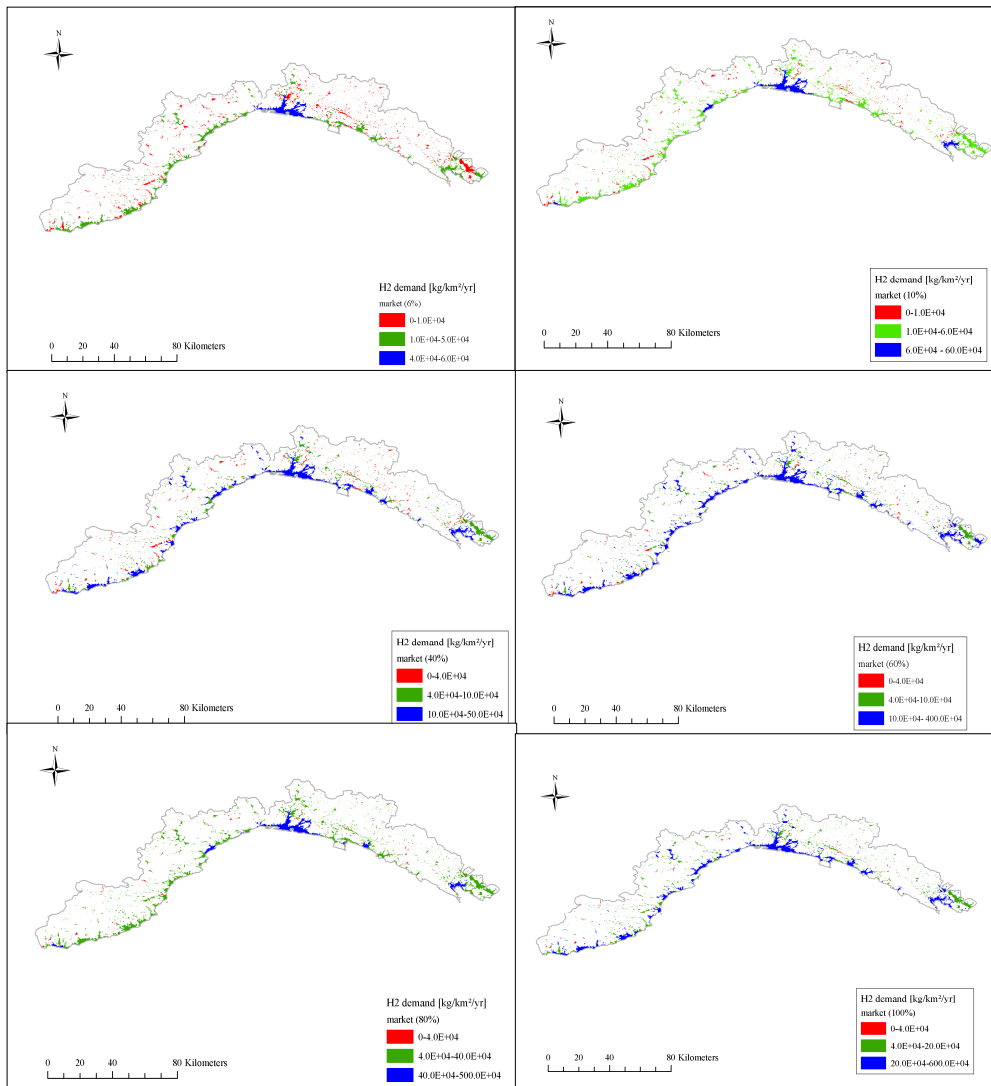

Figure 6.8 Snapshot of hydrogen demand for different scenario

7.2 Locations of hydrogen refuelling stations

The geographical location of the future hydrogen petrol station is based on the analysis of this information related to hydrogen potential production and main roads of the region. The most likely sites for alternative fuel refueling infrastructure were identified to satisfy the hydrogen demand and to minimize the risk. Different criteria were used to select several potential locations for hydrogen refueling stations including available infrastructure (roadways & highways), hydrogen market penetration, accessibility (remoteness of the station is avoided), locations of promising potential alternative fuel users, demand and population. Information related to existing petrol stations, and locations available for use as refueling sites were gathered, and displayed on Figure 6.9. While figure 6.10 displays the potential sites for the onsite hydrogen production.

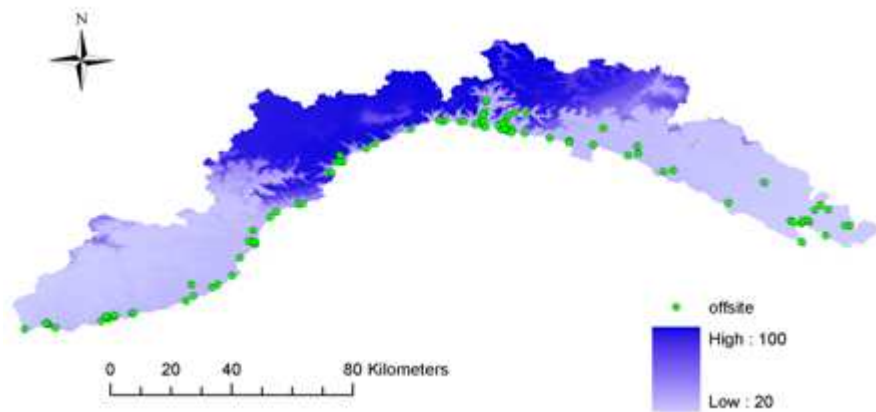

Figure 6.9 Offsite hydrogen refueling station sites

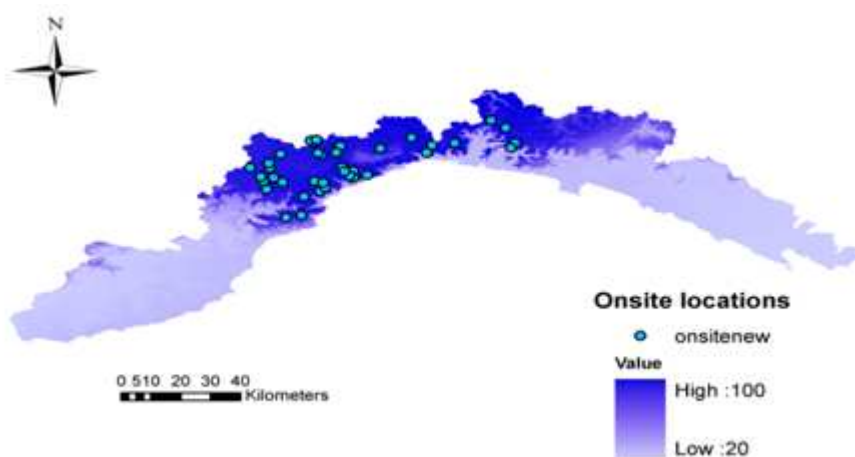

Figure 6.10 Onsite hydrogen sites

7.3 Eligible hydrogen refueling stations

As mentioned above, the decision support related to the risk aims to exclude all station that can bring higher risk to population and environment. Figure 6.11 displays the buffer of the onsite location, while Figure 6.12 is related to the buffer of the offsite locations. This GIS based decision support system, even it is a rough one, but it has enabled the reduction of 28 offsite station from a number of 93. As regards the onsite station, the procedure has enabled the exclusion of two stations. This remark is due to the low density of hydrogen in places of high hydrogen production potential. This remark could favor the installation process of new onsite station operating on the renewable energy resources.

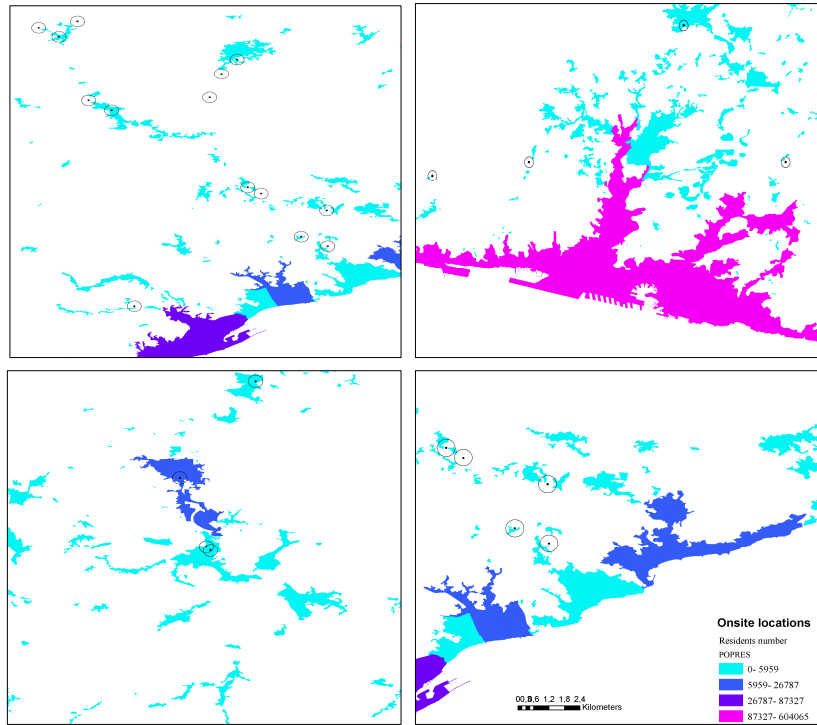

Figure 6.11 Onsite buffer location versus population

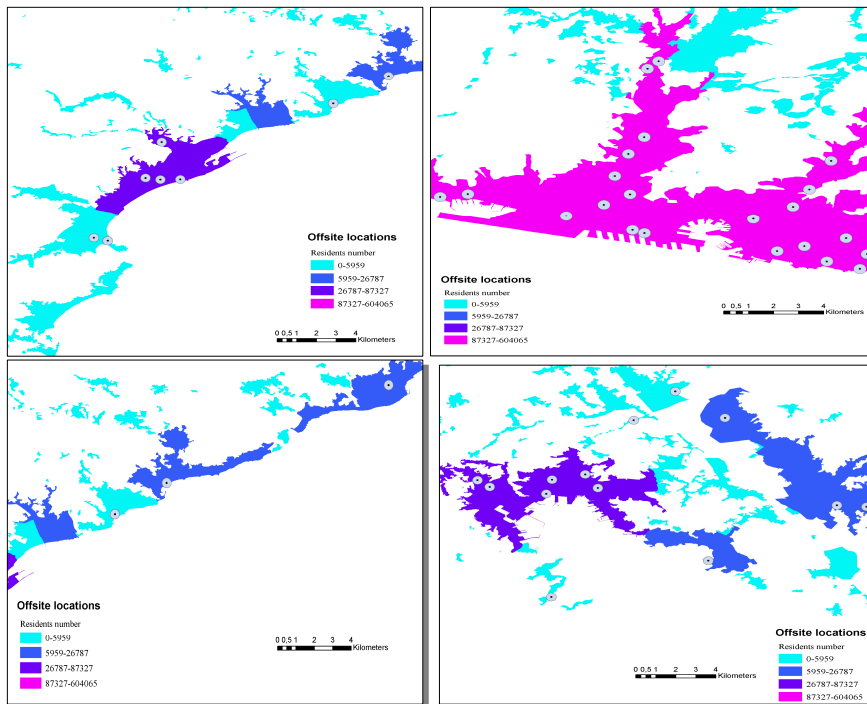

Figure 6.12 Offsite locations versus population

8. Conclusion and future work

In this chapter, an integrated approach considered as a decision support system for the selection of hydrogen refueling stations has been presented. The method combines two different approaches: a detailed spatial data analysis using a geographic information system with a mathematical optimization model of set covering. The DSS will identify the suitable sites providing information on multi-criterion level evaluation of locating the hydrogen infrastructure. Here, the first part related to the use of geographical information systems has been detailed while the application of mathematical model is projected as a future work since the model still in the development phase.

The GIS based approach has been applied to the Liguria region.

B-Hazard and risk evaluation in hydrogen pipeline

1. Introduction

Generally, hydrogen is produced, stored, and then transported to the end-users; in general, it must be transported from production plants to the storage or demand points, so that, the delivery process of its supply chain brings new hazards exposures. Hence, a safe and sustainable transition to the use of hydrogen requires that the safety issues associated with the hydrogen have to be investigated and fully understood (Venetsanos *et al.*, 2003). About 1013 km of transmission pipelines in the United States transport hydrogen today, most of which are located in the Gulf Coast region (DOE Pipeline Working Group Workshop, 2005). The pathways involved between different supply chains nodes is realized by a variety of delivery technologies. Among them, the pipeline has proven to be one of the cheapest ways to transport hydrogen, especially for large areas with large hydrogen demand. In addition, pipeline compressed gas transportation provides an environmental friendly way to satisfy demand, with zero greenhouse gas emissions. However, this infrastructure is often exposed to interference from accidents, human errors, abnormal operations, equipments failures, etc. So, it is more important to study the failure case linked to the hydrogen compressed gas delivery or storage in order to evaluate the danger that hydrogen accidents may cause. The purpose of this work is the definition and the implementation of a mathematical model to estimate the hazard and the risk related to the use of high pressurized hydrogen pipeline. Basing on the combination of empirical relations and analytical models, this method sets the basis for suitable models for consequence analysis in terms of estimating fire length and of predicting its thermal radiation. The results are compared either with experimental data available in the literature, thus by setting the same operations and failure conditions; or with other conventional gaseous fuel currently used.

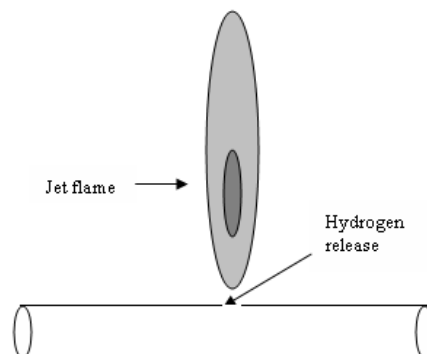

Figure 6.13 System under study

2. Release model

The escaped mass flow rate of hydrogen is determined according to two flow conditions, which are choked and non-choked (Montiel *et al.*, 1998), so that, the value of flow rate at the hole will depend on whether the flow is sonic or subsonic. This will be established by the calculation of the critical pressure ratio. In this study, the pressure at which the gas escapes from the hole is supposed to be strictly higher than the critical pressure. For the case of hydrogen, the value of this critical pressure is equal to 1.92 Bar. Unlike the release in the hydrogen high pressured tank, which mainly depends on the stagnation conditions of the tank, the release rate of high pressurized hydrogen from a leak in the pipeline depends on the operating pressure, the pipeline diameter and the length of pipeline from the supply point to the failure point. Due to large differences between the pipeline and the environment, the flow conditions at the release become critical, so that a sonic flow will release from the failure point, and then the flow rate of hydrogen can be estimated as:

$$Q_{Hole} = \frac{Q_{h-s}}{F_c} \quad (6.4)$$

The Q_{h-s} is the peak initial release rate defined as follow (Crowl and Louvar, 2002):

$$Q_{h-s} = \frac{\pi D_p^2 \lambda}{4} \sqrt{\gamma \rho_0 P_0 \left[\frac{2}{(\gamma+1)} \right]^{(\gamma+1)/(\gamma-1)}} \quad (6.5)$$

The term in the denominator of the Q_{Hole} is due to the frictional loss in the pipeline and it is determined using (Jo and Ahn, 2003):

$$F_c = \sqrt{1 + \frac{4\lambda^2 f_F L_R}{D_p (2/\gamma + 1)^{2/(\gamma-1)}}} \quad (6.6)$$

where:

- F_c [-] is the term responsible for the loss of pressure inside the pipeline;
- D_p [m] is the hole diameter;
- f_F [-] is the fanning friction factor;
- λ [-] is the dimensionless hole size which is the ratio of effective hole area to the pipe cross-sectional area;
- L_R [m] distance from the hydrogen supply point to the failure occurrence;
- ρ_0 [kg/m³] the stagnation density of hydrogen gas at operating conditions;
- P_0 [Pa] is the stagnation pressure of gas at operating conditions

- $\gamma[-]$ is the specific heat ratio of gas, equal to 1.41 for hydrogen gas.

3. Jet flame length

The geometry of jet fire is an important parameter in the consequence analysis, since it allows the prediction of the safety distance that must be kept in order to minimize the individual and the environmental risks, and it also constitutes fundamental information for hazard analysis. The length of the jet flame is the dominant feature to be known in order to simulate the possibility of the flame impingement on nearby facilities (Bagster and Schubacht, 1996).

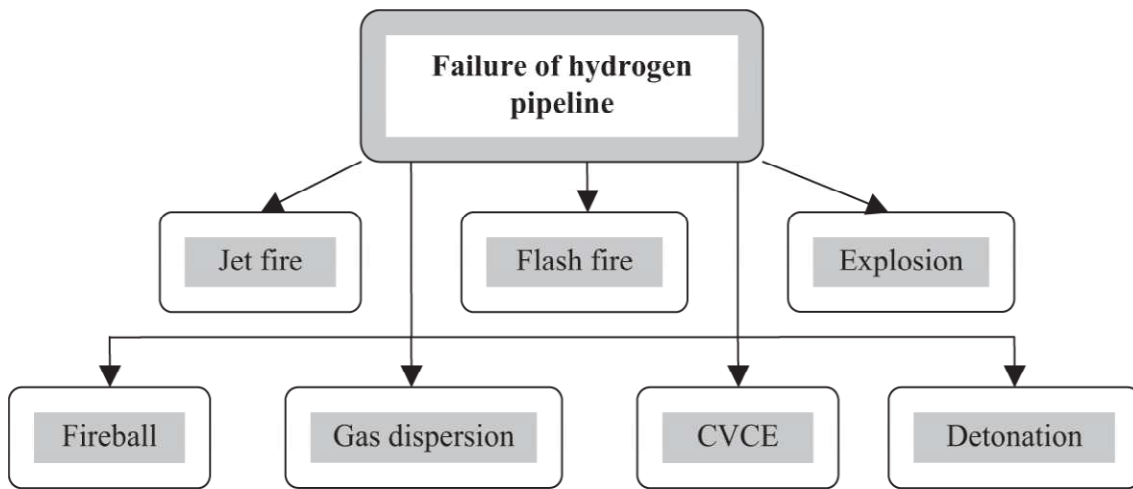

Figure 6.14 Diagram of hydrogen accidental scenarios

As compressed hydrogen is abruptly released into air, the choked release is generated ahead of the under-expanded jet. The pressure will drop gradually until it reaches the ambient pressure. Studies in the literature have defined many relations to calculate the length of the flame, (Delichatsios, 1993) developed a relation basing on the non-dimensional Froude number that measures the ratio of buoyancy-t-momentum forces in jet flames. According to the experimental investigations done by (Mogi and Horiguchi, 2009), the flame length is proportional to 0.53 power of the mass flow rate, thus for an operating pressure up to 0.1MPa. This relation is valid for the case of high pressurized hydrogen tank. So, in order to simplify the computation of the flame length, the second relation (Mogi and Horiguchi, 2009) was adopted in this study. For that main reason, it has been considered that the pipeline operates as a tank or, in others words, that the dimension of the hole is very small comparing to the dimension of the pipe. The flame length is expressed as:

$$L_f = 20.3Q_m^{0.53} \quad (6.7)$$

where L_f [m] is the length of the flame and Q_m [kg/s] is the mass flow rate of hydrogen.

4. Thermal effect from jet fire

Due to the large pressure ratio between the pipeline and the outside environment at atmospheric pressure, critical conditions occur at the leak. The flow becomes sonic in a very small leak dimension. So, the total energy released into the environment becomes higher, inducing then a thermal radiation that can exceed many GW by surface (Wilkening and Baraldi, 2007). In order to calculate the thermal radiation from the jet fire, the flame jet could be idealized as point source heat emitters spread along the flame envelope. The total heat flux reaching a given point is obtained by summing the radiation received from each point source emitter. One simplified assumption that could be incorporated in the calculation of the thermal radiation is to collapse the set of heat emitters into a single point source emitter, located in the ground level (Quaranta *et al.*, 2002). Even if the implemented model induces some errors in the heat flux, it is preferred to many others since, firstly, it avoids the tedious calculation of the heat flux of each axial position of the flame, and secondly, it incorporates many parameters that can play a paramount role in real jet fire events, for instance, those responsible for the gas/air combustion (H_c). The thermal radiation from the flame is inversely proportional to the square of the distance. It can be estimated as suggested in (API RP 521, 1990):

$$I = \frac{\eta \tau_a Q_{eff} H_c}{4 \pi r^2} \quad (6.8)$$

where:

- η [-] is the combustion efficiency factor (=0.15 for H₂ and 0.2 for CH₄)
- H_c [J/kg] is heat of combustion (=141.80 MJ/kg for H₂ and 55.50 MJ/kg for CH₄)
- τ_a [-] is emissivity factor (=1 for H₂ gas and 0.2 for CH₄ gas); it is defined as the fraction

of the total chemical heat release that is radiated to the surroundings.

- Q_{eff} [kg/s] is the effective gas release rate;
- r [m] is the radial distance from heat source (flame) to the location of interest;

The effective hydrogen release rate reflects a representative steady-state approximation to the actual release rate. It can be approximated using the formula below:

$$Q_{eff} = C Q_{h-s} \quad (6.9)$$

where C is the decay factor, it reflects the tendency at which the released hydrogen flow rate lose its effectiveness, In others words, the decay factor describes the change in pressure between the atmospheric pressure and the pressure inside the pipe just before escaping from the leak. (Hill and Catmur, 1994) quote a value of 0.25 for the decay factor.

5. Risk evaluation

The combination of hazardous release, and jet flame associated with high pressure hydrogen pipeline operations, are drastically encountered with higher fatalities. The aim of consequence analysis is to determine the failure case, and then to identify its damage. Hydrogen is a flammable gas, so that, the consequence of fire is almost present, and may specifically results in damages caused by thermal radiation. Once the gas is escaping from the leak, it is ignited and a jet of flame is created in the air; the heat radiated from the flame may be considerable. According to the h2 Incidents report, many hydrogen failures in the phase of the delivery affect human life, damage the properties in neighbourhood and create others injuries. A statistical treatment has been done on the h2 incidents report (h2 Incidents) so to evaluate the consequences of hydrogen failure in the delivery. Results are summarized in Figure 6.14. It can be depicted that property damages are the one that have the higher percentage (39%).

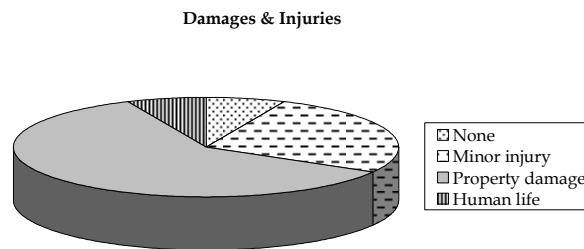

Figure 6.15 Pie bars of the damages and injuries due to the hydrogen failure in the delivery mode

The consequence modelling consists in simulating the behaviour of the release of hazardous substances and the impact of such events on receptors (individuals, buildings, and environment). The damage caused by the pipeline failures can be determined using the following formula (Gerboni and Salvador, 2009):

$$D_{am} = D_p \cdot A \cdot V_c \quad (6.10)$$

where:

- D_{am} : [the number of facilities/event] is the damage;
- D_p [persons/km²] the population density
- V_c : [-] the vulnerability coefficient, (it means the number of people who die because of the accident event. According to (Mannan, 2005), the value of the vulnerability is taken equal to 5%).
- A : [m²] the area in vicinity of the pipeline involved in the accident. It is related to the radial distance from the failure point by πr^2

The quantitative risk evaluation is an important phase in studying the feasibility implementation of a new infrastructure. So that it answers the questions related to the acceptability by national/regional and local scales authorities. In order to calculate the value of risk, the frequency of the failure event is estimated to be equal to 5.10^{-6} . Generally, the risk of a specified failure can be summarized in the following formula:

$$\text{Risk} = \text{probability} \times \text{adverse consequences} \quad (6.11)$$

6. Results and discussions

Numerical simulations have been carried out so to depict the effect of the dimensionless hole size on the flow rate of hydrogen released. We assume that the length at which the failure occurs is 5000m far from the hydrogen supply point. Figure 6.15 shows that the release rate varies increasingly according to the pressure for values of λ that range from 0.0252 to 0.04. As λ increases, this variation tends to have a constant shape for higher values of the dimensionless hole size.

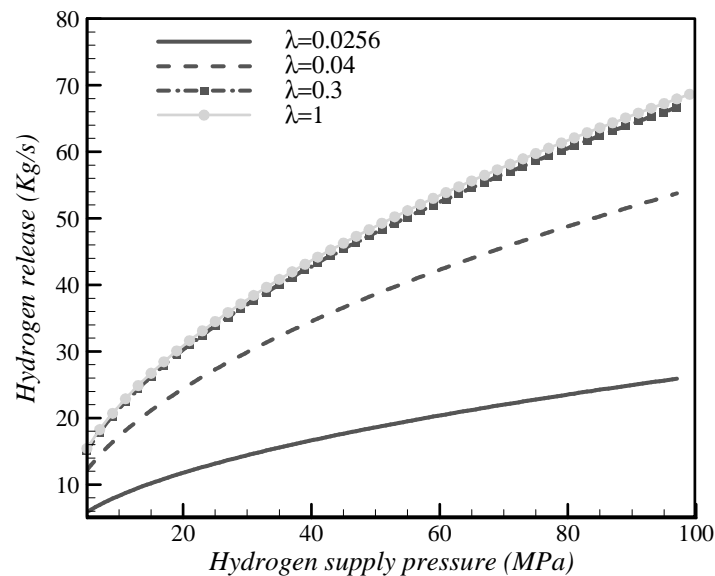

Figure 6.16 The variation of the release flow rate of hydrogen versus the pressure at the supply point for different values of λ

In order to highlight the relationship that exists between the whole diameter and the hydrogen release rate - to better understand the results of Figure 6.15. Figure 6.16 show this variation. It appears that the hole diameter from which hydrogen gas is escaped highly affects the amount of hydrogen released from the leak, up to a value of approximately 0.3 m; after which the release rate remains unchanged at a maximum of 43 Kg/s. The stagnation of the release rate for higher values of

the leak diameter is due to the fact that the release can not exceed the maximum rate that can flow in the pipeline. This is in perfect agreement with the method proposed by (Yuhu *et al.*, 2003).

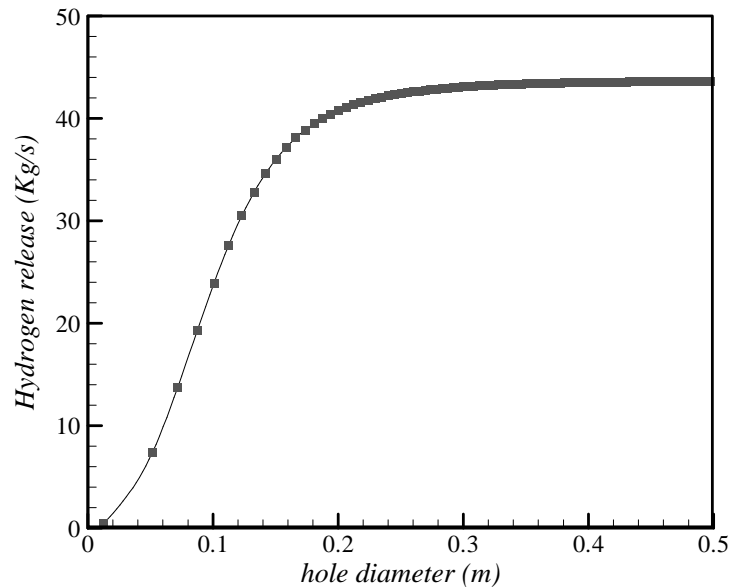

Figure 6.17 Relationship between the hole diameter and release rate

Figure 6.17 shows a comparison of the hydrogen flame length as a function of the stagnation pressure at the hydrogen supply point; the curve displays this variation for various values of leaks diameters. The data obtained for the flame length are valid for a value of operation pressure higher than 0.1MPa. For instance, a value of 10 m for the flame length is observed for a leak diameter of 10 mm, this value of the flame length remains unchanged for different values of the hydrogen pressurized supply point. We remark that this trend will change gradually as we increase the value of d_h . However, enhancing the pressure will in turn increase the value of the flame length, for example, for a leak diameter equal to 79 mm, the hydrogen flame length can have 50m for $P_0=5\text{MPa}$ to attain a value of 117m for $P_0=100\text{MPa}$. The observed behavior is due to the fact that increasing the diameter of the hole, the hydrogen mass released will increase, inducing then, a higher jet velocities, that will in turn enhances the flame length, but, once the maximum flow rate that can release is reached, this increasing behavior of the flame stops.

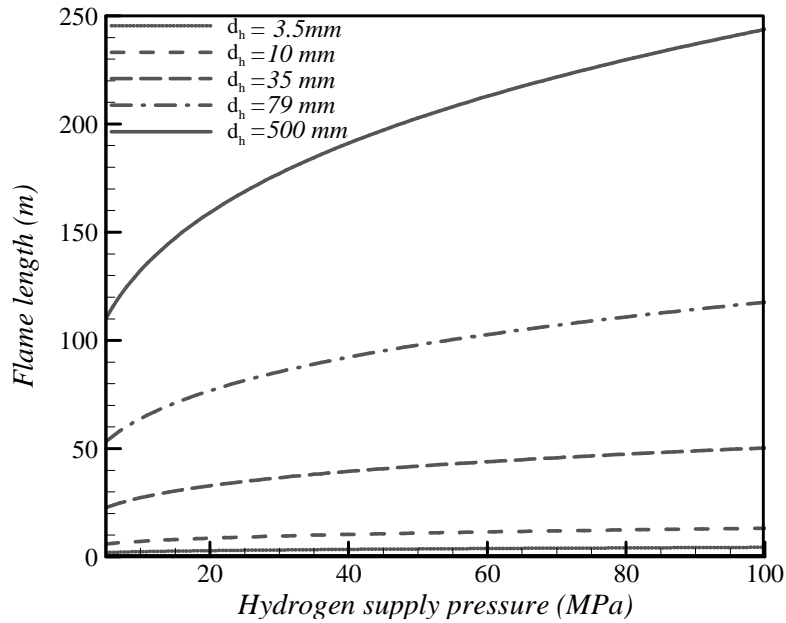

Figure 6.18 The jet flame length as function of the pressure at the supply point

Computational results have been also compared with those reported by (Mogi and Horigoshi, 2009). Figure 6.18 shows this comparison for same values of pressure and leak diameter. It appears that there is a slightly over-prediction using the flame length model for the pipeline. For instance, a value of 0.802 m is obtained using the current model, instead of a 0.6 m for experimental data. This difference could be justified by the fact that the mass flow rate used in the pipeline formulation suppose the pipeline as tank, furthermore, it does not take into account the contact between the released hydrogen and the outside meteorological conditions.

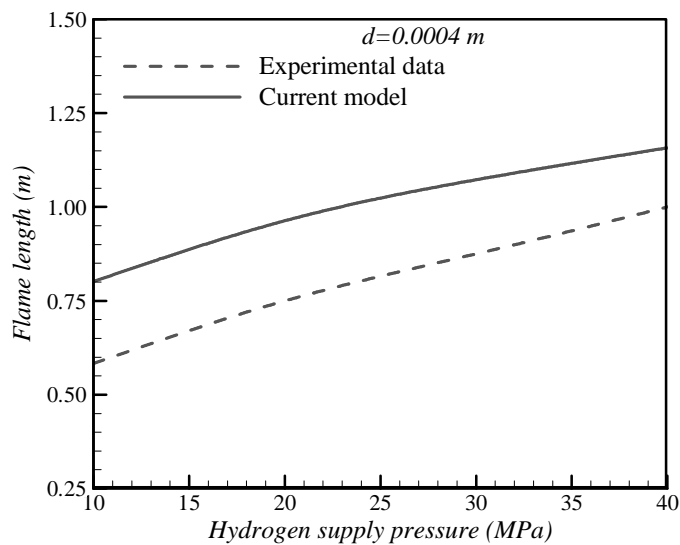

Figure 6.19 Comparison of the current model and experiments by T, Mogi and S, Horiguchi

The characterization of the thermal radiation from the jet flame is a crucial part to assess the consequence of the pipeline failure; also, it constitutes an important task to develop new safety codes, and to have an exact knowledge of the suitable places where the thermal sensors should be placed to detect hydrogen gas releases. In this framework, it is expected that the downstream region from the hydrogen jet flame is particularly susceptible to thermal hazards. This hazard is shown in term of the thermal radiation or heat flux in Figure 6.19. It illustrates the variation of the thermal radiation as a function of the radial distance (from the centered flame point to the location of interest). For a radial distance less than approximately 7 m, the values of the thermal radiation of the hydrogen gas are higher than those obtained for the methane gas, for instance, the thermal radiation for hydrogen is equal to 4761.33 W/m^2 versus a value of 2025 W/m^2 for the methane gas, thus for $P_0=20.7\text{MPa}$ - this is mainly due to the fact of higher energy content of hydrogen compared with methane. On the other hand, for a radial distance higher than 7 m, the thermal radiation retains a constant value, either for pressure equal to 207bar or 0.5bar. The remark may be due to the dissipation of the thermal radiation faraway from the flame centered point.

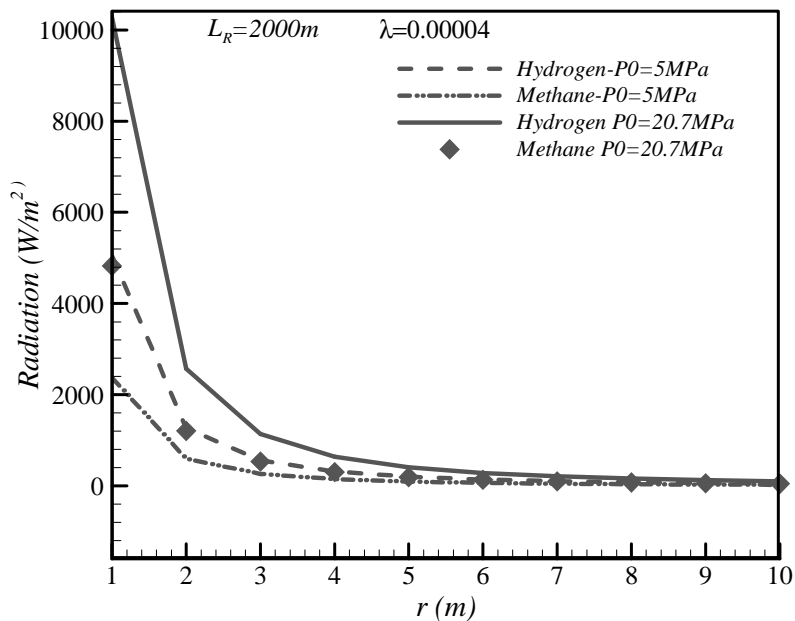

Figure 6.20 The heat flux from the hydrogen jet flame as a function of the radial distance

Based on the mathematical analysis of the pipeline network that has been done, consequences of failures may be estimated. By determining the hazard linked to manipulating hydrogen gaseous substance, the decisions makers might take suitable measures regarding the safety issues. Hereinafter, the application of quantitative risk analysis is briefly discussed.

depicts that the quantitative value of the damage caused by the pipeline failure increases with the type of the population living in proximity of the infrastructure. Thus, by characterizing the risk

according to the population surrounding the pipeline infrastructure, this will bring important knowledge about the societal risk acceptance criteria.

	The radial distance from the failure(m)	Thermal radiation (W/m²)	Damage (fatalities/event)
Large population D _{pop} =20000(persons/ Km ²)	1	159735	0.0003
	6	4437	0.1130
	16	624	0.8038
	36	124	4.0694
Medium population D _{pop} =12000 (persons/ Km ²)	1	159735	0.0002
	6	4437	0.0068
	16	624	0.4823
	36	124	2.4417
Low population D _{pop} =1500(person/ Km ²)	1	159735	0.00024
	6	4437	0.00848
	16	624	0.06023
	36	124	0.305

Table 6.5 Thermal radiation and damages as function of the radial distance from the failure point, for large; medium and small population

7. Conclusion

In this work an approach to assess the thermal hazard related to the release of hydrogen high pressure from a pressurized pipeline has been proposed. The failure case of hydrogen transmission pipeline can lead to outcomes that can cause serious damage in the immediate vicinity of the failure point. However, a good knowledge of these dangers and their consequences is intended to implement a safe design of systems using hydrogen. In these conditions, it is possible to envisage the development of hydrogen as an energy carrier with a low risk level socially acceptable. The model settled in this paper aims to estimate the hydrogen flow rate that release from the leakage, the length of the ignited flame gas as well as the thermal radiation. The study includes also a risk analysis for damaged areas assessment, thus, taking into account the density of the population that lives in the vicinity. In this respect, a promising future development may be included to the overall resulting model as a specific add-on of classical geographic information system software for the assessment of the risk in hydrogen pipeline planning.

Chapitre 7 : Smart renewable systems and hydrogen as storage medium

A la lumière du développement durable et de large diffusion des technologies de production d'énergie renouvelable, la 1^{ère} partie du chapitre 7 présente un modèle dynamique innovant d'un système hybride intégrant des sous-systèmes tels qu'un électrolyseur, une centrale hydroélectrique, des stations de pompage, des éoliennes, des piles à combustible et un système de stockage. Ce modèle a été bien testé sur une installation existant dans la province d'Azilal, au Maroc. En effet, en se basant sur ce modèle dynamique, un problème d'optimisation sous contraintes a été formulé afin de satisfaire, en temps réel, différentes demandes d'énergie électrique fluctuantes au cours de la journée. Le modèle développé repose sur un problème de contrôle optimal en temps réel de la gestion opérationnelle d'énergie. Le modèle d'optimisation développé est défini comme un problème de programmation mathématique non linéaire, qui a été résolu en utilisant un outil commercial d'optimisation Lingo-Lindo. Le système hybride proposé permet de satisfaire la demande en temps réel de l'énergie électrique. Différents sous-systèmes sont activés en fonction des fluctuations des vents disponibles en termes de vitesse et de demande d'énergie. Le cas d'étude a démontré qu'une approche énergétique durable pourrait être tout à fait commune dans un proche avenir. Le cas d'étude intègre deux régions qui sont plus au moins éloignées l'une de l'autre, reliées par le réseau électrique national, et qui ont deux particularités différentes et complémentaires: une région avec un potentiel énergétique élevé (en terme de potentiel éolien) et une autre région qui dispose d'une centrale naturelle de stockage d'énergie (un réservoir d'eau), cette hypothèse adoptée entre dans le cadre des politiques et accords entre les villages, même éloignés et qui sont susceptibles de se joindre au stockage et l'énergie. En effet, cette approche peut représenter la première étape pour la définition d'un problème complexe, mais avec de nombreuses hypothèses simplificatrices.

Les micro-réseaux peuvent fonctionner à la fois de façon autonome ou connectée à un réseau électrique principal. Pour être performant, le micro-réseau doit mettre en œuvre le concept de "Smart Grid", qui stipule une production propre, souple, fiable et économique. En outre, le "smart grid" nécessite un soutien par le biais d'une meilleure communication et d'une plateforme d'information. Un des principaux avantages des micro-réseaux, c'est la possibilité d'utiliser une exploitation coopérative des sources d'énergie renouvelables, malgré leur séparation physique.

Toujours, dans le but de promouvoir les systèmes hybrides de sources d'énergies renouvelables, un modèle d'aide à la décision optimal dans un réseau de micro-réseaux est proposé dans la *partie B* du

chapitre 7. Le modèle est formalisé comme étant un problème d'origine discrète et centralisé, défini comme un réseau de coopération entre réseaux électriques intelligents. Les variables de contrôle sont les flux de puissances instantanées échangées entre les micro-réseaux, et qui peuvent être obtenus à partir de la solution d'un problème linéaire quadratique gaussien sur un horizon temporel fixe. L'état du système est représenté par l'énergie stockée dans chaque micro-réseau. L'objectif est de minimiser les variations de l'énergie stockée dans chaque dispositif de stockage à partir d'une valeur de référence, ainsi que de minimiser l'échange d'énergie.

A- A dynamic decision model for the real time control of hybrid hydrogen renewable energy production systems

1. Introduction

Renewable energy systems (RES) have attracted considerable interest because their use is one of the fundamental measures to fight against climate change and to reduce the dependence on fossil fuels. The use of renewable resources is well suited to cope with the limitations of current patterns of energy generation and consumption, to complement existing energy production systems, and to contribute to the further modernization of the energy sector (Viera *et al.*, 2009). Nowadays, among the renewable sources, wind energy provides an indigenous, environmental friendly option that can reduce dependence on energy imports, ensure the sustainable security of energy supply, and contribute to an overall strategy of sustainable development.

However, due to their intermittent behavior, most RES do not follow the energy demand. As a consequence, storage systems are required to avoid wasting the fraction of the produced energy which is not immediately used. Therefore, the problem of energy storage becomes more and more crucial as its development may increase the diffusion, the effectiveness and the profitability of renewable energy plants. Actually, the main problem of the RES plants is that electricity generation cannot be fully forecasted and does not usually match with the demand pattern over time. This is the case, for example, of a wind farm where, in relation to a certain (future) time horizon, the energy produced depends on the wind speed, whose prediction is clearly affected by uncertainty. This fact causes a certain degree of uncertainty even on the satisfaction of the energy demand (also when the demand pattern is assumed to be known) over the considered time horizon (Bueno *et al.*, 2006, Bernal-Agustin *et al.*, 2008).

One way to reduce this uncertainty, and, at the same time, to increase customer satisfaction, is to install an energy storage system that, as far as possible, can help in matching the irregular pattern of the energy supply from wind turbines to the demand pattern (Bueno *et al.*, 2006). The adoption of a hybrid system can be taken into account as a reasonable solution, which can support energy demands of both, stand-alone and grid connected users.

Within the framework of the mixed use of renewable sources in order to satisfy a large part of the electric energy demand, there are various possibilities for the storage of the produced electrical energy. For example, some of such possibilities are: water pumping reversible hydro plants, batteries, compressed air energy storage, and hydrogen storage. In particular, the stored hydrogen could later be used to generate electricity via a fuel cell during times of peak demand. This capacity

for energy storage could significantly mitigate the drawbacks due to the fluctuating nature of the wind and provide a cost-effective means of meeting peak demand (Kottentette *et al.*, 2004).

As regards hydroelectric power generation, there are two main classes of methods: conventional methods (dams and run-of-the-river), which produce electricity via water flow in one direction, and pumped storage methods (Zhao *et al.*, 2009). At the present time, the only feasible means of storing large quantities of electrical energy is the use of pumped storage systems (Bueno *et al.*, 2006).

When a wind park is combined with pumped-hydro and hydrogen storage systems, several advantages can be achieved. For example, during low consumption hours, the wind energy that is not used to satisfy demand (and if not used is discarded) can be used to produce hydrogen as well as to pump water to an upper reservoir (stored as potential energy), that can be discharged whenever there is a need to produce energy. Moreover, when the wind has high fluctuations, these storage systems can be used to regulate the energy delivery. In fact, the stored energy both in the pumped-hydro system and in the hydrogen tank can be re-utilized to generate electricity.

In this chapter, a hybrid system coupling a wind turbine with both hydrogen production/storage and water storage systems is considered. A hybrid model has been defined integrating several subsystems (i.e., electrolyzer, hydroelectric plant, pumping stations, wind turbines, fuel cell). The reason to integrate hydrogen and water as storage systems lies in the increase of the flexibility and the operability of the overall system. In addition, the hybrid system can be used for different time varying demands, specifically, electric energy, hydrogen for automotive use and water supply.

On a specific hybrid system, a dynamic decision problem is formulated whose aim is to satisfy a variable hourly demand in electric energy, hydrogen and water. The objective function also includes economic costs related to the operation of the fuel cell and of the hydroelectric plants. The resulting constrained optimization problem can be solved using mathematical programming. The structure of the considered decision model is consistent with the assumption of a stand-alone system, located in an isolated area or on an island or in an area where there is not the possibility to sell the energy produced in excess to the electric network manager.

In the next section, a brief survey on the optimization of storage systems in RES is given. In the third section, the model used for the assessment of the wind turbine power curve on the basis of the predicted wind speed data is described. Then, in the fourth section, the overall model of the integrated RE hybrid system is presented in detail. In the fifth section, the dynamic optimization problem is formulated, and numerical results on a specific case study (Afourar village, Morocco) are presented.

2. Energy storage systems and optimization of RES: State of the art

As regards RES and related energy storage systems, several recent contributions are available in the literature. Some of them, with special reference to hydrogen production and storage, are quoted hereinafter. Christopher *et al.* (2007) presented a method for the evaluation of a wind–hydrogen energy system. The method includes simulations and economic computations to define the size of the plants. Lilia *et al.* (2009) present a feasibility study on hydrogen production from wind power on the site of Ghardaia (Algeria). Bernal-Agustin *et al.* (2008) proposed a complete technical-economic analysis of the hourly energy management in wind-hydrogen systems. In particular, the authors propose a method to adjust the generation curve to the demand curve, consisting of the generation of hydrogen and storing it in a hydrogen tank during off-peak (low demand) hours, while during the rest of the hours (peak hours, high demand) the stored hydrogen can be used to generate electricity. Anderson *et al.* (2004) investigate the integration of hydrogen systems with wind power generation systems in order to make wind energy generation profitable and increase the diffusion of wind energy generation plants. Vieira *et al.* (2008) highlight the importance of finding methods to determine the best hourly operation for a pumped storage system for one day, according to the electricity price. Anagnostopoulos *et al.* (2007) present a numerical study for the optimum sizing and design of a station unit in a hybrid wind-hydro plant (i.e., wind turbines and hydroelectric plant).

Korpas *et al.* (2006) present a methodology for the definition of control strategies for a hybrid plant with wind power and hydrogen storage. Their objective is to maximize the expected profit from power exchange in a day-ahead market. The generation scheduling is based on forecasts of electricity price, loads, and wind generation. During online operation, a receding horizon strategy is applied to determine the set points for the electrolyzer power and the fuel cell power. The market model is defined both for isolated and grid-connected systems. Instead, in (Korpas *et al.*, 2003), an operation strategy for a general energy storage device connected to a wind farm is presented. A dynamic algorithm is applied for daily scheduling in a power market. The objective of the online operation strategy is to follow a given generation schedule as closely as possible.

DufoLopez *et al.* (2007) present a novel strategy, optimized by genetic algorithms, to control stand-alone RE hybrid electrical systems with hydrogen storage. In another approach, using water to store energy, Niang *et al.*, (2004) develop optimal pumped-storage unit bidding strategies in a competitive electricity market, highlighting advantages offered by the optimal strategy in comparison with a fixed-schedule weekly generating and pumping strategy. In the same framework, Castelnovo *et al.* (2004) propose an hourly-discretized optimization algorithm to identify the

optimum daily operational strategy to be followed by the wind turbines and the hydro generation pumping equipments, provided that a wind-power forecasting is available.

The novelties of the present work lie first of all in the definition of a quite complex hybrid system, integrating several subsystems, i.e., wind turbine, water storage, hydrogen storage, electrolyzer, fuel cell, and hydroelectric plant. Beside the electric energy satisfaction, the objective function also aims to satisfy the hydrogen and water demands. Finally, unlike most contributions available in the literature, in this work an overall optimization problem is defined in connection with a dynamic system model, with the aim of defining optimal real time control strategies.

3. The wind model

In the literature, there are numerous studies on wind models and on their exploitation for energy production. The wind turbines power curve is defined as the power output of the machine as a function of wind speed. The behaviour of the output power of the machine is generally dependent on four characteristic parameters. It is assumed that power generation starts at the cut-in wind speed v_c [m/s], that the output power increases as the wind speed increases from v_c to the rated wind speed v_r [m/s], and that a constant value of the output power, namely the rated power P_r [kW], is produced when the wind speed varies from v_r to the cut-out wind speed v_f [m/s], which is the maximum wind speed value at which the turbine can correctly work.

In the current chapter, a simplified linear model (Notton *et al.*, 2001) available in literature is used in the optimization model to obtain energy produced from wind resources. However, other models (Mosgorove *et al.*, 1988, Pallabazzer, 1995) might also be used in the decision model.

The linear wind model (Notton *et al.*, 2001) assumes a linear (affine) dependence (within the interval $[v_c, v_r]$) of the wind turbine power output, P^t , on the current wind speed at the hub height v^t , $t=0, \dots, T-1$, being T the time horizon in hour. In detail,

$$P^t = \begin{cases} 0 & v^t < v_c \\ P_r(a + bv^t) & v_c \leq v^t \leq v_r \\ P_r & v_r \leq v^t \leq v_f \\ 0 & v^t > v_f \end{cases} \quad t=0, \dots, T-1 \quad (7.1)$$

$$\text{with } \begin{cases} a = v_c / (v_c - v_r) \\ b = 1 / (v_r - v_c) \end{cases}$$

It should be observed that wind speed v^t in (5.1) is that corresponding to the wind turbine hub height, H_{hub} . Since, in general, wind speed data can be measured or forecasted with reference to a height H_{data} that is different from the hub height, it is necessary to use an equation relating the wind speed at hub height with the wind speed v_{data}^t at H_{data} , taking into account the surface roughness length z_0 [m] which is a parameter that can be estimated on the basis of the land use at the wind farm location. The relation proposed in previous chapter has been used.

4. The Integrated System Model

The system to be modeled is characterized by a hybrid electric energy generation obtained by a wind farm, a hydro-turbine, and a fuel cell. It is supposed that one pumping station and two reservoirs are connected with the hydro turbine, and one electrolyzer is connected with the fuel cell. Figure 7.1 reports a scheme of the overall system.

The performance of such a system has to be optimized in order to produce electric energy satisfying (as close as possible) the predicted various time varying demands (i.e., electric energy, water and hydrogen demands).

Electrical energy produced by the wind farm can be used directly to satisfy the demand. In the case of energy surplus, part of energy can be sent to the pumping station in order to elevate water from the lower to the upper reservoir, or/and sent it to produce hydrogen through an electrolyzer.

The amount of pumped water is proportional to the electrical energy used for this purpose. The water is sent to an upper storage system from where it can be sent either to a hydro-electric plant or used to satisfy a demand of water. Water coming out from the hydro-electric plant is sent to the lower reservoir from which the pumping station takes the necessary water to be sent to the upper reservoir. The electrolyzer is used to produce hydrogen that is stored and then can be sent to a set of fuel cells or can be used to satisfy the hydrogen demand. The fuel cells can produce energy from the hydrogen spilled from the storage. Thus, three different kinds of demand are considered, namely the electric energy demand (which can be satisfied either directly by the wind farm, or by the hydroelectric plant, or by the fuel cells), the demand of hydrogen (which can be sold to different customers), and the demand of water (which can be used for several purposes different from energy generation)

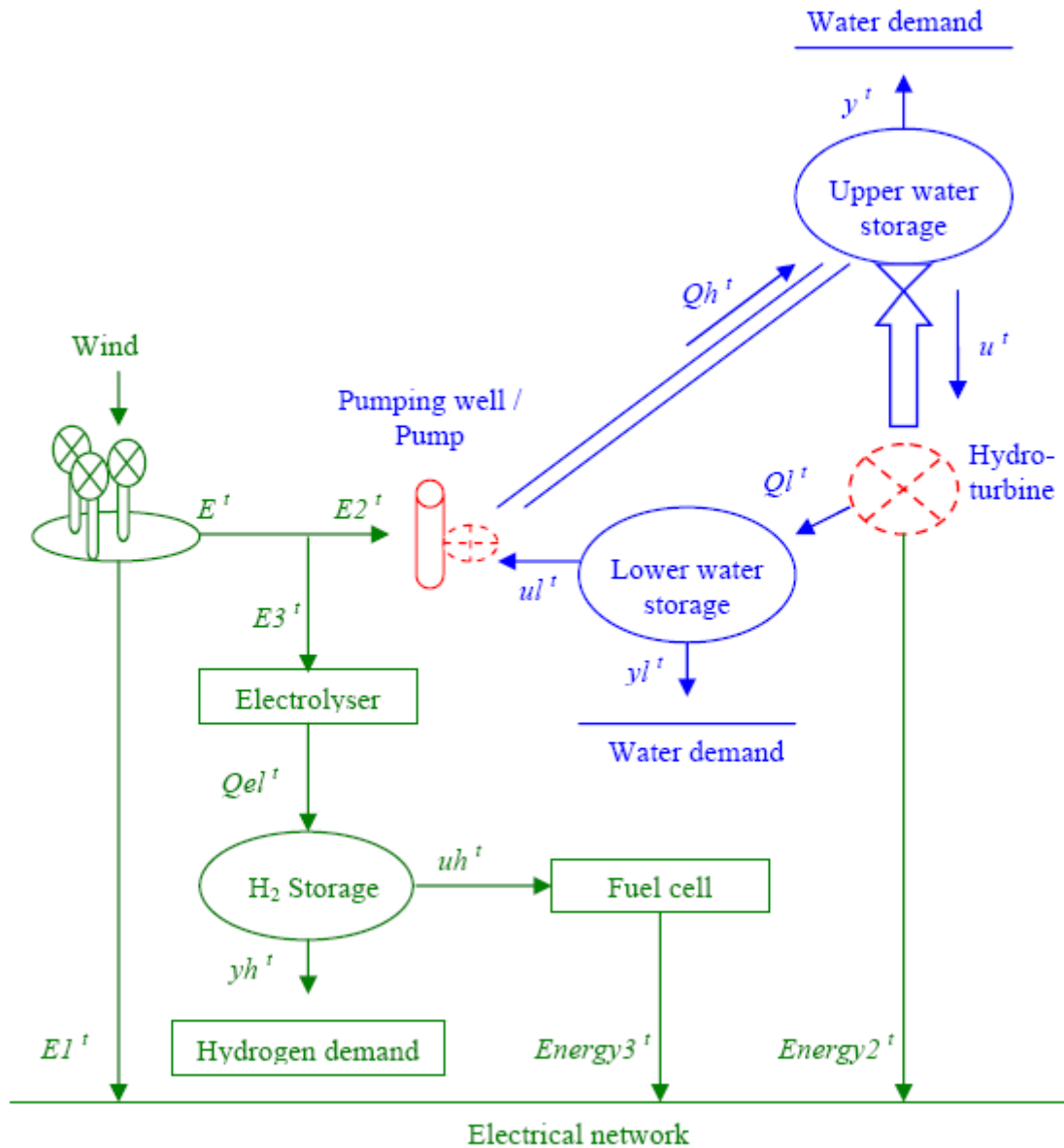

Figure 7.1 The integrated renewable energy system

4.1 State and control variables

The overall model includes state equations defined by state and control variables.

The system state variables are:

- h^t : the water volume in the higher reservoir at time t , $t=0, \dots, T-1$ [m^3].
- \tilde{h}^t : the water volume in the lower water reservoir at time t , $t=0, \dots, T-1$ [m^3].
- \bar{h}^t : the hydrogen volume in the hydrogen storage at time t , $t=0, \dots, T-1$ [m^3].

The control variables are:

- E^t : electric energy produced from the wind farm, in time interval $(t, t+1)$, that is immediately used [kWh].

- $E2^t$: electric energy produced from the wind farm that is used by the pump in time interval $(t, t+1)$ [kWh].
- $E3^t$: electric energy produced from the wind farm that used for hydrogen production in time interval $(t, t+1)$ [kWh].
- u^t : the water flow that is spilled from the upper reservoir and is dedicated to energy production through the hydro-electric turbine, in time interval $(t, t+1)$ [m^3s^{-1}].
- y^t : water flow that is spilled from the upper reservoir and is dedicated to the water demand satisfaction, in time interval $(t, t+1)$ [m^3s^{-1}].
- yl^t : water flow that is spilled from the lower reservoir and is dedicated to the water demand satisfaction, in time interval $(t, t+1)$ [m^3s^{-1}].
- uh^t : hydrogen flow that is extracted from the storage and used to produce energy in the fuel cell, in time interval $(t, t+1)$ [m^3s^{-1}].
- yh^t : hydrogen flow that is dedicated to hydrogen demand satisfaction, in time interval $(t, t+1)$ [m^3s^{-1}].
- $\delta_{hy}^t, \delta_p^t, \delta_{el}^t, \delta_{fc}^t$: binary control variables related to the hydroelectric power plant, pumping station, electrolyzer, fuel cell plant, respectively; each of these variables is set to 1 if and only if the plant is active in time interval $(t, t+1)$.

Other variables are directly dependent on the state and control variables. These variables are:

- E^t : energy produced by the wind farm, in time interval $(t, t+1)$ [kWh].
- Qh^t : water flow that enters the higher water reservoir in time interval $(t, t+1)$ [m^3s^{-1}].
- Ql^t : water flow that enters the lower water reservoir from hydro-electric power plant in time interval $(t, t+1)$ [m^3s^{-1}].
- ul^t : water flow that is pumped from the lower water reservoir, in time interval $(t, t+1)$ (m^3s^{-1}), to be sent to the upper reservoir.
- Qel^t : hydrogen flow that enters the hydrogen storage from the electrolyzer in time interval $(t, t+1)$ [m^3s^{-1}].
- $Energy2^t$: energy produced from hydro-electric plant and directly used in time interval $(t, t+1)$ [kWh].
- $Energy3^t$: energy produced from fuel cell that is directly used in time interval $(t, t+1)$ [kWh].
- $Etot^t$: total produced energy used to satisfy the electric energy demand in time interval $(t, t+1)$ [kWh].

4.2 Data and forecasts

The knowledge of the following information is necessary for the statement of the problem:

- v_{data}^t : predicted average wind speed at H_{data} in the t-th time interval ($t, t+1$), $t=0, \dots, T-1$ [m^3s^{-1}].
- D^t : hourly energy demand to be satisfied in time interval per residential unit ($t, t+1$), $t=0, \dots, T-1$ [kWh].
- DWh^t : water demand to be satisfied in time interval ($t, t+1$) from the lower reservoir [m^3s^{-1}].
- DWl^t : water demand to be satisfied in time interval ($t, t+1$) from the higher reservoir [m^3s^{-1}].
- DH^t : hydrogen demand to be satisfied in time interval ($t, t+1$) [m^3s^{-1}].

4.3 Model parameters

The following parameters are used in the model

- NR : number of residential units in the considered study area.
- N : number of wind turbines.
- H_1 : the difference between the altitudes of the higher and lower water reservoirs [m].
- H_2 : the difference between the altitudes of the higher water reservoir and the hydroelectric turbine site [m].
- ρ : water density [kg m^{-3}].
- ρ_{H_2} : hydrogen density [kg m^{-3}].
- g : gravity constant acceleration [m s^{-2}].
- μ_{ht} : hydro-electric turbine efficiency.
- HHV: hydrogen higher heating value [kWh/kg].
- LHV: hydrogen lower heating value [kWh/kg].
- η_1, η_2 : parameters of the electrolyzer plant: the first one represents the efficiency of the electrolysis system, while the second one is an additional efficiency coefficient included to take into account the (energy) losses in the electrolyzer.
- η_{FC} : the fuel cell efficiency.
- η_p : the pumping station efficiency.
- η_h : a coefficient that takes into account the water losses in the hydro-electric turbine;
- $Ul_{fc}, Ul_p, Ul_{hy}, Ul_{el}$: parameters indicating the required minimum flow for the activation of the fuel cell, pumping, hydroelectric and electrolyzer plants, respectively [m^3s^{-1}].

-- Um_{fc} , Um_p , Um_{hy} , Um_{el} : parameters indicating the maximum flow admissible for the different plants [m^3s^{-1}].

-- \bar{h}^* , \tilde{h}^* , h^* : maximum volumes in the storage systems [m^3], respectively in the hydrogen storage, lower water reservoir and higher water reservoir.

-- Δt : the length of the time interval [h].

4.4 State equations and other equations of the model

Two state equations related to the water reservoirs have to be modelled

$$h^{t+1} = h^t + \Delta t(Qh^t - u^t - y^t) / 3600 \quad t=0, \dots, T-1 \quad (7.2)$$

$$\tilde{h}^{t+1} = \tilde{h}^t + \Delta t(Ql^t - ul^t - yl^t) / 3600 \quad t=0, \dots, T-1 \quad (7.3)$$

A third state equation is related to hydrogen storage

$$\bar{h}^{t+1} = \bar{h}^t + \Delta t(Qel^t - yh^t - uh^t) / 3600 \quad t=0, \dots, T-1 \quad (7.4)$$

The energy production by the wind turbines, E^t , in each time interval is given by

$$E^t = P^t \Delta t N \quad t=0, \dots, T-1 \quad (7.5)$$

The hourly wind energy E^t (kWh) can be used for three different purposes in the same time interval: direct use of wind energy to satisfy the demand ($E1^t$), water pumping ($E2^t$), and hydrogen production ($E3^t$). Thus,

$$E1^t + E2^t + E3^t = E^t \quad t=0, \dots, T-1 \quad (7.6)$$

The water entering the higher reservoir is proportional to the energy used for this purpose. That is,

$$ul^t = \frac{E2^t}{\rho g H_1 / 3600} \quad t=0, \dots, T-1 \quad (7.7)$$

Moreover,

$$Qh^t = ul^t \eta_p \quad t=0, \dots, T-1 \quad (7.8)$$

The water coming out from the hydroelectric plant and entering the lower water reservoir is given by:

$$Ql^t = u^t \eta_h \quad t=0, \dots, T-1 \quad (7.9)$$

Finally, as regards the electrolyzer functioning, the produced hydrogen, i.e., the hydrogen flow entering the hydrogen storage is given by:

$$Q_{el}^t = E_3^t \eta_1 \eta_2 / (HHV \rho_{H_2} 3600) \quad t=0, \dots, T-1 \quad (7.10)$$

Thus, the electric energy produced by the hydro-electric plant and the fuel cell is given respectively by:

$$Energy_2^t = H_2 u^t \rho \mu_{ht} g \Delta t / 3600 \quad t=0, \dots, T-1 \quad (7.11)$$

$$Energy_3^t = u h^t LHV \eta_{FC} \rho_{H_2} \Delta t / 3600 \quad t=0, \dots, T-1 \quad (7.12)$$

Finally, the total energy that is used in time interval $(t, t+1)$ to satisfy the electrical energy demand is given by:

$$E_{tot}^t = Energy_2^t + Energy_3^t + E_1^t \quad t=0, \dots, T-1 \quad (7.13)$$

5. The Optimization problem

The objective function to be minimized consists of four terms, penalizing lower and upper water, hydrogen and energy demand dissatisfaction/over-satisfaction, and two terms related to variable costs when energy is produced through the hydroelectric turbine or the fuel cell. In particular, since it is required to satisfy the demands as close as possible, avoiding to exceed demands, it seems reasonable to penalize both a dissatisfaction and an over satisfaction of an assigned demand.

In the problem formulation considered in this work, a quadratic loss function symmetrically weighting deviations from the assigned demands has been used. Indeed, the choice of a symmetric loss function may be questionable. However, in any case, as a mathematical programming approach will be followed in the solution of the considered management/control problem, other formulations of the loss functions could well be considered without heavy variations in the proposed approach.

The additional two terms in the cost function have been introduced to take into account that energy produced by hydroelectric and fuel cell plants needs the functioning of storage systems and additional plants (instead the wind energy does not need other conversion plants or storage systems when it is directly dedicated to energy demand satisfaction). Thus, the overall objective function to be minimized is:

$$J = \sum_{t=0}^{T-1} \left\{ \xi (Etot^t - D^t NR)^2 + \beta (y^t + yl^t - DW h^t)^2 + \bar{\beta} (yl^t - DW l^t)^2 + \sigma (yh^t - DH^t)^2 + \vartheta Energy_2^t + \chi Energy_3^t \right\} \quad t=0, \dots, T-1 \quad (7.14)$$

Where $\xi, \beta, \bar{\beta}, \sigma$ are weighting factors, and ϑ, χ are unit costs related to the functioning of the hydroelectric and fuel cell plants, respectively.

Different classes of constraints have to be taken into account in the optimization problem: constraints related to storage capacities (i.e., an upper bound for levels in the storage systems), constraints related to the plant capacities and activation, non-negativity constraints and the system model equations

Constraints related to storage capacities

$$h^t \leq h^* \quad t=0, \dots, T-1 \quad (7.15)$$

$$\tilde{h}^t \leq \tilde{h}^* \quad t=0, \dots, T-1 \quad (7.16)$$

$$\bar{h}^t \leq \bar{h}^* \quad t=0, \dots, T-1 \quad (7.17)$$

Constraints related to plant capacities and activation

For the hydroelectric plant, the constraints are:

$$u^t \geq \delta_{hy}^t U l_{hy} \quad t=0, \dots, T-1 \quad (7.18)$$

$$u^t \leq \delta_{hy}^t U m_{hy} \quad t=0, \dots, T-1 \quad (7.19)$$

$$u^t - \delta_{hy}^t M \leq 0 \quad t=0, \dots, T-1 \quad (7.20)$$

Where M has a very big value [$m^3 s^{-1}$].

Constraints (21) are used to represent the following relation between flow water and plant activation,

$$\delta_{hy}^t = \begin{cases} 0 & \text{if } u^t = 0 \\ 1 & \text{if } u^t > 0 \end{cases} \quad t=0, \dots, T-1 \quad (7.21)$$

Note that the introduction of the binary variable δ_{hy}^t is necessary as the lower bound for u^t , $U l_{hy}$, is assumed different from zero.

For the pumping station, the constraints are:

$$ul^t \geq \delta_p^t U l_p \quad t=0, \dots, T-1 \quad (7.22)$$

$$ul^t \leq \delta_p^t U m_p \quad t=0, \dots, T-1 \quad (7.23)$$

$$ul^t - \delta_p^t M \leq 0 \quad t=0, \dots, T-1 \quad (7.24)$$

Similarly, for the electrolyzer, the constraints are:

$$E3^t \geq \delta_{el}^t U l_{el} \quad t=0, \dots, T-1 \quad (7.25)$$

$$E3^t \leq \delta_{el}^t U m_{el} \quad t=0, \dots, T-1 \quad (7.26)$$

$$E3^t - \delta_{el}^t M \leq 0 \quad t=0, \dots, T-1 \quad (7.27)$$

Finally, for the fuel cell, the constraints are:

$$uh^t \geq \delta_{fc}^t U l_{fc} \quad t=0, \dots, T-1 \quad (7.28)$$

$$uh^t \leq \delta_{fc}^t U m_{fc} \quad t=0, \dots, T-1 \quad (7.29)$$

$$uh^t - \delta_{fc}^t M \leq 0 \quad t=0, \dots, T-1 \quad (7.30)$$

Non-negativity constraints

$$h^t \geq 0 \quad t=0, \dots, T-1 \quad (7.31)$$

$$\tilde{h}^t \geq 0 \quad t=0, \dots, T-1 \quad (7.32)$$

$$\bar{h}^t \geq 0 \quad t=0, \dots, T-1 \quad (7.33)$$

$$u^t \geq 0 \quad t=0, \dots, T-1 \quad (7.34)$$

$$ul^t \geq 0 \quad t=0, \dots, T-1 \quad (7.35)$$

$$uh^t \geq 0 \quad t=0, \dots, T-1 \quad (7.36)$$

$$y^t \geq 0 \quad t=0, \dots, T-1 \quad (7.37)$$

$$yh^t \geq 0 \quad t=0, \dots, T-1 \quad (7.38)$$

The system model equations

The equations (7.2)-(7.15) that describe the overall system model are included as constraints in the optimization problem.

6. Case Study

The optimization problem introduced in Section V has been solved in connection with the data available for the Afourar village (Province of Azilal, Morocco, see Figure 7. 2).



Figure 7.2 The considered case study in Morocco

In particular, in this study area, one pumping station, one lower and one higher water reservoirs are present. The station was put into service by the National Office of Electricity in 2004. Figures 7.3 and 10.4 also refer to the study area.

In particular, the storage capacity is about 1.3 million m^3 for each water reservoir, and the parameters H_1 and H_2 of the model are $H_1=583m$ and $H_2=683m$, respectively.



Figure 7.3 Lower water reservoir



Figure 7.4 Higher water reservoir

The wind model described by equation (7.1) has been applied to the specific case study, inserting the following parameters: $v_c = 4$ [m/s], $v_r = 13$ [m/s], $P_r = 600$ [kW], $v_f = 25$ [m/s], $H_{hub} = 52$ [m], $H_{data} = 10$ [m], $z_0 = 0.03$ [m]. Moreover, for the specific wind turbine, the technical power curve supplied by the manufacturer has been compared with the power curve that results from the linear wind model. As criteria of comparison, the root mean square error (RMSE) and chi-square (χ^2) have been used. That is,

$$RMSE = \left(\frac{\sum_{i=1}^N ((P_{model,i}^t - P_{machine}^t) / P_r)^2}{Nc} \right)^{\frac{1}{2}} \quad (7.39)$$

$$\chi^2 = \frac{\sum_{i=1}^N ((P_{model,i}^t - P_{machine}^t) / P_r)^2}{Nc - n} \quad (7.40)$$

Where $P_{model,i}^t$ is the simulated (i.e., provided by the model) power output, $P_{machine}^t$ is the real power output of the machine, N is the number of wind speed data and n is number of parameters. The RMSE and Chi-square for $Nc=30$, at intervals of $1m/s$, are 0.0508 and 0.002869, respectively. Which are good values since they are of the order of 10^{-2} and 10^{-3} . As regards the optimization problem, the parameters reported in Table 10.1 have been used as inputs.

In order to evaluate the validity of the proposed decision scheme, it is assumed that a very reliable forecast of the wind speed pattern is available. In the considered case study, such a pattern is simply obtained by choosing a set of real collected data. The available wind data (reported in Figure 7.5) are those observed in the Essaouira site which benefits of a considerable wind potential, with approximately a mean wind speed value of 9 m/s. The data are given at intervals of 10 minutes.

In this chapter, it is supposed that the wind farm will be installed at the Essaouira site (see Figure 7.2), and then the produced energy will be transported to the Afourar village through the national grid (Afourar site has a low wind potential), where, instead, there are the energy, water and hydrogen demands to be satisfied.

Symbol value	
v_{data}^t = Wind speed at anemometer height (m/s), reported in Fig. 5.5.	$\rho_{H_2} = 0.0899 \text{ kg m}^{-3}$
D^t = Energy demand to be satisfied in time interval per residential unit ($t, t+1$) (kWh), reported in Fig. 5.6.	$g = 9.81 \text{ m s}^{-2}$
$DWh^t = 0.01 \text{ m}^3 \text{ s}^{-1}$	$\mu_{ht} = 0.7$
$DWl^t = 0$	HHV = 39.4 kWh/kg
$DH^t = 0.001 \text{ m}^3 \text{ s}^{-1}$	$\eta_1, \eta_2 = 0.75, 0.9$
$NR = 8500$	LHV = 33.3 kWh/kg
$N = 50$	$\eta_{FC} = 0.6$
$H_1 = 583 \text{ m}$	$\eta_p = 0.9$
$H_2 = 683 \text{ m}$	$Ul_{fc}, Ul_p, Ul_{hy}, Ul_{el} = 0, 0, 0, 0 \text{ m}^3 \text{ s}^{-1}$
$\Delta t = 1 \text{ hours}$	$Um_{fc}, Um_p, Um_{hy}, Um_{el} = 100 \text{ m}^3 \text{ s}^{-1}$
$T = 24$	$\bar{h}^*, \tilde{h}^*, h^* = 100, 770.9 \cdot 10^5, 900.9 \cdot 10^5 \text{ m}^3$
$\rho = 999.93 \text{ kg m}^{-3}$	$\xi, \beta, \bar{\beta}, \sigma, \vartheta, \chi = 10000, 0.1, 0, 0.1, 100, 10$
	$\bar{h}(0), \tilde{h}(0), h(0) = 0, 325000, 1300 \text{ m}^3$

Table 7.1 Optimization problem parameters

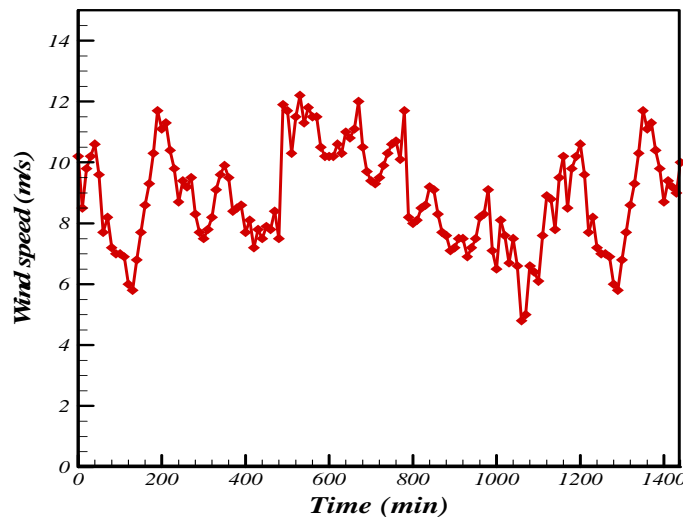

Figure 7.5 Wind speed on 1st November 2007 of Essaouira site

Figure 7.6 shows the energy demand to be satisfied in the hourly time interval per residential unit. It appears that the demand peaks are reached during two time periods, between approximately 6:00 and 8:00 and between 15:00 and 19:00, where the demand values are equal respectively to 2.4kWh and 2.1kWh.

In general, the decision model is quadratic with binary and continuous control variables, and continuous state variables. Lingo 9.0 (www.lindosystems.com) is used to solve the optimization problem (run time about 5 seconds). LINGO is a comprehensive tool designed to make building and solving Linear, Nonlinear (convex & nonconvex/Global), Quadratic, Quadratically Constrained, Second Order Cone, Stochastic, and Integer optimization models faster, easier and more efficient. LINGO provides a completely integrated package that includes a powerful language for expressing optimization models, a full featured environment for building and editing problems, and a set of fast built-in solvers. The developed optimization model has been written using the LINGO's modeling language and solved by the lingo's solvers.

Figure 10.7 shows the results obtained by solving the optimization problem. Specifically, the hourly produced energy from wind farm, E^t , and the hourly wind energy that is used to satisfy the demand, $E I^t$, are compared. The energy produced from the wind farm ranges from a maximum value of 18 MWh that is reached at 9:00 and 10:00 to a minimum value of 8.35 MWh at 17:00. In the periods of low demand, the excess of energy between produced wind energy and energy demand is sent either to the water pumping plant or/and to the electrolyzer plant.

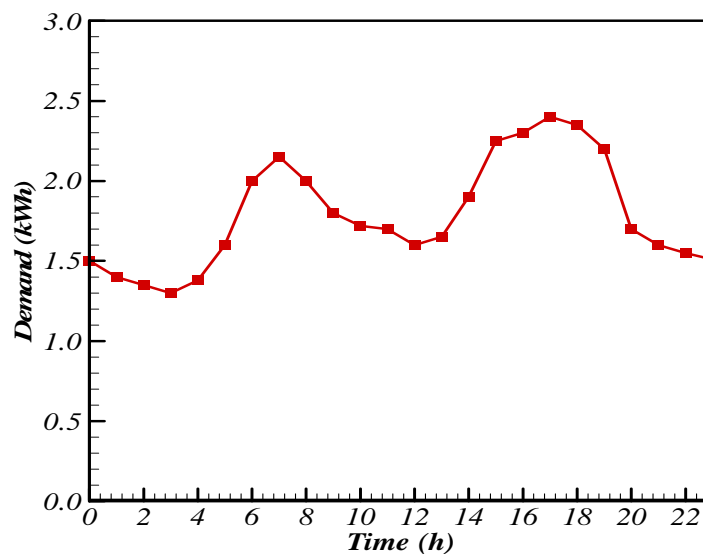

Figure 7.6 The energy demand per residential unit.

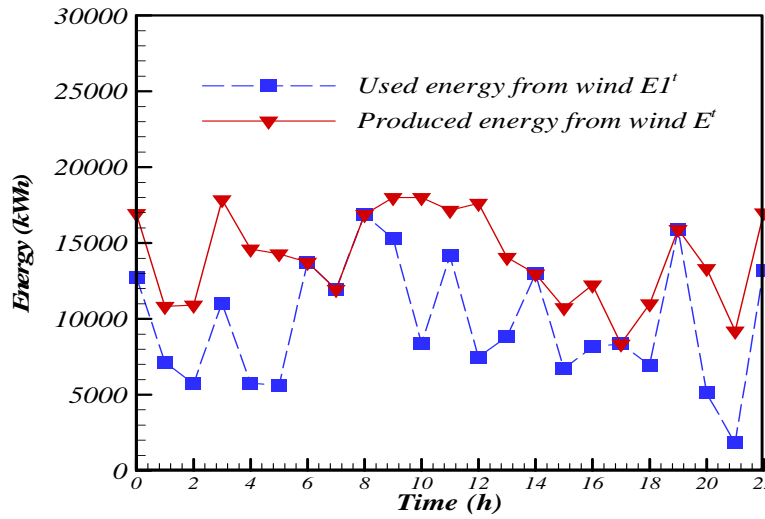

Figure 7.7 Hourly energy from the wind farm vs used wind energy

Figure 7.8 shows the hourly optimal use of the energy provided by the wind farm for the first day of November 2007. The most part of the wind energy is sent to the pumping station, while a small quantity of the energy is sent to the electrolyzer. Specifically, in the legend, $Pump E2^t$ is the energy that is sent to the pump, while $H_2 E3^t$ is the energy that is sent to the hydrogen production.

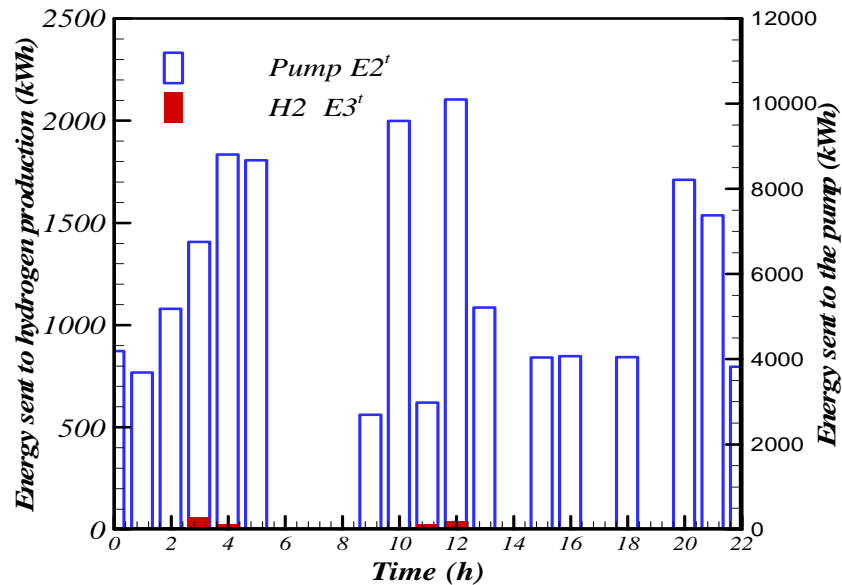

Figure 7.8 Optimal use of hourly wind energy potential

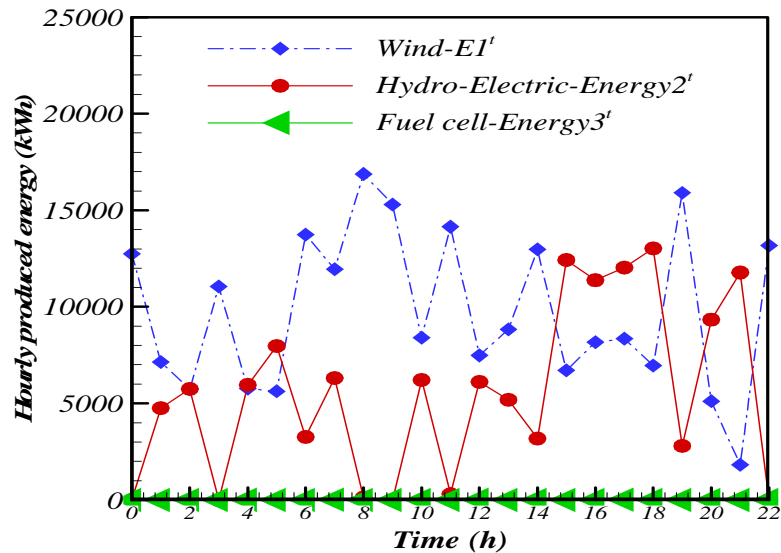

Figure 7.9 Hourly electrical energy production that is used to satisfy the electrical energy demand

Figure 7.9 shows the hourly energy that is produced from the different power plant systems (wind turbines, hydro-electric plant and fuel cell). It can be seen that most part of the energy is provided directly by the wind farm, whereas the rest is guaranteed by the hydro-electrical system, and the contribution of the fuel cell is very low (though not always zero).

The maximum hourly energy produced by the hydro-electric plant is observed between 15:00 and 18:00, with values between 12.42 MWh and 13 MWh, respectively. The occurrence of this maximum peak value is due to the energy drop of the wind farm which is explained by the intermittent character of the wind speed.

As a result of the impossibility of the wind farm to directly satisfy the energy needs, the system uses the hydro-electric plant to satisfy the energy demand, and, as a consequence, the water stored in the higher reservoir is used. For the same reason, the hydrogen stored in the tank may be used to produce energy.

Finally, in Figure 7.10, a comparison between the total hourly produced energy (E_{tot}^t) and the energy demand to be satisfied for $NR=8500$ is reported. It appears that the sum of energy from wind, hydro-electric and the fuel cell plants well satisfies the hourly energy needs. Whatever demand during the day, the energy is guaranteed and available for consumers.

In particular, an exact agreement has been observed between the demand and the provided energy. Thus, since the optimization process ensures the needs without any energy loss, the efficiency of the proposed hybrid system is demonstrated.

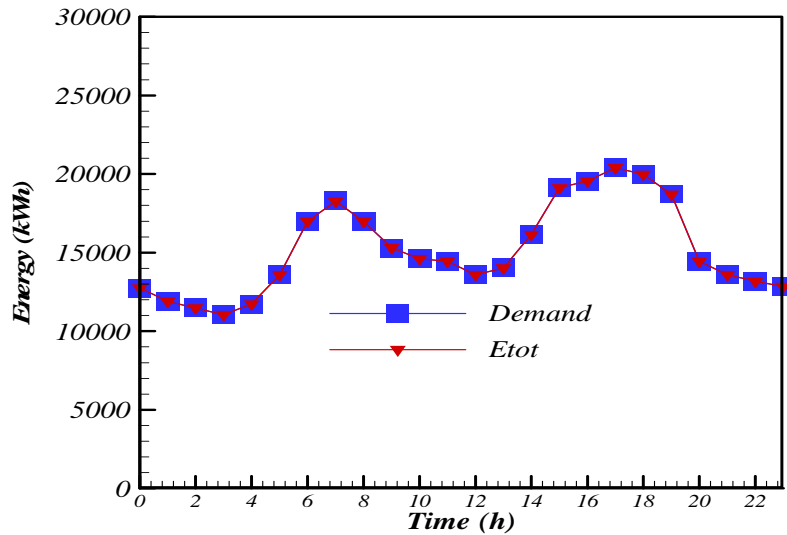

Figure 7.10 Total hourly energy production vs hourly energy demand

Finally, in Figure 7.11, for the same wind speed pattern, the results have been reported in case the wind turbines are the only active plants, and the energy cannot be stored. The energy demand cannot be satisfied in some time intervals, while in others it is lost.

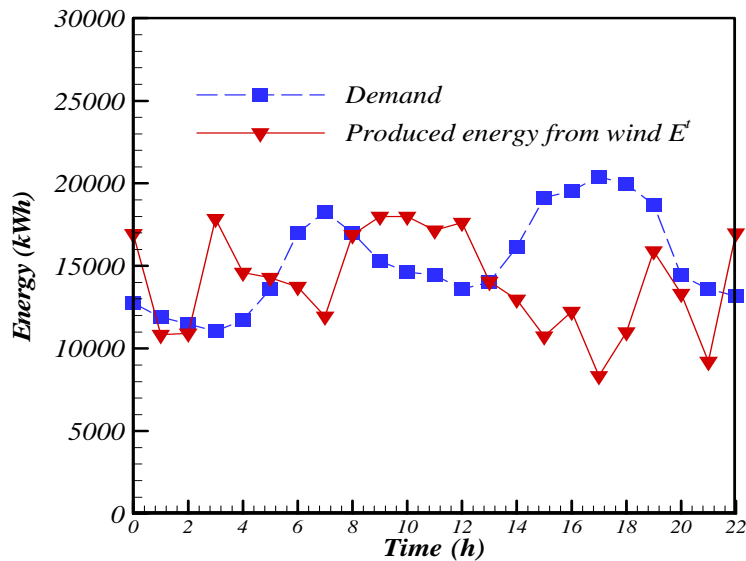

Figure 7.11 Hourly wind energy production vs hourly energy demand

7. Conclusion

A dynamic model of a hybrid system integrating a virtual power plant composed by a subsystems such as electrolyzer, hydroelectric plant, pumping stations, wind turbines, fuel cell, is presented. Moreover, on the basis of this dynamic model, a constrained optimization problem is formulated to satisfy a variable hourly electric energy demand fluctuating during the day. The sizes of the plants

and of the storage systems are known and fixed. In fact, the aim of this work is not the one of building a long term optimization problem for planning and design purposes, but the one of proposing an optimal control problem for real time operational management. The constrained optimization model is defined as a mathematical programming model and the results are reported for the area of Afourar village (Province of Azilal, Morocco). It is shown that the hybrid system allows satisfying the hourly energy demand, and the different plants are activated according to the fluctuating available wind speed and energy demand. In the case study, it is shown an approach to a sustainable energy system which might be quite common in the near future. In fact, the case study includes two regions that are quite distant, but which are connected by the grid network, and that have two different complementary peculiarities: one region has the energy (in terms of wind) and the other has already a natural way to stock energy (a water reservoir). In the future, policies and agreements among even distant and transnational villages are likely to happen, joining storage and energy. Future developments regard the definition of optimal control strategies for small sub-problems, to be formalized in a decentralized scheme. In fact, this work may represent the first step of the definition of a problem, where a monolithic, complex, although with many simplifying modelling assumptions, non-linear decision model has been formulated.

B-Optimal control of power flows and energy local storages in a network of microgrids modelled as a system of systems

1. Introduction

Active distribution systems are one of the most promising measures for the introduction of renewable energy resources (RES) into the distribution systems. They have the capability to allow the distributed energy resources integration at reasonable costs, opening new business opportunities (Pilo *et al.*, 2010); (McDonald, 2008); (Costa and Matos, 2009); (Borghetti *et al.*, 2010). In remote areas, the integration of RES has favored the penetration of distributed generation (DG) sources close to the energy consumers. These DG systems may include several technologies, such as microturbines (MTs), photovoltaics (PVs), small wind turbines (WTs), fuel cells and others (Tsikalakis and Hatziargyriou, 2008). From a microgrids perspective and approaching a system-of-systems modelling (Phillips and Jamshidi, 2008), the overall microgrid system is a collection of systems including small power sources, storage devices, and power conditioners interconnected to meet the power requirements of a designated cluster of community (Phillips and Jamshidi, 2008), (Hatziargyriou, <http://microgrids.eu>), (Korba *et al.*, 2009)). The microgrids can operate both standalone or connected to a main power grid. In this latter configuration, the microgrid is connected to the main or other grids, and it can be taken into account as a controlled entity which can operate both as a single aggregated load and as a small source of power supporting the other grids. In order to be successful, the microgrid needs to implement the concept of smart grid, which stipulates clean, flexible, reliable and economic electricity. In addition, the smart grid requires a support through a better communication and information platform. The increasing interest in microgrids is caused by the considerable growth of RES and DG (Yuen *et al.*, 2011). Figure 7.12 display the main components of a microgrid system.

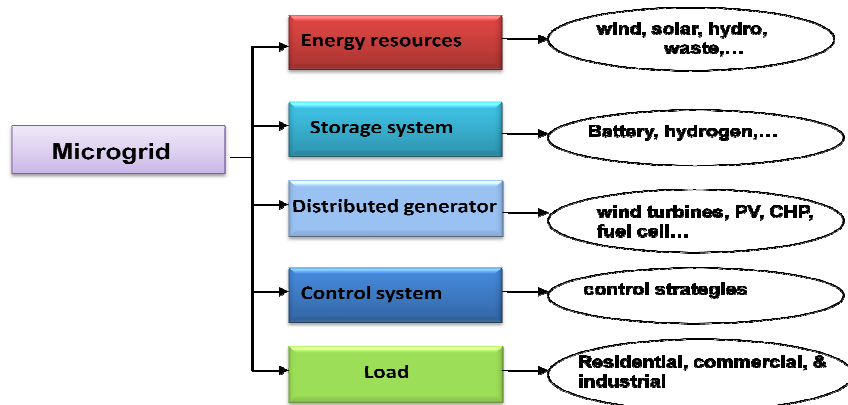

Figure 7.12 Microgrid components

Due to the variation of renewable energy in time and space, the interconnection among DG sources may offer great opportunities to the overall system stability and reliability. Hence, the proper coordination, control and communication among distributed resources is a key factor enabling their better utilization (Ochoa *et al.*, 2010), (Dominguez-Garcia and Hadjicostis, 2010).

One of the main advantages of microgrids is the possibility to use a cooperative exploitation of DG RES with other grids despite their physical separation. In other words, each microgrid can deliver power to the local load from its own power sources in an independent way. Alternatively, it can choose to get power either from other microgrids or from the main grid to supply its load when its local sources are insufficient or fail. The approach is completely different when a competitive or cooperation scenario is followed among grids. In the first one, the power cost variation, the availability of information to other grids, and a related bidding strategy are likely to play a key role, following for example, autonomous agent or game theory paradigms. Under a cooperation viewpoint, for example, when there is a single decision maker (DM) with the capability to find out the optimal strategy to exchange power among the whole system of microgrids, to store energy locally, and to acquire energy from the main grid, an optimal control approach may play a key role. In this paper, the latter viewpoint is followed.

In the literature, several authors studied a variety of microgrids configurations and control models which are, explicitly or implicitly, connected to the system-of-systems paradigm under a viewpoint of cooperation of subsystems. Dagdougui *et al.* (2010) introduced a dynamic decision model for the real time control of hybrid renewable energy production systems, which can be particularly suitable for autonomous systems, such as islands or isolated villages. In their paper, the demand of energy was coupled with the demand of water and hydrogen, where the hydrogen and water reservoirs also worked as storage energy systems. The problem of how to split an operating grid into islands to best serve current loads with operating sources was addressed in (Zhao *et al.*, 2003), where the aim was to determine where to split the grid to best serve the demand. Juan Li *et al.* (2010) proposed an algorithm that is applicable to very large power grids. This algorithm consists of a smart grid technology that applies an efficient multilevel and multi-objective graph partitioning technique. Molderink *et al.* (2010) presented a three-step control methodology to manage the cooperation between distributed generation, distributed storage, and demand-side load management. Li *et al.* (2010) investigated the major features and functions of the smart transmission grids in detail through three interactive, smart components: smart control centers, smart transmission networks and smart substations.

This paper focuses on the problem to control a cooperative network of power grids, viewed as a system of systems, fully exchanging real-time information on household energy demand and wind

power production. Section II introduces the microgrid system, including its different components and the definitions of different parameters. In section III, the network of power microgrids is defined as a system of systems. In the last section, an application of the previous sections has been performed, where a network of four microgrids in a regional scale has been proposed.

2. The Microgrid system model

Each microgrid is modeled according to several modelling components which are referred to: household consumption, wind power generation, the energy storage device (ESD), the internal power flows, the external power flows, the control unit and the information flows. Figure 7.13 shows the conceptual model of the microgrid system. The microgrid components are described in the following subsections. The continuous lines represent the power flows. The dotted lines represent the information and control flows.

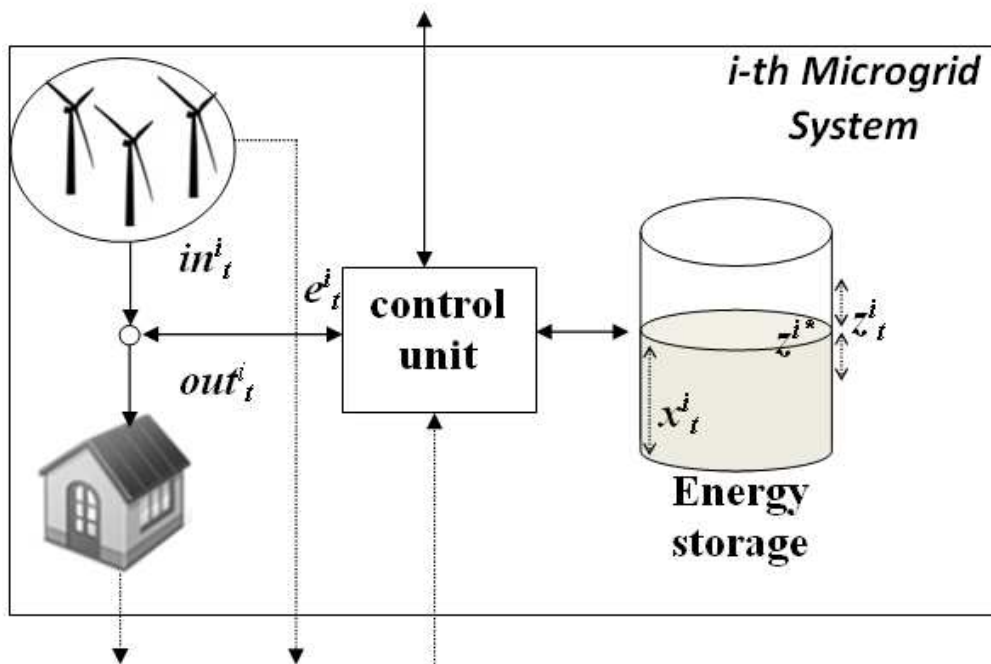

Figure 7.13 The conceptual model of a microgrid system

2.1 Household consumption

Households consume about one third of all end-use energy (Morna and vanVuuren, 2009). In 2004 the final energy consumption in households in the European Union (EU-25) approached 300 Mtoe, which represents about 26.9% of the total energy consumption (Beccali *et al.*, 2008). At the National level, in 2004, the Italian total electric energy consumption in household has reached a value of 66.6 GWh comparing to a 61.1 GWh in 2000 (GRTN, 2005). Several approaches for power load forecasting have been developed for accurate investment planning and to ensure that energy

supply fits the demand at each time period. Two kinds of forecasting may be performed: short term and medium to long term. Medium to long-term forecasting consists of the prediction of the energy consumers' demand of the coming weeks, months, or even years (Romera *et al.*, 2007). However, short-term electric load forecasting is vital for the control and scheduling of power systems (Al-Hamadi and Soliman, 2004). The forecasting period can vary from minutes to hours. The results of the short term load forecast are generally required to schedule the optimal control strategy that needs to be established in a given time period. The electric demand forecasts help in determining how the microgrid will operate and how demand will be satisfied. Among those who have focused on the short-term load forecasting, in (Kucukali and Baris, 2010), a short term forecast of the Turkey's gross annual electricity demand has been done, where a fuzzy logic methodology is applied. Papalexopoulos and Hesterburg (Papalexopoulos and Hesterburg, 1990) developed a linear regression-based model for the calculation of short-term system load forecast. Liu *et al.* (1996) addressed a very short-term load forecasting. In an earlier paper, Capasso *et al.* (1994) implemented a model for generating the tendency of the load diagram of residential end-use in Italy.

2.2 Wind power generation

The estimation of the wind potential is based on the knowledge of wind regimes of the considered territory. The accuracy of this phase is crucial as the provided power is proportional to the cube of wind speed. Nowadays, several methods can forecast wind speed in a short term (less than 24h) with a reasonable accuracy ($\pm 1\text{m/s}$) ((Alexiadis *et al.*, 1998), (Wang *et al.*, 2009)). The output energy generated by the wind power plant (WPP) is mostly dependent on the mean wind speed at the location. The knowledge of the probability distribution function of the wind speed is crucial to evaluate the wind energy potential. The commonly Weibull probability distribution function has been used to represent the frequencies of the wind speed. Its general form is represented by:

$$f(v) = \left(\frac{k}{c}\right) \left(\frac{v}{c}\right)^{k-1} \exp\left(-\left(\frac{v}{c}\right)^k\right) \quad (7.41)$$

where $f(v)$ is the probability of occurrence of wind speed v [m/s], k is the dimensionless Weibull shape parameter, and c [m/s] is the Weibull scale parameter.

The wind speed data are generally collected at the height h_{data} which is different from the wind speed at the hub height. The computation of the Weibull distribution at the hub height is necessary to represent the wind characteristics at the h_{hub} , the following relation is adopted (Ouammi *et al.*, 2010), (Ouammi *et al.*, 2010):

$$C_{hub} = C_{data} \frac{\ln(h_{hub}/z_0)}{\ln(h_{data}/z_0)} \quad (7.42)$$

$$k_{hub} = \frac{k}{(1-0.088 \log(h_{hub}/h_{data}))} \quad (7.43)$$

The wind power density of a site based on Weibull's probability density function is expressed by:

$$P = \int_0^{\infty} P(v) f(v) dv = \frac{1}{2} A \rho c^3 \Gamma\left(\frac{k+3}{k}\right) \quad (7.44)$$

where A is the blade sweep area [m^2] and ρ is the air density [kg/m^3]. So, the wind power density at the hub height is given by:

$$P_{hub} = \frac{1}{2} A \rho c_{hub}^3 \Gamma\left(\frac{k_{hub}+3}{k_{hub}}\right) \quad (7.45)$$

where gamma function is described by the following equation:

$$\Gamma(y) = \int_0^{\infty} e^{-x} x^{y-1} dx \quad (7.46)$$

The electric energy E_w [Wh] produced per time period T is given by:

$$E_w = C_{wpp} \cdot T \cdot P_{hub} \quad (7.47)$$

where C_{wpp} is the WPP performance coefficient.

2.3 Hydrogen energy storage device

The energy storage has the potential to ensure appropriate operation of the microgrids, since it can enhance the value of the wind power in the power system of the microgrid by avoiding the mismatch generated by the uncertainties between the wind power generation and the electric demand for the households. The ESD is modeled as an energy reservoir with a certain degree of performance. While under a simplifying hypothesis, the performance of charge and discharge energy in the ESD is supposed to be lossless, it is supposed that the energy stored has a certain decay in time, α^i , whose behavior depends on the type of the storage system implemented in the microgrid. Many storage systems have been developed worldwide to store the energy generated from renewable energy systems. One of the most interesting developments of energy systems is the one based on the use of hydrogen as an energy vector. The possibility of storing hydrogen for later use in a fuel cell for stationary power generation is studied here. Hydrogen as a suitable storage medium in renewable energy systems has been subject of many recent studies. In this analysis,

hydrogen storage is restricted to be used for storing excess of wind energy that will be used later to satisfy the requirement of the households or exchanged with the others microgrids.

The state variable in each microgrid is x_t^i [kWh] which represent the quantity of energy stored in the ESD at instant t . This value can be also expressed as a variation from the reference value of the ESD in the i -th microgrid, z^{i*} [kWh], as expressed in the following equation:

$$z_t^i = x_t^i - z^{i*} \quad (7.48)$$

In this work, it is assumed that the hydrogen energy system is composed by an electrolyser, storage tank and fuel cell. The electrolyser is directly connected to the hydrogen storage system. So that, due to the capacity of the storage, it is worth to notate that a Proton exchange membrane PEM-electrolyser is used to ensure that pressure in the output of the electrolyser is higher enough to permit the storage of hydrogen. In addition, the PEM electrolysis systems can respond rapidly to varying power inputs and therefore it can be easily integrated with renewable energy systems.

The hydrogen mass produced by the electrolyser is defined as follow:

$$M_{H2-t} = \frac{\eta_e \cdot z_t}{HHV_{H2}} \quad (7.49)$$

where HHV_{H2} is the higher heating value of hydrogen that is equal to 39.7 kWh/kg and η_e is the efficiency of the electrolyser taking into account the energy losses.

In the case of lack of energy, a quantity of hydrogen will transferred to the fuel cell for electricity generation purpose. The electrical energy delivered by the fuel cell will be calculated by [kWh]:

$$E_{fc_t} = \eta_{fc} \cdot LHV_{H2} \cdot M_{fc_{H2-t}} \quad (7.50)$$

where η_{fc} is the fuel cell efficiency (0.6), LHV_{H2} is the lower heating value of hydrogen that is equal to 33.3 kWh/kg, $M_{fc_{H2-t}}$ is the mass of hydrogen transferred from the hydrogen tank to the fuel cell system [kg].

It is not possible that the mass of stored hydrogen exceeds the rated capacity of the tank. The capacity of the hydrogen storage tank depends upon the characteristics of compensation being provided, that are -in the context of the paper- the connection or the cooperation with others microgrids that can exchange power. The production of hydrogen via electrolyser considers the availability of power in the system through the calculation of the residual power e_t (that is the difference between the energy produced by the wind energy system (in_t) and the energy load

required by the households (out_t)) and the power exchanged (ut) that may be exchanged from and to the others microgrids between time t and t+1.

the ESD state equation as an autonomous isolated system can be simply written as:

$$\begin{cases} x_{t+1}^i = \alpha^i x_t^i \\ x_0^i = x0^i \end{cases} \quad (7.51)$$

or alternatively as:

$$\begin{cases} z_{t+1}^i = \alpha^i z_t^i + (\alpha^i - 1)z^{i*} \\ z_0^i = z0^i = x0^i - z^{i*} \end{cases} \quad (7.52)$$

The choice of the reference value z^{i*} is technology dependent, in addition, it must be adequately sized to face quick changes in either demand and/or production.

2.4 Internal and external power flows

In each microgrid i , in each temporal interval $[t, t+1)$, the power in_t^i is generated by the WPP, and the power out_t^i is consumed by the household. The difference between the generated and the consumed power is a stochastic variable e_t^i . If positive, e_t^i can be sent either to the ESD or outside to other grids. If negative, e_t^i must be obtained either by the ESD or from other grids. The power flows towards the outside grids in the time interval is represented by the vector u_t [kW].

2.5 Information and control flows

It is supposed that the instantaneous information on the generated and consumed power, as well as on the ESD current state, can be sent in a negligible time towards a centralized controller, which in turn, after the acquisition of all the information from all the microgrids and the specific computation, can send the information on the power flows optimal control in the overall system of systems.

2.6 The Controller

It is supposed that, in each microgrid and at each instant t , a controller has the possibility to control the external and internal power flow according to a given strategy that is communicated from a central main controller.

3. The Network of power Microgrids as a system of systems model

In this work, the network of power microgrids is seen as a system of systems, whose power flow control - within each grid and among each other – is centrally computed by a system of system controller. The resulting conceptual model is shown in figure 7.14. Each circle G_i represents either a specific microgrid or one main grid. Each grid may exchange power with the other grids according to a specific network topology definition. In addition, each grid can send and receive information in real time with the system of systems controller. The main components of Figure 7.14 and their functions are described in the following subsections. The continuous lines represent the power flows. The dotted lines represent the information and control flows.

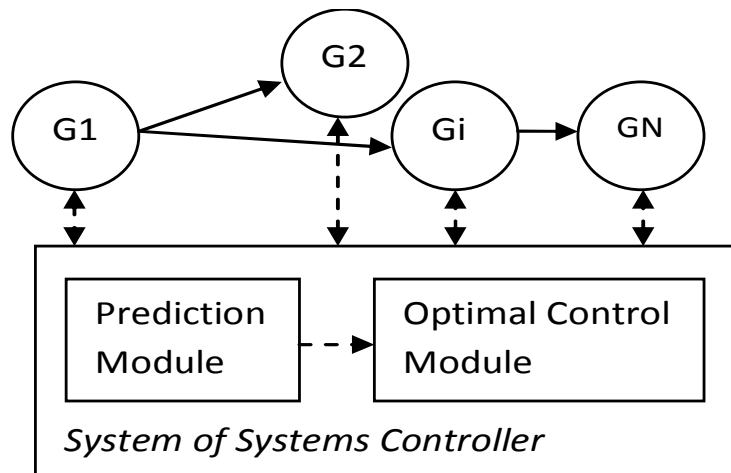

Figure 7.14 The conceptual model of the network of microgrids, and of the related controller

3.1 The microgrid network

Each smart power microgrid is supposed to be connected to a regional network of similar grids, and, at least for one microgrid, to one main grid. This network is modeled as a directed graph $G = (V, E)$, where V is the set of vertex with cardinality S , representing either microgrids or the main grid, and E is the set of directed links with cardinality W , representing the power connections existing among the vertexes. As a convention, the S -th node is associated to the main grid. It is worthwhile to underline that real world power grids are sparsely connected, and the system of systems configuration will generally be associated to a configuration modeled as small-world networks (Wang *et al.*, 2010). The network topology is defined by the matrix B , which is the $(S - 1) \times W$ incidence matrix, representing the network topology, such that each element $b_{i,j} = -1$ if there is a link exiting the i -th microgrid, $b_{i,j} = 1$ if there is a link entering the i -th microgrid and 0 otherwise.

3.2 The system of systems controller

The controller is composed by two main modules.

3.2.1 The prediction module

The prediction module is able to forecast, for each microgrid, the produced/consumed power and as the consequence, the vector e_t [kW] that is the vector of energy balance whose components for each microgrid are e_t^i . The forecasted deterministic value is $\eta_t \in R^{S-1}$. The vector $\omega_t \in R^{S-1}$ is the stochastic error in the prediction of the deterministic power balance η_t in time interval $(t, t + 1]$, modeled as a zero-mean normal distribution vector with variance n , not correlated with η_t and u_t .

3.2.2 The optimal control module

At each instant \tilde{t} , the optimal control module sends the optimal strategy for flow control in time interval $[\tilde{t}, \tilde{t} + 1)$, and for a certain number T of intervals $(t = \tilde{t} \dots T + \tilde{t} - 1)$ to the different microgrid controllers. This procedure is performed at each instant according to a receding horizon approach. Minciardi and Sacile (2011) have proposed a control approach to support optimal decisions in a network of cooperative grids. The main decisions are whether to store instantaneous exceeding energy production or to send it to some of the grid connections, or, alternatively, in case of lack of energy, whether it is convenient to acquire energy from some other grids or to use (if any) the energy stored in the local energy storage system. The optimization function to be minimized is:

$$\min J(z, u) = E\{\sum_{t=0}^{T-1} z_t' M z_t + u_t' N u_t + z_T' M_T z_T\} \quad (7.53)$$

where:

M , $M > 0$, is a $(S - 1) \times (S - 1)$ matrix, related to the cost of an exceeding/lacking quantity of energy stored in each energy storage device. M_T , $M_T > 0$, has the same definition of M , but it is only defined for instant $t = T$.

N is a $W \times W$ matrix, $N > 0$, related to the cost of the power sent on each edge of the network. Each microgrid is supposed to be subject to the following discrete time state equation:

$$\begin{aligned} z_{t+1} &= A z_t + B u_t + \mu_t + \omega_t & t = 0 \dots T - 1 \\ z_0 &= z_0 \end{aligned} \quad (7.54)$$

$$\mu_t = \eta_t \Delta t + (A - I) z^*$$

where:

$z_t \in R^{S-1}$ [kWh], state variable, is the vector of ESD inventory at instant t . A is a $(S-1) \times (S-1)$ diagonal matrix describing, in each diagonal element α_i , the efficiency of the energy storage technology in the i -th grid. In this respect, it holds that $0 \leq \alpha_i \leq 1$.

$\mu_t \in R^{S-1}$ [kWh] is a known sequence of deterministic values.

The optimal control of the problem defined by (7.53) and (7.54) is given by the equation defined hereinafter, whose demonstration is found in (Minciardi and Sacile, 2011):

$$u_t^* = K_t(z_t - z_t^{d2}) + K_t^g g_{t+1} \quad (7.55)$$

K_t is a $W \times (S-1)$ matrix given by:

$$K_t = -(N + B'P_{t+1}B)^{-1}(B'P_{t+1}A) \quad (7.56)$$

where P_{t+1} is a $(S-1) \times (S-1)$ matrix given by the discrete time algebraic Riccati equations (DARE):

$$P_t = M + A'P_{t+1}(I + BN^{-1}B'P_{t+1})^{-1}A \quad (7.57)$$

$$P_T = M_T$$

K_t^g is a $W \times (S-1)$ matrix given by

$$K_t^g = (N + B'P_{t+1}B)^{-1}B' \quad (7.58)$$

the vector z_t^{d2} is given by:

$$\begin{aligned} z_{t+1}^{d2} &= Az_t^{d2} + \mu_t & t = 0..T-1 \\ \square_0^2 &= \square_0 \end{aligned} \quad (7.59)$$

and the vector \square_\square is given by:

$$\begin{aligned} \square_\square &= (\square' - \square' \square_{\square+1} (\square + \square \square^{-1} \square' \square_{\square+1})^{-1} \square \square^{-1} \square') - Mz_t^{d2} \\ \square_\square &= \square_\square \square_\square^2 \end{aligned} \quad (7.60)$$

The behavior of the network of microgrids and the related degree of cooperation as a system of systems is dependent on the definition of \square , \square_\square , and \square matrices. An extreme reference solution of the problem may be to take into account the charge of the power flow among the grids as not relevant. In this assumption, the optimization of the control variable can be neglected, resulting in a “weak control” optimization.

Result: Under the hypothesis of weak control that is when N tends to the null matrix, the optimal control for the system defined by (7.53), (7.54) is:

$$u_t^* = -Q^{-1}B'M[Az_t + \mu_t] \quad (7.61)$$

where:

$$Q = B'MB \quad (7.62)$$

Proof: The proof follows the theorem demonstrated in (Bruni and Iacoviello, 2001). Due to its linearity, system (7.51) can be written in its stochastic and deterministic components:

$$z_{t+1}^s + z_{t+1}^d = A(z_t^s + z_t^d) + B(u_t^s + u_t^d) + \mu_t + \omega_t \quad (7.54^i)$$

System (7.54ⁱ) can be so decomposed into a stochastic subsystem:

$$\begin{aligned} z_{t+1}^s &= Az_t^s + Bu_t^s + \omega_t \\ z_0^s &= 0 \end{aligned} \quad (7.54^{ii})$$

and into a deterministic subsystem:

$$\begin{aligned} z_{t+1}^d &= Az_t^d + Bu_t^d + \mu_t \\ z_0^d &= z_0 \end{aligned} \quad (7.54^{iii})$$

Similarly, the cost function can be decomposed into its stochastic and deterministic components represented by the functions $J(z^s, u^s)$ and $J(z^d, u^d)$. The original problem can be so decomposed into a discrete state feedback LQG regulation and a deterministic discrete Linear Quadratic (LQ) problem. So, for the LQG problem, the optimal control is (Whittle, 1990):

$$u_t^{*,s} = K_t z_t^s \quad (7.63)$$

Adopting the weak control hypothesis, the equation (7.56) will take the following expression:

$$K_t = -(B'P_{t+1}B)^{-1}(B'P_{t+1}A) \quad (7.64)$$

where P_{t+1} is given by the DARE in equation (7.57), that will take the following value under the weak control hypothesis:

$$\begin{aligned} P_t &= M \\ P_T &= M_T \end{aligned} \quad (7.65)$$

So the feedback gain (K_t) will become:

$$K_t = -(B'MB)^{-1}(B'MA) \quad (7.64^i)$$

The LQ problem is not in a standard LQ form due to the presence of the element μ_t in (7.54ⁱⁱⁱ). Nevertheless, it can be easily transformed into an equivalent LQ tracking problem, whose solution is well known, as shown hereinafter. Let z_t^d be composed into two components z_t^{d1} and z_t^{d2} , such that:

$$z_t^d = z_t^{d1} + z_t^{d2},$$

and:

$$\begin{aligned} z_{t+1}^{d1} &= Az_t^{d1} + Bu_t^d \quad t = 0..T-1 \\ z_0^{d1} &= 0 \end{aligned} \quad (7.54^{iv})$$

and

$$\begin{aligned} z_{t+1}^{d2} &= Az_t^{d2} + \mu_t \quad t = 0..T-1 \\ z_0^{d2} &= z_0 \end{aligned} \quad (7.54^v)$$

Obviously z_t^{d2} is a known vector for each instant t , and putting $z_t^{d2} = -r_t$, the following cost function can be written (under the weak control hypothesis):

$$J(z^{d1}, u^d) = \sum_{t=0}^{T-1} \left((-r_t + z_t^{d1})' M (-r_t + z_t^{d1}) \right) + (-r_T + z_T^{d1})' M_T (-r_T + z_T^{d1}) \quad (7.66)$$

whose solution is:

$$u^{*,d} = K_t z_t^{d1} + K_t^g g_{t+1} \quad (7.68)$$

where the feedback gain K_t is defined above (in (7.56)), and the feed forward gain K_t^g is given by (under the weak control hypothesis):

$$K_t^g = (B'P_{t+1}B)^{-1}B' = (B'MB)^{-1}B' \quad (7.69)$$

Under the weak control hypothesis, the vector g_t is given by the following equation:

$$\begin{cases} g_t = -Mz_t^{d2} \\ g_T = M_T z_T^{d2} \end{cases} \quad (7.70)$$

By replacing the expressions the K_t^g and g_t into the optimal control of the deterministic discrete Linear Quadratic (LQ) problem:

$$u^{*,d} = -(B'MB)^{-1}(B'M)[Az_t^{d1} + z_{t+1}^{d2}] \quad (7.71)$$

So for each admissible solution (z, u) , and for the corresponding stochastic (z^s, u^s) and deterministic (z^d, u^d) components, the following identity holds

$$J(z, u) = J(z^s, u^s) + J(z^d, u^d) \quad (7.72)$$

This immediately follows from the definitions and taking into account that $E\{z_t^s\} = E\{u_t^s\} = 0 \forall t$. Furthermore, from the above expression, it follows that

$$z^* = z^{*,s} + z^{*,d} \quad (7.73)$$

$$u^* = u^{*,s} + u^{*,d} \quad (7.74)$$

is the unique optimal solution for the CNSPG problem. In fact, for every admissible solution (z, u) , the following relationship can be written:

$$J(z, u) = J(z^s, u^s) + J(z^d, u^d) \geq J(z^{*,s}, u^{*,s}) + J(z^{*,d}, u^{*,d}) = J(z^*, u^*) \quad (7.75)$$

So, by replacing the optimal control of the discrete state feedback LQG regulation and deterministic discrete Linear Quadratic (LQ) into (7.74), it seems obvious that:

$$u_t^* = \square_{\square}^{*,\square} + \square_{\square}^{*,\square} = -(B'MB)^{-1}B'M[Az_t + \mu_t] \quad (7.76)$$

with: $\square = B'MB$

$$u_t^* = -(Q)^{-1}B'M[Az_t + \mu_t] \quad (7.77)$$

4. Example: A network of four Microgrids

4.1 Case study: Liguria Region

Liguria Region, is located in the North of Italy between the following geographical coordinates, latitudes 43°47' and 44°10' and longitudes 7°36' and 9°80'. The province of Savona is one of the four provinces of the Liguria region (Figure 7.15).



Figure 7.15 Savona district and the locations of the four microgrid

A case study follows illustrating one possible application of the decisional model quoted in the previous section. Four microgrids -Monte Settepani (G1), Castellari (G2), Capo Vado (G3) and Savona (G4).

4.2 Electricity demand for the households

The electric consumption model for the households is based on the statistics given in the literature (Beccali and Cellura, 2008, Capasso *et al.*, 1994), assuming that each microgrid in the case study is composed by 100 households. The households are supposed to have a peak of demand of 355 kWh at 20h30, and other two peaks of 185 kWh and 225 kWh, respectively at 8h30 and 11h30. It is assumed that the coincidence factor is equal to 1, which means that the maximum households consumption is equal to the sum of the maximum individual consumption.

It is then supposed that the actual consumption is the one resulting from the model, adding a white noise component which is supposed with a probability distribution function $N(0,0.05)$. Figure 7.16 shows the trend of energy consumption for each microgrid, showing its deterministic forecasted component and the related stochastic uncertainty.

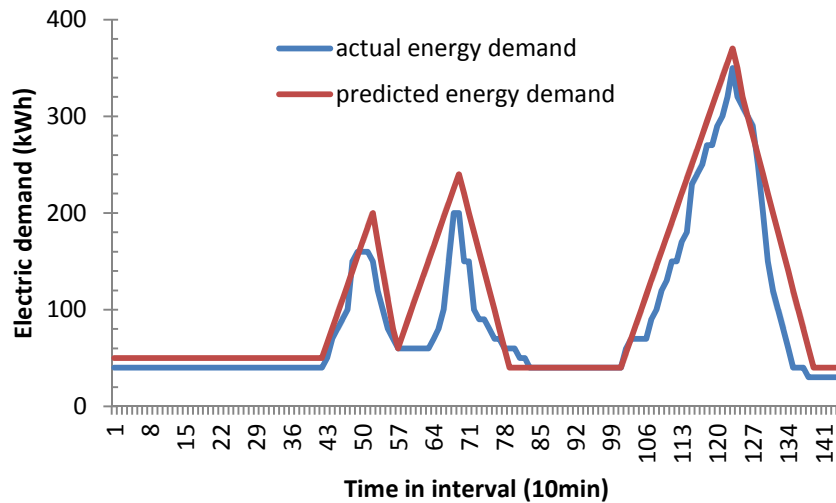

Figure 7.16 The deterministic energy demand versus the predicted electric demand in Savona site

4.3 Wind energy

The annual and seasonal wind energy characteristics of the four sites have been analyzed. The available mean annual wind energy of Capo Vado, Monte Settepani, Savona and Castellari is equal respectively to 4270, 1776, 352 and 53 kWh/m².yr. It is observed that the two first sites are more promising than the others, their seasonal wind power density ranges respectively between 135 W/m² in spring and 872 W/m² in autumn and 134 W/m² in summer and 307 W/m² in autumn, the highest wind power density is observed in the autumn season which coincides with the increased demand of energy. The wind energy characteristics of these sites reflect the need of adopting proper strategies to adapt the wind exploitable energy to the demand at regional scale. From a Weibull distribution viewpoint, the four sites namely Capo Vado, Monte Settepani, Savona and Castellari have a weibull parameters c [m/s] and k equal respectively to ($k=1.43$, $c=7.18$ [m/s]), ($k=1.84$, $c=6.13$ [m/s]), ($k=2.44$, $c=3.91$ [m/s]), ($k=1.10$, $c=1.32$ [m/s]). Further details on the wind speed regime of the province of Savona are available in the work of Ouammi *et al.* (2011).

Figure 7.17 shows the wind speed frequencies of the four sites as determined taking into account the statistical analysis of wind speed data on the whole period of measurements.

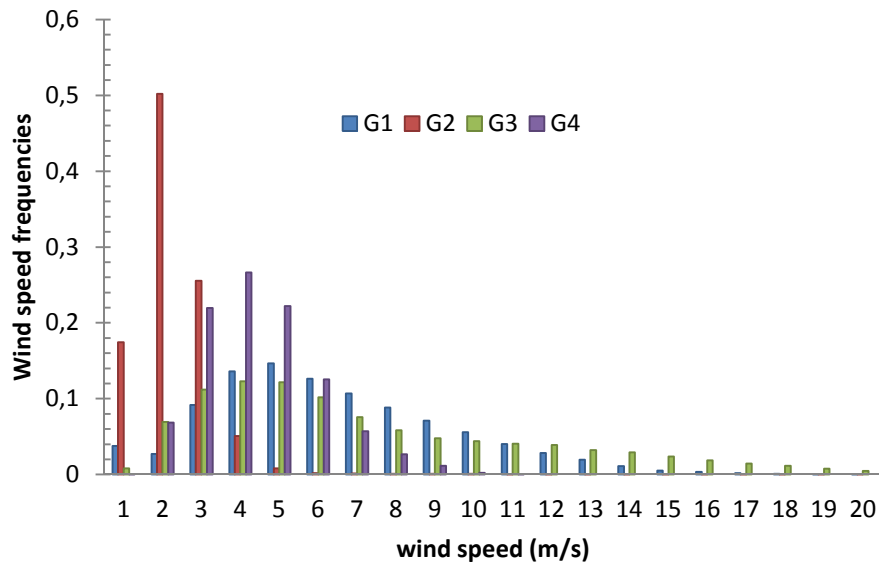

Figure 7.17 Histograms of wind speed frequencies of the four sites

4.4 Energy balance in the four microgrids on a given time interval

This exemplificative case study is performed on real wind data taken for 24 hours in a day of January 2008. The resulting power balance for the four microgrids is shown in Figure 7.18: for each microgrid i , e_i shows the actual power balance, while μ_i represents the power balance as a forecasted by the consumption and the wind power production model. Data are sampled on time interval of 10 minutes.

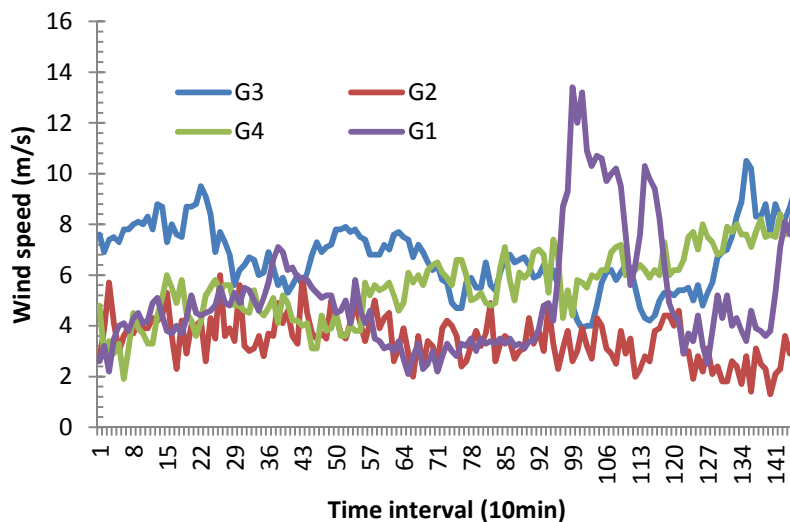

Figure 7.18 Wind speed data

4.5 Optimal control strategy

The four microgrids are also already connected and the fourth microgrid is joint to the main electrical network, with which exchanges power. The DM of all grids would like to evaluate whether a cooperative behavior, that is exchanging power between the four microgrids can help to improve the working conditions of the hydrogen storage technology, and to reduce the overall input/output load to the main grid. Specifically, Figure 7.19 shows the existing connections between microgrids.

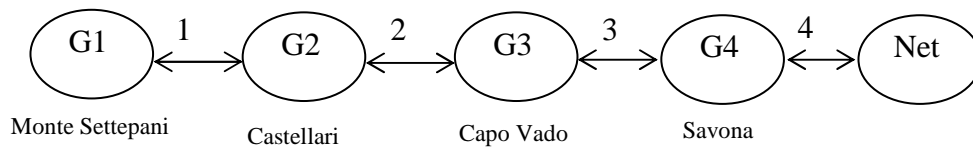
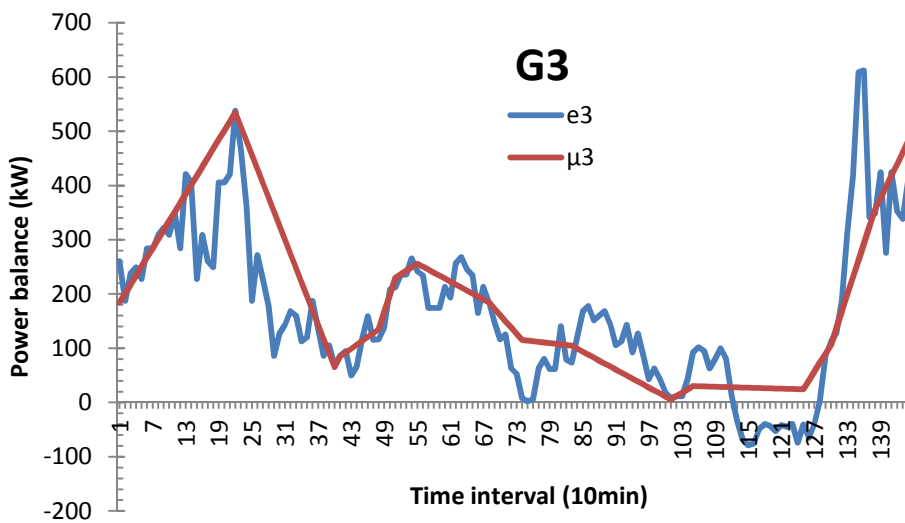
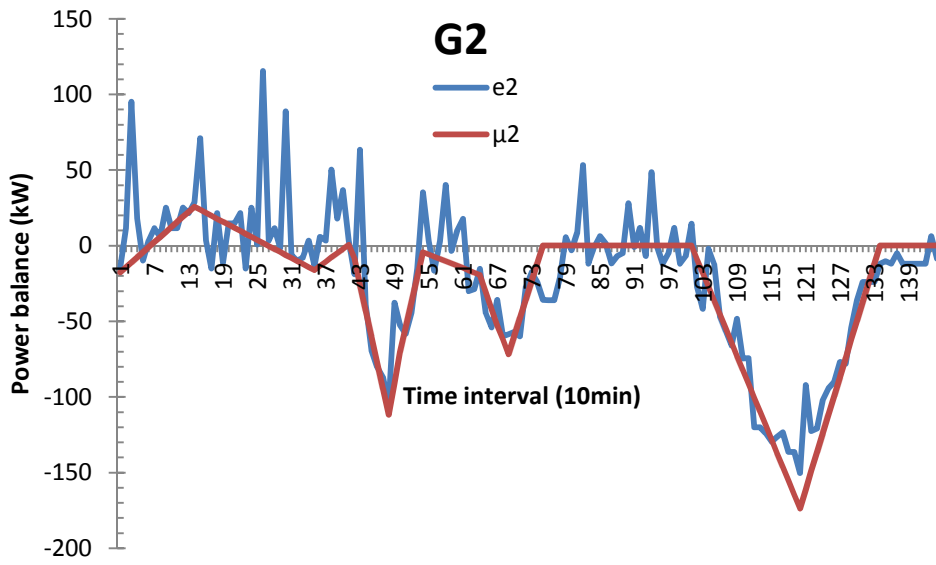
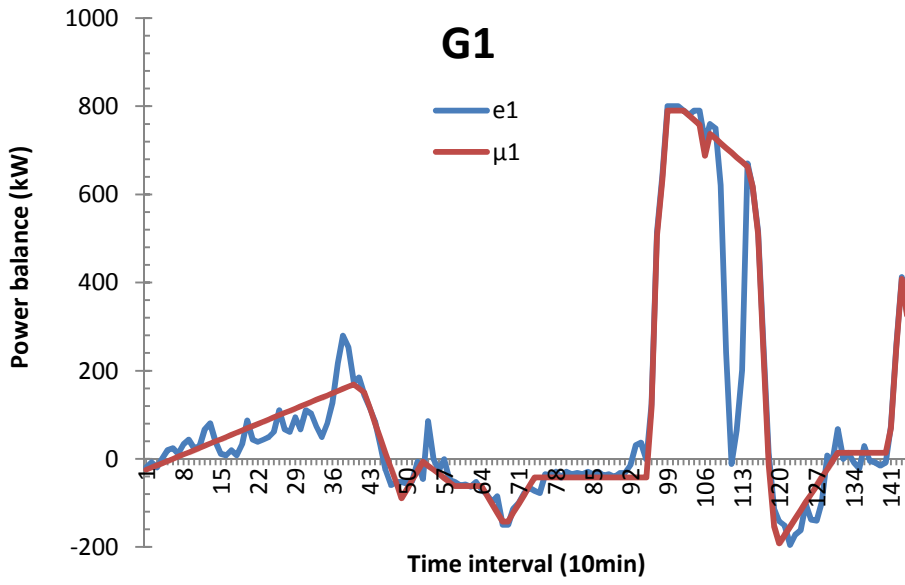

Figure 7.19 Directed connections planned among the microgrids

The network to be studied is composed by $S=5$ vertexes, where the fifth vertex refers the main grid. In the network there are $W=4$ links, including the new connection whose performance has to be evaluated. The link direction is taken into account as positive from left to right, and negative otherwise.

5. Results & discussion

This evaluation is done on a period of one day (1440 minutes). For the four microgrids, the predictions of the local energy balance (that is μ_{\square}) are available. For this fictional case study, the prediction of μ_t^i , and the a posteriori true energy balance \square_{\square} for the microgrids $\square = 1, \dots, 4$ are plotted in Figure 7.20 (a, b, c, d).



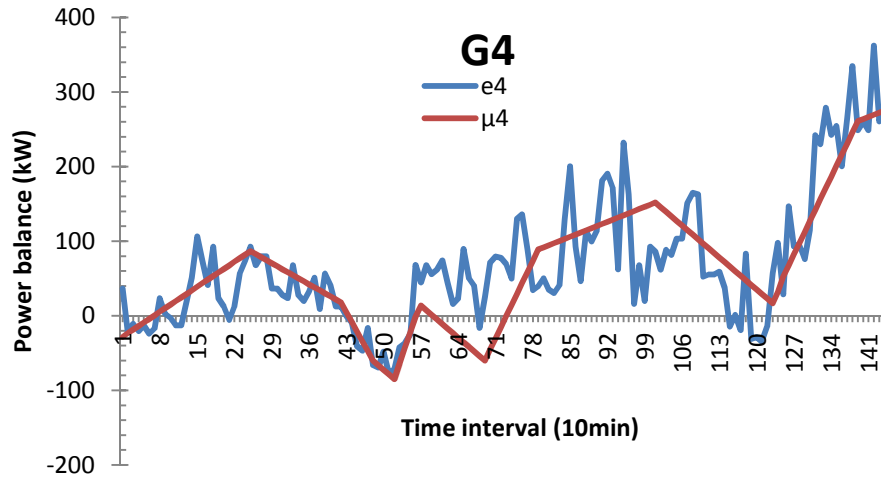

Figure 7.20 (a, b, c, d). The prediction of μ_t^i , and the a posteriori true power balance e_t^i for the microgrid $i = 1, \dots, 4$ (in top down order).

The true power balance is supposed to result from the sum of the predicted power balance and an additional Gaussian white noise \square_t . The difference (e_t) between the wind power production and the power load is plotted in Figure 7.20 (a, b, c, d). For instance, as can be seen from Figure 7.20 (c), which corresponds, to microgrid G3, this difference is almost positive during the simulation period. This remark means that the microgrid 3 is almost supplying the demand of power to the households directly by using the wind power production in the site.

In terms of local microgrid autonomy, it can be deduced that the local microgrids can supply the power demand to their households during 52%, 27%, 86% and 76% of the day for the respectively microgrids G1, G2, G3 and G4.

5.1 System of systems optimal strategy

Here the four microgrids and the main grid are supposed to be cooperative and to be connected according to the network shown in Figure 7.19. The related 4x4 incidence matrix \square is as follows:

$$\square = \begin{bmatrix} -1 & 0 & 0 & 0 \\ 1 & -1 & 0 & 0 \\ 0 & 1 & -1 & 0 \\ 0 & 0 & 1 & -1 \end{bmatrix}$$

The 4x4 matrix A is as follows:

$$\square = \begin{bmatrix} 0.85 & 0 & 0 & 0 \\ 0 & 0.85 & 0 & 0 \\ 0 & 0 & 0.85 & 0 \\ 0 & 0 & 0 & 0.85 \end{bmatrix}$$

The following 4×4 N matrix is defined:

$$\square = \begin{bmatrix} 0.1 & 0 & 0 & 0 \\ 0 & 0.1 & 0 & 0 \\ 0 & 0 & 0.1 & 0 \\ 0 & 0 & 0 & 100 \end{bmatrix}$$

Finally, the following 4×4 \square and 4×4 \square_{\square} matrices are defined:

$$\square = \begin{bmatrix} 1 & 0 & 0 & 0 \\ 0 & 1 & 0 & 0 \\ 0 & 0 & 1 & 0 \\ 0 & 0 & 0 & 1 \end{bmatrix}$$

$$\square_{\square} = \begin{bmatrix} 10 & 0 & 0 & 0 \\ 0 & 10 & 0 & 0 \\ 0 & 0 & 10 & 0 \\ 0 & 0 & 0 & 10 \end{bmatrix}$$

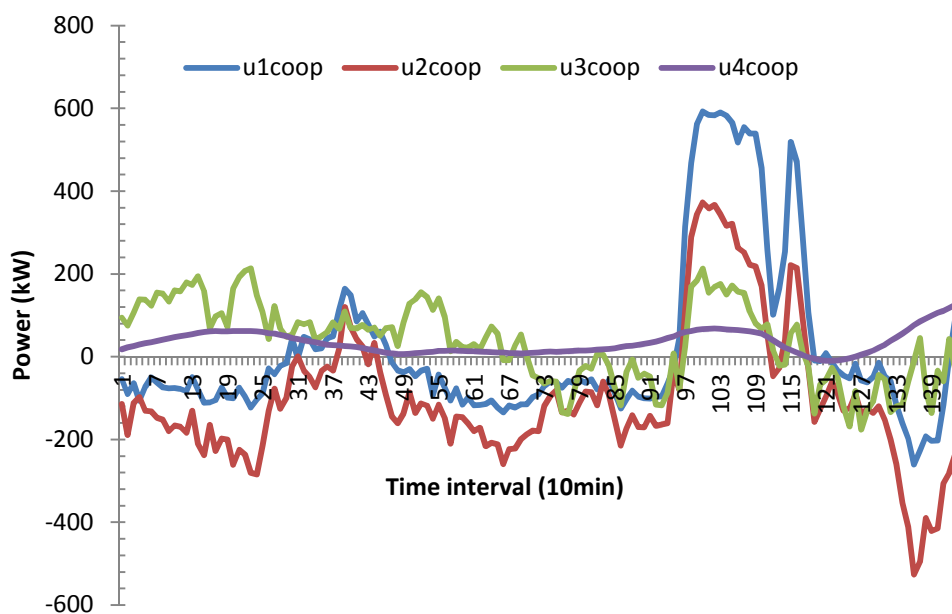

Figure 7.21 Trends of the optimal values for the $u_t^{*,i}$ $i=1,..,4$ elements of the control variables under a cooperative strategy (u1coop, u2coop, u3coop and u4coop in the legend).

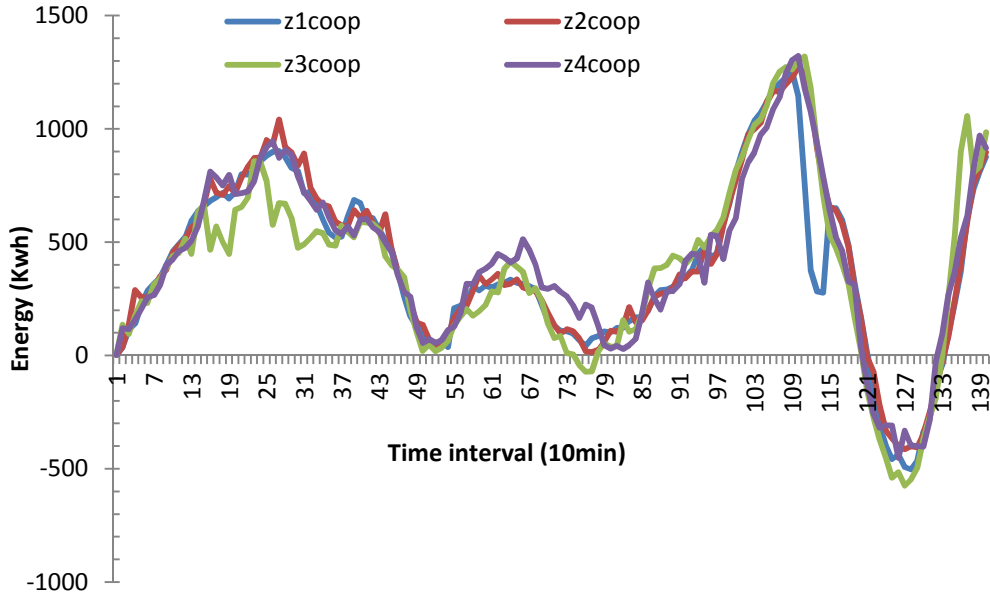

Figure 7.22 Trends of the optimal values for the state variables z^* under a cooperative strategy (respectively for microgrids 1,..4 referred to in the legend as z1coop, z2coop, z3coop and z4coop)

It can be shown from the Figure 7.21 that the maximum exchanged power is observed for microgrid G1, where a value of about 600 kWh is sent to G2. This can be explained by the excess of energy available in this period. As regard, power exchange in microgrid G4, this value does not exceed a value of 100 kWh. Figure 7.22 reports the trends of the optimal control of the ESD level under a cooperative strategy respectively for each microgrid.

5.2 Weak control optimal strategy

The weak control is a good reference value when priority is given to the control of the state (storage), in order to dimension the maximum power exchange over the links.

Figure 7.23 shows the optimal control of the power flows exchanged among the microgrids under the weak control hypothesis. From the weak grid hypothesis, it results that the optimal values for the state variables z^* under a cooperative strategy for G1, G2, G3 and G4 are set to zero, whereas, for the control variables, the values ranged between a positive values of 1300 kWh and a negative values of 540 kWh.

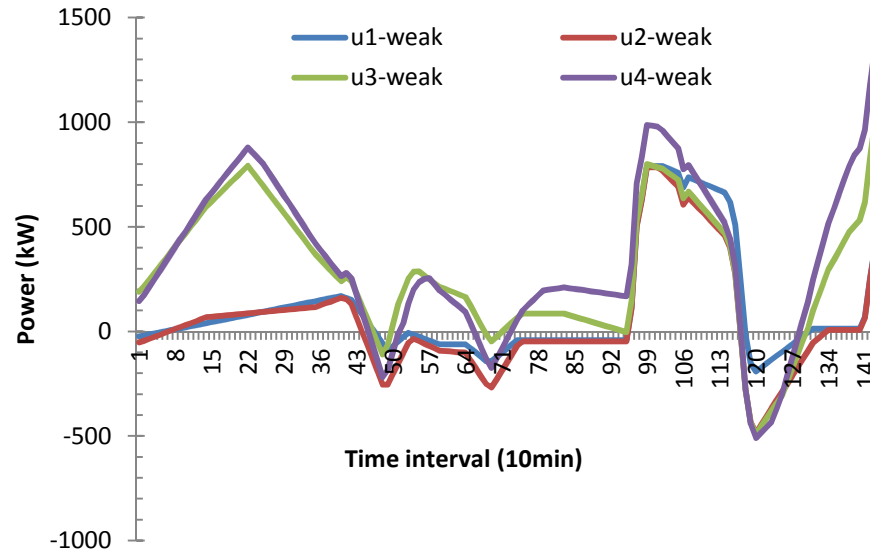

Figure 7.23 Weak control hypothesis: Trends of the optimal values for the $u_t^{*,i}$ $i=1,..4$ elements of the control variables under a cooperative strategy (u1-weak, u2-weak, u3-weak and u4-weak in the legend)

6. Conclusion

The methodology and the case study described in this paper are in the direction required by international governments, such as European Union (European SmartGrids Technology, 2006), as concerned microgrids, and their role in active distribution. The cooperation among grids has significant advantages and benefits to the unit grid operation in terms of profitability and stability. Those benefits are manifested in power exchanging, especially in case of the availability of fluctuant distributed energy resources with demand clusters, where electric energy must be supplied to each cluster. However, this cooperation may share some drawbacks with the centralized approaches, which include, among others, the delay in power transmission, the failure of real-time communication with one or more grids.

Chapitre 8 : General conclusion

1. Main contributions

The thesis has highlighted the increasing interest of hydrogen as the basis for an energy system with reduced carbon dioxide emissions. The hydrogen special characteristics render it the ideal alternative energy that could lead to more sustainable energy systems. Hydrogen could be exploited as a fuel for transportation sector, distributed heat and power generation, and for energy storage. Here, three different applications have been implemented: (1) the use of hydrogen as an alternative fuel, (2) as a storage medium and (3) as a bridge for power generation. This diversity in exploitation is certainly enhancing and enriching the discussion about an upcoming 'hydrogen economy'.

In this thesis, we have explored the combined role of renewable energy sources and hydrogen. We demonstrate that through the use of hydrogen, the drawbacks of RES could be overcome, such as the intermittent behavior and the exploitation of RES in the transportation sector.

We provided a detailed analysis of the hydrogen infrastructure focus on a network of production, storage and transportation facilities. Then, we made a review which is the first of its kind published in the literature that presents different approaches that are used for the planning and design of the future hydrogen supply chain. On this basis, a classification of these approaches is made and which could be very helpful for the worldwide research communities to know the current state-of-art of the methods available for the design a future hydrogen supply chain. Meaning this state of art, we were able to find the research needed to be explored to better plan a sustainable hydrogen supply chain. We have based on the use of the optimization methods and GIS based approaches which have been proved to be powerful for the planning of future infrastructure.

In this study, different methods and approaches have been formalized for the planning of the future hydrogen energy systems. These methods have used different tools such as the implementation of geographical information system (GIS), the mathematical modelling, the development of optimization methods for the design of future hydrogen based energy systems.

One of the original work developed within the thesis was to propose an innovative frame of hydrogen supply chain, mainly based on the use of renewable energy sources (RES) as a clean feedstocks for production. This clean route of production has been recognized to be the long term way to reach the main goals for an economic and environmental sustainability.

In addition, instead of adopting the classical definition of the supply chain, generally based on the use of some deterministic feedstocks, we have used a feedstock that is surrounded by many uncertainties-in space and time- which increase the difficulties in solving the problem.

The study implements different component related to these feedstocks such as the assessment of the potential, the design of the network of the production-demand points, the estimation of the demand, the distribution of the energy, management and control of the renewable hydrogen based systems to supply the hydrogen and electric needs.

In chapter 5, we presented a methodology that formalizes a decision support system based on the use of RES for hydrogen production. This chapter starts with a detailed approach to assess the potential of RES, with special reference to wind and solar energy sources. We continue the chapter by proposing a model that controls the hydrogen and the energy flows in a network of green hydrogen refuelling stations, which is powered by renewable energy technologies. To our knowledge, the green network is the first design of its kinds which introduce a green frame of hydrogen refuelling station network. The proposed model has been formulated as a mathematical programming, where the main objectives within the optimization problem is to minimize the risk of hydrogen refuelling stations location beside of satisfying the hydrogen and electric flows that need to be sent to the refuelling stations. The approaches presented within this chapter can be exploited as a top-down approach for the decision support system for the future hydrogen supply chain.

In chapter 6, we present two decision support systems. In a first part, an integrated approach considered as a decision support system for the selection of hydrogen refueling stations is presented. The method combines two different approaches: a detailed spatial data analysis using a geographic information system with a mathematical optimization model of set covering. Regarding GIS component, criteria related to the demand and safety are considered for the selection of the hydrogen stations, while in the mathematical model, criteria that regard costs minimization are considered. In general, the DSS will identify the suitable sites providing information on multi-criterion level evaluation of locating the hydrogen infrastructure. The GIS component of the integrated approach is applied to the region of Liguria, North of Italy, while the application of mathematical model is projected as a future work since the model still in the development phase.

In the second part, we define a mathematical model to estimate the hazard and the risk related to the use of high pressurized hydrogen pipeline. The study could be considered as a tool for decision makers to envisage the development of hydrogen with a low risk level. A promising future development may be included to the overall resulting model as a specific add-on of classical geographic information system software for the assessment of the risk in hydrogen pipeline planning.

In chapter 7, we have focused on the use of hydrogen as a storage medium for power generation, in this frame an analysis of how the hydrogen infrastructure could be implemented. The aim is to develop spatial-temporal models to design energy storage and transmission strategies for renewable energy delivery. In this chapter, we propose two mathematical optimization models for the control of a combined RES based hydrogen system. In a first part, a dynamic decision problem is formulated whose aim is to satisfy a variable hourly demand in electric energy, hydrogen and water. The objective function also includes economic costs related to the operation of the fuel cell and of the hydroelectric plants. The structure of the considered decision model is consistent with the assumption of a stand-alone system, located in an isolated area or on an island or in an area where there is not the possibility to sell the energy produced in excess to the electric network manager. The model has been applied to a real case study based in Morocco. In a second part, "Smart Grid" topic is been approached. A problem to control a cooperative network of power grids, viewed as a system of systems, fully exchanging real-time information on household energy demand and wind power production is been presented. It consists of a network of microgrid, where each microgrid is modeled according to several modelling components which are referred to: household consumption, wind power generation, the energy storage device (ESD), the internal power flows, the external power flows, the control unit and the information flows.

The thesis is particularly devoted to develop new frame of sustainable energy systems based on the use of clean and sustainable energy resources to generate energy and hydrogen to satisfy both the transportation sector and the electric demands.

2. Discussions and future perspectives

In this section, we provide discussion points on the approach designed and developed but also the results concerning the deployment of infrastructure for distribution of hydrogen fuel.

The main limitations of our approach concern the consideration the following:

- The results of optimization depicted in Chapter 5 are limited because the design of the network does not take into account the economic aspects of the supply chain, in fact, these aspects are of paramount interest to ensure an economic sustainability of the future hydrogen supply chain.
- Under the frame of GIS based decision support presented in the Chapter 5, the model needs to be extended to other part of the Italian territory or maybe applied to other regions. The

objective is to prove the potential of the approach to be applied in different areas where regulations and policies may change.

- In addition, it would be interesting to present the model taking into account a multi-periods optimization approach which gives better representation on the transition trend of the hydrogen demand. On this basis, the RES production plant could be better sized taking into account the hydrogen that is needed to be supplied to the network of hydrogen refuelling stations.

- In chapter 6, an integrated approach is been described which could be of high interest to the decision makers to locate the future hydrogen refuelling stations on a specific territory. Here, the first part of the approach is presented, and which consists of the use the geographical information system as a preliminary tool for selection taking various criteria of selection such as the hydrogen demand, the safety criteria among others. As a future work, the model will be completed through the incorporation of the mathematical optimization

- One attractive future development of the work displayed in Chapter 7 is to deepen the complexity of the system, defining a network of various interacting new subsystems, referred to specific components such as the water reservoirs or the user demand, brought together to satisfy the multiple objectives required by the decision model. Two interesting examples in this respect are described in (Philips *et al*, 2008, Korba *et al*, 2009).

- From a "Smart Grid" perspective, this route of research worth more attention. An interesting development of the proposed approach will be devoted to adopt a distributed control strategy, thus allowing decisions to be taken locally. In this respect, examples can be found in (Nayyar *et al*), (Kreidl and Willsky, 2006), (Ji and Hong-yu, 2009). An interesting future development would be to adapt the current methodology and case study with team theory and delays in information as modeled in (Rantzer, 2006) and (Rantzer, 2007). Another interesting future development would be to shift the theoretical view of the problem as presented in this paper, to more practical and technological aspects allowing its practical implementation.

References

- Abdeen Mustafa Omer. Energy, environment and sustainable development. *Renewable and Sustainable Energy Reviews* 12 (2008) 2265–2300.
- Agator, J.M., Avril, S., Towards a French Hydrogen Energy Roadmap: the HyFrance Project. WHEC 16/13-16 June 2006.
- Aiche-Hamane, L., Belhamela M., Benyoucef B., Hamane, M., 2009. Feasibility study of hydrogen production from wind power in the region of Ghardaia. *International Journal of Hydrogen Energy*, Vol. 34, pp. 4947:4952.
- Ajanovic, A., 2008. On the economics of hydrogen from renewable energy sources as an alternative fuel in transport sector in Austria. *International journal of hydrogen energy*, Vol.33, pp. 4223-4234
- Akpinar, E.K., Akpinar, S., 2005. An assessment on seasonal analysis of wind energy characteristics and wind characteristics. *Energy Conversion and Management*, Vol.46, pp.1848-1867.
- Alexiadis, M.C., Dokopoulos, P.S., Sahsamanoglou, H.S, Manousaridis, I.M, 1998. Short-term forecasting of wind speed and related electrical power. *Solar Energy*, vol. 63, pp. 61–68.
- Afgan, N.H., Carvalho, M.G., 2002. Multi-criteria assessment of new and renewable energy power plants. *Energy*, Vol.27, pp.739–55.
- Afgan, N.H., Carvalho, M.G., 2004. Sustainability assessment of hydrogen energy systems. *Int J Hydrogen Energy*, Vol.29, pp.1327–42.
- AIChE/CCPS. Guidelines for chemical process quantitative risk analysis, second Edition, American Institute of Chemical Engineers (AIChE), New York, 2000.
- Al-Hamadi H.M., Soliman, S.A., 2004. Short-term electric load forecasting based on Kalman filtering algorithm with moving window weather and load model. *Electric Power Systems Research*, Vol. 68, pp. 47-59.
- Almonacid, F., Rus, C., Pérez, P.J., Hontoria, L., 2009. Estimation of the energy of a PV generator using artificial neural network. *Renewable Energy*, Vol.34, pp.2743–2750.
- Alsamamra, H., Ruiz-Arias, J.A., Pozo-Vazquez, D., Tovar-Pescador, J., 2009. A comparative study of ordinary and residual kriging techniques for mapping global solar radiation over southern Spain *Agricultural and Forest Meteorology*, Vol.149, pp.1343–1357.
- Anagnostopoulos, J.S, Papantonis, D.E., 2007. Pumping station design for a pumped-storage wind-hydro power plant. *Energy Conversion and Management*, Vol. 48, pp. 3009–3017.
- Anderson D., Leach M., 2004. Harvesting and redistributing renewable energy: on the role of gas and electricity grids to overcome intermittency through the generation and storage of hydrogen. *Energy Policy*, Vol. 32, pp.1603–1614.

Alcock, J.L., Shirvill, L.C, Cracknell, RF. Compilation of Existing Safety data on Hydrogen and Comparative fuels. Deliverable report, EIHP2, May 2001.

Almansoori, A., Shah, N., 2009. Design and operation of a future hydrogen supply chain: Multi-period model. *International Journal of Hydrogen Energy*, Vol. 34, pp. 7883-7897.

Almansoori A, Shah N., 2006. Design and operation of future hydrogen supply chain Snapshot Model. *Chemical engineering Research and Design*, Vol. 84, pp. 423-438.

Andrews, J.D., Moss TR. Reliability and risk assessment. Harlow: Longman Scientific & Technical; 1993.

Alvin Peter Bergen. Integration and Dynamics of a Renewable Regenerative Hydrogen Fuel Cell System. Ph. D thesis. University of Victoria 2008.

Aydin, N.Y, Kentel, E., Duzgun, S., 2010. GIS-based environmental assessment of wind energy systems for spatial planning: A case study from Western Turkey. *Renewable and Sustainable Energy Reviews*, Vol.14, pp.364–373.

Apra, JL. 2008. New standard on safety for hydrogen systems in spanish: Keys for understanding and use. *International Journal of hydrogen energy*, Vol.33, pp.3526-3530.

Ayyub, B. M., 2003. Risk analysis in engineering and economics. Chapman & Hall/CRC, ISBN 1-58488-395-2.

Backhaus, J., Bunzeck, I.G. 2010. Planning and permitting procedures for hydrogen refuelling stations Analysis of expected lead times for hydrogen infrastructure build-up in the Netherlands. ECN-E--10-051.

Bagster, D.F., Schubacht, S.A., 1996. The prediction of jet-fire dimensions, *J. Loss Prev. Process Ind*, Vol. 9, no. 3. 241-245.

Balat, M., Balat, M., 2009. Political, economic and environmental impacts of biomass-based hydrogen. *International journal of hydrogen energy*, Vol.34, pp.3589–3603.

Balat, B., 2008. Potential importance of hydrogen as a future solution to environmental and transportation problems. *international journal of hydrogen energy*, Vol. 33, pp. 4013–4029.

Balat, H., Kırtay, E., 2010. Hydrogen from biomass e Present scenario and future prospects. *Int J of hydrogen energy*, Vol. 35, 7416-7426.

Ball, M., Wietschel, M., Rentz, O., 2007. Integration of a hydrogen economy into the German energy system: an Optimising modelling approach. *International Journal of Hydrogen Energy*, Vol.32, pp.1355–1368.

Barbir, F., 2009. Transition to renewable energy systems with hydrogen as an energy carrier. *Energy*, Vol.34, pp

Barbir, F., 2005. PEM electrolysis for production of hydrogen from renewable energy sources. *Solar Energy*, Vol.78, pp.661–669.

- Bargaoui, Z.K., Chebbi, A., 2009. Comparison of two kriging interpolation methods applied to spatiotemporal rainfall. *Journal of Hydrology*, Vol. 36, pp. 56–73.
- Barton, J, Gammon, R., 2010. The production of hydrogen fuel from renewable sources and its role in grid operations. *J Journal of Power Sources*, Vol. 195, pp.8222–8235.
- Beccali, M., Cellura, M., Brano, V.L., Marvuglia A., 2008. Short-term prediction of household electricity consumption: Assessing weather sensitivity in a Mediterranean area. *Renewable and Sustainable Energy Reviews*, vol. 12, pp. 2040–2065.
- Bernal-Agustin, Dufo-Lopez, R., 2008. Hourly energy management for grid-connected wind–hydrogen systems, *International journal of hydrogen energy*, vol. 33, pp. 6401-6413
- Borghetti, A., Bosetti, M., Grillo, S., Massucco, S., Nucci, C.A., Paolone, M., Silvestro, F., 2010. Short-Term Scheduling and Control of Active Distribution Systems with high Penetration of Renewable Resources. *IEEE Systems Journal*, Vol. 4, Issue 3.
- Benchrif, R., Bennouna, A., Zejli, D., 2007. Role de l'hydrogène dans le stockage de l'électricité a base des Energies renouvelables. *2IWH 2007*, 27-29 October 2011, Ghardaïa – Algeria.
- Bersani, C., Minciardi R., Sacile, R., Trasforini E., 2009. Network planning of fuelling service stations in a near-term competitive scenario of the hydrogen economy. *Socio-Economic Planning Sciences*, Vol. 43, pp. 55–71.
- Bruni, C., Iacoviello, D., 2001. Some results about the optimal LQG tracking problem. *Int. J. Control*, vol. 74, pp. 977-987.
- Bueno, C., Carta, J.A., 2006. Wind powered pumped hydro storage systems, a means of increasing the penetration of renewable energy in the Canary Islands. *Renewable and Sustainable Energy Reviews*, vol. 10, pp. 312–340.
- Belmonte, S., Núñez, V., Viramonte, J.G., Franco, J., 2009. Potential renewable energy resources of the Lerma Valley, Salta, Argentina for its strategic territorial planning. *Renewable and Sustainable Energy Reviews*, Vol.13, pp. 1475–1484.
- Blanchette, S., 2008. A hydrogen economy and its impact on the world as we know it. *Energy Policy*, Vol.36, pp.522–530.
- Bokris, J., Veziroglu, T., 2007. Estimates of the price of hydrogen as a medium for wind and solar sources. *International Journal of Hydrogen Energy*, Vol. 32, pp. 1605–1610.
- Borghetti, A., Bosetti, M., Grillo, S., Massucco, S., Nucci, C.A., Paolone, M., Silvestro, F., 2010. Short-Term Scheduling and Control of Active Distribution Systems with high Penetration of Renewable Resources. *IEEE Systems Journal*, Vol. 4, Issue 3.
- Bossel, Ulf., 2006. Does a Hydrogen Economy Make Sense?. *Proceedings of the IEEE* . Vol. 94, no.10.
- Brey, J.J., Brey, R., Carazo, A.F., Contreras, I., Hernández-Díaz, A.G., Gallardo, V., 2006. Designing gradual transition to hydrogen economy in Spain. *Journal of Power Sources*, Vol.159, pp.1231–1240.

Bruni, C., Iacoviello, D., 2001. Some results about the optimal LQG tracking problem. *Int. J. Control*, vol. 74, pp. 977-987.

Capasso, A., Grattieri, W., Lamedica, R., Prudenzi, A., 1994. Bottom-up approach to residential load modelling." *IEEE Transactions on Power Systems*, vol. 9, no. 2.

Casamirra, M., Castiglia, F., Corchia, L., Giardina, M., Lombardo, C., Messina, G., Risk analysis of the storage unit in a hydrogen refueling station. Available in http://conference.ing.unipi.it/ichs2007/fileadmin/user_upload/CD/PAPERS/11SEPT/4.1.294.pdf.

Casamirra, M., Castiglia, F., Giardina, M., Lombardo, C., 2009. Safety studies of a hydrogen refuelling station: Determination of the occurrence frequency of the accidental scenarios. *international journal of hydrogen energy*, Vol.34, pp.5846–5854.

CEC: California Energy Commission. Failure modes and effects analysis for hydrogen fueling options. CEC-600-2005-001.

Clarke, RE., Giddey, S., Ciacchi, F.T., Badwal, S.P.S., Paul, B., Andrews, J., 2009. Direct coupling of an electrolyser to a solar PV system for generating hydrogen. *International Journal of Hydrogen Energy*, Vol. 34, pp. 2531–2542.

Clark II, W.W., Rifkin, J., 2006. A green hydrogen economy. *Energy Policy*, Vol. 34, pp.2630-2639.

Campen, A., Mondal, K., Wiltowski, T., 2008. Separation of hydrogen from syngas using a regenerative system. *International Journal of Hydrogen Energy*, Vol. 33, pp. 332-339.

Carta, J.A., Ramirez, P., Velazquez, S., 2009. A review of wind speed probability distributions used in wind energy analysis Case studies in the Canary Islands. *Renewable and Sustainable Energy Reviews*, Vol.13, pp.933–955.

Castronuovo, E.D, Peças Lopes, J.A., 2004. On the Optimization of the Daily Operation of a Wind-Hydro Power Plant. *IEEE Transactions on Power Systems*, Vol.19, pp.1599-1605.

Celik, A.N., 2006. A simplified model for estimating yearly wind fraction in hybrid-wind energy systems. *Renewable Energy*, Vol.31, pp.105–118.

Cellura, M., Cirrincione, G., Marvuglia, A., Miraoui, A., 2008. Wind speed spatial estimation for energy planning in Sicily: a neural kriging application. *Renewable Energy*, Vol. 33, pp.1251-1266.

Cherigui, A., Belhamel, M., 2005. Hydrogen Energy roadmap in Algeria. In: *First International Workshop on Hydrogen Energy*, Algeria; 21–23.

Chiabrando, R., Fabrizio, E., Garnero, G., 2009. The territorial and landscape impacts of photovoltaic systems: Definition of impacts and assessment of the glare risk. *Renewable and Sustainable Energy Reviews*, Vol.13, pp.2441–2451.

Christoph, S., Philipp, S., Ulrich, B., Martin, W., Assessment of the regional hydrogen demand and infrastructure build-up for 10 European Countries. London: *Fuel Cell Today*, <http://www.fuelcelltoday.com/events/archive/2007-08/Assessment-ofthe-RegionalHydro>; 2007.

- Conte, A., Pavone, A., Ratto, C.F., 1998. Numerical evaluation of the wind energy resource of Liguria. *Journal of Wind Engineering and Industrial Aerodynamics*, Vol.74,pp.355–64.
- Contini, S., Amendola, A., Ziomas, I., Benchmark exercise on major hazard analysis: vol. 1, description of the project, discussion of the results and conclusions; 1991. EUR 13386 EN.
- Costa P.M., Matos M.A., 2009. Assessing the contribution of microgrids to the reliability of distribution networks. *Electric Power Systems Research*, vol. 79, pp. 382-389.
- Crowl, D. A., and Louvar, J. F., 2002. *Chemical process safety fundamentals with applications* (2nd ed.), New Jersey: Prentice-Hall (p. 100).
- Dagdougui, H., Minciardi, R., Ouammi, A., Robba, M., Sacile R., 2010. A dynamic decision model for the real time control of hybrid renewable energy production systems. *IEEE Systems Journal*, Vol. 4, pp. 323:333.
- Damon, H., Patrick, M., 2009. Estimating global hydrogen production from wind. *International Journal of Hydrogen Energy*, Vol.34, pp. 727-736.
- Decreto Ministeriale 31 agosto 2006. Approvazione della regola tecnica di prevenzione incendi per la progettazione, costruzione ed esercizio degli impianti di distribuzione di idrogeno per autotrazione.
- Delichatsios MA (1993), "Combust Flame", 92,349-64.
- Demirbas, A., 2008. Present and future transportation fuels. *Energy Sources Part A*, 30:1473.
- Demirbas, A., 2005. Potential applications of renewable energy sources, biomass combustion problems in boiler power systems and combustion related environmental issues. *Progress in Energy and Combustion Science*, Vol.31,pp.171–192.
- Dincer, I., 2002. Technical, environmental and exergetic aspects of hydrogen. *International Journal of Hydrogen Energy*, Vol.27, pp. 265–285.
- Dickson, E.M., Ryan, J.W., Smulyan, M.H., 1976. Systems considerations and transition scenarios for hydrogen economy. *International Journal of Hydrogen Energy*, Vol.1,pp.11–21.
- Diveux, T., Sebastian, P., Bernard, D., Puiggali, J.R., Grandidier, J.Y., 2001. Horizontal axis wind turbine systems: optimization using genetic algorithms. *Wind Energy*, Vol. 4, pp.151-171.
- Doll, C., Wietschel, M., 2008. Externalities of the transport sector and the role of hydrogen in a sustainable transport vision. *Energy Policy*, Vol. 36, pp. 4069–4078.
- Dominguez-Garcia, A.D., Hadjicostis, C.N., 2010. Coordination and Control of Distributed Energy Resources for Provision of Ancillary Services. *IEEE Smart Grid Communications (SmartGridComm)*, 2010 First IEEE International Conference on, pp. 537-542.
- Draft of guideline for the fire prevention characterization of specific components and vehicles fuelled with gaseous hydrogen. Under approval of Italian Ministry of the Interior.

- Dufo-Lopez, R., Bernal-Agustin, J.L., 2008. Multi-objective design of PV-wind-diesel-hydrogen – battery systems. *Renewable Energy*, Vol. 33, pp. 2559-2572.
- Dufo-Lopez, R., Bernal-Agustin, J.L., Contreras, J., 2007. Optimization of control strategies for stand-alone Renewable energy systems with hydrogen storage. *Renewable Energy*, Vol. 32, pp.1102–1126.
- El-Amin, M.F., Kanayama, H., 2009. Similarity consideration of the buoyant jet resulting from hydrogen leakage. *international journal of hydrogen energy* xxx 1–7.
- Elder, R., Allen, R., 2009. Nuclear heat for hydrogen production: coupling a very high/high temperature reactor to a hydrogen production plant. *Progress in Nuclear Energy*, Vol.51, pp.500–25.
- Eisenberg, N.A., Lynch, C.J., Breeding, R.J., 1975. Vulnerability model: a simulation system for assessing damage resulting from marine spills, Final Report SA/A-015 245, US Coast Guard.
- Eskin, N., Artar, H., Tolun, S., 2008. Wind energy potential of Gokçeada Island in Turkey. *Renewable and Sustainable Energy Reviews*, Vol.12, pp.839-851.
- European SmartGrids Technology Platform. Vision and Strategy for Europe’s Electricity Networks of the Future, Office for Official Publications of the European Communities, 2006, Luxembourg.
- Ewan, B.C.R., Allen, R.W.K., 2008. A figure of merit assessment of the routes to hydrogen. *International Journal of Hydrogen Energy*, Vol.30, pp.809–19.
- Franco, A., Salza, P., 2011. Strategies for optimal penetration of intermittent renewables in complex energy systems based on techno-operational objectives. *Renewable Energy*, Vol.36, pp.743-753.
- Fukuda K, et al. Development for safe utilization and infrastructure of hydrogen. Research on fundamental properties of hydrogen (FY2003-FY2004) final report (1), p. 15–37.
- Farrell, A.E., Keith, D.W., Corbett, J., 2003. A strategy for introducing hydrogen into transportation. *Energy Policy*, Vol.31, pp.1357–1367.
- Fyrrippis, I., Axaopoulos, J.P., Panayiotou, G., 2010. Wind energy potential assessment in Naxos Island Greece. *Applied Energy*, Vol.87, pp.577–586.
- FY 2008 annual progress report. DOE hydrogen program. Available from: www.hydrogen.energy.gov/pdfs/progress08/ii_0_hydrogen_production_overview.pdf.
- Garbolino E. HDR thesis: Contributions à l’étude du risque de transport sur route de marchandises dangereuses dans un espace transfrontalier. Habilitation à Diriger des Recherches en Géographie. Université de Nice – Sophia Antipolis.
- Gastli, A., Charabi, Y., 2010. Solar electricity prospects in Oman using GIS-based solar radiation maps. *Renewable and sustainable Energy reviews*, Vol. 14, pp.790-797.
- Gerboni, R., Salvador, E., 2009. Hydrogen transportation systems: Elements of risk analysis, *Journal of Energy*, Vol. 34, pp. 2223-2229.

Germany - Taking the Fast Lane to Hydrogen Infrastructure Development. P. Schmidt. August 2008.

Guidelines for the evaluation of the characteristics of vapor cloud explosions, flash fires, and bleves, center for chemical process safety. American Institute of Chemical Engineers; 1998.

Granovskii, M., Dincer, I., Marc, A., 2006. Rosen. Environmental and economic aspects of hydrogen production and utilization in fuel cell vehicles. *Journal of Power Sources*, Vol.157, pp.411–421.

Grasso, N., Ciannelli, N., Pilo, F., Carcassi, M., Ceccherini, F., Fire prevention technical rule for gaseous hydrogen refuelling stations. *Proceedings of the International Conference on Hydrogen Safety*, 8–10 September 2005, Pisa, Paper 420064.

Gerd P. Haugom. Hydrogen applications-risk acceptance criteria and risk assessment methodology. Norsk Hydro ASA.

Greiner, C., Korpås, M., Holen, A. 2008. A Norwegian case study on the production of hydrogen from wind power. *International Journal of Hydrogen Energy*, Vol. 32, pp.1500–1507.

Gronich, S., H2 & FCV implementation scenarios, 2010–2025. DOE 2010-2025 Scenario analysis meeting 2006; August 9–10.

Guoxin, H., Hao, H., 2009. Hydrogen rich fuel gas production by gasification of wet biomass using a CO₂ sorbent. *Biomass and Bioenergy*, Vol.33, pp.899–906.

GRTN: Italian National Grid Operator, Operation data. Available on-line at: www.grtn.it, access on September 2005.

Guillén-Gosálbez, G., Mele, F., Grossmann, I., A bi-criterion optimization approach for the design and planning of hydrogen supply chains for vehicle use with economic and environmental concerns. *AIChE* Published online: <http://dx.doi.org/10.1002/aic.12024>; September 2009.

Haimes, Y. Y. (2009). *Risk modelling, assessment, and management* (3rd ed.). A John Wiley & Sons Inc. Publication, ISBN 978-0-470-28237-3.

Hajimiragha, A., Fowler, M.W., Canilare, C.A., 2009. Hydrogen economy transition in Ontario – Canada considering the electricity grid constraints. *international journal of hydrogen energy*, Vol.34, pp.5275–5293.

Hake, J.F., Linssen, J., Walbeck, M., 2006. Prospects for hydrogen in the German energy system. *Energy Policy*, Vol.34, pp.1271-83.

Haugom, G., Friis-Hansen, P., 2010. Risk modelling of a hydrogen refuelling station using Bayesian network. *Int J Hydrogen Energy*, Vol. 36, pp.2389-97.

Hatziargyriou, N., *Microgrids– large scale integration of micro-generation to low voltage Grids*, Available on <http://microgrids.eu/micro2000/presentations/16.pdf>.

Henrik Lun., 2007. Renewable energy strategies for sustainable development. *Energy*, Vol.32, pp.912–919.

Hill, R. T., and Catmur, J. R., 1994. Risks from hazardous pipelines in the United Kingdom, Health and Safety Executive contract research report no. 82/1994.

Himri, Y., Stambouli, A.B., Draoui, B., 2009. Prospects of wind farm development in Algeria. *Desalination*, Vol. 23, pp.130–138.

Hoesen, J.V., Letendre, S., 2010. Evaluating potential renewable energy resources in Poultney, Vermont: A GIS-based approach to supporting rural community energy planning. *Renewable Energy*, Vol. 35, pp.2114–2122.

Honnery, D., Moriarty, P., 2009. Estimating global hydrogen production from wind. *International Journal of Hydrogen Energy*, Vol.34, pp.727-736.

Houf, W.G., Schefer, R.W., 2007. Predicting radiative heat fluxes and flammability envelopes from unintended releases of hydrogen. *Int J Hydrogen Energ*, Vol. 32, pp.136–51.

<http://www.eihp.org/>

<http://www.h2it.org/en/regions/toscana/toscana-progetti/stazione-di-servizio-agip-di-grecciano-collesalvetti>

<http://www.h2fc.com/reframe.php?top=/global/indust.shtml&bot=/industry/infra/electrolyzers.shtml>

HyWays the European hydrogen Roadmaps. Project report. EUROPEAN commission. Contract SES6-502596. 2008.

Høj and Kröger, 2002 N.P. Høj and W. Kröger, Risk analyses of transportation on road and railway from a European perspective, *Safety Science* 40 (1–4) (2002), pp. 337–357.

h2 incidents database. <http://www.h2incidents.org/>

Hong, E.-S., Lee, I.-M., Shin, H.-S., Nam, S.-W., & Kong, J.-S. (2009). Quantitative risk evaluation based on event tree analysis technique: application to the design of shield TBM. *Tunnelling and Underground Space Technology*, 24(3), 269e277.

Hogan, L., Curtotti, R., Austin, A., APEC energy security and sustainable development through efficiency and diversity: economic issues in technology R&D, adoption and transfer. In: AARE research report. Prepared for the eighth meeting of APEC energy ministers, Darwin, May 2007.

Honnery, D., Moriarty, P., 2009. Estimating global hydrogen production from wind. *International Journal of Hydrogen Energy*, Vol. 34, pp. 727–736.

Hugo, A., Rutter, P., Pistikopoulos, S., Amorelli, A., Zoiac, G., 2005. Hydrogen infrastructure strategic planning using multi-objective optimization. *International Journal of Hydrogen Energy*, Vol. 30, pp. 1523–1534.

Hugo, A., Rutter, P., Pistikopoulos, tratos., Amorelli, A., Zoia, G., 2005. Hydrogen infrastructure strategic planning using multi-objective optimization. *International Journal of Hydrogen Energy*. Vol. 30, pp. 1523 –1534.

HyApproval-WP2 – Deliverable 2.2. Handbook for Hydrogen Refuelling Station Approval. Version: 2.1. June 4, 2008.

IEA Energy technology Essentials. Oecd/IEA 2007. <http://www.iea.org/techno/essentials6.pdf>.

IEA Statistics. CO2 emissions from fuel combustion Highlights.<http://www.iea.org>. edition 2009.

Ingason H.T., Ingolfsson H.P., Pall J., 2008. Optimizing site selection for hydrogen production in Iceland. *International Journal of Hydrogen Energy*, Vol. 33, pp. 3632-3643.

Ilinca, A., McCarthy, E.d., Chaumel, J.L., Rétiveau, J.L., 2003. Wind potential assessment of Quebec Province. *Renewable Energy*, Vol. 28, pp.1881-1897.

IUPAP Energy reports. IV R&D of Energy Technologies. Annex A. Hydrogen Energy. <http://www.iupap.org/wg/energy/annex-1d.pdf>.

Janke, J.R., 2010. Multicriteria GIS modelling of wind and solar farms in Colorado. *Renewable Energy*, Vol. 35, pp.2228-2234.

Jefferson, M., 2006. Sustainable energy development: performance and prospects. *Renewable Energy*, Vol.31, pp.571–582.

Jeffries, R.M., Hunt, S.J., Gould, L., 1997. Derivation of fatality of probability function for occupant buildings subject to blast loads. Health & Safety Executive.

Ji, G., Hong-yu, M.A., 2009. A Research on the Construction of Team Leadership Effectiveness and its relationship with Big-five Personality. ISECS International Colloquium on Computing, Communication, Control, and Management.

Johnson, N., Yang, C., Ogden, J., 2008. A GIS-based assessment of coal-based hydrogen infrastructure deployment in the state of Ohio. *international journal of hydrogen energy*, Vol.33, pp.5287–5303.

Jørgensen, C., Ropenus, S., 2008. Production price of hydrogen from grid connected electrolysis in a power market with high wind penetration. *International Journal of Hydrogen Energy*, Vol. 33, pp. 5335–5344.

Jo, Y.D., Ahn, B.J., 2006, Analysis of hazard area associated with hydrogen gas transmission pipelines. *International Journal of Hydrogen Energy*, Vol.31, pp. 2122-2130.

Jo, Y.D., Crowl, D.A, 2008. Individual risk analysis of high-pressure natural gas pipelines. *Journal of Loss Prevention in the Process Industries*, Vol. 21, pp.589–595.

Jo, Y.-D., and Ahn, B. J., “A simple model for the release rate of hazardous gas from a hole on high pressure pipeline”, *Journal of Hazardous Materials*, 97 (2003),,(1–3), 31–46.

Johnson, N., Yang, C., Ogden J., 2008. A GIS-based assessment of coal-based hydrogen infrastructure deployment in the state of Ohio. *International journal of hydrogen energy*, Vol. 33, pp: 5287–5303.

- Joffe, D., Hart, D., Bauen, A., 2004. Modelling of hydrogen infrastructure for vehicle refueling in London. *Journal of Power Sources*, Vol.13, pp.13-22.
- Jordi Dunj6, Vasilis Fthenakis, Juan A. V6lchez, Josep Arnaldos, 2010. Hazard and operability (HAZOP) analysis. A literature review. *Journal of Hazardous Materials*, Vol.173, pp.19-32.
- Kamarudin, S.K., Daud, W.R.W., Yaakub, Z., Misron, Z., Anuar, W., Yusuf, N.N.A.N., 2009. Synthesis and optimization of future hydrogen energy infrastructure planning in Peninsular Malaysia. *International journal of hydrogen energy*, Vol.34, pp.2077-2088.
- Kantar, Y.M., Usta, I., 2008. Analysis of wind speed distributions: Wind distribution function derived from minimum cross entropy principles as better alternative to Weibull function. *Energy Conversion and Management*, Vol.49, pp.962-973.
- Kaygusuz, K., 2002. Renewable and sustainable energy use in Turkey: a review. *Renewable and Sustainable Energy Reviews*, Vol.6, pp.339-366.
- Kikukawa, S., Mitsuhashi, H., Miyake, A., 2009. Risk assessment for liquid hydrogen fueling stations. *International Journal of Hydrogen Energy*, Vol.34, pp.1135-1141.
- Kim, J., Lee, Y., Moon, I., 2008. Optimization of a HSC under demand uncertainty. *International journal of hydrogen energy*, Vol.33, pp. 4715-4729.
- Kim, J., Moon, II., 2008. The role of hydrogen in the road transportation sector for a sustainable energy system: A case study of Korea. *International journal of hydrogen energy*, Vol.33, pp.7326-7337.
- Kim, J., Moon, I., 2008. Strategic design of hydrogen infrastructure considering cost and safety using multiobjective optimization. *international journal of hydrogen energy*, Vol.33, pp.5887-5896.
- Kim, J., Lee, Y., Moon, II., 2008. Optimization of a hydrogen supply chain under demand uncertainty. *International Journal of Hydrogen Energy*, Vol. 33, pp. 4715-4729.
- Koca, A., Ozt6p, H.F., Varol, Y., Koca, G.O., 2011. Estimation of solar irradiation using artificial neural networks with different input parameters for Mediterranean region of Anatolia in Turkey. *Expert Systems with Applications*, Vol.38, pp.8756-8762.
- Konda, NVSN., Shah, N., Brandon, N.P., 2011. Optimal transition towards a large-scale hydrogen infrastructure for the transport sector: The case for the Netherlands. *International journal of hydrogen energy*, Vol.36, pp.4619-4635.
- Korba, P., Hiskens, I.A., Jamshidi, M. "Operation and Control of Electrical Power Systems", in *System of Systems Engineering-Innovations for the 21st Century*. New York: Wiley, ch. 16, pp. 385-408, 2009.
- Korpas, M., Holen, A.T., 2006. Operation Planning of Hydrogen Storage Connected to Wind Power Operating in a Power Market. *IEEE Transactions on Energy Conversion*, Vol. 21, pp. 742-749.
- Korpas, M., Hildrum, R., Holen A.T., 2003. Operation and sizing of energy storage for wind power plants in a market system. *Elect. Power Energy Syst*, Vol. 25, pp. 599-606.

- Kothari, R., Buddhi, D., Sawhney, R.L., 2008. Comparison of environmental and economic aspects of various hydrogen production methods. *Renewable and Sustainable Energy Reviews*, Vol.12, pp.553–563.
- Kothari, R., Buddhi, D., Sawhney, R.L., 2004. Sources and technology for hydrogen production: a review. *Int J Global Energy Issues*, Vol.21, pp.154–78.
- Kottenstette, R., Cotrell, J., 2004. Hydrogen storage in wind turbine towers,” *International Journal of Hydrogen Energy*, vol. 29, pp. 1277 – 1288.
- Kreidl, O.P., and Willsky, A.S., 2006. An Efficient Message-Passing Algorithm for Optimizing Decentralized Detection Networks, *Proceedings of the 45th IEEE Conference on Decision & Control*.
- Kruger, P., Blakeley, J., Leaver, J., 2003. Potential in New Zealand for use of hydrogen as a transportation fuel. *International Journal of Hydrogen Energy*, Vol.28, pp.795–802.
- Kruse, B., Grinna, S., Buch, C., Rapport 6:2002 "Hydrogen - status og muligheter". 82-92318-04-6. Available on: (<http://www.bellona.no>).
- Kruse, B., Grinna, S., Buch, C., Hydrogen Status og muligheter Bellona rapport nr. 6. 2002
- Barbir, F., 2005. PEM electrolysis for production of hydrogen from RES. *Solar Energy*, Vol. 78, pp. 661–669.
- Kuby, M., Schultz, L.L.R., Xie, Z., Kim, J.G, Lim, S., 2009. Optimization of hydrogen stations in Florida using the Flow-Refueling Location Model. *International Journal of Hydrogen Energy*, Vol. 34, pp. 6045-6064.
- Kuby, M., Lines, L., Schultz, R., Xie Z., Kim J.G., Lim S., 2009. Optimization of hydrogen stations in Florida using the Flow-Refueling Location Model. *International journal of hydrogen energy*, Vol.34, pp:6045–6064.
- Kucukali, S., Baris, K., 2010. Turkey’s short-term gross annual electricity demand forecast by fuzzy logic approach. *Energy Policy*, vol. 38, pp. 2438–2445.
- LaChance, Jeffrey., Tchouvelev, Andrei., Ohi, Jim., 2009. Risk-informed process and tools for permitting hydrogen fu. eling stations. *international journal of hydrogen energy*, Vol.34, pp.5855–5861.
- LaChance, J., Tchouvelev, A., Engebo, A., 2010. Development of uniform harm criteria for use in quantitative risk analysis of hydrogen infrastructure. *International Journal of Hydrogen Energy*, Vol. 36, pp.2381-2388.
- Landucci, G., Tugnoli, T., Cozzani, V., Safety assessment of envisaged systems for automotive hydrogen supply and utilization. *Int J Hydrogen Energy* 2010, Vol.35, pp.1493-505.
- Lagorse, J., Simões, M.G., Miraoui, A., Costerg, P., 2008. Energy cost analysis of a solar-hydrogen hybrid energy system for standalone applications. *International Journal of Hydrogen Energy*, Vol.33, pp.2871–9.

- Landry, B.M., Master Thesis. Green hydrogen: site selection analysis for potential biomass hydrogen production facility in the Texas-Louisiana coastal region. Faculty of the Louisiana State University and Agricultural and Mechanical College. May 2006.
- Landucci, G., Tugnoli, T., Cozzani, V., 2008. Inherent safety key performance indicators for hydrogen storage systems. *J Hazard Mater*, Vol.159, pp.554-66.
- Linnemann, J., Steinberger-Wilckens, R., 2007. Realistic costs of wind-hydrogen vehicle fuel production. *International Journal of Hydrogen Energy*, Vol.32, pp.1492–1499.
- Lee, J.Y., Yu, M.S, Cha, K.H, Lee, S.Y., Lim, T.W., Tak Hur., 2009. A study on the environmental aspects of hydrogen pathways in Korea. *International journal of hydrogen energy*, Vol.34, pp.8455–8467.
- Lee, Y., Kim, J., Kim, J., Kim, E.J., Kim, Y.G., Moon, I., 2010. Development of a web-based 3D virtual reality program for hydrogen station. *International Journal of hydrogen energy*; 1–7.
- Lemus, R.G., Martínez Duart, J.M., 2010. Updated hydrogen production costs and parities for conventional and renewable technologies. *International journal of hydrogen energy*, Vol.35, pp.3929–3936.
- Levene, J.I., Mann, M.K., Margolis, R.M., Milbrandt, A., 2007. An analysis of hydrogen production from renewable electricity sources. *Solar Energy*, Vol. 81, pp.773–780.
- Levin, D.B., Chahine, R., 2010. Challenges for renewable hydrogen production from biomass. *international journal of hydrogen energy*, Vol.35, pp.4962–4969.
- Li, Z., Gao, D., Chang, L., Liu, P., Pistikopoulos, E., 2008. Hydrogen infrastructure design and optimization: a case study of china. *International Journal of Hydrogen Energy*, Vol.33, pp.5275-86.
- Li, X., 2005. Diversification and localization of energy systems for sustainable development and energy security. *Energy Policy*, Vol.33, pp.2237–2243.
- Lin, Z., Chen, C., Ogden, J., Fan, Y., 2008. The least-cost hydrogen for Southern California. *International Journal of Hydrogen Energy*, Vol.33, pp.3009-14.
- Li, J., Liu, C.C., Schneider, K.P., 2010. Controlled Partitioning of a Power Network Considering Real and Reactive Power Balance. *IEEE Transactions on Smart Grid*, vol. 1, pp. 261-268.
- Li, F., Qiao, W., Sun, H., Wan, H., Wang, J., Xia, Y., Xu, Z., Zhang, P., 2010. Smart Transmission Grid: Vision and Framework. *IEEE Transactions on Smart Grid*, Vol. 1, pp. 168-177.
- Li, Y., Xue, B., He, X., 2009. Catalytic synthesis of ethylbenzene by alkylation of benzene with diethyl carbonate over HZSM-5. *Catalysis Commun*, Vol.10, pp:702.
- Lin, Z., Ogden, J., Fan, Y., Chen, C., 2008. The fuel-travel-back approach to hydrogen station siting. *International Journal of Hydrogen Energy*, Vol.33, pp.3096-101.
- Lindell, M., Earle, T.C., 1983. How close is close enough: public perceptions of the risks of industrial facilities. *Risk Analysis* 3, 245–253.

- Little, M., Thomson, M., Infield, D., 2007. Electrical of integration of renewable energy into stand-alone power supplies incorporating hydrogen storage. *Int J Hydrogen Energy*, Vol. 32, pp. 1582–1588.
- Liu, K., Subbarayan, S., Shoults, R.R., Manry, M.T., Kwan, C., Lewis, F.L, Naccarino, J, 1996. Comparison of a very short-term load forecasting techniques, *IEEE Transactions on Power Systems*, Vol. 11, no. 2.
- López, R., Bernal-Agustín, J.L., Mendoza, F., 2009. Design and economical analysis of hybrid PV–wind systems connected to the grid for the intermittent production of hydrogen. *Energy Policy*, Vol.37, pp.3082–3095.
- Lu, N., Chow, J.H, Desrochers, A.A, 2004. Pumped-Storage Hydro-Turbine Bidding Strategies in a Competitive Electricity Market. *IEEE Transactions on Power Systems*, Vol. 19, pp. 831-841.
- Mabel, M.C., Fernandez, E., 2008. Growth and future trends of wind energy in India. *Renewable and Sustainable Energy Reviews*, Vol.12, pp.1745–1757.
- Malczewski, J., *GIS and multicriteria decision analysis*. New York: JohnWiley & Sons, Inc.; 1999.
- Malczewski, J., 2006. Ordered weighted averaging with fuzzy quantifiers: GIS-based multicriteria evaluation for land-use suitability analysis Ordered weighted averaging with fuzzy quantifiers: GIS-based multicriteria evaluation for land-use suitability analysis. *International Journal of Applied Earth Observation and Geoinformation*, Vol. 8, pp. 270–277.
- Mannan S., 2005. Lees’ loss prevention in the process industries”. Elsevier. p. 9/64. Available at :<http://knovel.com/web/portal/browse/display?_EXT_KNOVEL_DISPLAY_bookid¼1470&VerticalID¼0>.
- Marhavilas, P. K., & Koulouriotis, D. E., 2008. A risk estimation methodological framework using quantitative assessment techniques and real accidents’ data: application in an aluminum extrusion industry. *Journal of Loss Prevention in the Process Industries*, 21(6), 596e603. doi:10.1016/j.jlp.2008.04.009.
- Markert, F., Nivolianitou, Z., Christou, M., Assurance-A benchmark exercise on risk analysis of chemical installations. *Proc of the 2nd Internet Conference on Process Safety 2000*.
- Martin, K.B, Grasman, S.E., 2009. An assessment of wind-hydrogen systems for light duty vehicles. *International Journal of Hydrogen Energy*, Vol. 34, pp. 6581–6588.
- McDowell, W., Eames, M., 2006. Forecasts, scenarios, visions, backcasts and roadmaps to the hydrogen economy: a review of the hydrogen futures literature. *Energy Policy*, Vol.34, pp.1236–50.
- McCarthy JJ, Canziani OF, Leary NA, Dokken DJ, White KS, editors. *Climate change 2001:impacts, adaptation and vulnerability contribution of Working Group II to the third assessment report of the Intergovernmental Panel on Climate Change(IPCC)*.UK: Cambridge University Press; 2001. See also: /<http://www.ipcc.ch/S>.
- McDonald, J., 2008. Adaptive intelligent power systems: active distribution networks. *Energy Policy*, Vol. 36, pp. 4346-4351.

Melendez M, Milbrandt A. Regional Consumer Hydrogen Demand and Optimal Hydrogen Refuelling Station Sitting. Technical Report NREL/TP-540-42224 April 2008.

Melaina, M.W., 2003. Initiating hydrogen infrastructures: preliminary analysis of a sufficient number of initial hydrogen stations in the US. *International Journal of Hydrogen Energy*, Vol. 28, pp. 743–755.

Melaina, M.W., 2005. Estimating relative station sizes in early hydrogen station networks. In: *Proceedings of the National Hydrogen Association*, Washington, D.C.

Melendez, M., 2006. Transitioning to a hydrogen future: learning from the alternative fuels experience. Golden, CO: National Renewable Energy Laboratory,. Technical Report No. NREL/TP-540-39423.

Minciardi, R., Sacile, R., 2011. Optimal control in a cooperative network of smart power grids. *IEEE Systems Journal*, In press 2011.

Minnesota Renewable Hydrogen Roadmap. Report to the Minnesota Legislature. Office of Energy Security Minnesota Department of Commerce April 2010.

MHIDAS: Major Hazard Incident Data Service 2008. Database developed for health and safety executive. Available under subscription at Ovid Technologies, Inc. Available at: <<http://www.hse.gov.uk/infoserv/hseline.htm>>

Mogi, T., Horiguchi, S., 2009. experimental study on the hazards of high pressure hydrogen jet diffusion flame. *Journal of Loss Prevention in the Process Industries*, Vol. 22, pp. 45-51.

Molderink, A., Bakker, V., Bosman, M.G.C., Hurink, J.L., Smit, G.J.M, 2010. Management and Control of Domestic Smart Grid Technology. *IEEE Transactions on Smart Grid*, vol. 1, pp.109-118.

Moriarty, P., Honnery, D., 2007. Intermittent renewable energy: The only future source of hydrogen?. *International Journal of Hydrogen Energy*, Vol.32, pp.1616–1624.

Moriarty, P., Honnery, D., 2009. Hydrogen's role in an uncertain energy future. *International Journal of Hydrogen Energy*, Vol. 34, pp.31–39.

Montiel, H., Vilchez, J.A., Casal, J., Arnaldos, J., 1998. Mathematical modelling of accidental gas releases. *Journal of hazardous Materials*, Vol. 59, pp.211-233.

Morna, I., vanVuuren, D.P., 2009. Modelling global residential sector energy demand for heating and air conditioning in the context of climate change,” *Energy Policy*, vol. 37, pp. 507–52.

Mosgorove, A.R., 1988. The optimization of hybrid energy conversion systems using the dynamic programming model. *International journal of energy research*, Vol. 12, pp.447-457.

Mubiru, J., Banda. E.J.K.B., 2008. Estimation of monthly average daily global solar irradiation using artificial neural networks. *Solar Energy*, Vol.82, pp.181–187.

Mueller-Langer, F., Tzimas, E., Kaltschmitta, M., Peteves, S., 2007. Techno-economic assessment of hydrogen production processes for the hydrogen economy for the short and medium term. *International Journal of Hydrogen Energy*, Vol.32, pp. 3797–810.

NAS, 2004. *The Hydrogen Economy - Opportunities, Costs, Barriers, and R&D Needs*. National Research Council and National Academy of Engineering, National Academies Press, Washington, DC.

Nayyar, A., Mahajan, A., Teneketzis, D. Optimal Control Strategies in Delayed Sharing Information Structures. Preprint submitted to *IEEE Transactions on Automatic Control*.

New York Hydrogen Energy Roadmap. New York state Energy Research and Development authority. Final report 05-10 October 2005.

Ni, J., Johnson, N., Ogden, J.M, Yang, C., Johnson, J., 2005. Estimating hydrogen demand distribution using geographic information systems (GIS). Washington, DC: National Hydrogen Association.

Ni, M., Leung, M.K.H., Sumathy, K., Leung, D.Y.C., 2006. Potential of renewable hydrogen production for energy supply in Hong Kong. *International Journal of Hydrogen Energy*, Vol.31, pp.1401–1412.

Nicholas, M.A., Handy, S.L., Sperling, D., 2004. Using geographic information systems to evaluate siting and networks of hydrogen stations. *Transportation Research Record*, Vol. 1880, pp.126–34.

Notton, G., Muselli, M., Louche, P.P, 2001. A Decentralized wind energy system providing small electrical loads in remote areas. *International Journal of Energy Research*, Vol. 25, pp.141-164.

Ochoa, L.F., Cradden, L.C., Harrison, G.P., 2010. Demonstrating the Capacity Benefits of Dynamic Ratings in Smarter Distribution Networks. *Innovative Smart Grid Technologies (ISGT)*, pp. 1-6.

Ogden JM. Prospects For building a hydrogen Energy Infrastructure. *Annu. Rev. Energy Environ.* 1999; 24: 227–79.

Ogden, J.M., Yang, C., Johnson, N., Ni, J., Lin, Z., 2005. Technical and economic assessment of transition strategies toward widespread use of hydrogen as an energy carrier. UCD-ITSRR- 05-06.

Ogden, J.M., Mintz, M., Ringer, M., H2A scenarios for delivering hydrogen from a central production plant to light-duty vehicles. In: 15th annual NHA hydrogen conference, Los Angeles CA 2004.

Ogden, J.M., 1999. Prospects for building a hydrogen energy infrastructure. *Ann Rev Energy Environ*, Vol. 24, pp. 227–79.

Ogden, J., 1999. Developing an infrastructure for hydrogen vehicles a Southern California case study. *International Journal of Hydrogen Energy*, Vol.24, pp.709-730.

Official Journal of the Italian Republic no. 213, 13/09/2006.

Oikonomou, E.K., Kiliyas, V., Goumas, A., Rigopoulos, A., Karakatsani, E., Damasiotis, Papastefanakis, M.D, Marini, N., 2009. Renewable energy sources (RES) projects and their barriers

on a regional scale: The case study of wind parks in the Dodecanese islands, Greece. *Energy Policy*, Vol.37, pp. 4874–4883.

Ouammi, A., Sacile, R., Mimet, A., 2010. Wind energy potential in Liguria region. *Renewable and Sustainable Energy Reviews*, vol. 14, pp. 289-300,.

Ouammi, A., Dagdougui, H., Sacile, R., Mimet, 2010. Monthly and seasonal assessment of wind energy characteristics at four monitored locations in Liguria region (Italy). *Renewable Sustainable Energy Reviews*, vol. 14, pp. 1959-1968.

Papalexopoulos, Hesterburg, T., 1990. A regression-based approach to short-term load forecasting, *IEEE Trans Power Syst*, Vol. 4, pp.1535-1547.

Parker, N., Fan, Y., Ogden, J., 2009. From waste to hydrogen: An optimal design of energy production and distribution network. *Transportation Research Part E*, Vol. 46, pp.534-545.

Pasman, H., 2011. Challenges to improve confidence level of risk assessment of hydrogen technologies. *international journal of hydrogen energy*, Vol.36,2407-2413.

Pasman, H.J., Rogers, W.J, 2010. Safety challenges in view of the upcoming hydrogen economy: An overview. *Journal of Loss Prevention in the Process Industries*, Vol.23, 697-704.

Pallabazzer, R., 1995. Evaluation of wind generator potentiality. *Solar energy*, Vol. 55, pp. 49-59.

Pat Fowler, Goran Krajacic, Drazen Loncar, Neven Duic. Modelling the energy potential of biomass – H2RES. *Int journal of hydrogen energy* 34 (2009) 7027–7040.

Pavia, G.E., Brien, J.O., 1986. Weibull statistics of wind speed over the ocean. *J Climate Appl Meteo*, Vol.25, pp.324 -332.

Pearce, F., Special report: climate change. *New Scientist.com* news service, 2006. See also: [/http://environment.newscientist.com/channel/earth/climate-change/dn9903S](http://environment.newscientist.com/channel/earth/climate-change/dn9903S).

Pereira, J., Soares, J.B., Oliveira, R.G., Queiroz, R.P., 2008. Energy in Brazil: Toward sustainable development?. *Energy Policy*, Vol.36, pp.73-83.

Perez, I.A., Garcia, M.A., Sanchez, M.L., de Torre, B., 2004. Analysis of height variations of sodar-derived wind speeds in Northern Spain. *Journal of Wind Engineering and Industrial Aerodynamics*, Vol. 92, pp.875–894.

Phillips, L.R., Jamshidi, M., 2008. The microgrid as a system of systems, in *Systems of Systems Engineering-Principles and Applications*, CRC, ser. SoS Engineering. London, U.K.: Taylor & Francis, vol. 1, ch. 10, pp. 251–280. 2008.

Pilavachi, P.A., Chatzipanagi, A.I., Spyropoulou, A.I., 2009. Evaluation of hydrogen production methods using the Analytic Hierarchy Process. *International journal of hydrogen energy*, Vol.34, pp.5294–5303.

Pilo, F., Celli, G., Mocci, S., Soma G.G., 2010. Multi-objective programming for optimal DG integration in active distribution systems. *IEEE Power and Energy Society General Meeting*.

- Prince-Richard, S., Whalel M., Djilali N., 2005. A techno-economic analysis of decentralized electrolytic hydrogen production for fuel cell vehicles. *International Journal of Hydrogen Energy*, Vol. 30, pp. 1159–1179.
- Pula, R., Khan, F.I., Veitch, B., Amyotte, P.R., 2006. A grid based approach for fire and explosion consequence analysis. *Trans IChemE, Part B, Process Safety and Environmental Protection*, Vol: 84, pp.79-91.
- Quaranta, N., DeMartini, A , Bianconi, R., Marioni, M., 2002. A decision support system for the simulation of industrial accidents. *Environmental Modelling and Software*, Vol. 17, pp. 497-504.
- Ramírez-Salgado, J., Estrada-Martínez, A., 2004. Roadmap towards a sustainable hydrogen economy in Mexico. *Journal of Power Sources*, Vol. 129, pp.255–263.
- Rantzer, A., 2007. On Prize Mechanisms in Linear Quadratic Team Theory, *Proceedings of the 46th IEEE Conference on Decision and Control New Orleans, LA, USA, Dec. 12-14*,
- Rantzer, A., 2006. Linear quadratic team theory revisited, *Proceedings of the 2006 American Control Conference Minneapolis, Minnesota, USA*.
- Regione Liguria. I finanziamenti di Regione Liguria per rinnovabili e risparmio energetico: Aggiornamento del piano energetico regionale: le prospettive dell'eolico in Liguria. March 2009.
- Rehman, S., 2004. Wind energy resource assessment for Yanbo, Saudi Arabia. *Energy Conversion and Management*, Vol. 45, pp.2019–2032.
- Reikard, G., 2009. Predicting solar irradiation at high resolutions: A comparison of time series forecasts. *Solar Energy*, Vol.83, pp.342–349.
- Reniers, G.L.L., Dullaert, W., Ale, B.J.M., Soudan. K., 2005. Developing an external domino prevention framework: Hazwim. *Journal of Loss Prevention in the Process Industries*, Vol.18, pp.127-138.
- Rigas, F., Sklavounos, S., 2005. Evaluation of hazards associated with hydrogen storage facilities. *International Journal of Hydrogen Energy*, Vol. 30, pp.1501 – 1510.
- Risk acceptance criteria for hydrogen refueling stations. Norsk Hydro ASA and Det Norske Veritas AS for WP5.2 European Integrated Hydrogen Project 2; February 2003.
- Roads2hydrogen available on: <http://www.roads2hy.com>; *European Hydrogen Infrastructure Atlas*. J. Perrin. July 2007.
- Rodolfo, D.L., Bernal J.L., 2008. A Multi-objective design of PV-wind-diesel-hydrogen –battery systems. *Renewable Energy*, Vol.33, pp. 2559-2572.
- Romera, E.G., Jaramillo-Morán, M.A., Fernández D.C., 2007. Forecasting of the electric energy demand trend and monthly fluctuation with neural networks. *Computers & Industrial Engineering*, Vol. 52, pp 336-343.
- Rodríguez, C.R., Riso, M., Yob, J.G., Ottogalli, R., Santa, C.R., Aisa, S., Jeandrevin, G., Leiva, E.P.M., 2010. Analysis of the potential for hydrogen production in the province of Córdoba, Argentina, from wind resources. *International journal of hydrogen energy*, Vol.35, pp.5952–5956.

Roadmap on manufacturing R&D for the hydrogen economy. In: Washington, D.C.: workshop on manufacturing R&D for the hydrogen economy 2005.

Roosa, S.A., Sustainable Development Handbook. The Fairmont Press, Inc. Taylor & Francis Ltd. 2008.

Rosyd OA. System-analytic safety evaluation of hydrogen cycle for energetic utilization, Doctoral dissertation, Otto-von-Guericke-Universität Magdeburg, Germany, 2006.

Rosyd, O.A., Jablonski, D., Hauptmanns, U., 2007. Risk analysis for the infrastructure of a hydrogen economy. *Int J Hydrogen Energy*, Vol.32, pp.3194-200.

Rumelhart, D.E., Hinton, G.E., Williams, R.J., 1986 Learning representations by back-propagating errors. *Nature*, Vol. 323, pp.533-536.

Sabio, N., Gadalla, M., Guillén-Gosálbez, G., Jiménez, L., 2010. Strategic planning with risk control of hydrogen supply chains for vehicle use under uncertainty in operating costs: A case study of Spain. *International journal of hydrogen energy*, Vol.35, pp.6836-6852.

Salgi, G., Donslund, B., Alberg Østergaard, P., 2008. Energy system analysis of utilizing hydrogen as an energy carrier for wind power in the transportation sector in Western Denmark. *Utilities Policy*, Vol.16, pp.99-106.

Scott D.S., 2004. Back from the future: to built strategies taking us to a hydrogen age. In Sperling, D. & Cannon, J.S. (Ed.) *The hydrogen energy transition: moving toward the post petroleum age in transportation*. Amsterdam: Elsevier, cop. 21-32.

Segura, I., Pérez-Navarro, A., Sánchez, C., Ibáñez, F., Payá, J., Bernal, E, 2007. Technical requirements for economical viability of electricity generation in stabilized wind parks. *International Journal of Hydrogen Energy*, Vol 32, pp. 3811–3819.

Senkal, O., 2010. Modelling of solar irradiation using remote sensing and artificial neural network in Turkey. *Energy*, Vol.35, pp.4795-4801.

Seymour, E.H., Murray, L., Fernandes, R., 2008. Key Challenges to the introduction of hydrogen-European stakeholder views. *International Journal of Hydrogen Energy*, Vol. 33, pp.3015-3020.

Shad, R., Mesgari, M.S., Abkar, A., Shad, A., 2009. Predicting air pollution using fuzzy genetic linear membership kriging in GIS. *Computers, Environment and Urban Systems*, Vol. 33, pp.472–481.

Shakya, B.D., Aye, L., Musgrave, P., 2005. Technical feasibility and financial analysis of hybrid wind–photovoltaic system with hydrogen storage for Cooma. *International Journal of Hydrogen Energy*, Vol.30, pp.9–20.

Shane, S.R., Samuelsen, S., 2009. Demonstration of a novel assessment methodology for hydrogen infrastructure deployment. *International journal of hydrogen energy*, Vol. 34, pp.628–641.

Shata, A.S.A., Hanitsch, R., 2008. Electricity generation and wind potential assessment at Hurghada. *Renewable Energy*, Vol.33, pp.141–148.

- Schefer, R.W., Houf, W.G., Bourne, B., Colton, J., 2006. Spatial and radiative properties of an open-flame hydrogen plume. *Int J Hydrogen Energ*, Vol. 31, pp.1332–40.
- Schefer, R.W., Houf, W.G., Williams, T.C., Bourne, B., Colton, J., 2006. Characterization of high pressure, under-expanded hydrogen- jet flames. *International Journal of Hydrogen Energy*, in press.
- Sherif, S., Barbir, F., Veziroglu, T., 2005. Wind energy and the hydrogen economy – review of the technology. *Solar Energy*, Vol. 18, pp. 647–60.
- Sherif, S., Barbir, F., Veziroglu, T., 2005. Wind energy and the hydrogen economy – review of the technology. *Solar Energy*, Vol. 18, pp. 647–60.
- Shoko E and al, 2006. Hydrogen from coal : Production and utilisation technologies”, *International Journal of Coal Geology*, Vol. 65, pp. 213-222.
- Schulte, I., Hart, D., van der Vorst, R., 2004. Issues affecting the acceptance of hydrogen fuel. *Int J Hydrogen Energy*, Vol.29, pp.677–85.
- Sliz-Szkliniarz, B., Vogt, J., 2011. GIS-based approach for the evaluation of wind energy potential: A case study for the Kujawsko–Pomorskie Voivodeship. *Renewable and Sustainable Energy Reviews*, Vol.15, pp.1696-1707.
- Smit, R., Weeda, M., de Groot, A., 2007. Hydrogen infrastructure development in The Netherlands. *International Journal of Hydrogen Energy*, Vol.32, pp.1387-95.
- Sperling, D. & Cannon, J.S. 2004a. Introduction and overview. In Sperling, D. & Cannon, J.S. (Ed.) *The hydrogen energy transition: moving toward the post petroleum age in transportation*. Amsterdam: Elsevier, cop. 1-19.
- Steven, R.E., John, A.M., 1990. Safety recommendations for liquid and gas bulk hydrogen systems. *Profess Saf*, Vol.35, pp32–8.
- Stiller, C., Seydel, P., Bünger, U., Wietschel, M., 2008. Early hydrogen user centres and corridors as part of the European hydrogen energy roadmap (HyWays). *international journal of hydrogen energy*, Vol.33, pp. 4193–4208.
- Stiller, C., Bünger, U., Møller-Holst, S., Svensson, A.M., Espegren, K.A., Nowak, M., 2009. Pathways to a hydrogen fuel infrastructure in Norway. *International journal of hydrogen energy*, Vol.35, pp.2597-2601.
- Strachan, N., Balta-Ozkan, N., Joffe, D., McGeevor, K., Hughes, N., 2009. Soft-linking energy systems and GIS models to investigate spatial hydrogen infrastructure development in a low-carbon UK energy system. *Int J Hydrogen Energy*, Vol.34, pp.642-57.
- Streimikiene, D., Ciegis, R., Grundey, D., 2007. Energy indicators for sustainable development in Baltic States. *Renewable and Sustainable Energy Reviews*, Vol.11, pp.877-893.
- Systèmes solaires le journal de l'éolien n° 8-2011. Baromètre éolien - eurobserv'er.

Taljan, G., Cañizares, C., Fowler, M., Verbic, G., 2008. The Feasibility of Hydrogen Storage for Mixed Wind-Nuclear Power Plants. *IEEE Transactions on power systems*, Vol.23, no. 3.

Texas Hydrogen Roadmap. Houston Advanced Research Center The Woodlands, Texas. January 2009.

Thanaa, F.E., Eskander, M.N., El-Hagry, M.T., 2006. Energy flow and management of a hybrid wind/PV/fuel cell generation system. *Energy Conversion and Management*, Vol.47, pp.1264–1280.

The Impact of Increased Use of Hydrogen on Petroleum Consumption and Carbon Dioxide Emissions. Energy Information Administration. August, 2008.

Thomas, CE, Kuhn, I.F., James, B.D., Lomax, F.D, Baum, G.N., 1998. Affordable hydrogen supply pathways for fuel cell vehicles. *International Journal of Hydrogen Energy*, Vol: 23, pp. 507-516.

Tsikalakis, A.G., Hatziargyriou, N.D., 2008. Centralized Control for Optimizing Microgrids Operation. *IEEE Transactions on Energy Conversion*, Vol. 23, no 1.

Tsuchiya, Haruki., Innovative renewable energy solutions for hydrogen vehicles. *Int. J. Energy Res.* 2008; 32:427–435. Wiley InterScience.

Towards a European hydrogen energy roadmap. Preface to HyWays—the European hydrogen energy roadmap integrated project executive report, 12 May 2004, Prepared by the HyNet partners, www.HyNet.info.

Tzimas, E., Castello, P., Peteves, S., 2007. The evolution of size and cost of a hydrogen delivery infrastructure in Europe in the medium and long term. *International Journal of Hydrogen Energy*, Vol. 32, pp.1369–1380.

Ucar, A., Balo, F., 2009. Evaluation of wind energy potential and electricity generation at six locations in Turkey. *Applied Energy*, Vol.86, pp.1864–1872.

US Dept of Energy. National hydrogen energy roadmap, 2002. Washington, DC: US Dept of Energy.

USDOE. The National Hydrogen Energy Roadmap. US Department of Energy, Office of Energy Efficiency and Renewable Energy, Washington, DC, November 2002.

U.S National Hydrogen Energy Roadmap. United States Department of Energy. November 2002.

Van den Heever, S., Grossmann, I., 2003. A strategy for the integration of production planning and reactive scheduling in the optimization of a hydrogen supply chain network. *Comput Chem Eng*, Vol.27, pp.1813–39.

Venetsanos, A.G., Huld, T., Adams, P., Bartzis, J.G., Source, dispersion and combustion modelling of an accidental release of hydrogen in an urban environment. *Journal of Hazardous Materials*, Vol.105, pp.1–25.

Venetsanos, A.G., Baraldi, D., Adams, P., Heggem, P.S., Wilkening, H., 2008. CFD modelling of hydrogen release, dispersion and combustion for automotive scenarios. *Journal of Loss Prevention in the Process Industries*, Vol. 21, pp.162–184.

Vidueira, J.M., Contreras, A., 2003. PV autonomous installation to produce hydrogen via electrolysis, and its use in FC buses. *Int J Hydrogen Energy*, Vol.28, pp.927–37.

Vieira, F., Ramos, H.M., 2009. Optimization of operational planning for wind/hydro hybrid water supply systems. *Renewable Energy*, vol. 34, pp. 928–936.

Vieira, F., Ramos, H.M., 2008. Hybrid solution and pump-storage optimization in water supply system efficiency: A case study. *Energy Policy*, Vol. 36, pp. 4142– 4148.

Von Helmolt, R., Eberle, U., 2007. Fuel cell vehicles: status. *J Power Sources*, Vol.165, pp.833-43.

Waegel, A., Byrne, J., Tobin, D., Haney, B., 2006. Hydrogen highways: lessons on the energy technology–policy interface. *Bulletin of Science, Technology and Society August*, Vol.26, pp.288–298.

Wang, Y.W, Lin, C.C., 2009. Locating road-vehicle refueling stations. *Transportation Research Part E*. Vol. 45, pp. 821–829.

Wang, C., Lu, Z., Qiao, Y., 2009. Modelling of Wind Pattern and Its Application in Wind Speed Forecasting. *Sustainable Power Generation and Supply, SUPERGEN '09. International Conference on*, pp. 1–6.

Wang, Z., Scaglione, A., Thomas, R.J., 2010. Generating Statistically Correct Random Topologies for Testing Smart Grid Communication and Control Networks”. *IEEE Transactions on Smart Grid*, vol. 1, pp. 28-39.

Whittle, P., *Risk-sensitive Optimal Control*. Wiley Chichester,1990.

Wietschel, M., Seydel, P., 2007. Economic impacts of hydrogen as an energy carrier in European countries. *International Journal of Hydrogen Energy*, Vol.32, pp.3201-3211.

Wietschel, M., Hasenauer, U., Arend de Groot, 2006. Development of European hydrogen infrastructure scenarios-CO₂ reduction potential and infrastructure investment. *Energy Policy*, Vol.34, pp.1284–1298.

Wilkening H., Baraldi D., 2007. CFD modelling of accidental hydrogen release from pipelines. *International Journal of Hydrogen Energy*, Vol. 32, pp.2206–2215.

Williams, R.H., *Crude oil, climate change, coal, cane and cars*. Princeton Environmental Institute, Princeton University; 2004.

Woodruff, J. M., 2005. Consequence and likelihood in risk estimation: A matter of balance in UK health and safety risk assessment practice. *Safety Science*, Vol.43, pp.345-353..

www.h2incidents.org/

www.netinform.net/h2/H2Stations.

- Xu, B.P., EL Hima, L., Wen, J.X., Dembele, S., Tam, V.H.Y., 2008. Numerical study on the spontaneous ignition of pressurized hydrogen. *Journal of Loss Prevention in the Process Industries*, Vol.21, pp. 205–213
- Yamanaka, Y., et al. Development for safe utilization and infrastructure of hydrogen. Basic research on technologies for safe utilization of hydrogen (FY2003-FY2004) final report, p. 89–93.
- Yang, C., Ogden, J., 2007. Determining the lowest-cost hydrogen next term delivery mode. *International Journal of Hydrogen Energy*, Vol. 32, pp. 268-286.
- Yildiz B, Kazimi MS., 2006. Efficiency of hydrogen production systems using alternative nuclear energy technologies. *International journal of hydrogen energy*, Vol.31, pp.77-92.
- Ying-Wei Wang and Chuah-Chih Lin., 2009. Locating road-vehicle refuelling stations. *Transportation Research Part E*, Vol.45, pp.821–829.
- Yuen, C., Oudalov, A., Timbus, A., 2011. The Provision of Frequency Control Reserves From Multiple Microgrids. *IEEE Transaction on Industrial Electronics*, Vol. 58, pp. 173-183.
- Yuhu, D., Huilin, G., Jingen, Z., Yaorong, F., 2003. mathematical modelling of gas release through holes in pipelines. *Chemical Engineering Journal*, Vol. 92, pp. 237–241.
- Yuhua, D., Datao, Y., 2005. Estimation of failure probability of oil and gas transmission pipelines by fuzzy fault tree analysis. *Journal of Loss Prevention in the Process Industries*, Vol.18, pp. 83-88.
- Zhao, Q., Sun, K., Zheng, D.Z., Ma, J., Lu, Q., 2003. A study of system splitting strategies for island operation of power system: a two-phase method based on OBDDS. *IEEE Trans. on Power Systems*, vol. 18, pp. 1556–1565.
- Zhao G., Davison, M., 2009. Optimal control of hydroelectric facility incorporating pump storage. *Renewable Energy*, Vol. 34, pp. 1064–1077.
- Zhiyong, L., Xiangmin, P., Jianxin, M., 2010. Harm effect distances evaluation of severe accidents for gaseous hydrogen refueling station. *International journal of hydrogen energy*, Vol. 35, pp. 1515–1521.
- Zhiyong, L., Xiangmin P, Jianxin M., 2010. Quantitative risk assessment on a gaseous hydrogen refueling station in Shanghai. *International journal of hydrogen energy*, Vol. 35, pp. 6822-6829.
- Zhiyong, L.I, Xiangmin, PAN., Jianxin MA., 2011. Quantitative risk assessment on 2010 Expo hydrogen station. *International journal of hydrogen energy*, Vol. 36, pp. 4079-4086.
- Zhou, K., Ferreira, J.A., de Haan SWH., 2008. Optimal energy management strategy and system sizing method for stand-alone photovoltaic-hydrogen systems. *International Journal of Hydrogen Energy*, Vol. 33, pp. 477-489.

**SYSTEME D'AIDE A LA DECISION POUR LA DURABILITE DES SYSTEMES ENERGETIQUES
RENOUVELABLES ET DES INFRASTRUCTURES D'HYDROGENE: MODELISATION, CONTROLE ET
ANALYSE DE RISQUES**

RESUME :

L'utilisation d'un vecteur énergétique tel que l'hydrogène couplé aux ressources renouvelables offre une variété d'avantages sur plusieurs échelles. L'hydrogène facilite l'exploitation des ressources renouvelables dans le secteur de transport. En effet, il permet de remplacer les carburants fossiles, assurant ainsi une réduction des émissions polluantes. L'hydrogène peut être alors une solution pour les défis énergétiques actuels, or, cela ne pourra se réaliser qu'en surmontant des obstacles tels que ceux liés aux caractères intermittents des ressources renouvelables. Une attention particulière doit être accordée à la faisabilité technique de la chaîne d'approvisionnement en hydrogène, qui est principalement entourée par le caractère intermittent des ressources renouvelables. Par ailleurs, l'infrastructure d'hydrogène présente de nombreuses difficultés qui doivent être traitées pour une transition réussie vers une économie dépendante de l'hydrogène. Ces difficultés sont principalement dues à des problèmes purement économiques, ainsi qu'à l'existence de nombreuses options technologiques pour la production, le stockage, le transport et l'utilisation d'hydrogène. Pour cette raison principale, il est primordial de comprendre et d'analyser la chaîne logistique d'hydrogène à l'avance, afin de détecter les facteurs importants qui peuvent jouer un rôle imminent dans l'élaboration d'une configuration optimale.

Mots clés : Energies renouvelables, logistique d'hydrogène, systèmes durables, systèmes d'aide à la décision, analyse des risques, méthodes d'optimisation

**DECISION SUPPORT SYSTEMS FOR SUSTAINABLE RENEWABLE ENERGY SYSTEMS AND HYDROGEN
LOGISTICS: MODELLING, CONTROL AND RISK ANALYSIS**

ABSTRACT :

A transition to a renewable based energy system is crucial. Hydrogen produced from renewable energy sources (RES) offers the promise of a clean, sustainable energy carrier that can be produced from domestic energy resources around the globe. The production of hydrogen from renewable energy resources is not well understood. This complexity that exists comes from many facts such that related to the intermittent behaviour of renewable energy resources. The alternative fuels and energy carriers that are produced from the RES are challenging for the sustainable development of renewable energy. These systems need to be better investigated to first manage the flux of renewable energy and hence produce alternative fuel and energy. In addition, attention must be given to the technical feasibility of the hydrogen supply chain, which is mainly driven by uncertain, but clean solar and wind energy resources. Furthermore, the infrastructure of hydrogen presents many challenges and defies that need to be overcome for a successful transition to a future hydrogen economy. These challenges are mainly due to the existence of many technological options for the production, storage, transportation and end users. Given this main reason, it is essential to understand and analyse the hydrogen supply chain (HSC) in advance, in order to detect the important factors that may play increasing role in obtaining the optimal configuration.

Keywords : Renewable energy sources, Hydrogen logistics, sustainable systems, Decision support systems, risks analysis, optimization methods.