



**HAL**  
open science

# Value-risk based performance evaluation of industrial systems

Liaqat-Ali Shah

► **To cite this version:**

Liaqat-Ali Shah. Value-risk based performance evaluation of industrial systems. Other. Arts et Métiers ParisTech, 2012. English. NNT : 2012ENAM0033 . pastel-00745792

**HAL Id: pastel-00745792**

**<https://pastel.hal.science/pastel-00745792>**

Submitted on 26 Oct 2012

**HAL** is a multi-disciplinary open access archive for the deposit and dissemination of scientific research documents, whether they are published or not. The documents may come from teaching and research institutions in France or abroad, or from public or private research centers.

L'archive ouverte pluridisciplinaire **HAL**, est destinée au dépôt et à la diffusion de documents scientifiques de niveau recherche, publiés ou non, émanant des établissements d'enseignement et de recherche français ou étrangers, des laboratoires publics ou privés.

2012-ENAM-0033

École doctorale n°432 : Sciences des Métiers de l'ingénieur

## Doctorat ParisTech

# THÈSE

pour obtenir le grade de docteur délivré par

**L'École Nationale Supérieure d'Arts et Métiers**

**Spécialité " Génie Mécanique et Industriel "**

*présentée et soutenue publiquement par*

**Liaqat Ali SHAH**

le 3 octobre 2012

## **Value-Risk based Performance Evaluation of Industrial Systems**

Directeur de thèse : **François VERNADAT**

Co-encadrement de la thèse : **Ali SIADAT et Alain ETIENNE**

### Jury

<b>M. Jean-François PETIN</b> , Professeur, CRAN, Université de Lorraine	Président
<b>M. Angel ORTIZ</b> , Professeur, CIGIP, Universidad Politécnica de Valencia, Espagne	Rapporteur
<b>M. Damien TRENTESAUX</b> , Professeur, Laboratoire TEMPO, Université de Valenciennes	Rapporteur
<b>M. Laurent GENESTE</b> , Professeur, Equipe SDC, Ecole Nationale d'Ingénieurs de Tarbes	Rapporteur
<b>Mme Lamia-Amel BERRAH</b> , Maître de Conférences, LISTIC, Polytech'Savoie	Examineur
<b>M. François VERNADAT</b> , HDR, Cours des comptes européenne, Luxembourg	Examineur
<b>M. Ali SIADAT</b> , Maître de Conférences, LCFC, Arts et Métiers ParisTech, Metz	Examineur
<b>M. Alain ETIENNE</b> , Maître de Conférences, LCFC, Arts et Métiers ParisTech, Metz	Examineur

THÈSE



## Preface

This doctoral dissertation is a summary of my research activities conducted during the last three and half years at LCFC laboratory (*Laboratoire de Conception, Fabrication Commande*) of Arts et Metiers ParisTech and LGIPM laboratory (Laboratoire de Génie Industriel et Production Mécanique) of University of Lorraine. The PhD research was performed after getting a scholarship from Higher Education Commission (HEC) of Pakistan that lasted from September 2008 to March 2012. This scholarship was awarded after a national level examination (NTS) and selection process under the scheme “Overseas Scholarships for PhD studies in Selected Fields (Phase II)”. The aim of these scholarships was to foster research activities and promote higher education in order to build up the capacity of Universities, R&D organizations and Industries in Pakistan.

The doctoral research focuses on developing a method that attempts to address the contemporary performance measurement and management issues in industrial systems. To this end, it relies on modeling, evaluation and decision making approaches, tools and techniques and proposes a performance measurement and management system to assist evaluator/decision maker in the assessment of industrial systems while relying on two performance dimensions: **Value** and **Risk** measured respectively by global value and risk indicators. These indicators are then used to assess and rank several courses of action (i.e. alternatives) on the basis of desirability or undesirability in the decision-making context. Moreover, these two performance dimensions measured via global performance indicators of value and risk will then be integrated with two other dimensions of performance: **Cost** and **Benefits** to develop a global performance evaluation framework.

Because of the international nature of the scholarship, the Director-General of Arts et Métiers ParisTech authorized, as per decision DG2009-46 of 1<sup>er</sup> October 2009, the writing of this dissertation in two languages: English and French. For this reason, the manuscript comprises an extended summary in French language (without figures) and a detailed description of the research in English (with figures).



## Acknowledgment

I would like to thank all people and organizations who helped me during my PhD research. First and foremost, I would like to express my sincere gratitude to my PhD director, François Vernadat for his continuous support of my PhD study and research, for his patience, motivation, and immense knowledge. His guidance helped me in all the time of research and writing of this thesis. I am also indebted to my co-supervisors: Ali Siadat and Alain Etienne for their insight, advice and professional collaboration in the course of PhD research. In addition to the academic mentoring, Ali Siadat support during PhD is appreciable.

Besides my advisors, I am also obliged to my dissertation committee: François Pétin, Laurent Geneste, Angel Ortiz and Damien Trentesaux, Lamia Berrah, and invited member, Patricia Cardoso from Brazil, for their encouragement, insightful comments, and enlightening questions.

I thank my fellow lab-mates and friends of the past and present in LCFC: Aamer Baqai, Armaghan Khan, Jawad Ahmed, Sajid-Ullah Butt, Shirin Mirdamadi, Xavier Godot and all other colleagues at LCFC and Arts et Métiers ParisTech Metz for all the fun we have had in the course of my PhD studies. I appreciate the support of the research group at LCFC particularly of the Jean-Yves Dantan who was always there for assistance whenever required. My sincere thanks also go to my friends Fahd Amjad, Khuda Bux, Mohsin and Muhammad Sadiq and for their support during my stay in Metz.

Immense gratitude goes to my parents, brothers, sisters, relatives and friends back home for their unfailing support and love throughout my life. Moreover, I am thankful to my “belle famille” and my wife, Julie whose support and understanding made my stay memorable in France and exposed me to rich French culture and traditions.

I am also grateful to Higher Education Commission of Pakistan (HEC) for its financial support of my PhD studies and for its continued commitment to enhance the quality of higher education in Pakistan. In the end, I appreciate the annual grant provided by the Lorraine region during the PhD research.



# Table of Contents

## FRENCH VERSION

<b>CHAPTER 1 INTRODUCTION ET PRESENTATION</b> .....	<b>1</b>
1.1 PROBLEMATIQUE .....	1
1.2 ORGANISATION DE LA THESE .....	2
<b>CHAPTER 2 L'ANALYSE DE LA PERFORMANCE: CONCEPTS FONDAMENTAUX ET EVOLUTIONS</b> .....	<b>5</b>
2.1 LA LITTÉRATURE DE LA PERFORMANCE: PRÉSENTATION .....	5
2.2 LES DIFFÉRENTS ASPECTS DE LA PERFORMANCE .....	5
2.3 MESURE ET GESTION DE LA PERFORMANCE .....	6
2.4 EVOLUTION DE LA MESURE DE LA PERFORMANCE .....	8
2.5 LES CONCEPTS MULTIDIMENSIONNELS DE LA PERFORMANCE .....	9
2.6 LES RÔLES DE LA MESURE ET DE LA GESTION DE LA PERFORMANCE .....	11
2.7 CONCLUSION .....	11
<b>CHAPTER 3 MESURE ET GESTION DE LA PERFORMANCE: CADRES ET SYSTEMES</b> .....	<b>13</b>
3.1 MODÈLES DE PERFORMANCE PROPOSANT DES RECOMMANDATIONS .....	13
3.2 SYSTEMES DE MESURE DE PERFORMANCE BASÉS SUR LES ASPECTS FINANCIERS.....	13
3.3 EXIGENCES DES SYSTÈMES INTÉGRÉS DE MESURE DE PERFORMANCE .....	14
3.4 REVUE DES SYSTÈMES INTÉGRÉS DE MESURE DE PERFORMANCE .....	15
3.5 EVALUATION DES SYSTÈMES DE MESURE DE PERFORMANCE .....	19
3.6 DISCUSSION.....	19
3.7 MESURE DE PERFORMANCE BASÉE SUR L'ACTIVITÉ.....	20
3.8 CONCLUSION .....	20
<b>CHAPTER 4 MESURE ET GESTION DE PERFORMANCE : OUTILS ET TECHNIQUES</b> .....	<b>23</b>
4.1 DETAILS DES BESOINS ET EXIGENCES.....	23
4.2 GESTION DE PERFORMANCE PAR L'APPROCHE DE LA VALEUR .....	23
4.3 SYSTÈME DE GESTION DE PERFORMANCE ORIENTÉS PROCESSUS : OUTILS ET TECHNIQUES DE MODÉLISATION .....	26
4.4 L'INGÉNIEURIE BASÉE SUR LE RISQUE ET L'INGÉNIEURIE DU RISQUE BASÉE SUR LES PROCESSUS .....	28
4.5 CONCLUSION .....	37
<b>CHAPTER 5 GESTION DE LA PERFORMANCE BASEE SUR LE COUPLE VALEUR-RISQUE</b> .....	<b>39</b>
5.1 LE MODÈLE STRUCTUREL DE VR-PMS.....	39
5.2 LE MODELE METHODOLOGIQUE.....	42
5.3 LA PRISE DE LA DECISION .....	46
5.4 CONCLUSION .....	48
<b>CONCLUSION GÉNÉRALE</b> .....	<b>49</b>

## ENGLISH VERSION

1.1 PROBLEM DEFINITION .....	54
1.1.1 Current situation.....	54
1.1.2 Research agenda .....	55
1.1.3 Methodology .....	56
1.2 CONTRIBUTIONS OF THE THESIS .....	56
1.2.1 Significance of the study.....	57
1.2.2 Limitations of the study .....	57
1.3 THESIS ORGANIZATION.....	58
<b>CHAPTER 2 PERFORMANCE ANALYSIS: CORE CONCEPTS AND DEVELOPMENTS</b> .....	<b>63</b>
2.1 PERFORMANCE LITERATURE OVERVIEW .....	63
2.1.1 The word "Performance" in the literature .....	64
2.1.2 Different aspects of performance .....	66
2.2 PERFORMANCE MEASUREMENT AND MANAGEMENT (PMM) .....	67



2.2.1 Performance indicators and definitions.....	67
2.2.2 Performance measurement .....	70
2.2.3 Performance measurement systems (PMS).....	70
2.2.4 Performance measurement and management.....	71
2.3 EVOLUTION OF PERFORMANCE MEASUREMENT LITERATURE: OPERATIONS MANAGEMENT PERSPECTIVE .....	72
2.3.1 Productivity management: Pre-1980.....	72
2.3.2 1980-2000: Integrated performance measurement .....	73
2.3.3 2000- Present: Integrated performance management .....	73
2.4 MULTIFACETED PERFORMANCE CONCEPTS .....	76
2.4.1 Multiple criteria .....	76
2.4.2 Multi-level perspective.....	79
2.4.3 Multiple stakeholders perspective .....	80
2.5 ROLES AND PURPOSES OF PERFORMANCE MEASUREMENT AND MANAGEMENT (PMM) .....	81
2.5.1 Monitoring and controlling role.....	81
2.5.2 Diagnostic and interactive role .....	82
2.5.3 Process improvement role .....	82
2.5.4 Learning .....	82
2.5.5 Summary of the roles and purposes of PMM.....	82
2.1 CONCLUSION .....	83
<b>CHAPTER 3 PERFORMANCE MEASUREMENT AND MANAGEMENT (PMM): FRAMEWORKS AND SYSTEMS .....</b>	<b>85</b>
3.1 PERFORMANCE MODELS PROPOSING RECOMMENDATIONS .....	85
3.1.1 Performance criteria systems .....	85
3.1.2 Performance measurement for world-class manufacturing.....	86
3.1.3 Performance management system frameworks.....	86
3.2 FINANCIAL BASED PERFORMANCE MEASUREMENT SYSTEMS.....	87
3.2.1 Activity-based costing and activity-based management.....	87
3.2.2 Theory of constraints (TOC) .....	88
3.3 INTEGRATED PERFORMANCE MEASUREMENT AND MANAGEMENT SYSTEMS .....	89
3.3.1 Requirements of integrated performance measurement and management systems.....	90
3.3.2 Integrated performance measurement systems review .....	93
3.3.3 Performance measurement systems comparison .....	100
3.3.4 Discussion .....	101
3.4 ACTIVITY-BASED PERFORMANCE MEASUREMENT .....	103
3.5 CONCLUSION .....	104
<b>CHAPTER 4 PERFORMANCE MEASUREMENT AND MANAGEMENT TOOLS AND TECHNIQUES: REVIEW AND SELECTION .....</b>	<b>107</b>
4.1 REQUIREMENTS SPECIFICATION.....	107
4.2 VALUE FOCUSED PERFORMANCE MANAGEMENT.....	108
4.2.1 Concept of value .....	108
4.2.2 Eliciting value via objectives modeling .....	110
4.2.1 Objectives modeling: Tools and techniques.....	112
4.3 PROCESS-CENTERED PERFORMANCE MANAGEMENT SYSTEMS: TOOLS AND TECHNIQUES FOR MODELING .....	116
4.3.1 Business process modeling languages: Overview .....	117
4.3.2 Evaluation of business process modeling languages .....	125
4.4 PROCESS-ORIENTED RISK MANAGEMENT AND RISK-ORIENTED PROCESS MANAGEMENT .....	126
4.4.1 The concept of risk.....	127
4.4.2 Risk management process .....	128
4.4.3 Comparison of risk assessment techniques .....	137
4.4.4 Risk management model according to Larson and Kusiak .....	138
4.5 PERFORMANCE MEASURE PRIORITIZATION AND AGGREGATION: TOOLS AND TECHNIQUES.....	143
4.5.1 Multiple criteria decision making (MCDM).....	144
4.5.2 Multiple criteria decision making techniques .....	144
4.5.3 Multiple criteria decision-making techniques review .....	145

4.5.4 MACBETH.....	147
4.5.5 Choquet Integral (CI).....	150
4.6 CONCLUSION .....	152
<b>CHAPTER 5 VALUE-RISK BASED PERFORMANCE MANAGEMENT SYSTEM.....</b>	<b>157</b>
5.1 THE VR-PMS STRUCTURAL FRAMEWORK.....	157
5.1.1 Abstraction levels.....	158
5.1.2 Generic candidate models .....	159
5.1.3 Mapping of generic candidate models .....	162
5.1.4 Conceptual value-risk model construction.....	166
5.2 THE METHODOLOGICAL FRAMEWORK .....	168
5.2.1 Establish the context (Phase 1).....	169
5.2.2 Business process performance modeling (Phase 2).....	169
5.2.3 Risk modeling (Steps 4a, 4b and 4c).....	174
5.2.4 Performance assessment phase (Phase 3).....	179
5.3 THE DECISION-MAKING PROCESS (PHASE 4) .....	182
5.3.1 The MACBETH method.....	182
5.3.2 Choquet integral.....	183
5.4 VALUE-RISK GRAPH AS A DECISION-MAKING TOOL .....	185
5.5 CONCLUSION .....	187
<b>CHAPTER 6 CASE STUDY .....</b>	<b>189</b>
6.1 DESCRIPTION OF THE COMPANY AND THE REFERENCE PRODUCT .....	189
6.1.1 Case Study description.....	190
6.1.2 Production scenarios.....	190
6.2 APPLICATION OF VR-PMS TO THE FIRST SCENARIO .....	192
6.2.1 Objective modeling (Phase 2a) .....	193
6.2.2 Generation of alternatives process plans (Phase 2b) .....	196
6.2.3 Activity modeling (Phase 2b).....	198
6.2.4 Risk modeling (Phase 2c) .....	199
6.2.5 Simulation of the objective-oriented risk aware process plans (Phase 3).....	202
6.3 APPLICATION OF VR-PMS TO THE SECOND SCENARIO.....	208
6.4 DISCUSSION.....	211
6.5 CONCLUSION .....	212
<b>CONCLUSION AND PERSPECTIVES .....</b>	<b>213</b>
<b>REFERENCES.....</b>	<b>219</b>
<b>APPENDICES.....</b>	<b>235</b>



# Table of Figures

FIGURE 1-1: THESIS STRUCTURE .....	58
FIGURE 2-1: GLOBAL BUSINESS TRENDS AND PERFORMANCE MEASUREMENT & MANAGEMENT.....	64
FIGURE 2-2: PERFORMANCE TRIANGLE (VERNADAT, 1996) .....	64
FIGURE 2-3: PERFORMANCE TRIPTYCH OF EFFECTIVENESS, EFFICIENCY AND RELEVANCE (JACOT, 1990) .....	65
FIGURE 2-4: PERFORMANCE INDICATOR MODEL (BERRAH, 2002).....	69
FIGURE 2-5: PM&M INTERRELATIONSHIP (LEBAS, 1995).....	71
FIGURE 2-6: MULTIPLE CRITERIA: HIERARCHICAL ORGANIZATION .....	77
FIGURE 2-7: FLEXIBILITY CONCEPTUAL FRAMEWORK (GERWIN, 1993) .....	79
FIGURE 2-8: LEVELS OF INDUSTRIAL PERFORMANCE (JACOT, 1996).....	80
FIGURE 3-1: BASIC STRUCTURE OF ACTIVITY-BASED COSTING (RAFFISH <i>ET AL.</i> , 1991) .....	88
FIGURE 3-2: SMART PYRAMID (LYNCH AND CROSS, 1992) .....	94
FIGURE 3-3: BALANCED SCORECARDS (KAPLAN AND NORTON, 2000) .....	94
FIGURE 3-4: PERFORMANCE PRISM (NEELY <i>ET AL.</i> , 2002) .....	95
FIGURE 3-5: THE ECOGRAI APPROACH (DUCQ AND VALLESPIR, 2005) .....	96
FIGURE 3-6: STRUCTURED APPROACH OF ECOGRAI (DUCQ AND VALLESPIR, 2005).....	97
FIGURE 3-7: A REFERENCE MODEL FOR THE INTEGRATED PMS (BITITCIET <i>AL.</i> , 1997) .....	98
FIGURE 3-8: INTEGRATED PM FRAMEWORK (MEDORI AND STEEPLE, 2000).....	98
FIGURE 3-9: QMPMS MODEL (SUWIGNJOET <i>AL.</i> , 2000).....	100
FIGURE 4-1: VALUE-FOCUSED PROCESS ENGINEERING (NEIGER <i>ET AL.</i> , 2006) .....	111
FIGURE 4-2: OBJECTIVES HIERARCHY AND OBJECTIVES NETWORK (HURRI, 2000) .....	115
FIGURE 4-3: CIMOSA CUBE (VERNADAT, 1996) .....	118
FIGURE 4-4: CIMOSA PROCESS MODEL FOR THE ORDER PROCESSING EXAMPLE .....	119
FIGURE 4-5: IDEF3 PROCESS MODEL FOR THE ORDER PROCESSING EXAMPLE.....	120
FIGURE 4-6: EPC PROCESS MODEL FOR THE ORDER PROCESSING EXAMPLE .....	122
FIGURE 4-7: BPMN PROCESS MODEL FOR THE ORDER PROCESSING EXAMPLE .....	124
FIGURE 4-8: PETRI NET PROCESS MODEL FOR THE ORDER PROCESSING EXAMPLE.....	125
FIGURE 4-9: RISK MANAGEMENT PROCESS (ISO 31000:2009) .....	129
FIGURE 4-10: FAULT TREE DIAGRAM .....	134
FIGURE 4-11: SAMPLE OF CONVENTIONAL EVENT TREE DIAGRAM (FERDOUSET <i>AL.</i> , 2011) .....	135
FIGURE 4-12: IDEF3 MODEL WITH 10 UNITS OF BEHAVIOUR .....	139
FIGURE 4-13: CLASSIFICATION OF MULTI-CRITERIA METHODS .....	145
FIGURE 4-14: THE MACBETH PROCEDURE (CLIVILLÉ <i>ET AL.</i> , 2007) .....	148
FIGURE 5-1: OVERVIEW OF ABSTRACTION LEVELS .....	158
FIGURE 5-2: IDEF0 ACTIVITY DIAGRAM.....	160
FIGURE 5-3: ACTIVITY MODEL IN A PERFORMANCE PERSPECTIVE.....	160
FIGURE 5-4: RISK FACTORS AND OBJECTIVE RELATIONSHIPS .....	161
FIGURE 5-5: ACTIVITY EXPOSURE TO RISK FACTORS .....	162
FIGURE 5-6: MAPPING OF CANDIDATE MODELS ON COMBINED MODEL DOMAIN.....	163
FIGURE 5-7: INTEGRATION OF CANDIDATE MODELS .....	165
FIGURE 5-8: TETRAHEDRAL RELATIONSHIPS OF VALUE, RISKS, ACTIVITIES AND -OBJECTIVES .....	165
FIGURE 5-9: COMPLETE CONCEPTUAL VALUE-RISKMODEL .....	167
FIGURE 5-10: VALUE CREATION PROCESS IN THE PRESENCE OF RISKS.....	167
FIGURE 5-11: THE METHODOLOGICAL FRAMEWORK OF VR-PMS.....	168
FIGURE 5-12: INTEGRATED BUSINESS PROCESS PERFORMANCE MODELLING APPROACH (INTEGRATED BPPM).....	170
FIGURE 5-13: FUNDAMENTAL OBJECTIVES HIERARCHY .....	171
FIGURE 5-14: MEANS-OBJECTIVES NETWORKS .....	172
FIGURE 5-15: MODIFIED IDEF3-BASED PROCESS MODEL .....	174
FIGURE 5-16: STEP OF AN OBJECTIVE-ORIENTED PROCESS MODEL.....	174
FIGURE 5-17: OBJECTIVE-DRIVEN RISK IDENTIFICATION .....	175
FIGURE 5-18: RISK FACTORS FOR THE MANUFACTURING DELAY .....	176
FIGURE 5-19: OBJECTIVE-ORIENTED RISK AWARE PROCESS MODEL .....	178
FIGURE 5-20: SIMULATION PROCESS .....	180
FIGURE 5-21: VALUE RANGES .....	185
FIGURE 5-22: RISK RANGES .....	185

FIGURE 5-23: VALUE-RISK GRAPH .....	186
FIGURE 6-1:MECHANICAL LOCATOR CONFIGURATIONS: FREE (LEFT) AND LOADED (RIGHT).....	189
FIGURE 6-2: PERFORMANCE EVALUATIONUSING VR-PMS.....	190
FIGURE 6-3: FUNDAMENTAL OBJECTIVES HIERARCHY.....	194
FIGURE 6-4: PERFORMANCE MEASURES TREE (VALUE TREE) .....	194
FIGURE 6-5: ALGORITHM FOR PROCESS SELECTION (SORMAZ AND KHOSHNEVIS 2003) .....	196
FIGURE 6-6: AXLE PART GEOMETRY AND TOLERANCES .....	196
FIGURE 6-7: FEATURE PRECEDENCE NETWORK .....	196
FIGURE 6-8: PROCESSES NETWORK FOR THE PART AXLE .....	198
FIGURE 6-9: MANUFACTURING PROCESS PLAN FOR THE AXLE PART .....	198
FIGURE 6-10: SCHEDULE RISK HIERARCHY .....	199
FIGURE 6-11: EXTRACT OF A RISK AWARE PROCESS PLAN MODEL.....	202
FIGURE 6-12: OBJECTIVE-ORIENTED RISK AWARE PROCESS PLAN MODEL.....	202

TABLE 2-1: DEVELOPMENT OF THE PM LITERATURE AND GLOBAL TRENDS (BITITCIET AL., 2011).....	75
TABLE 2-2: ROLES AND PURPOSES OF PMM .....	83
TABLE 3-1: RECOMMENDATIONS FOR THE DESIGN AND DEVELOPMENT OF PERFORMANCE MEASUREMENT FRAMEWORKS AND SYSTEMS (FOLAN AND BROWNE, 2005).....	90
TABLE 3-2: PERFORMANCE MEASUREMENT SYSTEMS COMPARISON .....	101
TABLE 4-1: TECHNIQUES FOR IDENTIFYING OBJECTIVES (KEENEY, 1996).....	113
TABLE 4-2: HIERARCHIES AND NETWORKS CONSTRUCTION (CLEMEN AND REILLY, 2000).....	114
TABLE 4-3: IDEF3 PROCESS NOTATION .....	120
TABLE 4-4: EVENT-DRIVEN PROCESS CHAIN (EPC) ELEMENTS .....	121
TABLE 4-5: BPMN ELEMENTS.....	123
TABLE 4-6: EVALUATION OF BPMLs .....	126
TABLE 4-7: RISK CLASSIFICATION AND DEFINITION .....	130
TABLE 4-8: QUALITATIVE RISK ASSESSMENT .....	131
TABLE 4-9: PROCESS FMEA EXAMPLE .....	132
TABLE 4-10: FAULT TREE SYMBOLS.....	133
TABLE 4-11: SYNTHESIS OF THE COMPARISON OF RISK ASSESSMENT TECHNIQUES .....	138
TABLE 4-12: PATH SETS FOR THE IDEF3 MODEL.....	139
TABLE 4-13: PROBABILITY OF OCCURRENCE AND SUCCESSFUL COMPLETION OF UOBS.....	140
TABLE 4-14: SCENARIO PROBABILITIES FOR ALL PATH SETS .....	142
TABLE 4-15: CALCULATION OF PROCESS RISK FOR THE IDEF3 MODEL OF FIGURE 4-12.....	143
TABLE 4-16: MACBETH VERBAL SCALE.....	149
TABLE 5-1 : ESTABLISH THE CONTEXT PHASE DELIVERABLES .....	169
TABLE 5-2: LINKS BETWEEN RISK EVENTS AND ACTIVITIES .....	177
TABLE 5-3: EXCERPT OF THE FMEA TABLE FOR SCHEDULE RISK .....	178
TABLE 6-1: AXLE FEATURES AND CORRESPONDING PROCESS CANDIDATES.....	197
TABLE 6-2: ACTIVITY/RISK MATRIX .....	200
TABLE 6-3: EXTRACT OF PROCESS FMEA TABLE (FOCUSING ON THE SCHEDULE RISK).....	201
TABLE 6-4: RUN PARAMETERS FOR SIMULATION MODEL.....	203
TABLE 6-5: PROCESS PLAN PARAMETERS FOR SIMULATION MODEL.....	204
TABLE 6-6: SCENARIO PARAMETERS FOR SIMULATION MODEL.....	204
TABLE 6-7: PERFORMANCE AND RISK LEVELS .....	205
TABLE 6-8: MINIMUM PERFORMANCE AND MAXIMUM RISK ACCEPTABLE EXPRESSIONS.....	205
TABLE 6-9: SIMULATION RESULTS FOR PROCESS PLAN MODELS (PRODUCTION SCENARIO 1).....	206
TABLE 6-10: VALUE AND RISK FUNCTIONS FOR PRODUCTION SCENARIO 1 .....	207
TABLE 6-11: VALUE AND RISK INDICATORS FOR PRODUCTION SCENARIO 1.....	207
TABLE 6-12: MINIMUM AND MAXIMUM ACCEPTABLE MEASURES .....	209
TABLE 6-13: MINIMUM ACCEPTABLE AND MAXIMUM ACCEPTABLE RISK EXPRESSIONS .....	209
TABLE 6-14: SIMULATION RESULTS FOR PROCESS PLAN MODELS (PRODUCTION SCENARIO 2) .....	209
TABLE 6-15: VALUE AND RISK FUNCTIONS FOR PRODUCTION SCENARIO 2 .....	210
TABLE 6-16: VALUE AND RISK INDICATORS FOR THE SCENARIO 2 .....	210
TABLE E-1: FREQUENTLY USED FLOW CHART MODULES IN PRODUCTION SCENARIOS 1 & 2 .....	246



## Glossary and acronyms

**BPML:** Business Process Modeling Languages

**Business process:** A set of end-to-end tasks or activities across an organization that creates value for process stakeholders. The end-to-end signifies that simply a collection of tasks or activities cannot be called a business process. For example, registering an order delivery for a client does not qualify it to be a business process but instead a part of a business process: order fulfillment.

**Choquet integral:** As opposed to other MCDM techniques, Choquet Integral (CI) is a decision-making technique that is based on fuzzy theory and thus not employing additive model for the purpose of aggregation.

**DM:** Decision Maker

**FMEA:** Failure mode and effect analysis is a risk analysis technique used for identifying potential failure modes within a system and, thereafter, analyzes the consequences of those failures on the system.

**IDEF3:** Integration DEFinition 3

**Integrated BPPM:** Integrated Business Process Performance Modeling

**MACBETH:** Measuring Attractiveness by a Categorical-Based Evaluation TecHnique or simply MACBETH is an interactive MCDM technique used to develop value functions (or performance expressions) and weights (or importance of performance criteria) employing principles of preference and measurement theories. The values functions along with their weights are then used to obtain an aggregated global value for a set of alternatives for the purpose of ranking them on the basis of desirability.

**Metric:** It refers to the quantitative or decimal scale of performance measure. However, it is often used interchangeably with performance measure in the performance literature.

**MAUT:** Multiple attribute utility theory (MAUT) is a structured methodology to handle trade-off among multiple objectives (and so performance measures/criteria) and assign a utility value to each measure by rescaling these measures of interest onto a 0-1 scale with 0 represents the worst preference and 1 represents the best. It is based on utility theory which is used to quantify individual preferences in any decision context.

**MAVT:** Multiple attribute value theory (MAVT) similar to MAUT is a methodology to handle trade-off among multiple objectives. However, it does not take into account the uncertainty element of the consequences as is the case in MAUT.

**MCDM:** Multiple Criteria Decision Making

**Objective:** Statements of something that one wants or desire to achieve and hence, essential to value analysis. It can be characterized by a context, an object and direction of preference (Keeney, 1996). For example, in the *context* of “customer order processing”, the *object* is “product supply” while the *direction of preference* is “in-time supply”.

**Performance indicator (PI):** Performance indicator “expresses or interprets” a level of performance of a process/system achieved with regard to its attended objectives.



**Performance measure:** It is fundamental to performance indicator and refers to the description of elementary performance expression which can be measured quantitatively.

**Performance management:** Performance management uses PM as information to affect positive change in organization culture, systems and processes. It identifies and sets goals, objectives and constraints for a given system/process.

**Performance measurement (PM):** Performance measurement is the process of quantifying the performance in terms of performance measures so that the latter could be used as a tool to monitor and improve process/system performance, reveal progress, diagnose problems, enhance motivation and communication.

**Performance measurement system:** Performance measurement system (PMS) is a set of structural and procedural frameworks as well as measurement tools i.e. performance indicators, measures used to analyze and assess the qualitative and quantitative aspects of performance in a balanced and systemic manner.

**Process-centered organization:** It is a philosophy of managing organization by processes as opposed to the concept of functional silos in organization.

**Process scenario:** A process scenario in the context of IDEF3 model is a set of all units of behaviors that define a path from a source to a sink element of the process.

**Risk:** Risk is an effect of uncertainty on objectives

**Risk appetite:** *An amount and type of risk an organization is willing to pursue or retain (ISO Guide, 73-2009)*

**Risk factors:** They refer to the sources of risks.

**Risk tolerance:** An organization or stakeholder's readiness to bear the risk in pursuit of objectives satisfaction

**UOB:** Unit of behavior

**Value function:** A value function  $v$  assigns a number  $v(x)$  to each consequence  $x = \{x_1, x_2, \dots, x_n\}$ . Here,  $x_i$  is the level of performance measure/criteria measuring objective  $O_i$  such that the  $v(x)$  indicates the relative desirability of the consequence. By consequence, we mean the level of performance of a performance measure or criteria in a particular alternative.

**Value:** Value in the current thesis refers to satisfaction of stakeholder's objectives. The concept is modeled through a conceptual value model in order to develop a performance indicator: value indicator.

**VFT:** Value Focused Thinking

**VR-PMS:** Value and Risk based Performance Management System

---

**French Version**  
**(Extended Summary)**

---



## **Chapter 1 Introduction et Présentation**

Il est apparu ces dernier temps que le management de la performance de processus métier représente un défi pour répondre aux besoins ou objectifs des parties-prenantes dans toute forme d'entreprises privées ou publiques. L'entreprise répond à certains besoins mais aux dépens d'autres à cause de la relation agonistique qui existe entre les attentes des différentes parties-prenantes. Dans cette situation, une entreprise est obligée de gérer ses processus métier de telle manière que les attentes ou objectifs de toutes les parties-prenantes soient plus ou moins gérés.

Par ailleurs, la satisfaction des objectifs exige de mesurer la performance dans un but d'évaluation. Cependant, les objectifs globaux ne peuvent pas être opérationnalisés facilement à cause de leurs multiples dimensions. D'autre part, le besoin de mesurer un système ou processus de manière holistique complique le processus de mesure de performance.

Pour aborder cette situation, la thèse que nous défendons est qu'un système d'entreprise doit être évalué suivant des quatre axes principaux : le coût, le bénéfice, la valeur et le risque. Le coût et le bénéfice ont déjà été largement étudiés par ailleurs mais la valeur et le risque ne sont pas abordés dans un cadre intégré et surtout dans le contexte de l'approche processus. Nous développons donc nos arguments autour de ces deux derniers axes de performance mais le même principe peut être appliqué aux deux autres axes : le coût et le bénéfice. Cette approche peut s'appliquer tout aussi bien à l'analyse de la performance d'un système, d'un produit, d'un processus ou d'un projet.

### **1.1 Problématique**

La littérature existante du domaine de la performance souligne l'importance de la mesure et la gestion de la performance dans les entreprises. Elle se focalise souvent sur l'élaboration de la mesure de performance à partir des objectifs de l'entreprise. Pour satisfaire ces objectifs afin de créer de la valeur pour les parties-prenantes, les entreprises conçoivent et mettent en place des activités. Cependant, la création de la valeur par des activités est soumise à des incertitudes et des risques qui influencent négativement le processus de la création de la valeur. Dans ce contexte, le rôle de la mesure et de la gestion de performance est à la fois de déterminer des objectifs, dériver des mesures de performance à partir de ces objectifs, définir les risques et évaluer à la fois les objectifs et les risques pour l'aide à la décision.

D'une manière générale, on peut dire qu'actuellement la mesure de performance comprend les aspects financiers et non-financiers (Dossi and Patelli, 2010; Ittner and Larcker, 1998). C'est le résultat du changement de paradigme qui a fait suite à l'inadéquation de la mesure de performance financière comme seul indicateur de performance d'une entreprise dans un premier temps (Tan et al. 2008; Johnson and Kaplan, 1987). L'émergence et la popularité du concept de tableau de bord équilibré (Kaplan and Norton, 1992; 1996; 2000 and 2004) est l'exemple le plus marquant de ce changement de paradigme. En outre, la littérature sur les systèmes de mesure de performance se concentre sur l'alignement de la mesure de performance avec la stratégie de l'entreprise (Bhimani, 2006, p. 107). De plus, de nombreux chercheurs préconisent la prise en compte du risque pour améliorer l'analyse de la performance (Gourc, 2006; Tuncel and Alpan, 2010). Cependant, la gestion du risque s'effectue à part de la mesure de performance intégrée. Par ailleurs, le processus de mesure de

performance n'est pas strictement lié à l'aide à la décision et peut donc être vu comme un système d'information.

Bien sûr, le système de mesure de performance et les techniques de l'ingénierie du risque jouent un rôle important pour gérer la performance de processus métier. Cependant, ces systèmes et techniques échouent lorsqu'il s'agit de performance globale de processus. Plusieurs raisons peuvent être attribuées à cet échec :

- Le problème de traitement d'information quand l'entreprise veut tout mesurer.
- La plupart des systèmes de mesure de performance n'offrent pas le cadre procédural ou méthodologique nécessaire pour guider le processus de mesure et de gestion de performance.
- Les frontières des entreprises sont de moins en moins marquées car celles-ci collaborent en chaînes ou réseaux logistiques alors que les systèmes de mesure de performance ont été développés pour les entreprises vues comme une entité fonctionnelle propre.
- Souvent, les systèmes de mesure de performance ne sont pas (ou insuffisamment) liés au mécanisme de prise de décision de l'entreprise.

Au vu des défis mentionnés ci-dessus, cette thèse propose d'aborder le problème de performance et d'évaluation du risque d'une manière globale. Pour cette raison, la thèse a pour objectif de développer :

« Un système de mesure et de pilotage afin de guider un évaluateur dans les évaluations de processus métier en fonction de deux critères globaux : la valeur et le risque. Ces deux indicateurs peuvent être utilisés pour évaluer et classer les différentes alternatives de processus métier sur la base des avantages dans un contexte de décision ».

Le choix des deux indicateurs ou couple (valeur, risque) a pour objectif de faciliter l'aide à la décision.

## **1.2 Organisation de la thèse**

Ainsi, ce mémoire de thèse s'articule autour de six chapitres (cf. Figure 1-1)

Après le chapitre d'introduction, le Chapitre 2 présente une analyse critique de la littérature du domaine de la performance afin d'étudier les tendances pertinentes et les concepts de performance dans une perspective très large. Le chapitre aborde les aspects financiers et non financiers de la performance, leur évolution et la nature multidimensionnelle, multi niveau et multi parties-prenantes d'un système de mesure de performance. De plus, le rôle et l'objectif du système de mesure et de gestion de performance sont également discutés.

Le Chapitre 3 présente et critique certains systèmes de mesure de performance faisant référence jusqu'à maintenant. Il discute leurs points forts et points faibles par rapport aux défis de performance contemporains et les évaluent par rapport aux concepts nécessaires à aborder dans un SIP.

Le Chapitre 4 a pour but de synthétiser les exigences des systèmes de mesure de performance, puis de trouver les outils et techniques nécessaires afin de modéliser et évaluer les exigences identifiées. L'objectif principal est de trouver les technique permettant de traduire les attentes des parties-prenantes dans l'indicateur de valeur dans le contexte d'incertitude.

Dans le Chapitre 5, un système de mesure de performance basé sur les indicateurs de valeur et de risque, appelé VR-PMS, est proposé afin d'évaluer la performance des processus métier de l'entreprise en utilisant les outils et techniques identifiés dans le chapitre précédent. Le VR-PMMS intègre les concepts associés avec la connaissance sur l'évaluation de performance recueillie dans divers domaines de performance et ce, dans un cadre unique afin de satisfaire les exigences de gestion de performance intégrée.

Le Chapitre 6 a pour objet de tester la validité et l'adéquation du système de gestion de performance proposé. A cet effet, un cas d'étude a été analysé dans le domaine de la production manufacturière et qui valide l'adéquation de système proposé.

Enfin, le Chapitre de conclusion présente le synthèse du travail de recherche. Il identifie et propose des axes de recherche et certaines de leurs perspectives. De plus, la conclusion discute les limites du système de mesure et de gestion de performance basé sur la valeur et le risque.



## **Chapter 2 L'analyse de la Performance: Concepts Fondamentaux et Evolutions**

Le système de mesure de performance est utilisé comme un outil de management pour quantifier, analyser, piloter et améliorer les processus de l'entreprise. L'indicateur de performance (noté IP), élément essentiel du système de mesure de performance (SIP), est donc utilisé pour exprimer les objectifs et stratégies d'une entreprise et d'évaluer l'adéquation de ses processus réels. Pour expliquer ces objectifs via un système de mesure de performance, l'entreprise doit, en premier lieu, élaborer et mettre en place un système de mesure de performance basé sur des concepts bien définis. Pour cela, ce chapitre propose d'analyser les concepts de performance car, bien que largement utilisés dans de nombreux domaines, leur définition reste floue.

### **2.1 La littérature de la performance: présentation**

Le processus de mesure de performance existe depuis longtemps dans les entreprises mais il a connu un développement important durant l'âge industriel, qui continue de nos jours. Ces développements ont contribué à l'élaboration de plusieurs concepts de performance, qui ont été adoptés par les SIP afin de répondre aux besoins constamment en évolution du marché (cf. Figure 2-1).

Néanmoins, selon Franco-Santos et al. (2007) le mot « performance » manque de définition claire et explicite. Selon Vernadat (1996), la performance est le triptyque : organisation, compétence et motivation. Par ailleurs, de nombreux concepts sont liés à la performance dans le contexte industriel. La performance repose sur efficacité et efficience (Neely et al., 2005), efficacité, efficience et pertinence (Jacot, 1990) ou encore efficacité, efficience, pertinence et effectivité (Bescos, 1995).

Dans le contexte du management, la performance est directement liée à la réalisation des objectifs organisationnels. Cette réalisation peut se comprendre au sens strict (résultat, aboutissement) ou au sens large du processus qui mène au résultat (action) (Bourguignons, 2000). Pour expliquer ce concept, le management utilise différents termes comme « performance management » (Neely, 1999, Taticchi, 2010), « performance evaluation » ou « performance measurement » (Merchant and Stede, 2007), et « performance appraisal » (David, 1994) de façon interchangeable afin de modéliser le processus de management de la performance.

Par ailleurs, d'autres termes sont également employés dans la littérature comme « succès » (Cantner et al., 2011) ou « valeur » (Porter, 1998, pp. 33–61) qui font également référence au concept de performance.

En bref, quel que soit le terme utilisé, le mot « performance » reste un terme évasif. Bourguignons (1995) l'appelle « un mot-valise » où chacun met le concept qui lui convient en laissant le contexte prendre en charge la définition (Neely, 2002, p. 67) et rend ainsi le concept de performance contextuel (Neely, 2007, pp. 322).

### **2.2 Les différents aspects de la performance**

La performance peut être décomposée en deux dimensions : une financière et une non-financière (Dossi and Patelli, 2010; Ittner and Larcker, 1998). La performance financière concerne la performance d'un point de vue comptable. Cet aspect de la performance est le plus ancien et le plus étudié. Il mesure la performance en termes



monétaires (Horngren et al., 1999; Kaplan, 1984). Les mesures utilisées sont : les revenus, le retour sur investissement (ROI) et la valeur économique ajoutée (EVA). La promotion de l'indicateur EVA comme mesure globale de la performance insiste sur l'importance de l'aspect financier de la performance (David, 1999).

Les études menées par les chercheurs et praticiens dans le domaine de la performance financière ont donné naissance à des méthodes comme « Activity-Based Costing » (ABC), l'EVA ou « customer profitability analysis » (Abdel-Maksoud et al., 2005). Malgré leur contribution à l'évaluation de la performance d'une entreprise, ces méthodes se sont avérées insuffisantes et ont donc fait l'objet de critiques au cours de ces dernières décennies du fait de leur incapacité à déterminer la performance potentielle.

C'est à cause de cette incapacité que les chercheurs et les praticiens ont commencé à remettre en cause la pertinence de la performance basée uniquement sur la dimension financière. C'est ce débat (nommé dans la littérature « relevance debate ») qui est à l'origine de la performance non-financière. Celle-ci se base par exemple sur les concepts de délai (Stalk, 1988), de qualité (Deming, 1982) et de flexibilité (Slack, 1983). De nombreux auteurs pensent que la performance non-financière augmente la performance financière ; malheureusement ce lien n'est pas encore bien établi. Les travaux de recherche d'Ittner and Larcker (1998) défendent cette idée, ce qui pousse ces auteurs à étudier le rapport entre la satisfaction des clients et la performance financière.

Pour résumer, on peut conclure que les mesures de performance non-financière sont répandues dans l(es) entreprise(s). D'après Chenhall (1997), elles sont plus utilisées dans le contexte manufacturier avancé comme le juste-à-temps, la qualité totale et les systèmes manufacturiers flexibles (FMS). De plus, les domaines techniques ont beaucoup contribué à développer la performance non-financière. Enfin, la performance améliorée ne peut être obtenue qu'en utilisant de façon conjointe la performance non-financière avec la performance financière (Stern et al., 2001; Johnson and Kaplan, 1987).

## **2.3 Mesure et gestion de la performance**

Le thème central de la performance se concentre sur la mesure de celle-ci, afin d'aider au pilotage de l'entreprise. Toutefois, le concept de performance n'est pas très clair tout comme celui d'indicateur de performance. Cette partie est donc consacrée à la discussion des concepts essentiels de performance : l'indicateur de performance (IP) et le processus de mesure de la performance (PM).

### **2.3.1 L'indicateur de performance**

Les indicateurs de performances sont des descripteurs de performance et sont donc essentiels. Ceux-ci ont pour but d'identifier le degré d'atteinte de l'objectif considéré. Selon Neely (2005), la performance peut être définie comme « une métrique pour quantifier l'efficacité et l'efficacités d'une action ». Cependant, il manque à cette définition de la performance l'aspect qualitatif comme l'innovation (Rosenberg et al. 1992) ou la satisfaction du client qui ne peuvent pas être vus à partir de la définition mécanistique ou opérationnelle.

D'après l'Association Française de Gestion Industrielle (AFGI, 1992), un indicateur de performance est défini comme « *une donnée quantifiée qui exprime l'efficacité et /*

*ou l'efficience de tout ou partie d'un système (réel ou simulé), par rapport à une norme, un plan déterminé et accepté dans le cadre d'une stratégie d'entreprise ».*

Cette définition caractérise un Indicateur de Performance comme un Triplet constitué des trois dimensions : objectif, mesure et variable. Berrah (2002), en se basant sur la définition de l'AFGI, développe cette définition en la décomposant en trois facettes distinctes :

- une facette « objectif » permettant d'exprimer les objectifs rattachés aux indicateurs,
- une facette évaluation (appelée également « facette capteur »), qui compare les mesures atteintes par rapport aux objectifs attendus. Les performances évaluées sont exprimées de manière homogène, sur la base de certains mécanismes de calcul, facilitant ainsi une agrégation ou une évaluation ultérieure,
- une facette appréciation (appelée également « facette observateur ») qui analyse la performance atteinte en fonction du contexte de déroulement du processus ainsi que du savoir-faire de l'observateur.

En plus de l'indicateur de performance, d'autres termes sont couramment employés dans la littérature afin de décrire l'évaluation de la performance d'un système ou d'un processus : métriques, critères ou attributs. Tous ces termes sont donc utilisés de façon interchangeable, mais ils n'ont pas la même capacité pour exprimer un objectif.

### **2.3.2 La mesure de la performance**

Traditionnellement, la mesure de la performance est définie comme le processus de quantification de l'efficacité et de l'efficience des actions (Neely et al., 2002). Cependant, dans le contexte actuel, la mesure de performance joue un rôle plus important que celui défini auparavant. Elle fournit un retour d'informations sous forme de mesures pour surveiller, gérer et améliorer la performance, révéler les progrès, diagnostiquer un problème ou augmenter la motivation et la communication (Waggoner et al., 1999). Mais la mesure de performance ne peut jouer tous ces rôles que si elle est effectuée de manière systématique et équilibrée. C'est pour cette raison qu'il est nécessaire d'avoir un cadre ou un système de mesure de performance.

### **2.3.3 Système de mesure et de gestion de la performance**

D'après Globerson (1985), le système de mesure de performance évalue de manière systématique les entrées, les sorties, les transformations et la productivité dans les processus manufacturiers et non-manufacturiers. Bititci et al. (1997) le définissent comme un système d'informations (SI). Pour Neely et al. (2005), un système de mesure de la performance est *un ensemble de métriques utilisées pour quantifier l'efficience et l'efficacité d'une action.*

Pour obtenir un système de mesure de performance fructueux, il est nécessaire, en plus des outils de mesure de performance tels qu'une liste de mesures de performance, d'utiliser deux cadres (Folan and Browne, 2005). Ces deux cadres sont:

- un cadre structurel qui précise une typologie pour la gestion de la performance
- un cadre procédural pour guider le développement de mesure de performance de la stratégie.

Par exemple, l'outil « Balanced Scorecards » (Kaplan and Norton, 1996) fournit ces deux cadres permettant de gérer la performance d'une entreprise. Le cadre structurel de tableau de bord équilibré vise à mesurer la performance d'une entreprise en quatre perspectives : finances, clients, processus et apprentissage. Alors que le cadre procédural comprend quatre processus : traduire la vision, communiquer la vision, planifier les activités et donner du feedback et enrichir l'expérience (apprentissage).

Suite aux différentes définitions présentées ci-avant, nous pouvons reformuler la définition d'un système de mesure de performance comme étant « un ensemble de deux cadres, l'un structurel et le second procédural, accompagnés d'outils de mesure de performance comme l'indicateur de performance, utilisés pour analyser et apprécier l'aspect qualitatif et quantitatif de la performance ».

Toutefois, les systèmes de mesure de performance ne sont pas suffisants pour gérer la performance d'une entreprise d'une manière holistique parce que ces systèmes ne sont pas complets. On peut en effet remarquer qu'à l'heure actuelle le contrôle et la boucle de rétroaction ne sont toujours pas pris en compte.

La gestion de la performance, contrairement au système de mesure de la performance, implique l'action de planning et de contrôle. Ce point de vue du management de performance est largement soutenu dans la littérature (Lebas, 1995; Kaplan and Norton, 1996; Bourne et al., 2003). Bititci et al. (1997) distinguent le système de mesure de performance du management de performance en nommant le premier système d'informations, ce qui permet au second de fonctionner effectivement et efficacement.

Amaratunga and Baldry (2002) définissent la gestion de performance comme l'utilisation d'informations de mesure de performance afin d'opérer un changement positif dans la culture organisationnelle, dans les processus. Les mesures de performance fixent : un but de performance, l'allocation et les priorisations des ressources. Cette gestion tient également informé le gestionnaire pour soit confirmer, soit changer les stratégies existantes ou l'orientation de la performance afin d'atteindre les objectifs et de partager les résultats de la performance en suivant ces objectifs (Neely, 2003).

En résumé, le système de mesure de performance est un sous ensemble de la gestion de la performance. Le premier système fournit des éléments essentiels au second afin de gérer la performance d'une entreprise.

## **2.4 Evolution de la mesure de la performance**

Il est nécessaire de rappeler ici que la philosophie de la mesure de performance et ses concepts correspondants sont en constante évolution. Cette évolution de la performance, qui est ainsi passée d'une vision unidimensionnelle (uniquement comptable) à une vision multidimensionnelle, multi niveaux et multi parties-prenantes, est largement attribuée aux pratiques industrielles et du marché qui ont également fortement évoluées au cours de ces dernières années. Cette période de changements peut se diviser en trois grandes périodes. Ces dernières sont détaillées dans les chapitres suivants.

### **2.4.1 Gestion de la productivité : Pre-1980**

Cette période peut se caractérisée par la spécialisation des ouvriers (Taylor, 1911) et la production à grande échelle (Ford, 1922). A cette période, la demande des produits

surpasse les capacités de production. La production à grande échelle devient alors un mode de production qui amène l'industrie à se focaliser sur les concepts de performance comme la vente et l'amélioration de la productivité sans prêter attention aux clients (Neely, 2002; Suzaki, 1987). Pour cela, l'entreprise se concentrait sur les indicateurs de performance uniquement financiers (Johnson and Kaplan, 1987) comme le coût, la productivité et le retour sur investissement.

Au cours des années 60 et 70, quelques auteurs et praticiens ont remis en cause la mesure de performance basée uniquement sur les mesures financières. Par conséquent, d'autres critères comme la flexibilité (Slack, 1983), le délai (Stalk, 1988), la qualité et la satisfaction des clients (Deming, 1982) apparaissent dans le domaine de la performance. En incluant ces dimensions, la performance est devenue multidimensionnelle (Hayes and Abernathy, 1980; Skinner, 1973; Kaplan and Norton, 2000). Ce changement de paradigme a mené au développement des systèmes de mesure de performance intégrés (Johnson and Kaplan, 1987; Kaplan and Norton, 1992).

#### **2.4.2 1980-2000: La mesure de performance intégrée**

Cette période est caractérisée par l'introduction d'autres dimensions de performance et les critères de performance correspondants. Cette intégration de plusieurs dimensions a complexifié la gestion de la performance, ce qui a mené au développement de mesure de la performance intégrée par des solutions telles que : « Balanced Scorecards » (Kaplan and Norton, 1992, 1996, 2000), ECOGRAI (Bitton, 1990), SMART (Lynch and Cross, 1992) ou Performance Prism (Neely et al., 2002).

#### **2.4.3 2000-aujourd'hui: Gestion de la performance intégrée**

Après l'essor de la mesure de performance intégrée, une question fondamentale reste sans réponse : comment les indicateurs de performance peuvent être mis en place pour gérer la performance (Bourne et al., 2000) ? Cette orientation a conduit à la mise en place de la mesure de performance en tant que processus. De plus, les chercheurs ont étudié la performance dans différents domaines comme : la recherche et le développement (R&D), l'innovation (Adams et al., 2006; Chiesa and Frattini, 2007; Chiesa et al., 2009), la chaîne logistique et les réseaux collaboratifs (Chan and Qi, 2003; Ganga and Carpinetti, 2011; Hernández-Espallardo et al., 2010; Luras et al., 2011; Clivillé and Berrah, 2011) et les PME (Garengo et al., 2005).

En résumé, le système de mesure de performance évolue avec les tendances des entreprises. A cause de ces tendances, le processus de mesure de performance est devenu très difficile à gérer du fait de l'important flot d'informations (Shah et al. 2012). Par ailleurs, d'autres aspects tels que la performance dans le contexte multiculturel, les PME, la chaîne logistique verte et les réseaux collaboratifs sont encore des points à aborder (Bititci et al., 2011).

### **2.5 Les concepts multidimensionnels de la performance**

L'excellence dans une dimension de performance ou à un certain niveau de l'entreprise ou encore pour une partie prenante ne peut pas garantir le succès global de l'entreprise, parce que la performance, comme montré dans la section précédente, revêt plusieurs dimensions, divers niveaux et considère plusieurs parties prenantes. Ce chapitre se focalise sur ces trois caractéristiques actuelles de la performance.

### **2.5.1 Multi-critères**

Concernant le caractère multidimensionnel, la performance doit prendre en compte plusieurs aspects, puis trouver un compromis admissible entre eux parce que l'optimum global, souvent difficilement atteignable, n'est jamais la somme des optimums locaux (Slack et al., 2007). Pour aborder plusieurs dimensions de la performance, plusieurs attributs ou critères doivent être déterminés. Ensuite, l'utilité de chaque critère est analysée (cf. Figure 2-6), ce qui aboutit à l'expression de performances élémentaires. L'agrégation des expressions de performance définit alors la valeur globale du processus.

Au fil du temps, plusieurs dimensions de la performance ont été identifiées. Chaque dimension représente un objectif. L'entreprise doit rendre explicite chaque objectif et doit déterminer des critères afin de le mesurer. Les dimensions les plus importantes d'après (Neely et al., 2005; Slack, 2007) sont : la qualité, le délai, le coût et la flexibilité. En outre, d'autres dimensions comme la réactivité, l'agilité ou l'interopérabilité (dans le contexte de réseaux d'entreprise) sont également importantes.

### **2.5.2 Multi-niveaux**

La performance effective ne peut pas résulter seulement de la sélection d'un ensemble de critères équilibrés. En effet, il faut également les classifier au niveau stratégique, tactique et opérationnel (Gunasekaran et al., 2001). Ces niveaux reflètent le degré de hiérarchie au sein de l'entreprise et des différents horizons de temps. Ces hiérarchies et horizons de temps ont leurs propres exigences de décision et de mesure (Rushton et al., 2010).

Au niveau stratégique, les principales activités sont des activités de planning nécessaires pour atteindre un objectif stratégique. Au niveau tactique, il faut se focaliser sur le déroulement des activités associées pour achever l'objectif stratégique. De même, au niveau opérationnel, on gère des processus opérationnels du système représentant des activités cœur de métier de l'entreprise. Les principales activités sont basées sur des décisions prises au jour le jour ; elles sont également mises en œuvre selon des plans opérationnels et sont contrôlées selon un cadre normatif et des règles.

Jacot (1996) propose une structure multi niveaux de l'entreprise afin de conceptualiser la performance à différents échelons (cf. Figure 2-8). Chaque niveau a ses propres objectifs, critères et niveaux de performance.

### **2.5.3 Multi-Parties Prenantes**

La performance est devenue multi-parties prenantes en plus d'être multi-critères et multi-niveaux. Il est donc de la responsabilité des entreprises d'identifier les attentes de leur parties-prenantes et d'essayer de les satisfaire (Atkinson et al., 1997). Dans le cas contraire, cela est préjudiciable à la performance de l'entreprise (Greenley and Foxall, 1997). Pour cette raison, plusieurs auteurs ont considéré le concept de partie-prenante pour améliorer la performance (Bosch-Mauchand et al., 2010; Marques et al., 2011; Andy Neely, 2002). Il est à noter que pour les petites et moyennes entreprises, il est difficile de répondre aux besoins des différentes parties-prenantes à cause du manque de ressources (Garengo et al., 2005). Dans ce cas, il est recommandé d'ordonner les parties prenantes selon les principes de Mitchell et al. (1997).

## 2.6 Les rôles de la mesure et de la gestion de la performance

Le rôle et l'objectif de la performance sont bien expliqués par Rose (1995) : « *la mesure de la performance est un langage d'avancement pour l'organisation. Elle indique où se trouve l'organisation et où elle se dirige. Elle fonctionne comme un guide pour déterminer si l'entreprise est en route afin d'atteindre ses objectifs. Elle est également un outil fort parce qu'elle communique aux employés ce qui est important pour atteindre les objectifs* ».

D'après cette définition, on en déduit que la mesure de la performance a plusieurs rôles et objectifs. Une revue de la littérature révèle davantage ces rôles et objectifs.

L'objectif principal de la mesure de la performance est de contrôler et de gérer. D'après Atkinson et al. (1997), le système de mesure de la performance fournit des informations qui identifient :

- le niveau de performance souhaité par rapport aux objectifs,
- les opportunités pour améliorer les processus et permettant de suggérer des améliorations,
- le degré de réalisation des objectifs des processus existants,
- l'atteinte ou non de la performance potentielle de ces processus.

Chacun de ces rôles sont importants car ils sont nécessaires afin d'assurer l'évaluation et l'amélioration des processus étudiés. Berrah (2002) a aussi défini le rôle de la mesure de performance comme étant un outil de contrôle en gestion.

En plus des rôles de surveillance et de contrôle, la mesure de la performance peut être utilisée pour étudier les relations entre les différents facteurs qui contribuent à la performance (Atkinson et al., 1997 ; Suwignjo et al., 2000) et permet d'établir une relation de causalité entre eux. Ce rôle est important pour éviter la surveillance des processus ou des systèmes, car les relations de causalité entre les facteurs de performance déterminent le comportement d'un système ou d'un processus. Ainsi, il est possible de corriger les systèmes ou les processus en dysfonctionnement.

Par ailleurs, la mesure de la performance est utilisée pour améliorer la performance des systèmes ou des processus (Dixon et al., 1990 ; Neely et al., 1996; Bond, 1999 ; Sahraoui, 2009). De plus, le rôle de la mesure de performance a évolué au cours du temps : il est passé d'un rôle de surveillance à un rôle didactique. Le processus de comparaison fournit une base à l'apprentissage et une boucle de contrôle permet de comparer le résultat à l'objectif.

## 2.7 Conclusion

Ce chapitre propose une explicitation des concepts (en constante évolution), rôles et objectifs de la performance. L'analyse critique du domaine de la performance montre qu'il est clair que cette notion a été largement et librement utilisée dans la littérature, ce qui rend le concept difficile à cerner.

La performance peut être divisée en deux grandes dimensions : la performance financière et la performance non-financière. Pour qu'une entreprise fonctionne bien, ces deux dimensions doivent être prises en compte car un seul aspect de la performance n'est plus suffisant pour garantir un retour d'information complet permettant de prendre des décisions et de la piloter.

De plus, le concept de la performance n'est pas figé mais évolue avec l'évolution des pratiques de l'entreprise. Il est donc nécessaire de déterminer cette tendance et ses leviers qui font évoluer le concept de la performance.

Par ailleurs, la prise en compte d'un aspect supplémentaire à l'aspect financier a fait évoluer le concept de performance vers un caractère multidimensionnel. En outre, la performance est multi-niveaux et multi parties-prenantes, ce qui permet la surveillance, le diagnostic, l'amélioration continue et l'apprentissage d'un système d'entreprise ou des processus.

Etant donné que ce chapitre a pour objectif d'expliquer les concepts essentiels utilisés dans le domaine de la performance, le chapitre suivant est consacré à l'examen des systèmes de mesure de la performance afin d'identifier leurs points forts et faibles.

## **Chapter 3 Mesure et Gestion de la Performance: Cadres et Systèmes**

Le chapitre précédent a proposé une étude des concepts de performance et de leur évolution au cours du temps. Ce chapitre est consacré à la synthèse des systèmes de mesure de performance. L'objectif est d'identifier les points forts et les points faibles de ces systèmes afin d'identifier des exigences pour proposer, le cas échéant, un nouveau système de mesure et de gestion de la performance. Pour effectuer au mieux l'état de l'art des systèmes de mesure de performance, ces derniers ont été divisés en trois grandes catégories : ceux qui proposent des recommandations, ceux qui se focalisent uniquement sur les aspects financiers et enfin ceux qui proposent des systèmes de mesure intégrés.

### **3.1 Modèles de performance proposant des recommandations**

Cette section présente les modèles de performance qui proposent plusieurs recommandations pour concevoir un système de mesure de performance. Ces modèles ont été proposés afin de pallier à l'inadéquation des systèmes de mesure de performance traditionnels.

#### **3.1.1 Performance Criteria System (PCS)**

Les quatre recommandations émanant de PCS (Globerson, 1985) sont les suivantes :

- 1) Choisir un ensemble de critères de performance bien définis.
- 2) Mesurer les critères choisis.
- 3) Affecter un standard à chaque critère de performance.
- 4) Développer une procédure de traitement pour éliminer les écarts entre la performance standard et la performance actuelle.

#### **3.1.2 Performance Measurement for World Class Manufacturing**

Les sept recommandations de Maskell (1991) sont les suivantes :

- 1) Utiliser des IP en rapport avec la stratégie de l'entreprise.
- 2) Utiliser des IP non financiers, en plus des IP financiers.
- 3) Adapter les IP suivant le département de l'entreprise.
- 4) Adapter les IP suivant le contexte.
- 5) Les IP doit être simples et faciles à utiliser.
- 6) Les IP doivent fournir un feedback.
- 7) Les IP doivent être utilisés pour de l'amélioration continue plutôt que comme simples outils de contrôle.

### **3.2 Systèmes de mesure de performance basés sur les aspects financiers**

Cette partie se propose de lister les différentes méthodes se focalisant majoritairement sur l'aspect financier.

#### **3.2.1 Activity-Based Costing and Activity-Based Management**

Activity-based costing (ABC) est une méthode développée par Cooper (1988a, 1988b, 1989a, 1989b) et encouragée par Kaplan et Cooper (1988) et Brimson (1991). La différence fondamentale entre ABC et un système traditionnel basé sur les coûts



est que, dans le système traditionnel, on suppose que le produit ou le service consomme le coût, alors que dans l'ABC, ce sont les activités qui consomment toutes les charges pendant que le produit ou les services consomment toutes les activités (Bharara and Lee, 1996).

Le consortium nommé Advanced Management-International (CAM-I) définit l'Activity-Based Costing comme étant :

*“a methodology that measures cost and performance of activities, resources and cost objects. Resources are assigned to activities, then activities are assigned to cost objects based on the use of consumption of the relevant activities. Activity-Based Costing recognizes the causal relationships of cost drivers to activities”.*

Activity-Based Management (Cokins, 2001) est par contre, un terme général qui comprend le management de l'activité, l'ABC ainsi que les concepts associés avec la méthode d'organisation et de gestion de production Juste à temps et la théorie des contraintes.

### **3.2.2 La théorie des contraintes (TOC)**

La théorie des contraintes est une philosophie de management total développée par Goldratt (1990). Elle est réapparue plus tard comme système d'amélioration continue qui se focalise sur les contraintes s'appliquant aux processus pour améliorer la performance de ces derniers.

Le processus d'application de la théorie des contraintes est constitué de cinq étapes :

- 1) Identifier les contraintes du système.
- 2) Décider comment exploiter ces contraintes.
- 3) Subordonner tous les processus à la décision de l'étape 2.
- 4) Eliminer des contraintes du système.
- 5) Lorsqu'une contrainte est supprimée, retour à l'étape 1.

### **3.2.3 Les systèmes intégrés de mesure et de gestion de performance**

Les systèmes intégrés de mesure comprennent à la fois les aspects financiers et non-financiers. Ils tiennent donc compte des critères tels que le coût, la qualité, le délai ou la flexibilité des processus qu'ils mesurent.

## **3.3 Exigences des systèmes intégrés de mesure de performance**

Etant donné que le besoin pour un système intégré de mesure de performance est bien établi dans l'environnement économique fluctuant actuel (Bititci et al., 2011), plusieurs auteurs soulignent l'intérêt d'avoir un système de mesure de performance car il est l'élément clé pour maintenir un avantage concurrentiel durable (Bititci, 1995). Cependant, ces auteurs oublient souvent de fournir les exigences essentielles de ce système de mesure de performance. Folan and Browne (2005) synthétisent les recommandations (i.e. les exigences) des systèmes de mesure de performance et les appellent des briques fondamentales de toute initiative de mesure de performance. On peut les diviser en deux grandes parties :

- Recommandations pour des Indicateurs de Performance.
- Recommandations pour les Systèmes de Mesure de Performance (PMS).

Neely et al. (1997) ont listé les différents besoins des IP de la littérature et les ont présentés sous forme de recommandations de performance dans une liste non-exhaustive. En fait, un bon IP se résume en un mot : SMART ; c'est-à-dire: Spécifique, Mesurable, Atteignable, Réaliste et Temporellement défini (Doran, 1981).

De plus, Folan and Browne (2005) ont fait une synthèse des recommandations proposées par les différents auteurs pour concevoir un système de mesure de performance. (cf. Tableau 3-1). Ces recommandations englobent principalement les aspects multi dimensionnels, y compris la performance financière et non-financière, les mesures dérivées des objectifs, un rapport simple en termes de peu de mesures de performance ou la transparence du processus de mesure de performance, par exemple.

Jusqu'à présent, de nombreux systèmes de mesure de performance ont été développés en prenant en compte une ou plusieurs recommandations telles que mentionnées dans le Tableau 3-1. Toutefois, aucun d'entre eux ne traite toutes les recommandations.

Dans le cadre de cette thèse, nous proposons de définir les attributs (recommandations) nécessaires afin de faciliter la gestion et la mesure de la performance. Ces attributs sont :

- Les mesures de performance dérivées des objectifs,
- L'approche basée sur les processus,
- La prise en compte des perspectives des parties prenantes,
- Le contrôle, l'amélioration et l'apprentissage dans le contexte de la performance,
- La multi dimensionnalité de la performance,
- Les mécanismes d'intégration des mesures,
- L'interaction entre les mesures de performance,
- L'organisation hiérarchique et la performance,
- L'ingénierie du risque,
- Un système de décision associé.

Ces attributs représentent des exigences fondamentales pour développer un système de mesure et gestion de performance utile. Dans la section suivante, nous faisons une analyse critique des systèmes de mesure de performance sur la base de ces attributs.

### **3.4 Revue des systèmes intégrés de mesure de performance**

Cette section a pour objectif d'analyser les systèmes et modèles de mesure de performance existants sur la base des critères définis précédemment.

#### **3.4.1 Strategic Measurement Analysis and Reporting Technique**

Le système de mesure de performance SMART a été développé par Lynch et Cross (1992). Son architecture (également appelée pyramide de performance) est fondée sur les relations entre les mesures de performance présentes à tous les niveaux de l'entreprise et les lie avec la stratégie. SMART comporte quatre niveaux (cf. Figure 3-2) qui sont dédiés à l'efficacité externe axée sur les clients et à l'efficacité interne de l'entreprise axée sur les processus employés.

Au sommet de la pyramide se trouve la vision de l'entreprise qui sert de base à sa stratégie. La direction assigne ensuite un rôle à chaque unité de travail et leur affecte des ressources pour les supporter.

Au deuxième niveau de la pyramide, la stratégie se traduit par des objectifs liés au marché et aux finances. Par ailleurs, les plans sont faits de sorte à atteindre ces objectifs.

Au troisième niveau, des objectifs opérationnels sont traduits en termes de satisfaction des clients, flexibilité et productivité. Ce niveau comble le vide entre les mesures opérationnelles et financières.

Enfin, à la base de la pyramide, les mesures du niveau précédent sont représentées par des critères opérationnels comme la qualité, le délai, la distribution et le coût. Ce sont ces critères de performance qui participent à l'accession des objectifs du sommet de la pyramide et assurent donc la réussite de la mise en place de la stratégie de l'entreprise.

### **3.4.2 Tableau de bord équilibré (Balanced Scorecards)**

Le tableau de bord équilibré (Kaplan et Norton, 1992,1996, 2000, 2004) est un outil de gestion qui regroupe la performance d'une entreprise en quatre perspectives : financière, des clients, des processus internes et de croissance et d'apprentissage (cf. Figure 3-3). De plus, ce tableau repose sur la notion d'équilibre entre ces quatre perspectives et est guidé par la vision stratégique de l'entreprise.

Comme le modèle SMART, l'identification de mesures de performance commence à partir de la vision et de la stratégie qui se déclinent dans ces quatre perspectives. La perspective financière indique de quelle façon les affaires satisfont les attentes des actionnaires. La perspective des clients détermine dans quelle mesure l'entreprise répond aux besoins des clients, alors que la perspective des processus internes évalue l'efficacité des processus pour fournir un service aux clients afin de réaliser un profit. Dans cette perspective, le manager identifie les processus clés afin d'atteindre les objectifs clients et financiers. Enfin, la perspective d'apprentissage organisationnel a pour but de déterminer des objectifs et des mesures de performance correspondants afin de conduire l'apprentissage et la croissance de l'entreprise.

Chaque objectif et indicateur de performance sélectionné dans le tableau de bord est un élément d'une chaîne de relations de cause à effet déterminant l'orientation stratégique de l'entreprise.

### **3.4.3 Prisme de la performance**

Alors que les autres systèmes de mesure de performance se focalisent sur la stratégie de l'entreprise pour obtenir les mesures de performance, le prisme de la performance (Neely et al., 2002) se focalise sur les parties prenantes afin de déterminer des objectifs et mesures de performance. Ce prisme est divisé en cinq facettes qui sont les suivantes (cf. Figure 3-4) :

- 1) La satisfaction des parties prenantes : qui sont les parties prenantes ? Quels sont leur besoins ?
- 2) La stratégie : quelle est la meilleure stratégie répondant aux besoins et souhaits des parties prenantes ?

- 3) Les processus: quels sont les processus à mettre en œuvre afin de réaliser les objectifs ?
- 4) La capacité : quelles sont nos capacités pour exécuter et développer ces processus ?
- 5) La contribution des parties prenantes : que voulons-nous de nos parties prenantes afin de maintenir et développer nos capacités ?

Les auteurs de ce prisme mettent en avant les parties prenantes. Il faut donc d'abord identifier les parties prenantes, leurs attentes et besoins, puis essayer de les réaliser. Pour cela, des stratégies sont développées, ce qui permet de trouver les processus à mettre en place pour les réaliser. Pour cela, il faut définir les capacités nécessaires à l'exécution et à la conception de ces processus. Enfin, l'entreprise doit prendre en compte les contributions de chacune des parties prenantes.

#### **3.4.4 ECOGRAI**

ECOGRAI (Bitton, 1990, Merle, 1993, Doumenings, 1998) est une méthode de conception et d'implantation des systèmes de mesures de performance qui peut évoluer continuellement selon les besoins de l'entreprise (Ducq and Vallespir, 2005). Cette méthode définit d'abord l'ensemble des objectifs pour une entreprise ou partie d'une entreprise. Ensuite, les variables de décision sont déterminées pour chaque objectif, celui-ci constituant ainsi un indicateur de la performance (cf. Figure 3-5).

Cette méthode comprend six phases (cf. Figure 3-6) dont les cinq premières sont dédiées à la conception du système de mesure de performance et la dernière consiste à la mise en place de ce système. De plus, cette méthode utilise les outils (grilles et réseaux) de la méthode GRAI afin de décomposer l'objectif global en objectifs de niveaux inférieurs et identifie les variables de décision et les indicateurs de performance. Un système de mesure de performance qui détermine la performance d'une partie ou de la totalité de l'entreprise par rapport à un objectif global est ainsi obtenu.

En résumé, l'approche ECOGRAI permet de définir un ensemble d'objectifs pour chaque niveau hiérarchique d'une entreprise. Cependant, l'identification de variables de décision ainsi que de l'indicateur de performance est faite au niveau opérationnel.

#### **3.4.5 Modèle des systèmes intégrés de mesure de performance**

IPMS (Bititci et al., 1997) est un modèle de référence des systèmes intégrés de mesure de performance. Ce modèle comprend une méthodologie de révision des systèmes de mesure de performance qui évalue leur robustesse et leur intégrité. Il est utilisé dans le domaine de l'industrie manufacturière. Par ailleurs, ce modèle restructure les dimensions de performance en quatre groupes principaux : entreprise, unité de travail, processus essentiels et processus de soutien (cf. Figure 3-7).

A chaque niveau, le modèle a besoin de :

- 1). Reconnaître et comprendre les attentes et les besoins des parties prenantes.
- 2). Surveiller la position de l'entreprise par rapport à ses concurrents et identifier les besoins du marché.
- 3). Fixer les objectifs basés sur l'implication et l'importance des besoins nécessaires au développement, ainsi que les buts associés à programmer dans le temps.

- 4). Définir, communiquer, surveiller and revoir ces objectifs via une mesure de la performance.

IPMS, contrairement au tableau de bord équilibré, prend en plus en compte toutes les parties prenantes.

### **3.4.6 Integrated Performance Measurement Framework (IPMF)**

IPMF a été développé par Medori and Steeple (2000). La structure de ce cadre se compose de deux documents distincts mais interdépendants : le document A comportant six étapes pour concevoir un système de mesure de performance et le document B contenant une liste de mesures des performances.

Les six étapes du document A comprennent (Figure 3-8) :

- 1) Etape 1: Les facteurs de succès de l'entreprise.
- 2) Etape 2: Une grille des mesures de performance.
- 3) Etape 3: La sélection des mesures de performance.
- 4) Etape 4: La révision (« audit » en anglais) des mesures de performance.
- 5) Etape 5: La mise en œuvre des mesures de performance.
- 6) Etape 6: La maintenance périodique de ces mesures.

Le document B liste des mesures de performances financières et non-financières. Ces mesures sont définies et leur méthode de calcul est donnée.

Les auteurs affirment que ce cadre est utilisé pour atteindre cinq objectifs. Le premier objectif est de faciliter la conception du système de mesure de performance (si une entreprise n'a pas encore de SIP). Le deuxième consiste à réviser le système de mesure de performance (si une entreprise a déjà un système de mesure de performance). Le troisième est de déceler les indicateurs de performance obsolètes. Le quatrième est d'identifier et de sélectionner les indicateurs de performance non-financiers qu'on ne peut pas mesurer. Enfin, le cinquième objectif met en place les indicateurs de performance sélectionnés.

### **3.4.7 Quantitative Model for Performance Measurement System**

QMPMS (Suwignjo et al., 2000) est une méthode qui modélise les relations entre les mesures de performance. Elle est constituée des trois étapes suivantes (Figure 3-9) :

- 1) Identification des facteurs qui affectent la performance.
- 2) Structuration des facteurs de performance identifiés.
- 3) Quantification de ces facteurs de performance.

Pour déterminer les facteurs qui influencent la performance d'un système, le QMPMS se sert d'outil de cartographie cognitive. L'étape de structuration peut se faire à l'aide d'un diagramme de cause à effet. Le diagramme de cause à effet trouve les relations de causalité entre les différents facteurs de performance et les différents niveaux structurels. Enfin, dans la dernière étape l'outil AHP (Analytical Hierarchical Process) est employé pour quantifier les facteurs.

En résumé, QMPMS est une méthode solide pour mesurer la performance d'un système. De plus, elle essaye de simplifier les rapports de performance en diminuant le nombre de mesures de performance en les agrégeant.

### **3.5 Evaluation des systèmes de mesure de performance**

Cette partie a pour objectif de proposer une étude des différents systèmes de mesure de performance qui ont été présentés dans les sections de ce chapitre et de les comparer par rapport aux attributs qui ont été identifiés après avoir fait une revue bibliographique des approches de mesure de performance. Pour rappel, ces attributs sont synthétisés dans le paragraphe (§3.3.1). Le Tableau 3-2 présente une synthèse de cette évaluation.

Cette analyse permet de conclure qu'aucun des systèmes étudiés ne répond à la totalité des attributs souhaités. Les attributs les plus négligés sont : l'ingénierie des risques, l'orientation processus et l'aide à la décision. La section suivante fournit une discussion des principaux cadres pour SIP et explique leurs points forts et leurs points faibles.

### **3.6 Discussion**

Ce chapitre a présenté les principaux cadres de systèmes de mesure de performance, notamment les solutions intégrées. Après ces différentes comparaisons, force est de constater que la plupart des systèmes de mesure de performance sont bien intégrés et prennent en compte la multi dimensionnalité de la performance. Toutefois, le problème d'interaction entre les critères de performance n'est pas abordé. De plus, la volonté de mesurer tous les aspects de performance pose le problème de traiter toutes les informations de mesure de performance. Il est donc impératif de considérer les indicateurs de performance critiques, puis de les agréger de façon à ne pas perdre le sens originel. Cet aspect de la mesure de la performance n'est pas abordé dans les solutions existantes.

En outre, les systèmes de mesure de performance commencent à prendre en compte les parties prenantes (on peut ainsi noter le prisme de la performance). Cependant, ces systèmes ne proposent pas encore de mécanisme évaluant leurs contributions et leurs profits.

Quant à la performance des différents niveaux hiérarchiques de l'entreprise, cet aspect est bien établi dans plusieurs systèmes de mesure de performance comme dans SMART par exemple. Mais un mécanisme de décomposition des objectifs globaux en sous-objectifs est toujours manquant dans la plupart des solutions étudiées. Par ailleurs, l'ingénierie des risques n'est pas encore suffisamment abordée. En outre, le système de mesure de performance est trop rarement lié au système de décision, seuls ECOGRAI et QMPMS proposent cette liaison.

En résumé, après avoir analysé les systèmes de mesure de performance les plus connus, nous pouvons conclure qu'aucun d'entre eux ne propose une méthodologie holistique pour aborder la performance. Ils proposent tous des solutions intéressantes pour résoudre certains des besoins exprimés mais ils souffrent tous de lacunes pour d'autres besoins.

D'autre part, les systèmes de mesure de performance existants sont développés pour une entreprise en particulier. Les changements du mode du fonctionnement de l'entreprise ou du marché comme la collaboration intercontinentale, les réseaux d'entreprises, la chaîne logistique verte ou le problème de viabilité des entreprises ont changé le paysage du domaine de la performance. Face à ces problèmes, les systèmes existants ne sont plus suffisants. Une question se pose alors : comment aborder ces nouveaux défis et se préparer aux suivants. De notre point de vue, la

solution réside dans les approches basées sur les processus, leur valeur et les risques associés.

### **3.7 Mesure de performance basée sur l'activité**

Pour diminuer la complexité des systèmes dans une entreprise, il est nécessaire de passer d'un système basé sur les fonctions à un système basé sur les processus. Ce dernier simplifie la vision de l'entreprise ou d'un réseau d'entreprises en offrant une vue horizontale et non plus verticale et cloisonnée. Par exemple, une entreprise basée sur les processus équivaut à un ensemble d'activités. Ces activités ont un coût et elles créent de la valeur pour les parties prenantes. Mais en même temps, une activité expose l'entreprise à des risques internes et externes. En faisant abstraction des mesures de performance, on se réfère au concept d'activité et on détermine si l'activité ajoute de la valeur ou non. Le travail d'organisation doit éliminer un maximum d'activités qui n'ajoutent que trop peu de valeur ou qui sont exposées à des risques jugés trop importants. Ainsi, déterminer la performance n'est pas plus complexe. Il suffit de décomposer l'objectif global en objectifs plus élémentaires qui sont mesurables et les associer à des activités. En effet, l'activité est elle aussi décomposable : en considérant la relation de causalité entre les différentes mesures de performance et l'activité. Une fois l'activité associée à l'objectif, on agrège les mesures de performance pour prendre une décision.

En outre, le problème de mesure et de gestion de la performance dans les réseaux d'entreprise peut aussi être résolu puisque que les processus traversent les cloisonnements fonctionnels et hiérarchiques des départements au sein d'une ou de plusieurs entreprises. Par ailleurs, les processus sont décomposables et donc, on peut les hiérarchiser. De plus, l'activité est modélisable et simulable. Grâce à plusieurs méthodologies de modélisation de processus, il est possible de modéliser les activités à différents niveaux d'abstraction. Ensuite, à l'aide d'outils du monde de la simulation, la performance d'un processus est évaluable a priori, soit dès la conception du système, en plus de l'être a posteriori, soit lors du pilotage.

Pour conclure, la mesure et la gestion de la performance basées sur les activités des processus présentent plusieurs avantages : simplification de la structure des indicateurs de performance et des problèmes qui lui sont associés à l'intérieur comme à l'extérieur de l'entreprise. Comme les activités créent de la valeur, une fois identifiées, on peut s'en servir dans les techniques de modélisation et simulation pour évaluer la performance avant d'investir ou de prendre une décision quant au processus piloté.

### **3.8 Conclusion**

Ce chapitre a présenté les systèmes de mesure de performance les plus connus. Cette étude a mis en exergue que ces systèmes ne sont pas capables de mesurer la performance d'un système de façon holistique. Ils doivent donc faire face à plusieurs problèmes liés à la gestion des risques, la performance inter-organisationnelle, la gestion de plusieurs mesures de performance, leur intégration et leurs interactions.

Ce chapitre conclut cette étude en offrant une mesure et une gestion de performance basées sur les activités des processus. Les problèmes et nouveaux défis évoqués par la littérature peuvent être résolus dans une certaine mesure si l'approche par activités est utilisée.

Ainsi, sans avoir à gérer différentes mesures de performance, il est judicieux de les agréger et de les présenter sous la forme d'un indicateur global mixte valeur-risque. Cet indicateur de performance basé sur le couple valeur-risque est l'essence de ce travail de recherche. Le chapitre suivant a pour objectif de le détailler.





## **Chapter 4 Mesure et Gestion de Performance : Outils et Techniques**

Le chapitre précédent s'est focalisé sur l'étude et l'analyse des systèmes de mesure de performance les plus couramment employés. Après avoir montré leurs limites et l'intérêt de baser un système de mesure de performance orienté processus considérant le couple valeur-risque, il est nécessaire de spécifier, tout d'abord, les exigences détaillées et de trouver ensuite des outils et techniques pour aborder ces exigences. A cet effet, ce chapitre a pour but de synthétiser des outils et techniques nécessaires pour aborder les exigences identifiées et choisir ceux qui peuvent satisfaire les exigences facilement et effectivement.

### **4.1 Détails des besoins et exigences**

En faisant la critique des systèmes de mesure existants et à la lumière des problèmes contemporains auxquels ont à faire face les entreprises, une liste de six exigences a été établie. Le système de gestion de performance doit :

- *être basé sur le concept de la valeur,*
- *être basé sur les processus et leurs activités et non plus sur les fonctions,*
- *gérer le risque en plus de mesurer la performance,*
- *avoir un mécanisme qui consolide ou agrège des indicateurs de performance et doit pouvoir déterminer l'interaction entre ces indicateurs de performance,*
- *comporter un système de décision,*
- *être précis et peut être mis en œuvre facilement.*

Pour répondre à ces exigences, les sections suivantes de ce mémoire proposent un ensemble d'outils et de techniques compatibles.

### **4.2 Gestion de performance par l'approche de la Valeur**

La valeur est ce qui nous intéresse et qui doit être la force motrice des actions qui se déroulent et doit déterminer les décisions prises. Dans le contexte de la prise de décision, les valeurs sont des mesures utilisées pour évaluer la conséquence actuelle ou potentielle d'une action ou d'une décision d'un processus actuel ou d'une de ses alternatives (Keeney, 1996). Ainsi, avant de développer un système de mesure de performance basé sur le concept de la valeur, il est nécessaire de définir de manière explicite ce concept.

#### **4.2.1 Concept de Valeur**

La valeur est polysémique : la signification de cette notion est donc fortement déterminée par le contexte comme le dit Bourguignons (2005). Ce caractère contextuel est illustré par le fait que plusieurs définitions sont proposées dans la littérature. D'après Martinez (2003), « La valeur réside dans la satisfaction et réalisation des atteintes des objectifs, en même temps génère la richesse pour l'organisation ». Cependant, cette définition de la valeur est limitée au client et à l'organisation et ignore la multiplicité des parties prenantes.

La norme AFNOR X-50-150 (AFNOR 1991) définit la valeur d'un produit ou d'un service comme étant un « *jugement porté sur le produit par l'utilisateur sur la base de ses attentes ou de ses motivations. Plus spécialement, [la valeur est une] grandeur qui croît lorsque la satisfaction de l'utilisateur augmente ou que la dépense afférente au produit diminue* ». Cette définition formalise le triptyque « client-produit-entreprise » (Ahmed and Yannou, 2003). L'entreprise matérialise la valeur dans un *produit* ou *service* afin de *satisfaire le client en consommant les ressources*. Cette perspective est largement reconnue dans l'analyse de la valeur (ou l'ingénierie de la valeur). Néanmoins, Yannou (1999) explique que cette définition de la valeur est très générique et ne propose pas de guide pour l'évaluer. Pour combler cette déficience, Yannou lie la valeur aux fonctions (techniques et de service) du produit (Cf. Equation 4-2).

Dans le contexte des sciences de la gestion, la valeur est extension de l'analyse de la valeur mais ajoute à la définition de la valeur une notion d'objectif et de jugement de la valeur (Neap and Celik, 1999). Dans cette thèse, nous retiendrons le point de vue du management par rapport à la valeur parce qu'il comprend l'approche *soft thinking* de la valeur : jugement de la valeur et objectif subjectif.

En outre, la littérature se focalise notamment sur la définition de la valeur mais explique rarement comment celle-ci est créée et pour qui. La réponse à la première question n'est pas facile : cela dépend des facteurs externes et internes. Pour simplifier, la valeur est créée par des activités et leur coordination mais elle ne peut être évaluée qu'au regard des objectifs. Pour répondre à la seconde question, Chazelet et Lhote (2001) préconisent de créer de la valeur pour toutes les parties prenantes. Cependant, toutes les parties prenantes ne peuvent pas être considérées au même niveau (Chazelet and Lhote, 2001; Garengo *et al.*, 2005). C'est donc à l'entreprise de décider de l'importance des différentes parties prenantes.

#### **4.2.1.1 Quantification de la valeur par la modélisation des objectifs**

La valeur est rendue explicite pour les parties prenantes via la satisfaction des objectifs attendus : il est donc nécessaire de les identifier clairement. Pour cela, un modèle des objectifs va permettre de les identifier et de les formaliser dans un processus métier. Cependant, les méthodologies de modélisation des processus ne prennent pas explicitement en compte la modélisation des objectifs. En revanche, les méthodologies pour formaliser des objectifs dans le domaine de la prise de décision sont cohérentes et bien structurées.

De notre point de vue, les méthodologies dans ces deux domaines ont pour but d'évaluer la valeur d'un système ou d'un processus étudié. Les méthodologies de modélisation de processus approchent la valeur en modélisant l'activité alors que les méthodologies dans le domaine de la prise de décision l'approchent en modélisant des objectifs. Un mariage de ces deux domaines paraît donc utile pour évaluer la valeur d'un processus afin de fournir une solution intégrée en termes de performance. Dans les sections suivantes, nous détaillons une approche pour modéliser les objectifs.

#### **4.2.1.2 Modélisation des objectifs : outils et techniques**

Dans le cadre de cette thèse, les travaux de Keeney (1996) sont considérés comme une référence de la modélisation des objectifs. Il propose une approche appelée « *value focused thinking* » qui s'inscrit dans le domaine de l'aide à la prise de décision. Dans ce cadre, un objectif est défini par Keeney (1994) comme étant un

état vers lequel on souhaite tendre. Keeney catégorise ainsi les objectifs en deux ensembles : les objectifs de finalité et les objectifs de moyen. Les premiers représentent la raison essentielle dans un contexte de décision alors que la seconde fait référence aux “actions pour achever la finalité”.

#### **4.2.1.2.I Identification des objectifs**

L'identification des objectifs est l'étape principale permettant d'évaluer la valeur. Pour cela, Keeney propose d'identifier tout d'abord l'objectif global qui caractérise la raison qui nécessite la prise de décision (Keeney, 1996, p. 77). D'après l'auteur, l'objectif global est facile à identifier comparé aux objectifs de finalité et de moyen. Pour faciliter l'identification des objectifs de finalité et de moyen, il propose d'utiliser divers outils et techniques (cf. Tableau 4-1).

Lorsqu'on détermine l'objectif global, on le décompose en sous-objectifs ou en objectifs d'un niveau plus bas appelés objectifs de finalité. La décomposition de ces objectifs se fait en se posant la simple question : « que signifie cet objectif ? ». Cette détermination des objectifs de finalité peut continuer ainsi jusqu'à ce qu'ils ne soient plus décomposables. De plus, ces objectifs d'un niveau plus bas représentent des facettes ou dimensions d'un objectif duquel ils dérivent.

Contrairement aux objectifs de finalité, l'objectif de moyen, qui ne représente pas une fin en soi mais un moyen d'atteindre un objectif de finalité (Keeney, 1994), est déterminé à partir d'un objectif de finalité de plus bas niveau et en posant la question : « comment peut-on l'atteindre ? ». La réponse à cette question permet de trouver les objectifs de moyen.

#### **4.2.1.3 Structuration des objectifs**

Les objectifs de finalité sont structurés dans un arbre (Keeney, 1996). Les objectifs de plus haut niveau font référence à des objectifs très généraux. Alors que les objectifs de niveau bas caractérisent des objectifs de niveau plus fin. En outre, il existe un lien de cause à effet entre l'objectif de finalité et de moyen alors que la relation entre des niveaux attenants à des objectifs de finalité est abstraite (Keeney, 1996). Par ailleurs, l'objectif de moyen peut être lié à un ou plusieurs objectifs de finalité. Pour structurer des objectifs de finalité et de moyen, Clemen and Reilly (2000) font une synthèse des techniques sous forme de questions indiquées dans le Tableau 4-2. Ces techniques permettent d'organiser respectivement les objectifs de finalité et de moyen en arbre et en réseau.

#### **4.2.1.4 Identification des mesures de performance**

La génération des mesures de performance est essentielle pour évaluer l'intérêt des différents processus de l'entreprise. Dans le cadre de l'approche par la valeur, les mesures de performance peuvent être dérivées à partir des objectifs de finalité de plus bas niveau. En effet, les objectifs de finalité aux niveaux les plus opérationnels sont mesurables et quantifiables. Les mesures de performance identifiées sont ensuite organisées sous forme arborescente.

Pour conclure cette description de la modélisation des objectifs, le cadre de l'approche par la valeur a le mérite d'être une approche claire et systématique pour identifier et structurer des objectifs. Elle est de ce fait la candidate la plus intéressante pour réaliser la modélisation des objectifs dans ces travaux de thèse.

### **4.3 Système de gestion de performance orientés processus : Outils et techniques de modélisation**

Hammer (1997) propose l'idée d'une organisation orientée sur ses processus qu'il préconise pour minimiser les activités à faible valeur ajoutée ainsi que pour faciliter l'expansion d'un système. De cette organisation, est apparu le concept de gestion et de mesure orientées processus étudié par plusieurs auteurs (Acar et al., 2010; Beamon, 1999; Chan and Qi, 2003; Folan and Browne, 2005; Meyer, 2003, Kueng, 2000). Grâce à cette nouvelle approche, l'ingénierie des processus peut résoudre la complexité des silos fonctionnels dans une entreprise et permet également de focaliser l'attention sur l'activité (Bandara et al., 2005). A cet effet, la méthodologie de modélisation des processus est employée pour l'évaluation éventuelle des processus (Vernadat, 1996; Indulska et al. 2009).

#### **4.3.1 Langage de modélisation des processus métier : Présentation**

La littérature propose un important panel de langages de modélisation de processus. Ces langages modélisent un ou plusieurs aspects, comme les aspects fonctionnels, comportementaux, organisationnels et informationnels (Curtis et al. 1992; Vernadat, 1996). Dans le contexte de la gestion de la performance, ces aspects sont nécessaires pour évaluer la performance du processus.

Dans le cadre de ces travaux de recherche, plusieurs langages de modélisation comme CIMOSA, IDEF3, ARIS EPC, BPMN et les réseaux de Pétri ont été retenus afin de les évaluer et de pouvoir sélectionner celui qui est compréhensible et permet de modéliser facilement un processus métier pour gérer la performance d'une organisation orientée processus. Les sections suivantes présentent brièvement les avantages et les inconvénients de chaque méthode.

**CIMOSA :** Cette méthode (cf. Figure 4-3) repose sur un cadre d'architecture pour la modélisation et l'intégration d'une entreprise (ESPRIT Consortium AMICE, 1991; Vernadat, 1996). Le cadre (appelé le Cube CIMOSA) définit quatre vues différentes : la vue fonctionnelle, informationnelle, ressource et organisationnelle. La vue fonctionnelle permet de gérer le modèle de processus car elle permet de réaliser la décomposition de ces derniers en différents modules tels que Domaines (DM), Processus Domaine (DP), Processus Métier (BP), Activité d'Entreprise (EA).

Pour évaluer la performance d'un processus métier avec CIMOSA, la simulation s'effectue au niveau de la spécification de la conception du cube CIMOSA. Cependant, CIMOSA n'est pas capable de prendre en compte les concepts de plus bas niveau comme les files d'attente, les unités de production ou les ressources (Galland et al., 2003). Cette approche étant limitée, la simulation peut être faite en utilisant les réseaux de Petri (Ryan and Heavey, 2006). De plus, elle ne prend pas en compte la gestion des risques dans les processus.

**IDEF3:** IDEF3 est une méthode descriptive permettant de modéliser le comportement des processus (Mayer et al. 1993). Elle modélise les processus en utilisant le concept d'unité de comportement (UDC). Les UDC sont connectées par des boîtes de jonction et des liens. L'unité de comportement modélise l'aspect fonctionnel d'un processus, alors qu'une boîte de jonction (*ET, OU, OU Exclusif*) représente les différents connecteurs de flux comme, par exemple, les situations de séquençement, de parallélisme ou de synchronisation des activités.

La Figure 4-5 montre que la méthode est bien adaptée pour capturer les aspects fonctionnels et comportementaux d'un processus. Cependant, elle n'arrive pas à gérer l'aspect organisationnel. Un avantage notable de cette approche est qu'elle reste accessible et compréhensible et peut donc être communiquée facilement - même à des personnes qui ne sont pas des experts dans le domaine de la modélisation de processus. Néanmoins, on peut reprocher à IDEF3 son incapacité à représenter les risques et les objectifs. Elle peut cependant être étendue à cet effet.

**Event-driven Process Chains (EPC) :** EPC est une méthode de modélisation de processus s'inscrivant dans le cadre de l'architecture ARIS (Scheer, 1992). Un diagramme EPC comprend principalement des fonctions, des événements et des connecteurs logiques (les mêmes que ceux proposés par IDEF3) (cf. Tableau 4-4). L'extension de cette méthode propose également de pouvoir représenter les livrables, les unités organisationnelles et leurs rôles.

L'EPC (comme l'illustre la Figure 4-6) permet de modéliser l'enchaînement des activités associées aux tâches dans le système d'événements discrets. Cependant, ce langage ne permet pas de modéliser un changement d'état ou le contrôle de systèmes discrets (Ryan and Heavey, 2006). De plus, il ne peut modéliser ni les risques, ni les objectifs d'un processus.

**Business Process Modeling Notation (BPMN) :** BPMN est un langage graphique récemment développé par (OMG, 2009) permettant de capturer les processus métier. L'objectif principal de ce langage de modélisation est de fournir une notation facile à comprendre de tous les utilisateurs. Les quatre éléments de base de sa représentation graphique sont : les nœuds de graphe, les objets de flux, les conteneurs (swimlanes) et les artefacts (cf. Tableau 4-5). Les points forts de BPMN sont : un vocabulaire visuel riche et adapté aux besoins de conception de processus complexes, une représentation des acteurs des processus en utilisant des pistes et des corridors et un lien fort avec le format d'échange BPEL. Cependant, la richesse de son vocabulaire la complique. Par ailleurs, ni les objectifs ni les risques ne peuvent être explicitement modélisés dans BPMN, qui reste un langage du domaine de l'IT.

**Réseaux de Petri (RdP):** Ce type de réseaux forme un langage mathématique permettant de spécifier à la fois formellement et de manière abstraite un système à événements discrets (Petri, 1962 ; Murata, 1989). Les RdP sont très souvent utilisés dans le domaine industriel où ils servent principalement à traiter les problèmes de synchronisation d'activités. Les notions graphiques sont : les *places*, les *arcs* et les *transitions* (cf. Figure 4-8). Les places correspondent aux états des activités des processus modélisés, les arcs représentent les flux de contrôle et d'informations et l'évolution des processus, alors que les transitions représentent les conditions qui doivent être vérifiées pour passer d'un état à un autre des processus.

Parmi les points forts des réseaux de Petri, nous pouvons citer : leur rigueur et le fait qu'ils supportent facilement la simulation des processus dans un système à événements discrets (Tuncel and Alpan, 2010). Cependant, concevoir un réseau de Petri est relativement compliqué d'autant plus que les modèles obtenus deviennent rapidement complexes. Une autre limite de ce type de modèle est qu'il est difficile de déchiffrer un réseau de Pétri pour un non-expert, ce qui limite son utilisation en tant qu'élément d'échange et de communication avec des tiers. Tout comme les autres langages précédemment étudiés, les réseaux de Pétri ne permettent pas de modéliser directement les objectifs et les risques d'un processus. Cette limite peut être résolue

en ayant recours à certaines extensions comme l'indique la littérature (Tuncel and Alpan, 2010).

### **4.3.2 Evaluation des langages de modélisation de processus**

Ce paragraphe a pour objectif de comparer les différents langages de modélisation de processus décrits dans les sections précédentes, en considérant les concepts nécessaires à l'évaluation de la performance d'un processus. La synthèse de cette évaluation est consignée dans la Tableau 4-6.

Cette vue d'ensemble montre que toutes les méthodes sont capables de contribuer à l'ingénierie du risque mais qu'aucune ne possède un composant permettant de le représenter clairement. De même, les objectifs ne peuvent pas être représentés ou modélisés explicitement dans la plupart de ces langages de modélisation. Parmi l'ensemble de ces solutions, c'est la méthode IDEF3 qui est retenue comme le langage de modélisation de processus parce qu'il est : simple, facilement compréhensible de tous et bien connu et maîtrisé du monde industriel.

## **4.4 L'ingénierie basée sur le risque et l'ingénierie du risque basée sur les processus**

La raison d'être d'un processus métier est de créer de la valeur pour les parties prenantes concernées. Néanmoins, des événements incertains peuvent avoir lieu et affecter ce processus, ayant par conséquent des impacts sur l'atteinte des objectifs. Une dégradation de la valeur du processus est ainsi notée. De plus, la création de valeur d'un processus et le risque qui lui est associé sont fortement liés à la performance du processus. Pourtant, ce lien n'a pas encore été établi. C'est pourquoi, ces travaux de thèse s'efforcent de lier ces deux concepts. A cet effet, plusieurs techniques, utilisées largement dans l'ingénierie de risque sont analysées. Avant d'effectuer cette analyse, le concept du risque ainsi que les processus de l'ingénierie du risque sont plus précisément détaillés dans les sections suivantes.

### **4.4.1 Le concept de risque**

A l'instar de la performance et de sa mesure, il n'existe pas de définition unique du concept de risque. Sienou (2009) confirme cela en insistant sur le caractère polysémique du mot « risque ». Toutefois, il est intéressant de constater que toutes les définitions ont en commun les éléments suivants : l'évènement, l'incertitude et les conséquences (Aven, 2010). Aven formalise donc ces trois éléments sous la forme d'une fonction mathématique  $R = (E, C, P)$ , où  $E$  représente l'évènement,  $C$  la conséquence et  $P$  la probabilité d'occurrence de  $E$ . Ces trois éléments sont considérés par l'auteur comme suffisants pour caractériser le risque.

Par ailleurs, le concept de risque comme celui de performance est un terme utilisé largement et librement dans la littérature. Il est pourtant quantifiable et mesurable en utilisant les outils synthétisés dans la littérature (ISO/IEC 31010:2009). Dans le cadre de cette thèse, c'est la définition ISO (ISO Guide 73 : 2009) qui est retenue. Selon elle, le risque est décrit comme étant « *l'effet d'une incertitude sur des objectifs* ». Pour évaluer les différentes techniques de risque, nous allons d'abord définir le processus de management du risque.

## 4.4.2 Le processus de gestion des risques

Le processus de gestion des risques est l'application systématique de politiques, procédures et pratiques de gestion appliquées aux activités de : communication, de concertation, d'établissement du contexte, ainsi qu'aux activités d'identification, d'analyse, d'évaluation, de traitement, de surveillance et de revue des risques (ISO Guide 73 : 2009). La norme ISO divise les processus de gestion des risques en sept étapes (comme l'illustre la Figure 4-9) :

- l'établissement du contexte,
- l'identification du risque,
- l'analyse du risque,
- l'évaluation,
- le traitement,
- la communication
- et la concertation et enfin la surveillance et la revue.

La première partie du processus de gestion des risques a déjà été traitée dans la partie modélisation des processus. Les autres étapes sont décrites plus en détails dans les sections suivantes.

### 4.4.2.1 Appréciation du Risque

Les étapes 2, 3 et 4 du processus décrit précédemment, respectivement : l'identification du risque, l'analyse et l'évaluation du risque constituent l'appréciation du risque qui permet de prendre une décision dans le contexte d'ingénierie des risques.

**L'identification du risque :** D'après la norme ISO 31000:2009, cette étape consiste à identifier les facteurs de risque, les événements les déclenchant, leurs causes ainsi que leurs conséquences potentielles.

Pour faciliter l'identification des risques, il est conseillé de les catégoriser (cf. Tableau 4-7) soit sur la base de leur nature, soit sur la base de leur activité (c'est-à-dire externe ou interne à l'activité) (Salah, 2005). De plus, l'approche par les objectifs peut être utilisée pour identifier et classer les risques (Moeller, 2007).

Par ailleurs, l'approche basée sur l'expérience et le brainstorming peut également être employée pour identifier des risques (Royer, 2000). Ces deux approches sont secondées par des outils et techniques afin de les identifier de façon efficace.

**L'analyse du risque:** Il s'agit de déterminer la nature et le niveau du risque (ISO 31000 : 2009). En outre, l'analyse du risque fournit une image des causes et conséquences et a pour but de décrire le risque soit qualitativement, soit quantitativement (Aven, 2008).

Dans l'analyse qualitative du risque, le gestionnaire du risque détermine la description de la probabilité (comme par exemple : certain, probable, improbable) et l'impact (comme par exemple : insignifiant, significatif, modéré) de chaque risque identifié (Vose, 2008). Le niveau du risque est ensuite déterminé qualitativement avec des termes tels que : fort, faible, moyen (comme l'illustre la Tableau 4-8).

Dans l'analyse quantitative du risque, le modèle du risque est structuré afin de modéliser la variabilité des paramètres du risque sous forme d'une loi de probabilité. Cependant, au lieu d'exprimer la loi entièrement, il est commun d'utiliser une



mesure de tendance centrale, c'est-à-dire l'espérance avec la variation comme l'écart-type ou le quartile (Aven, 2008, p. 24).

**L'évaluation du risque :** Cette étape propose de comparer le résultat de l'analyse des risques avec des critères afin de déterminer si le risque considéré est acceptable / tolérable (ISO 31000: 2009). A cet effet, on emploie des objectifs, critères ou exigences (Aven, 2008, p. 149). Ce processus peut être divisé en trois grandes phases : sélectionner les critères, comparer les risques et classer les risques.

Après avoir identifié et apprécié tous les risques, la prochaine étape consiste à développer des stratégies et des mesures pour gérer ces risques. Les stratégies principales de la gestion des risques sont les suivantes : le refus du risque, son atténuation, son partage ou la prise de risque (USCG, 2001). En revanche, les mesures de risque se réfèrent à de nombreuses méthodes, approches et techniques employées pour gérer du risque au niveau opérationnel ou tactique (Zsidisin and Ritchie, 2008).

Afin de guider le processus d'ingénierie du risque, de nombreux outils et techniques ont été développés. Les sections suivantes décrivent certains de ceux-ci.

#### **4.4.2.2 Techniques pour évaluer les risques**

Cette partie présente les techniques les plus couramment utilisées dans l'ingénierie du risque. Toutes ces techniques ont des points forts et faibles et sont utilisées dans différents domaines. Dans les sections suivantes, ces techniques seront détaillées.

**Analyse des modes de défaillance, de leurs effets et de leur criticité :** L'AMDEC est un outil permettant d'identifier et d'évaluer les effets et la défaillance potentielle d'un produit ou d'un procédé (Teoh and Case, 2004). Tous les éléments du risque sont organisés en colonnes dans un formulaire comme l'illustre la Tableau 4-9. De plus, L'AMDEC a été adoptée par l'organisme de standardisation ISO comme un outil d'analyse du risque.

En outre, l'AMDEC traditionnel est effectué en faisant un brainstorming (Teoh and Case, 2005) au cours duquel les informations par rapport aux risques sont obtenues et enregistrées dans le formulaire de l'AMDEC. Toutefois, cette technique présente quelques inconvénients : par exemple, des informations récoltées par l'AMDEC traditionnel d'un procédé, d'un processus ou d'un produit sont difficilement réutilisables. Cette difficulté a récemment été résolue grâce à son automatisation proposée par Teoh and Case (2004).

On peut remarquer que l'AMDEC ne fait que proposer un bilan systématique des défaillances importantes dans un système ou processus, qu'il faut analyser quantitativement plus tard. En outre, il oblige le gestionnaire de risque à identifier les composants critiques d'un système et joue ainsi un rôle important dans la fiabilité du système (Aven, 2008; Chen, 2007). Cependant, l'AMDEC n'est pas très utile pour des systèmes ou processus où un composant individuel ou une activité unique ne déclenche pas de défaillance du système.

**Analyse par Arbre de Pannes :** L'arbre de pannes ou l'arbre de défaillances est une technique déductive appliquée largement pour identifier et analyser des facteurs qui peuvent contribuer à un événement indésirable appelé événement sommet (ISO: IEC 31010, 2009). Les facteurs de causalité sont identifiés par déduction, organisés de manière logique et représentés graphiquement dans un diagramme sous forme d'arbre employant des liens logiques (Contini and Matuzas, 2011). L'objectif est de

descendre progressivement jusqu'aux causes finales initiatrices d'un événement sommet, c'est-à-dire jusqu'aux causes élémentaires.

Les éléments constitutifs d'un arbre de défaillances sont : les événements indésirables, les événements de base et les connecteurs logiques (comme le détaille le Tableau 4-10). De plus, l'arbre de défaillances peut être utilisé pour l'analyse à la fois des risques qualitatifs et quantitatifs.

On peut remarquer que l'arbre de défaillances est utilisé pour mesurer « le risque global » dans un système ainsi que les facteurs de risque. La technique est simple à comprendre et à utiliser. De plus, elle oblige le gestionnaire de risque à comprendre le système et donne donc une idée du système étudié (Rahmat and Jovanovic, 2009). Cependant, l'arbre de défaillances est plutôt difficile d'emploi lors de l'étude d'un système ayant plusieurs événements, niveaux et connecteurs logiques (Amornsawadwatana, 2003). Par ailleurs, elle donne une image statique du risque, cette technique est donc inutile pour un système ayant des caractéristiques dynamiques.

**Analyse par Arbre d'Évènements :** L'analyse par arbre d'évènements est une technique graphique permettant de représenter des séquences d'évènements mutuellement exclusifs suivant un événement initiateur en fonction du fonctionnement du système (IEC/ISO 2009:31010). Elle est souvent couplée avec la méthode du nœud papillon pour étudier les conséquences d'un événement initiateur (Markowski and Kotynia, 2011). Cette technique peut être utilisée qualitativement et quantitativement. Dans le premier cas, elle détermine les conséquences d'un événement initiateur possible et donne ainsi l'image d'un scénario possible. Dans le cas quantitatif, elle estime la probabilité d'un événement de sortie (Mokhtari et al., 2011).

En quelques mots, l'analyse par les arbres d'évènements permet une représentation graphique des défaillances possibles, identifiées et quantifiées à la suite d'un événement initiateur. De plus, c'est une technique qui prend en compte la temporalité, le séquençage des événements et leurs effets domino (Cozzani et al. 2005). Cependant, cette représentation ne propose pas de mécanisme permettant d'identifier les événements initiateurs potentiels, car elle se base sur l'hypothèse que tous les événements sont déjà listés.

**Simulation de Monte Carlo :** Monte Carlo est une technique statistique qui permet d'estimer les incertitudes dans un processus ou système, dans une configuration particulièrement complexe où les techniques analytiques ne peuvent plus s'appliquer (Mun, 2006; Vose, 2008).

Le modèle de simulation Monte Carlo est capable de manier l'aspect temporel avec facilité comparé à d'autres techniques analytiques où l'aspect du temps est rarement abordé. De plus, ce modèle demande un certain nombre de données d'entrée mais la sortie de ce modèle est riche en informations.

L'inconvénient principal de cette simulation reste le temps de calcul et les efforts requis pour développer et exécuter la simulation. En outre, il est difficile de vérifier si le résultat fourni par l'algorithme est fiable (Wang and Roush, 2000).

**Approche d'analyse du risque de Larson and Kusiak:** Ce modèle d'analyse du risque est développé par Larson et Kusiak (1996) pour analyser la fiabilité d'un processus modélisé préalablement en IDEF3. Le langage de représentation a été

modifié afin de pouvoir prendre en compte la partie traitement des risques ainsi que les mécanismes de prise de décision.

Ainsi, les différents chemins qui peuvent être parcourus dans un modèle IDEF3 sont utilisés pour identifier les différents scénarii opérationnels d'un processus. Un chemin potentiel, noté  $p_k (k = 1, \dots, K)$ , dans un modèle IDEF3 est composé d'un ensemble d'unités de comportement allant d'une source jusqu'à un puits du processus et reliées par des connecteurs logiques. De plus, la probabilité d'un scénario est déterminée à partir des probabilités de divergence de chaque jonction composant le chemin correspondant. L'échec d'un processus peut alors provenir d'une ou plusieurs activités de ces chemins. Les facteurs de risque sont alors identifiés et agrégés pour chaque activité de chaque chemin du modèle IDEF3. La somme de tous les risques du chemin incriminé constitue le risque global.

D'après ce modèle, le risque dans un projet ou un processus  $R$  déclenché par les événements d'un scénario  $S$  de probabilité d'occurrence  $P$  et avec un impact ou conséquence noté  $C$  peut être formulé par :  $R = \{S, P, C\}$ . Pour calculer le risque global d'un projet ou d'un processus, le modèle mathématique montré par l'équation 4-7 est employé.

Contrairement aux techniques traditionnelles de management du risque, la méthodologie proposée par Larson et Kusiak pour évaluer le risque est une approche nouvelle car elle s'appuie sur les activités du processus pour l'évaluer. De plus, elle oblige l'évaluateur à modéliser le processus avant d'évaluer le risque et prépare donc ce dernier au développement du contexte. En outre, le même modèle peut aussi être utilisé pour évaluer la valeur du processus.

L'inconvénient principal de cette méthodologie est le fait qu'une préparation approfondie est nécessaire avant de pouvoir évaluer les risques. Pour cela, toutes les activités doivent être connues d'avance et doivent être modélisées. De plus, cette méthodologie n'a aucun mécanisme intégré pour identifier les risques.

#### 4.4.2.2.1 Comparaisons des techniques d'appréciation du risque

La Tableau 4-11 synthétise les évaluations des différentes techniques de gestion des risques afin de les classer pour choisir la plus adaptée aux besoins de cette étude. Après avoir critiqué les techniques pour l'ingénierie du risque, c'est l'approche de Larson et Kusiak qui est retenue car c'est le seul modèle orienté activités et donc compatible avec les besoins de ces travaux. Puisque le modèle du risque en question ne permet ni d'identifier ni d'évaluer le risque qualitativement, il est nécessaire de le compléter par l'analyse des modes de défaillance (AMDEC) qui a été présentée dans la section 4.4.2.2 .

La section suivante se propose de détailler l'approche ainsi retenue afin d'en montrer le fonctionnement et le mode de calcul des deux éléments essentiels que sont l'évaluation du risque et de sa probabilité d'occurrence.

#### 4.4.2.3 Modèle de gestion du risque selon Larson and Kusiak

Dans cette partie, le modèle proposé par Larson and Kusiak (1996) est détaillé. Ce modèle caractérise le risque selon la formule :  $\hat{R} = \{\hat{S}, \hat{P}, \hat{C}\}$  de Kaplan and Garrick (1981). Selon ce formalisme, la quantification du risque exige deux paramètres : la vraisemblance d'un événement ou la probabilité du risque et l'impact de cet événement sur un ou plusieurs objectifs du processus.

#### 4.4.2.3.I Les scenarii

Tout d'abord, le modèle du risque définit plusieurs chemins  $p_k$  ( $k = 1, \dots, K$ ) pour un modèle de processus, comme le montre la Figure 4-12. Un chemin représente une alternative du processus qui commence à partir de l'unité de comportement UDC1 et finit à UDC10. Le nombre de chemins  $p_k$  dans un processus dépend des boîtes de jonction sortantes qui leur sont associées. Pour le processus illustré par la Figure 4-12, les différents chemins possibles sont précisés dans la Tableau 4-12.

#### 4.4.2.3.II Calculer la probabilité d'un scenario

La probabilité d'un scenario est conditionnée par l'occurrence du chemin  $p_k$ . La vraisemblance qu'un chemin du processus soit pris et qu'il conduise à une défaillance dans le processus peut se calculer en utilisant l'équation 4.9 :

#### 4.4.2.3.III Calcul de la probabilité $Pr(p_k)$

La probabilité de prendre un chemin  $p_k$ , notée  $P_r(p_k)$ , est calculée en utilisant la probabilité d'occurrence d'une boîte de jonction sortante de l'unité de comportement  $i$  ( $P_i$ ) (Larson and Kusiak, 1996b). Pour le modèle (voir Figure 4-12), la probabilité d'occurrence UDC  $i$  ( $P_i$ ) à la boîte de jonction sortante est récapitulée (cf. Table 4-13).

Les probabilités d'occurrence des différents flux sortants des boîtes de jonction ne sont pas calculées de la même façon. La probabilité d'occurrence de la boîte de jonction ET est égale à 1 parce que toutes les unités de comportement après cette jonction doivent être activées. Concernant la boîte de jonction OU Exclusif, la somme de toutes les probabilités d'occurrence des unités de comportement en sortie de la jonction est également égale à un 1 et un seul chemin peut être pris. Cependant, selon Larson and Kusiak (1996b) lorsqu'une boîte de jonction OU est rencontrée, la probabilité ( $P_i$ ) n'est pas conditionnée et est donc calculée différemment. Si le nombre d'unités de comportement ( $N$ ) se connectant à cette jonction est supérieur à 2, il aura  $2^N - 1$  combinaisons d'unités de comportement. Soit  $C_j$  l'ensemble des unités de comportement liées à la jonction  $j$  et soit  $M$  le nombre total de combinaisons possibles. Ainsi, la probabilité d'effectuer une unité de comportement dans une combinaison  $j$ , notée  $P_r(C_j)$ , est calculée par la formule de Bayes (Voir Equation 4.11).

#### 4.4.2.3.IV Probabilité d'un échec dans un chemin $p_k$ ( $\Psi(p_k)$ )

La probabilité de défaillance d'un chemin  $p_k$  ( $\Psi(p_k)$ ) est supposée être une mesure agrégée (Larson and Kusiak, 1996). Initialement, la probabilité de succès d'une unité de comportement ( $R_i$ ) est estimée. Puis la probabilité d'un défaut dans un chemin  $p_k$  ( $\Psi(p_k)$ ) est calculée en soustrayant  $R_i$  de 1 (cf. Equation 4-13).

La probabilité de succès de la  $i^{\text{ème}}$  unité de comportement, notée  $R_i$ , du modèle d'IDEF3 est présentée dans la Tableau (voir Table 4-13). De même, les probabilités qu'un processus complet échoue ( $\psi(p_k)$ ) sont calculées pour l'ensemble des autres chemins  $p_k$ . La vraisemblance qu'un chemin échoue, notée  $P$ , est donc calculée en multipliant la probabilité d'emprunter un chemin  $P_k(P_r(p_k))$  par la probabilité d'échec du chemin considéré  $P_k(\Psi(p_k))$  comme indiqué dans la Table 4-14.

#### 4.4.2.3.V Calculer la conséquence d'une défaillance dans un scenario

La conséquence (ou l'impact) de la défaillance d'un chemin est contextuelle et dépend du projet ou du processus étudié. Cela peut se traduire en termes de délai qui peut causer une pénalité financière ou perdre un contrat, ainsi que des clients.

#### 4.4.2.3.VI Le modèle de mesure des risques

Après avoir identifié la vraisemblance d'un scénario et les conséquences de ses défaillances, les risques d'un processus sont ensuite calculés à partir de l'équation (cf. Equation 4.14).

### 4.4.3 Priorisation de mesures de performance et leur agrégation : outils et techniques

Après avoir identifié les outils et techniques permettant d'analyser et d'évaluer les processus en employant des approches de modélisation et de simulation, l'étape suivante consiste à déterminer une technique permettant de classer les mesures de performances puis de les agréger.

Ces mesures obtenues par un modèle des objectifs sont hétérogènes et le plus souvent contradictoires. Elles sont donc difficiles à agréger en une seule dimension. En outre, en plus de cette hétérogénéité et de la nature contradictoire des mesures de performances dans le contexte de gestion de la performance, on doit souvent faire face à plusieurs processus alternatifs pour atteindre les objectifs. Cette situation nécessite d'analyser des décisions multicritères afin de faciliter le travail des décideurs pour qu'ils agissent de façon cohérente et réduisent leurs réflexions.

#### 4.4.3.1 La décision multi-critère

Le processus de prise de décision dans un contexte multicritère consiste à choisir en premier lieu une solution ou une alternative parmi un ensemble d'alternatives  $\{x^h\}$ , avec  $h = 0$  à  $m$ , et sur la base d'un ensemble de critères de la performance  $\{c_i\}$ ,  $i = 1$  à  $n$ . Ainsi, la tâche du décideur n'est pas seulement de juger la performance de chaque alternative ou solution  $\{x^h\}$  selon les critères  $c_i$  mais également de donner un poids ou une importance relative à chaque critère afin d'arriver à un jugement global. L'alternative idéale est celle qui est la mieux classée selon chaque critère de performance.

Pour guider ce processus de décision, une technique de choix multicritère est nécessaire. Pour cela, la partie suivante propose de détailler plusieurs techniques permettant d'aborder le problème de manière efficace.

#### 4.4.3.2 Techniques d'aide à la décision multicritère

Cette partie détaille plusieurs techniques de choix multicritère pour le problème généralisé (Voir Equation 4.15).

Parmi l'ensemble des solutions disponibles, il est possible de les classer sur la base des critères alternatifs finis ou infinis, certitude ou incertitude par exemple (cf. Figure 4-13). D'après cette figure, le problème étudié fait partie du contexte de choix multicritère parce que le nombre de solutions est déjà déterminé et limité. De plus, à ce point-là, le problème étudié est celui de la certitude, le choix de la technique se réduit donc à la valeur multi-attribut.

Parmi ces approches, les plus répandus et les plus largement utilisées sont les *Simple Multi-Attribute Rating Techniques* appelée SMART (Von Winterfeldt and Edwards, 1994 ; 2007), l’AHP (Analytical Hierarchy Process) de Saaty (2004), le MACBETH (Bana e Costa et al., 2003; Bana e Costa and Vansnick, 1994) et le cadre de décision de l’intégrale de Choquet (Grabisch and Labreuche, 2009). Dans le cadre de ces travaux, ce sont ces deux dernières méthodes qui ont été retenues. Elles sont détaillées et explicitées dans les sections suivantes.

#### 4.4.3.2.I MACBETH

MACBETH, pour *Measuring Attractiveness by a Categorical-Based Evaluation Technique*, est une technique d’aide à la décision multicritère (Bana e Costa et Vansnick 2003; 1997; 1994). Ce modèle a besoin de jugements qualitatifs de la part du décideur afin de développer les valeurs quantitatives en se basant sur six catégories d’intensité de préférence comme par exemple : “très faible”, “faible”, “modéré”, “fort”, “très fort” et “extrême” (voir la Tableau 4-16). De plus, la méthode a pour but d’élaborer la fonction de la valeur et leurs poids compatibles avec la théorie de la mesure et des préférences (Grabisch and Labreuche, 2009).

Pour déterminer l’ensemble des fonctions de la valeur (c’est-à-dire, les expressions de performances élémentaires), Clivillé et al. (2007) ont identifié les quatre étapes permettant d’aborder le problème de prise de décision dans le contexte de mesure de la performance (voir Figure 4.14).

Etape 1 : Définition du contexte

Etape 2 : Détermination des expressions de performance

Etape 3 : Déterminations des poids

Etape 4 : Agrégation

Ces différentes étapes sont détaillées dans la suite de ce mémoire.

**Définition du contexte (Etape 1) :** Dans le cas de ces travaux de recherche, le contexte de décision est déjà défini par la phase précédente qui a identifié l’ensemble des mesures de performance ou critères  $C = \{c_1, c_2, \dots, c_n\}$  et plusieurs alternatives de processus  $X = \{x_1, x_2, \dots, x_l\}$ . A partir des mesures de performance et des alternatives, les scénarii sont développés sous la forme :  $S_1 = \{x_1^1, x_2^1, \dots, x_n^1\}$ ,  $S_2 = \{x_1^2, x_2^2, \dots, x_n^2\}$ ,  $S_3 = \{x_1^3, x_2^3, \dots, x_n^3\}$ . De plus, deux situations fictives sont déterminées et sont utilisées comme point de référence, assurant ainsi la commensurabilité entre les différentes mesures de performance hétérogènes.

**Détermination des expressions de performance (Etape 2) :** Pour déterminer les fonctions de valeurs ou expressions de performance élémentaire, MACBETH utilise une série de questions. Ces questions font évoluer en deux étapes le jugement du décideur par rapport à une mesure de performance pour une alternative.

**Les préférences du décideur :** Les préférences sont données à chaque mesure de performance, ce qui permet d’acquérir les informations sous la forme suivante :

- Le scénario  $S^k$  est préférable au scénario  $S^1$ , ce qui signifie que :  $S^k > S^1$
- Le scénario  $S^k$  n’est pas préférable au scénario  $S^1$  et inversement, et donc :  $S^k = S^1$
- Les scénarii  $S^k$  et  $S^1$  ne sont pas comparables.

Etant donné que la valeur est une performance  $P$ , les informations recueillies peuvent être exprimées sous la forme :

$$S^k > S^1 \leftrightarrow P^k > P^1$$

$$S^k = S^1 \leftrightarrow P^k = P^1$$

**L'intensité des préférences du décideur :** Afin d'identifier plus d'informations à propos de la situation  $S^k$  en terme d'intensité de préférence, le décideur recueille des informations descriptives, de *nul* jusqu'à *extrême*. Ainsi à la qualification *Nul* on fait correspondre la note 0 et à *extrême* la note 6 (cf. Tableau 4-16). Dans ce cas, la situation prend la forme  $S^k > S^1 \leftrightarrow P^k > P^1 = h \alpha$ , où  $h$  est la valeur numérique comprise entre 0 et 6 alors que  $\alpha$  est une coefficient nécessaire pour satisfaire la condition  $P^k$ . Ce coefficient reste entre l'intervalle [0,1] ou [0,100].

Le livrable de cette étape est un ensemble d'expressions de performance ou fonctions de valeur pour chaque mesure de performance.

### Détermination des poids (Etape 3)

La troisième étape permet au décideur de déterminer l'importance relative de chaque mesure de performance. Cette étape commence par la construction deux scénarii hypothétiques notés  $S^B$  et  $S^W$ , où  $S^B$  représente le meilleur scénario (ou espéré) et  $S^W$  représente le pire scénario, que l'on souhaite éviter à tout prix. Les deux scénarii sont représentés par des vecteurs d'expression de la performance (1, ... 1, ... 1) et (0, ... 0, ... 0), correspondant au scénario espéré et redouté. La performance agrégée  $P^{agg,h}$  s'écrit comme indiqué dans l'équation 4.16. Cependant, les pondérations  $w_i$  sont inconnues dans l'équation. Pour simplifier cette relation, MACBETH propose de considérer un vecteur d'expression de performance qui annule toute l'expression de performance sauf une composante, comme par exemple : (0, ..., 1, 0, ..., 0). Ce qui signifie que la performance agrégée se réduit à :  $P_{Ag}^i = w_i$ .

Pour agréger les  $n$  expressions de performance,  $n$  poids sont alors nécessaires. Pour cela, le décideur a besoin de  $n$  expressions mathématiques. Pour résoudre ce problème, MACBETH propose les comparaisons de situations deux à deux. Par conséquent, il en résulte  $n$  systèmes d'équations similaires à l'équation (cf. Equation 4.17).

**Agrégation des expressions de performance :** Une fois que toutes les expressions de performance et leurs poids respectifs ont été déterminés, il est maintenant possible de les agréger par une moyenne pondérée (Voir Equation 4.18).

#### 4.4.3.2.II Intégrale de Choquet

Considérons un ensemble fini d'alternatives  $A = \{a_1, a_2 \dots a_n\}$  et un ensemble fini de critères  $C = \{c_1, c_2 \dots c_n\}$ . A chaque alternative  $a \in A$  est associé un profil  $x_i^a = (x_{c_1}^a, x_{c_2}^a \dots x_{c_n}^a) \in S^a$ , où tout  $i \in C$ ,  $x_i^a$  représente le score partiel de l'alternative  $a$  sur le critère  $i$  dans un intervalle [0, 1] ou [0,100].

A partir du profil d'une alternative quelconque  $a$ , peut être calculé un score global  $\mu(C)$  grâce à l'intégrale de Choquet  $\mu(C) : S^a \rightarrow \mathbb{R}$  qui prend en compte les poids d'importance de tous les critères. Dans ce but, il est nécessaire de définir un concept de mesure floue.

**Définition (Mesure floue) :** Soit  $P(C)$  l'ensemble des parties de  $C$  (*power set*), la mesure floue (ou capacité) de  $C$  est une fonction monotone  $\mu: P(C) \rightarrow [0,1]$  vérifiant les conditions suivantes :  $\mu(\emptyset) = 0$ ,  $\mu(C) = 1$  et  $\mu(C) > \mu(C')$  si  $C' \subseteq C$ .

**Définition (Intégrale de Choquet):** Soit  $\mu$  une capacité ou mesure floue sur  $C$ . L'intégrale de Choquet d'une fonction  $f: C \rightarrow [0, 1]$  par rapport à  $\mu$  est donnée par la formule (cf. Equation 4.19). Pour des raisons de simplicité, on utilise le cas particulier de l'intégrale de Choquet appelée intégrale de Choquet 2-additive (Voir le modèle mathématique montré par l'équation 4.20).

## 4.5 Conclusion

Ce chapitre a présenté et examiné les outils et les techniques permettant de modéliser des objectifs, des activités et des risques d'un processus pour l'évaluer en termes de valeur et de risque. De plus, plusieurs techniques d'analyse multicritère ont été examinées afin de lier l'évaluation du processus à la prise de décision.

Cette chapitre conclut que :

1. La modélisation des objectifs est une exigence essentielle pour la mesure et la gestion de performance basée sur la valeur parce qu'elle permet de déterminer les mesures de performance de façon descendante.
2. Afin de modéliser les activités qui contribuent à atteindre les objectifs, ce qui est essentiel pour créer de la valeur, la méthode IDEF3 est retenue en y apportant une légère amélioration permettant de représenter les objectifs et le risque des processus modélisés.
3. Pour modéliser les risques des processus, ce sont les techniques AMDEC et l'approche de Larson et Kusiak qui sont utilisées de façon complémentaire. Le premier outil est ainsi employé pour analyser qualitativement les risques et le second est retenu pour effectuer l'analyse quantitative dans un environnement de simulation.
4. Pour développer les fonctions de valeur et de risque ainsi que l'indicateur global du couple (Valeur-Risque), c'est la méthode MACBETH et l'intégrale de Choquet 2-additive qui sont utilisées.

Le chapitre suivant développe le système de mesure et de gestion de la performance proposé et conçu lors de ces travaux de thèse. Il présente ainsi comment ces traitements sont réalisés en utilisant les concepts détaillés dans la première partie et les outils et techniques décrits dans la seconde partie de la thèse.





## **Chapter 5 Gestion de la Performance Basée sur le Couple Valeur-Risque**

Contrairement aux SIP, le système de gestion de la performance est un système qui ne guide pas seulement les évaluateurs pour mesurer la performance dans un cadre bien défini mais mène le processus de mesure vers l'atteinte des objectifs. A cet effet, une gestion de la performance a besoin de deux modèles : un modèle structurel et un modèle méthodologique. Le modèle structurel a pour but de définir et structurer les concepts de performance alors que le modèle méthodologique vise à déterminer l'approche étape par étape pour évaluer les processus.

Dans le cadre de cette thèse, nous allons proposer un système de mesure et de gestion de la performance orienté processus appelé système de mesure de performance basé sur les indicateurs de la valeur et du risque (« Value and Risk based Performance Management System or VR-PMS » en anglais). Ce système comprend ces deux modèles. Les sections suivantes détaillent chacun de ces deux modèles.

### **5.1 Le modèle structurel de VR-PMS**

Le modèle structurel de VR-PMS est élaboré pour intégrer et structurer de façon cohérente les caractéristiques souhaitées nécessaires pour évaluer la performance du processus. Ces caractéristiques proviennent des concepts d'activité (ou de processus), d'objectif et de risque. Le triptyque de ces trois concepts est suffisant pour expliquer la création de la valeur et du risque dans un processus afin de l'évaluer. Cependant, le concept de l'abstraction est nécessaire pour expliquer le mécanisme de création de la valeur et du risque.

#### **5.1.1 Niveaux d'Abstraction**

Le système de gestion de performance proposé supporte à la fois l'abstraction horizontale et verticale ainsi que l'abstraction de l'agrégation. Pour décomposer le système de valeur (ou chaîne de valeurs) dans les valeurs intermédiaires des activités opérationnelles, on utilise l'abstraction verticale. Au contraire, l'abstraction horizontale est employée pour identifier les sous-domaines de processus métier comme le domaine fonctionnel, informationnel, comportemental et organisationnel.

De la même manière, on utilise le concept d'abstraction pour raffiner les objectifs des processus métier. L'objectif global d'un processus métier est décomposé jusqu'à l'objectif fonctionnel lié à l'activité opérationnelle. En plus des objectifs fonctionnels, les objectifs non-fonctionnels sont également décomposés. Par ailleurs, le risque global du processus est raffiné de la même façon que les objectifs.

Pour établir une cohérence et une consistance dans les différents niveaux d'abstraction des processus métier, des objectifs et des risques, une décomposition synchronisée de ces trois concepts est nécessaire (voir Figure 5-1).

#### **5.1.2 Les Modèles Élémentaires**

Le modèle structurel de VR-PMS modélise les trois vues d'un processus métier à savoir : la vue des objectifs, la vue des activités et celle du risque à plusieurs niveaux d'abstraction. Le modèle obtenu, après mapping de ces trois modèles de trois vues, est appelé modèle générique conceptuel. Ce modèle générique est capable

d'expliquer la création de la valeur en présence du risque. Les sections suivantes expliquent ces trois modèles relatifs aux objectifs, aux activités et aux risques.

#### **5.1.2.1 Modèle des objectifs**

La première étape pour développer un modèle conceptuel de la valeur pour un processus métier est d'identifier un ensemble d'objectifs  $O_i, i = 1, \dots, n$  appropriés au processus métier et de définir les mesures de performance  $M_i, i = 1, \dots, n$  par rapport à ces objectifs afin de savoir dans quelle mesure ces objectifs sont atteints. Cela demande une approche structurée pour guider le processus de détermination des objectifs à partir des attentes des parties prenantes et permet ensuite de déterminer les mesures de performance.

Ainsi, les principes du modèle « Value Focused Thinking » sont appliqués. Ces principes nous permettent de définir les objectifs de finalité et de moyens. Les objectifs de finalité nous intéressent dans le contexte de la décision alors que les objectifs de moyens permettent d'atteindre les objectifs de finalité.

Une fois déterminés, les objectifs de finalité et de moyens sont structurés respectivement sous forme d'arbres et de réseaux. Les mesures de performance sont ensuite dérivées des objectifs de finalité raffinés qui se trouvent au plus bas niveau de l'arbre des objectifs. Par ailleurs, l'objectif de moyen nous permet de déterminer les activités nécessaires qui ultérieurement atteindront les objectifs de finalité ; il peut donc être connecté au modèle d'activité.

#### **5.1.2.2 Modèle d'activité**

Après avoir identifié les objectifs et les mesures de performance correspondantes via le modèle d'objectifs, l'étape suivante est d'identifier les activités nécessaires à la réalisation des objectifs.

Pour modéliser une activité, la méthode IDEF0 peut être employée en complément à IDEF3 (cf. Figure 5.2). Cette méthode formalise une activité en termes d'entrée, sortie, contrôle et mécanisme. Pour passer de l'entrée à la sortie, une entreprise consomme ses propres ressources. Pour assurer l'efficacité et l'efficience de la transformation, l'activité est soumise au contrôle.

À partir de ce formalisme d'activité, un modèle générique d'activité peut être développé pour le modèle de la valeur. Dans ce but, des attributs supplémentaires de l'activité, dans le contexte de performance, sont définis. Il s'agit de la qualité, du coût et du délai.

Pour appliquer le modèle d'activité à la création de la valeur, une activité qui comporte un certain niveau de qualité (maturité, recoverabilité, performance etc.) a un coût et prend du temps pour finir par donner un livrable. Ce livrable est une valeur intermédiaire dans la perspective de la valeur, dont la grandeur est mesurée par rapport à l'objectif. De plus, l'efficience et l'efficacité d'activité sont conditionnées par des modèles de coût, de ressources et d'ordonnement ainsi que par la politique opératoire qui surveille les processus de transformation. Cependant cette valeur intermédiaire est soumise à des événements incertains qui peuvent la mettre en danger. C'est la raison pour laquelle le modèle du risque a été introduit.

#### **5.1.2.3 Modèle du risque**

Une activité est destinée à réaliser un ou plusieurs objectifs, cependant elle s'expose à plusieurs types de facteurs de risque - externes ou internes à l'activité (Salah,

2005). Ces facteurs de risque peuvent déclencher l'occurrence d'un ou plusieurs risques qui à leur tour affectent le déroulement de l'activité. La Figure 5-4 explique cette relation entre le facteur de risque, l'évènement du risque et l'objectif.

Le modèle du risque est donc inclus dans l'approche existante pour identifier et évaluer les risques provenant des facteurs de risque. L'identification de ces risques se fait en utilisant l'approche par les objectifs. Les risques identifiés sont évalués qualitativement dans l'AMDEC en collaboration avec le modèle d'activité. Les risques clés sont donc incorporés dans le modèle du processus pour évaluer le risque quantitativement dans l'environnement de la simulation.

L'évaluation du risque orientée processus a comme un avantage le fait que le risque et la valeur peuvent être déterminés dans un seul environnement. Pour cette raison, nous avons choisi le modèle du risque de Larson et Kusiak. L'hypothèse sous-jacente d'appréciation du risque basée sur l'activité est qu'une activité s'expose à plusieurs facteurs de risque  $RF_i$  ( $i = 1, \dots, n$ ) (voir Figure 5-5) et peut donc déclencher un ou plusieurs évènements affectant un ou plusieurs objectifs associés. Ces risques sont ensuite quantifiés en utilisant un modèle mathématique implanté dans le modèle de la simulation.

### **5.1.3 La cartographie de modèles génériques élémentaires**

Après avoir défini les modèles des objectifs, d'activités et de risque pour évaluer le processus métier, l'étape suivante est la combinaison de ces modèles en un seul. Le modèle obtenu aura les caractéristiques héréditaires des modèles individuels et sera donc clair et complet. Pour analyser les caractéristiques des modèles individuels et du modèle combiné, nous avons fait une analyse ontologique (voir Figure 5-6). Cette analyse des modèles élémentaires nous permet de déterminer les situations indésirables : déficit, redondance, surcharge et accès ontologiques des constructions lors des cartographies de ces modèles élémentaires pour obtenir un modèle conceptuel combiné (Recker, 2011).

Par ailleurs, la combinaison des trois modèles élémentaires en un modèle conceptuel combiné nécessite le choix d'un modèle parmi d'autres pour qu'il comporte toutes les caractéristiques des modèles élémentaires en plus de ses propres caractéristiques. Pour cela, le modèle d'activités a été choisi comme modèle commun puisqu'il aura toutes les caractéristiques nécessaires du modèle conceptuel combiné de valeur/risque. Ensuite, une analyse ontologique est menée afin de trouver la complétude et la clarté des modèles élémentaires (Wand et Weber, 2002).

Après cette analyse, les trois modèles sont liés en établissant les liens entre eux comme indiqué dans Figure 5-8. D'après cette Figure, la valeur des processus métier peut être exprimée en termes d'objectifs (flèche 1) et réalisée par des activités (flèche 2) via la réalisation des objectifs (flèche 3). Cependant, ces activités sont soumises au risque (flèche 4) qui ultérieurement affecte la réalisation des objectifs (flèche 5) et influence donc négativement la création de valeur (flèche 6).

Après avoir établi la relation entre les modèles, il est pratique de développer le modèle conceptuel de la valeur/risque.

### **5.1.4 La élaboration du modèle conceptuel de valeur/risque**

Le but principal du modèle conceptuel est de déterminer deux types d'indicateurs : l'indicateur de valeur et l'indicateur de risque. Ces deux indicateurs sont exprimés

sous la forme du couple (valeur-risque) et peuvent être calculés pour chaque alternative de processus métier dans le contexte de décision. Ce couple fournit un classement souhaitable ou non-souhaitable d'une alternative et donc, propose une base pour faire un choix parmi les alternatives existantes.

Le modèle conceptuel de la valeur/risque comme indiqué dans la section 5-9 représente une unité atomique du modèle en détaillant les éléments et les concepts nécessaires à la modélisation de la valeur et du risque. Pour représenter l'objectif et le risque sur la boîte représentant l'activité, les coins en haut à droite et en bas à gauche sont respectivement rognés.

Pour rendre opérationnelle l'idée de la création de valeur dans les conditions d'incertitude, on se réfère à la Figure 5-9. Elle illustre les concepts essentiels pour créer la valeur ou le risque intermédiaires à la sortie du modèle. Pour juger si la valeur/risque intermédiaire est créée ou dissipée, on les compare aux objectifs et à l'appétit du risque. Pour obtenir les grandeurs, on évalue le jugement de la valeur en se référant aux préférences et à l'échelle d'intensité des préférences du décideur (cf § 5.3.1). Les préférences et intensités de préférence nous permettent de développer la fonction de la valeur et de risque en employant la théorie de l'utilité.

Pour obtenir la valeur globale du processus métier (Figure 5-10), les valeurs intermédiaires et de risque sont agrégées via des principes de fusion de l'information (Voir Equations 5-4 et 5-5)

## **5.2 Le Modèle Méthodologique**

Le modèle méthodologique a pour but de guider le décideur méthodiquement pour effectuer l'évaluation du processus métier basé sur la valeur et risque. La Figure 5-11 indique les différentes phases du cadre méthodologique. Chaque phase a ses propres outils, méthodes et techniques.

### **5.2.1 Etablissement du contexte (Phase 1)**

Cette phase du modèle méthodologique définit le domaine d'application et délimite le problème à l'étude. Elle comprend l'identification des parties prenantes, leurs exigences et responsabilités ainsi que la délimitation de l'ingénierie du risque qui détermine l'appétit, l'acceptabilité ainsi que les critères du risque.

### **5.2.2 La modélisation de la performance du processus métier (Phase 2)**

La phase de modélisation de la performance vise à intégrer les objectifs du contexte de décision et les risques au modèle du processus. Pour faciliter cette phase de modélisation, nous proposons un cadre appelé « integrated business process performance modeling approach ». Ce cadre (voir Figure 5-12) a été construit principalement sur le contenu de la recherche de Keeney (1996), Clemen & Reilly (2000), Neiger et al. (2006), Sienou (2009), et Larson et Kusiak (1996). Le livrable final de ce cadre est un « objective-oriented risk aware business process model », qui sert à évaluer le processus métier basé sur la valeur et le risque. Chaque étape de ce cadre est expliquée dans les sections suivantes.

#### **5.2.2.1 L'identification et la modélisation des objectifs de finalité**

Les objectifs par valeur (en anglais « value-driven objectives ») sont des déclarations reflétant l'exigence des parties prenantes concernant un système ou processus métier.

Keeney (1996, p. 57) fournit une liste des techniques pour faire apparaître les objectifs des parties prenantes. Pour cela, nous avons besoin de déterminer d'abord l'objectif global du processus métier. D'après Keeney (1996, p. 77), cet objectif de processus métier est « *the breadth of concern* ».

Une fois identifiés, les objectifs plus spécifiques par rapport à l'objectif global peuvent être identifiés en se demandant « *ce que signifie cet objectif* ». La réponse à cette question décompose l'objectif global en objectifs de plus bas niveau. Ces derniers sont les facettes d'un objectif plus général. Ces objectifs de bas niveau peuvent à leur tour être décomposés en objectifs de finalité de plus bas niveau encore jusqu'à ce qu'ils ne soient plus décomposables. Une fois déterminés, on développe un arbre des objectifs de finalité.

A l'inverse, nous pouvons regrouper plusieurs objectifs de finalité au sein d'un même objectif s'ils sont les diverses facettes ou dimensions d'un même objectif plus général. Pour cela, nous posons la question: « *Of what more general objective is this an aspect* ». Cette question nous permet également de valider la nature des objectifs, c'est-à-dire de savoir s'ils sont vraiment les objectifs de finalité ou non.

#### **5.2.2.2 L'identification et la modélisation des objectifs de moyen**

L'objectif de moyen permet de réaliser les objectifs de finalité et spécifie donc les actions alternatives. Pour les déterminer, la question qui va nous guider est : « *how can this be achieved* ». En posant cette question pour chaque objectif de finalité, on identifie une liste d'objectifs de moyen. Une fois déterminés, ils sont structurés en un réseau d'objectifs (cf. 5.14).

#### **5.2.2.3 Restructuration des objectifs**

Après avoir identifié les objectifs de finalité et de moyen, la première structuration des objectifs peut faire apparaître des objectifs de moyen dans l'arbre des objectifs de finalité. Il est donc nécessaire de reformuler les objectifs et de vérifier que les objectifs de finalité reflètent bien les attentes des parties prenantes et leurs préférences.

A cet effet, on se demande pourquoi c'est important. Cette question est aussi appelée le **WITI test**, qui sert à séparer les objectifs de finalité des objectifs de moyen et à révéler les connections entre eux. Si la réponse à cette question est que l'objectif est important, c'est un objectif de finalité. Si la réponse est ce que l'objectif est là pour atteindre un autre objectif, c'est un objectif de moyen.

De plus, l'objectif de finalité peut être différencié de l'objectif de moyen via abstraction et causalité. Il existe bien un lien de cause à effet entre les objectifs de moyen et de finalité. Cependant, le lien entre les objectifs de finalité est celui de l'abstraction, c'est-à-dire que les objectifs de bas niveau sont de dimensions différentes de l'objectif de haut niveau et sont *mutuellement exclusifs*.

En structurant les objectifs de moyen, les connecteurs logiques sont utilisés pour savoir si tous les objectifs de bas niveau doivent être satisfaits afin de répondre à l'objectif de haut niveau (*ET-logique*), ou si un ou plusieurs objectifs de niveau bas sont suffisants pour satisfaire l'objectif de haut niveau (*OU-logique*), ou si l'un ou l'autre est suffisant pour satisfaire l'objectif de haut niveau (*OU Exclusif-logique*).

#### 5.2.2.4 Les mesures de performance

Les objectifs de finalité de plus bas niveau sont des objectifs non-décomposables ou mesurables. Cette couche des objectifs peut donc fournir une base au développement des mesures de performance ou critères de performance afin de les utiliser pour évaluer des processus alternatifs. Le résultat de cette section est un livrable sous forme d'un arbre de valeurs ou mesures de performance qui est également compatible avec la méthode MACBETH.

#### 5.2.3 La modélisation des activités (Etape 3)

La modélisation de processus dans les travaux de recherche existants est l'identification et la modélisation des activités qui soutiennent la réalisation des objectifs de moyens afin de répondre aux objectifs globaux. Pour identifier ces activités, la question : « *What activities are aimed at achieving these objectives* » est posée pour chaque objectif de moyen. Elle facilite l'identification des activités principales par rapport aux objectifs de plus haut niveau dans le réseau des objectifs de moyens (Neiger et al. 2008). De plus, Kueng et Kawalek (1997) proposent d'identifier une activité pour chaque objectif de moyen et si le décideur ne peut pas dériver une activité à partir de l'objectif de moyen, il faut le raffiner.

Malgré ces propositions, l'identification des activités n'est pas abordée et exige donc une recherche afin de bien formaliser cette approche. Sans tenir compte de la méthode utilisée pour identifier les activités afin de répondre aux objectifs, les activités doivent être complètes et avoir une entrée et une sortie bien définies. Il est important de mentionner que les activités sont identifiées pour des objectifs fonctionnels mais sont évaluées à la fois pour des objectifs fonctionnels et non-fonctionnels.

Une fois que les activités sont définies, elles sont ensuite ordonnées en définissant les dépendances logiques et les contraintes entre elles. A cet effet, la méthode IDEF3 modifiée basée sur le modèle conceptuel de la valeur et du risque est employée (cf. 5-9). Ce dernier peut modéliser la logique et la dépendance temporelle qui existent entre les différentes activités de processus métiers (cf. Figure 5-15).

Après avoir défini et modélisé les activités, il faut lier les objectifs au modèle d'activité. Une simple question : « *What objective is this aimed at* » est suffisante pour lier l'activité ou un ensemble d'activités dans le modèle du processus (voir Figure 5.16).

#### 5.2.4 La modélisation des risques (Etapes 4a, 4b et 4c)

Pour identifier et évaluer le risque associé au processus métier, nous proposons, dans le cadre de cette thèse, deux approches : identification du risque par objectifs et évaluation du risque basé sur le processus.

##### 5.2.4.1 Approche par objectifs pour identifier des risques (Etape 4a)

L'approche par objectifs pour identifier les risques est basée sur l'hypothèse que les facteurs de risque sont des obstacles à l'atteinte des objectifs. Les objectifs sont là pour identifier les conditions désirables alors que les facteurs de risque capturent les conditions indésirables (Lamsweerde and Letier, 2000). Une affirmation, sous forme de question (étape 4a), à savoir ce qui fait obstacle à l'objectif, est suffisante pour déterminer l'évènement du risque.

De la même façon que le modèle des objectifs, le risque global est identifié en posant la question par rapport à l'objectif global. Le risque de bas niveau représente l'échec de l'objectif à l'étude (voir Figure 5-17). Contrairement au modèle d'objectifs, les risques de bas niveau au sein d'objectifs de haut niveau ne sont pas nécessairement exclusifs l'un de l'autre. Comme notre méthode est basée sur la théorie du flou pour agréger et non pas sur un modèle additif comme c'est le cas dans la cadre de l'approche par valeurs de Keeney, la non-exclusivité ne nous pose aucun problème.

Une fois les risques identifiés et structurés dans l'arbre de risques, l'étape suivante est de déterminer les facteurs de risque qui déclenche les risques. La question directive est "*What causes this risk to occur?*" En se posant plusieurs fois cette question pour un risque, on va découvrir les facteurs de risque. La Figure 5-18 présente l'arbre des risques liés aux facteurs de risque. .

L'identification du risque est importante pour développer le plan de contrôle. Si la source ou le facteur sont connus, le gestionnaire du risque peut mettre en place un plan d'action pour mitiger les risques.

A la fin, l'arbre de risques et le réseau du risque sont suffisants pour cartographier tous les risques ainsi que leurs causes. Cependant, les risques ne peuvent pas être évalués car il manque l'information contextuelle. Ainsi, les risques identifiés sont évalués dans l'environnement du processus où ils se produisent.

#### **5.2.4.2 L'appréciation de risque basée sur le processus (Etape 4b)**

Les risques identifiés en utilisant l'approche par objectifs sont évalués via la technique l'AMDEC. Pour cela, les informations contextuelles sont obtenues d'après le modèle de processus (Etape 4b) mais il est nécessaire d'identifier les activités sujettes au risque ou qui peuvent le causer. Pour les déterminer, nous choisissons de développer une matrice d'activité-risque. Celle-ci établit un lien entre une activité et le risque identifié (cf. Tableau 5-2)

Après avoir déterminé les risques et les activités sur lesquelles ils agissent, ils sont ensuite entrés dans la grille l'AMDEC pour les évaluer (voir Tableau 5-3). Le risque critique identifié par l'AMDEC est incorporé au modèle du processus pour l'évaluer quantitativement.

#### **5.2.4.3 L'intégration de risque au modèle de processus (Etape 4b)**

Les risques critiques identifiés sont ensuite incorporés au modèle du processus. L'incorporation des risques au modèle du processus (cf. Figure 5-19) signifie que le risque identifié autour une activité va être évalué (c'est dire que sa probabilité d'occurrence et son impact dans l'environnement de la simulation vont être calculés). En résumé, pour intégrer les risques aux processus métier, un modèle « *objective-oriented risk aware business processus model* » a été développé. Ce modèle est le livrable final de cette phase de modélisation de la performance. L'objectif est de modéliser la performance dans le contexte de processus métier afin de les évaluer en termes de valeur et de risque. Ce modèle est prêt à être utilisé dans la phase d'évaluation.

### **5.2.5 La phase d'évaluation de performance**

L'évaluation de la performance peut s'effectuer en utilisant l'approche de simulation par évènements discrets. Pour cela, nous avons besoin d'un modèle de simulation. Les étapes principales sont le développement d'un modèle conceptuel, le codage de



ce modèle, l'expérimentation et l'implémentation (Robinson, 2004 ; Ryan et Heavey, 2006 ; Marquès, 2010).

Indépendamment de l'approche utilisée, un modèle est prérequis pour l'expérimentation de la simulation. Cependant, le modèle de la simulation n'est pas suffisant pour fournir toutes les données nécessaires à une expérimentation de la simulation. On a besoin de collecter suffisamment de données pour effectuer l'évaluation via la simulation. Cette thèse divise l'expérimentation de la simulation en trois grandes étapes (voir Figure 5-20). Ces trois étapes sont brièvement discutées dans les sections suivantes.

#### **5.2.5.1 La génération des données d'entrée**

Il s'agit de la phase de collecte des exigences du processus métier de l'étude. Elle est divisée en deux parties : les données fonctionnelles et les variables d'entrée (facteurs ou paramètres dans le langage de la simulation).

Dans la première partie, le modèle conceptuel est suffisant pour accumuler des données fonctionnelles via IDEF3 pour effectuer la simulation. Cependant, dans la deuxième partie, le VR-PMS emploie plusieurs outils pour les collecter. Shah et al. (2012) suggèrent de diviser les variables en plusieurs catégories sur la base de leur nature et domaine d'application dans la simulation. Une fois collectées, elles sont traitées en utilisant l'approche statistique.

#### **5.2.5.2 Le modèle de la simulation et l'expérimentation**

Après avoir défini un processus métier valide et les variables d'entrée correspondantes, le modèle peut être transformé en modèle de simulation. Cette transformation comprend deux étapes : codage du modèle et entrée des données des variables d'entrée. Dans VR-PMS, l'étape d'expérimentation concerne la conversion du modèle *objectif-oriented risk aware business processus model* en modèle de la simulation numérique exécutable.

Une fois le modèle de simulation développé, validé et vérifié, l'étape suivante est la conception du plan d'expérience. Celui-ci consiste à déterminer la durée de la simulation et le nombre de répliques par exemple.

#### **5.2.5.3 La collection des sorties et l'analyse**

Le modèle de simulation est ensuite exécuté selon le plan d'expérience. Après chaque simulation, on collecte les paramètres d'intérêts. Dans le contexte de VR-PMS, ces paramètres d'intérêt sont des mesures de performance et de risque tels que prédéfinis dans le modèle d'objectifs.

Les mesures de performance et de risque issues de l'expérimentation de la simulation sont collectées et traitées dans la phase d'aide à la décision car ces mesures ne peuvent pas être utilisées directement pour l'aide à la décision.

### **5.3 La prise de la décision**

Un modèle a moins de valeur intrinsèque sauf s'il est utilisé pour supporter l'aide à la décision (Robinson, 2004). La décision basée seulement sur les mesures de performance et de risque issues de la simulation fournit peu de perspectives sur la performance du processus métier. En réalité ces mesures de performance ou risque ne reflètent pas la performance d'un processus mais servent à fournir des informations à moins qu'elles soient comparées aux objectifs ou valeur de but.

De plus, dans un processus de management de la performance, plusieurs alternatives en plus des mesures de performance sont impliquées. En outre, ces mesures ne sont pas de même nature et sont donc hétérogènes. La prise de décision dans ce contexte est très difficile pour un manager. Il est donc nécessaire de transformer ces mesures de performance en une forme commensurable pour faciliter leur gestion. Cette transformation nous donne une mesure élémentaire que nous appellerons dans cette thèse la fonction de valeur ou risque.

Pour construire ces fonctions de valeur, les méthodes multicritères sont employées. Dans le cadre de nos travaux, nous avons choisi la méthode MACBETH. Cependant, nous n'utilisons pas cette méthode pour l'agrégation de fonctions de valeur et risque en raison de leur modèle additif pour cette partie. A cet effet, l'intégrale de Choquet est choisie comme outil pour l'agrégation de fonction de valeur. Nous discutons des deux méthodes dans les sections suivantes.

### 5.3.1 La Méthode MACBETH

Dans le cadre de notre travail, la méthode MACBETH a été employée pour modéliser la fonction de valeur et risque. Cette méthode a seulement besoin du jugement qualitatif de chaque critère dans différentes alternatives. Ces jugements facilitent la décision pour quantifier les attractions relatives à la mesure de performance à partir d'un ensemble de mesures de performance  $X = \{x_1, x_2, \dots, x_n\}$  selon les alternatives  $A = \{a_1, a_2, \dots, a_l\}$  et affecte un nombre réel  $v(x)$  à chaque critère  $x_i$  de  $X$  en utilisant une échelle verbale {nulle, très faible, faible, modérée, forte, très forte, extrême}.

Pour quantifier les préférences, la méthode MACBETH se base sur l'intensité de préférences  $h$  de la théorie de multi-attributs. Mais cela, pour obtenir la commensurabilité inter-critères, MACBETH propose deux points de référence comme *bon* et *neutre* ayant respectivement 1 et 0 pour niveau. Ce point de référence permet de cartographier la fonction de valeur et risque sur un intervalle de  $[0,1]$ . La quantification est obtenue à partir de l'équation 5-1. Cette équation nous mène à un système d'équations pour chaque critère.

Résoudre ce système d'équations de nous donne la fonction de valeur et risque pour chaque critère  $x_i$ . Une fois les fonctions de valeur et risque déterminées, elles sont agrégées en utilisant l'intégrale de Choquet.

### 5.3.2 L'Intégrale de Choquet

L'intégrale de Choquet est une méthode complète mais dans le cadre de cette thèse on l'utilise pour agréger les fonctions de valeur et risque issues de MACBETH. Comme cette méthode est basée sur les conditions comme l'indépendance préférentielle, l'indépendance faible, indépendance en utilité et l'indépendance additive mentionnée dans la littérature (Kirkwood et Sarin, 1980). En fait, toutes les mesures de performance sont indépendantes et ne s'influencent pas. Pour pallier à cette déficience, nous utilisons l'intégrale de Choquet comme un moyen d'agrégation (voir Equation 5-13) Cependant dans cette thèse, nous utilisons le cas particulier de  $k$ -additive CI notée 2-additive CI où les interactions des paires de critères sont considérées (voir Equation 5-14).

## **5.4 Conclusion**

Ce chapitre a présenté le management de performance basé sur la valeur/ risque (VR-PMS). Ce système est pourvu de deux modèles : structurel et méthodologique.

Le premier est développé pour intégrer tous les concepts s'articulant autour de la performance et détermine les caractéristiques désirables pour modéliser la valeur et le risque. Le livrable de cette phase est un modèle appelé modèle conceptuel de valeur/risque. Il est encore utilisé comme base pour évaluer les différentes alternatives du processus métier au cours de sa conception.

Le modèle méthodologique fournit une approche étape par étape pour évaluer les processus métier. Chaque étape de ce modèle est illustrée par un exemple simple.

Finalement, le chapitre se termine avec la pensée que VR-PMS est théoriquement judicieux et prend ses racines dans différents domaines dédiés aux disciplines de la performance comme l'ingénierie de la valeur, la gestion du risque, la gestion de processus métier et les sciences de décision.

## Conclusion Générale

Le but de cette thèse de recherche est de proposer un système de mesure et de gestion de performance basé sur la valeur et le risque. Le couple valeur-risque représente deux des quatre dimensions de performance qui peuvent formaliser la performance globale d'un système/produit/ processus. Cette thèse se focalise sur les deux aspects de performance car le coût et le bénéfice ont déjà été largement étudiés mais la valeur et le risque ne sont pas abordés dans un cadre intégré et surtout dans le contexte processus. Nous développons donc nos arguments autour de ces deux derniers axes de performance mais les mêmes principes peuvent être appliqués aux deux autres axes : le coût et le bénéfice.

Développer un système basé sur le couple valeur-risque pour évaluer la performance simplifie le processus de mesure et de gestion de la performance. La valeur reflète les atteintes des parties-prenantes et a également vocation de représenter ces atteintes en un seul indicateur. De plus, elle peut être utilisée pour évaluer les conséquences actuelles ou potentielles des alternatives dans un contexte de décision. A cette fin, la valeur doit prendre en compte la corrélation des objectifs des parties prenantes. Cependant, cette valeur est exposée aux facteurs de risques qui peuvent l'influencer négativement. Il est donc, impératif d'aborder le risque en parallèle avec la valeur pour une solution intégrée.

Face à cette situation, cette thèse propose un système de mesure et de gestion de performance basé sur le couple (valeur, risque) noté VR-PMS. Le système est constitué des deux cadres :

1. Cadre conceptuel : Il a pour but d'expliquer les concepts de la performance et de les intégrer de façon cohérente dans un seul cadre de « Conceptual value-risk model ». Ce modèle détaille ensuite la création de valeur en présence d'incertitudes dans un contexte de processus.
2. Cadre méthodologique : Le cadre méthodologique établit une approche étape par étape pour guider un évaluateur dans la détermination de la valeur et du risque dans un processus à partir des attentes et inquiétudes des parties prenantes. Ainsi, il compte quatre phases différentes : définition du contexte, modélisation de la performance, évaluation de la performance et aide à la décision. Chaque phase a ses propres outils, méthodes et techniques.

Pour conclure, le VR-PMS intègre les différents concepts de mesure et de gestion de la performance dans un seul cadre pour répondre aux questions soulevées dans l'état de l'art. Il intègre les théories (ex. théorie de l'utilité), des pratiques (ex. de l'ingénierie du risque) et des approches (la modélisation et la simulation) dans un seul cadre pour évaluer la performance de processus.

Même si l'approche proposée a plusieurs avantages, elle a également quelques inconvénients. L'inconvénient majeur est le temps nécessaire à l'évaluation de la performance d'un processus parce que la méthode est basée sur la simulation pour cette partie. Cependant, dans certains contextes, l'évaluation de la performance est intéressante car les conséquences si on n'évaluait pas la performance pourraient avoir des effets nuisibles sur la compétitivité à long terme d'une entreprise.

Concernant les perspectives, le travail de recherche peut être élargi à plusieurs axes. Pour l'instant, l'approche est validée sur des processus manufacturiers mais nous

pouvons l'appliquer à tous les types de systèmes, produits, processus ainsi qu'aux projets. De plus, la technique d'élucidation peut être intégrée pour déterminer l'apport de chaque mesure ainsi que la coalition des mesures de performance dans le score global. Cela nous permet de déterminer des objectifs et la coalition des objectifs critiques. Un autre domaine d'investigation est l'application du couple (valeur, risque) pour contrôler le système, processus ou projet en temps réel. Par ailleurs, dans le modèle risque, la relation de causalité entre l'évènement du risque et le facteur de risque n'est pas abordée. Ceci est nécessaire pour trouver quels facteurs de risque sont importants afin de préparer les plans de mitigation de risque de manière efficace. Enfin, l'approche proposée sera élargie pour inclure le couple coût/bénéfice afin de construire un cadre global à l'évaluation de la performance.

---

**English Version**  
**(Detailed Dissertation Description)**

---



## Chapter 1 Introduction and Overview

Performance management poses daunting challenges to organizations in terms of meeting multiple stakeholder objectives. Often, companies are able to meet some objectives but at the expense of others. However, it is not an easy task for organizations to meet all the objectives simultaneously. The issue complicates further when two or more conflicting objectives are required to be met at the same time, *e.g.* improving the quality of the product while reducing cost and delay objectives. Yet companies are forced to do it due to competition in the era of globalization.

Globalization has a major impact on the evolution and competitiveness of businesses. It forces them to compete on the international market. On one hand, it offers them the opportunity to gain larger market share, but, on the other hand, it poses even more threats to their existence. The British philosopher Herbert Spencer idiom suits well here when he coined the expression “*survival of the fittest*”. What it means in this context is that the organizations that satisfy their stakeholder expectations will survive in the market and the rest is doomed to fail. In such circumstances, it becomes mandatory for organizations to identify and then strive to meet the expectations of their stakeholders. However, each stakeholder needs, wishes and level of satisfaction vary from one another. In the most general sense, if an organization performs “better, faster, cheaper and safer”, then the expectations of all stakeholders can possibly be addressed. However, this mantra is a set of conflicting objectives where each of them represents a facet of performance in its own right with its own tools and techniques to deal with. The organization role in this entire conflicting situation is to find a tradeoff among the performance facets for managing the stakeholders’ expectations and satisfying their objectives. But the question arises whether the organization would be able to make a tradeoff among the conflicting objectives acceptable to all parties? Also, would the stakeholders be ready to share the risks that the project or system is subject to? If yes, then to what extent?

Furthermore, satisfying objectives requires performance measures for the purpose of evaluation. But, more general objectives are difficult to operationalize since they involve many dimensions of performance. Therefore, further drilling down of objectives to make them more concrete is compulsory. However, this pursuit of holistic and detailed performance measurement leads to the propagation of performance measures, which in turn makes the performance management difficult due to the high number of indicators to be considered.

To overcome this situation, the claim of this doctoral dissertation is that any enterprise system should be evaluated from only four main global dimensions which are: costs, benefits, value and risks. Costs and benefits have been largely studied in the past and are now widely used in practice. This thesis develops the arguments on the other two dimensions or (value, risk) pair, but the same principles can apply to the four dimensions (4-tuple).

In view of the above mentioned situations, an organization will be at a better competitive position if it has methods, firstly to decompose the overall system value into manageable chunks in order to facilitate their performance assessments and secondly, to aggregate them to facilitate the decision making process.

This chapter serves as an executive summary. It highlights the major themes of the dissertation, defines the research problem, outlines the research approach, presents



the contribution of the thesis and concludes by summarizing the key points of the chapters that make this dissertation.

## 1.1 Problem definition

The existing literature about the performance discipline highlights the importance of performance measurement and management in organizations. It often focuses on the design of performance measures reflecting organizational objectives, the accomplishment of which ultimately creates value for the stakeholders. In this context, performance measures act as management tools which are used as yardsticks to evaluate the performance with regard to objective achievements.

To satisfy objectives, activities are designed and implemented to support the achievement of these objectives and in turn determine the value creation process. However, this value creation process is subject to uncertainties in the form of risk factors, which negatively impact the process objectives. In such circumstances, performance and risk measures are employed for determining to what extent the process objectives have been achieved or suffered. So, the role of performance measurement and management, in the more general terms, is to:

- Provide useful information in the form of performance measures indicating the level of achievement of individual objectives.
- Identify critical risk factors, the occurrence of which can impact negatively the process objectives.
- Identify the success factors or improvement areas to improve the process value.
- Facilitate the identification and implementation of solutions for the purpose of improving the process value.
- Link to decision-making mechanism.

In brief, the performance measurement and management role is to provide information for informed decision-making in order to guide the process to objective achievement.

### 1.1.1 Current situation

Currently, the performance measurement and management literature stresses the importance of non-financial performance measures in addition to the financial ones (Ittner and Larcker, 1998; Dossi and Patelli, 2010). This paradigm shift towards non-financial performance comes as a result of the inadequacy on the part of financial performance measures as the sole indicators of organization performance (Tan *et al.*, 2008; Johnson and Kaplan, 1987). The emergence of balanced scorecards (Kaplan and Norton, 1992; 1996; 2000 and 2004) has played a significant role in this paradigm shift whose major contribution to the performance measurement discipline is in the expansion of business focus from traditional financial performance measurement to the corporate non-financial measurements. It relies on four major strategic “perspectives” and each one has an integrated set of objectives, measures and initiatives to translate strategy into actions.

Alignment of performance measures with strategy has been advocated vehemently in many integrated performance measurement systems (Bhimani, 2006) in addition to BSC. Folan and Brown (2005) term strategy as a starting point for a performance measurement system (PMS) and define a step by step process for developing

performance measures from strategy. However, some authors (Neely *et al.*, 2002; Garengo *et al.*, 2005) criticize strategy as the starting point and put stakeholders' expectations to be the driving force for performance measures derivations for PMS.

In addition to performance measures as descriptors of performance and their alignment with organization strategy, the risk management literature also stresses the role of managing risk in performance improvement (Gourc, 2006; Tuncel and Alpan, 2010). To this end, the use of a wide range of techniques to manage risk in order to improve process performance is also advocated (ISO 31000:2009). Similarly, Marques *et al.* (2011) include risk as one of the dimensions of performance besides cost, time and quality. However, Sienou (2009) defines risk management process as the value preservation scheme for a business process.

Of course, performance measurement and management systems and risk management techniques play a significant role in business processes management. They are taught and practiced in industry as well. However, they often fall by the wayside when it comes to performance assessment in the overarching sense. The reasons behind this failure may be attributed to several reasons among which we can mention:

- Information handling problems when an organization tries to measure everything.
- Most PMS do not have a procedural framework to guide the process of performance measurement and management.
- In today's changing business trends, organizational boundaries are less significant. Organizations work within networks or business chains but the PMSs are designed mostly for function-centric organizations.
- Most often, they are not linked to decision-making mechanisms.

### **1.1.2 Research agenda**

In view of the above mentioned challenges, the research problem addressed deals with the issue of performance and risk assessment in business processes in an overarching sense. In performance measurement terms, being complete signifies measuring everything and every aspect of performance, which puts extra burden in terms of efforts and money on organizations, which in turn questions the viability of the performance measurement and management process. Building on the literature review and changing business trends, the research aims to develop:

*A performance measurement and management system to assist decision makers in the assessment of business processes while relying on two global performance indicators: value and risk. The global performance and risk indicators will then be used to assess and rank several courses of action (i.e. alternative business processes) on the basis of desirability or undesirability in the decision-making context.*

The choice of only two indicators, value and risk (out of the four mentioned earlier – benefits, cost, value and risks), is to facilitate the decision-making process. Moreover, the value and risk indicators model the expectations of business process stakeholders and the uncertainty surrounding the expectations fulfillment.

### **1.1.3 Methodology**

The purpose of the dissertation is to develop a performance management system to help the assessor of business processes to model stakeholder expectations in an uncertain and conflicting situation and then to propose a solution from a set of candidate solutions that deliver value in congruence with stakeholders' values. Thus, this dissertation is the result of a methodological work and the proposed method is developed in the form of value and risk based performance management approach which, again, could be generalized to a more generic cost/benefit/value/risk method.

The study has been carried out in six phases over the last three and a half years. Meanwhile, these phases did not exactly roll out in the chronological order given below but used to switch phases overtime.

The first phase of the research work aims to identify and understand the requirements needed to develop a performance measurement and management system. In this phase, extensive literature review with regard to performance measurement is performed. The characteristics of performance indicators and their design requirements are identified. Moreover, the existing performance measurement systems are critically studied in order to find their strengths and weaknesses.

The second phase of the research focuses on risk analysis and assessment in the context of business processes. Different tools and techniques for qualitative and quantitative risk assessment are studied. In addition to the risk assessment techniques, the risk factors and types of risk factors relevant to business processes are identified and assessed.

The third phase of the research deals with performance and risk assessments on a common ground. To this end, the activity concept is chosen as the federating element from which to account for and assess both performance and risk of a given project. This arouses the problem of risk integration into the process models, which is then solved by employing a process aware approach to risk management.

The fourth phase of the research focuses on the modeling and simulation phase. Herein, modeling and simulation tools and techniques are studied for their strengths and weaknesses and analyzed to see whether they are capable to respond to the problem at hand.

The fifth phase identifies several methods for the purpose of value and risk function development for each individual performance measure in the decision-making context. The literature review identifies two major decision-making techniques: MACBETH and Choquet Integral. The former is used to develop value and risk functions employing utility theory while the latter is used to aggregate the individual value and risk functions to form global value and risk indicators.

The sixth and final phase of the research is the experimentation and validation phase. To this end, a case study, regarding the industrialization phase of a manufactured product is proposed and different simulation scenarios are developed under different sets of conditions. The results obtained are then analyzed, which confirmed the validity of the proposed value and risk based performance management system.

## **1.2 Contributions of the thesis**

This section highlights the contributions and limitations of the doctoral work.

### **1.2.1 Significance of the study**

Addressing the issue of value and risk management in a business process context is a challenging task since both the value and risk concepts are difficult to conceptualize and operationalize. Furthermore, the overall value of a business process is a balance of many but conflicting objectives quantified in terms of performance measures. Conceptualization of these objectives to determine these values is well-thought well-structured in the decision-making (DM) and the requirements engineering (RE) disciplines. However, operationalization of value is only possible in the business process context, which is not addressed in the DM discipline and not well-documented in the RE discipline.

This dissertation proposes a methodology whereby the conceptualization and operationalization of value for the purpose of decision making is made possible in a coherent manner. Since the methodology guides the risk assessment process and the performance assessment process on a common basis, the activity, thus helping the assessor of the business process to assess it in an integrated way.

In addition, the use of utility theory in combination with performance measurement in the business process context is the most promising contribution of the current dissertation. The whole approach right from the beginning to the end is integrated in a seamless manner to provide useful information for the purpose of informed decision making. Moreover, it identifies the success areas or factors and the means to improve these process areas in order to improve the overall value of the business process.

Finally, the proposed performance management system facilitates the decomposition of general objectives representing stakeholders' expectations into more concrete objectives for performance measures elicitation and assessing them in the business process models and simulation environment. To make the decision making simple, the method proposes the use of an aggregation approach to consolidate the individual values and risk functions into global value and risk indicators.

### **1.2.2 Limitations of the study**

Although the dissertation proposes a value and risk based performance management system for a business process assessment which facilitates performance management and decision making, the method has some limitations in the implementation phase.

Because the method relies on simulation approaches for performance management, it takes some time to prepare a simulation experiment in terms of data collection, process modeling and process validity. Furthermore, a process modeler and simulation expert is needed to carry out the measurement and management process in addition to the decision maker.

Moreover, eliciting accurate performance measures to reflect corresponding objectives is a tedious task which is prone to error due to subjectivity on the part of the assessor. For instance, the maturity of a business process can be measured using constructed performance measures, but there lies a risk of losing the sense of process maturity. Furthermore, it depends on how the assessor views process maturity in that particular context.

### 1.3 Thesis organization

The thesis document is structured around three major parts comprising six chapters as illustrated in Figure 1-1. Part 1 critically reviews the literature regarding performance as well as performance measurement systems. The deliverable is a state-of-the-art study on the domain of performance measurement. Part 2 relates to the review and selection of tools and techniques for developing a value and risk based performance measurement and management system. The third and final part of the thesis presents the contribution of the research work and the application of the proposed performance management system for the purpose of validity.

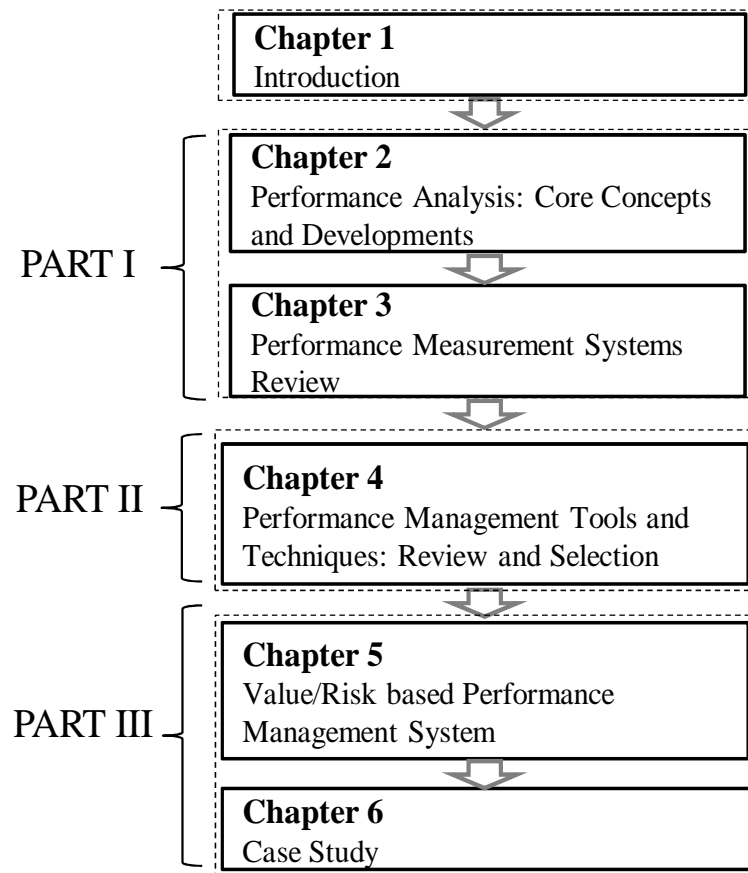

**Figure 1-1: Thesis structure**

Following the introductory chapter of the dissertation, Chapter 2 reviews the existing literature about the performance field and investigates the relevant trends and the corresponding performance concepts in a broad perspective. It touches on the financial and non-financial aspects of performance and its evolution, which led to the progressive migration from mono-criterion to multiple criteria, multiple stakeholders and multi-echelons performance measurement systems. It also discusses the role and purpose of the performance measurement and management systems. The chapter concludes with presenting the emerging trends and the relevant concepts.

Chapter 3 describes few of the well-known existing performance measurement systems developed in response to the inadequacy on the part of the accounting-based measurement systems. The chapter discusses their strengths and weaknesses with regard to the contemporary performance issues. It synthesizes and evaluates them

against the identified performance concepts required to develop a contemporary performance measurement and management system.

Chapter 4 specifies, on the basis of the literature survey, the requirements for a new contemporary performance measurement and management system. To this end, the chapter embarks on the review and selection of tools and techniques appropriate to meet the specified requirements in the requirements specification sheet. The main theme is to choose tools and techniques for transforming the expectations of the stakeholders into quantifiable value indicator in the backdrop of uncertainty.

To evaluate the performance of any business process on the basis of global value and risk indicators, a new performance management system called Value-Risk based Performance Measurement and Management System (VR-PMMS) is developed in Chapter 5 that makes use of the tools and techniques identified and selected in Chapter 4. The proposed VR-PMMS seamlessly integrates different performance evaluation concepts and corresponding constructs from diverse domains into a single framework to meet the requirements of a robust performance management system.

Chapter 6 is dedicated to test the validity and suitability of the proposed performance management system. For this reason, a case study in the manufacturing domain is chosen. The proposed VR-PMMS is then applied to two manufacturing case studies, which confirm its validity and suitability.

The conclusion presents a synthesis of the research works carried out. It identifies and proposes future research objectives and directions. In addition, the conclusion comments on the limitations of the proposed value and risk based performance measurement and management system.



---

**Part I**

**Performance Measurement and  
Management: Literature Review**

---





## Chapter 2 Performance Analysis: Core Concepts and Developments

**Y**ou can't manage what you can't measure". It is an old management adage which remains equally true today. Therefore, measurement is fundamental to management effectiveness. Performance measurement is at the heart of management for controlling, reporting as well as learning and improvement. Performance measures, as fundamental tools of performance measurement processes, can articulate organizational purpose and strategy. Potentially, they identify key aspects of organization value chains that direct organizations towards achieving their strategy and goals. To explicate these objectives, making use of performance measurement and management (PMM), organizations should first explicitly design, develop and implement performance measurement and management systems on well-defined and elaborated concepts that constitute the system.

Hence, this Chapter is dedicated to investigate and define explicitly the underlying concepts from the literature which form the basis of PMM. The idea is essential in the sense that the language in the field of PMM is widely but loosely used. In addition, the word performance is used across a range of bodies of knowledge in the literature including strategy, operations management, accounting, marketing, finance and even sociology with more or less the same meaning but in different perspectives, thus making the words and the concepts around it more ambiguous.

To develop performance measurement and management systems, it is mandatory to strip away the superfluous terminology and define explicitly the concepts which mean different interpretations to different stakeholders in the intra and inter-organizational settings. Moreover, each performance measure in the PMM system should be clearly defined so that all stakeholders understand and interpret the measure in a similar fashion, *i.e.* apprehend the *raison d'être* of the measure the way it is evaluated and preserved. A poorly defined performance measure will create a lot of misunderstanding by different people and will lead to unnecessary conflicts among stakeholders.

In addition to the concepts that need to be defined explicitly for performance measurement and management design, there is also a need to determine factors which force organizations to shape their performance measurement and management systems. Identification of such factors or trends is imperative as these trends are the driving forces behind the evolution of performance measurement and management discipline and help identify the challenges for the future shaping of PMM systems.

### 2.1 Performance literature overview

Performance measurement is an old field of study but it has been practiced for over 500 years in commercial organizations. Luca Pacioli first introduced the double entry accounting system to record the transactions for the merchants of Venice (Kempf-Leonard, 2004). However, major developments in the field started in the industrialization era, which continues to the present day. These developments have contributed new performance concepts that in turn forces PMM to adopt the newly introduced concepts in order to respond to the changing global business trends. Hence, PMM never stands still but continuously evolves. Figure 2-1 shows the relationships between business trends, performance concepts and performance measurement systems.

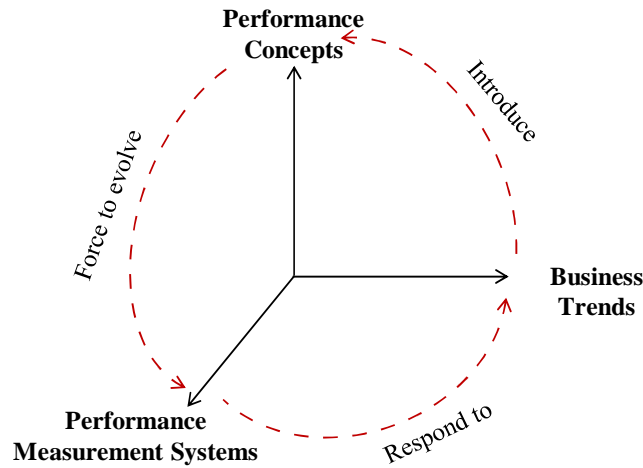

**Figure 2-1: Global business trends and performance measurement & management**

The next section briefly describes the term performance and its major facets in general before embarking on the synthesis of the performance measurement and management literature.

### 2.1.1 The word “Performance” in the literature

Performance is a recurrent theme, widely and loosely used in all fields of management. Although it has become the mantra of recent years in almost all organizations, a clear and explicit definition is still missing (Franco-Santos *et al.*, 2007). Lebas (1995) states “*Few people agree on what performance really means: it can mean anything from efficiency, to robustness or resistance or return on investment, or plenty of other definitions never fully specified*”.

Vernadat (1996) defines performance to be a triptych of organization, competence and motivation as shown in Figure 2-2.



**Figure 2-2: Performance triangle (Vernadat, 1996)**

In the industrial context, several authors have tried to equate performance with effectiveness and efficiency (Neely *et al.*, 2005), effectiveness, efficiency and relevance (Jacot, 1990) (as illustrated by Figure 2-3) or effectiveness, efficiency, effectively and relevance (Bescos, 1995).

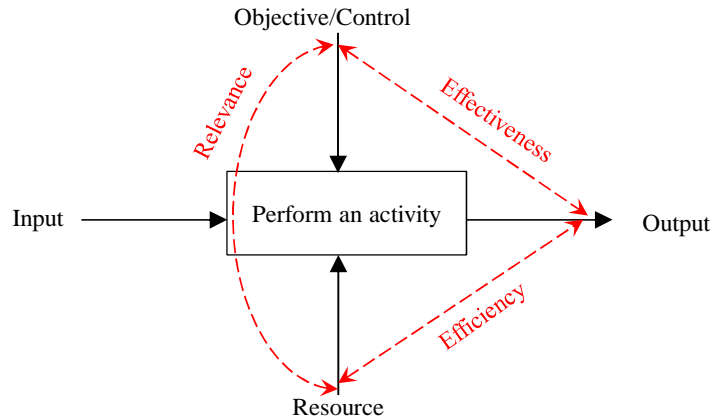

**Figure 2-3: Performance triptych of effectiveness, efficiency and relevance (Jacot, 1990)**

Figure 2-3 shows the relationships between the performance concepts in IDEF0 formalism. Here, effectiveness relates the output (or result) with the objective of an activity to indicate “whether the system is doing the right thing”. Similarly, efficiency is the ratio of the output with the resources consumed in order to measure “whether the system is doing things right”. In addition, the relevance concept of performance reflects the appropriateness of the objective with the resources consumed to determine “whether the resources used correspond to the objective”. Finally, “effectivity” as defined by Senechal (2004) is the balance of objective, resources and the output produced with regard to the finality of the organization.

In management terms, performance evaluates the realization of organizational objectives. It interchangeably employs different terms such as “performance management” (Neely, 1999; Taticchi, 2010); “performance evaluation or measurement” (Merchant and Stede, 2007) and “performance appraisal” (David, 1994) to describe the performance capturing process.

In addition to the word performance, similar other terms have been used in the literature still referring to the performance concept. For instance, the word “success” in the similar conceptual sense as performance has been used (Cantner *et al.*, 2011). Contrary to performance, which could be either positive or negative, the word “success” is always a positive concept. It may either be present or absent. However, the use of the word for conceptualization of performance is very limited.

Value is another loosely used term in the literature alluding to the performance concept. The value concept originates from “value of money”, first referring to financial and product exchanges (Anderson *et al.*, 2000) but soon having a broader sense. Especially, the strategy literature describes the value chain model of Porter (1998) and terms it source of competitive advantage. However, the value chain still focuses on cost aspects and, hence, interprets the concept of value financially. A contrast can be drawn between performance and value as performance refers to some form of achievement while value alone does not.

In short, performance is an elusive term. Bourguignon (1995) calls it a “*suitcase word*” in which everyone places the concept to suit them, letting the context to take care of the definition (Neely, 2002, p. 67), hence making the performance concept contextual (Neely, 2007, pp. 322).

## 2.1.2 Different aspects of performance

This section takes apart the concept of performance in general and divides it in two broad aspects: financial and non-financial ones as often found in the performance literature (Dossi and Patelli, 2010; Ittner and Larcker, 1998; Venkatraman and Ramanujam, 1986). When explaining performance concepts, the explanation is often based on performance measures as they are the manifestation of performance or more precisely the descriptors of different aspects of performance.

### 2.1.2.1 Financial aspects of performance

Financial aspects of performance are often concerned with the shareholder view of performance. The earliest concepts of performance investigated are financial ones and there exists substantial management accounting literature dealing with measuring it in monetary terms (Hornngren *et al.*, 1999; Kaplan, 1984) using financial measures for instance: income, return on investment (ROI) or economic value added (EVA). An early example from the general management literature that focuses on financial measures is the one of Ridgway (1956) focusing upon return on investment, while later Bacidoreet *al.* (1997) in their article turn EVA the best financial measure in terms of its correlation with the shareholder value measures. The recent publicity surrounding the EVA measure as an overall measure of company performance can be seen as sign of new emphasis on the financial aspects of performance (David, 1999).

Researchers and practitioners have investigated in depth the financial performance of organization, which has led to the developments of contemporary practices such as activity-based costing (ABC), economic value added, customer profitability analysis (Abdel-Maksoud *et al.*, 2005). Even though the accounting practices helped to shape the performance measurement of organizations over a considerable period of time and continue to contribute to the performance discipline, it has however serious drawbacks. It falls short of capturing the actual performance of an organization.

Generally, financial performance refers to the future cash flows which are discounted to present value (Franklin, 1988). Marshal Mayer (2003) comments on the financial measures and states that future cash flows, by definition, cannot be measured. What is really measured is past cash flows. Therefore, it can be concluded that financial performance is based on lagging performance measures. The leading performance measures are the non-financial measures or operational measures, which are forerunners of future cash flows (Ittner and Larcker, 1998).

### 2.1.2.2 Non-financial aspects of performance

In any organization, at the most senior levels, financial measures are inevitably a major consideration but at the lowest levels of the organizational hierarchy, especially at operational and tactical levels, non-financial or operational performance measures are commonly used to capture the performance. The “relevance debate” (Johnson and Kaplan, 1987; Johnson, 1992) has considerably changed the landscape of performance by reorienting the performance discipline more towards non-financial measures for the purpose of overcoming the perceived limitations of financial measures.

The interest in operational measures can be attributed, to a large extent, to the performance initiatives such as lean enterprise practices, just-in-time (JIT) or total quality management (TQM). The advent of time (Stalk, 1988) or flexibility (Slack,

1983) as competitive variables in addition to quality (Deming, 1982) gave an impetus to the importance of non-financial aspects of performance.

There is scarcity of research that could establish a direct link between non-financial measures usage in the performance improvement initiatives and enhanced performance. Ittner and Larcker (1998) has investigated the link of customer satisfaction to high accounting performance and argued that non-financial performance measures are prelude or leading performance measures. Empirical evidences consider the usefulness of non-financial measures in the operation management (Bhimani, 2006). Some studies report usefulness of non-financial performance measures in the manufacturing settings (Chenhall, 1996; Abernethy and Lillis, 1995; Symons and Jacobs, 1995). However, some studies contradict the previous claims and report no association of non-financial measures with enhanced performance (Perera *et al.*, 1997). But Chenhall argues that it is important to note how performance measurement systems were examined and disagree with Perera on the implementation mechanism of performance measures (Bhimani, 2006).

To conclude, non-financial measures of performance are widespread in and across organizations and, according to Chenhall (1996), are more widely adapted in advanced manufacturing settings such as just-in-time, total quality management and flexible manufacturing settings. Moreover, insights from different non-accounting disciplines have contributed significantly to the non-financial aspects of performance. However, there seems to be a consensus that improved performance can only be achieved when used with financial measures of performance (Stern *et al.*, 2001; Johnson and Kaplan, 1987).

## **2.2 Performance measurement and management (PMM)**

The central theme of performance literature is performance measurement for the purpose of management. This section of the literature review defines and analyzes the key concepts that constitute performance measurement and management processes. The clarity of fundamental concepts is necessary as people often confuse performance indicator, performance measure and performance metrics. Data or information such as *number of on-time product delivery* is often mistaken for performance indicator. Although it provides some information to the management, it cannot be classified as a performance measure because it does not provide information about the efficiency, effectiveness or efficacy (*i.e.* performance) of the process. In addition, performance measurement is confused with performance measurement system. These and some other themes will be brought under discussion in the next sections.

### **2.2.1 Performance indicators and definitions**

Performance indicators (PIs) are descriptors of performance and vital tools for organizations for the identification of the degree that an objective has been achieved. Neely (2005) defines performance to be “*a metric used to quantify the efficiency of and/or effectiveness of an action*”. This definition, although produced after reviewing the literature on performance measurement, has some limitations. For example, it does not take into account the qualitative aspect of performance such as innovation (Rosenberg *et al.*, 1992) or customer satisfaction which cannot be viewed from such a mechanistic and operational viewpoint.

According to AFGI (which is the French association of production management), a performance indicator is a quantified data which describes the effectiveness or efficiency of the whole or part of the system (real or simulated) with reference to a norm, plan or objective in the context of company strategy (AFGI 1992). A similar definition of the performance indicator has been proposed by Fortuin (1988). This definition contextualizes the performance indicator but still focuses on the efficiency and effectiveness elements.

Berrah (2002) takes on the definition proposed by AFGI and elaborates it further by decomposing it into three distinct facets (cf. Figure 2-4):

- Objective Determination: Linking an objective to a performance indicator,
- Performance Evaluation: Compare the measure with a predefined objective,
- Performance Appreciation or Analysis: Analyze performance in the context in which the process is carried out.

The first facet defines objectives for the process or system under consideration. Performance is then determined with reference to the clearly defined objective(s).

The second facet of the performance indicator compares outcome with determined objectives using a performance measure or metric and, hence, evaluates performance of the system under study. Performance evaluation is carried out by transforming performance metrics into commensurable performance expressions for ulterior evaluation and aggregation.

The third facet is for the purpose of performance analysis. It makes possible, on one hand, to validate the performance measure whereas, on the other hand, it analyzes the performance in the context in which the process is carried out.

In short, Berrah defines a broader role for performance indicator than simply a tool that quantifies efficiency or effectiveness of a process or system. The evaluation facet relies on systematic mechanisms for capturing the qualitative aspects of performance while relying on fuzzy theory. Briefly, the performance indicator model provides both a procedural and structural framework to evaluate and analyze the performance.

In order to integrate the concepts of evaluation (to pass a judgment on desired performance) with appreciation (contextualization and validity of the measure) in addition to objective in the performance indicator, Berrah proposes the following definition of a performance indicator:

*“Performance expression, less or more valid, described in the way with regard to the global objective, appreciated with reference to the context in which the activity, process or considered system is carried out”.*

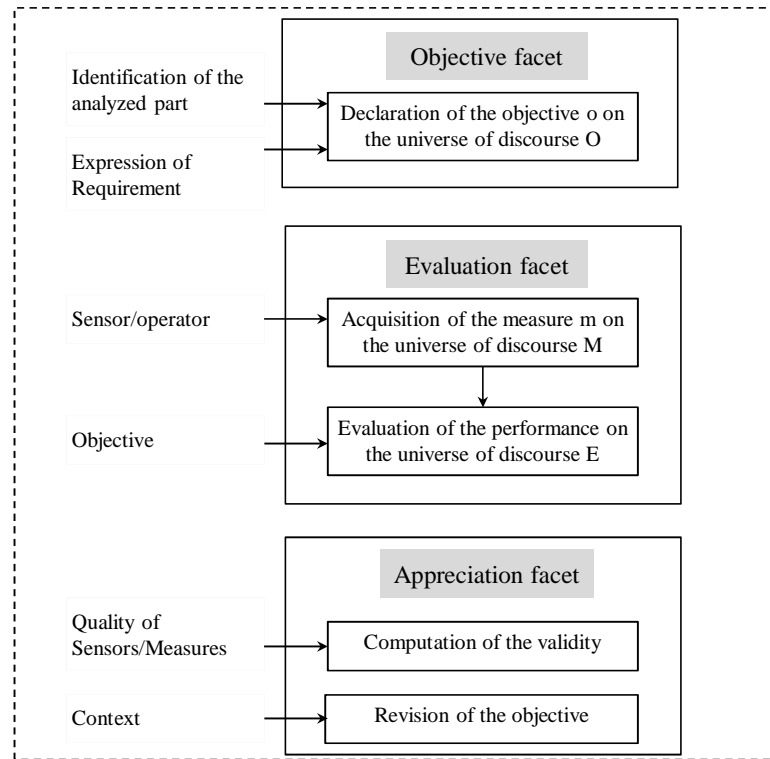

**Figure 2-4: Performance indicator model (Berrah, 2002)**

Before winding up the discussion on performance indicator, it is necessary to briefly discuss the difference among performance metric, indicator and measure, which are used interchangeably in the performance literature.

**Performance indicator:** It “expresses or interprets” a level of performance but does not claim to “measure” it. For example, to assess customer satisfaction, the performance indicator will give an indication of how much the customer feels but it will never “measure” the customer satisfaction in its totality. However, employing the approach proposed by Berrah (2002), the performance indicator can transform the qualitative performance into a quantitative scale, which will indicate the level on some ordinary scale of  $[0, 1]$ , where 0 indicates no satisfaction at all while 1 means complete satisfaction.

**Performance measure:** It is fundamental to performance indicator and should not be used interchangeably. It refers to the description of elementary performance expression which can be measured (quantitatively).

**Performance metric:** It is a narrower term than performance indicator or measure. It refers to quantitative or decimal scale of performance measure. However, in the performance literature, it is often used interchangeably with performance measure (Gunasekaran *et al.*, 2001; Hausman, 2004).

Moreover, performance criteria are used in the literature referring to performance measures (Parnell *et al.*, 2010). In the context of decision making, they are used to evaluate alternative courses of actions and are derived from fundamental objectives. Additionally, attribute is another synonym for performance criteria or performance measure in the decision sciences (Keeney, 1994).



### 2.2.2 Performance measurement

Traditionally, performance measurement is defined as the process of quantifying the effectiveness and efficiency of actions (Neely *et al.*, 2002). In other words, process measurement is the process of determining how successful organizations or individuals have been in attaining their objectives (Evangelidis, 1992) employing performance indicators/measures.

In modern business management, performance measurement assumes a far more significant role than quantification of efficiency and effectiveness. It provides important feedback information in the form of performance measure to enable managers to monitor and improve performance, reveal progress, diagnose problems, enhance motivation and communication (Waggoner *et al.*, 1999). However, it can play a significant role only if performed in a systematic and balanced way. For this purpose, performance measurement frameworks and systems are developed.

### 2.2.3 Performance measurement systems (PMS)

Researchers and practitioners have sought to broaden the measurement base of performance measures to provide an integrated set of measures that establishes a business model of the organization. This approach has been developed in France as so-called “Tableau de bord” (Lebas, 1994) and elsewhere as Balance Scorecards (Kaplan and Norton, 1996) or performance prism (Neely *et al.*, 2002). These developments have moved performance measurement from a simple diversity of both financial and non-financial measures to more complex frameworks and systems based on a balanced suit of measures that explicitly link these measures to strategy (Bhimani, 2006).

Globerson (1985) defines a performance measurement system to be a systematic way of evaluating the inputs, outputs, transformation and productivity in manufacturing or non-manufacturing operations. Bititci *et al.* (1997) term it an information system that can be used to monitor performance, identify areas that need attention, enhance motivation, improve communication and strengthen accountability (Neely *et al.*, 2002). For Neely *et al.* (2005), PMS is the set of metrics used to quantify both efficiency and effectiveness of actions.

The basic requirements for a successful PMS are two frameworks in addition to other performance measurement tools such as lists of performance measures (Folan and Browne, 2005). The two frameworks are:

- A structural framework, which specifies a typology for performance measures management, and
- A procedural framework, which proposes a step by step process that assists in developing performance measures from strategy.

The Balanced Scorecards (Kaplan and Norton, 1992) provide a structural framework based on four perspectives namely, financial, customer, internal business and learning and growth. An additional procedural framework (Kaplan and Norton, 1996) was developed to apply balanced scorecards as a system. The four stages of the framework are:

- Translating the vision
- Communicating and learning
- Business planning

- Feedback and learning

In view of the above discussion, we reformulate the definition of a performance measurement system as:

*A performance measurement system is a set of structural and procedural frameworks as well as measurement tools, i.e. performance indicators used to analyze and assess the qualitative and quantitative aspects of performance.*

#### 2.2.4 Performance measurement and management

Further to existing research on performance measurement, the term “performance management” is also used. Often the two words are used interchangeably. However, there exists a conceptual difference between performance measurement and management.

Performance management, unlike performance measurement, involves actions of planning and controlling performance. This view on performance management is widely supported in the literature (Lebas, 1995; Kaplan and Norton, 1996; Bourne *et al.*, 2003). Bititciet *al.* (1997) draw a clear distinction between performance measurement and management as they call the former to be an information system which enables the latter to function effectively and efficiently. Further to Bititciet *al.* (1997), Radnar and Barnes (2007) suggest feedback control in performance measurement systems to make each of them a management system.

A performance measurement system, therefore, collects relevant information about different processes at different organizational or process hierarchical levels and feeds it in the organization hierarchy at an appropriate point. Hence, there is a notion of feedback loop for the purpose of decision making and control in the performance management process.

Amaratunga and Baldry (2002) define performance management as *the use of performance measurement information to effect positive change in organizational culture, systems and processes, by helping to set agreed upon performance goals, allocating and prioritizing resources, informing managers to either confirm or change current policy or performance directions to meet these goals, and sharing results of performance in pursuing these goals.*

Lebas’s conceptualization (1995) suggests that performance measurement and performance management follow one another in a virtuous spiral (see Figure 2-5).

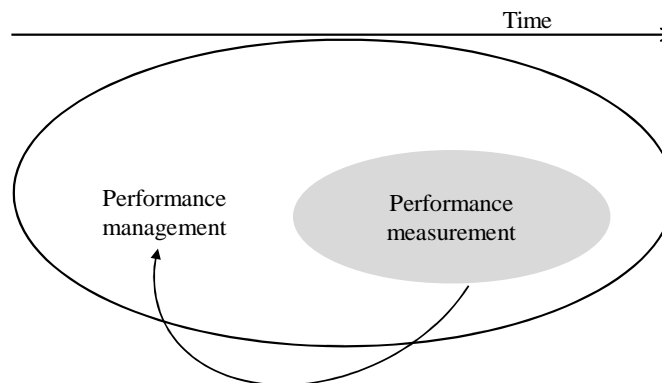

Figure 2-5: PM&M interrelationship (Lebas, 1995)

In this spiral management both precedes and follows measurement and, in doing so, creates the *context* for measurement as shown in Figure 2-5.

From the concepts described above in relation to measurement and management, it can be concluded that performance measurement is a subset of performance management. Moreover, to differentiate the two concepts on the basis of planning, control and feedback, some literature suggests drawing a difference line on the basis of whether they influence performance. Halachmi (2005) has highlighted that performance measurement alone cannot change performance. However, performance management employing planning and controlling action on the basis of performance measurement can change performance.

### **2.3 Evolution of performance measurement literature: Operations management perspective**

Performance measurement and the relevant concepts never stand still. The journey that started from the accounting domain loses its relevance over the passage of time due to the changing nature of industrial, business and social trends. Insights from non-accounting domains such as operations management, marketing, human resource management and corporate strategy have broadened the role for performance management in organizations (Chenhall and Langfield-Smith, 2007). Even though, these disciplines have considerable impact on the overall performance of the organization but field of inquiry for current research work is operations management.

Operations Management primarily deals with the management of production processes and is often referred to as production management and more recently world class manufacturing. However, principles of operations management are equally applicable to service organizations. Performance measurement and management in this discipline have developed over a number of phases as follows.

- Pre-1980: Productivity Management and Budgetary Control
- 1980-2000: Integrated Performance Measurement
- 2000- present: Integrated Performance Management

Each of the above periods will be briefly discussed in the context of trends, which ultimately lead to new performance concepts. This literature review about the evolution of the performance measurement and management domain is mostly adapted from literature such as (Neely, 2002; Kempf-Leonard, 2004; Nudurupatiet al., 2011; Bititciet al., 2011). The purpose is to identify key themes that shaped performance measurement and management over the period of time.

#### **2.3.1 Productivity management: Pre-1980**

The second industrial revolution that started over a century ago can be typified by labor specialization (Taylor, 1911) and mass production (Ford, 1922). Taylor's theory of scientific management addresses the problem of productivity for individual workers (Kempf-Leonard, 2004, pp. 228). The emergence of multiple plants brings with it organizational and managerial complexities which led to the concepts of divisional and departmental budgets (Chandler, 1977).

In the early stages of globalization, demand surpassed supply and mass production was the mode of production, the dominant management paradigm appeared to be sale and productivity improvement practices rather than customer (Neely, 2002; Suzuki,

1987) with more focus on financial indicators (Johnson and Kaplan, 1987) such as cost, productivity and ROI. The performance view during this period can better be captured from Andrew Carnegie's maxim "Watch the costs and the profits will take care of themselves".

During the 60's and 70's, some authors and practitioners questioned the veracity of financial based performance measures and demanded for a broader view of performance measures in the face of new trends that took place during that period (Kaplan, 1984). As a result, new aspects, mostly non-financial such as flexibility (Slack, 1983), speed (Stalk, 1988), quality and customer satisfaction (Deming, 1982), appeared on the performance measurement arena. These developments turn the performance measurement field into a multi-dimensional one (Hayes and Abernathy, 1980; Skinner, 1973; Kaplan and Norton, 2000). This paradigm shift in the performance measurement arena led to the development of integrated and balanced approaches for performance measurement (Johnson and Kaplan, 1987; Kaplan and Norton, 1992).

### **2.3.2 1980-2000: Integrated performance measurement**

Following the developments that took place in the previous phase in addition to Japan's economic success, which Hayes and Abernathy (1980) attributed to the operational efficiency and effectiveness of Japanese companies, accounting-based performance measurement still pervaded the industry, and created widespread dissatisfaction across industries.

The use of financial criteria for measuring performance was widely criticized: historically focused (Dixon *et al.*, 1990); provided little indication of future performance and encouraged short-termism (Hayes and Abernathy, 1980); internally rather than externally focused, with little regard for competitors or customer (Kaplan and Norton, 1996); lack strategic focus (Skinner, 1969, 1973); and often inhibited innovation (Richardson and Gordon, 1980). This sharp criticism on traditional performance measures forced academia and practitioners to rethink and overhaul performance measurement systems because cost-based systems were insufficient for effective management of business in rapidly changing and highly competitive environments (Bourne *et al.*, 2003).

The criticism from academia and dissatisfaction of practitioners reported during this period led to the performance measurement crisis. Subsequently, people started to look for new cost accounting systems and integrated performance measurement systems. Activity-Based Costing was developed to calculate more accurate cost absorption (Brimson, 1997). To have a balanced view of the performance by including different dimensions especially non-financial performance measures, the Balanced Scorecards method was developed (Kaplan and Norton, 1992, 1996, 2000). In addition, many other performance measurement systems, especially integrated performance measurement systems, were developed in the 90's such as ECOGRAI (Bitton, 1990), SMART (Lynch and Cross, 1992) and Performance Prism (Neely *et al.*, 2002).

### **2.3.3 2000- Present: Integrated performance management**

Following the boom of integrated performance measurement frameworks and systems in the last decade of the 20<sup>th</sup> century, a fundamental question was unanswered: How performance measures should be used to manage the performance

of organizations (Bourne *et al.*, 2000)? This line of thought led to establishing performance management as a process in which performance measures are used to facilitate the management of organization performance (Lebas, 1995; Bititciet *al.*, 1997; Kennerley and Neely, 2003). Lebas (1995) defines performance management as a philosophy which is supported by performance measurement. The research work during this period identified other factors that influence organizational performance such as system maturity, decision making based on measures, organizational structure, size and culture, management style or information and communication (Franco and Bourne, 2003).

In this phase of evolution, researchers focused on managing the performance of different processes such as research & development (R&D) and innovation (Adams *et al.*, 2006; Chiesa and Frattini, 2007; Chiesa *et al.*, 2009), supply chain and collaborative networks (Chan and Qi, 2003; Ganga and Carpinetti, 2011; Hernández-Espallardo *et al.*, 2010; Lauraset *al.*, 2011; Clivillé and Berrah, 2011).

A group of researchers has also studied performance management from the small and medium-sized enterprise (SME) perspective. They argued that the performance measurement frameworks do not take into account the fundamental difference of managerial culture and management systems that exist between large organizations and SMEs when developing performance measurement systems and which cause dysfunctional performance practices (Garengo *et al.*, 2005; Taticchi, 2010).

In brief, the last three decades have witnessed considerable development in the field of performance measurement and management. Issues identified before and during the 80's were addressed in the form of integrated performance measurement models and systems. However, the performance field is a dynamic one because trends in business force it to evolve continuously. For instance, contemporary issues of sustainability and green supply chains, collaborative networks particularly in multi-cultural environments, SMEs and so many other factors are not yet presented in the form of holistic performance framework and systems. The future research work will, therefore, be geared to address these issues. Bititciet *al.* (2011) state that the performance-measurement community has three big challenges to address in an integrated manner which are:

- Understanding performance measurement as a social system
- Understanding performance measurement as a learning system
- Understanding performance measurement in autopoietic networks.

Table 2-1 provides a synthesis of the past and future trends and the corresponding performance relevant concepts.

**Table 2-1: Development of the PM literature and global trends (Bititciet *al.*, 2011)**

Development of the performance measurement field and emerging trends								
	Periods of development & corresponding man't systems (Ansoff, 1984)	1900	1920	1940	1960	1980	2000	2020
	Familiar period Procedure and Control		Extrapolable period Management by objectives and long range planning		Familiar Discontinuity periods Periodic strategic planning		Novel Discontinuity periods Dealing with unpredictable	
Rate and scale of change	Slow and incremental		Fast, Predictable and incremental		Turbulent and discontinuous		Disruptive and transformational	
Dominant means of production	Infrastructure owned by the organization		Infrastructure and IP owned by the organization		IP owned by the organization supported by the knowledge-worker		Knowledge and network connections owned by net-workers	
Competitive forces	Unclear mix of all factors dominated by costs		Focus and differentiation		Value propositions		Beings unique in different ways	
Nature of Work	Unclear mix of all factors dominated by costs		Focus and differentiation		Value propositions		Being unique in different ways	
Organizing principles	Autocracy		Bureaucracy		Adhocracy		Netocracy	
Organizational Power	Few powerful individuals		Organizational structure		Processes, process owners and process teams		Individuals an autopoietic teams as innovators and heuristics	

People	Labour-force seen as necessary evil	Human resources seen as assets	Teams assets and investment	Individuals an autopoietic teams as innovators and heuristics
Regulatory System	Contracts, laws and regulations	Contracts, laws, regulation and industry standards	Contracts, laws, regulation industry standards and accepted best practices	Trust, relationships and network standards
Organizational Relationships	Inter-organizational and Adversarial	Inter-organizational and Collaborative	Inter/ trans organizational and Collaborative	Trans organizational, communities of practice
Market dominance	Producer	Cost-conscious customer	Value-conscious, loyal customer	Disloyal, picky, curious, impulse-customer

## 2.4 Multifaceted performance concepts

Performance excellence in one aspect or dimension does not guarantee success of an organization. As pointed out in the preceding section (§2.3), effective performance management can be obtained by incorporating its different dimensions and then determine the compromise among them as excellence in all dimensions simultaneously is nearly impossible keeping in view contemporary managerial practices and technology (Slacket *al.*, 2007). Moreover, performance requirements and measures change across the organization hierarchy. Similarly, performance is relative and means different things to different stakeholders.

### 2.4.1 Multiple criteria

Performance measurement and management involves multi-dimensional attributes, which can be measured in different units. An attribute is a property or quality of process/system in question. To evaluate the process/system, a criterion is setup for each attribute. Because of one-to-one correspondence between attribute and criterion, sometimes an attribute is also referred to as criterion and used interchangeably in the multi-criterion decision analysis.

In order to evaluate and analyze the performance of a process, the most relevant attributes of the process are identified. By relevant, we mean to avoid the measurement crisis-drowning in data- as referred by (Neely, 2002) and to associate a utility with each attribute, which ultimately forms the value function (elementary

performance expression). Multiple value functions are then aggregated to form the overall performance of the process as depicted in Figure 2-6.

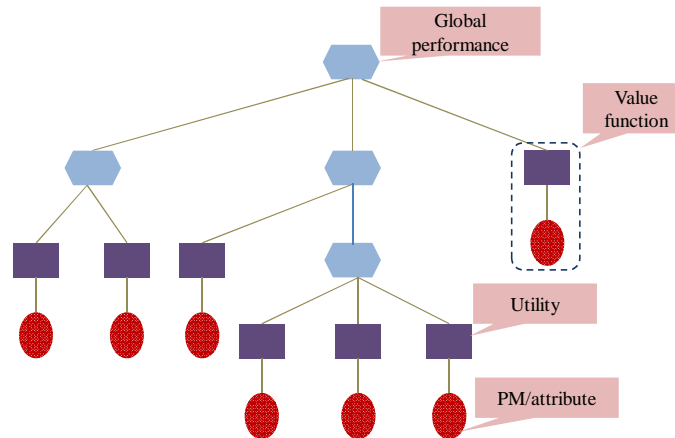

**Figure 2-6: Multiple criteria: hierarchical organization**

In the operations management domain, performance measurement and management can be based on five operation performance objectives (Slack *et al.*, 2007), which ultimately become the criteria for evaluation. To excel in all five performance objectives is tantamount to superior performance. However, it is almost impossible to excel in all these performance objectives simultaneously and there exists a trade off or compromise among them, a concept proposed by Skinner (1969). But the extent of this trade-off is time- and context specific (Neely *et al.*, 2005).

The most important operations performance objectives are quality, speed, cost, flexibility and dependability. A good compromise among these criteria determines superior performance at the operational level (Neely *et al.*, 2005; Slack *et al.*, 2007).

#### 2.4.1.1 Performance measures relating to Quality

Quality is traditionally defined in terms of conformance to specifications. According to (ISO 9000: 2000), quality is “the degree to which the set of inherent characteristics fulfill the requirements”. For Juran and Goldfrey (2003), “Quality is free from deficiencies”. This definition of quality prompts quality measures such as the number of defects produced and the cost of quality. Feigenbaum (2004) argues that the true cost of quality is the function of the prevention, appraisal and failure cost. Crosby (1980) statement “quality is free” is based on the assumption that an increase in prevention costs will be more than offset by a decrease in failure costs.

With the emergence of total quality management (TQM), quality took a broader role than simply “conformance to specifications” as described by (Powell, 1995). Quality emphasis shifted from “conformance to specification” towards “customer satisfaction (Neely *et al.*, 2005). Motwani (2001) identifies more than 45 performance measures of total quality management.

Manufacturing process improvement initiatives, such as six sigma, lean manufacturing and statistical process control, have introduced new ranges of quality related measures. For example, in the six sigma initiative, the highest quality is to achieve six sigma capability meaning  $3.4$  defects per million. Statistical process control measures consist of capability indices, *i.e.* Cp, Ca, Cpk, etc. (Chen *et al.* 2003).



#### 2.4.1.2 Performance measures relating to Time

During the 80's, quality was a well established strategic weapon in the competitive battle (Eccles, 1991) followed by time - a new competitive advantage (Stalk, 1988). In addition, it is one of the essential criteria of operational performance (Slack *et al.*, 2007). Due to its importance in the performance arena, the time notion stimulated academia and practitioners leading to the development of a plethora of techniques such as just-in-time (JIT), optimized production technology (OPT) and throughput accounting (Galloway and Waldron, 2004). JIT is based on the assumption of a precise timing between a supplier and a customer (Iyer *et al.*, 2009). Similarly, the OPT main objective is to minimize throughput times. Galloway and Waldron (2004) developed the notion of throughput accounting employing the theory of constraints. The technique is based on the assumption that throughput in operation is constrained by bottleneck processes.

The most common performance measures related to time are manufacturing cycle time, on-time delivery, time-to- market on new product and so on.

#### 2.4.1.3 Performance measures relating to Cost

Cost-based performance measures have their origin in accounting management. An accounting-based measure called return on investment (ROI) has been developed for Dupont de Neumour to serve as an indicator of the efficiency of their decentralized business units (Kaplan, 1984). In the industrialization age and till the beginning of the globalization era, productivity, a cost-based performance measure, has been widely documented. In response to the severe criticisms on traditional accounting management, Kaplan and Cooper (1997) developed an approach called activity-based costing (ABC). The fundamental assumption underlying ABC is that it is activities, and not products, that cause cost and hence overcome the problem of "invisible cost" that exists in traditional accounting systems.

#### 2.4.1.4 Performance measures relating to Flexibility

Flexibility has been widely recognized as a competitive priority (Slack, 1983, 2005; Meyer *et al.* 1989; Gerwin, 1993). Bolwijn and Kumpe (1990) argue that innovation without flexibility is impossible because innovation involves a renewal process, which is not possible without change. However, confusion over what constitutes flexibility still occurs (Parker and Wirth, 1999). It is a complex, multi-dimensional and hard-to-capture concept (Sethi and Sethi, 1990). Therefore, there is no common definition of flexibility (Nilsson and Nordahl, 1995). For us, flexibility is the capacity of an organization to easily and quickly switch from one type of production to another in the manufacturing context.

Gerwin (1993) proposed a conceptual framework as depicted in Figure 2-7 to understand the relationship between five variables: environmental uncertainties, manufacturing strategy and flexibility, methods and performance measurement. The management uses strategy reactively or proactively to cope with uncertainties. Different manufacturing strategies need different manufacturing flexibilities. A variety of methods, including production equipment, product design, work organization, planning and control systems, material management and information technology can be used to attain flexibility. The role of performance measurement is to make sure that existing flexibility supports the strategy. For more discussion on the conceptual framework (cf. Figure 2-7), the interested reader is referred to the literature (Gerwin, 1993).

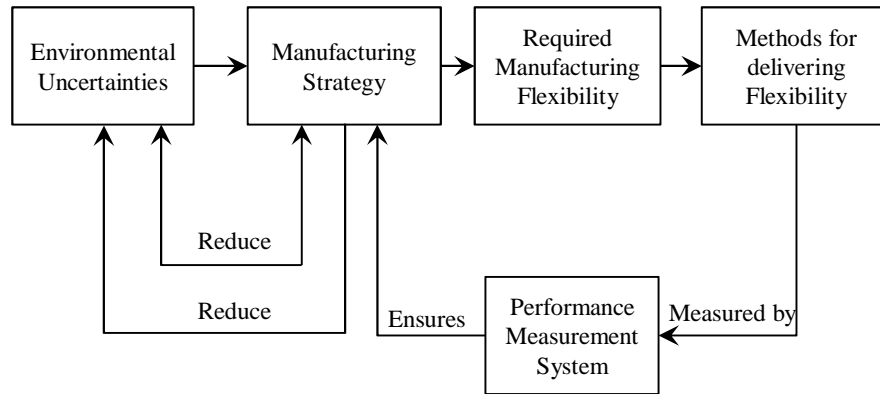

**Figure 2-7: Flexibility conceptual framework (Gerwin, 1993)**

Moreover, Gerwin identifies different dimensions of flexibility and proposes flexibility measures such as mix flexibility, changeover flexibility, rerouting flexibility and so on. He is however of the view that no well-accepted conceptualization of the concept exists.

Due to the difficulty of measuring flexibility in physical units, few authors have investigated the impact of flexibility on performance (*i.e.* on the economic value) (Chenhall, 1996; Graweet *et al.*, 2011). The economic value associated with flexibility is normally the difference between expected profit with flexibility and without it.

#### 2.4.1.5 More performance measures

In addition to the above mentioned performance objectives and their relevant performance measures, other objectives such as dependability, reactivity and interoperability also play an important role in describing organizational performance.

### 2.4.2 Multi-level perspective

Effective performance management cannot be achieved by only selecting the appropriate and balanced set of performance criteria and well defined objectives but also classifying the performance measures at strategic, tactical and operational levels (Gunasekaran *et al.*, 2001). These levels reflect, according to certain hierarchy, the different planning time horizons having their own decision and measurement requirements (Rushton *et al.*, 2010).

The multi-level performance activities can be divided into three broad levels. Each of the level has its own scope in time and space. These levels are:

- Strategic level, which is concerned with the planning of activities in order to achieve the strategic objectives. They determine the nature and scope of the performance measurement by defining what is important, what to measure and how to measure and what level of results to expect (such as low cost product).
- Tactical level, where activities are carried out to refine and implement the plan chosen at strategic level (to respond to low cost, implement JIT production system as an example), and
- Operational level, where operating activities manage the existing processes and systems. The main activities at this level are the day-to-day decision

making, implementation of operational plans and the control of activities against standards and rules.

To synthesize the multilevel concept of performance, Jacot (1996) proposes a multi-level structure for an organization (cf. Figure 2-8). Each level has its own objective, criteria and performance levels.

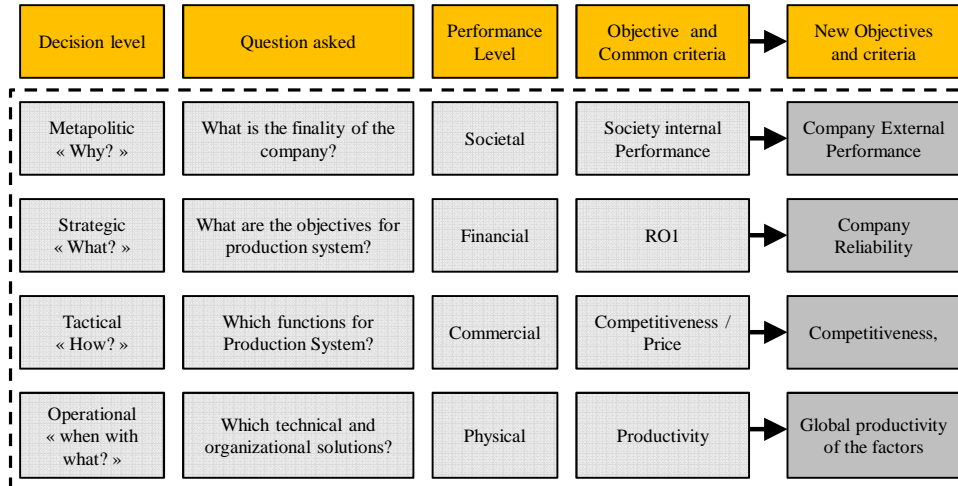

Figure 2-8: Levels of industrial performance (Jacot, 1996)

Operational level measures require accurate data and assess the results of decisions of low level managers (Gunasekaran *et al.*, 2004). At the operational level, performance is closely related to internal operating efficiencies such as input and output measures.

### 2.4.3 Multiple stakeholders perspective

*“The days when organizations survive and prosper by focusing on the wants and needs of one stakeholder-share holder- are long gone. The days when organization could survive and prosper by focusing on the wants and needs of two stakeholders – the shareholders and customers- are also numbered, if not yet already passed”*(Neely *et al.*, 2002, chap. 1).

The attention towards multi-stakeholders has increased significantly in the last three decades. Edward Freeman was the first to define stakeholders as the group of people who can influence or can be influenced by the achievement of company’s objective (Freeman, 1984). It is the responsibility of a company to look for stakeholders’ expectations and strive to achieve these expectations (Atkinson *et al.*, 1997). Failure to address the interests of multiple stakeholders may be detrimental to company performance (Greenley and Foxall, 1997). Therefore, in recent years some authors have incorporated stakeholders’ perspectives in their performance measurement approaches (Bosch-Mauchand *et al.*, 2010; Marques *et al.*, 2011; Neely, 2002).

Even though multiple stakeholder perspectives integration in PM has begun to adopt the stakeholder approach, assessment of stakeholder satisfaction is simple in SMEs due to scarcity of resources (Garengo *et al.*, 2005). In such scenario, organizations prioritize stakeholders and take into consideration those which contribute or have more stakes in the process or project.

## 2.5 Roles and purposes of performance measurement and management (PMM)

The role of performance measurement is best explained by Rose (1995) who states that “*performance measurement is the language of progress for the organization. It indicates where the organization is and where it is heading. It functions as a guide to whether the organization is en route to achieving its goals. It is also a powerful behavioral tool, since it communicates to the employees what is important and what matters for the achievement of the organization’s goal*”.

From Rose’s definition of performance measurement, it can be concluded that a PMS has several roles and purposes. A literature survey further reveals these roles and purposes. Simon *et al.* (1954) classified PMSs according to three categories: scorecards, problem solving and attention directing. Similar categories were addressed by Vandebosch (1999) but added one more category: legitimization (legitimizing decisions). Similarly, Atkinson *et al.* (1997) define three roles for PMSs: coordination, monitoring and diagnosis. Moreover, a few authors have also defined a process improvement role (Bond, 1999; Sahraoui *et al.*, 2007) as well as a learning role (Neely and Najjar, 2006; Davenport and Harris, 2007) for performance measurement and management.

After analyzing the different roles of PMM discussed in the literature, we define monitoring, diagnostic and interactivity, process improvement and learning as the most common roles for performance measurement and management. It is relevant to say at this stage that most often the PMM purpose is to provide information for informed decision-making. The following sections discuss briefly each role of the PMM.

### 2.5.1 Monitoring and controlling role

Monitoring is defined as a feedback system relying on a cybernetic logic where goals are set in advance, output is measured and compared with goals, feedback is provided and, if necessary, corrections are made (Hofstede, 1978). In a monitoring context, a performance measurement system provides information that identifies (Atkinson *et al.*, 1997):

- Realized performance levels on objectives
- Opportunities to improve process performance and to suggest what improvements are required
- Whether existing processes are meeting expectations in terms of how they are contributing to the objectives
- Whether existing processes are achieving their performance potential

Each role is critical to the organization success because these roles ensure continual evaluation and improvement of processes under study. In addition to monitoring, control is yet another function performed by PMM as explained in the literature (Olsen *et al.*, 2007) which says that information obtained from performance measurement through performance measures are needed for monitoring, controlling, evaluating and feedback functions in operations. Berrah (2002) also supports the idea and considers performance measures as tools or instruments for control in management.

### **2.5.2 Diagnostic and interactive role**

The diagnostic role of PMM is, in general terms, the determination of causality between performance factors and process performance (Atkinson *et al.*, 1997; Suwignjoet *al.*, 2000), enabling managers to determine a link between process performance and activities at operational, tactical and planning levels. At the tactical and planning levels, it could be the cause and effect relationship between objectives (such as increased customer satisfaction) and goals (such as profit) or on-time delivery and customer satisfaction at operational and tactical levels.

The all-time monitoring role of PMM is tedious for managers in organizations. Diagnostic information eliminates the manager burden of constant monitoring (Simons, 1995). Once a causality model of PMS identifies the root cause of abnormal behavior, corrections are made once and for all and managers move on to other issues.

The use of performance measurement and management as a tool for diagnosis is supported in the literature (Nilsson and Kald, 2002). They found that Nordic companies use performance management diagnostically and interactively. The idea of interactive use besides diagnostic use is also supported by Simon (1995). One feature of interactive use of PM is that the whole company is involved in the development of strategy.

### **2.5.3 Process improvement role**

Performance management encourages continuous improvement of a process (Dixon *et al.*, 1990; Neely *et al.*, 1996; Bond, 1999; Sahraoui, 2009). According to Berrah (2002), performance measure is the core element of continuous improvement philosophy. According to the Deming's Wheel or PDCA cycle (Plan, Do, Check and Act) (Deming, 1982), performance measure examines the effect of changes to see if the desired result is achieved. The aim is to correct the cause not the symptom for the purpose of eradicating it permanently and so to bring in permanent improvement (Bond, 1999).

### **2.5.4 Learning**

The ultimate goal of performance measurement should be learning rather than control (Davenport 2006). Neely and Najjar (2006) also emphasize the learning role of performance measurement. It is commonplace practice and perception that performance measures are means to track progress of a process and make sure that process is unfolding in the right direction. In essence, this is the fundamental philosophy of performance measures that underpins ideas of management control. Employing performance measures to obtain performance insights and then building this insight to achieve high performance should be the objective of any organization. Comparison forms the basis of learning and control loops provide the ground for comparison, *i.e.* compare outcome (measure) with objective.

### **2.5.5 Summary of the roles and purposes of PMM**

This section summarizes the roles and purposes of performance measurement and management and presents some new themes where it plays an important role. An overview of the literature is summarized and presented in a tabular form. Table 2 is not exhaustive but includes some of the important roles of PMM.

**Table 2-2: Roles and purposes of PMM**

<b>Roles and Purposes</b>	<b>Literature</b>
Monitoring role	Atkinson <i>et al.</i> (1997), Berrah (2002), Oslen <i>et al.</i> (2007)
Diagnostic and interactive role	Atkinson <i>et al.</i> (1997), Nilsson and Kald, (2002), Simons (1995)
Process improvement role	Berrah (2002), Deming (1982), Sahraoui (2009)
Learning role	Davenport (2006), Neely et Najjar (2006)
Sustaining competitive advantage	Chiesa <i>et al.</i> (2008), Lebas (1995)
Decision making role	Chiesa et Fratini (2007), Shah <i>et al.</i> (2012), Pfeffer and Sutton (2006)
Strategic role	Chris (1977)

## 2.1 Conclusion

This Chapter synthesized the notion of performance with a particular focus on performance concepts, their evolution as well as the roles and purposes of performance measurement and management systems in organizations. The main objective was to highlight the core concepts and themes in order to use them for the development of performance measurement and management systems. Moreover, the Chapter aimed at determining the application of PMM systems in the business environment.

The literature review reveals that the performance concept is widely and loosely used. In the loose sense, it refers to the effectiveness and efficiency of a system/process. However, performance is a broader concept which cannot be measured in its totality. Besides, performance is often divided into two main aspects: financial and non-financial aspects. For an organization to perform well, it should include both aspects of performance in performance measurement and management systems because alone financial or non-financial performance cannot guarantee success of an organization.

In addition, the evolution of performance concepts resulting from changing business trends also comes under discussion in the Chapter. Determination of trends is important as they define new frontiers for PMM systems which, in turn, make them evolve constantly.

Performance is a multi-dimensional, multi-level and multiple stakeholder concept. Aggregation of multiple criteria at different organizational hierarchy levels contributes to overall performance but is viewed differently by different stakeholders. Therefore, it is imperative to consider all these concepts when designing a PMM system for an organization or a collaborative network.

At the end, the roles and purposes of performance measurement and management systems are presented. PMM systems are used for diverse purposes in diverse environments. The applications of PMM in an organization range from controlling and monitoring functions to coordination, diagnostic as well continuous process improvement and organization learning. Performance measurement systems act as

information systems and help managers in their activities of decision-making and reporting as well as for strategy communication.

Since the current Chapter is aimed at explaining the major concepts and themes used in the performance literature, the next chapter is dedicated to review the most popular existing PMM frameworks and systems and identify their strengths and weaknesses.

## **Chapter 3 Performance Measurement and Management (PMM): Frameworks and Systems**

Chapter 2 has examined the literature on core performance concepts and their developments. Moreover, insufficiency and irrelevance of the traditional performance concepts in the changing business environment came under discussion and current challenges to the performance measurement and management discipline were presented. Finally, the literature review also touched on the roles and purposes of performance measurement and management systems.

Chapter 3 continues the state-of-the-art review on performance by reviewing performance measurement and management frameworks and systems developed so far. The objective is to identify the strengths and weaknesses of the existing frameworks and systems and to get some insights for the purpose of developing a new performance management system.

Many reports have been published in the last two and half decades about the development and application of new performance measurement systems. Researchers with diverse backgrounds have developed new performance measurement systems using different approaches. Some use a corporate vision and strategy (Lynch and Cross, 1992) as the starting point for development, others use stakeholder requirements (Bititciet *al.*, 1997) while yet others focus on performance improvement (Clivillé *et al.*, 2007). Although the research has produced significant results, the notion of global performance is still not fully clarified in the literature (Paranjapeet *al.*, 2006; Bititciet *al.*, 2011). The evolution of performance as a result of business and social trends further complicates the issue.

From a review perspective, the existing frameworks and systems can be divided into three broad categories: performance models which propose recommendations, financial-based performance measurement systems and integrated performance measurement systems. The aim of the Chapter is to focus more on integrated performance measurement frameworks and systems and, hence, will analyze them in more details.

### **3.1 Performance models proposing recommendations**

During the “relevance debate”, performance measurement based solely on financial criteria received severe criticism. Researchers and practitioners alike made attempts to offset the inadequacy of traditional performance measurement systems. The inadequacy is related to the dimensions of performance, implementation mechanisms and their adaptation to the new business environment. The results of these attempts partly led to the development of some performance measurement models proposing recommendations on how a good performance measurement system should look like and what characteristics it should have in order to respond to the problems evoked in the relevance debate. In that respect, performance criteria systems and performance measurements for world-class manufacturing frameworks are noteworthy and are discussed in the following subsections.

#### **3.1.1 Performance criteria systems**

A performance criteria system (Globerson, 1985) is not a performance measurement system per se but provides guidelines concerning performance criteria for developing



a performance measurement system. Following are the four recommendations proposed by Globerson for PM system development:

- 1) Choosing the preferred set of performance criteria
- 2) Measuring the chosen performance criteria
- 3) Assigning standards to the performance criteria
- 4) Designing a feedback loop to respond to discrepancies between standard and actual performances

In addition, Globerson gives the guidelines to choose among a preferred set of performance criteria, which has been discussed in (Neely *et al.*, 1997). Moreover, he provides three techniques which could be used for assigning weight (or relative importance) to each performance criterion and he suggests the use of the Analytical Hierarchy Process (AHP) technique of Saaty (2004). He also provides techniques for assigning targets for each performance criterion.

### **3.1.2 Performance measurement for world-class manufacturing**

This framework was developed by Maskell (1991). This is not a performance measurement system in its own right but it is similar to a performance criteria system and it suggests characteristics of a PMS suited to world-class manufacturing. Maskell focuses on developing and measuring different performance measures. He identifies that irrespective of performance measures used for evaluation of performance, which may vary considerably, they have the following seven common characteristics.

- 1) They are directly related to the manufacturing strategy
- 2) They use non-financial measures in addition to financial measures
- 3) They vary with locations (*i.e.* part of a system, department, etc.)
- 4) They are contextual
- 5) They are simple and easy to use
- 6) They provide feedback
- 7) They are used for improvement process rather than a simple control tool

### **3.1.3 Performance management system frameworks**

To move from performance measurement systems towards performance management systems, Ferreira and Otley (2009) put forward a framework that provides a broader view of the performance measurement and control. The framework is designed in the form of 12 questions. The 12-question PMS scheme is outlined below.

- 1) What is the vision and mission of the organization?
- 2) What are the key success factors?
- 3) What is the organization structure and what impact does it have on the use of the PMS?
- 4) What strategies and plans has the organization adopted? What are the processes and activities that it has decided that will be required for it to ensure its success?
- 5) What are the organization's key performance measures?

- 6) What level of performance does the organization want to achieve for each level of performance measure?
- 7) What processes, if any, the organization follows to evaluate performance?
- 8) What rewards – financial and/or non-financial - will managers and other employees get by achieving the targets?
- 9) What specific information flows - feedback and feed-forward -, systems and networks has the organization in place to support the operation of its PMS?
- 10) What type of use is given to feedback and feed-forward information flows and to the various control mechanisms in place? Is use predominantly diagnostic, interactive or a combination of both?
- 11) How has the PMS altered in the light of the change dynamics of the organization and its environment? Have the changes in PMS design or use been made in a proactive or reactive manner?
- 12) How strong and coherent are the links between the components of the PMS and the ways in which they are used

In the above 12 questions, the first eight questions are about the functional issues/questions related to the management of ends (results) to achieve and the management of means (determinants) to achieve these ends, while the remaining 4 issues/questions are related to the contextual issues which guide the way the eight questions are addressed (Broadbent and Laughlin, 2009).

### **3.2 Financial based performance measurement systems**

Even though financial based performance measurement systems and approaches were severely criticized due to their limitations as mentioned in the relevance debate, the accounting domain continues to address the issues of traditional PMSs while solely focusing on the financial aspect. This has resulted into modified performance measurement systems based on the financial aspect of performance such as activity-based costing (ABC) and theory of constraints (TOC).

#### **3.2.1 Activity-based costing and activity-based management**

The Activity-Based Costing (ABC) method was first developed by Cooper and Kaplan (1988) and then promoted by Brimson (1991). This method focuses on the financial aspect (*i.e.* cost) of performance and emerged as a result of an attempt to resolve some of the fundamental inadequacies of traditional costing systems (Kaplan and Cooper, 1998). The fundamental difference between an ABC system and a traditional costing system is that the latter assumes that product causes costs, whereas ABC assumes that activity causes costs and the cost objects create demand for activities (Bharara and Lee, 1996).

The consortium for Advanced Management-International (CAM-I) defines activity-based costing as follows:

*“Activity-Based Costing is a methodology that measures cost and performance of activities, resources and cost objects. Resources are assigned to activities, then activities are assigned to cost objects based on the use of consumption of the relevant activities. Activity-Based Costing recognizes the causal relationships of cost drivers to activities”.*

Figure 3-1 shows the pictorial representation of the basic structure of an ABC system.

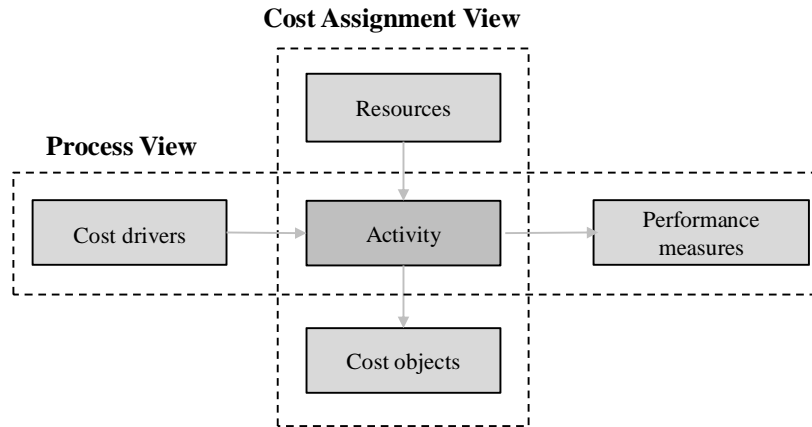

**Figure 3-1: Basic structure of activity-based costing (Raffish et al., 1991)**

From Figure 3-1, resources (*i.e.* economic elements that are applied in order to execute organization activities) are traced to activities (*i.e.* work performed within the organization) employing the resource cost drivers (*i.e.* factors which cause a change in the cost of an activity). Activities are then traced to cost objects (*i.e.* any customer, product, service, contract, project or other work unit for which a separate cost measurement is desired). Finally, performance measures are used to measure the output of an activity.

Activity-Based Management (Cokins, 2001) on the other hand is a broad umbrella term that includes activity management, activity cost and activity-based product costing as well as many of the concepts associated with just-in-time and theory of constraints.

### 3.2.2 Theory of constraints (TOC)

The Theory of Constraints (TOC) is an overall management philosophy developed by Goldratt (1990). It later emerged as a process of on-going improvement and geared to help organizations continuously improve the performance of a process by focusing on the constraints.

Conceptually the Theory of Constraints (TOC) is based on the idea that any organization has identifiable constraints. A constraint within a system, and hence in a process, is anything that limits the process from achieving higher performance (Goldratt and Cox, 1992). Management jobs have to identify these constraints and manage them so that resources are used most efficiently. *The Goal* is simply to make money by maximizing a global measure called *Throughput* while minimizing two other global measures referred to as *Inventory* and *Operating expenses*. The theory of constraints relies on these three global performance measures for assessing an organization to achieve the goal (*i.e.* making money).

**Global performance measures:** The global performance measures of TOC are defined mathematically as follows:

$$Net\ Profit = T - OE$$

$$ROI = \frac{T - OE}{I}$$

Where,

$T$  = Throughput, *i.e.* the rate at which the system generates money through sales

$I$  = Inventory, *i.e.* all the money that the system invests in purchasing things that the system intends to sell

$OE$  = Operating expense, *i.e.* all the money that the system spends in turning inventory into throughput

$ROI$  = Return-On-Investment, *i.e.* net profit divided by investment

NB: The terminology associated with the theory of constraints (TOC) is different from traditional accounting terminology but the key concepts are the same.

**Five continuous steps to obtain *The Goal* (Net profit):** TOC offers a systematic and focused process that organizations use to successfully pursue on-going improvement for the purpose of maximizing *Throughput*. The TOC's five steps of focusing are conducted in the following way:

- 1) Identify the system constraints
- 2) Decide how to exploit the system constraints
- 3) Subordinate everything else to the above decision
- 4) Eliminate the system constraints
- 5) If in the previous step, a constraint has been broken, Go back to step 1

To summarize, the performance measures within the TOC approach are easy to access and simple to understand. However, TOC is far from being a complete PMS as it simplifies a reality a little too far (Tangen, 2004). In addition, it assumes that there is always a constraint in a system (or process), which is not necessarily true.

### **3.3 Integrated performance measurement and management systems**

Integrated performance measurement and management systems are information systems that incorporate both the financial and non-financial aspects of performance. They are designed to capture the performance of an organization or extended enterprise on a multiple criteria basis employing some established framework. According to Kaplan and Norton (1996a), focusing on individual performance measures such as cost, quality, time and flexibility will lead to local optimization. Therefore, performance measures must be treated in an integrated manner to support company's strategy. Using this concept, a global optimization can be achieved instead of a local one. But questions are: How to establish the integrated set of measures? How to implement them in order to better make use of and what characteristics an integrated performance measurement system should have? These and many other questions have been dealt in numerous integrated performance systems which are discussed in the following sections.

### 3.3.1 Requirements of integrated performance measurement and management systems

The need for an integrated performance measurement and management system is well established in today's dynamic business environments (Bititci *et al.*, 2011). Many authors stress to have a good PMM system as it is considered a key element of sustainable competitive advantage (Bititci, 1995). However, often the authors fail to provide the fundamental requirements of a useful performance measurement and management system. According to Folan and Browne (2005), performance measurement recommendations are the building blocks of all PM initiatives which can be grouped into two core areas:

- 1) Recommendations for performance measures;
- 2) Recommendations for performance measurement systems.

After reviewing extensively the PM literature, Neely *et al.*, (1997) provided the recommendations for performance measures. Other recommendations not included in Neely *et al.* recommendations include Stalk and Hout (1990), who propose two rules for performance measures: (1) The measures should be physical (*i.e.* quantitative) and (2) they should be taken as close to the customer as possible. Furthermore, Melnyk *et al.* (2004) argue that performance measures should be based on an agreed-upon set of data and a well-documented and well-understood process that could transform the data into measures. Given the data and process, independent sources could arrive at the same metric value. They further define three functions for a performance measure which are: control, communication and improvement. Characteristics of a useful performance measure can be summarized to have SMART (*i.e.* Specific, Measurable, Achievable, Relevant and Temporal) criteria (Doran, 1981).

Furthermore, Folan and Browne (2005) synthesize recommendations proposed by different authors for the development of performance measurement frameworks and systems (see Table 3-1). According to their view on the above recommendations, actual serviceable advice for the design and implementation of PMM is rare, which in turn has made the process of developing a single unifying system which satisfies all the above issues unrealistic. The view is also supported in the literature by (Meyer, 2003).

**Table 3-1: Recommendations for the design and development of performance measurement frameworks and systems (Folan and Browne, 2005)**

No	Recommendations
1	Should be based upon the strategic role of the company
2	Should be based upon multi-criteria (critical activities)
3	Criteria should evaluate group not individual work
4	Specific goals must be established and revised when met
5	Measurements should be easy to understand by those being evaluated
6	Data should be collected, where possible, by those whose performance is being evaluated
7	Graphs should be the primary method of reporting performance

- 8 Data should be available for constant review
- 9 Performance should be reviewed daily or weekly
- 10 Supplier should be evaluated upon quality and delivery performance
- 11 Emphasis is upon evolving, dynamic, continuous improvement and learning in PM system design
- 12 The connection between accounting and performance measurement should be cut
- 13 PM systems should be mutually supportive and consistent with business's goals, objectives, critical success factors and programs
- 14 Should convey information through as few and as simple set of measures as possible
- 15 PM systems should reveal how effectively customer's needs and expectation are satisfied
- 16 Focus upon measures that customers can see
- 17 Provide measures that allow all members of organization to understand how they affect the entire business
- 18 System consist of well-defined and measurable criteria for the organization
- 19 Routine must be established so that measures can be measured
- 20 Feedback from PM systems should report at numerous levels of the organization
- 21 Feedback from PM systems must be linked cross-functionally to ensure it supports and not inhibit strategy implementation
- 22 Should enable managers to view performance in several areas simultaneously
- 23 Should provide complementary non-financial performance measures alongside financial measures
- 24 Should measure the entire product delivery system from the supplier to the customer
- 25 PM system designed, so that at plant and divisional level, the evaluation of PM standards is consistent with the manufacturing objectives of the facility
- 26 PM system designed, so that at plant and divisional level, the evaluation of PM standards is consistent with the manufacturing environment
- 27 PM system designed, so that information on the strategic objectives of the firm are shared at plant and divisional level to provide organizational focus between them
- 28 PM system information on the strategic objectives of the division must be shared across functional areas to provide organizational focus with in plants and divisions
- 29 PM system should be used to challenge strategic assumptions
- 30 PM system should be implemented in such a way that it does not induce fear, politics and subversion

- 31 PM systems should be designed so that they facilitate auditing
- 32 PM system designed should be viewed as a co-ordination effort to understand current metrics in detail, to identify shortcomings and to include ongoing initiatives that affect PM

These recommendations are intended for developing performance measurement systems especially for integrated PMSs. The core aspects covered in the recommendations are: multi dimensionality including financial and non-financial aspects of performance, objective-driven measurement, simple reporting in terms of a few number of performance measures, avoiding individual performance measurement and transparency of measurement process, just to name a few.

From the recommendations of Table 3-1, it can be concluded that, firstly, process-oriented performance measurement is not given heed so far. Secondly, the aggregation of performance measures within a PMS to simplify the performance reporting is also ignored. Moreover, the role of PMM systems as decision making tools is also not taken into account.

So far, several integrated frameworks and systems have been developed for performance measurement and management. All of these frameworks and systems have taken into account one or more of the above mentioned recommendations. However, none is capable to address all of the recommendations into a single system. The reason, according to Neely *et al.* (2002), is that most of the writings on PM are too superficial to be implemented. Additionally, from Table 3-1, actual serviceable recommendations that can be employed for PM frameworks or systems are rare (Folan and Browne, 2005).

In the current dissertation, based on the literature review and our experience we use some critical attributes (*i.e.* recommendations or requirements) that a PMM system should have in order to facilitate the performance measurement and management process. Existing frameworks and systems will be critically reviewed against these attributes. These attributes are:

- 1) **Objective/Strategy driven:** Whether the system is driven by the organization strategy or not and the measures are aligned to the organization's strategy.
- 2) **Process oriented:** Whether the model or process employs a process approach or not.
- 3) **Stakeholder's perspective:** The performance measurement system considers stakeholders needs while evaluating performance measurement.
- 4) **Control, improvement and learning:** Whether the performance measurement system suggests mechanisms to control (feedback loop) and aid in continuous improvement or not.
- 5) **Multiple performance dimensions:** What specific dimensions (criteria) of performance the system takes into account.
- 6) **Integration mechanism:** Whether the performance dimensions are normalized and integrated or not.
- 7) **Criteria Interaction:** Whether the system recognizes criteria interaction or not.

- 8) **Organization level:** Whether the organization hierarchy is addressed or not while evaluating performance.
  - 9) **Risk assessment:** Whether risk management is dealt with or not.
  - 10) **Decision system:** Does the performance measurement system have a decision system?
- 

### 3.3.2 Integrated performance measurement systems review

Based on the requirements defined in the previous section, the existing frameworks and systems will be critically reviewed. The objective is to determine the strengths and weaknesses of each performance measurement framework and system developed against already defined attributes. The list of PM frameworks and systems is not exhaustive. Indeed, there are more than thirty five well known methods that have been developed around the world for the determination and implementation of either performance measures or performance systems (Ravelomanantsoa *et al.*, 2010). The current thesis takes into consideration for review only those that gained sufficient popularity in academia and industry.

#### 3.3.2.1 Strategic measurement analysis and reporting technique

The Strategic Measurement and Analysis Technique (SMART), also known as Performance Pyramid, was developed at Wang laboratory, Inc., Massachusetts (Lynch and Cross, 1992). It results from dissatisfaction with traditional performance measures such as utilization, efficiency, productivity and other variances used for financial purpose. The technique was first developed to implement a just-in-time approach, which was later extended to define a framework for:

- Measuring departments and functions on how they are contributing separately and together in meeting manufacturing strategic mission.
- Linking operations to strategic goals.
- Integrating financial and non-financial information in a way that can be used by operating managers.
- Focusing all business activities on the future requirements of business, as dedicated by the customer.
- Changing performance, incentive and rewards systems as necessary.

The efforts led to the development of the SMART system. A diagrammatical representation of the SMART technique is depicted in Figure 3-2.

At the top level of the pyramid, a vision for the business is setup which forms the basis for corporate strategy. The senior management then assigns a corporate portfolio role to each business unit (cash flow, growth, innovation, etc.) and allocates resources to support them.

At the second level, objectives for each business unit are defined in market and financial terms. Strategies to reach these goals are worked out.

At the third level, more tangible operating objectives and priorities are defined in terms of customer satisfaction, flexibility and productivity.



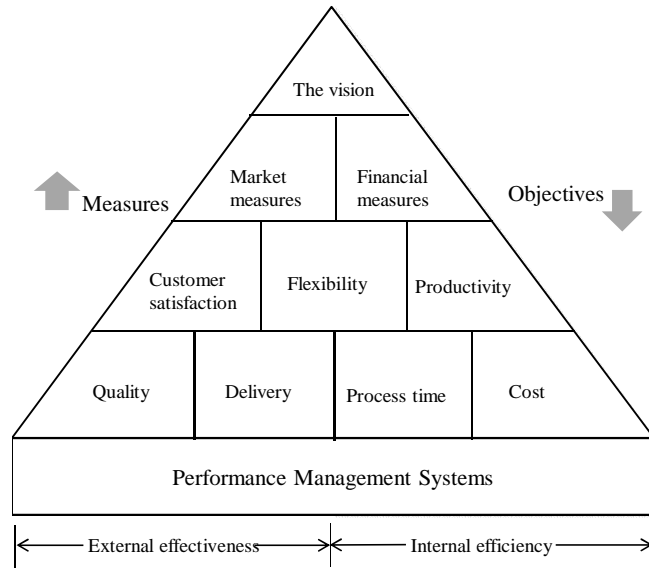

Figure 3-2: SMART pyramid (Lynch and Cross, 1992)

At the fourth level, or foundation level, customer satisfaction, flexibility and productivity are represented by criteria such as quality, delivery, process time and cost. These criteria or operational measures are the keys to achieving higher level results and ensuring successful implementation of the company strategy.

### 3.3.2.2 Balanced scorecards (BSC)

Kaplan and Norton (1992, 1996, 2000, 2004) developed and promoted balanced scorecards (BSC) at Harvard Business School as a measurement framework for strategic, operational and financial measures. The balanced scorecard method proposes that an organization should use a balanced set of performance measures that will help top managers to take at a glance a comprehensive view of the their business from four important perspectives as shown in Figure 3-3.

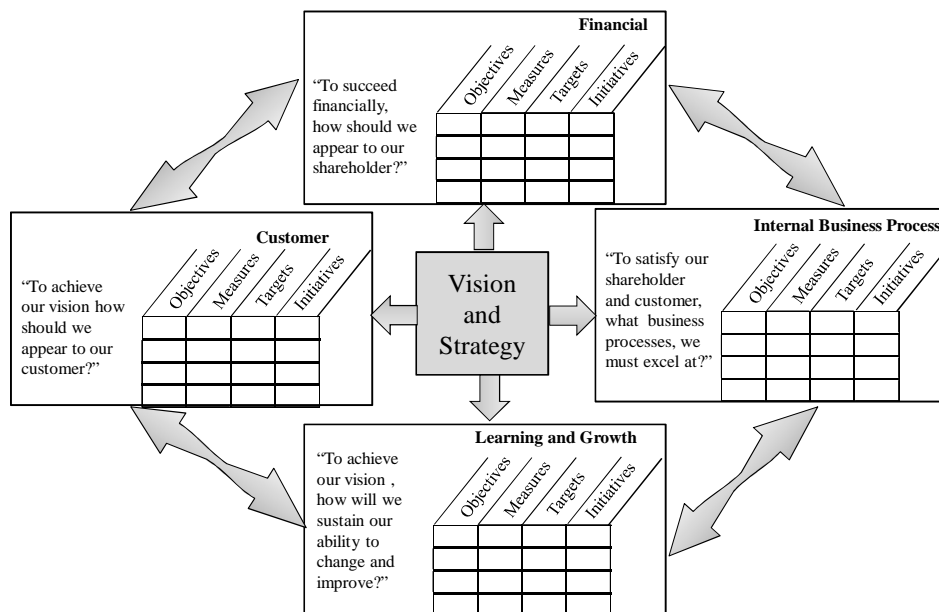

Figure 3-3: Balanced scorecards (Kaplan and Norton, 2000)

The concept of the balance scorecards is to align corporate values with operational objectives, customer satisfaction, shareholder values and expectations as well as individual employee's objectives, competencies and aspirations.

Similar to the SMART model, performance measures identification starts from vision and business strategy, which are then translated into the four perspectives. The financial perspective measures how well the business is doing in satisfying the needs of the stakeholders who are looking for the return on investment. The customer perspective measures how well the business is satisfying the needs of the customers while the internal process perspective measures how efficiently customer needs are met and profit is made. In this perspective, the manager identifies the most critical processes for achieving the customer and financial objectives. The final perspective of the Balanced Scorecard method develops objectives and measures to drive learning and growth for the organization.

BSC answers four questions in general: How do we look to shareholders? (*i.e.* financial perspective); How do customers see us? (*i.e.* customer perspective); What must we excel at? (*i.e.* internal process perspective); and Can we continue to improve and create value? (*i.e.* innovation and learning perspective). To be competitive and survive on the market, there must be a balance between the four perspectives.

### 3.3.2.3 Performance prism

The Performance Prism (Neely *et al.*, 2002) was developed at Cranfield School of Management, United Kingdom. Prism advocates that a PMS should be organized around five distinct but linked perspectives of performance.

- 1) Stakeholder satisfaction: Who are the stakeholders and what do they want and need?
- 2) Strategies: What are strategies we require to ensure the wants and needs of our stakeholders?
- 3) Processes: What are the processes we have to put in place in order to allow our strategies to be delivered?
- 4) Capabilities: What are the capabilities we require to operate our processes?
- 5) Stakeholder contribution: What do we want and need from stakeholders to maintain and develop these capabilities?

Figure 3-4 illustrates the Prism performance measurement framework.

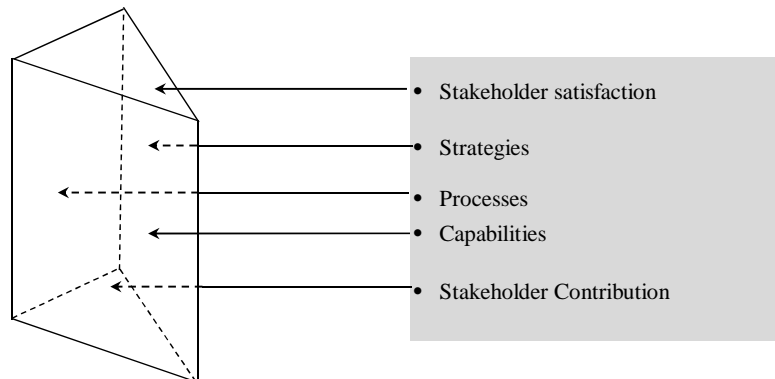
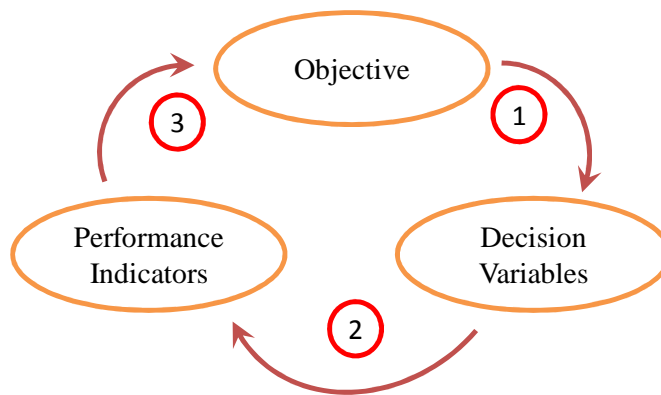

Figure 3-4: Performance prism (Neely *et al.*, 2002)

The authors of the Performance Prism stress that all performance measures should not be derived from strategies because strategy is not the aim to be reached but a tool to help managers achieve the objectives. They argue that it is the wants and needs of the stakeholders that first must be considered. Therefore, organizations should first identify stakeholders, their needs and expectations and then strive to satisfy them. For this purpose, strategies are then devised and processes are designed and implemented in the light of already formulated strategies. Capabilities are evaluated while designing and implementing processes and, in the end, stakeholder contribution is taken into consideration.

### 3.3.2.4 ECOGRAI

The ECOGRAI methodology was developed by the GRAI Laboratory at the University of Bordeaux, France, for measuring the performance of organizations (Bitton, 1990). It has evolved continuously since then according to the evolution of enterprise performance requirements (Ducq and Vallespir, 2005). It defines a set of global objectives for a particular organization or a part of an organization (*i.e.* a functional department). Then, decision variables are determined for each of these functions. Actions are performed and to evaluate actions against objectives, performance indicators are defined. This relationship between an objective, decision variables and performance indicators is illustrated by Figure 3-5.



**Figure 3-5: The ECOGRAI approach (Ducq and Vallespir, 2005)**

The ECOGRAI approach uses the GRAI nets and the GRAI grid to decompose global objectives into lower level objectives and to identify, for each level, decision variables and performance indicators. The result of using the approach is a performance measurement system which measures the performance of a function relative to a global objective. Figure 3-6 shows the logical structured approach to define performance indicators for objectives via decision variables.

The approach (cf. Figure 3-6) is decomposed into six phases. The first phase models the control structure (*i.e.* decision system) and the controlled structure (*i.e.* physical transformation system). The following three phases concern the identification of coherent objectives and the decision variables. In the fourth phase, performance indicators are identified whereas, the fifth phase designs the information system to build the performance indicators. In the last and sixth phase, the performance indicators are implemented in the enterprise information system.

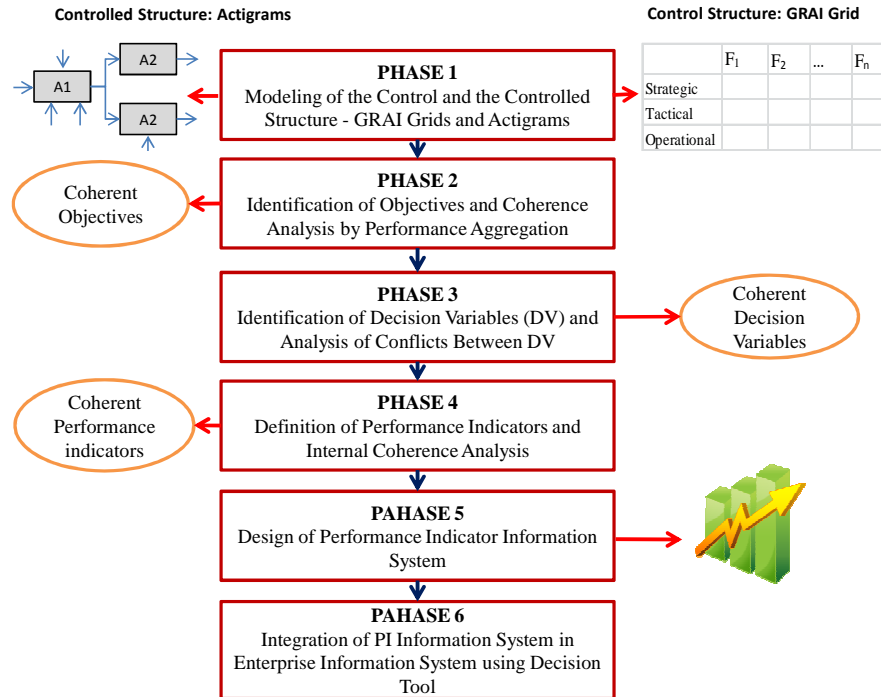

**Figure 3-6: Structured approach of ECOGRAI (Ducq and Vallespir, 2005)**

In brief, the ECOGRAI approach enables one to define a set of objectives for each hierarchical level of an organization such as strategic, tactical and operational levels. However, the identification of decisional variables and performance indicators is done at the operational level.

### 3.3.2.5 Integrated performance measurement system model

The Integrated Performance Measurement System (IPMS) was developed by (Bititciet *et al.*, 1997) at the University of Strathclyde, UK. The model describes the structure and constituent parts of a robust, integrated, efficient and effective performance measurement system. The model has an audit methodology to assess robustness and integrity of performance measurement systems used within manufacturing industries. Figure 3-7 shows the IPMS model.

At each level of the business, the model requires the organization to:

- Recognize and understand its stakeholder requirements
- Externally monitor its position against competitors and world-class performance to identify the development needs of the business
- Set objectives based on implications and criticality of the development needs together with appropriate targets and time scales
- Define, report, monitor and review these objectives through a performance measure

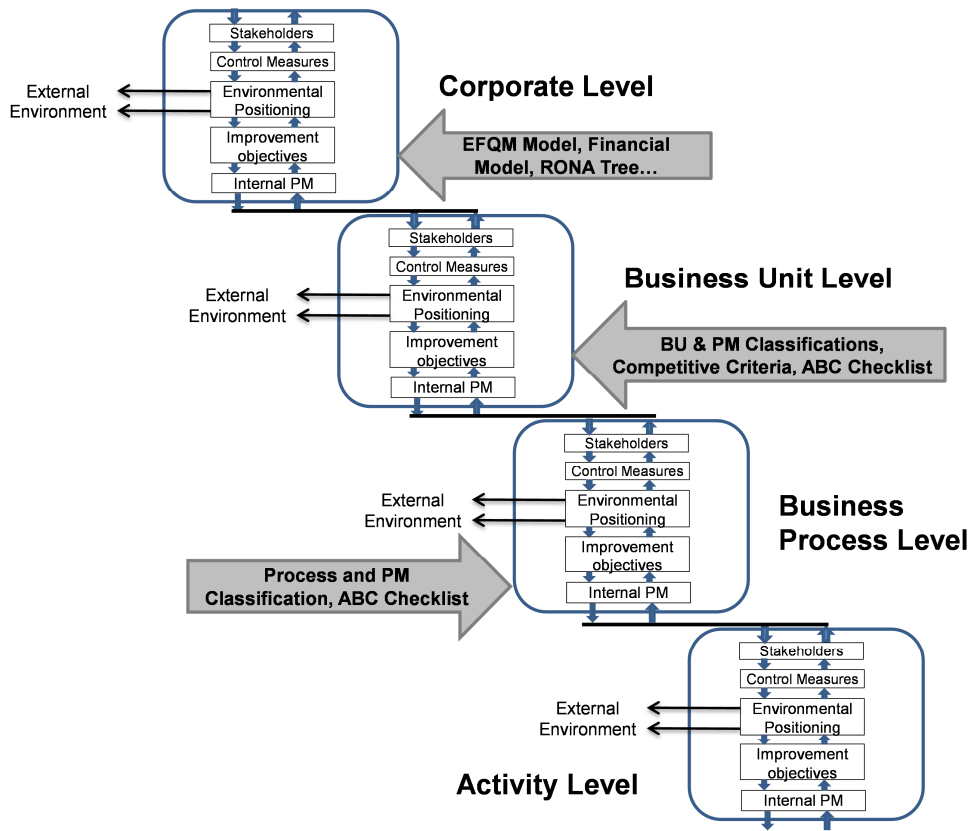

Figure 3-7: A Reference model for the integrated PMS (Bititciet *al.*, 1997)

### 3.3.2.6 Integrated performance measurement framework

Medori and Steeple (2000) developed a performance measurement framework that contains two separate documents called (1) “Document A”, which is a six stage plan (cf. Figure 3-8) and (2) “Document B”, which is a spectrum checklist containing non-financial performance measures segregated by six competitive priorities.

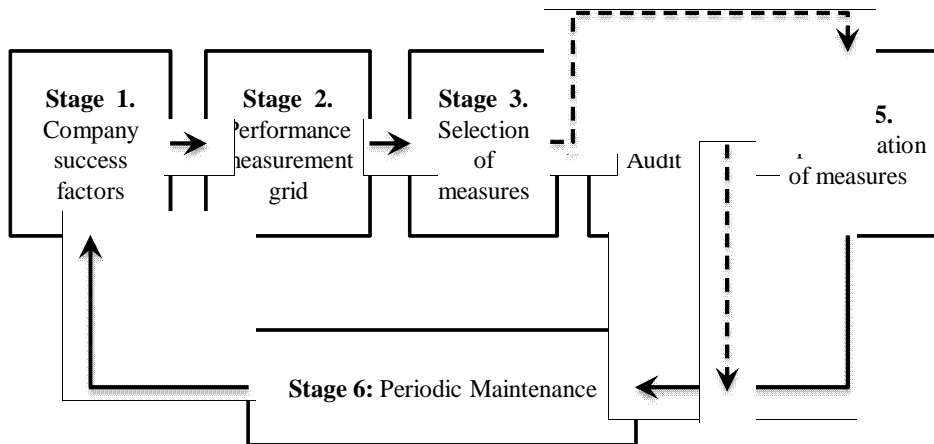

Figure 3-8: Integrated PM framework (Medori and Steeple, 2000)

The six stages of Document A include:

- *Stage 1: Company Success factors*
- *Stage 2: Performance Measurement Grid (PMG)*

- *Stage 3: Selection of measures using spectrum/checklist.*
- *Stage 4: Audit*
- *Stage 5: Implementation of measures*
- *Stage 6: Periodic maintenance*

The second document, “Document B”, contains 105 mainly non-financial measures, with full description and methods for calculation of each measure. These measures are categorized according to the competitive priorities of the company. For instance, quality, identified as a competitive priority, includes performance measures such as supplier quality, complaints and cost of quality. Similarly, for the competitive priority such as time, the document B proposes the lead-time performance measure.

The framework in Stage 1 defines success factors based on the manufacturing strategy of the company. In Stage 2, the company matches the success factors with the competitive priorities (cost, quality, flexibility, future growth, etc.). For instance, for the competitive priority of quality, the success factor identified is: “improve supplier quality”. Next, the company selects the most appropriate measures for each of the competitive priority using the Document B. After selection of the measures, the framework proposes to audit the measures in order to determine whether the selected measures (new measures and in-use measures) are relevant in the current context or not. If yes, they are then implemented in Stage 5. The dashed line in Figure 3-8 indicates that if no gap is identified in Stage 4, then this stage is omitted. Stage 5 of the framework concerns the implementation of measures. The last stage (Stage 6) is designed to review periodically the company’s PMS.

The authors claim that the framework is dedicated to achieve five objectives: firstly, it can aid in setting up a new performance measurement system if a company does not have any; secondly, it has an audit capability to examine the existing measurement system; thirdly, it can aid in identifying obsolete measures; fourthly, it can help a company to identify and select core non-financial measures not being measured (gap); and fifthly, it identifies the guidelines to implement any selected measures.

### **3.3.2.7 Quantitative model for performance measurement system**

QMPMS (Suwignjoet *al.*, 2000) was developed at the Center for Strategic Manufacturing, University of Strathclyde, UK. The system models the relationships between performance measures in quantitative terms. There are three main steps in QMPMS (cf. Figure 3-9):

- Identification of factors affecting performance and their relationships
- Structuring the factors hierarchically
- Quantifying the effect of factors on performance

To carry out each step, QMPMS relies on tools. To explore and identify factors, it uses cognitive maps. For structuring the identified factors hierarchically, cause and effect diagrams are used while a tree diagram is used to represent the hierarchical structure of factors. Finally, the Analytical Hierarchy Process (AHP) of Saaty is employed to quantify the relative effects of the factors.

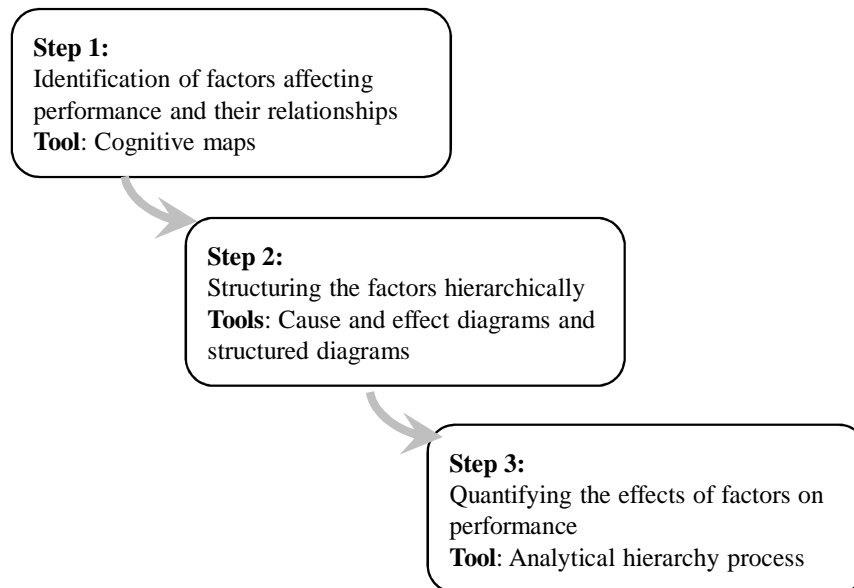

**Figure 3-9: QMPMS model (Suwignjoet *al.*, 2000)**

The QMPMS model has a well-structured approach to identify and prioritize factors affecting performance of an organization. In addition, the model classifies performance measures and proposes the consolidation of the performance measure in order to reduce the number of performance measurement reports. However, the aggregation mechanism is not well-defined and is based on simple weighted arithmetic mean aggregation operator.

### **3.3.3 Performance measurement systems comparison**

In this section, performance measurement frameworks and systems reviewed in the previous sections are synthesized and they are examined against the already defined set of attributes (§ 3.3) as shown in Table 3-2.

From the analysis of the performance measurement frameworks and systems, it can be concluded that none of them respond to all the attributes (requirements) identified in section 3.3. The most neglected attributes in the PMSs are: risk assessment, process orientation and decision-making mechanisms.

The following section discusses in detail the review of the PMSs and explains the relative weaknesses and strengths in the current performance measurement and management process.

**Table 3-2: Performance measurement systems comparison**

	Objective Driven	Performance measures derivation	Process oriented	Stakeholder's Perspectives	Control & Improvement	Multi-Criteria	Levels of organization	Integration Mechanism	Criteria Interaction	Risk Assessment	Decision System
<b>ABC/ ABM</b>			✓								
<b>SMART</b>	✓	✓				✓	✓	✓			
<b>Balanced Scorecards</b>	✓	✓		✓	✓	✓					
<b>Performance Prism</b>	✓	✓		✓		✓					
<b>ECOGRAI</b>	✓	✓									✓
<b>IPMS Model</b>	✓			✓	✓	✓	✓				
<b>IPMF</b>	✓					✓					
<b>QMPMS</b>	✓					✓		✓			✓

### 3.3.4 Discussion

This chapter reviews performance measurement systems. From their review, it can be concluded that some architects of PMSs still focus on specific dimensions of performance such as cost, quality, delivery or flexibility. However, the majority of them, after the relevance debate, proposed integrated performance systems to measure and manage performance globally instead of locally.

In the integrated approaches, the issue of multi-criteria analysis has been taken into consideration. There appears to be a consensus in academia and industry alike that performance in any organization has multi-facets and, hence, should be measured using multiple dimensions (or criteria) of performance. However, the issue of criteria interaction has not yet been dealt with because criteria often interact either positively or negatively and affect the global performance. For instance, in-time delivery may increase customer satisfaction or high manufacturing cycle time might have negative effect on customer satisfaction as well product cost. Therefore, it is necessary to consider multi-dimensional performance but at the same time investigate the interaction among the performance criteria to avoid sub-optimal performance.

Nevertheless, the desire to measure many dimensions of performance employing multi-criteria techniques has confronted academia and industry with a new challenge



- *drowning in data* - as Neely *et al.* (2002) referred to it. The emergence of information technology has facilitated data collection because performance measurement is becoming commonplace practice in every organization whether it is a profit or not-for-profit organization. But, realistically, organizations cannot afford to measure everything they would like to measure and even if they could, managers would not be able to manage all such data. Therefore, it is imperative to consider few critical performance measures and then aggregate them in such a way that they do not lose their significance in the aggregated performance measure. This aspect of performance, however, has not been handled thoroughly in the current performance measurement systems.

Furthermore, the stakeholder's perspective has been integrated in few performance measurement systems such as Balanced Scorecards and Performance Prism. However, the balanced scorecards view of the stakeholder perspective is limited to customers and shareholders only. On the other hand, the Performance Prism has a more comprehensive view of different stakeholders (*e.g.* investors, customers, employees, regulators, etc.). Here, the stakeholder perspective is a two-way approach: stakeholder contributions to organization and stakeholder satisfaction (*i.e.* in terms of value). Despite this comprehensive view of stakeholder perspective in Performance Prism, this method proposes neither value trade-off among its stakeholders nor can it judge their contribution.

Concerning performance at different levels of the organizational hierarchy, many PMSs (*e.g.* SMART or IPMS) take it into account. However, BSC deals with this aspect of performance only partially. The performance hierarchy levels in organizations refer to the refinement of a global objective into more manageable objectives and then their aggregation in a bottom-up sequence. Though this concept has been employed in a formulaic manner in the literature (Clivillé *et al.*, 2007), it has not been integrated in PMSs.

Moreover, risk management has not yet taken roots in integrated PMSs. Despite the fact that risk is the sole element affecting organizational performance, but still it is managed independently of the integrated PM discipline. In order to have a clear and comprehensive picture of organizational performance, risk should be part of the integrated PM approach. This will help managers to know what performance they expect from a system and how much the system is exposed to risk, and whether the organization in the presence of the risk(s) can achieve the expected performance (objectives) or not.

Similarly, the literature review reveals the missing link of PMSs to the decision-making mechanism. The only PMS equipped with a formal decision-making mechanism is the ECOGRAI method. The remaining PMSs (to our knowledge) have no built-in decision-making capability.

In brief, after a thorough review and analysis of the most common PMS frameworks and methods, we come to the conclusion that none of them proposes a holistic approach. They offer solutions in some areas but lack power in other domains. Moreover, the existing PMSs can be applied to a system or part of a system or more specifically, they are intra-organizational PMSs. The changing nature of business trends such as collaboration across the continents, networking of business entities, green supply chains, sustainability issues and so many other trends are being changing the very landscape of the PMSs, hence making the existing PM approaches too restrictive or inadequate. Then the question arises on how to deal with current

challenges and to remain prepared for the upcoming ones? The solution lies in process-based approaches and analysis of process activities.

### 3.4 Activity-based performance measurement

The fundamental problem that we are facing today with regard to PMS is the archaic conception of an organization and its performance as pointed out by Meyer (2003). We consider a firm as a black-box where investment flows in, activities happens out of sight within the box, products or services are created and delivered and then income statements, balance sheets and market valuations are made and reported. These aggregated financial measures conceal important sources of variation and therefore critical information about the performance is obscured.

Moreover, to know more about the performance of the internal processes, we dig into the black-box and break up organization into patches (*i.e.* departments, business units and even individuals) and then try to evaluate piecemeal performance while ignoring the causality relationships between different factors that exist vertically or horizontally in an organization. The result of this piecemeal performance evaluation is suboptimal performance instead of a global one, whereas an organization constantly strives to achieve global performance.

To resolve this issue of PM, we must return to a fundamental conception of the organization and what it does. An organization is nothing but a bundle of interconnected *activities* and *decisions*. These *activities* incur *cost* as a result of decisions taken and create *value* for the stakeholders but at the same time they are exposed to external as well as internal *risks*. Therefore, without indulging in complicated matters of organizations about what an organization does and what measures it requires, we must resort to the activity concept as a step in a process and determine activities which add value and those which do not. The organization task would then be to eliminate as much as possible the non-value adding activities and keep or improve the value-adding activities and safeguard them from risk both external and internal to the activity. Finding performance is then a trivial issue. To this end, it is necessary to decompose a global objective into sub-objectives for sets of activities (*i.e.* processes) and measure performance for each of them keeping in mind the causality relationships between different factors that influence performance and finally, aggregate the performance across the processes and along the organization hierarchy.

In addition, the issue of performance measurement and management in extended organizations can also be resolved because processes can be extrapolated across multiple units of organization as well as across different organizations. Besides, processes can be decomposed into sub-processes and to fundamental blocks, *i.e.* activities, along the hierarchy of the organization. Therefore, horizontal and vertical integration is only possible through processes.

The most important aspect of activity-based performance measurement and management is that activity is a modelable and simulatable element. It can easily capture the real-world complexities and represent them in the form of simple and understandable activity models. The level of complexity of the activity model is then proportional to the level of abstraction of the real-world. High level of abstraction means high level of activity model complexity and is therefore a matter of choice.

Therefore, modeling and simulation techniques can be employed to measure the performance. There exists a plethora of modeling techniques such as the IDEF suite,

BPMN, activity networks, etc. that can be used to model activities. The available modeling techniques can mimic the real-world complexities of temporality, hierarchy, etc. Once processes are modeled, they are simulated in a simulation environment for the purpose of evaluating them against certain performance criteria. The real issue in performance measurement employing modeling and simulation techniques is to design performance criteria that are coherent with strategies or objectives.

To summarize the discussion, activity-based performance measurement and management has numerous advantages. It simplifies the performance relevant issues of performance integration within and across organizations. It is one of the important sources of value creation. Once properly identified, modeling and simulation can then be used to measure performance before investments or real decisions are made.

### **3.5 Conclusion**

This Chapter has presented and reviewed the most popular PMSs. From the review, it can be concluded that the existing systems for PM cannot measure performance in a holistic and integrated manner. Each one has strengths and weaknesses. When they are good in one area, they lack power in other domains.

In addition, many current issues relevant to PM are not yet fully addressed such as risk management, performance in inter-organizational setups, managing with multiple performance measures, integration of performance measures, interaction of performance measures and so on.

Moreover, the changing business trends forces the performance measurement and management systems to evolve constantly. The traditional PMSs followed by modern performance measurement and integrated systems are less relevant in the face of changing business environments.

The Chapter concludes the discussion by advocating an activity-based approach for performance measurement and management. Issues and challenges evoked in the literature review can be resolved to a large extent by employing an activity or process approach. Activity is one of the sources of value creation, which is the ultimate goal of every organization.

Therefore, without indulging in managing multiple measures, it is prudent to aggregate elementary performance measures and present them in the form of a global measure which we call “value measure”. Besides, activity is exposed to both external and internal risks of different nature. Similar to performance measures, risk factors can also be aggregated and be presented in the form of a global risk measure.

This is the essence of the thesis and this is the reason why we propose a (value-risk)-based approach as a novel approach for performance management, as detailed in the subsequent Chapters.

---

**Part II**

**Performance Measurement and  
Management Tools and Techniques:  
Review and Selection**

---



## Chapter 4 Performance Measurement and Management Tools and Techniques: Review and Selection

**P**erformance management is a complex practice. It is concerned with the identification of stakeholders' expectations and their transformation into objectives and performance measures, employing then these performance measures to monitor and control progress as well as preparing back-up action plans in case of anomalies and so forth. In addition, deployment of performance measures, dissemination of these measures across the organization and audit of performance measures add further complexity to the practice.

From the review of the performance measurement systems, it was concluded that none of them answers to all these complexities. Some weak links namely, objective-driven PM derivations, their non-consolidation for performance report simplicity, non-consideration of PMs Interaction, absence of risk management are identified in the previous chapter. Hence, a performance management system is required to manage these complexities in order to bridge the current gap to some extent between requirements and practices concerning performance.

To this end, this chapter is committed to define such requirements, elaborate a new performance management system and determine the appropriate tools and techniques to help in fulfilling the identified requirements.

### 4.1 Requirements specification

After a thorough review of the current performance measurement systems in the light of contemporary performance issues, a list of requirements is proposed in order to meet the PM challenges being faced by organizations. The list of requirements for an ideal PMS is exhaustive, however, the current research narrows down the requirement specifications to the critical few ones, which are described in the following lines.

The list of requirements for the new performance management system (PMS) includes:

- *Value-focused PMS*

The PMS should focus on value as a performance measure instead of many heterogeneous performance measures which are difficult to deal with and often surpass human cognitive limits when used in decision making context. Introduction of value as a performance measure will significantly simplify performance management in organizations.

- *The PMS should be process-centered and not function-oriented*

The PMS should be process-centered instead of function-centered. The advantage of a process-centered PMS is that it could easily capture both the horizontal (*i.e.* flow of entities in a business process) and vertical (*i.e.* hierarchical orientation) aspects of an organization. Moreover, it can be extended across departments and organizations likely. It is then compatible with Activity-Based Costing (ABC), a widely adopted technique for process assessment.

- *The PMS should manage risk in addition to performance measurement*

Organizations perform activities to create value for stakeholders. However, these activities are subject to uncertainty that could derail them from achieving the desired

objectives. So, the PMS should have integrated procedures to tackle the uncertainty residing in and around the process. In addition, all risks cannot be treated or are almost impossible to eliminate. So, the PMS should have the capability to sort out risks and prioritize them for treatment as some risks take precedence over others.

- *The PMS should have a built-in mechanism to aggregate the performance measures and identify the interactions among these performance measures*

The performance measures affecting performance are multi-dimensional. Unless the aggregation and interaction of these measures are performed, the overall performance of the organization cannot be accurately measured. The aggregation mechanism is to limit performance measures (or reports) so that it cannot pass the cognitive capability of human being to interpret and manage all the measures.

- *The PMS should have a decision system in place*

Although a performance management system has several roles, as it has been pointed out in section 2.5, the most important role which the current thesis is intended to handle is its use for decision-making purpose. Therefore, the new PM system should have built-in decision making mechanisms.

Because performance management is a manager job, not all managers are familiar or comfortable with mathematics or complex theories. Therefore, the method should be kept as simple as possible while not losing originality.

- *The PMS should be accurate and can be easily implemented*

A performance measurement system is an information system that collects and provides information about a process or system to managers. Therefore, the tools employed should collect and provide accurate information to the extent it claims to be correct. In addition, the method or tool used in the performance management should be easily implemented, demanding less effort, resource and time.

The following sections discuss each of the requirements in detail.

## **4.2 Value focused performance management**

Value is what we care about. As such, it should be the driving force behind the actions we perform and the decisions we make. In the decision-making context, values are principles used for evaluation of actual or potential consequences of an action or inaction, of decisions and of proposed alternatives (Keeney, 1996). Therefore, value is, for the most part, the ultimate end to which all the activities and decisions of organizations are committed.

To develop value-based performance management systems, it is required to define the scope of value because the value literature is vast and pervades almost in every field of study. Consequently, these fields define, and in some cases measure, and develop theories of value, but only from the perspective of their fields (Martinez, 2003), which in turn renders the concept more ambiguous. So, the following section is dedicated to briefly explain the concept of value and to define its limits for the proposed performance management system.

### **4.2.1 Concept of value**

“Value” is a polysemic term and therefore, like all polysemic words, the clue to its meaning is given by the context (Bourguignon, 2005). Perspectives on value change across different fields of study and even change within the same field of study. For

instance, in economics, value can either be “exchange value” or “usage value”. No matter what perspective it adopts in different fields of study, the concept always refers to “value is what we care about”. The underlying ambiguity of the concept can be attributed to the way it is approached.

Martinez (2003), after a thorough review of definitions regarding value, defines value as: “*the satisfaction and fulfillment of customer expectations, at the same time, generating wealth for organizations*”. In other words, value for an organization is simply *wealth* while value for customers **is the satisfaction of their expectations on fulfillment of their perception**. However, the author’s perspective on value is limited to customer and organization and ignores other important stakeholders in the value circle.

In addition to the above definition of value, which depicts an organizational and global perspective, value can also be defined for a product or a service. AFNOR standard (AFNOR 1991) defines value in the product context as: *a judgment made on product by users on the basis of their expectations and motivations. More specifically, value increases when customer satisfaction increases or the incurred cost on product decreases*. This definition can be mathematically symbolized as (Equation 4-1):

$$Value = \frac{Satisfaction}{Cost} \quad 4-1$$

In this definition, the presence of a triptych of customer-product-company is formulated: *the company* materializes value into a *product or a service* in order to satisfy a *customer* by spending its resources (Ahmed and Yannou, 2003). This perspective on value has been adopted in value analysis (also called value engineering). Value analysis perceives value as the maximization of process efficiency through the identification and elimination of waste at the business process level (Chatterjee, 1998). Lean initiative tools such as Kaizen and value mapping tools are used to support this approach (Womack and Jones, 2003).

Continuing the discussion on Equation 4-1, Yannou(1999) explains that satisfaction to cost ratio definition of value is very generic and does not provide guidance to evaluate value of a product. To answer the deficiency, Yannou modifies the previous definition by relating it to the functions of a product (Equation 4-2).

$$\begin{aligned} Value_{global} &= \sum_{function\ i} I_i \times valeur_j(function\ i) & 4-2 \\ &= \sum_{function\ i} I_i \times \frac{I_i \times S_{ij}}{C_{ij}} \end{aligned}$$

Where,

- $I_i$  Importance of a function  $i$
- $S_{ij}$  Satisfaction of function  $i$  in scenario  $j$
- $C_{ij}$  Cost of function  $i$  in scenario  $j$

The concept of value in the management discipline is an extension of value in value analysis, which considers also ambiguous objectives and value judgments in the



definition of value (Neap and Celik, 1999). However, Bréchet and Desreumaux (2001) state that in management “*there is no definition of value, but a plurality of concepts, even plurality of tools or techniques to measure a given concept*”. Nevertheless, one finds various definitions and usages of value in management sciences (Ahmed and Yannou, 2003). In finance, it alludes to creation of wealth for shareholders. Whereas in the marketing domain, value is what the customer is ready to pay for. Similarly, in human resource management, it refers to the skills of company employees. In design, as mentioned before, value is satisfying customers by meeting product functions at low cost.

In brief, this is an environment with plurality of visions simply because value is interpretable in different ways by different fields of study. This interpretation as explained earlier can be attributed to the context in which value is dealt with. The current research retains the management view of value because it includes a soft thinking approach towards value: value judgments and ambiguous objectives.

Furthermore, research work more often focuses on what value is but very little attention has been given on how value is created and for whom it is created? Therefore, before embarking on evaluating value one must ask the questions: for whom value should be created and how value can be created?

To reply to the first question, Chazelet and Lhote(2001) envisage three visions:

1. The first school of thought asserts that the company has to create value to pay the shareholders who took the risk to invest in the company (Bréchet and Desreumaux, 2001).
2. The second school of thought advocates the creation of value for the customer and the shareholder alike(Anderson *et al.*, 2004).
3. The third vision urges the creation of value for all stakeholders (Epstein 2003).

Today’s business environments favor the third school of thought. However, all stakeholders cannot be considered at the same level (Chazelet and Lhote, 2001; Garengoet *al.*, 2005). So, it is up to the company to decide which stakeholders are more important.

To answer the second question is not as simple. For this, it is important to understand internal as well as external factors. It requires in-depth understanding from different fields around business, strategy, operations and even more from customers. However, for this research, which has a process perspective, we establish that activities and their coordination are the sources of value creation.

The aim of the current research is not to provide a new definition of value but to find how the created value can be reified and measured in the context of performance measurement and management. To this end, objectives need to be determined in the first place in order to explain the values of the stakeholders in a given context.

#### **4.2.2 Eliciting value via objectives modeling**

“Value”, which is of concern in a given context, is made explicit to stakeholders through objectives. However, this requires long and hard thought to determine what objectives reflect the value of the stakeholders. For this purpose, objectives should be determined meticulously before proceeding to the value evaluation. Inadequate statement of objectives will lead to wrong performance measures and in turn the

stakeholders’ expectations judgment process will get off on the wrong foot. Therefore, it is a must to model objectives with scientific rigor.

An objectives model is therefore used to facilitate the identification and structuring of objectives in order to measure the level of performance in any business process. However, individual modeling methodologies focus primarily on the specific aspects of process representation and measurement. For example, process modeling methodologies provide a support for value analysis, particularly in the Porter’s value chain paradigm. However, few process modeling methodologies (except CIMOSA) model objectives or goals. Although the modeling methodologies assume that goals or objectives are known to the modeler in advance, these goals or objectives are not explicitly defined (Kueng and Kawalek, 1997; Neiger and Churilov, 2004). Due to this inadequacy on the part of process modeling methodologies, it cannot be used to model objectives of a business process.

Unlike process modeling, objectives modeling in decision models are carried out using well-established techniques, explored in the framework of “value focused thinking” developed by Keeney (1996). As opposed to the traditional decision making models, where the focus is often on alternatives evaluation, the value focused thinking framework recognizes the need for clear and structured objectives to approach value.

In brief, we believe that process modeling methodologies approach value through activity modeling while decision-making approaches do this via objectives modeling. The former uses an activity model as a support to evaluate the value, whereas the latter employs a decision model incorporating an objectives model for this purpose. However, the real-world business is not split along process and decision modeling lines and, still, the two approaches continue to work separately (Neiger and Churilov, 2003). Therefore, it is necessary to integrate the two domains and hence the methodologies to provide an overall solution.

Building on the theory of value-focused thinking, Neiger(2006) proposed a value-focused process engineering model that creates links between business processes and business objectives at the operational and strategic level as illustrated in Figure 4-1. The author defends the view that defining objectives within the process-modeling context would result in a more effective process and decision modeling tools.

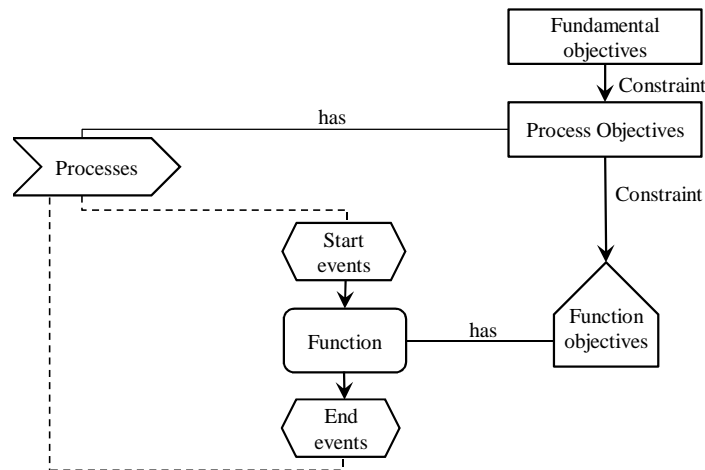

Figure 4-1: Value-focused process engineering (Neiger et al., 2006)

### 4.2.1 Objectives modeling: Tools and techniques

Quantitative objectives models are motivated by the need to translate qualitative objective statements into quantitative statements (also called performance criteria) which can be used to evaluate the impact of business operations on its objectives (Neiger *et al.*, 2008). Quantitative objectives modeling can be carried out using methodologies such as value-focused thinking (VFT) (Keeney, 1996), balanced scorecards (Kaplan and Norton, 2000) and system dynamics (Sternan and Sternan, 2000). Unlike other models, the VFT framework provides an explicit and articulated approach for objectives modeling and links it to the multi-attribute utility theory. Therefore, the current research prefers the VFT framework as a foundation for objectives modeling.

Within the VFT framework, an objective is “*a statement of something that one wants to strive toward*” (Keeney, 1994). Keeney categorizes objectives into fundamental and means objectives. The former concern the ends that the decision-makers (DM) value in a specific decision context, whereas the latter refer to the “*methods to achieve fundamental objectives*”.

In addition, for the VFT framework to align objectives, another useful technique called Goal Question Metric (GQM) can be used to facilitate the identification of measures from objectives (Basili and Weiss, 1984; Basili *et al.*, 1994). As opposed to the *bottom-up* approach, performance measures (called metrics in the approach) are found using the *top-down* approach. First goals are defined and then questions are asked. Answers to the questions help in attaining performance measures for the goal. The approach is detailed in the literature (Eusgeld *et al.*, 2008).

For the current dissertation, the VFT framework is selected for objectives modeling since the framework makes explicit the value through objectives and then define performance measures for the purpose of evaluation. The following sections explain the objectives modeling approach of the VFT framework.

#### 4.2.1.1 Identification of objectives

Identifying objectives is the fundamental and crucial step towards value evaluation. It requires significant creativity and hard thinking and therefore it is often helpful to start discussion with decision-makers and stakeholders.

The first step in the identification of objectives within the VFT framework is to identify the overall objective that characterizes “*the reason for interest in the decision situation*” (Keeney, 1996, p. 77). Fortunately, it is relatively easy to identify the essence of the overall fundamental objective. In the production context, it could be “*improve delivery time*” or “*reduce time to market*”. However, fundamental objectives and means objectives are comparatively more difficult to identify. Therefore, the process of objectives determination can be supplemented with tools and techniques.

There are several tools and techniques that can help to stimulate the identification of possible objectives. Table 4-1 lists the techniques that can be employed for the determination of objectives. For more details, the reader is referred to (Keeney, 1996, p. 57). In addition, in a multiple-stakeholders perspective, objectives are determined applying stakeholder analysis techniques such as interviews, questionnaires and surveys (Jepsen and Eskerod, 2009; Parnell *et al.*, 2010) to avoid conflict of interest. Additionally, causal loop diagrams (Sternan, 2000, p. 137) or post-it diagrams in

combination with qualitative maps (Santos *et al.*, 2002) can foster creative thinking and can generate possible objectives.

**Table 4-1: Techniques for identifying objectives (Keeney, 1996)**

1. Develop a wish list	What do you want? What do you value? What should you want?
2. Identify alternatives	What is a perfect alternative, a terrible alternative, some reasonable alternatives? What is good or bad about each?
3. Consider problems and shortcomings	What is wrong or right with your organization? What needs fixing?
4. Predict consequences	What has occurred that was good or bad? What might occur that you care about?
5. Identify goals, constraints and guidelines	What are your aspirations? What limitations are placed on you?
6. Consider different perspectives	What is each stakeholder's perspective?
7. Determine strategic objectives	What are your ultimate objectives? What are your values that are absolutely fundamental?
8. Determine generic objectives	What objectives do you have for your customers, your employees, your shareholders, yourself? What environmental, social, economic, or health and safety objectives are important?

Continuing the discussion on the objectives identification process, once the overall fundamental objective is identified, it can be drilled down into lower level fundamental objectives, which represent the different dimensions or aspects of the higher level objective. For example, for the overall fundamental objective “maximize utility of the product development project”, lower objectives such as “maximize utility for sales operations” and “maximize utility for R&D” can be identified. To facilitate the process, Keeney (1996, p. 79) suggests the use of categories as for the lower level fundamental objective “maximize utility for sales operations”, the further subset of fundamental objectives can be: “maximize sales to customers” and “maximize product superiority over rival products”. Similarly, for the objective “maximize product superiority over rival products”, the different possible aspects can be: “increase reliability”, “decrease weight” and “increase use time”.

Conversely to fundamental objectives, means objectives aim to address the issue: what causes the fundamental objective to be achieved (Keeney, 1994, p. 34). In the running example, for the fundamental objective “maximize product superiority over rival products”, the means objectives can be: “develop light saving mode”, “use second backup battery”. To drill down further, other means objectives would appear such as “use backup battery type X” “use backup battery Y”.

So, means objectives not only provide a means but also create alternative ways to achieve the fundamental objectives. Once all objectives are identified, they are then structured in the next step.

#### 4.2.1.2 Structuring objectives

Fundamental objectives are structured into a *strict hierarchy* (Keeney, 1996, p. 69–71). The upper level refers to more general objectives while the lower levels represent the characterization of higher-level objectives and there should be at least two lower-level objectives connected to one higher-level objective (Keeney, 1996, p. 98). The identification process is iterative. Upon identification of lower level objectives, the higher level objectives need to be revised to avoid redundancy and make sure that all important aspects of the higher-level objectives are covered.

The relationship between the adjacent levels of the means objectives is causal (*i.e.* a lower level objective is a means or causal factor to a higher-level objective) (Keeney, 1996, p. 78). For example, in the running example, “develop light saving mode” will cause to “increase reliability” thus causing the fundamental objective to be achieved. Once all means objectives are identified, they are then structured as an objectives network. Unlike the fundamental objectives hierarchy, the means objectives network does not need a minimum of two lower level objectives since the latter does not form the hierarchy.

To organize fundamental and means objectives, Clemen and Reilly (2000) summarize the techniques in Table 4-2.

**Table 4-2: Hierarchies and Networks Construction (Clemen and Reilly, 2000)**

	<b>Fundamental Objectives</b>	<b>Means Objectives</b>
To Move:	<i>Downward in the hierarchy:</i>	<i>Away from fundamental objectives:</i>
Ask:	“What do you mean by that?”	“How could you achieve this?”
To Move:	<i>Upward in the hierarchy:</i>	<i>Toward fundamental objectives:</i>
Ask:	“Of what more general objective is this?”	“Why is this important?”

In situations where multiple stakeholders are involved, Keeney (1994, p. 34) suggests that the objectives are first structured for each individual and then integrated “into a common set of objectives”.

This whole methodology is illustrated with an example adopted from (Hurri, 2000, pp. 31–32) as shown in Figure 4-2.

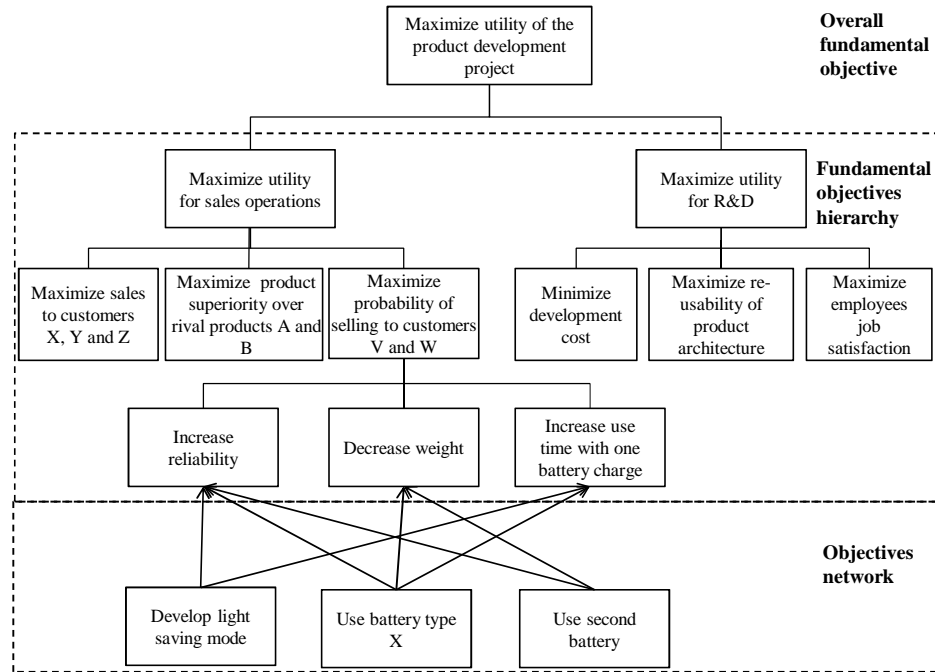

Figure 4-2: Objectives hierarchy and objectives network (Hurri, 2000)

#### 4.2.1.1 Eliciting performance measures

The generation of performance criteria is core to the evaluation of processes or alternatives. Often in practice, performance criteria for measurement purpose are defined using a bottom-up approach. However, this approach is generally considered problematic. Without the inclusion of context or objectives, it is usually unclear which criterion should be selected and how it can be interpreted (Eusgeld *et al.*, 2008, p. 39). Within the context of VFT, like with other methodologies, objectives or goals are defined at conceptual level and cannot be measured directly. To make them operational, a performance criterion has to be defined.

In the VFT framework, the term *attribute* is used to refer to the criterion. It is important to note that attributes are derived from the fundamental objectives hierarchy as opposed to the network objectives, which are used to identify alternatives to achieve the fundamental objectives.

An *attribute* measures the degree to which an objective is achieved (Keeney, 1996). Keeney defined three types of attributes: natural, constructed and proxy attributes. Natural attributes are those that have a common interpretation to everyone. For example, if the objective is to “minimize cost”, then the corresponding attribute is “cost in monetary terms and, hence, is a natural attribute. Similarly, the objective “reduce cycle time” could be measured with an attribute such as “cycle time in time units”.

However, if a natural attribute does not exist or it seems to have inappropriate built-in value judgment as for the objective “maximize quality”, then there are two possibilities: either use proxy or constructed attributes.

Constructed attributes are developed for a given context unlike natural attributes, which are relevant to numerous contexts. A good example of a constructed attribute is the scale for severity and detection in the FMEA method.

Proxy attributes could be the last resort to operationalize an objective. For example, the objective “maximize process quality” can be measured with “process yield”. Similarly, the objective “maximize process recoverability” can be measured with the proxy attribute “mean-time between failures (MTBF)”.

Once all performance criteria are identified, it is worthwhile to bring some structures to the list of performance measures. The use of a simple tree, henceforth performance measure tree or value tree, can be helpful in structuring all the performance measures (Santos *et al.*, 2002).

To conclude the discussion on the objectives modeling, it is worth to mention that the VFT framework provides an explicitly articulated and systematic approach for the identification and structuring of objectives and links them to multi-attribute utility theory. However, we are not interested on how the VFT framework can be used for decision making because the current research relies on other multi-criteria decision making techniques such as MACBETH and Choquet Integral. The reasons and details of these techniques are discussed in Section 5. For the purpose of objectives modeling, materials are drawn from the VFT framework for the proposed performance management work and would try to implement the technique in a process modeling context.

### **4.3 Process-centered performance management systems: Tools and techniques for modeling**

Michael Hammer, who originated the idea of process-centered organization (Hammer, 1997), declares process centering to be the first and foremost shift in perspective, an Escherian reversal of foreground and background, in which primary (tasks) and secondary (processes) exchange places. Hammer’s idea of process-centered organization is in contrast to Adams Smith’s idea of labor specialization where the focus is on tasks and not on processes. Hammer advocates the use of a process-centric approach to minimize non-value adding activities while expanding the boundaries of the system with ease. In addition, the process-centered design of organization, according to Indulskaet *al.* (2009), is generally seen as an appropriate response to the increased economic pressure on organizations.

The idea of process-centered organization brings with it process-centered measurement and management. Numerous authors advocate the use of a process-centric approach towards performance management (Acar *et al.*, 2010; Beamon, 1999; Chan and Qi, 2003; Folan and Browne, 2005; Meyer, 2003; Kueng, 2000) for the simple reason that performance management of processes instead of tasks or functional departments (*i.e.* functional silos) deconstructs inherent organizational complexity and lets one to focus solely on activities (Bandara *et al.*, 2005). However, the methodology to capture appropriate process knowledge for evaluation purpose still needs to be standardized.

The core methodology for process-centered organization is process modeling (Vernadat, 1996; Indulskaet *al.*, 2009), an approach to depict and illustrate the way organizations conduct current or future processes at various levels of abstraction. Process models, in their most basic form, typically depict in a graphical way at least the activities, events/states and control flow logic that constitute the business processes (Curtis *et al.*, 1992). In addition, process models may also incorporate information about involved data, organization/IT resources and potentially other

artifacts such as external stakeholders and performance metrics (Scheer, 2000). This idea is supported by Indulska *et al.* (2009), who analyzed perceived benefits of the process models where performance measurement is among the main ones.

Due to the growing importance of the process methodologies, various business process modeling languages have been developed, which are discussed briefly in the following section in the context of performance management.

### **4.3.1 Business process modeling languages: Overview**

Currently, numerous conceptual business process modeling languages (BPMLs) are available. To adequately describe a business process, various process relevant perspectives (*e.g.* functional, behavioral, organizational and informational) must be integrated into a process model (Curtis *et al.*, 1992; Vernadat, 1996). BPMLs differ in the extent to which their constructs highlight these process perspectives. These differences can be attributed largely to the domain area targeted.

For process-oriented performance management, the important process perspectives are functional, behavioral and organizational ones. The functional perspective refers to activity modeling which is a must for any simulation-based process evaluation. The behavioral perspective represents when process elements are performed (such as sequencing, temporal relation...) as well as aspects of how they are performed through feedback loops, iterations, complex decision-making conditions, entry and exit criteria and so on. The organizational perspective represents where and by whom (*i.e.* which agents) the process elements are performed. More details about these perspectives can be found in the literature (Curtis *et al.* 1992 and Vernadat, 1996, 1999). Furthermore, in business process performance management, some additional information is required for the process models such as objectives modeling, risk inclusion, etc. in order to provide an overall solution as far as the performance management is concerned.

In the current dissertation, a few well-established BPMLs have been chosen for review. The purpose is to select a BPML easily comprehensible and capable to model a business process along with the required information with little effort for value and risk assessment.

Furthermore, each BPML language is described using a business process example of order processing of manufacturing goods. The order processing process starts with the arrival of an order. The company sales department then checks the inventory to verify if the required number of goods is available to supply. Depending on the inventory level, the order is either rejected, accepted, or modified. In the latter two scenarios, the order is processed by dispatching the goods along with the invoice, which marks the end of the business process.

#### **4.3.1.1 CIMOSA**

CIMOSA is open system reference architecture for enterprise modeling and integration (ESPRIT Consortium AMICE, 1991; Vernadat, 1996). It provides a modeling framework, also known as the CIMOSA cube (see Figure 4-3), which structures the reference architecture into a generic and a partial modeling level, each one supporting different views to develop a particular enterprise architecture made of models (Kosanke, 1995). The CIMOSA framework defines four different views, namely the function, information, resource and organization views to build these



models. However, this number of views is not limitative and can be further expanded if required (Vernadat, 1996).

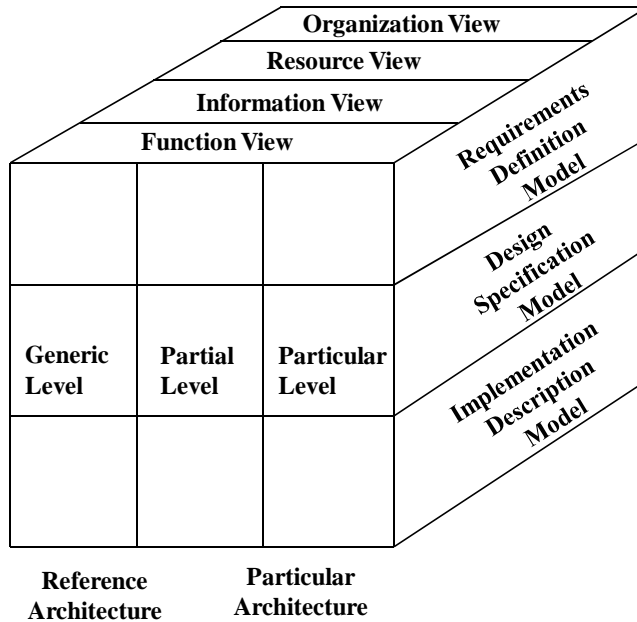

Figure 4-3: CIMOSA cube (Vernadat, 1996)

The function view of CIMOSA deals with process models. Essential constructs of the function view are: event, domain, domain process, business process, enterprise activity and functional operation. They are used to model enterprise functionality and behavior.

CIMOSA uses a set of constructs to define the problem and decompose the enterprise into manageable modules called *domains (DM)*. Each domain comprises a set of core processes called *domain processes (DP)* that represent stand-alone processes of the enterprise. A *domain process* can be decomposed into lower-level processes, which are further decomposed into sub-processes, and so on employing the functional decomposition principle. The root of the functional decomposition tree is a domain process followed by intermediate nodes called *business processes (BP)* down to the leaves which are *enterprise activities (EA)*. This tree structure naturally defines three types of constructs used to represent enterprise functions as follows.

*Domain processes* (the roots) are triggered by events only which, in turn, initiate sequences of enterprise activities to realize the desired enterprise behavior. The process behavior is described in terms of behavior rules as defined in the reference architecture.

*Business processes* (intermediate nodes), a term coined by the CIMOSA architecture, are similar to domain processes except that they cannot be triggered by events but must be called on by a parent structure, and their termination conditions must be defined as *ending statuses*. A process is a partially ordered set of steps, *i.e.* business processes and/or enterprise activities.

*Enterprise activities* (the leaves) are elementary steps in a process. They are the locus of action and transform inputs into outputs using resources. They can further be decomposed into functional operations at the system design level and assigned to

resources called functional entities. CIMOSA functional entities are resources which can receive, send, process and store information (Kosanke, 1999). Figure 4-4 depicts the order processing business process model in CIMOSA.

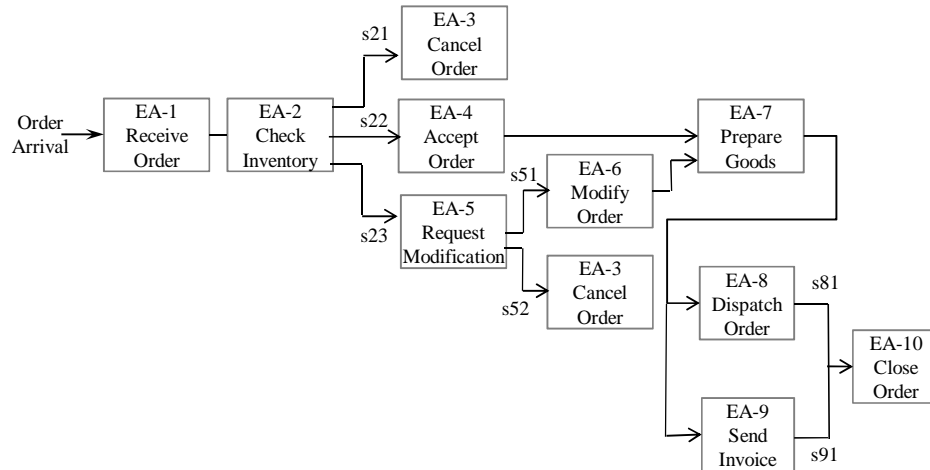

**Figure 4-4: CIMOSA process model for the order processing example**

Simulation can be employed to analyze processes at the design specification level of CIMOSA. However, it lacks the power to support more low level concepts such as queues, processing units or resource usage (Galland *et al.*, 2003). Moreover, simulation in CIMOSA is enabled through Petri Nets, hence inheriting the limitations of this approach (Ryan and Heavey, 2006). It also lacks the ability to model risk.





#### 4.3.1.2 Integration Definition 3 method (IDEF3)

IDEF3 is a process capture and description method within the context of a specific scenario (Mayer *et al.* 1993). It provides two views: the process-centered view and the object-centered view. The process-centered view captures the behavioral aspects of a system by modeling the process sequence with their temporal, causal and logical relationships. The object-centered view models objects and their changing states in a given process or system.

The process-centered IDEF3 documents events, activities, decisions and relationships of a process in so-called *Units of behavior* (UOBs), *Junction boxes* and *Links* as shown in Table 4-3. A UOB captures information regarding activity, function or decision in the process. It is depicted by a rectangle with a unique label. Links, represented by arrows, act as glue that connect UOBs and junction boxes to form representations of dynamic processes. They are used primarily to denote relationships (such as temporal, logical, causal, natural and conventional) among UOBs in a process. Junction boxes provide a mechanism to represent logical branching and synchronization in the process. Generally, there are three types of junction boxes: *AND* (&), *OR* (O) and *Exclusive OR* (X).

The *AND* junction box represents that all preceding activities connected to this junction box must be carried out. The *OR* junction box indicates that at least one activity of all the anterior activities connected to this junction box must be performed. Finally, the *X* junction box indicates that only one of all preceding activities connected to this junction box can be performed.

**Table 4-3: IDEF3 process notation**

Name	Description	Symbols
Unit of Behavior (UOB)	Represents an activity or a sub-process	
Junction boxes	Specify logical branching of UOBs: (Fan-In and Fan-Out) - XOR (labeled X) - OR (labeled O) - And (labeled &)	
Links	Represent the precedence relationships (or constraints) or interactions	 Precedence Link  Relational Link  Object Flow Link

Moreover, it is possible to include *Referents* and *Notes* in IDEF3 models. A referent is used to refer to either a previously defined UOB, to transfer control or to form references between the processes and object schematics. A referent can either be a *Call-and-Continue referent* or a *Call-and-Wait referent*. A note allows annotating additional information to a process. Figure 4-5 shows the order processing example modeled in IDEF3 notation.

From Figure 4-5, it is clear that the language is well-suited to capture relevant knowledge such as functional and behavioral aspects of a process. However, it fails to include the organizational aspects of the business process. Furthermore, an IDEF3 model is simple to understand and can be communicated easily to those who even do not have enough process modeling knowledge. Additionally, risk and objective modeling cannot be carried out clearly in the language.

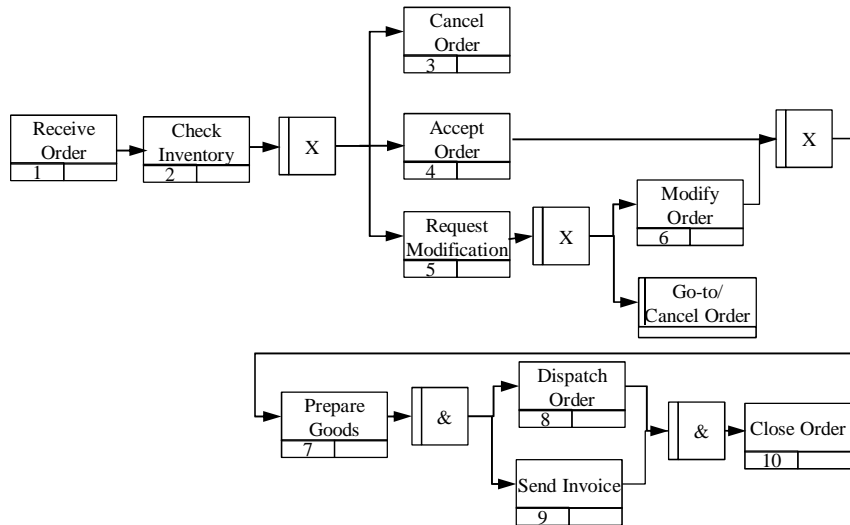

**Figure 4-5: IDEF3 Process model for the order processing example**

### 4.3.1.3 ARIS event-driven process chains (EPC)

The Event-driven Process Chain (EPC) is a method developed by Keller, Nuttgens and Scheer within the framework of ARIS (Architecture for Information Systems (1992) to model business processes. The method has been used in many business process initiatives such as business process reengineering (BPR), enterprise resource planning (ERP) and workflow management (WFM). The corresponding tools include ARIS ToolSet, SAP R/3 and Visio. EPC diagrams describe processes on the level of their business logic and are targeted to be comprehensible and used by business people (Van der Aalst, 1999).

An EPC diagram consists of the following elements: *Function*, *Event* and *Logical connectors* (*AND*, *OR* and *XOR*). Extended EPC includes *Organizational unit*, *Organization role* and *Deliverable* (see Table 4-4).

**Table 4-4: Event-driven process chain (EPC) elements**





Element	Description	Symbol
Function	Function is the basic building block of an event driven process chain and used to model an activity (task, process step).	
Event	Describes the situations both before and after the function is executed. It may correspond to the post-condition of one function and act as a pre-condition of another function.	
Logical connectors	Logical connectors connect functions and events and exist in three forms: AND, XOR and OR.	
Organization- al unit	Responsible for performance an activity.	

Figure 4-6 models the order processing business process in EPC. Similar to IDEF3, the language is rich enough to model functional and behavioral aspects of the process.

In addition to them, some organizational aspects are also covered. However, it is a bit complex compared to IDEF3 because every function is sandwiched between two event constructs, which in turn requires more time and space to model a process.

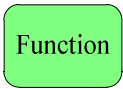
EPCs can model with precision the flow of activities that are associated with the execution of tasks within a discrete event system. However, the technique is not capable to model the state of change or the control of a discrete event system (Ryanand and Heavey, 2006). Furthermore, it does not model either objectives or risks in a process.

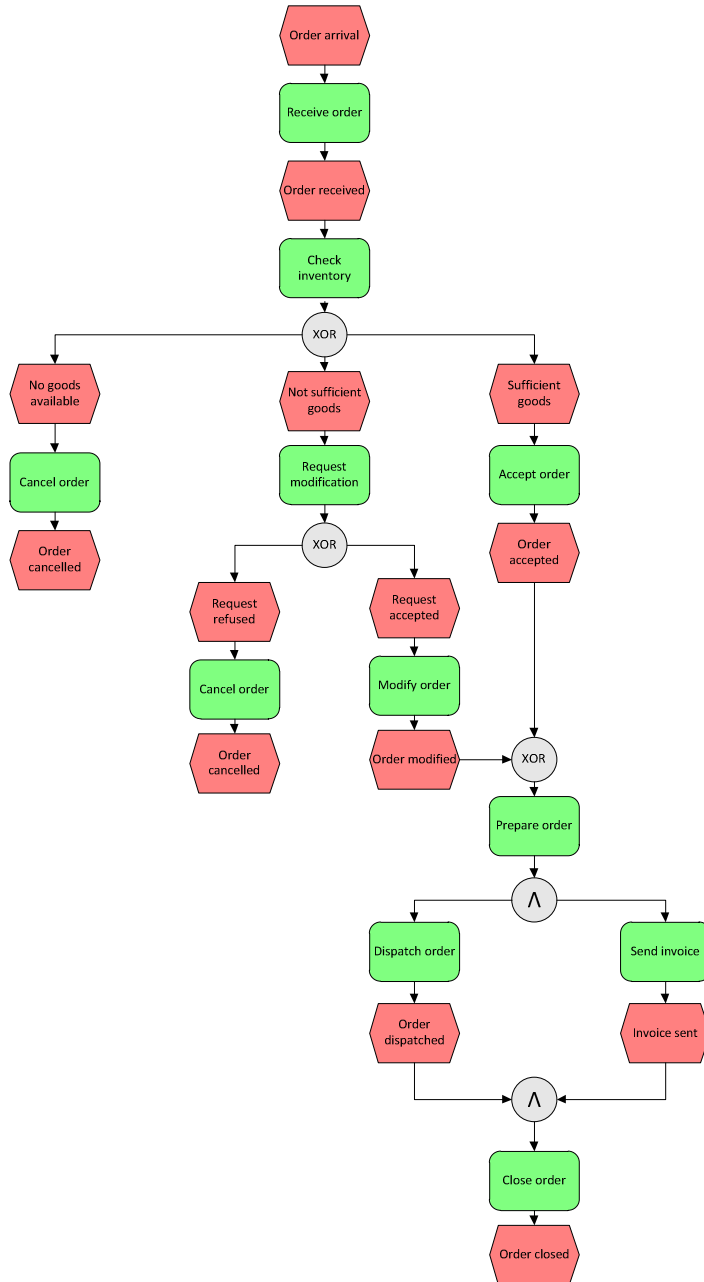

Figure 4-6: EPC process model for the order processing example

#### 4.3.1.4 Business process modeling notation (BPMN)

BPMN is a recent *de facto* standard graphical language supported by the Object Management Group (OMG, 2009) for capturing business processes, especially at the level of domain analysis and high level system design (Dijkman *et al.*, 2008). The basic idea behind BPMN is to provide a notation that is easily readable and understandable for all business users. The notation draws on elements from previously proposed process modeling notations including UML, IDEF, ebXML, LOVeM, RossetaNet and even event-driven process chains (Muehlen and Recker, 2008).

BPMN is made up of a set of graphical elements used to develop process diagrams. The complete BPMN specification defines 50 constructs plus attributes, grouped into four basic categories, namely: flow objects, connecting objects, swimlanes and artifacts as shown in Table 4-5.

**Table 4-5: BPMN elements**







Category	Construct	Description	
Flow objects	Event	Event is something that happens during the course of a business process. Three types of events, based on when they affect the flow, are: <i>start</i> , <i>intermediate</i> and <i>end</i> (the figures illustrated respectively).	
	Activity	Activity is a generic term for work that company performs. The types of activities are: <i>Task</i> and <i>sub-process</i> . The Sub-process is distinguished by a small “+” sign in the bottom center of the shape.	
	Gateway	It is used to control the sequence of flows and determines the decisions as well as the forking, merging and joining of paths.	
Connecting objects	Sequence flow	It is used to show the order in which activities will be performed in a process.	
	Message flow	It shows the flow of messages between two separate process participants.	
	Association	It is used to associate data, text and other artifacts with flow objects.	
Swimlanes	Pool	A pool represents a participant in a process.	
	Lane	A lane is a sub-partition within a pool. Lanes are used to organize activities.	
Artifacts	Data object	It is a mechanism used to show how data is required or produced by activities and connected to activities through associations.	
	Group	Group is used for documentation and analysis purposes.	
	Annotation	Annotation is a mechanism for a modeler to provide additional text information for the reader of the BPMN diagram.	

Figure 4-7 shows the order processing example modeled in BPMN for the purpose of illustration.

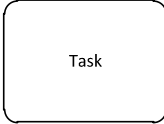
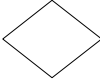

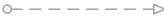
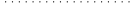
**Figure 4-7: BPMN process model for the order processing example**

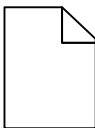
Comment: BPMN provides a rich library of modeling constructs but at the cost of additional complexity. Muehlen and Recker (2008) examined, using statistical techniques, the use of BPMN elements in practice and observed that most often four core set constructs, namely task, sequence flow, start event and end event, are used in practice. The empirical study shows very little application of extended modeling constructs of BPMN. Concerning notations to represent process stakeholders, BPMN makes use of pools and swimlanes. However, modeling of objectives and risks is not represented.

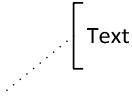
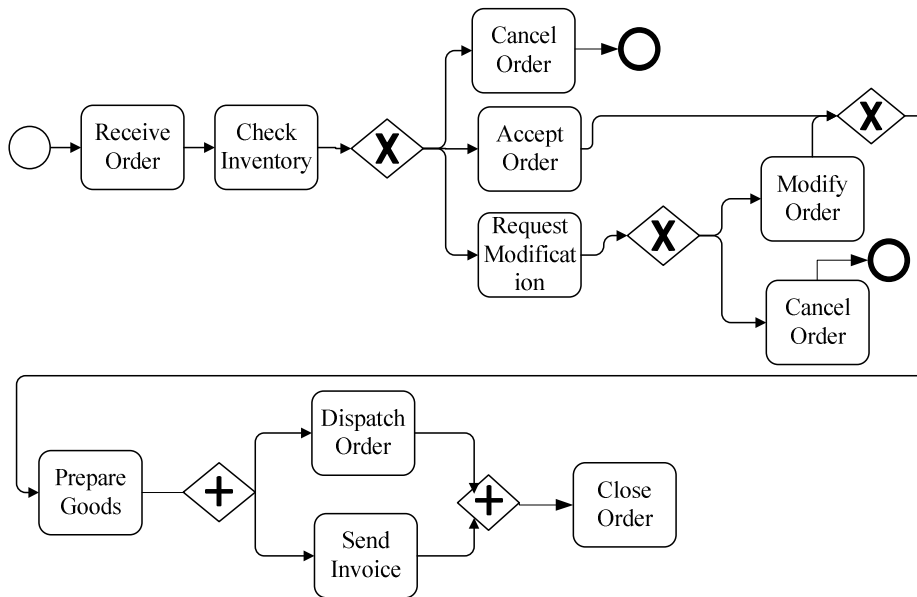
#### 4.3.1.5 Petri nets

Petri nets (PN) are a formal mathematical modeling language for specifying discrete event systems in a formal and abstract way (Petri, 1966). Petri nets have both graphical representation as well as mathematical formalization and are used to model dynamic systems with static structure, which is represented by a Petri net, where the dynamic behavior is captured by tokens moving in places of the PN (Peterson, 1981). They can therefore be used to model business processes (Van Der Aalst, 1999).

Petri nets consist of two types of nodes, *places* and *transitions*, connected by directed *arcs*. An arc runs from a *place* to a *transition* or vice-versa. In graphical notation, *places* are represented by circles, *transitions* by rectangles and *arcs* by arrows. To model the dynamic behavior of the system, a PN contains a discrete number of marks called *tokens* that reside in places and that move from place to place via transitions following the arrows according to firing rules of the token game that govern the PN behavior (Peterson, 1981; Murata, 1989). The structure of a PN remains fixed, whereas tokens may change their position according to the firing rules.

A Petri net characterizing the order processing example is shown in Figure 4-8. The process is initiated with the arrival of a token at place P1 (*Receive order*). As soon as a token is in place P1, transition T1 fires and the token moves to place P2, which

represents the execution of the *check inventory* activity. The execution time of each activity is not represented.

After *check inventory*, the token either moves to P3, P4 or P5 depending on the condition of the inventory. In the case the token moves to P3 or P7, which are sink places, the process stops. Otherwise, the token continues its path until it arrives at the sink place P11, which terminates the order processing process.

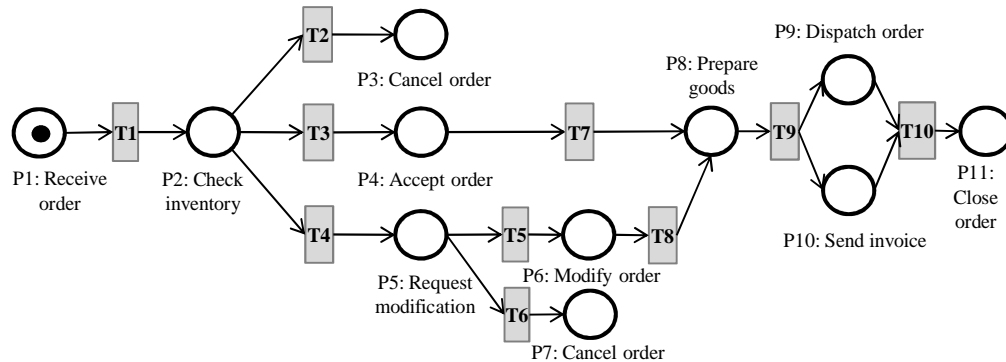

**Figure 4-8: Petri net process model for the order processing example**

Comment: It has been shown that Petri nets can be used to support process simulation (Tuncel and Alpan, 2010) or be a modeling tool to support activity modeling for simulation in CIMOSA (Kosanke, 1999). They are capable of very accurate modeling to represent a real-world system (Ryan and Heavey, 2006). However, modeling real-world systems using Petri nets is very tedious and the resulting networks are very large and complex models. In addition, it is difficult for non-expert to understand the logic of the model, therefore making it difficult to use PNs across the organization. Model developers and system users cannot easily use this formalism as a communication tool with regard to system operational issues. In addition, OR-nodes (constructs used to split process branches as in IDEF3) cannot be easily represented in PNs and therefore business processes are modeled differently as it is the case in most of BPMLs. Finally, PNs do not directly model objectives and risks although they can be extended to model for instance risk elements as shown by Tuncel and Alpan (2010).

### 4.3.2 Evaluation of business process modeling languages

In this section, business process modeling languages (BPMLs) are evaluated against notation elements and concepts required for performance assessment of a business process. Each assessment criterion consists of up to three signs (made of “+” or “-“). The three signs mean that a certain BPML offers a specific graphical notation to symbolize a business process performance concept (the “+” sign means a positive match whereas the “-” sign signals the non-fulfillment of a specific performance concept by BPML). Table 4-6 demonstrates the possible representations of business process concepts in terms of performance management in BPMLs.



**Table 4-6: Evaluation of BPMLs**

	Functional aspect		Behavioral aspect		Organizational aspect		Risk modeling		Objective modeling		Simple/accurate	
IDEF3	+++	U	++	L&J	-		-/+		-		+++	
CIM-OSA	++		+	Syn.	-		-/+		-		+	
EPC	+++	Fn	++	LG	++	OU&R	-/+		-		++	
BPMN	+++	Tsk	+++	LG	++	P	-/+		-		+	
Petri Nets	++	Tr.	+	Syn.	-		-/+		-		+	

Legends:

- Does not support the concept
- + Weakly supports the concept
- ++ Supports the concept
- +++ Strongly supports the concept
- /+ Can be extended (*i.e.* can be represented partially)

Abbreviations: U=UOB; L&J=Links and junctions; LG=Logic gates; OU&R=Organizational units and role; P= Pool, Syn. = Synchronization; Tsk=Task; Fn= Function; Tr.=Transition

Table 4-6 provides an overview of the business process modeling languages (BPMLs) which can be used to model business processes for performance and risk management. All the BPMLs can be used to integrate risk but none of them has a specific construct for risk modeling. Besides, objective modeling and performance measure representation are not taken into account in any of the reviewed BPMLs except CIMOSA to some extent. However, the IDEF3 technique is simple to implement, readily understandable by humans and widely applied in industry. Based on these considerations, IDEF3 has been selected as a business process modeling language in the current research. BPMN could have been used as well.

#### **4.4 Process-oriented risk management and risk-oriented process management**

*A business process is a structured, measured set of activities across time and space, with a beginning, an end and clearly identified inputs and outputs designed and executed to create value for stakeholders* (Davenport, 1993). However, it may encounter uncertain and unexpected events which could derail the achievement of process objectives and, consequently, affect the process value. Moreover, it could impact the image of the organization, its future market potential and long term competitiveness. Hence, it is mandatory for the organization to identify and assess

such events through risk management practices for preserving the value created by its processes.

Risk management has developed into a mature discipline in management and decision sciences. However, risk issues are traditionally separated in these disciplines from operational concerns of the business (Neigeret *al.*, 2006) and risk is, in these disciplines, typically characterized as the probability of occurrence of loss or gain multiplied by its respective magnitude. In the context of business processes, risk representation and analysis is linked directly to the individual activities within a process. Nevertheless, a sufficient link is missing between business processes and quantitative risk models (Scott and Vessey, 2002). Moreover, process modeling methodologies and risk management remain independent of each other.

As mentioned previously, a process-oriented approach towards holistic performance management is the only way out of the current performance quagmire. Additionally, performance management without risk management is meaningless. Therefore, one must adapt process-oriented approaches to risk management in conjunction with performance measurement for the ease of use while dealing with the two disciplines in an integrated fashion. For this purpose, efforts are afoot to incorporate risk into process models so that process performance can be determined in an over-arching sense (Cope *et al.*, 2010; Sienouet *al.*, 2009; Neigeret *al.*, 2006). Moreover, the rationale for adapting process modeling is to enable the individual stages in the overall risk management process to be both structured and readily communicated (Chapman, 2006, p. 107). However, linking risk models to process models is still in its infancy.

This section reviews at a glance the risk management discipline. It covers different steps of risk management like context definition, risk identification, analysis and evaluation and risk treatment. In addition, the applicability, strengths and weaknesses of the risk management techniques in the process-centered perspective are discussed.

#### 4.4.1 The concept of risk

Risk is a concern in almost every discipline such as finance, management and decision sciences, physiology, medical sciences and so on. Each discipline has different definitions and measures of risk (Rothschild and Stiglitz, 1971; Haim, 1977; Kaplan and Garrick, 1981; Luce, 1980; Sarin and Weber, 1993; Jia and Dyer, 1996; Szegö, 2005; Aven, 2010). Therefore, Sienou(2009) terms risk as a highly polysemic word, which carries different meanings in different domains of application. Some typical definitions are:

- 1) The variance of return or the variability of future value of a position or portfolio due to uncertain event in the finance domain (Artzneret *al.*, 1999).
- 2) *Uncertainty concerning loss in the insurance field*(IFRIMA, 1994).
- 3) A possibility of unwanted event whose occurrence will trigger some consequences either positive or negative on project activity in project management discipline (Gourc, 2006).
- 4) In engineering context, it is often linked to the expected loss (Verma and Verter, 2007).
- 5) In management domain, risk is a measure of the probability and severity of adverse effects (Aven, 2010).

- 6) Generally, risk is equal to the triplet( $S_i, P_i, C_i$ ), where  $S_i$  is the  $i$ th scenario,  $P_i$  is the probability of the scenario, and  $C_i$  is the consequences of the  $i$ th scenario,  $i=1, 2, 3...N$  (Kaplan and Garrick, 1981).

The common elements of all these definitions are: event (*i.e.* initiation), uncertainty and consequences. Uncertainty is usually translated into probabilities for the purpose of assessment while consequences are expressed in severity terms. All these elements can be formalized as follows in Equation 4-3 proposed by (Aven, 2010):

$$Risk = f(E, C, P) \quad 4-3$$

Where,  $E$  represents the event,  $C$  the consequence of the event  $E$  and  $P$  shows the probability of the event occurrence. The three terms are rather sufficient to characterize risk.

Additionally, risk has many variants in the risk management literature such as uncertainty, vulnerability, threat and hazard. All refer to the same concept of risk. Risk and uncertainty have been used interchangeably, both representing unexpected outcome (Raftery, 1993). However, some authors make a distinction between risk and uncertainty because the former has quantifiable attributes whereas the latter has not (Wynne, 1992). While for others, risk is the measure of uncertainty and the consequences thereof. Similarly, vulnerability (Aven, 2007) is used when one is concerned about the consequences given that an event has occurred. Looking into the future, the consequences are not known, therefore, vulnerability is understood as the combination of consequences and the associated uncertainty. However, Aven terms vulnerability as an aspect of risk.

To conclude, risk is a term widely and loosely used in the literature like performance. However, it is quantifiable and measurable using several tools and techniques that have been developed so far, See for instance (ISO IEC 31010, 2009). The following section explains few of the well-known risk assessment techniques that can be applied to assess risk in business processes. For the purpose of this research, we rely on the ISO Guide 73:2009, which defines risk as an effect of uncertainty on objectives, whereas an effect is a deviation from the expected positive and negative.

#### 4.4.2 Risk management process

A risk management process is a systematic application of management policies, procedures and practices to the activities of communicating, consulting, establishing the context and identifying, analyzing evaluating, treating, monitoring and reviewing risk (ISO Guide 73: 2009). Its purpose is to safeguard process value for the stakeholders of the process. However, this process is subject to internal as well as external sources of risks, henceforth called risk factors, which lurk within and outside an activity.

A risk management process forms a logical sequence of stages necessary for a robust approach to the implementation of risk management in any organization for the preservation of process value in the presence of risk factors either external or internal to the activity. These sequences of stages are almost the same in all standards and approaches developed so far for risk management practices (Chapman, 2006). The overall risk management process is depicted in Figure 4-9.

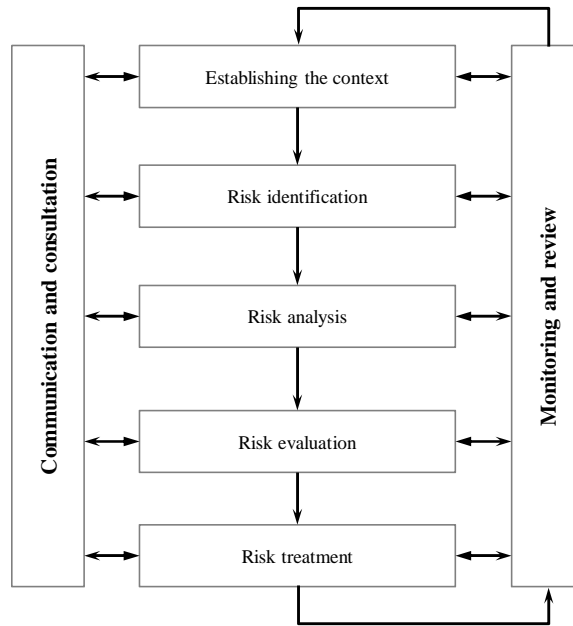

**Figure 4-9: Risk management process (ISO 31000:2009)**

The risk standard divides the risk management process into seven elements including establishing the context, risk identification, risk analysis, risk evaluation, risk treatment, communication and consultation and monitoring and review.

The following sub-sections explain each of the steps except *establishing the context*, which has already been covered in the business process modeling section. Context is about defining external and internal parameters to be considered when managing risk and setting the scope and risk criteria for the risk management policy (ISO Guide 73:2009). The remainder of the risk management process is discussed in the following sub-sections.

#### **4.4.2.1 Risk assessment process**

Risk identification, analysis and evaluation are referred together as the risk assessment process. The purpose of risk assessment is to set a stage for decision making. The following sections briefly discuss each of the steps involved in risk assessment.

##### **4.4.2.1.I Risk identification**

Next to establishing the context, comes the process of risk identification in order to determine risk profiles or risk register. According to ISO 31000:2009, risk identification comprises identification of risk factors, events, their causes and their potential consequences based on historical data, theoretical analysis and expert opinions.

To facilitate risk identification, it is recommended to classify or categorize risk types and then identify the potential risk factors for each classification and stakeholder needs. Several schemes for classification are possible. A first scheme is based on the nature of risk such as schedule risk, quality risk and so on. A second scheme can be based on activity, *i.e.* it could be external or internal to the activity (Salah, 2005). In addition, an objective-driven approach can be used to identify and classify risk (Moeller, 2007). Table 4-7 shows the classification of risks after assimilating the risk

taxonomy of many authors. The definitions of risks in Table 4-7 have been adapted from the literature (Browning, 1998).

**Table 4-7: Risk classification and definition**

Risk taxonomy	Definition	References
Schedule risk	Schedule risk refers to the uncertainty in the ability of a process to achieve its objective within a span of time and the consequences thereof.	(Salah, 2005; Browning <i>et al.</i> , 2003; Larson and Kusiak, 1996)
Financial risk or cost overrun	Financial risk refers to the uncertainty of a process to achieve its objective within the given budget and the consequences thereof.	(Browning <i>et al.</i> , 2003; Larson and Kusiak, 1996; Remenyi and Heafield, 1996; Leong and Gay, 1993)
Quality risk	Quality risk is the uncertainty in the ability of a process to achieve the technical requirements of a product or service, or meet the quality criteria and the consequences thereof.	(Caillaudet <i>et al.</i> , 1999; Leong and Gay, 1993)
External risk	External risk is the uncertainty in the inability of a process to achieve process objective because of uncontrollable external factors and the consequences thereof.	(Caillaudet <i>et al.</i> , 1999; Larson and Kusiak, 1996; Webb, 1996)

Once the classification of risks is carried out, the next step is their identification, which can be performed by any of the two approaches: experienced-based approach and brainstorming-based approach (Royer, 2000). In the former approach, risks are identified while relying on previous experiences in similar circumstances. In the latter approach, risk identification is realized through discussions and brainstorming with risk team members and stakeholders. However, both approaches are supplemented with risk identification tools and techniques so that risks are determined effectively.

**4.4.2.1.II Risk analysis**

The risk identification process leads to risk analysis. This process of risk analysis is about to determine the nature and the level or magnitude of risk (ISO 31000: 2009) where, the magnitude of risk is the combination of risk consequences and their likelihood. Additionally, risk analysis develops causal and consequence picture. However, the causality determination depends on the method or technique to be applied and how the results are to be used. Irrespective of the technique used, the intent is always to describe risk either qualitatively or quantitatively (Aven, 2008).

In qualitative analysis, the risk assessor is asked to assign descriptions to the probability and impact of each risk from a predetermined set of phrases. In probability terms, the set of phrases can be: almost certain, likely, possible, unlikely and rare. Similarly, the impact is categorized in linguistic terms such as insignificant, minor, moderate, major and catastrophic (Vose, 2008). The risk level is then determined using linguistic terms such as low (L), moderate (M), high (H) and extreme (E) (see Table 4-8). Besides that, constructed risk attributes can be defined

for each element of risk, *i.e.* probability and severity as it has been carried out in failure mode and effect analysis (FMEA) to analyze risk qualitatively.

**Table 4-8: Qualitative risk assessment**

Probability	Impact				
	Insignificant	Minor	Moderate	Major	Severe
Almost certain	M	H	H	E	E
Likely	M	M	H	H	E
Possible	L	M	M	H	E
Unlikely	L	M	M	M	H
Rare	L		M	M	H

In the quantitative approach, the risk model is structured around modeling the variability (randomness) of the risk parameter, which results into a probability distribution. Instead of expressing the entire probability distribution of a parameter, it is common to use a measure of central tendency, *i.e.* expectation, together with a measure of variation such as standard deviation or quantile(Aven, 2008, p. 24).

**4.4.2.1.III Risk evaluation**

The risk evaluation process compares the results of risk analysis with risk criteria (*i.e.* a term of reference against which the significance of risk is evaluated) to determine whether the risk is acceptable or tolerable (ISO 31000: 2009).

The principal reason of risk evaluation is to assist in decision making. Risk analysis alone does not provide a sound base for decision making as it simply presents a risk picture or description. Therefore, to make risk management a decision-making tool, evaluation is mandatory.

To evaluate risk, it is common to use a hierarchy of goals, criteria and requirements (Aven, 2008). The whole process can be divided into the following three stages:

**A - Select criteria**

Similar to performance criteria, risk criteria are contextual and can vary from project to project. It represents the views, usually of regulators, of how much risk is acceptable (Zsidisin and Ritchie, 2008, p. 92). In business process context, it can be derived from the process objectives much the same way as in value focused performance management (explained in section 4.2). Furthermore, it should be identified before risk analysis is carried out (Aven and Vinnem, 2005).

**B - Compare risks**

To determine the significance of risk, the estimated risk is compared against selected risk evaluation criteria (Johnson, 2004).The purpose is to see whether the estimated risk violates the criteria or surpasses the acceptability limit or not.

**C - Rank risks**

Risk ranking is to determine which risk is significant. The idea is to rank risks according to their significance in order to prioritize risk management strategies and measures and, subsequently, resources and efforts for managing risk (Mullai, 2009).

Once all risks are evaluated, it is possible then to develop and present a detailed list of risk management strategies and measures to deal with the current level of risks. The main risk management strategies are: avoidance/elimination, reduction, transfer and acceptance (USCG, 2001). Risk management measure, in contrast to risk management strategies, refers to a wide range of methods, approaches or tools that are employed for managing risk at a more operational or tactical level (Zsidisin and Ritchie, 2008).

To guide the risk management process, various tools and techniques have been developed. The following section presents some of the well-known risk assessment techniques.

**4.4.2.2 Risk assessment techniques**

This section presents a selection of techniques that have been developed to assess risk in a given context. (Tixier *et al.*, 2002) and (ISO/IEC31010:2009) present a detailed review of these techniques. They have strengths and weaknesses and are aimed at different application domains. In the current section, well-known risk assessment techniques are discussed in order to find the one appropriate to the process centric management.

**4.4.2.2.I Failure mode and effect analysis**

Failure Mode and Effect Analysis (FMEA) is a tool used to identify potential failure modes of a product or a process as well as the effects of the failure and to assess the effects of the failures on the product functionality (Teoh and Case, 2004). In addition, it has been adopted by the International Standards Organization (ISO) as a tool for risk analysis.

A general FMEA structure of a manufacturing process is shown in Table 4-9 where the procedure is carried out as follows: a cross functional team analyses the product/process (*Op01* in the table) to identify the failure modes (*High scrap*) within the process/or product and a severity rating or consequence (*6* in the example) is assigned to each failure mode. It is followed by determining the potential causes (*Unstable process*) and effects of the identified failure mode (*Delay in manufacturing*). An occurrence rating –likelihood- is assigned to each potential cause while a detection rating in the range of 0 to 10 is aimed at assessing the effect of the cause (*5 and 6 respectively*). A risk priority number (called RPN) is then calculated to prioritize risk by multiplying the three parameters such as likelihood (P), severity (C) and detection (D). This priority number in the example is assessed as 150.

**Table 4-9: Process FMEA example**

Process	Failure mode	Causes	Effects	P	C	D	RPN
<i>Op 01</i>	<i>High scrap</i>	<i>Unstable process</i>	<i>Delay in manufacturing</i>	<i>5</i>	<i>6</i>	<i>6</i>	<i>150</i>

Furthermore, the traditional FMEA method is conducted using brainstorming (Teoh and Case, 2005) where knowledge is captured and recorded into FMEA sheets. This method has some drawbacks as the knowledge collected this way cannot be reused. However, FMEA has been automated and the issue of knowledge reusability has been addressed (Teoh and Case, 2004). Additionally, there are many variants of FMEA such as cost-based FMEA (Hassan *et al.*, 2010) and failure mode, effects and

criticality analysis (FMECA). FMECA is an extended method of FMEA to rank criticality in a failure mode based on severity and probability of occurrence.





**Remarks:** FMEA gives a systematic overview of the important failures in the system and provide a good basis for more comprehensive quantitative analysis. Moreover, it forces the evaluator to identify the critical system components; hence it plays an important role in the reliability analysis of the system (Aven, 2008; Chen, 2007). However, FMEA is not suitable for systems or processes where a single component or activity does not cause the failure of the system but instead a chain of events or activities lead to the failure of the system.

4.4.2.2.II **Fault tree analysis**

Fault Tree Analysis (FTA) is a widely applied deductive technique for identifying and analyzing factors that can contribute to a specified undesired event called the top event (Contini and Matuzas, 2011; ISO: IEC 31010, 2009). Causal factors are deductively identified, organized in a logical manner and represented pictorially in a tree diagram employing logical gates.

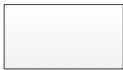
Each analyzed main even is connected to causal sub-events through any of the gates such as AND-gate, OR-gate or INHIBIT-gate. An AND-gate indicates that all sub-events occurrences are necessary to trigger the main event while in an OR-gate, only one sub-event is sufficient to trigger the main event. However, for INHIBIT-gate the condition mentioned in the oval shape needs to be true in order to initiate the main event. Table 4-10 synthesizes the elements of FTA.

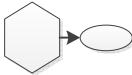
**Table 4-10: Fault tree symbols**

Name	Descriptions	Symbols
Top event	The undesirable event.	
AND-gate	The output event (above) occurs if all input events (below) occur.	
OR-gate	The output event (above) occurs if at least one of the input events (below) occurs.	
INHIBIT-gate	The condition noted in the oval has to be true to trigger the main event in addition to the cause stated in the sub-event.	
Basic event	Event at the lowest level in the fault tree model.	

FTA can be used both for qualitative and quantitative risk analysis. In the qualitative case, FTA deals with methods for obtaining the minimal sets: minimal cut sets and minimal paths. A cut set is a set of basic events, the occurrence of which ensures that the top event occurs. A cut set is minimal if it cannot be reduced and still ensures the occurrence of the top event.



For simple fault trees, the minimal cut sets can be determined directly from the fault tree. In most cases, it would be more convenient to use reliability block diagrams (Rahmat and Jovanovic, 2009). However, for more complex fault trees, there is a need of an algorithm. One such well-known computer-based algorithm is MOCUS (Purbaet *al.*, 2010).

In quantitative analysis, FTA comprises on one hand the evaluation of the probability of the top event and on the other hand the study of influence regarding sensitivity and the importance of events with regard to top event (Limnios, 2007).

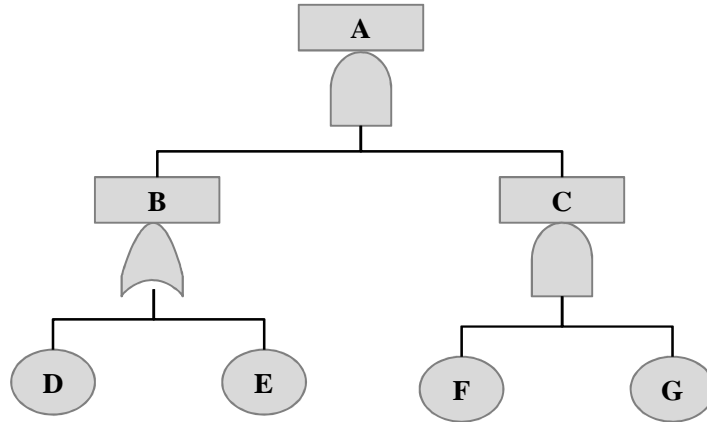

Figure 4-10: Fault tree diagram

Probability of the top event named A (cf. Figure 4-10),  $P(A)$  is:

$$P(A) = P(B) \times P(C)$$

Whereas  $P(B)$  and  $P(C)$  are independent events and  $P(B)$  is

$$P(B) = P(D) + P(E)$$

And  $P(C)$  is

$$P(C) = P(F) \times P(G)$$

Hence,  $P(A)$  is calculated as (Equation 4-4):

$$P(A) = P(D) \times P(F) \times P(G) + P(E) \times P(F) \times P(G) \quad 4-4$$

**Remarks:** Fault tree analysis is used to measure overall risk (“hazard”) in a system as well as the major risk factors that contribute to the top event. The technique is easy to understand and simple to use. Moreover it forces an assessor to understand the system and, therefore, provides an insight into the structure of the system (Rahmat and Jovanovic, 2009). However, FTA is rather difficult for systems having a huge number of events, levels and logical gates (Amornsawadwatana, 2003). In addition, it gives a static picture of the failure combinations that can cause the top event. Another major drawback of the technique is mishandling of common-mode failures (Aven, 2008). So, the fault tree analysis technique is not a suitable candidate for systems with dynamic properties.

4.4.2.2.III Event tree analysis

Event Tree Analysis (ETA) is a graphical technique used to represent the mutually exclusive events following an initiating top event (ISO/IEC 31010:2009). It is often coupled with bow-tie diagrams to study the consequences of an initiating event (Markowski and Kotynia, 2011). The technique may be used both qualitatively and quantitatively.

Qualitative analysis in an event tree determines the eventual events of a possible initiating event and, therefore, provides a picture of the possible scenario (event sequences). While in the quantitative analysis, the technique estimates the probability of an outcome event (Mokhtari *et al.*, 2011).

An event tree analysis is carried out by asking a number of questions whose answer is either “yes” or “no”. It is common to pose the branch questions in such a way that the desired answer is either up (yes) or down (no) for the entire branch questions. This approach will lead to arrange the best scenario at one end, and the worst scenario at the other end (Aven, 2008). The branch questions can be divided into two main categories:

1. Those related to physical phenomena such as fire break out, explosion
2. Those related to the barriers in the system such as firefighting situations

ETA covers both these categories.

The next step in the analysis is to draw up a consequence matrix which describes the consequences arising from each terminating event or group of terminating events. The consequences could be either specified by using a fixed number, expected value or by determining a probability distribution (Aven, 2008).

The initiating event has a branching probability and summation of all probabilities at a particular branch should be equal to 1 as described by Equation 4-5.

$$P(\text{Event Occur}) + P(\text{Event does not occur}) = 1 \quad 4-5$$

An event tree starts by selecting an initiating event. Functions and systems which are in place to mitigate risks are then listed in a sequence. For each system or function, a line is drawn to represent their success or failure while assigning them conditional probabilities. The total probability of each branch (scenario) is then calculated by multiplying the probabilities of the sub-branch on the path. Figure 4-11 represents a conventional event tree diagram.

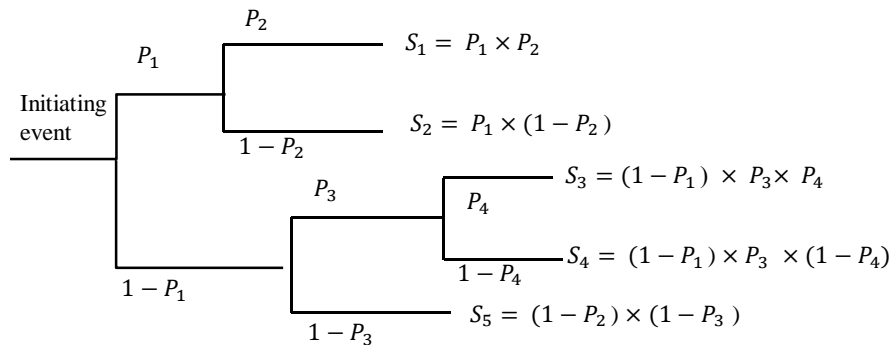

Figure 4-11: Sample of conventional event tree diagram (Ferdouset *al.*, 2011)

**Remarks:** The event tree analysis displays all possible failures, identified and quantified, from an initiating event. In addition, it is a useful technique to account for timing and sequence of the risk events as well as the domino effect of the initial event (Cozzaniet al., 2005). It can be used at any stage of the life cycle of a product or process. However, the technique fails to provide a mechanism for identification of initiating event and is, hence, based on the assumption that all initiating events are already listed. It does not account for delayed success and recovery events.

#### 4.4.2.2.IV Monte Carlo simulation

Monte Carlo simulation is a statistical technique used to evaluate uncertainties in a process or system particularly in complex settings where analytical methods fail to deliver satisfactorily (Mun, 2006; Vose, 2008). Its goal is to investigate stochastic permutations of project/process uncertainties and to assign a stochastic value to each uncertainty in the range of an upper and a lower bound (Rezaieet al., 2007).

The Monte Carlo simulation procedure is carried out in the following way

1. Define a distribution function for each uncertainty or variable (based on past history, expert opinion or intuition)
2. Determine a probability distribution for each variable
3. Assign the variable to random number generators with selected probability distributions
4. Draw probable values of the variable for the desired number of simulations for calculations
5. Draw the frequency diagram for obtained utilities

As per illustration, for a two-state component, the uptime and downtime are the two variables to be determined. Uptime is sampled from a lifetime distribution while downtime from a repair time distribution. If  $T$  represents the lifetime of a component, then the probability distribution  $F(t) = P(t \leq T)$ . The system states are computed while simulating and are logged as time elapses. To estimate the probability  $P$  of downtime at a particular point in time, the model is simulated a number of times, say  $n$  times. For  $n$  simulations,  $P$  is the average value of realizations where the system is down. By increasing the number of simulations  $n$ , the estimation error can be reduced.

**Remarks:** With a Monte Carlo simulation model, the temporal aspect is more easily handled compared to the analytical techniques where time aspect is not often taken into account. The Monte Carlo simulation model even though requires, in general, detailed input data. On the other hand, the output from the model is very extensive and informative.

The main disadvantage of the Monte Carlo simulation technique is the time and effort required to develop and execute the simulation model. Moreover, with complex Monte Carlo simulation models, it is difficult to check if the program has been written correctly and, therefore, if the results are sufficiently reliable (Wang and Roush, 2000, p. 220).

#### 4.4.2.2.V Larson and Kusiak's risk assessment approach

Larson and Kusiak (1996) developed an IDEF3-based risk assessment methodology for concurrent engineering projects, which was later modified to include risk treatment and decision making mechanisms (Kayiset al., 2007). The authors have

adapted traditional system reliability and risk assessment concepts to the IDEF3 modeling technique.

As such, IDEF3 model path sets were used to identify the operational scenarios in a process. A path set  $p_k (k = 1, \dots, K)$  in an IDEF3 model is the set of all units of behavior that define a path from a source to a sink in the process model. To execute a process, only one path set is taken at a time. In addition, the probability of the scenario is determined by the branching probabilities of the stochastic fan-out junction boxes in the corresponding path set. Failure to complete a process may result from individual activities in the path set. Therefore, risk factors are identified and aggregated for each activity in the model. The overall risk is the summation of all risks existing in a path set.

According to this approach, a project risk  $R$  resulting from scenario of events Shaving a probability of occurrence (of events)  $P$  with impact or consequence  $C$  is defined by Equation 4-6:

$$R = \{S, P, C\} \quad 4-6$$

Equation 4-6 defines the risk as a quantitative measure derived from the likelihood of the failure event and its consequence. The technique employs the following mathematical model (Equation 4-7) to calculate the overall risk of a process (*i.e.* path set):

$$R = \sum_{k=1}^K (P_k \times C_k) \quad 4-7$$

Where,

$R$  Estimated risk of the whole process

$P_k$  Probability that path set  $k$  is taken in the process

$C_k$  Consequences of the failures in path set  $k$

**Remarks:** The Larson and Kusiak's risk assessment methodology is, unlike traditional risk management techniques, a novel approach towards risk management because the risk assessment is activity-based. The methodology is well-suited to the process-based risk management because it draws on all process modeling concepts and couples it with risk management discipline. In addition, it forces the evaluator to model the process before carrying out risk assessment and, therefore, helps to establish and model the context in advance. Moreover, the same IDEF3 model can also be used for value evaluation.

The main disadvantage of the approach is that a thorough preparation is needed before proceeding to the risk assessment. For this purpose, all the activities should be known in advance and should be modeled. Furthermore, the methodology has no mechanism to identify risk and therefore need to be coupled with other risk assessment techniques for risk identification.

#### 4.4.3 Comparison of risk assessment techniques

Table 4-11 provides an assessment table for selecting a tool or a technique for risk management in process context. The selection criteria are based on the requirements

of the process-oriented PMM system, which means that a business process should be risk aware and, hence, activity becomes the point of interest whether it is for performance assessment or risk assessment in such systems. Details about these risk assessment techniques can be found in (ISO IEC: 31010/2009).

**Table 4-11: Synthesis of the comparison of risk assessment techniques**

	Risk identif.	Risk analysis	Risk evaluation	Qualit. analysis	Quanti. analysis	Process-centered	Simple/a accurate
FMEA	SA	SA	SA	SA	NA	A	E/M.Ac.
Fault Tree Analysis	A	A	A	A	A	NA	M
Event Tree Analysis	A	A	NA	A	A	NA	M
Monte Carlo Simulation	NA	A	SA	NA	SA	SA	D/Ac.
IDEF3-L&K	NA	SA	SA	NA	SA	SA	E/Ac.

Legends:

SA: Strongly applicable; NA: Not applicable; A: Applicable; E, M, D: Easy, Moderate, Difficult; Ac., M.Ac.: Accurate, Moderately accurate

From the review of the techniques, it is concluded that only the Larson and Kusiak’s approach is process-oriented. In addition, Monte Carlo technique can be used to model and evaluate risk in a business process. However, the technique is not compatible with process-oriented PM systems, which aim to model risk and objectives in one process configuration. To make the assessment of both value and risk simple, the only technique that can be employed in the current scenario is the Larson and Kusiak’s risk assessment approach. However, the method has no built-in mechanism for qualitative risk identification and assessment. Therefore, FMEA is chosen as a technique for qualitative assessment of the risks and Larson and Kusiak’s method is then employed to assess risk quantitatively. The following section discusses in detail the Larson and Kusiak’s approach.

#### 4.4.4 Risk management model according to Larson and Kusiak

The Larson and Kusiak’s risk assessment approach (1996) relies on Kaplan and Garrick (1981) definition of risk for risk characterization, which describes  $\hat{R}$  in a process to be the combination of the following parameters:  $S$  is a scenario of a problem,  $P$  is the likelihood of the scenario and  $C$  is the consequence of the scenario as formulated in Equation 4-8.

$$R = \{S, P, C\} \tag{4-8}$$

Equation 4-8 defines risk as a quantitative measure based on two basic parameters: the likelihood or probability of a risk event and the consequence thereof in a given

scenario. The formulation of the overall risk in any given scenario from Equation 4-8 is discussed in detail in the following sections. The sections also discuss how the IDEF3 modeling technique can be adapted to the risk assessment process. Moreover, to illustrate the different steps of the approach, a hypothetical process has been modeled in IDEF3 as shown in Figure 4-12.

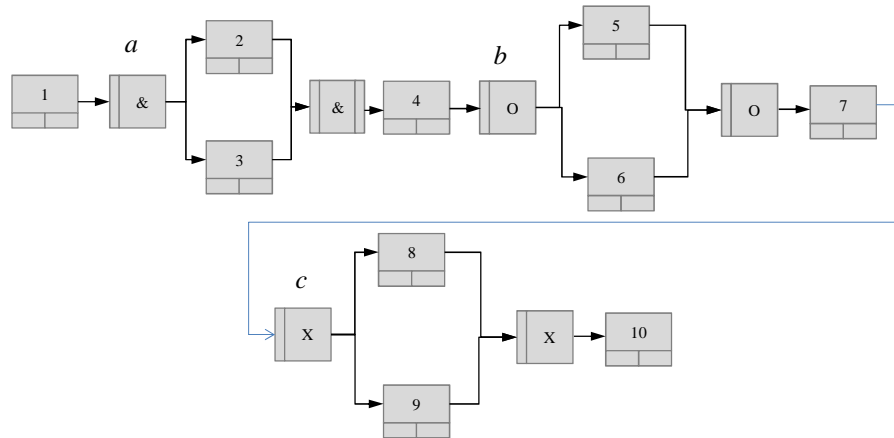

Figure 4-12: IDEF3 model with 10 units of behaviour

#### 4.4.4.1 The scenarios or path sets

As mentioned in the section 4.4.2.2.V, path sets are used to identify operational scenarios in a process whereas each scenario or decision set is determined by junction boxes (AND, OR and XOR) in the IDEF3 model. To determine path sets in a given IDEF3 model, Larson and Kusiak propose two methods. The first method finds all possible path sets in the IDEF3 model of a process. The second method relies on a general set of customer requirements and information of the IDEF3 elaboration document. The objective is to eliminate the inferable path sets and the corresponding process scenarios, *i.e.* only specific activities are assessed in the model, hence, reducing the number of scenarios for further risk assessment.

To illustrate the path set finding on the basis of the first method, the IDEF3 model of Figure 4-12 is considered. All path sets start from UOB1 and end at UOB10. The number of possible path sets and decision sets (*i.e.* {a, b, c}) in Figure 4-12 in between these UOBs depends on junction boxes in the IDEF3 model. For a simple process, it can be calculated manually. However, for large processes involving multiple UOBs, the path set algorithm (Larson and Kusiak, 1996b) can be applied to identify all possible paths and decision sets. From Figure 4-12, possible path sets and decision sets are identified and tabulated in Table 4-12.

Table 4-12: Path sets for the IDEF3 model

$k$	path set $p_k$
1	1,2,3,4,5,7,8,10
2	1,2,3,4,6,7,8,10
3	1,2,3,4,5,6,7,8,10
4	1,2,3,4,5,7,9,10
5	1,2,3,4,6,7,9,10
6	1,2,3,4,5,6,7,9,10

**4.4.4.2 Calculating the probability of a scenario**

The probability of a scenario that results in a process failure (*i.e.* there is a failure in the course of the process) is conditional on the occurrence of the corresponding path set  $p_k$ . The likelihood that a path set  $p_k$  is taken and has resulted in process failure is calculated using Equation 4-9 :

$$P_k = P_r(p_k) \times \psi(p_k)$$

$$\sum_{k=1}^K P_r(p_k) = 1 \tag{4-9}$$

Where,

- $P_k$  Likelihood of scenario that results in a process failure
- $P_r(p_k)$  Probability that the path set  $p_k$  is taken
- $\psi(p_k)$  Probability of a process failure in a path set  $p_k$
- $K$  Number of all possible path sets  $p_k$

**4.4.4.3 Probability of a path set  $p_k$**

The probability of taking a path set  $p_k$  such as  $P_r(p_k)$  is calculated using branching probabilities of occurrences of UOB  $i$  ( $P_i$ ) at fan-out junctions (Larson and Kusiak, 1996b). For the IDEF3 model of Figure 4-12, the probability  $P_i$  of occurrence of UOB  $i$  through all fan-out junctions is summarized in Table 4-13.

**Table 4-13: Probability of occurrence and successful completion of UOBs**

UOB <sub><i>i</i></sub>	probability of occurrence $P_i$	Probability of completion $R_i$
1	1	0.9
2	1	0.95
3	1	1
4	1	0.9
5	0.6	0.8
6	0.6	0.9
7	1	0.85
8	0.5	1
9	0.5	0.9
10	1	0.9

The value of  $R_i$  represents the probability of successfully completing a UOB. It is based on prior experience and performance data and thus is somewhat subjective (Larson and Kusiak, 1996a, p. 755).

To determine the probabilities of occurrences following &, X or O junction boxes, the procedure is carried out in the following manner.

At an AND junction, because all the UOBs need to be performed, therefore the probability of occurrence of each UOB is equal to 1.

At an XOR junction, the summation of all probabilities of occurrences of the UOBs is equal to 1 because only one of all the UOBs connecting to this junction box can be

performed. As an illustration, consider UOB8 and UOB9 from Figure 4-12. Both these UOBs perform exclusively. Therefore, probabilities of occurrence of UOB8 ( $P_8$ ) and UOB9 ( $P_9$ ) can be defined as in Equation 4-10:

$$P_8 + P_9 = 1 \quad 4-10$$

If there are  $n$  UOBs, then the aggregate probability will be equal to 1.

However, at an OR junction box, the probability ( $P_i$ ) is unconditional and is calculated differently (Larson and Kusiak, 1996b). If the number of UOBs connecting to this junction box ( $N$ ) is greater than 2, then there are  $2^{N-1}$  combinations of UOBs. Let us assume that  $C_j$  is the set containing UOBs in combination  $j$  and  $M$  is the total number of all possible combinations thus the probability of performing only UOBs in a combination  $j$ ,  $P_r(C_j)$ , is calculated from Bayes' formula in Equation 4-11.

$$Pr(C_j) = \frac{\prod_{i \in C_j} P_i \times \prod_{i \notin C_j} (1 - P_i)}{1 - \prod_{i=1}^N (1 - P_i)} \quad 4-11$$

Where,  $j = 1, 2, \dots, M$

In Figure 4-12, if  $C_1$  refers to only UOB 5,  $C_2$  refers to only UOB6 and  $C_3$  refers to both UOB5 and UOB6 connected by an OR junction box, then the probability of occurrence between UOB5 and UOB 6 at the OR junction can be calculated as:

$$P_5 = \frac{0.6 \times (1 - 0.6)}{1 - (0.4 \times 0.4)} = 0.2857$$

$$P_6 = \frac{0.6 \times (1 - 0.6)}{1 - (0.4 \times 0.4)} = 0.2857$$

$$P_{56} = \frac{0.6 \times 0.6}{1 - (0.4 \times 0.4)} = 0.4286$$

Hence, the probability of a path set  $P_k, P_r(p_k)$ , can be calculated by multiplying the probabilities of occurrences all along the path set, *i.e.*

$$P_r(P_1) = P_1 \times P_2 \times P_3 \times P_4 \times P_5 \times P_7 \times P_8 \times P_9$$

$$P_r(P_1) = 1 \times 1 \times 1 \times 1 \times 0.2857 \times 1 \times 0.5 \times 1 = 0.1428$$

$$P_r(P_2) = P_1 \times P_2 \times P_3 \times P_4 \times P_6 \times P_7 \times P_8 \times P_9$$

$$P_r(P_2) = 1 \times 1 \times 1 \times 1 \times 0.2857 \times 1 \times 0.5 \times 1 = 0.1428$$

$$P_r(P_3) = P_1 \times P_2 \times P_3 \times P_4 \times P_{56} \times P_7 \times P_8 \times P_9$$

$$P_r(P_3) = 1 \times 1 \times 1 \times 1 \times 0.4286 \times 1 \times 0.5 \times 1 = 0.214$$

Probabilities of the remaining path sets, *i.e.*  $P_r(P_i)$  with  $i = 3$  to 6 can be calculated in the same way. The probability of all path sets  $P_k$  with  $k = 1$  to 6 should be equal to 1 as shown in Equation 4-12.

$$\sum_{k=1}^6 P_r(p_k) = 1 \quad 4-12$$



**4.4.4.4 Probability of system failure in a path set p**

The probability of a system failure in a path set  $p_k$  (called  $\Psi(p_k)$ ) is intended to be an aggregate measure (Larson and Kusiak, 1996). Initially, the success probability of individual UOB  $i$  ( $R_i$ ) is estimated or assessed. However, determining the quantitative measure for the reliability of a path set in the concurrent process is challenging and very little research has been done in this area. Consequently, system reliability calculation is performed using a subjective approach (Larson and Kusiak, 1996).

Once all probabilities of  $R_i$  are known, then the probability of a system failure in a path set  $p_k$  ( $\Psi(p_k)$ ) is calculated by subtracting  $R_i$  from 1 as shown in Equation 4-13:

$$\psi(p_k) = 1 - \prod_{i \in p_k} R_i \tag{4-13}$$

The success probability of UOB  $i$  ( $R_i$ ) from the IDEF3 model is shown in Table 4-13. As an illustration, the probability of a process failure in a path set  $p_k$  is  $\Psi(p_k)$  and is calculated as follows:

$$\begin{aligned} \psi(P_1) &= 1 - (0.9 \times 0.95 \times 1 \times 0.9 \times 0.80 \times 0.85 \times 1 \times 0.90) \\ &= 1 - (0.471) = 0.529 \end{aligned}$$

Similarly, the probabilities of a process failure ( $\psi(p_k)$ ) are calculated for the rest of the path sets  $p_k$ . Hence, the likelihood of a path set that results in a system failure  $P$  is calculated by multiplying the probabilities in the path set  $P_k(P_r(p_k))$  and the failure probability of path set  $P_k(\Psi(p_k))$  as shown in Table 4-14.

From Table 4-15 the expected likelihood of a scenario that results in a system failure is equal to 0.555 and the path set  $P_6$  has the highest likelihood of a scenario that results in a system failure at 0.132.

**Table 4-14: Scenario probabilities for all path sets**

$P_k$	$P_r(p_k)$	$\Psi(p_k)$	$P_r(p_k) \times \psi(p_k)$
1	0.143	0.529	0.076
2	0.143	0.47	0.067
3	0.214	0.576	0.123
4	0.143	0.576	0.082
5	0.143	0.523	0.075
6	0.214	0.619	0.132
Total	1	-	0.555

**4.4.4.5 Calculating the consequence of a scenario**

The consequence of a path set represents the negative impact or outcome when the path set fails to deliver the associated objectives. In terms of utility, the consequence is the utility difference between the outcome and the target of the scenario.

Consequences can be of diverse nature depending on the type of business process and the associated process objectives. Typical consequences in business environments could be poor product quality, process delay and cost exceeding the limit. Also, the consequence can be in the form of a constant or a function of path set  $p_k$ . In the former case, it could be a constant in the form of a penalty for not meeting the specifications of the product or process. However, in the latter case, it can be a function of time such as \$100 per day for not delivering the product at the agreed upon date. Let us assume that a due date is established for the business process of the IDEF3 model. If the final plan fails to satisfy the product requirements, a 15 day delay may result. Since the probabilities of path sets that fail to successfully complete have already been calculated, therefore the risk of the path sets that results in a process failure can then be calculated using the risk measurement model that follows.

**4.4.4.6 Risk measurement model**

Once the likelihood of the scenario and the consequence thereof are determined, the business process risk is then calculated using Equation 4-14:

$$R = \sum_{k=1}^K (P_k \times C_k) \tag{4-14}$$

Where  $R$  models the expected risk magnitude of a business process. For the IDEF3 model of shown in Figure 4-12, a path set overall risk is the multiplication of  $P_k$  with the impact (15 days in this case). Similarly, the risk for each path set is calculated and the total risk of the IDEF3 model (cf. Figure 4-12) is then the summation of risks occurring in each path set of the model as shown in Table 4-15.

**Table 4-15: Calculation of process risk for the IDEF3 model of Figure 4-12**

$k$	$P_k$	$C_k$	$P_k \times C_k$
1	0.076	15	1.135
2	0.067	15	1.009
3	0.123	15	1.849
4	0.082	15	1.236
5	0.075	15	1.122
6	0.132	15	1.986
Total	0.555	-	8.337

In brief, the risk assessment methodology based on the IDEF3 model developed by Larson and Kusiak(1996a; 1996b) provides a useful foundation to calculate risk quantitatively in any process-oriented setup.

**4.5 Performance measure prioritization and aggregation: Tools and techniques**

Having identified the tools and techniques to analyze and evaluate business processes and to obtain sets of performance measures on the basis of value-focused objectives modeling, the next step is to determine which of the various techniques used in decision analysis are the most appropriate to prioritize and aggregate the pre-determined performance measures. This step is important in the sense that

elementary performance measures obtained from process analysis do not provide enough insight in the decision-making context. Therefore, it is always desirable to choose the right multiple evaluation criteria technique in order to facilitate the selection of the preferred alternative based on a set of conflicting criteria. This sort of problem typically falls in the field of multiple criteria decision analysis.

Decision analysis is crucial to performance management. However, the decision analysis emerged as a discipline separate from the performance management discipline. As the latter is multi-dimensional and it is very likely that the set of performance measures in a performance management system will be made of heterogeneous performance measures which cannot be reduced easily to a single dimension. Furthermore, performance measures often happen to be conflicting. In addition to the heterogeneity and conflicting nature of performance criteria in a typical performance management system, one is often confronted with several alternatives to achieve the business process objectives. Such a situation demands multi-criteria decision analysis in the framework of performance management system in order to enhance the ability of an assessor to act consistently and reduce his cognitive load.

#### 4.5.1 Multiple criteria decision making (MCDM)

*“The field of multiple criteria decision making concerns the design of mathematical and computational tools to support the subjective evaluation of a finite number of decision alternatives under a finite number of performance criteria by a decision maker”* (Lootsma, 1999). So, a typical decision problem is founded on three pillars: the potential actions (alternatives), the performance criteria and the modeling of one or several preference systems (Zopounidis, 2010).

Therefore, a decision process in the context of MCDM would be to define a set of alternatives  $\{x^h\}$  where  $h = 0$  to  $m$  and a set of performance criteria  $\{c_i\}$ ,  $i = 1$  to  $n$ . The assessor’s task then is to judge the performance of each alternative  $\{x^h\}$  under performance criterion  $c_i$  and to determine the relative importance of the criteria to arrive at a global judgment. The ideal alternative is the one which outranks all the others under each of the performance criterion. However, in MCDM, such alternative generally does not exist (Ravindran, 2008).

Numerous MCDM techniques have been developed since the 60’s to deal with multiple criteria problems (Edwards *et al.*, 2007, chap. 2). Their suitability in the context of PMM needs to be investigated. To this end, a decision problem regarding performance management is formulated and then various MCDM techniques are studied to identify their appropriateness for the decision problem in question.

#### 4.5.2 Multiple criteria decision making techniques

In this section, different MCDM techniques are reviewed for the following generalized decision problem (Equation 4-15):

$$\mathcal{V}(X) = F(v(x_1), v(x_2), \dots, v(x_n)) \quad 4-15$$

Where,

$x \in X$  Represents a performance measure of set  $X$

$v(x)$  Is a utility/value function of a performance measure

$\mathcal{V}(X)$  Is an overall utility function for the set  $X$

$F$  Is an aggregation operator (or aggregation function)

So, the decision problem is to find a technique capable of constructing the utility functions (or value functions) as well as an aggregation operator. Additionally, the inter-criteria interaction should also be taken into account as it is often the case in real-world problems. For details about inter-criteria interactions in the aggregation mechanism, the interested reader is referred to (Büyüközkan and Ruan, 2010; Narukawa, 2010; Clivillé *et al.*, 2007).

### 4.5.3 Multiple criteria decision-making techniques review

To respond to the decision problem formulated in Equation 4-14, a whole range of multi-criteria techniques are reviewed and filtered out as shown in Figure 4-13. For this purpose, several classification criteria such as the number of alternatives in a decision problem, the consequences of a decision and many other criteria are identified. These classification criteria (precised with arrows in Figure 4-13) help to narrow down the choice of the MCDM techniques for the decision problem.

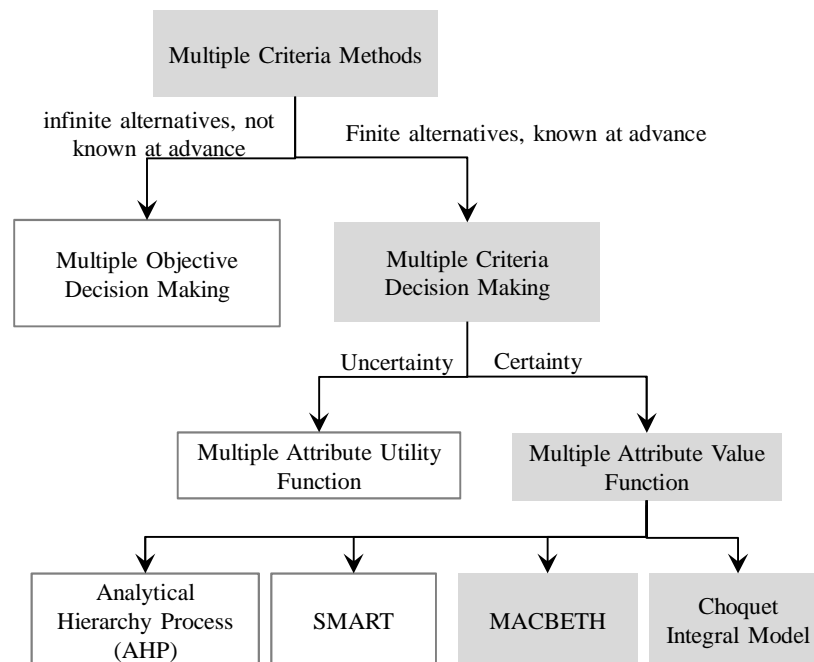

Figure 4-13: Classification of multi-criteria methods

Generally, multi-criteria methods are classified on the basis of alternatives into two broad categories: multi-criteria selection problems and multiple criteria mathematical programming (also known as multiple-objective decision making or vector optimization). The former category focuses on selecting the best or preferred alternative from a finite set of alternatives, which are usually known a priori. Whereas the latter deals with the decision problems when the possible number of alternatives is high (theoretically infinite) and all alternatives are not known in advance (Ravindran, 2008, chap. 5). For the decision problem under study, the problem falls into the former category because the numbers of alternatives for

business process assessment are finite, which has been identified in the second phase of the performance management (dealt in section 5.2.2 ).

Multiple attribute decision making models can further be divided on the basis of consequences of the decision or action (Ananda and Herath, 2009). If the assessor can predict the consequences of an action or decision with certainty, then the problem is categorized as decision making under certainty. Otherwise, the problem falls into the category of decision making under uncertainty. Multi-attribute value theory model (MAVT) belongs to the former category while the latter category includes Multi-Attribute utility theory models (MAUT) (Greco, 2004). This distinction is arbitrary and was made by Keeney and Raiffa(1976) in their pioneering book on the use of utility theory in decision-making.

Since the effects of performance measures on global performance of a business process is known to the assessor in advance, therefore the problem under study is related to the category under certainty *i.e.* multi-attribute value model. Now, we are left with multiple attribute value function models suited to the problems of certainty.

The known multi-attribute value function models are multi-attribute value function models developed by Keeney and Raifa (1976; 1993) and the Simple Multi-Attribute Rating Techniques (SMART) developed by Von Winterfeldt and Edwards (2007; 1994), which respectively use non-numerical (bisection method) techniques and direct numerical (direct rating) to build an interval value scale (Farquhar and Keller, 1989). However, both these techniques, according to Farquhar and Keller, require an assessor to perform extensive cognitive tasks and therefore prove to be substantively meaningless (Greco, 2004, p. 410).

Additionally, the AHP technique (Saaty, 1990) is another well-known multi-attribute value model. Due to its simplicity and power, the AHP has found ready acceptance by academia and practitioners alike, and has led to its widespread use across multiple domains (Bhushan and Rai, 2004). However, the AHP cannot be considered for the decision problem because of several reasons:

- The AHP method is not consistent with the objectives model of the VFT framework. The former violates the principle of hierarchical composition – the requirement that the evaluation criteria be independent of the alternatives considered.
- The issue of rank reversal that exists in AHP (see Dyer, 1990), which is regarded as inconsistent with rational decision making (Dodgson *et al.*, 2009).
- Determinations of performance expressions and weight elicitation mechanisms are carried out independently and are therefore inconsistent (Clivillé, 2004).
- Similar to SMART and Keeney and Raifa model, AHP is also a pure additive model and, as a consequence is not appropriate for the problem in question.

In response to the inefficiencies on the part of the above mentioned multi-attribute value function techniques; MACBETH was developed (Bana e Costa *et al.*, 2003; Bana e Costa and Vansnick, 1994). The main advantage of MACBETH over AHP is its consistency judgment because the latter lacks the condition of order preservation which is necessary in decision-making (Bana e Costa and Vansnick, 2008). However, the method relies on the weighted arithmetic mean, which is not consistent with the current research requirement. Garbish and Labreuche (2009) recommend

using MACBETH for value function constructions and then propose to use the Choquet Integral (CI) to model the criteria interactions, which is missing in all the other MCDA methods.

To conclude, both MACBETH and CI are used to model and resolve the problem of decision making in the context of PMMS.

#### 4.5.4 MACBETH

MACBETH (Measuring Attractiveness by a Categorical-Based Evaluation TecHnique) is an interactive multi-criteria decision analysis approach developed in the mid 1990's by Bana e Costa and Vansnick(2005; 1997; 1994). The method enables the construction of value functions and weights with the weighted sum in a meaningful sense of measurement and preference theories (Grabisch and Labreuche, 2009).

The strength of MACBETH lies in its structured approach towards information solicitation and its transformation into a value function employing principles of the theory of measurement. The transformation of ordinal information (*i.e.* preference) into cardinal (*i.e.* strength of preference) to build a value function (interval scale) is carried out to analyze and evaluate different courses of actions (options in MACBETH jargon) (Bana e Costa *et al.*, 2003). This way of information handling is quite natural to decision-makers in contrast to traditional additive value models, which require rich information concerning the decision-maker preference in order to produce mathematically significant results (Bana e Costa *et al.*, 2005).

##### 4.5.4.1 MACBETH procedure

To proceed with MACBETH, (Clivillé *et al.* 2007) identify four steps to deal with decision-making problems in the context of PMM. The four steps are as follows (cf. Figure4-14):

- Step 1.** Context definition
- Step 2.** Determination of performance expressions vectors
- Step 3.** Weight elicitation
- Step 4.** Aggregation

In the following sections, each of these steps is explained in detail.

##### 4.5.4.1.I Context definition (Step 1)

Typical to decision-making processes, the MACBETH procedure is used to define a decision context. In the decision context, sets of alternatives or courses of actions (called *options* in MACBETH) and criteria to evaluate each alternative are defined.

For instance, let  $X$  be a finite set of alternatives that a decision-maker wants to evaluate or compare in terms of their relative attractiveness, *i.e.* value or desirability (Bana e Costa and Vansnick, 1997) on the basis of some criteria or attributes (*i.e.* performance criteria).

Alternative set:  $= \{ a_1, a_2, \dots a_l \}$

Criterion set  $C = \{ c_1, c_2, \dots c_n \}$

Then scenarios for evaluations become:

$S_1 = \{ x_1^1, x_2^1, \dots x_n^1 \}, S_2 = \{ x_1^2, x_2^2, \dots x_n^2 \}, S_3 = \{ x_1^3, x_2^3, \dots x_n^3 \}$  and so on.

Where  $x_n^l$  represents the partial score of a criterion  $n$  in a scenario  $l$ .

In the framework of the current research, these alternatives and performance measures (or criteria) are defined in the precedent stage of the performance measurement and management process.

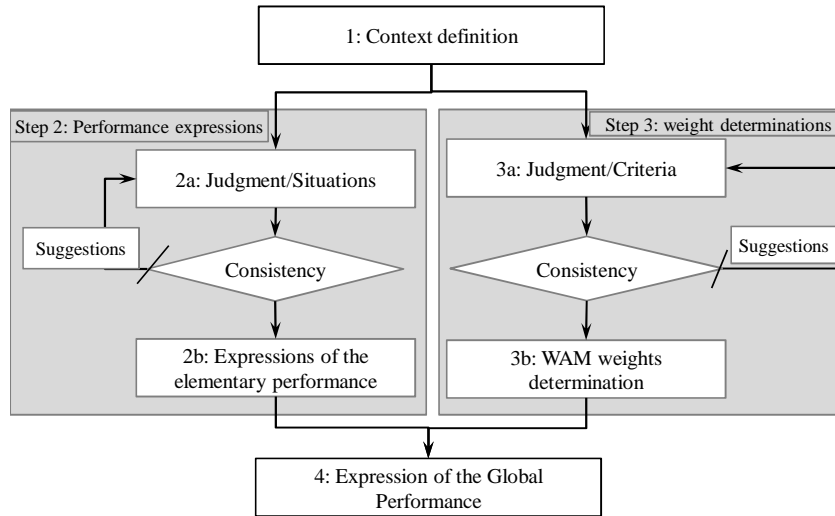

**Figure4-14: The MACBETH procedure (Clivillé et al., 2007)**

In addition to the set of scenarios, two fictive scenarios are introduced. The scenario “good” refers to the ideal scenario, whereas scenario “neutral” refers to the unacceptable or neutral one. Both scenarios are used as reference points and ensure commensurability between heterogeneous performance expressions.

#### 4.5.4.1.II Determination of performance expressions (Step 2)

The power of MACBETH is that the utility or value functions  $u_i$  or  $v_i$  are determined simply by means of questions regarding elements of  $X$ . To determine the value functions, first some preferential information about elements of alternative sets for a given criterion  $c_i$  is gathered. The preferential information is of two types: ordinal information (DM’s preference) and cardinal information (DM’s strength of preference) represented on an interval scale.

##### *Decision maker’s preference (Step 2a)*

To obtain the decision maker’s preference about any of the two alternatives or options, a question is asked whose formulation uses only two elements (*i.e.* criteria) of set  $X$ , similar to AHP pair-wise comparison, at a time.

Questions  $Q_i$  are asked from decision maker:

$Q_1$ : Is one of the two elements more attractive than the other? If yes, then

$Q_2$ : Which of the two elements is the most attractive?

The information obtained can be in the form of, for a given criterion  $i$ :

1. Scenario  $S^k$  is attractive compared to scenario  $S^1$ , mathematically this preference is written as  $S^k > S^1$
2. Scenario  $S^k$  is not attractive compared to scenario  $S^1$  and vice versa, *i.e.*  $S^k = S^1$
3. Scenario  $S^k$  and scenario  $S^1$  are not comparable in terms of their attractiveness.

In the performance context, the value function  $V_i$  is a performance  $P$ . Therefore; the above information can be rewritten as follows:

$$S^k > S^1 \leftrightarrow P^k > P^1$$

$$S^k = S^1 \leftrightarrow P^k = P^1$$

**Decision maker’s strength of preference (Step 2b)**

To elicit information about the preferences of the decision maker, the next step is to transform ordinal information (*i.e.* simply ranking of options by order of preference with no degree of preference) into cardinal information or interval scale. In this step, the decision maker gives more knowledge about the comparison between the considered options. To characterize his level of strength about alternatives for a particular criterion, seven semantic categories of difference of attractiveness  $h$  are the difference of attractiveness “ $h$ ” can take the following seven values as tabulated in the Table 4-16.

**Table 4-16: MACBETH verbal scale**

Description	Numerical Value
Null	0
Very weak	1
Weak	2
Moderate	3
Strong	4
Very strong	5
Extreme	6

The ordinal information or simply value judgments are transformed into interval scale relying on the second step of questioning procedure.

$Q_3$ : How do you judge the difference of attractiveness between two elements  $x$  and  $y$ ?

The answer could take any value from Table 4-17, which is in the range of 0 to 6 or a succession of these (in case of disagreement over the available scale). Here, the preferential information is numerically represented, *i.e.* value function  $V_i: X \rightarrow \mathcal{R}$ .

For example, the decision maker prefers  $S^k > S^1 \leftrightarrow P^k > P^1 = h \alpha$ , where  $h$  is the numerical value between 0 and 6 while  $\alpha$  is a coefficient necessary to meet the condition:  $P^k$  remains in the interval  $[0, 1]$  or  $[0, 100]$  depending on the choice of the decision maker.

The results of these steps are a set of commensurate elementary performance expressions or value functions for each performance criterion in each alternative.

**4.5.4.1.III Weight elicitation (Step 3)**

Like all multi-attribute measurement techniques, the MACBETH tool provides a mechanism for weight determination of criteria. Weight elicitation is used to provide relative importance to one criterion over another one in the decision making context. MACBETH comprises the SWING method (Winterfeldt *et al.*, 1986) and the TRADE-OFF method elements (Keeney and Raïffa, 1993) for weight elicitation.

Weight elicitation for a performance expression in a MACBETH procedure begins by constructing two hypothetical scenarios  $S^B$  and  $S^W$ , where  $S^B$  represents the best scenario, presenting the best performance in all criteria, whereas  $S^W$  indicates the worst scenario having worst performance in all the considered criteria. To represent



them mathematically, a vector of performance expression for the best scenario would then be  $(1, \dots, 1, \dots, 1)$  and  $(0, \dots, 0, \dots, 0)$ , corresponding to best and worst scenario respectively. The aggregated performance can be calculated using Equation 4-16:

$$p^{\text{agg},h} = w_1 p_1^h \dots + w_i p_i^h \dots + w_n p_n^h \quad 4-16$$

However,  $w_i$  is unknown in the equation. To simply solve the system of equations, the authors of the MACBETH method propose to consider a vector of performance expressions which cancels all performance expressions except one which carries a value of 1, *i.e.*  $(0, \dots, 1, 0, \dots, 0)$ . It implies that the aggregated performance expression is simply reduced to:  $P_{Ag}^i = w_i$ . Here,  $P_{Ag}^i$  is the aggregated performance from the vector of performance  $p_i$  carrying value 1 and all other performance expressions  $p_g = 0$  with  $g = 1$  to  $n$  and  $g \neq i$ . (Clivillé et al., 2007).

For the aggregation of  $n$  performance expressions, one needs  $n$  numbers of weights. For this, the approach requires  $n$  mathematical expressions as it is the case for solving the system of equations. To approach this problem, MACBETH suggests a pair-wise comparison between two characteristic situations. As a result of this comparison, we will have  $n$  systems of equations similar to Equation 4-17:

$$P_{Ag}^i - P_{Ag}^g = h\alpha = w_i - w_g \quad 4-17$$

and  $\sum_{i=1}^n w_i = 1$

Where,

$h$  Strength of preference (can take value from 0 to 6)

$\alpha$  Coefficient to meet the condition  $p^k \in [0, 1]$

#### 4.5.4.1.IV Aggregation of performance expressions (Step 4)

Once all the elementary performance expressions are identified along with their corresponding weights, it is now possible to move on to the aggregation step. In a decision-making context, aggregation is usually employed to fuse the degree of satisfaction of all criteria in any alternative in order to obtain a value that corresponds to a global degree of satisfaction (Narukawa, 2010).

For any given scenario noted  $S^k$ , the aggregated value is obtained using Equation 4-18:

$$S^k: w_1 \times p_1^k + \dots + w_i \times p_i^k + \dots + w_n \times p_n^k \quad 4-18$$

### 4.5.5 Choquet Integral (CI)

So far, the thesis has discussed multi-criteria methods which were based on additive measures. This implies that the measure of a set is the summation of the measures of the elements. Thus, no interaction among the elements with respect to the measure is considered. To aggregate the elements of the set, the weighted arithmetic mean is employed as it is the case in almost all MCDM methods. However, in many decision-making contexts, additive measures cannot model the preference of an assessor (Grabisch and Labreuche, 2008; Modave and Grabisch, 1998) and, therefore, fuzzy measures, as named by Sugeno (1989), are needed to account for interaction among elements.

In the fuzzy measure case, for any pair  $x_i$  and  $x_j$  of set  $X$ , we might have  $\mu(\{x_i, x_j\}) \neq \mu(\{x_i\}) + \mu(\{x_j\})$ . The weighted arithmetic mean cannot aggregate fuzzy measures. So there is a need for another aggregation tool to solve the aggregation problem.

The Choquet Integral (CI) is the answer to the problem and is defined with respect to non-classical measure, often known as fuzzy measure or non-additive measure or capacity (Labreuche and Grabisch, 2003). It was developed by Choquet (1953) but later in 1989 it was rediscovered by Schmeidler (1989) and applied to multi-criteria decision analysis by many researchers (Berrahet *al.*, 2008; Büyüközkan and Ruan, 2010; Büyüközkan *et al.*, 2009; Karsak, 2005).

#### 4.5.5.1 Choquet integral based decision making

Consider a finite set of criteria  $C = \{c_1, c_2 \dots c_n\}$  and a finite set of alternatives  $A = \{a_1, a_2 \dots a_n\}$ . Then, each alternative  $a \in A$  and criterion  $c \in C$  can be associated with a profile  $x_i^a = (x_{c_1}^a, x_{c_2}^a \dots x_{c_n}^a)$  where  $x_i^a$  represents a partial score of criterion  $i$  in alternative  $a$  on an interval scale of either  $[0, 1]$  or  $[0, 100]$ . The interval scale is just a question of choice on the part of the assessor. The idea is to represent all the partial scores on the same interval scale for the purpose of commensurability (Labreuche and Grabisch, 2003).

To aggregate the partial scores, the Choquet integral based aggregation function will be defined. As the Choquet integral is defined with respect to fuzzy measures, thus fuzzy measure is first defined.

**Definition (Fuzzy measure):** Let  $P(C)$  denote the power set of  $C$ , then a discrete fuzzy measure of  $C$  is a monotonous set function  $\mu : P(C) \rightarrow [0, 1]$  satisfying the following axioms:

- $\mu(\emptyset) = 0, \mu(C) = 1$ ;
- $\mu(C) > \mu(C')$  if  $C'$  is a subset of  $C$ .

In this context,  $\mu(C)$  represents the weight of importance of the set  $C$ . The first axiom refers to boundary condition while the second one to monotonicity. Monotonicity of the function  $\mu$  means that the weight of a subset or coalition can only increase when one introduces a new criterion to the subset or coalition. For each subset of criteria  $C' \in C$ ,  $\mu(C')$  can then be interpreted as the importance or weight of the coalition  $C'$ .

**Definition (Choquet integral):** Let  $\mu$  be a fuzzy measure on  $C$ . The Choquet Integral of a function  $f: C \rightarrow [0, 1]$  with respect to  $\mu$  is defined by:

$$\begin{aligned} C_\mu(f(x_1, \dots, f(x_n))) \\ = \sum_{i=1}^n (f(x_i) - f(x_{(i-1)})) \times \mu(C_i); \end{aligned} \tag{4-19}$$

with  $f(x_0) = 0$ ,  $\mu(C_i)$  represents the importance of criteria  $C_i$

Equation 4-19 represents discrete CI of  $x$  with respect to the fuzzy measure  $\mu$ . The value  $(.)$  in subscripts represents a permutation operator such that  $0 \leq x_{(1)} \leq x_{(2)} \leq \dots \leq x_{(n)} \leq 1$ .

However, a decision problem containing  $n$  criteria requires  $2^n$  coefficients in  $[0, 1]$  to define the fuzzy measure  $\mu$  on every subset, which is a difficult task as it obliges the decision maker to provide huge information. The concept of  $k$ -order fuzzy measure was therefore proposed to rectify this difficulty (Grabisch, 1997). A  $k$ -order fuzzy measure can be represented as:  $\sum_{i=1}^k \binom{n}{i}$  coefficients. The 2-additive fuzzy measure is relatively simple with only quadratic complexity; it requires only  $n + \binom{n}{2}$  coefficients to define a fuzzy measure for a problem involving  $n$  criteria. In this respect, we assume that in the aggregation process of elementary performance expressions, the interaction exist only between two performance expressions at a time. This proposition of Choquet integral significantly reduces the computational and information burden on the part of DM. 2-additive CI can be expressed in the following form of Equation 4-20 (Mayag, 2010).

$$C_u(x) = \sum_{i=1}^n v_i x_i - \frac{1}{2} \sum_{i=1}^n I_{ij} |x_i - x_j| \quad 4-20$$

where  $C_u$  models vectors of elementary performance expressions or value functions,  $v_i$  denotes a Shapley index with  $\sum_{i=1}^n v_i = 1$  that represents importance of criterion  $i$  relative to all other criteria and  $I_{ij}$  represents interaction between criteria  $(c_i, c_j)$ , ranging in  $[-1, 1]$ .

## 4.6 Conclusion

This chapter has presented and reviewed available tools and techniques to model objectives, activities and risks of a business process so as to assess the process in terms of value and risk measures. Moreover, MCDM techniques have been identified to link the business process assessment to the decision-making context.

The Chapter concludes that:

1. Objectives' modeling is an essential requirement for value-focused performance management system because it provides a base for determining performance criteria in a top-down fashion as opposed to the traditional bottom-up approaches. For this purpose, the VFT framework is considered.
2. To model business processes for evaluation purpose, the IDEF3 language is used because the language is rather comprehensive, easy to understand and to communicate. However, a slight modification in the unit of behavior construct is needed because the IDEF3 language does not provide special construct for risk representation. The BPMN language could have been selected alternatively but because we do not need pools and swimlanes and mostly consider the control flow of processes, IDEF3 is sufficient and well known in industrial engineering circles.
3. To model risk in a business process, the failure mode and effect analysis (FMEA) in combination with Larson and Kusiak's risk assessment methodology is chosen. The former is used to identify risk and assess the risk qualitatively, whereas the latter is employed to model and assess risk quantitatively.

4. To develop value and global risk measures, multiple criteria decision making tools are employed in order to develop value function of each performance criteria (or performance expressions) and then they are aggregated. For the former case, the MACBETH method is recommended while for the latter case, the 2-additive Choquet integral has been chosen.

To identify the issues in performance discipline as well as the tools and techniques to cope with these issues, the next chapter discusses and proposes a value and risk based performance management system. Tools and techniques such as objectives modeling tools, IDEF3 process modeling language, FMEA, Larson and Kusiak's risk assessment framework, MACBETH method and Choquet integral are used to develop a process-centered value and risk based performance management system.



---

**Part III**  
**A Value-Risk Based Performance**  
**Management System**

---



## **Chapter 5 Value-Risk Based Performance Management System**

*The main contribution of this thesis works is the development of a value and risk based process-oriented performance management system (named VR-PMS) for the purpose of decision making. A value and risk based approach to performance management using business process modeling and simulation methodologies offers an effective performance management system as it covers many of the deficiencies highlighted in the performance measurement literature review. The most promising contribution of the VR-PMS is to provide a conceptual value and risk model and a methodological framework. The former intends to combine value and risk concepts into one model, whereas the latter guides the performance assessment of a business process.*

*This chapter therefore presents the main contribution of the dissertation and describes the proposed VR-PMS in view of the requirements identified in the literature review. Due to the multidimensional nature of the performance concepts, the VR-PMS draws contents from different fields of study including value management, requirements engineering, business process management, risk management, simulation and decision sciences and integrate them in a coherent manner to answer the performance problem in question.*

### **Value and Risk based performance measurement and management system (VR-PMS)**

A performance management system, unlike a performance measurement system, is a system that not only guides a performance assessor to measure the performance of a system through a well-defined framework, but also helps him to guide the process of measurement towards objectives achievement. To this end, a performance management system requires two frameworks: a structural framework to provide a conceptual model by incorporating the main concepts around “performance”, and a methodological framework to guide the process of performance management.

The proposed VR-PMS comprises both a structural and a methodological framework. The former one integrates and models the relevant performance concepts of a process employing a conceptual value-risk model. The latter one lays down a step by step approach towards value and risk quantification of a business process right from stakeholder expectations.

#### **5.1 The VR-PMS structural framework**

According to Hammer (1997) a business process is “a group of tasks that together create a value to a customer [...] its purpose is to offer each customer the right product or service with a high degree of performance measured against cost, longevity, service and quality” (Jacobson *et al.*, 1995). Thus, while they lack the visibility in process modeling languages, process measures and objectives are available in process theory (List and Korherr, 2006). Similar to objectives, risk is often quoted in the context of business processes but its representation is missing in business process modeling languages.

The primary purpose for modeling a business process with relevant information of objectives and risks is to make the process model complete. A process model is considered as complete when all the desirable properties within the business process



model in order to assess it in terms of value and risk are capitalized. The objective, activity and risk triangle within an objective-oriented risk aware process model provides these desirable properties to this end. However, a conceptual model is still required to integrate these desirable properties in a coherent way in order to explain the value creation and preservation of a business process. To make the value creation and preservation explicit, the abstraction concept is used in the proposed structural framework.

### 5.1.1 Abstraction levels

The proposed performance management system supports horizontal and vertical aggregation abstractions. To decompose a value system (or value chains) into interim values of the operational activities, vertical abstraction is used. It refines the process by decomposing it into sub-processes and, ultimately to activities (see Figure 5-1). Horizontal abstraction, on the other hand, identifies subdomains of a process to be modeled such as functional, informational, behavioral and organizational. In this context of value and risk based performance assessment, all these views are relevant to quantify value and risk.

Similarly, the abstraction levels are also defined for the business process objectives. At the top-level is the overall fundamental objective of a business process, which is then refined to the functional objectives associated with an operational activity. In addition to functional objectives, non-functional objectives are also refined at various levels of abstraction. For instance, the delay objective of a process is a non-functional objective, which is decomposed and assigned to activities at various levels of abstraction

Likewise, a business process risk can be defined at different abstraction levels. At the highest level is the business process risk (quoted BP risk in Figure 5-1), which represents the negation of the overall fundamental objective of the business process. The decompositions of the top-level risk provide a way to address its multiple dimensions and form a risk hierarchy similar to the objectives hierarchy. The more risk is decomposed, the better it can support risk management of a process.

To establish consistency in abstraction levels of a process and the corresponding objectives and risks, a synchronized decomposition of all the three concepts is required as shown in Figure 5-1.

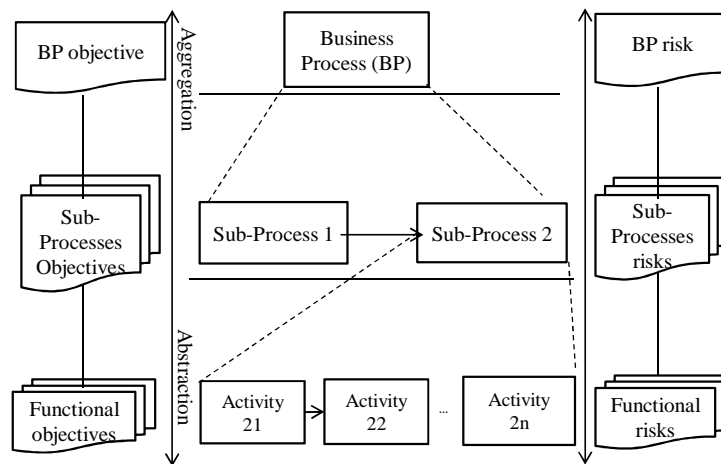

Figure 5-1: Overview of abstraction levels

Figure 5-1 shows a top-down decomposition mechanism of business processes and the corresponding objectives and risks in a synchronized manner. Conversely, going bottom-up is the aggregation abstraction mechanism. Here, the multiple elements of the lower levels of abstraction can be grouped and represented by a single artifact. In the context of VR-PMS, the aggregation abstraction is primarily used in the informational sub-domain where lower level objectives and risks are combined to create global value and risk indicators for a business process.

### 5.1.2 Generic candidate models

The structural framework of the VR-PMS models three views of a business process related to objectives, activities and risks at various abstraction levels. The resulting models are called generic candidate models since they are candidates to the combined conceptual value-risk model. The mapping of these three candidate models into the conceptual value-risk model provides the environment that facilitates the understanding of the value creation and preservation of a business process under study.

#### 5.1.2.1 Objectives model

The first step in building a conceptual value model for a business process is to identify a set of objectives  $O_i$  ( $i = 1, \dots, n$ ), appropriate for the process considered, and to define performance measures  $M_i$  ( $i = 1, \dots, n$ ) in order to measure the degree to which these objectives are met. For this reason, a structured approach to guide the process is required. The objectives model, therefore, provides this structured approach and provides guidelines to elicit objectives from stakeholder values usually expressed in the form of qualitative objective statements. The identified objectives are refined from higher level to lower level in a hierarchical structure so that they can be expressed explicitly.

The explicated objectives on the lower side of the hierarchical structure are quantifiable and, hence, performance measures are defined for each of these objectives. The defined performance measures form the basis for assessment of alternative processes when VR-PMS is used as a decision-support system. Otherwise, they provide useful information about the process performance. The lower level objectives are then aggregated through an aggregation operator, ultimately leading to the global process performance.

To operationalize the achievement of the fundamental-objectives, means-objectives are developed. The means-objectives are structured in a mean-ends network and suggest methods to address the fundamental objectives. Furthermore, as opposed to the value focused thinking framework, the current objectives model also incorporates the temporal logic in the means-ends network. With this modification, the means-ends network is provided with *XOR* and *OR* logic operators in addition to the *AND* operator while decomposing the objectives (van Der Aalst *et al.*, 2003; Neiger and Churilov, 2004).

Since means-objectives are aimed at determining the activities that support objectives realization, they are therefore linked to the activity model.

#### 5.1.2.2 Activity model

Having identified the objectives and the corresponding performance measures using the objectives model, the next step is to identify the activities, which are used to

support the objective realization. The identified activities of a business process are essential sources of value creation and risk that is why they are central concept to the process-centric performance management system.

To model an activity, the IDEF0 method (see Figure 5-2) is commonly used. It describes an activity in terms of: inputs, controls, outputs and mechanisms (*i.e.* resources). To transform an *input* into an *output*, an organization consumes various resources. However, to ensure the effectiveness and efficiency of this transformation, it is subject to *controls* for monitoring and control.

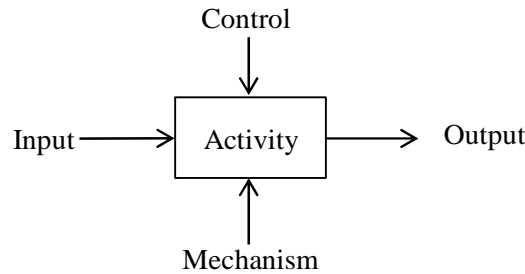
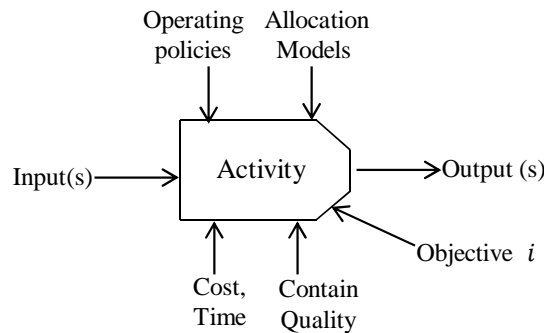

**Figure 5-2: IDEF0 activity diagram**

From the IDEF0 formulation of an activity, a generic activity model can be developed for a value model. To this end, additional generic attributes of an activity in the context of performance assessment namely, cost, time and quality, are defined. The cost of the activity model represents the financial aspects of performance, whereas the time and quality attributes refer to the non-financial aspects.

Furthermore, the quality of an activity is relevant to the inherent product characteristics (Etienne, 2007, pp. 76), because quality of the activity (*e.g.* process variations) naturally affects the technical performance of the product from a manufacturing perspective. In addition to the technical performance, reliability, efficiency, availability and security are the other dimensions of process quality (Heidari *et al.*, 2011).

To operationalize the activity model for value creation, activities carrying several degrees of quality (for instance: maturity, recoverability, performance) consume cost and time and produce several deliverable. This deliverable is the interim value in the value perspective whose magnitude is measured with reference to the associated objectives. Additionally, the effectiveness and efficiency of the activity to produce the interim value is subject to cost, resource and scheduling models as well as the operating policies, which govern the transformation process of the activity model. Figure 5-3 shows the operational activity model for value assessment purpose.

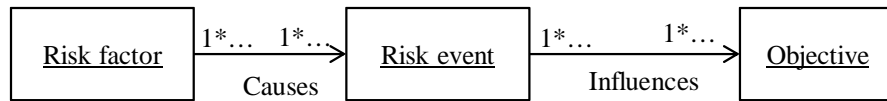

**Figure 5-3: Activity model in a performance perspective**

By determining the activity model, which is responsible for objective realization, which in turn creates the business process value, a generic risk model for the purpose of value preservation is also introduced.

### 5.1.2.3 Risk model

As mentioned in the previous section, an activity is designed to achieve objectives, either functional or non-functional ones. However, uncertainties reside “internal” and “external” to the activity in the form of risk factors (Salah, 2005), which may trigger the occurrence of any undesirable events. In case of occurrence of risk events, the activity progress towards objective attainment can be affected. Figure 5-4 shows how the risk factors influence business process objectives. They are linked to the objectives via risk events.



**Figure 5-4: Risk factors and objective relationships**

The risk model is, therefore, included in the current approach to assess the impact of risk events originating from the risk factors on the defined objectives. Moreover, a risk event may have been triggered by one or many risk factors and it is often difficult to identify which risk event is triggered by which risk factors. However, an objective-driven approach is used to identify the potential risk events and the corresponding risk factors, which are assessed qualitatively with the help of the activity model in the framework of the failure mode and effect analysis (FMEA). The qualitative risk assessment using FMEA enables one to prioritize risks for further assessment in quantitative terms in the process simulation environment.

The advantage of process-based assessment of risk events is that both the value and risk assessment are carried out in the same business process model. In addition, risk may not happen because of a single undesirable event but may have been the result of a chain of events that leads to failure of the business process (or system). In such situations, the simulation technique is the right approach to quantitatively assess risk during process design of the risk aware business process model. To this end, Larson and Kusiak risk assessment approach (1996) is relevant since it is activity-based and can be carried out in the same context, used for process value assessment. This approach parameterizes risk using Kaplan and Garrick (1981) definition of risk, as expressed by Equation 5-1:

$$R = (S, P, C) \quad 5-1$$

Where  $R$ ,  $S$ ,  $P$  and  $C$  represent risk, risk scenario, likelihood and consequence, respectively.

The underlying assumption for activity-based risk assessment is that each activity in a process is exposed to risk factors  $RF_i$  ( $i = 1, \dots, n$ ) and thus can trigger one to many risk events, which in turn can affect the attainment of business process objectives (as illustrated in Figure 5-5).

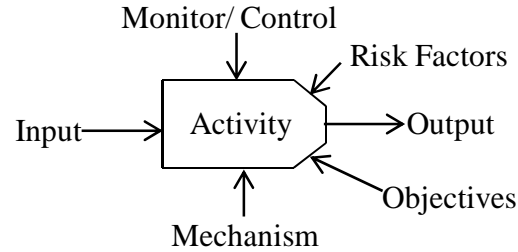

**Figure 5-5: Activity exposure to risk factors**

To quantify the business process risk of the same nature, the likelihood of all risk events multiplied by their corresponding consequences (same effect) on an individual activity are first combined and then aggregated all along the business process. Equation 5-2 calculates the magnitude of risk on an individual activity in a business process.

$$R_i = \sum_{j=1}^J (P_{ij} \times C_{ij}^{obj}) \quad 5-2$$

Where  $R_i$  is the risk magnitude of an activity  $i$ ,  $P_{ij}$  is the probability of a risk event  $j$  of the activity  $i$  while  $C_{ij}^{obj}$  is the consequence (in terms of cost, time or qualitative scale) of a risk event  $j$  in the activity  $i$ . The overall risk magnitude in a business process path  $p_k$  made of activities can then be described as:

$$R(p_k) = \sum_{\forall i \in p_k} R_i \quad 5-3$$

Where  $R(p_k)$  = Risk magnitude in a particular business process *path*  $p_k$ .

Quantification of all risks of diverse natures of a business process into one single global risk is then carried out. This requires an aggregation procedure which involves value judgments and is dealt in the framework of the decision-making phase (§ 5.3).

### 5.1.3 Mapping of generic candidate models

Having defined the objectives, the activity model and the risk model for a business process performance assessment, the next step is to map all these models into a combined model. The resulting conceptual value-risk model should have the hereditary properties of the individual models in order to be *complete* and *clear*. Ontological *completeness* is achieved when the combined model possesses a maximum of desirable hereditary properties of the candidate models. *Clarity* refers to the minimum overlap in the representation of the same concept by the combined model (Wand and Weber, 2002). However, Wand and Weber argue that four types of undesirable situations due to lack of isomorphism can arise while mapping candidate models (Recker, 2011) as shown in Figure 5-6.

- 1 **Property deficit:** An ontological construct exists that has no mapping from any modeling construct (a 1:0 mapping).
- 2 **Property redundancy:** Two or more modeling constructs map to a single modeling construct (a 1: m mapping).

- 3 **Property overload:** A single modeling constructs maps to two or more modeling constructs (an  $m: 1$  mapping).
- 4 **Property excess or overlap:** A modeling construct does not map onto any ontological construct (a  $0:1$  mapping).

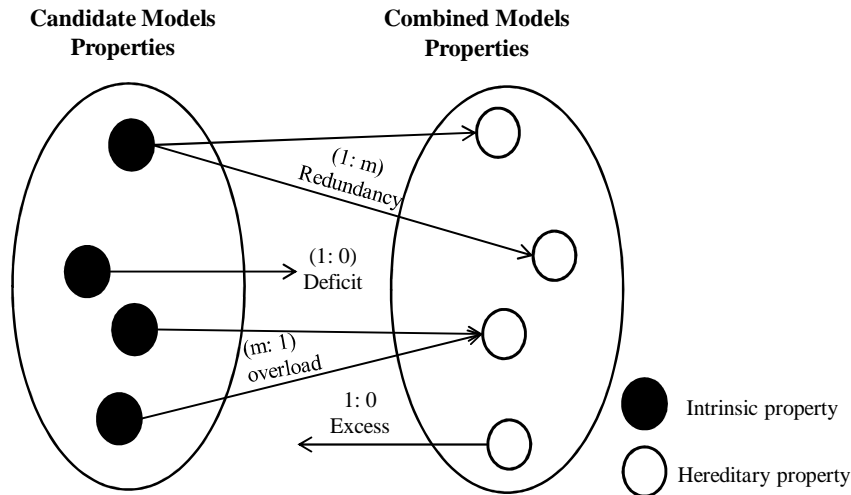

**Figure 5-6: Mapping of candidate models on combined model domain**

Figure 5-6 depicts the four mapping shortcomings. On the left are the intrinsic properties (in black) of candidate models while, on the right, are the hereditary properties. A combined model can be formed from candidate models if there exist (Neigeret *et al.*, 2008, pp. 118):

- A common element (requirement 1).
- There exists a representation mechanism for this element in the candidate models (requirement 2).

In the current configuration, the activity is the element common to all the three candidate models (objectives, activity and risk models). Indeed, an activity is core to at least one objective and subject to risk factors. So, the activity model is chosen as the primary model which will host all the desirable properties of the combined value-risk conceptual model. Additionally, in the process-centric PMS, the activity model is the core concept and can easily accommodate hereditary properties of the candidate models with slight modification.

To see whether the hereditary properties in the combined model (*i.e.* conceptual value-risk model) are complete and clear after mapping the three candidate models which are: objectives model, activity model and risk model, their desirable properties are examined in the combined model in the value and risk perspectives.

### 5.1.3.1 Properties deficit

From the view point of value analysis in a business process, the activity model based on the IDEF3 method lacks the ability to analyze the process and provides a decision support. Although it analyzes the process qualitatively, quantitative analysis can be carried out only when linked with a decision model and a simulation tool. Moreover, the activity model cannot model objectives explicitly and therefore is not a suitable candidate model for objective-oriented process modeling.

The objectives model, on the other hand, is good enough to represent objectives, differentiate between fundamental and means-objectives and define levels of abstraction. Additionally, the objectives model has a well-established link with the MCDM methods. However, it has no well-established link with business processes. Fortunately, the objectives model can be connected to the activity model through means-ends objectives.

Similar to objectives, risk cannot be modeled explicitly in the activity model. The latter has no defined construct to accommodate it. To satisfy the condition of “common element” for any two candidate models to be combined, activity elements can be used. Risk acts on activities or resides “internal” or “external” to the activity. Therefore, activity on one hand is the fundamental element of the activity model and on the other hand is related to risk management in the process perspective. As for the representation of risk within the activity model, the activity construct can be modified for the purpose.

### **5.1.3.2 Properties redundancy and overload**

In the mapping process, none of the candidate models is redundant and therefore all the three models need to be included as candidate models in order to contribute the desirable properties to the combined model. So, redundancy is not a major concern in mapping these models. Similarly, no property of the candidate models overloads in the combined model, *i.e.* no two hereditary properties of the candidate models are represented by a single property or construct in the combined model.

### **5.1.3.3 Properties overlap**

Overlap of properties in all the three candidate models is possible since all of them are aimed at maximizing the value (implicitly) of a business case (*i.e.* an order processing). However, the approach to maximize value of the business case is different in each of the candidate model. The objectives model focuses on objectives achievement while relying on decision theories, particularly multi-attribute utility theory in order to maximize the value of a business process, but less efficient in identifying the activities required to achieve them. Although means objectives of the objectives model clearly refers to activities in order to achieve the fundamental objectives, it fails to provide a mechanism to depict process activities in a way that account for their sequence, coordination, organization, resources required to carry out the process, inputs and outputs.

The activity model, on the other hand, provides all the essential elements such as functional (activities), behavioral (temporal and logical) as well as informational aspects needed to assess the value of a business process. It can model objectives: functional and non-functional ones. So, objective property of the two models overlap, however the property is not redundant because it lacks visibility in activity model and modeled implicitly. Therefore, objective property is a candidate property for the combined model.

Also, in the activity-based risk assessment, the risk model shares the same business process view with the activity model. The latter analyzes a process for value and the former analyzes the business process to determine risk and preserves the value created by these activities. So, activity property itself is shared (which is synonymous to the concept of overlapping) between the activity model and the risk model in the risk analysis of the process perspective.

Therefore, the property overlap provides a foundation to link the different models into a combined coherent model. However, the desirable properties inherited from the candidate models and which allude to the same property should be made explicit in the combined model.

The summary of the mapping, also called ontological analysis is provided in Figure 5-7

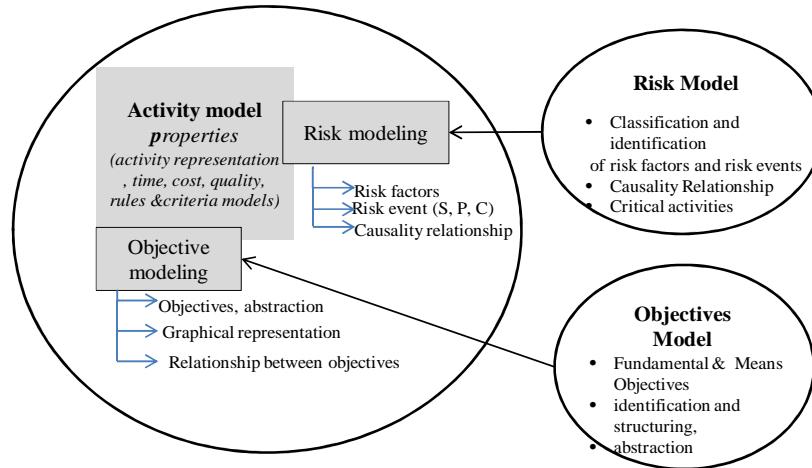
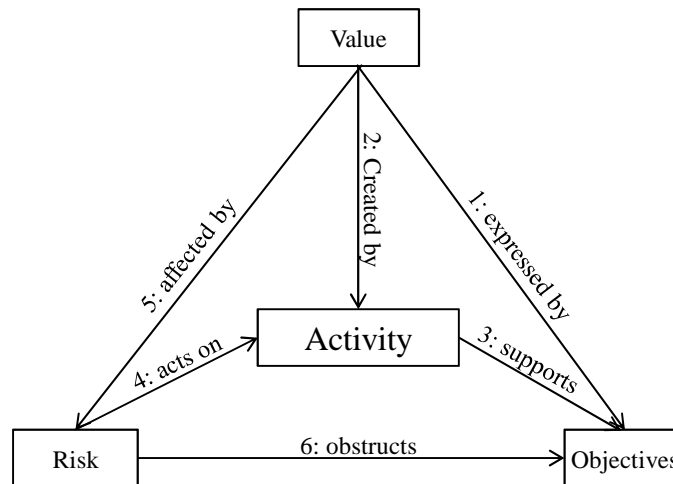

**Figure 5-7: Integration of candidate models**

The ontological analysis highlights the desirable properties of the combined conceptual value-risk model. These properties are then used to define the requirements for linking them in a combined and coherent way.

#### 5.1.3.4 Linking candidate models

Having identified the desirable and hereditary properties for a combined model, it is time to link them with one another to form a conceptual value-risk model. Figure 5-8 shows the relationships of candidate models and their associations with the value model.



**Figure 5-8: Tetrahedral relationships of value, risks, activities and -objectives**

Referring to Figure 5-8, the value of a business process or any activity-based entity can be expressed in terms of objectives (arrows 1) and realized by activities (arrows



2) via objective realization (arrows 3). However, the activities are subject to risk (arrow 4), which ultimately affect the objective attainment (arrow 5) and negatively influence the value creation process (arrows 6).

To conceptualize the ideas, activities are defined as the atomic units of work in elementary form (van Der Aalst *et al.*, 2003) linked through constructs (control flow logics) to make up a process and are intended to support and realize process objectives. Similarly, the objectives in their elementary form are atomic units of intention (Neiger *et al.*, 2008) combined through constructs (logical connections) and are intended to express a process value. Therefore, at the lowest abstract level, activities (or functions) can be linked to intentions. Therefore, the activity model and the objectives model can be linked through function and intention relationships. For example, each unit of work (*i.e.* function) has at least one intention (*i.e.* functional or non-functional one) quantified via a performance measure.

Similarly, risk can be linked to the activity model either through a unification approach or an integration approach (Sienou, 2009). However, for the purpose of simplicity, it is sufficient to assume that risk events triggered by risk factors act on activities, which in turn obstruct the realization of objectives and, hence, affect the value creation process.

#### 5.1.4 Conceptual value-risk model construction

By identifying and establishing the links between the hereditary properties of the objectives, the risk model and the activity model within the combined model, it is now convenient to construct a conceptual value-risk model. The conceptual value-risk model provides sufficient conditions to elaborate the value creation mechanism of a business process in the presence of risk factors.

The primary purpose of the conceptual value-risk model is to determine two indicators, referred to as value and risk indicators. These indicators are expressed in the form of pair of numbers (value, risk) that can be calculated for each of the alternative business processes in a decision context. This pair of numbers provides a ranking of desirability or undesirability of each alternative (business processes, thereby providing the basis for making a choice among the alternatives). Moreover, the conceptual value-risk model determines the interactions (dependency and correlation) among various elementary performance expressions (or value functions) derived from performance measures and reports whether they influence each other positively, negatively or neutrally.

The proposed conceptual value-risk model is shown in Figure 5-9. This Figure represents an atomic unit of the conceptual value-risk model detailing the fundamental elements and concepts required to value and risk modeling in the process perspective. To represent objectives and risks on the activity model (requirement 2, see §5.1.3), the upper right and lower sides of the activity construct are clipped to model risks and objectives, respectively.

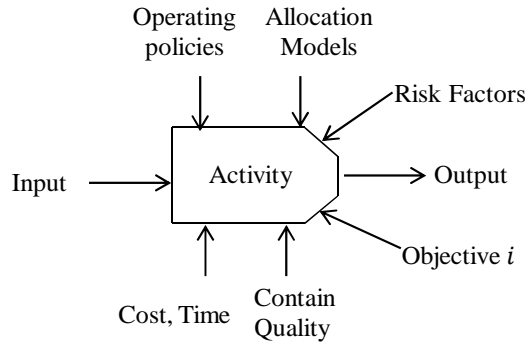
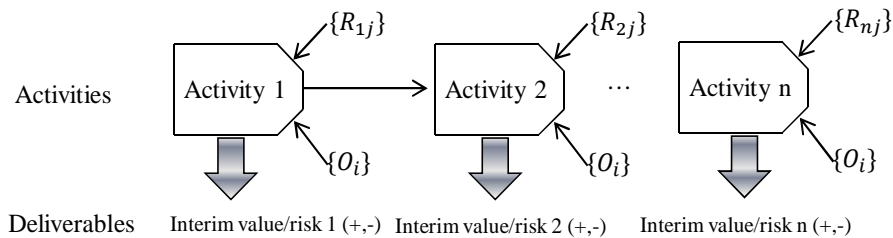

**Figure 5-9: Complete conceptual value-risk model**

To operationalize the idea of value creation and preservation in any given process, Figure 5-9 is proposed. An activity with a certain degree of quality consumes cost and time to produce deliverables, the quality of which (in the broader sense) is controlled by the allocation models (which can be: ABC cost model, resource model or scheduling model) and operating policies as well as the quality of the resources used and the provided input. This deliverable (or interim value) in the context of manufacturing can be a change in the morphology of an unfinished or finished workpiece or information creation from inspection activities.

To judge whether the interim value, called  $\mu_i$ , or interim risk, noted  $r_i$ , is created or dissipated can be obtained by comparing the deliverable (or interim value or risk) with the assigned objectives (functional and non-functional ones). The magnitude of the interim value created by the activity can be assessed through value judgments (cardinal and ordinal information values), which are solicited from the process assessors (or experts) in a systematic manner thanks to several questions more detailed in the section 5.3.1. In a decision context, these questions lead to determine the preferences and strengths of preferences of the assessor regarding the interim value in several alternative courses of actions, which are then transformed into elementary performance expressions (value functions) employing the theory of preferences (or utility theory).

To obtain the overall value of a business process (Figure 5-10), the interim values and interim risks obtained in the form of value and risk functions are then aggregated as shown in Equations 5-4 and 5-5.



**Figure 5-10: Value creation process in the presence of risks**

$$Global Value = F(\mu_1, \mu_2, \dots, \mu_n) \quad 5-4$$

$$Global Risk = R(r_1, r_2, \dots, r_n) \quad 5-5$$

Where, F represents the aggregation function which is determined thanks to the Choquet Integral in VR-PMS.

## 5.2 The methodological framework

In the previous sections, the conceptual value-risk model is developed which has its roots in the fundamentals of value creation and preservation in process-centric environments. From now on, it is convenient to introduce the methodological framework which guides the assessor in a step by step manner to carry out value and risk-based assessment of a business process.

The generic methodological framework shown in Figure 5-11 includes methods relying on tools and techniques dedicated to different phases of the framework. The phases 1, 2 and 3 of the framework constitute the performance measurement process. The 4<sup>th</sup> phase of the framework links the performance measurement process to decision-making mechanisms. The different phases of the framework roll out in a sequential order.

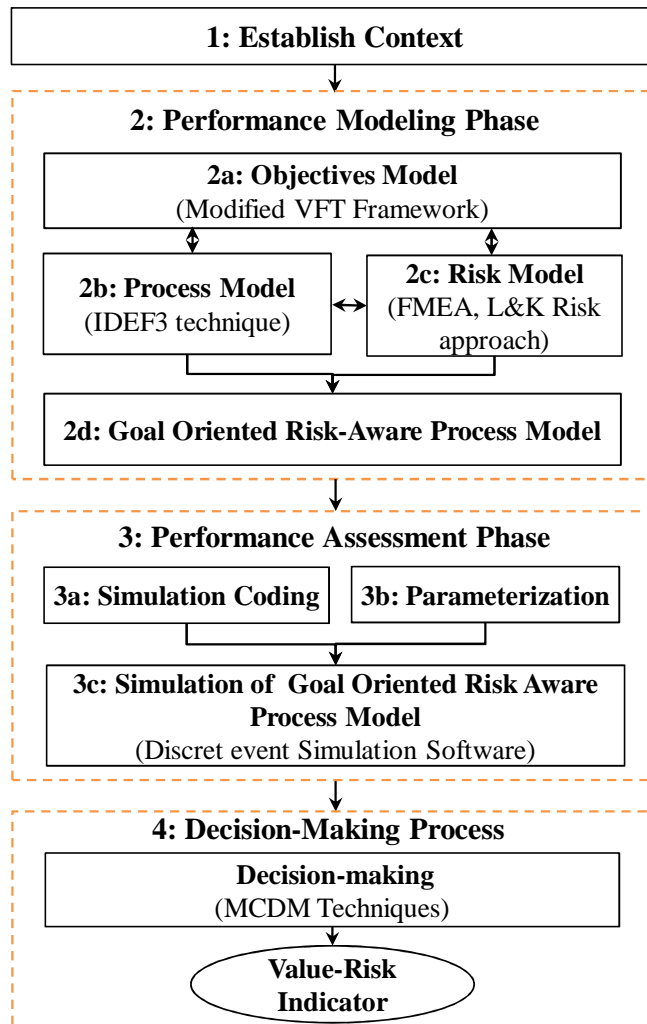

Figure 5-11: The Methodological framework of VR-PMS

Each phase of the methodological framework is detailed in the subsequent sections.

### 5.2.1 Establish the context (Phase 1)

The first phase of the method deals with the identification of the application domain, which can be manufacturing, supply-chain processes, logistic processes or any administrative processes. Although the application domain is known in advance in any performance measurement and management context, the scope of the study, the stakeholders involved in the business process, their expectations and responsibilities and the risk management scope need to be defined explicitly.

To identify the stakeholders of a business process, Mitchell *et al.*, (1997) suggest three attributes which are generalized here to a business process:

1. The stakeholder’s *power* to influence the business process
2. The *legitimacy* of the stakeholder relationship to the business process
3. The *urgency* of the stakeholder claim on the business process

Moreover, Matty, in his doctoral (2010, chap. 4), connects these attributes to the value creation process. Matty posits that stakeholder *legitimacy* strongly influences value identification, *power* strongly influences value positioning and *urgency* strongly influences value execution.

By identifying the stakeholders and their importance based on Mitchell’s attributes, the next step is to determine stakeholder expectations and responsibilities. In addition, stakeholder risk appetite, tolerance and risk criteria are also determined in this phase of the framework.

Once the problem is scoped out, an artifact is prepared, which contains a list of attributes as shown in Table 5-1.

**Table 5-1 : Establish the context phase deliverables**

<ul style="list-style-type: none"> <li>● <b>Establish a Context</b></li> </ul>
<ul style="list-style-type: none"> <li>● Domain of interest</li> <li>● Stakeholders involved</li> <li>● Stakeholder expectations</li> <li>● Roles and responsibilities</li> <li>● Risk management scope</li> <li>● Risk acceptance</li> <li>● Risk criteria</li> <li>● Risk appetite</li> </ul>

### 5.2.2 Business process performance modeling (Phase 2)

This phase of the methodological framework is concerned with integrating the objectives and risks in the framework of the business process model. The modeling of objectives with process models has been detailed in the literature (Andersson *et al.*, 2005; Kavakli, 2002; Kueng and Kawalek, 1997; Neiger and Churilov, 2004; Shahzad and Zdravkovic, 2009). Similarly, risk integration in process models has been recently studied in the literature (Sadiq *et al.*, 2007; Sienou, 2009; Cope *et al.*, 2010). However, the integration of objectives and risk in business process models is still in its infancy and requires attention of the business process management and risk management communities.

To develop an objective-oriented risk aware business process model for the purpose of performance assessment in terms of value and risk, this research work relies mostly on the research accomplishments of Keeney (1996), Clemen & Reilly (2000), Neigeret *et al.*, (2006), Sienou (2009) and Larson and Kusiak (1996). A new framework is proposed to model the objective-oriented risk aware business process. Figure 5-12 explains the major steps involved in the proposed approach.

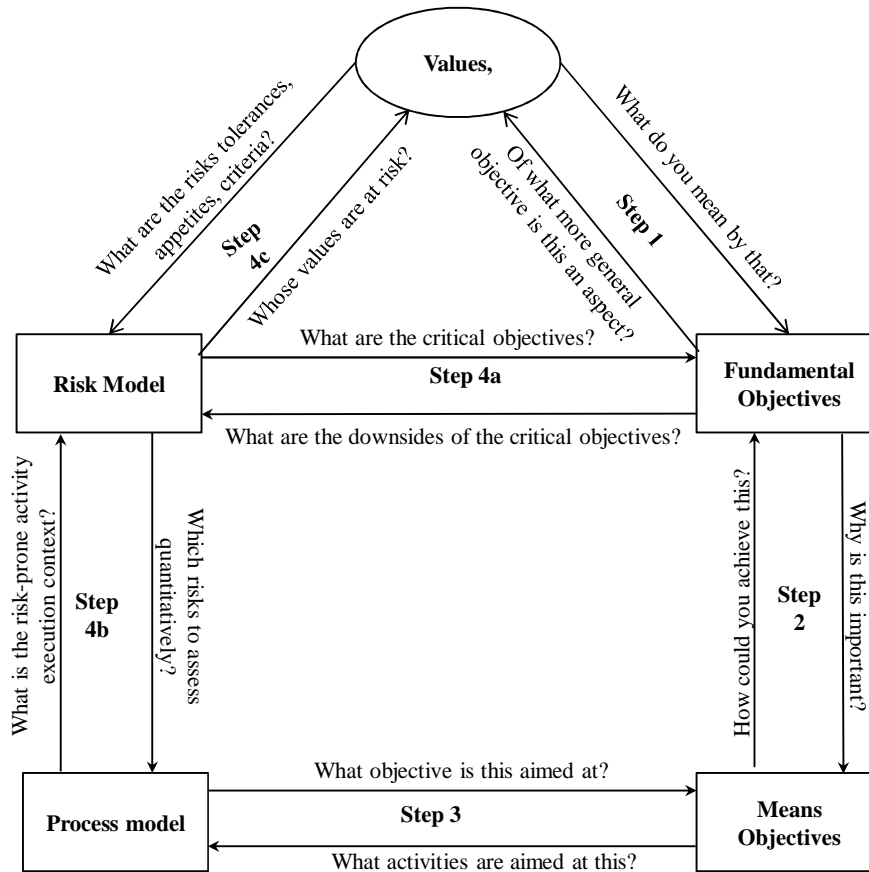

**Figure 5-12: Integrated business process performance modelling approach (Integrated BPPM)**

The approach determines value-driven performance measures elicitation using the objectives model (steps 1 and 2), facilitates activity definition to realize the objectives model (step 2), models the identified activities (step 3), identifies risk via an objectives-driven approach (step 4a) and assesses qualitatively the identified risks with regard to the risk management scope (step 4c) in the process perspective (step 4b). The final deliverable of the approach is an objective-oriented risk aware process model, which serves as the basis for value and risk-based assessment of business processes. Each of these steps is explained in the following sections.

### 5.2.2.1 Identify and model fundamental objectives (Step 1)

Value-driven objectives are qualitative statements reflecting stakeholder expectations. Their identification begins with stakeholder values about a business process. For this purpose, Keeney (1996) provides a list of techniques that can help to stimulate the identification of possible objectives. However, the process is iterative and demands creativity and hard thinking.

The objectives modeling process begins with the identification of the overall fundamental objective of a business process. In the words of Keeney (1996, p. 77), it defines “*the breadth of concern*”. For instance, in a supply chain context, a higher level fundamental objective can be “To satisfy customer demand”.

Once identified, the more specific objectives with regard to the overall fundamental objective can be identified using a guiding question such as: ***What do you mean by that?*** The answer to the question specifies lower level objectives such as “on-time delivery”, “minimum cost” and “high quality” of the delivered products. Each identified objective can be further refined. For instance, the objective “high quality” means “reliability of the business process”, “conformance to specification” and so on. Similarly, the reliability of the process means “maturity of the process” and “recoverability of the process”. This process continues until the fundamental objectives in question become clear to quantify and a performance measure can be constructed for each lower level objective. They are then structured into a hierarchy as shown in Figure 5-13.

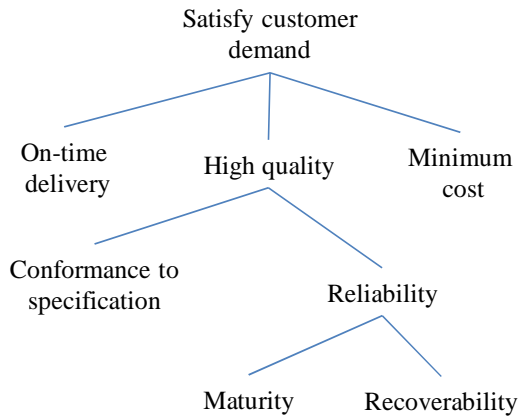

**Figure 5-13: Fundamental objectives hierarchy**

From Figure 5-13 it can be seen that the lower level objectives in the hierarchy are the facets or dimensions of higher level objectives and each one of them can be more or less important in a given case study.

Similarly, the analysis can move upward in the objectives hierarchy starting at one of the lower level objectives and ask the question: ***Of what more general objective this sub-objective is an aspect?*** For instance, “of what more general objective of business process maturity is an aspect?” The answer to the question would be “business process reliability” and repeating the same question with respect to the reliability objective would lead us to the fundamental objective of “high quality” and finally to the “satisfy customer demand”.

**5.2.2.2 Identify and model means-objectives (Step 2)**

Means objectives are the means to achieve the fundamental objectives and specify actions or alternative courses of actions to realize the fundamental objectives. The guiding question of: ***How can this be achieved*** facilitates the identification of means-objectives. For instance, as illustrated in Figure 5-14, the answer of the question “how to achieve minimum manufacturing time”, is for instance: “optimize operations sequencing”, “maximize throughput”, “minimize bottlenecks in the process”. Once a sound list of means objectives for the fundamental ones is identified, they are then

structured in the objectives network (one is given in Figure 5-14). The first layer immediately after the “on-time delivery” objective consists of fundamental objectives.

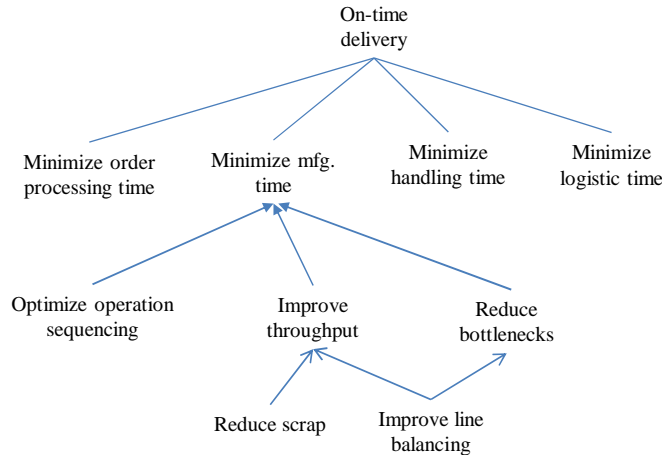

**Figure 5-14: Means-objectives networks**

Note: An arrow in the means-objectives network means “influences”.

### 5.2.2.3 Restructuring objectives (Step 1 and Step 2)

Having identified the objectives, it is not highly unlikely that the initial structuring of objectives contains both fundamental and means objectives. So, it is highly recommended to reformulate the objectives and make sure that the fundamental objectives hierarchy includes and reflects the stakeholder expectations and directions of preference. Although, the objectives identified involve subjective judgment on the meaning of objectives, however, the subjective and contextual elements cannot be avoided in the value-focused thinking. Techniques such as the Delphi methods can also be used to reduce the effects of subjective judgments (Reckeret *al.*, 2009).

To this end, the guiding question of: **Why is this important** is asked. This question, also called **WITI test**, serves two purposes: (1) to separate fundamental objectives from means objectives and (2) to reveal connections. For example, if the answer to the question is “this objective is important because it accomplishes objective X”, then this is a means-objective; otherwise, it is the candidate for a fundamental objective. The assessor can repeat the WITI test for the objective X. By continuing to ask why this objective is important, the assessor traces out the link from one means objective to the next until he arrives at an objective where the answer to the WITI test is “This objective is important. This is the essential reason why I care about”. In this case, the assessor has identified a fundamental objective (Clemen and Reilly, 2000; Keeney, 1996).

To illustrate how the WITI test works, it is applied to one of the objectives in the running example such as “reduce scrap”. The objective is important because it contributes to “improve throughput”. Why the “throughput” is important is because it reduces manufacturing cycle time and cost. Why cost is important, the answer is: “because we care about it in this decision context”. It means that the cost is a fundamental objective. Once all objectives - fundamental and means - are determined, they are structured in hierarchies and networks, respectively.

Moreover, the fundamental objectives can be distinguished from means-objectives through abstraction and causality relationships. The lower level objectives in the hierarchy are part of the higher level objectives and are mutually exclusive. However, in the means-objectives network, the relationships between adjacent levels are causal (Keeney, 1996, pp. 78). Similarly, means objectives are structured in a network form. It means that each network objective has a many-to-many relationship. While structuring objectives in a network hierarchy, logical connectors are used to make clear whether all the lower level objectives need to be met to satisfy the upper level objective (*AND-logic*), or one or more of the lower level objectives can satisfy the upper level objective (*OR-logic*), or either of the lower level objective is sufficient to fulfill the upper level objective (*XOR-logic*).

Finally, when objectives are structured, it is time to test all the fundamental objectives against the nine properties defined by Keeney (1996). An important step is to remove redundancy or double counting of objectives.

#### 5.2.2.4 Performance measures (PMs)

At the lowest tier of the fundamental objectives hierarchy are the objectives that are measurable and serve as a basis for the identification of performance measures (PMs). The importance of the PMs is to use them as tools for the evaluation and assessment purpose.

To develop PMs for the running example, each of the objectives of the hierarchy (synthesized in Figure 5-13) is consulted. For instance, “Recoverability” can be measured using the performance measure “Mean-time between failures or MTBF”. Similarly, the maturity of the business process can be measured using the performance measure such as “Number of errors occurred in a business process”. Likewise, for the objective “Conformance to specs”, a performance measure “Process yield” can be employed.

Most often, the performance assessment may involve a wide range of performance measures and it is necessary to bring some structure to the list of derived performance measures. The use of a performance measure tree or value tree can help in structuring these performance measures. The value tree format is also compatible with the MACBETH approach, which is used to determine value and risk functions for each performance measure.

#### 5.2.2.5 Business process modeling (Step 3)

Process modeling, in the current dissertation, is the identification and representation of activities that support the realization of means-objectives to ultimately lead to the attainment of the overall fundamental objective. To identify such activities, the guiding question: “*What activities are aimed at achieving these objectives*” is asked for each objective in the means-ends network. This helps the assessor to identify the major activities with respect to the top level means-objective (Neiger *et al.*, 2008).

In addition, Kueng and Kawalek (1997) suggest deriving at least one activity for each means-objective. If the assessor is not able to derive an activity from a means-objective, then the objective has to be further refined. In addition to the means-objectives as sources of activity identification, Kueng and Kawalek (1996) determine other sources namely, measurement of objective achievement (inspection relevant activities) and input delivery (process triggering activities). However, activity identification has not been paid enough attention and therefore requires further



research to formalize the approach. Irrespective of the method used to identify activities to respond to the objectives, they need to be complete and will have well-defined inputs and outputs. It is relevant to mention that activities are determined only for functional objectives and evaluated against both functional and non-functional objectives.

Once the activities are defined, they are then arranged by defining the logical dependencies and constraints between them. To this end, the IDEF3 method with a modified UOB (unit of behavior) construct based on the activity construct of our conceptual value-risk model (see Figure 5-9) is used, which can easily model the logical and temporal dependencies existing within the business process activities (cf. Figure 5-15).

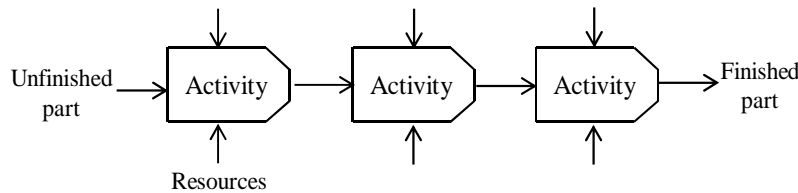

**Figure 5-15: Modified IDEF3-based process model**

By defining and modeling activities, it is time to relate objectives to the activity model. The initial means-objectives network has already been developed and refined, which can be used as a point of reference for determining functional objectives within the IDEF3 process model. To link them to the activities within the process, the question asked is: *What objective is this aimed at?* The answer to the question helps to identify the activity or the set of activities for a particular objective. This practice also helps to identify the critical activities in the process model, which is needed in the risk modeling phase. For example, in the context of satisfying a customer demand, an activity “Turn feature  $i$ ” is identified as a process step whose objectives ( $O_i$ ) are to realize the feature with “ $x \text{ mm} \pm x$ ” dimension (see Figure 5-16).

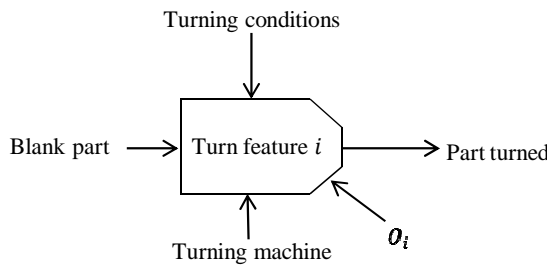

**Figure 5-16: Step of an objective-oriented process model**

So,  $O_i$  represents the functional objective  $i$  associated with the activity “Turn feature  $i$ ”. Other non-functional objectives relevant to time and cost can also be associated to the activity.

### 5.2.3 Risk modeling (Steps 4a, 4b and 4c)

In the process perspective, risk stems from the uncertainty regarding the ability of the process to deliver “the value proposition”— and the consequences thereof. The value proposition refers to the implicit or explicit promise a company makes to its stakeholders to deliver a particular combination of values (Martinez, 2003). So,

business process risks should be modeled to account for the uncertainties and their consequences on the “value proposition”.

To this end, the VR-PMS risk management process after taking into account the risk appetites, tolerances and criteria (Step 4c), proposes a two-pronged approach to risk assessment, which is detailed in the following sections.

### 5.2.3.1 Objective-driven approach to risk identification (Step 4a)

The general approach to risk identification starts with objectives identification (Narasimhan and Talluri, 2009; COSO, 2007). Relying on this theory, an objective-driven approach to risk identification is proposed in the current dissertation. The main idea behind this approach is that risk factors are obstacles to objectives attainment or, in other words, objectives (or goals) capture desirable conditions, whereas risk factors (=obstacles) capture the undesirable conditions (Lamsweerde and Letier, 2000). An assertion in the form of a question (step 4a) that obstructs the objectives attainment is sufficient to identify the relevant risk events.

For instance, in the running example, the global risk event of the business process is its failure to deliver the value proposition, i.e. dissatisfaction of the customer. The lower level risks are then identified by an assertion that reflects the downside of the objective in question. For instance, what are the downsides of the cost, quality and time objectives? The answer can be cost overrun, performance risk and schedule risk, respectively. Once fundamental risks as dimensions of the global risk are identified, a simple question of the VFT framework “*What do you mean by that*” is sufficient to drill down lower level risks. For instance, what do you mean by the schedule risk? The schedule risk means the delay in the order processing, manufacturing and logistic processes. Each of the lower level risk represents a different facet of the higher level schedule risk. The process of questioning is repeated for each of the fundamental risks understudy. Once sufficient risks are determined, they are then organized in a hierarchical structure as shown in Figure 5-17.

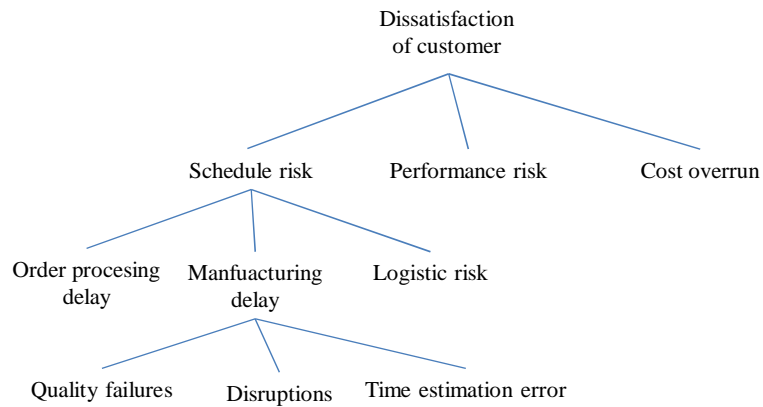

**Figure 5-17: Objective-driven risk identification**

Furthermore, the higher level risk is defined by the set of lower level risks directly under it in the risk hierarchy, but not necessarily mutually exclusive as it is the case in the VFT framework. For instance, the risk events such as quality failures, disruptions and time estimation errors under the higher level risk of manufacturing delay are mutually exclusive risk events. However, the cost overrun, schedule risk or performance risk are depend in nature because change in one affects risk in another. This makes no problem in the VR-PMS because the latter uses a non-additive model

(as explained 5.3.2 ) for the purpose of aggregation as opposed to the VFT framework, which employs additive models (based on axioms of preferential independence).

Additionally, the VR-PMS risk hierarchy can have risk events shared among various facets of the global risk event. For instance, the quality failures dimension can be the lower level risk under the schedule risk facet but at the same time it is also the lower level abstraction of the performance risk. However, they are not the same risk in the risk hierarchy. The quality risk as a dimension (or facet) of the schedule risk refers to the delays incurred in the case quality failures happen. For example, a part non-conformance to specification may lead to either the rejection or rework of the part, which in turn may trigger a schedule delay. Therefore, the impact of this quality failure can have different implications for technical performance risk and schedule risk. In the realm of the schedule risk, only the impact relevant to delay will be considered while the impact on the technical performance is dealt in the dimension “high quality”. In brief, the probability parameter of the risk is shared but the impact or consequence will be different and therefore they are not considered the same risk.

Once all risks are identified and structured in the risk hierarchy, the next step should be to determine the sources of risks or risk factors, which trigger these risk events. For instance, the risk factors for the risk event of quality failures can be identified by asking a simple question “*What causes this risk to occur?*” By asking the same question over and over for a particular risk event will explore the risk factors. For the risk event quality failures the sources can originate from the complexity of the product, process or novelty of the process, the operator of the machine, the machine itself and so on. The principle of 6M’s (man, machine, method, material, measurement and milieu) or Ishikawa diagram can also facilitate the identification of risk factors for a given risk event. Figure 5-18 shows the risk events and their corresponding risk factors.

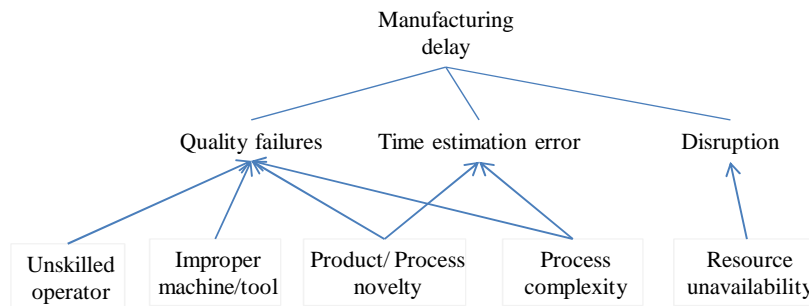

**Figure 5-18: Risk factors for the manufacturing delay**

The identification of risk factors is required to develop control action plans for risk treatment. If sources of risks are known, then a risk manager can deploy a risk treatment policy to reduce the likelihood of the risk event.

Furthermore, a causality link exists among risk factors. In addition to the causality relation, there exist 1-to-many relationships among risk factors as well as risk events on the lower level of the risk hierarchy and risk factors. Risk factors may cause (= are means to) risk events occurrence whose uncertainty is modeled using the probability of the risk event. The identified risk factors are then structured in the risk networks as shown in Figure 5-18.

The risk hierarchy and risk networks are sufficient to map all the relevant risks and their causes. However, the identified risks with their risk factors cannot be assessed because they lack the contextual information. For this purpose, they are further investigated in the business process environment where they may happen.

**5.2.3.2 Activity-based approach to risk assessment (Step 4b)**

The identified risk events of the risk hierarchy are assessed using the FMEA technique. For this reason, the required contextual information is obtained from the process model. Because the process model contains sufficient information regarding the execution of the activities, and the environment thereof, they are therefore consulted when analyzing a particular risk (Step 4b). For instance, without knowing the type of machine/tool and operator to be employed to machine a critical feature of a part, it is difficult to know whether the risk event may be triggered or not and, hence, risk assessment cannot be performed.

To identify the activities subject to risk of the lower tier of the risk hierarchy, a simple guiding question of “*What activities are accountable to the risk event*” is asked. The answer to the question is a matrix, which links risk events to the activities of the business process as shown in Table 5-2.

**Table 5-2: Links between risk events and activities**

Activities \Risk events	R1	R2	R3	R4	R5	R6
A1			×		×	
A2					×	
A3			×	×	×	×
A4	×					
A5		×			×	×

For instance, if R1 represents the quality risk of mechanical part “Feature *i* non-compliance to specifications”, then A4 is identified as the relevant activity which is accountable to realize feature *i*. Similarly, R5 represents the risk event “Time estimation error”, which may be applied to all activities or those activities whose duration is quite uncertain (subject to variations). The same procedure is repeated for all the risk events, which ultimately leads to the identification of activities for each risk event identified in the risk hierarchy structure.

Once all risks and associated activities are determined, they are then populated in the process FMEA table as shown in Table 5-3. The risk parameters such as the probability of occurrence (P), consequence (C) as well as probability of detection (D) are then determined using contextual information contained in the process model. From the risk parameters, the magnitude of risk in terms of RPN is calculated qualitatively and is ranked on the basis of their criticality to the process success.

**Table 5-3: Excerpt of the FMEA table for schedule risk**

Process	Failure mode	Causes (Risk factors)	Effects	<i>P</i>	<i>C</i>	<i>D</i>	<i>RPN</i>
Activity <i>i</i>	Duration estimation error	<ul style="list-style-type: none"> <li>- Unavailable information</li> <li>- Wrong information</li> <li>- Incomplete information</li> <li>- Wrong belief</li> </ul>	Uncertain Lead time	5	7	6	210

The critical risks identified in the FMEA table are then incorporated in the business process models for quantitative assessment.

**5.2.3.3 Risk integration in the process model (Step 4b)**

The integration of risk in the process model to build a risk aware business process model is aimed at assessing the critical risks of the FMEA table quantitatively in the simulation environment. All the risks identified and analyzed in the FMEA exercise can be included in the process model for further investigation. However, it is practically insignificant. Only high profile risks should be selected and assessed in the process model. Figure 5-19 depicts a risk aware process model.

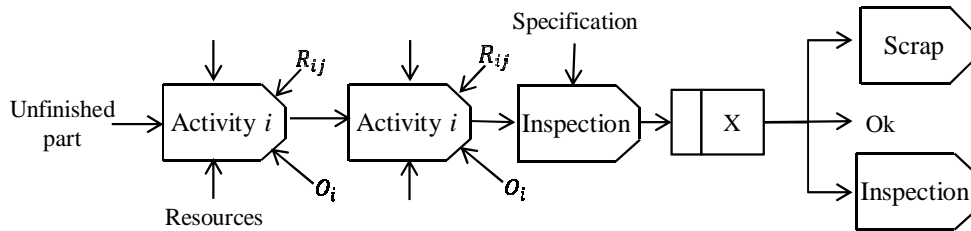

**Figure 5-19: Objective-oriented risk aware process model**

The risks incorporated into the process model can then be assessed quantitatively in a simulation experiment. For this purpose, first of all, risks of the same nature that act on an individual activity (UOB) are evaluated and integrated using the Choquet Integral to account for the dependencies that exist in different risk events causing the same failure effect. For instance, consider a critical activity *i* that is subject to a risk *R<sub>i</sub>*. The analysis assumes that a risk event occurs and the risks on the individual activity will be modeled using Equation 5-6:

$$\text{Risk of the activity } i = P_{ij} (C_{ij}^q + C_{ij}^c + C_{ij}^t) \quad 5-6$$

Where,

- $P_{ij}$  Probability or likelihood of a risk event *j* on activity *i*
- $C_{ij}^q, C_{ij}^c, C_{ij}^t$  Impact on quality, cost and time objectives, respectively

Therefore, the global risk for an activity *i* due to risk event is given by Equation 5-7:

$$R_i = \sum_{j=1}^J d_{ij}(P_{ij} \times C_{ij}) \quad 5-7$$

Where,

$d_{ij}$  The importance of risk  $j$  on individual activity  $i$

$C_{ij}$  The impact of risk  $j$  on individual activity  $i$

And the global risk of the process path  $P_k$  is given by Equation 5-8:

$$\begin{aligned} R(p_k) &= \sum_{\forall i \in p_k} R_i \\ &= \sum_{\forall i \in p_k} \sum_{j=1}^J d_{ij}(P_{ij} \times C_{ij}) \end{aligned} \quad 5-8$$

And probability  $P_r(P_k)$  of the path set (or scenario) is such that:

$$\sum_{k=1}^K P_r(P_k) = 1 \quad 5-9$$

So, the expected risk of the process  $P$  made of  $K$  path sets is:

$$E(R_p) = \sum_{k=1}^K P_r(P_k) \left( \sum_{\forall i \in p_k} \sum_{j=1}^J d_{ij}(P_{ij} \times C_{ij}) \right) \quad 5-10$$

Equation 5-10 calculates the expected risk of the whole process.

By the integration of critical risks in the objective-oriented business process model, an objective-oriented risk aware business process model is developed. The developed objective-oriented risk aware model is the final deliverable of this phase. The purpose of the model is to collect sufficient information to assess the process performance in terms of value and risk indicators. To this end, the developed model is transformed into an executable model via a simulation technique.

### 5.2.4 Performance assessment phase (Phase 3)

In the process-centered PMS, discrete event simulation seems to be an appropriate method since it offers a great potential in analyzing processes (Bosilj-Vuksic *et al.*, 2007). Its major application is to predict and analyze process performances without the process being actually implemented. For this reason, it has proven to be a well-established decision making tool among process practitioners.

In discrete simulation approaches, the construction and use of a simulation model is a multi-stage and iterative process. Robinson (2004) summarizes the main stages of the process namely, conceptual modeling, model coding, experimentations and implementation. Furthermore, a 40-20-40 rule is a widely quoted rule in simulation literature (Ryan and Heavey, 2006), where 40 % of the time and effort is dedicated to requirements gathering, 20% to model translation and 40 % to experimentation.

Marquès (2010) divides the simulation process into abstraction, implementation and analysis.

Irrespective of the approach used, a model is a pre-requisite to conduct simulation experiments. However, the process model alone is inadequate to provide a complete model for simulation experimentations. Simulation variables (parameters/factors and instructions) in addition to the process model are needed, which makes the process model executable. To analyze the business process model through simulation experiments, we divide the simulation process into three stages as shown in Figure 5-20.

The following sections explain the three stages of the simulation process.

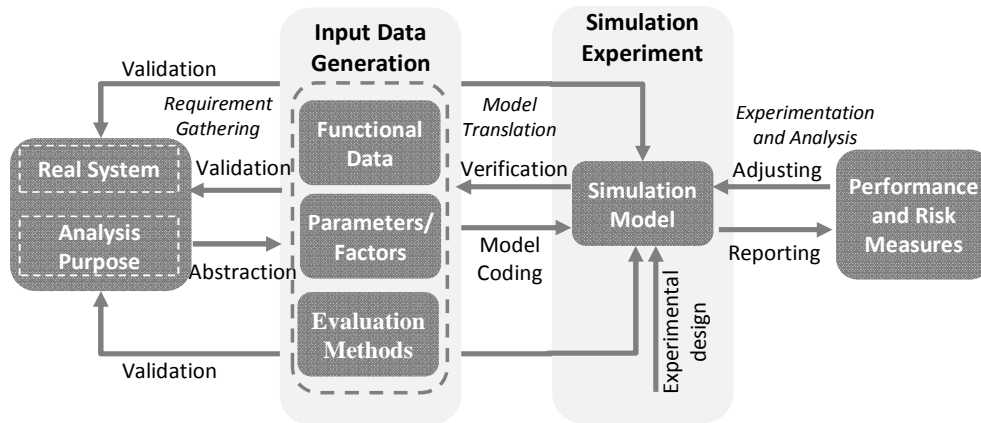

Figure 5-20: Simulation process

#### 5.2.4.1 Input data generation

The input data generation step is concerned with the requirements gathering phase of the process simulation model under study and is divided into two broad categories, which are:

- Functional data generation, which represents the activities of the business process.
- Input variables or factors (in simulation parlance).

Functional data generation refers to the conceptual modeling stage of the Robinson’s framework (2004). It involves the real world abstraction of processes as well as their inputs, outputs and the associated objectives. To this end, the VR-PMS relies on the global approach for objective-oriented risk aware process modeling (cf. Figure 5-12). This approach provides step by step guidelines to collect functional data including risk and objective information, models them graphically using the IDEF3 process modeling language. Once built, the conceptual model is then validated to see how *realistic* the modeling assumptions are (Altiok and Melamed, 2007).

Regarding the input variables, the VR-PMS employs many devices to collect them, depending on the type of input variables such as preliminary or contextual data, parameters and validation data (Pidd, 2009). The preliminary data (*e.g.* the layout of machines, process routing and capabilities in the manufacturing context) can be easily collected as they are usually known. Concerning the parameters (such as duration of activities, machine breakdowns, part arrival patterns, etc.) of the simulation, they can be collected using recorded history, expert opinions or

guesswork. Shah *et al.* (2012) suggests dividing the input variables into categories based on their nature and application area in the simulation experiment.

Furthermore, the input data to the simulation experiments in probabilistic configurations require data analysis so that to obtain a good fit to the data. For this purpose, goodness-of-fit tests are used. The most widely used goodness-of-fit tests in the simulation experiments are *chi-square test* and *Kolmogorov-Smirnov test* (Altiok and Melamed, 2007).

#### 5.2.4.2 Simulation model and experimentation

By defining a valid process model and the corresponding input variables, the model can now be translated into a simulation model. This translation involves two major activities in the context of discrete event simulation:

- Model coding.
- Input variable (or parameters) feeding.

The model coding refers to the translation of conceptual model into a computer model, whereas the input variable feeding is the incorporation of the parameters and the preliminary data into the simulation model. Additionally, the parameters for performance measures or criteria are also fed into the simulation model. In the VR-PMS, the experimentation stage involves the transformation of objective-oriented risk aware business process model into an executable computer simulation model.

Furthermore, it is advised to verify the simulation model in the course of development. The verification assesses the *correctness* of the formal representation of the simulation model by inspecting computer codes, test runs and performing consistency checks on their statistics. The various approaches used to validate and verify the model are discussed in details in the literature (Sargent, 2010).

Once the simulation model is built, verified and validated, the next step is the design of experiments. This involves the determination of length of simulation, the number of runs (also called replications) and the manner of initialization (*i.e.* warm period). (Banks, 1998) proposes details about experimentation requirements.

#### 5.2.4.3 Output data collection and analysis

Once the simulation model is ready to be experimented, it is then run according to the design of experiments. At the end of the simulation experiments, parameters of interest, *i.e.* performance and risk measures defined already in the objectives model of VR-PMS, are collected and analyzed.

Simulation results are the sample history of a simulated process from which various statistics are computed. These statistics are estimates of various parameters of interest (in the current thesis, mainly performance measures). Therefore, statistical procedures are then employed to compute confidence intervals for the performance measures.

The performance measures obtained from simulation experiments are then fed to the decision-making methods to compute elementary performance expressions (value functions) for each performance measure.



### 5.3 The decision-making process (Phase 4)

A model has little intrinsic value unless it is used to support decision-making (Robinson, 2004). Decision-making solely based on performance measures that issue out of the simulation experiments provides little insight about the performance of a business process. In reality, these performance measures do not reflect the performance of the business process and serve as mere information about the different dimensions of performance unless they are compared with some objective or target values.

Furthermore, in a typical performance management process, multiple alternatives in addition to numerous performance measures are involved. A Skandia IC report (Tan *et al.*, 2008) uses 112 performance metrics to measure five areas of focus including financial, customer, process, renewal and development as well as human resources. Moreover, performance measures are heterogeneous in nature due to the multidimensionality of the performance concept and it is often hard for the assessor of a business process to reach a logical conclusion. A further treatment is required to transform the performance measures into performance expressions in the light of value judgments of stakeholders. These performance expressions to their corresponding performance measures are, in reality, the value functions.

To construct these value functions, multiple criteria decision-making methods are employed. In the current dissertation, the MACBETH method is chosen as a tool for value functions construction. The advantage of the MACBETH method over other MCDM methods for the construction of value functions is its systematic and straightforward process of simple questioning to elicit information regarding the performance measures (or criteria) and their importance in that particular context. The resulting value functions are dimensionless and commensurable in nature, which facilitates the decision-making process.

To further facilitate the decision-making process, information fusion theory is recalled to aggregate these value functions for the purpose of developing global value and risk measures. To this end, Choquet Integral and more particularly the 2-additive Choquet Integral is used. Choquet Integral is an expressive mathematical technique used to respond to the inadequacy of additive models used in multi-attribute theory for decision making process. Choquet Integral, since it is based on fuzzy measures, ignores the marginal probability and takes into account the interaction that exists between different performance measures.

#### 5.3.1 The MACBETH method

In the proposed approach, the conceptual value-risk model employs the MACBETH method to model value and risk functions. The method requires only qualitative judgments about differences of values to help the assessor in quantifying the relative attractiveness of performance measures from a set  $X = \{x_1, x_2, \dots, x_n\}$  over a set of alternatives  $A = \{a_1, a_2, \dots, a_l\}$  and assigning a real number  $v(x)$  to each criterion  $x_i$  of  $X$ .

To develop  $v(x)$  for each performance measure, the MACBETH method considers a set of process alternatives  $A$  with at least two elements. As the MACBETH is an interactive decision-making method, an assessor asks questions and compares the relative attractiveness of the process alternatives with regard to a criterion  $x_i$ . Depending on the choice of the decision problem, the assessor can rank the

alternatives directly or through pairwise comparison. To retrieve relative attractiveness of two alternative processes, the assessor has to provide a qualitative judgment (or preference) on the attractiveness of two alternatives employing a verbal scale which is more detailed in section 4.5.4.1.II .

To quantify preferences, the MACBETH procedure relies on strength of preferences of the multi-attribute utility theory. But before strength of preference elicitation, for the purpose of inter-criteria commensurability MACBETH proposes two common reference points such as “good” and “neutral” with performance values 1 and 0, respectively. This enables one to map value and risk functions on the interval [0,1].

The next step consists in describing the preference criterion  $x_i$  in the alternative  $a_l$  to  $a_k$  with a strength of preference  $h$  , where  $h$  can take any value ranging from 0 to 6 (0 and 6 correspond to null and extreme strength of preference, respectively), then the value function  $v_i^k$  for the criterion  $x_i$  in alternative  $x_l$  and  $x_k$  can be calculated by Equation 5-11:

$$v_i^k - v_i^l = h. \alpha \quad 5-11$$

Where  $\alpha$  is a coefficient to meet the condition  $v_i^k \in [0,1]$ . Therefore, the strength of preference for each criterion for a set of process alternatives gives a system of equations. Solving this system of equations provides value functions for each criterion  $x_i$ . Once the value and risk functions for the respective performance measure and risk measure are determined, they are then aggregated independently with the help of Choquet integral to form value and risk indicators.

### 5.3.2 Choquet integral

Choquet Integral (CI) is a MCDM method in its own right. However, in the current dissertation, it is only used to aggregate the value and risk functions computed using the MACBETH method. The choice of MACBETH for value and risk functions determination is the power of MACBETH to elicit information from the assessor in a very simple and straightforward questioning procedure. Nevertheless, the MACBETH aggregation mechanism is based on four preference conditions such as preferential independence, weak-difference independence, utility independence and additive independence mentioned in the literature (Kirkwood and Sarin, 1980). In simple words, all criteria are independent of one another and do not influence each other, which is not the case in real life. To overcome this deficiency, the Choquet Integral is used as an aggregation operator and not a MCDM method in totality. Choquet Integral is used to solve the following aggregation problem:

$$V(X) = F(v(x_1) + v(x_2) \dots v(x_n)) \quad 5-12$$

Where,

$c \in X$  An attribute or performance measure of set  $X$

$v(x)$  A value or risk function

$V(X)$  Global value function

$F$  Aggregation operator (CI)

Since  $v(x)$  or simply  $x_i$  are known from the MACBETH procedure, the following equation (Equation 5-13) is then used to aggregate all the value functions:

$$V(X) = \sum_{i=1}^n (f(x_i) - f(x_{(i-1)})) \times \mu(C_i) \quad 5-13$$

Equation 5-13 represents the discrete CI of  $x$  with respect to the fuzzy measure  $\mu$ . The value  $(.)$  in subscripts represents a permutation operator such that  $0 \leq x_{(1)} \leq x_{(2)} \leq \dots \leq x_{(n)} \leq 1$ .

However, in the current dissertation, a particular Choquet Integral is used: the 2-additive CI where pairwise interactions among criteria are considered. This type of CI can be defined by Equation 5-14 as:

$$C_u(x) = \sum_{i=1}^n v_i x_i - \frac{1}{2} \sum_{i=1}^n \sum_{j=1, j \neq i}^n I_{ij} |x_i - x_j| \quad 5-14$$

Where  $C_u$  models vectors of value and risk functions,  $v_i$  denotes a Shapley index (with  $\sum_{i=1}^n v_i = 1$ ) that represents importance of criterion  $i$  relative to all other criteria and  $I_{ij}$  represents interaction between criteria  $(c_i, c_j)$ , ranging in  $[-1, 1]$ .

To calculate the Shapley indices  $v_i$  as well as interaction criteria  $I_{ij}$  in order to aggregate the value and risk functions employing Equation 5-14, this approach needs systems of equations having  $v_i$  and  $I_{ij}$  as variables. To this end, a set of equations can be used. These equations are based on the principles of MACBETH for weight determination where MACBETH proposes to consider some fictive situations for each value or risk function. In such fictive situations, the alternatives satisfy one or two value or risk functions simultaneously. A preference ranking of these situations along with the strength of preference will give a system of equations whose solution determines the CI parameters.

The fictive situations where only one  $P_i = 1$  and all others are equal to zero, the aggregated performance is as follows (Clivillé and Berrah, 2007):

$$P_{ag}^i = v_i - \frac{1}{2} \sum_{\substack{j=1 \\ j \neq i}}^n I_{ij} \quad 5-15$$

The aggregated performance of the situations where one  $P_i = 0$  and all other equals to one will be as follows in Equation 5-16:

$$P_{ag}^i = 1 - v_i - \frac{1}{2} \sum_{\substack{j=1 \\ j \neq i}}^n I_{ij} \quad 5-16$$

In situations where only two value or risk functions are equal to  $P_i = 1$  and  $P_j = 1$  and all other are equal to zero will be as follows in Equation 5-17 (Gurbuz, 2010):

$$P_{ag}^{i,j} = v_i + v_j - \frac{1}{2} \left( \sum_{k \in \mathbb{N}_{1,n}} I_{ik} + \sum_{k \in \mathbb{N}_{1,n}} I_{jk} \right) \quad 5-17$$

### 5.4 Value-Risk graph as a decision-making tool

The decision-making process will be more convenient if zones of aversion, acceptability and desirability are determined both for value and risk for a business process, similar to the ALARP principle in the risk management. For this purpose, a two dimensional graph is proposed and value  $\mathcal{V}$  and risk  $\mathcal{R}$  respectively in the range of  $[0, 1]$  on the x-axis and y-axis, are defined.

To define value on the x-axis, the value range is divided in three ranges: value aversion /indifference, value tolerance/acceptable and value desirability. The value indifference refers to the range of value which is not significant and the company avoids pursuing the process. The value tolerance or acceptable range remains between the upper bound of value indifference, until the point where the value starts becoming desirable. In this range, the company may pursue the process. Beyond the acceptable range is the desirable range. These ranges are drawn on the x-axis line as shown in Figure 5-21.

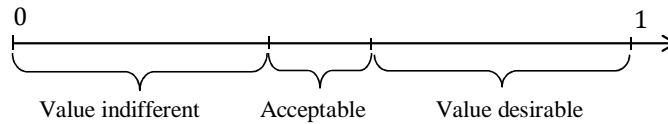

Figure 5-21: Value ranges

In a similar way, the y-axis is divided into three ranges: risk appetite, risk tolerance and risk intolerance. The risk appetite refers to the risk which an organization is willing to accept in pursuit of business process objectives. The risk tolerance specifies the maximum risk the organization is willing to take in pursuit of business process objectives and the risk intolerance alludes to the risk level which is not acceptable in any respect. The ranges have been shown in Figure 5-22.

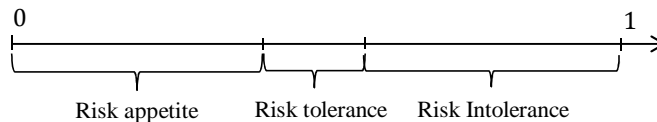

Figure 5-22: Risk ranges

To determine value and risk ranges quantitatively, the approach developed in the current dissertation proposes to take each performance and risk measure and define a target limit for each of them as well as the degree of variation. For example, the target limit for the process cost measure is 12 units and is acceptable, to the upper bound is set to 16 units and we wish to bring the lower bound (LB) to 10 units. This gives a range of 10 to 16 units for process cost measure that needs to be normalized in the range of  $[0, 1]$  using whatever value elicitation technique (numerical estimation such as direct rating, or indifference method like: bisection method, or semantic judgments). Because the VR-PMS employs the MACBETH method, which

is based on indifference method to elicit value, therefore we choose the semantic judgment technique to elicit value and risk functions for normalization purpose. The advantage of using the semantic judgment is that the same upper and lower bounds defined for each measure in this part will be used when eliciting value and risk functions for performance measures that issue out of simulation experiments. Since these bounds on cost measure are 16 and 10 and they correspond to 0 and 1, respectively on the normalized scale. Now, let us assume a target value of 12 units for the cost measure. Using the MACBETH method, a value function for the target value of 12 is then obtained which will be in between 0 and 1.

By the same token, value is evaluated as well as risk functions for all the performance and risk measures for a given process. To obtain a global or synthesized measure for the value functions as well as the risk functions, they are aggregated by Choquet Integral. The aggregation measures obtained determine the minimum acceptable value and maximum acceptable risk for the process or project in question.

In addition to the minimum acceptable value and maximum acceptable risk for a process, we propose to develop a value to risk curve to model the acceptability of a process if the value progresses with regard to risk. In reality, organizations may take risk beyond the risk appetite in pursuit of value creation for their stakeholders. For this purpose, we need to define a value/risk ratio that will be restricted in between minimum acceptable value and a point of risk beyond which an organization cannot afford to pursue its objectives.

The aim of the value/risk ratio is to determine the upper bound for the acceptability of a process in pursuit of objectives fulfillment. The value to risk ratio signifies how much risk an organization is ready to take if the value of the process progresses along with risk. However, its determination is still subjective and depends on the company's attitude towards pursuing its objectives (value creation) and risk taking. The final value risk graph takes the shape as shown in Figure 5-23.

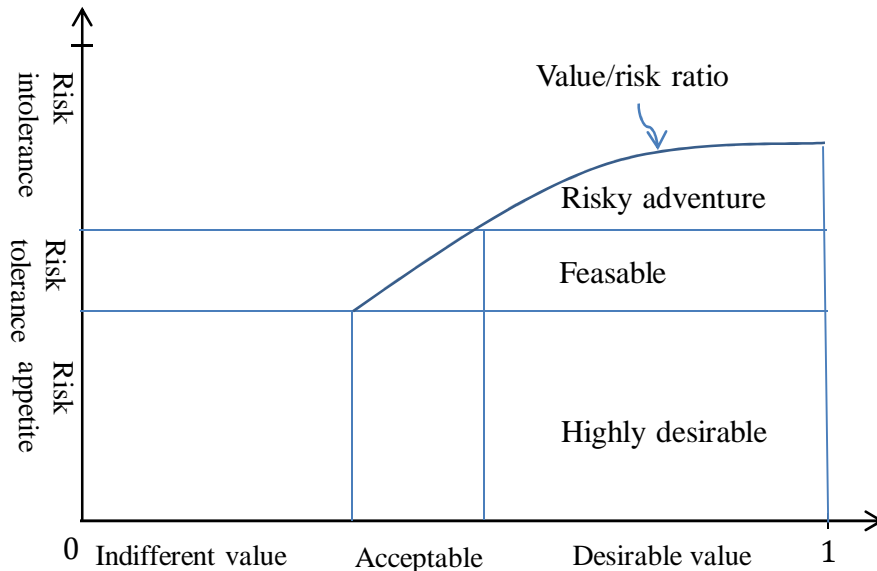

Figure 5-23: Value-risk graph

## **5.5 Conclusion**

This chapter has presented the value-risk based performance management system (VR-PMS). The system is equipped with two frameworks: a structural one and a methodological one.

The former one is developed to integrate all the concepts around “performance” in a value and risk view and to determine the desirable properties for value and risk modeling. The deliverable of the framework is a conceptual value-risk model. This model is then used as the foundation for evaluating different process alternatives, which rank them for their desirability and undesirability.

The methodological framework, on the other hand, provides step by step guidelines to assess business process performance. Each phase of the methodological framework is illustrated with simple examples to facilitate the understanding of the VR-PMS system.

Finally, the chapter concludes with the belief that the VR-PMS is theoretically sound and has its roots in different domains dedicated to the performance field such as value engineering, risk management, process management and decision sciences. However, the application of VR-PMS to a real case study is required to check its validity. For this reason, the next chapter is dedicated to carry out a practical case so that the validity of the approach is demonstrated.



## Chapter 6 Case Study

*This chapter presents the application of the proposed VR-PMS. For this purpose, a case study has been developed that focuses on the industrialization phase of a simple mechanical product. The purpose is to validate the performance management system capability as a decision making tool in the selection of the most appropriate process plan in the imposed scenario. Two manufacturing scenarios are treated to demonstrate that, although the approach is generic in its principles, its operational experimentation depends on the objective of the system or process to be evaluated.*

### 6.1 Description of the company and the reference product

The company is a small hypothetical manufacturing company that manufactures and assembles mechanical systems on make-to-order (MTO) basis. It has a design department, a process planning department, a production planning department and a manufacturing facility. Currently, the company aims to develop a performance management system that could enable it to assess the performance of their manufacturing processes. The main objective of the company is to use the PMS for the purpose of decision making when responding to the uncertain customer demands. For this reason, the company has identified the manufacturing domain as a focal point of interest in its supply chain network. Furthermore, the company works closely with its customers to identify and realize their needs and requirements.

For the purpose of illustration, the company considers production of a mechanical locator as a reference product which is displayed in Figure 6-1. The mechanical locator is a work holding device that is placed in a modular fixture in order to locate a work piece during machining. Details about the reference product, its parts and parts drawings are described in 0

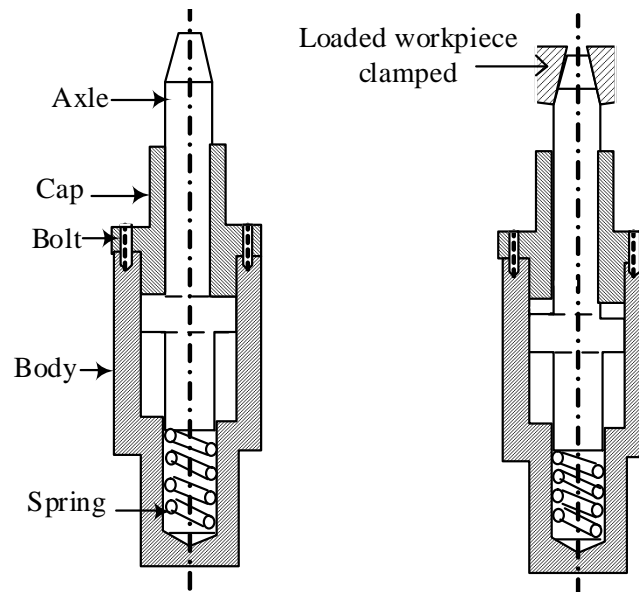

**Figure 6-1: Mechanical locator configurations: free (left) and loaded (right)**

Moreover, simulation relevant data used in this illustration are based on estimates. The purpose is to validate the proposed VR-PMS in the context of manufacturing processes



### 6.1.1 Case Study description

The case study reviews the performance assessment of the manufacturing phase of the mechanical locator using the proposed VR-PMS. To proceed with the performance assessment of manufacturing processes of the mechanical locator in terms of value and risk, the case study takes the mechanical locator specifications as input to the assessment process. These specifications are then translated into candidate manufacturing processes and manufacturing process plans. Additionally, the contractual requirements of the product realization in addition to its functional requirements are fixed as objectives and constraints of the identified manufacturing processes. To determine whether the objectives would be met or not, risk assessment is carried out in parallel to performance assessment and, finally, the different manufacturing process plans are assessed for their value creation and risk exposure.

For the purpose of performance assessment, the VR-PMS will primarily take into account the product specifications, the objectives, risk factors and simulation parameters as inputs, VR-PMS as mechanism (method) that will result into a value-risk pair as the deliverable (Figure 6-2).

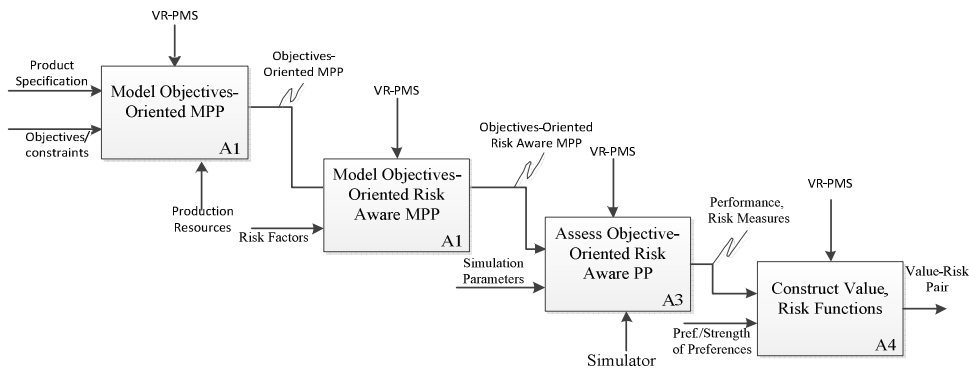

**Figure 6-2: Performance evaluation using VR-PMS**

The deliverables of the VR-PMS are the global indicators: value and risk. The value-risk pair for each manufacturing process plan is then used as a decision making tool to determine its desirability or acceptability in the imposed scenario. To this end, production scenarios are developed in order to test the validity of the proposed VR-PMS in the context.

### 6.1.2 Production scenarios

To validate the VR-PMS for value and risk assessment of manufacturing processes under different sets of demands, different production scenarios are developed. No company operates under one fixed production scenario as the uncertainty in the competitive market is a well-known phenomenon. Each production scenario characterizes a unique manufacturing environment with its own stimulus (*i.e.* order arrival), objectives, requirements (functional and non-functional ones) and constraints as well as manufacturing processes.

In this case study, two production scenarios have been considered. Before developing these scenarios, key factors of the product value dimensions such as cost, time and technical performance are determined. Next, for each key factor, 2 to 4 projections are defined. In the case of technical performance of a product, the projections defined are: high-quality (HQ) and low quality (LQ). The HQ level, in this case study, is

defined in terms of tolerances of the product/part features that guarantee proper assembly or adequate product service operation. The LQ level, on the other hand, provides acceptable tolerance values, yet with a sizable risk of failure and must not be exceeded. The HQ and LQ product definitions are detailed in the Appendix B .

In the following sections, production scenarios 1 and 2 are each described in detail. Since the scenario 2 unrolls in the same business environment as the scenario 1, therefore, the parts of the scenario 2 are outlined in more detail, which are either different or additional to the aspects taking place in scenario 1.

#### **6.1.2.1 Case study: Production scenario 1**

The company under study has a medium sized manufacturing and assembly facility which runs on make-to-order basis and, hence, it has developed a well-defined coordination mechanism with its suppliers. The company's manufacturing and process planning departments assess thoroughly each order on value and risk basis.

The scenario 1 assumes that the company receives an order of 1000 mechanical locators. The client needs them in a period of two weeks. Therefore, a lead-time of 2 weeks (10 working days) is fixed between the company and the client. Due to the short lead-time, the client compromises to some extent on the technical performance of the product and, therefore, orders for low-quality (LQ) mechanical locators. The price (P units) of the product has already been agreed and has been kept at normal rate. After finalizing the terms and conditions, the contract is prepared and awarded to the company.

It is assumed that the company has at its disposal sufficient resources at the manufacturing facility, so it does not outsource the project. Most of the product parts are manufactured with its production equipment except the parts which need special skill or equipment or can be purchased at cheap rates on the market.

In this scenario, the hypotheses are:

- For the required order of 1000 mechanical locators, all raw materials are provided in time by the suppliers. From the already developed Bill of Material for the mechanical locator, the company is going to manufacture three components of the locator: axle, body and cap while springs and bolts are purchased from local suppliers.
- The required purchased parts are delivered in time.

Furthermore, the operating policy in the assembly shop is straightforward. If two components due to maximum or least material conditions (MMC & LCM) do not fit together at first place, they are not scrapped but tried with another component up to 3 times in that particular lot until the part fits into assembly, otherwise it is scrapped.

In the case of non-delivery at agreed upon lead-time, the company can ask for due date tolerance, already defined in the contract. If the due date passes, then the company is subject to penalty cost of 2 per unit time tardy up to 5 days. Failing to provide the product in that period of time will lead to cancellation of the product with a backlog cost of 10000 units for 1000 mechanical parts.

#### **6.1.2.2 Case study: Production scenario 2**

In the scenario 2, the company has the same operational policies, resources and manufacturing environment as described in the production scenario 1. Moreover, the

coordination mechanism with its suppliers is maintained. However, this time the company receives an order of 200 mechanical locators. As opposed to the first scenario, the client requires the product technical performance to be of high-quality. Besides, the client allows sufficient time for the delivery of the mechanical locators and, therefore, lead-time is not a critical objective of the order. Similar to the scenario 1, the cost of the product is maintained.

So, the most critical objective of the order is the technical performance of the product as required by the customer. For this reason, the company has put in place a strict quality control and quality assurance practices. In addition, preference is given to machines demonstrating high process capability so that rework or scrap could be reduced. In the case the product does not meet the required specifications; it is either reworked or scrapped. The decision to rework a part is taken if the part is still in the tolerance limit, otherwise it is scrapped. Moreover, the part fitting practice due to maximum or minimum material conditions is kept up to 5 parts in each lot of the assembly shop.

If the company fails to deliver the mechanical locator to the customer with the desired functional requirements, then the company is subject to penalty cost as agreed upon in the contract.

By describing the two production scenarios for the case study, the proposed VR-PMS is then applied to each of the scenario understudy. The production scenario 1 will be explained in more detail, while the scenario 2 will be more briefly described due to the similarity of the approach.

## **6.2 Application of VR-PMS to the first scenario**

Having identified the scenarios, the methodological framework of the VR-PMS (see Figure 5-12) is then applied to assess their performances on the basis of the conceptual value-risk model (cf. Figure 5-9). The methodological framework begins with context establishment for the scenario, which has just been, for the most part, defined in the supplier-customer agreement here above. Additionally, the roles and responsibilities to deal with the scenario are supposed to have been assigned.

Furthermore, the value creation objects in a given scenario are different to different stakeholders. For instance, performance is relevant to process owner and customer, compliance to quality manager and customer while safety and security as well as the operating conditions to operators. For that reason, the expectations and the values thereof of the stakeholders vary in the scenario. In the current case study, for the purpose of simplicity, the safety and security aspects of the value delivery system in the multiple stakeholder perspective are omitted and the approach focuses only on the three important stakeholders: the company, the employees and the customer. Figure 6-3 reminds the methodological framework to be applied.

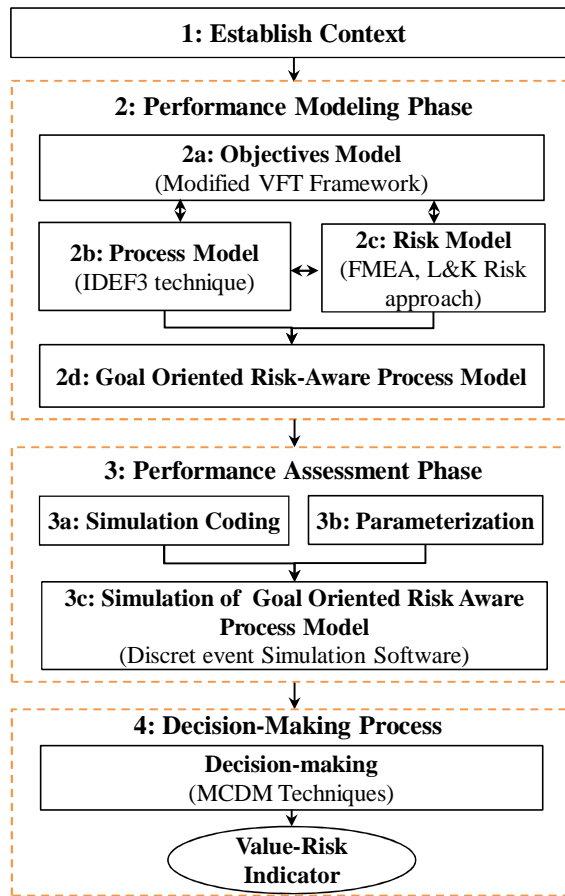

Figure 6-3: Global approach of the methodological framework

### 6.2.1 Objective modeling (Phase 2a)

Before determining the objectives of each stakeholder (customer, manufacturer and employee) in the given scenario, an overall fundamental objective (henceforth, global objective) is defined. Because the production scenario 1 deals with the customer order satisfaction, therefore “Customer order satisfaction” is chosen as the global objective for the business process understudy. The more refined objectives of the global one are then obtained by employing the objectives model of the VR-PMS.

#### 6.2.1.1 Fundamental objectives

A little thought can bring forward the fundamental objectives for the order satisfaction business process, focused on the manufacturing processes as the order processing is a routine process. The customer order satisfaction means low price, high quality and on-time delivery to the customer (quoted C in the Figure 6-3), low cost and customer satisfaction to the manufacturer (M in the Figure 6-3) and satisfactory working conditions to the operators (E in the Figure 6-3). Each of the fundamental objectives is then more refined using the objectives model principles (§. 5.2.2 in Chapter 5) and a list of lower level objectives is determined.

By defining the fundamental objectives, the next step is to combine and structure them in the hierarchy. Figure 6-3 shows an excerpt of the fundamental objectives hierarchy. The complete objectives hierarchy is given in Appendix D

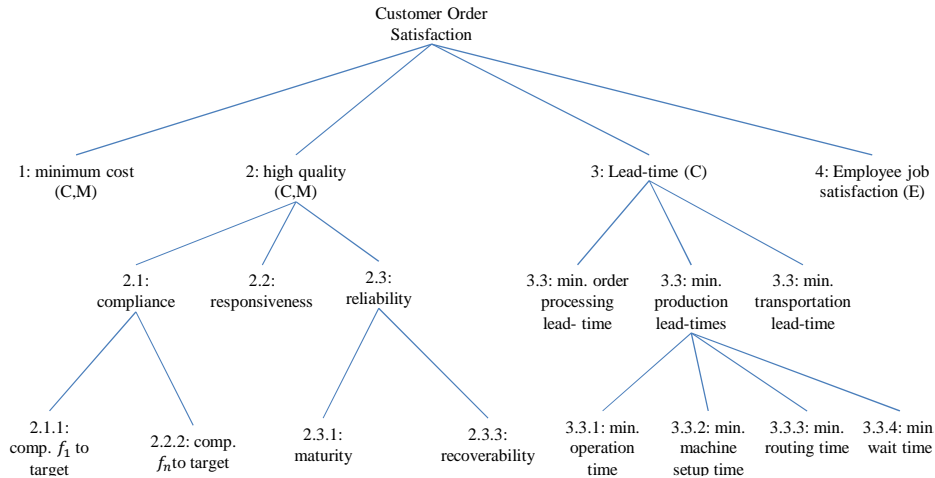

**Figure 6-3: Fundamental objectives hierarchy**

Furthermore, the meanings of many of the objectives are obvious. However, some explanations are appropriate. The employee job satisfaction, in the current scenario, refers to the satisfactory working conditions in terms of workload and affiliation of the employees, particularly the operators on the shop floor of the company. Moreover, the compliance objective can be drilled down into individual features  $f_i$  compliance to specifications. Furthermore, responsiveness as a dimension of high quality specifies flexibility and availability of the business process. Because the current scenario considers one product and one customer, this aspect of high quality becomes less relevant.

By identifying the fundamental objectives for the scenario 1, it is convenient now to define the performance measures. Figure 6-4 depicts the value tree for the fundamental objectives detailed in Figure 6-3.

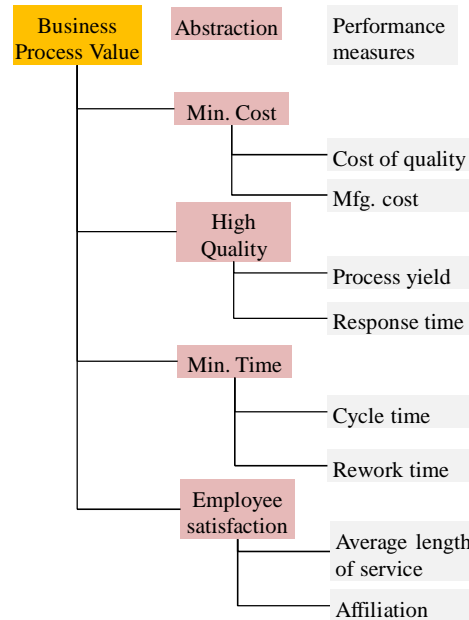

**Figure 6-4: Performance measures tree (value tree)**

While Figure 6-4 links the business process values with performance measures via the fundamental objectives, it does not describe the mechanism on how these performance measures contribute to the process value. To operationalize the process value creation, means objectives are determined which link the performance measures to the activity model which, in turn, provides the environment necessary to explain the value creation mechanism.

### 6.2.1.2 Means objectives

To define means objectives, each objective on the lower tiers of the fundamental objectives hierarchy is put to “How can we achieve it?” test. For instance, to achieve the “*minimize operation time*”, several means objectives can be deduced such as:

- Optimize operations sequencing
- Improve throughput
- Minimize scrap rate
- Reduce bottlenecks
- Reduce operation time

The current case study is not aimed at improving the processes so that to improve their value creation capability. The purpose here is to assess the current manufacturing processes of the mechanical locator and choose the one which suits better the imposed scenario in terms of value and risk. In other words, it focuses on the “*as-is*” process model assessment rather than the “*to-be*” process model. In the case of *to-be* process model, the proposed methodology suggests to use each of the means-objectives as alternative course of actions to improve the overall business process value.

To assess the value and risk of the production processes, alternative process plans are generated using the approach proposed by Sormaz and Khoshnevis (2003) as shown in the Figure 6-5. These alternative process plans are then assessed against the performance measures derived from the objectives model.

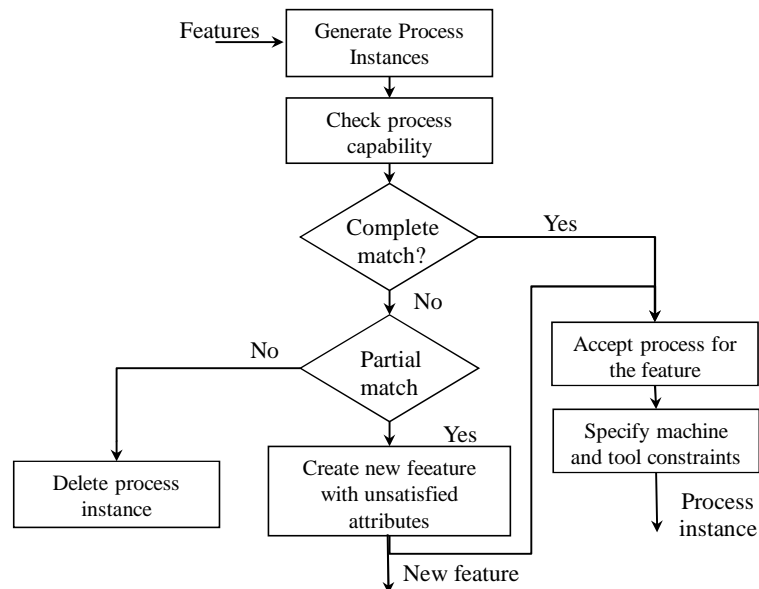
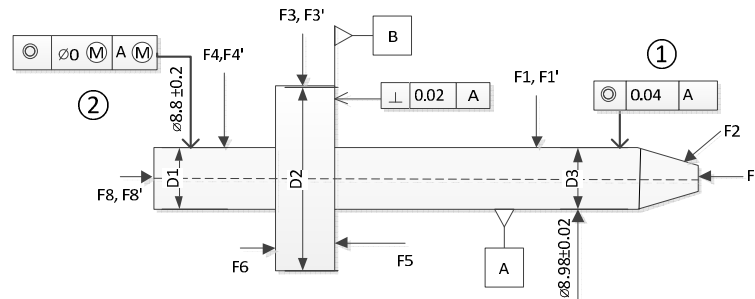

**Figure 6-5: Algorithm for process selection (Sormaz and Khoshnevis 2003)**

### 6.2.2 Generation of alternatives process plans (Phase 2b)

To generate alternative process plans for a mechanical part/product, various approaches have been proposed in the literature (see for detail (Etienne, 2007)). However, the current case relies on the Sormaz and Khoshnevis approach, which is modeled in Figure 6-5, to identify and sequence activities (process candidates) for the realization of the mechanical locator.

To illustrate the approach, only the axle part (see Figure 6-6) of the mechanical locator is considered here. Process plan alternatives for the other parts of the mechanical locator are described in the Appendix A.

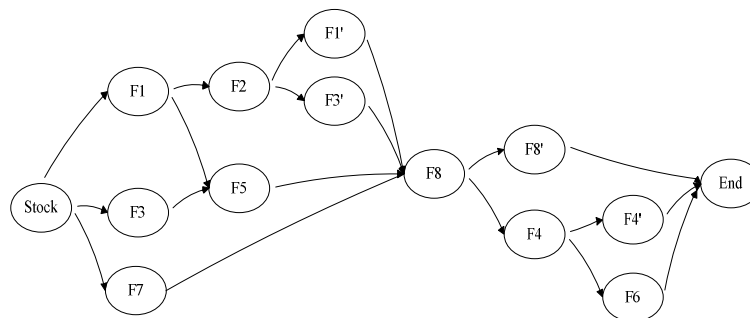

**Figure 6-6: Axle part geometry and tolerances**

As shown in Figure 6-6, the axle part consists of features F1 to F8. Before proceeding to identify the process candidates for each feature of the axle using the algorithm as depicted in Figure 6-5, the feature precedence relations is established while keeping in view the technological, geometrical as well as economic constraints.

#### 6.2.2.1 Feature precedence network

To determine the sequence of features to be machined for a given part of the mechanical locator, a precedence relationship among features is developed as shown in Figure 6-7. From the Figure, the operations for features F1, F3 and F7 can take precedence. Feature F1 can be followed by F2 and F5. However, F5 cannot be machined before F1 because of geometrical constraints. Similarly, due to the economic considerations, F1 should precede F2. This process continues until all the features of the axle part are considered. Once the features precedence network is complete, the process moves on to the selection of candidate processes for the part features.



**Figure 6-7: Feature precedence network**

### 6.2.2.2 Candidate process selection and network generation

In this section, features are enlisted and then the required manufacturing processes are selected for each individual feature (as proposed in Table 6-1). In the current context, the differences in process candidates for features are only represented by selecting different resources (i.e. machines). To check the capacity and availability of machines (potential process candidates) for the required manufacturing processes, a resource model is consulted. The model ensures the availability and capacity of the process candidates for the individual features.

**Table 6-1: Axle features and corresponding process candidates**

		Machines (and manufacturing operation candidates)			
Features	Manufacturing processes	M1	M2	M3	M4 (
F1	Turning	×	×		
F1'	Finishing				×
F2	Taper turning	×	×		
F3	Turning	×	×		
F3'	Finishing		×		×
F4	Turning	×	×		
F4'	Finishing		×		×
F5	Facing	×	×	×	
F6	Facing	×	×	×	
F7	Parting	×	×	×	
F8	Parting	×	×		
F8'	Facing	×	×	×	

After identifying the potential operation candidates for each feature of the analyzed part, several process plan networks are generated considering the feature precedence network displayed in Figure 6-7. The procedure starts from stock (S) and considers only features that can be machined at the first stage of the features precedence network (F1, F3 and F7 in the current example). Process candidates for these features are clustered through layers of process plan network (cf. Figure 6-8). For instance, M1, M2 and M3 are the candidate machines (and hence the manufacturing process options) to machine fully or partially the considered features of the first stage. In the following stage, new features are selected along with the unused feature from the previous stage (if any). For instance, M3 machines only feature F7 while the F1 and F3 are non-machined features from the previous stage for this particular process plan.



Therefore, in the next stage features F1, F2, F3 and F5 are the considered features for machining. This procedure is repeated until all the features from the precedence network are used and the network from start S to end node E includes all the part features.

Once the process plans network is generated, the assessor can carry out qualitative assessment in order to choose the alternatives that seem more appropriate in meeting the objectives and, therefore, reduce the modeling and computational task of the assessor. Figure 6-8 shows an extract of the process plan network for the axle part.

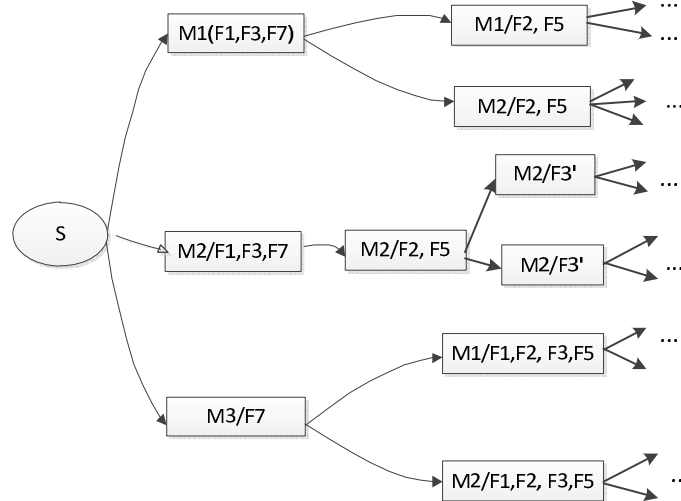

Figure 6-8: Processes network for the part axle

### 6.2.3 Activity modeling (Phase 2b)

Having determined the alternatives process plans, the next step is to transform these plans into conceptual process plan models which serve two purposes in the current case study: information collection (functional data such as activities) prior to simulation and provides a context for risk assessment.

To develop such a conceptual process plan model, the modified IDEF3 model is used as shown in Figure 6-9.

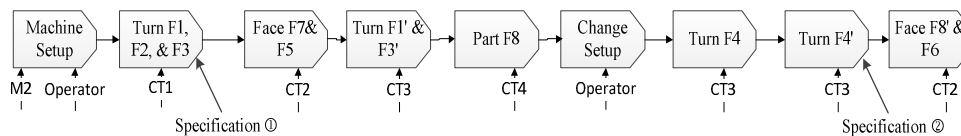

Figure 6-9: Manufacturing process plan for the axle part

To model objectives into the process model, it is sufficient to associate functional objectives with each activity in the process plan model. For instance, in Figure 6-6, two objectives in the form of concentricity requirements (specifications ① and ②) for the features F1 and F4 of the axle part have been identified. So, these objectives are assigned to the corresponding responsible activities such as “Turn F1” and “Turn F4” of the manufacturing process plan model (cf. Figure 6-9). Concerning the non-functional objectives such as time and cost, they are usually determined in a global way for the whole process via estimation or a simulation experiment.

Once all the manufacturing process plans are modeled, the next step consists in carryout risk analysis of the manufacturing processes. It is worth mentioning that the informal risk analysis starts with the inception of the candidate process selection. Only those process candidates are selected for a given feature if it can satisfy requirements to some extent of that feature (cf. Figure 6-5). However, a more thorough risk assessment is still needed to get a clear picture of the risks involved in the processes.

#### 6.2.4 Risk modeling (Phase 2c)

To carry out risk assessment of the process plans, VR-PMS proposes a two steps approach: objective-driven risk identification and activity based risk analysis.

##### 6.2.4.1 Objective-driven approach to risk identification

To determine risks employing the objective-driven approach, a risk hierarchy similar to the fundamental objectives hierarchy is developed. The approach starts by first defining a global risk such as “failure to satisfy the customer order” for a given manufacturing process plan. The lower level risks are the inverse mirrors of the fundamental objectives hierarchy such as schedule risk corresponds to on-time delivery objective, cost overrun cost objective, and performance risk corresponds to high quality.

In the current scenario, the “on-time delivery” is the critical objective, so it requires further analysis. For this reason, the schedule risk is refined further using modified risk model of the VR-PMS. The question “What does it mean?” brings forward lower level schedule risks dimensions such as order processing delay, manufacturing delay and delivery delay as shown in Figure 6-10.

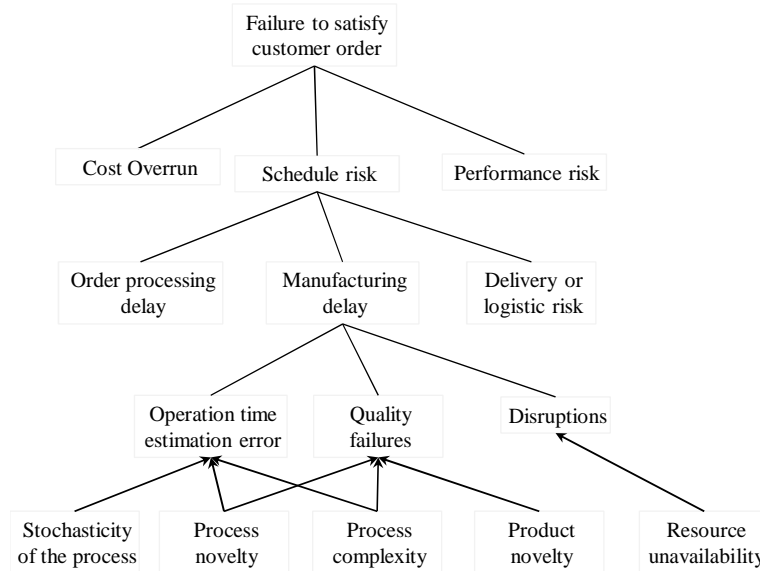

**Figure 6-10: Schedule risk hierarchy**

Since the focus is more on the manufacturing processes, the order processing and logistic delays are excluded from further investigation. The manufacturing delay is further refined to operation time estimation error, quality failures and disruptions in the process execution. Because the risk model depends on the likelihood and impact

of a risk event for modeling purpose, it is important to figure out these two parameters.

To calculate the impact of a risk event on a schedule and other fundamental objectives, the contract agreement is consulted. As for the delay, the impact function  $y = f(x)$  is calculated as:  $y = a \cdot e^{bx}$ , where  $a$  and  $b$  are the coefficients and  $x$  is the dependent variable indicating the range which exceeds the due date. Similarly, the cost impact function is calculated assuming a quadratic function (i.e. per unit cost overrun  $x$  has an impact  $x^2$ ). As for the quality failure impact, FMEA technique severity scale is used.

For the probability of a risk event, it can be determined only putting the risk into the context. For this purpose, the activity model (process plan model) is referred to, since risk analysis is meaningless without looking into the environment in which it executes and the process plan model provides that context.

#### 6.2.4.2 Process-based approach to risk analysis

To analyze the identified risks in the context of process plan models, they are first related to the activities influenced by these risks. For this purpose, the activity/risk matrix is developed as shown in Table 6-2. The first column of the matrix enlists all the activities (machining operations) of the process plan, whereas the first row is populated with all the identified risks.

**Table 6-2: Activity/risk matrix**

Activities \ Risks	Failure to adjust in the modular fixture	Axel / body assembly failure	Duration estimation error
Turn F4_B	×		×
Turn (F6, F6')_C		×	×
Part F8_A			

Table 6-2 illustrates that the risk event “Failure to adjust in the modular fixture” can originate if the operation “Turn F4-B” of the Body process plan is not carried out per specification requirement. Additionally, this operation is assumed to have uncertain time duration and hence is subject to two risk events. However, the operation “Part F8\_A” of the axle process plan confronts no risk in any respect. Similarly, all the activities of the process plan are linked to the identified risks.

Once a link between the activities and the risks is established, it is now convenient to analyze the risks in the process environment. Since, the activity execution environment (i.e. operating conditions, operator or machine and tool) is known through the process plan model, it is therefore reasonable to estimate the likelihood and detection parameters for risk analysis in FMEA table. For instance, if a critical objective is assigned to an error-prone activity, then the risk event is more likely to occur as compared to an error-free and robust activity. The risks are then assessed qualitatively in the process FMEA Table. Table 6-3 shows an excerpt of the process FMEA for the schedule risks. The complete FMEA Table is given in Appendix B .

**Table 6-3: Extract of process FMEA table (focusing on the schedule risk)**

<i>Fundamental risk</i>	<i>Process</i>	<i>Failure mode</i>	<i>Causes (Risk factors)</i>	<i>Effects</i>	<i>P</i>	<i>C</i>	<i>D</i>	<i>RPN</i>
Schedule risk	Operation Turn F4_B	Failure to adjust in modular fixture	Improper dimensions /tolerances	Manufacturing delay	5	7	6	210

By putting the risks into the process context, the risk parameters, and consequently the RPN for each risk event, are determined using the FMEA technique as illustrated in Table 6-3. On the basis of the observations made in the FMEA table, high RPN risks are then integrated into the process models for quantitative assessment in the simulation step.

#### 6.2.4.3 Risk integration into the process model

Having identified and assessed the risks using the objectives model, activity models and FMEA technique, the next step aims to proceed to the integration of high profile risks into the process plan model.

In the running example, a functional objective such as concentricity of the feature F3 with respect to the plan A of the axle part (cf. Figure 6-6) is a critical assembly requirement (specification ①) whose probability of failure to meet the specifications is determined in the simulation model. For this purpose, machine M1 (2-axis CNC lathe), whose  $C_p$  value is estimated about 1.67, is used to realize the F3. The likelihood of the failure is the frequency of the part when it exceeds the tolerance limit specified and have an effect on the final assembly and hence on delay. Similarly, the quality risks such as MMC or LMC analyzed in the FMEA table have an impact in terms of delay, cost and operational performance of the product. So, MMC and LMC both are included in the process plan model as quality risks. Furthermore, the duration estimation error assessment which can negatively impact the schedule can be calculated quantitatively in the following way:

- Evaluate the risk of each activity and represent their durations with probability distribution.
- Combine these probability distributions using discrete event simulation to derive the probability of the final date occurring.
- If the cycle time exceeds the due date limit (or final date occurring), then it is considered a risk event whose impact is a function of the duration beyond the due date.

In short, all the critical risks are integrated into the process plan model for further assessment.

Figure 6-11 shows an excerpt of the risk aware business process.

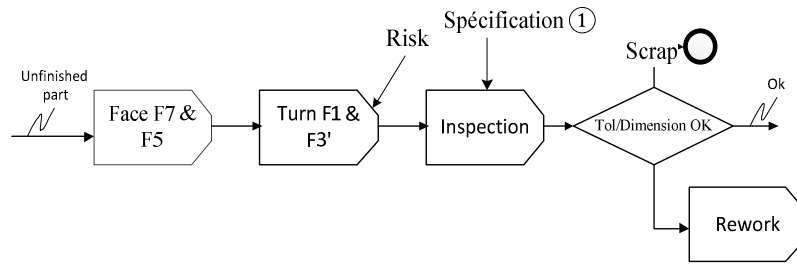

**Figure 6-11: Extract of a risk aware process plan model**

#### 6.2.4.4 Objective-oriented risk aware business process model

The final deliverable of the integrate BPPM approach (cf. Figure 5-12) is an objective-oriented risk aware process plan model. The process plan model is enriched with information regarding objectives, activity execution conditions, risks, risk factors and risk appetite and so on. This information is sufficient to characterize the desirable properties required to value and risk assessment of the process plans. Figure 6-12 shows an extract of the objective-oriented risk aware process plan model.

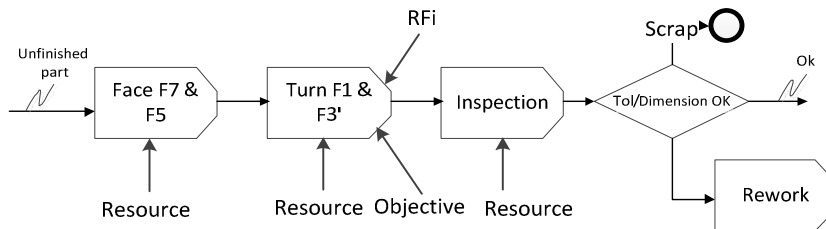

**Figure 6-12: Objective-oriented risk aware process plan model**

The final conceptual process plan model is then examined in the simulation environment in order to evaluate the value and risk of the manufacturing processes of the mechanical locator.

#### 6.2.5 Simulation of the objective-oriented risk aware process plans (Phase 3)

The pre-requisite to a simulation experiment is an operational simulation model requiring both functional data (i.e. activities) and simulation parameters. Having already defined the functional data and some informational data (risks, performance measures) through an integrated business process performance modeling (BPPM) approach, the next step is to simulate the process for performance assessment purpose. However, the simulation parameters are yet to be determined to make the model operational. The following section describes the input data collection for the simulation experiment.

##### 6.2.5.1 Input data generation

The functional data of the simulation model has already been collected through the process plan models. The data about the manufacturing facility layout is also integrated in the simulation model. However, the parameters regarding simulation experiments are collected and tabulated in Table 6-4 to Table 6-6.

Parameters in Table 6-4 are required to initialize the simulation run (replication). The part arrival law is assumed to be exponential (called “EXPO” in Table 6-4) in nature since this distribution is a suitable choice for modeling inter-event times in random arrivals besides the Poisson distribution. Furthermore, replications are designed to reduce variance in the simulation output. In addition, the warm-up period are aimed at removing the bias that exists in the initial conditions. There is no rule of thumb to calculate the warm-up period for a simulation experiment. The good practice is to simulate the model and observe the random numbers for variance and truncate the interval where significant variance can be found in the initial time period.

**Table 6-4: Run parameters for simulation model**

Parameter Types	Categories	Value
Part Arrival law	NA	<i>EXPO()</i>
Parts/Arrival	Batches	<i>Number of units/arrivals</i>
Replications	NA	<i>10</i>
Replication length		<i>1000 products</i>
Warm-up period		<i>X time units</i>
Process Trigger	NA	<i>Customer order</i>

To facilitate the process plan data collection (cf. Table 6-5), a process plan is divided into different categories such as value adding activities (operations), non-value adding activities (such as machine and tool setups), quality control related activities (inspection) and resource specific (*i.e.* capability of machines, machine speed factor). The machine speed factor is an important parameter in the estimation of operation time, which is calculated through the Equation 6-1:

$$\text{Machine Speed Factor} = \sum \frac{\text{Machine } i \text{ speed}}{\text{Work Cell standard speed}} \quad 6-1$$

To estimate the operation times, the triangular distribution (*i.e.* *TRIA* () in Table 6-5) is chosen because its input parameters (the minimum, the maximum and the most likely) are straightforward and easy to model at the expense of a little loss in the precision. Other durations can be modeled either triangularly or normally. In addition, we assume that the capability indices ( $C_p$ ) for the machines used to realize the parts are in the range of 1 to 1.67. Table 6-5 shows the process plan relevant data for the simulation experiments.

**Table 6-5: Process plan parameters for simulation model**

Parameter Types	Categories	Value
Operations	Operation times	$TRIA()$
Inspection	Inspection type	<i>Manual</i>
	Inspection time	$NORM()$
	# of inspections	<i>1 to many</i>
Setup	Setup time	$NORM()$
	# of setups	<i>1 to many</i>
Machine Specific	Capability of machines	$Cp = 1 \text{ to } 1.67$
	Machine speed factor ( <i>msf</i> )	$0 < msf \leq 1$

Moreover, the scenario specific data (given in Table 6-6) can be obtained from the contract agreement between the supplier and the customer. This sort of data represents the process goals, objectives and constraints.

**Table 6-6: Scenario parameters for simulation model**

Parameter Types	Categories	Value
Order quantity	NA	<i>D units</i>
Objectives /constraints	Product cost	<i>P \$</i>
	Quality level	<i>Satisfaction index</i>
	Lead-time	<i>T minutes</i>

#### 6.2.5.1.I Evaluation methods

Once all parameters are determined and fed into the simulation model, the next step is to select performance measures/criteria to assess the performance of the simulation model against these performance measures. The performance measures have already been derived from the objectives, however, the calculation method needs to be developed. For the current case study, the calculation method for each performance measure is developed and presented in Appendix C . For the sake of simplicity, the current case study considers only the following four performance measures:

- Manufacturing cycle time ( $C_1$ )
- Manufacturing total cost ( $C_2$ )
- Process yield ( $C_3$ )
- Employee/operator satisfaction ( $C_4$ )

Furthermore, for the purpose of risk assessment in the process plan models, the following risk measures representing the downsides of the lead-time, cost and quality objectives have been selected.

- Schedule risk ( $R_1$ )
- Cost overrun ( $R_2$ )
- Performance risk ( $R_3$ )

Moreover, the assessor defines the minimum performance and maximum risk levels with respect to each performance and risk measure, respectively. The minimum performance levels for each of the performance measure are obtained from Table 6-6. Concerning the maximum risk level for each of the risk measure, the risk management scope is consulted. The maximum level of risk an organization can support depends on its culture and capacity to manage its risk inherent in its business activities. Table 6-7 enlists the upper and lower bounds as well as the target values for the performance and risk measures.

**Table 6-7: Performance and risk levels**

	$C_1$	$C_2$	$C_3$	$C_4$	$R_1$	$R_2$	$R_3$
Upper Bound	22	16	100	100	4	5	1
Target level	18	12	95	75	2	3	0.5
Lower Bound	16	10	85	60	1	1	0.2

The performance and risk measures are then transformed into normalized scale in the range of [0, 1] by employing MACBETH method for three options of upper bound, target level and lower bound. The target level represents the minimum acceptable performance measure or maximum acceptable risk measure in the scenario. The minimum performance value function and maximum risk function (or expression) are then obtained and presented in Table 6-8.

**Table 6-8: Minimum performance and maximum risk acceptable expressions**

	$C_1$	$C_2$	$C_3$	$C_4$	$R_1$	$R_2$	$R_3$
Expressions	0.5	0.6	0.67	0.43	0.65	0.14	0.43

From these expressions, the global minimum value and global maximum risk indicators are developed. For this purpose, the mathematical model of 2-additive Choquet integral (Equation 5-14) is employed. The  $x_i$  of this integral, *i.e.* the expressions both for risk and value have been already determined via MACBETH; however the Choquet Integral parameters (Shapley index and interaction parameters) need to be calculated. To this end, the criteria are ordered and the assessor provides the strength of preference both for the criteria in pairs and individual criterion in the ordering as depicted below (*i.e.* ordinal preference modeling).

$$\begin{aligned}
 C_1 \&C_3 >^3 C_1 \&C_2 >^3 C_2 \&C_3 >^4 C_1 \&C_4 >^3 C_3 \&C_4 >^2 C_2 \&C_4 >^2 C_1 >^3 \\
 C_2 >^2 C_3 >^4 C_4 >^4 "0"
 \end{aligned} \tag{6-2}$$



Using Equations 5-15 and 5-17, the ordinal preference modeling is then transformed into systems of equations whose solution determines the parameters of the integral. These parameters as well as the minimum acceptable value and risk functions are then put into Equation 5-14 and the following scores for the production scenario 1 are calculated:

- Global minimum value ( $\mathcal{V}$ ) = **0.52**
- Global maximum risk ( $\mathcal{R}$ ) = **0.36**

These global minimum value and global maximum risk indicators will be used to decide on the alternatives process plans. By defining these values, the next step of the approach consists in performing the simulation model experimentations.

### 6.2.5.2 Simulation experiments

With the definition of operational simulation models (or simulable process plan alternatives), and performance and risk measures as well as their minimum and maximum acceptable levels, the process plans are now ready to be simulated in the simulation environment for the purpose of performance assessment. To this end, a discrete-event simulation software Rockwell Arena V13.5 has been used.

The simulation models are simulated in Arena. As detailed in the Table 6-4, 10 independent replications (or simulation runs) are carried out for 1000 mechanical locators. In each replication, the process plan model is loaded with the input data as given in the Table 6-4. To avoid correlation between parallel replications, different random number seeds are used (*i.e.* initialize data in the beginning of each replication). At the end of each replication, observations about the performance measures and risk measures are collected which are then analyzed at 95 % confidence interval in the output analyzer of Arena software.

### 6.2.5.3 Simulation results analysis

For the production scenario 1, 3 manufacturing process plans for each part of the mechanical locator and one assembly process plan are simulated. To verify the significance of the simulation results, paired t-test between the different scenarios for 95% confidence interval inside the output analyzer of Arena software are performed. The output of the simulation experiments after statistical analysis is tabulated in Table 6-9.

**Table 6-9: Simulation results for process plan models (Production scenario 1)**

	$C_1$	$C_2$	$C_3$	$C_3$	$R_1$	$R_2$	$R_3$
<i>PP1</i>	18.3	14.2	0.98	0.90	0.00574	5.3	0.145
<i>PP2</i>	19.6	12.14	0.97	0.93	0.08	0.95	0.132
<i>PP3</i>	23.6	11.9	0.87	0.67	6.31	0.08	0.244

The performance measures issued out of the simulation experiments can then be used as input to the value and risk function construction phase of the VR-PMS.

### 6.2.5.4 Value and risk functions

To develop performance expressions or value and risk functions, the MACBETH method is used. For this purpose, the assessor pre-orders the alternative process plans

for each criterion on the basis of his preferences (from left to right) and strength of preferences as shown in the following Equation 6-3 .

$$\begin{aligned}
 C_1 &\Rightarrow \text{Good} >^1 \text{PP1} >^2 \text{PP2} >^4 \text{Neutral} >^1 \text{PP3} \\
 C_2 &\Rightarrow \text{Good} >^2 \text{PP3} >^1 \text{PP2} >^2 \text{PP1} >^1 \text{Neutral} \\
 C_3 &\Rightarrow \text{Good} >^1 \text{PP1} >^1 \text{PP2} >^2 \text{PP3} >^3 \text{Neutral} \\
 C_4 &\Rightarrow \text{Good} >^0 \text{PP3} >^4 \text{PP1} >^1 \text{PP2} >^1 \text{Neutral}
 \end{aligned}
 \tag{6-3}$$

From this preferential information, value and risk functions (by assigning a number to a consequence i.e. performance measure in a given scenario) are determined via the M-MACBETH software while employing Equation 5-11. The output of the MACBETH method is then presented in Table 6-10.

**Table 6-10: Value and risk functions for production scenario 1**

	$C_1$	$C_2$	$C_3$	$C_4$	$R_1$	$R_2$	$R_3$
PP1	0.9	0.6	0.89	0.33	0.1	1.0	0.22
PP2	0.6	0.5	0.78	0.17	0.2	0.29	0.11
PP3	-0.2	0.2	0.44	1.0	1.0	0.14	0.44

By identifying the value and risk functions using the MACBETH method, it is now convenient to aggregate them using 2-additive Choquet integral mathematical model (Equation 5-14) to obtain global scores *i.e.* global value and risk indicators. The required Shapley index  $v_i$  and interaction parameter  $I_{ij}$  for the 2-additive integral have already been identified in section 6.2.5.1.I and are presented in Table 6-11. Using these parameters in Equation 5-14, the value and risk functions are aggregated and then tabulated in Table 6-11.

**Table 6-11: Value and risk indicators for production scenario 1**

	C1	C2	C3	C4	$P_{ag}$	R1	R2	R3	$R_{ag}$
PP1	0.6	0.9	0.89	0.33	<b>0.56</b>	1.0	0.22	0.1	<b>0.36</b>
PP2	0.5	0.6	0.78	0.17	<b>0.39</b>	0.29	0.11	0.2	<b>0.18</b>
PP3	0.2	-0.2	0.44	1.0	<b>0.12</b>	1.0	0.14	0.44	<b>0.42</b>
$v_i$	0.33	0.24	0.28	0.13		0.47	0.18	0.34	
$I_{ij}$	$I_{12}$	$I_{13}$	$I_{14}$	$I_{23}$		$I_{12}$	0.052		
	0.049	0.131	0.049	0.098		$I_{13}$	0.052		
	$I_{24}$			$I_{34}$		$I_{23}$ 0.10			
	0.016			0.081					

The global value and risk indicators obtained and synthesized in Table 6-11 are then compared with the global minimum acceptable value ( $\mathcal{V}_1 = 0.52$ ) and global maximum risk ( $\mathcal{R} = 0.36$ ). The only process plan that falls into the acceptability zone is the process plan 1 (PP1) with  $\mathcal{V}_{pp1} = 0.52$  and ( $\mathcal{R}_{pp1} = 0.36$ ). The remaining two process plans, *i.e.* PP2 and PP3, do not lie in the acceptability zone and hence dropped from the selection list.

### 6.3 Application of VR-PMS to the second scenario

The production scenario 2 is carried out with the same manufacturing facility as production scenario 1. However, in production scenario 2, the customer satisfaction is more oriented towards the quality of the product than on-time delivery of the customer order.

Because of change of focus on performance objectives (from time to quality) in the current scenario with regard to the first one, the performance measures may remain the same but they do reflect the same degree of satisfaction and hence, contribute differently to the global value of the production processes. In addition, the approach towards value creation would require different amount of rigor to pursue the objectives fulfillment (*i.e.* high quality level mechanical locator in addition to the cost and schedule objectives) and need modifications in the execution of production processes. For example, the production scenario 2 focuses more on quality dimension than the time aspect. For this purpose, the company first defined the requirements specifications for the high quality mechanical locator and then implements several additional activities related to the quality assurance and quality control of the product. These activities definitely increase the cost of production and cycle time but reduce the chance of supplying defective products to the customer. In addition to the modification in process plans, the preference modeling on the part of the assessor of the process changes and give more weight to the quality dimension over schedule when making value judgments (*i.e.* in the determination of Shapely and interaction parameters).

Similarly, with the change of focus on performance objectives, the perspective on business process risk also changes. The scenario then gives rise to risk events caused by different risk factors. For example, in the current scenario most risks have impact in terms of failure to conformity instead of manufacturing delay as is the case of the first scenario. The detailed qualitative risk assessment of production scenario 2, is more particularly detailed in the quality oriented FMEA proposed in Appendix B

#### 6.3.1.1.I Evaluation methods

To assess the process plans, the global minimum acceptable value and global maximum risk is determined similar to the first scenario but with different upper and lower bounds with respect to each performance and risk measure as presented in

**Table 6-12.**

**Table 6-12: Minimum and maximum acceptable measures**

	$C_1$	$C_2$	$C_3$	$C_4$	$R_1$	$R_2$	$R_3$
Upper bound	24	18	100	100	4	5	1
Target level	20	14	80	75	2	2	0.3
Lower bound	18	12	75	60	1	1	0.2

The minimum acceptable value and maximum acceptable risk functions are calculated via MACBETH method and presented in Table 6-13.

**Table 6-13: Minimum acceptable and maximum acceptable risk expressions**

	$C_1$	$C_2$	$C_3$	$C_4$	$R_1$	$R_2$	$R_3$
Expressions	0.33	0.4	0.43	0.48	0.57	0.67	0.55

To determine the Shapley index  $v_i$  and interaction parameters  $I_{ij}$ , the assessor is first asked to provide the preferences modelling for measures in pair as well as individual ones which are as follows:

$$C_3 \& C_1 >^3 C_3 \& C_2 >^3 C_2 \& C_1 >^4 C_3 \& C_4 >^3 C_1 \& C_4 >^2 C_2 \& C_4 >^2 C_3 >^3 \\ C_1 >^2 C_2 >^4 C_4 >^4 "0"$$

The preference modelling is then transformed into systems of equations using Equations 5-15 and 5-16, whose solution provide the Shapley indices and interaction criteria as presented in Table 6-16. These parameters are then put into the Equation 5-14 to obtain the global minimum acceptable value and global maximum risk value for the production scenario 2:

- Global minimum acceptable value level= **0.39**
- Global maximum acceptable risk level = **0.59**

Having modified the process plans by adding extra quality control related activities, allocating machines having less variation as well as identifying and assessing quality-oriented risks qualitatively employing FMEA technique, the objectives-oriented risk aware simulation model is developed for the production scenario 2. The model is then simulated similar to the first scenario in the same manufacturing facility but with different operating conditions as prescribed by processes requirements. The results of the simulation experiments are obtained and tabulated in Table 6-14.

**Table 6-14: Simulation results for process plan models (Production Scenario 2)**

	$C_1$	$C_2$	$C_3$	$C_3$	$R_1$	$R_2$	$R_3$
PP1	20.5	16.6	0.87	0.94	0.715	5.57	3.96
PP2	20.4	13.8	0.90	0.91	0.28	2.46	4.12
PP3	22.4	12.4	0.78	0.74	3.6	0.415	3.94

To obtain the value and risk functions, the process plans are ranked on the basis of desirability along with strength of preferences for each criterion as follow:

$$C_1 \Rightarrow \text{Good} >^1 PP2 >^2 PP1 >^4 PP3 >^1 \text{Neutral}$$

$$C_2 \Rightarrow \text{Good} >^2 PP3 >^1 PP2 >^2 PP1 >^1 \text{Neutral}$$

$$C_3 \Rightarrow \text{Good} >^1 PP2 >^1 PP1 >^2 PP3 >^3 \text{Neutral}$$

$$C_4 \Rightarrow \text{Good} >^0 PP3 >^4 PP2 >^1 PP1 >^1 \text{Neutral}$$

By the same token, information is provided on alternatives for each risk measure. This ordinal preference modelling is then transformed into value and risk functions in m-MACBETH software by employing the principle of Equation 5-11. The resulting value and risk functions are then populated in Table 6-15

**Table 6-15: Value and Risk Functions for Production Scenario 2**

	$C_1$	$C_2$	$C_3$	$C_4$	$R_1$	$R_2$	$R_3$
PP1	0.63	0.1	0.5	0.14	0.12	0.98	0.66
PP2	0.83	0.5	0.6	0.20	0.38	0.57	0.78
PP3	0.18	0.7	0.11	1.0	0.88	0.14	0.56

The 2-additive Choquet integral model of Equation 5-14 is then used to aggregate the value and risk functions. The Shapley index and interaction for the mathematical model have been already developed in the global maximum and global minimum calculation. The resulting aggregated indicators are then tabulated in Table 6-16 besides their value and risk functions as well as their Shapley indices and interaction parameters.

**Table 6-16: Value and risk indicators for the scenario 2**

	$C1$	$C2$	$C3$	$C4$	$P_{ag}$	$R1$	$R2$	$R3$	$R_{ag}$
PP1	0.1	0.63	0.5	0.14	<b>0.45</b>	0.98	0.66	0.12	<b>0.53</b>
PP2	0.5	0.83	0.6	0.20	<b>0.31</b>	0.57	0.78	0.38	<b>0.59</b>
PP3	0.7	0.18	0.11	1.0	<b>0.16</b>	0.14	0.56	0.88	<b>0.56</b>
$v_i$	0.26	0.24	0.30	0.18		0.34	0.18	0.48	
$I_{ij}$	$I_{12}$	$I_{13}$	$I_{14}$	$I_{23}$		$I_{12}$	0.090		
	0.211	0.211	0.117	0.2		$I_{13}$	0.13		
	$I_{24}$	$I_{34}$		$I_{23}$ 0.090					
	0.159		0.158						

By comparing the global value and risk indicators with the minimum acceptable value and maximum risk for the given context, we have the PP1 which meet the

minimum performance requirements. As for the PP2 and PP3, although they fall in risk acceptability zone but fall in the value indifference range and therefore cannot be implemented.

#### 6.4 Discussion

To test the validity and applicability of the proposed VR-PMS, a case study with two production scenarios have been conducted. The aim to conduct the two scenarios was to explain the generality of the proposed method.

In the production scenario 1, the purpose is to determine how the VR-PMS could produce the desirable results (value-risk pair) in the time-oriented performance management context if the assessor confronts multiple alternatives. This is how the production scenario 1 takes into consideration the “on-time delivery” as the most important fundamental objective compared to other dimensions of performance and carrying a Shapley index ( $v_i$ ) of 0.33 (cf. Table 6-11). The Shapley indices for other dimensions: cost, quality and employee satisfaction are: 0.24, 0.28 and 0.13, respectively. Moreover, the dependencies among the various performance measures are given in Table 6-11. The most notable interaction is  $I_{13}$  that exists between lead-time and quality measures. This interaction models the influence of the quality over the lead-time of the processes.

Similarly, the schedule risk in the global risk indicator carries more importance with a Shapley index of 0.47, followed by 0.34 and 0.18 for cost overrun and quality risk respectively. Concerning the criteria mutual influences, the noteworthy interaction exists between cost and quality measures (*i.e.*  $I_{23} = 0.10$ ). It means that quality failures contribute 10% more cost to the final product cost. In short, the production scenario 1 confirms the conceptual and operational validation of the VR-PMS.

The production scenario 2, on the other hand, focused on the quality-oriented performance management of the same manufacturing processes. The quality dimension with a Shapley index of 0.3 carries more weight in the current scenario because of the customer interest in high quality products. In addition to the customer satisfaction in quality aspect of the manufacturing process, the company take into consideration the satisfaction of its employees ( $v_4 = 0.18$ ), particularly of the shop floor operators. However, employee satisfaction has the least Shapley index value of all the performance criteria. In brief, the production scenario 2 validates the applicability of the VR-PMS in the quality-oriented performance management context.

To conclude, both production scenarios 1 & 2 support the conceptual and operational validity as well as the generality of the VR-PMS. The approach of the VR-PMS towards value and risk assessment of any business process is the same however, the elements of assessment changes according to stakeholders objectives. In the current two scenarios, although the performance measures/criteria used for evaluation of the production processes are the same, they do not reflect the same degree of satisfaction for the stakeholders due to change of focus on the importance of the objectives. Nevertheless, the risk measures derived in production scenario 2 are different than the ones derived in production scenario 1 (see Appendix B ). They may belong to the same categories of risks as production scenario 1 but the risk parameters are not the same in both the scenarios.

In short, the proposed method is capable to evaluate any business process/system. It is generic in nature and can be applied to a wide range of processes whether they are manufacturing, services or administrative processes. The reason of its generality is its foundation on the concepts of value creation and risk which are common to all types of processes. A process, in general, is designed to achieve certain objectives in the uncertain environment. The VR-PMS capture this relationship of process with objectives and risk and model them for assessment and ultimately for decision-making purpose. A change in either element of the triptych will influence the final (value-risk pair) of a decision context in question.

## 6.5 Conclusion

This chapter has presented a case study to test the validity and applicability of the proposed VR-PMS. For this purpose, two production scenarios have been modeled and simulated. The simulation output (performance and risk measures of interest) is then transformed into value and risk functions using multi-criteria decision-making techniques.

The value and risk functions model the preferences and strengths of preferences of stakeholders concerning the performance and risk measures in different alternative courses of actions. These individual value and risk functions, once calculated, are then consolidated to form a global value measure representing the overall performance in a given scenario and a global risk measure indicating the overall process risk.

The results of the case study validate the VR-PMS strength as a performance management system for decision making purpose. Although improvement of the business process is not part of the case study, it can be used for the improvement purpose while relying on the different courses of actions derived using the means-objectives network. The network identifies the areas of improvement and the success factors to improve the value creation of a business process.

Finally, the proposed method is generic in nature and follows the same steps towards value and risk assessment of a process but the final outcome in terms of value and risk indicator depend on the triptych of objectives, activities and risk factors.

## Conclusion and Perspectives

The work reported in this doctoral dissertation has proposed and described a performance measurement and management framework based on the (value, risk) pair, both in methodological and theoretical terms and instrumented with quantitative analysis methods and tools.

From a broader perspective and due to the current business environment, we come to the conclusion that an enterprise system performance can be evaluated mostly from four global performance dimensions: costs, benefits, value and risks as shown in Figure 1. In our view, the four dimensions are sufficient to describe the performance management discipline. The *Cost* dimension of the framework refers to the global price of a system, product or process (in monetary units). In most cases, it remains the most prevailing or final decision-making criterion. The *Benefits* qualitatively evaluate the strengths or advantages of the system, product or process. The *Value* dimension, however, models quantitatively the “stakeholder” satisfaction as an aggregation of indicators with regard to the system, product or process. Finally, the *Risk* dimension of the global performance management framework determines qualitatively and quantitatively the overall risk associated with the system, product or process. This also applies to projects.

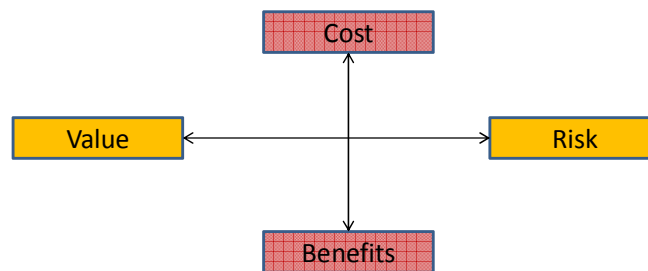

**Figure 1: Global performance management framework**

Because the cost and benefits dimensions have been largely studied in the past and are now widely used in practice, they have not been developed in the dissertation. However, the value and risk dimensions, although widely studied separately, were not elaborated so far in an integrated way in one framework, particularly in a process-centric perspective.

Therefore, the aim of this research was to holistically develop the value and risk dimensions of performance in the process context that would then be integrated with the cost and benefits dimensions to form a global performance management framework for process-centric systems or organizations. This is the reason why this dissertation is limited to value and risk dimensions and proposes a performance management system which is mainly based on the value and risk pair. This pair is then used as a decision-making tool and provides ranking of desirability or undesirability of the alternatives (in this case, manufacturing processes) in any performance context.

Considering the value and risk dimensions of performance holistically in the form of a value-risk pair is aimed to simplify the performance measurement and management process. There are several reasons that justify the concept of using the value-risk pair for decision-making purpose. For example:



- The performance measurement process of an enterprise system involves a large number of performance data to deal with multiple dimensions of performance. The difficulty lies not in collecting the performance relevant data but in their transformation into useful performance measures and performance indicators for the purpose of informed decision making. In this case study “useful” means to have performance measures/indicators that truly reflect the objectives of the enterprise system.
- The need to collect and develop as many performance measures as possible may lead to another performance crisis: the performance measures/criteria management crisis. Dealing with many performance measures may exceed the cognitive limits of the performance assessors that may result in a loss of performance relevant information. The problem can further be aggravated when dealing with heterogeneous performance measures. This heterogeneity of performance measures originates because of different dimensionality/facets of enterprise performance as well as measuring the performance in a piecemeal fashion.
- The piecemeal performance measurement practice happens because of the focus of the performance measurement process. Organizations have different measures for different aspects, departments or workgroups and even for individuals. When these measures are combined or aggregated to get a performance insight about the system, often they lose relevance which may cause suboptimal or distorted performance measurement of the system.
- For the purpose of performance measures aggregation, most often practitioners and academia propose to consolidate these measures to get an aggregated performance measure. The point they miss in the course of this consolidation is the interaction or influencing factors that exist among these performance measures. In real-world problems, all the measures/criteria often influence each other either positively or negatively. Simple consolidation of performance measures using the weighted arithmetic mean can be misleading.
- Last, but not least, is the missing link of performance measurement and management practices with the risk management practices on a common ground. Organizations often conduct risk assessment processes and devise strategies according to the risk management policies to deal with the system risk factors. However, these risk management practices are often carried out independently of the performance measurement and management practices by employing diverse approaches.

In view of the above contemporary issues in the domain of performance and risk management, the current dissertation was geared to address them. For this purpose, the following list of requirement specifications and the corresponding methods, tools and techniques to assist in modeling these requirements are identified:

- The performance measurement process should be value-focused rather than a simple process of collecting a bunch of performance measures, which lacks strategic alignment. Since values reflect the expectations of stakeholders in a given performance context, they therefore represent the actual system performance. Furthermore, by employing value as performance indicator has the vocation to combine all the objective assessments into a single indicator. To this end, an objectives model based on the VFT framework has been identified as an appropriate technique to elicit and model the values and expectations of the stakeholders for ulterior performance assessment.

- To avoid the piecemeal performance measurement and deconstruct the organizational boundaries, a process-centered approach for performance measurement and management is selected as the suitable option. A process is the source of value creation. Furthermore, it has no organizational limits and therefore can be extended across departments and organizations in the intra-organizational and inter-organizational configurations, respectively. It therefore can be used to measure the overall performance instead of individuals or individual sections (functional departments or organizations). The IDEF3 method is employed for the purpose of modeling the processes under study.
- To get a holistic performance picture and avoid a suboptimal performance assessment, risk factors and risks need to be handled in addition to value assessment in the process context. This requires a common basis to account for value and risk of a system. For this reason, the dissertation relies on the process FMEA technique for the qualitative assessment and on the Larson and Kusiak's risk assessment approach to deal with the risk in the process environment qualitatively.
- To have a global value and risk indicator, consolidation of different heterogeneous measures need to be carried out. However, the consolidation should be based on methods and techniques that take into account the interaction or influencing phenomena of different performance measures. The MACBETH method has been selected to model the preferences and strengths of preferences in order to develop normalized value and risk functions. To integrate them together, the Choquet Integral has been used because it can model the inter-criteria interactions, as opposed to the weighted arithmetic mean.
- Finally, the proposed performance measurement system should be simple to implement and accurate.

By identifying the requirement specifications and the corresponding methods, tools and techniques to address the contemporary performance measurement and management issues, the current dissertation proposes a value-risk based performance management system (VR-PMS). The VR-PMS is made of two frameworks: a conceptual framework, called conceptual value-risk model, and methodological framework to guide the process of performance measurement and management.

The conceptual value-risk model integrates the objectives, activity and risk models of any business process and defines their relationships with each other. We believe that the triptych made of the three candidate models is sufficient to describe the value creation mechanism of any business process in the backdrop of uncertainty. By choosing the activity model as the primary model to host all the desirable properties of the remaining two candidate models, the latter are then mapped onto the activity model to explain the value creation process in the process context. The valuation of performance measures are then carried through value judgments in the MCDM context. The same principles are applied to risk measures for constructing risk functions.

The methodological framework, on the other hand, divides the whole process of performance management into the following four phases:

1. Context development,
2. Performance modeling,
3. Performance assessment, and
4. Value-risk based decision-making.

The context development (Phase 2) prepares the performance management context by scoping the performance management problem at hand. The performance modeling (Phase 2) is aimed at modeling the objectives, the processes proposed to realize these objectives as well as the risks influencing the processes to obstruct the objectives realization. An integrated BPPM model within the performance modeling phase is proposed to guide the process of developing an objectives-oriented risk aware business process model. The model is sufficient to formalize the business process performance in the presence of risk events emanating from risk factors.

The performance assessment (Phase 3) is aimed at assessing the conceptual model: objectives-oriented risk aware business process model. The assessment process is carried out in the simulation environment. For this purpose, the conceptual model is transformed into a computer-based simulation model and the relevant information (input variables) are defined and fed into the simulation model and assessed against the performance measures, which are derived from the objectives model of the conceptual value-risk model. The quantitative performance measures obtained from this phase are then used as input to the decision-making phase.

Finally, the decision-making (Phase 4) is designed to transform the quantitative performance measures into value and risk functions and ultimately into value-risk performance indicators. The value and risk functions are expressed via multi-attribute utility theory. For this purpose, MACBETH method is used. The value and risk functions obtained from MACBETH method are then aggregated through the 2-additive Choquet Integral to compute the global indicators.

To conclude, the VR-PMS framework connects the different fundamental concepts about performance measurement and management to address the different contemporary issues evoked in the literature review. The proposed method provides a useful contribution to the performance measurement and management discipline. It combines theories (such as utility theory, performance measurement theory), practices (risk management practices) and approaches (modeling and simulation approaches) into one framework and uses them for performance measurement and management of business processes.

Although the proposed method has obviously some merits, it still has some limitations. One limitation is about the time taken for performance evaluation of a range of business processes. The proposed approach, although it ranks business process alternatives for their desirability or undesirability, is time-consuming because it uses a simulation approach. However, the benefits in system design may be worth the time devoted to the performance assessment because the consequences of not assessing the business processes can be detrimental for the enterprise productivity and competitiveness on the long term.

Concerning the perspectives, the research work can be to extend in several directions. First, a generalization of the method can be made for the performance assessment of any kind of system, product, process or project. The approach has been developed and illustrated in the context of manufacturing processes. We think it is generic and that it can be extended to any type of processes and systems.

The proposed method can be extended to include elucidation technique to determine the contribution of partial scores as well as set of partial scores in order to enlighten the decision maker about the decision being made. The insights of “how” and “why” of global value obtained through aggregation mechanism makes the decision more

clear and helps to justify the decision. The answer to the “Why” question can then be quantitatively expressed in terms of the relative influence of a particular criterion on the global score.

The application case study concerns the engineering phase of a mechanical part, and especially the industrialization phase, where several alternative manufacturing processes can be evaluated and compared and for which simulation is required. The approach described and illustrated in this doctoral dissertation can be extended to the product or system design phase.

Another promising field of investigations is the use of the value-risk pair in the on-line control of a system, process or project. Indeed, it would be interesting in system or project control to constantly have a measure of the global expected value and exposure to risk of this system or project. If the value is too low or the risk gets too high, then control decisions must be taken to reduce risk or increase value.

Another interesting area that remains to explore, and that could only be presented but not developed in the dissertation, is the extension of the framework to the concept of tolerable level of risk and tolerance on value. Having fixed a maximum level of risk and a minimum of acceptable value, there could be situations in which we can accept a little lower value than the minimum level fixed if the risk is really low (and if cost is still profitable). Conversely, to which extend a high value but with a significant risk can be accepted? In addition, determining these minimum and maximum levels of risk or value as well as tolerances on these levels would also be interesting questions to investigate.

Furthermore, the objectives-driven approach to risk identification can further be exploited to determine the causality relationship between risk factors and risk events to make the risk model complete. At the moment, the proposed method assumed that risk events are triggered by the risk factors. However, a quantitative causality is missing between risk events and risk factors. To determine the relationship between risk events and risk factors in the objective-driven risk model, a Bayesian network is the potential candidate to model this relationship. This relationship, in quantitative terms, is important because it will assure cost-effective risk mitigation. By identifying the risk factors that contribute more to the global risk, they can then be reduced according to the risk treatment policies.

Finally, the proposed method will be extended to include the cost and benefits dimensions in order to make it a complete global performance management framework (as illustrated in Figure 1: global performance management framework and challenge methods such as the Balanced Scorecards method).



## References

- Abdel-Maksoud, A., Dugdale, D., Luther, R., 2005. Non-financial performance measurement in manufacturing companies. *The British Accounting Review* 37, 261–297.
- Abernethy, M.A., Lillis, A.M., 1995. The impact of manufacturing flexibility on management control system design. *Accounting, Organizations and Society* 20, 241–258.
- Acar, Y., Kadipasaoglu, S., Schipperijn, P., 2010. A decision support framework for global supply chain modeling: an assessment of the impact of demand, supply and lead-time uncertainties on performance. *International Journal of Production Research* 48, 3245–3268.
- Adams, R., Bessant, J., Phelps, R., 2006. Innovation management measurement: A review. *International Journal of Management Reviews* 8, 21–47.
- AFGI, 1992. Evaluer pour évoluer, les indicateurs de performance au service du pilotage. Association Française de Gestion Industrielle, Paris, France.
- Ahmed, W.B., Yannou, B., 2003. Polysemy of values or conflict of interests: A multi-disciplinary analysis. *International Journal of Value-Based Management* 16, 153–179.
- Altioik, T., Melamed, B., 2007. *Simulation Modeling and Analysis with ARENA*. Academic Press.
- Amaratunga, D., Baldry, D., 2002. Moving from performance measurement to performance management. *Facilities* 20, 217–223.
- Ananda, J., Herath, G., 2009. A critical review of multi-criteria decision making methods with special reference to forest management and planning. *Ecological Economics* 68, 2535–2548.
- Anderson, J.C., Thomson, J.B., Wynstra, F., 2000. Combining value and price to make purchase decisions in business markets. *International Journal of Research in Marketing* 17, 307–329.
- Andersson, B., Bider, I., Johannesson, P., Perjons, E., 2005. Towards a formal definition of goal-oriented business process patterns. *Business Process Management Journal* 11, 650–662.
- Artzner, P., Delbaen, F., Eber, J., Heath, D., 1999. Coherent Measures of Risk. *Mathematical Finance* 9, 203–228.
- Atkinson, A.A., Waterhouse, J.H., Wells, R.B., 1997. A stakeholder approach to strategic performance measurement. *Sloan Management Review* 38, 25–38.
- Aven, T., Vinnem, J.E., 2005. On the use of risk acceptance criteria in the offshore oil and gas industry. *Reliability Engineering & System Safety* 90, 15–24.
- Aven, T., 2007. A unified framework for risk and vulnerability analysis covering both safety and security. *Reliability Engineering & System Safety* 92, 745–754.
- Aven, T., 2008. *Risk analysis: assessing uncertainties beyond expected values and probabilities*. Wiley & Sons, New-York.
- Aven, T., 2010. On how to define, understand and describe risk. *Reliability Engineering & System Safety* 95, 623–631.
- Bacidore, J.M., Boquist, J.A., Milbourn, T.T., Thakor, A.V., 1997. The search for the best financial performance measure. *Financial Analysts Journal* 53, 11–20.
- Bana e Costa, C.A., Vansnick, J.-C., 2008. A critical analysis of the eigenvalue method used to derive priorities in AHP. *European Journal of Operational Research* 187, 1422–1428.

- Bana e Costa, C., Corte, J.M., Vansnick, J.C., 2005. On the Mathematical Foundation of MACBETH. *Multiple Criteria Decision Analysis: State of the Art Surveys* 409–437.
- Bana e Costa, C.A., de Corte, J.M., Vansnick, J.C., 2003. *Macbeth*. Working Paper 03.56, London School of Economics.
- Bana e Costa, C.A., Vansnick, J.-C., 1994. MACBETH — An interactive path towards the construction of cardinal value functions. *International Transactions in Operational Research* 1, 489–500.
- Bandara, W., Gable, G.G., Rosemann, M., 2005. Factors and measures of business process modelling: model building through a multiple case study. *European Journal of Information Systems* 14, 347–360.
- Banks, J. (Ed.), 1998. *Handbook of Simulation: Principles, Methodology, Advances, Applications, and Practice*, 1st ed. Wiley-Interscience, New-York.
- Basili, V.R., Weiss, D.M., 1984. A methodology for collecting valid software engineering data. *Software Engineering, IEEE Transactions on* 728–738.
- Basili, V., Caldiera, G., Rombach, H., 1994. *Goal Question Metric Approach Paradigm*. John Wiley & Sons, *Encyclopedia of Software Engineering*
- Berrah, L., 2002. *L'indicateur de performance: Concepts et applications*. Editions Cépaduès, Toulouse.
- Bescos, P.L., 1995. *Contrôle de gestion et management*. Editions Montchrestien.
- Bharara, A., Lee, C.-Y., 1996. Implementation of an activity-based costing system in a small manufacturing company. *International Journal of Production Research* 34, 1109–1130.
- Bhimani, A., 2006. *Contemporary Issues in Management Accounting*. Oxford University Press, USA.
- Bititci, U.S., 1995. Modelling of performance measurement systems in manufacturing enterprises. *International Journal of Production Economics* 42, 137–147.
- Bititci, U.S., Ackermann, F., Ates, A., Davies, J., Garengo, P., Gibb, S., MacBryde, J., Mackay, D., Maguire, C., Van Der Meer, R., others, 2011. Managerial processes: business process that sustain performance. *International Journal of Operations & Production Management* 31, 851–891.
- Bititci, U.S., Carrie, A.S., McDevitt, L., 1997. Integrated performance measurement systems: a development guide. *International Journal of Operations & Production Management* 17, 522–534.
- Bititci, U., Garengo, P., Dörfler, V., Nudurupati, S., 2011. Performance Measurement: Challenges for Tomorrow. *International Journal of Management Reviews*.
- Bitton, M., 1990. *ECOGRAI: Méthode de conception et d'implantation de systèmes de mesure de performances pour organisations industrielles*. Ph.D. dissertation, University of Bordeaux 1.
- Bolwijn, P.T., Kumpe, T., 1990. Manufacturing in the 1990s—Productivity, flexibility and innovation. *Long Range Planning* 23, pp. 44–57.
- Bond, T.C., 1999. The role of performance measurement in continuous improvement. *International Journal of Operations & Production Management* 19, 1318–1334.
- Bosch-Mauchand, M., Siadat, A., Perry, N., Bernard, A., 2010. VCS: value chains simulator, a tool for value analysis of manufacturing enterprise processes (a

- value-based decision support tool). *Journal of Intelligent Manufacturing* 1–14.
- Bosilj-Vuksic, V., Ceric, V., Hlupic, V., 2007. Criteria for the evaluation of business process simulation tools. *Interdisciplinary Journal of Information, Knowledge, and Management* 2, 73–88.
- Bourguignon A, 2005. Management accounting and value creation: the profit and loss of reification. *Critical Perspectives on Accounting* 16, 353–389.
- Bourguignon, A., 1995. «Peut-on définir la performance?». *Revue française de comptabilité* 269, 61–66.
- Bourne, M., Franco, M., Wilkes, J., 2003. Corporate performance management. *Measuring Business Excellence* 7, 15–21.
- Bourne, M., Mills, J., Wilcox, M., Neely, A., Platts, K., 2000. Designing, implementing and updating performance measurement systems. *International Journal of Operations & Production Management* 20, 754–771.
- Brimson, J.A., 1997. *Activity Accounting: An Activity-Based Costing Approach*, 1st ed. Wiley & Sons, New-York.
- Bréchet, J.P., Desreumaux, A., 2001. Le thème de la valeur en sciences de gestion: représentations et paradoxes. *Revue Sciences de Gestion* 217–245.
- Brinkkemper, S., Lyytinen, K., Welke, R.J., 1996. *Method Engineering: Principles of Method Construction and Tool Support: Proceedings of the IFIP TC8, WG8.1/8.2 Working Conference on Method Engineering 26-28 August 1996, Atlanta, USA*. Springer.
- Broadbent, J., Laughlin, R., 2009. Performance management systems: A conceptual model. *Management Accounting Research* 20, 283–295.
- Browning, T.R., 1998. Modeling and analyzing cost, schedule, and performance in complex system. Massachusetts Institute of Technology, PhD thesis.
- Büyükoçkan, G., Ruan, D., 2010. Choquet integral based aggregation approach to software development risk assessment. *Information Sciences* 180, 441–451.
- Cantner, U., Joel, K., Schmidt, T., 2011. The effects of knowledge management on innovative success – An empirical analysis of German firms. *Research Policy* 40, 1453–1462.
- Chapman, R.J., 2006. *Simple Tools and Techniques for Enterprise Risk Management*. Wiley & Sons, New-York.
- Chan, F.T.S., Qi, H.J., 2003. An innovative performance measurement method for supply chain management. *Supply Chain Management: An International Journal* 8, 209–223.
- Chandler, A.D., 1977. *The visible hand: The managerial revolution in American business*. Belknap Press.
- Chazelet, M., Lhote, F., 2001. Repères pour un *modus vivendi* sur la valeur. *Revue Française de Gestion Industrielle* 21–34.
- Caillaud, E., Gourc, D., Garcia, L.A., Crossland, R., McMahon, C., 1999. A Framework for a Knowledge-Based System for Risk Management in Concurrent Engineering. *Concurrent Engineering* 7, 257–267.
- Chenhall, R.H., 1997. Reliance on manufacturing performance measures, total quality management and organizational performance. *Management Accounting Research* 187–206
- Chenhall, R.H., 1996. Strategies of manufacturing flexibility, manufacturing performance measures and organizational performance: an empirical investigation. *Integrated Manufacturing Systems* 7, 25–32.



- Chenhall, R.H., Langfield-Smith, K., 2007. Multiple perspectives of performance measures. *European Management Journal* 25, 266–282.
- Chiesa, V., Frattini, F., 2007. Exploring the differences in performance measurement between research and development: evidence from a multiple case study. *R&D Management* 37, 283–301.
- Chiesa, V., Frattini, F., Lazzarotti, V., Manzini, R., 2009. Performance measurement in R&D: exploring the interplay between measurement objectives, dimensions of performance and contextual factors. *R&D Management* 39, 487–519.
- Choquet, G., 1954. Theory of capacities. *Annales de l'Institut Fourier* 5, 131–295.
- Chris, A., 1977. Organizational learning and management information systems. *Accounting, Organizations and Society* 2, 113–123.
- Clemen, R.T., Reilly, T., 2000. *Making Hard Decisions with DecisionTools*, 1st ed. Duxbury/Thomson Learning.
- Clivillé, V., Berrah, L. 2011. Overall performance measurement in a supply chain: towards a supplier-prime manufacturer based model. *Journal of Intelligent Manufacturing*.
- Clivillé, V., Berrah, B. Mauris, G. 2007. Quantitative expression and aggregation of performance measurements based on the MACBETH multi-criteria method. *International Journal of Production Economics* 105, 171–189.
- Cokins, G., 2001. *Activity-Based Costing Management*. John Wiley & Sons Inc., New-York
- Contini, S., Matuzas, V., 2011. Analysis of large fault trees based on functional decomposition. *Reliability Engineering & System Safety* 96, 383–390.
- Cooper, R., Kaplan, R.S., 1988. Measure costs right: make the right decisions. *Harvard Business Review* 66, 96–103.
- Cooper, R., 1997. *Activity-Based Costing: Introduction*. Harvard Business School Press.
- Cope, E.W., Kuster, J.M., Etzweiler, D., Deleris, L.A., Ray, B., 2010. Incorporating risk into business process models. *IBM J. Res. & Dev.* 54, 4:1–4:13.
- Cozzani, V., Gubinelli, G., Antonioni, G., Spadoni, G., Zanelli, S., 2005. The assessment of risk caused by domino effect in quantitative area risk analysis. *Journal of Hazardous Materials* 127, 14–30.
- Crosby, P.B., 1980. *Quality Is Free: The Art of Making Quality Certain*. Mentor.
- Curtis, B., Kellner, M.I., Over, J., 1992. Process modeling. *Commun. ACM* 35, 75–90.
- Davenport, T.H., 1993. *Process innovation: reengineering work through information technology*. Harvard Business Press.
- Davenport, T.H., Harris, J.G., 2007. *Competing on analytics: the new science of winning*. Harvard Business Press.
- David, O., 1994. Management control in contemporary organizations: towards a wider framework. *Management Accounting Research* 5, 289–299.
- David, O., 1999. Performance management: a framework for management control systems research. *Management Accounting Research* 10, 363–382.
- Deming, W. E. 1982. *Quality, Productivity and Competitive Position*. Massachusetts Institute Technology, Cambridge, MA.
- Dijkman, R.M., Dumas, M., Ouyang, C., 2008. Semantics and analysis of business process models in BPMN. *Information and Software Technology* 50, 1281–1294.

- Dixon, J.R., Nanni, A.J., Vollmann, T.E., 1990. The new performance challenge: Measuring operations for world-class competition. Dow Jones-Irwin Homewood, Illinois.
- Doran, G.T., 1981. There's a SMART way to write management's goals and objectives. *Management Review* 70, 35–36.
- Dossi, A., Patelli, L., 2010. You learn from what you measure: Financial and non-financial performance measures in multinational companies. *Long Range Planning* 43, 498–526.
- Ducq, Y., Vallespir, B., 2005. Definition and aggregation of a performance measurement system in three aeronautical workshops using the ECOGRAI method. *Production Planning & Control* 16, 163–177.
- Eccles, R.G., 1991. The performance measurement manifesto. *Harvard Business Review* 69, 131–137.
- Edwards, W., Miles, R.F., Von Winterfeldt, D., 2007. *Advances in decision analysis: from foundations to applications*. Cambridge Univ Press.
- Epstein, M. J., 2003. *Measuring and Managing Performance in the 21st Century, The Performance Prism*. Available at <http://www.som.cranfield.ac.uk/som/cbp/prism%20book%20chapter%201.pdf>
- ESPRIT Consortium AMICE (Eds.), 1991. *CIMOSA: Open System Architecture for CIM*, 2nd, revised and extended edition, Springer Verlag, Berlin.
- Etienne, A., 2007. *Intégration Produit/Process par les concepts d'activités et de caractéristiques clés-Application à l'optimisation de l'allocation des tolérances géométriques*. Ecole d'Artset Métiers ParisTech Ph.D. thesis
- Eusgeld, I., Freiling, F.C., Reussner, R., 2008. *Dependability Metrics: Advanced Lectures*. Springer-Verlag, Berlin.
- Evangelidis, K., 1992. Performance measured performance gained. *The Treasurer* 2, 45–70.
- Farquhar, P.H., Keller, L.R., 1989. Preference intensity measurement. *Annals of Operations Research* 19, 205–217.
- Feigenbaum, A.V., 2004. *Total Quality Control*, 4th ed. McGraw-Hill Professional.
- Felix T.S. Chan, 2003. *An innovative performance measurement method for supply chain management*.
- Ferdous, R., Khan, F., Sadiq, R., Amyotte, P., Veitch, B., 2011. Analyzing system safety and risks under uncertainty using a bow-tie diagram: An innovative approach. *Process Safety and Environmental Protection*. 10.1016/j.psep.2011.08.010
- Ferreira, A., Otley, D., 2009. The design and use of performance management systems: An extended framework for analysis. *Management Accounting Research* 20, 263–282.
- Folan, P., Browne, J., 2005. A review of performance measurement: Towards performance management. *Computers in Industry* 56, 663–680.
- Ford, H., 1922. *My life and work*. Garden City, NY: Doubleday, Page and Company
- Fortuin, L., 1988. Performance indicators — Why, where and how? *European Journal of Operational Research* 34, 1–9.
- Franco, M., Bourne, M., 2003. Factors that play a role in “managing through measures”. *Management Decision* 41, 698–710.
- Franco-Santos, M., Kennerley, M., Micheli, P., Martinez, V., Mason, S., Marr, B., Gray, D., Neely, A., 2007. Towards a definition of a business performance measurement system. *International Journal of Operations & Production Management* 27, 784–801.

- Franklin M., F., 1988. Accounting data and the economic performance of firms. *Journal of Accounting and Public Policy* 7, 253–260.
- Freeman, R.E., 1984. *Strategic Management: A Stakeholder Approach*. Harpercollins College Div.
- Galland, S., Grimaud, F., Beaune, P., Campagne, J.P., 2003. MAMA-S: An introduction to a methodological approach for the simulation of distributed industrial systems. *International Journal of Production Economics* 85, 11–31.
- Galloway, D. and Waldron, D., 2004. Throughput accounting: the need for a new language for manufacturing, *Management Accounting*, November, pp. 34-35.
- Ganga, G.M.D., Carpinetti, L.C.R., 2011. A fuzzy logic approach to supply chain performance management. *International Journal of Production Economics* 134, 177–187.
- Garengo, P., Biazzo, S., Bititci, U.S., 2005. Performance measurement systems in SMEs: A review for a research agenda. *International Journal of Management Reviews* 7, 25–47.
- Gerwin, D., 1993. Manufacturing Flexibility: A Strategic Perspective. *Management Science* 39, 395–410.
- Globerson, S., 1985. Issues in developing a performance criteria system for an organization. *International Journal of Production Research* 23, 639–646.
- Goldratt, E., 1990. *What is this thing called theory of constraints and how should it be implemented?* North River Press, Great Barrington, MA.
- Goldratt, E.M., Cox, J., Whitford, D., 1992. *The goal: a process of ongoing improvement*. North River Press, Great Barrington, MA.
- Goodwin, P., Wright, G., 2004. *Decision analysis for management judgment*. John Wiley & Sons, New-York.
- Gourc, D., 2006. *Vers un modèle général du risque pour le pilotage et la conduite des activités de biens et de services*. Habilitation à diriger les recherches. Ecole des Mines d'Albi-Carmaux, France.
- Grabisch, M., 1997. k-order additive discrete fuzzy measures and their representation. *Fuzzy Sets and Systems* 92, 167–189.
- Grabisch, M., Labreuche, C., 2009. A decade of application of the Choquet and Sugeno integrals in multi-criteria decision aid. *Annals of Operations Research* 175, 247–286.
- Grawe, S.J., Daugherty, P.J., Roath, A.S., 2011. Knowledge synthesis and innovative logistics processes: Enhancing operational flexibility and performance. *Journal of Business Logistics* 32, 69–80.
- Greco, S. (Ed.), 2004. *Multiple Criteria Decision Analysis: State of the Art Surveys*, 1st ed. Springer-Verlag, Berlin.
- Greenley, G.E., Foxall, G.R., 1997. Multiple stakeholder orientation in UK companies and the implications for company performance. *Journal of Management Studies* 34, 259–284.
- Gunasekaran, A., Patel, C., McGaughey, R.E., 2004. A framework for supply chain performance measurement. *International Journal of Production Economics* 87, 333–347.
- Gunasekaran, A., Patel, C., Tirtiroglu, E., 2001. Performance measures and metrics in a supply chain environment. *International Journal of Operations & Production Management* 21, 71–87.
- Gurbuz, T., 2010. Multiple Criteria Human Performance Evaluation Using Choquet Integral. *International Journal of Computational Intelligence Systems* 3, 290.

- Halachmi, A., 2005. Performance measurement is only one way of managing performance. *International Journal of Productivity and Performance Management* 54, 502–516.
- Hammer, M., 1997. *Beyond Reengineering: How the Process-Centered Organization is Changing Our Work and Our Lives*, 1st ed. HarperBusiness.
- Hausman, W.H., 2003. Supply chain performance metrics. In: Harrison, T.P., Lee, H.L., and Neale, J.J, eds. *The practice of supply chain management: where theory and practice converge*. Boston: Kluwer Academic Publishing, 61-73.
- Hayes, R.H., Abernathy, W.J., 1980. Managing our way to economic decline. *Harvard Business Review*, 58.
- Heidari, F., Loucopoulos, P., Kedad, Z., 2011. A Quality-oriented business process meta-model, in: Barjis, J., Eldabi, T., Gupta, A. (Eds.), *Enterprise and Organizational Modeling and Simulation*. Springer-Verlag Berlin Heidelberg, pp. 85–99.
- Hernández-Espallardo, M., Rodríguez-Orejuela, A., Sánchez-Pérez, M., 2010. Inter-organizational governance, learning and performance in supply chains. *Supply Chain Management: An International Journal* 15, 101–114.
- Hofstede, G., 1978. The Poverty of Management Control Philosophy. *The Academy of Management Review* 3, 450–461.
- Horngren, C.T., Foster, G., Datar, S.M., 1999. *Cost Accounting: A Managerial Emphasis*, 10th ed. Prentice Hall, Englewood-Cliffs, NJ.
- Hurri, J., 2000. Using decision tools in deciding system product requirements: Literature review and a behaviourally motivated lightweight tool. Helsinki University of Technology, PhD thesis.
- IFRIMA, 1994. *International Risk Management Lexicon*, International Federation of Risk and Insurance Management Associations.
- Indulska, M., Green, P., Recker, J., Rosemann, M., 2009. Business process modeling: Perceived benefits, *The 28th International Conference on Conceptual Modeling*, Gramado, Brazil. Pp. 458-471.
- Ittner, C.D., Larcker, D.F., 1998. Are non-financial measures leading indicators of financial performance? An analysis of customer satisfaction. *Journal of Accounting Research* 36, 1–35.
- Iyer, A., Seshadri, S., Vasher, R., 2009. *Toyota Supply Chain Management: A Strategic Approach to Toyota's Renowned System*, 1st ed. McGraw-Hill.
- Jacobson, I., Ericsson, M., Jacobson, A., 1995. *The Object Advantage: Business Process Reengineering with Object Technology*. Addison-Wesley, Reading, MA.
- Jacot, 1996. *La Performance économique en entreprise*. Hermès Sciences Publications, Paris.
- Jacot, J.H., 1990. A propos de l'évaluation économique des systèmes intégrés de production. ECOSIP France. *Gestion industrielle et mesure économique*, Editions Economica, Paris.
- Jepsen, A.L., Eskerod, P., 2009. Stakeholder analysis in projects: Challenges in using current guidelines in the real world. *International Journal of Project Management* 27, 335–343.
- Johnson, B.B., 2004. Varying risk comparison elements: Effects on public reactions. *Risk Analysis* 24, 103–114.
- Johnson, H.T., Kaplan, R.S., 1987. *Relevance lost: The rise and fall of management accounting*. Harvard Business School Press.
- Johnson, T.H., Johnson, T.H., 1992. *Relevance regained*. Free Press.

- Juran, M.J., Godfrey, A.B., 2003. Juran's Quality Handbook, 5th ed. McGraw-Hill, USA.
- Kaplan, R.S., 1984. The Evolution of Management Accounting. *The Accounting Review* 59, 390–418.
- Kaplan, R.S., Cooper, R., 1998. Cost & effect: using integrated cost systems to drive profitability and performance. Harvard Business Press.
- Kaplan, R.S., Norton, D.P., 1992. The balanced scorecard—measures that drive performance. *Harvard Business Review* 70.
- Kaplan, R.S., Norton, D.P., 1996a. Using the balanced scorecard as a strategic management system. *Harvard Business Review* 74, 75–85.
- Kaplan, R.S., Norton, D.P., 1996b. *The Balanced Scorecard: Translating Strategy into Action*. Harvard Business School Press.
- Kaplan, R.S., Norton, D.P., 2005. The Balanced Scorecard: Measures That Drive Performance. *Harvard Business Review*. 83, 172–180.
- Kaplan, R.S., Norton, D.P., 2004. Strategy maps: converting intangible assets into tangible outcomes. Harvard Business Press.
- Kaplan, S., Garrick, B.J., 1981. On The Quantitative Definition of Risk. *Risk Analysis* 1, 11–27.
- Karsak, E.E., 2005. Choquet Integral-Based Decision Making Approach for Robot Selection, in: Khosla, R., Howlett, R.J., Jain, L.C. (Eds.), *Knowledge-Based Intelligent Information and Engineering Systems*. Springer Berlin Heidelberg, pp. 635–641.
- Kavakli, E., 2002. Goal-Oriented Requirements Engineering: A Unifying Framework. *Requirements Engineering* 6, 237–251.
- Kayis, B., Arndt, G., Zhou, M.S. Amornsawadwatana, 2007. A Risk mitigation methodology for new product and process design in concurrent engineering projects. *CIRP Annals - Manufacturing Technology* 56, 167–170.
- Keeney, R.L., Raiffa, H., 1976. *Decision analysis with multiple conflicting objectives*. Wiley & Sons, New York.
- Keeney, R.L., 1994. Creativity in decision making with value-focused thinking. *Sloan Management Review* 35, 33–33.
- Keeney, R.L., 1996. *Value-Focused Thinking: A Path to Creative Decision-making*, New ed. Harvard University Press.
- Keller, G., Nüttgens, M., Scheer, A.W., 1992. Semantische prozessmodellierung auf der grundlage “ereignisgesteuerter prozessketten (epk)”. *Veröffentlichungen des Instituts für Wirtschaftsinformatik* 89.
- Kempf-Leonard, K., 2004. *Encyclopedia of Social Measurement*, Three-Volume Set, 1st ed. Academic Press.
- Kennerley, M., Neely, A., 2003. Measuring performance in a changing business environment. *International Journal of Operations & Production Management* 23, 213–229.
- Kirkwood, C.W., Sarin, R.K., 1980. Preference Conditions for Multiattribute Value Functions. *Operations Research* 28, 225–232.
- Kosanke, K., Zelm, M., 1999. CIMOSA modelling processes. *Computers in Industry* 40, 141–153.
- Kueng, P., 2000. Process performance measurement system: a tool to support process-based organizations. *Total Quality Management* 11, 67–85.
- Kueng, P., Kawalek, P., 1997. Goal-based business process models: creation and evaluation. *Business Process Management Journal* 3, 17–38.

- Van Lamsweerde, A., Letier, E., 2000. Handling obstacles in goal-oriented requirements engineering. *Software Engineering, IEEE Transactions on* 26, 978–1005.
- Larson, N., Kusiak, A., 1996. Managing design processes: A risk assessment approach. *IEEE Transactions on Systems, Man, and Cybernetics- Part A: Systems and Humans* 26, 749–759.
- Lauras, M., Lamothe, J., Pingaud, H., 2011. A business process oriented method to design supply chain performance measurement systems. *International Journal of Business Performance Management* 12, 354 – 376.
- Lebas, M., 1994. Managerial accounting in France Overview of past tradition and current practice. *European Accounting Review* 3, 471–488.
- Lebas, M., 1995. Performance measurement and performance management. *International Journal of Production Economics* 41, 23–35.
- Lee, J., Lee, D., Kang, S., 2007. Advances in Web and Network Technologies, and Information Management, in: *Lecture Notes in Computer Science*. Springer Berlin / Heidelberg, pp. 384–395.
- Leitch, M., 2010. ISO 31000: 2009—The New International Standard on Risk Management. *Risk Analysis* 30, 887–892.
- Limnios, N., 2007. *Fault trees*. John Wiley & Sons, New-York.
- List, B., Korherr, B., 2006. An evaluation of conceptual business process modelling languages, in: *Proceedings of the 2006 ACM Symposium on Applied Computing*. pp. 1532–1539.
- Lootsma, F.A., 1999. *Multi-Criteria Decision Analysis via Ratio and Difference Judgement*, 1st ed. Springer-Verlag, Berlin.
- Lynch, R.L., Cross, K.F., 1992. The SMART way to define and sustain success. *National Productivity Review* 8, pp. 23-33
- Markowski, A.S., Kotynia, A., 2011. “Bow-tie” model in layer of protection analysis. *Process Safety and Environmental Protection* 89, 205–213.
- Marquès, G., 2010. *Management des risques pour l’aide à la gestion de la collaboration au sein d’une chaîne logistique: une approche par simulation*, University of Toulouse, Ph.D. Thesis,
- Marques, G., Gourc, D., Lauras, M., 2011. Multi-criteria performance analysis for decision making in project management. *International Journal of Project Management* 29, 1057–1069.
- Martinez, V., 2003. *Understanding value creation: the value matrix and the value cube*. University of Strathclyde, Glasgow, Ph.D. Thesis.
- Maskell, B.H., 1991. *Performance Measurement for World Class Manufacturing: A Model for American Companies*, 1st ed. Productivity Press.
- Matty, D.M., 2010. *Stakeholder Saliency Influence on Bureaucratic Program Enterprise Value Creation*. Cambridge MA, Massachusetts Institute of Technology. Ph.D. Thesis.
- Mayag, B., Grabisch, M., Labreuche, C., 2011. A characterization of the 2-additive Choquet integral through cardinal information. *Fuzzy Sets and Systems* 184, 84–105.
- Mayer, R.J., Menzel, C., Painter, M., deWitte, P., Blinn, T., Benjamin, P., 1993. *IDEF3 process description capture method report*. Wright-Patterson AFB, Ohio, AL/HRGA.
- Medori, D., Steeple, D., 2000. A framework for auditing and enhancing performance measurement systems. *International Journal of Operations & Production Management* 20, 520–533.

- Melnyk, S.A., Stewart, D.M., Swink, M., 2004. Metrics and performance measurement in operations management: dealing with the metrics maze. *Journal of Operations Management* 22, 209–218.
- Merchant, P.K., Stede, P.W.V. der, 2007. *Management Control Systems: Performance Measurement, Evaluation and Incentives*, 2nd ed. Financial Times/ Prentice Hall.
- Meyer, A., Nakane, J., Miller, J.G., Ferdows, K., 1989. Flexibility: The next competitive battle the manufacturing futures survey. *Strategic Management Journal* 10, 135–144.
- Meyer, M.W., 2003. *Rethinking Performance Measurement: Beyond the Balanced Scorecard*. Cambridge University Press.
- Mike, K., Andy, N., 2003. Measuring performance in a changing business environment.
- Mitchell, R.K., Agle, B.R., Wood, D.J., 1997. Toward a Theory of Stakeholder Identification and Salience: Defining the Principle of Who and What Really Counts. *The Academy of Management Review* 22, 853–886.
- Moeller, R., 2007. *COSO Enterprise Risk Management: Understanding the New Integrated ERM Framework*, 1st ed. Wiley& Sons, New-York.
- Mokhtari, K., Ren, J., Roberts, C., Wang, J., 2011. Application of a generic bow-tie based risk analysis framework on risk management of sea ports and offshore terminals. *Journal of Hazardous Materials* 192, 465–475.
- Montmain, J., Mauris, G., Akharraz, A., 2005. Elucidation and decisional risk in a multi-criteria decision based on a Choquet integral aggregation—a cybernetic framework. *Journal of Multi-Criteria Decision Analysis* 13, 239–258.
- Motwani, J., 2001. Critical factors and performance measures of TQM. *The TQM Magazine* 13, 292–300.
- Muehlen, M. zur, Recker, J., 2008. How Much Language Is Enough? Theoretical and Practical Use of the Business Process Modeling Notation, in: Bellahsène, Z., Léonard, M. (Eds.), *Advanced Information Systems Engineering*. Springer Berlin Heidelberg, Berlin, Heidelberg, pp. 465–479.
- Mullai, A., 2009. Risk Management System – A Conceptual Model, in: Zsidisin, G.A., Ritchie, B. (Eds.), *Supply Chain Risk*. Springer US, Boston, MA, pp. 83–101.
- Mun, J., 2006. *Modeling Risk: Applying Monte Carlo Simulation, Real Options Analysis, Forecasting, and Optimization Techniques*. Wiley& Sons, New-York.
- Murata, T., 1989. Petri nets: Properties, analysis and applications. *Proc. of the IEEE*. 77 (4), 541-580.
- Narasimhan, R., Talluri, S., 2009. Perspectives on risk management in supply chains. *Journal of Operations Management* 27, 114–118.
- Narukawa, Y., 2010. *Modeling Decisions: Information Fusion and Aggregation Operators*. Springer-Verlag, Berlin.
- Neap, H.S., Celik, T., 1999. Value of a product: A definition. *International Journal of Value-Based Management* 12, 181–191.
- Neely, A. 2002. *Business Performance Measurement*. Cambridge University Press.
- Neely, A., Adam, C., Kennerley, M., 2002. *The Performance Prism: The ScoreCard for Measuring and Managing Business Success*. FT Prentice Hall, London

- Neely, A., 1999. The performance measurement revolution: why now and what next? *International Journal of Operations & Production Management*, Vol. 19 Iss: 2, pp.205 - 228
- Neely, A., 2007. *Business Performance Measurement: Unifying Theory and Integrating Practice*, 2nd Revised ed. Cambridge University Press.
- Neely, A., Al Najjar, M., 2006. Management learning not management control: the true role of performance management? *California Management Review* 48, 101–114.
- Neely, A., Bourne, M., Mills, J., Platts, K., Richards, H., 2002. *Strategy and Performance: Getting the Measure of Your Business*. Cambridge University Press.
- Neely, A., Gregory, M., Platts, K., 2005. Performance measurement system design: a literature review and research agenda. *International Journal of Operations & Production Management* 25, 1228–1263.
- Neely, A., Mills, J., Platts, K., Gregory, M., Richards, H., 1996. Performance measurement system design: Should process based approaches be adopted? *International Journal of Production Economics* 46-47, 423–431.
- Neely, A., Richards, H., Mills, J., Platts, K., Bourne, M., 1997. Designing performance measures: a structured approach. *International Journal of Operations & Production Management* 17, 1131–1152.
- Neiger, D., Churilov, L., 2003. Goal-Oriented Decomposition of Event-Driven Process Chains with Value Focused Thinking. *ACIS Proceedings*.
- Neiger, D., Churilov, L., 2004. Goal-Oriented Business Process Modeling with EPCs and Value-Focused Thinking, in: Desel, J., Pernici, B., Weske, M. (Eds.), *Business Process Management*. Springer Berlin Heidelberg, pp. 98–115.
- Neiger, D., Churilov, L., Flitman, A., 2008. *Value-Focused Business Process Engineering: a Systems Approach: with Applications to Human Resource Management*. Springer-Verlag, Berlin.
- Neiger, D., Churilov, L., Muehlen, M., others, 2006. Integrating risks in business process models with value focused process engineering. *Proceedings of the 14th European Conference on Information Systems*, Sweden, Goteborg.
- Nilsson, C.H., Nordahl, H., 1995. Making manufacturing flexibility operational—part 1: A framework. *Integrated Manufacturing Systems* 6, 5–11.
- Nilsson, F., Kald, M., 2002. Recent Advances in Performance Management: The Nordic Case. *European Management Journal* 20, 235–245.
- Nudurupati, S.S., Bititci, U.S., Kumar, V., Chan, F.T.S., 2011. State of the art literature review on performance measurement. *Computers & Industrial Engineering* 60, 279–290.
- Olsen, E.O., Zhou, H., Lee, D.M.S., Ng, Y.-E., Chong, C.C., Padunchwit, P., 2007. Performance measurement system and relationships with performance results: A case analysis of a continuous improvement approach to PMS design. *International Journal of Productivity and Performance Management* 56, 559–582.
- Paranjape, B., Rossiter, M., Pantano, V., 2006. Performance measurement systems: Successes, failures and future—a review. *Measuring Business Excellence* 10, 4–14.
- Parker, R.P., Wirth, A., 1999. Manufacturing flexibility: Measures and relationships. *European Journal of Operational Research* 118, 429–449.
- Parnell, G.S., Driscoll, P.J., Henderson, D.L., 2010. *Decision Making in Systems Engineering and Management*. John Wiley and Sons, New-York.



- Perera, S., Harrison, G., Poole, M., 1997. Customer-focused manufacturing strategy and the use of operations-based non-financial performance measures: A research note. *Accounting, Organizations and Society* 22, 557–572.
- Peterson, J.L., 1981. *Petri Net Theory and the Modeling of Systems*. Prentice-Hall, Inc., Englewood Cliffs, NJ.
- Petri, C.A., 1966. *Communication with automata: Volume 1 Supplement 1*. DTIC Document.
- Pfeffer, J., Sutton, R.I., 2006. Evidence-based management. *Harvard Business Review* 84, 62.
- Pidd, M., 2009. *Tools for Thinking: Modelling in Management Science*, 3rd ed. John Wiley & Sons, New-York.
- Porter, M.E., 1998. *Competitive advantage: creating and sustaining superior performance: with a new introduction*. Free Press.
- Powell, T.C., 1995. Total quality management as competitive advantage: A review and empirical study. *Strategic Management Journal* 16, 15–37.
- Purba, J.H., Lu, J., Ruan, D., Zhang, G., 2010. A Hybrid Approach for Fault Tree Analysis Combining Probabilistic Method with Fuzzy Numbers, Springer-Verlag, Berlin, pp. 194–201.
- Radnor, Z.J., Barnes, D., 2007. Historical analysis of performance measurement and management in operations management. *International Journal of Productivity and Performance Management* 56, 384–396.
- Rahmat, M.K., Jovanovic, S., 2009. Reliability modeling of uninterruptible power supply systems using fault tree analysis method. *European Transactions on Electrical Power* 19, 258–273.
- Ravelomanantsoa, M., Ducq, Y., Vallespir, B., 2010. Integration of Requirements for Performance Indicator System Definition and Implementation Methods, in: Vallespir, B., Alix, T. (Eds.), *Advances in Production Management Systems. New Challenges, New Approaches*. Springer Berlin Heidelberg, pp. 530–537.
- Ravindran, A.R., 2008. *Operations research methodologies*, CRC Press.
- Recker, J., 2011. *Evaluations of Process Modeling Grammars: Ontological, Qualitative and Quantitative Analyses Using the Example of BPMN*. Springer-Verlag, Berlin.
- Recker, J., Rosemann, M., Indulska, M., Green, P., 2009. Business process modeling-a comparative analysis. *Journal of the Association for Information Systems* 10, 1.
- Rezaie, K., Amalnik, M.S., Gereie, A., Ostadi, B., Shakhseniaee, M., 2007. Using extended Monte Carlo simulation method for the improvement of risk management: Consideration of relationships between uncertainties. *Applied Mathematics and Computation* 190, 1492–1501.
- Remenyi, D., Heafield, A., 1996. Business process re-engineering: some aspects of how to evaluate and manage the risk exposure. *International Journal of Project Management* 14, 349–357.
- Richardson, P.R., Gordon, J.R.M., 1980. Measuring total manufacturing performance. *Sloan Management Review* 21.
- Ridgway, V.F., 1956. Dysfunctional Consequences of Performance Measurements. *Administrative Science Quarterly* 1, 240–247.
- Robinson, S., 2004. *Simulation: The Practice of Model Development and Use*, 1st ed. Wiley & Sons, New-York.
- Rose, K.H., 1995. A performance measurement model, *Quality Progress*, 28(2): 63–66.

- Rosemann, M., Recker, J., Green, P.F., Indulska, M., 2009. Using ontology for the representational analysis of process modelling techniques. *International Journal of Business Process Integration and Management* 4, 251–265.
- Rosenberg, N., Landau, R., Mowery, D.C., 1992. *Technology and the wealth of nations*. Stanford University Press, Stanford, CA.
- Royer, P., 2000. From My Experience - Risk Management: The Undiscovered Dimension of Project Management. *Project Management Quarterly*. 31, 6.
- Rushton, A., Croucher, P., Baker, P., 2010. *The Handbook of Logistics and Distribution Management*, Fourth ed. Kogan Page.
- Ryan, J., Heavey, C., 2006. Process modeling for simulation. *Computers in Industry* 57, 437–450.
- Saaty, T., 2004. Fundamentals of the analytic network process — Dependence and feedback in decision-making with a single network. *Journal of Systems Science and Systems Engineering* 13, 129–157.
- Saaty, T.L., 1990. How to make a decision: the analytic hierarchy process. *European Journal of Operational Research* 48, 9–26.
- Sadiq, S., Governatori, G., Namiri, K., 2007. Modeling control objectives for business process compliance, in: *Proceedings of the 5th International Conference on Business Process Management*. pp. 149–164.
- Sahraoui, S.A. 2009. *Vers un système d'aide à la décision pour l'optimisation de la mise en oeuvre de démarches d'amélioration de la performance industrielle*. University of Savoie, Ph.D. Thesis.
- Sahraoui, S., Berrah, L., Montmain, J., others, 2007. *Techniques d'optimisation et modèle d'agrégation pour l'outillage d'une démarche d'amélioration industrielle*. 7e Congrès international de génie industriel (GI 2007), Trois Rivières, Québec, Canada.
- Salah E., E., 2005. On the fallacy of averages in project risk management. *European Journal of Operational Research* 165, 307–313.
- Santos, S.P., Belton, V., Howick, S., 2002. Adding value to performance measurement by using system dynamics and multicriteria analysis. *International Journal of Operations & Production Management* 22, 1246–1272.
- Sargent, R.G., 2010. Verification and validation of simulation models, in: *Proceedings of the 2010 Winter Simulation Conference*, Baltimore, Maryland, USA. pp. 166–183.
- Scheer, A.-W., 2000. *ARIS: Business Process Modeling*, 3rd ed. Springer-Verlag, Berlin.
- Scott, J.E., Vessey, I., 2002. Managing risks in enterprise systems implementations. *Commun. ACM* 45, 74–81.
- Senechal, 2004. *Automatique et Informatique des Systèmes Industriels et Humains*. Habilitation à diriger les recherches, University of Valenciennes and du Hainaut Cambresis.
- Sethi, A., Sethi, S., 1990. Flexibility in manufacturing: A survey. *International Journal of Flexible Manufacturing Systems* 2.
- Shahzad, K., Zdravkovic, J., 2009. A goal-oriented approach for business process improvement using process warehouse data. *The Practice of Enterprise Modeling*, pp 84–98.
- Sienou, A., 2009. *Proposition d'un cadre méthodologique pour le management intégré des risques et des processus d'entreprise*. University of Toulouse, Ph.D. Thesis.

- Sienou, A., Lamine, E., Pingaud, H., Karduck, A., 2009. Aspects of the BPRIM Language for Risk Driven Process Engineering, in: Meersman, R., Herrero, P., Dillon, T. (Eds.), *On the Move to Meaningful Internet Systems: OTM 2009 Workshops*. Springer Berlin Heidelberg, pp. 172–183.
- Simon, H.A., 1954. Centralization vs. decentralization in organizing the controller's department: A research study and report. Controllership Foundation.
- Simons, R., 1995. Control in an age of empowerment. *Business Credit-New York*-97, 25–25.
- Skinner, W., 1969. Manufacturing—missing link in corporate strategy. *Harvard Business Review* 47, 136–145.
- Skinner, W., 1973. The decline, fall, and renewal of manufacturing plants. Division of Research, Graduate School of Business Administration, Harvard University.
- Slack, N., 1983. Flexibility as a manufacturing objective. *International Journal of Operations & Production Management* 3, 4–13.
- Slack, N., 2005. The changing nature of operations flexibility. *International Journal of Operations & Production Management* 25, 1201–1210.
- Slack, N., Chambers, S., Johnston, R., 2007. *Operations Management*, 5th ed. Trans-Atlantic Publications, Inc.
- Sormaz, D.N., Khoshnevis, B., 2003. Generation of alternative process plans in integrated manufacturing systems. *Journal of Intelligent Manufacturing* 14, 509–526.
- Stalk, G., 1988. Time -The Next Source of Competitive Advantage. *Harvard Business Review* 66(4), pp.41-51.
- Stalk, G., Jr, Hout, T.M., 1990. How time-based management measures performance. *Strategy & Leadership* 18, 26–29.
- Sterman, J., Sterman, J.D., 2000. *Business Dynamics: Systems Thinking and Modeling for a Complex World*. McGraw-Hill/Irwin.
- Stern, J.M., Shiely, J.S., Ross, I., 2001. *The EVA Challenge: Implementing Value Added Change in an Organization*, 1st ed. Wiley & Sons, New-York.
- Suwignjo, P., Bititci, U., Carrie, A., 2000. Quantitative models for performance measurement system. *International Journal of Production Economics* 64, 231–241.
- Suzaki, K., 1987. *New Manufacturing Challenge: Techniques for Continuous Improvement*. Free Press.
- Symons, R.T., Jacobs, R.A., 1995. A Total Quality Management-based Incentive System Supporting Total Quality Management Implementation. *Production and Operations Management* 4, 228–241.
- Tan, H.P., Plowman, D., Hancock, P., 2008. The evolving research on intellectual capital. *Journal of Intellectual Capital* 9, 585–608.
- Tan, W.A., Shen, W., Xu, L., Zhou, B., Li, L., 2008. A business process intelligence system for enterprise process performance management. *Systems, Man, and Cybernetics, Part C: Applications and Reviews*, IEEE Transactions on 38, 745–756.
- Tangen, S., 2004. Evaluation and revision of performance measurement systems. Royal Institute of Technology, Sweden, PhD Thesis.
- Taticchi, P., 2010. *Business Performance Measurement and Management: New Contexts, Themes and Challenges*. Springer-Verlag, Berlin.
- Taylor, F.W., 1911. *The Principles of Scientific Management*. 1st World Library.

- Teoh, P.C., Case, K., 2005. An evaluation of failure modes and effects analysis generation method for conceptual design. *International Journal of Computer Integrated Manufacturing* 18, 279–293.
- Teoh, P.C., Case, K., 2004. Failure modes and effects analysis through knowledge modelling. *Journal of Materials Processing Technology* 153-154, 253–260.
- Tixier, J.G., Dusserre, O. Salvi, D. Gaston, 2002. Review of 62 risk analysis methodologies of industrial plants. *Journal of Loss Prevention in the Process Industries* 15, 291–303.
- Tuncel, G., Alpan, G., 2010. Risk assessment and management for supply chain networks: A case study. *Computers in Industry* 61, 250–259.
- Vandenbosch, B., 1999. An empirical analysis of the association between the use of executive support systems and perceived organizational competitiveness. *Accounting, Organizations and Society* 24, 77–92.
- Van Der Aalst, W.M.P., TerHofstede, A.H.M., Kiepuszewski, B., Barros, A.P., 2003. Workflow patterns. *Distributed and parallel databases* 14, 5–51.
- Van Der Aalst, W.M.P., 1999. Formalization and verification of event-driven process chains. *Information and Software Technology* 41, 639–650.
- Venkatraman, N., Ramanujam, V., 1986. Measurement of Business Performance in Strategy Research: A Comparison of Approaches. *The Academy of Management Review* 11, 801–814.
- Vernadat, F.B., 1996. *Enterprise Modeling and Integration: Principles and Applications*. Chapman & Hall, London.
- Vernadat, F., 1999. *Techniques de Modélisation en Entreprise: Applications aux Processus Opérationnels*. Economica, Paris.
- Vose, D., 2008. *Risk Analysis: A Quantitative Guide*, 3rd ed. Wiley & Sons, New-York.
- Waggoner, D.B., Neely, A.D., P. Kennerley, M., 1999. The forces that shape organisational performance measurement systems: An interdisciplinary review. *International Journal of Production Economics* 60-61, 53–60.
- Wand, Y., Weber, R., 2002. Research commentary: Information systems and conceptual modeling-a research agenda. *Information Systems Research* 13, 363–376.
- Wang, J.X., Roush, M.L., 2000. *What Every Engineer Should Know About Risk Engineering and Management*, 1st ed. CRC Press.
- Webb, A., 1996. *Managing innovative projects*. Cengage Learning.
- Yu, E., 2011. Modeling strategic relationships for process reengineering. *Social Modeling for Requirements Engineering* 11.
- Zopounidis, C., 2010. *Handbook of Multicriteria Analysis*. Springer-Verlag, Berlin.
- Zelm, M., Vernadat, F.B., Kosanke, K., 1995. The CIMOSA business modelling process. *Computers in Industry* 27, 123–142.
- Zsidisin, G.A., Ritchie, B., 2008. *Supply Chain Risk: A Handbook of Assessment, Management, and Performance*, 1st ed. Springer-Verlag, Berlin.



## Appendices

### Appendix A The mechanical locator

#### 1 Description of the Product

A mechanical locator is a work holding device that is intended to be placed on a machining machine in a modular fixture for holding work-pieces. The one considered is made of five component parts: axle, body, cap, bolt and spring (as drawn in Figure A-1). The top of the cap is considered as one of the three small supports contributing to the planned support of the work-piece to be machined. The tapered portion of the axle allows the work-piece to be centered through a conical hole. The axial mobility of the axis compensates for the dimensional variations of the hole in the casting. Figure A-1 shows two configurations: a free-state configuration and a loaded-state one. The proposed detailed design defines three main parts called: axle, body and cap.

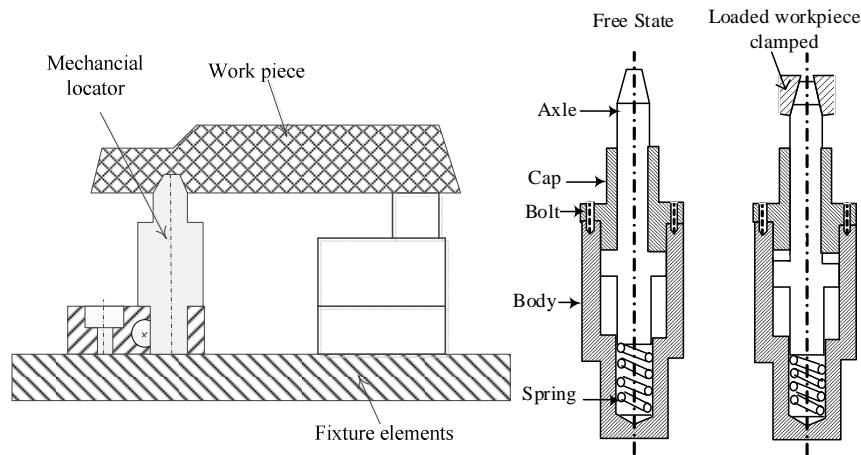

**Figure A-1: Mechanical locator: Product in context (to the left), product sans context (to the right) in free and loaded situation**

#### 2 Process plans for axle, body and cap

First of all, features for component parts are identified and indexed. The  $F_{index}$  indicates a feature on a part while  $F_{index}'$  (index prime) represents the newly generated feature after the unfulfilled feature  $F_{index}$  or more precisely, the feature needs further operations to be fully machined. Employing the principle of Sormaz and Khoshnevis (2003), a number of process plans have been identified and expressed. Out of them, only three process plans for each component part are selected and modeled. The selection of these process plans for further evaluation can be carried out either on the basis of availability of machines or simply selecting processes that can better satisfy objective functions (such as minimum time and cost, minimum risk). If machines are not available, those nodes on the process plan network are simply excluded.

Figure A-2 to Figure A-4 show the process plan models for the axle, body and cap, respectively

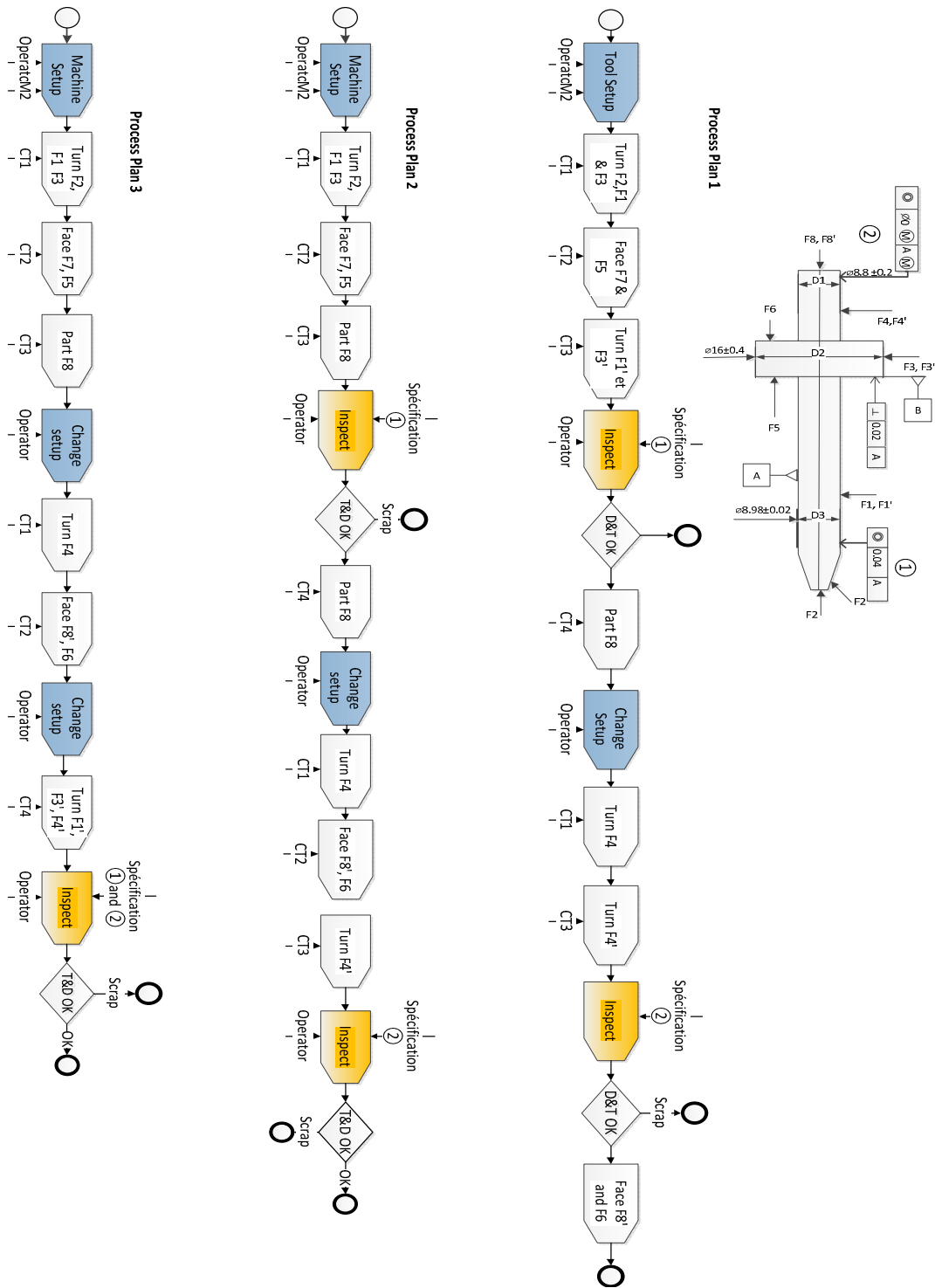

Figure A-2: Process plans for the axle part

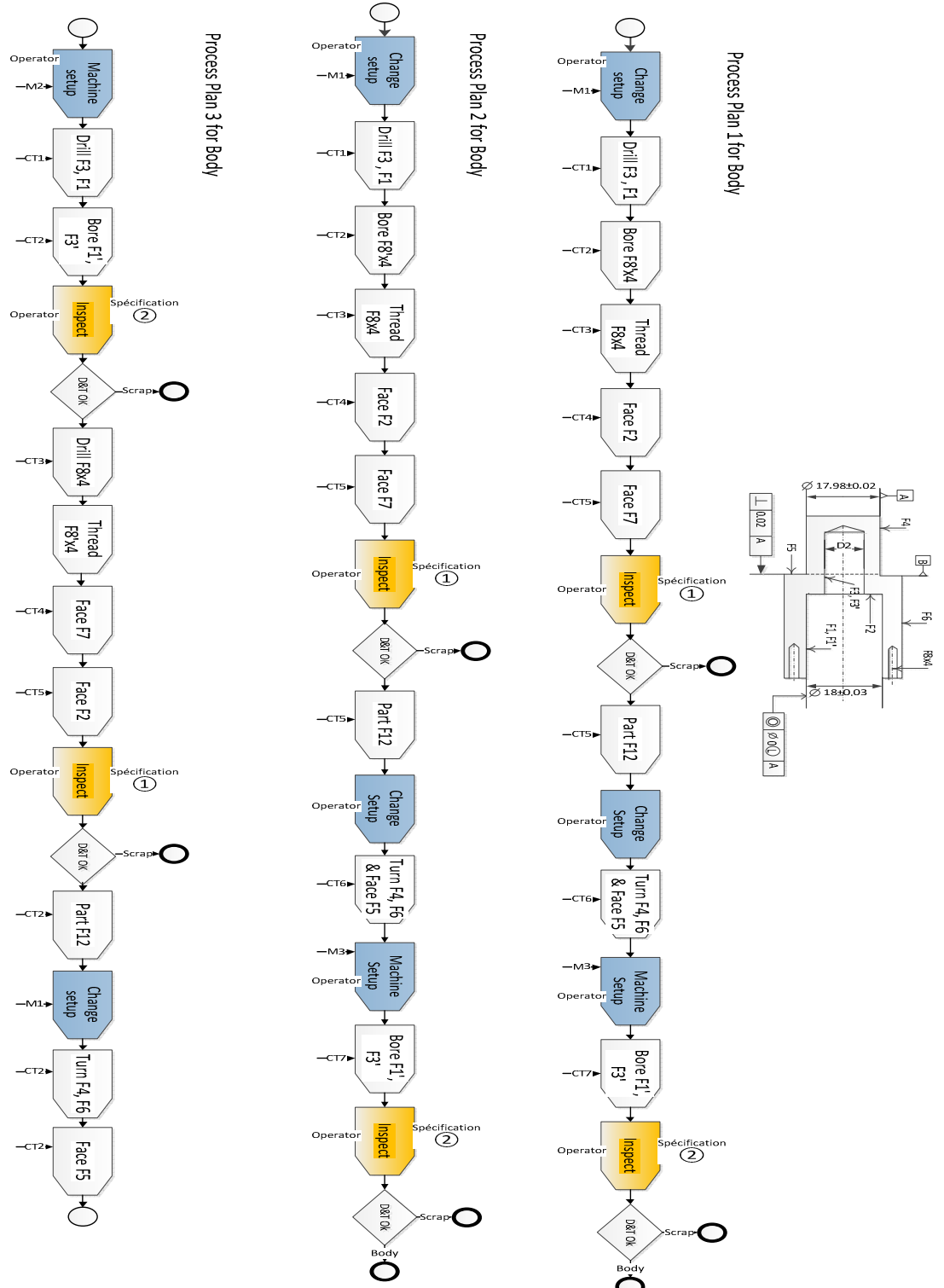

Figure A-3: Process plans for the body part



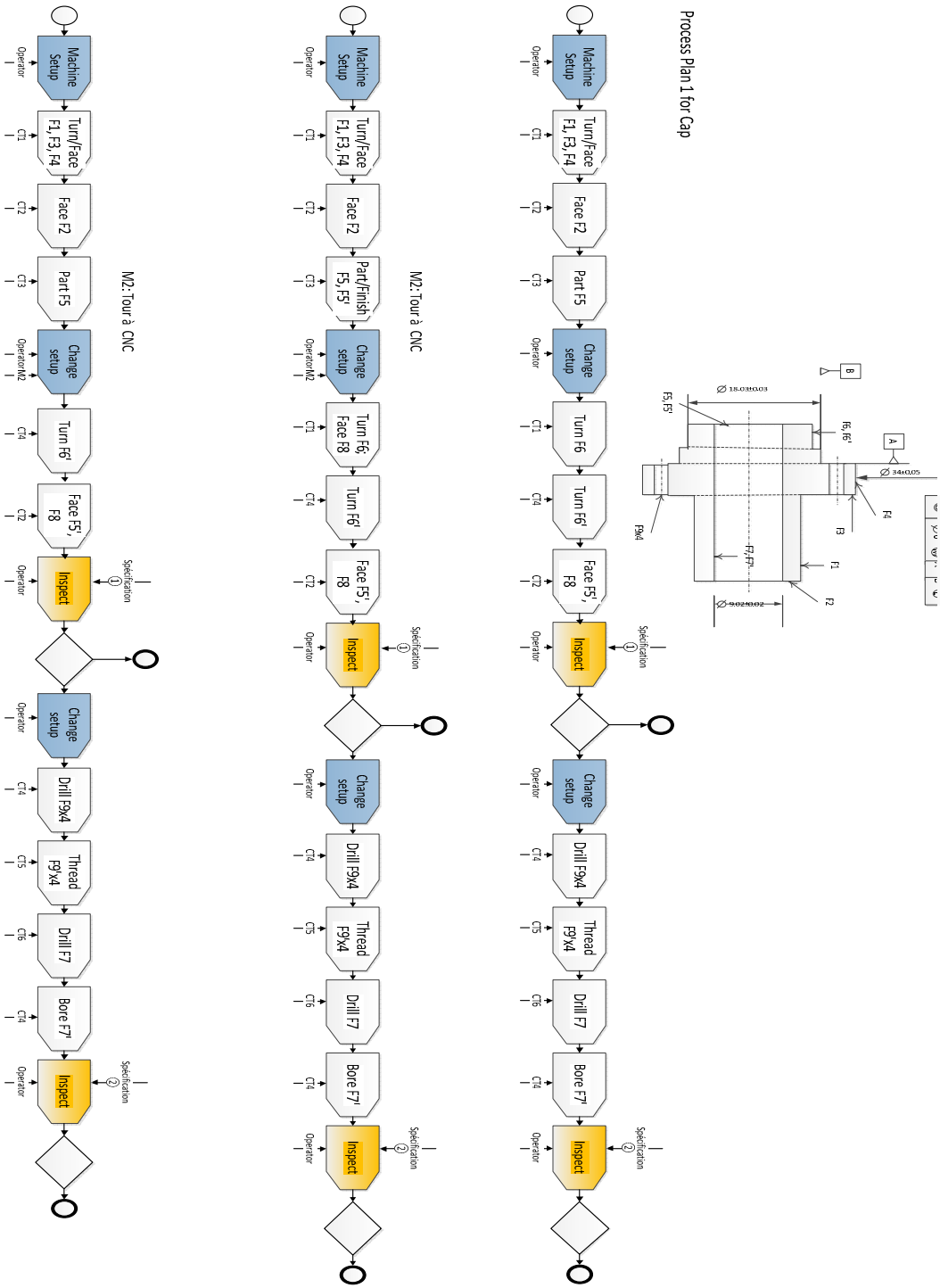

Figure A-4: Process plans for the cap pa

## Appendix B Risk Assessment of Production Scenarios

In the production scenario 1, a customer orders 1000 mechanical locators (see §6.1.2.1 ). Because the customer needs the required products in a short period of time, therefore the lead time objective becomes a critical objective in this scenario. To avoid any dissatisfaction on the part of the customer, the company carries out a risk assessment of the manufacturing processes. The risk assessment of the processes mainly focuses on the identification of the activities which adversely affect the objective of lead-time. Therefore, a scheduled risk based process FMEA is developed with a main focus on the delay oriented failure modes (see Table B-1).

In the production scenario 2, the customer orders 200 mechanical locators of high quality and allows sufficient time for the order to be delivered (see §6.1.2.2 ). Therefore, the lead-time objective is no more the critical objective in the current scenario. Instead, the quality is.

As quality of the product is the critical dimension in scenario 2, therefore the risk assessment of manufacturing process plans is carried out with a focus on critical activities/operations. Critical activities are the ones which are aimed at realizing features with tight tolerances.

On the other hand, in the production scenario 2, the customer orders high quality mechanical locators while compromising to some extent on the other dimensions of performance, i.e. cost and time.

For determining the quality levels of the mechanical locator, two levels are defined: high-quality and low quality. A high quality product has a satisfaction index ( $q$ ) of 100%. With this value, there is no problem of product functionality. However, the product cost will increase. On the other hand, low quality products have specifications for each product functionality that are acceptable but beyond this value, the risk of malfunctioning (not meeting the functional requirement and not possible to assemble) is high and  $q = 0$ .

For example, the geometrical tolerances for the mechanical locator are determined as expressed in Figure B-1:

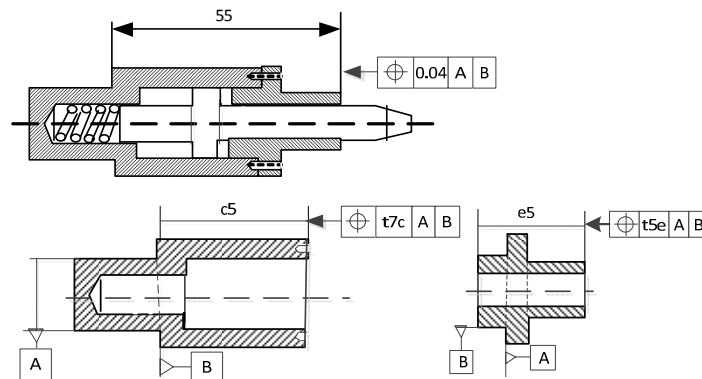

**Figure B-1: Geometrical tolerance of the mechanical locator**

From Table B-1, the following specifications should be respected to satisfy one of the functionality of the product, as required by the customer.

$$X_{max} = X_{avg.} + variation. \frac{x}{2} = c5 + e5 + \frac{t7c + t5e}{2} \leq 55.02$$

$$X_{min} = X_{avg.} - variation. \frac{x}{2} = c5 + e5 - \frac{t7c + t5e}{2} \geq 54.98$$

Similarly, other specifications have been determined and are analyzed in FMEA proposed in Table B-2. The degree of satisfaction of the customer is then proportional to the degree of satisfaction of each critical specification of the mechanical locator. Furthermore, the requirements in the FMEA table are grouped into S, P and D referring to serviceability, positioning and design requirements, respectively of the mechanical locator.

**Table B-1: FMEA Table for schedule risks**

Fundamental Risk	Risk Levels	Process	Function	Potential Failure Mode	Potential Effects of Failure	SEV	Potential Causes	PROB	DET	RPN
Schedule Risk	Quality failures	Turning of feature F4 (part body)	Body adjustment in the modular fixture (service. Req.)	failure to adjust in the modular fixture	Manufacturing delay	7		5	5	175
		Turning of features F1 , F3' (part axle)	Axle fitting into the cap (position. Req.)	Axle/cap assembly failure	Manufacturing delay	7		5	5	175
		Turning of features F6, F6' (part cap)	Cap/Body fitting (position. Req.)	Failure to assemble Cap/Body		7		8	5	280
		Body/Assembling process	Axle dia (D3_A) fitting into Body dia (D2_B) (Design req.)	Parts non assemblable	Manufacturing delay	8		7	4	224
	Estimation Error	Operation i , i = { 10; 40; 70, ... } of the process plan	N/A	Duration estimation error	Uncertain lead time	5	Unavailable information Wrong information Incomplete information Wrong belief	6	5	150
	Disruptions	Operation i , i = { 20, 30, 70, ... }	N/A	Machine Mi breakdown bottleneck in machine i	Manufacturing delay	5	Insufficient maintenance of machines imbalance in the	7	3	105
		Manufacturing Process i	highly smooth texture to reduce friction between parts	Operator absent	Manufacturing delay	3	absenteeism	5	6	90

**Table B-2: FMEA tablefor performance risks**

Appendix B Risk Assessment of Production Scenarii

Fundamental risk	Risk Levels	Process Description	Requirement	Potential Failure Mode	Potential Effects of Failure	SEV	Potential Causes	PROB	DET	RPN	
Performance Risk	Non-conformity	Parting /Facing F2 (Cap), Facing F7 (Body)	Tolerance interval 0.04 of Plan A w.r.t Plan B (req. S1)	Poor length of the parts	Malfunctioning of the mechanical locator	8	Improper assembly tolerance allocation, wrong machine set up	5	5	200	
		Tapering operation (F2, Axle)	Coaxiality with tolerance of $\varnothing$ 0.04mm (req. S9)	Cone of the Axle does not locate (center) the work piece	Unable to hold the work piece rightly	3	Improper assembly tolerance allocation,	4	4	48	
		Turning of dia (F4, Body)	Tolerance interval $\varnothing$ 0.08mm (req. S4)	Failure to fit body into modular fixture	Unable to hold the object tightly	3	Machine tool not properly set to angle spindle vibration	5	4	60	
		Facing operation (F5, Body)	Perpendicularity with TI = 0.05 w.r.t Plan A (req. S11)	Mal Contact of mechanical locator assembly							
		Facing/finish. (F5, F5', Cap)	Matting requirement, TI= 0.05 (req. P2)	Improper matting of Cap end with axle shoulder	Play/clearance in assembly						
		Assembly process	D3_Axle >= D2_B, T=?	Diameter are not equal	Assembly failure	5		4	6	120	
			D1_A >= D1_C	D3 or D1 are not equal	Assembly failure						
	Humman Error	Inspection process	N/A	Type 1 error (falsely rejected non defective parts)	Warranty claims, Client complaints etc.	6	Human error, sampling method inefficient	4	6	144	
				Type 1 error (falsely rejected non defective parts)							
		N/A	Type II error (falsely acceptance)	Warranty claims, Client complaints etc.	8	Human error, sampling method inefficient	5	5	200		

## Appendix C Performance Evaluation Methods

**Table C-1: Performance evaluation method**

Performance measures		Calculation Method
Process cost		$C_m = \sum_{i=1}^N C_{activity}^i$
Cost of quality		$\sum (\text{Appraisal cost}) + (\text{prevention cost}) + (\text{internal failure cost}) + (\text{external failure cost})$
	Prevention cost	$\sum_{i=1}^N C_{quality\ prevention\ activities}^i$
	Appraisal cost	$\sum_{i=1}^N C_{inspection}^i$
	Internal failure cost	$\sum scrap + rework\ cost$
Manufacturing time		$T_m = \sum_{i=1}^N t_{activity}^i$ $= \sum_{i=1}^N (t_{processing}^i + t_{setup}^i + t_{handling}^i + t_{load-unload}^i + t_{idling}^i)$
Process yield		(1-Scrap parts/Total parts)
Employee satisfaction		Length of time an employee work (in terms of workload)

Similarly, to identify risk in the processes, the calculation methods to calculate the risks quantitatively are also determined.

**Table C-2: Risks evaluation**

Cost Risk	$R_c(PP_k) = \sum_{i=1}^n P_i(C_i > UB) * C(x) R_c(PP_k)$
Schedule Risk	$= \sum_{i=1}^n P_i(C_i > duedate) * C(x)$
Quality Risk	$R_q(PP_k) = \sum_{i=1}^n P_i(Q_i \neq Specification) * C$



# Appendix D Fundamental Objectives Hierarchy

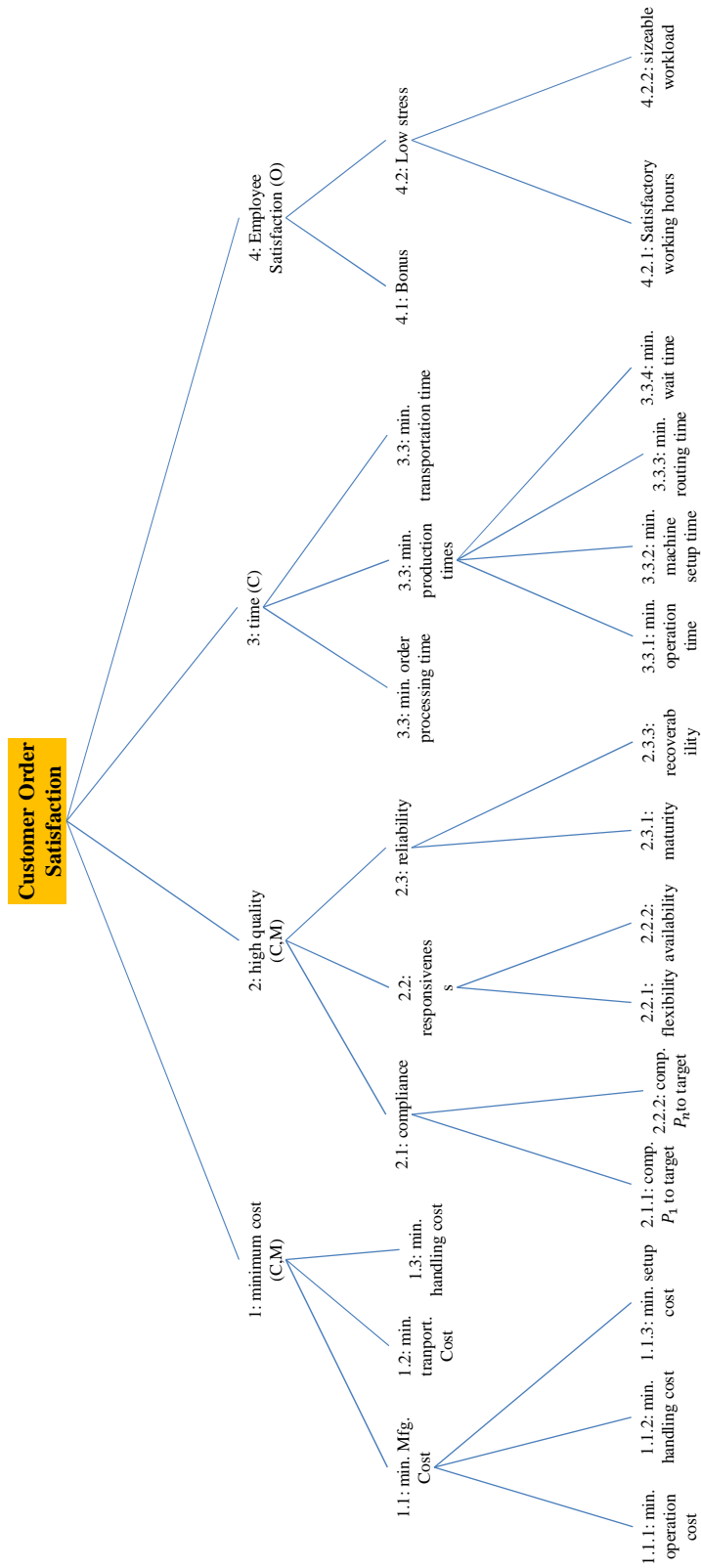













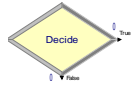

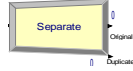
## Appendix E ARENA Simulation

### 1 Simulation constructs: Arena Modules

Modules are the flow charts and data objects that define a process to be simulated. The frequently used modules (flow charts only) in the current dissertation case studies are shown in Table E-1.

**Table E-1: Frequently used flow chart modules in production scenarios 1 & 2**

Modules	Description	Constructs
Create	Used to create entities.	
Process	Same as process model, used to seize and release resources as well as delay entities as needed.	
Decide	Used as a decision point in a simulation model. Decision is either based on probability or variable condition.	
Batch	Used to combine entities either temporarily or permanently.	
Separate	Used to separate a batched entity into its constituent parts.	
Assign	Used to manipulate attributes or variables every time an entity passes through.	
Record	Used to record tallies or counters that can be used to average statistics at the end of the simulation.	
Delay	Used to delay entities during logic flow.	
Hold	Used to hold an entity in a queue until a specified condition is met.	
Match	The match module brings together a specified number of entities waiting in different queues. Typical use in our case for assembly of axle, body and cap in assembly shop.	
Station	The station module defines a station (or a set of stations) corresponding to a physical or logical location where processing occurs, as, for instance thecells1, 2 or 3 of the job shop.	
Route	Transfer an entity to a specified station. In the case of the locating product,this route box sends axle part to the assembly shop.	

In addition to the flow chart modules, the data modules is used to feed the input data such as input variables, expressions, resources used, duration of activity and costs to the simulation models to make them operational.

## **2 ARENA model logic: Simulation model building**

This section briefly describes the computer-based simulation model for the mechanical locator process plans. The logic of the simulation model is shown in Figure E-1. For the purpose of simplicity, only the body process plan (process plan 3) is explained as well as few selected parts of the assembly process plan. The axle and cap parts of the locator have almost similar logic as the one used in the body process plan. The whole logic of the simulation can be divided into four categories: part arrival logic, work cells logic, assembly shop logic and simulation exit logic. Each one of them is briefly described in the following sections.

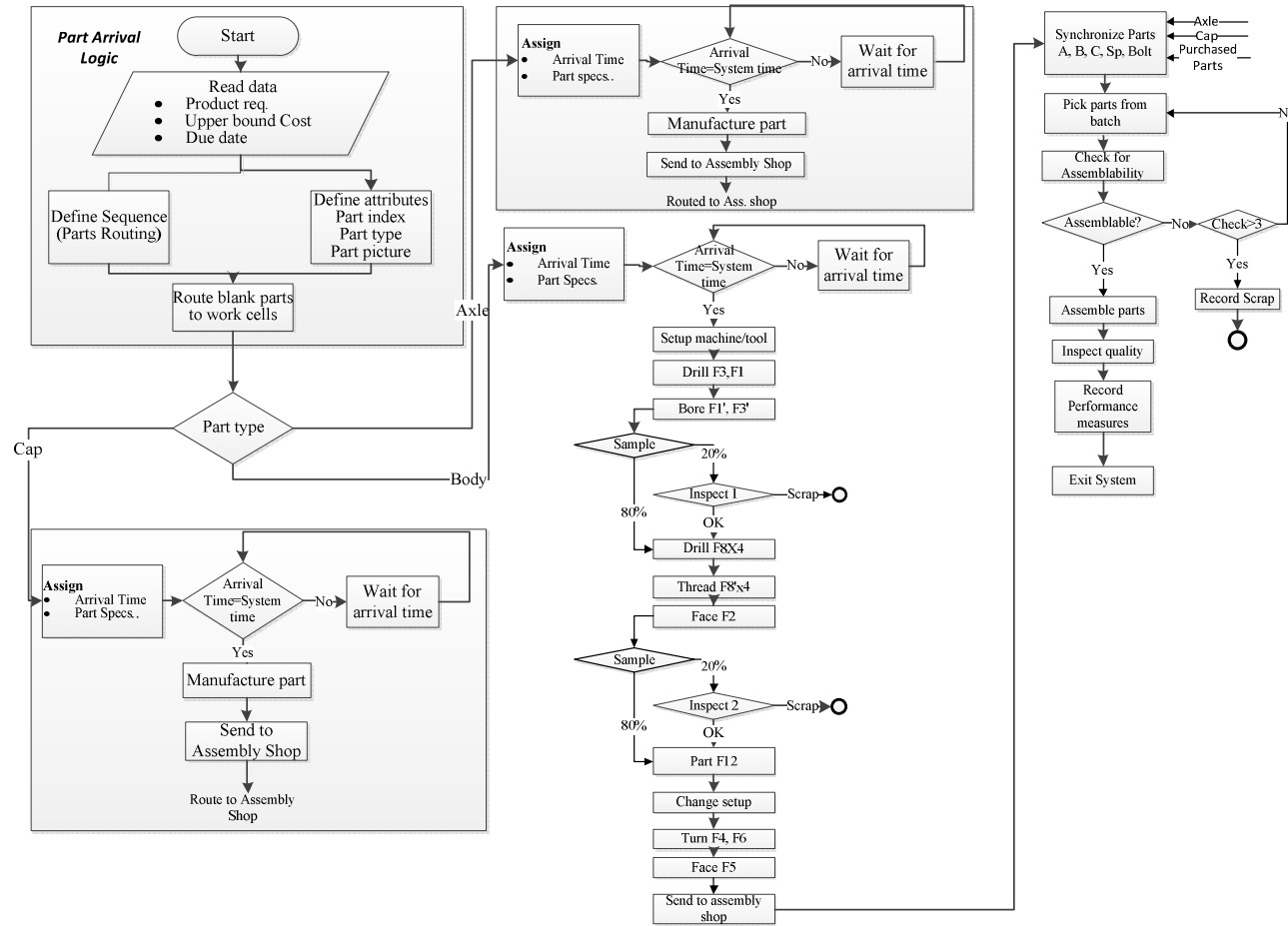

Figure E-1: Simulation logic

**Part Arrival Logic:** The simulation model starts with the arrival of entities at exponential rate in batch format via *create module* of the Arena (the first one displayed in Figure E-1). The global objectives (such as due date, upper bound cost, specifications for the quality level of the entire mechanical locator) are associated with each arriving entity in the simulation model using *Assign module* (sixth element in Figure E-4). Next, a part index is defined to distribute the coming entities using the discrete distribution function, i.e. DISC (). Basically, the part index is designed to assign, on one hand, the coming entity to one of the blank part of the mechanical locator and, on the other hand, to allow us to index into the set *part sequence* so that proper sequence will be associated with the arrival entity (or blank part). To define the part sequence, the sequence data module from the advanced transfer panel of Arena is used. This module assigns a sequence to each part of the locator according to the relevant process plan (cf. Figure E-2) in order to control the flow of the part in the system. For instance, the part A (in the case of the locator: part axle) moves through Cell 1 (containing machines M1 and M2) and Cell 4 (assembly shop in the current case study) where it becomes part of the assembly and then leaves the simulation system. The same procedure is repeated for the two other parts.

Sequence - Advanced Transfer	
Name	Steps
1 ▶ Part A Process Plan	3 rows
2 Part B Process Plan	3 rows
3 Part C Process Plan	3 rows

Steps				
	Station Name	Step Name	Next Step	Assignments
1	Cell 1	Part A Step 1		0 rows
2	Cell 4	Part A Step 4		0 rows
3	Exit system	Part A Step 5		0 rows

Figure E-2: Part sequencing logic

Next, a resource set for each work cell is defined. For instance, a machine set for work cell 3 as shown in Figure E-3 is composed of three machines (milling, grinding and 2-axis CNC lathe machines). These machines, their execution time and cost are then associated to the respective activities as required by the conceptual process plan model.

Set - Basic Process			
	Name	Type	Members
1	Cell 1 Machines	Resource	2 rows
2	Cell 2 Machines	Resource	2 rows
3 ▶	Cell 3 Machines	Resource	3 rows
4	Entity Types	Entity Type	
5	Part Pictures	Entity Picture	
6	Operator Set	Resource	
7	Assembler Set	Resource	
8	Assembler	Resource	

Members	
	Resource Name
1	Milling Machine
2	Grinding Machine
3	2 Axis CNC Lathe

Figure E-3: Definition of resource sets

By defining the required attributes for the incoming entities, the system is now ready to send the entities or blank parts to their respective work cells. This task is accomplished using the Station and Route modules as depicted in Figure E-4. The former module tells Arena the actual location of the entity while the latter transfer the entity to the location as assigned in the sequence data module.

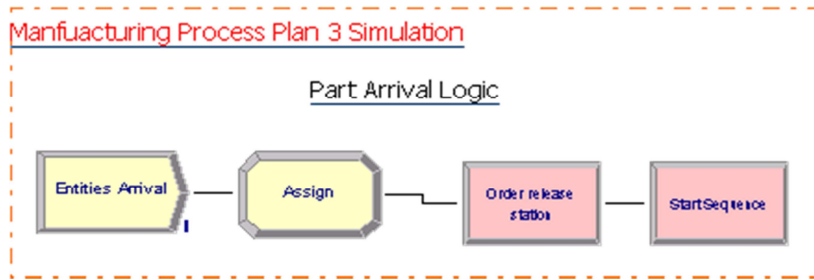

**Figure E-4: Part arrival logic**

**Work Cells Logic:** The work cell logic is simple to understand because it is the transformation of a conceptual process plan into a computer-based process plan model. However, the part arrival to the work cell requires a bit extra logic. At the *assign module* (on the top of the Figure E-5), the arrival time of the entity is marked with attribute *ArrTime* but hold in the *Hold module* until the conditions (the availability of resource sets) become true. Additionally, part specifications are defined using attributes and variables for ulterior evaluation of the part (mainly for the assembly condition inspection).

The remaining portion of the simulation model is mostly the translation of the conceptual process plan along with the input data relevant to the process plan (see Table 6-4 to Table 6-6). At this stage, the already defined resources and time durations are associated to each step (operation/activity) of the process plan. The cost allocation to the activity is based on either per use/busy per hour and idle per hour basis employing the resource data module.

To see whether an activity has realized its associated objective, it is checked in the *Decide module* of the Arena. To this end, it needs to be defined already in the *Assign module* for the corresponding part as shown in Figure E-5.

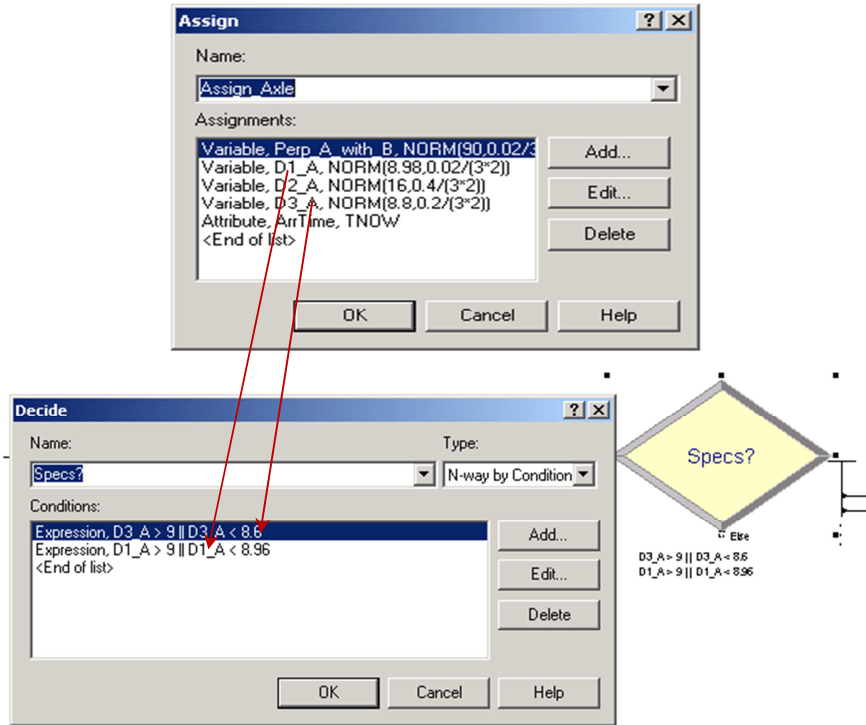

Figure E-5: Variable assignment and decision-making logic

**Assembly shop logic:** In the assembly shop, all the parts manufactured in their respective work cells are brought and assembled. For this purpose, the *match module* is employed to first synchronise the arrival of the manufactured parts and then branch out to *record modules* so that data such as functional specifications of individual parts are recorded for assemblability purpose in the following steps. The *Decide modules* then use this data to check whether the parts can be assembled and meet the required quality levels or not. Figure E-6 shows one of the *Decide modules* along with its pop-up windows in the assembly shop.

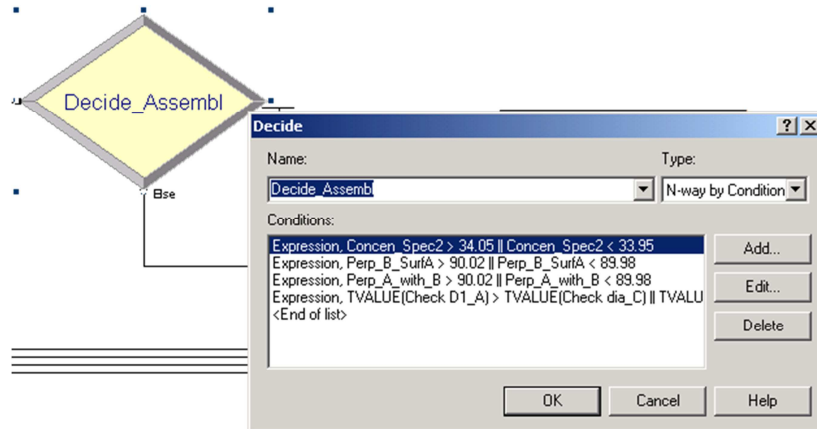

Figure E-6: Quality control in assembly shop

In addition, the parts which cannot be assembled are checked with other parts in the batch from three to five times, exceeding beyond these trials, the part is scrapped. For this purpose, the part is assigned the attribute *Retry* in the assign module to

identify that particular part each time it passes through part fitting practice. The decide module then checks the condition: *if attribute (Retry)>5*, scrap it.

The component parts once found assemblable are batched (permanent) in the *batch module* of the assembly shop. The outgoing entity or representative entity can be either of the grouped entities. Also, a new represented entity can be defined. In all cases, the outgoing entity replaces the members of the batch by taking into account their attributes relevant to cost and time. The representative entity then leaves the assembly shop and enters into the exit logic of the simulation logic.

**Exit Logic:** The exit logic is simple since it refers to disposal of an entity from the system. A simple *dispose module* from the *Basic Process* template is sufficient to this end. However, it is mandatory to define some logic in order to get some measures of interest before disposing the entity out of the system.

For this purpose, the *record module* is mostly used to get cycle time, cost consumed by the departing entity just to name a few. These recorded data are then used in the *statistic data module* to provide expressions so that performance measures of interest are developed and assessed.

By defining the logic for the simulation model in the previous sections, replication parameters such as number of replications, warm-up period, replication length and the simulation terminating condition can then be defined. In our case, the terminating condition is based on the number of parts that leave the system (i.e. customer order quantity).

Once the conceptual model is translated into a computer-based simulation model employing the logic shortly discussed in the previous sections, it is ready to be experimented in the simulation environment.





## METHODE D'EVALUATION DE PERFORMANCE DE SYSTEMES INDUSTRIELS BASEE SUR L'INDICATEURS VALEUR-RISQUE

**RÉSUMÉ:** La mesure et la gestion de la performance posent problème aux entreprises en termes d'atteinte des objectifs des multi parties prenantes. L'évaluation de ces objectifs et ainsi de la performance est essentielle pour plusieurs raisons : le contrôle et la surveillance, le diagnostic, l'amélioration, l'apprentissage et la prise de la décision de processus ou système d'entreprise. Les mesures de performance étant les descripteurs de la performance jouent un rôle important dans cette évaluation. Cependant, la multi-dimensionnalité de la mesure de performance, l'interdépendance entre elles et la recherche pour mesurer plusieurs dimensions de la performance compliquent le processus de mesure de performance. De plus, l'incertitude en ce qui concerne l'atteinte des objectifs atours du processus métiers ou système d'entreprise y ajoute encore de la complexité. Pour aborder cette situation, un système de mesure de performance basé sur l'indicateur du couple (valeur-risque) (appelé VR-PMS) orienté processus a été proposé. L'objectif est de transformer les attentes et inquiétude des parties prenantes en un indicateur de la performance et un de risque respectivement pour prendre une décision en connaissance de cause. A cet effet, un modèle conceptuel de valeur/risque est proposé : il vise à intégrer les concepts associé aux objectifs, activités et risque dans un seul cadre et conceptualise l'idée de la gestion de performance basée sur la valeur et risque. En outre, un modèle méthodologique est élaboré et divise les processus de mesure de performance en trois étapes : la modélisation de performance, évaluation et prise de décision. Chaque phase du modèle est dotée d'outils et méthodes pour l'analyse quantitative. Le livrable de VR-PMS est un classement de solutions (c'est-à-dire alternatives de processus métier) évaluée vis-à-vis l'indicateur développé à partir de valeur et risque.

**Mots clés:** Gestion de la performance, gestion de la valeur, ingénierie du risque, modélisation de processus, simulation à événements discrets, prise de décision

## VALUE-RISK BASED PERFORMANCE EVALUATION OF INDUSTRIAL SYSTEMS

**ABSTRACT:** Performance measurement and management (PMM) poses daunting challenges to organizations in terms of meeting multiple stakeholder objectives. Evaluation of these objectives, and hence performance is essential for many reasons such as monitoring and control, diagnosis, improvement, learning and decision-making of processes or enterprise systems. Performance measures as descriptors of performance are the key tools in this evaluation process. However, the multidimensionality of performance, the inter-dependencies among performance measures and the pursuit to manage many dimensions of performance complicate the PMM process. Furthermore, the uncertainty in terms of objectives satisfaction surrounding the business processes or enterprise systems adds further complexity. To deal with these issues, a process-centered value-risk based performance management system (VR-PMS) is proposed in the current research work. The purpose is to transform the expectations and fears of stakeholders into value and risk indicators respectively for informed decision making. For this purpose, a conceptual value-risk model is developed aimed at integrating consistently the concepts relevant to objectives, activities and risks in one framework and conceptualizing the idea of value and risk based performance management. In addition, a methodological framework is developed that divides the PMM process into three phases: performance modeling, assessment and decision-making. Each phase of the framework is instrumented with quantitative analysis methods and tools. The deliverable of the VR-PMS is a set of ranked solutions (i.e. alternative business processes) evaluated against the developed value and risk indicators.

**Keywords:** Performance management, value management, risk management, process modeling, objectives modeling, discrete event simulation, decision-making support.

