



HAL
open science

Multisensor Monitoring of Aeronautical Drilling/Countersinking Operations

Gwéno le Le Moal

► **To cite this version:**

Gw no le Le Moal. Multisensor Monitoring of Aeronautical Drilling/Countersinking Operations. Mechanical engineering [physics.class-ph]. Arts et M tiers ParisTech, 2012. English. NNT : . pastel-00872459

HAL Id: pastel-00872459

<https://pastel.hal.science/pastel-00872459v1>

Submitted on 13 Oct 2013

HAL is a multi-disciplinary open access archive for the deposit and dissemination of scientific research documents, whether they are published or not. The documents may come from teaching and research institutions in France or abroad, or from public or private research centers.

L'archive ouverte pluridisciplinaire **HAL**, est destin e au d p t et   la diffusion de documents scientifiques de niveau recherche, publi s ou non,  manant des  tablissements d'enseignement et de recherche fran ais ou  trangers, des laboratoires publics ou priv s.

École doctorale n° 432 : Sciences des Métiers de l'Ingénieur

Doctorat ParisTech

THÈSE

pour obtenir le grade de docteur délivré par

l'École Nationale Supérieure d'Arts et Métiers

Spécialité " Conception, risque et industrialisation "

présentée et soutenue publiquement par

Gwénohé LE MOAL

le 19 décembre 2012

Multisensor monitoring of aeronautical drilling/countersinking operations

Directeur de thèse : **Philippe Véron**

Co-encadrement de la thèse : **George Moraru**

Jury

M. Roberto TETI	Professeur, Department of Materials and Production Engineering, University Federico II, Naples	Rapporteur
M. Thierry DENOEU	Professeur, Heuristique et Diagnostic des Systèmes Complexes, Université de Technologie de Compiègne	Rapporteur
M. Krzysztof JEMIELNIAK	Professeur, Chair of automation, Machine tools and Metal cutting, University of Technology, Warsaw	Examineur
M. Gérard POULACHON	Professeur, Laboratoire Bourguignon des Matériaux et Procédés, Arts et Métiers ParisTech, Cluny	Examineur
M. Philippe VERON	Professeur, Laboratoire des Sciences de l'Information et des Systèmes, Arts et Métiers ParisTech, Aix-en-Provence	Examineur
M. George MORARU	Maître de conférences, Laboratoire des Sciences de l'Information et des Systèmes, Arts et Métiers ParisTech, Aix-en-Provence	Examineur
M. Patrice RABATE	Ingénieur, EADS Innovation Works, Nantes	Invité
M. Marc DOUILLY	Docteur, EADS Innovation Works, Méaulte	Invité

When I met Patrice in February 2008, as a trainee at the Méaulte Airbus plant, and George in September of the same year as a candidate to be a research engineer at Arts et Métiers ParisTech in Aix-en-Provence, I never thought about a completing PhD thesis. One year later, I was hired as a PhD candidate under a collaboration between Arts et Métiers and EADS Innovation Works, knowing few about the subject, but totally confident in the people I would have to work with. Indeed, many people that completed a PhD complain about they have felt alone sometimes. I had the chance to never had this feeling installed, thanks to your incredible energy to make things and people better. In the same time, you both gave me all the latitude I needed to follow my own tracks. Thank you for your confidence, your open minds, and, once again, for the energy you spent to make this project go ahead at every moment. I'm grateful to have met you both, as supervisors, but also as people. I wish you the best for the future.

In the same manner, I would like to thank Marc and Philippe V. for their contributions to this work, the time they spent trying to make it better by their numerous advices, from the beginning to the end of the thesis. Thank you to have shared your experience with me.

Thank you to Phillipe H. and Guillaume to have supported my works at Aérolia and to have given me access to information and resources necessary to complete this work.

Thank you to the numerous other people that have been involved for different tasks: helping to perform tests campaigns, discussing scientific problems, dealing with administrative issues, or simply putting up with my sense of humor.

Concerning this last point, a particular reward has to be given to the two bunches of colleagues I worked with. In Aix-en-Provence first, where I met a lot of very sympathetic people all along my thesis duration. Due to the great turnover of PhD students, and members of the lab in general, during these three years, I will not mention them all, so congratulations to those who are now doctors, and good luck to the others! It was a pleasure to work with you, and thank you for all the laughs.

Then, in Méaulte, thanks to the members of the 'VIP corner' with who I also spent great times at work, and sometimes later. I hope that although the diaspora, we will met again, listening to some jokes of the 'smart one' (who gave him its nickname? Anyway, good luck for your PhD!) around some Pierrot Gourmand.

A particular thought goes to the jury members, that accepted to read the manuscript, and made useful remarks that will help to improve the quality of the work. Generally, I want to thank all the people that helped this work going on.

- Wait?! No family, or close friends?

- Do you really think their place is in a report concerning the monitoring of drilling operations? They deserve much more!

Anyway, thank you all, I wish to see you soon!

Finally, I want to thank my beloved Cécilia, for having supported my nomad PhD life and its consequences. You are by far the most singular element my multisensor monitoring systems have ever detected. Thank you.

Contents

1	Introduction	4
1.1	General introduction	4
1.2	Context & objectives of the study	7
1.2.1	From an industrial use case...	7
1.2.2	... To scientific challenges	12
1.3	Manuscript organization	14
2	State of the art	16
2.1	Drilling monitoring techniques	16
2.1.1	Feature extraction, artificial learning and decision making techniques	16
2.1.2	Phenomena of interest in drilling	29
2.1.3	Monitoring approaches using multisensor data fusion	47
2.1.4	Overview and discussion	56
2.2	Data fusion techniques for monitoring applications	57
2.2.1	General introduction	57
2.2.2	Implementation of multisensor data fusion systems	61
2.2.3	Presentation of data fusion frameworks suited for multisensor on-line monitoring of drilling operations	65
2.2.4	Overview on data fusion for monitoring applications	75
2.3	Conclusion	75
3	Monitoring of industrial processes	86
3.1	Description & mathematical formalization	86
3.2	Challenges for monitoring in difficult environments	89
3.2.1	Variability of operating conditions related challenges	89
3.2.2	Quality of data related challenges	90
3.2.3	Process complexity and dispersive behavior related challenges	92
3.2.4	Overview on challenges for monitoring in difficult environments	94
3.3	Solutions for reliable monitoring	94
3.3.1	Robustness facing harsh industrial environments	94
3.3.2	Robustness facing process dispersions & operating conditions variations	95
3.3.3	Overview	97
3.4	Implementation of a monitoring system	97
3.4.1	Global methodology	97
3.4.2	Problem position	98
3.4.3	Sensor integration	99
3.4.4	Feature selection	100
3.4.5	Estimator choice	101
3.4.6	Monitoring system evaluation & industrial implementation	102
3.5	Conclusion	104

4	Singularity identification in difficult contexts	108
4.1	Introduction	108
4.1.1	From general applications to drilling monitoring	109
4.1.2	Problem formalization	109
4.2	Presentation and proposition of different approaches	114
4.2.1	A probabilistic approach for singularity detection	114
4.2.2	An existing evidential approach for singularity detection	114
4.2.3	A novel evidential approach for singularity detection	115
4.2.4	Differences in behavior of evidential approaches for data modeling	116
4.2.5	Data fusion and decision making using the evidential approaches	119
4.3	Performance assessment: numerical experiments	120
4.3.1	Numerical experiments goals and set-up	120
4.3.2	First application case	120
4.3.3	Second application case	121
4.3.4	Third application case	122
4.4	Conclusion	124
5	Implementation of drilling monitoring subsystems	128
5.1	Sensors integration	128
5.1.1	Sensors for drilling monitoring	128
5.1.2	Force sensors integration	132
5.1.3	Acoustic emission sensors integration	136
5.1.4	Overview on sensors integration	162
5.2	Feature selection	163
5.2.1	Introduction	163
5.2.2	Feature selection for complex systems monitoring	164
5.2.3	Choice of a feature weighting algorithm	166
5.2.4	Data fusion for feature selection	168
5.2.5	Performance assessment on a real case study: drill cutting edge chipping	172
5.2.6	Overview on feature selection	182
5.3	Drilling monitoring applications	183
5.3.1	Drilling operations phases identification	183
5.3.2	Tool cutting edge chipping detection	192
5.3.3	Overview on drilling monitoring applications	201
5.4	Conclusion	202
6	Conclusion & perspectives	209
6.1	Review of the work	209
6.2	Main strengths & weaknesses of the work	211
6.3	From the lab to the shop floor	211
6.4	Perspectives	212
A	Test campaigns description	214
B	Résumé des parties en français	225

Chapter 1

Introduction

1.1 General introduction

The main objective of any *industrial production process*, is that the products satisfy some quality criteria. Other important objectives often exist, like optimized productivity or sustainable production for instance. In order to reach the first one and ensure the products match the expected quality criteria, three strategies, that are not mutually exclusive, can be implemented:

- Accurate and reliable predictions of the production process results
- Systematic quality controls of the products
- Online monitoring of the production process

The first strategy takes place *before* the beginning of production and allows mastering the product characteristics as a function of the production process parameters. It is an auto-sufficient solution: if estimations of the products characteristics are *reliable* and *accurate* enough, neither systematic control nor process monitoring are needed to ensure products meets the quality requirements. However, it is not relevant for every processes because some are difficult to model, and/or show dispersive behaviors due to their complexity and/or unmastered parameters changes. In some also, predictions by process models are too uncertain to ensure a sufficient probability for the products characteristics to fall into the required tolerance intervals.

The second strategy takes place *after* the production process. Its main advantage is that it allows avoiding the delivery of products that do not fit the quality requirements. However, in mass production contexts or under some productivity constraints, this strategy becomes too expensive because it can lead to the loss of numerous products due to non-quality, and also because the time and resource consumption it implies. Moreover, it is only a control solution and does not allow bypassing a process parameters setting phase.

The last one takes place *during* the production process. As it is also a control strategy, it may lead to the loss of some products. However, online monitoring allows, in the worst case, stopping the process just after a non-quality occurred, and avoid the use of systematic control at the end of the production process. It is also an ideal complement to the first strategy to deal with complex processes in order to detect unexpected behaviors due to the aforementioned reasons, namely process complexity and dispersive behavior.

Consequently, in cases where high quality is required for products issued from complex processes, and where productivity is also an important issue, both accurate *process modeling* and *online monitoring* should be used together in order to achieve good production performance. Many monitoring solutions are based on process models when available.

In this work, we will focus on a high added-value production process: airframe and airframe substructures assembly, and, in particular, the high precision drilling operations this kind of assemblies involve. As their number is too important to perform systematic quality controls, and no reliable and accurate enough predictive model is available to master the drilling process, online monitoring is the only solution to implement in order to improve the production performance. The goal of this study is to provide guidelines for the implementation of such a drilling monitoring system.

Monitoring is a multidisciplinary activity that can take diverse forms regarding the field of applications it concerns. In its general sense, it consists in following the state of a system, which can be natural or artificial, alive or not, in order to ensure that no anomaly occurs.

Monitoring of industrial production systems, which is often associated with *diagnostics*, has mainly been developed for energy and high added-value goods production systems. In both cases, financial concerns, security issues and the impossibility to make reliable or accurate enough models of the system have been the main motivations for the development and implementation of such systems. They consist in sensors implemented together with associated hardware devices and software developments, that are aimed at the detection of eventual deviations of the monitored system from its *normal functioning domain*. This information is then communicated, so preventive and/or corrective actions can be applied either automatically or by a human operator.

Manufacturing industry increasing needs of quality, productivity and flexibility coupled with costs reduction objectives made monitoring of complex production means a subject of major importance. Such monitoring systems have to perform despite flexible operating conditions, harsh environments and complex decision making situations. These constraints make the design of robust monitoring systems a difficult task. It requires multidisciplinary skills going from devices behavior modeling to artificial intelligence techniques, passing through signal processing and decision theory [9]. Moreover, because of the limited availability of precise information about the status of these systems and the lack of knowledge in understanding exactly the physical phenomena for unanticipated events, decisions have sometimes to be made under some degree of uncertainty [8].

Machining, which encompasses various operation of cutting or grinding on a workpiece, represents an important part of manufacturing operations. As it is an expensive process, its use is preferred for the fabrication of high added-value products where the apparitions of defects is therefore to avoid. The optimal use of consumables (cutting tools) and production means is also an important financial concern. In this context, monitoring systems able to detect process dysfunctions and to provide the user up-to-date information about the production system state would be of great interest.

Following the definition given by Teti *et al.* in [7], the typical **machining process monitoring** system operates according to the following scheme. In the cutting region there are several process variables, such as cutting forces, vibrations, acoustic emission, noise, temperature, surface finish, etc., that are influenced by the cutting tool state and the material removal process conditions. Variables that are prospectively effective for machining process monitoring can be measured by the use of appropriate *sensors*. Signals detected by these sensors are subjected to signal conditioning and processing with the aim to generate functional signal *features* correlated (at least potentially) with tool state and/or process conditions. Sensor signal features are then fed to and evaluated by cognitive *decision making support systems* for the final diagnosis. This can be communicated to the human operator or fed to the machine tool numerical controller in order to suggest or execute appropriate adaptive/corrective actions.

Drilling represents an important part of machining operations linked with assembly of manufactured products. Due to the high number of operations and the constantly increasing need of productivity, drilling has become an important research field. This is particularly true within the *aeronautical industry* where drilling is *the basis of numerous assemblies* and where quality is primordial due to the added-value of concerned structures. Moreover, the continuous introduction of new materials presenting higher mechanical properties, but lower machinability, makes the mastering of drilling operations a concern in constant evolution.

Drilling is a *complex machining operation* because of the cutting speed variation along the drill cutting edges. One of the major difference with other classical machining operations is the fact that drilling is a complex three dimensional material removal operation, unlike the relatively simple cases of orthogonal and oblique cutting. Drills also have vastly different geometries than turning or face milling tools for example [6]. Moreover, as the operation is confined, experimental studies are made difficult, and complexity is added to the study of phenomena linked with material cutting by the tribological and thermal aspects this confinement provokes. By now, a generic model allowing to simulate drilling operations that takes all influences parameters and quantities into account does not exist. This forbids the use of the only first strategy presented in order to guarantee products quality.

Importance of drilling operations in the aeronautical industry implies that a special attention is given on the quality of bores and on the optimization of productivity. The absence of theoretical model allowing to estimate the impact of the different parameters leads to the use of heuristic methods for their identification. Although they are widely used, those methods do not address all *requirements of industrial production*. First, they are not generic regarding the drilling process parameters, that is in contradiction with the increasing need of flexibility of production processes. Then, they only allow estimating the drilling process performances *a priori*, without taking into account neither external events and perturbations that could happen during the on-going drilling process, nor its dispersive behavior. This implies the use of additional monitoring means and the use of important security margins on process parameters in order to avoid eventual failures.

On-line monitoring methods are aimed at addressing these issues: by monitoring the process in real-time with the use of sensors, process failures should be quickly detected and identified, and security margins should be reduced for an optimal use of the production mean and consumables. However, their application to drilling monitoring often lead to mitigated results in industrial contexts. Indeed, sensed quantities, or *features*, linked with cutting phenomena that are usually used for drilling monitoring are subject to dispersions. The origin of these dispersions is the multiplicity of parameters, mastered or not, that possess influence at different scales. One direct consequence of this issues is the impossibility to implement generic monitoring systems, or even that perform in an acceptable manner for operations that seem similar *a priori*. By now, to the author knowledge, no reliable drilling monitoring system has been implemented in aeronautical assembly plants.

Several research fields face the same kind of problems: to *establish a diagnostic from recent data and prior knowledge*, knowing that these data can be not exactly similar to those that allowed building prior knowledge. Tracks proposed to answer this challenge, which are very active research fields, concentrate around the *modeling of uncertain information, information fusion*, and sometimes *artificial intelligence*. Only few or partial attempts of using these paradigms have been done for drilling monitoring.

The possibility to *use these novel methods in the frame of monitoring of drilling* automated operations will be assessed in this manuscript. In particular, the development of a robust monitoring methodology facing 'natural' dispersions of the drilling operation and eventual external perturbations (harmful environment for measurement, sensors failures, ...) will be tackled in an attempt to palliate, in some extent, to the lack of generality that suffer existing drilling monitoring systems. This approach only makes sense if theoretical devel-

opments are coupled with representative experiments, and assessed in industrial production conditions.

If this work is aimed at *demonstrating the potential improvements that could be achieved in monitoring of drilling operations* by using *multisensor fusion* and associated recent theoretical developments about *uncertainty modeling* and handling, the proposed methodology could be applied to *a broader scope of applications*, including most complex manufacturing automated operations. Efficient monitoring of complex systems is also an indispensable prior step to adaptive process control, which is an important research trend in the advanced manufacturing community.

1.2 Context & objectives of the study

The goal of this section is, in its first part, to present the industrial context of the study in order to underline the potential benefits that could be achieved by the implementation of a robust drilling monitoring system in the manufacturing of aircraft elementary parts and subassemblies. The second part will describe the scientific and technical challenges it implies, in order to serve as a basis for this manuscript organization.

1.2.1 From an industrial use case...

The different assembly stages of large airframe production will first be presented. In a second part, the typical operations of *assembly processes* used for airframe assembly will be described, with special emphasis on drilling operations. Levers of productivity enhancement concerning drilling operations will be detailed in a third part. Then, attention will be focused on existing automated solutions for drilling: the applicative scope of automated drilling devices, their expected benefits, but also the *challenges* their implementation imply will be evoked. *Solutions* to tackle those issues will then be assessed. Of the three aforementioned strategies to meet quality requirements in manufacturing industry, only the implementation of robust *monitoring* systems will be shown to be economically viable for large airframe assembly.

1.2.1.1 Description of the different stages of large airframe assembly

Usually, three stages are differentiated when considering large airframes assembly. If they all uses similar basic assembly processes, they differ by the size of the parts to be assembled, and consequently the means that are used.

The first assembly stage is dedicated to the building of *elementary parts* that are mainly composed by the *skin*, plus the *frames* and *stringers* that are used to stiffen it. Such assemblies are usually of reasonable dimensions (order of magnitude: $1m$).

The second stage concerns *subassemblies*. Elementary parts are the basic components of what will become *subsections* of the airframe. Subsections are then assembled to form complete *sections* (e.g. nose fuselage, wings,...). Dimensions of subassemblies increase all along this stage, orders of magnitude going from $1m$ to $10m$.

Finally the *final assembly* stage consists in putting together all the sections that have been previously assembled to obtain the complete airframe.

1.2.1.2 Description of the basic airframe assembly process

As described above, the assembly process of the airframe goes from building *parts*, to *subassemblies*, to the complete *airframe*. Typical operations used for the assembly of aeronautical structures will be summarized in this section. Other operations (e. g. sealant application, temporary fastening) and/or assembly types (e. g. friction steer welding) exist that will not be presented here, but, by now, most of airframe assembly processes integrate operations presented in the following.



(a) Elementary part made of aluminum skin, stringers and frames (b) Elementary part made of composite materials skin, stringers and frames

Figure 1.1 – Typical structures of aeronautical elementary parts: the skin is stiffened with stringers and frames



(a) Nose fuselage subsection subjected to robotized drilling operations (b) Fuselage subsection made of composite materials

Figure 1.2 – Examples of aeronautical subassemblies

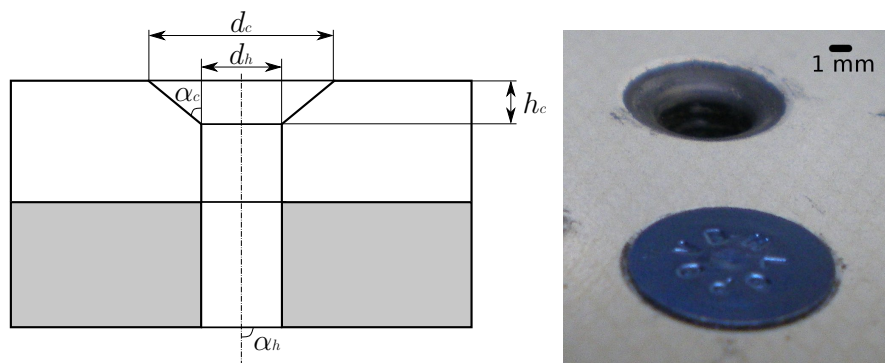
Pre-assembly consists in putting the parts (or previously assembled structures) to be assembled into fixtures that will hold the parts in position through the assembly process.

Drilling operations are then performed on the pre-assembled structure. As the goal is to assemble together structures, mainly *stacks* of different parts have to be drilled. As aeronautical drilling standards are very tight in order to ensure assemblies strength and resistance to fatigue, a *reaming* operation is sometimes necessary after the drilling process. However, many drills now allow ensuring both the drilling and reaming operation in the same process. Dimensional specifications on aeronautical holes are given hereafter and described in figure 1.4(a).

- Hole diameter d_h must be comprised into a tolerance interval depending on the material
- Countersink diameter d_c , angle α_c and depth h_c must be comprised into tolerance intervals ensuring accordance with a maximum authorized mismatch between the part surface and the rivet head once it has been installed (see figure 1.4(b)). The maximum authorized mismatch depends of the location of the part on the aircraft due to different aerodynamic constraints.
- Normality α_h of the hole regarding the surface of the drilled part must be comprised into a tolerance interval



Figure 1.3 – Example of an aeronautical final assembly line (FAL)



(a) Dimensional specifications of a hole and countersink (a typical stack drilling configuration is depicted)
 (b) A rivet (blue) is inserted in a countersunk hole: a mismatch is visible between its head and the part surface

Figure 1.4 – Dimensional specifications of aeronautical drillings (a) and picture of a rivet inserted in a hole (b)

Holes are also subject to damage-related requirements:

- Surface finish (Ra) must be under a certain level inside both hole and countersink
- Entry and exit burrs (see figure 2.19) in metallic materials must be under a certain height
- Delamination (see figure 2.11(b)) in composite materials must be under a certain limit of surface size
- No uncut fibers at hole entry or exit (see figure 2.11(a)) are allowed in composite materials
- Materials mechanical properties changes due to the heat provoked by the drilling operation must be under a certain limit

These numerous and tight specifications make drilling a strategic stage of the assembly process: due to their number and the quality requirements they are subjected to, the good progress of drilling operations is essential for the productivity of aircraft assembly plants.

Deburring, consists in removing burrs after the drilling process occurred, if any. As it is a manual operation, it is very time consuming. Moreover, if the parts in a stack were not *clamped* enough during the drilling operation, burrs could have appear at the interface between parts, as well as chips produced during the drilling operation could have slip in. As

burrs and chips at the interfaces of material stacks drastically reduce assemblies mechanical properties, parts have then to be disassembled in order to remove them, which is very time consuming too. Deburring is mainly performed when drilling are made manually, whereas automated drilling solutions often allow applying a sufficient clamping force for the apparition of interface burrs and chips to be avoided.

Fastening is the last step of the assembly process. Either rivets, screw or bolts can be used to fasten parts together as a function of the mechanical properties needs for the assembly. Some fasteners, blind rivets, do not requires intervention at each side of the assembly, and are then particularly interesting for automated assembly purpose. However, their use is restricted to low strength assemblies.

As holes concentrate numerous tight requirements and can be at the origin of time consuming operations in case of non-quality, *the mastering of hole quality represents a strong lever of aeronautical assembly plants productivity.*

1.2.1.3 Presentation of developments axes for aeronautical drilling operations

Drilling operations are key elements that have to be considered in order to *optimize the aeronautical assembly processes.* Gains could be obtained on three principal axes:

- Quality improvements
 - Decrease of the number of scrap parts
 - Decrease of unexpected manual interventions on workpieces due to non-quality
 - Decrease of the number of quality control operations
- Resources utilization improvements
 - Optimization of consumables
 - Application of a targeted maintenance
- Automation increase

Concerning the first axis, high quality tools and drilling equipment are used and processes are carefully designed in order to *reduce the non-quality impact and occurrence*; however, as failures are always possible, especially because of the high variability of the process, time consuming and expensive quality control processes are generally used in order to ensure the process specifications. Thus, *online process quality estimation* and failure detection could dramatically reduce the non-quality and control related costs.

As for the second axis, the principal resources concerning drilling operations are the cutting tools and the drilling devices. Drills are considered as *consumables*. The *cutting tools replacement strategy* is based on a statistical estimation of the tools life, which often shows a significant dispersion. This leads to the use of *large security margins*, which became a very expensive approach since the massive introduction of new materials. In particular, titanium alloys and carbon fiber reinforced plastics (CFRP) present properties that reduce drills life drastically because of the rapid tool wear they induce. Therefore, cutting tools replacement strategies should be based on their *online estimated condition* in order to reduce costs and go towards a more efficient production process.

The third axis, *automation*, is an old trend in manufacturing industry. However, due to the high quality requirements, the processes complexity and structures dimensions, most of the holes drilled on airframes are made by highly-skilled human operators equipped with portable drilling machines. However, more than only assisting humans to perform laborious operations, automated solutions can provide operators better working conditions by reducing their use of vibrating and noisy portable drilling devices, their contact with harmful products like sealants, adhesives, solvents or carbon dust, and avoiding them working in difficult-to-access parts of the structures that favor accidents. Of course, productivity gains are also expected.

1.2.1.4 On the potential of automated solutions for aeronautical drilling operations

As mentioned above, automated drilling solutions can bring many advantages, and several solutions have been integrated in production plants. No standard exists for automated drilling devices in the aeronautical industry, and dedicated machines have been developed to realize drilling -as well as riveting- operations for the three assembly stages presented above. A review of these machines is available in [3]. However, automated solutions implementations are very limited for the final assembly stage of large airframes due to their dimensions.

As the assembly processes present important similarities whatever the considered assembly stage, expectations for an automated drilling system are comparable, even if the machines structures are very different due to the various shapes and dimensions of parts they have to perform drillings on.

One of the main objectives of an automated system compared with human operators is achieving costs reductions by productivity improvement, or at least maintenance. This can be achieved by the combination of the maintenance of quality level reached by human operators with the reduction of necessary resources, and/or *reduction of time needed to perform operations*. This last point is difficult to ameliorate as a drilling duration is determined by the process parameters (cutting speed, feed rate) that are similar for a human operator and a machine.

As for *quality*, as holes have to be drilled in the same locations of the assemblies, with the same drills and parameters, it should be similar, even if the use of different devices can provoke changes that significantly affect hole quality regarding the tight requirements they have to meet. The main difference is that a human operator can detect, to some extent, the *apparition of defects* and take the decision to *stop the process* and/or to engage corrective actions in order to avoid drilling holes that will necessitate repairs, or will make the part unusable. Most machines do not possess such *perception* and *decision* abilities dedicated to quality control, that can lead to costly degradations of assemblies.

Concerning the *resource management* question, that mainly consist in cutting tool replacement strategy for drilling applications, the same statement is still valid: if a highly-skilled human operator can evaluate the tool wear by several sensory means (by looking at it, progress of the drilling operation, ...), and make a decision about the behavior to adopt, a machine without perception and decision ability dedicated to the monitoring of the process state cannot.

The economical viability of replacement of skilled human operators by automated machines is not obvious due to the complexity of the task and their absence of perception and detection abilities. On the other hand, continuous improvements have been made since 40 years on sensor technology, data acquisition and processing possibilities, but also in the field of machine intelligence that allow one thinking that perception and decision making abilities that are necessary for their economical viability and their integration in aeronautical assembly plants could be integrated on drilling machines. If, by now, their economical interest has not been totally proven in comparison with human operators ones, *automated drilling solutions present an important progression margin by integration of perception and decision making abilities* dedicated to monitoring of drilling operations.

1.2.1.5 On the interest of online monitoring system for drilling productivity improvement

Considering both the first development axes for the enhancement of drilling operation productivity, namely *quality of the product* and *optimization of the use of resources*, the 3 aforementioned strategies to meet quality requirements could theoretically be applied. However, systematic control of the products or production resources is too expensive in the context of aeronautical assembly, and no reliable model is available neither for the complex drilling

operations nor the evolution of production resources states (cutting tools, spindle, robot...). If much research effort has been and is done concerning these issues, one can reasonably think that no such model will be reliable enough to be used in production plants within the 10 next years. Therefore, the only remaining solution is *online monitoring*. The need of drilling monitoring systems has been emphasized for automated drilling devices in the previous section: due to the highly constrained context, perception and decision making abilities are needed to meet productivity requirements. This is also the case, to another extent, concerning portable drilling devices used by human operators in order to detect unexpected events that are not perceptible by human operators. Consequently, the whole range of drilling-based assembly operations done within the assembly of airframes are susceptible to be enhanced by the integration of online monitoring solutions.

If no reliable drilling monitoring system exist by now, literature present many encouraging attempts, and the rapid development of sensors, data acquisition possibilities and decision making techniques should make one optimistic concerning the rapid improvement of such systems.

1.2.1.6 Descriptions of challenges linked the implementation of a drilling monitoring system in the aeronautical industry

In order for a drilling monitoring system to be useful in industry, it must meet some *requirements*. First, the information that it will provide must be *accurate* enough to be useful, meaning that its estimations capabilities have to be high, even in absence of theoretical models. Then, it must be *robust* facing the dispersive behavior of the process, the external perturbations due to the harsh industrial environment, and the need of flexibility that production constrains impose. Finally, it must *not be intrusive*: no perturbations of the production process due to the monitoring system are acceptable. This is linked with robustness in some extent as is encompasses hardware reliability and false alarm rate for instance.

Although easy to identify, these requirements necessitate great efforts in terms of sensor integration, signal processing and feature extraction techniques implementation, and estimation and decision making algorithms development. Scientific challenges implied are presented in the next section.

1.2.2 ... To scientific challenges

Since more than 30 years, that brought important improvements in sensor and data processing technologies, a vast amount of work has been done in the field of drilling monitoring, concerning both hole quality and tool wear estimation. First, many approaches using a single sensor implementation have been developed. If some studies achieved reasonable success, they often have been done considering only narrow ranges of operating parameters, leading to a lack of flexibility when implemented in industrial environment. Other attempts gave mitigated results, especially concerning tool wear monitoring, because inadequate sensor information and process models have been used which did not satisfactorily reflect the process complexity. One reason is that the use of a single sensor signal in the development of a tool condition monitoring system fails to recognize the complex and diverse nature of the cutting process [5]. Many monitoring systems described in these studies are unlikely to leave the labs, as they were often considered difficult to implement, unreliable or not viable economically [2]. Moreover, neither the problem of sensor dysfunction nor the one of industrial environment impact on signals have been addressed.

To be efficiently introduced in aircraft structural assembly plants, a monitoring system have to meet requirements that are linked with scientific and technical challenges to address. Their *causes* can be summarized as follow:

- Inaccessibility of the phenomena of interest
- Complexity of the phenomena of interest
 - Dispersive behavior of the machining system and workpiece
 - Absence of reliable model for drilling operations
- Variability of the process parameters
 - Different operating conditions may be needed
 - Different behaviors as a function of machining system used or structure concerned
- Hostility of the environment for sensing applications

Although all these causes are specific, they raise a generic problematic. The sensing, data processing, estimation and decision making steps necessary to establish a *diagnostic* concerning the state of the process or of the production mean, will have to be performed *under uncertainty*. This statement is at the basis of the scientific positioning of this work: conversely to the majority of studies that have been done concerning drilling monitoring, uncertainty about process parameters, sensors condition and data quality will be taken into account from the early steps of design step of the monitoring system. Consequently, new constraints, but also new possibilities, will appear, that makes this work original in our opinion.

Solutions exist to tackle the problems raised by these requirements. Previous studies gave essential information on the type of sensors and signal processing techniques to be integrated in order to implement an efficient monitoring system. However, it is now generally acknowledged in the field of manufacturing technology that reliable process condition monitoring based on a single signal feature is not feasible [7, 4, 1]. The *use of multiple sensors* systems together with intelligent information processing techniques should improve reliability and flexibility of tool condition monitoring systems. Moreover, several studies showed that it allowed a better handling of the drilling process complexity that gave rise to an increase of performances in monitoring of complex phenomena. However, this has mainly been done under steady process conditions and in sensor-friendly lab environments, and neither issues about the variability of the operating conditions, nor quality of input data have been tackled.

This last issue is of great importance for an industrial monitoring system: the use of multiple sensors, or information sources, follows the absence of precise or sure enough data coming from one source. Uncertainty on sensor data should therefore be taken into account from the beginning of the design of a monitoring system. A precise knowledge on ways to *model and handle different forms of uncertainty* should help to better address the problems it involves. This is not done in most actual studies about machining process monitoring, and uncertainty on data and/or operating conditions has been treated in an implicit manner by the estimation or classification algorithms, which have become more and more complex. Monitoring performances did not increase as a function of this complexity, neither in term of accuracy nor reliability, showing the limits of approaches that disregard the data uncertainty related issues. Actually, this is a well-known fact for the data fusion community: even the best fusion algorithm will not provide good results if its input data are of low quality or are misinterpreted.

Hereafter are summarized points that requires particular attention, in our opinion, for the implementation of a reliable drilling monitoring system in industrial production plants:

- Sensor integration
- Robust data processing techniques
- Uncertainty modeling and handling

- Multisensor data fusion

Consequently, *expected contributions* of this work are:

- Development of sensor integration solutions dedicated to drilling monitoring applications
- Implementation of multisensor data fusion techniques for the monitoring of complex industrial processes
- Development of a generic methodology for the implementation of multisensor monitoring systems

Organization of research concerning these items that have been done in this work is described in the next section.

1.3 Manuscript organization

Chapter 2 will be divided in 2 major parts. With the goal in mind to develop a methodology to implement an industrial drilling monitoring system, we will naturally begin with a state of the art concerning sensor-based drilling monitoring applications, with a focus on multisensor based ones. It will allow assessing current trends and achievements, but also identifying weaknesses to be tackled, in particular those refraining the implementation of robust drilling monitoring systems in manufacturing plants.

Then, as multisensor data fusion is considered a promising tool, a state of the art on existing techniques which could help enhance drilling monitoring performance will be presented. Challenges and open problems will also be identified.

In **Chapter 3**, the monitoring problem will be formalized, and its associated requirements in terms of reliability, and challenges related to industrial implementation will be detailed in order to clearly position the problem. Based upon those considerations, the chosen approach to implement a monitoring system will be presented, and a deployment methodology for industrial implementation will be proposed.

Chapter 4, as a preamble to the development of a methodology aimed at the implementation of an industrial monitoring system, the central problem of singularity detection in difficult contexts will be discussed, and an approach using data fusion will be proposed and compared to existing ones.

Chapter 5 will be devoted to the presentation of technical and scientific contributions from integration of sensors to the development of building blocks of a monitoring system, following the implementation scheme presented in chapter 3.

Finally, conclusion and perspectives based upon the results obtained in this work will be given in **chapter 6**.

As it encompasses several issues and research domains, this manuscript has, as possible, been organized so that chapters can be read individually. Therefore, bibliographic references are indexed at the end of each part, and some repetitions will occur.

Bibliography

- [1] G. Byrne, D. Dornfeld, I. Inasaki, G. Ketteler, W. König, and R. Teti. Tool condition monitoring (TCM) - The status of research and industrial application. *CIRP Annals - Manufacturing Technology*, 44(2):541 – 567, 1995.
- [2] K. Jemielniak. Commercial tool condition monitoring systems. *International Journal of Advanced Manufacturing Technology*, 15:71 – 721, 1999.
- [3] Henrik Kihlman. *Affordable automation for airframe assembly*. PhD thesis, Linköpings Universitet, Linköpings, Sweden, 2005.
- [4] S. Y. Liang, R. L. Hecker, and R. G. Landers. Machining process monitoring and control: The state of the art. *ASME Conference Proceedings*, 2002(3641X):599 – 610, 2002.
- [5] A. Noori-Khajavi and R. Komanduri. Frequency and time domain analyses of sensor signals in drilling - II. Investigation on some problems associated with sensor integration. *International Journal of Machine Tools and Manufacture*, 35(6):795 – 815, 1995.
- [6] A. Rehorn, J. Jiang, and P. Orban. State-of-the-art methods and results in tool condition monitoring: a review. *The International Journal of Advanced Manufacturing Technology*, 26:693 – 710, 2005.
- [7] R. Teti, K. Jemielniak, G. O’Donnell, and D. Dornfeld. Advanced monitoring of machining operations. *CIRP Annals - Manufacturing Technology*, 59(2):717 – 739, 2010.
- [8] J.S. Wu, G.E. Apostolakis, and D. Okrent. Uncertainties in system analysis: Probabilistic versus nonprobabilistic theories. *Reliability Engineering and System Safety*, 30(1-3):163 – 181, 1990.
- [9] G. Zwingelstein. *Diagnostic des défaillances - Théorie et pratique pour les systèmes industriels*. Diagnostic et maintenance. Hermes, Paris, France, traité des nouvelles technologies edition, 1995.

Chapter 2

State of the art

This section is dedicated to provide the reader a comprehensive view of the drilling monitoring practice via the description of works that have been realized in the field and related techniques.

First, some concepts on popular techniques that are used to perform drilling monitoring will be provided in order for the reader to be familiar with notions that will be introduced in the second part, which will consist in the description of drilling monitoring applications reported in the literature. After the achievements and challenging aspects of drilling monitoring would have been emphasized by the literature review, and the need of sensor and data fusion in particular, a third part will introduce techniques that are suitable to perform fusion in the drilling monitoring context.

2.1 State of the art of drilling operations monitoring

2.1.1 Concepts on popular feature extraction, artificial learning and decision making techniques used in drilling monitoring

Several techniques have been used for drilling monitoring applications. They include signal processing techniques, estimation and classification algorithms and decision making strategies. The most popular ones are introduced in this section. Only necessary material for the understanding of works described in the following is provided, and is introduced from a practical point of view. Therefore, this review of techniques is not exhaustive, and only basic concepts will be introduced by the use of simple examples.

First, popular signal processing techniques aimed at feature extraction will be presented. *Feature extraction* consist in picking-up useful information out of the mass of raw data given by sensors. Then, fundamental concepts on *learning machines* used to model relationships between complex phenomena to be monitored and features issued from sensor measurements will be provided. Finally, as it has been widely used to represent states of drilling systems that are difficult to quantify and fuse features, some information on *fuzzy logic* and fuzzy systems will be introduced. As stated earlier, the goal of this introductory section is neither to be exhaustive concerning techniques used for drilling monitoring nor to rigorously presents their mathematical and theoretical foundations, but to provide the reader necessary material to understand works presented in the state of the art and some of our contributions.

2.1.1.1 Signal processing techniques for feature extraction

Time domain techniques. Time domain techniques are aimed at the *extraction of features that represent the signals in the time domain*. Signals may have been filtered prior to the feature extraction step in order to emphasize their most interesting characteristics. No details about common filtering procedures will be provided. An introduction and algorithms

for practical implementation can be found in [131].

Statistical descriptors of time series are often used as time domain features and can be interpreted in a physical sense most of the time when applied to sensor signals. The four first order statistical moments, namely the *mean* μ_x , *variance* σ_x^2 , *skewness* S_x and *Kurtosis* K_x of a signal \mathbf{x} are interesting and are described by equations 2.1, 2.2, 2.3 and 2.4 respectively. Their discrete form is given here as nowadays, all signals to be processed are given in a discrete form by data acquisition devices. In the following, \mathbf{x} represents a N samples signal in the form of a vector $[x_1, \dots, x_i, \dots, x_N]$.

$$\mu_x = \frac{1}{N} \sum_{i=1}^N x_i \quad (2.1)$$

$$\sigma_x^2 = \frac{1}{N} \sum_{i=1}^N (x_i - \mu_x)^2 \quad (2.2)$$

$$S_x = \frac{1}{N} \sum_{i=1}^N \left(\frac{x_i - \mu_x}{\sigma} \right)^3 \quad (2.3)$$

$$K_x = \frac{1}{N} \sum_{i=1}^N \left(\frac{x_i - \mu_x}{\sigma} \right)^4 \quad (2.4)$$

Figure 2.1 helps to understand their signification and potential uses. If the meaning of the *mean* value of a signal is straightforward, signals that present the same mean μ_x and possess different *standard deviation* σ_x are often encountered. This is the case for discrete signals depicted in figures 2.1(a) and 2.1(b). The standard deviation of signal is similar to another popular time domain feature: the signal *Root Mean Squared* (RMS) value. The calculation of the RMS of a discrete signal can be done according equation 2.5, and gives a representation of the *energy content* of the signal. For instance if the signal represents a voltage level, its RMS value will provide the voltage that would produce the same power dissipation as the original signal if applied to a resistor during the same time period. One can remark that the RMS and standard deviation of a centered (i. e. which have a zero mean) signal are equivalent.

$$RMS_x = \sqrt{\frac{1}{N} \sum_{i=1}^N x_i^2} \quad (2.5)$$

The *skewness* S_x of a time series reflects the distribution of its sample around its mean value μ_x . The signal depicted in Figure 2.1(c) has the same mean as the previous ones, but the distribution of samples around the mean value is unbalanced, so the skewness is not zero anymore. It is negative because of the strong influence (cubic) of the sample located far below the mean compared to those located above.

This figure also showed that the *Kurtosis* value of the time signal increased. Indeed, Kurtosis K_x indicates the presence of isolated high amplitude peaks in the signals. However, if the signal presents a larger standard deviation, like in figure 2.1(d), the Kurtosis will be lower even if strong amplitude variations are present. This due to the influence of the standard deviation σ_x in the calculation that gives Kurtosis its ability to emphasize the presence of isolated peaks.

Properties of statistical moments are used to detect several phenomena. For instance, systems monitoring vibrations incoming from rotating machinery uses RMS to detect abnormal vibration levels, skewness is used to detect imbalance, and Kurtosis to detect shocks. The RMS value have been used in more than a half of works cited in this review and was applied to signals issued from different sensors including current sensors, accelerometers, force and torque sensors and AE sensors. In some studies the *maximum* and *minimum* values of the signals have also been used as features.

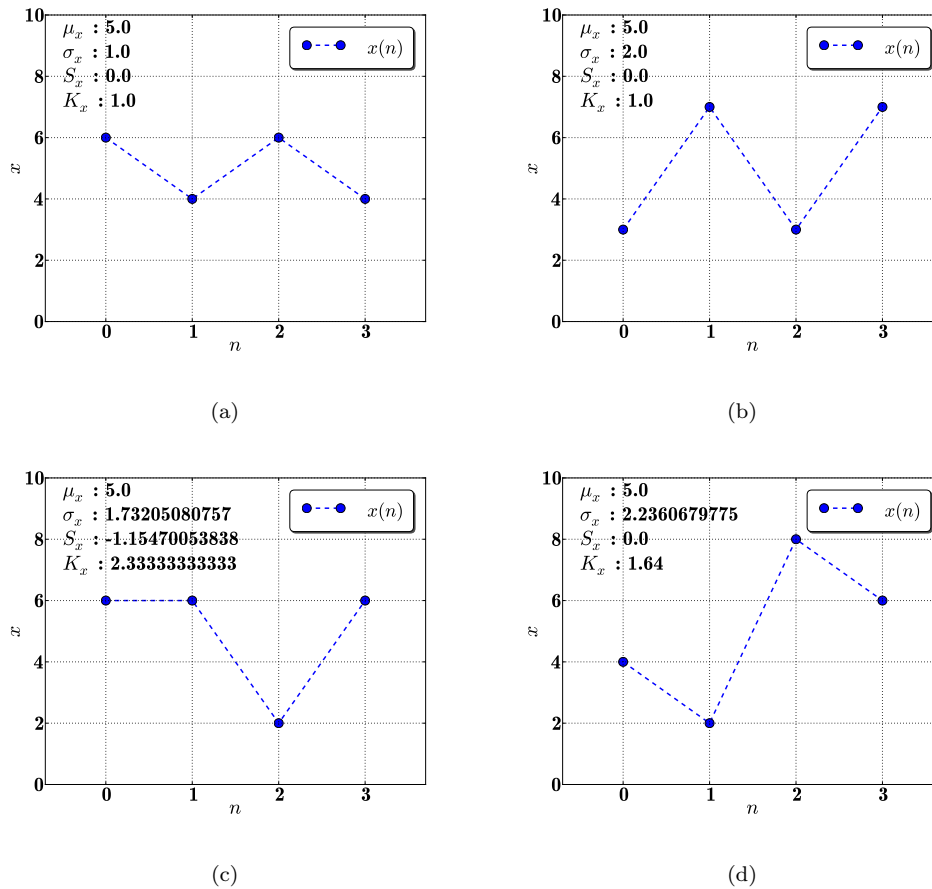


Figure 2.1 – Values taken by mean μ_x , standard deviation σ_x , skewness S_x and Kurtosis K_x for different shapes of discrete signals

Frequency domain techniques. Frequency domain techniques have become popular for drilling monitoring applications as drilling generates periodic patterns of forces and vibrations. The *Fourier transform* (equation 2.6 for its discrete form, the discrete Fourier transform (DFT)) and its inverse allow switching from the time to the frequency representation of signals. As they are usually given in the *time domain* by sensors, they can be converted in the *frequency domain* using the Fast Fourier Transform (FFT) algorithm which is based on the DFT.

$$X_k = \sum_{i=0}^{N-1} x_i \exp\left(-j2\pi \frac{k}{N} i\right) \quad (2.6)$$

The representation of a frequency component X_k of frequency k of the signal in the frequency domain is a complex number given by the inner product of the signal \mathbf{x} and a complex sinusoidal wave $\exp(-j2\pi \frac{k}{N} i)$. Therefore, different frequency sinusoids form a new basis and the signal is projected on its constituting vectors. The normalized squared modulus of the vector \mathbf{X} $|\mathbf{X}/N|^2$ gives the power distribution, or *power spectral density* (PSD) of the signal as a function of its frequency components while their phase is given by its argument $\langle \mathbf{X} \rangle$. The PSD of a signal is often referred as its *spectrum*. Figure 2.2 shows this decomposition and illustrates the ease of interpretation of *stationary* signals offered by the frequency domain. Frequency content of vibration and force signals often give useful information on both the drilling process and the rotating machinery condition for instance. Many authors stated that features extracted from the frequency domain are more useful for monitoring than those

extracted from time domain representation of signals [103, 102, 9]. Another popular technique consists in isolating frequency bands of signals that correspond to the phenomena of interest by using filters and apply it time domain techniques for example. As no location in time is possible in the frequency domain, spectral analysis only allows monitoring stationary process.

Time-frequency and time-scale domains techniques. Time-frequency and time-scale domains techniques are used when some patterns have to be located precisely in sensors signals both in time and frequency. Their short duration does not allow detecting their presence neither using time or frequency domain global representations of the signal. To overcome this limitation, Gabor [46] introduced a sliding *window* function g to the Fourier transform and obtained a frequency representation localized in the time domain. The so-called *short time Fourier transform* (STFT) is given in its discrete form in equation 2.7. As the use of windows modify the signal to be analyzed, several windows shapes have been proposed offering different characteristics in terms of energy or frequency distortion of signals content.

$$X_{u,k} = \sum_{i=0}^{N-1} x_i g(k-u) \exp\left(-j2\pi \frac{k}{N} i\right) \quad (2.7)$$

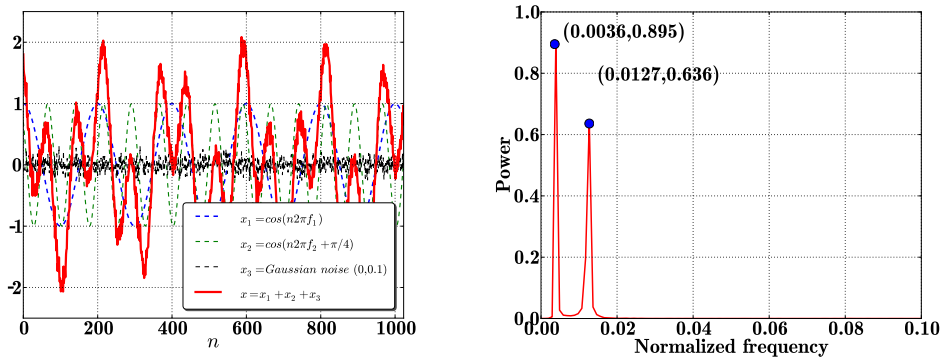
This method presents two main limitations. As stated earlier, the Fourier transform is to be used to analyze *stationary* signals, and it is not always the case for patterns to be find for drilling monitoring purpose, even within short time durations. For instance, severe tool chipping will produce a unique and sudden decrease in the thrust force signal. The second drawback of STFT also arises from the Fourier transform properties. The location of a phenomenon in time implies taking a smaller number of signal samples N into account when performing the transform. As saw earlier, the frequency resolution of the obtained signal representation in the frequency domain is inversely proportional to N ($N/2+1$ points will cover the whole frequency range running from 0 to the *Nyquist frequency*). Therefore, an increase in time resolution will result in a decrease in the frequency resolution and vice versa, forbidding precise localization of patterns in both time and frequency. An example of a STFT transform of a spindle motor phase current is given in figure 2.3.

Time-scale techniques, and *wavelets* introduced by Mallat in 1992 [94] in particular, provide solutions to address the time-frequency techniques limitations. If the principle of using inner products to project the signal into a new basis in order to obtain a more informative representation has been kept, its constitutive vectors are no longer sinusoids which are suited for stationary and theoretically infinite length signals. Instead, *wavelets* are used. They are finite in time (or space), and their location information is embedded in the vectors of the basis that is build upon, allowing to know where in the signal a pattern matched with the wavelet. Several wavelet types exist, and wavelets often present an one-period oscillating pattern which allow linking them with frequency components of the signals (figure 2.4 shows two classical wavelet families). All the frequency contents can be addressed by the same wavelet family ψ by the use of a *scaling* factor s which allows dilating or contracting the wavelet. The continuous wavelet transform is given in equation 2.8. The continuous implementation is given here for sake of understandability as the discrete wavelet transform (DWT) is performed according another scheme, even if following the same principle.

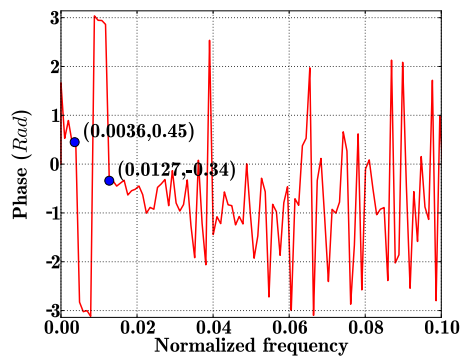
$$X_{u,s} = \frac{1}{\sqrt{|s|}} \int x(t) \Psi\left(\frac{t-u}{s}\right) dt \quad (2.8)$$

The aforementioned properties made wavelet a popular tool for pattern recognition, filtering and noise removing applications in drilling monitoring applications, and in many other domains.

Figure 2.5 allows to understand benefits of wavelets compared with the Short Time Fourier



(a) Signal composed of 2 frequency component plus Gaussian noise represented in the time domain (b) PSD of the signal depicted in figure 2.2(a). The normalized frequency is the ratio between the actual frequency and the signal sampling frequency



(c) Phase plot of the signal depicted in figure 2.2(a)

Figure 2.2 – A signal composed of 2 frequency components plus Gaussian noise (a) represented in the time domain, and its PSD (b) and phase (c) plots in the frequency domain. Although the signal structure does not appear immediately in the time domain, it is clear from its frequency domain representation: the 2 frequency components are easily identified on the PSD where the normalized frequency stands for the ratio between the frequency components k and twice the sampling frequency. The maximum detectable frequency is called the *Nyquist frequency* and is half the sampling frequency. The relative phase shift between the two frequency components at f_1 and f_2 can be deduced from the phase plot: $|-0.34 - 0.45| = 0.79, \simeq \pi/4$. Other values taken by the phase have no meaning because of the too low magnitude level of frequencies they correspond to.

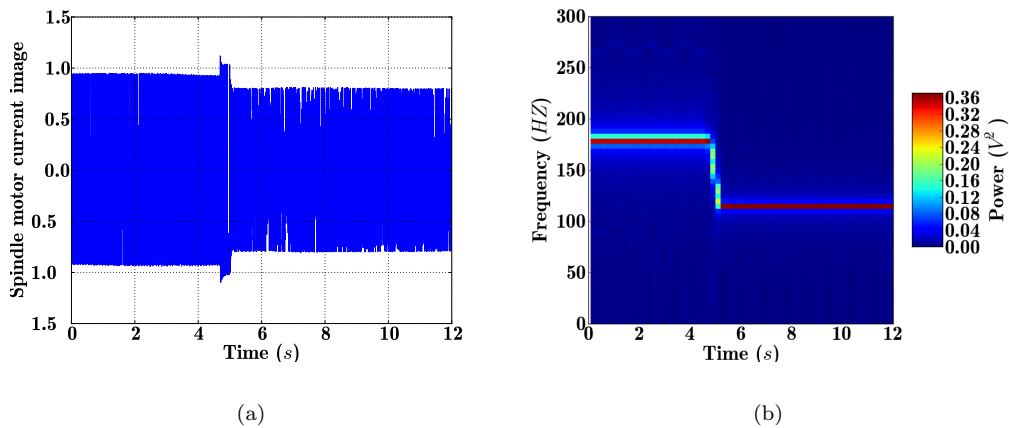


Figure 2.3 – Time (a) and time-frequency (b) representation of a signal: the STFT allows an easier understanding of the signal

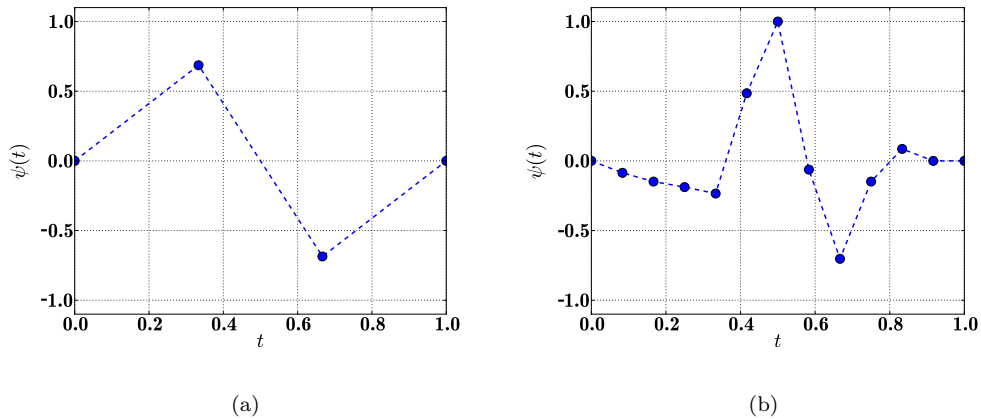


Figure 2.4 – Examples of two wavelet families: the first and simplest one, the Haar wavelet (a) and one of the most popular one, the Daubechies db2 wavelet (b)

Transform: a short duration signal (figures 2.5(a) and 2.5(b)) containing high frequency transients is analyzed with both STFT (figures 2.5(c) and 2.5(d)) and DWT (figures 2.5(e) and 2.5(f)). If the aforementioned resolution limitations of the STFT do not allow to localize precisely the transients neither in time or frequency, the wavelet decomposition allows it by finding the adapted decomposition level (when the wavelet *scale* correspond to the transient one) which authorize an accurate time location. The wavelet decomposition has been performed using the Haar wavelet.

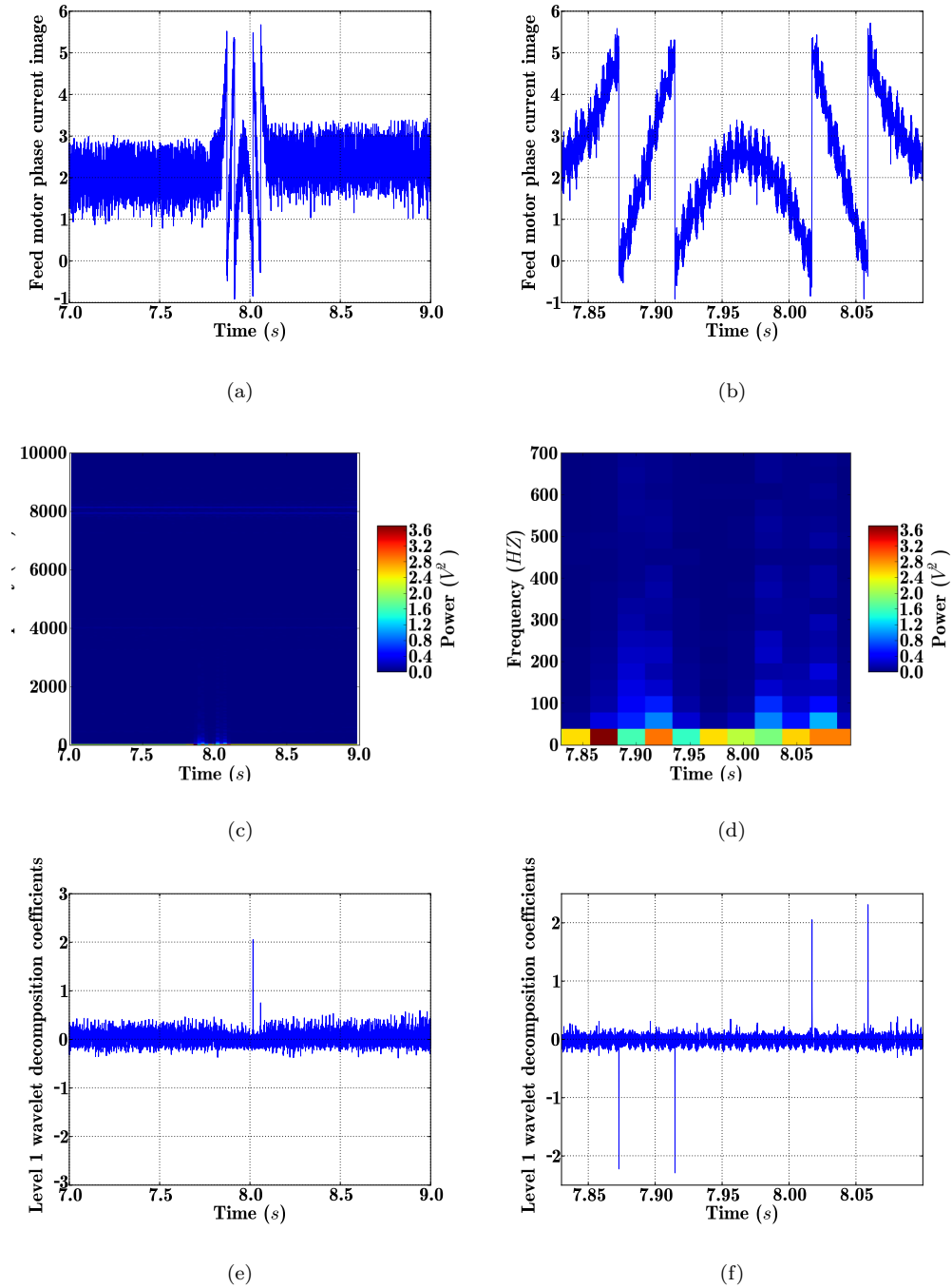


Figure 2.5 – A short duration signal containing high frequency transients (a)(b), its short time Fourier transform (c)(d), and its discrete wavelet transform decomposition at level 1 detail coefficient (e)(f)

2.1.1.2 Learning machines

Learning machines have been widely used for tool condition monitoring in order to determine mappings between *operating parameters* that influence the cutting operation, *features* extracted from sensors signals, and the process state. As this relationship has been shown to be complex and non-linear, techniques allowing non-linear modeling or discrimination, like multi-layered artificial neural networks (which have been used in 84% of papers involving machine learning for machining system monitoring [1]), have grown popular within the last 30 years.

For a learning machine, *learning* is the process which consists in the estimation of its parameters in order to perform the task which it has been designed for in the best manner.

Supervised learning techniques. Supervised learning techniques are used when no reliable algebraic function exists to estimate the process state from cutting parameters and features extracted from sensors signals. The task assigned to supervised learning machines is to realize a *statistical modeling*, or a *regression* from a finite number of measurements and their associated parameters. The fact that the variable(s) value (numerical or semantic) to be estimated is known for this finite number of *samples* that is used to *train the system* is at the origin of the name *supervised learning*. Supervised learning machine are used to perform both *classification* and *estimation*.

For classification, the learning step consists in using the set of input values given with their belonging *class*, the *training set*, in order to determine borders in the feature space that delimit the different *classes* that exist. Then, when a new data sample is given to the machine, its class is determined following the region of the feature space it belongs to. An illustration of a non-linear border between two classes in a two-dimensional feature space is depicted in figure 2.6(a).

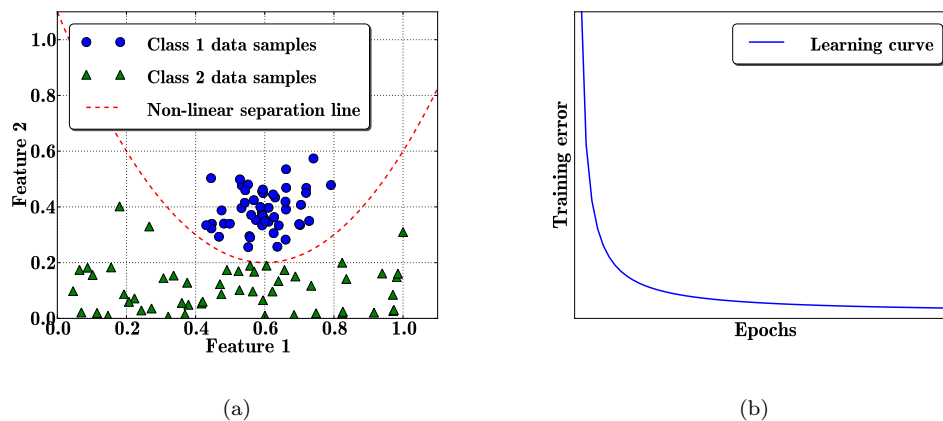


Figure 2.6 – Illustrations of a non-linear separating border in a two dimensional feature set(a) and of the typical shape of a supervised learning curve (b)

Concerning numerical variable(s) *estimation* applications, *training set* is used to set the machine parameters \mathbf{w} in order to obtain results close enough from the expected values associated with training inputs. This is usually done implementing an optimization procedure: a *cost* or *error function* (for example the mean square error (MSE) given in equation 2.9) based on the difference between the O ($O = \dim(\mathbf{d})$) known output values \mathbf{d}_i expected from input feature vector \mathbf{x}_i and the learning machine output values \mathbf{y}_i is minimized regarding \mathbf{w} . The minimization is done iteratively until an acceptable error rate as been reached or the

system converged. Each iteration involving all the N samples of the training set is called an *epoch*. A typical *learning curve* is depicted in figure 2.6(b).

$$E = \frac{1}{N} \sum_{i=1}^N \sum_{o=1}^O (d_{i,o} - y_{i,o})^2 \quad (2.9)$$

The *prediction performance*, or *generalization performance* of learning machines is assessed using a *testing set* of input samples that expected output values are known, but that were not used to train the machine. Then, comparing obtained output values with expected ones allows evaluating the goodness of the machine. As complex estimation or classification problems often require a large number of training samples, sophisticated methods exist that allow optimizing the use of available data to train and test learning machines. More details and a discussion on the special case of drilling monitoring applications will be given in section 3.4.

In drilling monitoring applications, *back propagation neural networks* (figure 2.8(a)) have been the most popular supervised learning machine by far. In particular, they have been used to detect or predict tool fracture [21], and to estimate tool wear [102, 92, 86, 3, 122, 126, 109, 113, 108, 112]. The learning principle is to iteratively compute the learning error obtained from the *training set* of data and to minimize it using an optimization procedure on the network parameters \mathbf{w} , the *synaptic weights*. The learning is stopped when the error reaches an acceptable level or when too much iterations, or *epochs*, have been done. The 'back propagation' name comes from a numerical method to calculate the gradient of function that is often used in the optimization procedure employed to minimize the training error. The synaptic weights updates from epoch e to $e + 1$ obtained using the gradient method is achieved in the form given in equation 2.10 where η stands for the *learning rate* which rules the speed and smoothness of the learning convergence.

$$\mathbf{w}_{e+1} = \mathbf{w}_e - \eta(e) \nabla E \quad (2.10)$$

Each hidden layer(s) neuron performs a weighted summation of its J inputs x_j and process it through an *activation function* f to determine the neuron output y , as described in equation 2.11 where w_0 denotes a bias input. Usually, sigmoid functions are used as activation functions because of their graceful balance between linear and non-linear behavior, and also because they are differentiable [54].

$$y = f\left(w_0 + \sum_{j=1}^{J-1} w_j x_j\right) \quad (2.11)$$

Some important concerns are to be taken into account when using supervised learning techniques. The first one is the coherence between the training set and the data that the machine will have to deal with. In particular, the size of the training set and the coverage of the feature space by the training samples are key points for an efficient learning. Illustrative examples of good and poor coverage of the feature space are given in figure 2.7. Moreover, one can remark that adding features implies exponential increase of the training samples number to achieve the same coverage rate of the feature space. This phenomenon is known as the *curse of dimensionality* and favors the use of feature spaces presenting low dimensionality, and so underlines the importance of an efficient *feature selection* [121].

Over-fitting is also a serious problem. A model over-fits the training data when it describes features that arise from noise or variance in the data, rather than the underlying distribution from which the data were drawn. Over-fitting usually leads to loss of accuracy and poor prediction performance [121].

These concerns will affect the generalization performance of the machine.

Concerning BPNN, the choices of the network architecture (network type, number of neurons, number of hidden layers) and parameters (type of the activation function, learning

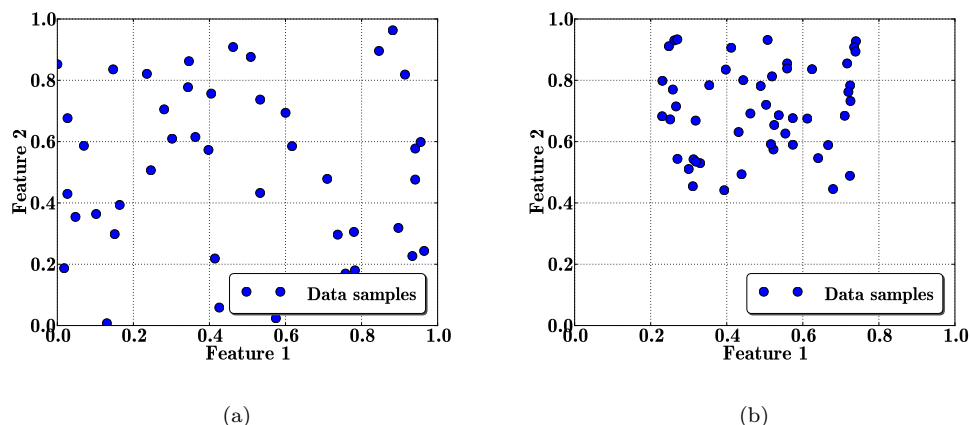


Figure 2.7 – Illustrations of good (a) and poor (b) coverages of normalized 2-dimensional features spaces

rate) have to be made carefully due to their respective influences on the overall prediction performance.

Unsupervised & hybrid learning techniques. Unsupervised & hybrid learning techniques are used to analyze data sets and discriminate them by looking for dissimilarities that are unknown *a priori*. Aggregating data samples according to their similarity is called *clustering*. As the learning machine finds the similarities in the data by itself, this learning type is called *unsupervised*. Nevertheless, once the parameters of the machine are set, an initialization phase using samples which output value are known is usually necessary for the user to determine how the machine organized the data. One of the oldest clustering algorithm is the *K-means* algorithm. It consists, for a given number k of classes to find within the samples of a data set, in building clusters of data points that are similar. To do so, clusters, that are defined by their position in the feature space, are updated iteratively by averaging the position of the data point they are *responsible* for. Once the clusters positions have been updated, the clusters *responsibilities* $R_{k,i}$ regarding each data point x_i are assessed according to their distance the points following equations 2.12 and 2.13, where f makes R decreasing as the distance increases.

$$R_{k,i} = f(\text{dist}(k, x_i)) \quad (2.12)$$

$$k_{resp}(x_i) = \min_k R_{k,i} \quad (2.13)$$

This iterative scheme is repeated until no changes occurs in the clusters position and data points they are responsible for. Several upgrades have been proposed to this basic version of the k-means algorithm, and it is also at the origin of the *self-organizing* procedure of *Radial Basis Function Networks* (RBFN). Kohonen's *self-organizing maps* (SOM) presents similarities with the k-means techniques in its learning phase too. These types of networks have been used for drilling monitoring applications in [49] for the latter, and [138, 108, 47] for the former. Basically they synthesize information contained in the input data by underlying dissimilarities. This allows detecting changing states as a function of the input data once the network has been trained, or simply identify a change in the process.

It is interesting to note that in the case of RBFNs, parameters μ_j and σ_j of the networks are not associated with the synaptic weights of the network, but within each neuron multi-dimensional Gaussian activation function, as it can be seen in equation 2.14. This function allows understanding how input data are discriminated by the network: the influence domain

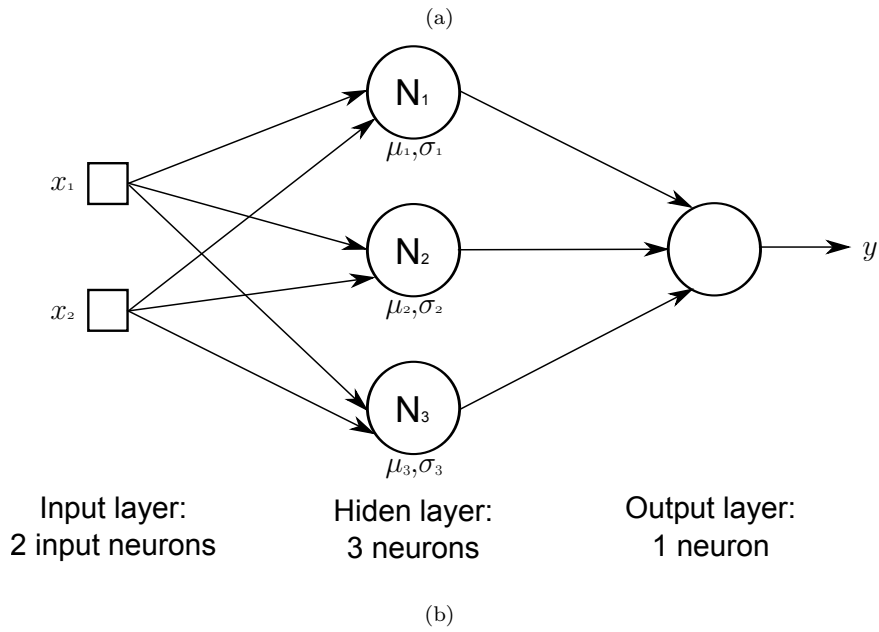
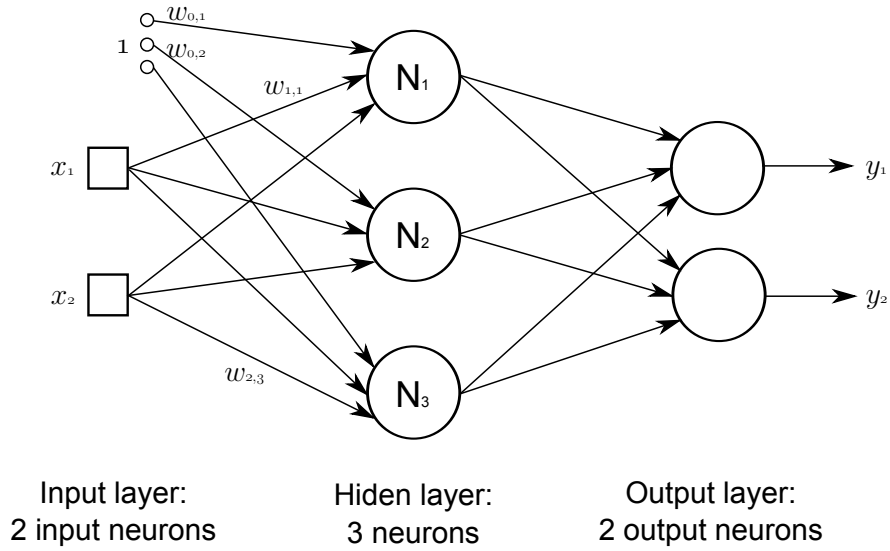


Figure 2.8 – Structures of a back propagation neural network (a) and of a radial basis function network (b)

of a neuron is local and determined by the parameters μ and σ of its Gaussian activation function. To each neuron correspond a cluster, or a category of data.

$$y = \exp\left(-\sum_{j=1}^J \frac{(x_j - \mu_j)^2}{2\sigma_j^2}\right) \quad (2.14)$$

RBFNs have only one hidden layer, and the output value is a weighted sum of hidden layer neurons outputs. The output $g(\mathbf{x}, \mathbf{w})$ of a RBFN containing P neurons in its hidden layer and where \mathbf{x} and \mathbf{w} are the input and the parameters vectors of the network respectively is given by equation 2.15. The structure of a RBFN is depicted in figure 2.8(b).

$$g(\mathbf{x}, \mathbf{w}) = \sum_{p=1}^P (w_{p+1,i} \exp\left(-\sum_{j=1}^J \frac{(x_j - \mu_{j,p})^2}{2\sigma_{i,p}^2}\right)) \quad (2.15)$$

Compared to supervised learning techniques, these methods should require less learning effort in terms of size of the training database and computational effort. Moreover, they sometimes adapt to new operating parameters under some conditions and are more flexible regarding variability of process parameters.

2.1.1.3 Fuzzy logic & fuzzy systems.

Fuzzy logic, which has been introduced by Zadeh in 1965 [149], is an extension of boolean logic based on *fuzzy sets* theory. Conversely to classical *crisp sets* to which an object can only belong or not belong, fuzzy sets introduce the notion of *membership degree*. This flexibility is appreciable when categorizing objects which evolve in a continuous manner or when different categories are difficult to define precisely. Each fuzzy set is defined by a *membership function* which allows determining the membership degree to a category of an object described by a numerical variable regarding it. An illustrative example of membership assignment is given in figure 2.9(a) where the tool state is determined as a function of its flank wear value. It would be difficult to define crisps partition between wear states because it would signify that an infinitesimal increase of tool wear would make the drill pass from a 'sharp' state to a 'worn' state, or from 'worn' to 'dull'. Trapezoidal membership functions have been used for the example, but many functions can be used under certain conditions. Rectangular membership functions are the special case of crisps sets.

Fuzzy systems are inference systems based on fuzzy logic. The input variables are first *fuzzy-fied* using the procedure mentioned above. Once their membership to each fuzzy sets have been determined, *fuzzy rules* are applied to define the membership to output fuzzy sets. Fuzzy rules use 'and' and 'or' operators to associate inputs, and output states are defined as a function of their combinations. Illustrative examples of fuzzy rules assessing the state of drilling system using drill and spindle states as inputs are:

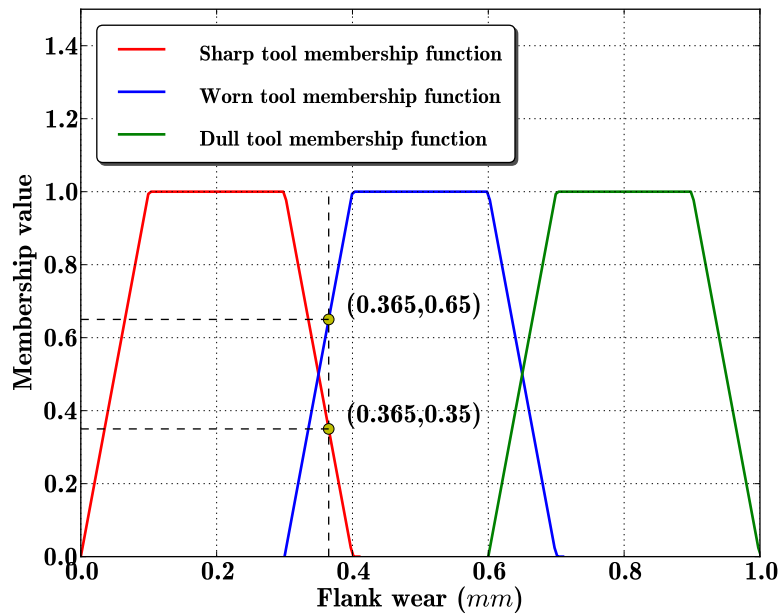
'if the spindle is unbalanced or the drill is dull then the drilling system is in critical state',

or

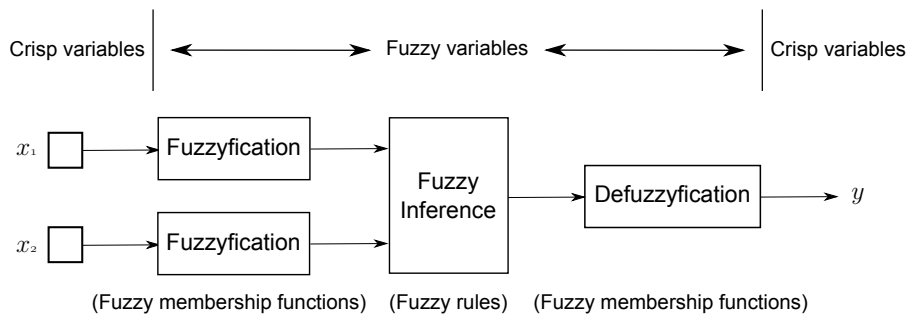
'if the spindle is well balanced and the drill is sharp then the drilling system is in good state'

The membership degrees to output fuzzy sets ('critical' and 'good' in the example) is then calculated from the membership degree of inputs using the fuzzy rules. Then, as crisp numerical values are often preferred to membership degrees, a *defuzzification* can be performed on the output variable(s). The fuzzy inference process is depicted in figure 2.9(b). Several definitions of the *fuzzy implication* exist, leading to different ways to calculate the

membership to output fuzzy set from input ones. In the same manner, several 'defuzzyfication' methods exist. Outputs of fuzzy inference systems are often a non-linear functions of their inputs. As membership functions are often based on linguistic variables, fuzzy logic systems are easier to set-up than classical ones for which the tuning of thresholds to differentiate between categories is often a complicated task. The membership functions and fuzzy rules are defined by the user.



(a)



(b)

Figure 2.9 – Illustrative example of fuzzy membership functions defining the drill states as a function of its flank wear: if the flank wears equals 0.365, the tool is 35% sharp and 65% worn (a), and illustration of a fuzzy inference process (b)

2.1.2 Description of phenomena of interest in drilling and common associated sensors and features

Monitoring systems consists in sensors, signal conditioners/amplifiers and a monitor that uses a strategy to analyze the signals from the sensors and to provide reliable detection of tool and process failures [62]. Following the industrial needs of monitoring in precision drilling, main phenomena of interest will be described, and related studies presented, including signal processing and decision making techniques used, if any.

Measuring techniques used for drilling operations monitoring have traditionally been categorized into two approaches: *direct* and *indirect*. In the direct approach the actual quantity of the variable (e.g. tool wear), is measured. Many direct methods can only be used as laboratory techniques due to the practical limitations caused by the difficulty to implement them in industrial contexts, the harsh industrial environment and the loss of productivity their implementation would cause. However, direct measurement has a high degree of accuracy and has been employed extensively in research laboratories to support the investigations of fundamental measurable phenomena during machining processes. They also serve as reference measure used during the design and implementation of monitoring systems. Through indirect measurement approaches, auxiliary quantities such as the cutting force components, the power consumption or the vibrations generated while drilling can be measured. The actual quantity is subsequently deduced via empirically determined correlations. Indirect methods are less accurate than direct ones but are also less complex and more suitable for practical applications. Only indirect methods are part of the scope of this work as it is aimed at the implementation of an online monitoring system suitable for industrial applications.

Differently from most reviews of drilling monitoring techniques where the type of measurand is used to classify applications [135, 60, 30, 62, 104, 23], they will be classified here according to the phenomena of interest evolution scheme (sudden or progressive), and therefore the detection and/or estimation techniques they imply. As it hints the premises of the architecture to be deployed, this classification is a first step through the design and implementation of an industrial drilling monitoring system, by emphasizing the whole approach to be used to monitor a phenomenon.

For each phenomenon and associated measurands, studies that investigated correlations between measurements and phenomenon will be presented first, followed by works aimed at the estimation of the value taken by the monitored phenomenon as a function of measurements, and lastly, studies going from measurement to decision making will be introduced.

2.1.2.1 Detection of sudden phenomena occurring untimely during drilling

Sudden phenomena occurring during drilling operations are at the origin of two principal issues: *workpiece alterations* leading to over-toleranced parts and sudden *tool failure*, the latter leading to the former one in most cases. Basically, monitoring of sudden phenomena should be done after each drilling operation using a binary classification scheme: did an undesired phenomenon occur or not? Sometimes, undesired phenomena occur that do not significantly affect the process from the end-user point of view. Then the border between acceptable and unacceptable process condition is not set upon the occurrence of a phenomenon, but on its level and the potential consequences it has on the process quality. In this context, robust decision making strategies are needed.

Monitoring of sudden workpiece alterations

In aeronautical applications, increase of the use of Carbon Fiber Reinforced (CFR) materials, and CFR Plastics (CFRP) in particular, has raised sudden occurrence of workpiece alterations occurring while drilling as a major concern. Indeed, the use of such laminated materials favor the apparition of new issues concerning holes quality in the form of *delamination* and *hole surface alterations*. Moreover, their frequent use in multi-material stacks

configuration together with metallic parts, which often present antagonist behavior in term of machinability, favor the use of cutting tools and parameters that are not fully adapted, and, in some extent, favor the apparition of defects. The laminated structure of such layered materials can be observed in figure 2.10.

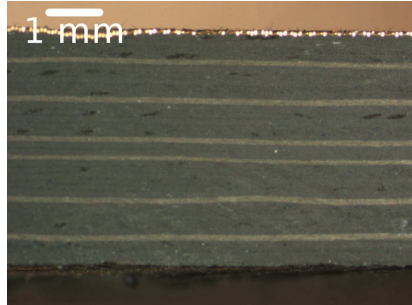
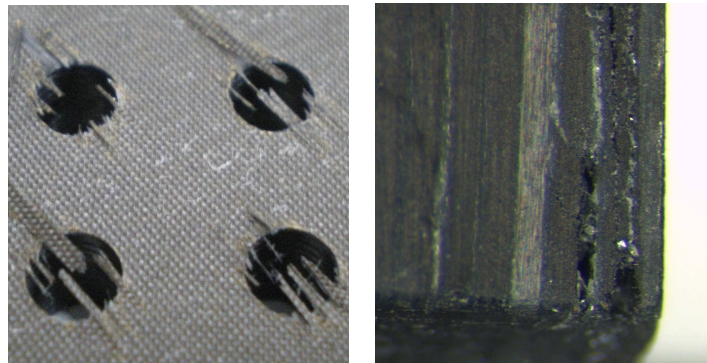


Figure 2.10 – A CFRP sample: the layered structure is clearly visible

Delamination. Delamination consists in an inter-laminar disbonding that reduces drastically assembly tolerance and bearing strength, but also has the potential for long term performance deterioration under fatigue loads [58]. If it mainly appears at holes exit as *push-out delamination* due to the application of a thrust force superior to the disbonding force limit of the few remaining material layers, it can occur at the hole entrance in the form of *peel-up delamination* [57], and also between workpiece internal plies (figure 2.11(b)). Hole exit can also be affected by fiber arrachement and uncut fibers and (figure 2.11(a)) that are considered drilling defects as they deteriorate the assembly properties.



(a) Delamination and uncut fibers on hole exit of a CFRP workpiece (b) Delamination between internal plies of a CFRP workpiece

Figure 2.11 – Examples of CFRP workpieces alterations

A great amount of work has been done in order to estimate optimum cutting parameters allowing avoidance of delamination while maximizing tool use and productivity (a recent review of these methods can be found in [88]). Use of theoretical models and realization of numerous experiments lead to the conclusion that excessive thrust force is one of the main factor favoring delamination.

Only a few studies have addressed the problem of in-process detection of delamination during drilling. All features that have been aimed at this purpose have been extracted from Acoustic Emission (AE) signals. The use of AE is well established in the field of non-destructive

structure health assessment, but AE signals obtained in drilling presents several specificities compared to other traditional measurements done for drilling monitoring purpose that imply the use of different techniques that will be explained further.

Because of its ability to sense sudden energy releases in deforming material [82], AE has been identified as a promising tool to detect delamination. However, studies showed that isolating the different sources of AE in a drilling operation is considered a very difficult task as the mechanism of generation of AE is not completely understood [118, 65] and analytical techniques are not completely developed [22]. Moreover, as AE signals are heavily depending on the machining process parameters [82, 59, 23, 136], using them for *flexible* monitoring purposes is a complicated task, especially in industrial context where operational conditions are often changing and *external perturbations* are expected. This issue, as well as some original solutions proposed in our work will be presented in chapter 5, section 5.1.3.

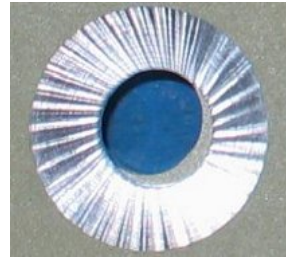
Ravishankar and Murthy [119, 118] used reverse engineering methods to correlate AE signals characteristics to the hole quality. They concluded that obtainment of a qualitative understanding about hole entrance and exit damage would demand rigorous statistical analysis, but noticed that AE signal RMS increased with applied thrust force, which can be a hint for monitoring delamination.

Jiaa [63] also examined the use of AE to detect delamination of composite laminates during drilling. A special signal processing scheme which consisted in subtracting the signal obtained after RMS computation using a 60 ms ('the medium AE energy signal') windows to the one obtained using a 10 ms window ('the fast AE energy signal') has been implemented, and the obtained 'residual' signal, which was independent of operating conditions, was compared to the 'medium' one. If pikes of the former crossed the latter, then a delamination occurred. Results also showed a linear energy level increase in normalized AE 'residual' signal as a function of the size of the entrance and exit hole delamination. Unfortunately, no other studies have been done that could validate this method.

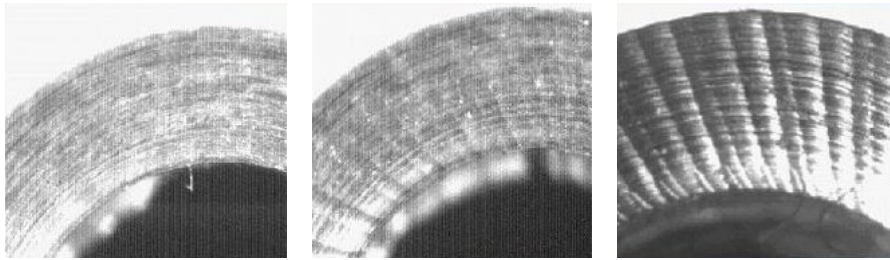
In 2007, a study [6] showed the existence of a correlation between hole exit shrinkage size and AE signal RMS when drilling Glass-FRP (GFRP) laminates and clusters of holes have been built according to their exit delamination state. Still, they were defined manually and no on-line monitoring method has been implemented. Moreover, it has been emphasized that AE signals were very sensitive to the drilling environment.

More recently, a wavelet-based method has been used on AE signals to investigate damage mechanisms during drilling of composite materials [56]. 10 mm HSS drills were used in GFRP at 2 cutting speeds and 2 feed rates. AE signals were recorded from a sensor mounted on the workpiece at a 1MHz acquisition rate. Discrete wavelet transform was used to decompose the signals in six levels, each one corresponding to a frequency band. The energy percentage of the signal in each component was then compared with the total energy of the signal. These percentages have been shown to be linked with thrust force, and so could be used to monitor delamination.

Countersink waviness. Countersinks waviness is another manifestation that is not systematic. It illustrates the variability of drilling operations performed on large structures when using complex drilling devices that exhibit different dynamic behavior as a function of the configuration of the machining system. This workpiece alteration consists in countersink surface finish that do not fit the required tolerance. No known reference (in our knowledge) exists on this problem in the context of airframe assembly. Experimental investigations made conjointly by Arts et Métiers Paristech and EADS IW showed that the waviness is due mainly to a lateral chatter phenomenon, occurring especially at the end of the countersinking phase of the machining operation. The chatter is a machining process instability that is generally explained by a regenerative effect in cut surface generation. Different levels of countersink waviness are visible in figure 2.12.



(a) A countersink where waviness is visible at the surface



(b) A countersink where waviness is not visible

(c) A countersink where waviness is slightly visible

(d) A countersink where waviness is clearly visible

Figure 2.12 – Different levels of countersink waviness manifestation

On-line detection of delamination is at early stage of research, and only few laboratories applications have been performed. Further theoretical (signal processing) and technical (sensor integration) developments are needed to clearly identify and isolate sources of AE while drilling in order to be able to reliably detect delamination occurring in diverse conditions. Moreover, thrust force measurements and a delamination prediction model could be used simultaneously with AE signals in order to make more reliable statements by *fusing* information.

Monitoring of drill failures

A drill failure is characterized by the fact that the tool geometry is significantly modified in a very short period of time, conversely from wear-related progressive phenomenon. Two main phenomena fall into this category: *tool fracture* and *tool cutting edge chipping*. While tool fracture implies that at least one of the drill cutting edges separates from the rest of the tool (figure 2.13(a)) and is always a critical issue, cutting edge chipping designates the separation of part(s) of the cutting edge, which can be considered as an alteration (figures 2.13(b) and 2.13(c)) and that does not always implies harmful influence on the process quality from the user point of view. However, it is often a forerunner of an advanced wear state of the tool and influences the incoming of wear related phenomena. As tool failure is considered as a stochastic process [60], it is of great interest to monitor its occurrence on-line.

Tool fracture. Tool fracture drastically modifies the on-going drilling operation, and studies aimed at its detection have been performed using different measurands.

Spindle currents have been the most used signals to do so. Works of Liu, Lee and Tarn [77, 134, 89] focused on the demodulation of the induction spindle motors current signals in

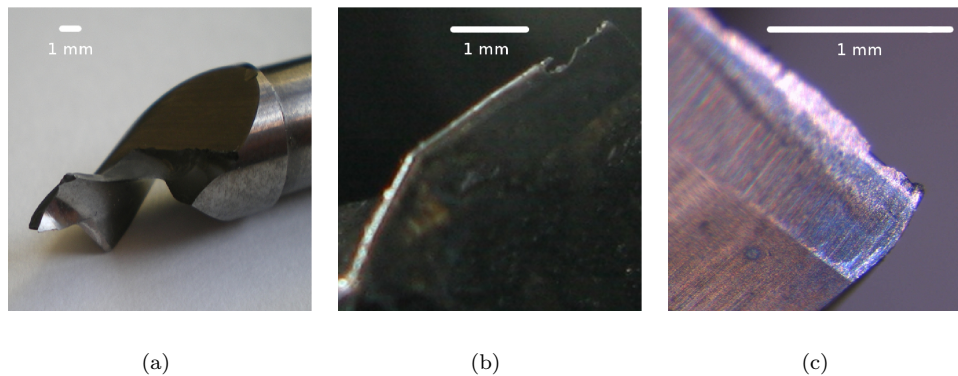


Figure 2.13 – Fractured tool (a), important tool cutting edge chipping (b) and small tool cutting edge chipping (c)

order to find tool fracture related features in it. Indeed, the occurrence of tool fracture while drilling will cause an excessive cutting force acting on the drill. A large spindle motor torque will then be generated in order to keep the spindle rotating at a constant speed against this force, and since the spindle motor torque is approximately proportional to the spindle rotor current, a large variation of the spindle motor current is then unavoidable [134]. Although the rotor current is very difficult to estimate in such induction motors, the authors showed that the stator current, whose phase components are easy to measure, can be seen as an amplitude modulating signal. The modulated signal has been proven directly related to the motor torque. Discrete wavelet transform [77, 134] and the combination of a bridge rectifier and a low pass filter [89] have been used to perform this demodulation and obtain an image of the motor torque. If tool fracture have clearly been identified in resulting signals, no on-line monitoring procedure has been set-up. Tests have been performed using 12 mm diameter drills in steel workpieces. Moreover, if tool fractures have been detected and identified in this study, some other phenomena could produce the same effects on current signals.

In another study [143], the ability of wavelet transform to detect tool fracture transient signatures that are barely visible in the spindle and feed motors signals has been shown over various cutting conditions using small drills ($< 5\text{mm}$).

In [21], the spindle power signal has been used to *classify* the drilling operations into two categories, 'normal' and 'abnormal', the latter corresponding to drill breakage or absence of drill. A two-stage neural network has been used to do so that took the raw power signal as an input instead of statistical features. Indeed, the first neural network stage was aimed at feature extraction while the second one was devoted to classification of the drilling state. Tests were performed drilling 12 mm holes in cast iron, and very good classification results and low false alarm rates have been achieved in industrial conditions. The authors noticed that failures type signals may sometimes be very different, leading to the impossibility for the system to recognize it correctly. They propose a periodic re-training of the network in order for him to learn new failure signal types when they happen, copying a human experience learning process.

Several merits of choosing spindle motor currents as sensors for monitoring tool fracture in machining have been cited: spindle motor systems are already built in machine tools, therefore, the cost of sensor investment is reduced and the mounting of the sensors does not interfere with the operations of machine tools [89]. However, it has been stated that in case of small drills, when drilling operation involving less power consumption due to the workpiece material lowest resistance (e.g. CFRP), or when high power spindle are used, spindle currents are not sensitive enough to tool fracture to allow detecting it in a reliable manner [45, 73].

Cutting forces and **torque** have also been investigated as means to detect tool fracture. In [19], a new method based on eddy-currents has been proposed to measure torque and predict tools failures. The stresses changes induced on the drill shank, that are mainly due to torque while drilling, will impact its micro-magnetic properties at the surface. Those changes have then been measured by the eddy current sensors and interpreted: significant changes appears in the sensed signals when a drill fracture is going to happen.

In another study [100], Mori used thrust force signal and wavelet analysis to monitor small diameter (2 mm) drillings in stainless steel. Contents of three frequency-bands of the signal ('energy', 'waviness' and 'irregularity' contents of the signal) were analyzed, which allowed to classify the drill state as 'prefailure' or 'normal' using a linear discriminant analysis algorithm on drillings representations in the so-defined three dimensional feature space. One interesting point in this study is that more than characterizing signals content as a function of the drill state, a clustering procedure has also been implemented that allow assessing monitoring ability of the system, which is shown to be very dependent on the *clustering* technique parameters choice.

Fu [44] also used wavelet transform within the matching pursuit approach to predict smalls drills (2 mm diameter) breakage. Fractures are predicted when some typical *patterns*, namely 'screeching' mode and 'sawtooth' mode, are recognized within the thrust force signal, which can directly lead to a classification of the tool state. The system has to be trained using a signals database to select the most discriminant *features* between 'normal' drilling mode or 'prefailure' modes. The method achieved a 100% good classification rate on a 88 drilling *test set* after it has been trained on a 88 drillings *training set*.

Another wavelet-based approach using thrust force and a neural network has been successfully implemented in [133] to predict micro-drills fractures, however it is only suitable for machining machines using stepper motors.

Most of these studies focused on metallic materials drilling that induce high power consumption, but thrust force and torque can be far less reliable for fracture monitoring when drilling less power-demanding materials and/or when small drills are used. Moreover, cutting forces and torque sensors are often difficult to implement on drilling machines in industrial environments [135, 45, 73]. More information about force and torque sensors integration will be provided in section 5.1.2.

Vibrations have not been very popular for tool fracture detection, probably because of its sensitiveness to noise which is present in cutting process [60]. Methods to identify small drills fracture have been presented in [35]. In the time domain, Kurtosis computed on signals coming from accelerometers sensing vibrations in both axial and radial directions of the workpiece fixture has been shown to be a pertinent feature to indicate imminent tool fracture, independently from cutting conditions. In the frequency domain, ratio of radial and axial vibration signals cepstra respectively presented a peak at the rotation frequency when the drill was broken. In this study, a pre-processing step on accelerations signals has been done in order to not take into account influence of vibrations that are not linked with the material removing, that may explain their successful results.

One of the main advantage of vibration monitoring lies in implementation of accelerometers that can be done without any modification of the machine or workpiece fixture.

Acoustic emission has been used as a mean to overcome issues encountered when using current and force to monitor tool fracture when low drilling power is needed. In [73], AE signal RMS has been shown to increase significantly after tool fracture, even if the sensor was mounted on a steady part of the machine, far from the AE source. Another study [71] conducted in industrial environment on a multi-spindle drilling machine also achieved good results in tool fracture detection using AE. A frequency band containing information mainly due to drill breakage (175-250 KHz) was identified and used to avoid influence of other drilling related phenomena. The maximum AE RMS level and the standard deviation

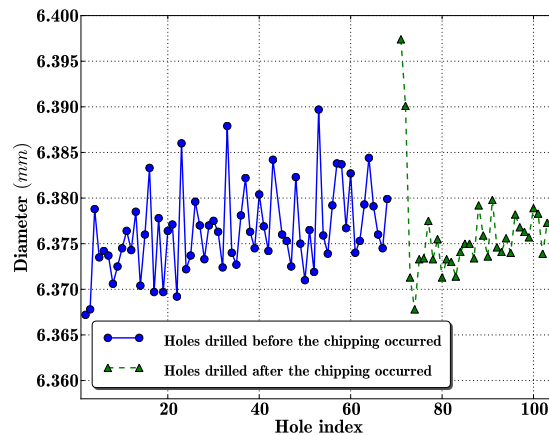


Figure 2.14 – Influence of a cutting edge chipping (figure 2.13(b)) on hole diameters when drilling Ti6Al4V

of AE RMS both present significant peaks when tool fracture occurs. However, the authors noticed that sensors placement plays an important role in the obtained results. They were placed on the workpiece fixture, and the contact pressure between the workpiece and this fixture has been shown to be heavily impacting the AE signals.

If AE seems to be one of the most sensible measurand to tool fracture, classical problems when using AE in drilling (sensitivity to process parameters and external perturbations, sensor integration, complexity of the signals) can make its use difficult.

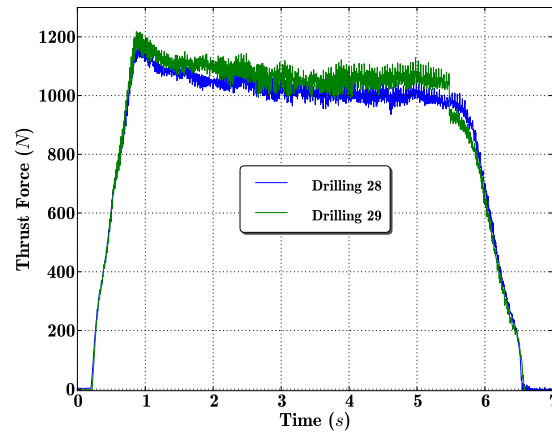
Input impedance of the spindle motor has also been used to sense tool fracture in micro-drilling, where spindle currents were not sensible enough to perform well [45]. It implies sensing current and voltage furnished to the spindle motor by the power input. The impedance of the motor computed at 50 Hz, which is the frequency of the power supply, has been shown to be well correlated with torque measurements performed at the same time. However, the study has been done on a simple DC motor type that is not often encountered in industry, and the authors stated that much work would be needed to obtain the necessary analytical values for voltage and current when using more complex motors, like the three-phases induction ones frequently encountered in industrial precision drilling applications.

Tool cutting edge chipping. Tool cutting edge chippings can be harder to identify because they do not systematically provoke high level perturbations during the drilling operation. However, it has been shown that even for small chippings, changes in cutting forces distribution along the cutting edges could lead to significant impacts on the hole geometry, which is usually the end-user main concern (see figure 2.14 for impact of tool chipping on diameter for instance). Moreover, it is important in the context of this work as it has been shown to be a classical issue when drilling CFRP and titanium alloys stacks using Polycrystalline Diamond (PCD) drills [111]. Tool chipping can be provoked by bad off-process manipulation of the tool as cutting edges are very sensitive to shocks (PCB coatings are very fragile for instance). It can also follow chip removal of build-up edge due to adhesive wear [16], or can be due to fatigue [30]. Although it is not a progressive phenomenon, and so can be considered as an opposite event from tool wear [8], it has often been associated with drill wear and has not been subject to many studies. However, their propensity to accelerate tool wear makes them very interesting *features* for wear monitoring.

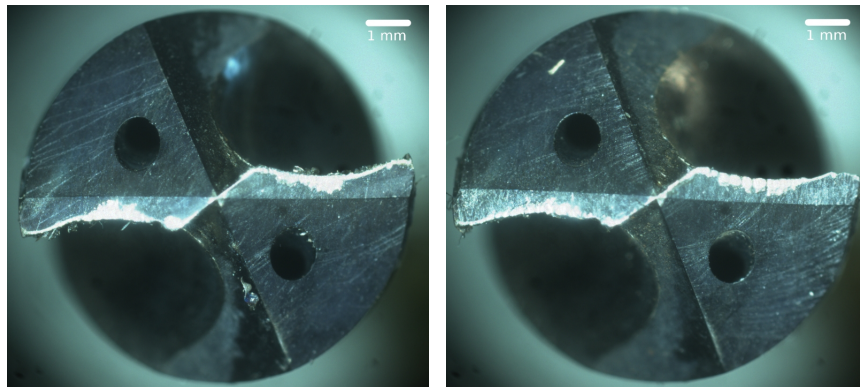
In [8], it was stated that *spindle power* was sensitive enough to monitor tool chipping in

drilling, but experiments were made on Inconel 718 with a 5.5 mm drill, inducing 10 N.m torque and 1000N feed force, making chipping visible although a powerful spindle was used.

Thrust force can also indicate tool chippings in cases where high cutting forces are involved. Figure 2.15(a) is an example of a cutting edge chipping signature obtained when drilling Ti6Al4V using 10 mm drill using a high feed rate (0.11mm/rev and a 50m/min cutting speed). Even small chippings as seen occurring between figures 2.15(b) and 2.15(c) are recognizable in these conditions.



(a) Thrust force recorded during two consecutive drillings: a tool fracture occurred at the end of the 29th hole (~ 5.5s) and is clearly visible due to the high level of force needed for the drilling



(b) picture of the drill cutting edges after the 28th hole has been drilled

(c) picture of the drill cutting edges after the 29th hole has been drilled and where a chipping is visible on the upper corner of the right cutting edge

Figure 2.15 – Illustration of a cutting edge chipping impacts on thrust force signal

Several applications of drill failure monitoring have been implemented. Spindle current sensors and accelerometers have been used due to their ease of integration, but showed limitations. Depending on drilling conditions (material, drill diameter, spindle power) spindle currents may not be sensitive enough to assess the presence of drill failures. As for accelerometers, they have not been very popular for tool failure detection, probably because of their sensitiveness to vibratory perturbations generated by the cutting process that make reliable statements about the tool state difficult to make. Thrust force and torque have been successfully used in some cases, but have been shown to be less reliable for fracture monitoring when drilling materials that do not require high cutting power and/or when small drills are used. Moreover, cutting forces and torque sensors are often difficult to implement on drilling machines in industrial environments. AE has been shown to be sensitive to tool fractures, but its sensitivity to process parameters and external perturbations, problems linked with sensor integration, and the complexity of the signals made its use difficult.

2.1.2.2 State estimation of progressive phenomena evolving hole after hole

A task of great importance in drilling monitoring is to follow evolution of critical variables as the number of drilled holes increases. Indeed, as every cutting based material removing operations, drilling induces tool wear due to the intimate contact and elevated temperatures at interface between the tool and the workpiece that leads to changes of the tool geometry. Then, holes can present geometrical properties that overcome allowed tolerances, so it is important to monitor these changes to avoid the realization of over-toleranced holes. A good accuracy when estimating those parameters is also required in order to reduce security margins applied for cutting tools replacement that take into account variations in tools life in a statistical manner [60]: due to the important number of drilling operations involved in the aeronautical industry, the optimization of tool replacement strategy is an important economical concern.

Although its impacts on hole geometry are the important variables to follow from an end-user point view, many studies have been aimed at the estimation of drill wear. If only tool wear is estimated, it implies that a correlation between its level and the hole geometrical properties have to be known by the end-user for him to decide when to decide a drill is worn and replace it. However, such a correlation can be very complex to explicit. Only few studies have tackled the problem from an end-user point of view and have focused on the estimation of geometrical properties of drilled holes from sensor signals.

Studies aimed at tool wear detection and estimation will first be introduced, classified according to the type of sensor used, and the deepness the monitoring problem has been tackled, from sensor detection ability, then wear estimation, to the implementation of a decision making strategy for tool replacement.

Then, the few studies that treated the problem from sensor signal to the estimation of holes geometrical parameters (diameter, burr height and hole surface quality) will be presented.

Tool wear estimation

Several mechanisms of interaction between the drill and the workpiece induce tool wear in drilling. Kanai *et al.* classified drill wear forms in five categories [67] linked with the location of the wear on the drill: flank wear, crater wear, corner wear, chisel edge wear and margin wear. In most research conducted on drill condition monitoring, progressive flank wear was the dominant failure mode and has been extensively investigated [3]. However, several authors stated that drill life is strongly characterized by corner wear on the drill [90, 35, 102]. Illustrations of both flank and corner wear popular measurements methods are given in figure 2.16. Pictures of corner wear when drilling CFRP, and flank wear evolution when drilling Ta6Al4V are visible in figures 2.17 and 2.20 respectively.

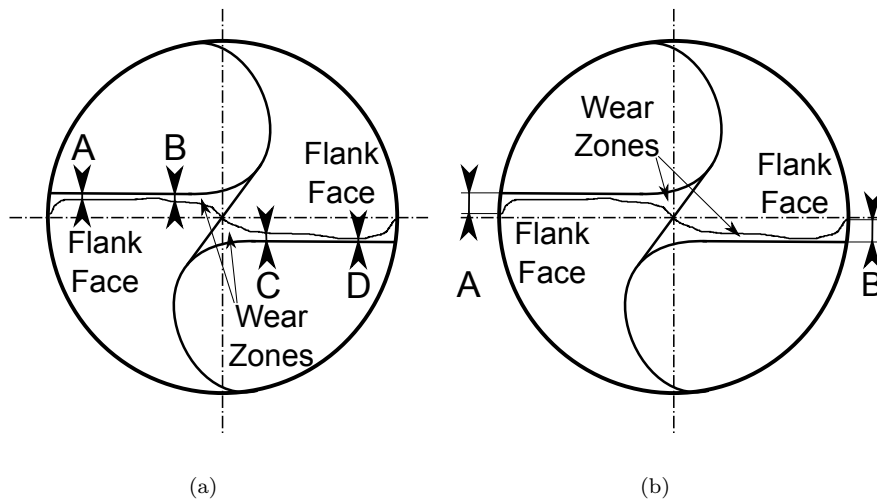


Figure 2.16 – Illustrations a drill flank wear (a) and drill corner wear calculation methods following [86] and [90]: $\bar{W}_{flank} = \frac{A+B+C+D}{4}$ and $\bar{W}_{corner} = \frac{A+B}{2}$

Spindle currents ability to sense tool wear has been assessed because they do not hinder the machining process and are cost effective [23]. In [42], spindle currents measured on the spindle driver have been filtered and processed using wavelet transform to be compressed into a simpler form. Then skewness between consecutive pulses of the obtained signal has been assessed using auto-correlation, and it has been shown that skewness increased significantly with tool wear. Experimental tests have been done drilling iron with large diameter drills (53 mm), which prevented aforementioned incomes of current low detection ability of current when using small drills.

In order to overcome problems encountered when using spindle currents during monitoring drillings that present low power consumption in comparison with the naturally dissipated by the spindle, an approach and a device have been presented in [4] which is based on differential power consumption, so only the power required for actual drilling is analyzed. Results showed wear detection ability when drilling CFRP with 12.7 mm drills using a 10 KW spindle. Only the ability of the system to sense tool wear has been demonstrated and the system has been patented, but no monitoring procedure has been implemented.

Spindle currents have also been used to perform *tool wear estimation* in drilling using Back Propagation Neural Networks (BPNN) in [113]. The operating conditions parameters have been taken into account and have been used as inputs of the neural networks with spindle current RMS. 12 different BPNN architectures have been implemented and assessed, and a regression model has also been implemented for comparison purpose. The neural networks and regression model have been trained on 35 different input patterns, and the estimation performance of the models have been done on 8 different patterns. All neural networks showed better performance than the regression model, probably due to their ability to map non-linear relationship between tool wear, cutting conditions and spindle currents, and one architecture in particular gave a 6% average prediction error. Although successful, this example underlines some drawbacks of neural networks: firstly, there is no analytical procedure to define the best architecture, or even network type for a given estimation task. Moreover, the networks ability to give accurate estimation heavily relies on the training database quality and size [55], which implies a great amount of experiments to implement a *flexible* system.

In [84], Li proposed an approach going *from current sensors measurement to tool replacement decision*. Its approach also necessitates the creation a database containing current

amplitudes as a function of cutting parameters and tool wear by performing experiments. Three tool wear states ('small', 'severe' and 'normal') have been used to build sets of fuzzy membership functions as a function of spindle current amplitude, each set corresponding to a particular combination of operating conditions. When drilling, the amplitudes and frequencies of spindle and feed currents signals are monitored, and the cutting conditions are first determined using the relationship between currents frequency and spindle/feed speed that have been investigated previously. The current amplitude was used as an input of the appropriate set of tool wear membership functions to determine the tool wear state. The decision making about tool replacement is then done according to a threshold on the membership level of the 'severe' tool wear state, but should be set by the user as a function of its needs.

Cutting forces and *torque* ability to monitor tool wear have been assessed in [9] and [103] leading to the same conclusions: no *correlation* between force or torque and flank wear appeared when using the time domain signals, but in the frequency domain, the power spectrum densities (PSD) of drilling signals were more informative.

In [9], the normalized damping ratios (NDR) of the thrust force PSD at the spindle rotation speed and of the torque PSD at twice this speed showed good correlation with flank wear, independently from the drill diameter, tool material and feed rate. This phenomenon has already been reported in turning operations.

In [103], the area under PSD from 0 Hz to 300 Hz was calculated and was well correlated with flank wear whereas mean and variance of force and torque signals in the time domain were not. Due to low signal-to-noise ratios (SNR), the PSDs used to perform correlations were actually an average of several PSDs obtained when drilling with tool presenting similar wear levels.

In [86], *flank wear has been estimated* when drilling copper alloy using force and torque separately. Cutting models proposed by Subramanian [132] have been used to make tool wear estimations. Thrust force allowed obtaining good predictions of flank wear over a wide range of cutting conditions if the cutting parameters are known as the average prediction error was about 10% of the measured value.

In [90], thrust force and torque have also been studied separately and used as inputs of polynomial neural networks to *predict corner wear*. As polynomial neural networks are self-organizing, the use of an algorithm to choose the best architecture on the basis of a tradeoff between prediction accuracy and network complexity has been possible. The training and test sets were only composed of 27 and 8 drillings respectively, and the average prediction error was about 7%. Once again, thrust force showed better ability to monitor tool wear.

In [37], a *state of wear was estimated* instead of a tool wear value using a hidden Markov models (HMM). The HMMs (one for the thrust force, the other one for the torque) were trained using sharp drills, and then they allowed obtaining a probability of the drill being sharp for each drilling. Results were encouraging, and the possibility to set a threshold on this probability to replace worn tools was demonstrated. It has been mentioned as a drawback by the authors that all experiments have been made in the same conditions.

In [147], two fuzzy logic and a neuro-fuzzy based decision systems have been implemented in order to determine tool wear state over different cutting conditions. The aim was to compare results obtained with a fuzzy system implemented using expert knowledge, and with a neuro-fuzzy system that used neural networks learning abilities to define the fuzzy membership functions of tool wear state as a function of statistical parameters (mean, maximum, standard deviation and RMS) calculated on the thrust force signal. Results were good using both systems, but it has been shown that as reliability of the neuro-fuzzy system decision depended on the quality of the training set (mainly its coherence with testing data), so *expert knowledge should be used when available* in order to avoid pitfalls due to bad neural networks training.

Yang [146] assessed the use of both k-means algorithm and radial basis function neural

network to discriminate tool wear states with *torque signal*. Wavelet packet decomposition was used to separate different frequency bands of the signal in order to compute energy contained in its frequency components corresponding to the spindle rotation speed and its 3 first harmonics. Indeed, they have been showed to increase as a function of tool wear. 26 drillings have been performed under different operating conditions on a CNC machine using 8 mm diameter carbide drills in silicon aluminum alloy. 3 Wear states have been considered: 'slight wear' (<0.1 mm), 'normal wear' (>0.25 mm) and 'severe wear' (>0.5 mm). The four aforementioned features have been used as inputs of a k-mean clustering algorithm and of a RBFN where a k-mean procedure was used to set the neuron centers at the first step of the learning procedure. 13 drillings have been used to train the network, and the 13 remaining to test the performance of both approaches. The k-means method allowed a 69.23% good classification rate (it was used to differentiate only between 'severe wear' and other states) whereas the RBFN reached 92.31%, which demonstrated the usefulness of the training phase, following the author. However, in our opinion, this results have to be considered with care because in both cases, only one sample has been misclassified, but the error calculation for the k-mean procedure seems to have been performed considering the 3 classes.

Most of works presented in this review stated that using thrust force was more informative than torque for monitoring tool wear. Approaches using cutting power consumption (force and currents sensing), have emphasized that cutting parameters like feed or drill diameter are heavily impacting the power consumption when drilling, and their respective influences have often been taken into account as input variables to build wear estimators and make predictions.

Another factor has been proved to be very important: the workpiece hardness. If the variation in thrust force, on account in changes in flank wear, is to be significant, the variation in workpiece hardness has to be held within 5% of the mean hardness value in order to be able to base the diagnosis of flank wear on the amplitude of thrust force and torque. Hence, torque, force and related currents measurements for monitoring drill wear should be attempted only after a very close tolerance has been obtained in the workpieces hardness [132].

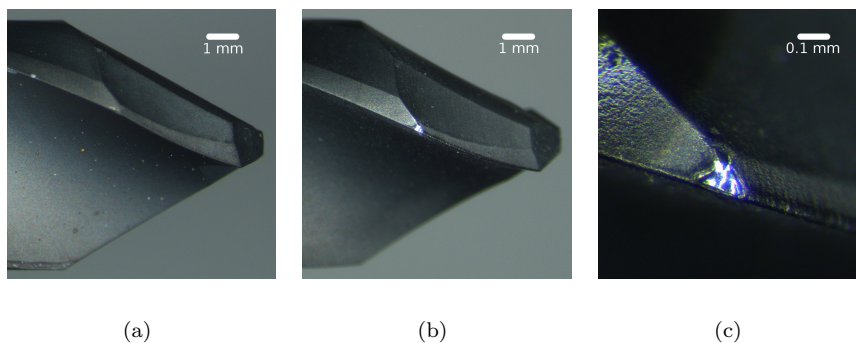


Figure 2.17 – New tool designed for CFRP drillings (a), same tool after 130 12mm deep drillings in CFRP (b), zoom on the corner wear zone (c)

Vibrations ability to sense tool wear has been assessed in [35] using 6 mm drills in cast iron. Different types of wear were reported to provoke peaks at different frequencies in the axial accelerometer signal spectrum: whereas a sharp drill did not significantly excite vibration modes, flank and chisel wear provoked peaks at 3.9 KHz and 5.3 KHz, corner wear was responsible of the apparition of a 3.2 KHz peak, margin wear at 4.5 KHz, and finally very large build-up edge was reported to provoke a 4.8 KHz spike. The area under the spectrum has been shown to be very well correlated with drill wear. The authors stated

that if these features have to be used for monitoring purposes, spectra of several drilling acceleration signals obtained with similar tool wear level should be averaged in order to avoid false alarms due to build-up edge or inhomogeneities in workpiece material that possesses harmful influence on the acceleration spectra.

In [10], an atypical framework to detect incipient drill wear has been introduced. Instead of using only features extracted from the power spectra of the axial acceleration signal, the bispectrum and second-order cumulant spectrum have also been used in order to emphasize the presence of non-linear time series generated by faults in rotating machinery that cannot be detected otherwise. A complete statistical study on classification results of drill wear states ('new tool' and 'slightly worn') classification has been performed on epoxy-glass composite material using drills going from 0.5 mm to 2.5 mm diameter, as used for printed boards preparation operations. It showed that the integration of features extracted within the introduced framework increased the probability of tool wear state good detection while it reduced the probability of false alarms.

In [83], a fuzzy neural network (FNN) has been implemented to process the RMS of five frequency bands of an axial acceleration signal. Five tool wear states based on flank wear level, namely 'initial', 'normal', 'acceptable', 'severe', and 'failure' have been defined and associated with a fuzzy membership function. Then the FNN output was on the form of a tool wear state membership level to each class, allowing to set a threshold to tool replacement. Results were mitigated going from 100% of severe wear state recognition to only 52% of correct initial tool state identification. They have been computed on only 10 test drillings, and the FNN has been trained using 20 drillings performed in different operating conditions (drill diameter, cutting speed and feed rate).

More recently, Abu-Mahfouz [3] used a feed-forward back propagation neural network (BPNN) to detect the presence of tool wear and classify its type using signal coming from an accelerometer clamped on the workpiece fixture. The inputs of the network were the cutting speed and feed rate, 16 averaged harmonics wavelet coefficient representing the acceleration signal power spectrum density (PSD), another compressed representation of this PSD in the form of its parametric definition given by the Burg model [96], and the mean, variance, skewness and Kurtosis of the time domain signal acquired during drilling. The network has been trained using 4 sets of cutting conditions, and its generalization ability has been assessed using 2 different sets. It allowed obtaining 100% of wear detection rate, and 90% good classification rate for the type of wear (chisel wear, crater wear, flank wear, edge wear or corner wear). The network architecture has been chosen in an arbitrary manner.

Shah *et al.* also investigated the use of acceleration measurements to sense tool wear [125]. An accelerometer clamped on the workpiece was used to record vibrations generated while drilling AISI4140 steel with 8 mm diameters drills under one operating conditions set. The average, RMS and standard deviation values of the signal in the time domain have been computed, but did not show good correlation with tool flank wear. The frequency domain representation of the signals, and the spikes related with the spindle rotation frequency and its harmonics increased with drill wear. A shift in the location of the dominant frequency has been observed when a cutting edge failure due to wear occurred. However, authors stated that vibration measurements were too noisy and lack linearity and stability to perform efficient tool condition monitoring.

The use of accelerometers to sense tool wear, although they are easy to integrate in an industrial environment, is quite limited to perform reliable wear monitoring in drilling due to their sensibility to noise and process parameters.

Acoustic emission is considered an efficient way to perform tool wear monitoring [32]. In [38], *correlations* between AE signal measurement parameters and drill lip height have been investigated when using robot to drill steel with 6.31 mm drills. AE sensors have first been mounted in different locations on the drilling robot end effector as it would be more practical for industrial use, but experiments did not show good results due to the presence

of too much mechanical spurious noise. The sample rate was set to 4 MHz. A hit-based system was used to measure key parameters (count rate, RMS, energy) of each AE hit, that is each signal that crosses a threshold. The threshold was set according to the noise level observable when the drill was rotating outside of the workpiece. When the sensors were placed on the workpiece, good correlation has been observed between lip height and AE energy, so variations of the former could be used to determine if the lip height is too large. Energy has been shown to decrease as wear increased. The distance between the AE source and the AE sensor has also been proven to have influence on the energy content of the AE signal, as well as adjacent holes that have been drilled previously.

A study [139] focused on composite laminates drilling using 6.5 mm drills. 16 Wavelet packets corresponding to 16 frequency bands of the AE signal were extracted, and their energy content has been shown to be correlated (non-linearly) with the tool flank wear. The energy first increased rapidly during the running-in period of the high speed steel drill, then started to decrease as wear increased.

In [74], the use of AE to monitor 10 mm drills wear when drilling steel and nodular gray iron has been investigated. AE signals have been analyzed in the frequency domain via energy contained in 4 KHz wide frequency bands between 180 KHz and 220 KHz. Tool wear significantly influenced AE signal from this point of view, and different behaviors were observed as a function of the workpiece material: energy increased with wear when drilling steel whereas it decreased when drilling iron. Another difference with the previous presented study is that neither the distance between the AE source and the sensor nor the presence of previously drilled holes seemed to affect the AE signal in a significant manner.

Different drilling configurations, including tool geometry, rotation speed and feed rate were used in [98] to drill carbon fiber/epoxy resin samples where an AE sensor was mounted, and a characteristic acoustic signature appeared in the 150 KHz - 200 KHz frequency range that was correlated with tool wear, independently from the drilling conditions.

AE signals served as a basis to *estimate flank wear* on drills with a BPNN in [112]. They have been processed within a bandpass filter (500 HZ - 50 KHz) to avoid low frequency vibrations influence and too high computation requirements due to high frequency measurement and processing. The RMS of 4 wavelet packets computed from AE signals have been assessed, and 2 showed non-linear relationship with tool wear. The RMS of the filtered AE signal has also been calculated. Two neural networks have been designed, the first one taking drill diameter, spindle rotation speed, feed rate and the AE signal RMS as inputs, whereas the former input was replaced by the RMS of the 2 wavelet packets contents for the second network. 75 Drilling tests were performed on mild steel with tool diameters of 8, 10 and 12 mm, at different cutting speeds and feed rates. 65 of these tests were used to train the networks, and the 10 remaining were used to assess their respective performances. The second one performed better and presented results with 12% maximum error rate on flank wear estimation. Its better performances are credited to the ability of wavelet packet processing to reduce influence of cutting condition on AE related extracted features. No arguments have been given on the choice of the neural networks architecture.

An AE based boring monitoring method has been presented in [144]. An apparatus was designed to implement AE sensor on the machine, near the cutting tool. A magnetic fluid was used to transmit the AE signal from rotating machinery to the sensor mounted on a steady part. This type of fluid has been shown to be one of the most efficient in AE transmission in a previous study by the authors. Transmitting AE via fluid to allow sensor implementation on steady part of rotating machinery has also been presented in [59]. After showing correlations between AE RMS and cutting speed and depth of cut, authors proposed to compute RMS of wavelet packets representing the AE signal in order to reduce influence of cutting conditions. 7 Of them have been shown to be linked with tool wear. A fuzzy c-means classification algorithm has then been used to *classify tool wear states* into 4 categories: 'initial', 'normal', 'acceptable' and 'severe' which were defined using flank wear as a criterion. Authors evoked a training phase of the algorithm, which is normally not necessary when

using clustering methods, and which probably stands for clusters initialization here. 90% of good classification rate was achieved. One could argue that if features are not sensitive to cutting conditions and so only tool wear influence them, and if a drilling test database is available, then classification method should have been used instead of a clustering one in order to delimit zones corresponding to the different tool wear states in the feature space. The important pros and cons of AE for drilling monitoring are underlined again in this review: although AE seems to be very sensitive to tool wear, the mapping between signals features and tool state is not yet completely established. Some contradictory results are given [38, 74], and a lot of influence quantities affect AE signals, which therefore require high level processing before being exploited. Moreover, no industrial satisfying solution has been found in order to solve the problem of AE sensor integration on rotating machinery. Some of these drawbacks will be addressed by innovative signal processing algorithms and technical developments in section 5.1.3.

Temperature of the workpiece has been investigated as a mean to sense tool wear in [125]. To do so, a thermocouple was set-up in the workpiece. If temperature increased with tool wear, its used as a monitoring mean remains complicated for several reasons. Only small temperature differences were observed when using a sharp and worn tool ($+7^{\circ}C$) due to the use of coolant while drilling. Moreover, the response of workpiece temperature to tool wear was sluggish due to the workpiece properties, and its thermal conductivity in particular. The location of the thermocouple in the workpiece regarding the drilled hole had a great influence, and results were difficult to interpret.

Because they do not hinder the machining process and are cost effective, current sensors ability to sense tool wear has been assessed with various strategies: from ad hoc feature extraction techniques to hardware device that allowed to show correlations between variations of electrical power consumption and tool wear, passing by learning machines for estimation of tool wear value or state. If experimental results were encouraging, no monitoring system has been implemented and assessed.

Using thrust force has been stated to be more informative than torque for monitoring tool wear. Correlations between cutting force and tool wear are well established, and learning machines (essentially BPNN) have also been used to perform wear estimations with reasonable success. It has been emphasized that cutting parameters like feed or drill diameter are heavily impacting the power consumption when drilling, and their respective influences have often been taken into account as input variables to build wear estimators and make predictions. Another factor has been proved to be very important: the workpiece hardness. Hence, torque, force and related currents measurements for monitoring drill wear should be attempted only after a very close tolerance has been obtained in the workpieces hardness.

The use of accelerometers to sense tool wear has been limited due to their sensibility to noise and process parameters. Complex signal processing and feature extraction techniques have been assessed and gave mitigated results.

AE seems to be very sensitive to tool wear, but as the mapping between signals features and tool state is not yet completely established, reliable estimations of tool wear have been difficult to obtain.

Hole surface quality

Quality of the drilled holes can be critical to the life of the riveted joints for which the holes are used. Aspects of the hole such as waviness/roughness of its wall surface can cause high stresses on the rivet, leading to its failure. On-line assessment of hole surface quality has been the subject of a study in [114]. The objective was to monitor changes in the surface profile due to evolution of drill wear in holes drilled in graphite epoxy laminate. To do so, the 'dynamic' part of *thrust force* and *torque* which the authors stated to be directly linked the cutting action of the drill, and hence the hole quality, have been used. They are putted in opposition with the 'static' part of the signals, often expressed in the form of their mean or maximum value, which can only provide a partial representation of the hole quality because they are affected by factors that are not related to the actual cutting action, and hence are unreliable when a close monitoring of the quality is required. A low frequency (less than 1.6 HZ) component was found in both the thrust signals and holes surface waviness profile which corresponded to the rate at which the drill penetrates through the layers of the laminated work material. This rate or 'lamination frequency' is given by (*lamination number per material thickness unit / time taken by the drill to penetrate a thickness unit*). Thrust force signal and surface waviness profile have been filtered to conserve only the 'lamination frequency' contribution (which has been previously experimentally shown to be the main contributor of hole surface waviness), and the standard deviation of the obtained signal was shown to be very well correlated with the standard deviation of the hole surface waviness. Such surface alteration on CFRP is visible in figure 2.18(a).

If no other attempts have been made in order to monitor the hole surface quality, it has become a serious issue with the increase of the number on drilling that have to be performed in composite laminates and metallic material stacks, (e.g. CFRP/Ti6Al4V). Indeed the chips generated while drilling the metallic part of the stacks, and titanium in particular, if not fragmented, can generate scratches once they are trapped between the drill flutes (figure 2.18(b)) and the hole surface while the drill is rotating. This can lead to extreme quality problems and decreased process reliability: Titanium chips transported through the CFRP-layer cause catastrophic erosion as well as delamination of the CFRP [16, 20]. Moreover, the stacking sequence of CFRP laminates are at the origin of 'V' patterns of holes surfaces 2.18(c), independently from process parameters.

Hole diameter

Monitoring the diameter of drilled holes is of major importance in industrial context because it is one of the main dimensional requirement. We found only one study that was aimed at finding direct correlations between sensors measurements and diameter. In [38], the objective was to correlate diameter of holes drilled in steel using 6.31 mm drills with any *acoustic emission* measurement parameter. The choice of AE was made because an oversized hole is caused by unbalanced cutting conditions due to cutting lips wear that increases friction and deformation of the hole and changes in the chips which can subsequently be monitored with AE. A hit based measurement system was used that allowed measured the RMS, energy, and count rate of each AE hit, that is each signal that crosses a threshold. AE sensors have been mounted on the drilling robot end effector at first, but results were not significant due to spurious mechanical noise. Then they have been placed directly on the workpiece, and correlation between AE RMS and energy and maximum and average hole diameters have been observed. Several negative conclusions have also been drawn: further research is needed to use AE for hole diameter estimation because the AE signal generated by the cutting process overrides the signal of the bit rubbing of the side of the hole. Moreover, sensor placement and mounting conditions have been shown to be heavily impacting results.

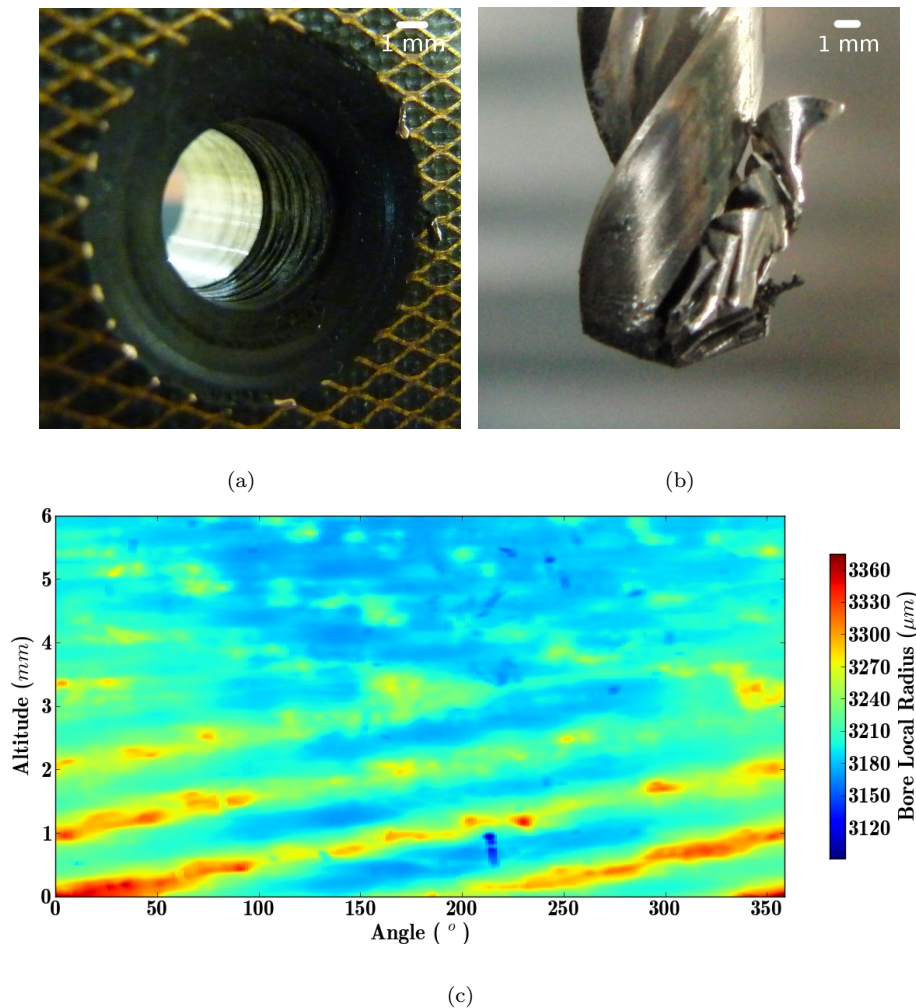


Figure 2.18 – Important hole surface waviness in CFRP in a CFRP/Ti6Al4V hole (a), Ti6Al4V non-fragmented chip stuck in a drill flute after drilling a CFRP/Ti6Al4V stack that could have caused scratches (b), surface reconstruction of a CFRP hole: a typical 'V' pattern depending on the CFRP stacking sequence [24] is visible (c)

Burrs height

Holes entrance and exit burrs height make part of the hole quality requirements in aeronautical manufacturing industry. Burrs mainly appears at hole exit when drilling metallic materials, and it has been raised as a major concern with the increasing use of titanium alloys. A definition of a burr is reported from Beier in [7]: a burr is a body created on a workpiece surface during the manufacturing of a workpiece, which extends over the intended and actual workpiece surface and has a slight volume in comparison with the workpiece, undesired, but to some extended, unavoidable. A classification of burrs in drilling has been proposed in [70]: 3 types of 'uniform' burrs (figure 2.19(a)) have been defined according to their size and the presence or not of a cap (figure 2.19(b)). When burrs present irregular shapes, their fall into the 'crown' and 'transient crown' categories.

The first study aimed at on-line burr height estimation by Peña and al. [101] assessed the capability of both *torque* and *thrust force* signals issued from the machine drivers to serve this purpose. On the 27 KW spindle they used, torque was the best signal to estimate exit burrs height when drilling aeronautical aluminum alloys with 10 mm drills. Five features

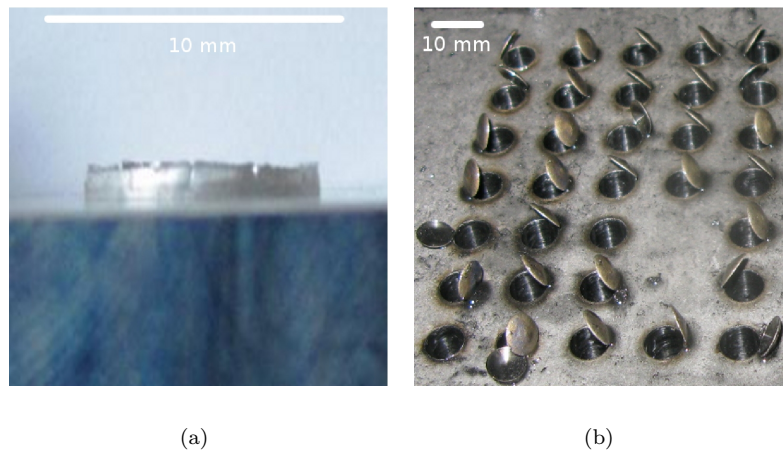


Figure 2.19 – Uniform burr of type 2 on titanium hole exit (a) and caps on titanium holes exits (b)

have been extracted from the wavelet-filtered torque signal that were not related to process parameters. Burrs height varied from $45 \mu\text{m}$ to $170 \mu\text{m}$, and finally, a *classification scheme* aimed at the determination of over tolerated burrs considering aeronautical requirements was set-up instead of an height estimator. It achieved 92% of good results on the 72 experiments that were made. The technique has been patented in 2007.

A data-mining approach to select features related to burrs height has been presented in [41], and it seems that the same data that has been used in the above mentioned study has been used again. The results of classification has been improved up to 95%. The authors proposed to apply their data-mining methodology to monitor other drilling related phenomena. They also envisage to use a framework that allows *taking uncertainty into account* in further works.

2.1.2.3 Overview on single sensor drilling monitoring applications

The classical scheme of research works in the field of drilling monitoring is to use one sensor to monitor one phenomenon, and multisensor monitoring often means providing the best sensor for each monitoring application [62]. If some studies achieved reasonable success or encouraging correlations, they unfortunately often have been done considering only few operating conditions states and lacked of extensive testing procedures, leading to a lack of flexibility when implemented in industrial plants [60, 85, 8]. Other attempts gave poorer results, especially concerning tool wear monitoring, because inadequate sensor information and process models have been used which did not satisfactorily reflect the process complexity. One reason is that the use of a single sensor signal in the development of a tool condition monitoring system fails to recognize the complex and diverse nature of the cutting process [30]. Jemielniak states that many of monitoring systems described in papers will never be applied as they will be proven to be unreliable or not viable economically [62]. Moreover, the problem of sensor dysfunction has not been tackled, and no experiments assessing impacts of noise on signals have been performed.

Even if these studies gave essential information on the type of sensors and signal processing techniques to be integrated has *the fundamental building blocks of a monitoring system*, it is now generally acknowledged that reliable process condition monitoring based on a single signal feature is not feasible [135]. Multisensor fusion coupled with the use of intelligent information techniques should improve reliability and flexibility of tool condition monitoring systems [85, 30, 23].

2.1.3 Presentation of drilling monitoring approaches using multi-sensor data fusion

Monitoring approaches using multisensor data fusion will be presented and analyzed. They will be classified as a function of the type of phenomena to monitor, and then following the data fusion and decision making techniques they use. Evolutions from the previous section conclusions and remaining blocking points will be emphasized.

2.1.3.1 Detection of sudden phenomena occurring untimely during drilling

Detection of sudden tool failure

In order to improve reliability of catastrophic tool failures monitoring, multisensor fusion approaches have been implemented to perform failure detection. Indeed, if many tool failures signatures have been determined in studies where only one sensor has been used, they could be mistaken for the expression of other stochastic phenomena occurring during the drilling operation. Thus, the use of multiple sensors to assess the occurrence of tool failure should increase the confidence in decisions. All techniques that have been developed are based on the detection of tool breakage signatures in time domain signals.

In [78], *AE* and *thrust force* sensors have been used together in a time sequenced manner to detect tool fracture of 5 mm HSS drills when drilling 1045 steel. Authors noticed that just before the fracture occurred, an AE burst was visible in the AE signal. Then, just after the tool failure occurred, a sudden drop was visible in the thrust force signal before it came back to a steady level. The AE signal provided by a sensor mounted on the workpiece and ranging from 100 KHz to 1 MHz was therefore used to trigger the thrust force signal inspection in order to detect the typical tool breakage pattern. Usage of both sensors ensured avoidance from faulty detection of tool breakage and practical usage under a production environment as well. The system has been experimented under one operating conditions set and worked very well on-line. Several parameters, like thresholds levels for AE burst detection and thrust force drop detection, AE burst duration, or the time interval required for the thrust force signal inspection have to be determined from experiments, which compromise the flexibility of such a system regarding changes in operating conditions.

An approach using *thrust force* and *torque* signals together was presented in [80]. The aim of the work was to make monitoring more reliable and suitable for a wider range of cutting conditions by associating thrust force and torque rather than choosing just one of them. If authors mentioned the presence of obvious signal signature on both the signals when a tool breakage occurred, they underlined the fact that if only one of them showed a sudden drop in amplitude before to come back to a steady level, it would not indicate positively that a tool breakage occurred because during tool breakdown, the signature exhibited by thrust force may be mistaken for with other kind of failures. A 'multi signature extraction technique' has been developed and the system has been implemented on a CNC machine to drill 8 mm and 12 mm holes on medium carbon steel. Force and torque signals were processed using a 10 Hz low-pass filter before the breakage signature detection began. No thresholds had to be set-up manually because they were automatically adjusted considering that the first drillings were done with a good shape tool. This can be considered as an *initialisation* of the monitoring system. A hardware device was designed and produced to guarantee real-time and reliable monitoring. No results concerning experimental validation of the system were given in the paper.

In these two studies, multiple sensors have been used to confirm their respective statements, and so ensure reliability of monitoring. In [78], two different kind of measurand were used for different purposes. AE was used to assess the *possibility* that a tool failure occurred in crude way, which triggered a fine analysis of the thrust force signal to detect a tool failure pattern. This *sequential use of different sensors* providing statements with *increasing detection ability*, but also computational effort needed, benefited both to the system reliability and to its industrial feasibility.

2.1.3.2 State estimation of phenomena evolving hole after hole

Tool wear monitoring

As for the review concerning monosensor monitoring studies, the multisensor attempts to monitor tool wear will be classified according to their goal. Studies emphasizing *correlations* between features extracted from sensors and the drill wear state will first be introduced. Works purposed to tool wear *estimation* will then be detailed, followed by attempts focusing on *classification* of drill wear state. Finally, works that presented developments going through *decision making* on tool replacement will be presented.

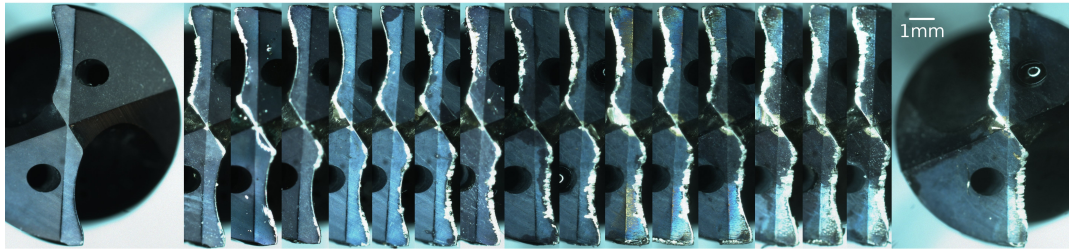


Figure 2.20 – Wear evolution on cutting edges of a 10 mm diameter drill used in Ti6Al4V

Correlation between tool wear and a feature issued from the fusion of two different sensor data has recently been shown in [140]. The *coherence function* between *thrust force* and *torque* spectra has been used to validate that both signals resulted from the same particular generating mechanism or source. Indeed, the authors stated that tool wear provoked periodic perturbations that are visible on both thrust force and torque spectra, conversely to other stochastic phenomena that manifest themselves in different manners on both. In the studied case of drilling *X4CrNiMo16* – 5 samples with 2.2 mm HSS drills, the coherence function presented a peak at 3500 HZ as wear increased. This frequency corresponded to a natural vibration frequency of the drill. This method suffers of its lack of wear level quantification and of its close relationship with the process parameters, the drill properties in particular.

Estimation of tool wear necessitates the use of predictors able to provide a numerical value as a function of input features. To do so, many studies have assessed *neural networks* ability to fuse features extracted from different sensors signals. Studies involving *supervised learning*, and *back propagation neural networks* in particular, will be evoked first. Then *unsupervised learning* or *hybrid learning* approaches using *radial basis function networks* will be detailed.

Back propagation neural networks have been the most popular type of networks to estimate tool wear. In [102], a first attempt was made to estimate corner wear using features extracted from *thrust force*, *torque*, and *radial forces* signals as inputs of a BPNN. One operating conditions set was used to drill 9 mm holes in A151 – 1045 steel. It was stated that the time domain signals did not present any correlation with tool wear, so the area under PSDs of the aforementioned signals spectra have been used. To avoid harmful stochastic effects, several PSDs issued from drillings made with a tool presenting similar wear level were averaged. A BPNN has been designed using results from previous works and a *trial and error scheme*. It has been trained using 51 drillings, and its generalization capacity has been assessed using 51 more. If good results have been obtained on the training data, the generalization results were not acceptable, probably due to *the presence of too much noise in signals*.

Influences of different architecture and parameters of BPNN have been assessed in another study [87]. The proposed case study was copper alloy drilling using three different HSS drill

diameters (5 mm, 7.5 mm and 10 mm) at different cutting speeds and feed rates (3 of each), and with three flank wear levels (0.1 mm, 0.5 mm and 0.9 mm). The networks inputs were the *thrust force* and *torque* average values, the drill diameter, cutting speed and feed rate. A preliminary study was done. It showed that the training data sequence had no influence on the learning performance, and also that using one or two hidden layers influenced only the training time if the overall number of neurons was the same. Most of the BPNN encountered in the drilling monitoring literature possess only one hidden layer. It has then been stated that all of the numerous assessed networks architectures worked quite well, even if a 88% estimation error has been reached on drillings performed with a drill affected by 0.1 mm flank wear. Increasing the number of neurons did not systematically provided a performance increase. Authors did not provide information on the size or structure of the training or testing data sets, so it is difficult to evaluate the pertinence of the presented results. Although a wide range of architectures and parameters of BPNN has been assessed, no clear conclusions could be drawn regarding these aspects.

More recently, the same kind of study has been performed assessing the influence of the number of neurons in the hidden layer of a BPNN [122]. Their number was varied from 1 to 20. The objective was to estimate flank wear on 8 mm HSS drills used within two different cutting speed and feed conditions. 40 Holes have been drilled for each process parameters set, and the *machining time of the drill* was used as an input in addition to the *torque* and the *thrust force* average values and the process parameters. The results were close to the measured flank wear value considering both operating conditions, but it is not clear if they have been obtained using a dedicated testing set or samples from the training set, which would not allow to assess the *generalization performance* of the networks. Two different networks architectures performed best for each of the 2 process parameters sets: a 2 neurons hidden layer gave the best results for one whereas a 10 neurons hidden layer allowed obtaining the best results for the other.

A series of works by Panda, Pal and Chakraborty *et al.* [126, 109, 108] assessed influences of different inputs on BPNN ability to estimate flank wear under different operating conditions. In the first one [126], *thrust force* and *torque* were used as inputs of several BPNNs with different architectures to predict flank wear over 3 drill diameters (5 mm, 7.5 mm and 10 mm), 6 different cutting speeds and 6 different feed rates. 49 Drillings were done in copper alloy, 36 randomly chosen ones were used to train the networks and the 15 remaining to test their prediction performance. The networks architectures and parameters were decided by trial and error. The best network architecture gave wear predictions comprised in an $\pm 7.5\%$ interval around the measured values which were comprised between 0.1 mm and 0.9 mm.

The same experimental scheme has been applied when drilling mild steel in [109], but the *chip thickness* has been added as an input to the assessed networks. 52 drillings were done, 39 were used to train the network and the remaining ones to test it. Including the chip thickness as an input make the flank wear estimations pass from a $\pm 7.5\%$ interval to a $\pm 2.5\%$ interval around the measured value. Moreover, less training effort was needed to achieve this result, but another architecture was found to be the best.

In [108], the influence of adding the maximum amplitude of *axial* and *radial vibrations* information has been assessed. The chip thickness was not part of the inputs. Experiments have been performed using 4 drill diameters (9 mm, 10 mm, 11 mm and 12 mm) in cast iron under 3 different cutting speeds and 3 different feed rates. 64 Drillings have been done, 37 were used to train the networks, 17 to test them and 10 to validate the results. These 3 data sets were used as follow: the error on the testing set was monitored during the training process. The *testing error* normally decreased during the initial phase of training, as did the *training error*. When the network began to *over fit the data*, the error on the testing set began to rise. When the testing error started increasing for a specified number of iterations, the training was stopped, and the *synaptic weights* at the minimum value of the testing error were returned. These behaviors of learning and testing errors are illustrated

in figure 2.21. The unseen data (*validation set*) were then fed to the trained network to check the percentage variation of predicted flank wear in comparison to the actual wear. This is the first study taking *over-fitting* into account, which is an important concern in machine learning, especially when training sets are of limited size [121] like it is often the case in drilling monitoring applications. The results showed that incorporation of vibration information allowed to decrease the interval around the measured value from $\pm 7.03\%$ to $\pm 6.25\%$ when taking only axial vibrations into account and to $\pm 6.17\%$ when including radial vibrations information. The networks architectures and parameters were chosen following a trial and error scheme based on criteria such as training and testing error rates, as well as the learning computational effort that was needed.

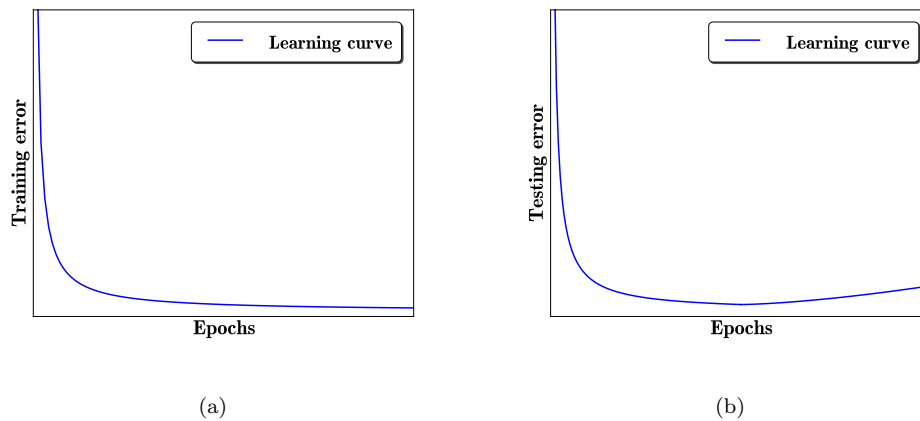


Figure 2.21 – Illustration of evolution of the prediction error on the training set (a) and the prediction error on the testing set (b) during the training phase of a BPNN. Over-fitting starts when the testing error starts increasing.

A modified version of BPNN, the *adaptive-function slope back propagation neural network*, has been used in [92] to estimate 6.35 mm diameter HSS drills used in stainless steel. Neurons activation functions of this type of networks present an adaptive slope which allow additional degree of freedom. The number of features to be used as inputs has been determined as a function of the number of available training samples following equation 2.16, as in [117], where N denotes the available training samples and F the number of features.

$$N = 2(F + 1) \quad (2.16)$$

This has been done to avoid using a feature space presenting a high dimensionality that could not be covered by available samples, forbidding a good mapping between the feature space and the tool wear state. The problem caused by high dimensional feature spaces in term of size of the training set needed for learning machines is known as the *curse of dimensionality* [121]. 8 features were extracted from the *torque* and *thrust force* signals: their average, maximum amplitude value, RMS value and areas under their PSD. Only one operating condition was applied. 13 drilling experiments have been done, and 33 artificial samples have been created from them by linear interpolation. These 46 data samples have been used to train the network. Differently from classical BPNN, the slopes of the activation functions are modified within the back propagation process taking place at the training set of the network. Several network architectures have been assessed, and for each, a classical BPNN and an adaptive-function slope BPNN have been implemented. The performance assessment has been done using 14 drillings and 36 artificial data samples obtained from them. Estimations showed a 7.73% mean and a 19% maximum errors compared with the measured values of tool wear. Results showed that when processing drill wear data, modified artificial neural networks with adaptive activation-function slopes converged much faster than

the conventional BPNN. It has also been noticed that increasing the number of neurons in networks did not necessarily improve their prediction accuracy.

Radial basis function networks (RBFN), have also been used to perform drill wear estimation. In [138], a RBFN has been implemented to estimate flank wear on 10 mm diameter drills used in stainless steel. Influence of the use of *TiN* or *TiCN coated depositions* on the drill has been assessed in addition to feed rate and spindle speed. *Torque* and *thrust force* signals have been measured during drilling operations and their averages have been used as input to the network together with the three aforementioned parameters. Experiments have been performed under different operating conditions, and several networks architectures and learning parameters have been assessed. 18 training data samples were used, and the best network after the trial and error scheme used for choosing an architecture gave an average absolute error of 0.4% on 9 verification samples.

In [108], RBFNs have also been implemented, and compared with BPNN. Maximum amplitude of *axial* and *radial vibrations*, *thrust force* and *torque* have been used as inputs together with feed rate, drill diameter and spindle speed. 64 drillings experiments have been done, 45 were used to train the network and 19 to test it. Different numbers of neurons in the hidden layer have been assessed from 10 to 40, and learning rate and momentum were set by a trial and error scheme. The error interval around the measured value was $\pm 8.12\%$, that was less than the $\pm 6.17\%$ reached by the BPNN. On the other hand, RBFN showed lower training time.

More recently, another study investigated the use of RBFN, underlying the heavy influence of network architecture [47]. Indeed, as it is the most important factor that governs the network prediction performance, authors used an optimization procedure based on *genetic algorithm* (GA) to determine the number of neurons in the network hidden layer. For comparison purpose, they also implemented a RBFN following a classical trial and error scheme in order to determine the best architecture to be used. Another advantage of the method they proposed was it encompassed the two-steps classical RBFN learning procedure, namely the k-means clustering for unsupervised network organization and the supervised learning phase for the synaptic weights optimization. Experiments were performed using 8 mm and 10 mm diameter HSS drills. 3 Different spindle speeds and feed rates were used. Maximum and average values of *thrust force* and *torque* have been used in addition to drill diameter, spindle speed and feed rates as inputs to the networks that were aimed at flank wear estimation. Out of the 67 drillings that were done, 50 were used for training purpose. Both GA-based and trial and error schemes found a 10 neurons hidden layer to provide the best results in flank wear prediction. The mean square error was 1.57% for the GA-trained RBFN and 2.02% for the one that used the classical learning procedure. The training time when using the classical scheme was twice the time required by the GA-based technique, even if the time spent for the trial and error procedure necessary for this approach to find the best architecture was not taken into account.

Numerical estimation of tool wear using sensor fusion mainly associated features issued from thrust force and torque signals. Studies mostly focused on the architecture and design parameters of estimators that have been used (mainly artificial neural networks) and it seems that less attention has been paid to feature selection. However, no clear conclusions can be drawn about neural networks architecture related concerns because of the variety of case studies they have been used for, and of the quasi-systematic use of trial and error schemes for their design. They often provided results really close to wear measurements, even when performing under different operating parameters that have often been used as inputs variables. Unfortunately, available experimental data sets were often of limited size, and only little attention was paid to classical issues encountered when using learning machines, like the *curse of dimensionality* or *over-fitting* for instance. To our knowledge, no drill wear on-line estimation system is commercially available nor has been implemented in industry to a large extent.

Discrimination of different tool wear states does not aim to provide a numerical value representing the physical state of tool wear, but to indicate its state by selecting a wear level category it belongs to, where the number and types of levels are an arbitrary variable. The different categories, or *classes*, are often user-defined and possess a name corresponding to the drill wear state which can be linked both to the wear level itself (an interval of flank wear value for instance), or the risk to continue using the same drill in function of the required quality of the workpiece. The section will be organized as follows: first, approaches that did not involve learning will be described, then supervised tool wear *classification* approaches will be presented, followed by unsupervised or hybrid methods based on *clustering* algorithms.

In [5], a two-stages *fuzzy inference system* was used to discriminate tool wear states. *thrust force*, *vibrations* and *sound signals* have been processed to extract their respective RMS, standard deviation, minimum and maximum values. Once normalized, these values have been used as inputs of the first stage of the fuzzy system and were 'fuzzified' using Gaussian membership functions representing three tool wear states: 'sharp', 'workable' and 'dull'. The design of wear membership functions as a function of tool wear was done manually so no learning was involved. A set of fuzzy rules allowed to determine, for each sensor and as a function of the statistical parameters extracted from the signal it provided, the state of tool wear within 9 states. The so obtained state was then defuzzified (i. e. a crisp value representing the drill wear state was given as a function of its memberships) using a set of Gaussian membership functions. In a second step, these crisp values have been used as inputs of a second fuzzy inference system in order to perform sensors fusion. The same input membership functions as in the first stage were used. A set of fuzzy rules allowed to obtain a normalized output response in the form of a monotonously increasing function that showed the status of the tool between 0 and 1 and that corresponded to degree of tool wear. As the value increased, it meant the tool get more worn or about to break. The experimental part of this work has not been detailed.

A *decision level fusion approach* (cf. 2.2.1.3) was used to identify drill wear states in [36]. Five *local approaches* have first been used separately to determine drill wear levels on 8 mm diameter cobalt drills in steel workpieces. For the first one, *torque* and *thrust force* signals were used to train *hidden Markov models* (HMM) of drilling with sharp drills. Then, each model generated a probability which quantitatively represented the similarity between a signal and the ones used to build the model, and so assess if the tool is sharp or not. The second approach also used HMMs, but this time a model was built for 5 different wear states so that a probability could be provided for each of them. HMM makes part *supervised learning* approaches as the expected output of the model is known during its training. The third method used a *phase plane representation* of torque and force signal. Indeed, thrust

force and torque levels recorded when using a sharp tool formed a cluster in the torque-thrust plane that was contained within a *reference rectangle*. The percentage of data point falling in this rectangle during a drilling operation allowed to assess the sharpness level of the tool. The fourth method focused on corner wear by investigating the *transient time* in torque signals. Indeed, as corner wear increased, it took more time for the cutting edges to enter completely in the workpiece due to roundness appearing in their corners, so the transient time in the torque signal (figure 2.22) increased. Finally the last approach used a *torque model* and the force coefficient it provided to estimate tool wear level. These 'local' approaches to estimate tool wear are also described in [37].

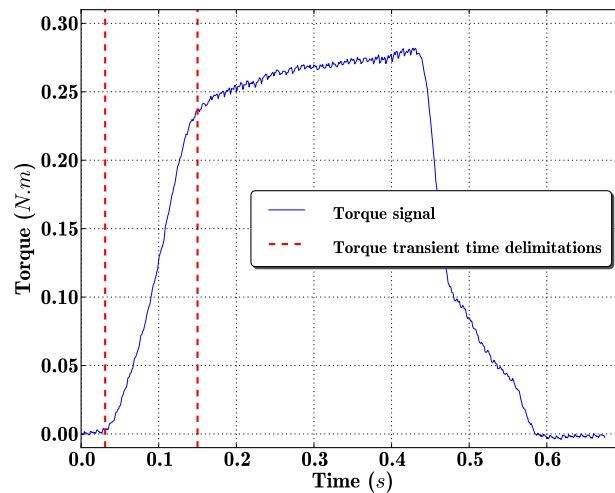


Figure 2.22 – Illustration of the transient time in a torque signal recorded during the drilling of a CFRP workpiece with a 6.35 mm diameter drill

Then a Decision Fusion Center Algorithm (DFCA) was used to merge statements u_i from the five wear quantification approaches in the form of a weighted average, as described in equation 2.17, in order to obtain an global decision variable U . The weighting coefficient w_i must follow conditions expressed in equation 2.18. Local results obtained by each of the five presented approached had to be adapted before being merged. This *data alignment* step consisted in a conversion of each local algorithm output value into a wear state, 'sharp', 'workable' or 'dull', which were associated with values 0, 0.5 and 1 respectively. Depending on the used approach, specific rules have been applied to determine the tool wear states. Following the DFCA processing of these normalized values, a decision on tool replacement could be taken when U crossed a threshold, 0.8 for instance. 169 holes have been drilled to test the performance of the method. If good correlation has been achieved between the DFCA results and drill wear, authors stated that thresholds and weighting coefficients of the method need to be tuned carefully, and that more experimental testing and a statistical analysis would be required to assess the system performance. As it directly uses torque and thrust force values to assess the tool wear state, the system can be set-up and used in only one set of operating parameters at a time, feed rate in particular.

$$U = \sum_{i=1}^{n=5} w_i u_i \quad (2.17)$$

$$w_i \geq 0, \sum_{i=1}^n w_i = 1 \quad (2.18)$$

An early attempt to *classify* tool wear states using sensor fusion and a *supervised learning* procedure was presented in [93]. The objective of the study was to determine on-line if drills were 'usable' or 'worn out' by using a two-categories *linear classifier*. Drillings were performed using 6.35 mm diameters drills and only one operating condition was investigated. Percentages of increase of *axial acceleration* and *thrust force* from the first drilled hole were used as features to discriminate tools wear states. Despite its simplicity, the approach underlined an advantage of sensor fusion: considering each feature alone, data samples of the different classes overlapped. When using the two features together, it was possible to linearly separate the classes in the two-dimensional feature space. An illustrative example of such a situation is depicted in figure 2.23. 10 Drillings were used to train the classifier by minimizing a perceptron criterion function. Then 30 drillings were used to test the system, and only one tool wear state was misclassified.

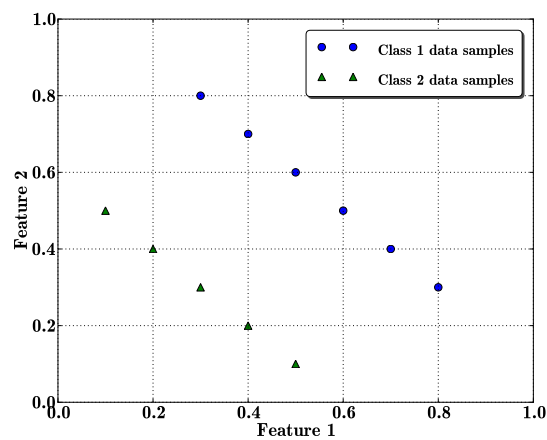


Figure 2.23 – Illustrative example of a two-dimensional feature space allowing linear discrimination between two classes whereas the variation ranges of features overlap in both dimensions

In [81], an *hybrid method* have been proposed to classify drill wear states into 4 classes: 'initial', 'small', 'normal' and 'severe' using *torque* and *thrust force*. A *fuzzy c-means clustering* method have first been used on a training set of 48 drillings experiments performed with 6.35 mm diameter HSS drills in one operating condition. This algorithm works in a similar way that the k-means one evoked in section 2.1.1.2, but responsibilities of clusters regarding data samples are assessed via fuzzy membership functions. It allowed determining 4 clusters centers and fuzzy membership functions associated with each aforementioned tool wear state. Authors used these results to classify new drilling operations as a function of their membership to each cluster. A test set composed of 64 consecutive drilling operations was used and classification results were good. This method can only be used with the same cutting parameters once it have been trained because the partition of the feature space is fixed. Author also underlined the superiority of fuzzy membership functions over crisp values to model transient states between drill wear level classes.

Another interesting attempt to classify flank wear states was made in [49]. In order to differentiate flank wear levels of $[0 \text{ mm}, 0.1 \text{ mm}]$, $[0.1 \text{ mm}, 0.2 \text{ mm}]$ and $[>0.2 \text{ mm}]$ when drilling steel with 8 mm diameter drills, a *self-organizing map (SOM)* has been implemented. The task of the network was to represent an empirical joint distribution (or an empirical model) of N training vectors containing features extracted from sensor signals and associated tool wear state by the mean of a smaller set of $K \ll N$ of *prototype* vectors during a phase called *adaptation*. A prototype vector describes the weights of a formal neuron in the network. Then the *recall* step allow to classify a new vector containing only features by finding its nearest prototype neighbor which tool wear state is followed to make a decision of the

new drilling wear state. The 0 HZ - 200 HZ frequency band of the *torque* and *thrust force* RMS-averaged spectra have been used to extract 30 features representing their respective norm and structure. Two experiments were designed. The first one consisted in building 40 prototype vectors from 400 training vectors. 90 Tests vectors, 30 corresponding to each of the three defined tool wear states were used, and a 13.3% maximum classification error rate was observed for the third wear state class. A second experiment was made to assess the ability of such a network to differentiate between only 2 states of tool wear. To do so, 20 prototype, 30 training and 30 test vectors have been used. The worst result was again, 13.3% misclassification rate, but authors proposed to average three consecutive estimated wear states (obtained from three consecutive drillings), and then classification error decreased to 0%. They also mentioned that for both the experiments, a nearest-neighbor algorithm (which is used during the adaptation step to organize the network architecture) used alone provided worst results, demonstrating the interest of the adaptation phase to define prototypes. The results and the need of numerous prototypes were justified by the fact that the different classes were not well separable as flank wear evolution is continuous. Moreover, it can be noticed that the tool wear value interval that classes are based upon are narrower than those employed in other studies. Similarly to most other works, types of neural networks architecture and functional parameters like the learning rate, adaptation rule, number of prototypes or neurons, and size of the training set were set following a *trial and error* scheme. It has been shown that the structure of the torque spectrum was not correlated to drill wear. If the results were similar to those obtained with BPNN in term of classification accuracy, authors emphasized that the training effort was much lower using self-organizing maps, as already mentioned in [64].

Several techniques aimed at discriminating different tool wear states have been assessed. One of the main difficulty that has been encountered lied in the categorization of samples issued of phenomenon evolving in a continuous manner. Crisp partitions of the possible wear states space lead to ambiguity for samples located near the borders that have been defined in the feature space. To overcome this issue, fuzzy approaches have been implemented, and examples of both manually or learning-based implementation of membership functions have been proposed with interesting results. Unfortunately, the definition of membership functions regarding sensor extracted input values forbids flexible implementation of such systems. On the other hand, when the problem consisted in differentiating between significantly different drill wear states, results were usually very good, even when using simple methods. Results also showed that a supervised learning step significantly improved performances of self-organizing approaches, and that this kind of hybrid learning allows gain in training effort compared to supervised learning ones for comparable performance levels.

Hole quality

On-line *estimation* of the *hole surface roughness*, *roundness error* and *residual stress* generated by reaming in EN4 steel using 20 mm drills has been investigated in [99]. *AE*, *thrust force*, *torque* and *vibrations* signals have been used with a BPNN. Comparisons between the estimation performances of the BPNN using multiple sensors data inputs and single sensor data input have been done over 4 operating parameters sets. If AE signals used alone were shown to provide results closely related to residual stress, force and torque alone were not able to predict hole quality. The use of multiple sensors inputs gave encouraging results on the 3 assessed criteria. Unfortunately, authors did not provide information about the neural network architectures, the training and testing procedures that have been used, or the form of input information given to the networks (raw data, statistical features, ...). This lack of details about the used procedures does not allow to draw general conclusion from their work.

2.1.3.3 Overview on the drilling monitoring application using sensor fusion

The use of multiple sensors allowed, for many researchers, to better handle the drilling process complexity, and doing so to obtain better performances in monitoring of complex phenomena like tool wear.

Issues concerning flexibility of drilling monitoring systems are evoked in many studies, and the use of supervised learning techniques taking process parameters into account as inputs has been the preferred solution to address it. The limitations of these approaches are linked with the amount of data needed for efficient learning and testing over wide ranges of operating conditions.

Their accuracy have been shown to increase when more input features are included, showing the interest of data fusion. On the other hand the data quantity required increase in an exponential manner as a function of the feature space dimensionality.

None of the assessed methodologies has shown clearly better performance level than others. Moreover, one can regret the absence of systematic benchmarks or public data sets aimed at the evaluation of drilling monitoring systems performance level.

No attention has been paid to quality of input data, even if it is recognized as a building part of the gap between lab and industrial applications of drilling monitoring systems [85, 106, 23]. An example of harmful influence of corrupted data on a multisensor based tool condition monitoring system is given in [104]. In the same manner, many concepts linked data fusion, and imperfect data modeling and handling in particular, have been neglected.

2.1.4 Overview and discussion

2.1.4.1 Challenges of sensor-based indirect drilling monitoring

Considering the state of the art presented above, three major issues have been identified concerning the implementation of an industrial drilling monitoring system:

- Difficulties inherent to the drilling operation complexity: many phenomena of interest have not been modeled as function of measurable variables and process parameters, making monitoring difficult
- Difficulties linked with the generalization of results: most of the obtained results are closely linked with the operating conditions they have been obtained in
- Difficulties linked with input data quality management: the harsh industrial working environments possess harmful influence on sensor measurements

The great majority of works have been focused on the first point, probably because it is the starting point of the implementation a monitoring system: it allows linking together the phenomena of interest, its related features and determining the sensors to be integrated. Moreover, it allows increasing knowledge about the drilling operation, and doing so improving the ability to design monitoring systems able to detect undesired phenomena. The multisensor approaches have mainly been used focusing on assistance in the determination of relationships between complex processes and sensors data [23].

However, realizations and commercial availability of monitoring systems are fairly limited and they often present narrow ranges of performance [85, 62, 23] and low reliability [30], underlining the importance of the two other issues. Indeed, the former is a *sine qua non* condition for emergence of efficient monitoring systems in high added-value structures manufacturing plants [106] to meet the *production flexibility requirements*. Concerning the latter, management of input data quality is of major importance in information fusion based inference systems as they will provide degraded results in case of incorrect information about sensor performance is used. Moreover, no downstream processing within the monitoring system can make up for upstream errors at the input data interpretation level [53].

2.2 State of the art of data fusion techniques related to monitoring applications

2.2.1 General introduction

2.2.1.1 Data fusion definitions

Data fusion has known an important growth in the last 40 years, resulting of advances in many scientific disciplines and covering a wide range of applications.

This diversity in both involved skills and application fields makes the definition of data fusion and multisensor data fusion a difficult task. From a chronological point of view, definition of the expression *data fusion* has evolved from the designation of a process to a complete field of research. The Joint Directors of Laboratory Data Fusion Working Group (JDL) has first defined in 1987 data fusion as a process dealing with the association, correlation, and combination of data and information from single and multiple sources to achieve refined position and identity estimates, and complete and timely assessments of situations and threats, and their significance. The process is characterized by continuous refinements of its estimates and assessments, and the evaluation of the need for additional sources, or modification of the process itself, to achieve improved results [66]. This military oriented definition has been followed the next year by the first one that directly involved sensors as the process by which data from a multitude of sensors is used to yield an optimal estimate of a specified state vector pertaining to the observed system [120].

Then, objectives of the data fusion process in term of achieved performances compared to processes using one information source have been emphasized in definitions [142, 2, 51, 52, 48] before Dasarathy defined the outline of a discipline in 2001: *information fusion encompasses the theory, techniques, and tools conceived and employed for exploiting the synergy in the information acquired from multiple sources (sensor, databases, information gathered by humans etc.) such that the resulting decision or action is in some sense better (qualitatively and quantitatively, in terms of accuracy, robustness and etc.) than would be possible, if these sources were used individually without such synergy exploitation* [26]. As a research field, data fusion borrows ideas from many disciplines such as signal processing, information theory, statistical estimation and inference and artificial intelligence [69].

Recently, a review of existing definitions and the proposition of a new one have been done in [17] where information fusion is considered as the study of efficient methods for automatically or semi-automatically transforming information from different sources and different points in time into a representation that provides effective support for human or automated decision making.

The expression *multisensor data fusion* mostly designates a process involving sensors and associated signal processing and data merging techniques, whereas *information fusion* refers either to a similar process involving any type of information sources, or to a multidisciplinary field of research. This convention will be followed in this work, and when the expression information fusion will be used, its meaning will be explicated if needed.

2.2.1.2 Expected advantages & limitations of data fusion

Following the definitions given above, the general objective of data fusion is clear: considering a system using data fusion, its performance should be improved compared to the same system using only one information source. The enhanced perception ability offered by multiple information sources should results in improvements in detection ability, confidence, reliability, reduction of data ambiguity and extension of spatial or temporal coverage for instance [51].

Despite its numerous potential advantages, data fusion presents limitations that have been detailed in [53] and that mainly fall into two categories: those linked with input data quality, and those linked with the fusion of data itself. Basically, the former states that without

relevant input data, data fusion will lead to irrelevant results, and the latter emphasizes the difficulties to implement efficient fusion procedures. If the last issue has been widely addressed by researchers by the development of generic or ad-hoc fusion algorithms presenting diverse desirable properties, the former remains a blocking point on which much research effort has to be done.

2.2.1.3 Fusion systems: from conceptual models to physical implementation

At the same period an effort has been made to define data fusion, functional models of the fusion process have also been proposed. They are aimed at putting altogether inputs, outputs, data flow and actions in a comprehensible manner in order to give an overview of such a process. Being so general keep those models as *conceptual* representations, and *architectural* issues in fusion systems design have then been studied with more attention. The deepest level is then the *physical* implementation of fusion system where hardware related issues have to be addressed.

Conceptual models of the data fusion process. Following the proposition of a definition, the *JDL* also presented a conceptual model of the data fusion process [68]. This model and its revised version [137] are by far the most popular. It allows distinguishing inputs, in the form of different potential information sources, output as a user interface, and the fusion process taking place between the former and latter which is divided in four different levels. After an eventual pre-processing step of input data, attributes of objects of interest are refined fusing different sources statements at level 1. Then, at the second level, those estimates of objects attributes are used to assess the global state within the system is. Being aware of this situation, impacts of planned actions are assessed on level 3, and those actions are updated in level 4 as a function of those impacts. A limitation of this sequential decomposition of the fusion process has been emphasized by its authors because it is artificial due to potential interactions between the operations taking place within the different levels, and the fact that they can take place at the same time.

Another approach has been proposed by *Dasarathy* [25] which focused on the processing level of input and output data (raw data, features, objects) of a fusion process and its eventual sub-processes to classify them. Although it makes the choice of a fusion algorithm more natural [137], no clues are given about the associated architecture to deploy.

Other conceptual models have been proposed, like for instance the *Boyd control loop*, the *Intelligence cycle* or the *Waterfall model*, that do not present much interest to implement a fusion system as they are comparable, but less detailed than the *JDL* model. A comparative study of different models and the proposition of the *Omnibus model*, which is an attempt to gather all the pre-cited ones, can be found in [14].

Despite they provide help in understanding data fusion related concepts, these models are not useful for physical implementation of fusion systems [18]. As emphasized by *Dasarathy's* model, types of available and required data are often key characteristics in order to define fusion algorithms which will be the building blocks of the system architecture.

Architectures of data fusion systems. The conceptual models described above can help one to define the information sources, expected performance and different tasks that are to be implemented, but a deeper dive into the fusion system is necessary to precise the data flows, the different fusion techniques that are needed and their time-sequencing and inter-dependencies. This step could lead to the creation of a *software architecture*.

By essence, each system architecture is ad hoc due to the specific goals a fusion system has to address. However recurrent schemes have been explained. The most popular ones are presented as a triplet of fusion levels [51] (in close relationship with the *JDL* levels mentioned above): the *data level* fusion (figure 2.24(a)), the *feature level* fusion (figure 2.24(b)) and the *decision level* fusion (figure 2.24(c)). As indicated by their names, the type of input data of the fusion algorithm is at the origin of this classification, which also involve a classification

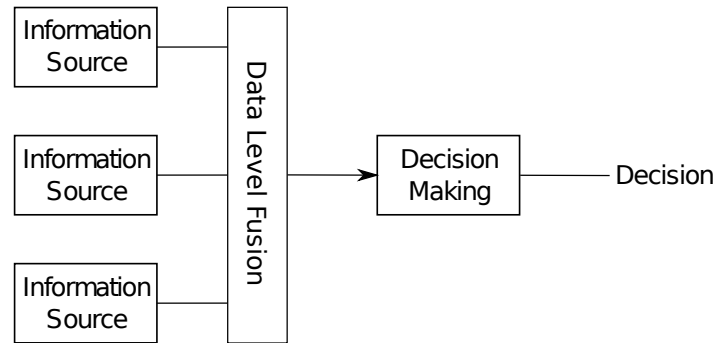
of fusion techniques that can be used to process it. A fourth level, the *temporal level* fusion, has been introduced to designate data integration over a period of time as a fusion process [25].

Another popular classification of fusion schemes is obtained by distinguishing between *centralized* fusion, *autonomous* fusion and *hybrid* fusion [51]. It is close to the previous one, but more linked with hardware: within a centralized fusion scheme sensors raw data are fused directly to define a feature on which decision will be based upon, like within the data level fusion, whereas within the autonomous scheme each sensor take a decision before they are merged to obtain the final one, in the same manner as the decision level fusion. The above mentioned feature level fusion is considered as an alternative approach to centralized fusion. After the global fusion system architecture has been defined, including the processing level of data flowing from input to decision, the best suited fusion algorithms can be selected for each fusion task. A review of fusion techniques associated with each fusion level is given by Kall in [51] for instance. A tentative of a formal classification of fusion techniques has been done in [72] in order to compare their performance not on empirical success, but from a formal point of view. However, the authors stated it is incomplete at the moment and needs further research.

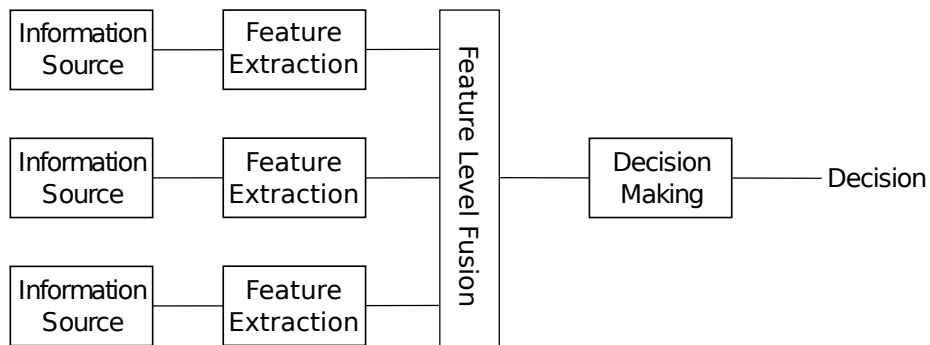
Once the data flows, fusion algorithms and fusion tasks interactions are explicated, or in other words, the *software architecture* is defined, the physical implementation, taking into account hardware concerns, have to be done.

Physical implementation of data fusion systems. Physical implementation of data fusion systems supposes to take data processing requirements, temporal synchronization and user interaction aspects into account. Obviously, these aspects are heavily dependent of the choice of the fusion system architecture, which actually may have been defined keeping some hardware constraints in mind. For instance, centralized fusion has the advantage that the whole raw data is taken into account to make a decision, and no information is lost by using feature representation of sensors signals. However, it can be very resource consuming in terms of processing and bandwidth, contrarily to an autonomous scheme where raw data are treated separately at the beginning of the process, and only decisions have to flow into and be processed by the fusion system. Those considerations often lead to trade-offs, and from a technical point of view the basic question to the system designer is "where in the processing flow should the fusion be performed?" [51]. Elements to be taken into account to answer it are: the hardware resources availability, the performance level needed and the existing fusion algorithms that could tackle the addressed problem.

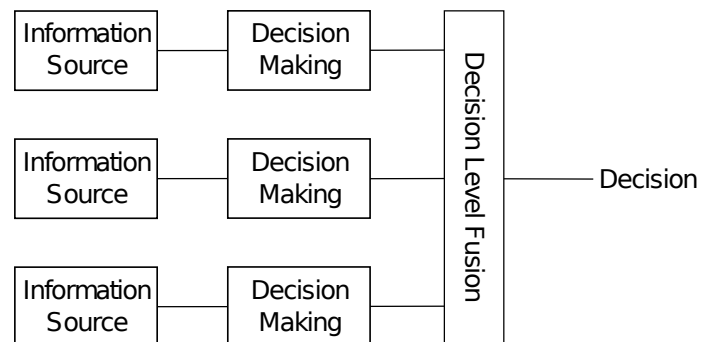
This brief introduction to data fusion allowed to detail its objectives, advantages and fundamental concepts, but also its limitations and difficulties encountered when implementing a fusion system. If a great amount of work have been done both on fusion systems conceptualization and fusion techniques, a key point impacting the system architecture and heavily influencing its overall performance is the type of available data and its quality.



(a)



(b)



(c)

Figure 2.24 – Data level fusion architecture (a), Feature level fusion architecture (b), and Decision level fusion architecture (c)

2.2.2 Challenges in the implementation of multisensor data fusion systems

As stated in the previous section, the implementation of a data fusion system aimed at monitoring complex processes presents challenging aspects. Issues are essentially linked with data to be fused, *diversity* of the sensor technologies, and nature of the application *environment* [69]. All of these concerns impact input data. Issues and challenges of data fusion will therefore be given from a data point of view.

A taxonomy of challenging problems of input data in data fusion has been proposed in [69], based on works of Smets [130] and Dubois and Prade [33] and is presented in figure 2.25. As it is very complete, this taxonomy will be followed to present data related problems. However, as other interesting classifications of data-related issues have been done, they will be introduced when needed. In particular, the aforementioned taxonomy can be related with a taxonomy of uncertainty types presented in figure 2.26 in which correlation, disparateness and granularity are not taken into account, and 'stochastic uncertainty' stands for the former 'uncertainty', and 'epistemic uncertainty' for the former 'imprecision'.

Only concerns related to monitoring applications, in dark on the figure 2.25, will be discussed in this section. Short descriptions of these data related issues will be provided with the goal in mind to emphasize different aspects that a drilling monitoring system should face, before the presentation of the mathematical frameworks that are suited to handle them, in the next section. Therefore, no deep analysis is made concerning the roots of data uncertainty and imperfection, and the interested reader can follow provided references.

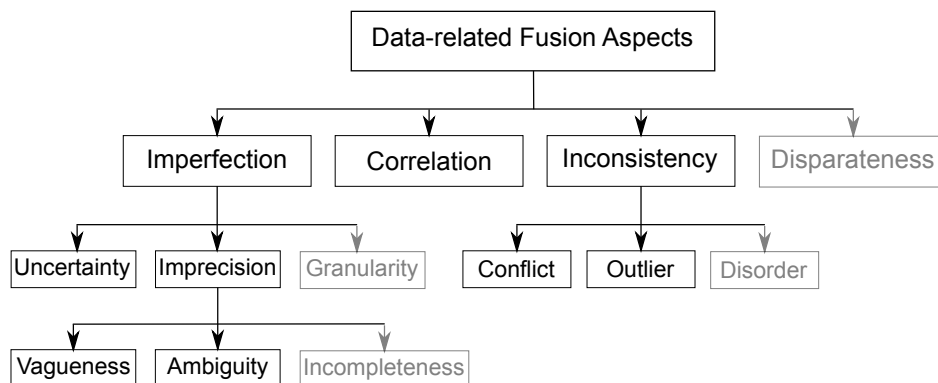


Figure 2.25 – Challenging problems of data fusion from an input data point of view following [69]: darker issues will be discussed in this work as they concern multisensor monitoring applications

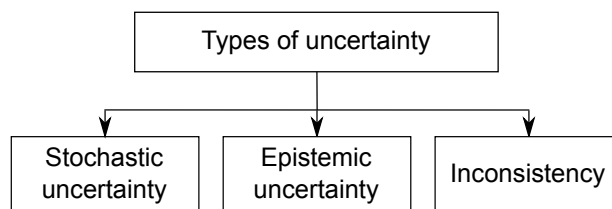


Figure 2.26 – Taxonomy of types of uncertainty

2.2.2.1 Data Imperfection

Uncertainty. Uncertainty on data arise when its confidence degree is not 1. In other words, the provided value (numerical, semantic, ...) is not certain. When dealing with sensors measurements for instance, the output value is not necessarily exactly the same as the sensed phenomenon is. This can be due to the measurement noise, or the sensor lack of accuracy. Generally, this type of uncertainty manifests itself in a stochastic manner, and is thus called *stochastic uncertainty*. It is well represented by *probability density functions* (PDFs) provided with the measurement. Figure 2.27 shows such a relationship between data provided by a sensor $\hat{\omega}$ and the real value of the phenomenon ω represented by PDFs.

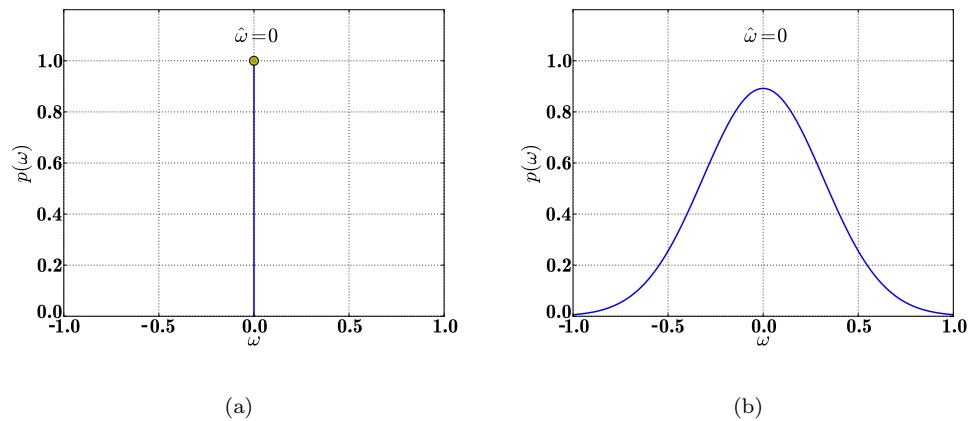


Figure 2.27 – Certain (a) and uncertain (b) statements about the value of the variable ω represented by probability density functions (discrete (a) and continuous (b))

Imprecision. Imprecision on data, which different manifestations can be grouped under the names *epistemic uncertainty*, or *lack of knowledge*, designate the fact that the information does not allow to make a precise statement. It is well represented by the use of *sets*, or *intervals*.

Ambiguity. Ambiguity stands when an imprecise statement is given with a confidence degree of 1. For instance, *intervals* or *sets* of values represents ambiguous statements. More knowledge is then needed to make a precise statement, indeed ambiguity denotes a lack of knowledge. Examples of ambiguous and non-ambiguous statements are provided in the following:

ω equals 1 is a non ambiguous statement

ω lies in $\{0.9, 1.1\}$ is an ambiguous statement

Vagueness. Vagueness manifests itself by ill-defined statements. Compared with ambiguous statements, not a crisp set or interval is provided, but instead a subjective description is given. This is often the case of semantic variables used by human experts. *Fuzzy sets* or *possibility functions* can be used to represent such imprecise statements. For instance, the statement x is large given by two different experts is represented using a fuzzy membership function in figure 2.28.

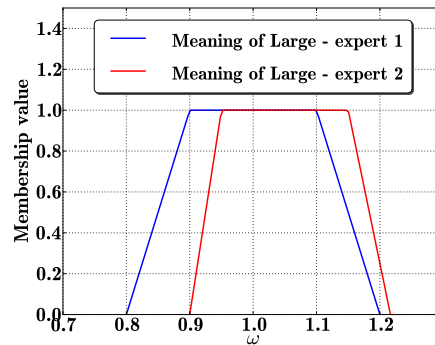


Figure 2.28 – Vague statement ω is large represented by a fuzzy membership functions for two different experts

2.2.2.2 Data correlation

As a function of the use made of correlated data, *redundant* information can have different purposes. In the following, the term *redundant* will be used to designate both redundant and *quasi-redundant* information. Quasi-redundant information has been defined by Frolik as coming from sensors that are not placed to measure exactly the same parameters, however these parameters may be very well correlated [43]. This is the case for many redundant sensor systems implemented in practice, that are aimed at following the same phenomena while not being impacted by the same perturbations.

When performing data fusion following data level (figure 2.24(a)) or feature level (figure 2.24(b)) fusion schemes, information from different sources are merged before the decision step. In this case, no additional information is gained by adding sources if they are truly redundant. However, noise reduction may be obtained by adding information that is presumably redundant if the data is independently and identically distributed (iid), but in this case, they are not considered truly redundant anymore [50]. An illustration of this statement is given in figure 2.29 that demonstrates how presumably redundant data can improve classification (a feature level fusion process) whereas truly redundant cannot.

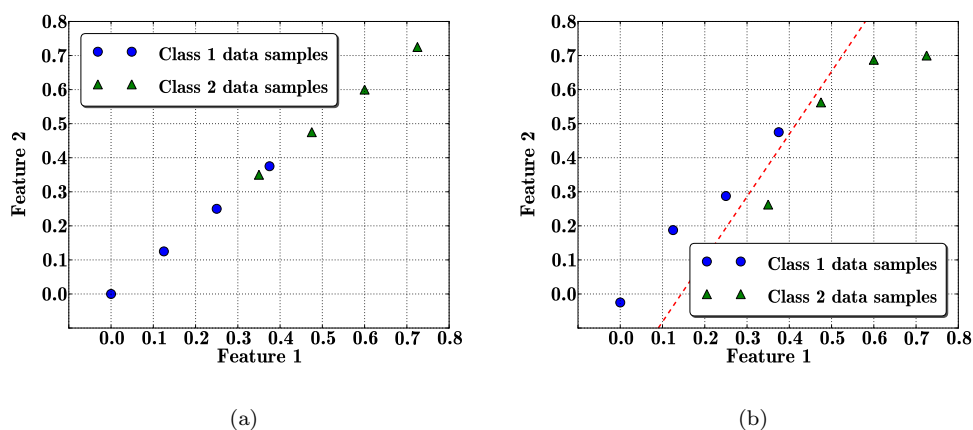


Figure 2.29 – Two classes samples represented in two-dimensional features spaces where features are truly redundant (a) and presumably redundant (b) respectively: as in the second case stochastic perturbations on feature values are iid, a gain of information is obtained by using the two features that allows performing a linear classification

As they imply a decision making from every information source, decision level fusion processes involve sources that are not systematically of the same type, but which are redundant in their ability to make a decision about a particular phenomena. Then the final decision is made upon all individual sources statements. In this case, sources redundancy is often aimed at overcoming sources failures which can be due to some inherent limitation of the sensor and/or some ambiguity in the environment [75]. As not many sources possess self-diagnostic features, the fusion strategy employed should be able to discard wrong sources in order to achieve right decisions. The problem of conflicting data that are presumably redundant raises another data related issue when performing fusion: inconsistency.

2.2.2.3 Data inconsistency

Data inconsistency is linked with fusion applications. It appears when different information sources do not agree, or in other words are in *conflict*. This is mainly due to the presence of *spurious data* which can be due to sources failure, either of short duration, nascent or permanent. By nature, such failures mechanisms are difficult to model and predict because they are not directly attributable to stochastic effects or other types of uncertainty mentioned above [75].

Data inconsistency only appears when redundant information sources are used. This usually implies that a critical phenomena is being monitored, and *robustness* is needed, therefore inconsistency handling is of major importance in high value added processes monitoring applications that use data fusion. Most of the time it requires the assessment of sources *reliability* to make a choice between their *conflicting* statements and perform the final decision. If several techniques for sensor validation and identification of inconsistent data have been proposed (a review is given in [75]), many of them are limiting because they are based on sources failures modes that are known and specific to the considered applications, but no *a priori* information is generally available concerning failures modes.

Two generic approaches using redundant sensors have been proposed in the literature using a high level fusion procedure. They were based on sensor consensus because more credit was given to those that corroborated the statement provided by the majority [76, 75].

Conflict management is an important concern in data fusion, and solution offered by different frameworks to handle it will be detailed in the next section.

The classification of issues on data provided here is somewhat artificial in the sense that some concepts detailed above overlap each other. In practice, sources may not fall precisely into either stochastic or epistemic uncertainty for instance [105]. However, this brief review of challenges of multisensor fusion from a data point of view allowed to identify issues that will have to be overcome and key points to take into account when implementing a monitoring system for drilling operations. In particular, data *uncertainty* and *ambiguity* have been identified as major concerns and necessitate special attention. Moreover, use of fusion systems implies dealing with *correlated* and *inconsistent* data which can be at the origin of diverse problems.

Following these statements, two mathematical frameworks providing tools to model and handle such data, namely the *probabilistic* and *evidential* frameworks will be introduced, and their respective advantages and limitations will be detailed in the next section.

2.2.3 Presentation of data fusion frameworks suited for multisensor on-line monitoring of drilling operations

The previous section allowed to identify which aspects of data imperfection have to be taken into account, and which problems will rise of the use of fusion systems when performing drilling monitoring. As input data are considered to come from sensors in our case, vagueness will not be discussed anymore because they only provide crisp values.

Several mathematical frameworks have been developed and used to handle imperfect and uncertain data and to perform data fusion. A review and useful references can be found in [69]. In the following, two of them will be introduced because of their respective ability to model and merge statements from sensors that are affected by aforementioned issues, and also due to their popularity. Indeed, the *probabilistic* and *evidential* frameworks are the most used to perform multisensor data fusion due to their properties. Special emphasize will be made on their behavior facing issues mentioned in the previous section.

Following the classical conceptual decomposition of fusion processes depicted in figure 2.30, tools offered by each framework to model data before the fusion step (*data alignment*) will first be presented, then principal fusion algorithms and decision making strategies will be detailed. Finally, a discussion will be carried on issues related to their use. Their respective specificities will be evoked and illustrated with simple examples, and projection on potential uses in monitoring applications will be given when possible.

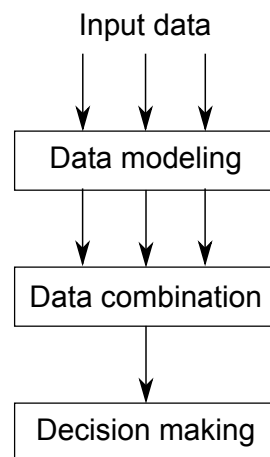


Figure 2.30 – Classical decomposition of a fusion process: in a first step called *data alignment*, data coming from each source are converted into common coordinate frame [141], they are then merged in a second step, and finally a decision is made which is based upon the fused statement

2.2.3.1 Formalization of the fusion problem

In the remainder of this work, the fusion problem will be formalized as follows: $\Omega = [\omega_1, \dots, \omega_N]$, the set of exhaustive and mutually exclusive propositions ω_n on states that can be taken by the phenomenon of interest, is called the *frame of discernment*. S sources provide degrees of belief that the true state of the phenomenon of interest lies in the proposition $A \in 2^\Omega$, which is a subset of elements of Ω . 2^Ω is called the *power set* and contains all the subsets of Ω including Ω and the empty set \emptyset . Then, the S statements about the state of the phenomenon of interest have to be merged to construct an unique distribution of degrees of belief on elements of Ω in order to make a decision.

For the sake of simplicity, discrete propositions will be used in the following, but most of the concepts that will be evoked also apply in continuous cases.

2.2.3.2 The probabilistic framework

The probabilistic framework has been widely used to model, merge, and make decisions based upon uncertain data. It possesses strong theoretical foundations and achieved many success in numerous and diverse applications.

As an introduction to this section, a reminder is given about the meanings given to probabilities. An interesting synthesis of their different meanings along history is proposed in [15]. Basically, two types of interpretations are in opposition: the *frequentist* one, which describes the behavior of a random variable over long run experiments, and the *subjective* one which allow one incorporating additional knowledge that can change the expected probability of an event. The second category encompasses the first one because it allows incorporating such information in order to build a *degree of belief* about an event. In this work probabilities will represent the degree of belief, and frequentist information will also be incorporated.

Basic concepts on probability functions

A probability measure $P(\omega_n)$, associated with every element of Ω , defines a real number satisfying the following properties:

$$0 \leq P(\omega_n) \leq 1 \quad (2.19)$$

$$P(\Omega) = 1 \quad (2.20)$$

$$P(\omega_i \cup \dots \cup \omega_j) = P(\omega_i) + \dots + P(\omega_j), \quad i, j \in [1, \dots, N] \quad (2.21)$$

One can remark that each element ω_n of Ω , or *singleton*, must have a degree of belief expressed in the form of a probability $P(\omega_n)$.

Bayesian inference. Bayesian inference [13] is a powerful tool to perform inference in the probabilistic framework. Considering our monitoring context, the objective is, given observations from sensors, to determine the state of the system and/or the drilling operation. Bayes defined a rule that allows incorporating observation x , to define probabilities of the *a posteriori* states of a system $p(\omega_n|x)$ also given *prior* information. The rule is defined as follow:

$$P(\omega_N|x) = kp(x|\omega_N)P(\omega_N) \quad (2.22)$$

where:

k is a normalizing factor that guarantees the result is a probability function

$P(\omega_n)$ is the *a priori* probability that the system is in the state ω_n

$p(x|\omega_n)$ is the *likelihood function* and represents the probability that the observation is x , knowing that the system lies in the state ω_n .

Bayes rule allows manipulating probability functions, however it is not always possible to obtain knowledge in this form. In particular, a lack of information sometimes exists on the prior and likelihood probability functions, and users have to make hypothesis about them. This is the main criticism done on the use of Bayesian inference: it requires a lot of prior information on the system, and in case where not enough information is available, the user have to make hypothesis.

Data modeling in the probabilistic framework

Information provided by a source on elements of Ω is given by *probability distributions* in the discrete cases, or *probability density functions* in the continuous ones. Examples have been given in figure 2.27.

Measurement *uncertainty* is usually expressed as a mean about the true value of the phenomenon of interest with uncertainty associated with a variance that represents the dispersion that could reasonably be attributed to it [61]. This dispersion depends both on the

measured quantity itself and the operational parameter of the sensor.

Sensor data modeling, which forms an important part of sensor fusion, deals with developing an understanding of the nature of measurements provided by sensors, its limitations, and its probabilistic understanding in terms of uncertainty. Probabilistic sensor models are particularly useful as they facilitate the determination of the statistical characteristics of the data obtained. This probabilistic model captures the probability distribution of measurement by the sensor $\hat{\omega}$ when the state of the measured quantity ω is known. These distributions are sensor specific and can be determined experimentally using calibration procedure [76]. Stochastic uncertainty on measurements are well handled by tools offered by the probabilistic framework to model data.

As for the second data related concern we focus on, **ambiguity**, the use of probability function is not straightforward. Indeed, as stated earlier, each element of the frame of discernment Ω have to possess a degree of belief. Therefore, even if a source provides an ambiguous statement: a degree of belief that concerns a set A of propositions, it has to be distributed over the corresponding singleton of A . Traditionally, the *principle of maximum entropy* is used: in case of an ambiguous statement is provided over a set A_Ω of singletons, no information allows to assess superior degree of belief to one of them. Then, the degree of belief given to A is distributed following the least informative manner on its singletons. The least informative distribution, which is equivalent to the one showing the *maximum entropy level*, is the *uniform* distribution which does not allow to choose between the singletons of A . An example of a uniform distribution is depicted in figure 2.31(b). For example, this principle is applied to define prior probability functions when performing Bayesian inference when no sufficient information is available.

This manner of handling ambiguous data has been criticized due to the fact that allowing a degree of belief to singletons is a creation of information that does not exist. However, this principle is widely used. An illustration of counter intuitive results obtained when using probability distributions and the maximum entropy principle to model ambiguous data is given in figure 2.31. In this particular case, the instability of probability distribution by non-affine transformation leads to the creation of knowledge on phenomenon states ω despite of the fact no knowledge is provided by available information x .

More generally, despite of strong oppositions in the Bayesian community, it is know generally admitted that probabilities are not suited to model ambiguous data.

Data fusion and decision making in the probabilistic framework

Data combination. Combination of data coming from multiple sources to perform inference is achieved following the Bayes rule incorporating knowledge and evidence from all sources:

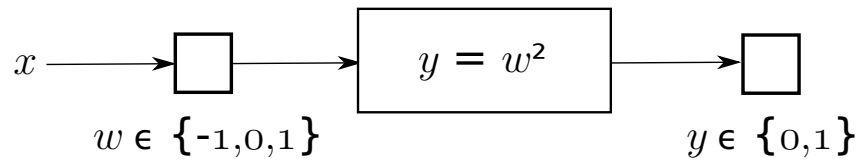
$$P(\omega_N|x_1, \dots, x_S) = kp(x_1, \dots, x_S|\omega_N)P(\omega_N) \quad (2.23)$$

where $p(x_1, \dots, x_S|\omega_n)$ is the joint likelihood function of the first source providing evidence x_1 , the second providing x_2 , ..., in case that the state of the sensed phenomenon is ω_n .

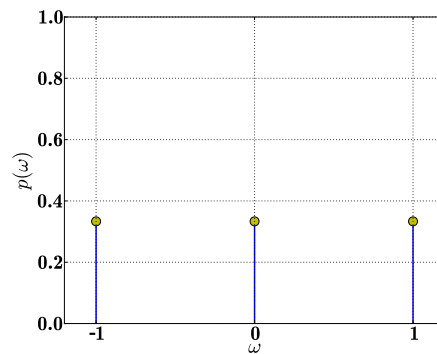
When the need of robustness leads to the usage of multiple information sources, it is interesting that these *sources are independent*. The concept of independence of the sources is not so easily described in real world applications as its mathematical definition. For instance, opinions of different people sharing overlapping experience could not be regarded as dependent sources whereas different measurements by different observers on different equipment would often be regarded as independent [27]. This concept has to be handled carefully.

If sources are considered independent, the joint likelihood function can be expressed as follows:

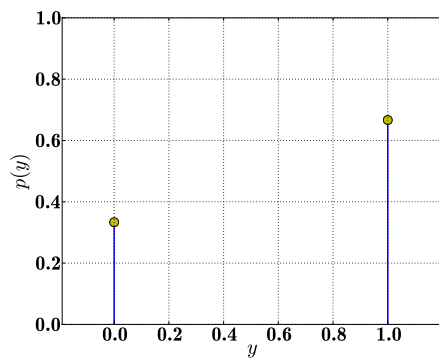
$$p(x_1, \dots, x_S|\omega_N) = \prod_{s=1}^S p(x_s|\omega_N) \quad (2.24)$$



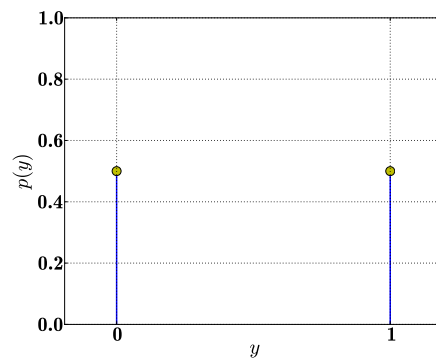
(a) A simple system where the input observation x is used to perform an inference on the state of a variable w which is then transformed by a non-affine function



(b) As no a priori information is available on the relationship between x and the possible states of the system ω , the maximum entropy principle is used to determine a probability distribution on Ω



(c)



(d)

Figure 2.31 – Probability distribution of y following the distribution of Ω depicted in figure 2.31(b) (c), and assuming no information is available on y as no information is available on Ω (d): these paradoxical results illustrate the inability of probability distributions to represent ambiguity by using the maximum entropy principle

Then it comes for the Bayes rule:

$$P(\omega_N|x_1, \dots, x_S) = k \prod_{s=1}^S p(x_s|\omega_N)P(\omega_N) \quad (2.25)$$

Decision making. Once the *a posteriori* probabilities of the different states of the original phenomenon have been computed, it comes naturally to choose the most probable one, which is called the *maximum a posteriori* decision rule:

$$\hat{\omega} = \max_n P(\omega_n|x_1, \dots, x_S) \quad (2.26)$$

Sometimes, however, the *maximum likelihood* decision rule is applied:

$$\hat{\omega} = \max_n P(x_1, \dots, x_S|\omega_n) \quad (2.27)$$

One can remark that if no prior information is available on ω and $P(\omega_n) = 1/N$ according to the maximum entropy principle, the maximum likelihood and maximum a posteriori decision rules will provide the same results.

Challenges linked with the use of probabilistic techniques

If it has been widely used and obtained successful results in many fields of application, challenging points remains when using the probabilistic framework to perform data fusion. Indeed, due to its *limited ability to model ambiguous information* coupled with the fact that Bayes rule necessitates a lot of knowledge, even if uncertain, the probabilistic approach can present shortcomings when performing fusion in uncertain context where ambiguous data are expected and little information about the system is available.

2.2.3.3 The evidential framework

Development of Evidence theory (or Dempster-Shafer theory, or theory of belief functions) is based on the pioneer works of Dempster [27] on *superior and inferior probabilities induced by multivalued mappings*, and the interpretation of Shafer [124] to model degrees of belief. The framework they defined allows handling incoming information without having to distribute degree of belief on every singletons of Ω . Later, Smets justified the use of belief functions and associated conditioning and combination rules to model degree of belief in the *Transferable Belief Model* (TBM) [129].

Basic concepts on belief functions

In this work, belief functions as defined in the transferable belief model are used to model information sources beliefs. Some concepts are presented following [27, 124, 129] in order to introduce main terms and formulas that are used in the remainder.

Considering an information source s , the basic belief assignment function m_s is used to allocate parts of an initial unitary amount of belief among the propositions of 2^Ω . Thus, considering a proposition A , $m_s(A)$ is a part of the s^{th} information source's belief that supports A and is called a *basic belief mass*. Every A such that $m(A) \neq 0$ is called a focal proposition or a focal element of the power set. Let $m_s : 2^\Omega \rightarrow [0, 1]$ with:

$$\sum_{A \in 2^\Omega} m_s(A) = 1 \quad (2.28)$$

The difference with probability model is that masses can be allocated to any proposition of 2^Ω instead of only elements of Ω . This multivalued mapping is particularly interesting to represent imprecise information since due to this imprecision, it does not always pinpoint

a unique proposition [91]. In the case when $m_s(\Omega) = 1$, which corresponds to a state of total ambiguity on propositions of Ω , we speak about a *vacuous* belief function, whereas if $m_s(A) = 1$ with $|A| = 1$, which represents a certain statement about a singleton, a *categorical* belief function is defined. From the basic beliefs assignment, other functions are derived that provide meaningful quantities. The *belief* function Bel_s gives the quantity $Bel_s(A)$ which can be viewed as a measure of the s^{th} information source's belief in the proposition A .

$$Bel_s(A) = \sum_{B \subseteq A} m_s(B) \tag{2.29}$$

The *plausibility* $Pl_s(A)$ can be interpreted as the amount of belief that could potentially be allocated to A in case of evidence that \bar{A} is false and is given by the plausibility function.

$$Pl_s(A) = \sum_{A \cap B \neq \emptyset} m_s(B) \tag{2.30}$$

$Bel(A)$ and $Pl(A)$ are the lower upper limits, respectively, of the belief level on proposition A . \bar{A} is the negation of hypothesis A . $[Bel(A), Pl(A)]$ is sometimes used to describe the ignorance about A . If information is missing or unreliable, the difference between $Bel(A)$ and $Pl(A)$ will increase. This is illustrated in figure 2.32.

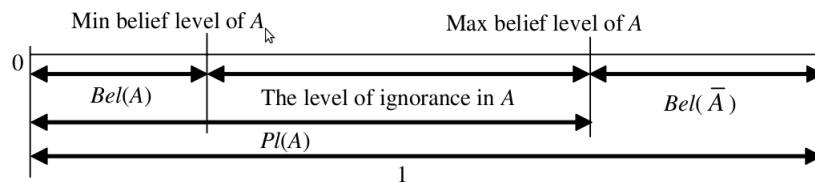


Figure 2.32 – Relationship between Bel and Pl from [39]

The *pignistic probability* measure $BetP(A)_s$ [129] allows constructing a probability distribution on Ω from the basic beliefs assignment, which is useful when decisions have to be made on elements of Ω . The probability distribution is built following the insufficient reason principle: if a probability distribution must be build on n elements in the case of a total lack of information, then the probability $1/n$ is attributed to each element. $BetP$ is a probability measure, but the term pignistic is added to stress its decision making purpose.

$$BetP_s(A) = \sum_{A \subseteq B} \frac{m_s(B)}{|B|} \tag{2.31}$$

where $|B|$ denotes the cardinality of set B .

The *commonality* measure $Q_s(A)$ can be interpreted as the belief that is free to move to A from propositions presenting a cardinal superior to $|A|$. It is commonly used to build an ordering concerning the specificity of different belief functions [128].

$$Q_s(A) = \sum_{A \supseteq B} m_s(B) \tag{2.32}$$

All these representations are equivalent in the sense that each one can be derived from any other [91]. So far, it can be noticed that the evidential framework presents more tools than the probabilistic one to describe degrees of belief.

Data modeling in the evidential framework

Evidential framework offers more latitude than the probabilistic one to assign degrees of belief.

Considering the case of *uncertain* data, evidential framework proposes the same modeling as the probabilistic one. Indeed, if basic belief are affected only to singletons of Ω (which is called a *Bayesian* belief function), then a probability distribution is obtained. In this sense, belief functions are considered as an extension of classical probabilities, which represent a special case in the evidential framework.

As for the case of *ambiguous* data, the multi-valued mapping allows assigning degrees of belief on subsets of 2^Ω that avoid the artificial creation of knowledge by making hypothesis on singletons when no information is available.

However one of the main difficulties lies in modeling the knowledge of the problem by initializing the basic belief functions m_s as well as possible [79]. On the other hand, the absence of a strict procedure to convert available information into basic belief masses allows adapting the data alignment step of a fusion process to fit the application requirements. This represents however an additional stage in the implementation of an information fusion system.

As stated earlier, sensors statements are often given in the form of a probability distribution, therefore, works have been done to derive beliefs functions from these probabilities in order to perform fusion in the evidential framework. Several approaches have been proposed [31]. The most popular one within the transferable belief model framework first uses the *inverse pignistic transform* (IPT) to generate the set $B_{iso}(BetP)$ of isopignistic belief functions that would lead to the original probability distribution using the pignistic transform given by equation 2.31 [129]. Then, the *least commitment principle* (LCP) is used to choose a belief function into the set $B_{iso}(BetP)$, following the principle that if there is no reason to prefer a belief function from another, then the least specific (or least informative) is chosen [128], in the same manner as the aforementioned *maximum entropy principle*. This implies the existence of a measure of the specificity of belief functions. Several measures have been proposed [34], and the *commonality* (see equation 2.32) is often used for this purpose. Such constructed belief functions are consonant, which means that their focal elements are nested. More explanations and an algorithm to derive the least committed basic belief distribution can be found in [128].

Another method has been proposed by the author and its performances have been compared with the aforementioned one and the probabilistic one in the context of singularity detection in data sets. Developments and results will be detailed in chapter 4.

Data fusion and decision making in the evidential framework

Evidential approaches provide tools for information merging and decision making that allow to implement several strategies leading to the choice of a proposition in the frame of discernment Ω . The fusion and decision steps are distinct operations but the combination of their respective influences has to be taken into account when setting-up a multiple information sources fusion and decision making system. Information sources are considered independent. Basic combination rules will first be exposed introducing the *conflict management* problem, followed by a rapid presentation of basic decision making strategies. Finally, their combinations influence will be detailed.

Combination rules. *Dempster's rule of combination* [27, 124] is the first which has been defined. Its usage requires that the propositions composing the frame of discernment are exhaustive. Let m_\oplus denotes the belief function resulting from the Dempster's combination of information sources belief functions:

$$m_\oplus(A) = \frac{m_\cap(A)}{1 - m_\cap(\emptyset)} \quad \forall A \in 2^\Omega, A \neq \emptyset \quad (2.33)$$

where m_{\cap} denotes the belief function issued from the *conjunctive combination* of the information sources basic belief functions:

$$m_{\cap}(A) = \sum_{\substack{B_1 \cap \dots \cap B_S = A \\ B_1, \dots, B_S \in 2^{\Omega}}} \prod_{s=1}^S m_s(B_s) \quad (2.34)$$

and $m_{\cap}(\emptyset)$ is the mass assigned to the empty set (i.e not assigned to a subset of 2^{Ω} containing propositions of the frame of discernment Ω) which can be interpreted as a measurement of the conflict existing among the different information sources. $m_{\cap}(\emptyset)$ is given by:

$$m_{\cap}(\emptyset) = \sum_{\substack{B_1, \dots, B_S \in 2^{\Omega} \\ B_1 \cap \dots \cap B_S = \emptyset}} \prod_{s=1}^S m_s(B_s) \quad (2.35)$$

One can remark that the Dempster's combination rule is not defined in case of total conflict between sources ($m_{\cap}(\emptyset) = 1$). The $1 - m_{\cap}(\emptyset)$ normalization factor has the effect of completely ignoring conflict [145], that can lead to counter intuitive results in case of combination of highly conflicting information. This drawback has first been pointed out in a classical medical diagnosis example [148] that showed the importance of taking into account the conflict between sources. The main origin of conflict is unexpected information sources behaviors: when abnormal measurements are provided by some sources, they are conflicting with the ones behaving normally [79].

Another cause of conflict is the multiplication of information sources: if sources provides exactly the same belief but this belief is not certain (the belief function is not categorical), conflict will grow as a function of the number of sources due to the non-idempotence of the conjunctive combination rule (CCR) [79, 97], which seems counter intuitive as all sources share the same statement, even if not certain.

Many other rules of combination have then been introduced to manage the conflict problem that are based on different interpretations and assumptions. Smets [127] assumes that all information sources are reliable so conflict can only comes from a bad definition of the frame of discernment. The empty set mass issued from the conjunctive combination of basic beliefs is not used as a normalization factor and is interpreted as the belief that the truth lies in one or more undefined propositions. The *Smets rule of combination* is defined by:

$$m_{SM}(A) = m_{\cap}(A) \quad (2.36)$$

Yager [145] kept the closed world assumption and justified the presence of conflict by the non reliability of some sources. The empty set mass is added to the frame of discernment mass, considering that non-reliable sources increase total ignorance. This scheme makes one source dysfunction affecting accuracy of the whole combined results.

$$m_Y(A) = m_{\cap}(A) \quad \forall A \in 2^{\Omega}, A \neq \emptyset, A \neq \Omega \quad (2.37)$$

$$m_Y(\Omega) = m_{\cap}(\Omega) + m_{\cap}(\emptyset) \quad (2.38)$$

$$m_Y(\emptyset) = 0 \quad (2.39)$$

One can remark similarities in results obtained using these three combination rules. The combined masses obtained with the Smets and Yager rules are the same except for the empty set and the frame of discernment. Using the Dempster rule, all propositions combined masses are proportional to the masses obtained with other rules except for the empty set and the frame of discernment.

A different approach can be made considering closed world assumption and non reliability of information sources. Dubois and Prade's *disjunctive rule of combination* (DRC) [34] does not generate any conflict and does not reject any information provided by the sources,

and its use is appropriate when conflict is due to poor reliability of some of the sources. However it often provides more imprecise results than expected [123, 28]. More specifically, considering consonant belief functions, if one source disagree with others about an eventual singleton, no mass will be allocated to singletons during the combination, which can lead to the impossibility to make decision over Ω in absence of additional evidence or knowledge. The DRC is defined following:

$$m_{\cup}(A) = \sum_{\substack{B_1, \dots, B_S \in 2^\Omega \\ B_1 \cup \dots \cup B_S = A}} \prod_{s=1}^S m_s(B_s) \quad (2.40)$$

These basic combination rules present drawbacks in the case of non-reliable sources. A lot of rules presenting sophisticated conflict redistribution algorithms over the power set propositions have been proposed, however they often present higher computational complexity and are adapted to precise use cases.

Decision making strategies. As said earlier, all representations of beliefs in the framework of evidence theory are equivalent and the choice is purely based on convenience. Masses are often a more natural and superior device for encoding evidence, whereas belief, plausibility and pignistic probability measures are a more intuitive summary of the impact of the evidence given by information sources on propositions [91] and help to make decisions.

Three basic strategies are generally considered to make a choice among the propositions of Ω : the maximum belief, maximum plausibility and maximum pignistic probability. The first one is often considered too pessimistic. Indeed equation 2.29 shows that no partial ignorance is taken into account while computing the belief on a proposition, which means that not all available information is considered when making the decision. Contrarily, the maximum plausibility rule is considered too optimistic: taking into account belief that could be given to a proposition to make a decision can be viewed as going further than what can be concluded from available evidence. Finally, the maximum pignistic probability appears as a good compromise by equal redistribution of partial ignorance over the concerned proposition following the insufficient reason principle. Moreover, it gives a probability distribution over Ω which makes decision making feeling more natural.

Influence of {Combination rule , Decision making strategy} couple. As evoked in the section concerning combination rules, the use of conjunctive based combination rules leads to the same ordering of singletons masses after combination. Following the definition given by equation 2.29, the belief transformation conserve this ordering. Thus decisions based on the maximum singletons beliefs will be identical for every combined masses computed using simple conjunctive, Dempster or Yager rules. Concerning maximum plausibility based choices, as all proposition beliefs except the frame of discernment are proportional, whatever the used pre-cited combination rule, these propositions beliefs are proportional too. In that case, considering the plausibility definition:

$$Pl(A) = 1 - Bel(\bar{A}) \quad (2.41)$$

and that the frame of discernment Ω can't be the complement of a proposition except the empty set, the plausibilities will be proportional too, leading to the same choice when selecting the most plausible singleton. In the same manner, considering the propositions beliefs proportionality and the fact that the pignistic probability distributes equally the mass of Ω over the singletons, the maximum pignistic probability based choice among singletons will be the same using the conjunctive, Dempster or Yager combination rule.

Challenges linked with the use of evidential techniques

Two main challenges remain when using belief functions:

- the first one has already been evoked **the construction of a mass distribution** over the power set 2^Ω from the available information. This is not every time an issue, and depending on the application case, latitude offered by evidence theory to assign degrees of belief can be an advantage.
- the second issue is a practical one: when compared with probability theory, evidence theory faces **higher computational complexity** due to the higher number of possible focal elements ($2^{|\Omega|}$ instead of $|\Omega|$, where $|\Omega|$ represents the cardinality of Ω) and the conjunctive combination rule requirements. Several approximation algorithms have been suggested to overcome this difficulty. A review and propositions such algorithms can be found in [29, 12].

Brief review of monitoring applications using evidence theory

As evidence theory is recent, not many applications have been done concerning monitoring applications. In particular, to the authors knowledge, no industrial monitoring application using evidence theory exist. This section gives a brief review of research works in the field. They have mainly concerned monitoring of engines, DC motors and chemical processes. Evidence theory have often been used for monitoring application in order to *merge classifiers outputs*. Most often, the frame of discernment is constituted by the different state/faults the monitored process can take/suffer from. Several classifiers were fed with features extracted from sensor data and provided a probability of the presence of each state/fault. These probabilities were used as basic beliefs assignments, and the different beliefs functions were then merged in order to obtain a final statement about the system state. This mass assignment method do not take full advantage of the possibility to model *ambiguity* explicitly offered by the evidential framework. Indeed, as classifiers provide probabilities on singletons of the frame of discernment, *Bayesian* belief functions were created. This method has been used in [95], [107] and [146]. Merged results offered better monitoring performance than single classifiers in all cases. Bayesian belief functions have also been used in [11], [40], [110], [116] and [115], where distances from features to values determined *a priori* that corresponded different states of the monitored system have been used to build masses. Only in [107], a basic belief assignment method has been implemented in a way such that ambiguity was explicitly modeled by assigning masses to sets of propositions of the frame of discernment. Results obtain by using this method to merge classifiers outputs on a railway track circuit fault diagnosis application were better than those obtained by using Bayesian beliefs functions.

Another interesting characteristic offered by evidence theory has been exploited for monitoring applications: the concept of *conflict* between information sources. In [95], level of conflict at the merging step has been used to detect unreliable sensors in a smart home application. The minority of sensors which provoked conflict when merging statements were considered faulty, assuming the majority of sensors worked well. In [116] and [115], the open world assumption of the TBM was considered, meaning that faults that were not listed in the frame of discernment could occur. Then, the conflict was used as a degree of confidence in the diagnostic, and as the degree of belief an undefined fault occurred. The authors also used the conflict level to discount belief functions in order to soften the sources statements in case of large conflict, and also to eliminate the minority of sources providing inconsistent information. The developed methodology has been assessed on monitoring of a DC motor and of a gas-liquid separation process. The use of evidence theory to merge statements from different sensors allowed to reduce the occurrence of false alarms and of missed alarms while not reducing the sensivity to faults.

These applications showed promising results for monitoring applications, but only few used

the whole potential framework offered by the evidential framework in terms of data modeling. This underlines the difficulty of automatically building masses based upon data, without an expert intervention.

Probabilistic framework is well adapted to handle data uncertainty, has strong theoretic foundations and has been widely used. Evidential framework presents several advantages to handle data imprecision, while conserving facilities offered by the probabilistic framework. Unfortunately, the computational complexity of operations increases exponentially as a function of the propositions number.

In both cases, special attention has to be given to information modeling and inconsistency in fusion context. These frameworks have often been in opposition, and only few numerical experiments allowed to assess their respective performance in general case studies. Research are still needed in this area [51].

2.2.4 Overview on data fusion for monitoring applications

This brief introduction to data fusion allowed to detail its objectives, advantages and fundamental concepts, but also its limitations and issues that will be encountered during the implementation of a monitoring system for drilling operations.

A classification of data-related issues has been provided that allowed identifying difficulties that will have to be overcome and key points to take into account, namely data *uncertainty* and *ambiguity*. Moreover, the use of fusion systems implies dealing with *correlated* and *inconsistent* data which can be at the origin of diverse problems.

Possibilities offered by both probabilistic and evidential frameworks to address these problems have been assessed: probabilities have strong theoretic foundations and has been widely used, whereas belief functions present several advantages to handle data imprecision, while conserving ability to model data uncertainty. Unfortunately, the computational complexity of operations increases exponentially as a function of the propositions number in this framework. In both cases, special attention has to be given to inconsistency.

The choice of a framework will be based upon these considerations and the case studies specificities. A important concern in monitoring application, *singularity identification*, has been detailed in chapter 4 and performances of approaches developed in both frameworks have been assessed.

2.3 Drilling monitoring and multisensor data fusion: general overview

This chapter first allowed to review achieved works and remaining challenges concerning sensor-based drilling monitoring. It showed that most effort has been focused on the handling of the drilling process complexity, often by using multiple sensors. However, concerns about generalization of obtained results and reliability facing industrial harsh environments have often been neglected. As a consequence a lack of robustness of developed monitoring systems have often been forbidden their industrial implementation.

In a second part, data fusion concepts and techniques that could help to overcome aforementioned issues, and so allow the industrial implementation of industrial monitoring systems, have been presented. The importance of data related issues has been emphasized, and 2 mathematical frameworks suited to model and handle imperfect data have been presented. The probabilistic and evidential frameworks pros and cons regarding issues linked with drilling monitoring have been detailed, allowing the *monitoring system designer* to make coherent choice between them.

Based upon these elements, the monitoring problem will be formalized, and issues related to industrial drilling operations monitoring will be detailed in chapter 3. Solutions will be

discussed, allowing to define guidelines that directed developments and contributions of this work.

Bibliography

- [1] J. Abellan-Nebot and F. Romero Subirón. A review of machining monitoring systems based on artificial intelligence process models. *The International Journal of Advanced Manufacturing Technology*, 47:237 – 257, 2010. 10.1007/s00170-009-2191-8.
- [2] M. A. Abidi and R. C. Gonzalez. *Data Fusion in Robotics and Machine Intelligence*. Academic Press, San Diego, CA, USA, 1992.
- [3] I. Abu-Mahfouz. Drilling wear detection and classification using vibration signals and artificial neural network. *International Journal of Machine Tools and Manufacture*, 43(7):707 – 720, 2003.
- [4] F. A. Al-Sulaiman, M. A. Baseer, and A. K. Sheikh. Use of electrical power for online monitoring of tool condition. *Journal of Materials Processing Technology*, 166(3):364 – 371, 2005.
- [5] C. Aliustaoglu, H. Ertunc, and H. Ocak. Tool wear condition monitoring using a sensor fusion model based on fuzzy inference system. *Mechanical Systems and Signal Processing*, 23(2):539 – 546, 2009.
- [6] S. Arul, L. Vijayaraghavan, and S. K. Malhotra. Online monitoring of acoustic emission for quality control in drilling of polymeric composites. *Journal of Materials Processing Technology*, 185(1-3):184 – 190, 2007.
- [7] J. C. Aurich, D. Dornfeld, P. J. Arrazola, V. Franke, L. Leitz, and S. Min. Burrs - Analysis, control and removal. *CIRP Annals - Manufacturing Technology*, 58(2):519 – 542, 2009.
- [8] D. Axinte and N. Gindy. Assessment of the effectiveness of a spindle power signal for tool condition monitoring in machining processes. *International Journal of Production Research*, 42(13):2679 – 2691, 2004.
- [9] P. Bandyopadhyay, E. Molina Gonzalez, R. Huang, and S. M. Wu. A feasibility study of on-line drill wear monitoring by DDS methodology. *International Journal of Machine Tool Design and Research*, 26(3):245 – 257, 1986.
- [10] R. W. Barker, G. Klutke, and M. J. Hinich. Monitoring rotating tool wear using higher-order spectral features. *Journal of Engineering for Industry*, 115(1):23 – 29, 1993.
- [11] O. Basir and X. Yuan. Engine fault diagnosis based on multi-sensor information fusion using Dempster-Shafer evidence theory. *Information Fusion*, 8(4):379 – 386, 2007.
- [12] M. Bauer. Approximation algorithms and decision making in the Dempster-Shafer theory of evidence - An empirical study. *International Journal of Approximate Reasoning*, 17(2 - 3):217 – 237, 1997.

- [13] T. Bayes. An essay toward solving a problem in the doctrine of chances. *Philosophical Transactions*, 53, 1763.
- [14] M. Bedworth and J. O'Brien. The omnibus model: a new model of data fusion? *Aerospace and Electronic Systems Magazine, IEEE*, 15(4):30–36, apr 2000.
- [15] I. Bloch. Uncertainty, imprecision and additivity in data fusion: An historical point of view. *Traitement du signal*, 13(4):267–288, 1996.
- [16] C. Bonnet. *Comprehensive study of cutting phenomena for Titanium alloys Ti6Al4V and CFRP stacks drilling in dry condition*. PhD thesis, Arts et Métiers ParisTech, Cluny, France, October 2010.
- [17] H. Boström, S. F. Handler, M. Brohede, R. Johansson, A. Karlsson, M. Nilsson J. Van Laereand L. Niklasson, A. Persson, and T. Ziemke. On the definition of information fusion as a field of research. Technical report, Informatics research center, University of Skövde, 2007.
- [18] C. Bowman. Private communication to D. L. Hall, 1995.
- [19] E. Brinksmeier. Prediction of tool fracture in drilling. *CIRP Annals - Manufacturing Technology*, 39(1):97–100, 1990.
- [20] E. Brinksmeier and R. Janssen. Drilling of multi-layer composite materials consisting of carbon fiber reinforced plastics (cfrp), titanium and aluminum alloys. *CIRP Annals - Manufacturing Technology*, 51(1):87–90, 2002.
- [21] B. Brophy, K. Kelly, and G. Byrne. Ai-based condition monitoring of the drilling process. *Journal of Materials Processing Technology*, 124(3):305–310, 2002.
- [22] S. T. S. Bukkapatnam, S. R. T. Kumara, and A. Lakhtakia. Analysis of acoustic emission signals in machining. *Journal of Manufacturing Science and Engineering*, 121(4):568–576, 1999.
- [23] G. Byrne, D. Dornfeld, I. Inasaki, G. Ketteler, W. König, and R. Teti. Tool condition monitoring (TCM) - The status of research and industrial application. *CIRP Annals - Manufacturing Technology*, 44(2):541–567, 1995.
- [24] S. Catché, R. Piquet, F. Lachaud, B. Castanié, and A. Bénaben. Interaction between surface texture after drilling and bearing behaviour of ud carbon/epoxy structures. In *Comptes Rendus des Journées Nationales du Composites 17*, Poitiers, France, 2011.
- [25] B. V. Dasarathy. Sensor fusion potential exploitation-innovative architectures and illustrative applications. *Proceedings of the IEEE*, 85(1):24–38, jan 1997.
- [26] B. V. Dasarathy. Information fusion - What, where, why, when, and how? *Information Fusion*, 2(2):75–76, 2001.
- [27] A. P. Dempster. Upper and lower probabilities induced by multivalued mapping. *Annals of Mathematical Statistics*, 38:325–339, 1967.
- [28] T. Denoeux. Conjunctive and disjunctive combination of belief functions induced by nondistinct bodies of evidence. *Artificial Intelligence*, 172:234–364, 2008.
- [29] T. Denoeux and A. Ben Yaghlane. Approximating the combination of belief functions using the fast Mobius transform in a coarsened frame. *International Journal of Approximate Reasoning*, 31(1-2):77–101, 2002.

- [30] E. Dimla. Sensor signals for tool-wear monitoring in metal cutting operations - A review of methods. *International Journal of Machine Tools and Manufacture*, 40(8):1073 – 1098, 2000.
- [31] P. E. Doré and A. Martin. About belief functions induced by probabilities. In *Proceedings of the first international conference on belief functions*, 2010.
- [32] D. Dornfeld. Application of acoustic emission techniques in manufacturing. *NDT&E International*, 25(6):259 – 269, 1992.
- [33] D. Dubois and H. Prade. *Decision Making Processes: Concepts and Methods*.
- [34] D. Dubois and H. Prade. A set-theoretic view on belief functions: Logical operations and approximations by fuzzy sets. *International Journal of General Systems*, 12:193 – 226, 1987.
- [35] T. I. El-Wardany, D. Gao, and M. A. Elbestawi. Tool condition monitoring in drilling using vibration signature analysis. *International Journal of Machine Tools and Manufacture*, 36(6):687 – 711, 1996.
- [36] H. M. Ertunc and K. A. Loparo. A decision fusion algorithm for tool wear condition monitoring in drilling. *International Journal of Machine Tools and Manufacture*, 41(9):1347 – 1362, 2001.
- [37] H. M. Ertunc and C. Oysu. Drill wear monitoring using cutting force signals. *Mechanics*, 14(5):533 – 548, 2004.
- [38] C. E. Everson and S. H. Cheraghi. The application of acoustic emission for precision drilling process monitoring. *International Journal of Machine Tools and Manufacture*, 39(3):371 – 387, 1999.
- [39] X. Fan and M. J. Zuo. Fault diagnosis of machines based on D-S evidence theory. Part 1: D-S evidence theory and its improvement. *Pattern Recognition Letters*, 27(5):366 – 376, 2006.
- [40] X. Fan and M. J. Zuo. Fault diagnosis of machines based on D-S evidence theory. Part 2: Application of the improved D-S evidence theory in gearbox fault diagnosis. *Pattern Recognition Letters*, 27(5):377 – 385, 2006.
- [41] S. Ferreira, B. Sierra, I. Irigoien, and E. Gorritxategi. Data mining for quality control: Burr detection in the drilling process. *Computers & Industrial Engineering*, 60(4):801 – 810, 2011.
- [42] L. A. Franco-Gasca, G. Herrera-Ruiz, R. Peniche-Vera, R. de Jesús Romero-Troncoso, and W. Leal-Tafolla. Sensorless tool failure monitoring system for drilling machines. *International Journal of Machine Tools and Manufacture*, 46(3 - 4):381 – 386, 2006.
- [43] J. Frolik, M. Abdelrahman, and P. Kandasamy. A confidence-based approach to the self-validation, fusion and reconstruction of quasi-redundant sensor data. *IEEE Transactions on Instrumentation and Measurement*, 50(6):1761 – 1769, dec 2001.
- [44] J. C. Fu, C. A. Troy, and P. J. Phillips. A matching pursuit approach to small drill bit breakage prediction. *International Journal of Production Research*, 37(14):3247 – 3261, 1999.
- [45] L. Fu, S. F. Ling, and C. H. Tseng. On-line breakage monitoring of small drills with input impedance of driving motor. *Mechanical Systems and Signal Processing*, 21(1):457 – 465, 2007.

- [46] D. Gabor. Theory of communication. *The Journal of the Institution of Electrical Engineers*, 3(93):429 – 457, 1946.
- [47] S. Garg, K. Patra, V. Khetrpal, S. K. Pal, and D. Chakraborty. Genetically evolved radial basis function network based prediction of drill flank wear. *Engineering Applications of Artificial Intelligence*, 23(7):1112 – 1120, 2010.
- [48] P. Gonsalves, R. Cunningham, N. Ton, and D. Okon. Intelligent threat assessment processor (itap) using genetic algorithms and fuzzy logic. In *Information Fusion, 2000. FUSION 2000. Proceedings of the Third International Conference on*, volume 2, pages THB1/18 – THB1/24 vol.2, July 2000.
- [49] E. Govekar and I. Grabec. Self-organizing neural network application to drill wear classification. *Journal of Engineering for Industry*, 116(2):233 – 238, 1994.
- [50] I. Guyon and A. Elisseeff. An introduction to variable and feature selection. *Journal of Machine Learning Research*, 3:1157 – 1182, March 2003.
- [51] D. L. Hall. *Mathematical Techniques in Multisensor Data Fusion*. Artech House, Norwood, MA, USA, 1992.
- [52] D. L. Hall and J. Llinas. An introduction to multisensor data fusion. *Proceedings of the IEEE*, 85(1):6 – 23, Jan 1997.
- [53] D. L. Hall and A. Steinberg. Dirty secrets in multisensor data fusion. In *Proceedings of the National Symposium on sensor data fusion*, San Antonio, TX, June 2000.
- [54] S. S. Haykin. *Neural Networks: A Comprehensive Foundation (2nd Edition)*. Prentice Hall, 2 edition, 1998.
- [55] S. S. Haykin. *Neural Networks and Learning Machines*. Prentice Hall, Englewood Cliffs, NJ, USA, 2009.
- [56] H. Heidary, A. R. Oskouei, M. Hajikhani, B. Moosaloo, and M. A. Najafabadi. Acoustic emission signal analysis by wavelet method to investigate damage mechanisms during drilling of composite materials. In *ASME Conference Proceedings*, volume 2010, pages 409 – 416. ASME, 2010.
- [57] H. Ho-Cheng and C. K. H. Dharan. Delamination during drilling in composite laminates. In *Proceedings of the ASME winter meeting*, Chicago, IL, USA, 1988.
- [58] H. Ho-Cheng and C. K. H. Dharan. Delamination during drilling in composite laminates. *Journal Of Engineering For Industry*, 112(3):236 – 239, 1990.
- [59] I. Inasaki. Application of acoustic emission sensor for monitoring machining processes. *Ultrasonics*, 36(1-5):273 – 281, 1998.
- [60] E. Jantunen. A summary of methods applied to tool condition monitoring in drilling. *International Journal of Machine Tools and Manufacture*, 42(9):997 – 1010, 2002.
- [61] JCGM. *Joint Committee for Guides in Metrology: Guide to the expression of uncertainty in measurements*. IEC-ISO, 1995.
- [62] K. Jemielniak. Commercial tool condition monitoring systems. *International Journal of Advanced Manufacturing Technology*, 15:71 – 721, 1999.
- [63] C. L. Jiaa, H. Ho-Cheng, and C. K. H. Dharan. Correlation between acoustic emission and delamination in drilling composites laminates. In *Monitoring and control of manufacturing process*, pages 177 – 192. ASME, 1990.

- [64] D. E. Dimla Jr, P. M. Lister, and N. J. Leighton. Neural network solutions to the tool condition monitoring problem in metal cutting - A critical review of methods. *International Journal of Machine Tools and Manufacture*, 37(9):1219 – 1241, 1997.
- [65] E. Kannatey-Asibu Jr. and D.A. Dornfeld. A study of tool wear using statistical analysis of metal-cutting acoustic emission. *Wear*, 76(2):247 – 261, 1982.
- [66] F. E. White Jr. Data fusion lexicon. Technical report, Joint Directors of Laboratory, Naval Ocean Systems Center, San-Diego, CA, USA, 1987.
- [67] M. Kanai, S. Fujii, K. Iwata, Y. Kanda, and Y. Tomonaga. Statistical characteristics of drill wear and drill life for the standardized performance tests. *CIRP Annals, STC C*, pages 61 – 68, 1978.
- [68] J. Kessler. Functional description of the data fusion process. Technical report, Office of Naval Technology, Naval Air Development Center, 1992.
- [69] B. Khaleghi, A. Khamis, F. O. Karray, and S. N. Razavi. Multisensor data fusion: A review of the state-of-the-art. *Information Fusion*, in press(0):-, 2011.
- [70] J. Kim, S. Min, and D. Dornfeld. Optimization and control of drilling burr formation of AISI 304L and AISI 4118 based on drilling burr control charts. *International Journal of Machine Tools and Manufacture*, 41(7):923 – 936, 2001.
- [71] J. Kiviö and P. H. Andersson. Tool breakage monitoring in a multi-spindle drilling operation. In *XVII IMEKO World Congress*, pages 2177 – 2180, Dubrovnik, Croatia, June 2003.
- [72] M. M. Kokar, J. A. Tomasik, and J. Weyman. Formalizing classes of information fusion systems. *Information Fusion*, 5(3):189 – 202, 2004.
- [73] W. König, K. Kutzner, and U. Schehl. Tool monitoring of small drills with acoustic emission. *International Journal of Machine Tools and Manufacture*, 32(4):487 – 493, 1992.
- [74] J. Kopač and S. Sali. Acoustic emission in drilling carbon steel and nodular gray iron. *Journal of Achievements in Materials and Manufacturing Engineering*, 19(1):91 – 95, 2006.
- [75] M. Kumar, D. P. Garg, and R. A. Zachery. A method for judicious fusion of inconsistent multiple sensor data. *Sensors Journal*, 7(5):723 – 733, may 2007.
- [76] M. Kumar, D.P. Garg, and R.A. Zachery. A generalized approach for inconsistency detection in data fusion from multiple sensors. In *American Control Conference*, pages 2078–2083, june 2006.
- [77] B. Y. Lee and Y. S. Tarng. Drill fracture detection by the discrete wavelet transform. *Journal of Materials Processing Technology*, 99(1-3):250 – 254, 2000.
- [78] J. M. Lee, D. K. Choi, and C. N. Chu. Real-time tool breakage monitoring for nc turning and drilling. *CIRP Annals - Manufacturing Technology*, 43(1):81 – 84, 1994.
- [79] E. Lefevre, O. Colot, and P. Vannooenberghe. Belief functions combination and conflict management. *Information Fusion*, 3:149 – 162, 2002.
- [80] G. S. Li, W. S. Lau, and Y. Z. Zhang. In-process drill wear and breakage monitoring for a machining centre based on cutting force parameters. *International Journal of Machine Tools and Manufacture*, 32(6):855 – 867, 1992.

- [81] P. G. Li and S. M. Wu. Monitoring drilling wear states by a fuzzy pattern recognition technique. *Journal of Engineering for Industry*, 110(3):297 – 300, 1988.
- [82] X. Li. A brief review: acoustic emission method for tool wear monitoring during turning. *International Journal of Machine Tools and Manufacture*, 42(2):157 – 165, 2002.
- [83] X. Li, S. Dong, and P. K. Venuvinod. Hybrid learning for tool wear monitoring. *The International Journal of Advanced Manufacturing Technology*.
- [84] X. Li and S. K. Tso. Drill wear monitoring based on current signals. *Wear*, 231(2):172 – 178, 1999.
- [85] S. Y. Liang, R. L. Hecker, and R. G. Landers. Machining process monitoring and control: The state of the art. *ASME Conference Proceedings*, 2002(3641X):599 – 610, 2002.
- [86] S. C. Lin and C. J. Ting. Tool wear monitoring in drilling using force signals. *Wear*, 180(1-2):53 – 60, 1995.
- [87] S. C. Lin and C. J. Ting. Drill wear monitoring using neural networks. *International Journal of Machine Tools and Manufacture*, 36(4):465 – 475, 1996.
- [88] D. Liu, Y. Tang, and W.L. Cong. A review of mechanical drilling for composite laminates. *Composite Structures*, 94(4):1265 – 1279, 2012.
- [89] H. S. Liu, B. Y. Lee, and Y. S. Tarnq. Monitoring of drill fracture from the current measurement of a three-phase induction motor. *International Journal of Machine Tools and Manufacture*, 36(6):729 – 738, 1996.
- [90] H. S. Liu, B. Y. Lee, and Y. S. Tarnq. In-process prediction of corner wear in drilling operations. *Journal of Materials Processing Technology*, 101(1-3):152 – 158, 2000.
- [91] L. Liu and R. Yager, editors. *Classic Works on the Dempster-Shafer Theory of Belief Function*, chapter 1 - An Introduction, pages 1 – 34. Springer Verlag, 2005.
- [92] T. I. Liu and K. S. Anantharaman. Intelligent classification and measurement of drill wear. *Journal of Engineering for Industry*, 116(3):392 – 397, 1994.
- [93] T. I. Liu and S. M. Wu. On-line detection of drill wear. *Journal of Engineering for Industry*, 112(3):299 – 302, 1990.
- [94] S. Mallat. *A Wavelet Tour of Signal Processing*. Wavelet Analysis and Its Applications Series. Academic Press, 1999.
- [95] B. Marhic, L. Delahoche, C. Solau, A. M. Jolly-Desodt, and V. Riquebourg. An evidential approach for detection of abnormal behaviour in the presence of unreliable sensors. *Information Fusion*, 13(2):146 – 160, 2012.
- [96] S. L. Marple. *Digital Spectral Analysis*, chapter Chapter 7. Prentice Hall, Englewood Cliffs, NJ, USA, 1987.
- [97] A. Martin and C. Osswald. Une nouvelle règle de combinaison répartissant le conflit - application en imagerie sonar et classification de cibles radar. *Traitement du Signal*, 24:71 – 82, 2007.
- [98] B. Mascaro, V. Gibiat, M. Bernardou, and Y. Esquerre. Acoustic emission of the drilling of carbon/epoxy composites. In *Proceedings of the Acusticum forum*, pages 2823 – 2827, Budapest, Hungary, 2005.

- [99] P. G. Mathews and M. S. Shunmugam. Neural-network approach for predicting hole quality in reaming. *International Journal of Machine Tools and Manufacture*, 39(5):723 – 730, 1999.
- [100] K. Mori, N. Kasashima, J. C. Fu, and K. Muto. Prediction of small drill bit breakage by wavelet transforms and linear discriminant functions. *International Journal of Machine Tools and Manufacture*, 39(9):1471 – 1484, 1999.
- [101] B. Pe na, G. Aramendi, A. Rivero, and L. N. López de Lacalle. Monitoring of drilling for burr detection using spindle torque. *International Journal of Machine Tools and Manufacture*, 45(14):1614 – 1621, 2005.
- [102] A. Noori-Khajavi and R. Komanduri. On multisensor approach to drill wear monitoring. *CIRP Annals - Manufacturing Technology*, 42(1):71 – 74, 1993.
- [103] A. Noori-Khajavi and R. Komanduri. Frequency and time domain analyses of sensor signals in drilling - I. Correlation with drill wear. *International Journal of Machine Tools and Manufacture*, 35(6):775 – 793, 1995.
- [104] A. Noori-Khajavi and R. Komanduri. Frequency and time domain analyses of sensor signals in drilling - II. Investigation on some problems associated with sensor integration. *International Journal of Machine Tools and Manufacture*, 35(6):795 – 815, 1995.
- [105] W. L. Oberkampf, S. M. Deland, B. M. Rutherford, K. V. Diegert, and K. F. Alvin. Estimation of total uncertainty in modeling and simulation. Technical Report SAND2000-0824, Sandia Report, 2000.
- [106] G. O'Donnell, P. Young, K. Kelly, and G. Byrne. Towards the improvement of tool condition monitoring systems in the manufacturing environment. *Journal of Materials Processing Technology*, 119(1-3):133 – 139, 2001.
- [107] L. Oukhellou, A. Debiolles, T. Denoeux, and P. Akinin. Fault diagnosis in railway track circuits using Dempster-Shafer classifier fusion. *Engineering Applications of Artificial Intelligence*, 23(1):117 – 128, 2010.
- [108] S. S. Panda, D. Chakraborty, and S. K. Pal. Flank wear prediction in drilling using back propagation neural network and radial basis function network. *Applied Soft Computing*, 8(2):858 – 871, 2008.
- [109] S. S. Panda, A. K. Singh, D. Chakraborty, and S. K. Pal. Drill wear monitoring using back propagation neural network. *Journal of Materials Processing Technology*, 172(2):283 – 290, 2006.
- [110] C. R. Parikh, M. J. Pont, and N. Barrie Jones. Application of Dempster-Shafer theory in condition monitoring applications: a case study. *Pattern Recognition Letters*, 22(6-7):777 – 785, 2001.
- [111] K. H. Park, A. Beal, D. Kim, P. Kwon, and J. Lantrip. Tool wear in drilling of composite/titanium stacks using carbide and polycrystalline diamond tools. *Wear*, 271(11-12):2826 – 2835, 2011.
- [112] K. Patra. Acoustic emission based tool condition monitoring system in drilling. In *Proceedings of the World Congress on Engineering*, volume 3, London, UK, 2011.
- [113] K. Patra, S. K. Pal, and K. Bhattacharyya. Artificial neural network based prediction of drill flank wear from motor current signals. *Applied Soft Computing*, 7(3):929 – 935, 2007.

- [114] T. Radhakrishnan and S. M. Wu. On-line hole quality evaluation for drilling composite material using dynamic data. *Journal of Engineering for Industry*, 103(1):119 – 125, 1981.
- [115] A. Rakar and D. Juričić. Diagnostic reasoning under conflicting data: the application of the transferable belief model. *Journal of Process Control*, 12(1):55 – 67, 2002.
- [116] A. Rakar, D. Juričić, and Peter Ballé. Transferable belief model in fault diagnosis. *Engineering Applications of Artificial Intelligence*, 12(5):555 – 567, 1999.
- [117] S. Rangwala and D. Dornfeld. Sensor integration using neural networks for intelligent tool condition monitoring. *Journal of Engineering for Industry*, 112(3):219 – 228, 1990.
- [118] S. R. Ravishankar and C. R. L. Murthy. Application of acoustic emission in drilling of composite laminates. *NDT&E International*, 33(6):429 – 435, 2000.
- [119] S. R. Ravishankar and C. R. L. Murthy. Characteristics of ae signals obtained during drilling composite laminates. *NDT&E International*, 33(5):341 – 348, 2000.
- [120] J. M. Richardson and K. A. Marsh. Fusion of multisensor data. *International Journal on Robotic Research*, 7(6):78 – 96, 1988.
- [121] C. Sammut and G. I. Webb. *Encyclopedia of Machine Learning*. Springer reference. Springer, 2011.
- [122] C. Sanjay, M. L. Neema, and C. W. Chin. Modeling of tool wear in drilling by statistical analysis and artificial neural network. *Journal of Materials Processing Technology*, 170(3):494 – 500, 2005.
- [123] K. Sentz and S. Ferson. Combination of evidence in Dempster-Shafer theory. Technical Report SAND2000-0835, Sandia Report, 2002.
- [124] G. Shafer. *A mathematical Theory of Evidence*. Princeton University Press, Princeton, NJ, USA, 1976.
- [125] M. Shah, L. Unanue, P. Bidare, U. Galfarsoro, L. M. Iriarte, K. P. Karunakaran, and P. J. Arrazola. Tool control monitoring applied to drilling. In *Proceedings of the 6th MUGV conference*, Cluny, France, 2010.
- [126] A. K. Singh, S. S. Panda, D. Chakraborty, and S. K. Pal. Predicting drill wear using an artificial neural network. *The International Journal of Advanced Manufacturing Technology*, 28:456 – 462, 2006. 10.1007/s00170-004-2376-0.
- [127] P. Smets. The combination of evidence in the Transferable Belief Model. *IEEE Transactions on Pattern Analysis and Machine Intelligence*, 12:447 – 458, 1990.
- [128] P. Smets. Belief functions on real numbers. *International journal of approximate reasoning*, 40:181 – 223, 2005.
- [129] P. Smets and R. Kennes. The Transferable Belief Model. *Artificial Intelligence*, 66:191 – 234, 1994.
- [130] P. Smets and R. Kruse. *Uncertainty in Information Systems : From Needs to Solutions*.
- [131] S. W. Smith. *The scientist and engineer's guide to digital signal processing*. California Technical Publishing, San Diego, CA, USA, 1997.
- [132] K. Subramanian. Prediction of drill life. *Transaction of ASME*, 99:295 – 301, 1977.

- [133] I. N. Tansel, C. Mekdeci, O. Rodriguez, and B. Urangun. Monitoring drill conditions with wavelet based encoding and neural networks. *International Journal of Machine Tools and Manufacture*, 33(4):559 – 575, 1993.
- [134] Y. S. Tarn and B. Y. Lee. Amplitude demodulation of the induction motor current for the tool breakage detection in drilling operations. *Robotics and Computer-Integrated Manufacturing*, 15(4):313 – 318, 1999.
- [135] R. Teti, K. Jemielniak, G. O'Donnell, and D. Dornfeld. Advanced monitoring of machining operations. *CIRP Annals - Manufacturing Technology*, 59(2):717 – 739, 2010.
- [136] R. Teti and G. F. Micheletti. Tool wear monitoring through acoustic emission. *CIRP Annals - Manufacturing Technology*, 38(1):99 – 102, 1989.
- [137] Third NATO/IRIS Conference. *Revisions to the JDL data fusion model*, Quebec city, Canada, 1998.
- [138] C. Tsao. Prediction of flank wear of different coated drills for jis sus 304 stainless steel using neural network. *Journal of Materials Processing Technology*, 123(3):354 – 360, 2002.
- [139] A. Velayudham, R. Krishnamurthy, and T. Soundarapandian. Acoustic emission based drill condition monitoring during drilling of glass/phenolic polymeric composite using wavelet packet transform. *Materials Science and Engineering: A*, 412(1-2):141 – 145, 2005. International Conference on Recent Advances in Composite Materials.
- [140] I. Vilcek, J. Kovac, and J. Janekova. Failure prediction by means of cepstral analysis and coherence function between thrust force and torque signals. In *Assembly and Manufacturing (ISAM), 2011 IEEE International Symposium on*, pages 1 – 4, may 2011.
- [141] L. Wald. Definition and terms of reference in data fusion. In *International Archives of Photogrammetry and Remote Sensing*, 1999.
- [142] E. L. Waltz and J. Llinas. *Multisensor Data Fusion*. Artech House, Norwood, MA, USA, 1990.
- [143] L. Xiaoli. On-line detection of the breakage of small diameter drills using current signature wavelet transform. *International Journal of Machine Tools and Manufacture*, 39(1):157 – 164, 1999.
- [144] L. Xiaoli and Y. Zhejun. Tool wear monitoring with wavelet packet transform - fuzzy clustering method. *Wear*, 219(2):145 – 154, 1998.
- [145] R. Yager. On the Dempster-Shafer framework and new combination rules. *Information Sciences*, 41:93 – 138, 1987.
- [146] Xu Yang. Wear state recognition of drills based on k-means cluster and radial basis function neural network. *International Journal of Automation and Computing*, 7:271 – 276, 2010. 10.1007/s11633-010-0502-z.
- [147] O. Yumak and H. Ertunc. Tool wear condition monitoring in drilling processes using fuzzy logic. In *Neural Information Processing*, volume 4234 of *Lecture Notes in Computer Science*, pages 508 – 517. Springer Berlin / Heidelberg, 2006.
- [148] L. Zadeh. Review of books: A mathematical theory of evidence. *The Artificial Intelligence Magazine*, 5:81 – 83, 1984.
- [149] L. A. Zadeh. Fuzzy sets. *Information and Control*, 8(3):338 – 353, 1965.

Chapter 3

Monitoring problem formalization, description of requirements and challenges, & proposed implementation approach

From the description and the formalization of the industrial processes monitoring problem, major challenges and requirements will be identified, and solutions will be reviewed and proposed. Even if these items are presented in different subsections, they present strong links which will also be detailed. They will then be used to build a methodology dedicated to the implementation of sensor-based monitoring systems for industrial production processes. Indeed, more than the monitoring system itself, its implementation also presents challenges and open questions that will be discussed. A special emphasis will be put on the drilling process, and specific examples will be provided, but statements and approaches may be generalized to other industrial manufacturing processes. This chapter will also allow precisising the main orientations of this work by underlying bottlenecks to overcome in order to develop reliable drilling monitoring systems.

3.1 Description & mathematical formalization of the monitoring problem

As mentioned in chapter 1 and following the definition given in [16], the typical *machining process monitoring system* operates according to the following scheme: several process variables that are influenced by the cutting tool state and the material removal process conditions are sensed by the use of appropriate *sensors*. Signals detected by these sensors are processed to generate *features* correlated with tool state and/or process conditions. Features are then fed to and evaluated by cognitive *decision making support systems* for the final diagnosis. This can be communicated to the human operator or fed to the machine tool numerical controller in order to suggest or execute appropriate adaptive/corrective actions. This generic sequence is summarized in figure 3.1 where the possibility to integrate *prior and/or external information* (that is not issued from sensors measurements) has been added. *Expert knowledge* about the sensors, features, estimators and decision making strategies to use is also mentioned.

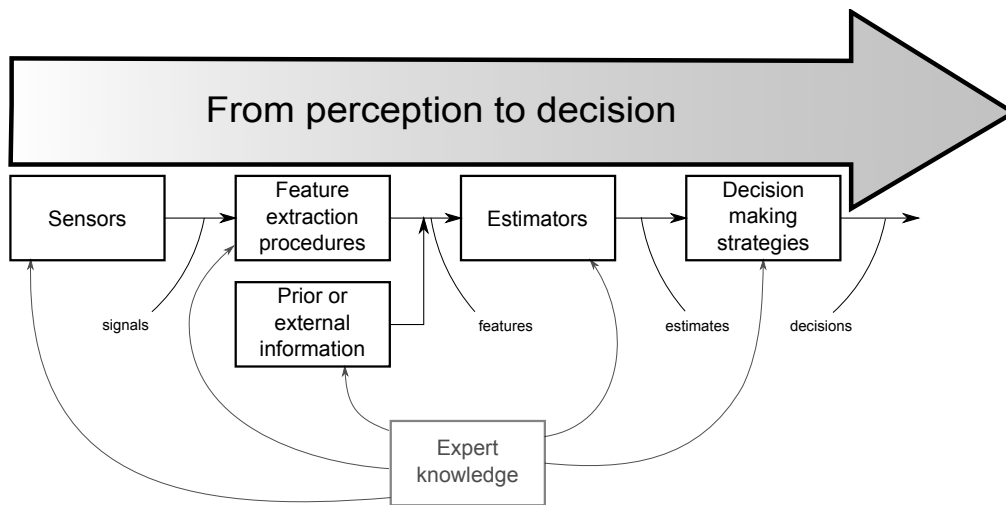


Figure 3.1 – Generic monitoring flowchart

The first tools, from sensors to features extraction procedures are *ad hoc* as a function of the goal of the monitoring system. However *sensors selection and integration* and the *selection and extraction of relevant features* are essential in the implementation of a monitoring system and will be discussed in sections 3.4, 5.1 and 5.2.

The next steps, from features (in a wide sense) to decisions, can be expressed in a generic manner for most monitoring applications. In order to have a standard basis for further developments, and the implementation of building blocks of a drilling monitoring system in particular, a mathematical formalization that encompasses these steps has been proposed and detailed hereafter:

$$\hat{s} = f(fe_1, \dots, fe_n, \dots, fe_{fn}) \quad (3.1)$$

which literally means that the estimation \hat{s} of the state s of a *process variable* is given as a function of fn features $\{fe_1, \dots, fe_{fn}\}$ by an estimator f . The estimated state can then be compared to some criteria in order to make decisions. Moreover, concerning each specific monitoring application, a domain of validity D can be defined in the space of operating conditions that delimits the parameter ranges inside which the estimation reach an acceptable quality level from the user point of view. Some precisions on the elements of this modeling, and examples related to the drilling monitoring application, are provided in the following. The *state* s and its estimate \hat{s} can take different forms as a function of the process variable that is being monitored. It can be:

- binary values for binary classification of the process variable (e. g. tool is broken **or** not broken)
- crisps values for classification of the process variable (e. g. hole diameter is under tolerance **or** into the tolerance interval **or** over tolerance)
- values in fuzzy sets (e. g. tool wear state example given in section 2.1.1)
- values in \mathfrak{R} (e. g. flank wear level)

The *features* fe_n that estimations are based upon can also be of different natures. They can be:

- real values extracted from sensor data (e. g. mean, energy of a frequency band of interest)
- prior information related to the monitored process variable (e. g. cutting parameters)

- other process variable estimates issued from previous monitoring tasks (e. g. statement about the absence/presence of a tool cutting edge chipping can be used for the estimation of the drill wear level)

Finally the type of the **estimator** f also depends on the task to accomplish. It can be:

- an analytical function in the case of a model of the monitored process variable behavior exist (e. g. cutting power as a function of thrust force and torque)
- an optimization algorithm in the case of parameters estimation of a known model as a function of the features (e. g. determination of tool wear increasing rate when an evolution pattern is available)
- a classification algorithm in the case of discrimination between different possible states known a priori
- a clustering algorithm in the case a detection of state evolution (e. g. tool cutting edge chipping application presented in section 5.3.2)
- predictors to anticipate future states of the monitored process variable (e. g. Kalmann filter)
- high level fusion algorithm to make a decision based on multiple sources statements about the state of the process variable of interest

This generic modeling of the last steps of a monitoring procedure, from features to decision, allows to encompass various kinds of data types and estimators, and can consequently be used for different monitoring use cases that can represent either part or the totality of a monitoring system. Indeed, several subsystems dedicated to specific monitoring tasks are needed to perform monitoring of complex processes. An illustrative example of such subsystems composing a global monitoring system is provided in figure 3.2.

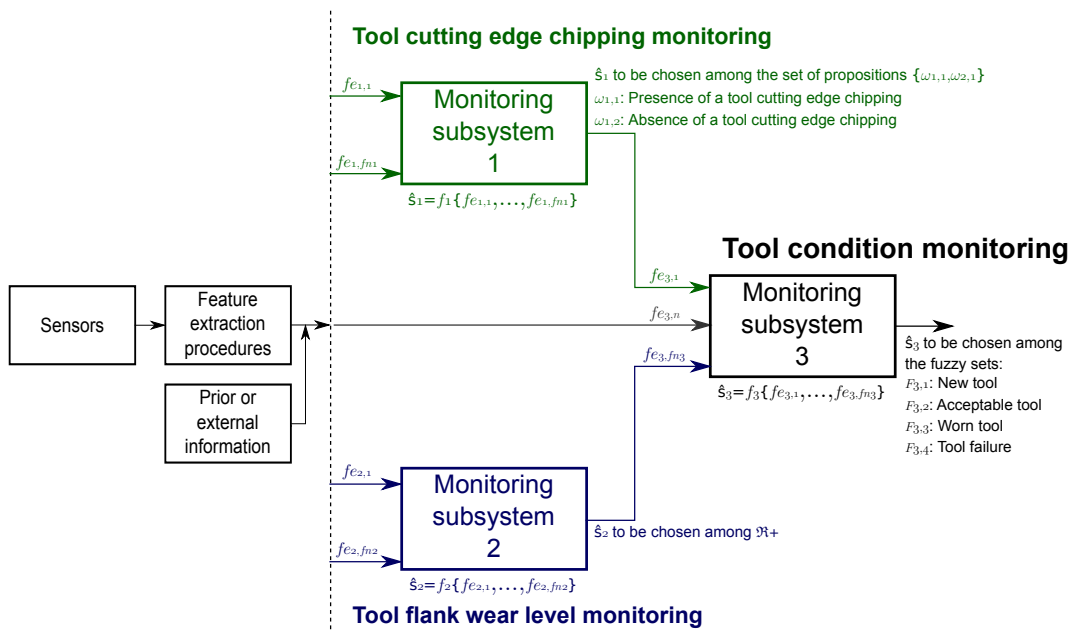


Figure 3.2 – Illustration of a global tool condition monitoring system composed by several monitoring subsystems

3.2 Description of requirements and challenges linked with monitoring of complex processes in harsh environments

As it has often been evoked here, monitoring complex processes in industrial environment is a tricky task. Some of the challenges described hereafter are specific to drilling operations while others are more general. The goal of this section is to detail the causes that made previous attempts to implement drilling monitoring systems in aeronautical assembly plants not always as successful as expected.

3.2.1 Variability of operating conditions related challenges

As stated in section 2.1, many studies on drilling monitoring have been done under steady process conditions, in sensor-friendly lab environments, and issues about the variability of operating conditions have not been tackled. Concerning industrial processes in a general manner, two types of operating conditions changes can occur and will be discussed here: mastered and unmastered. Considering the formalization proposed above, variations of operating conditions are linked with *domain of validity* D of a monitoring system.

3.2.1.1 Mastered variations of operating conditions

Mastered variations of operating conditions mainly consist in changes in process parameters. Indeed, due to the increasing need of flexibility in production plants, and of automated manufacturing solutions in particular, manufacturing operations can have to be performed in different conditions, requiring the use of different process parameters. Concerning drilling, not only cutting speed and feed rate are concerned, but also the material to be drilled, the lubrication type and quantity, the drill geometry, etc, are susceptible to change several times a day as a function of the part of the airframe that is drilled for example, and a monitoring system has to face these variations and remain *reliable*. If some of these changes can be, from a monitoring point of view, tackled by the use of process parameters as features (numerous studies presented in section 2.1 took cutting speed and feed rate as input parameters), others can be difficult to quantify and to integrate this way. The monitoring system must then be *robust* facing this latter category of changes of operating conditions.

3.2.1.2 Unmastered variations of operating conditions

If one can first think of influence quantities as ambient temperature for instance, more impacting sources of operating conditions variations exist. Concerning drilling operations for instance, the stiffness of the system formed by the drilling machine and the workpiece plays an important role in the progress of drilling operations. When considering large aeronautical substructures, like nose fuselage for instance, local variations of the workpiece stiffness are unavoidable. In the same manner, some automated machines that are used to perform drilling present different vibratory behaviors as a function of their positioning. Such a configuration favoring the apparition of stiffness variations in the system formed by the drilling machine and the part to be drilled is visible on figure 3.3. These kind variations linked with the process to be monitored, that are difficult to reproduce when performing lab experiments, contribute to the lack of robustness that manufacturing monitoring systems suffer from when implemented in the shop floor. Indeed such process variables variations are passed through sensors signals, then features, and so on until estimations and decisions are made by the system which, in most cases, has not been designed to face such dispersive behavior of its input parameters.



Figure 3.3 – Example of drilling operations being performed by a robot on a large structure presenting different local stiffness levels. Such robots also present different vibratory behaviors as a function of their positioning

Many sources of operating conditions variability exist that lead to the same reliability issues. For example, the transfer of a monitoring system from a machine to another one, which behavior is fatally different, have to be possible considering flexible production environments. Therefore, changes in operating conditions, either they come from the need of flexibility or unmastered variations, require that an industrial monitoring system be robust facing such changes, or, according to the proposed formalization, that its domain of validity D be large enough to cover industrial needs of flexibility and reliability.

3.2.2 Quality of data related challenges

Data passing from sensors to decision are the information vector within a monitoring system. Therefore quality of data is an important point. Mainly input data are subjected to quality related issues, and these imperfections are often propagated through the features $\{fe_1, \dots, fe_{fn}\}$ defined in the proposed formalization, until they decrease the global performance level of the monitoring system by affecting decision that are made.

3.2.2.1 Quality of input data

Quality of input data is of great importance for an industrial monitoring system: as input data coming from sensors are at the basis of all the monitoring sequence, misinterpretations at this level will propagate through all the different steps leading to inadequate decisions. *Imperfection on sensor data* is therefore a major issue that should be taken into account from the beginning of the design of a monitoring system. This is not done in most actual studies about machining process monitoring, and it has been treated in an implicit manner by the estimators, which have become more and more complex. Monitoring performances did not increase as a function of this complexity, neither in term of accuracy nor reliability, showing the limits of approaches that disregard the data imperfection related issues. Actually, this is a well-known fact: even the best algorithm will not provide good results if its input data are of low quality or are misinterpreted. Different types of perturbations that can affect input data are reported in figure 3.4.

The most usual, and also the most discussed, is *uncertainty* due to stochastic perturbations. Indeed, industrial plants are often hostile to sensor measurements due to the presence of many high power machines generating electrical perturbations that affect sensors signals. *Ambiguity* encompasses every phenomena that affect sensors detection ability and which cannot be considered as 'normal' stochastic perturbations. The border between these two types of imperfection is somewhat artificial [13] because noise can affect sensors detection ability in some extent. Causes of such lack of detection ability can be, but are not limited to: sensor partial or complete breakdown, presence of an external element that avoid a normal measurement, etc. Actually, many hostile elements to sensors exist in industrial plants that can be at the origin of sensors dysfunctions, like chemicals, diverse dusts, moving parts. *Inconsistency* arises when several sensors provide different statements about the same quantity of interest, and is caused by of one a the two aforementioned data quality related issues: due to perturbations on some of the input data, they are conflicting with reliable ones. This type of situations raises the importance of efficient fusion algorithms.

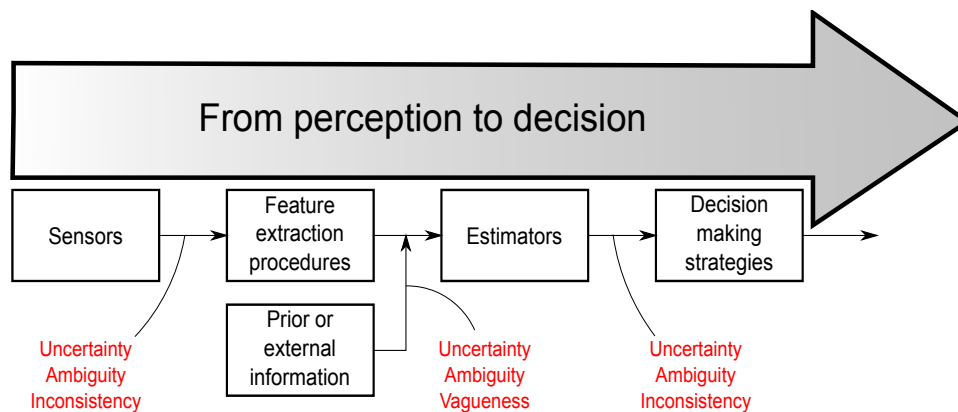


Figure 3.4 – Uncertainties on data through the monitoring sequence: some of them propagate while others can be reduced by the use of appropriate estimators and/or fusion algorithms

3.2.2.2 Quality of features definition and extraction

Apart from cases when low level data fusion solutions are implemented reducing avoidance of degraded or false information, *perturbations on input data are directly passed through features* at the feature extraction step. In addition to features extracted from sensors signals, information can be provided to the estimator: it consists in information that the user can possess, like process parameters for instance, or every information that are not issued from sensors. As depicted on figure 3.4, these inputs can suffer from *uncertainty* (e. g. a process parameter, like spindle rotation speed, may present a probability distribution as a function of the command), *vagueness* if one imagine the operator can make a choice over semantic variables to qualify the state of a phenomena (e. g. drill wear level, see figure 2.9(a) for an example of vague statements about it), or *ambiguity* if he is not able to choose between different propositions. The state of the art on drilling monitoring applications, if it allowed reporting many studies where process parameters had been used as input of estimators, did not allow finding studies neither where the quality of this input data has been assessed, nor where the possibility to integrate ambiguous or vague statements as input had been explored.

3.2.2.3 Estimations quality

The last stage before the decision making step, where issues related to data quality can manifest themselves, is after estimation procedure. If it can seem obvious that uncertain, vague or ambiguous features will provide poor estimates in terms of data quality, the estimation step can also be viewed as an opportunity to reduce harmful effects linked with data quality related issues, and possibilities offered in this sense will be detailed in a further section. The type of data imperfection that estimates can suffer from mainly depends of the estimator that has been used, and imperfect results can, to some extent, be acceptable. For instance, a vague statement issued from a fuzzy inference system, or probability distribution issued from the combination of uncertain features can be sufficient to make appropriate decisions. However, for such results to be valid, it implies that estimators had received reliable data as inputs, or possess the ability to deal with imperfect data.

Data quality, and especially input data, is of major importance for a monitoring system to achieve good performance. However, some causes of data imperfection and/or inconsistency are not avoidable, and therefore the system have to be able, in some extent, to deal with such data in order to become robust in an industrial environment. This can be done either by avoiding the creation of low quality features or by using estimators f able to deal with them. Solutions to address some of the aforementioned data quality related concerns are discussed in section 3.3.

3.2.3 Process complexity and dispersive behavior related challenges

The last concern about the implementation of an industrial process monitoring system is linked with the operations to be monitored. The particular case of drilling operation will be evoked here, but most of the statements may be applied to other manufacturing processes. As mentioned several times in section 1 and 2.1, drilling is a complex operation that shows a dispersive behavior. If these two issues are linked, they will be dissociated because their respective influences affect the monitoring system in different ways. *Drilling process complexity* implies that the estimator f is able to deal with such complicatedness, and often also imposes the use of high number of features. On the other hand, *process dispersive behavior* is linked with the domain of validity D of the system as well as with the ability of the estimator f to deal with data that are, to some extent, scattered.

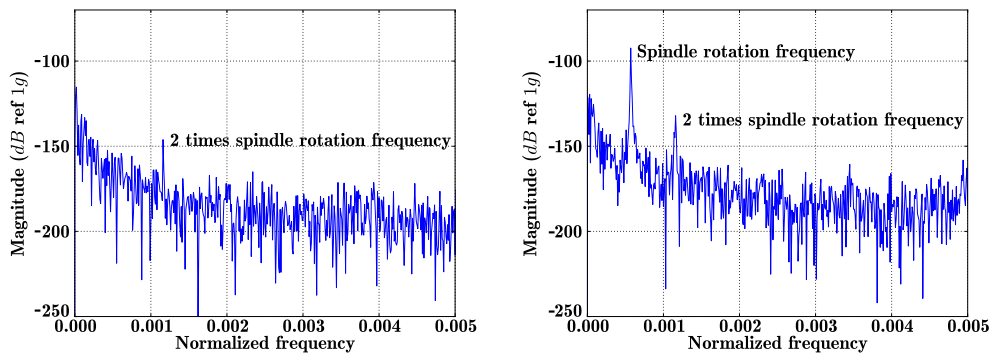
3.2.3.1 Process complexity

As stated in chapter 1 and section 2.1, the complexity of the drilling process forbade the development of mathematical models describing the evolution of process variables of interest (state of the workpiece and of the production mean) as a function of measurable quantities. Therefore, *model based monitoring methods* (also called quantitative monitoring approaches), that lie on observations of process features in order to estimate its state are not applicable in our case. Therefore, the use of *external* (or qualitative) monitoring methods is required: they are based on *knowledge* on the system behavior provided by users and/or experiments. All AI based monitoring methods fall into this category. One of the main challenging aspect of the implementation of such method is *knowledge modeling*. Therefore, statements related to the modeling of imperfect data presented in section 2.2.2 are to be taken into account in order to integrate every available knowledge. Then, the absence of theoretical model imposes to the *monitoring system designer* to perform the selection of relevant sensors and features, efficient estimators and decision making strategies, in brief, to define all the needs related to the whole monitoring procedure, from perception to decision. These tasks form the implementation steps of a monitoring system based on external methods and will be detailed in section 3.4.

3.2.3.2 Process dispersive behavior

Several studies related the randomness inherent to cutting processes [16, 11], and drilling in particular [15, 14, 12], to explain their dispersive behaviors. It may be more accurate to link, to some extent, these behaviors with unmastered (and sometimes undetected) variations of the process operating conditions that have been mentioned in section 3.2.1. Indeed, slightest changes in the operating conditions can lead to very different results during a drilling operation. For instance, a micro-chip trapped during the tool insertion in the tool holder can generate imbalance of the cutting process that will lead to unexpected vibratory behavior. This example is detailed in figure 3.5. In an airframe assembly plant, one can imagine many perturbation of this kind. If occurrences of such problems can be reduced by the application of strict procedures, they cannot be totally avoided, therefore a monitoring system must be able to face, or at least to identify them as *singular* events that necessitates a particular attention.

Complex processes, that often present dispersive behaviors, are challenging to be monitored. Indeed, as they do not allow the use of model-based monitoring approaches, monitoring strategies have to be build over knowledge of the process that is often difficult to model and to use in a reliable manner. Moreover, dispersive behaviors impose that monitoring systems are robust facing situations that were not known at their design phase.



- (a) Magnitude plot of the axial acceleration signal acquired during drilling Ti6Al4V in the frequency domain: only a pike at 2 times the spindle rotation frequency is visible, which is the expected behavior
- (b) Magnitude plot of the axial acceleration signal acquired during drilling Ti6Al4V: the dominant frequency is visible at the spindle rotation speed, as well as a pike at 2 times this frequency denoting an unbalanced drilling operation

Figure 3.5 – Illustration of the influence of slight process conditions changes in drilling. Magnitude plots of axial accelerations signals obtained during drilling Ti6Al4V in the frequency domain using the same process conditions (the drill has been replaced between them, but the same model has been used) are shown. The disassembly of the drill and tool holder after the second test series revealed the presence of a microchip stuck between two parts of the tool holder (it probably slipped in while the tool was being changed between the two test series) that had probably provoked the imbalance visible on plot (b) and that led to the fragmentation of titanium chips whereas they were long during the first test series

3.2.4 Overview on challenges for monitoring in difficult environments

Several challenges have to be overcome in order for a process monitoring system to perform in a way that allow satisfying industrial requirements. They can be summarized as follow: the absence of mathematical models of the process impose the design of a dedicated system, from the sensors needs to decision making strategies. Constraints on such a system are numerous because of the associated requirements, both in terms of accuracy and robustness due to the dispersive behavior of some processes, and also the difficult environment in which such systems are implemented in. Indeed, the harsh industrial context is a source of data imperfections that makes difficult to obtain reliable results.

3.3 Discussion on solutions to overcome challenges and meet expected requirements

In order to overcome challenges and meet expectations detailed in the previous sections, solutions exist that will be discussed hereafter.

Following the generally accepted statement that reliable process condition monitoring based on a single signal feature is not feasible [5], the use of multiple sensors together with intelligent information processing techniques has been described as one of the most promising strategies to improve the reliability and flexibility of tool condition monitoring systems [16, 11, 2]. Indeed, numerous studies (presented in section 2.1.3) using multiple sensors and diverse data fusion techniques and strategies have been performed, and several benefits should have followed the introduction of multisensor data fusion for drilling monitoring applications:

- a better handling of the process complexity
- an improved robustness facing the harsh industrial environment
- a better reliability facing the process dispersions & operating conditions variations

As concluded at the end of section 2.1.3, mainly the first point has been addressed. The use of multiple sensors providing information, that have most often been merged using neural networks, allowed obtaining interesting results for tool wear estimation or tool wear states discrimination in particular. This demonstrated one potential benefit of introducing sensor fusion in manufacturing process monitoring systems for ***a better handling of the process complexity***. However, this has mainly been done under steady process conditions and in sensor-friendly lab environments, and neither issues about the variability of the operating conditions, process dispersion nor quality of data have been tackled.

3.3.1 Robustness facing harsh industrial environments

This point is of great importance for an industrial monitoring system: basically, the use of multiple sensors, or *information sources*, follows the absence of precise or sure enough data coming from one source. Imperfections and inconsistency on sensors data should therefore be taken into account from the beginning of the *design of a monitoring system*. To do so, a precise knowledge on ways to model and handle different forms of *data related quality problems* will help to better address the challenges they involve.

From a formal point of view, sensor data and features $\{fe_1, \dots, fe_{fn}\}$ that are extracted from, dedicated to a monitoring task, will present contradictory values that will lead to difficulties at the estimation step. The estimator f must then have a strategy to face such cases.

Section 2.2 reviewed several multisensor data fusion concepts, frameworks and techniques that can be suitable to tackle data quality related issues. First of all, the awareness of

such issues is essential. If this statement can appear obvious and most recent review papers concerning monitoring of machining operations mentioned it, this concern is barely visible in attempts to develop monitoring systems for industrial machining processes. Coherent and understandable modeling of data imperfections has been proposed following the literature that should allow orienting the choice of relevant solutions to implement. Frameworks dedicated to the modeling and handling of such imperfect information have then been introduced with a special emphasis on the probabilistic and evidential ones. Their use, combined with relevant sensors integration and feature selection, should allow improving robustness of monitoring system in harsh environments.

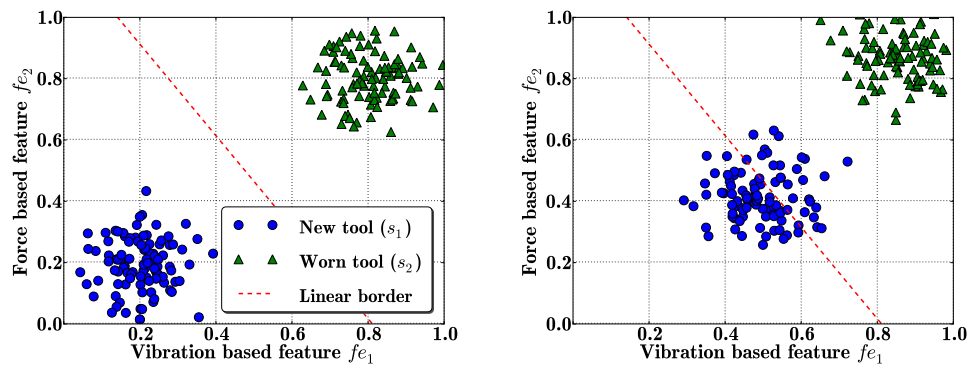
The multiplicity of information sources as a response to data quality related issues raises the notion of *information redundancy*. Indeed, one potential advantage of using information fusion is the capacity for the system to work in a degenerated mode, in case of some information sources dysfunction for instance [7]. Unfortunately, following the developments of section 2.2, this multiplicity is also a source of *inconsistency*. Indeed, the use of multiple sources aimed at providing statements on the same phenomena in harmful environment leads to the creation of conflicting statements that yet need to converge to a unique and reliable decision. In case of data coming from sensors, this problematic has been discussed, and solutions proposed, in [10] and [6] by the use of concepts issued from the probabilistic framework. Such solutions should also be available for other steps of the monitoring sequence depicted in figure 3.1, in order to be able, in particular, to merge redundant statements expressed as features at the estimation step. An attempt in this sense using belief functions has been proposed in chapter 4. The problem has been formalized as a *singularity identification* task, because behind numerous operations needed to perform monitoring, from feature extraction to decision making, the problem can be considered as choosing a particular (or *singular*) value (no supposition is made of the type of value, it can be numerical, semantic, ...) among others. Further details, as well as theoretical developments and comparison with existing approaches by numerical experiments will be presented in chapter 4, and application on diverse use cases will be detailed in sections 5.2 and 5.3.1.

3.3.2 Robustness facing process dispersions & operating conditions variations

Processes dispersive behavior and operating conditions variations are grouped together in terms of solutions to deal with in a robust manner. Anyway, what is perceived as dispersive behavior of the process may often be due to operating conditions variations that the user is not aware of. They are two of the main reasons that explain the lack of reliability of monitoring systems when implemented in industry, and affect both their *flexibility* and *reliability*.

From a formal point of view, the problem can be described as follows: due to change(s) in initial conditions, the features $\{fe_1, \dots, fe_{fn}\}$ used to monitor the process state will take different values than expected, and the estimator f will not be able to provide reliable statements. Expectations on features values come from the implementation of the monitoring system, and the *supervised learning* phase of estimators in particular, if any. An illustrative example of such a case in drill condition monitoring is given in figure 3.6.

As changes of features values due to variations of operating conditions are unavoidable, the solution to this problem has to be found at the *estimation* step of the monitoring sequence. The fact that estimators expect features to take values in regions of the *feature space* that have been delimited and labeled *a priori* is a drawback for the implementation of a robust and reliable monitoring system in cases where *variations are expected*. Concerning drilling, section 2.1 showed that many studies have focused on the use of supervised learning techniques, and neural networks in particular, to perform monitoring of various drilling linked phenomena of interest. However, as it is the case for the example described in figure 3.6, but also for many other monitoring purposes, the location of a data sample in the feature space is not as important as *the detection of unexpected variations of their locations* that



- (a) Subdivision of the feature space after supervised learning of a linear classifier f has been performed in order to discriminate between 2 states s_1 and s_2 of the process, corresponding respectively to the use of a new and a worn tool
- (b) The feature space subdivision issued from the learning phase is kept to perform drilling monitoring on a part with different stiffness behavior, and using a drill inducing more thrust force and less sensible to wear: some drillings are misclassified because the a priori feature space subdivision is not adapted to new operating conditions

Figure 3.6 – Illustration of the robustness problem involved by estimators based on supervised learning procedures: prior subdivision of the feature-based spaces may lead to misinterpretations in case where operating conditions are subject to variations

often reveals the presence of an abnormal behavior of the process. Then the presence of one or more data samples (representing manufacturing operations) that present *singular* locations compared with others should be considered for an eventual inspection and/or corrective action(s). The solution proposed here is partly based on this statement: instead of trying to characterize the process state by designing a feature-based space that subdivisions corresponding to process states are determined *a priori*, it may be more robust to detect when the process state image location evolve in an unexpected manner in the feature space. If the parameters of estimators aiming at the detection of such changes have not to be set up during a learning phase, and, consequently, are a solution to the problems linked with the construction of a priori labeled feature-based spaces subdivisions that often need many training data, they either necessitate an initialization phase to link regions, or more precisely *data samples clusters locations*, to process states, or will only be able to monitor relative changes without allowing the characterization of the process state.

Practically, the monitoring system designer should avoid estimators which parameters setting is based on supervised learning procedures, and prefer the use of unsupervised learning based ones, that are better to detect process conditions changes, together with an *initialization phase*. Such estimators should remain simple in order to necessitate only an initialization phase, as short as possible, because it can be considered intrusive depending on the process that is monitored. Concerning drilling of airframe subassemblies, each time a new part is about to be drilled, several holes are performed in a sample and checked in order to ensure they meet the quality requirements. This phase is called the *prior quality checking phase*. These drillings (under the hypothesis holes meet the quality requirements) that are representative of the process normal functioning state can serve as an initialization phase, and therefore no additional operations are required that would make the monitoring system intrusive. Such an initialization phase principle is depicted in figure 3.7.

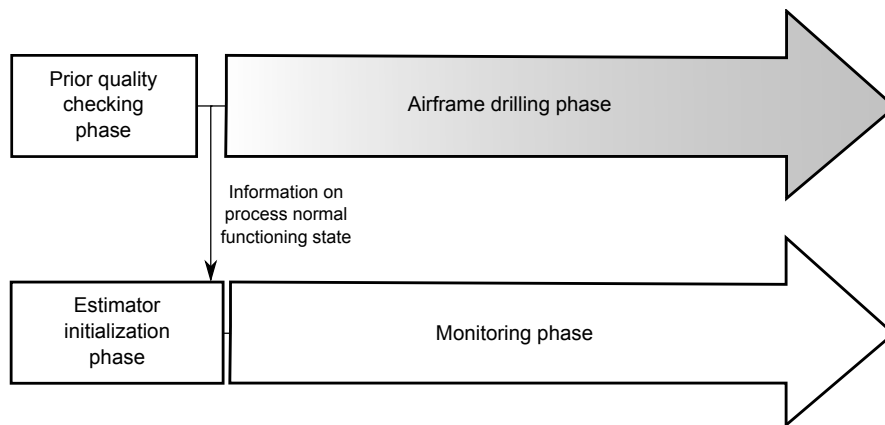


Figure 3.7 – Initialization phase of unsupervised learning algorithms integration through the monitoring of airframe subassemblies drilling operations

3.3.3 Overview

Multisensor data fusion, but also related concepts as data imperfection modeling and merging of conflicting statements, are of great interest to meet challenges implied by the running of process monitoring systems able to achieve the performance level required in the manufacturing industry. If the use of multiple information sources has been widely discussed and assessed, the use of concepts related with information imperfections and detailed in section 2.2 has been, to the author knowledge, barely been mentioned by now. Possibilities offered by these concepts and related techniques have been underlined, and their use will constitute one of the original contributions of this work. Descriptions of the different applications they have been used for drilling monitoring, and assessment of the performance improvements they provided, will be given in chapters 4 and 5.

3.4 Proposed approach for the implementation of monitoring systems for industrial production processes

In 2010, Abellan-Nebot and Subirón stated that in spite of the intensive research being carried out in the field, there was still no clear methodology for developing machining monitoring systems that allowed machining processes to be optimized, predicted or controlled. Furthermore, many of the research studies presented in the literature seemed to be contradictory [1]. Several steps are unavoidable during *the design of a drilling monitoring system*, and the goal of this section is to detail their content, their mutual links, their requirements and their challenging aspects in order to be able to implement a monitoring system that fits the aforementioned requirements. From the proposition of a global methodology, main steps of the implementation will be considered, leading to the determination of several contributions of this work.

3.4.1 Global methodology for the implementation of a monitoring system

A generic methodology, which is summarized in figure 3.8, has already been proposed in [1] in order to develop intelligent monitoring systems for machining process, based upon questions that monitoring system designers should ask themselves during the design process.

If the general framework and objectives for the implementation of a monitoring system for machining operations are shared, not exactly the same organization will be kept here. Propositions to meet the different aforementioned challenges will sometimes be different due

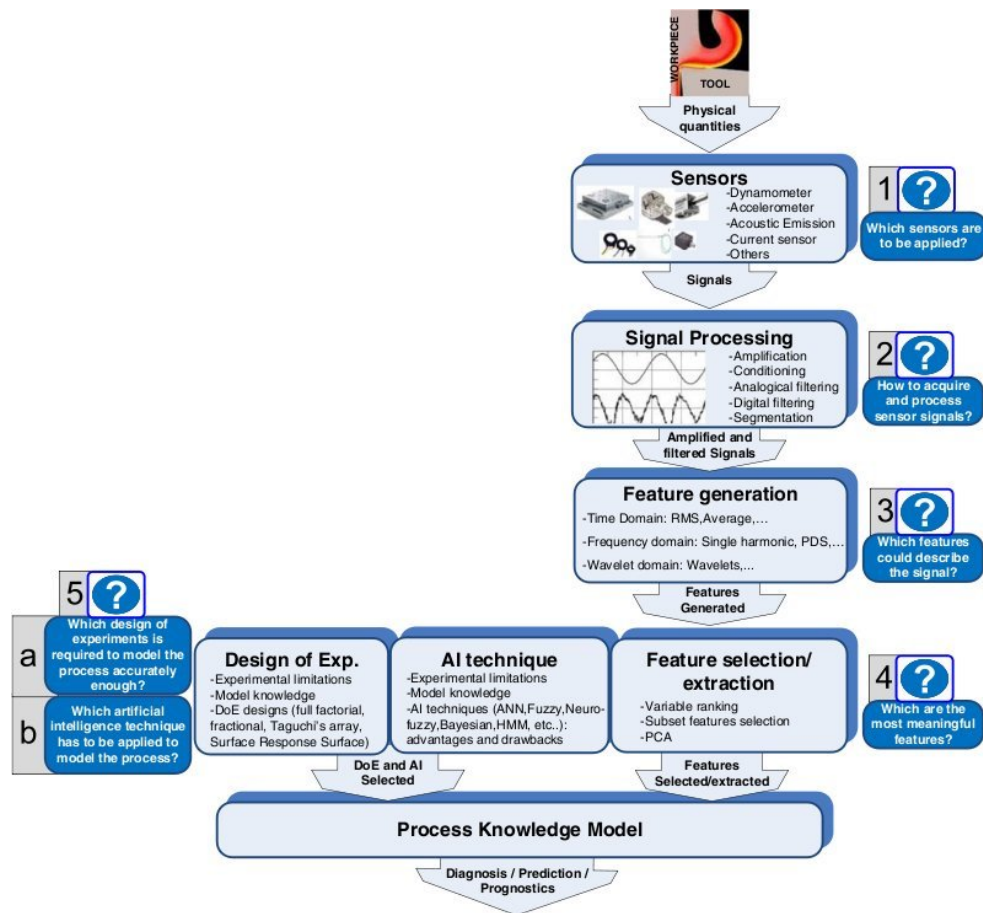


Figure 3.8 – Generic methodology to develop intelligent monitoring system for machining process from [1]

to the original tracks we decided to follow in this work, and some practical considerations too. This section will be organized according to the different steps necessary for the implementation of a monitoring system, and will allow introducing future parts of this work. The different steps of the development of a monitoring system are, according to the author: problem position, sensors integration, features selection, estimators selection, monitoring system evaluation, and industrial implementation. These steps, depicted in figure 3.9 with the eventual feedbacks, present *strong mutual links*, and sometimes overlap, but their separation provides an interesting view of the different stages to plan for the implementation of a monitoring system. They will be detailed in dedicated subsections.

3.4.2 Problem position

First of all, a good positioning of the monitoring problem to be addressed is mandatory. In addition of the formalization proposed in section 3.1 that allows describing the estimation problem in its wide sense, but which does not encompass sensors and signal processing related concerns, a precise knowledge of the production process, working environment and specific constraints is required.

All these information will be used in order to *design experiments* dedicated to the emphasis of the phenomena of interest in order to *collect the maximum amount of sensor data*. The constituted *sensors signal data base* will further serve to select the most relevant sensors and features to use for the monitoring application. Therefore, as many sensors as possible have

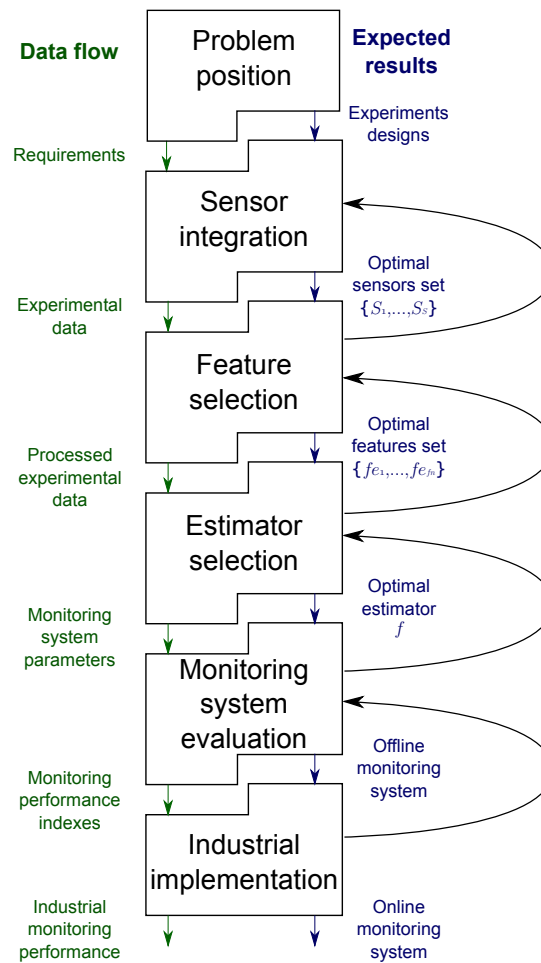


Figure 3.9 – Proposed approach for the implementation of industrial process monitoring systems: eventual feedbacks are represented by gray arrows while data flow and expected results at the end of each steps are given in green and blue respectively. The term optimal is related to the performance level of the monitoring system

to be used in order to then assess their potential relevance. For many processes, sensors to be implemented will be limited by integration constraints.

The design of such dedicated experiments is a complex task. As it is to be done in many fields of applications, many references are available for one to find the most relevant strategy regarding his specific needs and constraints. A complete introduction can be found in [3], and another one discussing this aspects from a machining process monitoring point of view is given in [1].

3.4.3 Sensor integration

Sensor integration encompasses, in this work, the *choice* of sensors to be used for monitoring as well as their *implementation* on the device the monitoring system has to be installed on, and associated techniques aimed at the *extraction of features* from signals they will provide. Many recent reviews provided synthesis on sensors that have been used for drilling and/or machining operations together with popular features that are extracted from signals [16, 1, 11, 8]. Section 2.1 also provides hints on sensors and associated feature extraction techniques to be used for drilling monitoring applications.

The respective abilities of sensors to provide information correlated with some phenomena

of interest have been widely investigated. From a practical point of view however, an important item has often been neglected: their implementation. One of the main reasons of this negligence is that sensor implementation heavily depends on the machine they will be mounted on, and is therefore an ad hoc problem. Still, this concern is very important because the ability of a sensor to provide informative features depends on its implementation. Moreover, several major concerns have only been partially tackled yet, as, for instance, the robust integration of force sensors on industrial rotating machining devices, or the influence of different implementations possibilities to mount acoustic emission sensors. Reviews of existing works and some contributions concerning both these issues will be discussed in section 5.1.

Within the proposed global methodology, the choice of sensors and associated features is performed in a systematic manner, rather than subjective choices that are based on literature or expert knowledge that could lead to the missing of informative data due, for instance, to particularities or special configuration of the system.

If more details on the feature selection procedure will be provided in the next section, from a sensors point of view, the principle is simple. During the sensor integration stage of the implementation of a monitoring system, as many different sensors as possible should be mounted on the machine to perform *dedicated experiments* in order, within the following steps, to be able to isolate the most informative ones and select a combination that allows reaching expected monitoring performance regarding the phenomena of interest. Other sensors will be discarded for the installation of the monitoring system in the industrial environment.

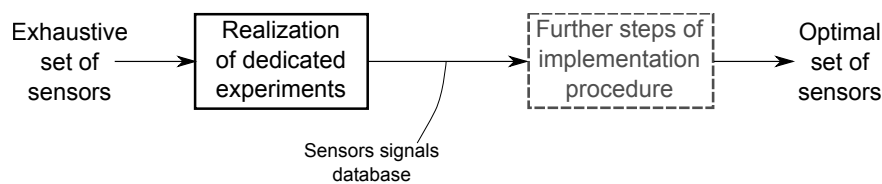


Figure 3.10 – Principle of sensors selection by reduction of an as exhaustive as possible set of sensors within the proposed monitoring system implementation scheme

3.4.4 Feature selection

The feature selection step consists in finding an *optimal set of features* $\{fe_1, \dots, fe_{fn}\}$ among the N features extracted in a systematic from the sensors signals database that will allow obtaining the best monitoring performances.

If the systematic approach for sensor selection may be heavily biased by the non-intrusion constraint that the monitoring system has to satisfy, this is not the case for the features selection step. Indeed, when a sensor signal is available, as many features as one can imagine can be extracted from it. This is therefore a step where the use of systematic approaches can significantly improve the performance compared with most of existing monitoring systems. Concerning the monitoring of machining operations, features have often been chosen without argued reasons, or only based on literature review [16]. Extraction of features from signal databases procedures are easy to implement (in an as exhaustive as possible manner), thanks to nowadays data processing facilities (e. g. personal computers), and allows avoiding the missing of relevant features regarding the phenomena of interest. Such an approach has been employed in [9] for machining monitoring application, but many similar examples exist in other fields of application.

Another important aspect of feature selection will be discussed in this work: as the quality of data has been shown to be a major concern while performing monitoring due to the harsh industrial environment, it is also the case when performing dedicated experiments implied in the design of monitoring systems. As a consequence, all the data quality related challenges

discussed in section 3.2 are to be considered when using the signals database dedicated to sensors and features selection. In [9] for instance, it has been showed, for turning operations, that performing feature selection on data from different test campaigns (but similar in terms of operating conditions), could lead to different *sets of relevant feature* concerning the same phenomenon of interest. The dispersive behavior of the cutting process has also been incriminated, showing that all challenges linked with online monitoring are also to be taken into account offline when designing monitoring systems. Solutions to tackle these issues that have been proposed in section 3.3 will also be investigated for the feature selection step. Both the systematic approach and data quality related solution will be developed and assessed in section 5.2. In particular, data fusion concepts and belief functions as implemented in chapter 4 for the identification of singular elements in data sets, will be used to perform feature selection and select the most relevant ones. The relevance of features will be considered as their singularity level, allowing to identify the most useful ones among the exhaustive feature set. Additional challenges linked with the selection of features from data acquired in difficult contexts, like the heterogeneity of data sets for instance, will also be discussed. Comparison with classical approaches on a tool cutting edge chipping detection application will allow assessing the performances obtained using these original methods developed to overcome challenges that feature selection implies in our context.

3.4.5 Estimator choice

Due to the great variety of tasks that the estimator can have to perform in process monitoring applications, many types of techniques can be used, as evoked in section 3.1, and therefore no precise procedure can be applied for its choice. However, some relevant points will be evoked in this section to provide guidelines in order to choose estimators that will allow monitoring systems meeting requirements discussed in previous sections.

In drilling monitoring applications presented in section 2.1, mainly discrimination between process states and estimation of numerical variables have been performed. Neural networks using supervised learning procedures have been very popular, especially when the fusion of multiple sensors had to be done. From the first attempts, the complexity of networks (or other types of estimators) and associated elements (training sets, architecture parameters,...) increased in order to overcome the difficulties linked with the expected flexibility of a drilling monitoring system regarding process parameters. If acceptable results have often been achieved in lab experiments, the fact that no such system is used in industry yet can be interpreted as a sign they are not robust enough to meet industrial requirements in term of reliability. Actually, from our point of view, estimators should, in order to be robust, remain as simple as possible. Every challenges discussed in section 3.2 should be considered and treated separately using, for instance, the formalization proposed in section 3.1. Addressing the different challenges involved one by one, instead of in a general and rather implicit way by the use of complex estimators, should allow a better understanding of eventual issues and facilitate their treatment. For instance, concerning the example given in section 3.3, a simple clustering algorithm, selected following the principles that simplicity and unsupervised learning improve robustness, would have easily made the discrimination between drilling operations performed with new and worn tool in both the presented application cases.

Several items have been listed in [1] in order to serve as a basis to select an estimator (types of estimators were limited to artificial intelligence techniques): number of experimental samples available, the stochastic nature of the process, the desired model accuracy, the explicit or implicit nature of the model and the previous knowledge available. The first one, namely *the necessary amount of experimental data*, is a major concern as manufacturing experiments are expensive, and access to production facilities to perform tests is often reduced. This is another advantage in favor of simple estimators that do not necessitates supervised learning. Another aspect to take into account is the combination of the estimator with selected features, emphasized on figure 3.9 by a feedback arrow. Indeed, given a monitoring task, the optimal set of relevant features will not necessarily be the same using different

estimators. Then, either a compromise have to be made between features and estimator, or one is chosen and the other has to be adapted. This is the case, for instance, when using *wrappers* feature selection approaches that use the estimation performance to perform feature selection, implying that the choice of an estimator must has been done previously. More details about this question will be provided in section 5.2 where feature selection is discussed. Except for cases when an estimator perfectly match the monitoring task needs, it is, to the author opinion, better to favor informative features because *quality information is mandatory for reliable estimations*.

3.4.6 Monitoring system evaluation & industrial implementation

Once the monitoring problem has been defined, and sensors, features and estimators have been selected, the complete skeleton of a monitoring system is available. It is called an *offline monitoring system* in figure 3.9 because it is still not implemented in industrial environment and still not working in real time at this point. Indeed, before an eventual industrial implementation, its performance must be assessed offline to fix eventual problems, if any, in order to avoid time consuming and production-intrusive interventions after its installation.

The *design and evaluation* phases of a monitoring system can be placed in parallel with the *learning and generalization* phases of learning machines evoked in section 2.1.1. Indeed, both necessitate the use of a database in order to be designed, and their generalization performance level have then to be assessed. Within the proposed approach for the design of a monitoring system, a sensors signals database is needed to perform sensors integration and feature selection. Then, the offline assessment of the developed monitoring system must be done using different data sets in order to assess its robustness facing input data coming from test campaigns the system has not been built upon, and to avoid a systematic optimistic bias in the evaluation of its performance. As stated earlier, the amount of available experimental data that are representative of the industrial production conditions is often limited. In order to optimize their use, both for *design* and *generalization performance assessment* phases, techniques traditionally used for machine learning can be adapted. The parallel between machine learning and implementation of monitoring systems in terms of experimental data needs for *learning/design* and *generalization performance assessment/monitoring system evaluation* is depicted in figure 3.11. Concerning the implementation of a monitoring system, the data sets necessary for these two phases will be called, respectively, *design set* and *evaluation set*.

Techniques allowing to use available data to design and evaluate the monitoring system will be adapted from [4] where they have been explained for the machine learning case. As various kind of estimators are considered in this work, no generic formulation can be provided to quantify the system performance level, which is actually often given in the form of an *estimate of the error probability* for the monitoring system. It can be the misclassification rate for classifiers, root mean square error (RMSE) for numerical estimators, ... Classical error measurements used for estimators performance assessment should be chosen as a function of the given monitoring task.

Holdout method, the simplest one, consists in isolating a part of available data at the design step in order to use it latter for the assessment of the system performance. It has 3 major weaknesses:

- A big *evaluation set* is needed to obtain a precise estimate of the system performance level
- It is thus a waste to isolate a big amount of data that could have been used within the *design* process of the system and improve its performance
- This method often leads to an overestimation of the error probability of the system (pessimistic bias)

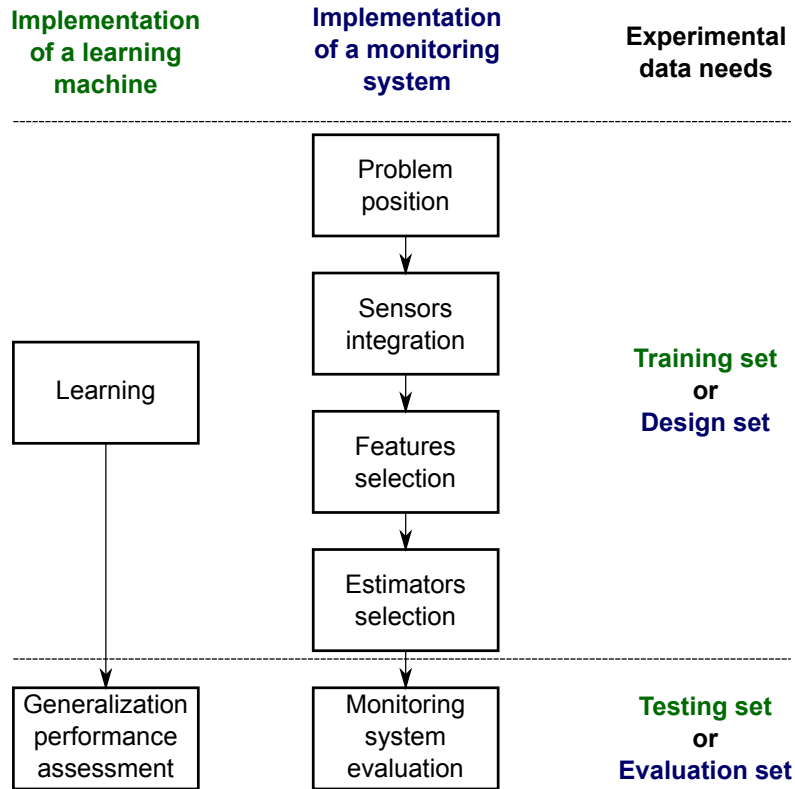


Figure 3.11 – Parallel in the need of experimental data for the implementation of a monitoring system and of a learning machine

Cross validation methods consists in dividing the experimental data set in v subsets, to perform the design phase using $v - 1$ sets and the evaluation phase with the remaining one. This is repeated v times, each time using a different subset for the evaluation step. Then, the estimated error probability is obtained by averaging the v ones that have been obtained. The extreme version of this approach is to chose v equal to the number of data samples in contained in the experimental data set. It is then called *leave one out* and allows obtaining a *Jackknife error*. The Jackknife error is usually a good estimate as the v classifiers that have been used to obtain it are close from the estimator to test (they only differ by one sample of the experimental data set).

Bootstrap methods use a different approach: the whole data set is used at the design stage, and a first estimate \hat{E} of the error probability E is computed using the same whole data set. This is called *resubstitution*. As stated earlier, this estimate suffers from an *optimistic bias* because the design step was aimed at the reduction of this error using the same data samples. The goal is then to estimate this bias in order to update \hat{E} and obtain a more accurate estimate. To do so, the data set is re-sampled M times by random drawing with replacement from the experimental data samples, and the design and evaluation step are performed, giving M error estimates \hat{E}_m , and M error estimates \hat{e}_m given by the designed systems evaluated with the original experimental data set. Then, the bias b is estimated by averaging the M biases:

$$b = \frac{1}{M} \sum_{m=1}^M (\hat{e}_m - \hat{E}_m) \quad (3.2)$$

The the final estimate of the error probability is given by $\hat{E} + b$. This method often leads to optimistic estimates because it is based on successive *resubstitutions* (i. e. testing with training data).

Of these different approaches, *the cross validation seems to be the best suited to provide accurate performance assessment* for industrial drilling monitoring applications. However, its implementation requires the design of an evaluation plan that industrial monitoring systems designers may be not used to, and also requires computation facilities. An approach derived from it can also be considered if the available data collection results from different test campaigns. Instead of dividing the sensors signal data set according to samples (drilling operations in our case), this could be done according to test campaigns. Two advantages of such an approach are that the computation needs should be drastically reduced, and if the test campaigns present differences in terms of operating conditions, the results can be representative of the robustness of the system facing implementation and use in different operating conditions or environments. Unfortunately, such an approach has not been implemented during this work, and its evaluation makes part of further research.

Depending on the performance achieved by the monitoring system and its matching with defined requirements, either a feedback can be done to ameliorate weaknesses in case of the system is not good enough, or the implementation in industry can take place. In the latter case, even if offline evaluation gave expected performance, some *verification* tests have to be performed in order to ensure that monitoring system will detect anomalies it has been designed for in a reliable manner, but also will not be production-intrusive because of too many false alarms.

3.5 Conclusion

This chapter provided a mathematical formalism to describe the monitoring problem, and separated the design, evaluation and industrial installation stages of the implementation of a process monitoring systems in industry. It allowed defining clearly the different tasks to be done.

As the proposed implementation approach has been based upon industrial requirements, and took into account the numerous challenges linked with monitoring in shop floors, it should provide process monitoring systems designers the ability to overcome the reliability and robustness issues encountered so far.

Several information fusion and artificial intelligence concepts have been used here as ways to explicitly describe challenges that have usually been treated in implicit manners, as well as solutions to overcome them and meet industrial requirements. This is in agreement with the philosophy of this work to bring recent development from several research fields in order to improve performance of drilling monitoring systems.

In particular, a method will be proposed in chapter 4 to perform singularity detection in harsh environments using multisensor data fusion and belief functions. It will then serve as a basis for the development of methodologies and building blocks necessary for the implementation of a drilling monitoring system that will be presented in chapter 5.

Bibliography

- [1] J. Abellan-Nebot and F. Romero Subirón. A review of machining monitoring systems based on artificial intelligence process models. *The International Journal of Advanced Manufacturing Technology*, 47:237 – 257, 2010. 10.1007/s00170-009-2191-8.
- [2] G. Byrne, D. Dornfeld, I. Inasaki, G. Ketteler, W. König, and R. Teti. Tool condition monitoring (TCM) - The status of research and industrial application. *CIRP Annals - Manufacturing Technology*, 44(2):541 – 567, 1995.
- [3] D. R. Cox and N. Reid. *The Theory of the Design of Experiments*. Chapman and Hall/CRC, 2000.
- [4] J. P. Asselin de Beauville and F. Kettaf. *Bases théoriques pour l'apprentissage et la décision en reconnaissance des formes*. Cepadues, Toulouse, France, 2005.
- [5] E. Dimla. Sensor signals for tool-wear monitoring in metal cutting operations - A review of methods. *International Journal of Machine Tools and Manufacture*, 40(8):1073 – 1098, 2000.
- [6] J. Frolik, M. Abdelrahman, and P. Kandasamy. A confidence-based approach to the self-validation, fusion and reconstruction of quasi-redundant sensor data. *IEEE Transactions on Instrumentation and Measurement*, 50(6):1761 – 1769, dec 2001.
- [7] S. Houzelle and G. Giraudon. Contribution to multisensor fusion formalization. *Robotics and Autonomous Systems*, 13:69 – 85, 1994.
- [8] E. Jantunen. A summary of methods applied to tool condition monitoring in drilling. *International Journal of Machine Tools and Manufacture*, 42(9):997 – 1010, 2002.
- [9] K. Jemielniak and P. J. Arrazola. Application of ae and cutting force signals in tool condition monitoring in micro-milling. *CIRP Journal of Manufacturing Science and Technology*, pages 97 – 102, 2008.
- [10] M. Kumar, D.P. Garg, and R.A. Zachery. A method for judicious fusion of inconsistent multiple sensor data. *Sensors Journal*, 7(5):723 – 733, may 2007.
- [11] S. Y. Liang, R. L. Hecker, and R. G. Landers. Machining process monitoring and control: The state of the art. *ASME Conference Proceedings*, 2002(3641X):599 – 610, 2002.
- [12] A. Noori-Khajavi and R. Komanduri. Frequency and time domain analyses of sensor signals in drilling - II. Investigation on some problems associated with sensor integration. *International Journal of Machine Tools and Manufacture*, 35(6):795 – 815, 1995.
- [13] W. L. Oberkampf, S. M. Deland, B. M. Rutherford, K. V. Diegert, and K. F. Alvin. Estimation of total uncertainty in modeling and simulation. Technical Report SAND2000-0824, Sandia Report, 2000.

-
- [14] S. R. Ravishankar and C. R. L. Murthy. Application of acoustic emission in drilling of composite laminates. *NDT&E International*, 33(6):429 – 435, 2000.
 - [15] S. R. Ravishankar and C. R. L. Murthy. Characteristics of ae signals obtained during drilling composite laminates. *NDT&E International*, 33(5):341 – 348, 2000.
 - [16] R. Teti, K. Jemielniak, G. O'Donnell, and D. Dornfeld. Advanced monitoring of machining operations. *CIRP Annals - Manufacturing Technology*, 59(2):717 – 739, 2010.

Chapter 4

On singularity identification in difficult contexts using data fusion: methods and contributions

4.1 Introduction

Monitoring of a system or a process implies detecting deviations from its normal functioning mode. Identification of these *singular* states is done by looking for singular values taken by the *system characteristic features*. Many examples of drilling monitoring applications based on singularity detection have been given in section 2.1. Identifying singularities can also help for other steps of the implementation of monitoring system: when looking for the *most* informative features to use to monitor a particular phenomenon, as it will be done in section 5.2 for instance. Actually, singularity detection is a very generic operation that is performed, either explicitly or implicitly, in many fields of application, every time there is to find an instance, a sample or a feature of a given data set that take a remarkable value. In most cases, after some data processing, this problem comes to find the maximal (or minimal) value of a data set.

Being aware of the importance of singularity detection and identification in monitoring applications, it becomes mandatory for the *monitoring system designer* to guarantee its *accuracy*. Therefore, in difficult contexts as aeronautical assembly plants, *robust methods* have to be implemented. Multisensor fusion appears as a natural solution to improve robustness, but calls for a good modeling of uncertain and imperfect information, and raises the problem of information inconsistency, as evoked in section 2.2.

This very important issue for monitoring is discussed in this chapter. The singularity identification problem will first be introduced and formalized. For the sake of generality, the case of multi-dimensional data sets will be treated. Then, two existing approaches, designed in the probabilistic and evidential frameworks respectively, will be briefly introduced before a novel evidential approach will be proposed. Finally, performances of each of them will be assessed with numerical experiments and results will be discussed.

4.1.1 Singularity identification from general applications to drilling monitoring: a brief introduction

Singularity detection in data sets is of major importance in many fields of application, like medical diagnosis [9, 23], structural health monitoring and mechanical systems monitoring [17, 18, 21], power plants and energy distribution systems monitoring [14, 1], or natural diseases anticipation [6, 2]. These applications need automatic singularity detection systems that are robust and able to achieve good performances levels even in critical cases involving sources dysfunction or other perturbations.

As for monitoring drilling operations on aircrafts high added-value structural parts, we already insisted on the importance of the quality of input data in order to reach good performance level. Thus, the correct identification of singular data or system states, which will serve as inputs in order to establish a *decision*, is primordial. As mentioned above, singularity identification, which consists in finding elements within a set which are somewhat different from others, can take place at many stages of drilling monitoring. Three illustrative examples are given in figure 4.1.

4.1.2 Formalization of the singularity identification problem

4.1.2.1 General considerations

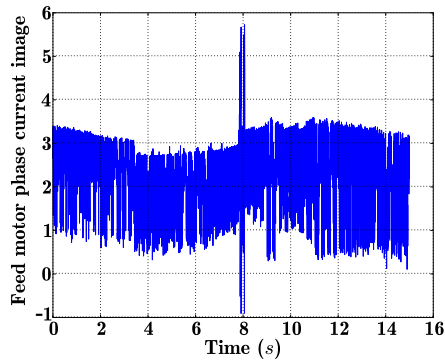
The singularity detection problem can be divided into two steps. The first one, for which numbers of ad-hoc techniques depending on the application have been developed, consists in finding some pattern of interest revealing the presence of a singularity in the observed data. Popular methods have been developed for singularity detection in time series [15] and images [8, 3], among others. Once this first step has been done, observations can be ordered considering their matching level with the pattern of interest, or more often their dissimilarity with the regular (non-singular) observations, which is usually easier as more knowledge on regular elements is available. This dissimilarity level is classically expressed as a distance between singular and regular observations in some specific parameter space, using a given metric.

The second step, called singularity identification, consists in making a decision about which observation is the singular one among the potential singular ones. This step is straightforward in many singularity detection problems as only one information source is used or low-level fusion between information sources allowed to build a unique statement, and the most dissimilar observation from regular ones is designated as the singular element. Considering applications taking place in difficult contexts where observed data are uncertain and imperfect, and solutions have to be found in order to achieve acceptable performance level in singularity detection.

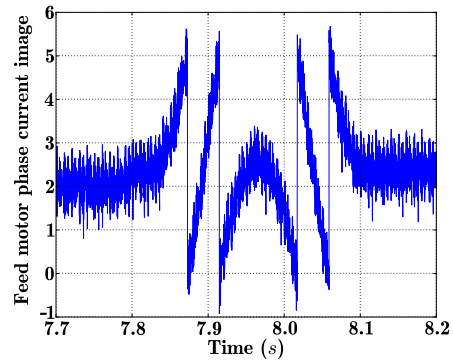
4.1.2.2 Multisensor applications of singularity identification in difficult contexts

Data related issues

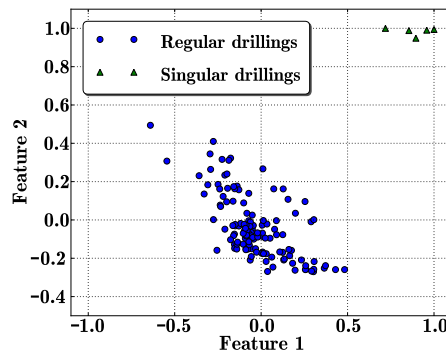
As evoked in section 2.2.2, in feature spaces possessing a metric, *uncertainty* about sensor measurements is usually defined by associated parameters that characterize the dispersion of the values that could reasonably be attributed to the original phenomenon being observed. These parameters are usually defined as the standard deviations of a probability density function which describes this dispersion. This expression of uncertainty associated with measurements which is derived from the normalized expression of uncertainty in measurements [10], and is often extended to any type of observations, assumes that the observation is free of *imperfection* due to systematic effects, meaning that only stochastic effects are taken



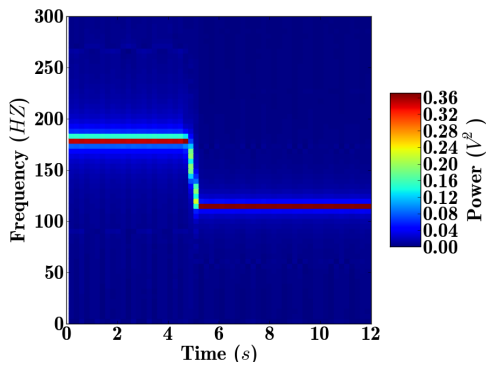
(a) Feed motor phase current signal acquired during a countersinking operation



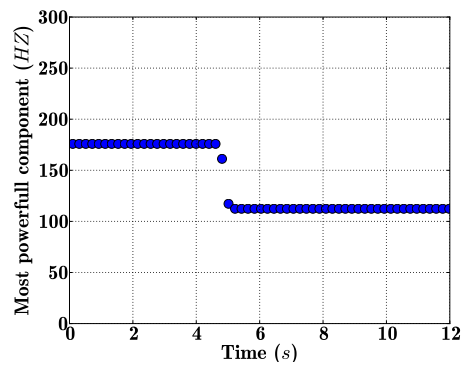
(b) The high frequency transients mark a shift in the feed direction and their presence can be used as a feature that indicates the end of the countersinking operation: the singularities identification consists in finding the time location of the data set maxima



(c) Consecutive drilling operations represented in a two-dimensional feature space where singular drillings have to be identified in order to monitor the apparition of eventual defects: the data samples presenting the maximal level regarding features of interest have to be identified



(d) STFT transform of a spindle motor phase current signal acquired during a drilling and countersinking operation: the most powerful frequency band indicates the spindle rotation speed at each time segment



(e) The most powerful frequency band (that contains the maximal energy level) can be used as a feature to discriminate between the drilling and countersinking phases

Figure 4.1 – Various examples of singularities that may be useful to identify when performing drilling monitoring: each time, after data processing, singularity identification consists in finding a maximal value among a set of data sample

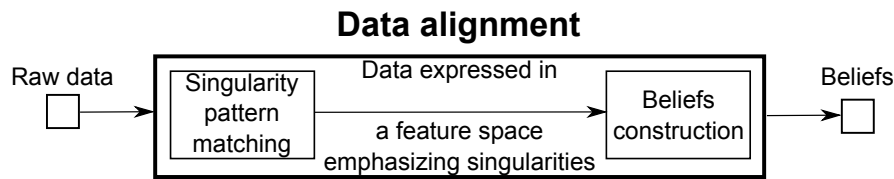


Figure 4.2 – The two stepped data alignment operation in the singularity detection problem

into account. However, uncertainties in sensor measurement are not only caused by device impreciseness and noise, but also manifest themselves from the ambiguities and inconsistencies present within the environment, and from inability to distinguish between them [12, 13]. This statement also rules for non-sensory data. Such cases occur when information sources fail by lack of detection ability due to new situations they haven't been designed for, or physical failure in the case of sensors for instance.

Performing fusion with redundant information sources

Usage of multiple redundant information sources appears as the natural solution to avoid issues due to information sources dysfunction. As evoked in chapter 3, one potential advantage of using information fusion is the capacity for the system to work in a degenerated mode [7], allowing trustful statements even in the case of one or more information sources behave in an unexpected manner. Usage of multiple information sources leads to the apparition of *inconsistency*, which is due to conflicting information coming from the different sources.

The use of several redundant sources also requests a fusion step in order to take a global decision from available source statements. Information fusion can take place at three different levels described in section 2.2.1.1, namely the *data level* (figure 2.24(a)), the *feature level* (figure 2.24(b)) and the *decision level* (figure 2.24(c)). Data level fusion can be applied only when information sources data are commensurate, so the raw data can be directly combined. It mainly applies for identical sensors and is therefore limited regarding potential applications [5]. Feature level fusion involves the extraction of features from information sources raw data. Usually, features extracted from different sources data are *complementary* and allow increasing the accuracy of the system. This kind of fusion scheme is not suited to merge redundant or quasi-redundant information. Finally, decision level fusion combines information after each source has made a statement on the phenomenon of interest, the singularity level of an input sample in our case.

Fusion of redundant or quasi-redundant data, and the need to deal with inconsistency it provokes, has already been addressed in previous works. Frolik and Abdelrahman [4] made an attempt based on sensors self-validation. This validation step took place for each sensor before the fusion process, making inference from the sensor actual behavior and its expected one using a fuzzy system. Then the data were fused taking into account the confidence level of the sensors, and a result was provided together with a global confidence level. The principle to assess a global confidence level was to compare sensors statements and to see if they were coherent. Thus, confidence associated with the results was inversely proportional to inconsistency.

Kumar et al. [11] also tried to assess the quality of data provided by redundant sensors before performing fusion. The probability that data given by a sensor was spurious was computed based on both its likelihood and its distance with the other sensors data. This probability was then integrated into a Bayesian fusion scheme, and if the fused result showed higher information content (characterized by its entropy level), then it was used, whereas if did not, the sensor which was considered the most reliable (sensor reliability was a prior information) was used.

In another work [12], they used the same principle to build a sequential fusion scheme where

sensor data were fused one by one, and each sensor that did not provide an information gain was excluded from the fusion process.

These works present several common points. First, they favor consensus between information sources: if a sensor does not follow the trend of its peers, it will be considered less reliable. Then, they require prior information on sources behaviors: an expected behavior in one case, and a confidence probability in the others. A major difference between them is that in the first one, *low level* fusion is performed as the decision is taken on artificial data build upon the fusion of sensors data, whereas in the other ones *high level* fusion is performed: each sensor provides a statement in the form of a probability distribution before the fusion of statements takes place. This allowed its use to fuse information from different types of sensors in [12].

High level fusion schemes for fusion of redundant information

High level fusion procedures will be emphasized due to their ability to fuse statements directly, whatever the type of data or information source they are issued from, and also their suitability for merging redundant or quasi-redundant data.

Voting techniques work quite well to detect information sources dysfunctions and eliminate them [22]. However, when several information sources are used, inconsistency arises when sources provide conflicting information, often leading to erroneous statements or to the impossibility to make a decision when using voting techniques. Moreover, these techniques do not allow taking stochastic and epistemic uncertainty into account. Sophisticated voting techniques exist, but they often include an information source reliability modeling step in order to weight propositions.

Classical inference, if it allows modeling stochastic uncertainty on information sources behavior, it also presents drawbacks for multiple sources based singularity detection. Indeed, as only two hypothesis can be assessed at a time, it implies to process each data sample separately to assess its singularity. Moreover, classical inference is rather aimed at the evaluation of observed data likelihood as a function of hypothesis than assessing the hypothesis as a function of the observed data.

Bayesian and evidential inference, which have been introduced in section 2.2.3, allow drawing conclusions on hypothesis as a function of observed data, therefore they will be investigated in the following.

4.1.2.3 Mathematical formalization of the singularity identification problem

Considering data distributed in multi-dimensional feature spaces, the singularity identification problem consists in determining which observation is *the most different from others*. Assuming the feature space has been built in order to emphasize the differences presented by singular elements of the data set and that the number of singular elements is much lower than the number of regular ones, the *distance* between an observation and a *feature that represents all the observed data* (e. g. their mean) can be used as a measure of singularity. The presented approaches should work whenever a distance is considered as a singularity measure.

S information sources, each providing N observations, are considered. Each observation, denoted \mathbf{x}_s^n where n and s represent respectively the observation and the source indexes, is a vector $[x_1^n, \dots, x_i^n, \dots, x_{I_s}^n]^T$ of size I_s , I_s representing the dimensionality of the feature space associated with the s^{th} source. Each component of a given observation can be expressed as a function of the original observed phenomenon and random noise, considering that only stochastic effects occur :

$$x_{i,s}^n = y_{i,s}^n + b_{i,s}^n \quad (4.1)$$

where $b_{i,s}^n$ is drawn from a known probability density function $p_{i,s}$ of mean $\overline{b_{i,s}}$ and standard deviation $\sigma_{i,s}$ associated with the i^{th} dimension of the s^{th} information source feature space, and $y_{i,s}^n$ is the unknown real value taken by the observed phenomenon. The random noises \mathbf{b}_s are considered independent regarding the observations. The singularity measure associated with the n^{th} instance of the original phenomenon is given by:

$$sing_s^n = dist(\mathbf{y}_s^n, G_s) \quad (4.2)$$

where $dist$ stands for any distance measure (e. g. Euclidian distance), and G_s for the feature that represents all the real values taken by the observed phenomenon. In the following, G_s will be defined as *the average location of samples in the feature space*.

$$G_s = \frac{1}{N} \sum_{k=1}^N \mathbf{y}_s^k \quad (4.3)$$

Hence, the original phenomenon elements can be ordered according to their singularity measure in a vector $\mathbf{SG} = [SG_1, \dots, SG_N]_s$ such that SG_1 denotes the observation presenting the highest singularity measure $sing_s$, and SG_N is the index of the closest original phenomenon element to the mean. As no *a priori* information is available on the original phenomenon, the singularity measure can be estimated using the distance derived from observations and available information about stochastic effects:

$$\widehat{sing}_s^n = dist(\mathbf{x}_s^n - \overline{\mathbf{b}}_s, \hat{G}_s - \overline{\mathbf{b}}_s) = dist(\mathbf{x}_s^n, \hat{G}_s) \quad (4.4)$$

$$\hat{G}_s = \frac{1}{N} \sum_{k=1}^N \mathbf{x}_s^k \quad (4.5)$$

where $\overline{\mathbf{b}}_s$ stands for the I_s -dimensional vector of the means of the noise probability density functions associated with each dimension of the s^{th} feature space. \hat{G}_s is the feature that represents all the observations. An illustration of the estimated singularity level is depicted in figure 4.3.

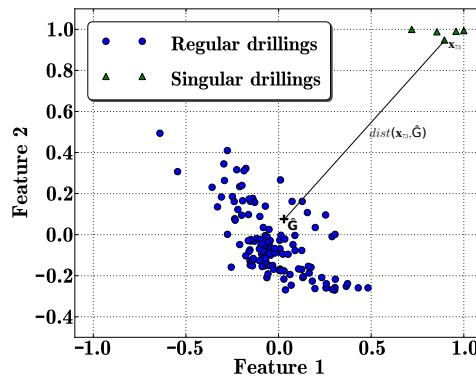


Figure 4.3 – Illustration of the estimated singularity level of an observation using the Euclidian distance

The frame of discernment $\Omega = [\omega_1, \dots, \omega_N]$ contains the propositions ω_n that the n^{th} value taken by the original phenomenon is the most singular one.

4.2 Existing approaches for singularity detection and description of a novel one

The probabilistic representation of sensor data and uncertainty make the use of the probabilist framework straightforward. On the other hand one of the main difficulties in applying the evidence theory lies in modeling the knowledge of the problem by initializing the basic belief functions. The first presented evidential approach, which uses the inverse probabilistic transform and the least commitment principle, is a classic one within the transferable belief model framework where beliefs are derived from probabilities. In our approach, a strong probabilistic background is held according to the fact that stochastic effects represent a big part of observation uncertainty, but advantage will also be taken of the use of multiple information sources. The belief construction step will be optimized considering the fusion step, and most informative sources will be favored.

4.2.1 A probabilistic approach for singularity detection

Given an observation \mathbf{x}_s^n and the stochastic perturbations vector \mathbf{b}_s , the probability of \mathbf{y}_s^n to be the most singular among the N original phenomenon states is defined by:

$$P_s(\omega_n) = P(\text{sing}_s^n > \dots, \text{sing}_s^k, \dots) \quad k \in 1, \dots, N, k \neq n \quad (4.6)$$

which is calculated by integration of the joint probability density function of distances of the original phenomenon instances to their mean. $P(\omega_n)$ is the *degree of belief* given by the source s to the n^{th} observation, which is also the n^{th} proposition of the frame of discernment, ω_n .

$$P_s(\omega_n) = \int_{-\infty}^{+\infty} \dots \int_{\text{sing}_s^n > \text{sing}_s^1} \dots \int_{\text{sing}_s^n > \text{sing}_s^N} \dots \int_{-\infty}^{+\infty} \dots \int_{-\infty}^{+\infty} p(\text{sing}_s^1, \dots, \text{sing}_s^N | \mathbf{x}_s^1, \dots, \mathbf{x}_s^N, \mathbf{b}_s) \prod_{n=1}^N \prod_{i=1}^I d_{i,s}^m$$

As S independent information sources are considered, the final decision about the identification of the singular element e is given by the *maximum a posteriori* decision rule applied to the N probabilities obtained after merging the different sources beliefs:

$$e = \max_n \{P(\omega_1), \dots, P(\omega_n), \dots, P(\omega_N)\} \quad (4.7)$$

$$P(\omega_n) = \frac{\prod_{s=1}^S P_s(\omega_n)}{\sum_{n=1}^N \prod_{s=1}^S P_s(\omega_n)} \quad (4.8)$$

One can remark the potential complexity of the integration of the $N \times I$ dimensional joint probability function when the dimensionality of the feature space or the number of data increase.

4.2.2 An existing evidential approach for singularity detection

Several approaches allow deriving belief functions from probabilities. As stated in section 2.2.3, the most popular one within the transferable belief model framework first uses the inverse pignistic transform (IPT) to generate the set $B_{iso}(BetP)$ of isopignistic belief functions that would lead to the original probability distribution using the pignistic transform given by equation 2.31 [20].

Here, the probabilities are obtained using the method presented in section 4.2.1. Then, when

no meta-knowledge is available concerning the information sources reliability, the least commitment principle (LCP) is used to choose a belief function into the set $B_{iso}(BetP)$, following the principle that if there is no reason to prefer a belief function from another, then the least specific (or least informative) is chosen [19].

The commonality measure (see equation 2.32) will be used to assess the specificity of belief functions. More explanations and an algorithm to derive the least committed basic belief distribution can be found in [19].

4.2.3 A novel evidential approach for singularity detection

Within our approach, beliefs are not derived from the probabilities obtained by equation 4.7, but their construction is guided by another philosophy which takes advantage of the fact that multiple information sources are available. Stochastic effects are taken into account using their classical probabilistic representation, and will serve as a basis to quantify uncertainty of an information source statement. The approach is designed to favor a rapid allocation of masses to sets of propositions presenting a cardinal superior to 1 when stochastic uncertainty grows up, which corresponds to a transformation from stochastic to epistemic uncertainty. This belief modeling method is based on the fact that in some applications, sources do not fall precisely into either stochastic or epistemic uncertainty [16], and more precisely in our case, when too much noise affects observations making a statement difficult, a lack of knowledge, or lack of ability detection, of the information source is considered. Making belief functions less specific by allowing high masses to uncertain propositions allows to favor specific information sources at the fusion step.

Multiple information sources based systems with all sources aimed at the detection of the same phenomenon are built to prevent lack of detection ability of one or more sources. As source failure are considered to be likely to occur, it seems more reasonable to give more credit to an information source which presents good behavior than merging all information sources statements by according them the same credit at the decision step. Thus, compared to existing ones, the proposed data alignment approach is expected to show a sharper behavior regarding the specificity of belief functions as a function of the uncertainty level of available information there are built upon. This construction method is detailed below.

First, observations indexes have to be ordered in a vector $\mathbf{D} = [D_1, \dots, D_N]_s$ such that D_1 denotes the observation presenting the highest *possible* estimated singularity level given \widehat{sing}_s and the perturbation level that affects the $s^t h$ source, and D_n is the index of the closest observation to the mean. The potential focal elements will be ordered following the same scheme and non-zero masses will eventually be allocated to the sets of observations $\{\omega_s^{D_1}\}, \{\omega_s^{D_1}, \omega_s^{D_2}\}, \dots, \{\omega_s^{D_1}, \dots, \omega_s^{D_N}\}$. The masses are calculated following:

$$m(\{\omega_s^{D_1}, \dots, \omega_s^{D_k}\}) = \int \cdots \int_{\max(sing_s^{k+1})}^{\max(sing_s^k)} p(sing_s^{D_1} | \mathbf{x}_s^{D_1}, \mathbf{b}_s) \prod_I d_{i,s} \quad (4.9)$$

and considering the special case of the mass of the frame of discernment:

$$m(\{\Omega\}) = \int \cdots \int_{\min(sing_s^{D_1})}^{\max(sing_s^{D_N})} p(sing_s^{D_1} | \mathbf{x}_s^{D_1}, \mathbf{b}_s) \prod_I d_{i,s} \quad (4.10)$$

where $\max(sing_s^{D_k})$ and $\min(sing_s^{D_k})$ represents respectively the maximum and minimum values that the singularity level $sing_s^{D_k}$ could take according to the observation $\mathbf{x}_s^{D_k}$ and the noise \mathbf{b}_s . As when calculating the masses for every potential focal element the density probability function $p(sing_s^{D_1} | \mathbf{x}_s^{D_1})$ is integrated from its lower bound to its upper bound, the sum of the masses will equals 1, with respect to equation 2.28. Each mass calculation

necessitates an I dimensional integration.

The mass of a focal element is the probability that the singularity level given by its belonging propositions are superior to the maximum possible singularity levels that can be achieved by propositions that does not belong to it. In other words, if more than one instance are possibly the most singular one on an interval of possible singularity values, they are considered equally able to be the most singular one, whatever their probability is.

In the case that the random noises probability density functions $p_{i,s}$ are not bounded, it is impossible to order observations according to their highest possible singularity levels (all equals $+\infty$), and equations 4.9 and 4.10 will always give 0 and 1 respectively. This case leads to the creation of a vacuous belief function which is a drawback in a decision making context because it cannot lead to a rational choice. In order to avoid this inconvenience we propose, both to order propositions and calculates their masses, to define an upper limit $max_{P_{cov}}(sing_s^{D_k})$ from the unbounded $p_{i,s}$ supports using a P_{cov} coverage interval such that $P(sing_s^{D_k} \leq max_{P_{cov}}(sing_s^{D_k}) | \mathbf{x}_s^{D_k}) = P_{cov}$. In this case, equations 4.9 and 4.10 become respectively:

$$m(\{\omega_s^{D_1}, \dots, \omega_s^{D_k}\}) = \int_{max_{P_{cov}}(sing_s^{D_{k+1}})}^{max_{P_{cov}}(sing_s^{D_{k_s}})} \dots \int p(sing_s^{D_1} | \mathbf{x}_s^{D_1}, \mathbf{b}_s) \prod_I d_{i,s} \quad (4.11)$$

$$m(\Omega) = \int \dots \int_{max(sing_s^{D_2})}^{max_{P_{cov}}(sing_s^{D_N})} p(sing_s^{D_1} | \mathbf{x}_s^{D_1}, \mathbf{b}_s) \prod_I d_{i,s} \quad (4.12)$$

and considering the new special case of the mass of the eventual singleton:

$$m(\omega_s^{D_1}) = \int \dots \int_{max(sing_s^{D_2})} p(sing_s^{D_1} | \mathbf{x}_s^{D_1}, \mathbf{b}_s) \prod_I d_{i,s} \quad (4.13)$$

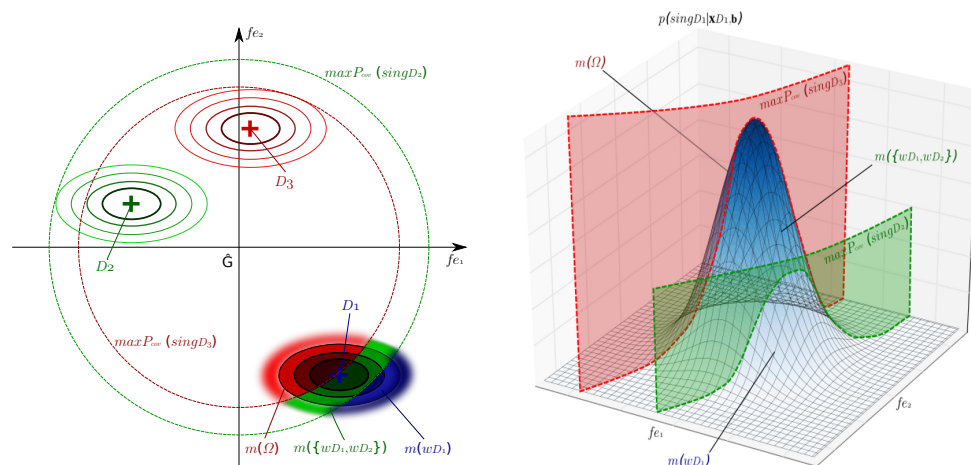
The mass of a focal element is then the probability that singularity levels given by its belonging observations are superior to $P_{cov} \times 100\%$ of the possible singularity levels presented by propositions that do not belong to it. Such constructed belief functions are consonant, as those obtained with the IPT-LCP approach.

An illustration the mass construction by this approach is presented in figure 4.4. It represents a case where a singular element has to found out of 3 in a 2-dimensional feature space. Perturbations are considered Gaussian according both features f_{e_1} and f_{e_2} , and present different perturbation levels according each. The common feature representing all the data samples \hat{G} has been set to the origin of the feature space. The integration limits $max_{P_{cov}}(sing_s^{D_k})$ are depicted, and allowed to order the 3 observations in a vector $\mathbf{D} = [D_1, D_2, D_3]$. The volumes under the probability density function $p(sing_s^{D_1} | \mathbf{x}_s^{D_1}, \mathbf{b})$ between the limits given by the surfaces $max_{P_{cov}}(sing_s^{D_k}), k \neq 1$ are represented on figure 4.4(b).

4.2.4 Differences in behavior of evidential approaches for data modeling

In order to assess behaviors of the commonality of belief functions obtained using the proposed and the IPT-LCP approach, a Monte Carlo simulation has been performed within a two observations set $\{\mathbf{x}_s^1, \mathbf{x}_s^2\}$, that leads to the creation of the frame of discernment $\Omega = \{\omega_s^1, \omega_s^2\}$ for different singularity identification difficulty levels. This numerical experiment is aimed at showing how does each approach transfer decision power to other information sources when difficulty of singularity detection arises on one of them.

We propose to define the singularity detection difficulty level Δ by the ratio between σ_s , the



(a) 3 observations D_1 , D_2 and D_3 have been ordered according to their maximum possible distance from \hat{G} considering P_{cov} and their associated perturbation level. The $max_{P_{cov}}(sing^{D_2})$ and $max_{P_{cov}}(sing^{D_3})$ value are used as integration limits to calculate the masses.

(b) The probability density function $p(sing^{D_1} | \mathbf{x}^{D_1}, \mathbf{b})$ from which are integrated the masses is represented. Surfaces that delimits the integration zone for each mass and given by the $max_{P_{cov}}(sing^{D_k}), k \neq 1$ values are also depicted

Figure 4.4 – Illustration of the mass construction with the proposed approach

standard deviation of the noise on the available observations, and the difference between the original phenomenon elements $\{\mathbf{y}_s^1, \mathbf{y}_s^2\}$ distances to the mean $\mathbf{y}_s^{SG_1} - \mathbf{y}_s^{SG_2}$.

$$\Delta = \frac{\sigma_s}{\mathbf{y}_s^{SG_1} - \mathbf{y}_s^{SG_2}} \quad (4.14)$$

Indeed, the singular proposition is harder to identify as other elements present close singularity measures, and identifying the singularity also becomes more difficult when noise affects observations.

A centered Gaussian noise has been used as it is very common in real life applications. As its probability density function support is not bounded, parameters $P_{cov} = 0.99999$ and $P_{cov} = 0.99865$, corresponding to $] -\infty, \mu + 5\sigma]$ and $] -\infty, \mu + 3\sigma]$ coverage intervals respectively, have been chosen to perform the proposed approach. Such high coverage intervals allow to produce behaviors that are similar to cases where noises have bounded probability density functions, being in agreement with the proposed approach philosophy. The commonality $Q(\omega_s^{D_2})$ of the proposition associated with the observation presenting the smallest distance $\mathbf{x}_s^{D_2}$, which is equivalent to the mass of the frame of discernment $m(\Omega)$ in this two proposition case, can be interpreted as an influence level eventually given to more specific information sources at the fusion step.

As expected, the proposed approach behaves sharper regarding the difficulty level of singularity identification when using a large coverage interval (figures 4.5(a) and 4.5(b)). It shows very high commonality even at low difficulty levels. On the other hand, the IPT-LCP approach gives statements that are not totally uncertain even when the Gaussian noise standard deviation is 10 times higher than the difference between the real phenomenon singularity levels, that can lead to erroneous statements. In the case of a narrower coverage interval (figures 4.5(c) and 4.5(d)), the proposed approach shows lower commonality level for the element associated with $\omega_s^{D_2}$ as not as much original phenomenon instances possible values are taken into account. The commonality level associated with the less probably singular proposition is still higher than when using the IPT-LCP approach.

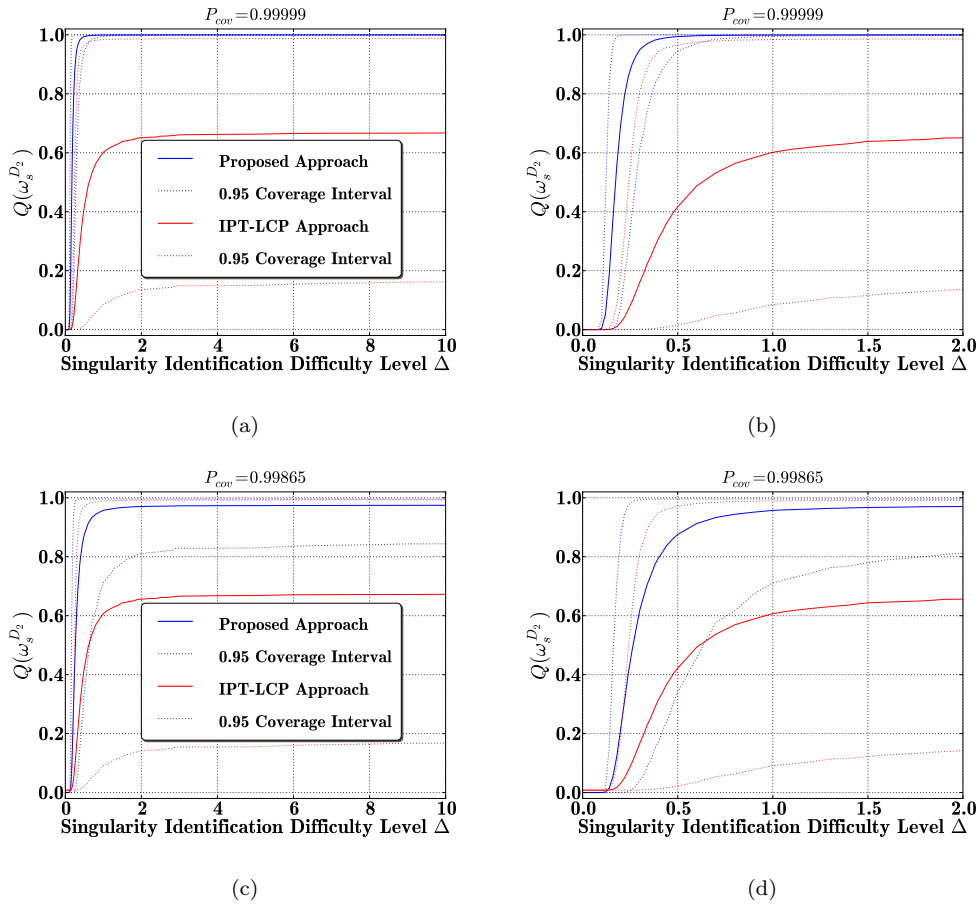


Figure 4.5 – Behavior of the commonality associated with the observation presenting the smallest distance to the mean as a function of the data alignment approach and the coverage interval used within the proposed approach. The largest 95% confidence interval on the calculated means after the Monte Carlo simulation is ± 0.003

4.2.5 Data fusion and decision making using the evidential approaches

As stated in section 2.2, evidential approaches provide tools for information merging and decision making that allow to implement several strategies leading to the choice of a proposition in the frame of discernment Ω . The respective influences of both combination and decision making strategy have to be taken into account. These influences will be discussed with emphasis on the conflict management problem, and the potential results considering the singularity identification problem will be detailed.

Combination rules As in the singularity identification application the open world assumption is not justified because the most singular observation has to be chosen among the available propositions, *Yager's combination rule*, where the presence of conflict is justified by the lack of reliability of some sources, appears a natural choice. The empty set mass is added to the frame of discernment mass, considering that non-reliable sources increase total ignorance.

On the other hand, the *disjunctive rule of combination*, that does not generate any conflict and does not reject any information provided by the sources, is appropriate when conflict is due to poor reliability of some of the sources. However it often provides more imprecise results than expected. More specifically, considering consonant belief functions as it is the case here, if one source disagree with others about the fact that an eventual singleton is the singular element, no mass will be allocated to singletons during the combination, which can lead to the impossibility to make decision over Ω in absence of additional evidence or knowledge.

Both of these rules will be assessed within numerical experiments. The problem of sources reliability when no meta-knowledge is available has always been addressed at the combination step. The proposed information modeling method, described in section 4.2.3, allows to anticipate and attenuate issues due to sources reliability by giving importance to sources that seems to be the most reliable at the fusion step when using conjunctive based combination rules. The Yager's combination rule appears to be adapted to combine evidence coming from such data alignment strategy.

Decision making strategy In this work, we place ourselves in a decision making context where decisions have to be made over the elements of Ω . Three basic strategies are generally considered to make a choice among the propositions of Ω : the maximum belief, maximum plausibility and maximum pignistic probability. The maximum pignistic probability appears as a good compromise between the two former ones, as explained in section 2.2, by equal redistribution of partial ignorance over the concerned proposition following the insufficient reason principle. Moreover, it gives a probability distribution over Ω which makes decision making feeling more natural. This approach will be used here.

4.3 Performances assessment of the different approaches and discussions

4.3.1 Numerical experiments goals and set-up

Numerical experiments have been performed in order to assess performance level of the different singularity detection approaches presented above. Influences of three parameters have been investigated:

- the type of dysfunction (when it exists) affecting the information(s) source(s)
- the difficulty to identify the singularity as defined in section 4.2.3
- the number of information sources

The problem was to identify the singular one-dimensional data point among 3. For each test configuration dysfunction, difficulty of singularity identification, number of sources, a Monte-Carlo simulation has been performed with 20000 random noise realizations. The *singularity identification rate* has then been calculated for each approach, achieving a $\pm 0.00395\%$ confidence interval around the computed results. In the case when no choice could be made, when using the disjunctive combination rule in particular, an absence of choice was considered as an incorrect singularity identification. A Gaussian noise has been used as it is the most encountered in real life situations. For the proposed approach calculations, its support has been bounded using a $]-\infty, \mu + 5\sigma]$ coverage interval.

The presentation of results is organized according to the information sources dysfunctions. First, the case when no dysfunction happens is presented. In a second part, the case of an information source providing observations affected by a different stochastic perturbations level from others is treated in order to assess the different methods respective abilities to handle differences of uncertainty level between sources statements. Finally the case of some sources providing only noise, thus simulating sensor failure or the presence of irrelevant feature, is described.

4.3.2 First application case: no information source dysfunction

In this case, only random effects were simulated that are considered to affect all information sources simultaneously. Therefore, the difficulty level Δ was the same for all sources. As perturbations were exclusively stochastic and all sources were equally reliable, the probabilistic approach is optimal as its modeling scheme reflects exactly the perturbations, and total consensus between sources is needed at the fusion step to achieve the best performance level. Figure 4.6(a) shows that whatever the combination rule used, probabilistic and ITP-LCP approaches gives better results than the proposed approach, and this difference of performances increases as a function of the number of information sources that are used. The decrease of the proposed approach performances regarding the number of sources is due to its sharpest behavior in modeling information that leads to a lower consensus level between sources at the combination step. As a consequence, the totality of relevant information is not taken into account leading to lower correct detection rates.

Simulations also allowed showing that the disjunctive rule of combination provides very quickly results that are too imprecise to make a choice, and that this phenomenon appears faster as the number of sources increases. As explained in section 2.2.3.3, this is due to the fact that if all sources do not agree about the choice of a favorite singleton, no decision is possible. The rate of impossibility to choose a singleton has been drawn in figure 4.6(b) for the 5 information sources case and shows the importance of this drawback of the DRC in a decision making context when dealing with consonant belief functions. One can remark that in the case of the Yager's combination rule and the probabilistic approach, when the singularity becomes very difficult to detect, correct identification rate tends to 0.33. This

is due to the fact that even when information provided by the sources is totally irrelevant due to the high level of stochastic perturbation, the singularity identification system has one chance out of three to designate the singular observation.

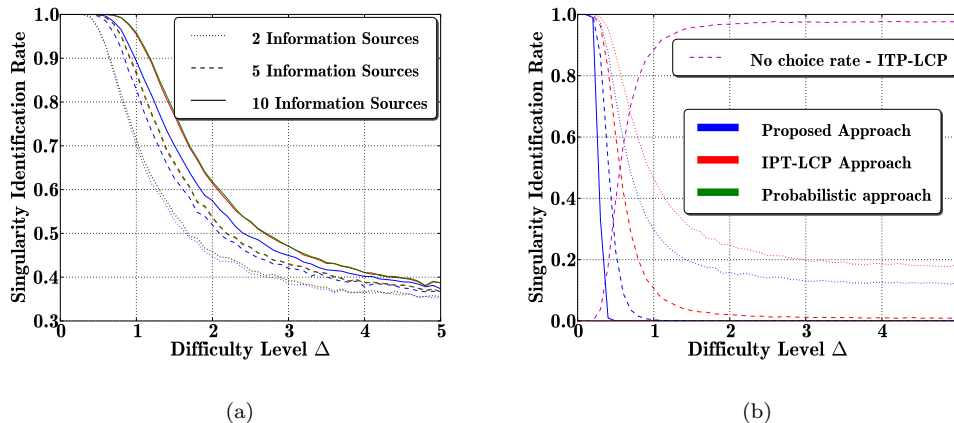


Figure 4.6 – Performances in singularity identification of the different approaches when information sources are identically affected by stochastic perturbations using the Yager (a) and the disjunctive (b) combination rules

4.3.3 Second application case: one information source provides observations affected by a different level of stochastic perturbations

This case study simulated a situation where one information source, the S^{th} , was affected by a different level of stochastic perturbations than others. Performance level of singularity identification has been assessed for three different steady difficulty levels of singularity identification of this source: $\delta_S = 0.2, 0.5$ and 1 . Considering the first one, only the extreme value that were expected to be reached by the Gaussian noise were susceptible to compromise the S^{th} source statements. On the other hand, within the last case, the standard noise magnitude reached the same level than the singularity measures, whereas the second case was a compromise. Simulation results are depicted in figure 4.7.

For every level of singularity identification difficulty, the correct identification rates decrease as a function of the number of information sources. Indeed, the consensus between sources taking place at the combination step incorporates more wrong statements when the stochastic perturbations levels make observations coming from the first $S-1$ sources irrelevant. The use of the DRC, depicted in figures 4.7(b), 4.7(d) and 4.7(f), leads to the same conclusions as in the previous case study: results provided after the combination of evidence are too imprecise to make a choice on a singleton. The proposed approach leads to the impossibility to make a choice quicker than the IPT-LCP approach by favoring allocation of mass to uncertain propositions at the data alignment step.

When using the Yager's combination rule in case of a low difficulty level of singularity identification on the steady source Δ_S (figure 4.7(a)), the proposed approach shows better correct identification rate compared to other methods as the number of information sources increases. This is due to its ability to discard the less reliable sources at the merging step thanks to its data alignment strategy. The probabilistic and IPT-LCP approaches give slightly better results when $0.6 < \sigma_s / (\text{sing}^{SG_1} - \text{sing}^{SG_2}) < 1$ for 10 information sources: in this interval, the $S-1$ first sources provide information that are relevant, despite they are affected by random effects and that are discarded by the proposed approach.

When the steady source difficulty level of singularity identification is 0.5 (figure 4.7(c)),

the above described behaviors are emphasized. When the difficulty level on the first $S - 1$ sources is important, the proposed approach shows lower performance level when using 2 information sources whereas results are better when 5 or 10 of them are considered: as the redundancy of sources can generate information inconsistency, it is better to favor the most informative one to avoid unexpected behaviors. The difficulty level interval where classical approaches perform better is extended to $0.4 < \sigma_s / (\text{sing}^{SG_1} - \text{sing}^{SG_2}) < 1.2$ because the 'relevance zone' of information provided by the $S - 1$ first sources is broader relatively to the difficulty level of singularity identification of the S^{th} source. The last case when the singularity identification difficulty level of the S^{th} source equals 1 (figure 4.7(e)) is favorable to classical approaches. Important differences are noticeable during the transient phases for high number of sources because relevant information coming from the $S - 1$ first sources is not taken into account within the proposed approach.

More generally, this case study allows to assess the combined influences of relevance of information provided by the different sources and consensus at fusion step, leading to the conclusion that the explicit representation of ignorance (partial or total) as permitted in the evidential framework is profitable in contexts where numerous redundant sources are involved. However the transition from stochastic to epistemic uncertainty has to be well modeled to take advantage of this possibility and achieve good performance levels in singularity identification. It can also be noticed that the IPT-LCP approach always gives results that are at least as good as those provided by the probabilistic approach, and often better.

4.3.4 Third application case: some sources only provide stochastic perturbations

This case study was aimed at the evaluation of the different approaches behavior facing sources dysfunction that are not identified: some faulty sources provides only noise but are considered as reliable as others, which will lead to combination and decision making under *information inconsistency*. Influence of the number of faulty sources has been evaluated. The different approaches respective performance levels are a function of the need of consensus between the sources: the probabilistic and IPT-LCP approaches gave the best results when the number of involved faulty sources is low in comparison of the total number of sources (figure 4.8(a)). When only one source is operational, the proposed data alignment method provides better results until stochastic perturbations on the operational source make it appear no more informative than others anymore (figure 4.8(b)).

It is important to note that not only the number of information sources impacts the different approaches performance, but also the number of faulty sources relatively to the total number of sources. This case study shows the different behaviors of the assessed approaches facing inconsistent information: the strong consensus held by the probabilistic and IPT-LCP methodologies better preserves influences of all sources, allowing to obtain better results when relevant information is issued from several sources. The sharper behavior of the proposed approach emphasizes the influence of the most informative source, so relevant information can be ignored if coming from several sources which do not appear very specific.

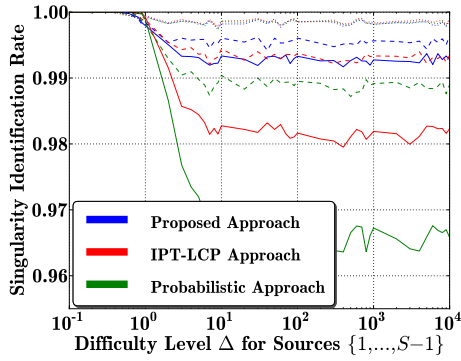
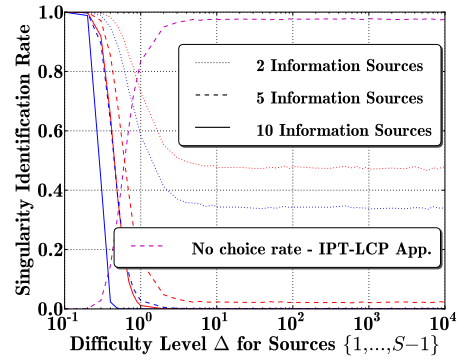
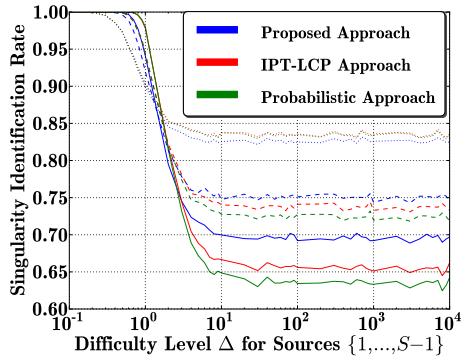
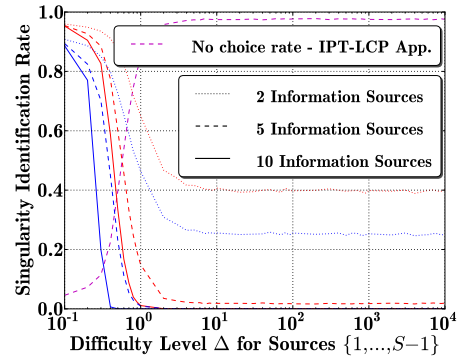
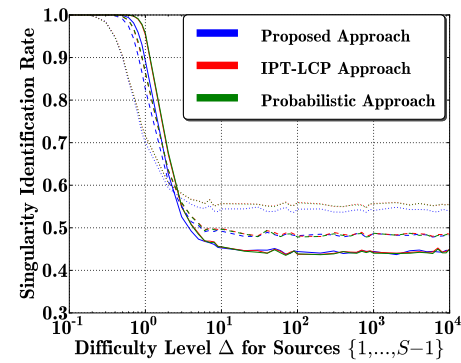
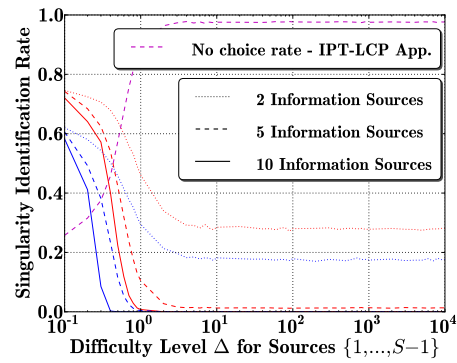
(a) $\Delta_s = 0.2$ (b) $\Delta_s = 0.2$ (c) $\Delta_s = 0.5$ (d) $\Delta_s = 0.5$ (e) $\Delta_s = 1$ (f) $\Delta_s = 1$

Figure 4.7 – Performances in singularity identification of the different approaches when one information source presents a different stochastic perturbations level using the Yager (a,c,e) and the disjunctive (b,d,f) combination rules

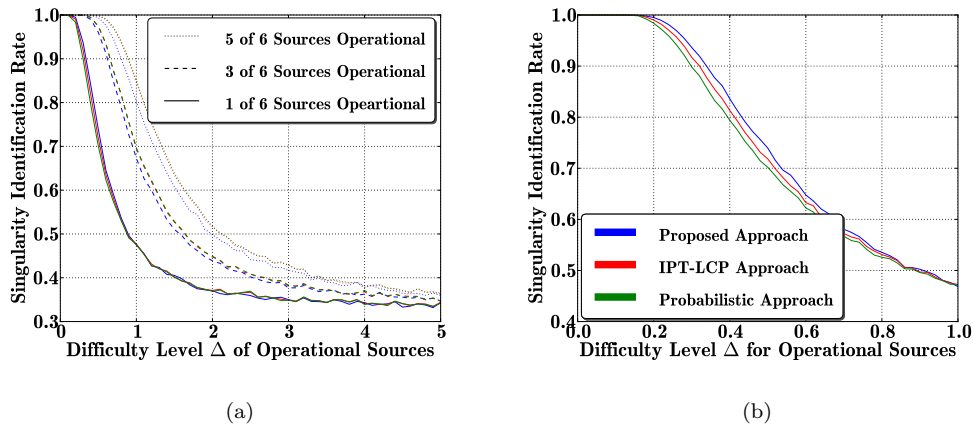


Figure 4.8 – Performances in singularity identification of the different approaches using the Yager’s combination rule when some information sources provide only stochastic perturbations

4.4 Conclusion

This chapter introduced the problem of singularity detection in difficult contexts using multiple information sources. It emphasized the importance of a good modeling of information their imperfections that takes the number of sources and their expected behavior into account. Benefits offered by evidential frameworks to model epistemic uncertainty, or ambiguity, are proven in a context where multiple information sources are involved, even when information uncertainty comes from stochastic phenomena. Hence, the question of the transition from stochastic to epistemic uncertainty is shown to be of major importance in information imperfection modeling, and needs further research.

The proposed data alignment approach is an example of solutions that evidential frameworks can offer: their flexibility in information imperfection modeling allow one to adapt this step in function of the application cases. In particular, the situation where one source is providing more specific information than others is well apprehended. The need of consensus between sources in function of their respective reliability appears as an interesting criterion to make a choice between the different approaches presented which are complementary. The probabilistic and IPT-LCP methods often show close results as they are derived from the same information modeling, but the latter one performed at least equally, and often better on the proposed application cases.

The proposed methodology will be used in the following to perform singularity identification both within online monitoring tasks and for feature selection. These developments will be exposed in chapter 5.

By assessing their performance level within the singularity detection context, this study also provides clues about the inference accuracy of the Bayesian and evidential methods, leading to the conclusion that in an information fusion context, when epistemic uncertainty occurs and is identified, evidential approaches can achieve better performances.

Bibliography

- [1] I. Al-Shidhani, S. Beck, and W. Staszewski. Leak monitoring in pipeline networks using wavelet analysis. *Key Engineering Materials*, pages 245–346, 2003.
- [2] M. Cao, Q. Ren, and H. Wang. A method of detecting seismic singularities using combined wavelet with fractals. *Chinese Journal of Geophysics*, 72:671–679, 2004.
- [3] W. Czaja and M. Wickerhauser. Singularity detection in images using dual local auto-covariance. *Applied and Computational Harmonical Analysis*, 13:77–88, 2002.
- [4] J. Frolik, M. Abdelrahman, and P. Kandasamy. A confidence-based approach to the self-validation, fusion and reconstruction of quasi-redundant sensor data. *IEEE Transactions on Instrumentation and Measurement*, 50(6):1761–1769, dec 2001.
- [5] D. L. Hall. *Mathematical Techniques in Multisensor Data Fusion*. Artech House, Norwood, MA, USA, 1992.
- [6] F. Herrmann. Singularity characterization by monoscale analysis: Application to seismic imaging. *Applied and Computational Harmonical Analysis*, 11:71–88, 2001.
- [7] S. Houzelle and G. Giraudon. Contribution to multisensor fusion formalization. *Robotics and Autonomous Systems*, 13:69–85, 1994.
- [8] T. Hsung and D. Lun. Application of singularity detection for the deblocking of JPEG decoded images. *IEEE Transactions on Circuits and Systems II: Analog and Digital Signal Processing*, 45:640–644, 1998.
- [9] B. Jalil, O. Beyat, E. Fauvet, and O. Lalignant. Singularity detection by wavelet approach: Application to electrocardiogram signal. In *Proceedings of the SPIE*, volume 7535, pages 6–8. The International Society for Optical Engineering, 2010.
- [10] JCGM. *Joint Committee for Guides in Metrology: Guide to the expression of uncertainty in measurements*. IEC-ISO, 1995.
- [11] M. Kumar, D.P. Garg, and R.A. Zachery. A generalized approach for inconsistency detection in data fusion from multiple sensors. In *American Control Conference*, pages 2078–2083, june 2006.
- [12] M. Kumar, D.P. Garg, and R.A. Zachery. A method for judicious fusion of inconsistent multiple sensor data. *Sensors Journal*, 7(5):723–733, may 2007.
- [13] G. Le Moal, G. Moraru, M. Douilly, P. Véron, and P. Rabaté. Multisensor data fusion and belief functions for robust singularity detection in signals. In *Proceedings of the International Conference on Information Fusion*, pages 961–968, 2011.
- [14] G. Li, M. Zhou, and Y. Luo. Power quality disturbance detection using mathematical morphology and fractal technique. In *Proceedings of the IEEE Power Engineering Society Transmission and Distribution Conference*, pages 1–6, 2005.

-
- [15] S. Mallat. Singularity detection and processing with wavelets. *IEEE Transactions on Information Theory*, 38:617–643, 1992.
- [16] W.L. Oberkampf, S.M. Deland, B.M. Rutherford, K.V. Diegert, and K.F. Alvin. Estimation of total uncertainty in modeling and simulation. Technical Report SAND2000-0824, Sandia Report, 2000.
- [17] Z. Peng and F. Chu. Application of the wavelet transform in machine condition monitoring and fault diagnostics: A review with bibliography. *Mechanical Systems and Signal Processing*, 18:199–221, 2004.
- [18] A. Robertson, C. Farrar, and H. Sohn. Singularity detection for structural health monitoring using holder exponents. *Mechanical Systems and Signal Processing*, 17:1163–1184, 2003.
- [19] P. Smets. Belief functions on real numbers. *International journal of approximate reasoning*, 40:181–223, 2005.
- [20] P. Smets and R. Kennes. The Transferable Belief Model. *Artificial Intelligence*, 66:191–234, 1994.
- [21] Q. Sun and Y. Tang. Singularity analysis using continuous wavelet transform for bearing fault diagnosis. *Mechanical Systems and Signal Processing*, 16:1025–1041, 2002.
- [22] A.S. Willsky. A survey of design methods for failure detection in dynamic systems. *Automatica*, 12:601–611, 1976.
- [23] J. Zhong, R. Ning, and D. Conover. Image denoising based on multiscale singularity detection for cone beam CT breast imaging. *IEEE Transactions on Medical Imaging*, 23:696–703, 2004.

Chapter 5

Implementation of drilling monitoring systems: Application examples

This chapter is devoted to the presentation of scientific and technical realizations that are directly related to the implementation of a drilling monitoring system. Contributions will be presented following the steps given by the design methodology of a monitoring system proposed in chapter 3. First, *sensors integration* will be evoked: a short description of sensors used for drilling monitoring will be provided, and some developments will be detailed. Then, a description of the *feature selection* problem will be given, and a methodology to address it using data fusion will be presented and assessed. Finally, *building blocks* useful for the implementation of a drilling monitoring system will be explained and evaluated in a third part.

5.1 Sensors integration

As sensor integration is the first step of the design of a monitoring system and drives the quality of all information used to perform estimations of the system state, special attention has to be given to it.

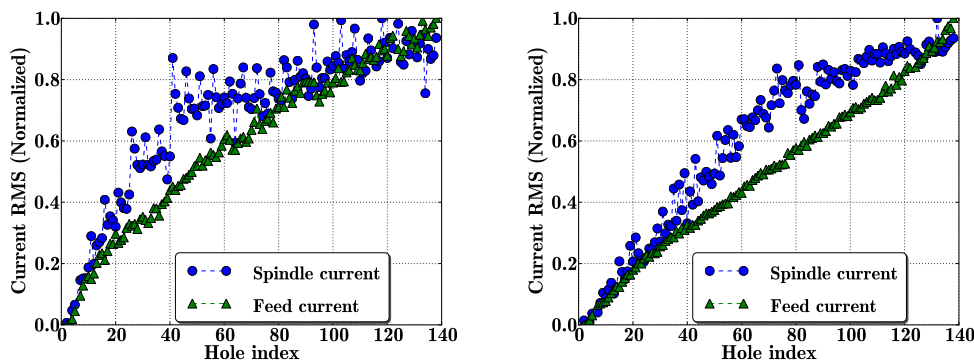
A short description of sensors used for drilling monitoring will first be provided in order to explain the pros and cons of each measurement and sensor types. Particular emphasis will be done on integration issues. Some developments will then be detailed: following conclusions of the state of the art on drilling monitoring applications, the *practical implementation* and use of force and AE sensors, which have shown good abilities for drilling monitoring purposes, will be discussed. Integration solutions will be provided for both of them, and a feature extraction method developed in order to use AE signals in a robust manner will be presented and assessed on experimental data.

5.1.1 Sensors for drilling monitoring

Several types of sensors have been used for drilling monitoring purpose. The state of the art presented in section 2.1 gave an overview of the different applications they have been used for. The goal of this section is to detail their different uses and integration possibilities, pros and cons, and also to provide some results obtained during experimental works. Only sensors allowing measurements related to the cutting process condition will be presented here. For example, sensors used to determine the spindle position or speed do not make part of this description.

5.1.1.1 Spindle & feed motor currents/power

Spindle and feed motors power consumption, which is often measured by their input currents, served to extract features linked with tool condition in many studies. Indeed, the electrical power consumption of motors is related, in some extent, to the mechanical power needed for material removal during the drilling operation. However, this strategy presents some issues related to the relationship between the input and output power levels of motors that have been underlined in section 2.1 and resumed in [61]: the amount of spindle power required for material removal may be a very small part of total power, and so be difficult to sense. In our work for instance, phases currents of spindle and feed motors of both a robot drilling end-effector and a machining center have been recorded during CFRP/Ti6Al4V stacks drilling test campaigns (see appendixes A.4 and A.1, A.2, A.5 for further details on tests campaigns) realized using the same cutting parameters. In the first case, as motors are designed for drilling purposes only, interesting trends that could have been related to the drill condition have been obtained (see figure 5.1), whereas on the machining center, which possess more powerful drives and spindle, no changes were detectable.



(a) Evolution of spindle and feed motors phase currents RMS during drilling CFRP as a function of the number of drilled holes (b) Evolution of spindle and feed motors phase currents RMS during drilling Ti6Al4V as a function of the number of drilled holes

Figure 5.1 – Trends in spindle and feed motors phase currents RMS when drilling CFRP and Ti6Al4V. A 8KW spindle was used

Other facts that limit the use of input power are that spindle motor power is proportional to the resultant cutting force, which the least wear sensitive parameter; that unavoidable temperature variations in motors influence their electrical consumption (they have been characterized in several studies reported in [61]), and finally, that drive motors are highly dependent on the axis lubrication state, transverse rate and axis condition. All these constraints make the use of current/power sensor difficult or ineffective in some cases.

The main advantage of this type of measurement is that it is not intrusive to the cutting process. Sensors are usually placed in the electric board of the machine.

Another way to sense power consumption of motors became popular within last years: CNC control panels now often allow accessing to internal signals in the numerical controllers such as motor power and current. This method presents the advantage of not requiring any sensor. Literature and experiments showed that signals obtained by this manner are sometimes of poor quality and necessitates important processing steps to be exploitable.

5.1.1.2 Temperature

If temperature has been identified as an interesting feature to sense tool wear in experimental studies, when drilling Ti6Al4V in particular, it has not been widely used for monitoring ap-

plications due to the difficulty to integrate sensors. In the description of drilling monitoring applications given in section 2.1, only one attempt to use temperature has been presented [55], and results were mitigated due to the number of influence quantities that affected the measurement done by a thermocouple placed in the workpiece.

When using thermocouples, two options are possible to mount them: in the workpiece or in the drill. The former requires a pre-machining of the workpiece step to integrate the sensor, and the second the use of a special tool equipped with an integrated sensor and an apparatus allowing to transfer supply energy and sensed signals from a rotating part to a static acquisition system. Both cases are impracticable in an industrial context and are only lab solutions. Moreover they imply the use of heat transfer models within the tool or workpiece to estimate the temperature at the interface between the tool and workpiece.

Another way to sense temperature is using contactless devices, like infrared thermometers or thermal cameras. Obviously, due to the confinement of the drilling operation, it will not allow sensing temperature at the interface between the tool and the workpiece, but a measure on the tool while exiting the material in repeatable conditions could provide relative results that could be interesting. An experimental attempt has been made about this during this work, but by the time (approximately 20s) the drill exited the Ti6Al4V workpiece and was placed within the infrared thermometer spot which was placed at 30cm of the drilling spot, its temperature decreased to only 1 or 2°C above the ambient temperature, and those variations were in the same range than the measurement noise of the sensor in the machining center. Moreover, the tool would have to be cleaned out from chips, lubricant and dust before the measurement is done, and this cleaning step would fatally provokes changes in the its temperature.

5.1.1.3 Vibrations

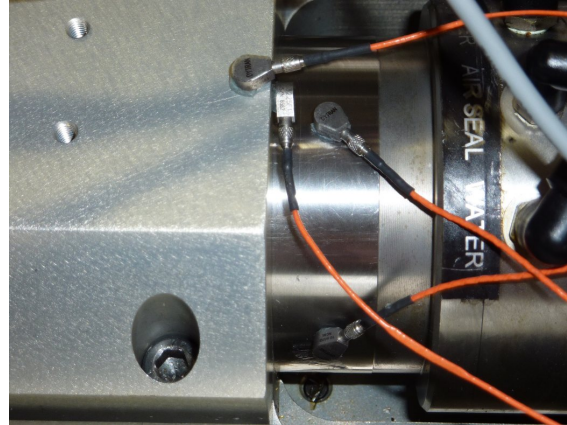
Vibrations have been used to monitor both tool wear and tool failure. Accelerometers, sensors that are used to sense vibrations, possess the advantage to be easy to implement. Indeed, they can be glued or clamped to the drilling device or workpiece. On the other hand, vibrations signals are often noisy, difficult to interpret and very sensible to process parameters. Moreover, the sensing ability of accelerometers concerning tool or workpiece alteration heavily depends on the propensity of the part they are mounted on to vibrate.

In this work, miniature piezoelectric accelerometers have been placed on the spindle of a drilling robot end-effector and of a machining center. Results confirmed aforementioned issues: those obtained on robot were informative about the tool condition (see figure 5.2, and also appendixes A.4 and A.1, A.2 for further details on concerned tests campaigns), whereas nothing can be drawn from signals obtained on the machining center: due to its high rigidity, no significant vibrations linked to the drilling operations were sensed.

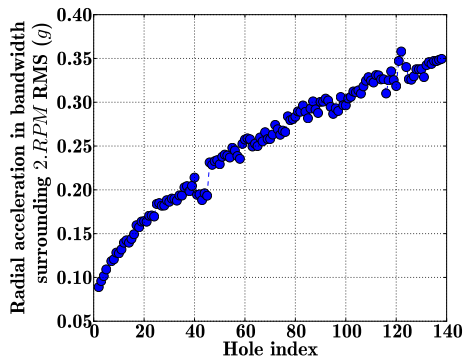
Accelerometers represent therefore a good solution on structures that are not too rigid: they should be able to sense vibrations linked to cutting phenomena, with no intrusive integration. However, due to their sensibility to process parameters, features issued from signals should be chosen with caution, especially regarding the spindle rotation speed, in order to avoid misunderstandings. For instance, feature extraction algorithms that auto-adapt to the spindle rotation speed are required if this variable may change.

5.1.1.4 Torque

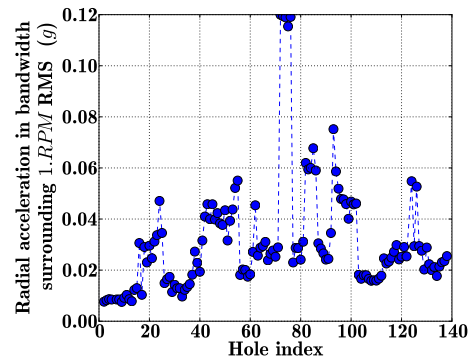
Torque measurement, as well as force measurement, is difficult to integrate in industrial environment [1, 61, 18, 37]. Two types of devices have mainly been used in labs: static and rotating piezoelectric dynamometers that allow both static and dynamic measurements. Unfortunately, these devices are not suited for harsh environments due to their sensitivity to external perturbation, their difficult integration, and the costly and heavy material needed to transform and amplify electrical charge provided by sensors into voltage.



(a) Miniature accelerometers mounted on the spindle and spindle housing of a robot end-effector



(b) Evolution of axial spindle acceleration RMS during drilling CFRP as a function of the number of drilled holes



(c) Evolution of radial spindle acceleration RMS during drilling CFRP as a function of the number of drilled holes

Figure 5.2 – Evolution of axial and radial accelerations RMS level in selected bandwidth when drilling CFRP with a robot. A trend is visible on the axial acceleration, while clusters of points are visible on radial accelerations chart: some of them have been linked with the position of holes on the workpiece, which present different vibrations behaviors as a function of the drilling location, and the most remarkable, from holes 72 to 76, is linked with a drill cutting edge chipping

In [11], a method that used eddy currents to sense the stress changes induced on the drill shank by drilling torque have been presented. The torque changes monitored this way allowed to predict drill fracture in gray cast iron and tempered steel. The sensor had to be placed at 0.5mm from the drill shank, which can be difficult to achieve without important machine modifications in some cases.

In [5], the same kind of apparatus has been designed depending on the *Villari effect*: a magnetic material produces a magnetic field which properties are a function of the applied strains. Coils systems have been implemented on an immobile part surrounding the tool holder in order to detect the magnetic field changes provoked by cutting torque and forces on a magnetic metallic part that was part of the tool holder in the force path. Results in turning showed that this methods had the capacity to sense both static and dynamic forces and torques changes while cutting.

If these two last integration solutions can appear difficult to integrate, they are some of the less intrusive because of their contactless principle: no signal or power supply has to transit by cable between static and rotating parts.

5.1.1.5 Partial overview

This rapid and, for the moment, incomplete overview of sensors used for drilling monitoring, and the presentation of challenges and solutions linked to their integration allow to draw the following conclusion: the more useful a sensor is for monitoring, the more difficult its integration is. Indeed, accelerometers and current sensors are not intrusive, but are not always informative depending on the type of machine used (robot, machining center) or the process parameters (workpiece material, drill diameter, cutting conditions). On the other hand, torque and temperature should provide useful information about the tool and/or workpiece condition, but are difficult to integrate.

The same statement can be done for the 2 following measurements types: cutting force and acoustic emission, which have been showed to be very effective for condition monitoring of machining operations in the literature, but are difficult to integrate. Due to their potential interest, a special emphasis has been done on integration and use of these two kinds of sensors in the next sections.

5.1.2 Force sensors integration

5.1.2.1 Force sensors integration in drilling

As mentioned above, cutting forces are one of the best signal for feature extraction for drilling monitoring purpose. Unfortunately, integration of force sensors is made difficult by the fact they have to be placed in the cutting force path. This particularity encourages the use of piezoelectric sensors due to their high stiffness that will not introduce flexibility in the drilling system and that could be at the origin of harmful vibratory behaviors.

As for torque measurements, solutions available on the market are limited to static and rotating dynamometers that do not fit industrial requirements. Some solutions have been developed to integrate force measurements in a way such that industrial use would be allowed.

In [14], two types of force sensor integration on a drilling device have been investigated: a *bearing sensor ring* and a *flange sensor ring* equipped with piezoelectric elements have been integrated into the force path, as depicted in figure 5.3(a). Results have been assessed during an experiment where a rotating dynamometer and AE sensor have also been mounted on the drilling device and the aluminum workpiece respectively for comparison purpose.

Evidence presented in the paper demonstrated that the integrated force sensors were capable of sensing the process forces during small diameter drilling operations. The integration of the sensors into the main force flux of the motor spindle provided other non-process related forces that contained rich information about the process, spindle and machine condition.

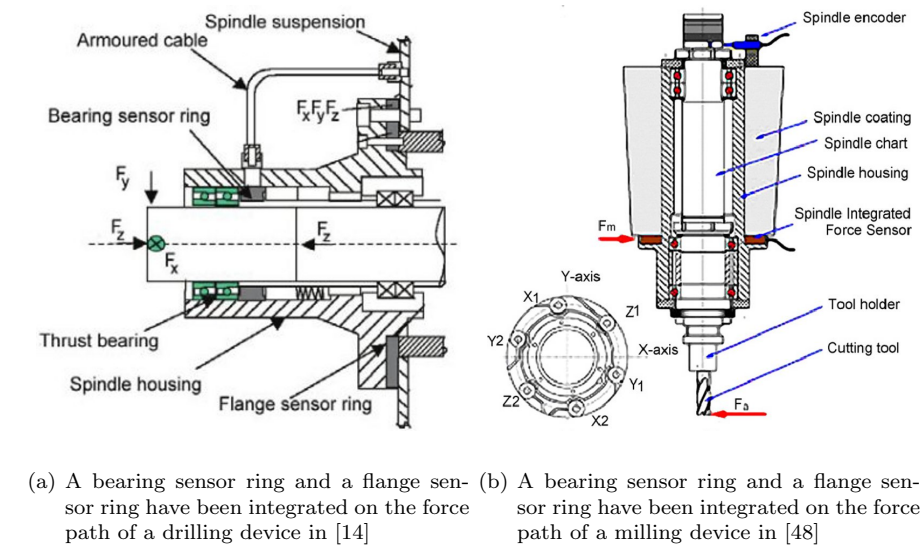


Figure 5.3 – Proposed solutions to integrate force measurements to the machining device

The higher frequency content of the integrated sensor signals revealed a spindle signature which forms the basis of spindle condition monitoring. This study also highlighted the potential benefits that exist by using a design for process monitoring approach—namely embedding sensing capability into the machine at the design stage. The authors emphasized a number of issues that remained to be investigated, including the development of algorithms for the in-situ characterization of the integrated sensors under different mass and acceleration conditions, depending on the device they are mounted on. This type of integration has also been proposed with success in [48] for milling applications (see figure 5.3(b)).

One of the main problem linked with the use of piezoelectric devices remains the conversion of the electric charges induced by cutting forces into voltage usable for data acquisition purpose. The low level of electrical charge produced by the piezoelectrical effects when forces are applied requires the use of costly and cumbersome charge amplifiers that do not suit industrial environments. Moreover, the transfer of electrical charges from sensors to amplifier must be made with specific cables that are fragile, expensive and not easy to integrate within an industrial drilling device.

Piezoelectrical sensors that integrate miniature charge amplifier have been developed under the IEPE (Integrated Electronic Piezo Electric) norm. This sensors require the use of special conditioning hardware in order to provide power supply to the charge amplifier. If this technology allows using sensors without cumbersome cables and amplifiers, it presents a severe drawback: it generally does not allow to measure direct current component of the signals, i. e. it acts as a high-pass filter that cuts the signal part above $1Hz$. Such systems, if they are suitable for accelerations measurements where DC current does not present interest, are therefore of limited use for force measurements in drilling monitoring applications (even if the dynamic force signature of cutting operations remains interesting). This technological limitation has two causes: the miniaturization of the charge amplifier has for consequence that a resistor cannot be as high resistive as wished due to dimensional constraints, and some charge is dissipated through it like in a first order dissipative system. However, IEPE force sensors often present dissipation times that are largely superior to the time of drilling operations, and then, only 1 or 2% of the charge should have been dissipated at the end of drilling, allowing to obtain accurate results enough for tool condition monitoring. The main cause of the impossibility to obtain DC component of force signal using IEPE sensor lies in the acquisition hardware which often possesses a high-pass filter on input in order to avoid influence of the power supply provided to the charge amplifier embedded in the sensor and

that transit on the same wire.

5.1.2.2 Proposed solution

A solution has been proposed and assessed to avoid this harmful dissipative effect: the sensor is normally wired to an IEPE acquisition card which provides it power supply, and also on a classical voltage acquisition channel which do not possess high-pass filter on its input. The signal acquired on this card is then the force response of the sensor, plus a steady offset due to the DC component used to supply the charge amplifier. In that case, the only the charge dissipation due to the embedded charge amplifier is visible on force signal. However, as the time constant of this dissipative behavior, related to the sensor properties, is very long regarding the average time of aeronautical drilling operations, this technique should allow accurate enough measurements for drilling monitoring purposes.

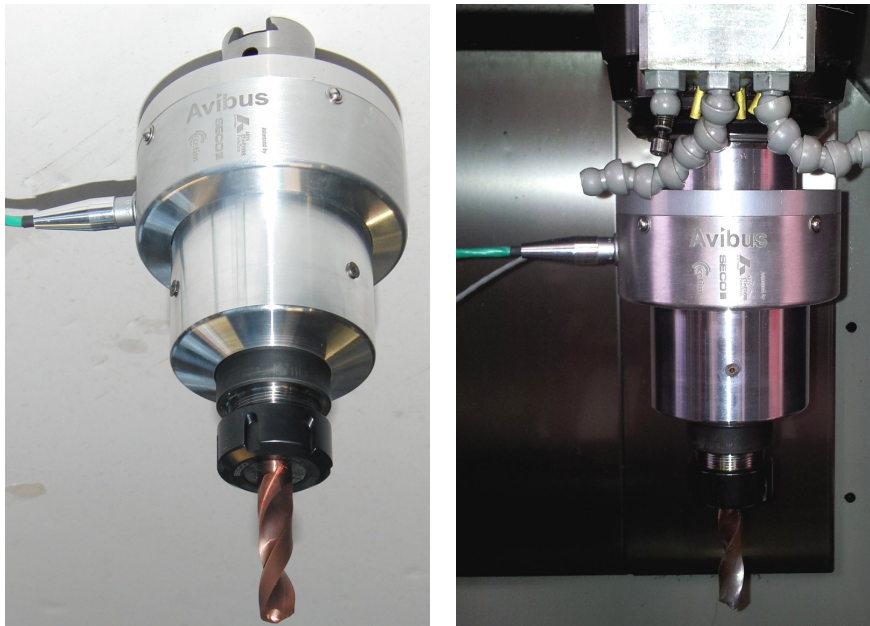
The integration of such a sensor in the force path remains a challenge. By now, at the exception of fragile rotating dynamometers, force sensors have been placed in steady positions in order to avoid the problem of signal (and eventually power supply in case of) transmission from a rotating device. Another solution has been proposed here: the use of a high performance *slip ring* integrated on a tool holder in order to transmit sensor signals from rotating parts. This device makes part of the AVIBUS project¹. Experiments showed that the maximum perturbing resistive effect over the rotation speed range used for aeronautical drilling operations was $50m\Omega$. Considering the typical low current levels of sensor signals ($< 2mA$), perturbations on acquired voltages can be neglected in most cases.

Both static and dynamic experiments have been performed to assess this method capabilities for drilling monitoring. First, once the the sensor has been integrated into the developed tool holder and wired through the slip ring, a static experiment has been performed to compare obtained results with those obtained with a static dynamometer Kistler 9255A used together with 5019A charge amplifier. It consisted in applying a steady axial $20N$ force on the developed tool holder, which was fixed on the static dynamometer. A picture of the tool holder and results of the experiment are depicted in figures 5.4(a) and 5.4(c) respectively. The dissipative behavior of the proposed solution is clearly visible, but inverted due to wiring. Its amplitude over $170s$ make this phenomenon acceptable for most aeronautical drilling monitoring applications. The observed noise level is also acceptable. A comparative experiment has been done while drilling a Ti6Al4V sample, and results provided by the proposed integration solution were very close to those obtained with a static dynamometer (figure 5.4(d)).

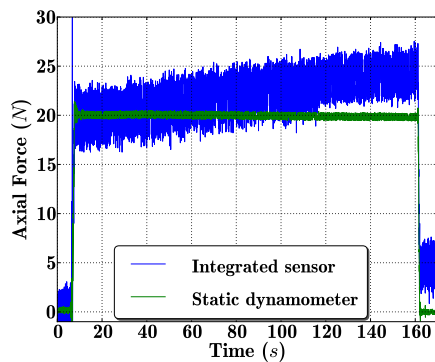
5.1.2.3 Overview on force sensor integration

An integration solution, the use of high performance slip rings to transfer signal from rotating parts to static ones, showed encouraging abilities for drilling monitoring. More experiments have to be carried in order to completely identify the device behavior and all the influence quantities it can be affected by. If the force sensor integration concepts presented above are encouraging, they are slow to transfer into machine shops because of the important modifications that have to be made on drilling devices, and once they are integrated, the spindle or structure have to be characterized in order to isolate process phenomena of interest from machine and spindle dynamics [61, 14].

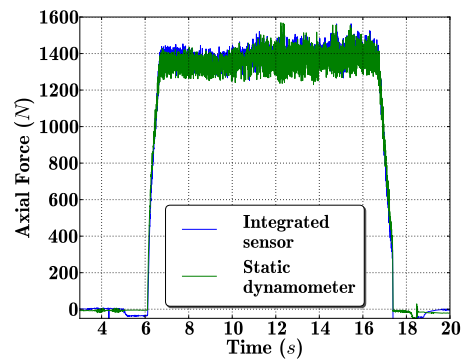
¹ The goal of the AVIBUS project (Assistance Vibratoire au Perçage par Actionneurs Piézoélectriques) is to develop active vibrating tool holders.



- (a) A special tool holder integrating a slip ring allowing signal transmission from rotating integrated sensors has been developed. This development makes part of the AVIBUS project (www.avibus.fr)
- (b) The same tool holder installed in a ring allowing signal transmission from rotating integrated sensors has been developed. This development makes part of the AVIBUS project (www.avibus.fr)



- (c) A static axial force load test allow to identify the dissipative effect (inverted due to wiring) of the integration solution when compared to results obtained with a static dynamometer



- (d) A drilling test allowed comparing thrust force measurements issued from the integration solution with results obtained with a static dynamometer

Figure 5.4 – Proposed solution to integrate axial force measurements into a tool holder equipped with a slip ring: if a harmful dissipative effect is visible with the proposed solution, its amplitude is compatible with force measurement during most aeronautical drilling operations due to their short duration

5.1.3 Acoustic emission sensors integration

5.1.3.1 Introduction

Acoustic emission (AE), which describes the technical discipline and measurement techniques linked to the transient elastic waves resulting from local microdisplacements in a material [60], has been widely used for machining processes monitoring during last years. More specifically, it has been shown to be an effective way to detect cutting tool dysfunctions like tool failure or cutting edge chipping [46, 35, 37] because of its ability to detect sudden energy releases in deforming material. Moreover, due to its high frequency working range which is normally not affected by machine vibrations or environmental noises [40], it allows to sense tool wear [46, 49, 63, 45, 17], and to detect workpiece damages, in particular delamination occurring when drilling composite materials [21, 6, 53, 52, 32]. Many drilling monitoring applications using AE have been introduced in section 2.1.

However, applications of AE for drilling monitoring did not always provide results as good as those obtained in other machining processes. Indeed, it has been observed that using AE in drilling is more complex than in other processes such as turning or milling because the chips trapped between the flute and the cylindrical wall of the hole is a significant additional source of AE [16]. Then, isolating the different sources of AE in a drilling operation is considered a difficult task as the mechanism of generation of AE is not completely understood [41, 33] and analytical techniques are not completely developed [13]. Some works have been aimed to link identifiable characteristics that distinguishes the different states of drilling mechanism in AE signals [52, 53, 16]. In particular, advanced statistical pattern recognition methods have been used to classify different cutting tool states from AE signals [23]. However, as AE signals are heavily depending on the machining process parameters [40, 25, 62], using them for monitoring remains a complicated task, especially in industrial context where operational conditions are often changing.

The literature concerning the use of AE for machining and drilling monitoring shows that if it is often presented as a promising tool, some theoretical and technical drawbacks are limiting its usage, changing process parameters (including mastered and unmastered changes) in particular, as concluded in section 2.1. Consequently, in order to exploit AE efficiently for monitoring drilling operations in industrial conditions, 2 major issues must be addressed:

- efficient integration of AE sensors on drilling devices
- robust feature extraction of AE signals

In this section, experimental studies concerning the impact of influence quantities (coupling, distance from sensors to the AE source, drilled material) on AE signals will be presented, and results will serve as a basis to the design of an integration solution.

Then, a method will be proposed which allows extracting features in AE signals in a robust manner facing process parameters changes. Moreover, it allows taking advantage of the particularities of different states of the drilling operation. It has been developed taking into account both observations coming from the AE literature and statistical characteristics of AE signals, and has been applied on experimental data.

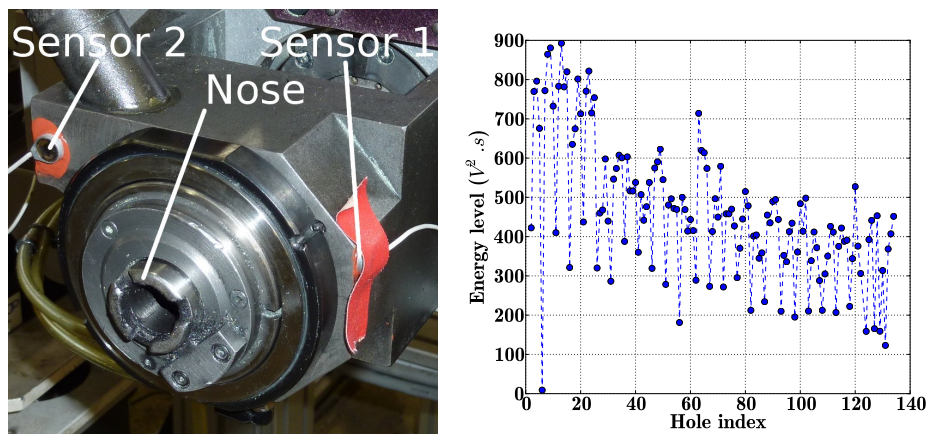
5.1.3.2 Issues related to AE sensors integration in drilling: experimental investigations

In order to achieve efficient integration of AE sensors, it is important to characterize impacts of influence quantities related to the environment that affect AE signals. In particular, respective influences of the couplant (substance providing an acoustic coupling between the propagation medium and the transducer [60]) between AE sensor and the workpiece, the distance between the AE sensor and the AE source, and the influence of the workpiece material on transmission of AE will be investigated.

Couplant

Two experimental studies will be presented that allow to demonstrate the influence of couplant on AE signal transmission.

The first illustration of the importance of *acoustic coupling* between the AE source and AE sensors has been given during a drilling test campaign (see appendix A.4). It consisted in the drilling of CFRP/Ti6Al4V stacks with a robot. During the drilling of the Ti6Al4V sample, micro-lubrication was set on. 2 AE sensors (Euro Physical Acoustics (EPA) S9220) were mounted on the drilling end-effector with a silicone gel couplant, as depicted in figure 5.5(a). Therefore, several interfaces were present between the AE generated by the drilling operation and the sensors. During this test campaign, the drill and tool holder were removed from the robot end-effector every 5 drillings in order to take a picture of the tool cutting edges, and the nose of the end-effector, the part which is in contact with the sample during the drilling operation, was clean out of lubricant, CFRP dust and eventual titanium chips. The bandwidth was ranging from 32KHz to 1.1MHz for both AE sensors due to the 40dB preamplifiers that have been used (EPA IL40S-32-1100), and the energy of AE signals have been computed, among other features. The evolution of the energy level recorded by the 2^{nd} sensor during the drilling of the CFRP sample as a function of the number of drilled holes is depicted in figure 5.5(b).



(a) Front part of the drilling end-effector: 2 AE sensors have been mounted using silicone gel (red) which plays the roles of couplant and sealant. The nose is the part which is in contact with the workpiece during drilling operations. (b) Energy level of AE signal acquired by the 2^{nd} sensor during the drilling of the CFRP sample as a function of the number of drilled holes: a 5 hole periodicity due to the absence of cutting fluid at the interface between the workpiece and the nose of the robot end-effector is visible

Figure 5.5 – Illustration of the influence of the presence of couplant at interfaces between the AE source(s) and AE sensors

It appeared that the cutting fluid present at the interface between the nose of the end-effector and the CFRP sample acted as couplant for the transmission of AE generated during the drilling to the sensors mounted on the end-effector. The cleaning of the nose done each time the tool holder was removed from the end-effector had the consequence to reduce the energy of the AE transmitted to sensors during the drilling of the CFRP sample at the next hole. This was due to the fact that no cutting fluid was present between the nose and the sample until the micro-lubrication was set on during the drilling of the Ti6Al4V.

Another experiment was realized in order to emphasize the role of couplant. It consisted in the realization of Hsu-Nielsen tests series, which consists in using a repeatable AE source in the form of the brittle fracture of a pencil lead in similar conditions [60] (figure 5.6).

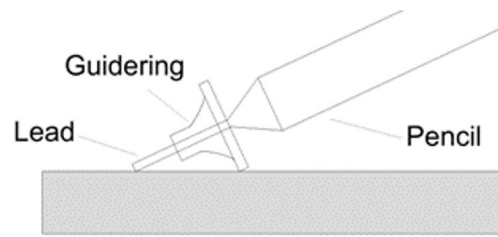
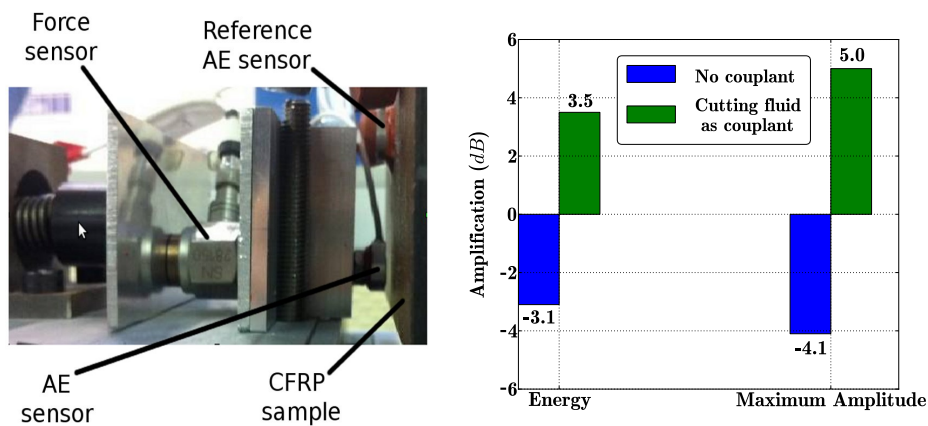


Figure 5.6 – Principle of an Hsu-Nielsen test: breakage of a pencil lead in repeatable conditions at the surface of a sample were AE sensors are mounted allow to characterize their response, or here the quality of the transmission of AE

A reference AE sensor was mounted on a CFRP sample with the same silicone gel as used in the experiment evoked above, while another sensor was kept in contact with the sample with a $50N$ force, using either no couplant or cutting fluid as couplant. The test bed is visible in figure 5.7(a). For each of the 2 configurations (no couplant, or cutting fluid as couplant) the amplification of the energy and maximum amplitude values between the test and reference sensors signals have been computed. Five tests have been realized for each configuration, and the results have been averaged. They are depicted in figure 5.7(b). The presence of cutting fluid as couplant allowed an amplification of energy and maximum amplitude levels compared to when silicone gel was used, whereas when no couplant was present, the quality of transmission of acoustic emission from the source to the sensor decreased. This series of experiment confirms what has been observed during the drilling test campaign mentioned above.



(a) Test bed used to compare the AE transmission performance of different couplants: a reference AE sensor mounted on the sample is used in order to compare signals acquired with another sensor using a different type of couplant
 (b) Amplification of energy and maximum amplitude levels compared with the reference AE signal as a function of the couplant used at the interface between the second sensor and the sample

Figure 5.7 – Test bed and results of an experiment dedicated to the characterization of AE transmission performance of different couplants

Both the above mentioned experiments emphasized the *critical role of coupling for a good transmission of AE* from its source to sensors. Therefore, it is an important point to take into account for the integration of AE sensors into a drilling monitoring system. Results also showed allows good transmission of AE.

Influences of distance from sensor to AE source and workpiece material

Another factor that has a potential influence on the transmission of AE is the distance between the AE source and the sensors. It has been evoked in [46] and [17] while drilling CFRP and steel respectively. Another study concerning the drilling of carbon steel and nodular gray iron concluded it had no influence [39]. In this section again, both drilling and dedicated experiments that have been implemented in order to characterize influence of distance between AE source(s) and sensors will be explained.

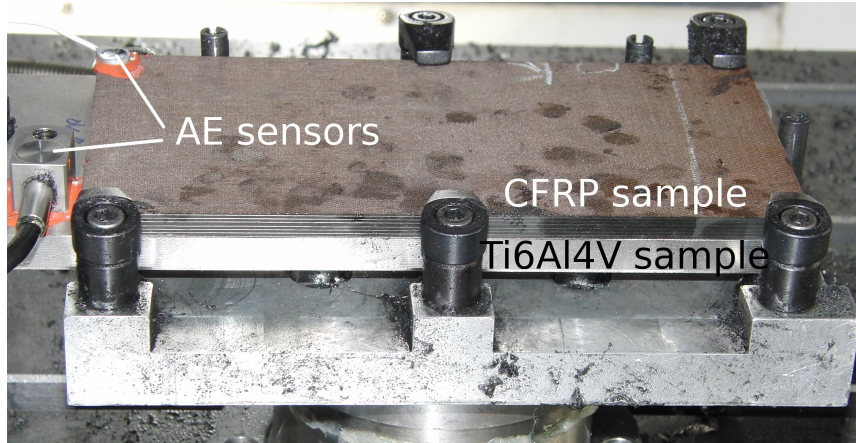
Two test campaigns have been performed on a machining center which consisted in drilling CFRP/Ti6Al4V stacks. During the 1st one (see appendix A.1, sample 2), AE sensors (EPA S9220 with an EPA IL40S-32-1100 preamplifier and Kistler 8152B211 with 5125B1 preamplifier) have been mounted on each sample of the stack, as depicted in figure 5.8(a). Holes have been drilled in an order such that the distance from hole to AE sensors varied significantly between consecutive holes in order to limit the influence of tool wear on AE signals while emphasizing influence of distance. The RMS levels of AE signals calculated during the drilling of CFRP and Ti6Al4V are depicted in figures 5.8(b) and 5.8(c) respectively as a function of the number of drilled holes and of the distance from holes to sensor. Distance between AE source(s) and sensor has an important influence on AE transmission in CFRP workpieces. The high difference of RMS levels observed between consecutive drillings in this sample clearly shows that more AE is transmitted when holes are close to the sensor. This behavior is less emphasized in the Ti6Al4V sample, even if visible after 10 holes had been drilled. It seems that distance between the AE source and sensor possesses less influence in this material.

As for the second test campaign (described in appendix A.5, samples 1 and 2), two stacks have been drilled with 2 AE sensors mounted as depicted in figure 5.9(a). The drillings started at the upper right corner of the sample and were performed column after column to reach the left part of the sample. The RMS levels obtained on the 2 sensors are compared for 2 samples in figures 5.9(b) and 5.9(c). Here again, the influence of distance between AE sources and sensor when drilling CFRP is clearly visible. Sensor 1, from which the distance to AE source decreased as the number of drilled holes increased, presents a decreasing trend, whereas an increasing trend is visible for signal energy on sensor 2 as its distance from the AE source increased. Clusters of 8 holes, which corresponds to the numbers of drillings realized in a column, are also visible, especially when the distance to the sensor decreased.

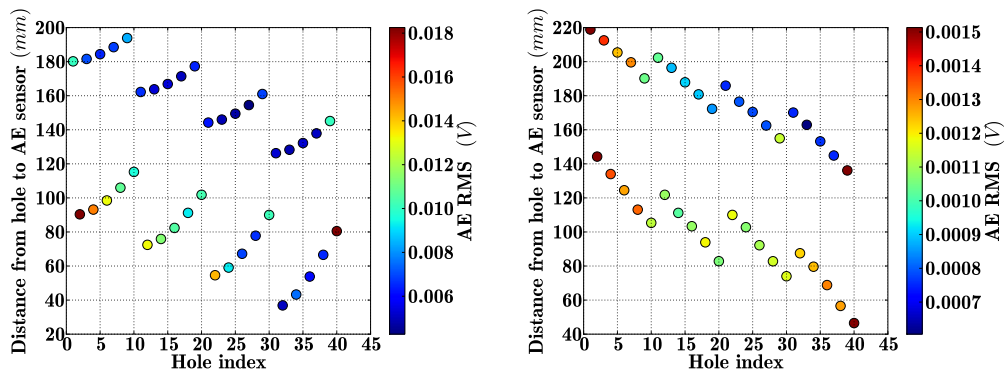
Another experiment has been realized in order to emphasize the influence of the distance from AE source(s) to sensor. It consisted in the realization of Hsu-Nielsen tests series at different distances from 2 sensors mounted on a sample, as showed in figure 5.10(a). 2 sensors have been used in order to compare results and avoid unexpected harmful influences. This test has been realized on a CFRP and on a Ti6Al4V samples. For each distance the maximum amplitude generated by the breakage of 10 pencil leads have been observed and the results have been averaged. They are depicted in figures 5.10(b) and 5.10(c).

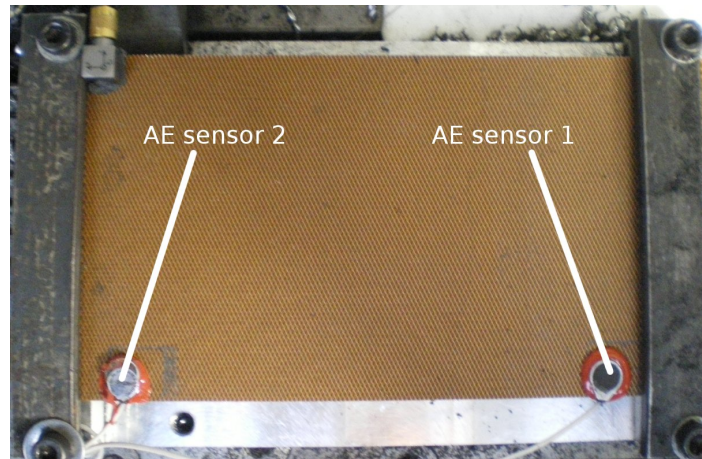
This series of experiments confirms that distance from AE source to sensors attenuates the AE signal in a CFRP workpiece: the observed maximum amplitudes of AE signal decreased as this distance increased. Moreover, the difference of maximum amplitudes observed on the 2 sensors was in good correlation with the difference of distances from each sensor to the AE source. Concerning the Ti6Al4V sample, distance from sensor to AE source did not show great influence on the maximal amplitude observed within the AE signal. Moreover, the difference of maximum amplitudes observed on each sensor does not show a good correlation with the difference of distances they presented from the AE source.

These experiments allowed showing that distance from AE source(s) to AE sensor has an influence on the acquired signal, which is stronger when CFRP workpieces are used. This strong influence has to be taken into account for integration of acoustic emission sensor within a monitoring system.

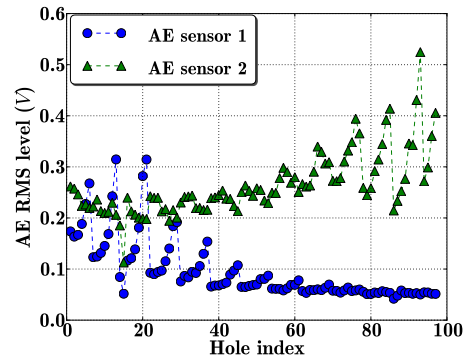
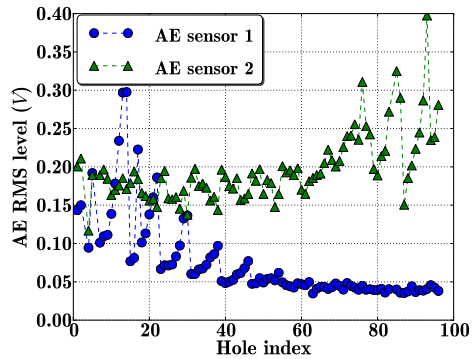


(a) Test bed used to assess respective influences of distance from AE source(s) to sensors and of the workpiece material on the AE transmission while drilling. Two different types of AE sensors have been used





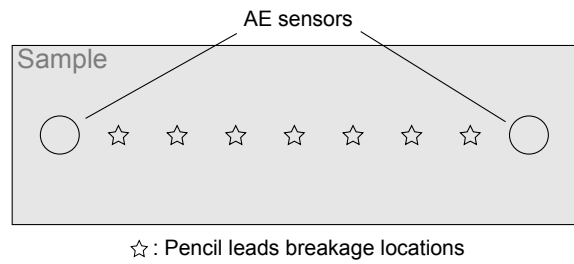
(a) Test bed used to assess respective influences of distance from AE source(s) to sensors on the AE transmission while drilling CFRP



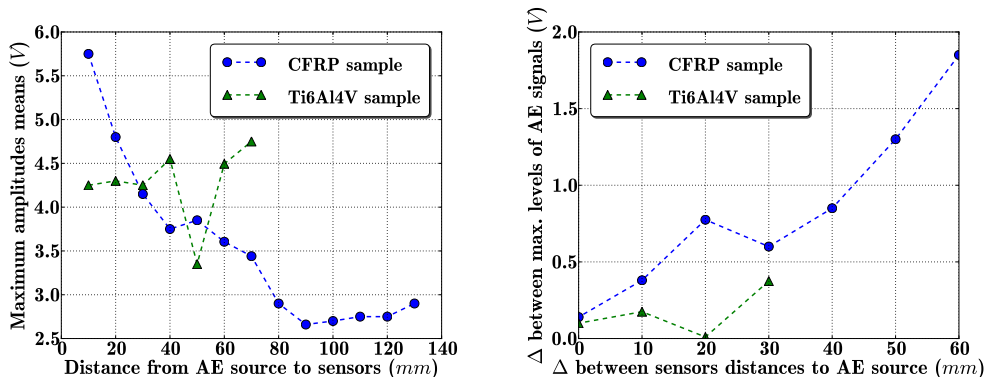
(b) RMS level of AE signals acquired on the 2 sensors during the drilling of the 1st CFRP sample as a function the number of drilled holes

(c) RMS level of AE signal acquired on the 2 sensors during the drilling of the 2nd CFRP sample as a function the number of drilled holes

Figure 5.9 – Test bed and results of a drilling experiment showing the influence of distance from AE source(s) to sensors on transmission of AE while drilling CFRP. Although the same AE source(s) are generated for each drilling, different trends are visible as a function of the sensor due to the influence of their distance to the AE source(s) on AE transmission.



(a) Test bed used to assess influence of distance from AE source(s) to sensors and of the workpiece material on the AE transmission



(b) Maximum amplitude means as a function of the distance from AE source to sensors (c) Difference Δ_a between the maximum amplitudes means as a function of the difference Δ_d between the distances from sensors to AE source

Figure 5.10 – Test bed and results of a drilling experiment showing the influences of distance from AE source to sensors and of workpiece material on transmission of AE

5.1.3.3 Integration of AE sensors in drilling

The 2 main uses of AE in drilling are the monitoring of *workpiece alterations* and *tool condition*. Concerning the first one, the best location for the sensor(s) to be mounted is on the workpiece the closer to the drilling operation position. However, it is often impossible to place sensors on aircrafts structural parts while they are assembled in production plants, and the distance linked issue emphasized in the previous section would affect measurements. As for their second use, the ideal position of AE sensor would be on the drill, or on a close part, like the tool holder for instance. The problem here lies in the transmission of sensor information and power supply from a rotating part to an immobile acquisition system. Several solutions have been proposed in the literature in order to address these issues. They will be presented, and a novel integration solution will be proposed following previous observations. As comparative experiments have been performed in order to assess this new system performances, results will be presented and discussed in a last part.

Presentation of existing approaches and devices

Several integration have been proposed for the integration of AE sensors on rotating machining devices. In [25], the coolant stream has been used as a medium for transmitting the AE wave. The goal was to keep the distance between the sensor and the cutting point constant. At first, the use of radio or optical methods to transmit the AE signal from rotating to non-rotating parts has been evoked, but these techniques has been stated not economically viable. Either the reliability of the system would not be sufficient, or the necessary expensive devices and the changes in the machine head would not make for practical usage in the machine shops. As one of the practical solution to meet the requirements in terms of the signal transmission, it has been proposed to use cutting fluid as a medium to transmit the AE signal. The AE sensor was attached to the cutting fluid supply nozzle so that the AE signal generated at the cutting point could be transmitted through the fluid and consequently detected by the sensor. This apparatus has been used for milling applications and is depicted in figure 5.11(a).

If it showed good ability in the detection of tool chipping, the author stated that AE sensor was too sensitive to the process state, and consequently further improvements would be necessary to make the monitoring system using this sensor a more reliable one. He also argued that one of the promising ways to take full advantage of high sensitivity of the AE sensor would be the fusion with other types of sensors.

An AE based boring monitoring method has been presented in [64] where an apparatus was also designed to implement AE sensor on the drilling machine, near the cutting tool. A magnetic fluid was use to transmit the AE signal from rotating machinery to the sensor mounted on a steady part. This type of fluid has been shown to be one of the most efficient in AE transmission in a previous study by the authors. The apparatus is depicted in figure 5.11(b). Following the authors, it presents several advantages: first it is able to obtain high signal/noise ratios signals and secondly, the magneto fluid can be kept at a suitable place in machining tool spindle without disturbing the cutting process. Thirdly, it can lengthen the signal existing time to make the signal sampling and processing simple. The combined use of this system with a wavelet based signal processing technique and a fuzzy classifier allowed good tool wear state classification results over a wide range of cutting conditions. Hutton and Hu also presented a system to integrate an AE sensor on a CNC machine [24]. The experimental set-up they used is depicted in figure 5.11(c) and was also liquid coupled. The low end of the stub shaft shown was threaded directly into the tool holder and served as the AE transmission path.

In [17], AE sensors have been mounted in different locations on a drilling robot end effector as it would be more practical for industrial use than mounting the sensors on the workpiece, but experiments did not show good results due to the presence of too much mechanical spurious noise.

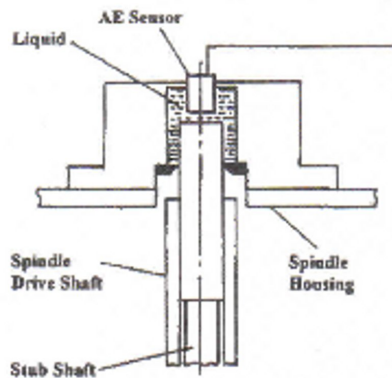
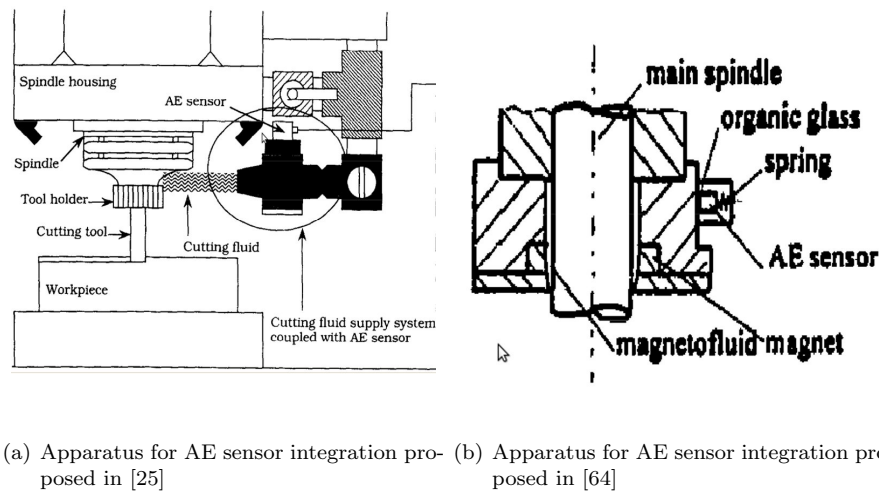
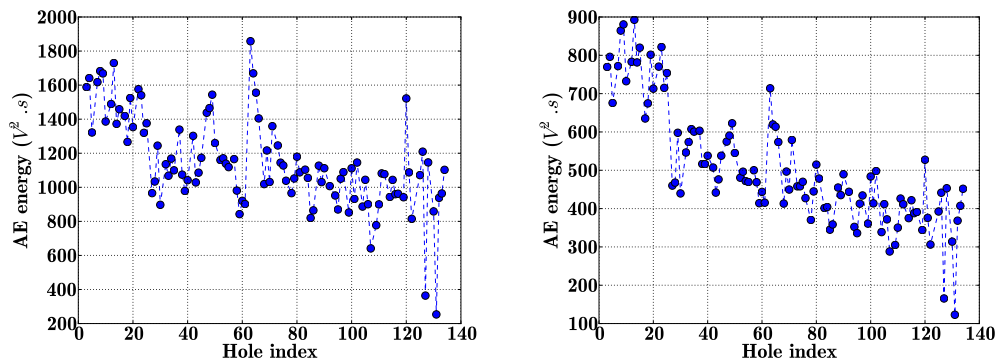


Figure 5.11 – Apparatus proposed for integration of AE sensor to sense tool condition on rotating machinery

However, results obtained after the experiment done where AE sensors were mounted on a drilling robot end-effector described in section 5.1.3.2 showed that it was possible to see a decreasing trend of AE energy as a function of the number of drilled holes, and consequently tool wear, despite the interfaces present between the sensors and the AE source. Sensors placement is visible on figure 5.5(a), and results obtained with both sensors (where effects of the coupling problem described in section 5.1.3.2 have been catered for) are depicted in figure 5.12.

Major differences appear between the two graphs. First, the energy level of the signal acquired with the first sensor is nearly twice more important although the same acquisition settings have been used. This is probably due to its closer location from the AE source. The trend is more visible (i. e. data points are less dispersed) on results issued from the second sensor, maybe because its distance from the AE source, and so the more interfaces, acted as a filter. Another interesting phenomenon is visible: a change is present in the trends after the 25th drilling. It correspond to a night break in the test campaign, however, no process parameters have been modified in-between. This unexplained change underlines the sensitivity of AE sensors to unmastered environmental changes.



(a) Energy level of AE signals acquired with sensor 1 (b) Energy level of AE signals acquired with sensor 2

Figure 5.12 – Energy of AE signals acquired by sensors mounted on a robot end-effector (see figure 5.5(a)) during the drilling of a CFRP sample

Proposition and evaluation of a new integration solution

A solution has been proposed to allow AE sensor being in contact with the workpiece while the distance between sensor and drilling operations remains constant. The principle is depicted on figure 5.13 and shows the axial compliance of the system allowing to maintain the contact with the workpiece during the whole drilling operation. The use of a spring implies that the contact pressure between the sensor and workpiece increases as the drill goes deeper in the material. The system has been designed so this pressure lies in an interval that has been shown to be adequate for AE measurements during lab Hsu-Nielsen experiments performed on the test bed depicted in figure 5.7(a). The real apparatus is visible in figure 5.14(b).

In order to assess the performance of this new apparatus for integration of AE sensors, a test campaign has been performed where the system has been implemented (see appendix A.2, sample 1), and a 2nd AE sensor has been mounted on the workpiece. The drilled sample was a CFRP/Ti6Al4V stack. As the used machining center did not allow center micro-lubrication, an external system has been used with 2 consequences: external micro-lubrication was set on during both the drillings of the CFRP and Ti6Al4V samples, and the formation of a mud made of cutting fluid and also CFRP dust at the surface of the CFRP sample. This second point has been converted into an advantage as it has been shown during previous experiments that this mix ensured acoustic coupling at the interfaces through the AE waves path (see section 5.1.3.2). Therefore no additional coupling has been used between the embedded AE sensor and CFRP sample, whereas the immobile AE sensor was mounted and sealed on the sample with silicone gel. Pictures of the test bed are visible in figure 5.14. The RMS levels of signals acquired by the embedded sensor are globally higher than the ones obtained with the sensor mounted on the sample. This is particularly visible when considering the highest frequency range of the signal (figure 5.15(e)) showing that the transmission of AE waves trough the workpiece acts as a low-pass filtering operation.

As for results coming from sensor mounted on the sample, the influence of distance from the drilling operation to the sensor is visible as energy-based clusters of drillings could be defined as function of this distance on figures 5.15(b), 5.15(d) and 5.15(f). An increase of energy can be seen on signals acquired with this sensor during the last 10 drillings that is not visible with the embedded sensor. This is probably due to the decreasing distance from AE source to the mounted sensor.

However, 4 of these drillings (58, 59, 60 and 61) presented higher energy level with the embedded sensor (figures 5.15(a) and 5.15(c)). A close look to the pictures of tool cutting

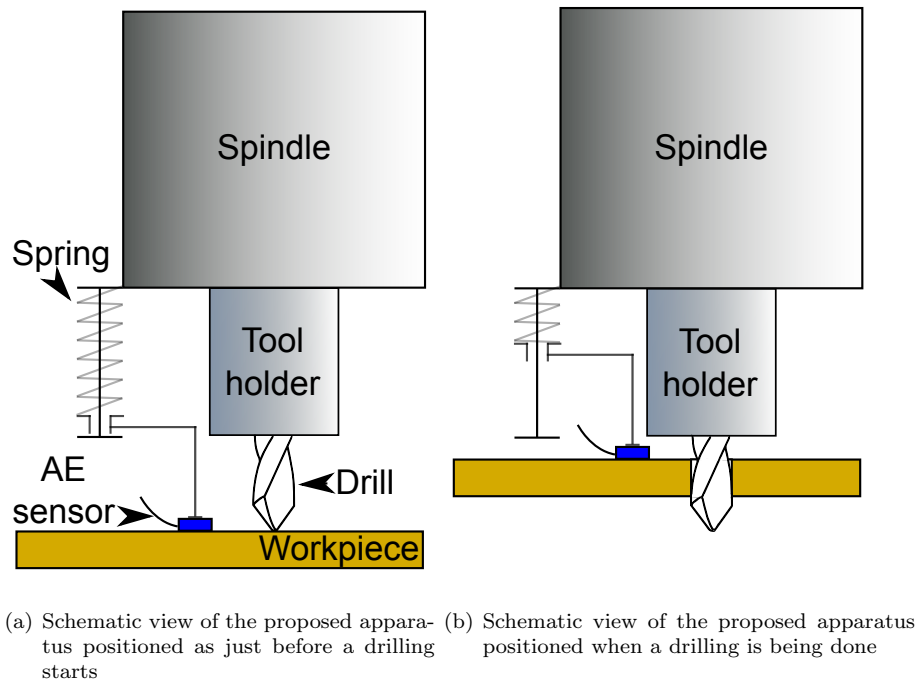


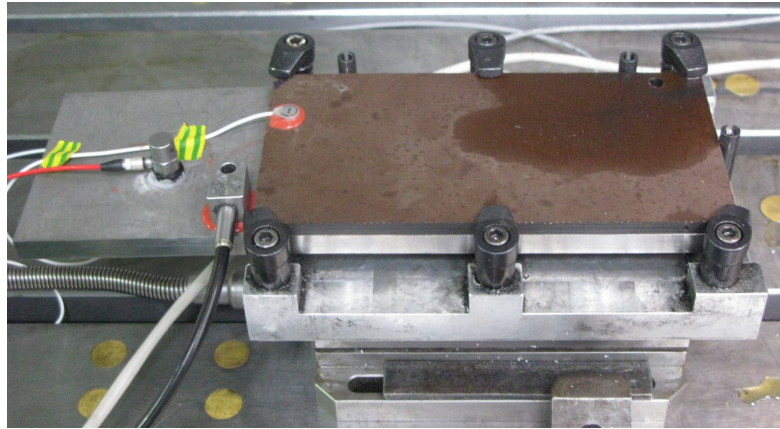
Figure 5.13 – Apparatus proposed for integration of AE sensor to sense tool and working condition on rotating drilling devices. The real system is visible on figure 5.14

edges presented in figure 5.16 taken after these drillings had been performed and compared to the previous and following ones (57 and 62) allows seeing important modifications of the cutting edges shapes that may be responsible of the observed energy variations.

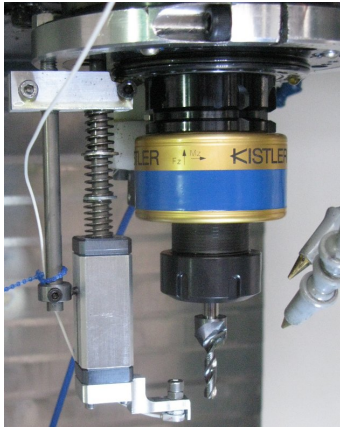
For the moment, no explanation is available concerning the energy dispersion observed between the first drillings with the embedded sensor (figures 5.15(a) and 5.15(c)). By now, we have not been able to determine if it is due to issues related to the integration solution or with some phenomenon that produced AE during the drilling operation.

Results obtained using an integration solution that allow avoiding influence of the distance between sensor to AE source are mitigated: if the results were not correlated with distance and showed higher sensitivity to some tool cutting edge alterations, they appeared more sparse with no apparent reason. As the proposed solution exposes the embedded AE sensor to external perturbations like the micro-lubrication flow, or the presence of unexpected material between the sensor and the sample at the moment when both enter in contact, it is impossible to argue that the observed energy variations are related to some phenomena of interest that occurred during the drilling operation.

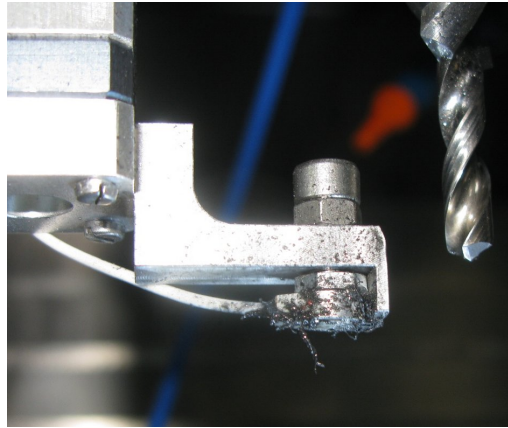
If those considerations should be taken into account when designing a more robust integration solution, promising results have been shown for a system allowing AE sensor placement on the workpiece, close to the drilling operation location, even to sense tool condition linked phenomena related to condition.



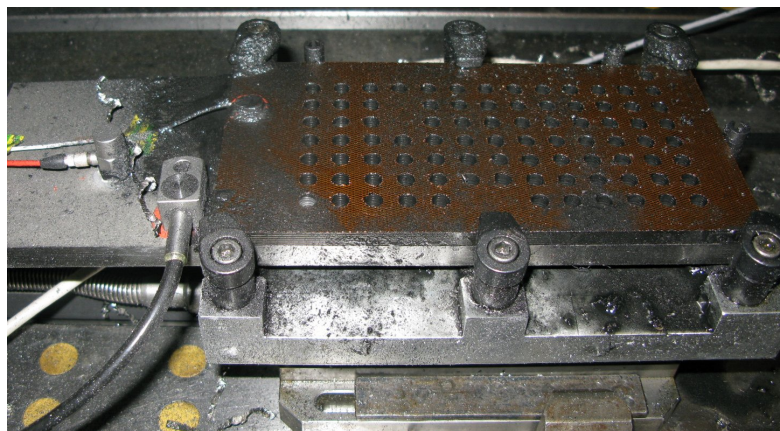
(a) Test bed used to assess the performance of the proposed integration solution for AE sensor: AE sensors have been mounted on each sample of the CFRP/Ti6Al4V stack



(b) The designed integration solution has been fixed to the spindle. The external lubrication apparatus is also visible



(c) The interface between the embedded AE sensor and the CFRP sample was made of cutting fluid and CFRP dust mud which stayed on the sensor between drillings



(d) View of the test bed after 88 drillings have been performed: the sample is covered by cutting fluid and CFRP dust mud. Only 68 out of the 88 drillings have been performed with the AE sensor integration apparatus

Figure 5.14 – Test bed used to assess the performance of the proposed integration solution for AE sensor

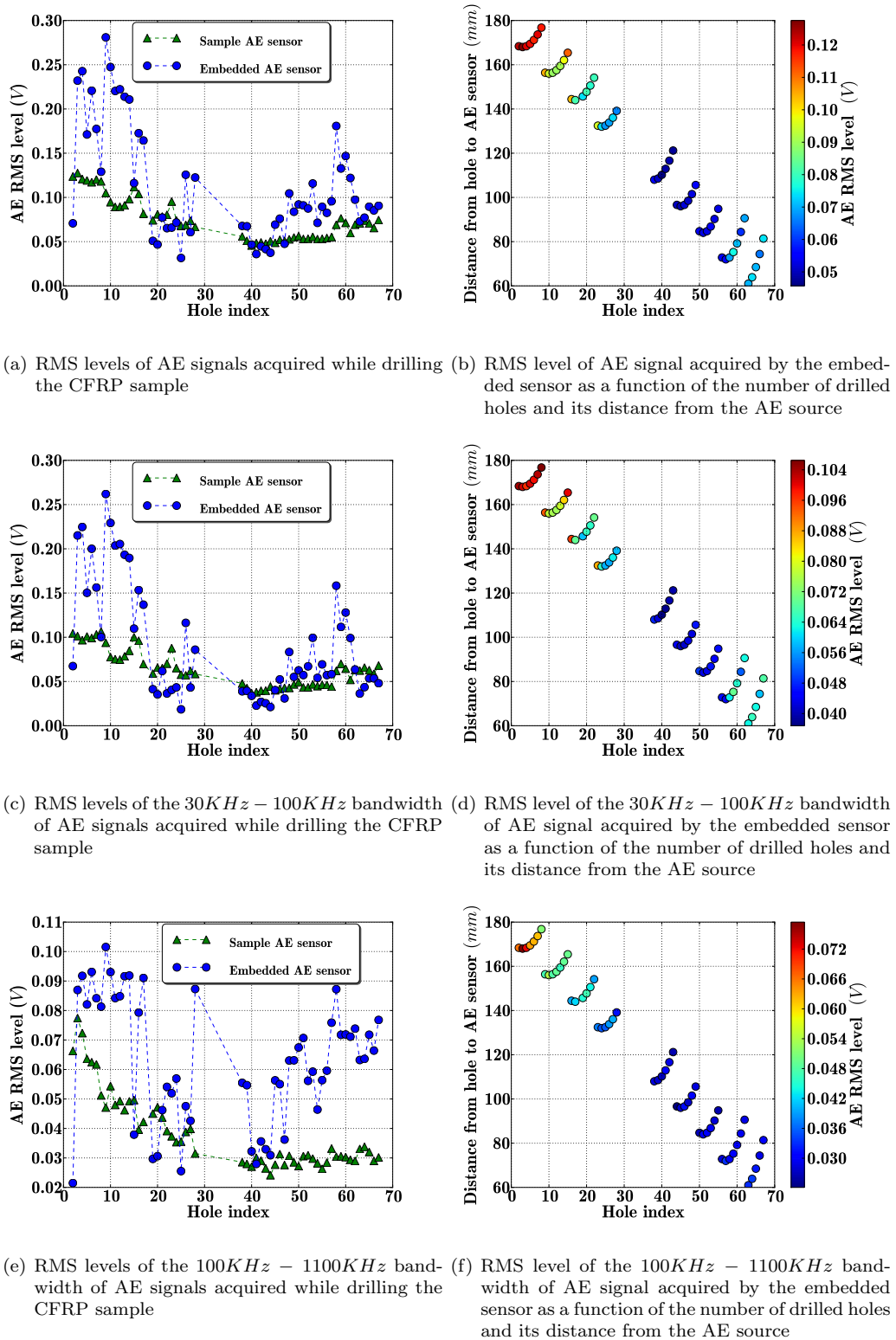
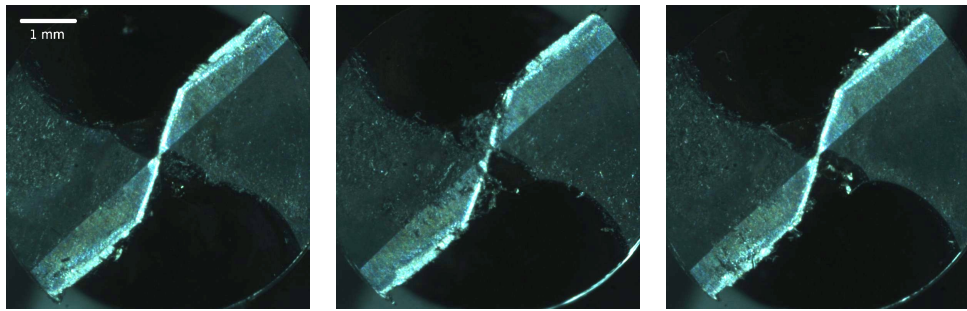
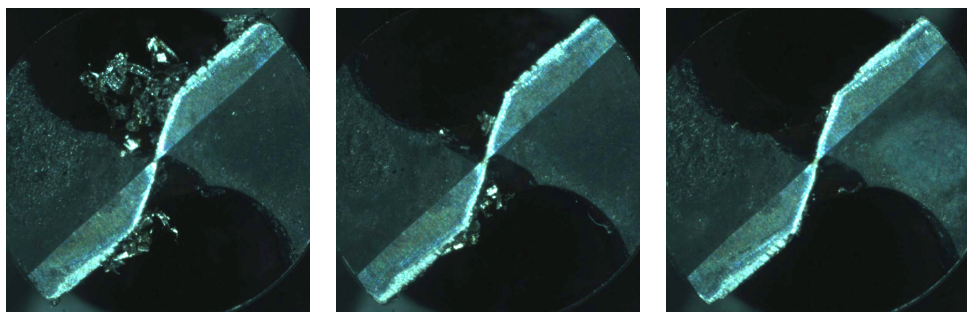


Figure 5.15 – Results obtained after a test campaign dedicated to an AE sensor integration solution performance assessment



(a) Drill cutting edges after the 57th has been drilled (b) Drill cutting edges after the 58th has been drilled (c) Drill cutting edges after the 59th has been drilled



(d) Drill cutting edges after the 60th has been drilled (e) Drill cutting edges after the 61th has been drilled (f) Drill cutting edges after the 62th has been drilled

Figure 5.16 – Results obtained after a test campaign dedicated to an AE sensor integration solution performance assessment

5.1.3.4 Exploitation of AE signals for drilling monitoring: proposition of a robust feature extraction method

Features of interest of AE signals for machining monitoring

Energy level. Energy level has usually been considered the best feature of AE signals to indicate the drill condition [17, 37]. It has often been used on particular frequency bands of AE signals in order to improve its performance [39, 63, 45]. However, it has been pointed out that energy, often presented by the RMS value of the AE signals, should be used with precaution and is not always adapted to detect sudden events like catastrophic tool failure [29, 31].

Considering a zero mean signal, the RMS is equivalent to the standard deviation which is the square root of the second order central moment of the signal. Third and fourth normalized central moments, respectively **skew** and **Kurtosis**, have been shown to be promising symptoms of catastrophic tool failure [31, 33] when applied on the instantaneous RMS value of AE signals. These symptoms are related to the instability of the cutting process, and are often used for monitoring rotating machinery, especially the Kurtosis which is widely used on acceleration signals to detect shocks as it quantifies their peakedness.

As it is difficult to mount sensors on the rotating drill, as evoked in section 5.1.3.3, the place where most useful information is collected is the workpiece. Unfortunately, it has been shown that the AE signal is influenced by relative positions between the AE source and the sensor, and also by adjacent holes when drilling. In order to reduce these harmful influences, solutions have been developed and experienced with sensor mounted on the machine in a way such that the distance from the sensor to the rotating tool remain constant. Position-

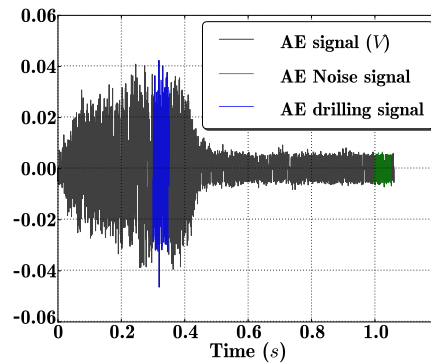
ing sensors on the spindle assembly and on the nose of a robot drilling end-effector did not provide good results because of mechanical spurious noise coming from additional interfaces in [17], and allow obtain trends affected by spurious points due to absence of couplant in experiments by the authors. More sophisticated systems have been developed showing better results in milling and drilling but that are still sensitive to process parameters and should be used in addition with other type of sensors for robust monitoring applications [25, 64]. The proposed integration solution also showed promising results, but is still an experimental apparatus and further developments are needed to enhance its robustness and performances. Up to date, the best results in term of machining process monitoring have been obtained with AE sensors mounted on the workpiece, even if the harmful influence of varying distance between the AE source and the sensor on signal energy has been established. Energy based features extracted of AE signals are heavily dependent of process parameters like distance from sensor to drill bit, but can also be affected by the presence of elements adding noise to the signals like cutting fluid spray or carbon dust vacuum cleaner for instance. Considering these drawbacks which are difficult to overcome, AE energy based monitoring needs additional efforts to isolate effects of different process parameters.

AE count rate. AE count rate, which is defined as the number of times the amplitude of an AE signal has exceeded a threshold in a specified unit of time [60], has also been investigated and linked to drill flank wear [26, 27] and cutting tool crater wear in turning [62]. Although AE count rate and tool wear seemed well correlated, the data presented significant scatter and many problems inhibited the usage of this relationship in process monitoring. Indeed, it has been pointed out that such a system would have to be calibrated for each specific machining condition and the selection of a threshold level for the AE count rate would be somewhat arbitrary [22, 62].

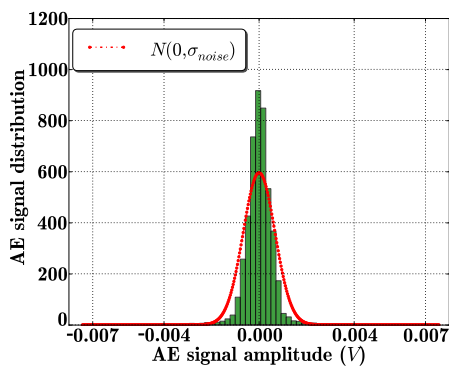
These drawbacks do not allow drilling monitoring in industrial conditions. However, a simple statistical comparison of AE signals obtained during drilling and noise (AE signal obtained when the drilling system is operating outside of the CFRP sample) can make one think that AE count rate is a relevant feature for drilling monitoring. Indeed, the distributions of measured points composing the drilling phase signal and the noise phase signal present differences showing that high amplitude pikes are more numerous in the signal during the drilling phase, and so may be linked to some phenomena occurring during material cutting. Such distributions are depicted in figure 5.17. Therefore, counting these pikes during the drilling phase can be interesting in order to observe changes related to the drill or workpiece condition.

In order to quantify the difference between the number of high amplitude pikes occurring during the noise and drilling phases, the size of the C_{95} 95% coverage interval of the normalized signal distribution has been used. A larger C_{95} coverage interval means that the distribution presents a bigger tail, and so contains more high amplitude pikes. It also allows avoiding influence of extreme points that appears in the noise and are not visible during the drilling operation. Table 5.1 contains the means of the C_{95} of each hole for different test campaigns and shows that the drilling phase presents more high amplitude pikes than the noise phase. Moreover, for campaign where 2 sensors have been used, one can remark that if the distributions of noise affecting both sensors can be different, the C_{95} of the drilling phase are very close, confirming the fact that drilling generates specific AE signal distributions.

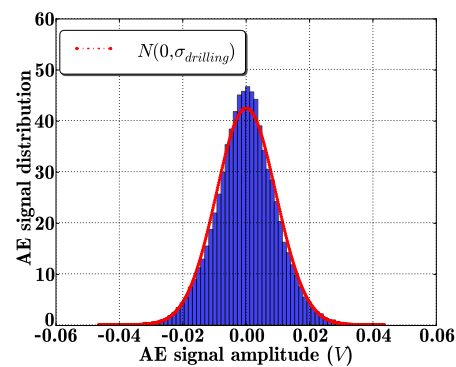
In order to implement an AE count rate algorithm, a *threshold* needs to be set. Issues concerning changes in process parameters compromise the relevance of a fixed threshold. For instance, if the distance between the AE sensor and the drilled hole in CFRP vary during a test campaign, and so energy levels of acquired signals present variations like evoked in previous sections, using the same threshold to perform hits count on each hole will lead to unusable results. Moreover, even in absence of energy variation from one hole to another, fixing a threshold would remain a problem considering the case of industrial monitoring because it would have to be calibrated for each specific machining condition, causing a lack



(a) AE signal acquired while drilling a CFRP sample



(b) Amplitudes normalized distribution of the noise content of the AE signal. A Gaussian distribution with the same parameters have been drawn for comparison purpose



(c) Amplitudes normalized distribution of the drilling content of the AE signal. A Gaussian distribution with the same parameters have been drawn for comparison purpose

Figure 5.17 – Difference of distributions of AE noise and drilling signals

of flexibility, and the selection of a threshold level for the AE count rate would also be arbitrary. In order to overcome the difficulties involved by the set-up of a threshold, it is interesting to have an *adaptive and scalable threshold* which allows attenuating effects of changing process parameters.

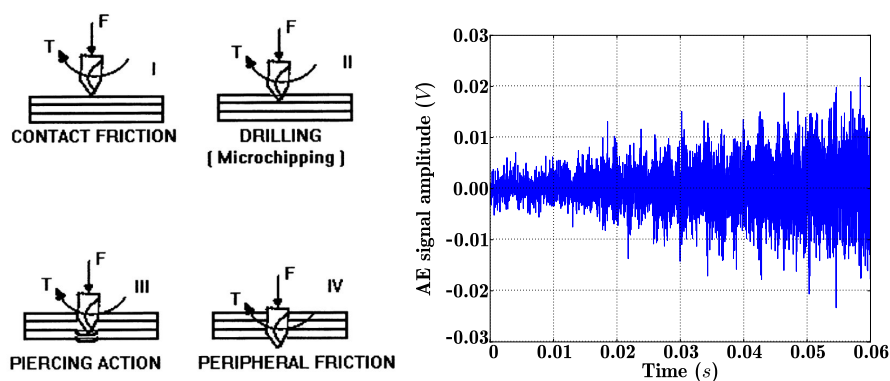
However, a simple threshold presents another drawback: it does not allow performing count rate on transient phases of AE signals. The complete process of drilling FRPs using twist drills can be viewed from a different angle relating to four major stages (see figure 5.18(a)) following [53]. In the initial stage, contact of chisel edge is ensued when the top of the workpiece is extruded to create an indentation. Spindle rotation invariably induces contact frictional rubbing. Further traverse of the drill bit, engages the secondary cutting edges (near the chisel edge) and the main cutting edges (lips) to generate cutting forces. This is the stage when the actual drilling operation begins and larger volume of material removal takes place. As the drill is further translated, it cuts and machine alternate layers until it reaches the last few plies before the drill tool completely exits out. Obviously, at this point, due to decrease in the thickness, the 'resisting stiffness' of the laminate is reduced and ply layers bend elastically under the influence of the applied compressive thrust force. If the compressive thrust force (generating interlaminar stresses) is larger than the interlaminar

Test Campaign	Drillings Number	Noise phase normalized \overline{C}_{95}	Drilling phase normalized \overline{C}_{95}
1	103	3.33	3.98
2	40	3.31	3.99
3	88	3.93	4.18
4	80	3.92	4.15
5 - Sensor 1	96	3.70	4.02
5 - Sensor 2	96	3.83	4.01
6 - Sensor 1	97	3.95	4.32
6 - Sensor 2	97	4.06	4.34
7 - Sensor 1	96	3.76	4.30
7 - Sensor 2	96	3.88	4.30

Table 5.1 – Means of normalized C_{95} of noise and drill phases acquired while drilling in CFRP samples in different test campaigns

bond strength then a crack is initiated and propagates to result in a finite damage around the hole. Cutting action is not effective during this course and this action is analogous to piercing an arrow onto a target. This is a crucial stage and is named piercing action, because this mechanism of sudden release of the drill bit to generate the hole decides the quality of the exit side of the laminate. The last stage involves simply rotation of the drill bit within the walls to induce peripheral friction. In order to facilitate the extraction of features of interest, it is useful to isolate the different phenomena occurring during these stages.

The drill bit entry into the material is a phase when only contact friction and cutting occur, therefore it is of particular interest for monitoring cutting edges wear, chipping or other degradation mechanism. The drill entry stage has been reported to be one of the best moment for tool where monitoring in [50]. However, AE signal acquired during the drill entry into the material is transient because of the increasing quantity of cut material (see figure 5.18(b)), and cannot be efficiently treated with a steady threshold. The idea developed here is to build an adaptive and scalable threshold which follows the signal shape and allows counting the events that are remarkable considering both the AE signal characteristics and the goals of the monitoring operation.



(a) Four stages of a drilling composite laminate operation following [53] (b) Transient AE signal acquired during the entry of the drill bit in a CFRP sample

Figure 5.18 – Different phases of AE drilling in composite laminates (a) and AE signal acquired during the beginning of the 2nd phase (b)

Building an adaptive and scalable threshold

The goal of a scalable threshold is to determine what is considered as a remarkable event at each moment of the signal. AE signals acquired during drilling present Gaussian like distributions, and the most extreme points seems to be linked with material cutting phenomena. Thus, the threshold level can be set considering the occurrence probability P_{event} of the events that are wanted to be taken into account. Then, using a Gaussian law table, P_{event} is used to determine the number n_σ with which to multiply the standard deviation σ_p of the signal portion that is considered in order to set-up the threshold.

Using this scheme for each signal portion gives a set of P points, each one giving a threshold level for a given signal portion. To be done, this requires to divide the signal in P different time portions. The choice of such a portion duration is governed by two parameters: the number P of points that will be used to build the threshold, which is also the number of portions, and the total duration of the signal extract of interest T_{signal} . They are linked together by the following relationship:

$$T_p \times P \leq T_{signal} \quad (5.1)$$

where T_p stands for the portions duration. Both parameters present constraints to deal with: the more number of portions P , the better the threshold will adapt itself to the signal shape, but in the same time, the portions duration T_p must be long enough for their distribution to be statistically representative of the signal information content and so give a coherent σ_p value to determine the threshold level $thre_p$ associated with the p^{th} signal portion:

$$thre_p = n_\sigma \times \sigma_p \quad (5.2)$$

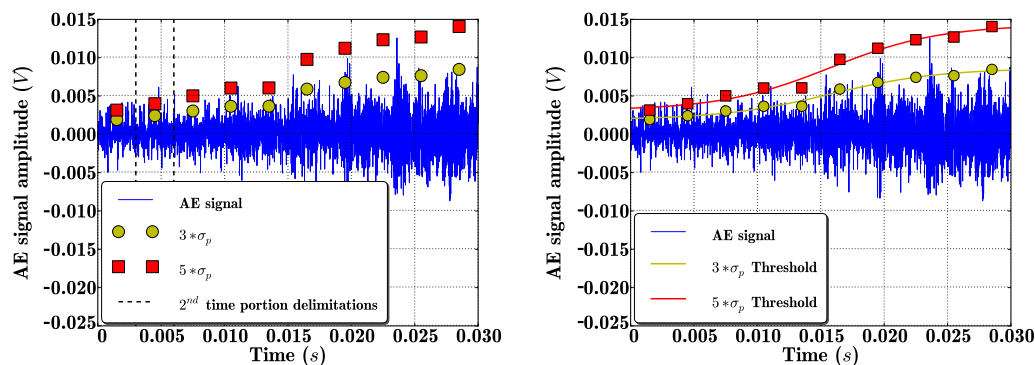
Depending on the complexity of the shape that is wanted for the scalable threshold, a minimal number P of points can be required, then T_p can be chosen with respect to equation 5.1.

Considering drilling monitoring using AE signals, the scalable threshold needs to adapt itself to different kinds of shapes. The potential of the drill entry phase, during which the signal energy is increasing, has been emphasized in a previous section, but the drilling phase during which the energy level remains quite stable also contains useful information on the drilling operation. Moreover, in case of blind holes, a decrease of the AE signal energy is visible as the feed decreases because of the spindle translation movement deceleration, so the threshold has to adapt too because the feed reduction has significant influence on AE signals [33].

As the threshold needs to be defined for every moment of the signal, we propose to build a parametric function that fits on the P previously determined points. A simple function which adapts itself to all the above mentioned kind of shapes is the sigmoid function defined by:

$$s(t) = d + \frac{a}{1 + e^{q(t-p)}} \quad (5.3)$$

The little number of parameters allows using a reduced set of points which is an advantage for short duration signals like the drill bit entry or spindle translation movement decelerating phases. As the problem is simple, fitting the function with the previously determined points can be done using any non-linear optimization algorithm. For instance, the Levenberg-Marquardt algorithm has been used in this work. Once the threshold is set in function of the wanted remarkableness of pikes driven by the user defined parameter P_{event} , an hit count algorithm can be applied to perform AE count rate.



(a) P points are built as a function of the standard deviations σ_p of the P time portions (b) A sigmoid function is fitted on the P point in order to obtain the auto-adaptive threshold

Figure 5.19 – Illustrations of the construction of auto-adaptive thresholds to perform hits count on the drill entry phase of an AE signal using the proposed approach

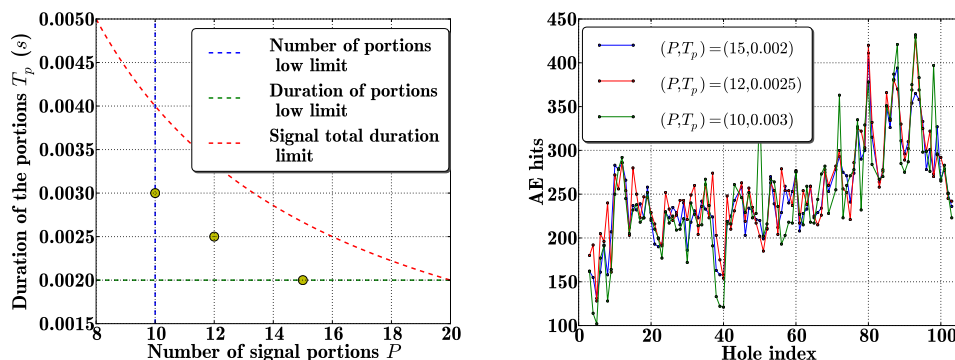
Adaptive and scalable threshold set up

The threshold parameters have been set up with respect to 5.1 considering the worst application case: the drill bit entry phase which presents a 0.05s duration because of the feed and the drill shape that have been used. In order to perform a good curve fit with a sigmoid function, a minimal number P of portions has been set to 10. A minimum portion duration T_p has also been fixed to 0.002s in order to obtain a distribution of the points which is representative of the AE drilling signal. Then, considering those constraints and a 0.01s margin on the drill bit entry phase duration, 3 possible (P, T_p) parameters sets have been chosen in the space of possible parameters values to be evaluated. The space of possible parameters and the chosen parameters sets are presented in figure 5.20(a) and the parameters sets are detailed in table 5.2.

Parameter set	P	T_p
PS_1	10	0.0030
PS_2	12	0.0025
PS_3	15	0.0020

Table 5.2 – Assessed (P, T_p) parameters couples

The same parameters have been used to perform feature extraction on the signals issued from the drill entry and the drilling phase in order to evaluate the method flexibility facing different signal shapes and characteristics. To assess the parameters influence, the 3 parameters sets have been used to perform AE count rate on a test campaign. The results are depicted in figure 5.20(b) and show that the parameters sets PS_2 and PS_3 give much closer results than PS_1 is involved. In particular, high differences in hits count has been achieved using PS_1 , which is due to the bad behavior of the optimization operation aiming to fit the sigmoid function on the P calculated points with a reduced number of data points. This phenomenon is visible for holes 50, 72, 78 and 98 on figure 5.20(b) obtained after performing AE count rate with the three parameters sets on the drill entry phase of 103 holes realized during a CFRP/Ti6Al4V drilling test campaign. The similarity between the results obtained using PS_2 and PS_3 shows that a 0.002s portion duration T_p is sufficient to give a representative statistical description of the signal. In order to avoid instabilities of the method due to optimization problems, PS_3 is chosen as the parameter set to perform feature extraction on the test campaigns data in the following.



(a) The parameters space for the couple (P, T_p) is delimited by several constraints (b) Hit count has been performed on signals (drill entry stage) acquired during a CFRP drilling test campaign with the 3 selected parameters couples in order to assess their performance

Figure 5.20 – Delimitation of the parameter space for T and T_p (a) and assessment of three couples on real AE data (b)

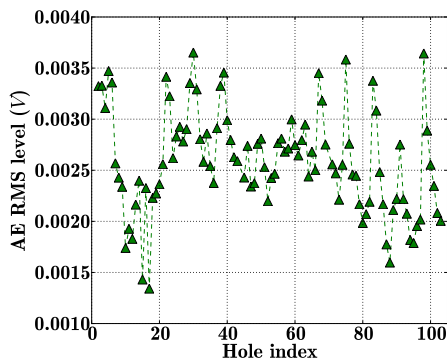
Application on experimental data

In order to assess performances of the proposed feature extraction method, it has been applied on data acquired during several tests campaigns. For all the results that will be presented, the sensor was mounted on the sample and coupled and sealed with silicone gel. The same acquisition set-up has been implemented and the AE signal bandwidth is $30\text{KHz} - 1100\text{KHz}$. First, a comparison of the hits count with the RMS extracted feature will be provided to emphasize differences between both. Then, the influence of the parameter P_{event} of the proposed approach will be characterized, and finally interest of isolating different drilling phases to perform feature extraction on will be discussed.

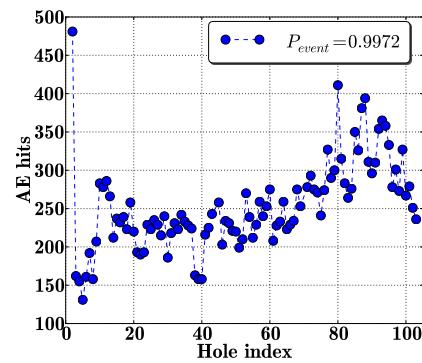
Comparisons between energy based features and auto-adaptive hits count. Comparisons between energy based and hits count based features have been done on several data sets. The first one consisted in a test campaign where 103 holes have been drilled in a CFRP/Ti6Al4V stack (see appendix A.1, sample 1). AE sensors were placed on both the samples, as depicted in figure 5.8(a). Feature extraction computed for the entry of the drill in the CFRP and the drilling of Ti6Al4V are depicted in figure 5.21. The RMS level of AE signals have been computed as the hits count performed with the scalable threshold with parameter P_{event} set to 0.99720 ($3 \times \sigma_p$) and 0.99999 ($5 \times \sigma_p$) respectively.

Considering the entry in CFRP, the proposed approach allows obtaining less dispersed results than RMS level. In particular, a 8 holes pattern linked to the distance from hole to sensor is visible that cannot be seen when using the proposed method. As for results obtained when drilling the titanium sample, trends are observed when using both the RMS of the proposed approach. If it is not possible to statue about an eventual influence of the distance from sensor to hole on the observed trends, it is important to remind this parameter possesses lower influence than in the CFRP. One can also observe that the first hole produces the highest hits number, and that the trend are different in the CFRP and the Ti6Al4V.

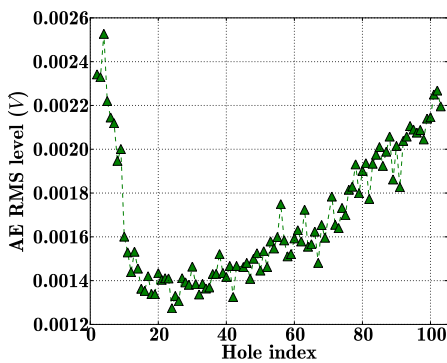
Data from another similar test campaign have also been used to perform feature extraction with both approaches. The main difference was the fact that consecutive drillings were performed at different distances from the sensor (see appendix A.1, sample 2). Results are depicted in figure 5.22 for the CFRP sample drilling phase.



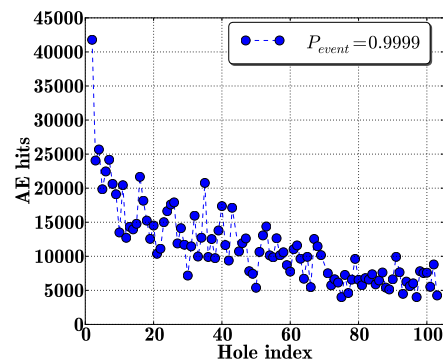
(a) RMS level of AE signals acquired during the entry in CFRP phase



(b) Number of hits of AE signals acquired during the entry in CFRP phase



(c) RMS level of AE signals acquired during the drilling of Ti6Al4V phase

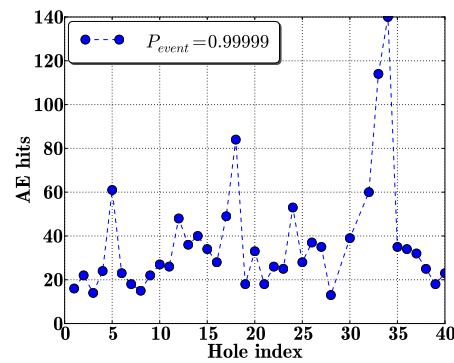
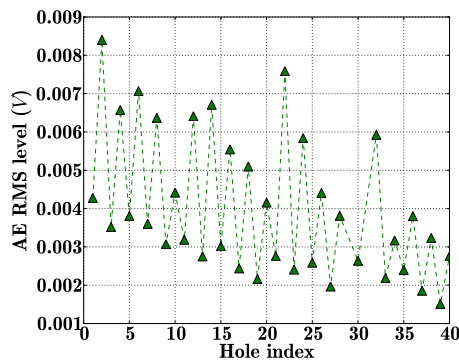


(d) Number of hits of AE signals acquired during the drilling of Ti6Al4V phase

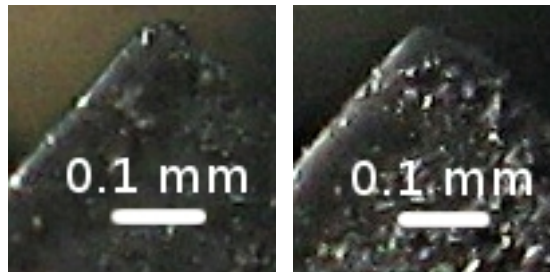
Figure 5.21 – Some feature extraction results obtained on data acquired during a CFRP/Ti6Al4V drilling test campaign

Once again, the influence of distance from AE sensor to AE source is clearly visible on the AE signal energy based feature, whereas the proposed approach provides results that seems less affected by this parameter. However, some high variations are observed for holes 5, 18 and 29-34. Observation of drill pictures that have been taken after each hole barely allows distinguishing alterations due to their poor quality. Pictures taken after hole 28 and 35 (figures 5.22(c) and 5.22(d)) show an important modification a cutting edge geometry that could explain the important hits number variations that have been observed on these holes. This ability of the proposed approach to sense tool sudden alteration will be discussed in the following section.

Particularities of the proposed approach & influence of P_{event} . Particularities of the proposed approach, and the influence of P_{event} in particular, have also been investigated. As seen in the previous example, the method showed an ability to sense drill significant alterations in several cases, especially when P_{event} is set to high levels, whereas lower levels allowed to obtain trend that seemed more linked with tool wear. Results presented in figure 5.23 illustrate this behavior: hits count have been performed with 2 different values of P_{event}



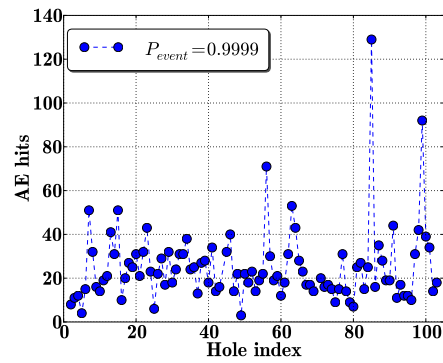
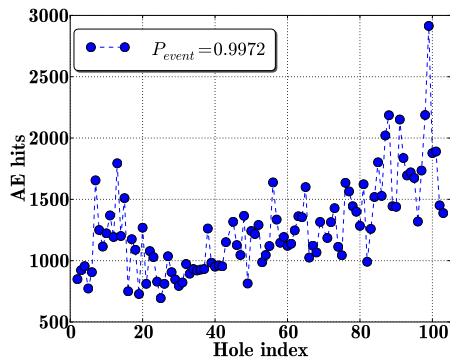
(a) RMS level of AE signals acquired during the drilling of CFRP phase (b) Number of hits of AE signals acquired during the drilling of CFRP phase



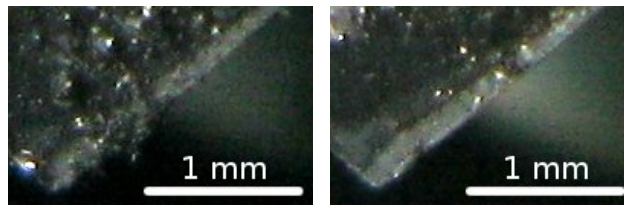
(c) Picture of the drill cutting edge after 28 holes have been drilled (d) Picture of the drill cutting edge after 35 holes have been drilled

Figure 5.22 – Feature extraction results obtained on data acquired during a CFRP/Ti6Al4V drilling test campaign ((a),(b)), and pictures of the drill cutting edge after 28 and 35 holes have been drilled ((c),(d))

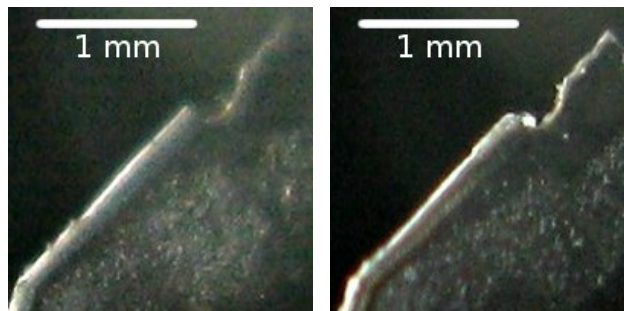
on the same AE signal acquired during the plain drilling phase in a CFRP sample. When using a 0.9972 probability to set the threshold, a trend is visible as the number of drilled holes increases, whereas for $P_{event} = 0.9999$ only high amplitude points (holes number 56, 85 and 99) are remarkable. Using the pictures of the drill bit taken after each hole, those high amplitude points reveal drill bit cutting edges alterations visible in figures 5.23(d) and 5.23(f). No picture has been taken after the 99th hole because of a camera problem. The big chipping present on pictures taken after holes 84 and 85 have been provoked manually between 2 holes so it does not appears in the results as a singular point. Another example of the proposed approach ability to detect the occurrence of tool cutting edge chipping has been given in another test campaign where 2 AE sensors were placed on the sample, as depicted in figure 5.9(a) (see appendix A.5 for further information about the test campaign). An alteration of both the drill cutting edges corners took place during the 4th drilling. It clearly appears on feature value extracted on the two sensors. It is interesting to note that again, previously to the alteration, the energy level has reached a very low level for the 3rd hole. Results provided by the second sensor also show the 17th hole as a singular one. Pictures 5.25(g) and 5.25(h) shows that a cutting edge corner has been altered.



(a) Number of hits of AE signals acquired during the drilling of CFRP phase obtained with $P_{event} = 0.9972$ (b) Number of hits of AE signals acquired during the drilling of CFRP phase obtained with $P_{event} = 0.9999$

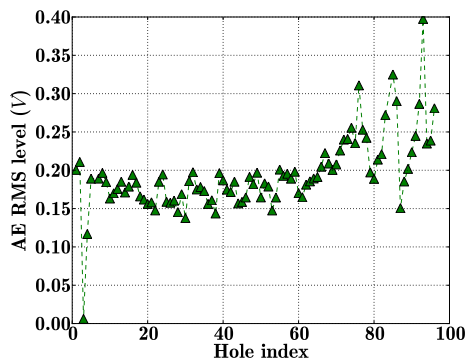


(c) Picture of the drill cutting edge after 55 holes have been drilled (d) Picture of the drill cutting edge after 56 holes have been drilled

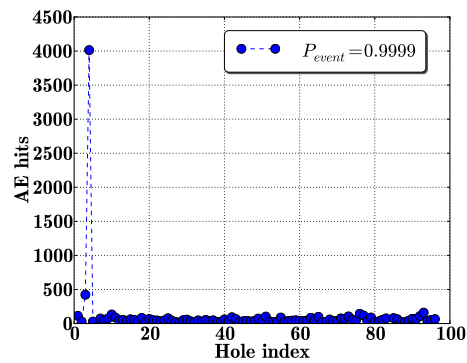
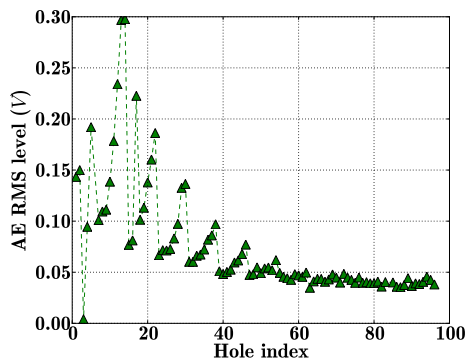


(e) Picture of the drill cutting edge after 84 holes have been drilled (f) Picture of the drill cutting edge after 85 holes have been drilled

Figure 5.23 – Feature extraction results obtained with the proposed approach 2 different values of P_{event} on data acquired during a CFRP/Ti6Al4V drilling test campaign ((a),(b)), and pictures of the drill cutting edge after 55, 56, 84 and 85 holes have been drilled ((c),(d),(e),(f))



(a) RMS level of AE signals acquired on sensor 1 during the drilling of CFRP phase

(b) Number of hits of AE signals acquired on sensor 1 during the drilling of CFRP phase obtained with $P_{event} = 0.9999$ 

(c) RMS level of AE signals acquired on sensor 2 during the drilling of CFRP phase

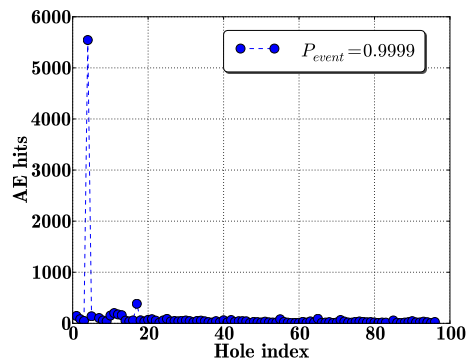
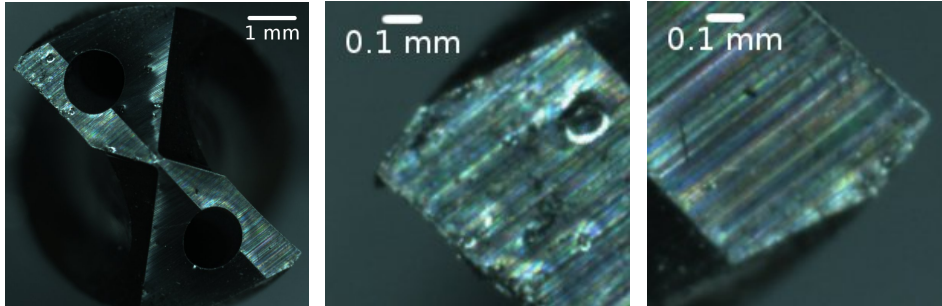
(d) Number of hits of AE signals acquired on sensor 2 during the drilling of CFRP phase obtained with $P_{event} = 0.9999$

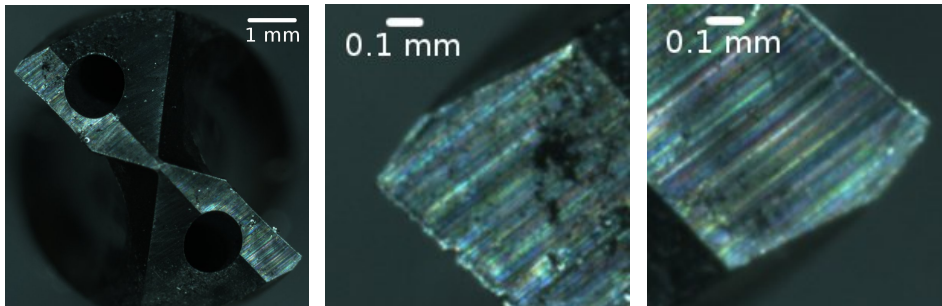
Figure 5.24 – Feature extraction results obtained for 2 AE sensors mounted on a CFRP sample during a drilling test campaign: holes number 4 and 17 are singular when looking at hits count results, and hole number 3 when looking at AE RMS

Interest of the separation of the drilling phases. Figure 5.26 allows comparing results of AE hits count using $P_{event} = 0.9999$ and shows the interest of the separation of the different phases of the drilling operation. Indeed, very different results are obtained between the drill entry phase and the drilling phase. As explained sooner in this section, performing AE count rate with $P_{event} = 0.9999$ allows detecting sudden events linked with tool cutting edges condition. Performing the same operation on the drill entry phase provided a trend. The high amplitude pikes hiding the trend for the drilling phase are probably not visible during the drill bit entry phase because the cutting edges alteration occurred during the drilling phase which took place just after.

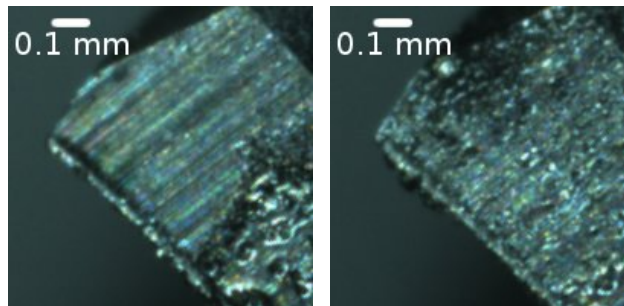
Another drilling stage, *peripheral friction*, has not been studied here but showed promising results as depicted in figure 5.27. As during this stage only the rotation of the drill bit within the walls induces the generation of AE, it could be interesting to use features extracted from AE signal recorded during this stage to look for correlations with the hole geometry and surface quality.



(a) Picture of the drill cutting edges after 3 holes have been drilled (b) Picture of the drill left cutting edge after 3 holes have been drilled (c) Picture of the drill right cutting edge after 3 holes have been drilled



(d) Picture of the drill cutting edges after 4 holes have been drilled (e) Picture of the drill left cutting edge after 4 holes have been drilled (f) Picture of the drill right cutting edge after 4 holes have been drilled



(g) Picture of the drill right cutting edge after 16 holes have been drilled (h) Picture of the drill right cutting edge after 17 holes have been drilled

Figure 5.25 – Pictures of the drill cutting edge after 3, 4, 16 and 17 holes have been drilled: alteration appear on the corners of the drill lips when high hits count rates have been observed

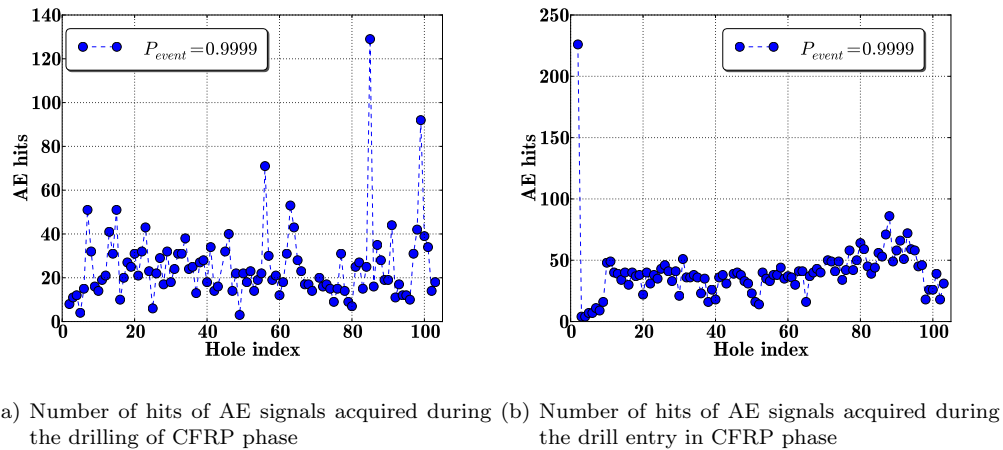


Figure 5.26 – Feature extraction results obtained with the proposed approach applied on the drilling phase of a drilling operation on a CFRP sample (a), and the drill entry phase (b)

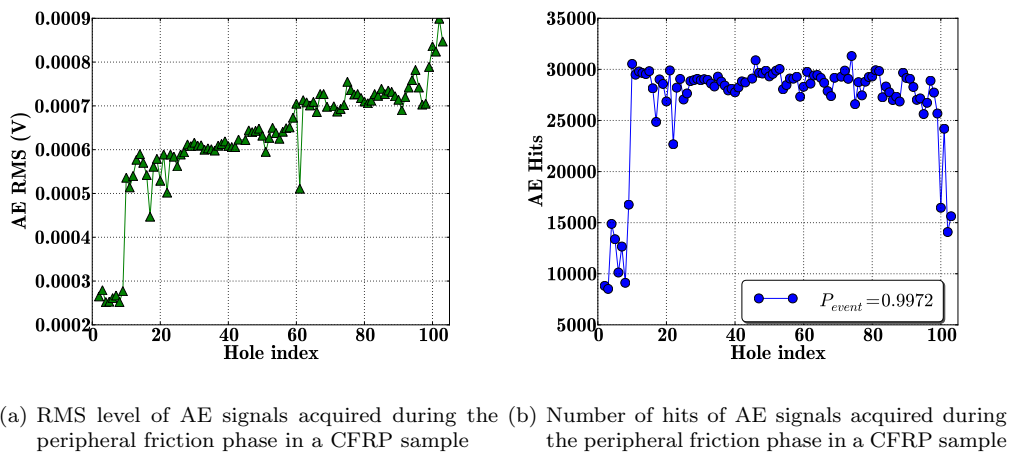


Figure 5.27 – Feature extraction results obtained with studying the peripheral friction phase of a drilling operation on a CFRP sample

5.1.3.5 Overview on AE sensors integration

A brief review on the use of acoustic emission in machining, and drilling in particular, has been done and showed a lack of robust methods for monitoring applications. This is essentially due to the classical approaches inability to handle perturbations induced by changing process parameters, and to the difficulty to efficiently integrate AE sensors on drilling devices.

Influences of some of these parameters (couplant, material and distance from AE source to sensor) have been investigated experimentally showing their importance and underlining the need to take them into account while designing an integration solution.

An integration solution has been proposed in order to address some of the issues encountered when using AE for drilling monitoring, keeping the distance between AE source and sensor constant in particular. It has been assessed during drilling experiments and results are not completely understood yet, so more effort is needed to exploit them and look for the potential enhancements that could be given to the system in order to achieve an efficient integration solution suited for industrial use.

An auto-adaptive feature extraction method for AE signal has also been proposed that allowed overcoming some of previously identified issues and taking advantage of the different phases of the drilling operation. Experimental results showed the robustness of the method facing some process parameters changes, and also its good detection ability both for sudden events and progressive phenomena. In a future work, a better statistical description of AE signals and a bigger database of signals acquired during test campaigns may lead to better results in terms of detection ability.

As concluded in section 2.1, Acoustic emission appears as a very promising way to perform drilling monitoring due to its high sensitivity. Works presented here are encouraging by showing integration solutions and robust feature extraction algorithm exist and could be used in industry soon. However, as mentioned by many authors, AE should be coupled with other types of sensors to perform the best monitoring results.

5.1.4 Overview on sensors integration

Sensors integration, as evoked in chapter 3, is a key point for the implementation of an efficient drilling monitoring system. Indeed, a good diagnostic is based on relevant features that are extracted from informative sensor signals. Sensors integration is made difficult by the constraints imposed by harmful industrial environments: measurement solutions have to be robust and non-intrusive for the process, while, in the same time, providing informative data. Unfortunately, most informative signals are issued from the most difficult to integrate sensors. Indeed, if vibrations and currents are easy to observe, it is often difficult to use them as reliable features for tool or workpiece condition monitoring, whereas force and AE measurements are informative but sensors are difficult to integrate.

Solutions have been reviewed and proposed for these two sensor types, showing encouraging results. A feature extraction procedure for AE signal has also been proposed which showed more robustness to process parameters changes and better tool cutting edge failure detection ability than the classical energy based ones.

These results confirm that sensors integration is an important step of the design of a monitoring system. In particular, when industrial constraints exist, they need to be taken into account from the beginning of the design of a monitoring solution.

Following the acquisition of informative sensor signals, feature that are relevant concerning the process state have to be extracted in order to achieve good estimation performance. The selection of such features is the scope of the next section.

5.2 Feature selection

5.2.1 Introduction

A drilling monitoring system should allow estimating the process state by deriving it as a function of critical variables, called *features*, that characterize the process condition. In drilling monitoring applications, these features have usually been chosen as a function of knowledge about correlations existing between the drilling process parameters and results and sensor measurements. Those correlations have been extensively investigated via theoretical or experimental studies, and some of them have been presented in section 2.1.2. A interesting overview of feature selection for machining monitoring applications has been given in [61]. The example of turning applications was given, and it was stated (after [56]) that in only 15% over 138 monitoring applications papers, the features were chosen due to their relationship with the phenomenon of interest. The most used correlation criterion between features and monitored phenomenon is the *Pearson correlation coefficient*, (see equation 5.12), which only takes into account *linear relationships*.

Nowadays, due to an increase in technology level and a decrease of prices of sensor and data processing devices, it is easy to acquire a large amount of data related to different measurands while drilling. From this data, many potential features can be extracted either using general techniques like those explained in section 2.1, or more particular ones, adapted to one type of sensor data or application. To give an idea of the number of potential features than can be extracted from a multisensor system implemented on a drilling device, lets consider 4 sensor types: forces (3 axes) and torque, acceleration (3 axes), power consumption (spindle and feed motors phase currents) and temperature. For all these measurements, the four first statistical moments are computed, plus their maximum and minimum values. Except for temperature, it is also interesting to analyze these measurements in the frequency domain and to determine the values and frequency locations of the three higher frequency peaks, the standard deviation and the Kurtosis of the frequency distributions. This provides a total number of features of $(3 + 1 + 3 + 2 + 1) \times 6 + (3 + 1 + 3 + 2) \times 8 = 132$. This number has then to be multiplied by the number of frequency bands of interest, the number of phases of the drilling operations of interest (entry of the drill, plain drilling, exit of the drill), etc... Thus, the number of potential features can be too high (500+) for them to be investigated one by one in order to find the ones that are correlated with the phenomenon of interest only by human interpretation. For instance, using only AE and force sensor, Jemielniak and Arrazola extracted 144 features in [30]. Moreover, as mentioned earlier, when several features are used, their combined use is to be taken into account as features that are useless alone can be useful when used with others. Finally, as most of features extracted following this *exhaustive* approach will be *irrelevant* regarding the the phenomenon of interest, a manual *feature relevance characterization procedure* would be a waste of time. Therefore, solutions have to be found to select *relevant features* in an efficient manner.

Process monitoring is not the only application dealing with high number of potential features, and the problem of *feature selection* has been widely studied (see [57, 4, 30, 58, 19] and [28] for tool condition monitoring applications). In its general form, it consists, given an *original set of features*, in finding a subset such the *estimation accuracy* of the monitoring system is the highest possible. Feature selection techniques have been developed for answering this need differ by their objectives, algorithms and complexity.

Considering difficult contexts and conditions detailed in section 3, feature selection can be tricky due to the imperfection of available data collections: depending on the data acquisition and the drilling system operating conditions, they can be heterogeneous, incomplete, imprecise, contradictory, or erroneous. For instance, it has been showed in turning that performing feature selection on data from different test campaigns could lead to different relevant feature sets [30]. This is especially the case when implementing a monitoring system in industrial environments: building data collections have often to be done in disparate conditions, on different devices, with different sensors, and are not representative of the

full operating conditions range of the process to be monitored. The main challenge for this important task is therefore obtaining a 'robust' feature set.

Classical feature selection techniques lack of solutions to take data coming from different collections into account, in particular when affected with *imprecision* and *inconsistency*. It is our assertion that data fusion should provide solutions to process data collections altogether in order to achieve coherent and more robust feature selection, even in such difficult cases. This section is devoted to the feature selection task using data fusion techniques.

After a short description of the feature selection problem for complex systems monitoring, a rapid review will allow finding which feature selection techniques are the best suited for the implementation of an industrial monitoring system and to select one of them. Then, considering difficulties linked with the harsh environment and drilling process complexity we have to face, and also the experimental data acquisition procedure used when implementing a monitoring system in an industrial production plant, a fusion approach for feature selection will be proposed that uses developments about the identification of singularities within data sets in difficult contexts presented in chapter 4. Classical approaches will also be introduced as they are used for explaining differences and for comparison purpose. A real case study, the detection of drill cutting edge chipping, will serve to illustrate the use of the different proposed developments and assess their performance via numerical experiments, using real-world experimental data.

Approaches aimed at *feature creation* or also called *feature extraction* in [1], that consist in combining several features to obtain meta-features that are more informative, are not discussed here. Although they are quite popular (principal and independent component analysis (PCA & ICA) in particular) because of their ability to reduce the feature space dimensionality, they lead to the creation of variables which do not possess physical meanings anymore. The general criterion for reducing the dimension is the desire to preserve most of the relevant information of the original data according to some optimality criteria. For monitoring applications however, it is desired to pick a subset of the original features rather than find a mapping that uses all of the original features. The benefits of finding this subset of features are the reduction of the cost of computations of unnecessary features, and also of unnecessary sensors [43].

5.2.2 Feature selection for complex systems monitoring

5.2.2.1 Problem description

Feature selection is one of the most important step in *the design of a monitoring system*. As estimations of the production process state are based upon some features of interest, a good selection of these features is essential. Indeed, a good *feature set* will improve prediction performance, provide faster and more cost-effective estimations and a better understanding of the underlying process [20], whereas the use of irrelevant features will lead to downgraded estimation performances and increase computation time. A reduced feature set is often wished as it implies the use of fewer sensors and data processing, and because it reduces risks of estimation performance degradation (*curse of dimensionality* evoked in section 2.1.1.2). Moreover, for most learning machines, the more features are used, the more training samples are needed [61], which is not always compatible with industrial implementation of monitoring systems. It has also been showed in [8] that a reduced set of 25 selected features allowed to performed better than a set of 138 features for tool condition monitoring in end milling.

When no exhaustive information is available about relevant features at the designing step of a monitoring system, feature selection is usually performed following a basic feature selection process (BFSP) depicted in figure 5.28. It consists in building an experiment dedicated to emphasize the phenomena to be monitored and collect raw data from sensors. Sensors are the same ones that will be used by the monitoring system. Large scale feature extraction is

then performed on the acquired data, being as exhaustive as possible in order not to miss useful features. Finally a *feature relevance characterization* procedure is applied in order to allow selection of the best ones regarding the phenomena of interest. This BFSP procedure has been applied in [4, 30, 19] and [28] for condition monitoring for instance. The design of dedicated experiments, which is an important concern of the BFSP, has not been discussed in this work. More information can be found in [1] for instance.

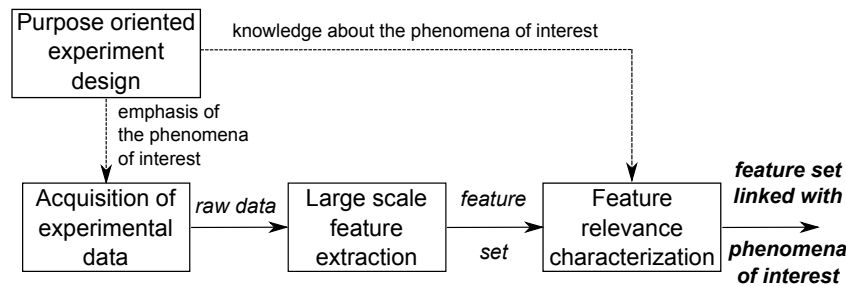


Figure 5.28 – Basic feature selection process (BFSP)

When working with complex systems like industrial drilling devices used for aircrafts structural assembly, this BFSP presents some limitations because of its sensibility to experimental conditions like process parameters, or influence quantities that affect sensor measurements. The design of experiments is a complicated task for which various techniques exist, and an overview of methods applied for machining monitoring applications can be found in [1]. Moreover, it is not suitable for dispersive systems showing significantly different behaviors when only slight changes, sometimes barely detectable, occurred in the operating conditions. In [19] for example, only one operating condition of the machining system has been investigated, so findings about selected features should not be generalized, and in [42] testing the monitoring system in variable operating conditions in order to assess the proposed feature selection methodology sensibility and effectiveness will be part of future work. This lack of robustness of this approach when quasi-exhaustive data about the monitored system are not available, which is likely to occur when working with flexible systems implemented in harsh environments and when experimentation is costly, as it is the case for machining, is an important issue.

Tracks to overcome these drawbacks and select features that allow improving the robustness and flexibility of monitoring systems exist. The first one consists in considering that *available data are not perfect* but tainted with uncertainty and imperfection coming from the monitored system dispersive behavior, and/or acquisition problems like noise, sensors failure, sensor mounting issues, harmful influence quantities... Keeping in mind that collected data may not exactly represent the monitored system behavior should prevent misleading interpretations. Moreover, the presence of *multiple data collections* concerning the monitored system, even if heterogeneous, incomplete or contradictory, should be considered as a chance for robustness improvement, and not as a drawback in order to obtain 'easy to interpret' results. The processing of these different data collections in order to obtain a single feature set is then an important issue, and data fusion becomes necessary to incorporate all the data into the analysis [15].

5.2.2.2 A short introduction on feature relevance characterization

The feature relevance characterization step of the BFSP has been widely studied, and a good introduction and useful references can be found in [20, 47, 36, 9]. The feature relevance characterization process can take three main forms: *filters*, *wrappers* and *embedded*.

Using **filters**, features are selected, or weighted (selection/rejection can be considered as special cases of weighting using binary weight values), according to their relevance regarding

the phenomena of interest. The weighting is performed independently of the estimator that will be used to perform monitoring. *Feature weights* are assigned following some relevance criterion, mainly correlation with the phenomena of interest or information theoretic based ones. If filters are often used because of their simplicity, scalability and good empirical success [20], they present limitations: one common criticism of feature weighting is that it leads to the selection of a redundant subset of features, and the same or better estimation performance could be achieved with a smaller subset of complementary variables. Moreover, dependencies between features are not taken into account, although variables that are useless by themselves can sometimes be useful together [20]. As the filtering process takes place before the estimator induction step, it can also be performed before applying any other feature relevance characterization process algorithm to reduce the dimensionality of the original feature space.

Wrapper approaches [36] use the estimator used within the monitoring system as a mean to evaluate relevance of features during the relevance characterization process. This form of feature relevance characterization guarantees coherence between the selected features and the estimator used in the monitoring system. It also allows taking into account influence of the use of several features simultaneously. However wrappers can be time consuming due to the multiple evaluations of the estimation algorithm, and when facing a large number of features, all feature combinations cannot be evaluated, requiring the use of *heuristic search methods* within the original feature power set.

Lastly, **embedded methods** integrate the feature relevance characterization process as a part of the estimator induction step. This form of feature relevance characterization implies the use of particular estimators. Embedded methods are usually faster than wrappers [20].

Hybrid methods, that mainly use filters as a preprocessing step in order to reduce the feature space dimensionality before using a wrapper or embedded approach have also been developed. Examples of hybrid strategies implemented to face high number of features can be found in [15] and [7] for instance.

For the sake of generality, a filter method will be used to perform feature weighting because it can be applied before using any estimation algorithm, or as a preprocessing step before implementing a wrapper or embedded feature relevance characterization method. Moreover, sensor-based monitoring of industrial production processes often requires the use of a reduced feature set. The choice of such a feature weighting algorithm is discussed in the next section.

5.2.3 Choice of a feature weighting algorithm

5.2.3.1 The IRELIEF algorithm

Several variations have been developed following the simplest filtering scheme which consists in assessing the correlation between a feature and the phenomenon of interest. The *FOCUS algorithm* [3] involves a greater degree of search among the feature space as it begins by looking at each feature in isolation, then pairs, triplets, and so on, halting only when good enough performance is achieved. As it addresses the problem of *feature interactions* and *feature redundancy*, it has shown good robustness facing the presence of irrelevant features, but its search procedure is likely to become intractable as a function of the number of features in the original feature set to be analyzed.

The RELIEF algorithm [34], developed at first for classification and clustering applications, uses a statistical based feature evaluation function: it collects all statistically relevant features by assigning, one instance at a time, high weights to features showing strong separation power between closest instances of different classes and keeping closest instances belonging to the same class close in the feature space. The final ranking is obtained by averaging those weights assessed for a statistically relevant number of instances. This algorithm combines several advantages compared to other feature weighting techniques: first, it handles the problem of features interaction by working within the whole feature space, so no time consuming *exploration of the feature space* is needed. Then, it allows obtaining good results

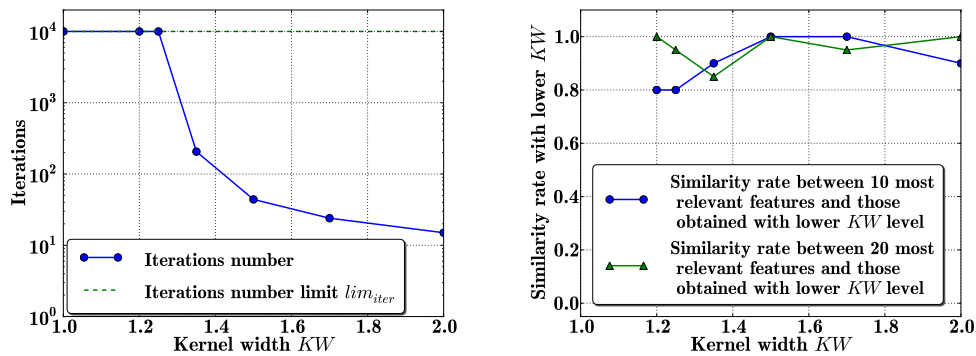
even when working with noisy data and/or in feature space containing a lot of irrelevant features [47, 34], which is particularly interesting in our drilling monitoring application case with the use of an *large scale feature extraction procedure*. However, RELIEF does not help with redundant features: if a feature is relevant, it will be well ranked whenever it is redundant with another one or not. Due to its simplicity and good empirical success, the RELIEF algorithm has been widely used and extended to feature weighting for multiclass classification/clustering and regression applications [38, 54]. An interesting analysis has been performed in [59] that allowed identifying two weaknesses of the algorithm: relevance evaluation is performed in the original feature space, but can be significantly different in the resulting weighted feature space. Then, as features weights are averages of their separation power over instances classes membership, the presence of outliers in the data set can lead to severe misleads. In our application case where uncertain data exist, those drawbacks can significantly affect the feature relevance characterization process results. Solutions have been proposed to address them: first, instead of using only the closest instances to assess the separation power of a feature, influences of several neighbors is taken into account via the use of a kernel function, which allows reducing harmful influence of outliers. Then, the last weighted feature space that has been calculated is used to evaluate features separation power at each iteration, leading, under easy-to-achieve conditions, to the convergence of the algorithm to an optimal weighted feature space. This last property gave its name to the new algorithm: IRELIEF for Iterative RELIEF. It has shown superior performance than the RELIEF algorithm in most cases [59].

Because of its clear theoretical foundations, good empirical success and robustness facing some data imperfections and uncertainties, the IRELIEF algorithm (see [2] for a Python version of the code) has been chosen to perform the feature relevance characterization step in this work.

5.2.3.2 The IRELIEF algorithm: use and parameters settings

The IRELIEF algorithm takes as inputs all data samples in the form of a vector containing their associated features and target class. For cutting edge chipping detection in drilling, these input samples represent drillings given in the form of a vector of features that have been extracted from raw data acquired during a test campaign, and an indicator of the class the sample belongs to, that indicates if the cutting edge was chipped or not during the drilling.

Then, the aforementioned iterative weighting of features as a function of their class separation power considering one data sample (and its neighbors via the use of a kernel function) at a time. 2 criteria can be used to stop the iterative process: the convergence of the features weights, which is achieved when no feature weight shows a difference higher than a limit ϵ from the previous iteration, or the when a limit number of iterations lim_{iter} has been reached. The convergence of the algorithm is mainly driven by a third parameter, the *kernel width* KW . Indeed, if $KW = 0$, only one neighbor of the considered sample is taken into account, as in the original RELIEF algorithm, and experiments showed that the algorithm then rarely converges [59]. On the other hand, if $KW \rightarrow \infty$, convergence is reached in one step because every samples are completely taken into account at the first iteration. The choice of a kernel width value can appears as a tricky task, however, KW has been showed to not be a critical parameter on features weights once convergence has been reached [59]. In this work, lim_{iter} and ϵ will be fixed to 10000 and 0.001 respectively. Then, the choice of a kernel width KW_s associated with each of the S available data collections will be done using a try and error scheme. Indeed, several KW_s values will be assessed, and one of the first one allowing to achieve fast convergence will be chosen, as depicted in figure 5.29.



(a) Number of iterations needed for the features weights to converge as a function of the kernel width KW when using the IRELIEF algorithm on a data collection concerning drill cutting edge chipping (b) Similarity rate between the most relevant feature sets (sets of features presenting the highest weights) selected when applying the IRELIEF algorithm with increasing kernel width KW

Figure 5.29 – Typical behavior of the IRELIEF algorithm on cutting edge chipping detection dedicated test campaigns: convergence is not achieved for low values of KW_s , and becomes very fast after it reached a certain value, 1.7 here (a). This value will be chosen to assess the feature weights. After convergence has been reached, not many changes occurs in the ranking of most relevant features as a function of KW (b)

5.2.4 Data fusion for feature selection

5.2.4.1 Basic fusion approach and related issues

Considering the existence of several data collections, data fusion is needed to perform feature selection taking all available information into account. The basic idea is to perform the BFSP using IRELIEF on every available data collection, and then merge the obtained weighted feature sets to obtain a *Generic Weighted Feature Set* (GWFS), as depicted in figure 5.30. As the feature relevance characterization step is identical for every available data collection, weighted features sets are given in the same form to the fusion algorithm. This allows avoiding the tricky *data alignment* task discussed in sections 2.2 and 4. For instance, feature weights issued of each BFSP can be averaged in order to obtain the generic weighted feature set. However, data collections do not always suit to such direct fusion. First, they may not allow extracting exactly the same features due to the use of different sensors, or a different drilling device. In that case, several strategies can be implemented depending on the fusion algorithm used, following the principle that a feature which is not present in every data collection should not be disadvantaged. Using feature weights for fusion without any preprocessing can also lead to erroneous conclusions because of the different scaling given by the feature relevance characterization algorithm as a function of the data collection specificities. Finally, all data collections may not be considered equally informative: for instance, if a large test campaign has been conducted in good conditions, using quality sensors with high sampling rates and no problem occurred, it should be considered more informative than another one that has provided little amount of noisy data, where acquisition problems occurred, and conducted in conditions (operating conditions or machine dynamic behavior for instance) that are different of the ones that are likely to be encountered by the monitoring system.

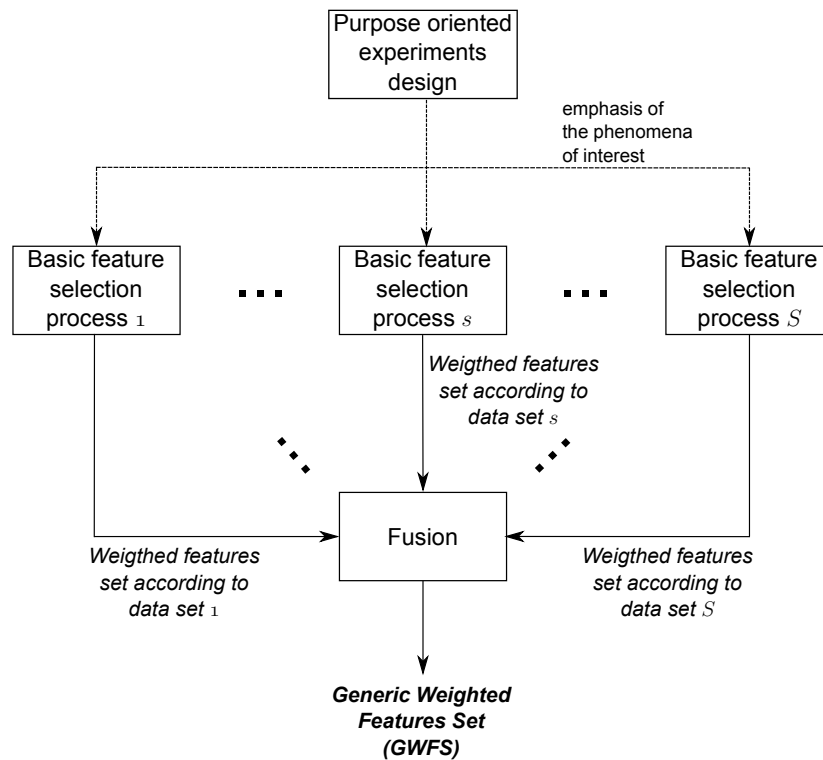


Figure 5.30 – Basic approach for feature selection based upon several data collections

In order to address these issues, it is possible to incorporate a data alignment step to the BFSP before the fusion process occurs, as depicted in figure 5.31. The data alignment step has several objectives:

- to give weights to features that are independent of the scaling resulting from the feature relevance characterization step
- to perform a coherent feature weighing regarding the fusion method used at the next step
- to let the monitoring system designer incorporate meta-knowledge concerning the quality of information provided by a data collection, if any

If the first objective is straightforward, the following ones are to be considered with particular attention. The last one raises the question of *uncertainty representation* because of its close relationship with the quality of information provided by data collections.

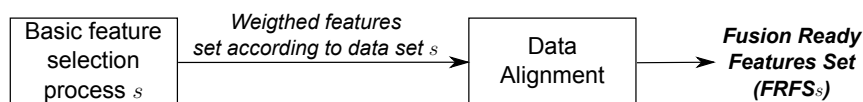


Figure 5.31 – Basic feature selection process incorporating a data alignment step

5.2.4.2 Uncertainty and imperfection sources and representations within the global feature selection process

If the IRELIEF algorithm allows handling low level stochastic uncertainty on features values and attenuating consequences of the presence of outliers in the data by the use of a kernel function, epistemic uncertainty due to lack of knowledge, which comes from the inability for a BFSP to draw conclusions about some features relevance, cannot be modeled at this sub-level of the global feature selection process.

Origins of epistemic uncertainty in sensor-based monitoring are various: everything that leads to the impossibility to prefer a feature instead of another one enters this category. First of all, sensor failures lead to lack of knowledge, as no information is available to draw conclusions. Then, everything that affects sensors detection ability, like mounting issues or too low sample rates increases the level of epistemic uncertainty. Moreover, as stated earlier in this work, uncertainty does not always fall precisely into either stochastic or epistemic uncertainty: when so much stochastic perturbations, or noise, affect measurements making statements based upon acquired data difficult, a lack of detection ability can be considered, so stochastic perturbations induce epistemic uncertainty.

Lack of information or ambiguity on results provided by a BFSP should be compensated at the fusion step by more accurate statements issued from the processing of other data collections, taking advantage of the data collections redundancy and complementarity. Thus, the choice of an information modeling procedure that allows a good uncertainty representation is critical to achieve good fusion performance.

Information modeling using the proposed evidential approach. Due to its ability to handle both stochastic and epistemic uncertainty and its suitability to information fusion contexts, evidence theory has been chosen to perform data modeling and merging at both the data alignment and fusion steps. It has been used following works aimed at singularity detection presented in chapter 4. In the feature selection context, the focused singularity is feature relevance and the information sources are the data collections. This approach proposes a data alignment procedure which has been designed to favor most informative data collections statements about feature relevance at the fusion step. The modeling of information coming from each BFSP at the data alignment step allows representing epistemic uncertainty explicitly, by the use of belief functions.

According to the notations used in chapter 4, the problem will be defined as follows: S information sources, or data collections, provide N_s relevance levels, each one associated with a feature. One can note that the total number of features N_s can vary from one data collection to another as a function of extracted features. Each provided relevance level, denoted x_s^n and where n and s represent respectively the feature and the data collection indexes, is a real number. As the IRELIEF algorithm provides relevance levels between 0 and 1, the singularity of a feature in term of its relevance is then not defined as the distance from its relevance level to the mean of every features relevance levels, but to 0, conversely to what has been done for singularity identification in chapter 4. Thus the singularity level equals the *original relevance level*.

$$sing_s^n = r_s^n \quad (5.4)$$

where r_s^n is the real, but unknown, relevance level of a feature. The uncertain relevance level provided by the IRELIEF algorithm is defined as follows:

$$x_s^n = r_s^n + b_s^n \quad (5.5)$$

where b_s^n is drawn from a known probability density function p_s of mean \bar{b}_s and standard deviation σ_s associated with the s^{th} data collection.

As no a priori information is available on the original relevance levels, they can be estimated using the *provided relevance levels*:

$$\widehat{sing}_s^n = x_s^n \quad (5.6)$$

Hence, the features can be ordered according to their estimated relevance in a vector $\mathbf{D} = [D_1, \dots, D_N]_s$ such that D_1 denotes the feature presenting the highest provided relevance \widehat{sing}_s . The frame of discernment Ω is thus composed of N propositions w_n arguing that the n^{th} feature is the most relevant one, with:

$$N = \max_s N_s \quad (5.7)$$

Then, the estimated relevance levels, or singularity levels, are used to build belief functions on the $2^{|\Omega|}$ elements of the power set following the method presented in chapter 4 using equations 4.11, 4.12 and 4.13. As perturbation distribution are considered Gaussian, the coverage interval P_{cov} needed for the masses calculation will be set to $]-\infty, \mu + 5\sigma]$, in accordance with the method philosophy to favor most informative information sources.

The parameter σ_s associated with each data collection represents the quality of information issued from a BFSP. It influences transition from certain statements about feature relevance to uncertain and ambiguous ones, then transferring more influence to more informative data collections at the fusion step. In the following, this parameter has been set-up manually as a function of the quality of the test campaign that generated each data collection in terms of *operating conditions*, *acquisition parameters*, and the *number of available instances* for each class. In a further attempt, a fuzzy system could be used due to its ability to transpose a combination of qualitative statements about the quality of a data collection into a numerical parameter suitable to be used by the algorithm as the σ_s parameter.

Classical approaches. In parallel with the evidence theory based approach, three simple data alignment procedures have also be implemented for comparison purposes. The features weights issued from the BFSPs have been respectively: conserved (equation 5.8), squared (equation 5.9), and cubed (equation 5.10). Power elevation of the feature weights is aimed at emphasizing the difference between highly relevant features and others, and doing so advantaging the most informative features in another way, even if present in low number of data collections. No epistemic uncertainty has been modeled explicitly.

$$m_s(\omega_n) = x_s^n \quad (5.8)$$

$$m_s(\omega_n) = x_s^{n^2} \quad (5.9)$$

$$m_s(\omega_n) = x_s^{n^3} \quad (5.10)$$

5.2.4.3 Fusion strategies

Issues evoked in the previous section emphasized the importance of the fusion algorithm. Four different $\{\textit{information modeling}, \textit{fusion algorithm}\}$ couples have been implemented. For the three first ones, very simple data alignment (power elevation) strategies and fusion algorithm (averaging, equation 5.11) were used.

$$m(\omega_n) = \frac{1}{S} \sum_{s=1}^S m_s(\omega_n) \quad (5.11)$$

As explained in the previous section, the last couple has been designed in the evidential framework. The fusion has been done according to the Yager combination rule (equation 2.37), giving a list of feature ranked according to their relevance. The evidential method presents a severe drawback that is encountered in applications of evidence theory: the complexity increases exponentially as a function of the number of features because calculations are done for every element of the features power set. Thus, in order to reduce computation time, a criterion, the *relevance lower limit* rel_s has been set-up for each data collection after observation of the IRELIEF results to eliminate most irrelevant features.

A redundancy filter has also been set-up as redundant features decreases prediction performance: it conserves only one of features showing a correlation coefficient superior to the correlation lower limit lim_{corr} . To assess the redundancy of 2 features f_1 and f_2 over S test campaigns, the S correlation coefficients $corr_s$ (equation 5.12) are averaged to compute a *global correlation coefficient* $corr_{global}$, as described in equation 5.13, which is then compared to the user defined limit lim_{corr} .

$$corr_s(f_1, f_2) = \sum_{d=1}^{d=D_s} \frac{(f_1(d) - \bar{f}_1)(f_2(d) - \bar{f}_2)}{\sqrt{\frac{1}{D_s}(f_1(d) - \bar{f}_1)^2} \sqrt{\frac{1}{D_s}(f_2(d) - \bar{f}_2)^2}} \quad (5.12)$$

where D_s represents the number of drillings, or data samples, associated with the s^{th} test campaign

$$corr_{global}(f_1, f_2) = \frac{1}{S} \sum_{s=1}^S corr_s(f_1, f_2) \quad (5.13)$$

The use of *relevance* and *redundancy filters* to pass from a big feature set to a reduced one before further processing has already been mentioned in [4, 30, 7]. The global process implemented in this work, from raw data to a global weighted feature set, is depicted for each approach in figure 5.32.

5.2.5 Performance assessment on a real case study: drill cutting edge chipping

In order to assess the performances of the feature selection approaches described above, data issued from a real case study will be used. Monitoring of drill bits cutting edge chipping has been investigated in industrial environment. Two drill bit cutting edge states have been considered: chipped or good shape. During the test campaigns that have been used in this work (see appendixes A.1 sample 1, A.2 sample 2, A.3, A.4, A.5 samples 1 and 2), multi-material stacks (CFRP/Ti6Al4V & CFRP/Alu) have been drilled, but only the detection of drill cutting edge chipping in CFRP has been considered here.

Using classification algorithms in order to discriminate drillings realized with good shape drills from ones performed with chipped drills was not possible due to presence of data

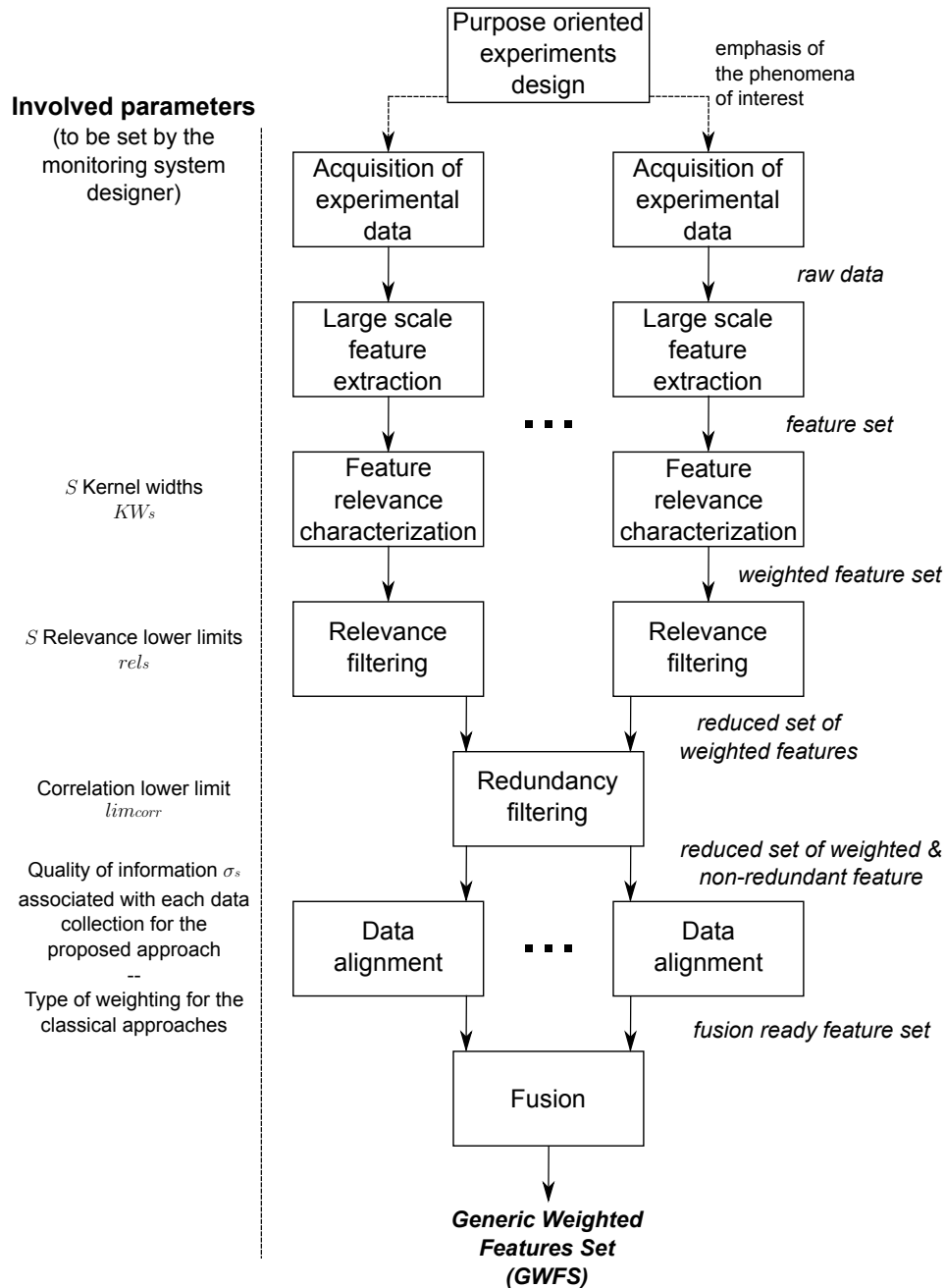


Figure 5.32 – Global feature selection process implemented in this work

acquired in different operating conditions that would have implied changes in the feature space topology, forbidding its separation in different regions before the monitoring processes had begun. Therefore, a clustering algorithm has been used as an estimator: it was aimed at finding two clusters of drillings within feature spaces obtained after the use of the above described feature selection processes. If the selected features are relevant, then the *clustering error rate* E , computed following equation 5.14 should be low as they allowed a robust discrimination between drillings realized with a good shape drill from those performed with a chipped one.

$$E = \frac{\text{Number of misclustered samples}}{\text{Total number of samples}} \quad (5.14)$$

An enhanced version of the *K-means* algorithm that take into account the supposed probability distributions of the drillings as a function of selected features (Gaussian), has been used as a clustering algorithm. Its description can be found in [44], and further information will be given in a further section concerning its implementation for cutting edge chipping detection. The important thing here is that it is representative of the estimator that will be used in the monitoring system. However, conversely to what will be implemented, the 2 initial clusters centers will be set randomly in the feature space for sake of generality of the performance assessment of the different feature selection processes.

As features are ranked according to their relevance at the end of the feature selection process, feature sets will be evaluated by adding one feature at a time: $\{f_1\}, \{f_1, f_2\}, \dots, \{f_1, \dots, f_N\}$ so the ability of the feature selection approaches to rank features, that will allow to build reduced feature sets by selecting only the top ranked features, will also be emphasized.

5.2.5.1 Description of the input data

6 Drilling test campaigns (data recorded during the drilling of the 1st and 2nd samples of the test campaign described in appendix A.5 are considered as different tests campaigns here) have been conducted in both industrial and lab conditions on 4 different drilling machines, 2 robots (robots 1 & 2) and two machining centers (MC 1 & 2). Data collections are of limited size, not exactly the same sensors were used during each test campaign, and operating conditions were not always identical neither. Further information about tests campaigns used to build data collection are given in appendix) Moreover, due to the harsh acquisition conditions, some measurements were affected by high noise levels and sometimes sensors failures occurred. An overview of data collections properties is provided in table 5.3. It is also important to note that each of the different chipping (depicted in figure 5.33) that occurred or was provoked is unique by its size, location and shape, so their respective influences on sensor measurements, and therefore on extracted features, are unique too. Between 6 and 11 sensors of five different types have been used for each campaign, and between 350 and 556 features have been extracted from the raw data after the large scale feature extraction step, depending on the number and location of mounted sensors during the test campaign.

Although the available data collections can be considered difficult to deal with, due to they heterogeneity, they are representative of real-life conditions where a tool condition monitoring system is needed, and also justify the incorporation of uncertainty in information modeling.

5.2.5.2 Numerical experiments design

As the objective of the monitoring system is to achieve the best clustering performance using the smallest feature set, clustering has been performed on each data collection using an increasing number of feature following their ranking (or weighting) after the feature selection process described in figure 5.32 has been applied for each of the 4 described approaches. The ability of each method to identify good features has been assessed by using the average

Test Campaign	Device	Cutting Speed	Feed	Drillings Number	With Chipping	Data Quality	Features Numbers
1	MC 1	+	+	103	33	++	556
2	MC 1	+	+	80	17	+	526
3	robot 1	++	++	9	6	+++	389
4	robot 2	+	+	137	5	+	350
5	MC 2	+	+	96	26	++	419
6	MC 2	+	+	97	27	++	419

Table 5.3 – Overview of data collections properties

clustering error rate computed over results of Monte-Carlo simulation in order to overcome the bias involved by the random clusters initialization. 200 runs of the K-means algorithm have been performed for each $\{ \textit{data collection}, \textit{Feature selection approach}, \textit{size of the feature set} \}$ triplet.

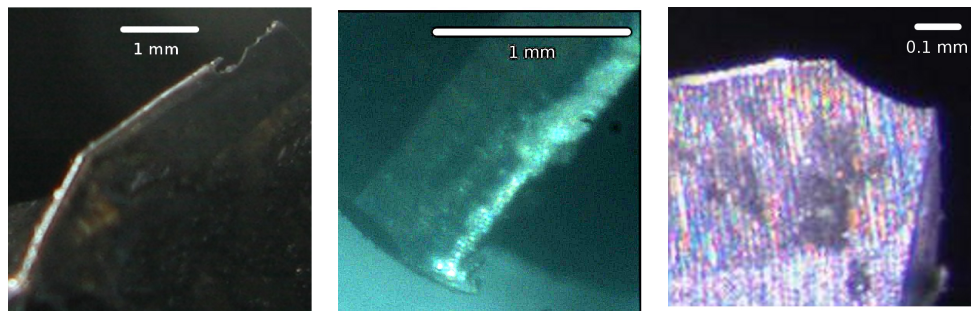
First series of experiments. The first series of experiments was aimed at understanding the influence of integration of a significantly different data collection into the global feature selection process, and also to compare behaviors of the different feature selection approaches on a simple case. The 3 first data collections have been used to do so.

First, only the 2 first data collections have been used to obtain the 4 generic weighted feature sets. The parameters settings that have been used are given in table 5.4. The kernel widths KW_1 and KW_2 used within the IRELIEF algorithm have been determined following the trial and error method explained in section 5.2.3.2. The rel_s parameters have been chosen so that the total number of features N in the GWFS does not exceed 8. The lower correlation coefficient limit lim_{corr} has been set to 0.95 in order to exclude only features that were so redundant that they cannot improve discrimination performance. σ_1 and σ_2 , which represent the quality of information provided by data collections 1 and 2 within the proposed approach data alignment method, have been set to 0.015 and 0.030 respectively, stating that the first test campaign is more informative than the second one. Several considerations have lead to this setting: first, more holes have been drilled during the 1st test campaign, and there was a higher proportion of drillings done with a tool presenting a chipped cutting edge. Then, more sensors have been used, and so more features have been obtained than during the 2nd test campaign. Moreover, the conditions in which the experimental data were acquired were not the same: due to different acquisition hardware and software material, the sampling frequency has been reduced for the 2nd test campaigns (which limits the information content of raw data), and crashes of the acquisition software occurred during the acquisition, leading to lower quality data. The clustering performance obtained using features of the GWFS on

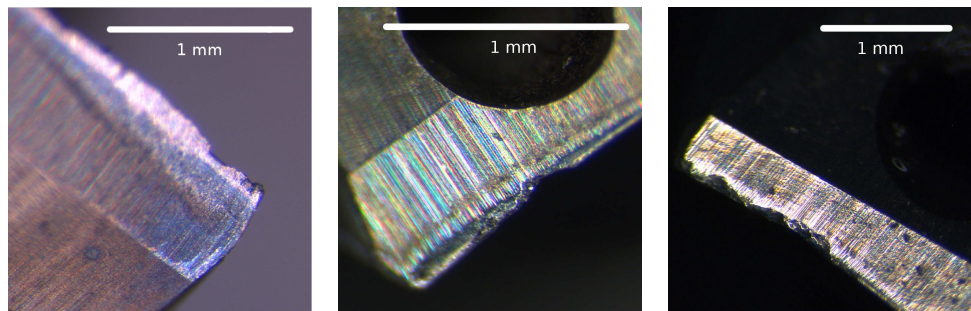
Test campaign s	KW_s	rel_s	lim_{corr}	σ_s
1	1.5	0.12	0.95	0.015
2	1.7	0.12	0.95	0.030

Table 5.4 – Parameters used in the feature selection process involving data collections 1 and 2

each of the 2 data collection has been assessed. Results are showed on figures 5.34(a) and 5.34(b) respectively. Concerning the first test campaign, all approaches gave comparable results except the 'cubic' one which did not behave of the same manner. One can note that *clustering performance tended to decrease as the feature number increased*. This is due to the fact that additional features did not provide useful information while increasing the feature space dimensionality and noise. The second data collection shows better results:



(a) Cutting edge chipping provoked during the 1st test campaign (b) Cutting edge chipping provoked during the 2nd test campaign (c) Cutting edge chipping provoked during the 3rd test campaign



(d) Cutting edge chipping that appeared during the 4th test campaign (e) Cutting edge chipping provoked during the 5th test campaign (f) Cutting edge chipping provoked during the 6th test campaign

Figure 5.33 – Tool cutting edge chippings that appeared or have been provoked during the 6 test campaigns used to assess feature selections approaches

lower error rates are achieved, even with low feature numbers. This is probably due to the apparition of a more impacting tool cutting edge chipping (see figures 5.33(a) and 5.33(b)). In particular, the proposed and simple averaging data alignment approaches outperformed the 2 other ones when using a low number of features, showing a good ability for efficient feature ranking in this case.

Not the same number of features has been used for different or data collections (7 for the 1st test campaign and 8 for the 2nd one): this is due to the fact that one feature have been selected in the GWFS that does not exist within the 1st data collection.

In a second time, the 3rd data collection, which differs significantly from the two others with respect to many points (see table 5.3), has then been fused with the two first ones in the global feature selection process. The parameters settings that have been used are given in table 5.5. The parameters related with the 2 first data collections remained the same. Concerning the 3rd one, σ_3 has been set to 0.015. Despite the low number of available data samples (or drilled holes), four reasons motivated the choice of such a value:

- the chipping size and location are representative of those happening in industry
- the cutting conditions (increased cutting speed and feed) used during this test campaign should emphasize perturbations due to a cutting edge chipping on a drill
- the data acquisition conditions were very good
- the test campaign has been realized in an industrial environment, on a robot that is

Test campaign s	KW_s	rel_s	lim_{corr}	σ_s
1	1.5	0.12	0.95	0.015
2	1.7	0.12	0.95	0.03
3	3.0	0.12	0.95	0.015

Table 5.5 – Parameters used in the feature selection process involving data collections 1, 2 and 3

usually used to perform drillings on aircrafts structural parts, which is representative of the systems on which the developed monitoring system should be implemented

Results are depicted in figures 5.34(c), 5.34(d) and 5.34(e). If they are quite similar for the 2nd data collection (except for the data alignment approach using original relevance levels for which performances decreased), they are better for the 1st one: the BFSP on the 3rd data collection allowed selection of features that are relevant but that were not selected when using only 2 data collections. Results are comparable using either the proposed approach or classical ones as nearly every feature are involved to achieve them, although one can remark that the proposed approach performance increases since 8 features are involved instead of 9 when using classical approaches, showing a better feature ranking ability. Considering the 3rd data collection, good cutting edge chipping identification has been achieved, and advantage is also given to the proposed approach confirming performance improvements can be achieved by taking epistemic uncertainty into account in the feature selection process. This case study also allowed to demonstrate that incorporating data from test campaigns that are different in the feature selection process could allow performance improvements in general.

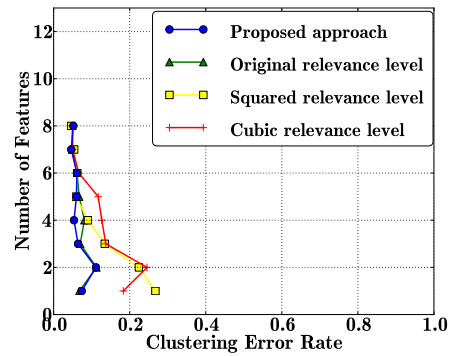
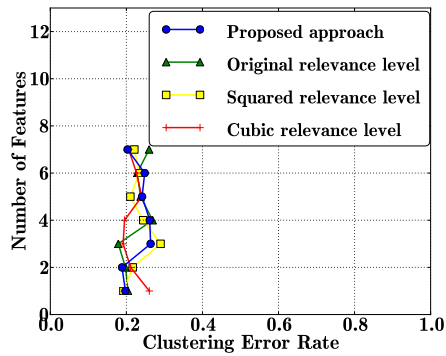
Second series of experiments. The second series of experiments consisted in the fusion of 4, and then 6 data collections in order to assess the influence of using an important number of heterogeneous test campaigns within the feature selection process.

First, data collections 1, 2, 3 and 4 have been used to create a GWFS. Parameters as described in table 5.6 have been used. The lower relevance limits rel_s have been decreased in order to allow the selection of more features than in the previous series of experiments. They have been set-up manually as a function of the feature weights distributions after performing the 4 BFSPs. One can remark the high value used for the parameter rel_4 : this is due to the fact that a high number of features had a high weight after the $BFSP_4$. σ_1 , σ_2 and σ_3 have been conserved from the previous experiment, whereas σ_4 has been set to 0.04 due to the little size of the chipping that occurred during the 4th test campaign, the low number of drillings that have been done with a bad shape drill, and the low number of features contained in the data collection.

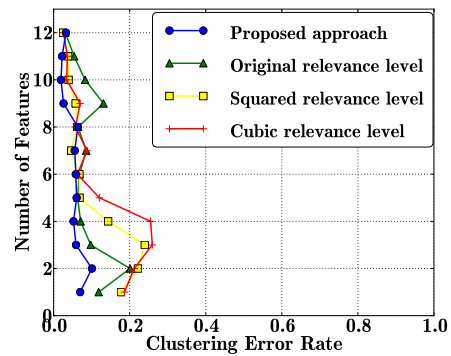
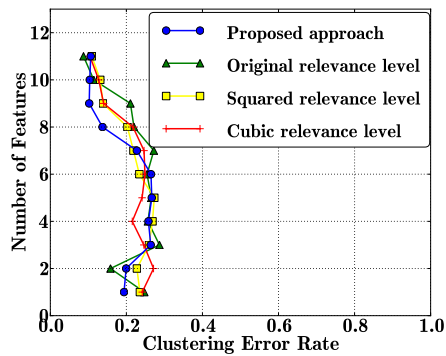
Test campaign s	KW_s	rel_s	lim_{corr}	σ_s
1	1.5	0.105	0.95	0.015
2	1.7	0.105	0.95	0.03
3	3.0	0.115	0.95	0.015
4	1.5	0.190	0.95	0.04

Table 5.6 – Parameters used in the feature selection process involving data collections 1, 2, 3 and 4

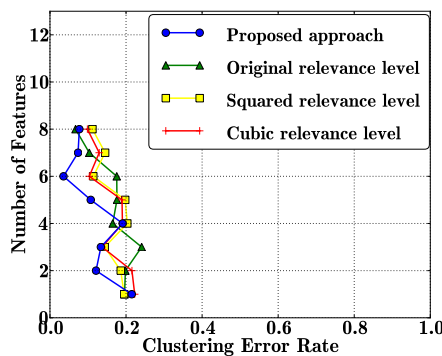
As more features have been used than in the previous series of experiments, clustering performance should be at least as good because all features that had weights superior to $rel_s = 12$



(a) Clustering performance obtained on the 1st data collection after feature selection was performed using data collections 1 and 2 (b) Clustering performance obtained on the 2nd data collection after feature selection was performed using data collections 1 and 2

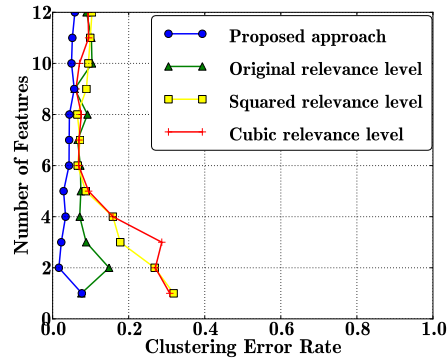
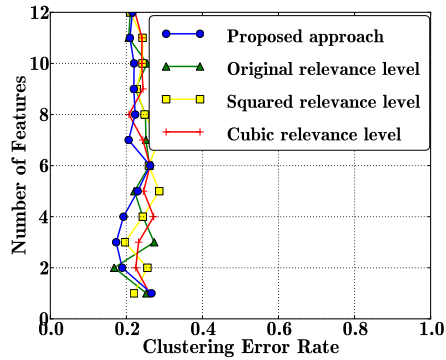


(c) Clustering performance obtained on the 1st data collection after feature selection was performed using data collections 1, 2 and 3 (d) Clustering performance obtained on the 2nd data collection after feature selection was performed using data collections 1, 2 and 3

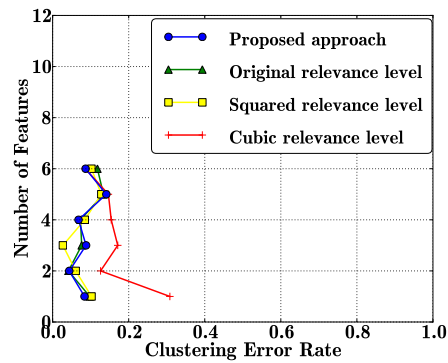
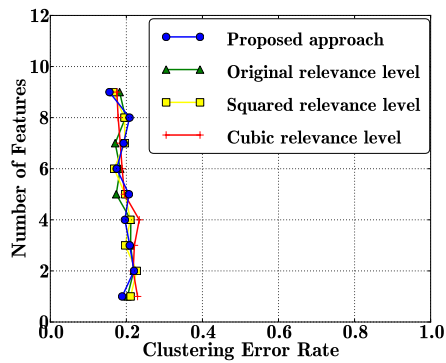


(e) Clustering performance obtained on the 3rd data collection after feature selection was performed using data collections 1, 2 and 3

Figure 5.34 – Performances in discriminating between drillings realized with good shape and chipped drillings on different data collections using features sets issued from fusion of 2 similar ((a),(b)), and 2 similar and 1 different data collections ((c),(d), (e))



(a) Clustering performance obtained on the 1st data collection after feature selection was performed using data collections 1 ,2, 3 and 4 (b) Clustering performance obtained on the 2nd data collection after feature selection was performed using data collections 1 ,2, 3 and 4



(c) Clustering performance obtained on the 3rd data collection after feature selection was performed using data collections 1 ,2, 3 and 4 (d) Clustering performance obtained on the 4th data collection after feature selection was performed using data collections 1 ,2, 3 and 4

Figure 5.35 – Performances in discriminating between drillings realized with good shape and chipped drills on different data collections using features sets issued from fusion of 2 similar and 2 different data collections

have been selected as rel_1 , rel_2 and rel_3 equaled 0.105, 0.105, and 0.115 respectively in the second series of experiments. However, this was not the case for the 1st and 3rd data collections (figures 5.35(a) and 5.35(c)), where performances decreased compared to the first series of experiments (figures 5.34(c) and 5.34(e)). This paradoxical results are due to the *redundancy filtering* step: following the process described in section 5.2.4.3, when redundant features are detected only the one presenting the highest relevance level is conserved. Therefore, some features that have been selected within the first series of experiments have been 'replaced' by presumably redundant ones in the second series of experiments. However, it appears that even if the global correlation lower limit lim_{corr} has been set to a high level (0.95), the redundancy filtering as it has been implemented in this work can lead to a loss of relevant information, emphasizing the critical role of redundant or quasi-redundant features can have in discrimination and estimation problems.

The proposed data alignment and fusion approach performed better on data of the 2nd data set and always allowed obtaining results that makes part of the best ones, whatever the approach that have been used. In the same manner as in the previous series of experiments, close results are often obtained when averaging original feature relevance and using the proposed approach.

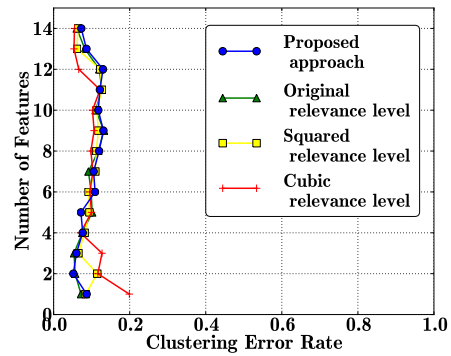
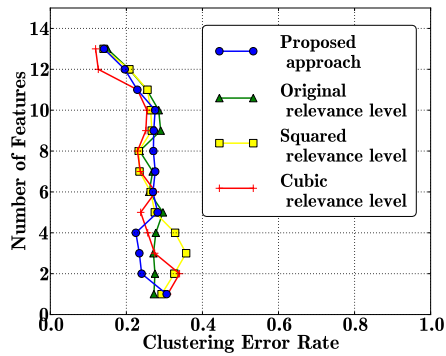
As for the 2nd data collection within the previous series of experiments, the 'cubic' data alignment approach gave bad results for the 2nd and the 4th data collection when few features were used. It is also the case of the 'squared' data alignment approach for the 2nd data collection. This illustrates the limitations of the method consisting in emphasizing features possessing high relevance level without taking the quality of information provided by the data collections into account via an adapted uncertainty modeling. Good discrimination performance has been achieved on data issued from the 4th test campaign for the 3 first approaches.

In a second time, the 5th and 6th data collections have been added to the feature selection process using parameters described in table 5.7. As these test campaigns have been realized in the same conditions, the same parameters have been used for both of them. σ_5 and σ_6 have been set to 0.02 because the test campaigns have been realized in good conditions, and a reasonable number of drillings have been realized, with a good proportion done with a bad shape tool.

Test campaign s	KW_s	rel_s	lim_{corr}	σ_s
1	1.5	0.105	0.95	0.015
2	1.7	0.105	0.95	0.03
3	3.0	0.115	0.95	0.015
4	1.5	0.190	0.95	0.04
5	1.0	0.110	0.95	0.02
6	1.0	0.110	0.95	0.02

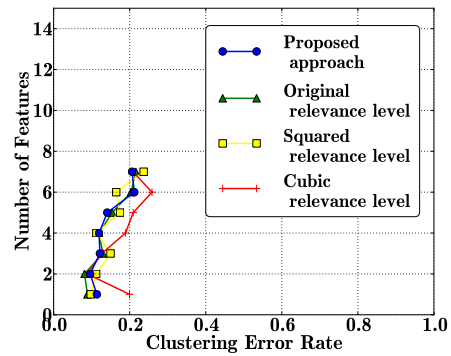
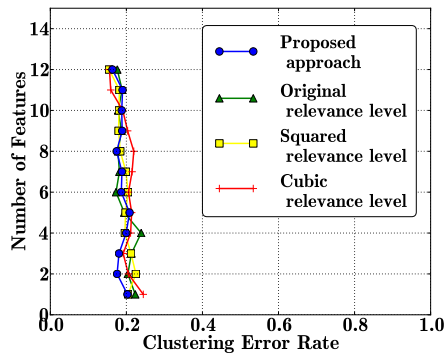
Table 5.7 – Parameters used in the feature selection process involving data collections 1, 2, 3, 4, 5 and 6

Clustering has then been performed on each of the 6 data collections using the so-obtained GWFS, and results are depicted in figure 5.36. They are very similar whatever the data alignment and approaches used. The 'cubic' approach outperformed other ones when very few features are used for the 5th and 6th collections. Globally, clustering error rates are higher than those obtained when fusing only 4 data collections. The similarity of the results whatever the used approach and the performance decrease can be explained by the fact that *integrating too much different types of data collection cannot help in improving accuracy of estimations*. However, the performance levels are still acceptable, so the obtained GWFS, if they do not allow obtaining the best performances on special cases, are able to provide interesting results on a wide range of drilling operation configurations, confirming the interest of information fusion to perform feature selection.



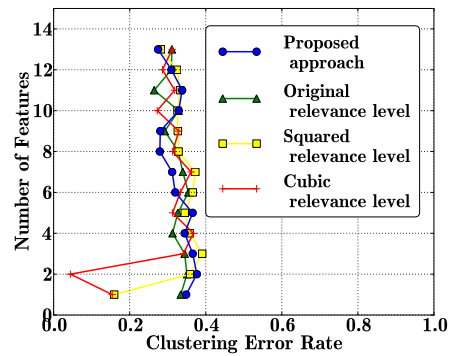
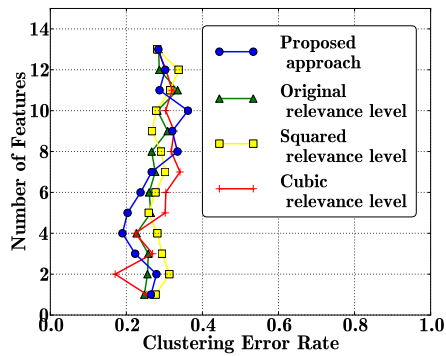
(a) Clustering performance obtained on the 1st data collection after feature selection was performed using data collections 1 ,2, 3, 4, 5 and 6

(b) Clustering performance obtained on the 2nd data collection after feature selection was performed using data collections 1 ,2, 3, 4, 5 and 6



(c) Clustering performance obtained on the 3rd data collection after feature selection was performed using data collections 1 ,2, 3, 4, 5 and 6

(d) Clustering performance obtained on the 4th data collection after feature selection was performed using data collections 1 ,2, 3, 4, 5 and 6



(e) Clustering performance obtained on the 5th data collection after feature selection was performed using data collections 1 ,2, 3, 4, 5 and 6

(f) Clustering performance obtained on the 6th data collection after feature selection was performed using data collections 1 ,2, 3, 4, 5 and 6

Figure 5.36 – Performances in discriminating between drillings realized with good shape and chipped drills on different data collections using features sets issued from fusion of 6 data collections

5.2.6 Overview on feature selection

Feature selection is a critical step in the implementation of an efficient drilling monitoring system. Different basic approaches have been underlined, and *feature weighting methods*, or filters, have been chosen due to their flexibility and ease of use. In particular, the IRELIEF algorithm address many issues encountered for feature selection from experimental data sets, as it is the case in this study.

Important points to consider when performing feature selection, namely *feature redundancy*, *feature interactions*, and *quality of data*, have been emphasized, and their respective influences have been characterized on a real case study.

The need of a fusion approach to perform feature selection within the implementation of an industrial monitoring system has been introduced, and several methods have been proposed and implemented. In particular, an approach designed in the evidential framework following principles detailed in chapter 4 allowed obtaining good results on a monitoring real case study of tool chipping detection. Its superiority to classical methods in some cases is due to its possibilities in terms of uncertain and imperfect data modeling.

It has also been shown that incorporating heterogeneous data collections into the feature selection process could contribute to the improvement of the accuracy and the robustness of a monitoring system.

Further works will focus on automatic quality assessment of data collection for the proposed approach, and on the design of experiments dedicated to the assessment of the generalization capabilities of feature sets build using the different approaches.

5.3 Drilling monitoring applications

This section will describe the development some essential tasks, taking the form of *building blocks of a drilling monitoring system* using concepts and approaches presented previously in this manuscript.

The first one, *the identification of the different drilling phases* while performing stacks drilling, will be shown to be an essential requirement for further monitoring operations.

The formalization and implementation scheme described in chapter 3 will be used to design these monitoring subsystems. This section should remain open to be completed with different specific monitoring applications, or building blocks, corresponding to the user needs.

5.3.1 Drilling operations phases identification

Drilling multi-materials stacks is a typical operation for airframe assembly. The 3 most encountered materials are CFRP, aluminum alloys and titanium alloys, but magnesium alloys can also be encountered. As detailed in section 1.2.1.2, parts of different materials are pre-assembled, and the drilling operation has to be performed for all the layers at the same time. Indeed, the drilling machine must keep its position until the hole has been completely drilled in order to avoid defects due to machine repositioning. Drilling stacks of materials that present antagonistic mechanical and thermal properties, like aeronautical titanium alloys and CFRPs for instance, is very challenging. Several studies [10, 51, 12] underlined the difficulties linked with such drilling operations, that have been detailed in section 2.1. The best solution, in addition to the use of adapted cutting tools, has been shown to be the adaptation of the cutting parameters as a function of the material. To do so, when the machine reached the drilling position, the first layer of the stack is drilled. The drilling operations is stopped while the machine position remains constant, and the cutting parameters are adapted to the second layer material while the drill is not in contact with the workpiece. Then, the drilling operation starts again, and so on as a function of the number of layers in the stack. This process is depicted in figure 5.37.

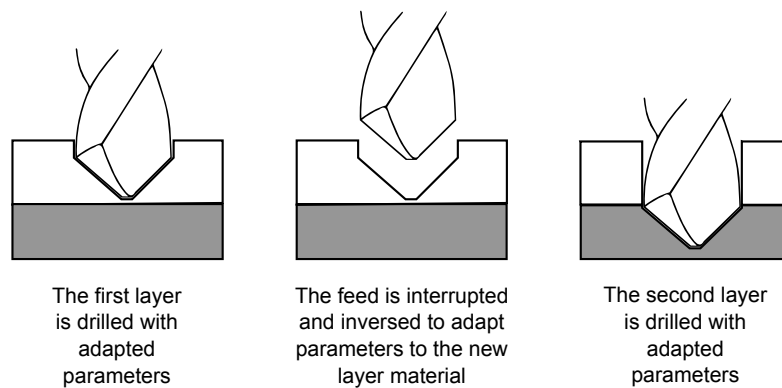


Figure 5.37 – Typical sequence of a multimaterial stack drilling

From the *monitoring system designer* point of view, such interrupts of the drilling operations due to the presence of different material layers are very important to be detected in a reliable manner. As the material properties and cutting parameters are different from one layer to another, the sensors signals, and consequently the features that will be extracted from, will present different properties. The identification of time intervals corresponding to countersinking operations, if any, is also concerned. In the same manner, depending on the triggering set-up of the monitoring system, maybe not the whole signals contain information related to the cutting operation. Then, their interesting part must be isolated before the feature extraction procedures take place in order not to incorporate irrelevant data that will decrease the quality of information provided by features.

The identification of the different phases of drilling operations is therefore a concern of major importance in order to perform online monitoring. A method will be presented that take full advantage of multisensor techniques: its *robustness* will be guaranteed by *redundancy* and data imperfection handling at the basis of the system, and its *accuracy* by the use of *complementary* sensors to detect different phenomena of interest. In order to preserve the generality, precise guidelines and different options that could be used will be described instead of a detailed description of what has been implemented during this work. Results obtained will be provided as illustrative examples. The system robustness and reliability have been assessed both by simulations and by experiments carried on a drilling robot and a machining center.

5.3.1.1 Problem position

The drilling phase identification problem consists in finding *singularities* in sensors signal that denote the entry of the drill (or its countersinking stage) in the workpiece, its exit, or the change of parameters occurring at interface between material layers. Thrust force has been the favorite signal to detect such events.

Figure 5.38 shows that thrust force signal, after a basic filtering operation, allows easy identification of the different phases in the drilling of a CFRP/Ti6Al4V stack. The use of a simple threshold should be sufficient to determine the time intervals corresponding to these phases, allowing then to perform feature extraction on other signals considering these time limits. However, this signal is issued from a lab experiment with a rotating dynamometer (Kistler). It has been showed that force sensors integration is difficult (see section 5.1), and that widely spread solutions to perform force measurements in industrial environments do not exist.

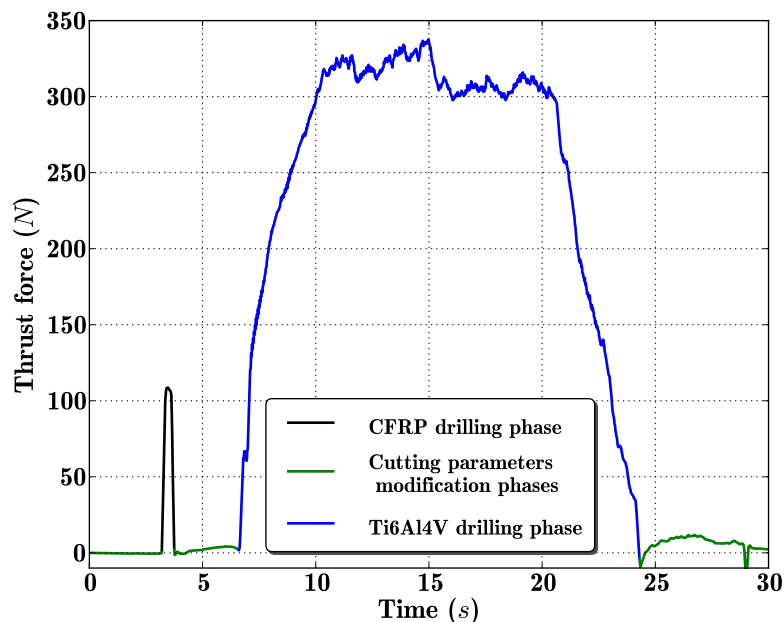
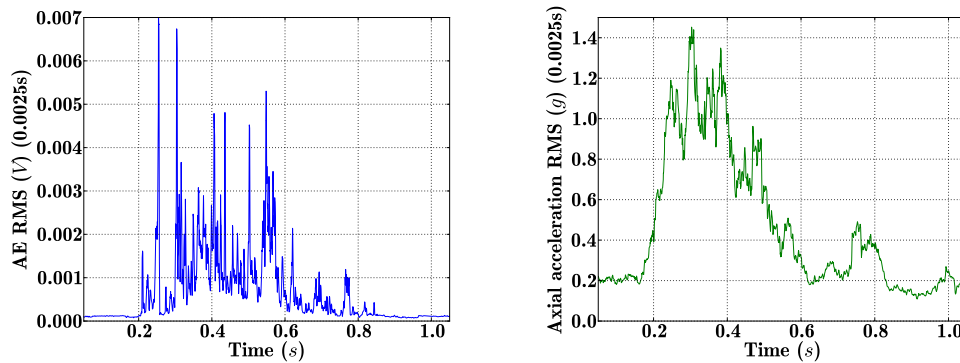


Figure 5.38 – Different phases of the drilling of a CFRP/Ti6AlV4 stack are visible on the thrust force signal. A moving average filter has been applied

Sensors integration. As drilling phases identification is a basic need in order to implement a monitoring system, different solutions than force sensors have been investigated, with a preference for non-intrusive and easy-to-integrate sensors. As the phenomena of interest are simple in this case, no systematic procedure will be applied for sensor selection. Available sensing options to detect drilling or countersinking beginning and ending, and that covers as many application cases as possible will be briefly discussed hereafter. Using sensors to detect the entry of the drill present the advantage, compared with estimations based on the CAD design of the process, to obtain a value free of deviation due to differences between the real and theoretical workpiece and drilling machine positions.

The drill entry in the material is visible in several sensors signals. In particular, sensors sensible to the cutting operation like AE sensors or accelerometers are very sensitive to the beginning of drilling operations. In order to facilitate the detection of the drill entry in the material, some preprocessing on the raw signals may be needed. Examples of moving RMS performed on AE and acceleration signals are given in figure 5.39. In a lower extent, feed currents, spindle currents, and information given directly by the drilling machine numerical command may be used to detect the entry of the drill. However, as stated earlier, their detection ability is limited to drilling operations where the needed cutting power is sufficient to be visible on these signals. This may not be the case for small diameters drilling in CFRP for instance.



(a) RMS of the CFRP drilling phase of an AE signal. The AE sensor was mounted on a drilling robot end-effector, as depicted in figure 5.5(a)
 (b) RMS of the CFRP drilling phase of a spindle axial acceleration signal. The accelerometer was mounted on a drilling robot end-effector, as depicted in figure 5.2(a)

Figure 5.39 – Examples of preprocessed signals allowing to determine the time of the drill entry in the workpiece: the RMS level of acceleration and AE signals present a strong increase around 0.2s that is simple to detect. Signals are provided by sensors that do not present high integration constraints

Feed interrupts while drilling are important to be detected in order to identify moments at which the drilling of a layer ends, or the ending of countersinking operation. As it can be seen on figures 5.39(a) and 5.39(b), the feed interruption is difficult to detect accurately using signals from sensors sensible to the cutting operation. Signals related to the feed control itself are much more informative in this case: a change in the feed direction, which is often done before changing the process parameters, is visible on feed motor phases currents and in several control signals usually available in the machine numerical controller. Such a signal issued from the controller of a machining center corresponding to the inversion of the feed direction at the end of countersinking operation is depicted in figure 5.40(a) together. A wavelet processed version of the same signal (figure 5.40(b)) allows easy identification of the feed inversion moment.

In this case again, sensors, if any, are not intrusive. Moreover, if current sensors are used,

as feed motors possess 3 phases, three sensors can be installed, opening the way to the implementation of a fusion system for robustness improvement.

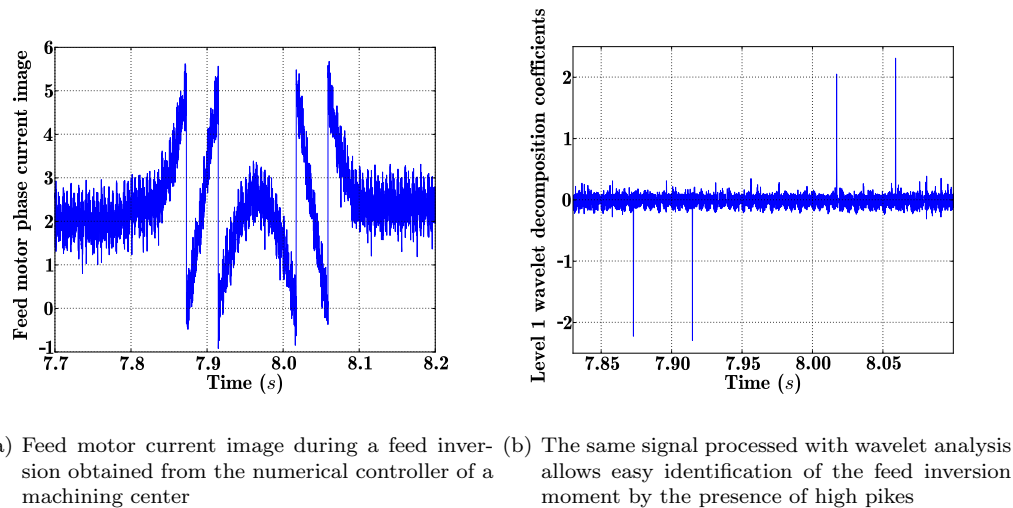


Figure 5.40 – Example of a signal allowing, after a processing step, to determine the moment when an inversion of the feed direction occurred

The drill exit of the material is more difficult to detect accurately without using thrust force sensors. Indeed, due to the conical profile of the drill tip, the sensed quantities tends to decrease slowly, which makes difficult a precise identification of the beginning or ending time of the drill tip exit of the workpiece. This is not the case when using thrust force because most of the thrust force is generated at the end of the drill tip, and not by the cutting edges. Therefore, an abrupt decrease of thrust force is visible once the drill tip end exits the material. In this study, as the workpieces thicknesses were known, the end of the drilling operation has been deduced as a function of the process parameters and of the time at which the drill entered in the material (the second layer). This is not the case for every parts to be assembled for airframe assembly: thickness variations can appear, especially when using CFRP, that may not allow the use of such an estimation procedure depending on the accuracy needed in the estimation.

We focused on the use of non-intrusive and easy-to-integrate sensors in order for this building block of a drilling monitoring system to be implementable in the widest range of application cases. It has been shown that it is possible to detect the beginning of drilling operations as well as feed direction inversions in signals with such sensors.

Feature selection & feature extraction. As for sensor selection, the simplicity of this use case in terms of phenomena of interest to be detected would make the use of a systematic feature selection procedure as described in section 5.2 irrelevant. Sensors signals presented above showed that the features to look for in order to identify the moments of occurrence of considered phenomena (drill entry and feed inversion) are only the values taken by the signal, or a processed version, at this moment. Consequently, based on the values of the signal at each moment, which compose the *feature set*, the estimator will have to determine which one corresponds to the occurrence of the phenomenon of interest, and then link it with its corresponding time of occurrence.

The *feature extraction* steps consists in signal preprocessing, if needed, to transform the signal in a form corresponding to the estimator needs.

Choice of estimators. Concerning the *drill entry* and *feed inversions*, and given the examples proposed above, at least two basic possibilities can be envisaged to find the *singular* feature value corresponding to the time of occurrence of the phenomenon of interest. The first one consists in setting-up a threshold and look for the first feature value that crosses it. Several variants of the implementation can be imagined following the user needs, like, for example, auto adaptive thresholds as the one presented in section 5.1.3.3. The second category of solutions is the use of an algorithm that detects abrupt changes in trends. Many algorithms have been developed to do so, and one should choose the most adapted to the kind of signal he is dealing with. As for the first case, once the singular feature value (the first one above the threshold) has been identified, the estimator has to map it with its corresponding occurrence time in the signal. Concerning the second category of solution, the estimator will directly provide the time of the first abrupt change in the signal trend.

As for the estimation of the time when the *drill exits the workpiece*, no sensor signal is needed directly: once the drill entry time in the last layer has been estimated, and knowing the feed rate and workpiece thickness, the exit time can be estimated analytically. This method may be affected by differences between theoretical and real feed rate, if any, however, feed rate feedback systems allow very high accuracy.

The schematic view of these monitoring subsystems functioning charts are given in figures 5.41(a), 5.41(b) and 5.41(c). In the case when no fusion is involved, no decision making strategy has to be implemented.

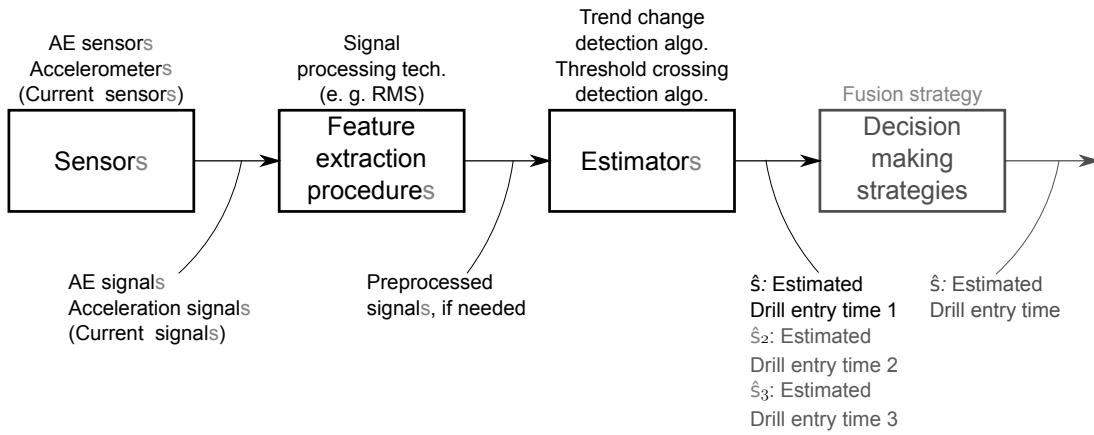
Data imperfection related concerns: discussion and solutions. As detailed in chapter 3, data can suffer from *imperfection*, especially if such monitoring systems are implemented in industrial environments. Concerning the simpler *drill exit detection* monitoring system, if imperfections on data, which are mainly expected to take the form of *uncertainty*, are quantified at the input level, it should be possible to quantify uncertainty at the output. Of course this should be done only the monitoring application requires it. Concerning the detection of the *drill entry* and *feed inversion*, more types of data imperfections are likely to manifest themselves due to the use of sensor data, as described in sections 2.2.2 and 3.2.2. In particular, *ambiguity* due to sensor failure may make the monitoring system designer decide to build a multisensor system. Then, a fusion procedure must be implemented to merge results, deal with *inconsistency* and make decisions. Many solutions are possible (from low level to high level fusion procedures), and the methodology presented in chapter 4 is transportable to such application cases. An example of its implementation will be provided hereafter.

5.3.1.2 Discussion on robustness of the approach

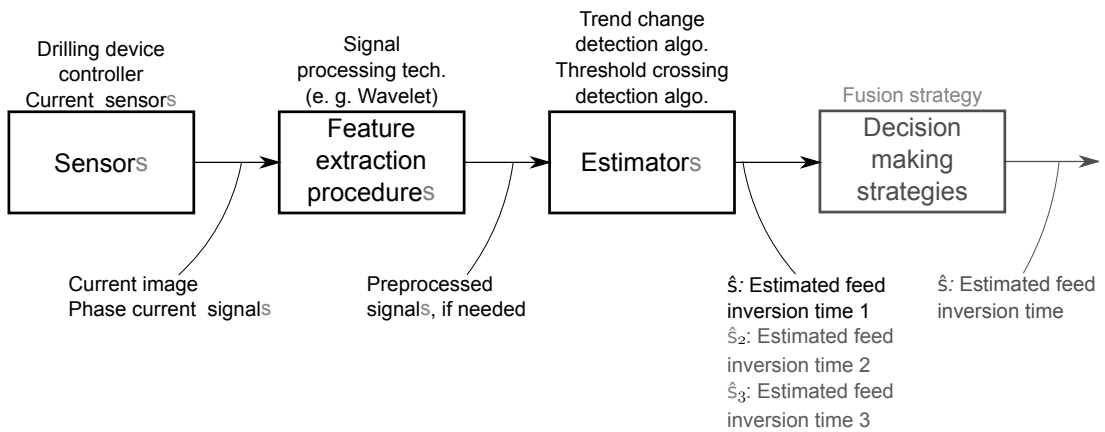
As mentioned earlier, the robustness of the drilling phases identification is primordial to perform efficient monitoring. Solutions to deal with data imperfections brought by the harsh shop floor environment have been proposed in the previous section. However, as it has been stated in chapter 3, a good positioning of problems allowing its decomposition in several simpler ones is often the best way to ensure robustness.

Considering the drilling phases identification problem, one can notice that in the case of CFRP/Ti6Al4V stacks, the duration of the countersinking operation or of the CFRP layer drilling are very low in comparison with the total drilling operation ($\sim 5\%$ in the example given in figure 5.38). The main consequence is that the research of the singular values over the (preprocessed) signal is done, in its majority, on signal portions that are susceptible to contain only perturbing information. Therefore, following the philosophy exposed in chapter 3, it should be better to avoid potential effects of such perturbations upstream, before the singular value identification procedure takes place, than downstream by using complex decision making strategies in order to annihilate harmful effects.

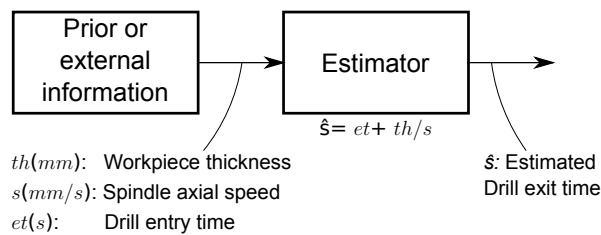
To implement such a methodology, a previous step that consists in a crude, but robust, identification of the drilling operation phases has been implemented. This *large scale* operation



(a) Proposition of a monitoring sequence dedicated to the detection of drill entry in the workpiece



(b) Proposition of a monitoring sequence dedicated to the detection of inversion of feed direction



(c) Proposition of a monitoring sequence dedicated to the detection of drill exit of the workpiece

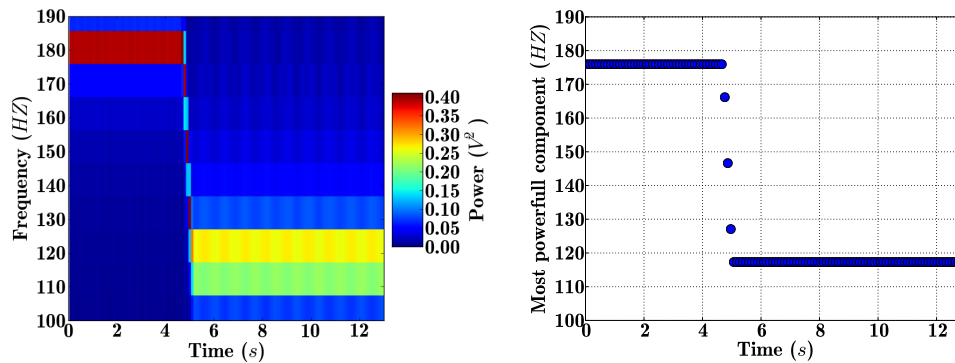
Figure 5.41 – Monitoring systems dedicated to the identification of the different phases of drilling operations performed in multi materials stacks. Gray parts are optional and concern the implementation of multisensor fusion procedures

is performed before the tasks aimed at the accurate identification of moments of interest (*low scale*) described above.

The implementation of this previous step in the case of CFRP/Ti6Al4V stacks drilling is detailed hereafter. It uses the fusion methodology described in chapter 4. The performance that this methodology allows in drilling phases identification will be compared on experimental data with those obtained when not using the multi-scale approach.

5.3.1.3 Proposition of a multi-scale fusion approach

Description of the crude drilling phase identification process. To perform crude identification of the different drilling phases, advantage will be taken of the cutting parameters changes occurring between the drilling of the different material layers. In particular, the *spindle rotation frequency* will serve as an indicator in order to determine the time intervals within which the CFRP or Ti6Al4V layers have been drilled. Spindle motor phase currents frequency are correlated with the spindle rotation frequency, therefore, non-intrusive current sensors can be used to perform this task. The typical evolution of the frequency a spindle motor phase current during a CFRP/Ti6Al4V stack drilling operation is depicted in figure 5.42(a).



(a) Typical evolution of the frequency of a spindle motor phase current signal during a CFRP/Ti6Al4V stacks drilling operation (b) The most energetic frequency component of the signal depicted in figure 5.42(a) have been selected for each time stamp

Figure 5.42 – Typical behavior of a spindle motor phase current signal during the drilling of CFRP/Ti6Al4V stack in time and frequency domains: it allows identifying crudely the different drilling phases

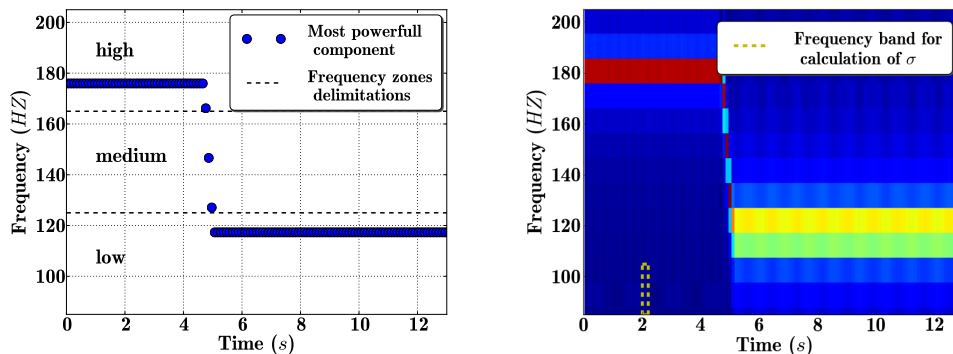
This plot allows differentiating 2 *times intervals*: the CFRP layer was drilled when the spindle was rotating faster, while the Ti6Al4V one was drilled during it was rotating slower. The goal of this first step is to determine the *transition time* between this two spindle rotation speeds. Then, the finer research for the CFRP drilling beginning and ending times, and for the titanium drilling beginning time could be performed in these restricted time intervals, limiting the amount of irrelevant information. One can remark that an error in the determination of these time intervals would be catastrophic for the low scale following tasks. Authors are fully aware that other sensors or information from the numerical controller could have been used to perform this task. A solution is proposed here that could be replaced by others. Moreover, the detection of the spindle rotation frequency variation does not ensure a correct detection of drilling phases if the process has been ill-defined.

To determine the transition time, *singular* frequency bands, the ones containing the more energy, are identified, for each time stamp, within the energy distribution of the spindle phase current signal in the frequency domain, providing the data points depicted in figure

5.42(b). Then, in a comparable manner to what has been done in section 5.1.3.3 to define a threshold, a *sigmoid function* (see equation 5.3) is fitted on these points using a classical non-linear optimization algorithm. The parameter p in equation 5.3, which correspond to the inflexion point of the sigmoid, is then the estimated transition time. Knowing this time and adding prior knowledge about the drilling operation cycle allow the monitoring system designer to drastically reduce time intervals within which pattern of interest have to be identified in signals.

In order for this step to be as robust as possible, and taking advantage of the fact that 3 spindle phase current signals are available, a fusion scheme will be implemented. It is important that the sigmoid function fitting step goes well in order to obtain a good estimate of the transition time. As every other procedure mentioned in this work, good performance is achievable only if good quality input data is provided to the optimization algorithm. To ensure the quality of input data samples that serve for the optimization step, and therefore ensure reliability of the transition time estimation, the data samples will be determined by a fusion procedure.

Description of the fusion problem and procedure. In order to simplify the problem of determining, for each time stamp, a singular frequency band, the resolution of the frequency scale can be downgraded: this will limit the number of *propositions* the fusion system will have to deal with. In this example, 3 frequency bands (low, medium and high), as depicted on figure 5.43(a), are sufficient: one encompasses the samples corresponding to high speed rotation of the spindle, the other one to low speed, and so on.



(a) Artificial down sampling of the frequency resolution for monitoring purposes: 3 frequency bands are defined (low, medium and high) (b) Illustration of the frequency band on which the signal perturbation level assessment for each time stamp can be based upon

Figure 5.43 – Definition of the 3 frequency bands corresponding to the power set propositions ω_{low} , ω_{medium} , and ω_{high} for the localization of the most energetic frequency band (a), and illustration of a frequency band where no relevant information is expected that can be used to calculate the parameter σ for each time stamp (b)

The fusion problem can be formalized as follows: each of the 3 phase current signals is decomposed in Ts time stamps. Then, degrees of belief concerning the belonging of the most energetic frequency component are given to the 3 propositions that compose the *frame of discernment* $\Omega = \{\omega_{low}, \omega_{medium}, \omega_{high}\}$, and its combinations that composes the power set $2^{|\Omega|}$, for each of the T time stamps. In this case study, the mass allocation and fusion approaches proposed by the author in chapter 4 have been used to do so. Indeed, this application case present redundant, or quasi-redundant data that are to be fused in a context where sensor failures are likely to occur, and such failure may stay undetected for a while as current sensors are located in the electrical closet of the drilling machine.

As given by equation 5.15, the singularity level of each proposition is the maximum energetic content of a frequency band that is encompassed by the frequency space subdivision the proposition corresponds to. As it was the case for the feature selection problem, the estimated singularity level of a proposition will not be assessed using its distance to the mean, but to 0. Indeed, the energetic content of frequency bands are positive, and we are looking for the maximum one.

$$\widehat{sing}_n^s = \max_f(E_f) \quad n \in \{low, medium, high\} \quad (5.15)$$

Where E_f represents the energy content of the f^{th} frequency band encompassed by the n^{th} proposition.

In order to build masses using the proposed approach, a probability distribution p_s of the expected perturbations on observed values and parameter σ_s have to be set for each source s . The probability distribution will be chosen Gaussian, as it is often the case for sensor measurements performed in harsh environments. The parameters σ_s , which is a mean to assess sources informative power, will be updated at each time stamp in order to guarantee that it will adapt itself in case of a sensor failure occurs during the monitoring process. It will be given by the standard deviation of a small frequency band where no relevant information is expected (as depicted in figure 5.43(b)), and will therefore represent the perturbation level the signal is affected by. The coverage interval P_{cov} needed for the masses calculation will be set to $]-\infty, \mu + 5\sigma]$, in accordance with the method philosophy to favor most informative information sources. Masses are then calculated following equations 4.11, 4.12 and 4.13.

Once s mass distributions over the power set $2^{|\Omega|}$ are available, the fusion is performed according the Yager combination rule and the estimated frequency zone given by the proposition that presents the highest pignistic probability is used to build the estimated (and downgraded in term of resolution) evolution of frequency of the spindle motor phase current during the whole drilling operation. Then, the optimization procedure takes place using these data samples in order to determine the transition time.

5.3.1.4 Performance assessment of the global drilling phase identification system

After the transition time has been determined, the aforementioned procedure for the detection of the different events of interest can take place. The global monitoring system dedicated to drilling phase identification is depicted in next figure.

Performances of the system have been assessed in two different configurations, offline and online, that allowed evaluating the *robustness facing perturbations in signals and sensors failures*. The first experiment consisted in a comparison of the multi-scale proposed approach with another one that do not uses crude identification of the different drilling phases before looking for a feed inversion pattern in feed current signals. The same pattern recognition techniques was used on the full length signal. The two methods have been implemented and tested on data from a test campaign that consisted in 138 CFRP/Ti6Al4V drilling operations. The multi-scale method allowed 100% good determination of the time at which the feed direction had been inverted whereas the simple one gave 96.5% of good determination of this time, underlining the robustness improvement achieved with the multi-scale method. The multi-scale system has also been implemented online on a machining center. The experiments consisted in the identification of the CFRP and titanium drilling phases within signals acquired during drilling CFRP/Ti6Al4V stacks in order to perform feature extraction on. The system worked well in normal configuration. Then, in order to assess its robustness against sensor breakdown, one, and then 2 out of the 3 implemented spindle phase current sensors have been unplugged. The system performed well also, even with only one plugged sensor remaining and the two other signals used being only ambient perturbations on the acquisition device.

The correct identification of the different phases of drilling operations is crucial in order to perform efficient monitoring. Solutions have been proposed following the methodology proposed in chapter 3: problems have been formalized and decomposed into simpler ones, and data fusion techniques have been used to overcome robustness challenges. The efficiency of the proposed approach has been assessed, both offline and online. Therefore, these developments can serve as a basis for the implementation of further building blocks of an industrial drilling monitoring system.

5.3.2 Tool cutting edge chipping detection

The detection of tool cutting edge chipping is an important concern for drilling monitoring applications. As evoked in section 2.1.2.1, chipping can provoke modifications of geometrical properties of drilled holes (see figure 2.14 concerning diameter for instance). Moreover, micro-chippings that do not necessarily significantly affect the hole properties are often *forerunners of an advanced wear state of the drill*, and should therefore be taken into account when sensing tool wear.

As the selection of relevant sensors and features have been discussed in details in sections 3.4 and 5.2, they will not be detailed for this application case. However, the use of prior, or *expert knowledge* as features, and the potential improvements they can bring to monitoring systems will be illustrated. Challenges and solutions linked with the choice of an estimator for this type of monitoring tasks will be emphasized. Experimental results will serve to illustrate the exposed opinions. A fusion based approach will also be proposed to improve robustness of the detection of cutting edge chipping.

Problem position

In order to take maximum advantage of the detection of tool cutting edge chippings, it should be done *just after the drilling operation during which it occurred* - or before which it has been caused by an external element. Then, the appropriate corrective actions, if needed, could to be applied before more holes that may not respect quality requirements are drilled on the workpiece. The problem is then, given relevant features, to be able to make a statement about the fact a hole has just been drilled with a drill that presented a cutting edge chipping.

The task of a dedicated monitoring system is therefore to *discriminate* between two types of drilling operations. In order to determine relevant features to achieve it, the *systematic sensors selection and feature selection procedures* described in sections 5.1 and 5.2 respectively have been applied.

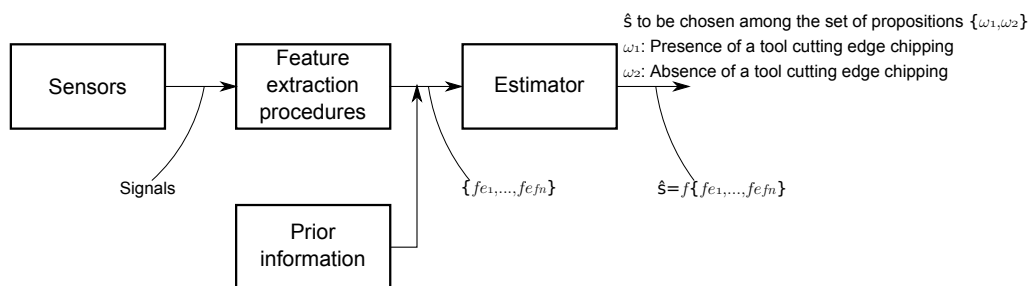
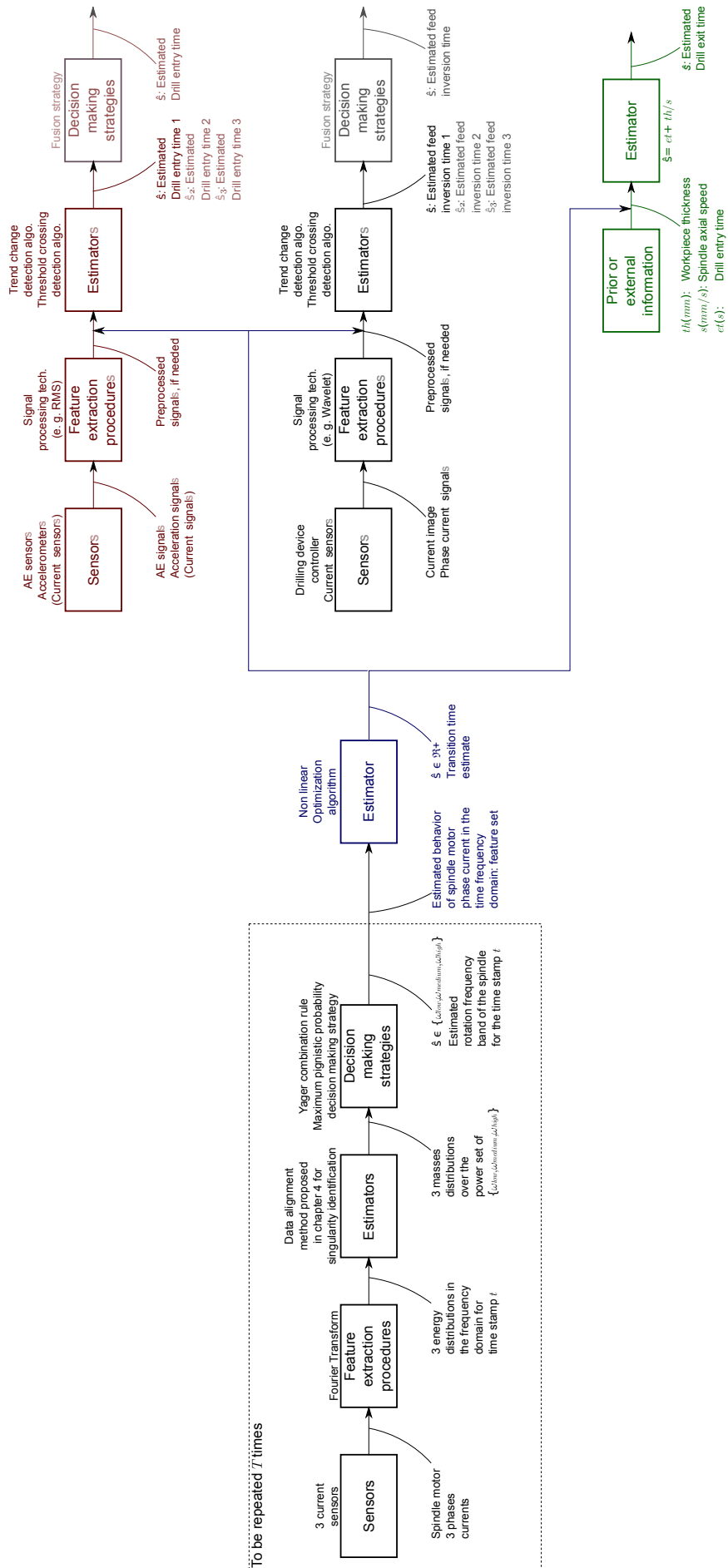


Figure 5.44 – Schematic view of a monitoring system dedicated to the detection of tool cutting edge chippings



Choice of an estimator

One of the main concerns involved in the choice of estimators able to discriminate between different process states has been present in section 3.3.2 and illustrated in figure 3.6: they must be robust facing both variations of the process operating conditions and its dispersive behavior. Therefore, *unsupervised* discrimination algorithms have been elected as an appropriate solution, used together with an initialization phase, as depicted in figure 3.7.

Concerning the detection of tool chippings, as only one type of data samples are expected in the feature space (representing drilling operations realized with a good shape drill), the problem is in fact to assess the presence of 2 *significantly different types of data samples* encompassing different types of drilling operations according to selected features. This will allow assessing if there has been a *deviation from the normal functioning state of the system* characterized during the initialization phase. This procedure, that is repeated each time a new drilling operation is performed, is depicted in figure 5.45.

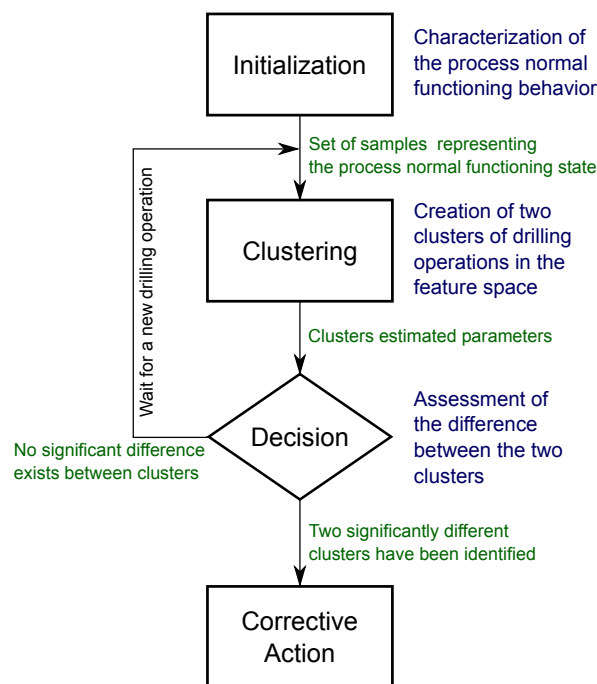


Figure 5.45 – Sequence dedicated to the assessment of the presence of 2 clusters encompassing different types of drilling operations in the feature space: the presence of a significantly different cluster indicates a deviation of the process state from its normal functioning state characterized at the initialization step

Such an implementation scheme necessitates that the estimator f possesses a *decision ability* in addition to its clustering one. Then, the estimate \hat{s} of the process state can take values in a set of 2 propositions $\{\omega_1, \omega_2\}$ corresponding respectively to the presence or absence of a cutting edge chipping on the drill. A schematic view of this monitoring system is depicted in figure 5.44.

Choice of a clustering algorithm. As for the choice of a particular clustering algorithm, several particularities of the detection of drill cutting edge chipping problem are to be taken into account:

- Normally, only one significant cluster - drilling operations performed with a good shape drill- will exist, or the second one will be small - it should not contain more than one sample, equivalent to one drilling operation performed with a chipped tool

- As a different physical phenomena may be involved, samples (representing drilling operations) distributions according to features are likely to be disparate
- Knowledge about the expected relative positions of samples in the feature space as a function of the state of the tool may be available (e. g. vibration level may increase with a chipped tool)

The two first points will determine the choice of a *clustering method*. Many clustering algorithms are based on the *distance* between data samples. Here, the *shape* and *size* of clusters seems to play a more important role. In order to take it into account, the *hypothesis* will be made that data samples are distributed following a Gaussian function regarding features. Then, instead of being responsible for the closer data samples, as it is the case for the *K-means* clustering algorithm presented in section 2.1.1, a cluster will be responsible of samples that are the most likely to belong to him, regarding its distribution.

The *likelihood* function $p(\text{sample}|\theta_c, H_c)$ of a data sample to belong to the c^{th} cluster can only be computed if the cluster distribution parameters $\theta_c = (\mu_c, \sigma_c)$ are known. $\mu_c = [\mu_1, \dots, \mu_{fn}]_c$ and $\sigma_c = [\sigma_1, \dots, \sigma_{fn}]_c$ are respectively the means and standard deviations of the Gaussian distributions according each of the fn features that compose the feature space. These parameters will be estimated and updated in a iterative manner in the same way that in a classical *k-means* clustering procedure. This is actually an optimization procedure on the C sets of parameters θ_c (2 in our case): clusters belonging samples and shapes are updated until the likelihoods functions reach a maximum.

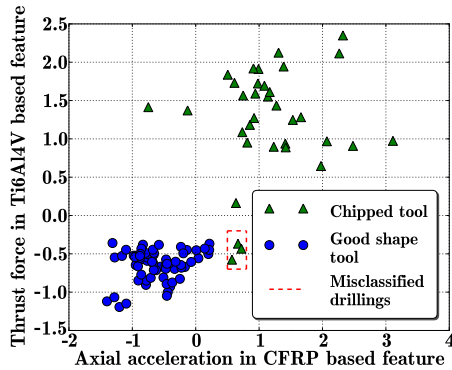
However, such a maximum where the algorithm will converge at is often local. One reason lies in the *initialization* of the algorithm: clusters parameters have to be set-up before the first iteration. Then, the algorithm may converge to different maxima as a function of its starting point. This is where *expert knowledge* concerning the relative positions of samples belonging to different clusters in the feature space can be used. It will favor the fact that the algorithm will converge to the maxima of interest in our case. An example of results of a clustering procedure applied in order to discriminate between drilling operations that have been performed with good shape and chipped tool is provided for both cases when no expert knowledge has been used (figure 5.46(a)) and when it has been (figure 5.46(b)). In the first case, the algorithm did not converge to the expected clusters, whereas in the second case it did. The integrated knowledge and data that have been used for this example are the same as described hereafter.

A quantitative comparison between results obtained with and without of the use of prior knowledge on features behavior as a function of the tool cutting edges state is provided in figures 5.46(c) and 5.46(d). Experimental data from a CFRP/Ti6Al4V (see appendix A.1) stack drilling test campaign where a cutting edge chipping has been provoked after 70 holes have been used to assess the performance of the aforementioned clustering algorithm in discriminating between drilling operations performed with a good shape and chipped tool. The algorithm has been implemented following [44] where it is referred by 'Soft K-Means V3'.

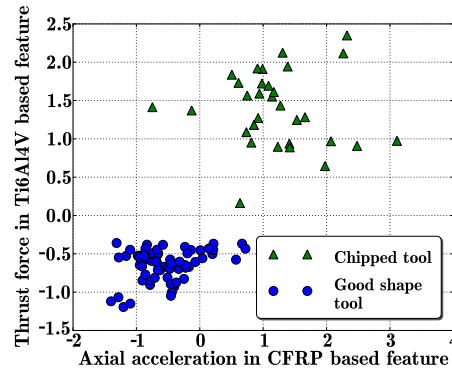
Axial vibration signal in CFRP and thrust force signal in titanium have been used to extract one feature from each. Two cases have been compared: concerning the first one, no prior knowledge on feature behaviors have been used and clusters means μ_c have been initialized randomly. As for the second case, *expert knowledge has been integrated*: previous experiments showed that when drilling with a chipped tool, axial vibration level increase in the CFRP, and thrust force level increase in titanium. Then, if a chipping occurs, samples (corresponding to drilling operations) will tend to be located in the upper right corner of the feature space (high force level, high vibration level). Therefore, the initial clusters means have been set according to this statement: one is located in the bottom left corner of the feature space to be responsible of samples representing drilling operations performed with a good shape drill, and the other one in upper right one to be responsible of drilling operations performed with a chipped drill, if any.

Results shows that the performance are better, both in terms of discrimination and computational needs, when prior knowledge is used. Moreover it allows a reliable detection (100%

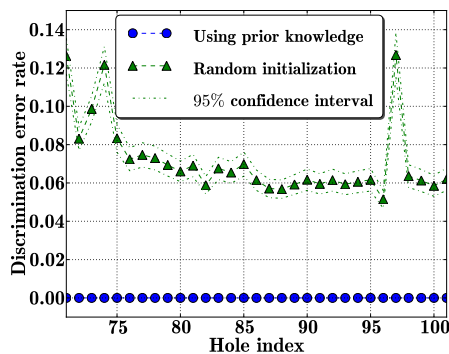
detection rate) of tool cutting edge chipping since the first drilling operation that has been performed with.



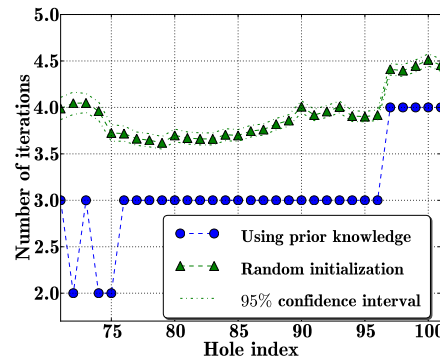
(a) Example of clusters obtained without integrating prior knowledge: 3 drilling operations are misclassified



(b) Clusters obtained when prior knowledge has been integrated: drilling operations performed with good shape and chipped tool are correctly discriminated



(c) Clustering error rate as a function of the number of drilling operations performed with a chipped tool. A Monte-Carlo simulation has been performed to estimate the average clustering error rate when using random clusters initialization



(d) Number of iterations needed by the clustering algorithm to converge as a function of the number of drilling operations performed with a chipped tool. A Monte-Carlo simulation has been performed to estimate the average number of iterations required when using random clusters initialization

Figure 5.46 – Example of the reliability and computational gains in monitoring of tool cutting edge chipping by incorporating prior knowledge on features behaviors

Choice of a decision criterion. As depicted in figure 5.45, after the cluster parameters have been estimated by the clustering algorithm, a decision has to be made about the fact that clusters encompasses *significantly different* samples or not. To do so, the Euclidian distance between the clusters means μ_c in the feature space has been used. Other measures exist to assess the separation of clusters. It is given by equation 5.16, and incorporates a normalization by the data samples standard deviation $\sigma_{samples}$ that is aimed at compensating *reduction* of data performed before each new drilling features are available prior to perform clustering. The distance is updated each time a new hole h has been drilled.

$$\Delta(h) = \sqrt{\sum_{n=1}^{fn} ((\mu_1^n(h) - \mu_2^n(h)) \times \sigma_{samples}^n(h))^2} \quad (5.16)$$

Evolutions of this criteria and of its variations $d\Delta/dh$ over a series of drilling operations during which a chipping occurred are depicted in figure 5.47. The results show that a threshold crossing or trend change detection algorithm can easily be implemented in order to detect the occurrence of cutting edge chipping. In the following, a threshold crossing detection algorithm will be implemented on Δ . As no clue is available a priori about the distance between clusters if a chipping occurs, an auto-adaptive threshold will be used. Its value, for the hole index h is based on variations observed on previous values of Δ , so if a significant increase occurs it will be detected. To do so, the standard deviation $\sigma_{\Delta, dn}$ of values taken by Δ after the dn previous drilling operations will serve as a basis to define the threshold value T_h corresponding to the h^{th} drilling.

$$\sigma_{\Delta, dn}(h) = \frac{1}{dn} \sum_{i=h-dn}^{h-1} (\Delta(i) - \mu_{dn}(i))^2 \quad (5.17)$$

$$\mu_{dn}(h) = \frac{1}{dn} \sum_{i=h-dn}^{h-1} \Delta(i) \quad (5.18)$$

$$T_h = c \times \sigma_{\Delta, dn}(h) \quad (5.19)$$

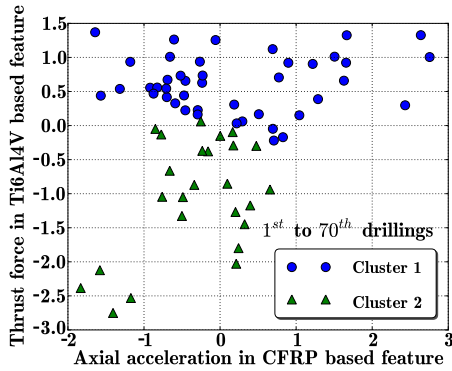
where c is a constant. In the following, dn will be set to 5 as its is the number of drilling operations used to initialize the monitoring system, and c will equals 5 (the two values are not related). This constant is a lever for the monitoring system user to set the amplitude of changes linked with the manifestations of eventual chippings he wants the system to detect. In brief, a low threshold setting will allow the system to detect small chippings, whereas a high threshold will make it detect only important alterations of the cutting edges. A too low threshold setting may lead to the apparitions of false alarms only due to the natural dispersion of the drilling process that have been evoked before.

On the use of features and decision level fusion solutions

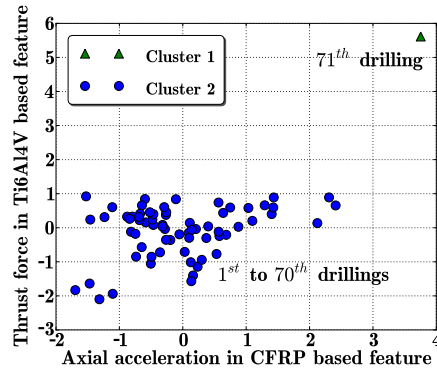
Given several relevant features regarding some phenomenon of interest, one may wonder about the best use to make of them. Indeed, some issues concerning high-dimensional *feature spaces* have been evoked in section 2.1.1, and it has been shown in section 5.2 that increasing the number of features did not always increased the clustering performance for tool cutting edge chipping detection. On the other hand, considering the difficulties to achieve reliable drilling monitoring in industrial environment, taking all available information into account seems essential.

In order to face this dilemma, the philosophy developed all along this work will be applied: several monitoring subsystems using different low-dimensional feature spaces will be implemented, and their statements will then be fused, instead of using a global feature set encompassing all relevant features.

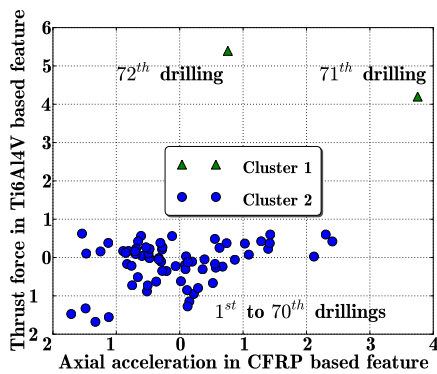
Experimental data issued from another CFRP/Ti6Al4V stacks drilling test campaign (see appendix A.2) where a tool cutting edge chipping has been provoked after 64 holes will be used. Developments presented above will be used to asses the presence of a cutting edge chipping. 3 features (the most relevant according to the IRELIEF algorithm) will be used: 1 extracted from the axial acceleration signal obtained while drilling Ti6Al4V, and the 2



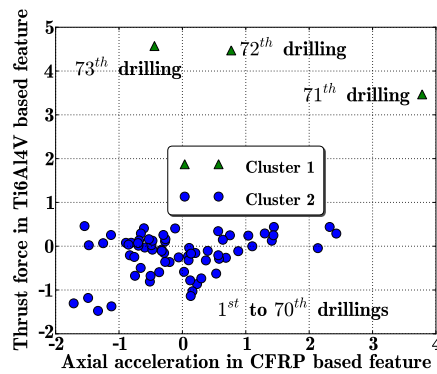
(a) Clusters obtained after clustering has been performed on the 70 first drilling operations



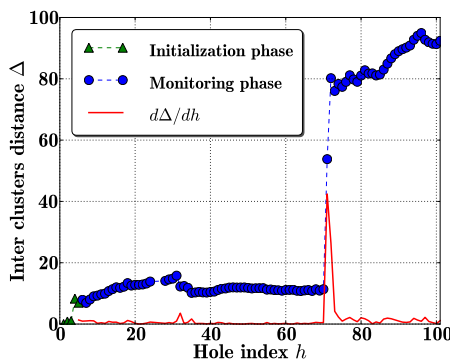
(b) Clusters obtained after clustering has been performed on the 71 first drilling operations



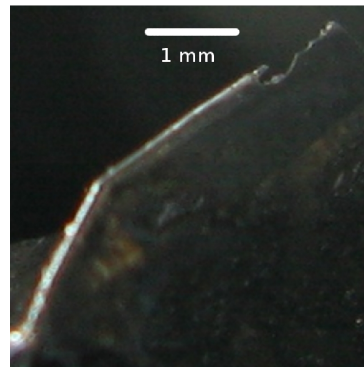
(c) Clusters obtained after clustering has been performed on the 72 first drilling operations



(d) Clusters obtained after clustering has been performed on the 73 first drilling operations



(e) Evolution of the distance between clusters as a function of the number of drilling operations that have been performed: a change is clearly visible between the 70th and the 71th holes



(f) Tool cutting edge chipping provoked between the 70th and 71th drilling operations

Figure 5.47 – Behavior of the clustering algorithm when a cutting edge chipping occurs: the distance between clusters increases suddenly because of the features sensitivity to the cutting edge chipping. Smaller distance variations are also visible after hole 31 and the big chipping that correspond to manifestations of smaller alterations of the cutting edges

other ones issued from AE signals obtained while drilling CFRP with the feature extraction method proposed in section 5.1.3.4, using two different parameters settings.

The ability of 4 monitoring systems using these features to detect the cutting edge chipping after the 65th hole has been drilled will be assessed. The 1st one will be the implementation of the method described above using the 3 features at the same time. The 2nd and 3th ones will be implemented with two couples of features (each couple composed by features issued from the 2 material layers drilling phases), and finally, the last one will use both the 2nd and 3th as quasi-redundant information sources, and their statements will be fused using the approach proposed in chapter 4.

No expert knowledge will be integrated, so the clusters initial parameters (positions) will be set randomly. Therefore, Monte-Carlo simulations will be performed in order to estimate the detection ability of each monitoring system. The average distances Δ obtained over the series of drilling operations together with the corresponding average threshold value T_{65} for the 65th drilling operations are depicted on the 3 first monitoring systems in figure 5.48. Results shows that the distance changes are comparable whatever the monitoring system that has been used. The global evolution of Δ is comparable also. The implementation of the 4th monitoring system will be described hereafter, and the results obtained with the 4 of them will then be compared.

Implementation of a decision fusion approach. In order to combine statements from the 2nd and 3rd monitoring systems, a decision fusion strategy will be implemented in the evidential framework following the approach proposed in chapter 4. The use of this approach is justified here as monitoring systems are quasi-redundant, thus favoring the most informative one considering the quality of provided statements seems to be a logical way to ensure robustness.

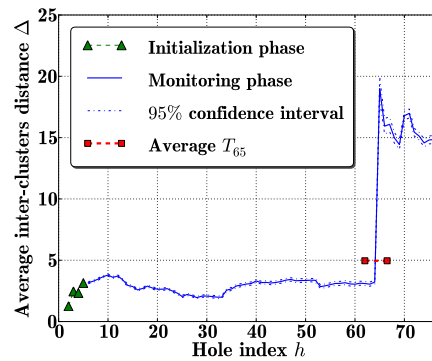
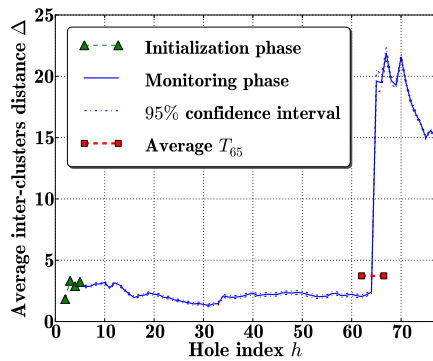
The frame of discernment is composed by 2 propositions ω_1 and ω_2 representing respectively the presence or the absence of a cutting edge chipping. As the approach using basic beliefs assignment strategy produces consonant belief functions, mass will be affected to only one of these singletons and their union eventually. The singleton will be chosen as a function of the fact that Δ_{65} is superior or not to the threshold value T_{65} . This allows defining the propositions ordering needed to apply the proposed approach. If $\Delta_{64} \geq T_{64}$, then $\mathbf{D}_s = [\omega_1, \omega_2]$, else $\mathbf{D}_s = [\omega_2, \omega_1]$. Then difference between these values will be used to as the estimated singularity level:

$$\widehat{sing}_s(\omega^{D_1}) = abs(\Delta_{65} - T_{65}) \quad (5.20)$$

$$\widehat{sing}_s(\omega^{D_2}) = 0 \quad (5.21)$$

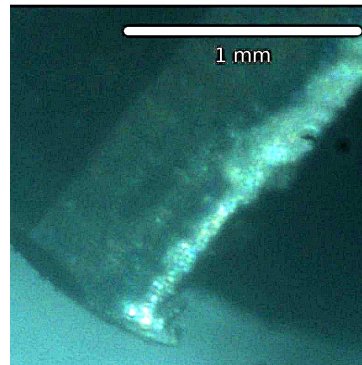
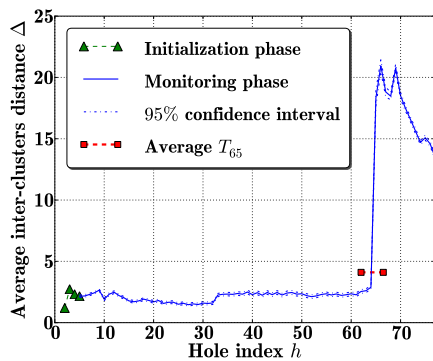
where s represents the information source index, and can here take values in $\{1, 2\}$ as 2 monitoring subsystems are used. As perturbation distribution will be considered Gaussian, the parameters σ_s , necessary for this approach, that allow assessing the quality of information provided by the source, will naturally be set as the standard deviation $\sigma_{\Delta, dn}$ used to calculate the threshold for each source. The coverage interval P_{cov} needed for the masses calculation will be set to $]-\infty, \mu + 5\sigma]$, in accordance with the approach philosophy to represent ambiguity explicitly, and thus favor most informative information sources.

Masses are then calculated following equations 4.11, 4.12 and 4.13. Yager combination rule will be used to perform the fusion of the 2 subsystems statements, and the proposition that presents the highest pignistic probability will be used as the estimate \hat{s} of the tool state.



(a) Average evolution of Δ and average value of T_{65} obtained with the 1st monitoring system which uses features 1, 2 and 3

(b) Average evolution of Δ and average value of T_{65} obtained with the 2nd monitoring system which uses features 1 and 2



(c) Average evolution of Δ and average value of T_{65} obtained with the 3rd monitoring system which uses features 1 and 3

(d) Tool cutting edge chipping provoked after the 64th hole has been drilled

Figure 5.48 – Average evolutions of the criterion used to assess the presence of a tool cutting edge chipping as a function of the number of holes that have been drilled for 3 monitoring systems using different feature sets. A cutting edge chipping has been provoked after the 64th hole has been drilled

Results. The average performance in detecting the cutting edge chipping after the 65th associated and the 95% confidence intervals are given in table 5.8. One of the systems using only 2 features performed better than the one using the 3 altogether. This illustrates the fact that using more features, even if relevant, does not systematically increase all performance criteria. The 4th system, which integrated the 2nd and 3rd within a global high level fusion strategy significantly outperformed others. This underlines the benefits that can be expected in terms of reliability of monitoring systems by the use of multisensor fusion strategies together with data imperfection modeling approaches. Authors want to attract the reader attention on the fact that the results are not optimized in terms of detection performance, due to the absence of integration of prior knowledge in particular. This experiments were aimed at emphasizing some points about the use of features and the potential advantages of using data fusion and related concepts to perform monitoring.

Monitoring system	Average correct detection rate	95% confidence interval
1: Using features 1, 2 & 3	0.708	[0.668, 0.748]
2: Using features 1 & 2	0.786	[0.750, 0.822]
3: Using features 1 & 3	0.626	[0.584, 0.668]
4: Fusion of monit. sys. 2 & 3	0.902	[0.876, 0.928]

Table 5.8 – Performance of different monitoring systems in detecting a cutting edge chipping after one drilling has been performed with

The detection of tool cutting edge chipping is important, both to avoid workpiece degradations and to assist the drill wear level estimation. Following developments provided in chapter 3, an unsupervised approach has been proposed that applies on any instrumented drilling device without setting parameters, requiring only a short initialization phase. This is an important point regarding the need of flexibility existing in production plants. The influence of integration of expert knowledge has been underlined as it allowed increasing performances of a monitoring system to discriminate between drilling operations performed with a chipped tool from other realized before the chipping has been provoked. A short discussion on the usage of relevant features has also been provided, and an experimental study allowed showing that a system able to take full advantage of redundancy between features and estimators by appropriate data modeling and merging techniques outperformed classical ones. To do so, the singularity detection approach developed in the evidential framework and proposed in chapter 4 have been used, and showed its good ability to deal with such applications cases.

5.3.3 Overview on drilling monitoring applications

The development of *building blocks of a drilling monitoring system* using concepts and approaches presented previously in this manuscript have been presented in this section.

The first one, *the identification of the different drilling phases* while performing stacks drilling, has been shown to be an essential requirement for further monitoring operations. A multi-scale and multisensor fusion approach has been proposed and used for identification of the different phases when drilling multi-material stacks. It has been shown to be robust facing both perturbations and sensors failures, and has been implemented successfully on an machining center.

Then, a methodology aimed at *the detection of tool cutting edge chippings* has been proposed. It answers challenges link with flexibility of operating conditions by the use of an unsupervised learning strategy. This example allowed to underline the importance of expert knowledge integration in monitoring systems, and also of a good usage of features and imperfect information modeling and merging techniques.

The formalization and implementation scheme described in chapter 3 has been used to design these monitoring systems. Moreover, the approach proposed in chapter 4 for singularity detection in difficult contexts has also been used successfully in both cases, demonstrating its performance and versatility. More generally, one of the main line of this work, which consist in keeping problems as simple as possible and tackle bottlenecks explicitly upstream in the monitoring sequence has been demonstrated to allow reliable monitoring in industrial conditions.

5.4 Conclusion

This chapter presented several developments and contributions related to the implementation of drilling monitoring systems. Key challenges have been addressed following the methodology and philosophy proposed in chapter 3.

First, two major sensor integration concerns have been evoked: as they have been elected as two of the most sensitive quantities to cutting related phenomena, solutions have been proposed for the integration of AE and force sensors and their functioning have been characterized.

Then, the feature selection problem, which is crucial for efficient monitoring but that has often been neglected in past studies, has been tackled. The use of fusion approaches including explicit data imperfection modeling has been shown to improve the performance of feature selection, especially for processes and contexts making monitoring difficult, as it is the case for industrial drilling operations.

Finally, the development of two monitoring systems have been described. The identification of drilling phases, which is a necessary step before any other monitoring task, has been addressed, and multisensor and multi-scale fusion strategies allowed providing the required robustness. A method aimed at the detection of tool cutting edge chippings has also been presented, and following remarks made in chapter 3, it has been shown that reliable monitoring was possible using unsupervised learning methods. It also allowed underlining the importance of integrating expert knowledge in the design of a monitoring system, and the improvements that could be achieved by using data fusion and imperfect data modeling related aspects.

Approaches and philosophy for the development of drilling monitoring systems exposed in this work has been proven to be successful on application cases in this chapter. Many other applications are possible and make part of future works.

Bibliography

- [1] J. Abellan-Nebot and F. Romero Subiròn. A review of machining monitoring systems based on artificial intelligence process models. *The International Journal of Advanced Manufacturing Technology*, 47:237 – 257, 2010. 10.1007/s00170-009-2191-8.
- [2] D. Albanese, R. Visintainer, S. Merler, S. Riccadonna, G. Jurman, and C. Furlanello. *mlpy: Machine Learning Python*, 2012.
- [3] H. Almuallim and T. G. Dietterich. Learning with many irrelevant features. In *Proceedings of the 9th international conference on artificial intelligence*, pages 547 – 552, 1991.
- [4] K. Jemielniak and S. Bombinski and P. X. Aristimuno. Tool condition monitoring in micromilling based on hierarchical integration of signal measures. *CIRP Annals*, 57(1):121 – 124, 2008.
- [5] H. Aoyama and T. Ishii. Sensor to detect cutting force components, cutting torque, and cutting tool deflections. *Journal of Manufacturing Processes*, 6(2):141 – 147, 2004.
- [6] S. Arul, L. Vijayaraghavan, and S. K. Malhotra. Online monitoring of acoustic emission for quality control in drilling of polymeric composites. *Journal of Materials Processing Technology*, 185(1-3):184 – 190, 2007.
- [7] J. Bins and B. Draper. Feature selection from huge feature sets. In *Proceedings of the international conference on computer vision*, volume 2, pages 159 – 165, 2001.
- [8] S. Binsaeid, S. Asfour, S. Cho, and A. Onar. Machine ensemble approach for simultaneous detection of transient and gradual abnormalities in end milling using multisensor fusion. *Journal of Materials Processing Technology*, 209(10):4728 – 4738, 2009.
- [9] A. L. Blum and P. Langley. Selection of relevant features and examples in machine learning. *Artificial Intelligence*, 97:245 – 271, 1997.
- [10] C. Bonnet. *Comprehensive study of cutting phenomena for Titanium alloys Ti6Al4V and CFRP stacks drilling in dry condition*. PhD thesis, Arts et Métiers ParisTech, Cluny, France, October 2010.
- [11] E. Brinksmeier. Prediction of tool fracture in drilling. *CIRP Annals - Manufacturing Technology*, 39(1):97 – 100, 1990.
- [12] E. Brinksmeier and R. Janssen. Drilling of multi-layer composite materials consisting of carbon fiber reinforced plastics (CFRP), titanium and aluminum alloys. *CIRP Annals - Manufacturing Technology*, 51(1):87 – 90, 2002.
- [13] S. T. S. Bukkapatnam, S. R. T. Kumara, and A. Lakhtakia. Analysis of acoustic emission signals in machining. *Journal of Manufacturing Science and Engineering*, 121(4):568 – 576, 1999.

- [14] G. Byrne and G.E. O'Donnell. An integrated force sensor solution for process monitoring of drilling operations. *CIRP Annals - Manufacturing Technology*, 56(1):89 – 92, 2007.
- [15] E. Cantú-Paz, S. Newsam, and C. Kamath. Feature selection for scientific applications. In *Proceedings of the 10th international conference on knowledge discovery and data mining*, pages 788 – 793, 2004.
- [16] W. P. Dong, Y. H. Joe Au, and A. Mardapittas. Characteristics of acoustic emission in drilling. *Tribology International*, 27(3):169 – 170, 1994.
- [17] C. E. Everson and S. H. Cheraghi. The application of acoustic emission for precision drilling process monitoring. *International Journal of Machine Tools and Manufacture*, 39(3):371 – 387, 1999.
- [18] L. Fu, S. F. Ling, and C. H. Tseng. On-line breakage monitoring of small drills with input impedance of driving motor. *Mechanical Systems and Signal Processing*, 21(1):457 – 465, 2007.
- [19] K. Goebel and W. Yan. Feature selection for tool wear diagnosis using soft computing techniques. In *Proceedings of the ASME, Manufacturing in engineering division*, volume 11, pages 157 – 163, 2000.
- [20] I. Guyon and A. Elisseeff. An introduction to variable and feature selection. *Journal of Machine Learning Research*, 3:1157 – 1182, 2003.
- [21] H. Heidary, A. R. Oskouei, M. Hajikhani, B. Moosaloo, and M. A. Najafabadi. Acoustic emission signal analysis by wavelet method to investigate damage mechanisms during drilling of composite materials. In *ASME Conference Proceedings*, volume 2010, pages 409 – 416. ASME, 2010.
- [22] G. Hermann. Application of neural network based sensor fusion in drill monitoring. In *Proceedings of SAMI*, Herlay, 2003.
- [23] A. A. Houshmand and E. Kannatey-Asibu Jr. Statistical process control of acoustic emission for cutting tool monitoring. *Mechanical Systems and Signal Processing*, 3(4):405 – 424, 1989.
- [24] D. V. Hutton and F. Hu. Acoustic emission monitoring of tool wear in end-milling using time-domain averaging. *Journal of Manufacturing Science and Engineering*, 121(1):8 – 12, 1999.
- [25] I. Inasaki. Application of acoustic emission sensor for monitoring machining processes. *Ultrasonics*, 36(1-5):273 – 281, 1998.
- [26] I. Inasaki and S. Yonetsu. In-process detection of cutting tool damage by acoustic emission. In *22nd International Machine Tool Design and Research Conference*, pages 261 – 268, Manchester, UK, 1981.
- [27] K. Iwata and T. Morikawi. An application of acoustic emission measurement to in-process sensing of tool wear. *Annals of the CIRP*, 25:21 – 26, 1977.
- [28] L. Jack and A. Nandi. Feature selection for ANNs using genetic algorithms in condition monitoring. In *Proceedings of the 7th European symposium on artificial neural networks*, pages 313 – 318, 1999.
- [29] K. Jemielniak. Some aspects of acoustic emission signal pre-processing. *Journal of Materials Processing Technology*, 109(3):242 – 247, 2001.

- [30] K. Jemielniak and P. J. Arrazola. Application of ae and cutting force signals in tool condition monitoring in micro-milling. *CIRP Journal of Manufacturing Science and Technology*, pages 97 – 102, 2008.
- [31] K. Jemielniak and O. Otman. Tool failure detection based on analysis of acoustic emission signals. *Journal of Materials Processing Technology*, 76(1-3):192 – 197, 1998.
- [32] C. L. Jiaa, H. Ho-Cheng, and C. K. H. Dharan. Correlation between acoustic emission and delamination in drilling composites laminates. In *Monitoring and control of manufacturing process*, pages 177 – 192. ASME, 1990.
- [33] E. Kannatey-Asibu Jr. and D.A. Dornfeld. A study of tool wear using statistical analysis of metal-cutting acoustic emission. *Wear*, 76(2):247 – 261, 1982.
- [34] K. Kira and L. Rendell. A practical approach to feature selection. In *Proceedings of the 2nd international conference on machine learning*, pages 249 – 256, 1992.
- [35] J. Kiviö and P. H. Andersson. Tool breakage monitoring in a multi-spindle drilling operation. In *XVII IMEKO World Congress*, pages 2177 – 2180, Dubrovnik, Croatia, June 2003.
- [36] R. Kohavi and G. H. John. Wrappers for feature subset selection. *Artificial Intelligence*, 97:273 – 324, 1997.
- [37] W. Konig, K. Kutzner, and U. Schehl. Tool monitoring of small drills with acoustic emission. *International Journal of Machine Tools and Manufacture*, 32(4):487 – 493, 1992.
- [38] I. Kononenko. Estimating attributes: Analysis and extensions of RELIEF. In *Proceedings of the European conference on machine learning*, pages 171 – 182, 1994.
- [39] J. Kopač and S. Sali. Acoustic emission in drilling carbon steel and nodular gray iron. *Journal of Achievements in Materials and Manufacturing Engineering*, 19(1):91 – 95, 2006.
- [40] X. Li. A brief review: Acoustic emission method for tool wear monitoring during turning. *International Journal of Machine Tools and Manufacture*, 42(2):157 – 165, 2002.
- [41] J. J. Liu and D. A. Dornfeld. Modeling and analysis of acoustic emission in diamond turning. *Journal of Engineering for Industry*, 118:199 – 207, 1996.
- [42] T. H. Loutas, D. Roulias, E. Pauly, and V. Kostopoulos. The combined use of vibration, acoustic emission and oil debris on-line monitoring towards a more effective condition monitoring of rotating machinery. *Mechanical Systems and Signal Processing*, 25(4):1339 – 1352, 2011.
- [43] Y. Lu, I. Cohen, X. Zhou, and Q. Tian. Feature selection using principal feature analysis. In *ACM Multimedia*, Augsburg, Germany, 2007.
- [44] D. J. C. MacKay. *Information Theory, Inference, and Learning Algorithms*. Cambridge University Press, 2003. available from <http://www.inference.phy.cam.ac.uk/mackay/itila/>.
- [45] B. Mascaro, V. Gibiat, M. Bernardou, and Y. Esquerre. Acoustic emission of the drilling of carbon/epoxy composites. In *Proceedings of the Acusticum forum*, pages 2823 – 2827, Budapest, Hungary, 2005.

- [46] G. Le Moal, P. Rabaté, G. Moraru, P. Véron, and M. Douilly. A robust method for drilling monitoring using acoustic emission. In *9th International conference on High Speed Machining*, San Sebastian, Spain, 2012.
- [47] L. C. Molina, L. Belanche, and A. Nebot. Feature selection algorithms: A survey and experimental evaluation. In *Proceedings of the international conference on data mining*, pages 306 – 313, 2002.
- [48] S. Park. *High frequency bandwidth cutting force measurements in milling using*. PhD thesis, University of British Columbia, Vancouver, Canada, 2004.
- [49] K. Patra. Acoustic emission based tool condition monitoring system in drilling. In *Proceedings of the World Congress on Engineering*, volume 3, London, UK, 2011.
- [50] A. L. Quadro and J. R. T. Branco. Analysis of the acoustic emission during drilling test. *Surface and Coatings Technology*, 94-95(0):691 – 695, 1997.
- [51] M. Ramulu, T. Branson, and D. Kim. A study on the drilling of composite and titanium stacks. *Composite Structures*, 54(1):67 – 77, 2001.
- [52] S. R. Ravishankar and C. R. L. Murthy. Application of acoustic emission in drilling of composite laminates. *NDT&E International*, 33(6):429 – 435, 2000.
- [53] S. R. Ravishankar and C. R. L. Murthy. Characteristics of ae signals obtained during drilling composite laminates. *NDT&E International*, 33(5):341 – 348, 2000.
- [54] M. Robnik and R. Kononenko. An adaptation of RELIEF for attribute estimation in regression. In *Proceedings of the 14th international conference on machine learning*, 1997.
- [55] M. Shah, L. Unanue, P. Bidare, U. Galfarsoro, L. M. Iriarte, K. P. Karunakaran, and P. J. Arrazola. Tool control monitoring applied to drilling. In *Proceedings of the 6th MUGV conference*, Cluny, France, 2010.
- [56] B. Sick. On-line and indirect tool wear monitoring in turning with artificial neural networks: A review of more than a decade of research. *Mechanical Systems and Signal Processing*, 16(4):487 – 546, 2002.
- [57] G. Silva and S. J. Wilcox. Sensor based condition monitoring feature selection using a self-organizing map. In *Proceedings of the World Congress on Engineering*, volume 2, London, U.K., 2008.
- [58] J. Sun, G. S. Hong, and Y. S. Wong M. Rahman. Identification of feature set for effective tool condition monitoring by ae sensing. *International Journal of Production Research*, 42(5):901 – 918, 2004.
- [59] Y. Sun. Iterative RELIEF for feature weighting: Algorithms, Theories, and Applications. *IEEE Transactions on Pattern Analysis and Machine Intelligence*, 29(6):1035 – 1051, 2007.
- [60] EWGAE codes for acoustic emission examination: Code IV - Definition of terms in acoustic emission. Code V - Recommended practice for specification, coupling and verification of the piezoelectric transducers used in acoustic emission. *NDT International*, 18(4):185 – 194, 1985.
- [61] R. Teti, K. Jemielniak, G. O'Donnell, and D. Dornfeld. Advanced monitoring of machining operations. *CIRP Annals - Manufacturing Technology*, 59(2):717 – 739, 2010.
- [62] R. Teti and G. F. Micheletti. Tool wear monitoring through acoustic emission. *CIRP Annals - Manufacturing Technology*, 38(1):99 – 102, 1989.

-
- [63] A. Velayudham, R. Krishnamurthy, and T. Soundarapandian. Acoustic emission based drill condition monitoring during drilling of glass/phenolic polymeric composite using wavelet packet transform. *Materials Science and Engineering: A*, 412(1-2):141 – 145, 2005. International Conference on Recent Advances in Composite Materials.
- [64] L. Xiaoli and Y. Zhejun. Tool wear monitoring with wavelet packet transform - fuzzy clustering method. *Wear*, 219(2):145 – 154, 1998.

Chapter 6

Conclusion & perspectives

6.1 Review of the work

Chapter 1 exposed both the potential benefits for airframe assembly operations that could be achieved by the use of drilling monitoring systems, and the challenges involved by the implementation of such systems in industry. It is clear that online process monitoring can bring improvements for the quality of drilling operations and for the cutting tools consumption, however many difficulties have to be overcome in order to do it in a reliable manner in airframe assembly plants.

Chapter 2, in its first part, reviewed attempts that have been made in order to monitor several aspects of the drilling process. These contributions brought essential information about sensors and features to be used for monitoring. In the last thirty years, the use of several sensors has been chosen as a key solution in order to handle the complex behavior of the drilling process. However, most of the proposed methodologies did not migrate from the labs to the shop floor; not always because they did not achieve sufficient performance levels in terms of accuracy, but mainly because of a lack of reliability and robustness when transferred to industrial plants. Two principal causes have been identified for these issues. The first one concerns the *flexibility* that is needed in production plants: operating conditions of the drilling process may change by many aspects, some controlled, others not. An efficient monitoring system must adapt itself to these *variations*, but this was difficult to accomplish because most monitoring methodologies were based on supervised learning techniques. The second challenging aspect that has barely been addressed is the *hostile environment* of production plants. The integration of sensors is difficult, and the harsh conditions perturb measurements. Thus, *data is made imperfect* due to harmful effects ranging from electrical noise to sensor breakdown.

The second part of the chapter was dedicated to the presentation of concepts and techniques that can contribute to better handling of the data variations and imperfections. *Multisensor* data fusion has already been widely used for monitoring purposes, mostly by the use of neural networks, but the possibilities offered by some frameworks to model and handle imperfect data have not been fully explored. In particular, the *probabilistic* and *evidential* frameworks allow one modeling *uncertain & uncertain & ambiguous* information respectively, as well as merge them with different level of performance. They may be used to address the reliability issues that traditional drilling monitoring systems encountered when facing conditions and data that are different from those they have been designed and set up with.

Chapter 3, after formalizing the process monitoring problem, provided a review of the requirements for monitoring systems to be efficient in industrial contexts. Obviously, *reliability* is mandatory. Also, *flexibility* is essential. These two constraints are required to

overcome many challenges in terms of *robustness*. It has been stated that *unsupervised learning techniques*, used together with algorithms dedicated to the *detection of singularities*, may be more robust than classical methods, which mainly consisted in the design of steady mappings between the feature space and the process state. Given these statements, a methodology dedicated to the implementation of process monitoring systems in industrial plants has been proposed. It is decomposed in six steps, namely: problem position, sensor integration, feature selection, estimator choice, offline evaluation, and finally, in-situ implementation. These steps have been described and, for some of them, experimented in further parts of the work.

Chapter 4 presented solutions to address a class of problems that, considering what has been stated before, is essential for the design of efficient process monitoring systems, i. e. the robust detection of singularities using multiple information sources. The attention has been focused on the modeling of data imperfections and the way to merge statements upcoming from several sources under such constraints. Existing methods that take advantage of possibilities offered by the probabilistic and evidential frameworks have been presented. A novel one that has been designed in order to merge statements of redundant sources in difficult contexts has also been proposed. These approaches have been compared by the use of numerical experiments that are representative of situations that are likely to occur in industrial process monitoring applications. Evidential methods have been shown to be generally superior to the probabilistic one for real world situations due to their ability to represent ambiguity explicitly. The proposed one will be used in several application cases.

Chapter 5 related some contributions at technological and methodological levels for some of the six steps described in Chapter 3.

As a contribution on a technological level, the integration of two kinds of sensors (thrust force and AE) that have been considered relevant for tool and workpiece state monitoring, has been evoked and solutions have been proposed based upon experimental works.

Most of our contributions concerned the methodological level. First, a feature selection procedure that could be used for the implementation of a monitoring system in industrial plants has been presented. The constraints linked with the flexibility of operating conditions, the difficulty to acquire representative sensor data on production means, and the harsh environment that can affect measurements have been taken into account. A general fusion methodology allowing to use heterogeneous experimental data sets have been proposed, and the data modeling and fusion method proposed in Chapter 4 has been applied. It showed superior performance to classical methodologies for fusion of experimental data dedicated to feature selection due to its ability to model data imperfection.

A first implementation of a drilling monitoring system has then been presented. Its task was to identify the different phases of aeronautical drilling operations, which is mandatory in order to extract informative features and perform efficient monitoring. A multi-scale and multisensor fusion approach has been proposed that allowed improving the robustness of the identification of different drilling operation phases. Here again, the singularity detection approach proposed in Chapter 4 have been used to fuse statements issued from redundant spindle phase current sensors.

Finally, an application dedicated to the detection of cutting edge chippings has been described. It allowed testing several of the guidelines that have been proposed in chapter 3 for the implementation of robust industrial monitoring systems. A systematic feature selection process has been applied, an unsupervised learning algorithm has been used together with an initialization phase, expert knowledge has been integrated, and the fusion (using the approach proposed in Chapter 4) of the statements coming from several simple subsystems has been shown to provide better results than the use of a global system, given the same features and information.

From the description of the industrial context of the work to application examples, passing through state-of-the-art and theoretical considerations and developments, efforts have been focused on the robustness of drilling monitoring systems in industry. Paradoxically, this precise industrial need brought most of the scientific challenges of this work. After analyzing the reasons why no reliable drilling monitoring system has been implemented in industry yet, solutions have been proposed and assessed. Results are encouraging.

6.2 Main strengths & weaknesses of the work

Considering the objective of this work - the development of a methodology allowing to implement industry-suited process monitoring systems - its main strength is, to my opinion, that fundamental practical considerations have been taken into account. For example, the basic building block of a drilling monitoring system is the robust identification of the drilling operations phase. The first development proposed in chapter 5 tackled this issue. In the same manner, the advised use of unsupervised learning algorithms implies an initialization phase. This has been discussed, and a methodology has been proposed that is in agreement with industrial production schemes. The difficulty to acquire good quality data from industrial processes has not been ignored either, that is, a method has been proposed that allows the use of heterogeneous and imperfect experimental data sets to perform feature selection, and some technological developments were proposed concerning sensor integration.

With the same concern for relevance regarding industrial contexts, a vast amount of experimental data has been acquired and used to assess the developed methodologies. These data came from the use of different drilling devices, cutting tools and operating conditions that allowed reducing - or at least being aware of - the bias existing when assessing monitoring systems using only one type of data. This is especially true and important due to the aforementioned flexibility and harsh environment constraints.

However, being aware of limitations in the generalization of results is not sufficient, and the evaluation of monitoring systems performance is a difficult task. Taking the example of methods used for the assessment of generalization performance of learning machines is, to my opinion, one of the possible ways to better evaluate real performance of monitoring systems before their integration in production plants. If solutions have been evoked for the feature selection process, they have not been applied here.

Also absent of this work is a monitoring system dedicated to the estimation of a continuous-evolving numerical variable, like tool wear size or hole diameters for instance. One can argue that such application cases, that are usually considered difficult, have not been discussed here. However, the monitoring cases which have been tackled (drilling phases identification and detection of tool cutting edge chipping) have integrated robustness and reliability constraints, that were lacking in most studies, raising important scientific challenges. These challenges have addressed proposed methodologies based on extensive state-of-the-art analysis.

6.3 From the lab to the shop floor

Guidelines of this work, both scientific and industrial, have been drawn from the challenges related to the industrial implementation of process monitoring systems. Indeed, in many previous studies, the fact that these considerations have not been sufficient, led to a lack of robustness of the proposed methodologies when implemented on the shop floor. At every step of this work, developments have been done with the goal of industrial implementation in mind. For example, sensor failure modes, initialization of unsupervised learning algorithms, or sensor integration solutions were designed in close relationship with the end-users of the monitoring systems in development. This has been possible due to the collaboration with AEROLIA teams who provided essential information about their processes.

For the moment, building blocks designed for the identification of drilling phases and for the detection of tool cutting edge chipping have been implemented online on a machining center dedicated to experimental works and characterization of cutting tools. Work is in progress for their integration on production lines. If technical obstacles linked with integration of these systems are being overcome step by step, then human factors are also of great importance. Production people have to be convinced of the interest of online monitoring, and are waiting on the shell systems, as there is no time available for trial and error developments schemes on airframe assembly production lines. The level of maturity of complex process monitoring solutions that left the labs was often below what was expected in production plants. This contributed to the gap that exists in the domain between academic and industrial communities, the latter becoming skeptical regarding promises of the former. A better knowledge of industrial requirements, as well as better lucidity about the real performance of the systems they developed are key points for researchers to introduce their drilling monitoring systems on the shop floor.

6.4 Perspectives

Improvements are possible at every step of the implementation of monitoring systems.

Concerning sensors integration, two trends have to be investigated. The first one is to position sensors closer to the process zone, as it has been done in this work for force and AE sensors. However, much effort must be made at the design step of machines to integrate sensors. Concerning drilling, and machining in general, the development of instrumented spindles and tool holders is therefore a major road to improvement. The second trend is to use information issued from the numerical controllers of machines directly. This avoids having to buy additional sensors and is not intrusive. However, sensing possibilities of such solutions is often more limited.

As for feature extraction and selection, if many works only made use of a few classical features, others presented sophisticated techniques for their extraction. The sensing, acquisition, and computational facilities available today allows the implementation of large scale extraction and selection procedures, as explained in section 5.2. This may be a promising way to investigate data issued from integrated sensors, and therefore bring new monitoring possibilities.

In this work, a bridge has linked monitoring systems and performance assessment procedures used in the machine learning field. This is a first step for better *predicting* the performance of monitoring systems once implemented in industry. A interesting progress vector could be, following the machine learning community again, the creation of shared signal databases dedicated to the evaluation of process monitoring systems. Concerning the strategic field of airframe assembly operations, the sharing of such data appears in contradiction to the confidentiality constraints of the production processes. However, academic researchers could make generic experiments on their equipment and share data and systematic measurements. These results would be at the disposal of the community as a basis to allow *assessment* of the performance of the monitoring solutions they develop in an *objective* way. Still, obstacles remain; the complexity of the drilling process makes it difficult to perform operations that emphasize one phenomenon of interest at a time. Signals will always be depending on the experimental set ups...

Concerning the use of sophisticated data modeling and fusion techniques for industrial applications, research could be done following three directions. The first one consists of the spreading of recent approaches, like evidence theory for instance. This would be made possible by the building of software libraries usable by non-specialists. Secondly, much research is needed on the specific requirements of process monitoring applications in terms of data fusion. Indeed, it would be interesting to specify the needs of robustness, redundancy, and accuracy at each point of such systems in order to identify the best suited fusion solution. This implies the third axis: strengths and weaknesses of different fusion techniques have to

be assessed on generic case studies, as done in Chapter 4 for instance, in order for one to be able to select the most suited to its problem.

After the definition of robust methodologies for process monitoring, another interesting aspect is the implementation of robust *embedded hardware and software*. These points require both skills in product design, real-time software design, and a good knowledge of the monitored process. Concerning this work for instance, only on-purpose software has been developed for experimental needs, and real effort is needed to implement a robust, time-deterministic, and embedded monitoring software. These points have not often been addressed in research oriented literature, but are of major importance for industrial implementation.

Appendix A

Test campaigns description

Description of test campaign number 1

A.1 General description

This test campaign has been performed on a machining center and was dedicated to the characterization of tool wear and tool cutting edge chipping in sensors signals (sample 1), and the influence of distance from drilling operation to sensors mounted on the sample on signals (sample 2). A tool cutting edge chipping has been provoked manually during the test campaign. Operating conditions were based on industrial ones. For confidentiality reasons, no information about the cutting tool or cutting parameters can be given here. A picture of the drill cutting edge was taken after each drilling operation with a camera placed inside the machining center.

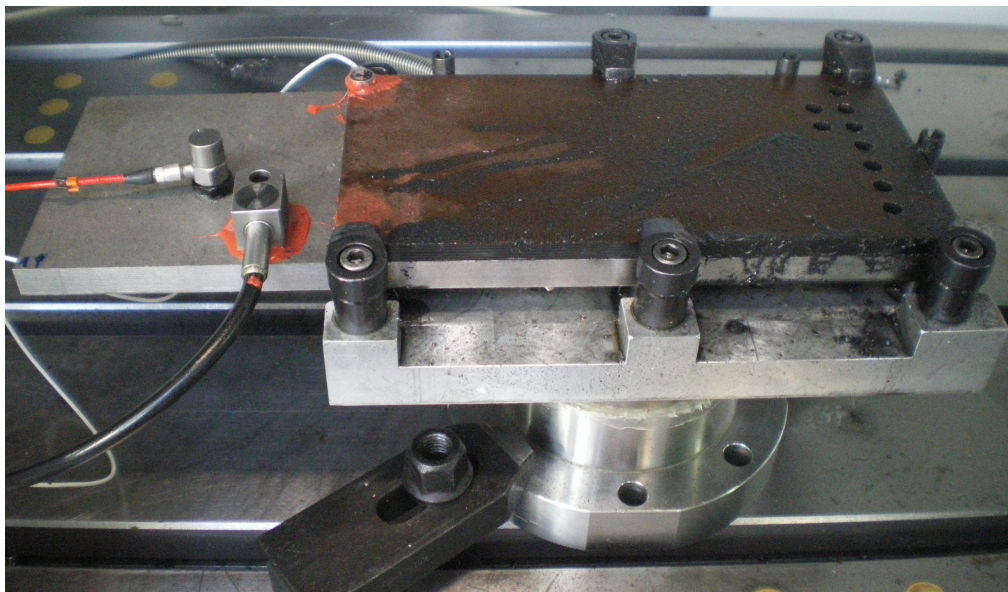


Figure A.1 – Test bed used for test campaign number 1

Drilling device	Stack type	Number of samples	Drilled holes	Lubrication
Huron KX 12	CFRP/Ti6Al4V	2	103 + 40	External micro-lubrication

Table A.1 – General parameters of test campaign number 1

Sensor(s) type	Model	Mounting	Conditioner	Sampling rate	Remarks
3+1 axis dynamometer	Kistler 9272	Under sample fixture	Kistler 5070A	20 KHz	-
2 radial accelerometers	Dytran 3225F1	On the spindle	-	20 KHz	-
1 axial accelerometer	PCB 353B01	On the Ti6Al4V sample	-	20 KHz	-
Acoustic emission sensor	EPA S9220	on the CFRP sample	EPA IL40S-32-1100	2 MHz	Bandwith: 32-1100 KHz
Acoustic emission sensor	Kistler 8152B211	on the Ti6Al4V sample	Kistler 5125B1	2 MHz	-
6 current sensors	LEM 867-601	Spindle (3) and feed (3) phases	-	20 KHz	-

Table A.2 – Sensors used for test campaign number 1

Description of test campaign number 2

A.2 General description

This test campaign has been performed on a machining center and was dedicated to the characterization of tool wear and tool cutting edge chipping in sensors signals, and the testing of an apparatus to embed an AE sensor (sample 1). A tool cutting edge chipping has been provoked manually during the drilling of the 2nd sample. Operating conditions were based on industrial ones. For confidentiality reasons, no information about the cutting tool or cutting parameters can be given here. A picture of the drill cutting edge was taken after each drilling operation with an industrial camera placed inside the machining center.

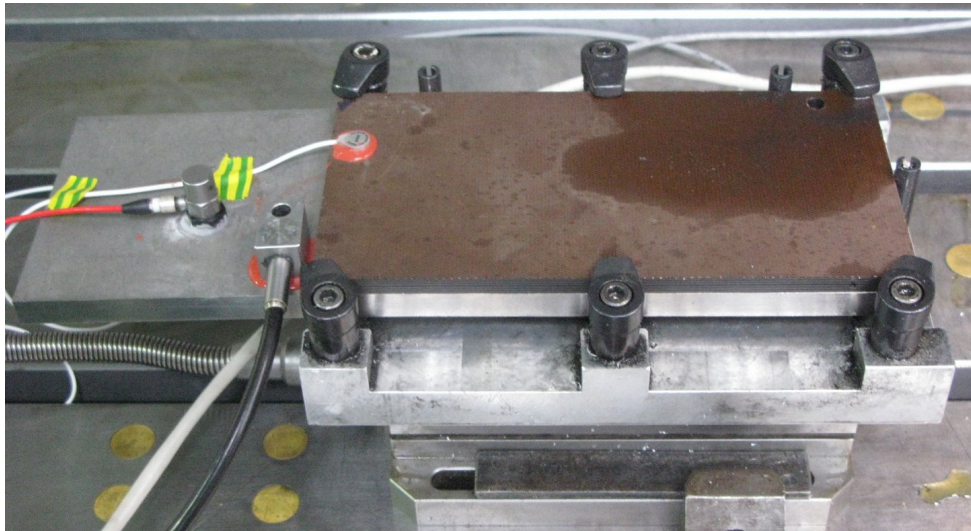


Figure A.2 – Test bed used for test campaign number 2

Drilling device	Stack type	Number of samples	Drilled holes	Lubrication
Huron KX 12	CFRP/Ti6Al4V	2	88 + 80	External micro-lubrication

Table A.3 – General parameters of test campaign number 2

Sensor(s) type	Model	Mounting	Conditioner	Sampling rate	Remarks
3 axis dynamometer	Kistler 9257B	Under sample fixture	Kistler 5070A	4 KHz	-
Rotating dynamometer	Kistler 9125A	As the tool holder	Kistler 5237	4 KHz	-
2 radial accelerometers	Dytran 3225F1	On the spindle	-	10 KHz	-
1 axial accelerometer	PCB 353B01	On the Ti6Al4V sample	-	10 KHz	-
Acoustic emission sensor	EPA S9220	On the CFRP sample	EPA IL40S-32-1100	1 MHz	Bandwidth: 32-1100 KHz
Acoustic emission sensor	Kistler 8152B211	On the Ti6Al4V sample	Kistler 5125B1	1 MHz	-
3 current sensors	LEM 867-601	Spindle (2) and feed (1) phases	-	20 KHz	-
Acoustic emission sensor	EPA S9220	on a dedicated apparatus	EPA IL40S-32-1100	1 MHz	Sample 1, hole 1 to 68 only, see figure 5.14(b)
Acoustic Emission	EPA S9220	on the CFRP sample	EPA IL40S-32-1100	1 MHz	Sample 2 only

Table A.4 – Sensors used for test campaign number 2

Description of test campaign number 3

A.3 General description

This test campaign has been performed with a robot equipped with a drilling end-effector and was dedicated to the characterization of drilling operations made with a chipped tool. A tool cutting edge chipping has been provoked manually during the test campaign. Operating conditions were based on industrial ones. For confidentiality reasons, no information about the cutting tool or cutting parameters can be given here.

Drilling device	Stack type	Number of samples	Drilled holes	Lubrication
Robot 1	CFRP/Alu	1	9	No

Table A.5 – General parameters of test campaign number 3

Sensor type	Model	Mounting	Conditioner	Sampling rate	Remarks
3 axis dynamometer	Kistler 9255B	Under sample	Kistler 5070A	25 KHz	-
Microphone	PCB 130E20	On the end-effector	-	25 KHz	-
3 axis accelerometer	Dytran 3023A	On the spindle	-	25 KHz	-

Table A.6 – Sensors used for test campaign number 3

Description of test campaign number 4

A.4 General description

This test campaign has been performed on a robot equipped with a drilling end-effector and was dedicated to the characterization of tool wear influence on sensors signals. Operating conditions were based on industrial ones. For confidentiality reasons, no information about the cutting tool or cutting parameters can be given here. A picture of the drill cutting edge has been taken after each series of 5 holes.

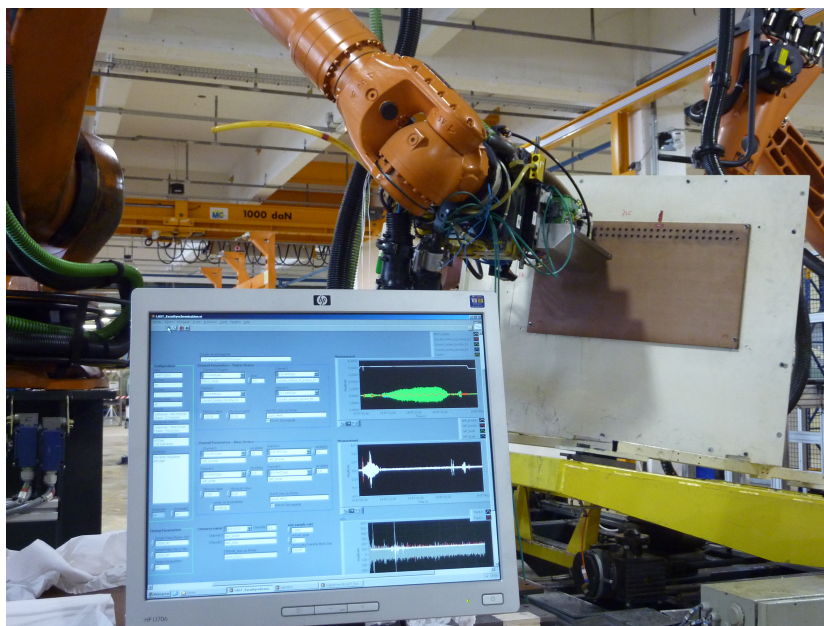


Figure A.3 – Test bed used for test campaign number 4

Drilling device	Stack type	Number of samples	Drilled holes	Lubrication
Robot 2	CFRP/Ti6Al4V	1	138	External micro-lubrication during Ti6Al4V only

Table A.7 – General parameters of test campaign number 4

Sensor(s) type	Model	Mounting	Conditioner	Sampling rate	Remarks
2 radial accelerometers	Dytran 3225F1	On the spindle	-	20 KHz	see figure 5.2(a)
2 axial accelerometers	Dytran 3225F1	On the spindle and spindle housing	-	20 KHz	see figure 5.2(a)
2 acoustic emission sensors	EPA S9220	On the end-effector nose	EPA IL40S-32-1100	2 MHz	Bandwith: 32-1100 KHz, see figure 5.5(a)
3 current sensors	LEM 867-601	Spindle (2) and feed (1) phases	-	20 KHz	-

Table A.8 – Sensors used for test campaign number 4

Description of test campaign number 5

A.5 General description

This test campaign has been performed on a machining center was and dedicated to the characterization of tool wear and tool cutting edge chipping in sensors signals. A tool cutting edge chipping has been provoked manually during the drilling of the 1st and 2nd samples. Operating conditions were based on industrial ones. For confidentiality reasons, no information about the cutting tool or cutting parameters can be given here. A picture of the drill cutting edge was taken after each drilling operation with an industrial camera placed inside the machining center.

Drilling device	Stack type	Number of samples	Drilled holes	Lubrication
Huron KX 10	CFRP/Ti6Al4V	3	96 + 97 + 96	Internal micro-lubrication during Ti6Al4V drilling only

Table A.9 – General parameters of test campaign number 5

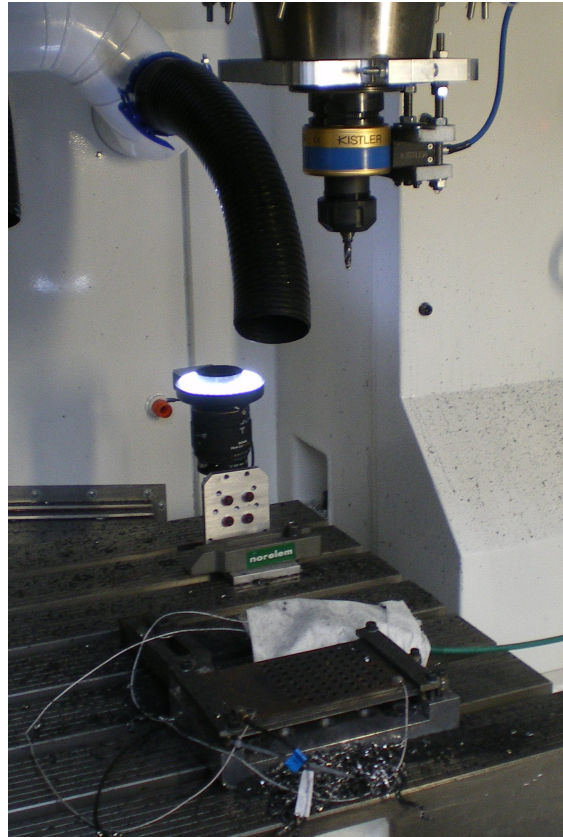


Figure A.4 – Test bed used for test campaign number 5

Sensor(s) type	Model	Mounting	Conditioner	Sampling rate	Remarks
Rotating dynamometer	Kistler 9125A	Tool holder	Kistler 5237	20 KHz	-
1 tri-axial accelerometer	Dytran 3023A	On the CFRP sample	-	20 KHz	See figure 5.9(a)
Acoustic Emission	EPA S9220	on the CFRP sample	IL40S-32-1100	2 MHz	Bandwith: 32-1100 KHz, See figure 5.9(a)
Acoustic Emission	EPA S9220	on the CFRP sample	IL40S-32-1100	2 MHz	Bandwith: 32-1100 KHz, See figure 5.9(a)
3 current sensors	LEM 867-601	Spindle phases	-	20 KHz	-

Table A.10 – Sensors used for test campaign number 5

Annexe B

Résumé des parties en français

Introduction

B.1 Introduction générale

L'objectif principal de tout procédé de production industrielle est que les produits finis satisfassent aux critères de qualité requis. D'autres objectifs existent, tel qu'une production optimisée ou encore respectueuse de l'environnement par exemple. En vue d'atteindre le premier objectif, trois stratégies, qui ne sont pas mutuellement exclusives, sont applicables :

- la prédiction précise des variables d'intérêt en sortie du procédé
- le contrôle systématique de la qualité des produits finis
- la surveillance en ligne du procédé

Concernant les situations impliquant haute qualité des produits issus de procédés de fabrication complexes, et où la productivité est un critère important, une modélisation précise du procédé ainsi qu'une stratégie de surveillance en ligne peuvent être utilisées de concert en vue d'atteindre les performances souhaitées.

Les opérations de perçage de précision nécessaires à l'assemblage de structures aéronautiques seront abordées au cours de cette étude. Leur nombre étant trop important pour envisager des contrôles systématiques de leur qualité, et le fait qu'aucun modèle robuste et prenant en compte les nombreux paramètres influents n'existe, la surveillance en ligne est la solution privilégiée pour améliorer la productivité de ces opérations. L'objectif de ce travail est de dessiner les lignes directrices du processus d'implémentation d'un système de surveillance des opérations de perçage aéronautiques.

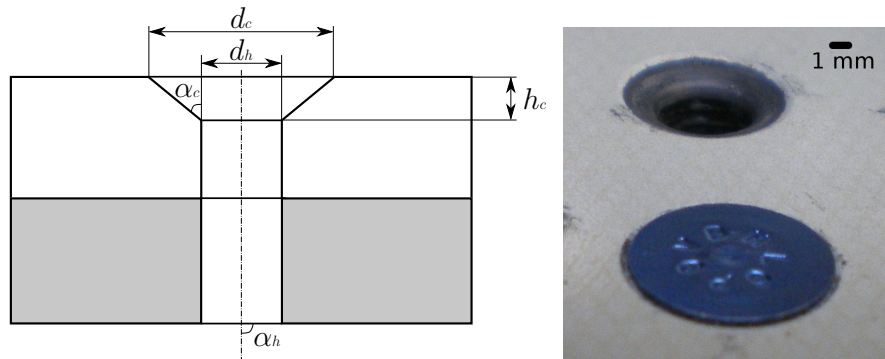
B.2 Contexte et objectifs de l'étude

B.2.1 Problématiques industrielles

La difficulté majeure concernant les perçages de structures aéronautiques réside dans le respect de normes de qualité présentées ci-après :

- Le diamètre de l'alésage d_h doit être compris dans un intervalle de tolérance dépendant du matériau percé
- Le diamètre de fraisure d_c , l'angle α_c la profondeur h_c doivent être compris dans des intervalles de tolérance garantissant un désaffleurement acceptable entre la tête du rivet et la structure (voir figure B.1(b)). Le désaffleurement maximum autorisé dépend de la localisation sur la structure avion et des incidences aérodynamiques induites.

- La normalité α_h de l'alésage par rapport à la surface de la pièce percée doit être comprise dans un intervalle de tolérance.



- (a) Spécifications dimensionnelles concernant les alésages et fraises (une configuration typique de perçage d'empilage de plusieurs matériaux est représentée)
- (b) Un rivet (bleu) inséré dans un alésage avec fraisure : un désaffleurement est visible entre la tête du rivet et la surface de la pièce

Figure B.1 – Spécifications dimensionnelles concernant les perçages/fraisurages aéronautiques (a) et image d'un rivet inséré dans un alésage avec fraisure (b)

Les alésages sont aussi sujets à des critères de qualité :

- L'état de surface (Ra) doit être inférieur à un certain niveau dans l'alésage et la fraisure
- La hauteur des bavures d'entrée et de sortie est limitée
- La surface des délaminages (matériaux composites) est limitée
- La présence de fibres non coupées (matériaux composites) est proscrite
- Les changements de propriétés mécaniques des matériaux dus à la chaleur dégagée pendant le perçage sont limités

Ces spécifications, nombreuses et contraignantes, font des opérations de perçage une étape stratégique des procédés d'assemblages aéronautiques.

B.2.1.1 Axes de développement pour la productivité des opérations de perçage aéronautique

Les opérations de perçage représentent un levier stratégique en vue d'optimiser la productivité des procédés d'assemblage aéronautique. Trois axes principaux sont à considérer :

- Diminution des non-qualités
 - Diminution du nombre de pièces rebutées
 - Diminution des interventions manuelles non planifiées dues aux non-qualités
 - Diminution du nombre de contrôles qualité

- Optimisation de l'utilisation des ressources
 - Rationalisation de l'usage des consommables
 - Application d'une maintenance ciblée
- Augmentation du degré d'automatisation

Concernant le premier axe, des forets et des équipements de haute qualité sont utilisés, et les procédés sont définis avec attention afin de réduire les occurrences de non-qualité. Cependant, des défauts sont toujours possibles, particulièrement en perçage étant donnée la variabilité du procédé. De coûteuses procédures de contrôle sont généralement utilisées en vue de s'assurer du niveau de qualité. Par conséquent, des estimations en ligne de la qualité du procédé, ainsi que la détection d'éventuels défauts pourraient réduire les coûts liés aux opérations de contrôle et aux non-qualités de manière significative.

Le consommable présentant le plus d'importance pour les opérations de perçage aéronautiques sont les forets. Leur stratégie de remplacement est basée sur des estimations statistiques de leur durée de vie, qui présente souvent une dispersion significative. Cela conduit à l'utilisation de marges de sécurité importantes, mais cette approche se révèle être particulièrement coûteuse depuis l'introduction massive de nouveaux matériaux pour les structures aéronautiques. Les alliages de titane et les matériaux composites en particulier présentent des propriétés qui réduisent considérablement la durée de vie des outils de part l'usure accélérée dont ils sont responsables. Par conséquent, la stratégie de remplacement des outils coupants devrait être basée sur des estimées en temps réel de l'état d'usure des outils coupants en vue de réduire les coûts et d'aller vers une production plus efficace.

Le dernier axe, l'automatisation, est un courant ancien dans l'industrie manufacturière. Pourtant, en raison de la qualité requise et de la taille des structures, la plupart des alésages réalisés pour l'assemblage de structures aéronautiques le sont par des opérateurs très expérimentés et à l'aide de machines portatives. Des gains de productivité pourraient être réalisés grâce à l'usage de procédés plus automatisés.

B.2.1.2 De l'intérêt de moyens de surveillance en ligne pour les opérations d'assemblage aéronautiques

Considérant les deux premiers axes de développement cités ci-dessus, les trois stratégies proposées pour atteindre la qualité requise en sortie de procédé pourraient théoriquement être appliquées. Cependant, le contrôle systématique des alésages s'avérerait être trop coûteux, et aucun modèle suffisamment évolué des opérations de perçage n'existe qui permette de prévoir les propriétés relatives à la qualité des perçages réalisés. Par conséquent, l'unique solution est l'implémentation de systèmes de surveillance en ligne.

Si de tels systèmes n'existent pas aujourd'hui dans l'industrie, la littérature recèle de tentative encourageantes, et le développement rapide des technologies de capteurs, d'acquisition de données et de stratégies d'aide au diagnostic et à la décision laisse entrevoir des possibilités intéressantes quant-au développement de systèmes robustes de surveillance des opérations de perçage.

B.2.1.3 Besoins liés à l'implémentation de systèmes de surveillance en ligne dans l'industrie aéronautique

Pour être exploitable industriellement, un système de surveillance en ligne des opérations de perçage doit satisfaire à plusieurs conditions. En premier lieu, les informations qu'il fournit doivent être assez précises pour être utiles, et ce malgré l'absence de modèles théoriques. Il doit aussi être robuste face aux dispersions liées au procédé de perçage et aux perturbations dues à l'environnement industriel, souvent hostile. Enfin, il ne doit pas être intrusif : le processus de production suivi ne doit en aucun cas être perturbé par le système de surveillance.

Bien que facile à identifier, ces besoins impliquent des efforts importants en terme d'intégration de capteurs, de traitement du signal, d'extraction d'indicateurs et de développement d'algorithmes d'estimation et de prise de décision. Les problématiques scientifiques qui en découlent sont décrites dans la section suivante.

B.2.2 Problématiques scientifiques

Depuis plus de 30 ans et l'avènement de nouvelles technologies de capteurs et de traitement de données, de nombreuses études ont été réalisées concernant la surveillance des opérations de perçage. Beaucoup d'approches utilisant un seul capteur ont d'abord été présentées. Si certaines ont permis d'obtenir des résultats intéressants, elles ont souvent été évaluées en considérant des paramètres opératoires stables, ce qui a conduit à un manque de flexibilité des systèmes développés. D'autres tentatives ont donné des résultats plus mitigés, notamment en ce qui concerne l'estimation de l'usure outil de part le fait que les capteurs utilisés ne permettaient pas de rendre compte de la complexité du procédé de perçage. Par conséquent, peu des méthodologies développées lors de ces travaux sont susceptibles d'être implémentées dans l'industrie. En outre, les challenges liés à l'environnement hostile aux mesures des sites de production a été éludé quasi-systématiquement.

Afin de pouvoir être introduit de manière efficace dans les usines d'assemblage de structures aéronautiques, un système de surveillance est soumis à des contraintes impliquant des challenges scientifiques et techniques. Leurs origines peuvent être résumées comme suit :

- Inaccessibilité des phénomènes d'intérêt
- Complexité des phénomènes d'intérêt
 - Comportements dispersifs des machines et des structures usinées
 - Absence de modèle performant
- Variabilité des paramètres du procédé
 - Différentes conditions opératoires peuvent être rencontrées
 - Différents comportements sont à prévoir en fonction du système usinant et des structures concernées
- Hostilité de l'environnement industriel aux mesures

Bien qu'elles soient spécifiques, ces causes soulèvent une problématique plus générale. Les étapes de mesure, de traitement des données, d'estimation et de prise de décision nécessaire à l'établissement d'un diagnostic doivent être effectuées sous incertitude. Ce constat est à la base du positionnement scientifique de ce travail : contrairement à la majorité des études concernant la surveillance des opérations de perçage, l'incertitude concernant les conditions opératoires, l'état des capteurs, et la qualité des données vont ici être prises en compte dès les premières étapes de conception d'un système de surveillance des opérations de perçage. Par conséquent, de nouvelles contraintes, mais aussi de nouvelles possibilités, vont apparaître, qui confèrent à ce travail son caractère original.

Des *solutions* existent pour répondre aux besoins explicités précédemment. Les études réalisées auparavant ont donné des informations essentielles sur les types de capteurs et de techniques de traitement du signal à implémenter afin de développer un système de surveillance des opérations de perçage. Pourtant il est aujourd'hui généralement admis qu'un seul type de capteurs ne permet pas de réaliser une surveillance en ligne robuste. L'utilisation de systèmes multi-capteurs combinés avec des techniques de traitement de l'information dites intelligentes devrait augmenter la robustesse et la flexibilité des système de surveillance

de procédés. De nombreuses études ont déjà montré que l'utilisation de plusieurs capteurs permettait une meilleure appréhension des phénomènes complexes dont le perçage est le siège. Cependant, ces travaux ont principalement été réalisés sous des conditions opératoires stables et dans les environnements protégés des laboratoires. Les contraintes relatives à la variabilité des conditions opératoires et de la qualité des données mesurées n'ont pas été prises en compte.

Pourtant, ces aspects revêtent une importance majeure : l'utilisation de plusieurs capteurs répond à une absence de données assez fiables ou précises provenant d'une seule source d'information. L'incertitude sur les données provenant des capteurs devrait donc être prise en compte dès le début de la conception d'un système de surveillance multi-capteurs. Une connaissance précise des moyens de modéliser et de manipuler les différentes formes d'incertitude doit aider à mieux répondre aux problématiques qu'elles impliquent. Actuellement, ces aspects ne sont pas pris en compte dans la grande majorité des études concernant la surveillance des opérations de perçage, et l'incertitude sur les données a été traitée de manière implicite au niveau des estimateurs utilisés. Pourtant, leur importance est capitale : les meilleurs estimateurs ne donneront pas de bons résultats en présence de données erronées ou mal interprétées.

Les points requérant une attention particulière, de notre point de vue, pour l'implémentation d'un système de surveillance en environnement industriel sont :

- L'intégration des capteurs
- Les techniques de traitement de l'information
- La modélisation des incertitudes sur les données
- La fusion multi-capteurs

Par conséquent, les *contributions escomptées* de cette étude sont :

- Le développement de solution d'intégration de capteurs pour la surveillance des opérations de perçage
- L'implémentation de techniques de fusion de données pour la surveillance de procédés industriels complexes
- Le développement d'une méthodologie générique pour l'implémentation de système de surveillance multi-capteurs

Synthèse de l'état de l'art

B.3 Principaux défis pour l'implémentation de systèmes de surveillance en ligne des opérations de perçage

L'état de l'art concernant la surveillance indirecte des opérations de perçage a permis d'identifier trois défis principaux relatifs à l'implémentation industrielle de tels systèmes :

- Les difficultés inhérentes à la complexité du procédé de perçage : la majorité des phénomènes d'intérêt n'ont pas été modélisés en fonction de variables mesurables, rendant la surveillance difficile
- Les difficultés liées à la généralisation des résultats : la majorité des résultats obtenus jusqu'à présent sont étroitement liés aux conditions opératoires dans lesquelles ils ont été obtenus
- Les difficultés liées à la qualité des données disponibles : l'environnement difficile des ateliers de production rend les mesures issues des capteurs imparfaites

La majorité des travaux ont été axés sur le premier aspect, probablement de part le fait qu'il est le point de départ à l'implémentation d'un système de surveillance. Il permet d'établir les liens entre les phénomènes d'intérêt, les indicateurs associés et les capteurs à utiliser. En outre, ces études ont permis d'améliorer la connaissance du procédé de perçage, et par conséquent les capacités à concevoir des systèmes de surveillance performants. Les approches multi-capteurs ont principalement été utilisées en ce sens, en vue d'aider l'appréhension de phénomènes complexes.

Pourtant, les exemples de mise en oeuvre et de mise sur le marché de systèmes de surveillance sont rares, et présentent souvent des plages de fonctionnement limitées et une faible robustesse, soulignant l'importance des deux autres aspects. En effet, le second est une condition sine qua none pour l'émergence de systèmes de surveillance dans les usines d'assemblage aéronautique pour répondre aux besoins de flexibilité des processus de production. Concernant le troisième aspect, la gestion de la qualité des données d'entrée revêt une grande importance : un système de surveillance dont les diagnostics sont basés sur des inférences issues d'informations dégradées ou mal interprétées ne peut fournir de bons résultats.

B.4 Fusion de données pour la surveillance : synthèse

La seconde partie de l'état de l'art concernant la fusion de données a permis de détailler ses objectifs, avantages, et concepts fondamentaux, mais aussi ses limites, ainsi que les problématiques à surmonter pour l'implémentation d'un système de surveillance des opérations de perçage.

Une classification des problèmes liés aux données d'entrée a permis d'identifier les difficultés qui seront rencontrées, ainsi que les principales problématiques à prendre en compte : l'incertitude et l'ambiguïté des données. En outre, l'utilisation de sources d'information multiples

implique de manipuler des données corrélées ou/et contradictoires, ce qui peut être à l'origine de nombreux problèmes.

Les possibilités offertes par les formalismes probabiliste et évidentialiste pour répondre à ces problématiques ont été évaluées : les fondations théoriques des probabilités sont établies et elles ont été largement utilisées par le passé, tandis que les fonctions de croyance présentent une meilleure capacité à traiter les données imprécises, tout en conservant la possibilité de modéliser l'incertitude. Malheureusement, la complexité calculatoire augmente de manière exponentielle avec le nombre de propositions à traiter dans ce formalisme. Dans les deux cas, une attention particulière doit être portée quant-à la manipulation et la fusion de données contradictoires.

Pour chaque problème rencontré, le choix d'un formalisme sera basé sur ces considérations et sur les spécificités du cas d'étude. Un aspect important des applications de surveillances, l'identification de singularités, a été détaillé au chapitre 4, et des approches développées dans les deux formalismes ont été comparées.

B.5 Surveillance des opérations de perçage et fusion de données : synthèse générale

L'état de l'art a d'abord permis de détailler les travaux réalisés et les défis restant à relever concernant la surveillance des opérations de perçage. La plus grande partie des efforts a été concentrée sur la gestion de la complexité du procédé de perçage, souvent en utilisant plusieurs capteurs. Les aspects concernant la généralisation des résultats obtenus ainsi que la robustesse face aux environnements industriels ont souvent été négligés. Par conséquent, le manque de robustesse de systèmes de surveillance développés a souvent rendu impossible leur implémentation industrielle.

Dans une seconde partie, les concepts et techniques associés à la fusion de données pouvant aider à la résolution des problèmes identifiés ont été présentés. L'importance des problématiques liées à la qualité des données a été soulignée, et deux formalismes mathématiques adaptés à la manipulation et à la fusion de données imparfaites ont été présentés. Les points forts et points faibles des formalismes probabilistes et évidentialistes concernant les problématiques associées à la surveillance des opérations de perçage ont été détaillés afin de permettre au concepteur d'un système de surveillance de choisir le plus adapté.

Formalisation du problème de surveillance, description des besoins et des défis, et proposition d'une approche d'implémentation

A partir de la description et de la formalisation du problème de la surveillance de procédés industriels, les principaux défis et besoins seront identifiés, et des solutions seront proposées et/ou passées en revue. Bien que ces différents aspects soient présentés dans des sous-sections distinctes, ils présentent des liens importants, qui seront détaillés eux aussi. Ces constats seront ensuite utilisés pour construire une méthodologie dédiée à l'implémentation de système de surveillance de procédés de production industriels. En effet, plus que le système de surveillance, son implémentation pose de nombreuses questions et défis qui seront discutés. Une attention particulière sera portée sur le procédé de perçage, mais les constats et approches proposées pourront être généralisés à d'autres procédés de production. Ce chapitre permettra aussi de dessiner les orientations principales de ce travail en soulignant les verrous scientifiques et technologiques à lever pour développer des systèmes de surveillance de perçage performants.

B.6 Description du problème de surveillance

Comme évoqué au chapitre 1, un système de surveillance de procédé d'usinage opère selon le schéma suivant : des variables liés au procédé sont influencées par l'état de l'outil coupant et les conditions de l'opération d'enlèvement de matière sont mesurées à l'aide de capteurs. Les signaux recueillis par ces capteurs sont traités afin de générer des indicateurs corrélés avec l'état de l'outil et/ou du procédé. Ces indicateurs sont ensuite utilisés par des systèmes destinés à estimer l'état du procédé. Cette estimation de l'état peut ensuite être communiquée à un opérateur, ou directement utilisée pour adapter les paramètres opératoires du procédé. Cette séquence générique est illustrée par la figure B.2.

B.7 Description des besoins et défis liés à la surveillance de procédés complexes en environnement difficile

La surveillance de procédés complexes en environnement industriel est une tâche difficile. Certains des aspects décrits ci-après sont génériques, tandis que d'autres sont spécifiques

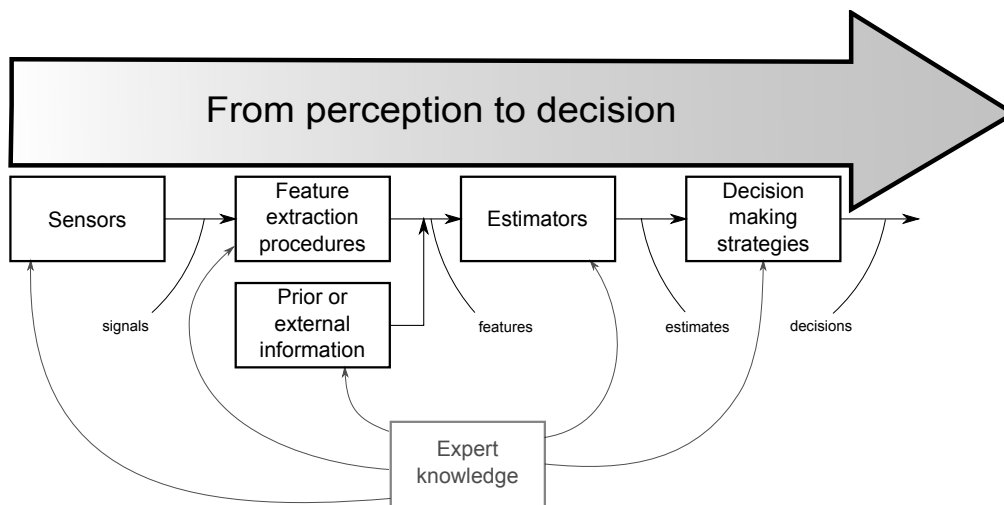


Figure B.2 – Séquence générique d'un processus de surveillance

aux opérations de perçage.

B.7.1 Défis liés à la variabilité des conditions opératoires

Comme évoqué dans la section 2.1, de nombreuses études concernant la surveillance des opérations de perçage ont été réalisées dans des conditions opératoires stables, dans des environnements propices à la réalisation de mesures, et les aspects liés à variabilité des conditions opératoires n'ont que rarement été abordés. De nombreuses sources de variabilité existent conduisant à des problèmes de robustesse des systèmes de surveillance. Par exemple, le transfert d'un tel système d'une unité de production à une autre, dont le comportement et l'environnement sont fatalement différents, doit être possible étant données les contraintes de flexibilité auxquelles sont soumis les processus de production. Par conséquent, des changements dans les conditions opératoires, qu'ils soient dus à un besoin de flexibilité ou à des grandeurs d'influences non maîtrisées, nécessitent qu'un système de surveillance soit robuste face à de tels changements.

B.7.2 Défis liés à la qualité des données

Les données transitant des capteurs jusqu'aux décisions portent l'information au long des différentes étapes du processus de surveillance. Par conséquent, la qualité de ces données est un point important. Les données d'entrée sont les plus sujettes à des problèmes de qualité, et les imperfections qu'elles comportent sont souvent propagées par les indicateurs jusqu'à ce qu'elles dégradent le niveau de performance global du système de surveillance en affectant les décisions qui sont prises.

La qualité des données, et particulièrement des données d'entrée, revêt donc une importance capitale pour qu'un système de performance donne de bonnes performances. Malheureusement certaines imperfections sur les données d'entrée sont inévitables, et, par conséquent, le système doit être capable de fonctionner malgré tout afin d'être robuste dans un environnement industriel. Ceci peut être fait en évitant la création d'indicateurs de mauvaise qualité, ou en concevant des estimateurs capable de les traiter.

B.7.3 Défis liés à la complexité des procédés et aux comportements dispersifs

Le dernier défi à relever pour l'implémentation de systèmes de surveillance de procédés complexes est directement lié aux opérations à surveiller. Le cas particulier du perçage sera évoqué ici, mais les constats seront souvent applicables à bon nombre de procédés de fabrication. Comme évoqué à plusieurs reprises, le perçage est un procédé complexe montrant un comportement dispersif. Si ces deux caractéristiques sont liées, elles seront traitées ici de manière séparée du fait que leur influences respectives affectera un système de surveillance de différentes manières.

La complexité du procédé implique que les estimateurs soient aptes à appréhender une telle complexité, ce qui passe généralement par l'utilisation simultanée de plusieurs indicateurs et l'utilisation d'algorithmes complexes. D'autre part, le caractère dispersif du procédé implique que le domaine de fonctionnement des systèmes de surveillance soit étendu, et que l'estimateur soit capable de gérer, dans une certaine mesure, des données d'entrée dispersées. Les procédés complexes et présentant un caractère dispersif sont donc difficiles à surveiller. En effet, comme ils interdisent l'utilisation d'approches basées sur des modèles, les stratégies de surveillances doivent être construites à partir de la connaissance du procédé, qui est souvent difficile à modéliser et à utiliser de manière robuste. En outre, les comportements dispersifs imposent aux systèmes de surveillance d'être en mesure de traiter des situations inconnues lors de leur conception.

B.8 Solutions pour des systèmes de surveillance robustes

En vue de relever les défis et d'atteindre les objectifs détaillés dans les sections précédentes, des solutions existent qui vont être discutées ici.

Suivant le constat généralement admis que la surveillance robuste de procédés complexes n'est pas réalisable à l'aide d'un seul capteur, l'usage de plusieurs sources d'informations couplées à des systèmes de traitement des données adaptés a été élevé au rang de solutions prometteuse en vue d'améliorer la précision et la robustesse des systèmes de surveillance. En effet, de nombreuses études où il a été fait usage de plusieurs capteurs et de diverses techniques de fusion de données ont été réalisées, où les bénéfices attendus étaient :

- une meilleure appréhension de la complexité du procédé
- une robustesse accrue face à des environnements difficiles
- une robustesse accrue face au caractère dispersif du procédé et aux variations de conditions opératoires

Essentiellement, le premier point a été réalisé. L'usage de plusieurs capteurs, dont les mesures et indicateurs ont le plus souvent été fusionnés grâce à l'usage de réseaux de neurones, a permis d'obtenir des résultats très intéressants, en particulier pour l'estimation de l'état d'usure de l'outil. Cela a permis de démontrer un des bénéfices potentiels de l'usage de fusion multi-capteur pour la surveillance de procédés industriels. Cependant, cela a été fait, le plus souvent, sous des conditions opératoires contrôlées et dans des environnements favorables à la mesure. Ni la problématique de la variabilité des conditions opératoires, ni celle de la qualité des données d'entrée n'ont été abordées.

Pourtant, la fusion multi-capteurs, mais aussi les concepts associés comme la modélisation des données imparfaites ou la fusion de données contradictoires présentent un grand intérêt pour atteindre les performances requises pour une introduction dans l'industrie. Les possibilités offertes par ces concepts ont été soulignées, et leur utilisation constitue une des contributions originales de ce travail.

B.9 Approche proposée pour l'implémentation de systèmes de surveillance de procédés de production industriels complexes

En 2010, Abellan-Nebot and Subirón ont constaté qu'en dépit des recherches intensives menées sur le sujet, aucune méthodologie claire de développement de système de surveillance d'opérations d'usinage n'existait, et qu'en outre, certaines études précédentes sur le sujet étaient contradictoires. Plusieurs étapes sont indispensables à la conception d'un système de surveillance de procédé. Le but de cette section est d'en détailler le contenu, les liens qu'elles entretiennent, les besoins et les défis qu'elles impliquent afin de pouvoir implémenter un système de surveillance répondant aux besoins de l'industrie. A partir de la proposition d'une méthodologie globale, les principales étapes de l'implémentation seront abordées, amenant à la détermination de plusieurs contributions de ce travail.

B.9.1 Méthodologie globale pour l'implémentation de systèmes de surveillance

Les différentes étapes de développement d'un système de surveillance sont, selon l'auteur : la position du problème, l'intégration des capteurs, la sélection d'indicateurs, la sélection d'estimateurs, l'évaluation du système, et enfin son implémentation industrielle. Ces étapes, reprises dans la figure B.3 avec d'éventuels retours, présentent de nombreux liens, et parfois se superposent, mais leur séparation donne une vision intéressante des étapes à mettre en œuvre pour l'implémentation d'un système de surveillance.

B.10 Conclusion

Ce chapitre a permis de séparer la conception, l'évaluation et l'installation industrielle d'un système de surveillance de procédé, et de définir clairement les actions à effectuer.

L'approche d'implémentation proposée étant basée sur les besoins industriels et tenant compte des nombreux défis liés à la surveillance dans les ateliers de production, elle devrait permettre aux concepteurs de systèmes de surveillance de dépasser les problèmes de robustesse rencontrés jusqu'à présent.

Plusieurs concepts liés à la fusion d'information et à l'intelligence artificielle ont été utilisés comme des moyens de description de problématiques qui ont été traitées de manière implicite jusqu'à présent, tout comme les solutions pour y répondre. Cela est en accord avec la philosophie de ce travail consistant à importer des développements de différents domaines de recherche pour améliorer les performances des systèmes de surveillance.

En particulier, une méthode sera proposée au chapitre 4 pour détecter des événements singuliers dans des environnements difficiles utilisant la fusion de données et les fonctions de croyance. Elle servira ensuite pour le développement de méthodologies et de briques nécessaires à l'implémentation de systèmes de surveillance au chapitre 5.

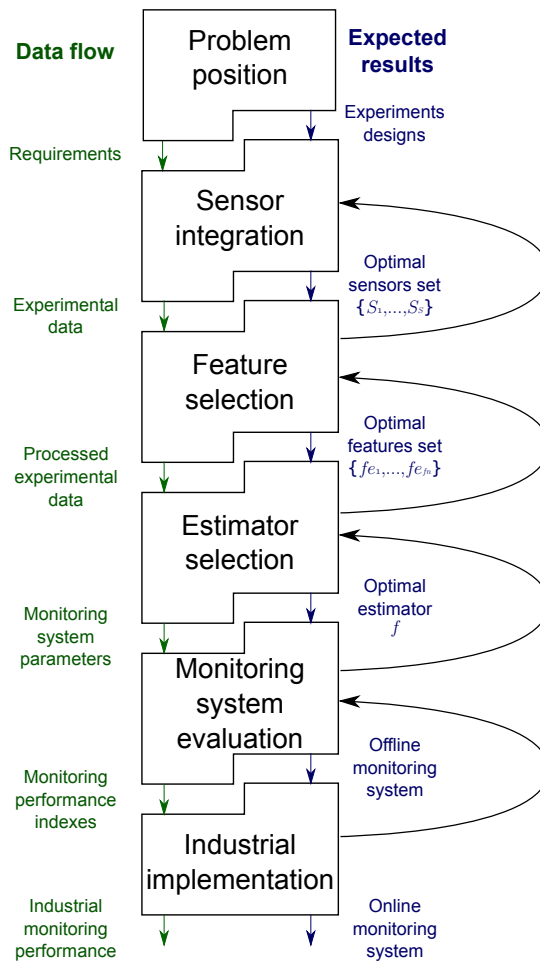


Figure B.3 – Approche proposée pour l'implémentation de systèmes de surveillance de procédés industriels. Les retours éventuels sont représentés par des flèches grises tandis que les données transitant et les résultats escomptés sont donnés en vert et bleu respectivement. Le terme optimal est à considérer en fonction des performances du système de monitoring

Identification de singularités en contexte difficile

La surveillance d'un système ou d'un procédé implique la détection de déviations par rapport à son fonctionnement normal. Ces états anormaux sont détectables par les valeurs singulières prises par certains indicateurs caractéristiques de l'état du procédé. De nombreux exemples d'application de surveillance de perçage basés sur la détection de singularité ont été donnés en section 2.1. L'identification de singularités peut aussi s'avérer utile à d'autres étapes de l'implémentation d'un système de surveillance, comme lors de la recherche des indicateurs les plus performants par exemple. L'identification de singularités est en réalité une tâche très générique qui est réalisée, tant de manière implicite qu'explicite, dans de nombreux cas d'application impliquant la recherche d'un élément prenant une valeur remarquable. Dans la plupart des cas, après que les données aient été traitées, il s'agit d'un problème de recherche d'extremum dans un jeu de données.

Etant donnée l'importance de l'identification de singularités dans les applications de surveillance, le bon déroulement de ces opérations est indispensable. Par conséquent, dans les contextes difficiles tels que les sites d'assemblage aéronautique, des méthodes robustes doivent être implémentées. La fusion multi-capteurs apparaît comme la solution naturelle pour garantir la robustesse, mais nécessite des efforts en termes de modélisation et de fusion des données imparfaites, comme évoqué en section 2.2.

Ce point capital pour la surveillance a été discuté dans ce chapitre. Le problème d'identification de singularités a été introduit, puis deux approches existantes ont été présentées, ainsi qu'une nouvelle, et toutes ont été évaluées par le biais de simulations représentatives de cas de figures industriels.

B.11 Considérations générales

Le problème d'identification de singularités peut être divisé en deux étapes. La première consiste à trouver une forme d'intérêt trahissant la présence d'une singularité dans les données observées. Une fois que ceci a été fait, les observations peuvent être classées en fonction de leur similarité avec la forme recherchée, ou de leur dissimilarité avec les observations régulières (non-singulières). Souvent, cette dissimilarité est exprimée sous la forme d'une distance.

La seconde étape consiste à prendre une décision visant à désigner l'élément singulier. Cette étape est évidente dans beaucoup de problèmes d'identification de singularité où une seule source d'information est utilisée : l'élément le plus singulier parmi le jeu de données est désigné. En revanche, considérant les applications dans des contextes difficiles ou les données observées sont imparfaites, des solutions doivent être trouvées afin d'identifier les singularités de manière robuste.

B.12 Problèmes relatifs à la qualité des données

Comme évoqué en section 2.2.2, dans les espaces descriptifs possédant une métrique, les incertitudes de mesure ou d'estimation sont usuellement représentées à l'aide de fonctions de probabilité caractérisant la dispersion des valeurs pouvant être raisonnablement attribuées au phénomène original connaissant la mesure/l'estimation. Cette modélisation assume que les observations ne sont pas entachées de perturbations systématiques, mais seulement de nature stochastiques. Pourtant, les imperfections sur les mesures capteurs ne sont pas seulement stochastiques mais peuvent aussi se manifester en termes d'ambiguïtés et de contradictions dues à l'environnement. Ces cas se présentent quand une ou plusieurs sources d'information sont en défaut à cause d'une inhabilité, partielle ou totale, à évaluer la grandeur d'intérêt. Ces assertions valent aussi pour les informations provenant d'autres sources que les capteurs.

B.13 Approches existantes pour l'identification de singularités, et proposition d'une nouvelle méthode

La représentation probabiliste des données incertaines issues de capteurs rend l'utilisation du formalisme bayésien directe. Concernant la théorie de l'évidence en revanche, une des difficultés majeures réside dans la modélisation des données lors de la création de fonctions de croyance. Une première approche sera présentée utilisant la transformée pignistique inverse et le principe de moindre engagement pour affecter des masses à partir des fonctions de probabilité. Ensuite, l'approche proposée, qui conserve un fort lien avec les probabilités, tirera avantage de la présence de plusieurs sources d'information. La construction des masses sera optimisée pour que lors de l'étape de fusion, les sources les plus informatives soient favorisées.

B.14 Conclusion

Ce chapitre a permis d'introduire le problème de l'identification de singularité dans des contextes difficiles à l'aide de sources d'informations multiples. L'importance d'une modélisation juste des informations et de leur imperfections, ainsi que du nombre de sources et de leur comportement attendu ont été soulignées. Les bénéfices tirés de l'utilisation de la théorie de l'évidence et de sa capacité à modéliser explicitement l'incertitude épistémique a été prouvée dans des contextes où plusieurs sources sont utilisées.

L'approche de modélisation des données proposée est un exemple de solutions que peut offrir la théorie de l'évidence : la flexibilité en terme de modélisation des données imparfaites permet de s'adapter à chaque cas d'application. Le cas particulier dans lequel une source fournit des informations plus spécifiques a été particulièrement bien appréhendé. Le besoin de consensus entre les sources semble être un critère intéressant en vue de faire un choix parmi les approches présentées qui sont complémentaires.

La méthodologie proposée sera utilisée par la suite pour des tâches de surveillance et de sélection d'indicateurs.

L'évaluation des performances des modélisations bayésiennes et évidentialistes dans le contexte de l'identification de singularités a aussi permis d'évaluer, dans une certaine mesure, les performances générales de ces deux formalismes.

Implémentation de sous-systèmes de surveillance de perçage

Ce chapitre est dédié à la présentation de réalisations scientifiques et techniques directement associées à l'implémentation d'un système de surveillance de perçage.

B.15 Intégration des capteurs

Comme souligné au chapitre 3, l'intégration des capteurs est un point crucial en vue d'implémenter un système de surveillance. En effet, un diagnostic correct ne peut-être basé que sur des indicateurs pertinents, eux-mêmes issus de signaux informatifs. L'intégration de capteurs est rendue difficile de part les contraintes imposées par l'environnement difficile des usines de production industrielle : les solutions de mesures doivent être à la fois robustes et non-intrusives, et en sus, permettre de recueillir des données informatives. Malheureusement, les signaux les plus informatifs sont issus des capteurs les plus difficiles à intégrer. Si les vibrations de broche et les puissances consommées sont faciles à observer, ces données sont souvent insuffisantes pour effectuer de la surveillance. En revanche, les mesures de force et d'EA sont informatifs, mais les capteurs associés sont difficiles à intégrer.

Les solutions d'intégration existantes concernant ces deux types de capteurs ont été passées en revue, et de nouvelles ont été proposées qui ont donné des résultats encourageants. Une méthode d'extraction d'indicateurs à partir des signaux d'émission acoustique a aussi été proposée qui s'est montrée plus robuste face à des changements de paramètres que les méthodes utilisées classiquement.

Ces résultats confirment que l'intégration des capteurs est une étape importante lors de la conception d'un système de surveillance. En particulier, quand des contraintes relatives à la production industrielle existent, elles doivent être prises en compte dès le début de la phase de conception.

B.15.1 Sélection des indicateurs

La sélection des indicateurs qui vont permettre d'assurer le suivi du déroulement du procédé est une étape critique de l'implémentation d'un système de surveillance. Différentes approches ont été introduites, et les méthodes de pondérations des indicateurs ont été sélectionnées de part leur flexibilité et facilité d'utilisation. En particulier, l'algorithme IRELIEF répond à de nombreuses problématiques relatives à la sélection d'indicateurs à partir de bases de données expérimentales, comme c'est le cas dans cette étude.

Les aspects dont la prise en compte est importante lors de la sélection d'indicateurs tels que la redondance des indicateurs, les interactions liées à l'usage simultané de plusieurs d'entre eux, mais aussi la qualité des données expérimentales disponibles ont été soulignés, et leur

influences respectives ont été caractérisées à l'aide d'un cas d'étude réel.

Le besoins d'approches basées sur la fusion de données pour l'implémentation d'un système de surveillance de procédés industriels a été explicité, et plusieurs ont été proposées et implémentées. En particulier, une approche développée à l'aide du formalisme évidentialiste et utilisant la méthodologie de construction des masses proposée au chapitre 4 a permis d'obtenir de bons résultats sur un cas d'étude concernant la détection d'ébréchures d'arrêtes des outils coupants. Elle s'est montrée supérieure aux méthodes classiques grâce aux possibilités étendues pour la modélisation de données imparfaites.

Il a aussi été démontré que l'intégration de jeux de données hétérogènes au processus de sélection des indicateurs pouvait contribuer à l'amélioration de la précision et de la robustesse d'un système de surveillance.

B.16 Applications à la surveillance des opérations de perçage

Le développement de sous-systèmes dédiés à la surveillance des opérations de perçage utilisant les approches et les concepts présentés dans ce travail ont été présentés dans cette section.

Le premier d'entre eux, dédié à l'identification des différentes phases des opérations de perçage d'empilages multi-matériaux, est très important car c'est un préalable à l'implémentation d'autres sous-systèmes. Une approche de fusion multi-capteurs et multi-échelles a été présentée qui permet l'identification des différentes phases de perçage. Elle s'est montrée robuste et a été implémentée sur un centre d'usinage.

Ensuite, une méthodologie dédiée à la détection des écaillages survenant sur les arrêtes des outils coupants a été proposée. Elle répond aux contraintes relatives à la flexibilité des conditions opératoires grâce à l'utilisation de techniques d'apprentissage non supervisées. Cette application a aussi permis de souligner l'importance de l'intégration des connaissances expert dans le processus de conception d'un système de surveillance, du bon usage des indicateurs et de la juste modélisation des informations imparfaites.

Les formalismes et séquence d'implémentation proposées au chapitre 3 ont été utilisés afin de concevoir ces sous-systèmes. En outre, l'approche proposée au chapitre 4 pour la détection de singularités dans les contextes difficiles a été utilisée avec succès dans les deux cas, démontrant sa pertinence et sa versatilité. Plus généralement, une des lignes directrice de ce travail, qui consiste à décomposer les problèmes de la manière la plus simple possible en vue de traiter les problèmes en amont de la conception d'un système de surveillance s'est montrée efficace.

Conclusion et perspectives

B.17 Synthèse des travaux

Au chapitre 1, les bénéfices potentiels pour les opérations d'assemblages aéronautiques découlant de l'usage de système de surveillance, mais aussi les défis liés à l'implémentation de tels systèmes ont été présentés. S'il apparaît clairement que la surveillance en ligne peut être à l'origine d'une qualité accrue des produits, ainsi que d'une meilleure utilisation des outils coupants, de nombreuses difficultés doivent être dépassées.

Le chapitre 2, dans une première partie, a permis de présenter les tentatives de surveillance de différents aspects liés aux opérations de perçage. Ces contributions ont donné des informations essentielles sur les capteurs et indicateurs pouvant être utilisés pour la surveillance des opérations de perçage. L'usage simultané de plusieurs capteur a été identifié comme une solution clé en vue d'appréhender la complexité du procédé de perçage. Cependant, la plupart des méthodologies développées n'ont pas quitté les laboratoires pour les ateliers, non pas du fait d'une incapacité à estimer l'état du système, mais surtout à cause d'un manque de robustesse. Deux des principales causes de ce problème ont été identifiées. La première concerne la flexibilité nécessaire dans les usines de production : les conditions opératoires peuvent varier, parfois de manière non contrôlée. Un système de surveillance doit, dans une certaine mesure, pouvoir s'adapter à de telles variations. Cela n'a pas été le cas à cause du large usage de techniques d'apprentissage supervisées dans le développement des méthodologies de surveillance. Le second point bloquant, qui n'a quasiment jamais été abordé dans la littérature, est l'environnement hostile des usines de production. L'intégration de capteurs y est difficile, et les conditions font que les mesures sont perturbées, les perturbations allant du bruit de mesure à la panne capteur, ce qui rend les données imparfaites.

La seconde partie du chapitre a été dédiée à la présentation de concepts et de techniques pouvant contribuer à une meilleure appréhension des variations et imperfections affectant les données. Si la fusion multi-capteurs a déjà été largement utilisée à des fins de surveillance, les possibilités offertes par certains formalismes en termes de modélisation et de fusion des données incertaines. En particulier, les formalismes probabilistes et évidentialistes permettent la fusion d'informations incertaines, et incertaines et ambiguës respectivement. Ils pourraient s'avérer utiles pour répondre aux problèmes de robustesse rencontrés jusque'alors par les systèmes de surveillance de perçage quand les conditions opératoires ou les données d'entrées présentent des différences par rapport à celles utilisées pour leur développement.

Le chapitre 3 a permis de formaliser le problème de surveillance de procédé. Ensuite, les besoins associés à l'implémentation d'un système de surveillance performant en contexte industriel ont été passés en revue. La robustesse et la flexibilité sont des critères essentiels, mais impliquent que de nombreux défis soient relevés. Il a été montré que l'usage de techniques non-supervisées associées à des algorithmes détectant des événements singuliers pouvaient être plus robuste que les méthodes présentées auparavant consistant essentiellement à définir une relation fixe entre les valeurs prises par certains indicateurs et l'état du procédé. Une méthodologie dédiée à l'implémentation de système de surveillance de procédés industriels a été proposée. Elle est composée de six étapes : position du problème, intégration de capteurs, sélection d'indicateurs, choix des estimateurs, évaluation hors ligne, implémentation

en ligne. Ces étapes ont été décrites et, pour certaines d'entre elles, mises en application dans la suite des travaux.

Le chapitre 4 a été dédié à la présentation de solutions à une classe de problèmes qui, en considérant les constats précédents, est essentiel pour la conception de systèmes de surveillance robustes : la détection de singularités en utilisant plusieurs sources d'information. L'attention a été portée sur la modélisation de données imparfaites et les moyens de les combiner lorsqu'elles proviennent de sources multiples. Des méthodes existantes tirant parti des possibilités offertes par les formalismes probabilistes et évidentialistes ont été décrites. Une nouvelle approche dédiée à la fusion d'information provenant de sources redondantes dans les contextes difficiles a aussi été présentée. Toutes ces méthodes ont été comparées par le biais de simulations représentatives de situations susceptibles d'être rencontrées en contexte industriel. Les méthodes évidentialistes ont, de manière générale, montré de meilleures performances du fait de la capacité à représenter l'ambiguïté de manière explicite. La méthode proposée sera utilisée pour plusieurs applications.

Le chapitre 5 a montré la mise en oeuvre de plusieurs étapes nécessaires à l'implémentation du système de surveillance de procédé industriel décrites dans le chapitre 3.

L'intégration de deux types de capteurs jugés particulièrement informatifs pour la surveillance de l'état du foret et de la pièce, les capteurs de force et d'EA, a été discutée et des solutions basées sur des travaux expérimentaux ont été proposées et testées.

Ensuite, une procédure de sélection d'indicateurs dédiée à l'implémentation de systèmes de surveillance dans les environnements de production a été présentée. Les contraintes liées à la flexibilité des conditions opératoires, à la difficulté d'obtenir des données représentatives des procédés de fabrications, et à l'environnement difficile pouvant affecter les mesures ont été prises en compte. Une méthodologie basée sur la fusion d'informations et autorisant l'utilisation de données hétérogènes a été proposée. La méthode de modélisation et fusion de données imparfaites pour l'identification de singularités présentée au chapitre 4 a été utilisée, entre autres, pour ce faire. Elle a démontré une meilleure habileté que les méthodes classiques pour identifier les indicateurs les plus pertinents grâce à une meilleure prise en compte de l'imperfection des données.

L'implémentation d'un premier système de surveillance a ensuite été présenté. Son objectif était l'identification des différentes phases composant une opération de perçage aéronautique, ce qui est obligatoire en vue d'extraire par la suite des indicateurs pertinents et assurer une surveillance de qualité. Une approche de fusion multi-capteurs et multi-échelle a été proposée qui a permis d'améliorer la robustesse de l'identification des différentes phases de perçage. Là encore, la méthode d'identification de singularités proposée au chapitre 4 a été utilisée afin de combiner les informations issues de capteurs de courants positionnés sur les trois phases du moteur de broche.

Enfin, une application dédiée à la détection d'écaillages survenant sur les arrêtes de coupe du foret a été décrite. Elle a permis de mettre en oeuvre plusieurs concepts proposés au chapitre 3 pour l'implémentation de systèmes de surveillance de procédés industriels robustes. Un processus systématique de sélection des indicateurs a été mis en oeuvre, un algorithme à apprentissage non-supervisé a été utilisé de concert avec une phase d'utilisation, de la connaissance expert a été intégrée, et la fusion (utilisant l'approche proposée au chapitre 4) de constats établis par plusieurs sous-systèmes simples a permis l'obtention de meilleurs résultats que par l'utilisation d'un système complexe, étant donné les mêmes informations. Depuis la description du contexte industriel jusqu'à la mise en oeuvre d'exemples applicatifs, en passant par un état de l'art et des développements plus théoriques, les efforts ont été concentrés sur la robustesse des systèmes de surveillance. Paradoxalement, ce besoin très industriel a été à l'origine des défis scientifiques les plus importants de ce travail. Suite à l'analyse des raisons pour lesquelles aucun système robuste de surveillance des opérations de perçage n'a été implémenté jusqu'à présent, des solutions ont été proposées et évaluées. Les résultats obtenus sont encourageants.

B.18 Perspectives

Des améliorations sont possibles à chaque étape de l'implémentation des systèmes de surveillance de procédés industriels.

Concernant l'intégration de capteurs, deux tendances se dégagent. La première consiste à positionner les capteurs au plus près de la zone de coupe. Les efforts sont à fournir à l'étape de conception des machines pour intégrer les capteurs. Pour le perçage, et plus généralement l'usinage, le développement de porte-outils et de broches instrumentées est un vecteur d'amélioration important. La seconde tendance consiste à utiliser les informations issues des commandes numériques des machines. En effet, aucun capteur supplémentaire n'est requis, et c'est une solution non-invasive. Cependant, ces informations ne sont pas toujours assez informative pour assurer à elles seules une surveillance performante.

Pour les techniques de sélection et d'extraction d'indicateurs, si beaucoup de travaux se sont limités à l'usage d'approches classiques, d'autres ont proposé des techniques plus sophistiquées. Les possibilités actuelles de mesure, d'acquisition et de traitement des données autorisent la mise en oeuvre de procédures de sélection et d'extraction à grande échelle. Cela représente une voie de développement intéressante, particulièrement si de nouvelles solutions sont proposées pour l'intégration de capteurs amenant de nouvelles informations.

Au cours de cette étude, un parallèle a été établi entre les systèmes de surveillance et les procédures d'évaluation de performances techniques d'apprentissage. Cela constitue un premier pas vers une meilleure prédiction des performances des systèmes de surveillance avant leur déploiement industriel. Une seconde étape consisterait, toujours à l'image de la communauté des machines à apprentissage, en la création de bases de données de signaux dédiés à l'évaluation des systèmes de surveillance. Concernant le domaine stratégique de l'assemblage de structures aéronautiques cependant, le partage de telles données est en contradiction avec les contraintes de confidentialité concernant les procédés de production. On pourrait donc imaginer que les chercheurs académiques réalisent des expériences génériques en utilisant leur équipements et partagent les données afin que la communauté dispose d'une base de données permettant l'évaluation objective des performances des systèmes de surveillance développés. Cependant, de nombreux obstacles restent à franchir : la complexité du procédé de perçage rend difficile la réalisation d'expériences mettant en avant un seul phénomène d'intérêt, les signaux seront dépendant des conditions expérimentales...

Concernant l'utilisation de techniques avancées de modélisation et de fusion de données pour des applications industrielles, des recherches doivent suivre trois directions. En premier lieu, il est nécessaire que les développements les plus récents, comme la théorie de l'évidence, soient diffusés par le biais de bibliothèques utilisables par des non-spécialistes. Dans le même temps, des recherches poussées sont nécessaires afin d'identifier les besoins spécifiques, à chaque étape de l'implémentation de systèmes de surveillance, en termes de robustesse, précision, flexibilité... Cela permettrait d'identifier les meilleures solutions à utiliser en fonction de chaque cas. Cela implique le dernier axe de recherche : les points forts et points faibles des différentes techniques de fusion doivent être évalués au travers de cas d'études génériques, comme cela a été fait au chapitre 4 par exemple.

Enfin, suite à la définition de méthodologies robustes, un autre aspect concerne leur implémentation : la définition de solutions logicielles et matérielles adaptées. Si ce point n'est pas un axe de recherche et n'a donc que très peu été abordé dans la littérature, il n'en demeure pas moins un aspect important pour l'implémentation de système de surveillance de procédé dans l'industrie.

Multisensor monitoring of aeronautical drilling/countersinking operations

ABSTRACT : Airframe assembly process needs many drilling and countersinking operations. The two main challenges concerning the drilling process are that the holes must fit in the required tolerances in order to ensure the assembly quality, and that the use of drills must be optimal in order to reduce production costs. These two objectives require the implementation of a reliable online monitoring system. A vast amount of work has been done in the field of drilling monitoring. Unfortunately, many methodologies described in these studies are unlikely to leave the labs as they were often considered difficult to implement, unreliable or not viable economically. The use of multisensor systems integrated with intelligent information processing techniques improved reliability and flexibility of tool condition monitoring systems. However, they have mainly been implemented under steady process conditions and in sensor-friendly lab environments, and neither issues about the variability of the operating conditions, nor quality of input data have been tackled. The work presented here is aimed at demonstrating the potential improvements that could be achieved in robust monitoring of drilling operations by using multisensor fusion and associated recent theoretical developments about uncertainty modeling and handling. The monitoring problem will be formalized, and its associated requirements in terms of accuracy and reliability, as well as issues related to industrial implementation will be detailed in order to position the problem. An approach to implement an industrial monitoring system will be proposed that covers the following steps: sensor integration, feature extraction, estimator choice, and monitoring system evaluation. The proposed methodology could be applied to a broader scope of applications, including most complex manufacturing automated operations.

Keywords : Multisensor data fusion, online monitoring, drilling process, evidence theory, acoustic emission, airframe assembly.

Surveillance multi-capteurs des opérations de perçage/fraisage aéronautiques

RÉSUMÉ : L'assemblage de structures aéronautiques nécessite de nombreuses opérations de perçage et de fraisage. Les deux problématiques principales concernant ces opérations sont que les alésages réalisés correspondent aux standards de qualité exigés, et que les outils coupants soient utilisés de manière optimale afin de réduire les coûts. Ces deux objectifs nécessitent l'implémentation d'une solution de surveillance en ligne des opérations de perçage. De nombreuses études ont été réalisées à ce sujet. Pourtant, une grande partie des méthodologies développées ont peu de chance de quitter les laboratoires au profit des sites de production industrielle en raison de leur difficulté d'implémentation et de leur manque de robustesse. L'utilisation de plusieurs capteurs, couplés à des techniques avancées de traitement de l'information a permis une meilleure appréhension de la complexité du procédé de perçage et une augmentation de la flexibilité des systèmes de surveillance. Cependant, la majorité des études ont été réalisées en laboratoire et dans conditions favorables, et les problématiques relatives à la flexibilité des conditions opératoires, ou encore à la qualité des données issues des capteurs n'ont pas été abordées. Cette étude a pour but de démontrer les améliorations potentielles que peuvent apporter les développements récents concernant la modélisation et la fusion de connaissances imparfaites pour la surveillance robuste des opérations de perçage. Une approche sera proposée pour l'implémentation industrielle de systèmes de surveillance de procédés. La méthodologie proposée doit pouvoir être transposée à un champ d'application plus large incluant la plupart des procédés de fabrication automatisés.

Mots clés : fusion multi-capteurs, surveillance en ligne, perçage, théorie de l'évidence, émission acoustique, assemblage de structures aéronautiques.