



HAL
open science

Sensitivity analysis for optimal control problems. Stochastic optimal control with a probability constraint

Laurent Pfeiffer

► **To cite this version:**

Laurent Pfeiffer. Sensitivity analysis for optimal control problems. Stochastic optimal control with a probability constraint. Optimization and Control [math.OC]. Ecole Polytechnique X, 2013. English. NNT: . pastel-00881119

HAL Id: pastel-00881119

<https://pastel.hal.science/pastel-00881119>

Submitted on 7 Nov 2013

HAL is a multi-disciplinary open access archive for the deposit and dissemination of scientific research documents, whether they are published or not. The documents may come from teaching and research institutions in France or abroad, or from public or private research centers.

L'archive ouverte pluridisciplinaire **HAL**, est destinée au dépôt et à la diffusion de documents scientifiques de niveau recherche, publiés ou non, émanant des établissements d'enseignement et de recherche français ou étrangers, des laboratoires publics ou privés.

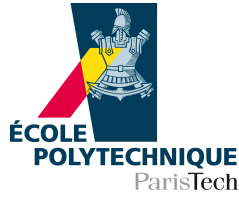

Thèse pour l'obtention du titre de

DOCTEUR DE L'ÉCOLE POLYTECHNIQUE

Spécialité : **Mathématiques Appliquées**

par

Laurent PFEIFFER

**Analyse de sensibilité pour des problèmes de
commande optimale**

**Commande optimale stochastique sous
contrainte en probabilité**

Soutenue le 5 novembre 2013 devant le jury composé de :

J. Frédéric BONNANS	INRIA et Ecole Polytechnique	Directeur
Pierre CARDALIAGUET	Université Paris-Dauphine	Rapporteur
Lionel THIBAUT	Université de Montpellier	Examinateur
Nizar TOUZI	Ecole Polytechnique	Examinateur
Richard B. VINTER	Imperial College London	Rapporteur

Sensitivity analysis for optimal control problems. Stochastic optimal control with a probability constraint.

Abstract

This thesis is divided into two parts. In the first part, we study constrained deterministic optimal control problems and sensitivity analysis issues, from the point of view of abstract optimization. Second-order necessary and sufficient optimality conditions, which play an important role in sensitivity analysis, are also investigated. In this thesis, we are interested in strong solutions. We use this generic term for locally optimal controls for the L^1 -norm, roughly speaking. We use two essential tools: a relaxation technique, which consists in using simultaneously several controls, and a decomposition principle, which is a particular second-order Taylor expansion of the Lagrangian.

Chapters 2 and 3 deal with second-order necessary and sufficient optimality conditions for strong solutions of problems with pure, mixed, and final-state constraints. In Chapter 4, we perform a sensitivity analysis for strong solutions of relaxed problems with final-state constraints. In Chapter 5, we perform a sensitivity analysis for a problem of nuclear energy production.

In the second part of the thesis, we study stochastic optimal control problems with a probability constraint. We study an approach by dynamic programming, in which the level of probability is a supplementary state variable. In this framework, we show that the sensitivity of the value function with respect to the probability level is constant along optimal trajectories. We use this analysis to design numerical schemes for continuous-time problems. These results are presented in Chapter 6, in which we also study an application to asset-liability management.

Remerciements

Mes premiers remerciements sont adressés à mon directeur de thèse Frédéric Bonnans. Je lui suis très reconnaissant pour ces trois années passionnantes, durant lesquelles il m'a guidé et formé. Je lui suis reconnaissant d'avoir permis que cette thèse se passe dans les meilleures conditions et d'avoir initié les différentes collaborations qui la constituent, elles ont été autant d'expériences véritablement enrichissantes. Je le remercie de m'avoir partagé sa très précieuse expertise du domaine de l'optimisation au cours d'innombrables discussions; j'espère qu'il y en aura encore beaucoup d'autres !

Je voudrais remercier sincèrement Pierre Cardaliaguet et Richard Vinter d'avoir accepté d'être les rapporteurs de ma thèse ainsi que Lionel Thibaut et Nizar Touzi de faire partie de mon jury. C'est un grand honneur pour moi. Je les remercie également pour la grande qualité de leurs cours, que j'ai eu le plaisir de suivre pendant le master OJME, le master de finance de l'X ou les écoles d'été du projet SADCO, ainsi que pour leur enthousiasme communicatif à ces occasions.

Je remercie très chaleureusement les différentes personnes avec qui j'ai eu le plaisir de travailler. Un grand merci à Xavier Dupuis pour les heures de réflexion et d'échanges passées au cours de cette dernière année. Pas d'autres papiers prévus, pour le moment, mais j'espère qu'il y en aura d'autres ! Je n'oublie pas non plus ses blagues toujours hilarantes (absolutely !). Je remercie Oana Serea pour nos nombreuses réflexions sur la relaxation, elles ont eu un impact non négligeable sur toute cette thèse. Je suis très reconnaissant à Kengy Barty de m'avoir proposé le projet sur les centrales nucléaires: il est devenu mon premier article et m'a véritablement mis le pied à l'étrier. Enfin, je remercie les membres du projet PGMO sur les contraintes en probabilité, Marie Bernhart, Noufel Frikha, Olivier Klopfenstein et Xiaolu Tan, pour les nombreux questionnements qu'ils ont partagés avec moi et leur enthousiasme lorsque les premiers résultats sont apparus.

Effectuer ma thèse au sein de l'équipe Commands a été une véritable chance et je souhaite remercier chacun des membres, passés et présents, pour leur dynamisme. Je remercie notamment Soledad Aronna, Zhihao Cen, Adriano Festa, Daphné Giorgi, Pierre Martinon, Athena Picarelli, Zhiping Rao, Francisco Silva et tout particulièrement Hasnaa Zidani pour son travail au sein du projet SADCO. Les conférences et écoles du projet ont considérablement enrichi ces trois années. Qu'Estelle Bouzat et chacun des participants du projet soient vivement remerciés. Enfin, je remercie tous les membres du Centre de Mathématiques Appliquées, pour l'atmosphère toujours agréable et stimulante qui règne au sein du laboratoire. Je voudrais adresser un grand merci à l'équipe administrative du CMAP, en particulier à Nasséra Naar et Alexandra Noiret. Un grand merci à Wallis Filippi, pour son professionnalisme sans faille et sa gentillesse. Je remercie également Sylvain Ferrand pour son aide précieuse.

Je remercie Razvigor Ossikovski d'avoir encadré la charge d'enseignement qui m'a été confiée au sein du département de physique de Polytechnique. Je suis très reconnaissant à Samson Lasaulce d'avoir partagé avec moi sa grande expérience de l'enseignement. Le lancement de la thématique Tigre des Modex a été une excellente expérience ! Merci à Jean-Paul Jacquet et Géraud Chandèze pour leur aide indispensable.

Je remercie Alejandro Jofré et Rodrigo Palma pour leur accueil chaleureux lors de

mon séjour au Centre de Modélisation Mathématique et au Centre d’Energie de Santiago du Chili. Je remercie vivement Olivier Beaude et Amar Azad pour les discussions passionnées que nous avons eues cette année. Je remercie aussi T erence Bayen et Emmanuel Gobet pour l’int er et qu’ils ont port e mes travaux, ainsi que Ren e A id pour son dynamisme et l’opportunit e de suivre la s erie de cours sur le contr ole stochastique   EDF. Je suis tr es reconnaissant envers Jean-Baptiste Pommet, ainsi que Bernard Bonnard, d’avoir soutenu ma candidature en post-doc au sein de l’ equipe McTao. Je voudrais enfin exprimer toute ma gratitude   l’ensemble des professeurs du master OJME pour l’excellente formation que j’ai re ue; je remercie  galement Romain Apparigliato et Sophie Auchapt qui ont encadr e mon stage de master.

Quelques lignes ne suffiront pas   remercier tous les doctorants et post-doctorants du CMAP que j’ai eu le plaisir de c otoyer pendant ces trois ann ees. Je tenais   adresser un merci tout particulier   Camille, L etitia, Maxime, Michael et Pascal et tous mes co-bureaux que je n’ai pas encore l’occasion de citer: Andrea, Chao, Etienne, Hao, Leila, Lorenzo, Nicolas, qui ont partag e ces nombreux mois de travail. Je n’oublie pas non plus mes amis de master, Daniel, Jean-Christophe, Lo ic, Vincent. Il serait impossible d’ enum erer tous ceux qui ont partag e ces agr eables moments en s eminaire comme en pause caf e, en pot de th ese, en conf erence ou en soir ee. Que tous ceux que je n’ai pas pu mentionner m’excusent, ainsi que tous ceux qui esp eraient trouver un peu de fantaisie dans ces remerciements !

Cette th ese doit aussi beaucoup   mes amis et   leur fid elit e. Il serait difficile de citer chacun, je tiens n eanmoins   adresser mes plus sinc eres remerciements   tous les musiciens, – au d etour d’un quatuor (avec piano !), d’une partition d’orchestre, d’une danse hongroise, ou d’un chant de No el ! –,   tous les nageurs du b atiment 80,   mes compagnons de vacances, depuis le pays des petits bretzels jusqu’  la Californie, en passant par Lacanau et V erone, enfin, tous ceux avec qui j’ai eu la joie de partager une f ete de mariage ou une soir ee de nouvel an.

Mes tous derniers remerciements sont adress es   ma famille. Je remercie mes grands-parents pour leurs encouragements constants ainsi que mes oncles, tantes, cousins et cousines, pour leur mobilisation lors de ma soutenance ! Je remercie tout particuli erement mon fr ere Eric, ma s œur Aur elie et mes parents pour leur affection et pour avoir su laisser se d evelopper ma “bosse” des maths...

Merci   tous.

Contents

1	General introduction	1
1.1	Sensitivity analysis of optimal control problems	2
1.2	Chance-constrained stochastic optimal control problems	22
1.3	List of publications	31
I	Sensitivity analysis in optimal control	33
2	Necessary optimality conditions in Pontryagin form	35
	Bibliography	35
2.1	Introduction	36
2.2	Setting	38
2.3	First-order conditions in Pontryagin form	42
2.4	Second-order conditions in Pontryagin form	49
2.A	Appendix	56
3	Sufficient conditions for bounded strong solutions	75
3.1	Introduction	76
3.2	Setting	78
3.3	Reduction of touch points	84
3.4	A decomposition principle	86
3.5	Quadratic growth for bounded strong solutions	92
3.6	Characterization of quadratic growth	97
4	Sensitivity analysis for relaxed optimal control problems	99
4.1	Introduction	100
4.2	Formulation of the problem and preliminary results	102
4.3	First-order upper estimate of the value function	108
4.4	Second-order upper estimate of the value function	111
4.5	Lower estimate of the value function	116
4.6	Two examples	123
4.A	Appendix	125

5	Sensitivity analysis for the outages of nuclear power plants	137
5.1	Introduction	138
5.2	Study of the reference problem	139
5.3	Sensitivity analysis	146
5.4	Technical aspects	158
5.5	Conclusion	168
II	Chance-constrained stochastic optimal control	169
6	Stochastic optimal control with a probability constraint	171
6.1	Introduction	172
6.2	Discrete-time chance-constrained control problems	173
6.3	Properties of continuous-time optimal control problems	183
6.4	HJB equations	187
6.5	Numerical methods	191
6.6	Numerical tests	196
6.7	Study of an asset-liability management problem	204
	Bibliography	211

Chapter 1

General introduction

Contents

1.1	Sensitivity analysis of optimal control problems	2
1.1.1	Setting and motivations	2
1.1.2	Introduction to sensitivity analysis and optimality conditions .	4
1.1.3	Main issues in the application to optimal control	12
1.1.4	Strong solutions and their specificities	14
1.1.5	Contribution of the thesis	18
1.1.6	Perspectives	21
1.2	Chance-constrained stochastic optimal control problems . . .	22
1.2.1	Introduction to stochastic optimal control	22
1.2.2	Chance-constrained optimal control problems	27
1.2.3	Contribution of the thesis	30
1.2.4	Perspectives	31
1.3	List of publications	31

1.1 Sensitivity analysis of optimal control problems

1.1.1 Setting and motivations

Optimal control This first part of this thesis deals with constrained deterministic optimal control problems of ordinary differential equations. These problems aim at optimizing controlled dynamical systems, that is to say, dynamical systems whose time-derivative can be influenced at each time. We distinguish two variables: a *control variable* u , standing for the taken decisions, and a *state variable* y , standing for the state of the system over time. The typical model for a controlled system is the following:

$$\begin{cases} \dot{y}_t = f(u_t, y_t), & \text{for a.a. } t \in [0, T], \\ y_0 = y^0, \end{cases} \quad (1.1)$$

where the time interval $[0, T]$ and the function $f : \mathbb{R}^m \times \mathbb{R}^n \rightarrow \mathbb{R}^n$ are given. For simplicity, we suppose that the initial state y^0 is given and fixed. The control u and the state variable y are respectively taken in the spaces

$$\mathcal{U} := L^\infty(0, T; \mathbb{R}^m) \quad \text{and} \quad \mathcal{Y} := W^{1, \infty}(0, T; \mathbb{R}^n). \quad (1.2)$$

For a given control u , we denote by $y[u]$ the unique solution to (1.1) and we say that a pair (u, y) in $\mathcal{U} \times \mathcal{Y}$ is a *trajectory* iff $y = y[u]$. An optimal control problem is of the following form:

$$\text{Min}_{(u, y) \in \mathcal{U} \times \mathcal{Y}} \phi(y_T), \quad \text{subject to: } y = y[u] \text{ and constraints.} \quad (1.3)$$

Optimal control problems have many applications in different fields, such as robotics, chemistry, power systems, aerospace engineering, biology... Two main approaches can be distinguished for the solving of optimal control problems: the first one based on Pontryagin's principle, which will be used in this first part, and a second one, based on dynamic programming, which will be used in the second part. For general introductions on this theory, we refer to [1, 63, 65, 69].

Constraints Let us describe the different constraints that will be considered:

▷ *final-state constraints*: $\Phi^E(y_T) = 0, \Phi^I(y_T) \leq 0$

▷ *pure state constraints* (in short, *pure constraints*):

$$g(y_t) \leq 0, \quad \text{for all } t \in [0, T]$$

▷ *mixed control-state constraints* (in short, *mixed constraints*):

$$c(u_t, y_t) \leq 0, \quad \text{for a.a. } t \in [0, T]$$

▷ *control constraints*: $c(u_t) \leq 0$, for a.a. $t \in [0, T]$.

The data functions Φ^E , Φ^I , c , g are smooth vector-valued functions. Let us mention two important facts about pure constraints.

1. In general, control constraints can be seen as a particular case of mixed constraints, but pure constraints cannot. Indeed, a technical assumption, called the *inward condition*, is in general required for mixed constraints and is not satisfied for pure constraints.
2. Systems controlled by their k -th time-derivative (i.e. $y_t^{(k)} = f(u_t, y_t)$) enter into this general framework: it suffices to consider the time-derivatives of y up to the order $k - 1$ as state variables. Pure constraints on state variables controlled by their k -th derivative are called *pure constraints of order k* .

In this introduction, we will sometimes use an abstract form for optimal control problems:

$$\text{Min}_{u \in \mathcal{U}} \mathcal{J}(u), \text{ subject to: } \mathcal{G}(u) \in \mathcal{K}. \quad (1.4)$$

The state variable being a function of the control u , it is omitted in this abstract formulation.

Sensitivity analysis Let us consider now a perturbed version of problem (1.4):

$$\text{Min}_{u \in \mathcal{U}} \mathcal{J}(u, \theta), \text{ subject to: } \mathcal{G}(u, \theta) \in \mathcal{K}, \quad (1.5)$$

where θ is a perturbation parameter, supposed to be a real number for simplicity. Sensitivity analysis is concerned with the following question: what is the behavior of the optimal solution and the value of the problem when θ varies? The sensitivity analysis will be performed locally, in the neighborhood of a reference value of θ , say $\bar{\theta}$, and we will consider solutions to the perturbed problems which are close (in a certain sense) to a solution \bar{u} to the reference problem (for $\theta = \bar{\theta}$). The typical results that can be expected are the following:

- ▷ a first-order Taylor expansion of the solutions of the perturbed problems
- ▷ a second-order Taylor expansion of the value of the perturbed problems.

We refer to [20] for a general introduction and to the book [21], which is a comprehensive treatment of the subject.

Sensitivity analysis is a natural issue in applied mathematics: when modelling a certain problem, one typically expects that the solution of this problem depends continuously on its parameters, to ensure the convergence of numerical schemes, for instance. Let us give some other motivations for sensitivity analysis.

1. In some situations, the variable θ is also an optimization variable. However, optimizing simultaneously u and θ can be a difficult task. A possible approach consists in fixing θ , solving the sub-problem for which θ is fixed. The sensitivity analysis allows to compute a first correction to apply to θ , or at least to decide which of the components of θ should be optimized in priority.

2. Similarly, some problems may be solved with the so-called *homotopy* method (or continuation method, see [2]). Typically, the considered problem is easy to solve for a given value $\bar{\theta}$ of the variable θ but may be hard for the other values. The sensitivity analysis allows to find approximate solutions to the hard problems, for values of θ close to $\bar{\theta}$, and given a solution to the reference problem.
3. The numerical methods which are not based on dynamic programming provide an open-loop solution. However, in real-time applications, it is of interest to be able to compute quickly a new approximate optimal solution if, for example, the system deviated from the initially planned trajectory [38].

Second-order optimality conditions The *second-order necessary and sufficient optimality conditions* are of key importance in sensitivity analysis of optimization problems. These conditions are very easy to understand in the case of an unconstrained problem such as

$$\text{Min}_{x \in \mathbb{R}^n} f(x). \quad (1.6)$$

Let $x \in \mathbb{R}^n$.

- ▷ The first-order necessary conditions state that $Df(x) = 0$; they are satisfied if x is locally optimal.
- ▷ The second-order necessary conditions state that $D^2f(x)$ is positive semi-definite; they are satisfied if x is locally optimal.
- ▷ The second-order sufficient conditions state that $Df(x) = 0$ and $D^2f(x)$ is positive definite; if they are satisfied, then x is locally optimal.

In the case of constrained optimization problems, the first-order necessary conditions state that there exists a Lagrange multiplier; the necessary and sufficient second-order necessary conditions state that the Hessian of the Lagrangian is respectively positive semi-definite and positive definite on a certain cone, called *critical cone*.

As we mentioned, the first- and second-order optimality conditions are key tools for sensitivity analysis and for characterizing local optimality. Moreover, the second-order sufficient condition is the main assumption for the justification of some numerical methods, such as the shooting method or the discretization method [10, 11, 22, 57], in the case of optimal control problems.

1.1.2 Introduction to sensitivity analysis and second-order optimality conditions

In this subsection, we introduce the main tools of sensitivity analysis. We describe two classical approaches for sensitivity analysis, a first one based on a stability analysis of the first-order optimality conditions with the implicit function theorem and a second one based on a variational analysis. For the sake of simplicity, we work with a finite-dimensional optimization problem.

Optimality conditions Let us consider an abstract finite-dimensional problem, defined as follows:

$$\text{Min}_{x \in \mathbb{R}^n} f(x), \text{ subject to: } g(x) \in K, \quad (1.7)$$

where $f : \mathbb{R}^n \rightarrow \mathbb{R}$ and $g : \mathbb{R}^n \rightarrow \mathbb{R}^{n_C}$ are C^2 -functions and K is a closed and convex subset of \mathbb{R}^{n_C} . For the moment, we do not consider any perturbation variable. From now on, we fix a feasible point \bar{x} .

Definition 1.1. We say that Robinson qualification condition holds at \bar{x} (or simply, that the constraints are qualified at \bar{x}) iff there exists $\varepsilon > 0$ such that

$$\varepsilon B \subset g(\bar{x}) + Dg(\bar{x})X - K, \quad (1.8)$$

where B is the unit ball of \mathbb{R}^{n_C} and where the signs $+$ and $-$ must be understood in the sense of the sum of Minkowski.

Proposition 1.2. Let us assume that Robinson qualification condition holds at \bar{x} . Then, there exist $\varepsilon > 0$ and $C > 0$ such that for all x with $|x - \bar{x}| \leq \varepsilon$, there exists \tilde{x} such that

$$g(\tilde{x}) \in K \quad \text{and} \quad |\tilde{x} - x| \leq C \text{dist}(g(x), K). \quad (1.9)$$

This property is called *metric regularity property*. It is an important property for the justification of all the linearized problems that will be introduced in the sequel. Let us recall the definitions of the *tangent* and *normal cones* $T_K(y)$ and $N_K(y)$ (in the sense of convex analysis), for all $y \in \mathbb{R}^{n_C}$:

$$T_K(y) := \{h \in \mathbb{R}^{n_C} : \text{dist}(y + \sigma h, K) = o(\sigma), \sigma \geq 0\}, \quad (1.10)$$

$$N_K(y) := \{\lambda \in \mathbb{R}^{n_C^*} : \lambda h \leq 0, \forall h \in T_K(y)\}. \quad (1.11)$$

Here, the notation $\mathbb{R}^{n_C^*}$ stands for the space of row vectors of size n_C . We define now the *Lagrangian* of the problem, given by

$$L : (\lambda, x) \in \mathbb{R}^{n_C^*} \times \mathbb{R}^n \rightarrow L[\lambda](x) = f(x) + \lambda g(x) \in \mathbb{R}. \quad (1.12)$$

The variable λ is called *dual variable*, we write it into brackets to distinguish it from the *primal variable* x . We define the set of *Lagrange multipliers* $\Lambda(\bar{x})$ as follows:

$$\Lambda(\bar{x}) = \{\lambda \in \mathbb{R}^{n_C^*} : DL[\lambda](\bar{x}) = 0\}. \quad (1.13)$$

Note that the symbol D (without subscript) stands for the derivative with respect to all the variables, except λ .

Definition 1.3. We define the *critical cone* $C(\bar{x})$ and the *quasi-radial critical cone* $C^{\text{QR}}(\bar{x})$ by

$$\begin{aligned} C(\bar{x}) &= \{h \in \mathbb{R}^n : Df(\bar{x})h = 0, Dg(\bar{x})h \in T_K(\bar{x})\} \\ C^{\text{QR}}(\bar{x}) &= \{h \in C(\bar{x}) : \text{dist}(g(\bar{x}) + \sigma Dg(\bar{x})h, K) = o(\sigma^2), \sigma \geq 0\}. \end{aligned}$$

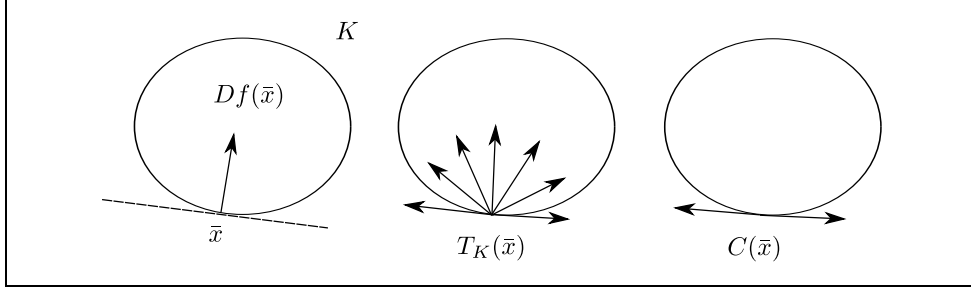

Figure 1.1: An example of critical cone (with $g(x) = x$).

In the following definition, the notation $\text{cl}(C)$ stands for the closure of a given set C .

Definition 1.4. *We say that:*

1. the first-order necessary conditions hold iff $\Lambda(\bar{x}) \neq \emptyset$,
2. the second-order necessary conditions hold iff

$$\text{Max}_{\lambda \in \Lambda(\bar{x})} D_{xx}^2 L[\lambda](\bar{x}) h^2 \geq 0, \quad \forall h \in \text{cl}(C^{\text{QR}}(\bar{x})), \quad (1.14)$$

3. the second-order sufficient conditions hold iff

$$\text{Max}_{\lambda \in \Lambda(\bar{x})} D_{xx}^2 L[\lambda](\bar{x}) h^2 > 0, \quad \forall h \in C(\bar{x}) \setminus \{0\}. \quad (1.15)$$

Note that the second-order sufficient conditions do not hold if the set of Lagrange multipliers is empty.

Assumption 1.1 (Extended polyhedricity). *We assume that*

$$\text{cl}(C^{\text{QR}}(\bar{x})) = C(\bar{x}). \quad (1.16)$$

From now on, we assume that the extended polyhedricity condition (defined above) holds. This condition is typically satisfied if K is described by a finite number of linear equalities and inequalities. Indeed, in this case, for all $y \in \mathbb{R}^{n_c}$, for all $h \in T_K(y)$, there exists ε such that

$$\text{dist}(y + \sigma h, K) = 0, \quad \forall \sigma \in [0, \varepsilon]. \quad (1.17)$$

It is still possible to state second-order necessary conditions on the whole critical cone if the extended polyhedricity condition does not hold, but in this case, an additional nonpositive term must be added to the Hessian of the Lagrangian in (1.14) [47]. We are not interested in this situation and prefer stating no-gap second-order conditions, that is to say that we want that the maximized terms in (1.14) and (1.15) are the same.

Definition 1.5. *We say that the quadratic growth property holds at \bar{x} iff there exist $\varepsilon > 0$ and $\alpha > 0$ such that for all $x \in \mathbb{R}^n$ with $|x - \bar{x}| \leq \varepsilon$,*

$$g(x) \in K \implies f(x) \geq f(\bar{x}) + \alpha |x - \bar{x}|^2. \quad (1.18)$$

Note that the quadratic growth property implies that \bar{x} is locally optimal.

Theorem 1.6. *Assume that the constraints are qualified at \bar{x} .*

1. *If \bar{x} is locally optimal, then the first- and second-order necessary conditions hold.*
2. *The quadratic growth property at \bar{x} holds if and only if the second-order sufficient conditions hold.*

Proof. \triangleright *Necessary conditions.*

Let $h \in C^{\text{QR}}(\bar{x})$, $d \in \mathbb{R}^n$ be such that

$$Dg(\bar{x})d + \frac{1}{2}D^2g(\bar{x})h^2 \in T_K(g(\bar{x})). \quad (1.19)$$

Then, for $\sigma \geq 0$,

$$\begin{aligned} & g(\bar{x} + \sigma h + \sigma^2 d) \\ &= g(\bar{x}) + Dg(\bar{x})h\sigma + \left(Dg(\bar{x})d + \frac{1}{2}D^2g(\bar{x})h^2\right)\sigma^2 + o(\sigma^2) \end{aligned} \quad (1.20)$$

and $\text{dist}(g(\bar{x} + \sigma h + \sigma^2 d), K) = o(\sigma^2)$. Thus, by the metric regularity property (Proposition 1.2), there exist $\varepsilon > 0$ and a mapping $x : [0, \varepsilon] \rightarrow \mathbb{R}^n$ such that

$$g(x(\sigma)) \in K, \quad \forall \sigma \in [0, \varepsilon] \quad \text{and} \quad x(\sigma) = \bar{x} + h\sigma + d\sigma^2 + o(\sigma^2). \quad (1.21)$$

We call this mapping a *path*. We obtain that

$$0 \leq f(x(\sigma)) - f(\bar{x}) = \left(Df(\bar{x})d + \frac{1}{2}D^2f(\bar{x})h^2\right)\sigma^2 + o(\sigma^2) \quad (1.22)$$

and therefore that the following linearized problem

$$\begin{cases} \text{Min}_{d \in \mathbb{R}^n} & Df(\bar{x})d + \frac{1}{2}D^2f(\bar{x})h^2 \\ \text{s.t.} & Dg(\bar{x})d + \frac{1}{2}D^2g(\bar{x})h^2 \in T_K(g(\bar{x})). \end{cases}$$

has a nonnegative value. Its dual has the same nonnegative value:

$$\text{Max}_{\lambda \in \Lambda(\bar{x})} D_{xx}^2L[\lambda](\bar{x})h^2, \quad (1.23)$$

which proves the result for $h \in C^{\text{QR}}(\bar{x})$. It easily extends to $\text{cl}(C^{\text{QR}}(\bar{x}))$, equal to $C(\bar{x})$ by assumption.

\triangleright *Sufficient conditions.*

We make a proof by contradiction. Assume that there exists a feasible sequence $(x_k)_k$ converging to \bar{x} which is such that

$$f(x_k) - f(\bar{x}) \leq o(|x_k - \bar{x}|^2). \quad (1.24)$$

Set $h_k = (x_k - \bar{x})/|x_k - \bar{x}|$ and denote by h a limit point of $(h_k)_k$. Note that $|h| = 1$. It is easy to check that $h \in C(\bar{x})$, as a consequence of (1.24). Observe that for all k and for all $\lambda \in \Lambda(\bar{x})$,

$$f(x_k) - f(\bar{x}) \geq f(x_k) - f(\bar{x}) + \lambda(g(x_k) - g(\bar{x})) = L[\lambda](x_k) - L[\lambda](\bar{x}), \quad (1.25)$$

since $\lambda \in N_K(g(\bar{x}))$ and since $g(x_k) - g(\bar{x}) \in T_K(g(\bar{x}))$, by convexity of K . Using the stationarity of the Lagrangian, we obtain that

$$f(x_k) - f(\bar{x}) \geq D_{xx}^2 L[\lambda](\bar{x})(x_k - \bar{x})^2 + o(|x_k - \bar{x}|^2) \quad (1.26)$$

and to the limit, we obtain that

$$D_{xx}^2 L[\lambda](\bar{x})h^2 \leq 0. \quad (1.27)$$

Therefore, by the second-order sufficient conditions, we obtain that $h = 0$, in contradiction with $|h| = 1$. We have proved that the quadratic growth held under the sufficient conditions. The converse property is easily checked with the necessary conditions. \square

Remark 1.7. *The compactness of the sphere of radius 1 is crucial in the proof of the quadratic growth. In an infinite-dimensional setting, this property does not hold. Therefore, a technical and restrictive assumption on the Hessian of the Lagrangian will be needed.*

Remark 1.8. *Inequality (1.26) is central in the proof of the quadratic growth.*

Sensitivity analysis Let us introduce now a perturbation parameter $\theta \in \mathbb{R}$ in our problem, with reference value $\bar{\theta} = 0$. We assume that \bar{x} is a local optimal solution to the reference problem with $\theta = 0$. The family of problems under study is the following:

$$V^\eta(\theta) := \underset{x \in \mathbb{R}^n}{\text{Min}} f(x, \theta), \text{ s.t. } g(x, \theta) \in K \text{ and } |x - \bar{x}| \leq \eta. \quad (P^\eta(\theta))$$

Observe that a supplementary constraint, called *localizing constraint*, has been added, with a small parameter $\eta > 0$ associated. The reason is that the results obtained are true only for perturbed solutions close to \bar{x} .

We consider a simplified framework for the constraints: we assume that the set K stands for equalities and inequalities. Therefore, we set:

$$g(x, \theta) = (g^E(x, \theta), g^I(x, \theta)) \quad \text{and} \quad K = \{0\}^{n_E} \times \mathbb{R}_-^{n_I}, \quad (1.28)$$

where $g^E : \mathbb{R}^n \times \mathbb{R} \rightarrow \mathbb{R}^{n_E}$, $g^I : \mathbb{R}^n \times \mathbb{R} \rightarrow \mathbb{R}^{n_I}$ and $n_C = n_E + n_I$. In this setting, the complementarity conditions $\lambda \in N_K(g(\bar{x}, 0))$ for Lagrange multipliers reads:

$$\lambda \in \mathbb{R}^{n_E^*} \times \mathbb{R}_+^{n_I^*} \quad \text{and} \quad g_i^I(\bar{x}, 0) < 0 \implies \lambda_i^I = 0. \quad (1.29)$$

The Lagrangian is now defined by $L[\lambda](x, \theta) = f(x, \theta) + \lambda g(x, \theta)$; the set of Lagrange multipliers $\Lambda(\bar{x})$ and the critical cone $C(\bar{x})$ are considered for a feasible point \bar{x} of the reference problem (with $\theta = 0$).

A first approach for sensitivity analysis We describe here a first approach based on a study of the stability of the first-order optimality conditions, with the implicit function theorem. To simplify, we assume that $g^I(\bar{x}, 0) = 0$. In other words, we do not take into account the inequality constraints which are not active at \bar{x} , for $\theta = 0$.

We say that the *strict complementarity* condition holds iff for all $\lambda \in \Lambda(\bar{x})$, $\lambda_i^I > 0$, for all $i = 1, \dots, n_I$. In the following theorem, we assume that $D_x g(\bar{x}, 0)$ is surjective. This assumption implies that there is a unique Lagrange multiplier, that we denote by $\bar{\lambda}$ and it also implies the qualification condition. Note that the results of the theorem are given for a small value of η and still hold for all the values $\eta' \in (0, \eta)$.

Theorem 1.9. *Assume that*

1. $D_x g(\bar{x}, 0)$ is surjective
2. the second-order sufficient conditions hold
3. the strict complementarity holds for all $\lambda \in \Lambda(\bar{x})$.

Then, the following statements hold true.

1. There exists $\eta > 0$ such that for θ in a neighborhood of 0, $(P^\eta(\theta))$ has a unique optimal solution $x(\theta)$ with a unique Lagrange multiplier $\lambda(\theta)$ associated. The mapping $\theta \mapsto (x(\theta), \lambda(\theta))$ is C^1 in the neighborhood of 0.
2. Set $\bar{h} = D_\theta x(0)$ and $\bar{\mu} = D_\theta \lambda(0)$, the following quadratic optimization problem

$$\text{Min}_{h \in \mathbb{R}^n} D^2 L[\bar{\lambda}](\bar{x}, 0)(h, 1)^2 \quad \text{s.t.} \quad Dg(\bar{x}, 0)(h, 1) = 0, \quad (1.30)$$

has for unique solution \bar{h} , with associated multiplier $\bar{\mu}$

3. The following expansion of $V^\eta(\theta)$ holds:

$$V(0) + (D_\theta L[\bar{\lambda}](\bar{x}, 0))\theta + \frac{1}{2} \left(D^2 L[\bar{\lambda}](\bar{x}, 0)(\bar{h}, 1)^2 \right) \theta^2 + o(\theta^2). \quad (1.31)$$

Proof. 1. Note that as a consequence of the strict complementarity, the critical cone is described by

$$C(\bar{x}) = \{h \in \mathbb{R}^n : D_x g(\bar{x}, 0)h = 0\}. \quad (1.32)$$

Consider the mapping

$$H : (x, \lambda, \theta) \mapsto \begin{pmatrix} D_x L[\lambda](x, \theta) \\ g(x, \theta) \end{pmatrix}.$$

We study the well-posedness of the equation $H(x, \lambda, \theta) = 0$, with unknown variables x and λ . The derivative $D_{x, \lambda} H(\bar{x}, \bar{\lambda}, 0)(h, \mu)$, given by

$$\begin{pmatrix} D_{xx} L[\bar{\lambda}](\bar{x}, 0)h + \mu D_x g(\bar{x}, 0) \\ D_x g(\bar{x}, 0)z \end{pmatrix} \quad (1.33)$$

is injective as a consequence of the surjectivity of $D_x g(\bar{x}, 0)$ and of the second-order sufficient condition. Therefore, there exists a unique mapping $\theta \rightarrow (x(\theta), \lambda(\theta))$ of class C^1 , defined in the neighborhood of 0 which is such that $H(x(\theta), \lambda(\theta), \theta) = 0$. We can check *a posteriori* that $x(\theta)$ is a stationary point to $(P^\eta(\theta))$ by using the strict complementarity condition, and that it is an optimal solution for a sufficiently small value of η .

2. It can be checked that problem (1.30) has a unique solution with the sufficient condition and the strict complementarity assumption. Let us set $\bar{h} = D_\theta x(0)$ and $\bar{\mu} = D_\theta \lambda(0)$, then $D_{x,\lambda,\theta} H(\bar{x}, \bar{\lambda}, 0)(\bar{h}, \bar{\mu}, 1) = 0$, and therefore, by (1.33),

$$\begin{pmatrix} D_{xx}L[\bar{\lambda}](\bar{x}, 0)\bar{h} + \bar{\mu}, D_x g(\bar{x}, 0) + D_{x,\theta}L[\bar{\lambda}](\bar{x}, 0)(\bar{h}, 1) = 0 \\ Dg(\bar{x}, 0)(\bar{h}, 1) = 0 \end{pmatrix} \quad (1.34)$$

This is the first-order optimality conditions for (1.30), which are sufficient, since the problem is convex.

3. Expand to the second order:

$$V^\eta(\theta) - V^\eta(0) = f(x(\theta), \theta) - f(\bar{x}, 0) = L[\bar{\lambda}](x(\theta), \theta) - L[\bar{\lambda}](\bar{x}, 0), \quad (1.35)$$

estimate (1.31) follows. \square

A second approach for sensitivity analysis The second approach for sensitivity analysis is a *variational* approach which uses the same techniques as the ones developed for the second-order conditions. By building feasible paths of points, we obtain an upper estimate of the value function $V^\eta(\theta)$ in the form of a second-order Taylor expansion. Under the sufficient second-order condition, this expansion is a lower estimate, as we prove by expanding the Lagrangian up to the second-order. The result that we obtain is weaker, but does not require the uniqueness of the Lagrange multiplier.

Let us define the first-order linearized problem

$$\text{Min}_{h \in \mathbb{R}^nC} Df(\bar{x}, 0)(h, 1) \quad \text{s.t. } Dg(\bar{x}, 0)(h, 1) \in T_K(g(\bar{x}, 0)), \quad (PL)$$

its dual is given by

$$\text{Max}_{\lambda \in \Lambda(\bar{x})} D_\theta L[\lambda](\bar{x}, 0). \quad (DL)$$

We denote respectively by $S(PL)$ and $S(DL)$ the sets of solutions to (PL) and (DL) .

Definition 1.10. We say that the strong second-order sufficient condition holds iff for all $h \in C(\bar{x}) \setminus \{0\}$,

$$\text{Max}_{\lambda \in S(DL)} D_{xx}^2 L[\lambda](\bar{x}, 0)h^2 > 0. \quad (1.36)$$

Theorem 1.11. Assume that the constraints are qualified at \bar{x} and that the strong sufficient second-order condition holds. Then, there exists $\eta > 0$ such that for $\theta \geq 0$, $V^\eta(\theta)$ has the following second-order development:

$$\begin{aligned} V^\eta(\theta) = V^\eta(0) + & \left(\text{Max}_{\lambda \in \Lambda(\bar{x})} D_\theta L[\lambda](\bar{x}, 0) \right) \theta \\ & + \left(\text{Min}_{h \in S(PL)} \text{Max}_{\lambda \in S(DL)} D^2 L[\lambda](\bar{x}, 0)(h, 1)^2 \right) \theta^2 + o(\theta^2). \end{aligned} \quad (1.37)$$

Moreover, denoting by $x(\theta)$ an optimal solution to (1.30), we obtain that the sequence

$$\frac{x^\theta - \bar{x}}{\theta} \quad (1.38)$$

is bounded and possesses all its limit points in $S(PL)$.

Proof. We prove this theorem in three steps.

▷ *First step: a second-order upper estimate.* Under the qualification condition, the set of Lagrange multipliers is bounded. Therefore, problem (DL) has a finite value and problem (PL) , which is linear, has the same finite value and possesses at least one optimal solution. For all $h \in S(PL)$, for $\varepsilon > 0$ sufficiently small, we can build a path $\tilde{x} : \theta \in [0, \varepsilon] \rightarrow x(\theta)$ which is such that:

$$g(\tilde{x}(\theta), \theta) \in K \quad \text{and} \quad \tilde{x}(\theta) = \bar{x} + \theta d + o(\theta). \quad (1.39)$$

It follows that

$$\begin{aligned} V(\theta) - V(0) &\leq f(\tilde{x}(\theta), \theta) - f(\bar{x}, 0) = (Df(\bar{x}, 0)(h, 1))\theta + o(\theta) \\ &= \left(\text{Max}_{\lambda \in \Lambda(\bar{x})} D_\theta L[\lambda](\bar{x}, 0) \right) \theta + o(\theta). \end{aligned} \quad (1.40)$$

Similarly to the proof of Theorem 1.6, we can build a second-order feasible path of the following form:

$$\tilde{x}(\theta) = \bar{x} + h\theta + d\theta^2 + o(\theta^2), \quad (1.41)$$

where d is a second-order direction of perturbation to be optimized. We obtain a second-order linearized problem which has for dual:

$$\text{Max}_{\lambda \in S(DL)} D^2 L[\lambda](\bar{x}, 0)(h, 1)^2. \quad (1.42)$$

Finally, we optimize h in $S(PL)$. This proves that the right-hand side of (1.37) is an upper estimate of $V(\theta)$.

▷ *Second step: a first lower estimate.*

We denote by $x(\theta)$ a optimal solution to the perturbed problem. Similarly to the proof of the quadratic growth (Theorem 1.6), we prove the following inequality, for all $\lambda \in \Lambda(\bar{x})$,

$$\begin{aligned} V(\theta) - V(0) &\geq L[\lambda](x(\theta), \theta) - L[\lambda](\bar{x}, 0) \\ &= D_\theta L[\lambda](\bar{x}, 0) + D^2 L[\lambda](\bar{x}, 0)(x(\theta) - \bar{x}, \theta)^2 \\ &\quad + o(|x(\theta) - \bar{x}|^2 + \theta^2). \end{aligned} \quad (1.43)$$

▷ *Third step: conclusion.*

We prove by contradiction that $(x(\theta) - \bar{x})/\theta$ is bounded. Indeed, if it is not the case, we can show that there exists a sequence $(\theta_k)_k \downarrow 0$ which is such that for all $\lambda \in S(DL)$,

$$h_k = \frac{x(\theta_k) - \bar{x}}{|x(\theta_k) - \bar{x}|} \rightarrow h \in C(\bar{x}) \setminus \{0\} \quad \text{and} \quad D_{xx}^2 L[\lambda](\bar{x}, 0)h^2 \leq 0, \quad (1.44)$$

thanks to the upper estimate. The contradiction follows with the strong sufficient second-order conditions. Then, it is easy to check that all limit points of $(x(\theta) - \bar{x})/\theta$ (and there exists at least one) belong to $S(PL)$.

Finally, let $\lambda \in S(DL)$ and $(\theta_k) \downarrow 0$. Extracting if necessary, we may assume that $(x(\theta_k) - \bar{x})/\theta_k$ converges to $h \in S(PL)$. Therefore,

$$D^2L[\lambda](\bar{x}, 0)(x(\theta_k) - \bar{x}, \theta_k)^2 = D^2L[\lambda](\bar{x}, 0)(h, 1)^2\theta_k^2 + o(\theta_k^2). \quad (1.45)$$

Combined with (1.43), we obtain that the right-hand side of (1.37) is also a lower estimate. The theorem is proved. \square

1.1.3 Main issues in the application to optimal control

The abstract theory of second-order optimality conditions and sensitivity analysis can be applied to optimal control problems. A certain number of specific difficulties must be solved, all related in a certain manner to the fact that optimal control problems are infinite-dimensional. This subsection reviews these difficulties. We refer to [56] for a recent introduction on the application of second-order optimality conditions to optimal control problems, to the thesis [41] and to the introduction of [45] for detailed bibliographies. This thesis is not concerned by the specific case of problems which are linear with respect to the control, we refer to [5] for these problems. We also refer to [51, 52] and the references therein for sensitivity results for optimal control problems.

Two-norm discrepancy The space $L^\infty(0, T; \mathbb{R}^m)$ is an appropriate choice for formulating optimal control problems. In most applications, the control is even uniformly bounded with explicit bounds. However, this space, which is not a Hilbert space, is not appropriate for the sufficient conditions since the quadratic growth property never holds in this space. Let us consider the case of an unconstrained optimal control problem, and let us set $v_\varepsilon(t) = 1$ if $t \in (0, \varepsilon)$, 0 otherwise, for all $\varepsilon > 0$. Then, for all u ,

$$\mathcal{J}(u + v_\varepsilon) \rightarrow \mathcal{J}(u) \quad (1.46)$$

but $\|v_\varepsilon\|_\infty = 1$, therefore there cannot be any $\alpha > 0$ such that

$$\mathcal{J}(u + v_\varepsilon) \geq \mathcal{J}(u) + \alpha\|v_\varepsilon\|_\infty^2 = \mathcal{J}(u) + \alpha. \quad (1.47)$$

A weaker distance is required to obtain a quadratic growth property, and the appropriate choice is the L^2 -distance. Therefore, we have to deal with two distances:

- ▷ the L^∞ -distance, for which the Lagrangian of the problem is twice-differentiable and metric regularity properties hold, but for which the quadratic growth cannot be satisfied,
- ▷ the L^2 -distance, which is natural to state a quadratic growth property, but for which the metric regularity properties do not hold and the Lagrangian is not differentiable.

This issue is called the *two-norm* discrepancy, and the typical quadratic growth property that can be obtained uses both norms: there exist $\varepsilon > 0$ and $\alpha > 0$ such that

$$\mathcal{G}(u) \in \mathcal{K} \text{ and } \|u - \bar{u}\|_\infty \leq \varepsilon \implies \mathcal{J}(u) \geq \mathcal{J}(\bar{u}) + \alpha \|u - \bar{u}\|_2^2. \quad (1.48)$$

The use of the L^2 -distance for the quadratic growth naturally imposes to use a critical cone defined in $L^2(0, T; \mathbb{R}^m)$ for the sufficient conditions, and it is therefore desirable to state necessary conditions for a critical cone defined in this space. This complicates much the proof of the results, in particular, building feasible paths and justifying linearized problems becomes much more technical. Consider the simple example where the optimal control is given by $\bar{u}_t = 0$ and control constraints are given: $-1 \leq u_t \leq 1$. If v is a critical direction in $L^2(0, T; \mathbb{R}^m) \setminus L^\infty(0, T; \mathbb{R}^m)$, there is no standard metric regularity result that can be applied to the path $\bar{u} + \theta v$, $\theta \in \mathbb{R}$.

Extended polyhedricity An important technical difficulty that arises in the statement of no-gap second-order optimality conditions lies in checking the extended polyhedricity condition in the case of control constraints, mixed constraints, or pure constraints. Indeed, even a simple constraint such as $u_t \geq 0$, for a.a. t , cannot be seen as a polyhedric constraint since it contains an infinite number of inequalities. Some supplementary assumptions are required in order to prove the density of the quasi-radial critical cone into the critical cone:

- ▷ The contact set (that is to say, the set of times at which the constraint is active) must be a finite union of intervals and isolated points, for pure, mixed, and control constraints.
- ▷ A certain linear form (obtained by linearizing the pure and mixed constraints) has to be surjective. This assumption can be seen as a controllability assumption or more generally as a strengthening of the qualification conditions.

A reformulation of the problem is also required in the case of second-order state constraints having touch points, a touch point being an isolated time at which the constraint is active. The associated technique is called *reduction*.

Strengthened Legendre-Clebsch condition As already mentioned, the proof of the quadratic growth (which is a proof by contradiction) in a finite-dimensional setting uses in an essential way the fact that the sphere of radius 1 is compact. This is of course no longer the case in $L^2(0, T; \mathbb{R}^m)$. A bounded sequence $(h_k)_k$ in this space may not have limit points for the L^2 distance and weak limits points may be equal to 0. It is possible to circumvent this difficulty by assuming that the Hessian of the Lagrangian is a *Legendre form*. In the absence of control constraints and mixed constraints, this assumption is equivalent to the uniform positive definiteness of the Hessian of the Hamiltonian with respect to the control variable, which is acceptable in so far as the Hamiltonian is minimized (with respect to u) by the optimal control. This condition is called the *strengthened Legendre-Clebsch* condition. When control and mixed constraints are present, the Hessian of the Lagrangian is a Legendre form if and only if the Hessian

of the augmented Hamiltonian (with respect to u) is uniformly definite positive in time, which is rather restrictive.

Sensitivity analysis When we use the variational method of sensitivity analysis, the difficulties that we encounter when we prove upper estimates and lower estimates are the same as the ones that we respectively encounter in the proofs of second-order necessary and sufficient conditions. A supplementary difficulty has to be mentioned for the proof of the upper estimate: the first-order linearized problem may not have an optimal solution if it contains an infinite number of inequalities.

1.1.4 Strong solutions and their specificities

As we pointed out in the previous section, all the available results are stated for local optimal solutions. In infinite-dimensional spaces, there are some nonequivalent distances and therefore, we have to make precise what we mean by local optimal solutions. Most of the available results in the literature concerning the second-order analysis and the sensitivity analysis of optimal control problems deal with *weak solutions*, that is to say, controls that are locally optimal for the L^∞ -norm. We introduce in this section two supplementary notions of local optimal solutions, namely *Pontryagin minima* and *bounded strong solutions*. Roughly speaking, these controls are locally optimal for the L^1 -norm. The generic term *strong solutions* that we use in this thesis refers to these two notions. These two notions were introduced in [55].

The specificity of the first three chapters of this thesis lies in the fact that strong solutions are considered. The main feature of results for strong solutions is that they involve a subset of the Lagrange multipliers that we call *Pontryagin multipliers*.

In this subsection, we first define the Pontryagin multipliers for problems with final-state constraints and give definitions for the two notions of strong solutions. Finally, we describe the two main tools that were used: a technique of *relaxation* [28] and a *decomposition principle* [18].

Lagrange and Pontryagin multipliers, strong solutions In this paragraph, we state the first-order optimality conditions for a simple case of optimal control problem with final-state constraints only. We describe the Lagrange and Pontryagin multipliers and the two kinds of strong solutions. We consider the problem:

$$\text{Min}_{(u,y) \in \mathcal{U} \times \mathcal{Y}} \phi(y_T), \text{ s.t. } y = y[u], \Phi^E(y_T) = 0, \Phi^I(y_T) \leq 0. \quad (1.49)$$

For all $p \in \mathbb{R}^{n^*}$, $u \in \mathbb{R}^m$, and $y \in \mathbb{R}^n$, we define the Hamiltonian $H[p](u, y)$ by

$$H[p](u, y) = pf(u, y). \quad (1.50)$$

Let \bar{u} be feasible and let $\bar{y} = y[\bar{u}]$. We associate to any $\lambda = (\lambda^E, \lambda^I)$ the *costate* p^λ uniquely defined by the following backward differential equation:

$$\begin{cases} -\dot{p}_t^\lambda = D_y H[p_t^\lambda](\bar{u}_t, \bar{y}_t), & \text{for a.a. } t, \\ p_T^\lambda = D\phi(\bar{y}_T) + \lambda^E D\Phi(\bar{y}_T) + \lambda^I D\Phi^I(\bar{y}_T). \end{cases} \quad (1.51)$$

In this framework, the set of Lagrange multipliers, denoted now by $\Lambda_L(\bar{u})$ is given by

$$\Lambda_L(\bar{u}) = \left\{ \lambda = (\lambda^E, \lambda^I) \in \mathbb{R}^{n_{\Phi^E}} \times \mathbb{R}_+^{n_{\Phi^I}} : \right. \\ \left. \Phi_i^I(\bar{u}_t) < 0 \implies \lambda_i^I = 0, \forall i = 1, \dots, n_{\Phi^I}, \right. \quad (1.52)$$

$$\left. D_u H[p_t^\lambda](\bar{u}_t, \bar{y}_t) = 0, \text{ for a.a. } t \right\}. \quad (1.53)$$

We consider now the set of Pontryagin multipliers $\Lambda_P(\bar{u})$, defined by

$$\Lambda_P(\bar{u}) = \left\{ \lambda \in \Lambda_L(\bar{u}) : H[p_t^\lambda](\bar{u}_t, \bar{y}_t) \leq H[p_t^\lambda](u, \bar{y}_t), \right. \\ \left. \forall u \in \mathbb{R}^m, \text{ for a.a. } t \right\}. \quad (1.54)$$

This two kinds of multipliers can also be defined for optimal control problems with control, mixed, and pure constraints. Let us define now the different notions of local optimality that we will use. We use the abstract formulation of an optimal control problem (1.4).

Definition 1.12. *We say that \bar{u} is*

- ▷ a weak solution *iff there exists $\varepsilon > 0$ such that for all $u \in \mathcal{U}$,*

$$\mathcal{G}(u) \in \mathcal{K} \quad \text{and} \quad \|u - \bar{u}\|_\infty \leq \varepsilon \implies \mathcal{J}(u) \geq \mathcal{J}(\bar{u}), \quad (1.55)$$

- ▷ a Pontryagin minimum *iff for all $R > \|\bar{u}\|_\infty$, there exists $\varepsilon > 0$ such that for all $u \in \mathcal{U}$ with $\|u\|_\infty \leq R$,*

$$\mathcal{G}(u) \in \mathcal{K} \quad \text{and} \quad \|u - \bar{u}\|_1 \leq \varepsilon \implies \mathcal{J}(u) \geq \mathcal{J}(\bar{u}), \quad (1.56)$$

- ▷ a bounded strong solution *iff for all $R > \|\bar{u}\|_\infty$, there exists $\varepsilon > 0$ such that for all $u \in \mathcal{U}$ with $\|u\|_\infty \leq R$,*

$$\mathcal{G}(u) \in \mathcal{K} \quad \text{and} \quad \|y[u] - \bar{y}\|_\infty \leq \varepsilon \implies \mathcal{J}(u) \geq \mathcal{J}(\bar{u}). \quad (1.57)$$

By Gronwall's lemma, the mapping $u \mapsto y[u]$ is Lipschitz-continuous, for the L^1 -norm on the control and the L^∞ -norm on the state variable. It follows that if \bar{u} is a bounded strong solution, then it is a Pontryagin minimum, and if it is a Pontryagin minimum, then it is a weak minimum.

Proposition 1.13. *Under a qualification condition, if \bar{u} is a weak solution, then $\Lambda_L(\bar{u})$ is non-empty and if \bar{u} is a Pontryagin minimum, then $\Lambda_P(\bar{u})$ is non-empty.*

This result is the well-known Pontryagin's principle. Unsurprisingly, when the notion of local optimality which is used is strengthened, we obtain a stronger result, that is to say, more restrictive conditions on the involved set of multipliers. Observe that a Pontryagin minimum is optimal with respect to controls that may be far for the L^∞ -norm, to the contrary of weak solutions. In the same way, for a Lagrange multiplier, the Hamiltonian is only stationary with respect to u , whereas for a Pontryagin multiplier, the Hamiltonian is minimized by the control: this statement involves some controls which are far for the uniform norm.

Relaxation The basic idea of *relaxation* consists in using simultaneously several controls, with some weights associated, such that the sum of the weights is equal to 1. Let us have a look on a simple example: we consider two controls, u^1 and u^2 with constant weights, both equal to $\frac{1}{2}$. The associated state variable is given by:

$$\dot{y}_t = \frac{1}{2}f(u_t^1, y_t) + \frac{1}{2}f(u_t^2, y_t), \quad y_0 = y^0 \quad (1.58)$$

and equation (1.58) is called *relaxed state equation*. Let us denote by y the solution to this equation. Let us consider now a sequence $(u^k)_k$ of controls, defined by

$$u_t^k = \begin{cases} u_t^1 & \text{if } \lfloor \frac{tk}{T} \rfloor \text{ is even,} \\ u_t^2 & \text{otherwise,} \end{cases} \quad (1.59)$$

where the symbol $\lfloor x \rfloor$ stand for the integer part of the real number x . It can be proved that the sequence of associated state variables $(y[u^k])_k$ converges uniformly to y . This means that the solution of the relaxed state equation can be approximated as accurately as wanted. If the constraints are qualified, it is possible to build the approximating sequence $(u^k)_k$ so that it is also feasible.

This idea can be generalized to infinite convex combinations of the controls, with Young measures. Roughly speaking, a Young measure $t \mapsto \mu_t$ is a measurable mapping from $t \in [0, T]$ to the space of probability measures on the control space U . The relaxed equation is given by:

$$\begin{cases} \dot{y}_t = \int_U f(y_t, u) d\mu_t(u), \\ y_0 = y^0. \end{cases} \quad (1.60)$$

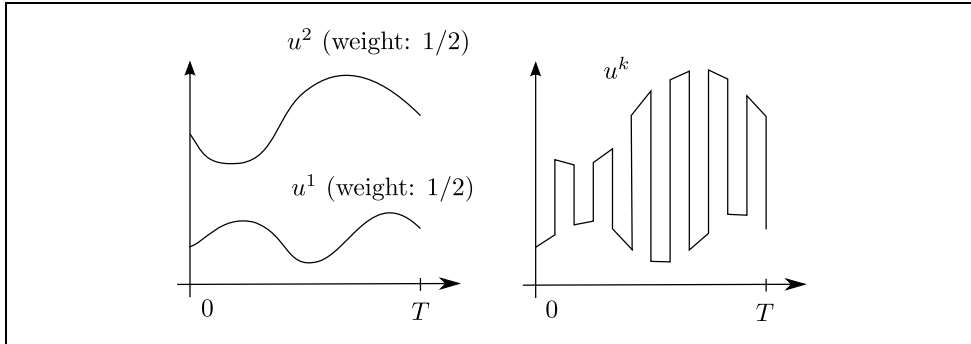

Figure 1.2: Illustration of the approximation of a relaxed control.

The effect of relaxation can also be understood from the point of view of differential inclusions [6]. Consider the control constraint $u \in U$ where U is compact, then the set of solutions to the state equation coincide with the set of solutions to the following differential inclusion:

$$\dot{y}_t \in F(y_t), \quad y_0 = y^0, \quad (1.61)$$

where $F : \mathbb{R}^n \rightrightarrows \mathbb{R}^n$ is the multimapping defined by

$$F(y) = \{f(u, y), u \in U\}. \quad (1.62)$$

Then, the set of solutions to the relaxed equation coincide with the set of solutions to the following differential inclusion:

$$\dot{y}_t \in \text{conv}(F(y_t)). \quad (1.63)$$

Relaxation provides a new way of building paths of feasible points. At the first-order, the standard way of building this paths is to consider a direction of perturbation v and to expand the cost function of the sequence $\bar{u} + \theta v$. But we can also consider the sequence of relaxed controls which are the combination of \bar{u} with a weight $(1 - \theta)$ and another control, say u , with a weight θ , where $\theta \in [0, 1]$. This results in the following state equation:

$$\dot{y}_t = (1 - \theta)f(\bar{u}_t, y_t) + \theta f(u_t, y_t). \quad (1.64)$$

Let us denote by y^θ the solution. Then,

- ▷ we can show that there exists a sequence $(u^\theta)_\theta$ of classical controls which is such that

$$\|y^\theta - y[u^\theta]\|_\infty = o(\theta) \quad \text{and} \quad \|u^\theta - \bar{u}\|_1 = O(\theta) \quad (1.65)$$

- ▷ and we can compute a first-order Taylor expansion of $\mathcal{J}(u^\theta)$.

These two elements justify the use of relaxation to build feasible paths, for the study of strong solutions, since the estimate (1.65) on u^θ involves the L^1 -norm. This technique allows to obtain necessary conditions (and upper estimates for sensitivity) expressed with Pontryagin multipliers instead of Lagrange multipliers. It has been used at the first order since the beginning of the development of the optimal control theory; in this thesis we use it for the second-order analysis.

Decomposition principle The *decomposition principle* is a particular second-order Taylor expansion of the Lagrangian of the problem. Let us fix a multiplier of the problem, and let us denote by $\mathcal{L}(u)$ the Lagrangian and by Ω its Hessian at \bar{u} , which is a quadratic form on the space $L^2(0, T; \mathbb{R}^m)$. When we try to prove a quadratic growth property, the approach consists in expanding up to the second order the right-hand side of the following inequality

$$\mathcal{J}(u^k) - \mathcal{J}(\bar{u}) \geq \mathcal{L}(u^k) - \mathcal{L}(\bar{u}), \quad (1.66)$$

where $(u^k)_k$ is a certain sequence of controls (see inequality (1.25) in the proof of Theorem 1.6). With Gronwall's Lemma, we can prove the following estimate:

$$\mathcal{L}(u^k) - \mathcal{L}(\bar{u}) = \Omega(u^k - \bar{u}) + O(\|u^k - \bar{u}\|_3^3), \quad (1.67)$$

which is satisfactory if we know that $(u^k)_k$ uniformly converges to \bar{u} , since then,

$$\|u^k - \bar{u}\|_3^3 = O(\|u^k - \bar{u}\|_\infty \|u^k - \bar{u}\|_2^2) = o(\|u^k - \bar{u}\|_2^2), \quad (1.68)$$

and therefore, the expansion (1.67) is suitable, since by combining (1.66), (1.67), and (1.68), we obtain that

$$\mathcal{J}(u^k) - \mathcal{J}(\bar{u}) \geq \Omega(u^k - \bar{u}) + o(\|u^k - \bar{u}\|_2^2). \quad (1.69)$$

When we study strong solutions, the uniform convergence of $(u^k)_k$ is not ensured anymore. Assuming the quadratic growth of the Hamiltonian, we prove in a first step that $\|u^k - \bar{u}\|_2 \rightarrow 0$. It means that for k large enough, the perturbation $|u_t^k - \bar{u}_t|$ may be very large, but only for times t in a small subset of $[0, T]$. Let us consider a sequence $(A_k, B_k)_k$ of partitions of the time interval, and let us define two new sequences of controls:

$$u_t^{A,k} = \begin{cases} u_t^k & \text{if } t \in A_k \\ \bar{u}_t & \text{otherwise,} \end{cases} \quad \text{and} \quad u_t^{B,k} = \begin{cases} u_t^k & \text{if } t \in B_k \\ \bar{u}_t & \text{otherwise.} \end{cases} \quad (1.70)$$

The subset A_k accounts for the small perturbations and the subset B_k for the large perturbations. Finally, if the sequence of partitions is suitably constructed, we obtain a series of estimates, among them,

$$\text{meas}(B_k) \rightarrow 0, \quad \|u^{A,k} - \bar{u}\|_\infty \rightarrow 0 \quad (1.71)$$

and above all,

$$\begin{aligned} \mathcal{L}(u^k) - \mathcal{L}(\bar{u}) &= \Omega(u^{A,k} - \bar{u}) \\ &+ \int_0^T (H[p_t^\lambda](u_t^{B,k}, \bar{y}_t) - H[p_t^\lambda](\bar{u}_t, \bar{y}_t)) dt + o(\|u^k - \bar{u}\|_2^2). \end{aligned} \quad (1.72)$$

In the study of strong solutions, this expansion is a key tool for the proof of quadratic growth and for the proof of a lower estimate in sensitivity analysis.

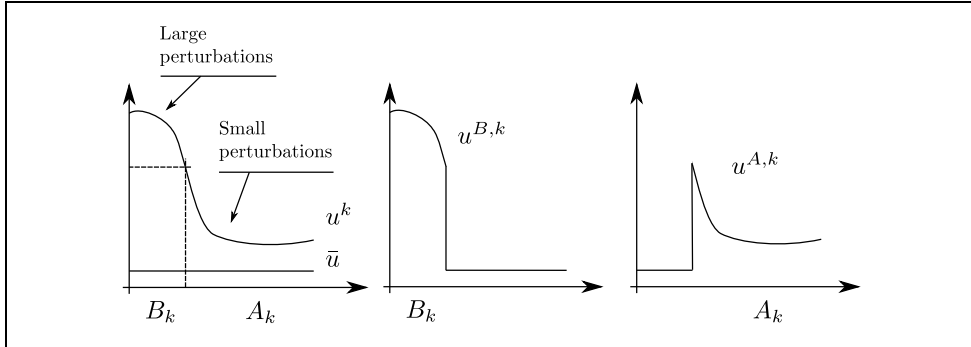

Figure 1.3: Decomposition principle.

1.1.5 Contribution of the thesis

This subsection summarizes in an informal way the main results of the first part of the thesis. We fix a feasible control \bar{u} , its associated trajectory \bar{y} and denote by $\Lambda_L(\bar{u})$ and $\Lambda_P(\bar{u})$ the set of Lagrange and Pontryagin multipliers. The Hessian of the Lagrangian in a given direction v is denoted by $\Omega[\lambda](v)$.

Chapter 2: Second-order necessary optimality conditions in Pontryagin form

In this chapter, we state and prove second-order necessary conditions for Pontryagin minima of optimal control problems with pure and mixed constraints. The result is expressed with Pontryagin's multipliers and is obtained with a finite relaxation of the state equation. The main results are the following:

- ▷ We give a new technique to build feasible paths for which the direction of perturbation possibly belongs to $L^2 \setminus L^\infty$, with a specific metric regularity property for the mixed constraints in Lemmas 2.49, 2.50, and 2.51.
- ▷ In Theorem 2.48, we give a new proof of second-order necessary conditions for weak solutions, which are already known (see [17, 64]). As we mentioned, the main difficulty lies in the proof of the extended polyhedricity condition, but the possibility of building paths with a direction in L^2 simplifies the proof of this condition. Under technical assumptions, if \bar{u} is a weak solution, then for all critical direction v ,

$$\sup_{\lambda \in \Lambda_L(\bar{u})} \Omega[\lambda](v) \geq 0. \quad (1.73)$$

- ▷ Theorem 2.31 is the main result, we prove the second-order necessary conditions for Pontryagin minima. Under technical assumptions, if \bar{u} is a Pontryagin minimum, then for all critical direction v ,

$$\sup_{\lambda \in \Lambda_P(\bar{u})} \Omega[\lambda](v) \geq 0. \quad (1.74)$$

- ▷ Theorem 2.57 is a new qualification condition, which is weaker than the usual qualification and ensures that Pontryagin's multipliers are non singular.

Chapter 3: Second-order sufficient conditions for bounded strong solutions

In this chapter, we state sufficient conditions ensuring a quadratic growth property for bounded strong solutions to optimal control problems with pure and mixed constraints. These conditions consist in:

- ▷ for all nonzero critical direction v , there exists $\lambda \in \Lambda_P(\bar{u})$ such that $\Omega[\lambda](v) > 0$.
- ▷ the quadratic growth of the Hamiltonian with respect to u : for at least one Pontryagin multiplier λ , there exists $\alpha > 0$ such that for almost all t , for all u in a certain multi-mapping $U(t)$,

$$H[p_t^\lambda](u, \bar{y}_t) \geq H[p_t^\lambda](\bar{u}_t, \bar{y}_t) + \alpha |u - \bar{u}_t|^2. \quad (1.75)$$

The main results are the following:

- ▷ Theorem 3.14 provides a decomposition principle for the constrained problem under study, extending the result of [18].

- ▷ Theorem 3.18 is the main result and proves the quadratic growth property for bounded strong solutions. Under the sufficient conditions, the Legendre-Clebsch condition, and technical assumptions, for all $R > \|\bar{u}\|_\infty$, there exist $\alpha > 0$ and $\varepsilon > 0$ such that for all u ,

$$\|u\|_\infty \leq R, \mathcal{G}(u) \in \mathcal{K}, \|y[u] - \bar{y}\|_\infty \leq \varepsilon \implies J(u) \geq J(\bar{u}) + \alpha\|u - \bar{u}\|_2^2. \quad (1.76)$$

- ▷ Theorem 3.21 proves that under technical assumptions, the sufficient conditions are necessary to ensure the quadratic growth.

Chapter 4: Sensitivity analysis for relaxed optimal control problems with final-state constraints

In this chapter, we perform a sensitivity analysis for a certain type of bounded strong solutions to relaxed optimal control problems with final-state constraints. The relaxation (with Young measures) and the decomposition principle are used in an essential way. The family of problems is given by:

$$V^n(\theta) = \text{Min}_{\mu \in \mathcal{M}} \phi(y_T, \theta) \quad \text{s.t. } y = y[\mu, \theta], \Phi^E(y_T, \theta) = 0, \Phi^I(y_T, \theta) = 0, \quad (1.77)$$

$$\|y[\mu, \theta] - \bar{y}\|_\infty \leq \eta, \quad (1.78)$$

where \mathcal{M} is a space of Young measures and $y[\mu, \theta]$ the trajectory associated with the relaxed control μ , parameterized by θ . The reference problem (with $\theta = 0$) is supposed to have a solution \bar{u} in L^∞ .

The main results are the following:

- ▷ A metric regularity property for relaxed controls, involving the L^1 -distance (for the Wasserstein distance) is proved in Theorem 4.9.
- ▷ An upper estimate of the $V(\theta)$ is proved in Theorem 4.26.
- ▷ An extension of the decomposition principle to relaxed controls is provided in Theorem 4.28.
- ▷ Finally, the lower estimate of $V(\theta)$ is given in Theorem 4.34.

The second-order expansion of $V(\theta)$ which is obtained is of the form:

$$V(\theta) = V(0) + C_1\theta + C_2\theta^2 + o(\theta^2), \quad (1.79)$$

where the coefficients C_1 and C_2 are the values associated with linearized problems, and are expressed with Pontrygin's multipliers.

Chapter 5: Sensitivity analysis for the outages of nuclear power plants

In this chapter, we consider a problem of nuclear energy production, parameterized by dates at which nuclear power plants must be stopped. Given a planning of the outages, the problem is a convex optimal control problem. We study the structure of optimal controls and perform a sensitivity analysis with respect to the dates. More precisely, we compute a first-order expansion of the value function. The main results are the following:

- ▷ In Theorem 5.15, we prove the first-order expansion of the value of the problems.
- ▷ In Theorem 5.16, we give a precise characterization of the Lagrange multipliers of the problem.

1.1.6 Perspectives

We mention in this section some possible developments of the first part of the thesis.

Quadratic growth The quadratic growth property that we establish lies on the Legendre-Clebsch hypothesis. This assumption is naturally satisfied if there are no control constraints neither mixed constraints, but may be wrong in the presence of such constraints. It would be an important improvement to obtain a quadratic growth property, even for weak solutions, without this assumption.

Remember that the proof of quadratic growth is a proof by contradiction. We typically consider a sequence $(u^k)_k$ which contradicts this property, and we have to show that the sequence of directions:

$$\frac{u^k - \bar{u}}{\|u^k - \bar{u}\|_2} \tag{1.80}$$

has a limit point v , for a suitable topology, which is in the critical cone, and which is such that for all multipliers, $\Omega[\lambda](v) \leq 0$. This limit point is therefore equal to 0, by the sufficient second-order condition. The topology which has been used so far is the weak topology of L^2 , which does not enable us to obtain directly the desired contradiction. In Chapter 4, we introduce the narrow topology for Young measures, which is finer and possesses good compactness properties. This topology would certainly enable us to obtain a better understanding of the sequence $(u^k)_k$ and to get the contradiction without the Legendre-Clebsch assumption.

Sensitivity analysis In Chapter 4, we are able to use the variational approach for the sensitivity analysis of optimal control problems with final-state constraints and obtain results which do not require the uniqueness of the multiplier. It would be of interest to extend this approach to more sophisticated problems, with control constraints, mixed constraints or even pure constraints. The main difficulty is to ensure the existence of at least one solution to the first-order linearized problem. Indeed, linear optimization problems with an infinite number of inequality constraints may not have solutions.

The case of control constraints is already interesting. As we show in the example of subsection 4.6.2, the behavior of optimal solutions may be complex in the presence of several Lagrange multipliers: in this precise example, the direction of perturbation of the optimal controls is itself a Young measure.

1.2 Chance-constrained stochastic optimal control problems

1.2.1 Introduction to stochastic optimal control

Setting The second part of this thesis is dedicated to the study of stochastic optimal control problems with a probability constraint. Stochastic optimal control problems aim at optimizing the behavior of uncertain controlled dynamical system. We are interested by systems modeled by a *stochastic differential equation*, typically formulated as follows:

$$\begin{cases} dY_t = f(u_t, Y_t) dt + \sigma(u_t, Y_t) dW_t, \\ Y_0 = y_0, \end{cases} \quad (1.81)$$

where the functions f and σ are given and respectively called *drift* and *volatility* and where $W = (W_t)_{t \in [0, T]}$ is a Brownian motion. We denote by $\mathbb{F} = (\mathcal{F}_t)_t$ the filtration associated with W . At each time, the control u is taken in a compact subset U of \mathbb{R}^m and is a stochastic process adapted to \mathbb{F} , which simply means that the control process cannot anticipate the future. We denote by \mathcal{U} the space of adapted control processes in U . For $u \in \mathcal{U}$, we denote by $(Y_t^u)_t$ the unique solution to (1.81). A simple formulation of a stochastic optimal control problem is the following:

$$\text{Min}_{u \in \mathcal{U}} \mathbb{E}[\phi(Y_T^u)]. \quad (1.82)$$

We refer to the book [76, 90, 105] for introductions on stochastic control theory.

Dynamic programming and HJB equation The intrinsic difficulty of stochastic optimal control is to describe in a convenient way the different values of the control in function of the possible realizations of the Brownian motion. In problem (1.82), the dynamic of the state variable is Markovian in the following sense: if for some time s , the control process $u \in \mathcal{U}$ is independent of \mathcal{F}_s , then for all $t \geq s$, for all $y \in \mathbb{R}^n$, for all measurable subset B of \mathbb{R}^n , and for all \mathcal{F}_s -measurable event A ,

$$\mathbb{P}[Y_t^u \in B \mid Y_s^u = y, A] = \mathbb{P}[Y_t^u \in B \mid Y_s^u = y]. \quad (1.83)$$

In other words, given a control process which is independent of the past of s , the behavior of the state variable, knowing its value at s , is also independent of the past. This fact, combined with the structure of the cost function, defined as the expectation of a function of the final state allows, in some sense, to decompose the problem in time, via a *dynamic programming principle* [78].

For all $s \in [0, T]$, for all $y \in \mathbb{R}^n$, and for all $u \in \mathcal{U}$, we denote by $(Y_t^{s,y,u})_{t \in [s, T]}$ the solution to

$$\begin{cases} dY_t^{s,y,u} = f(u_t, Y_t^{s,y,u}) dt + \sigma(u_t, Y_t^{s,y,u}) dW_t, \\ Y_s^{s,y,u} = y, \end{cases} \quad (1.84)$$

and we define the *value function* $V(t, y)$ by

$$V(t, y) = \min_{u \in \mathcal{U}} \mathbb{E}[\phi(Y_T^{t,y,u})]. \quad (1.85)$$

Theorem 1.14 (Dynamic programming principle). *Let t , let τ a stopping time be such that $\tau \geq t$. Then,*

$$V(t, y) = \min_{u \in \mathcal{U}} \mathbb{E}[V(\tau, Y_\tau^{t, y, u})]. \quad (1.86)$$

The interpretation of the principle is the following: knowing an optimal control from τ to T for each initial state at τ , one can obtain an optimal control from t to T by minimizing the right-hand side of (1.86) over controls on $[t, \tau]$. This principle contains the idea that an optimal control should be computed backwards in time. Considering a stopping time “infinitesimally” close to time t , we obtain a relation between the time derivative of V and the first- and second-order derivatives of V with respect to y . The corresponding partial differential equation is called *Hamilton-Jacobi-Bellman equation* (in short, *HJB equation*). Let us recall the main steps to recover the PDE. First, we assume that V is twice-differentiable and apply Itô’s formula to a given constant control u :

$$\begin{aligned} & V(t + dt, Y_{t+dt}^{t, y, u}) - V(t, y) \\ &= \int_t^{t+dt} \left(\partial_t V(s, Y_s^{t, y, u}) + DV(s, Y_s^{t, y, u}) f(u, Y_s^{t, y, u}) \right. \\ &\quad \left. + \frac{1}{2} D^2 V(s, Y_s^{t, y, u}) \sigma(u, Y_s^{t, y, u})^2 \right) ds \\ &\quad + \int_t^{t+dt} DV(s, Y_s^{t, y, u}) dW_s. \end{aligned} \quad (1.87)$$

Note that

- ▷ $\partial_t V$ stands for the partial derivative of V with respect to t
- ▷ DV and $D^2 V$ stand for the first- and second-order partial derivative of V with respect to y .

Consider that in the previous formula, we can take the derivatives of the value function as constant. We obtain that

$$\begin{aligned} & \mathbb{E}[V(t + dt, Y_{t+dt}^{t, y, u})] - V(t, y) \\ &= \left(\partial_t V(t, y) + DV(t, y) f(u, y) + \frac{1}{2} D^2 V(t, y) \sigma(u, y)^2 \right) dt \end{aligned} \quad (1.88)$$

Combining (1.86) and (1.88), and considering that on a small time, an optimal control is constant, we find that

$$- \partial_t V(t, y) = \inf_{u \in \mathcal{U}} \left\{ DV(t, y) f(u, y) + \frac{1}{2} D^2 V(t, y) \sigma(u, y)^2 \right\} \quad (1.89)$$

For all $u \in U$, $p \in \mathbb{R}^{n*}$ and $Q \in M_n$, where \mathbb{R}^{n*} is the space of row vectors of size n and M_n is the space of symmetric matrices of size n , we define the *Hamiltonian* $H(u, y, p, Q)$ by

$$H(u, y, p, Q) = pf(u, y) + \frac{1}{2} Q \sigma(u, y)^2 \quad (1.90)$$

and the *true Hamiltonian* by

$$H^*(y, p, Q) = \inf_{u \in U} H(u, y, p, Q). \quad (1.91)$$

Finally, the HJB equation satisfied by V is given by

$$\begin{cases} -\partial_t V(t, y) = H^*(y, DV(t, y), DV^2(t, y)), & \forall (t, y) \in (0, T) \times \mathbb{R}^n, \\ V(T, y) = \phi(y), & \forall y \in \mathbb{R}^n. \end{cases} \quad (1.92)$$

This equation has been obtained by assuming that V was twice-differentiable, but in general, this assumption is false. However, the theory of viscosity solutions provides a suitable framework in which the HJB equation (1.92) has a sense and has a unique solution, which is V . This theory was introduced in the seminal papers [89, 87] and in [88].

Definition 1.15. *We say that $V : [0, T] \times \mathbb{R}^n \rightarrow \mathbb{R}$ is a subsolution (respectively a supersolution) to the HJB equation (1.92) iff*

$$V(T, x) \leq \phi(x), \quad (\text{resp. } V(T, x) \geq \phi(x)) \quad (1.93)$$

and for all C^2 -function $\varphi : [0, T] \times \mathbb{R}^n \rightarrow \mathbb{R}$, for all local maximizer (respectively minimizer) $(t, y) \in [0, T] \times \mathbb{R}^n$ of $V - \varphi$,

$$-\partial V_t - H^*(y, D\varphi(t, y), D^2\varphi(t, y)) \leq 0, \quad (1.94)$$

(respectively, $-\partial_t \varphi - H^*(y, D\varphi(t, y), D^2\varphi(t, y)) \geq 0$).

We say that V is a viscosity solution iff it is a subsolution and a supersolution.

The following two theorems ensure the existence and the uniqueness of the solution to the HJB equation.

Theorem 1.16. *The value function V is a viscosity solution.*

Theorem 1.17 (Comparison principle). *Let V_1 and V_2 be respectively a subsolution and a supersolution. Then, $V_1 \leq V_2$.*

As a corollary of the comparison principle, the viscosity solution to the HJB equation is unique, and this solution is the value function V .

Numerical methods We give in this section the main ideas of the numerical resolution of (1.92). We describe two methods, a *semi-Lagrangian scheme* and a *finite-difference scheme*. For simplicity, we assume in this short presentation that y is of dimension 1, but these methods can be applied to multidimensional spaces. However, their complexity is exponential in the dimension of the state variable, since the number of discretization points is exponential with this dimension. This phenomenon, called the *curse of dimensionality*, is a severe restriction to the application of these methods

when the dimension of the state space increases. We refer to [97, 98] for an introduction to numerical methods in stochastic optimal control and to [77] for general proofs of convergence.

Let $M_t \in \mathbb{N}^*$, let $\delta t = T/M_t$ and let $\delta y > 0$. We aim at computing an approximation $(V_{j,k})_{j \in \{0, \dots, M_t\}, k \in \mathbb{Z}}$ of the value function, such that

$$V_{j,k} \approx V(j\delta t, k\delta y), \quad \forall j = 0, \dots, M_t, \quad \forall k \in \mathbb{Z}. \quad (1.95)$$

Note that we do not explain how to bound the domain of y . For all $j \in \{0, \dots, M_t\}$, we denote $V_j = (V_{j,k})_{k \in \mathbb{Z}}$. As expected, the approximation is obtained backwards in time: we first compute V_{M_t} , then, $V_{M_t-1}, \dots, V_1, V_0$, via a certain mapping Φ which is such that

$$V_j = \Phi(V_{j+1}), \quad \forall j \in \{0, \dots, M_t - 1\}. \quad (1.96)$$

The numerical scheme is convergent if this abstract mapping Φ (that has to be defined) is *monotone*, *stable*, and *consistent*. We do not define the notions of convergence, stability and consistency that are used but only on the one of monotonicity, which is the following:

$$\Phi(W^1) \leq \Phi(W^2), \quad \forall (W_k^1)_{k \in \mathbb{Z}}, (W_k^2)_{k \in \mathbb{Z}}, \text{ s.t. } W^1 \leq W^2, \quad (1.97)$$

where the inequalities have to be understood pointwise.

A semi-Lagrangian scheme \triangleright First step: discretization in time

The semi-Lagrangian scheme consists first in discretizing with respect to time the dynamic of $(Y_t)_t$. The new time variable is denoted by j and takes its value in the set $\{0, 1, \dots, M_t\}$, corresponding to $\{0, \delta t, \dots, \delta t M_t = T\}$. The discretized state variable has the following dynamics: for $j \in \{0, \dots, M_t - 1\}$,

$$Y_{j+1} = Y_j + f(u_j, Y_j)\delta t + \sigma(u_j, Y_j)\sqrt{\delta t}w_{j+1}, \quad (1.98)$$

where $(w_j)_{j=1, \dots, M_t}$ is a sequence of independently identically distributed processes, taking the values 1 and -1 with probabilities $1/2$. For all $j = 0, \dots, M_t$, we denote by \mathcal{F}_j the algebra generated by $\{w_1, \dots, w_j\}$. The new control process $(u_j)_{j=0, \dots, M_t-1}$ is supposed to be non-anticipative: for all j , $(u_j)_j$ is \mathcal{F}_j -measurable and thus, Y_j is also \mathcal{F}_j -measurable.

We consider now the same optimal control problem as in (1.82), where the control and the state are discretized in time. Denoting by $V_j(y)$ the value of the problem starting at time j with the initial state y , we obtain the following dynamic programming principle:

$$\left\{ \begin{array}{l} V_j(y) = \inf_{u \in U} \left\{ \frac{1}{2}V_{j+1}(y^+) + \frac{1}{2}V_{j+1}(y^-) \right\}, \\ \quad \text{where: } y^+ = y + f(u, y)\delta t + \sigma(u, y)\sqrt{\delta t}, \\ \quad \quad \quad y^- = y + f(u, y)\delta t - \sigma(u, y)\sqrt{\delta t}, \\ V_{M_t}(y) = \phi(y). \end{array} \right. \quad (1.99)$$

\triangleright Second step: discretization in space

Equation (1.99) cannot be solved, since the variable y is continuous. The second step of

the method consists in replacing a piecewise-affine approximation of V_{j+1} in (1.99), as follows:

$$\left\{ \begin{array}{l} V_{j,k} = \inf_{u \in U} \left\{ \frac{1}{2} \left((1 - \{k^+\}) V_{j+1, \lfloor k^+ \rfloor} + \{k^+\} V_{j+1, \lfloor k^+ \rfloor + 1} \right) \right. \\ \quad \left. + \frac{1}{2} \left((1 - \{k^-\}) V_{j+1, \lfloor k^- \rfloor} + \{k^-\} V_{j+1, \lfloor k^- \rfloor + 1} \right) \right\}, \\ \text{where: } k^+ = k + (f(u, k\delta y)\delta t + \sigma(u, k\delta y)\sqrt{\delta t})/\delta y, \\ \quad k^- = k + (f(u, k\delta y)\delta t - \sigma(u, k\delta y)\sqrt{\delta t})/\delta y, \\ V_{M_t, k} = \phi(k), \end{array} \right. \quad (1.100)$$

where $\{x\}$ is the fractional part of x , defined by $\{x\} = x - \lfloor x \rfloor$. Let us conclude the description of this methods with two general remarks.

1. In general, it is not possible to compute an analytical expression of the solution to the minimization problem (1.99). A basic approach consists in discretizing the control space and to look for a minimum by enumeration.
2. In state spaces of dimension greater than 1, one has to fix a triangulation of the space and for a given y , one has to be able to compute the triangle to which it belongs.

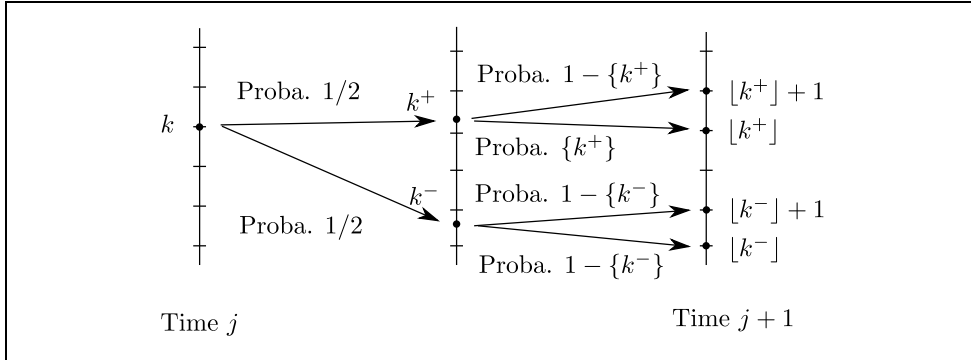

Figure 1.4: Discretization of the state variable in the semi-Lagrangian scheme.

A finite-difference scheme The finite-difference scheme is obtained by a discretization of the derivatives involved in the HJB equation. The time and the space variables are both discretized. We denote by $v_{j,k}$ the corresponding approximation of the value function. To simplify the notations, we denote: $f_{u,k} = f(u, k\delta y)$ and we use the same convention for σ .

▷ The approximation of the time derivative is

$$\partial_t V(j\delta t, k\delta y) \rightarrow \frac{v_{j,k} - v_{j-1,k}}{\delta t} \quad (1.101)$$

▷ If $f_{u,k} \geq 0$, the approximation of the first-order space derivative is

$$DV(j\delta t, k\delta y)f_{u,k} \rightarrow \frac{v_{j,k+1} - v_{j,k}}{\delta y} f_{u,k} \quad (1.102)$$

▷ If $f(u, k\delta y) \leq 0$, the approximation of the first-order space derivative is

$$DV(j\delta t, k\delta y)f_{u,k} \rightarrow \frac{v_{j,k} - v_{j,k-1}}{\delta y} f_{u,k} \quad (1.103)$$

▷ The approximation of the second-order space derivative is

$$D^2V(j\delta t, k\delta y) \rightarrow \frac{v_{j,k+1} - 2v_{j,k} + v_{j,k-1}}{\delta y^2} \quad (1.104)$$

Observe that we use an *upwind scheme*: the approximation of DV depends on the sign of f . This is required in order to obtain a monotone scheme. Let us set $x^+ = \max(x, 0)$ and $x^- = \min(x, 0)$, for all $x \in \mathbb{R}$. The discretization of the HJB equation reads: for all $j \in \{0, \dots, M_t - 1\}$, for all $k \in \mathbb{Z}$,

$$\begin{aligned} \frac{v_{j+1,k} - v_{j,k}}{\delta t} = \inf_{u \in U} \left\{ \frac{v_{j+1,k+1} - v_{j+1,k}}{\delta y} f_{u,k}^+ + \right. \\ \left. \frac{v_{j+1,k} - v_{j+1,k-1}}{\delta y} f_{u,k}^- + \frac{v_{j+1,k+1} - 2v_{j+1,k} + v_{j+1,k-1}}{2\delta y^2} \sigma_{u,k}^2 \right\}. \end{aligned} \quad (1.105)$$

Equivalently,

$$\begin{aligned} v_{j,k} = \inf_{u \in U} \left\{ \left(1 - \frac{|f_{u,k}|\delta t}{\delta y} - \frac{\sigma_{u,k}^2 \delta t}{\delta y^2} \right) v_{j+1,k} \right. \\ \left. + \left(\frac{f_{u,k}^+ \delta t}{\delta y} + \frac{\sigma_{u,k}^2 \delta t}{2\delta y^2} \right) v_{j+1,k+1} + \left(\frac{-f_{u,k}^- \delta t}{\delta y} + \frac{\sigma_{u,k}^2 \delta t}{2\delta y^2} \right) v_{j+1,k-1} \right\}. \end{aligned} \quad (1.106)$$

We set $\|f\|_\infty = \sup_{u \in U, y \in \mathbb{R}} |f(u, y)|$ and $\|\sigma\|_\infty = \sup_{u \in U, y \in \mathbb{R}} \sigma(u, y)$. Consider the following *condition of Courant, Friedrichs, and Lewy* (in short, *CFL condition*):

$$\|f\|_\infty \delta t \leq \frac{1}{2} \delta y \quad \text{and} \quad \|\sigma\|_\infty^2 \delta t \leq \frac{1}{2} \delta y^2, \quad (1.107)$$

then the numerical scheme given by equation (1.106) is monotone.

1.2.2 Chance-constrained optimal control problems

Setting In this thesis, we are interested in chance-constrained optimal control problems. We consider problems with a constraint on the final state that has to be satisfied with a given probability. Let us mention two arguments for ensuring this final-state constraint with only a certain probability:

▷ In some cases, it is impossible to satisfy almost surely the final-state constraint, because of the diffusion of the state variable.

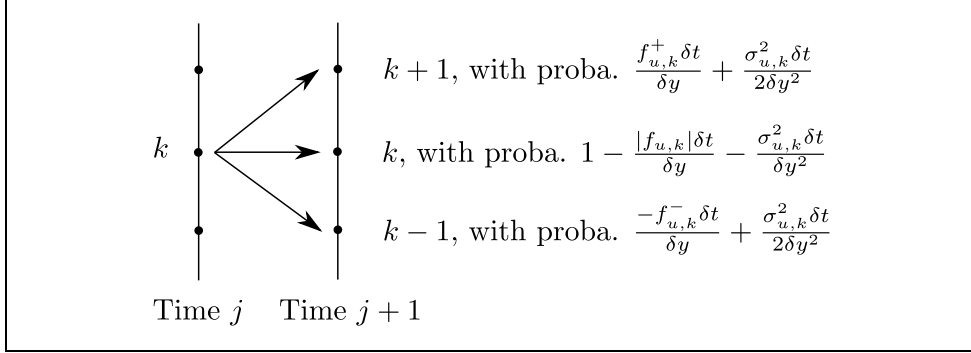

Figure 1.5: Discretization of the state variable in the finite-difference scheme.

- ▷ Even if it is possible to satisfy almost surely the constraint, it may be very expensive. Therefore, it is preferable to allow to break the constraint, but with a probability which is controlled.

We still consider problem (1.82) but with the following constraint:

$$\mathbb{P}[h(Y_T^u) \geq 0] \geq z, \quad (1.108)$$

where $h : \mathbb{R}^n \rightarrow \mathbb{R}$ and $z \in [0, 1]$ are given. Let us introduce the indicatrix function of a subset K of \mathbb{R}^n , denoted $\mathbf{1}_K$ and defined by

$$\mathbf{1}_K : x \in \mathbb{R}^n \mapsto \mathbf{1}_K(x) = \begin{cases} 1 & \text{if } x \in K \\ 0 & \text{otherwise.} \end{cases} \quad (1.109)$$

We set $g(y) = \mathbf{1}_{\mathbb{R}_+}(h(y))$, and thus, the probability constraint can be re-formulated as an expectation constraint:

$$\mathbb{E}[g(Y_T^u)] \geq z. \quad (1.110)$$

From now on, we focus on this formulation of the probability constraint. The following holds true even if g is not of the form $\mathbf{1}_{\mathbb{R}_+} \circ h$.

Let us mention the introduction to chance-constrained stochastic problems [94, 104] and the article [83] on the continuous-time case.

Dynamic programming The following lemma is a first step towards a dynamic programming approach.

Lemma 1.18. *Let $u \in \mathcal{U}$. Then, constraint (1.110) holds if and only if there exists a martingale $(Z_t)_t$ which is such that*

$$Z_0 = z \quad \text{and} \quad Z_T \leq g(Y_T^u), \quad \text{a.s.} \quad (1.111)$$

Proof. If such a martingale exists, then, taking the expectation of the inequality in (1.111), constraint (1.110) holds. Conversely, if (1.110) holds, set

$$Z_t = \mathbb{E}[g(Y_T^u) | \mathcal{F}_t] - (\mathbb{E}[g(Y_T^u)] - z). \quad (1.112)$$

It is easy to check that it is a martingale satisfying (1.111). \square

By the martingale representation theorem, for all martingale, there exists a square-integrable process which is such that

$$dZ_t = \alpha_t dW_t. \quad (1.113)$$

This process can be seen as a new control and Z as a new state variable. We denote by \mathcal{A} the space of adapted square-integrable processes. For all $t \in [0, T]$, $y \in \mathbb{R}^n$, $z \in \mathbb{R}$, and $\alpha \in \mathcal{A}$, we denote by $(Z_t^{s,z,\alpha})_{t \in [s,T]}$ the solution to

$$\begin{cases} dZ_t = \alpha_t dW_t, \\ Z_s = z, \end{cases} \quad (1.114)$$

and we introduce the value function $V(t, y, z)$ defined by

$$V(t, y, z) = \underset{u \in \mathcal{U}, \alpha \in \mathcal{A}}{\text{Min}} \mathbb{E}[\phi(Y_T^{t,y,u})] \text{ s.t. } Z_T^{t,z,\alpha} \leq g(Y_T^{t,y,u}), \text{ a.s.} \quad (1.115)$$

Note that at the final time,

$$V(T, y, z) = \begin{cases} \phi(y) & \text{if } z \leq g(y), \\ +\infty & \text{otherwise.} \end{cases} \quad (1.116)$$

We can state, at least formally, a dynamic programming principle for this value function: for all t , for all stopping time $\tau \geq t$,

$$V(t, y, z) = \underset{\substack{u \in \mathcal{U}, \\ Z \in \mathcal{Z}_\tau, \\ \mathbb{E}[Z(\tau)] = z}}{\text{Min}} \mathbb{E}[V(\tau, Y_\tau^{t,y,u}, Z(\tau))], \quad (1.117)$$

where \mathcal{Z}_τ is the space of τ -measurable random values.

Let us mention the difficulties that arise with this dynamic programming approach.

- ▷ Given (t, y) , the problem (1.115) may be infeasible for the higher values of z , the value function is therefore equal to $+\infty$. The boundary of the domain of V is *a priori* unknown.
- ▷ The true Hamiltonian associated with (Y, Z) may be unbounded.
- ▷ Finally, there is no direct adaptation of the numerical schemes for the problem.

Lagrangian relaxation This approach is standard [96], let us describe it in an abstract framework, with the following family of problems:

$$V(z) = \underset{x \in X}{\text{Min}} f(x) \text{ s.t. } g(x) \geq z, \quad (1.118)$$

where the space X is given, $f : X \rightarrow \mathbb{R}$ and $g : X \rightarrow \mathbb{R}$ are also given. Of course, problem (1.115) enters into this framework. Let $\lambda \geq 0$, we define the dualized problem as follows:

$$W(\lambda) = \underset{x}{\text{Min}} f(x) - \lambda g(x). \quad (1.119)$$

Observe that V and W are both decreasing. In the following lemma, we consider that the existence of optimal solutions to problems (1.118) and (1.119) is ensured for all $z \in \mathbb{R}$ and for all $\lambda \geq 0$. We denote by $x(\lambda)$ the solution to (1.119), for a given value of λ .

Lemma 1.19. *Let $\lambda \geq 0$. Then, $x(\lambda)$ is a solution to (1.118), with $z = g(x(\lambda))$. Moreover, the mapping $\lambda \in \mathbb{R}_+ \mapsto g(x(\lambda))$ is nondecreasing.*

Proof. Let $\lambda \geq 0$ and let x be such that $g(x) \geq g(x(\lambda))$. Then,

$$f(x) \geq f(x(\lambda)) + \lambda(g(x) - g(x(\lambda))) \geq f(x(\lambda)), \quad (1.120)$$

which proves the first part of the lemma. Let $0 \leq \lambda_1 < \lambda_2$, let $x_1 = x(\lambda_1)$ and $x_2 = x(\lambda_2)$, then

$$f(x_1) - \lambda_1 g(x_1) \leq f(x_2) - \lambda_1 g(x_2), \quad (1.121)$$

$$f(x_2) - \lambda_2 g(x_2) \leq f(x_1) - \lambda_2 g(x_1), \quad (1.122)$$

and summing these two inequalities, we obtain that

$$(\lambda_2 - \lambda_1)g(x_1) \leq (\lambda_2 - \lambda_1)g(x_2), \quad (1.123)$$

which concludes the lemma. \square

Suppose now that we are able to solve the dual problem, for any value of λ . Then, given a value of z , we can try to solve the primal dual by solving the following equation, with unknown variable λ :

$$g(x(\lambda)) = z, \quad (1.124)$$

by dichotomy. This approach may be efficient, but may also fail because the function $\lambda \mapsto g(x(\lambda))$ is not necessarily continuous and may have jumps. This situation typically arises for nonconvex optimization problem.

In the case of chance-constrained stochastic optimal control problems, the dual problem is actually much simpler, since the cost function is of the standard form:

$$\mathbb{E}[\phi(Y_T^u) - \lambda g(Y_T^u)]. \quad (1.125)$$

In general, this problem is not convex and therefore, the method by penalization may fail.

1.2.3 Contribution of the thesis

In Chapter 6, we make a link between methods by dynamic programming and methods by Lagrangian relaxation, via the Legendre-Fenchel transform of the value function, and via a relaxation technique. Similarly to deterministic problems, relaxation consists in using mixed strategies, or in other words, to use several controls simultaneously. This technique is natural in the framework of chance-constrained problems. The new value function which is obtained is convex with respect to z .

We study this link between these two approaches in a discrete-time framework. In continuous time, the convexity of the value function with respect to z is ensured if g is Lipschitz. We use the analysis of the discrete-time case to design numerical methods for the continuous-time case.

The main results are the following:

- ▷ In Proposition 6.11, we prove that in the relaxed framework, the derivative of the value function with respect to z is constant along the optimal trajectories and their associated martingale.
- ▷ In Theorem 6.14, we show that for continuous-time and unrelaxed problems, the value function is convex with respect to z , if the mapping g (used in (1.115)) is Lipschitz.
- ▷ We propose an HJB equation for the problem.
- ▷ We propose different numerical schemes for the solving of the problem and present numerical tests.

1.2.4 Perspectives

Chapter 6 contains many unresolved questions and axes of research. The first one deals with the justification of numerical methods. The issue seems rather difficult for the dynamic programming approach, because of the final-state constraints and because of the unboundedness of the volatility of the martingale. However, the numerical schemes for the Legendre-Fenchel transform are justified if the function g is sufficiently regular, and we hope to give a complete justification by combining general results for the Lagrangian relaxation with convergence results for unconstrained stochastic optimal control problems.

The discretized problems provides a feedback control for the initial continuous-time problem. However, it may be unfeasible for the expectation constraint of the initial problem. A relevant issue deals with the error which is induced by the discretization.

Finally, there is place for improvements of the numerical method. For example, an interesting issue is the update of the dual value λ in the Lagrange relaxation method.

Let us mention some other theoretical issues.

- ▷ Is it possible to prove the convexity of the value function if g is not Lipschitz ? In particular, does this property hold true for probability constraints ?
- ▷ Is it possible to prove that the derivative of the value function with respect to z is constant along optimal trajectories in the continuous case ?
- ▷ Can we prove that the value function is a viscosity solution to the HJB equation that we propose ? Is it possible to state a comparison theorem and to prove the uniqueness of the solution ? How should the boundary of the domain be taken into account in the HJB equation ?

1.3 List of publications

Accepted articles:

- ▷ J. F. Bonnans, L. Pfeiffer, and O. S. Serea. Sensitivity analysis for relaxed optimal control problems with final-state constraints. *Nonlinear Analysis: Theory, Methods & Applications*, 89(0):55 – 80, 2013.

- ▷ K. Barty, J. F. Bonnans, and L. Pfeiffer. Sensitivity analysis for the outages of nuclear power plants. Rapport de recherche RR-7884, INRIA, February 2012. Accepted for publication in *Energy Systems*.
- ▷ J. F. Bonnans, X. Dupuis, and L. Pfeiffer. Second-order sufficient conditions for strong solutions to optimal control problems. Inria Research Report RR-8307, INRIA, May 2013. Accepted for publication in *ESAIM: Control, Optimization, Calculus of Variations*.

Submitted article:

- ▷ J. F. Bonnans, X. Dupuis, and L. Pfeiffer. Second-order necessary conditions in Pontryagin form for optimal control problems. Inria Research Report RR-8306, INRIA, May 2013.

Part I

**Sensitivity analysis in optimal
control**

Chapter 2

Second-order necessary optimality conditions in Pontryagin form

Contents

Bibliography	35
2.1 Introduction	36
2.2 Setting	38
2.2.1 The optimal control problem	38
2.2.2 Definitions and assumptions	39
2.3 First-order conditions in Pontryagin form	42
2.3.1 Pontryagin's minimum principle	42
2.3.2 Partial relaxation	43
2.3.3 Proof of Theorem 2.11	47
2.4 Second-order conditions in Pontryagin form	49
2.4.1 Statement	49
2.4.2 Proof of Theorem 2.31	52
2.A Appendix	56
2.A.1 Abstract optimization results	56
2.A.2 Proof of Proposition 2.18	63
2.A.3 A qualification condition	67
2.A.4 An example about Pontryagin's principle	72

Abstract

In this chapter, we state and prove first- and second-order necessary conditions in Pontryagin form for optimal control problems with pure state and mixed control-state constraints. We say that a Lagrange multiplier of an optimal control problem is a Pontryagin multiplier if it is such that Pontryagin's minimum principle holds, and we call optimality conditions in Pontryagin form those which only involve Pontryagin multipliers. Our conditions rely on a technique of partial relaxation, and apply to Pontryagin local minima.

Résumé

Dans ce chapitre, nous énonçons et prouvons des conditions nécessaires du premier et second ordre sous forme Pontryaguine pour des problèmes de commande optimale avec contraintes pures sur l'état et mixtes sur l'état et la commande. Nous appelons multiplicateur de Pontryaguine tout multiplicateur de Lagrange pour lequel le principe de Pontryaguine est satisfait et parlons de conditions d'optimalité sous forme Pontryaguine si elles ne font intervenir que des multiplicateurs de Pontryaguine. Nos conditions s'appuient sur une technique de relaxation partielle et sont valables pour des minima de Pontryaguine.

2.1 Introduction

The optimization theory in Banach spaces, in particular optimality conditions of order one [60, 74] and two [26, 47, 53], applies to optimal control problems. With this approach, constraints of various kind can be considered, and optimality conditions are derived for weak local minima of optimal control problems. Second-order necessary and sufficient conditions are thereby obtained by Stefani and Zezza [64] in the case of mixed control-state equality constraints, or by Bonnans and Hermant [17] in the case of pure state and mixed control-state constraints. These optimality conditions always involve Lagrange multipliers.

Another class of optimality conditions, necessary and of order one, for optimal control problems comes from Pontryagin's minimum principle. Formulated in the historical book [58] for basic problems, including first-order pure state constraints, this principle has then been extended by many authors. Mixed control-state constraints enter for example the framework developed by Hestenes [43], whereas pure state, and later pure state and mixed control-state, constraints are treated in early Russian references such as the works of Milyutin and Dubovitskii [31, 32], as highlighted by Dmitruk [27]. Let us mention the survey by Hartl et al. [40] and its bibliography for more references on Pontryagin's principles.

Second-order optimality conditions are said in this article to be in Pontryagin form if they only involve Lagrange multipliers for which Pontryagin's minimum principle holds. This restriction to a subset of multipliers is a challenge for necessary conditions, and enables sufficient conditions to give strong local minima. To our knowledge, such conditions have been stated for the first time, under the name of quadratic conditions, for

problems with mixed control-state equality constraints by Milyutin and Osmolovskii [55]. Proofs are given by Osmolovskii and Maurer [56], under a restrictive full-rank condition for the mixed equality constraints, that could not for instance be satisfied by pure state constraints.

The main novelty of this paper is to provide second-order necessary conditions in Pontryagin form for optimal control problems with pure state and mixed control-state constraints. We use the same technique as Dmitruk in his derivation of Pontryagin's principle for a general optimal control problem [27]: a partial relaxation of the problem, based on the sliding modes introduced by Gamkrelidze [36]. These convexifications of the set of admissible velocities furnish a sequence of auxiliary optimal control problems, and at the limit, necessary conditions appear to be in Pontryagin form. We thereby get our own version of Pontryagin's minimum principle, as first-order necessary conditions. Then, combining the partial relaxation with a reduction approach [16, 44] and a density argument [13], we obtain second-order necessary conditions in Pontryagin form for a Pontryagin local minimum of our problem. This technique requires to consider a variant of the previous auxiliary problems, but not to compute any envelope-like effect of Kawasaki [47]. Another result that is worth being mentioned is the second-order necessary conditions for a local solution of an abstract optimization problem, that we apply to the partially relaxed problems. We derive them directly on a large set of directions in L^2 , which then simplifies the density argument, compared with [13], and avoid a flaw that we will mention in the proof of the density result in [17].

Second-order sufficient conditions for strong local minima of similar optimal control problems constitute another work by the same authors [15]. They rely on an extension of the decomposition principle of Bonnans and Osmolovskii [18], and on the reduction approach. Quadratic growth for a strong local minimum is then characterized.

The paper is organized as follows. In Section 2.2, we set our optimal control problem and define various notions of multipliers and of minima. Section 2.3 is devoted to the first-order necessary conditions: they are stated, under the form of Pontryagin's minimum principle, in Section 2.3.1; our partial relaxation approach is detailed in Section 2.3.2, and then used to prove the first-order conditions in Section 2.3.3. Section 2.4 is devoted to the second-order necessary conditions: they are stated in Section 2.4.1, and proved in Section 2.4.2 by partial relaxation combined with reduction and density. We have postponed our abstract optimization results to Appendix 2.A.1, the proof of an approximation result needed for the partial relaxation to Appendix 2.A.2, a qualification condition to Appendix 2.A.3, and an example about Pontryagin's principle to Appendix 2.A.4.

Notations For a function h that depends only on time t , we denote by h_t its value at time t , by $h_{i,t}$ the value of its i th component if h is vector-valued, and by \dot{h} its derivative. For a function h that depends on (t, x) , we denote by $D_t h$ and $D_x h$ its partial derivatives. We use the symbol D without any subscript for the differentiation w.r.t. all variables except t , e.g. $Dh = D_{(u,y)} h$ for a function h that depends on (t, u, y) . We use the same convention for higher order derivatives.

We identify the dual space of \mathbb{R}^n with the space \mathbb{R}^{n*} of n -dimensional horizontal

vectors. Generally, we denote by X^* the dual space of a topological vector space X . Given a convex subset K of X and a point x of K , we denote by $T_K(x)$ and $N_K(x)$ the tangent and normal cone to K at x , respectively; see [21, Section 2.2.4] for their definition.

We denote by $|\cdot|$ both the Euclidean norm on finite-dimensional vector spaces and the cardinal of finite sets, and by $\|\cdot\|_s$ and $\|\cdot\|_{q,s}$ the standard norms on the Lebesgue spaces L^s and the Sobolev spaces $W^{q,s}$, respectively.

We denote by $BV([0, T])$ the space of functions of bounded variation on the closed interval $[0, T]$. Any $h \in BV([0, T])$ has a derivative dh which is a finite Radon measure on $[0, T]$ and h_0 (resp. h_T) is defined by $h_0 := h_{0+} - dh(0)$ (resp. $h_T := h_{T-} + dh(T)$). Thus $BV([0, T])$ is endowed with the following norm: $\|h\|_{BV} := \|dh\|_{\mathcal{M}} + |h_T|$. See [4, Section 3.2] for a rigorous presentation of BV .

All vector-valued inequalities have to be understood coordinate-wise.

2.2 Setting

2.2.1 The optimal control problem

Consider the *state equation*

$$\dot{y}_t = f(t, u_t, y_t) \quad \text{for a.a. } t \in (0, T). \quad (2.1)$$

Here, u is a *control* which belongs to \mathcal{U} , y is a *state* which belongs to \mathcal{Y} , where

$$\mathcal{U} := L^\infty(0, T; \mathbb{R}^m), \quad \mathcal{Y} := W^{1,\infty}(0, T; \mathbb{R}^n), \quad (2.2)$$

and $f: [0, T] \times \mathbb{R}^m \times \mathbb{R}^n \rightarrow \mathbb{R}^n$ is the *dynamics*. Consider constraints of various types on the system: the *mixed control-state constraints*, or mixed constraints

$$c(t, u_t, y_t) \leq 0 \quad \text{for a.a. } t \in (0, T), \quad (2.3)$$

the *pure state constraints*, or state constraints

$$g(t, y_t) \leq 0 \quad \text{for a.a. } t \in (0, T), \quad (2.4)$$

and the *initial-final state constraints*

$$\begin{cases} \Phi^E(y_0, y_T) = 0, \\ \Phi^I(y_0, y_T) \leq 0. \end{cases} \quad (2.5)$$

Here $c: [0, T] \times \mathbb{R}^m \times \mathbb{R}^n \rightarrow \mathbb{R}^{n_c}$, $g: [0, T] \times \mathbb{R}^n \rightarrow \mathbb{R}^{n_g}$, $\Phi^E: \mathbb{R}^n \times \mathbb{R}^n \rightarrow \mathbb{R}^{n_{\Phi^E}}$, $\Phi^I: \mathbb{R}^n \times \mathbb{R}^n \rightarrow \mathbb{R}^{n_{\Phi^I}}$. Consider finally the *cost function* $\phi: \mathbb{R}^n \times \mathbb{R}^n \rightarrow \mathbb{R}$. The *optimal control problem* is then

$$\min_{(u,y) \in \mathcal{U} \times \mathcal{Y}} \phi(y_0, y_T) \quad \text{subject to} \quad (2.1)-(2.5). \quad (P)$$

2.2.2 Definitions and assumptions

Similarly to [64, Definition 2.1], we introduce the following Carathéodory-type regularity notion:

Definition 2.1. *We say that $\varphi: [0, T] \times \mathbb{R}^m \times \mathbb{R}^n \rightarrow \mathbb{R}^s$ is uniformly quasi- C^k iff*

(i) *for a.a. t , $(u, y) \mapsto \varphi(t, u, y)$ is of class C^k , and the modulus of continuity of $(u, y) \mapsto D^k \varphi(t, u, y)$ on any compact of $\mathbb{R}^m \times \mathbb{R}^n$ is uniform w.r.t. t .*

(ii) *for $j = 0, \dots, k$, for all (u, y) , $t \mapsto D^j \varphi(t, u, y)$ is essentially bounded.*

Remark 2.2. *If φ is uniformly quasi- C^k , then $D^j \varphi$ for $j = 0, \dots, k$ are essentially bounded on any compact, and $(u, y) \mapsto D^j \varphi(t, u, y)$ for $j = 0, \dots, k - 1$ are locally Lipschitz, uniformly w.r.t. t . In particular, if f is uniformly quasi- C^1 , then by Cauchy-Lipschitz theorem, for any $(u, y^0) \in \mathcal{U} \times \mathbb{R}^n$, there exists a unique $y \in \mathcal{Y}$ such that (2.1) holds and $y_0 = y^0$; we denote it by $y[u, y^0]$.*

The minimal regularity assumption through all the paper is the following:

Assumption 2.1. *The mappings f , c and g are uniformly quasi- C^1 , g is continuous, Φ^E , Φ^I and ϕ are C^1 .*

We call a *trajectory* any pair $(u, y) \in \mathcal{U} \times \mathcal{Y}$ such that (2.1) holds. We say that a trajectory is *feasible* for problem (P) if it satisfies constraints (2.3)-(2.5), and denote by $F(P)$ the set of feasible trajectories. We define the *Hamiltonian* and the *augmented Hamiltonian* respectively by

$$H[p](t, u, y) := pf(t, u, y), \quad H^a[p, \nu](t, u, y) := pf(t, u, y) + \nu c(t, u, y), \quad (2.6)$$

for $(p, \nu, t, u, y) \in \mathbb{R}^{n^*} \times \mathbb{R}^{n_{c^*}} \times [0, T] \times \mathbb{R}^m \times \mathbb{R}^n$. We define the *end points Lagrangian* by

$$\Phi[\beta, \Psi](y_0, y_T) := \beta \phi(y_0, y_T) + \Psi \Phi(y_0, y_T), \quad (2.7)$$

for $(\beta, \Psi, y_0, y_T) \in \mathbb{R} \times \mathbb{R}^{n_{\Phi^*}} \times \mathbb{R}^n \times \mathbb{R}^n$, where $n_{\Phi} = n_{\Phi^E} + n_{\Phi^I}$ and $\Phi = \begin{pmatrix} \Phi^E \\ \Phi^I \end{pmatrix}$.

We denote

$$K_c := L^\infty(0, T; \mathbb{R}_-^{n_c}), \quad K_g := C([0, T]; \mathbb{R}_-^{n_g}), \quad K_{\Phi} := \{0\}_{\mathbb{R}^{n_{\Phi^E}}} \times \mathbb{R}_-^{n_{\Phi^I}}, \quad (2.8)$$

so that the constraints (2.3)-(2.5) can be rewritten as

$$c(\cdot, u, y) \in K_c, \quad g(\cdot, y) \in K_g, \quad \Phi(y_0, y_T) \in K_{\Phi}. \quad (2.9)$$

Recall that the dual space of $C([0, T]; \mathbb{R}^{n_g})$ is the space $\mathcal{M}([0, T]; \mathbb{R}^{n_{g^*}})$ of finite vector-valued Radon measures. We denote by $\mathcal{M}([0, T]; \mathbb{R}^{n_{g^*}})_+$ the cone of positive measures in this dual space. Let

$$E := \mathbb{R} \times \mathbb{R}^{n_{\Phi^*}} \times L^\infty(0, T; \mathbb{R}^{n_{c^*}}) \times \mathcal{M}([0, T]; \mathbb{R}^{n_{g^*}}) \quad (2.10)$$

and let $\|\cdot\|_E$ be defined, for any $\lambda = (\beta, \Psi, \nu, \mu) \in E$, by

$$\|\lambda\|_E := |\beta| + |\Psi| + \|\nu\|_1 + \|\mu\|_{\mathcal{M}}. \quad (2.11)$$

Let $(\bar{u}, \bar{y}) \in F(P)$. Let N_{K_c} be the set of elements in the normal cone to K_c at $c(\cdot, \bar{u}, \bar{y})$ that belong to $L^\infty(0, T; \mathbb{R}^{n_{c^*}})$, i.e.

$$N_{K_c}(c(\cdot, \bar{u}, \bar{y})) := \left\{ \nu \in L^\infty(0, T; \mathbb{R}_+^{n_{c^*}}) : \nu_t c(t, \bar{u}_t, \bar{y}_t) = 0 \text{ for a.a. } t \right\}. \quad (2.12)$$

Let N_{K_g} be the normal cone to K_g at $g(\cdot, \bar{y})$, i.e.

$$N_{K_g}(g(\cdot, \bar{y})) := \left\{ \mu \in \mathcal{M}([0, T]; \mathbb{R}^{n_{g^*}})_+ : \int_{[0, T]} (d\mu_t g(t, \bar{y}_t)) = 0 \right\}. \quad (2.13)$$

Let N_{K_Φ} be the normal cone to K_Φ at $\Phi(\bar{y}_0, \bar{y}_T)$, i.e.

$$N_{K_\Phi}(\Phi(\bar{y}_0, \bar{y}_T)) := \left\{ \Psi \in \mathbb{R}^{n_{\Phi^*}} : \begin{array}{l} \Psi_i \geq 0 \\ \Psi_i \Phi_i(\bar{y}_0, \bar{y}_T) = 0 \end{array} \text{ for } n_{\Phi^*} < i \leq n_\Phi \right\}. \quad (2.14)$$

Finally, let

$$N(\bar{u}, \bar{y}) := \mathbb{R}_+ \times N_{K_\Phi}(\Phi(\bar{y}_0, \bar{y}_T)) \times N_{K_c}(c(\cdot, \bar{u}, \bar{y})) \times N_{K_g}(g(\cdot, \bar{y})) \subset E. \quad (2.15)$$

We denote

$$\mathcal{P} := BV([0, T]; \mathbb{R}^{n^*}). \quad (2.16)$$

Given $(\bar{u}, \bar{y}) \in F(P)$ and $\lambda = (\beta, \Psi, \nu, \mu) \in E$, we consider the *costate equation* in \mathcal{P}

$$\begin{cases} -dp_t = D_y H^a[p_t, \nu_t](t, \bar{u}_t, \bar{y}_t) dt + d\mu_t Dg(t, \bar{y}_t), \\ p_T = D_{y_T} \Phi[\beta, \Psi](\bar{y}_0, \bar{y}_T). \end{cases} \quad (2.17)$$

Lemma 2.3. *Let $(\bar{u}, \bar{y}) \in F(P)$. For any $\lambda \in E$, there exists a unique solution of the costate equation (2.17), that we denote by p^λ . The mapping*

$$\lambda \in E \mapsto p^\lambda \in \mathcal{P} \quad (2.18)$$

is linear continuous.

Proof. We first get the existence, uniqueness and the continuity of

$$\lambda \mapsto p^\lambda \in L^1(0, T; \mathbb{R}^{n^*}) \quad (2.19)$$

by a contraction argument. Then the continuity of

$$\lambda \mapsto (dp, p_T) \in \mathcal{M}([0, T]; \mathbb{R}^{n^*}) \times \mathbb{R}^{n^*} \quad (2.20)$$

follows by (2.17). □

Definition 2.4. Let $(\bar{u}, \bar{y}) \in F(P)$ and $\lambda = (\beta, \Psi, \nu, \mu) \in E$. We say that the solution of the costate equation (2.17) $p^\lambda \in \mathcal{P}$ is an associated costate iff

$$-p_0^\lambda = D_{y_0} \Phi[\beta, \Psi](\bar{y}_0, \bar{y}_T). \quad (2.21)$$

Let $N_\pi(\bar{u}, \bar{y})$ be the set of nonzero $\lambda \in N(\bar{u}, \bar{y})$ having an associated costate.

Let $(\bar{u}, \bar{y}) \in F(P)$. We define the set-valued mapping $U: [0, T] \rightrightarrows \mathbb{R}^m$ by

$$U(t) := \text{cl} \{u \in \mathbb{R}^m : c(t, u, \bar{y}_t) < 0\} \quad \text{for a.a. } t, \quad (2.22)$$

where cl denotes the closure in \mathbb{R}^m .

Definition 2.5. Let $(\bar{u}, \bar{y}) \in F(P)$. We say that the inward condition for the mixed constraints holds iff there exist $\gamma > 0$ and $\bar{v} \in \mathcal{U}$ such that

$$c(t, \bar{u}_t, \bar{y}_t) + D_u c(t, \bar{u}_t, \bar{y}_t) \bar{v}_t \leq -\gamma, \quad \text{for a.a. } t. \quad (2.23)$$

Remark 2.6. If the inward condition holds, then there exists $\delta > 0$ such that, for a.a. t ,

$$B_\delta(\bar{u}_t) \cap U(t) = B_\delta(\bar{u}_t) \cap \{u \in \mathbb{R}^m : c(t, u, \bar{y}_t) \leq 0\}, \quad (2.24)$$

where $B_\delta(\bar{u}_t)$ is the open ball in \mathbb{R}^m of center \bar{u}_t and radius δ . In particular, $\bar{u}_t \in U(t)$ for a.a. t .

In the sequel, we will always make the following assumption:

Assumption 2.2. The inward condition for the mixed constraints holds.

We can now define the notions of multipliers that we will consider. Recall that $N_\pi(\bar{u}, \bar{y})$ has been introduced in Definition 2.4.

Definition 2.7. Let $(\bar{u}, \bar{y}) \in F(P)$.

(i) We say that $\lambda \in N_\pi(\bar{u}, \bar{y})$ is a generalized Lagrange multiplier iff

$$D_u H^\alpha[p_t^\lambda, \nu_t](t, \bar{u}_t, \bar{y}_t) = 0 \quad \text{for a.a. } t. \quad (2.25)$$

We denote by $\Lambda_L(\bar{u}, \bar{y})$ the set of generalized Lagrange multipliers.

(ii) We say that $\lambda \in \Lambda_L(\bar{u}, \bar{y})$ is a generalized Pontryagin multiplier iff

$$H[p_t^\lambda](t, \bar{u}_t, \bar{y}_t) \leq H[p_t^\lambda](t, u, \bar{y}_t) \quad \text{for all } u \in U(t), \quad \text{for a.a. } t. \quad (2.26)$$

We denote by $\Lambda_P(\bar{u}, \bar{y})$ the set of generalized Pontryagin multipliers.

(iii) We say that $\lambda \in \Lambda_P(\bar{u}, \bar{y})$ is a degenerate Pontryagin equality multiplier iff $\lambda = (\beta, \Psi, \nu, \mu)$ with $\Psi = (\Psi^E, \Psi^I)$ is such that $(\beta, \Psi^I, \nu, \mu) = 0$ and if equality holds in (2.26). We denote by $\Lambda_P^D(\bar{u}, \bar{y})$ the set of such multipliers.

- Remark 2.8.** 1. The sets $\Lambda_L(\bar{u}, \bar{y})$, $\Lambda_P(\bar{u}, \bar{y})$ and $\Lambda_P^D(\bar{u}, \bar{y})$ are positive cones of non-zero elements, possibly empty, and $\Lambda_P^D(\bar{u}, \bar{y})$ is symmetric.
2. Assumption 2.2 will be needed to get that the component ν of a multiplier, associated with the mixed constraints, belongs to $L^\infty(0, T; \mathbb{R}^{n_{c^*}})$ and not only to $L^\infty(0, T; \mathbb{R}^{n_c})^*$. See [18, Theorem 3.1] and Theorem 2.47 in Appendix 2.A.1.
3. Let $\lambda \in \Lambda_P(\bar{u}, \bar{y})$. If Assumption 2.2 holds, then by Remark 2.6, \bar{u}_t is a local solution of the finite dimensional optimization problem

$$\min_{u \in \mathbb{R}^m} H[p_t^\lambda](t, u, \bar{y}_t) \quad \text{subject to} \quad c(t, u, \bar{y}_t) \leq 0, \quad (2.27)$$

and ν_t is an associated Lagrange multiplier, for a.a. t .

4. See Appendix 2.A.4 for an example where there exists a multiplier such that (2.26) holds for all $u \in U(t)$, but not for all controls in $\{u \in \mathbb{R}^m : c(t, u, \bar{y}_t) \leq 0\}$.

We finish this section with various notions of minima, following [55].

Definition 2.9. We say that $(\bar{u}, \bar{y}) \in F(P)$ is a global minimum iff

$$\phi(\bar{y}_0, \bar{y}_T) \leq \phi(y_0, y_T) \quad \text{for all } (u, y) \in F(P), \quad (2.28)$$

a Pontryagin minimum iff for any $R > \|\bar{u}\|_\infty$, there exists $\varepsilon > 0$ such that

$$\begin{aligned} \phi(\bar{y}_0, \bar{y}_T) \leq \phi(y_0, y_T) \quad \text{for all } (u, y) \in F(P) \text{ such that} \\ \|u - \bar{u}\|_1 + \|y - \bar{y}\|_\infty \leq \varepsilon \text{ and } \|u\|_\infty \leq R, \end{aligned} \quad (2.29)$$

a weak minimum iff there exists $\varepsilon > 0$ such that

$$\begin{aligned} \phi(\bar{y}_0, \bar{y}_T) \leq \phi(y_0, y_T) \quad \text{for all } (u, y) \in F(P) \text{ such that} \\ \|u - \bar{u}\|_\infty + \|y - \bar{y}\|_\infty \leq \varepsilon. \end{aligned} \quad (2.30)$$

Remark 2.10. Obviously, (2.28) \Rightarrow (2.29) \Rightarrow (2.30). Conversely, if (\bar{u}, \bar{y}) is a weak minimum for problem (P), then it is a Pontryagin minimum for the problem obtained by adding the control constraint $|u_t - \bar{u}_t| \leq \varepsilon$, and a global minimum for the problem obtained by adding the same control constraint and the state constraint $|y_t - \bar{y}_t| \leq \varepsilon$.

2.3 First-order conditions in Pontryagin form

2.3.1 Pontryagin's minimum principle

First-order necessary conditions in Pontryagin form consist in proving the existence of Pontryagin multipliers. See Definitions 2.7 and 2.9 for the notions of multipliers and of minima. Our version of the well-known *Pontryagin's principle* follows, and is proved in Section 2.3.3. See [27] for a variant with the same approach, and [40] for a survey of this principle.

Theorem 2.11. *Let (\bar{u}, \bar{y}) be a Pontryagin minimum for problem (P) and let Assumptions 2.1-2.2 hold. Then the set of generalized Pontryagin multipliers $\Lambda_P(\bar{u}, \bar{y})$ is nonempty.*

By Remark 2.10, we get the following:

Corollary 2.12. *Let (\bar{u}, \bar{y}) be a weak minimum for problem (P) and let Assumptions 2.1-2.2 hold. Then there exist $\varepsilon > 0$ and $\lambda \in \Lambda_L(\bar{u}, \bar{y})$ such that*

$$\begin{cases} \text{for a.a. } t, \text{ for all } u \in U(t) \text{ such that } |u - \bar{u}_t| \leq \varepsilon, \\ H[p_t^\lambda](t, \bar{u}_t, \bar{y}_t) \leq H[p_t^\lambda](t, u, \bar{y}_t). \end{cases} \quad (2.31)$$

Proof. The extra control constraint $|u - \bar{u}_t| \leq \varepsilon$ for a.a. t is never active, therefore the set of Lagrange multipliers is unchanged. The set of Pontryagin multipliers is the set of Lagrange multipliers for which (2.31) holds. \square

The proof of Theorem 2.11, given in Section 2.3.3, relies on first-order necessary conditions for a family of weak minima for auxiliary optimal control problems, namely the *partially relaxed problems*, presented in Section 2.3.2. These problems are defined using a *Castaing representation* of the set-valued mapping U , introduced at the beginning of Section 2.3.2. Second order necessary conditions in Pontryagin form in Section 2.4.1 will be derived from a variant of the partially relaxed problems, the reduced partially relaxed problems. Thus Section 2.3.2 is central. First and second order necessary conditions for a weak minimum are recalled, with some original results, in Appendix 2.A.1.

2.3.2 Partial relaxation

In this section, (\bar{u}, \bar{y}) is a given Pontryagin minimum for problem (P) , and Assumptions 2.1-2.2 hold.

2.3.2.1 Castaing representation

See [23, 25, 62] for a general presentation of set-valued mappings and measurable selection theorems.

Definition 2.13. *Let $V : [0, T] \rightrightarrows \mathbb{R}^m$ be a set-valued mapping. We say that a sequence $(v^k)_{k \in \mathbb{N}}$, $v^k \in U$, is a Castaing representation of V iff $\{v_t^k\}_{k \in \mathbb{N}}$ is a dense subset of $V(t)$ for a.a. t .*

Lemma 2.14. *There exists a Castaing representation $(u^k)_{k \in \mathbb{N}}$ of the set-valued mapping U defined by (2.22), and for all k , there exists $\gamma_k > 0$ such that*

$$c(t, u_t^k, \bar{y}_t) \leq -\gamma_k \quad \text{for a.a. } t. \quad (2.32)$$

Proof. For $l \in \mathbb{N}$, $l \geq 1$, we consider the set-valued mapping U_l defined by

$$U_l(t) := \left\{ u \in \mathbb{R}^n : c(t, u, \bar{y}_t) \leq -\frac{1}{l} \right\} \quad \text{for a.a. } t, \quad (2.33)$$

so that

$$U(t) = \text{cl}(\cup_{l \geq 1} U_l(t)) \quad \text{for a.a. } t. \quad (2.34)$$

Under Assumptions 2.1-2.2, by [23, Théorème 3.5] and for l large enough, U_l is a measurable with nonempty closed set-valued mapping. Then by [23, Théorème 5.4], it has a Castaing representation. By (2.34), the union of such Castaing representations for l large enough is a Castaing representation of U . \square

We define the following sequence of sets of generalized Lagrange multipliers: for $N \in \mathbb{N}$, let

$$\Lambda^N(\bar{u}, \bar{y}) := \left\{ \lambda \in \Lambda_L(\bar{u}, \bar{y}) : \begin{array}{l} H[p_t^\lambda](t, \bar{u}_t, \bar{y}_t) \leq H[p_t^\lambda](t, u_t^k, \bar{y}_t) \\ \text{for all } k \leq N, \text{ for a.a. } t \end{array} \right\}. \quad (2.35)$$

Observe that

$$\Lambda_P(\bar{u}, \bar{y}) \subset \Lambda^{N+1}(\bar{u}, \bar{y}) \subset \Lambda^N(\bar{u}, \bar{y}) \subset \Lambda_L(\bar{u}, \bar{y}), \quad (2.36)$$

and by density of the Castaing representation,

$$\Lambda_P(\bar{u}, \bar{y}) = \bigcap_{N \in \mathbb{N}} \Lambda^N(\bar{u}, \bar{y}). \quad (2.37)$$

Recall that E and $\|\cdot\|_E$ have been defined by (2.10) and (2.11).

Lemma 2.15. *Let $(\lambda^N)_{N \in \mathbb{N}}$ be a sequence in $\Lambda_L(\bar{u}, \bar{y})$ such that $\|\lambda^N\|_E = 1$ and $\lambda^N \in \Lambda^N(\bar{u}, \bar{y})$ for all N . Then the sequence has at least one nonzero weak $*$ limit point that belongs to $\Lambda_P(\bar{u}, \bar{y})$.*

Proof. By Assumption 2.2 and [18, Theorem 3.1], the sequence is bounded in E for the usual norm, i.e. with $\|\nu\|_\infty$ instead of $\|\nu\|_1$. Then there exists $\bar{\lambda}$ such that, extracting a subsequence if necessary, $\lambda^N \rightharpoonup \bar{\lambda}$ for the weak $*$ topology. Since $N(\bar{u}, \bar{y})$ is weakly $*$ closed, $\bar{\lambda} \in N(\bar{u}, \bar{y})$. Observe now that if $\lambda \in N(\bar{u}, \bar{y})$, then

$$\|\lambda\|_E = \beta + |\Psi| + \langle \nu, 1 \rangle_1 + \langle \mu, 1 \rangle_C \quad (2.38)$$

where $\langle \cdot, \cdot \rangle_1$ and $\langle \cdot, \cdot \rangle_C$ are the dual products in $L^1(0, T; \mathbb{R}^{n_c})$ and $C([0, T]; \mathbb{R}^{n_g})$, respectively, and the 1 are constant functions of appropriate size. Then $\|\bar{\lambda}\| = 1$ and $\bar{\lambda} \neq 0$. Let $p^N := p^{\lambda^N}$, $N \in \mathbb{N}$, and $\bar{p} := p^{\bar{\lambda}}$. By Lemma 2.3, $dp^N \rightharpoonup d\bar{p}$ for the weak $*$ topology in $\mathcal{M}([0, T]; \mathbb{R}^{n_*})$ and $p_T^N \rightarrow \bar{p}_T$. Since

$$p_0 = p_T - \langle dp, 1 \rangle_C \quad (2.39)$$

for any $p \in \mathcal{P}$, we derive that $\bar{p}_0 = D_{y_0} \Phi[\bar{\beta}, \bar{\Psi}](\bar{y}_0, \bar{y}_T)$. Then \bar{p} is an associated costate, i.e. $\bar{\lambda} \in N_\pi(\bar{u}, \bar{y})$. Next, as a consequence of Lemma 2.3, $p^N \rightharpoonup \bar{p}$ for the weak $*$ topology in L^∞ . Then $D_u H^a[p^N, \nu^N](\cdot, \bar{u}, \bar{y}) \rightharpoonup D_u H^a[\bar{p}, \bar{\nu}](\cdot, \bar{u}, \bar{y})$ for the weak $*$ topology in L^∞ , and then

$$D_u H^a[\bar{p}_t, \bar{\nu}_t](t, \bar{u}_t, \bar{y}_t) = 0, \text{ for a.a. } t, \quad (2.40)$$

i.e. $\bar{\lambda} \in \Lambda_L(\bar{u}, \bar{y})$. Similarly, for all $k \in \mathbb{N}$,

$$H[p^N](\cdot, u^k, \bar{y}) - H[p^N](\cdot, \bar{u}, \bar{y}) \rightharpoonup H[\bar{p}](\cdot, u^k, \bar{y}) - H[\bar{p}](\cdot, \bar{u}, \bar{y}) \quad (2.41)$$

for the weak $*$ topology in L^∞ , and then

$$H[\bar{p}_t](t, u_t^k, \bar{y}_t) - H[\bar{p}_t](t, \bar{u}_t, \bar{y}_t) \geq 0 \quad \text{for a.a. } t, \quad (2.42)$$

i.e. $\bar{\lambda} \in \Lambda^k(\bar{u}, \bar{y})$, for all $k \in \mathbb{N}$. By (2.37), $\bar{\lambda} \in \Lambda_P(\bar{u}, \bar{y})$. \square

Since $\Lambda^N(\bar{u}, \bar{y})$, $N \in \mathbb{N}$, are cones of nonzero elements (see Remark 2.8), it is enough to show that they are nonempty for all N to prove Theorem 2.11, by Lemma 2.15. This is the purpose of the *partially relaxed problems*, presented in the next section. Indeed, we will see that they are such that their Lagrange multipliers, whose existence can easily be guaranteed, belong to $\Lambda^N(\bar{u}, \bar{y})$.

2.3.2.2 The partially relaxed problems

As motivated above, we introduce now a sequence of optimal control problems.

Formulation Recall that (\bar{u}, \bar{y}) is given as a Pontryagin minimum for problem (P) has been given.

Let $N \in \mathbb{N}$. Consider the *partially relaxed state equation*

$$\dot{y}_t = \left(1 - \sum_{i=1}^N \alpha_t^i\right) f(t, u_t, y_t) + \sum_{i=1}^N \alpha_t^i f(t, u_t^i, y_t) \quad \text{for a.a. } t \in (0, T). \quad (2.43)$$

The u^i are elements of the Castaing representation given by Lemma 2.14. The controls are u and α , the state is y , with

$$u \in \mathcal{U}, \quad \alpha \in \mathcal{A}^N := L^\infty(0, T; \mathbb{R}^N), \quad y \in \mathcal{Y}. \quad (2.44)$$

The idea is to consider the problem of minimizing $\phi(y_0, y_T)$ under the same constraints as before, plus the control constraints $\alpha \geq 0$. To simplify the qualification issue, we actually introduce a *slack variable* $\theta \in \mathbb{R}$, with the intention to minimize it, and the following constraint on the cost function:

$$\phi(y_0, y_T) - \phi(\bar{y}_0, \bar{y}_T) \leq \theta. \quad (2.45)$$

The slack variable θ also enters into every inequality constraint:

$$-\alpha_t \leq \theta \quad \text{for a.a. } t \in (0, T), \quad (2.46)$$

$$c(t, u_t, y_t) \leq \theta \quad \text{for a.a. } t \in (0, T), \quad (2.47)$$

$$g(t, y_t) \leq \theta \quad \text{for a.a. } t \in (0, T), \quad (2.48)$$

$$\Phi^J(y_0, y_T) \leq \theta \quad (2.49)$$

and the equality constraints remain unchanged:

$$\Phi^E(y_0, y_T) = 0. \quad (2.50)$$

The *partially relaxed problem* is

$$\min_{(u, \alpha, y, \theta) \in \mathcal{U} \times \mathcal{A}^N \times \mathcal{Y} \times \mathbb{R}} \theta \quad \text{subject to} \quad (2.43)-(2.50). \quad (P_N)$$

Let $\bar{\alpha} := 0 \in \mathcal{A}^N$ and $\bar{\theta} := 0 \in \mathbb{R}$. As for problem (P) , we call a *relaxed trajectory* any (u, α, y, θ) such that (2.43) holds. We say that a relaxed trajectory is feasible if it satisfies constraints (2.45)-(2.50), and denote by $F(P_N)$ the set of feasible relaxed trajectories.

Under Assumption 2.1, for any $(u, \alpha, y^0) \in \mathcal{U} \times \mathcal{A}^N \times \mathbb{R}^n$, there exists a unique $y \in \mathcal{Y}$ such that (2.43) holds and $y_0 = y^0$; we denote it by $y[u, \alpha, y^0]$ and consider the mapping

$$\Gamma_N: (u, \alpha, y^0) \mapsto y[u, \alpha, y^0]. \quad (2.51)$$

Remark 2.16. 1. We have $(\bar{u}, \bar{\alpha}, \bar{y}, \bar{\theta}) \in F(P_N)$.

2. Robinson's constraint qualification holds at $(\bar{u}, \bar{\alpha}, \bar{y}, \bar{\theta})$ iff the equality constraints are qualified, i.e. iff the derivative of

$$(u, \alpha, y^0) \in \mathcal{U} \times \mathcal{A}^N \times \mathbb{R}^n \mapsto \Phi^E(y^0, \Gamma_N(u, \alpha, y^0)_T) \in \mathbb{R}^{n_{\Phi^E}} \quad (2.52)$$

at $(\bar{u}, \bar{\alpha}, \bar{y}_0)$ is onto. We say that problem (P_N) is qualified at $(\bar{u}, \bar{\alpha}, \bar{y}, \bar{\theta})$ if this is the case. See [21, Section 2.3.4] for the definition and characterizations of Robinson's constraint qualification.

Existence of a minimum A key result is the following:

Theorem 2.17. *Let Assumptions 2.1-2.2 hold and let problem (P_N) be qualified at $(\bar{u}, \bar{\alpha}, \bar{y}, \bar{\theta})$. Then $(\bar{u}, \bar{\alpha}, \bar{y}, \bar{\theta})$ is a weak minimum for this problem.*

Theorem 2.17 is a corollary of the following proposition, proved in the Appendix 2.A.2 for the sake of self-containment of the paper. It can also be deduced from other classical relaxation theorems, such as [28, Theorem 3].

Proposition 2.18. *Under the assumptions of Theorem 2.17, there exists $M > 0$ such that, for any $(\hat{u}, \hat{\alpha}, \hat{y}, \hat{\theta}) \in F(P_N)$ in a L^∞ neighborhood of $(\bar{u}, \bar{\alpha}, \bar{y}, \bar{\theta})$ and with $\hat{\theta} < 0$, for any $\varepsilon > 0$, there exists $(\tilde{u}, \tilde{y}) \in F(P)$ such that*

$$\|\tilde{u} - \hat{u}\|_1 \leq M \|\hat{\alpha}\|_\infty \quad \text{and} \quad \|\tilde{y} - \hat{y}\|_\infty \leq \varepsilon. \quad (2.53)$$

Proof of Theorem 2.17. Suppose that $(\bar{u}, \bar{\alpha}, \bar{y}, \bar{\theta})$ is not a weak minimum for problem (P_N) . Then there exists $(\hat{u}, \hat{\alpha}, \hat{y}, \hat{\theta}) \in F(P_N)$ as L^∞ close to $(\bar{u}, \bar{\alpha}, \bar{y}, \bar{\theta})$ as needed and with $\hat{\theta} < 0$. Let $\varepsilon > 0$ be such that

$$\|y - \hat{y}\|_\infty \leq \varepsilon \Rightarrow \phi(y_0, y_T) < \phi(\bar{y}_0, \bar{y}_T). \quad (2.54)$$

By the proposition, we get $(\tilde{u}, \tilde{y}) \in F(P)$ such that $\phi(\tilde{y}_0, \tilde{y}_T) < \phi(\bar{y}_0, \bar{y}_T)$ and

$$\|\tilde{u} - \bar{u}\|_1 + \|\tilde{y} - \bar{y}\|_\infty \leq M \|\hat{\alpha}\|_\infty + T \|\hat{u} - \bar{u}\|_\infty + \varepsilon + \|\hat{y} - \bar{y}\|_\infty. \quad (2.55)$$

Observe that the right-hand side of (2.55) can be chosen as small as needed. Thus we get a contradiction with the Pontryagin optimality of (\bar{u}, \bar{y}) . \square

Optimality conditions Problem (P_N) can be seen as an optimization problem over $(u, \alpha, y^0, \theta) \in \mathcal{U} \times \mathcal{A}^N \times \mathbb{R}^n \times \mathbb{R}$, via the mapping Γ_N defined by (2.51). Then we can define the set $\Lambda(P_N)$ of Lagrange multipliers at $(\bar{u}, \bar{\alpha}, \bar{y}_0, \bar{\theta})$ as in Appendix 2.A.1:

$$\Lambda(P_N) := \{(\lambda, \gamma) \in N(\bar{u}, \bar{y}) \times L^\infty(0, T; \mathbb{R}_+^{N*}) : DL_N[\lambda, \gamma](\bar{u}, \bar{\alpha}, \bar{y}_0, \bar{\theta}) = 0\} \quad (2.56)$$

where L_N is defined, for $\lambda = (\beta, \Psi, \nu, \mu)$, $\Psi = (\Psi^E, \Psi^I)$, $y = \Gamma_N(u, \alpha, y^0)$, by

$$\begin{aligned} L_N[\lambda, \gamma](u, \alpha, y^0, \theta) := & \theta + \beta(\phi(y_0, y_T) - \phi(\bar{y}_0, \bar{y}_T) - \theta) \\ & + \Psi^E \Phi^E(y_0, y_T) + \Psi^I (\Phi^I(y_0, y_T) - \theta) \\ & + \int_{[0, T]} [\nu_t(c(t, u_t, y_t) - \theta) dt + d\mu_t(g(t, y_t) - \theta) - \gamma_t(\alpha_t + \theta) dt]. \end{aligned} \quad (2.57)$$

In (2.57), θ has to be understood as a vector of appropriate size and with equal components. We have the following first-order necessary conditions:

Lemma 2.19. *Let problem (P_N) be qualified at $(\bar{u}, \bar{\alpha}, \bar{y}, \bar{\theta})$. Then $\Lambda(P_N)$ is nonempty, convex, and weakly $*$ compact.*

Proof. We apply Theorem 2.47 to $(\bar{u}, \bar{\alpha}, \bar{y}_0, \bar{\theta})$, locally optimal solution of (P_N) by Theorem 2.17. Let $\bar{v} \in \mathcal{U}$ be given by the inward condition for the mixed constraints in problem (P) (Assumption 2.2) and let $\bar{\omega} := 1 \in \mathcal{A}^N$. Then $(\bar{v}, \bar{\omega})$ satisfies the inward condition for the mixed constraints in problem (P_N) . The other assumptions being also satisfied by Assumption 2.1 and Remark 2.16.2, the conclusion follows. \square

2.3.3 Proof of Theorem 2.11

As explained at the end of Section 2.3.2.1, it is enough by Lemma 2.15 to prove that $\Lambda^N(\bar{u}, \bar{y}) \neq \emptyset$ for all N . To do so, we use the partially relaxed problems (P_N) as follows:

Lemma 2.20. *Let $(\lambda, \gamma) \in \Lambda(P_N)$. Then $\lambda \in \Lambda^N(\bar{u}, \bar{y})$.*

Proof. Let (u, α, y, θ) be a relaxed trajectory and $(\lambda, \gamma) \in E \times L^\infty(0, T; \mathbb{R}^{N*})$, with $\lambda = (\beta, \Psi, \nu, \mu)$ and $\Psi = (\Psi^E, \Psi^I)$. Adding to L_N

$$0 = \int_0^T p_t \left(\left(1 - \sum \alpha_t^i\right) f(t, u_t, y_t) + \sum \alpha_t^i f(t, u_t^i, y_t) - \dot{y}_t \right) dt, \quad (2.58)$$

and integrating by parts we have, for any $p \in \mathcal{P}$,

$$\begin{aligned} L_N[\lambda, \gamma](u, \alpha, y_0, \theta) = & \theta (1 - \beta - \langle \Psi^I, 1 \rangle - \langle \nu, 1 \rangle_1 - \langle \mu, 1 \rangle_C - \langle \gamma, 1 \rangle_1) \\ & + \int_0^T \left(H^a[p_t, \nu_t](t, u_t, y_t) + \sum_{i=1}^N \alpha_t^i (H[p_t](t, u_t^i, y_t) - H[p_t](t, u_t, y_t) - \gamma_t^i) \right) dt \\ & + \int_{[0, T]} (d\mu_t g(t, y_t) + dp_t y_t) + \Phi[\beta, \Psi](y_0, y_T) - p_T y_T + p_0 y_0 - \beta \phi(\bar{y}_0, \bar{y}_T). \end{aligned} \quad (2.59)$$

Let $(\lambda, \gamma) \in \Lambda(P_N)$. Using the expression (2.59) of L_N , we get

$$D_{y_0} \Phi[\beta, \Psi](\bar{y}_0, \bar{y}_T) + p_0^\lambda = 0, \quad (2.60)$$

$$D_u H^a[p_t^\lambda, \nu_t](t, \bar{u}_t, \bar{y}_t) = 0 \quad \text{for a.a. } t, \quad (2.61)$$

$$H[p_t^\lambda](t, u_t^i, \bar{y}_t) - H[p_t^\lambda](t, \bar{u}_t, \bar{y}_t) = \gamma_t^i \quad \text{for a.a. } t, \quad 1 \leq i \leq N, \quad (2.62)$$

$$\beta + \langle \Psi^I, 1 \rangle + \langle \nu, 1 \rangle_1 + \langle \mu, 1 \rangle_C + \langle \gamma, 1 \rangle_1 = 1. \quad (2.63)$$

Suppose that $\lambda = 0$. Then $p^\lambda = 0$ and by (2.62), $\gamma = 0$; we get a contradiction with (2.63). Then $\lambda \neq 0$ and $\lambda \in N_\pi(\bar{u}, \bar{y})$ by (2.60). Finally, $\lambda \in \Lambda_L(\bar{u}, \bar{y})$ by (2.61), and $\lambda \in \Lambda^N(\bar{u}, \bar{y})$ by (2.62) since $\gamma \in L^\infty(0, T; \mathbb{R}_+^{N*})$. \square

We need one more lemma:

Lemma 2.21. *Let problem (P_N) be not qualified at $(\bar{u}, \bar{\alpha}, \bar{y}, \bar{\theta})$. Then there exists $\lambda \in \Lambda^N(\bar{u}, \bar{y})$ such that $-\lambda \in \Lambda^N(\bar{u}, \bar{y})$ too, and for all $k \leq N$,*

$$H[p_t^\lambda](t, \bar{u}_t, \bar{y}_t) = H[p_t^\lambda](t, u_t^i, \bar{y}_t) \quad \text{for a.a. } t. \quad (2.64)$$

Proof. Recall that Γ_N has been defined by (2.51). By Remark 2.16.2, there exists $\Psi^E \neq 0$ such that

$$\Psi^E D\Phi^E(\bar{y}_0, \bar{y}_T) D\Gamma_N(\bar{u}, \bar{\alpha}, \bar{y}_0) = 0. \quad (2.65)$$

Let $\Psi = (\Psi^E, 0)$ and $\lambda := (0, \Psi, 0, 0)$, so that $D_{(u, \alpha, y^0)} L_N[\lambda, 0](\bar{u}, \bar{\alpha}, \bar{y}_0, \bar{\theta}) = 0$ by (2.57). By (2.59), we get

$$D_{y_0} \Phi[0, (\Psi^E, 0)](\bar{y}_0, \bar{y}_T) + p_0^\lambda = 0, \quad (2.66)$$

$$D_u H^a[p_t^\lambda, 0](t, \bar{u}_t, \bar{y}_t) = 0 \quad \text{for a.a. } t, \quad (2.67)$$

$$H[p_t^\lambda](t, u_t^i, \bar{y}_t) - H[p_t^\lambda](t, \bar{u}_t, \bar{y}_t) = 0 \quad \text{for a.a. } t, \quad 1 \leq i \leq N. \quad (2.68)$$

Then $\lambda \in \Lambda^N(\bar{u}, \bar{y})$ and (2.64) holds. \square

We can now conclude:

Proof of Theorem 2.11. We need $\Lambda^N(\bar{u}, \bar{y}) \neq \emptyset$ for all N . If problem (P_N) is qualified at $(\bar{u}, \bar{\alpha}, \bar{y}, \bar{\theta})$, then $\Lambda^N(\bar{u}, \bar{y}) \neq \emptyset$ by Lemmas 2.19 and 2.20. If problem (P_N) is not qualified at $(\bar{u}, \bar{\alpha}, \bar{y}, \bar{\theta})$, then $\Lambda^N(\bar{u}, \bar{y}) \neq \emptyset$ by Lemma 2.21. \square

Actually, we have the following alternative:

Corollary 2.22. *The partially relaxed problems (P_N) are either qualified for all N large enough, if $\Lambda_P^D(\bar{u}, \bar{y}) = \emptyset$, or never qualified, and then $\Lambda_P^D(\bar{u}, \bar{y}) \neq \emptyset$.*

Proof. If the problems (P_N) are never qualified, then we get a sequence a multipliers as in the proof of Lemma 2.21. By the proof of Lemma 2.15, its limit points belong to $\Lambda_P^D(\bar{u}, \bar{y})$. \square

See Appendix 2.A.3 for a qualification condition ensuring the non singularity of the generalized Pontryagin multipliers.

2.4 Second-order conditions in Pontryagin form

2.4.1 Statement

The second-order necessary conditions presented in this section involve Pontryagin multipliers only. They rely again on the partially relaxed problems, introduced in Section 2.3.2. These problems are actually modified into *reduced* partially relaxed problems, which satisfy an *extended polyhedricity condition*, [21, Section 3.2.3]. The idea is to get our second-order necessary conditions on a large cone by density of the so-called *strict radial critical cone*, so that we do not have to compute the *envelope-like effect*, Kawasaki [47].

The main result of this section is Theorem 2.31. It is stated after some new definitions and assumptions, and proved in Section 2.4.2.

2.4.1.1 Definitions and assumptions

For second-order optimality conditions, we need a stronger regularity assumption than Assumption 2.1. Namely, we make in the sequel the following:

Assumption 2.3. *The mappings f and g are C^∞ , c is uniformly quasi- C^2 , Φ and ϕ are C^2 .*

Remark 2.23. *If there is no pure state constraint in problem (P) (i.e. no mapping g), we will see that it is enough to assume that f is uniformly quasi- C^2 .*

For $s \in [1, \infty]$, let

$$\mathcal{V}_s := L^s(0, T; \mathbb{R}^m), \quad \mathcal{Z}_s := W^{1,s}(0, T; \mathbb{R}^n). \quad (2.69)$$

Let (\bar{u}, \bar{y}) be a trajectory for problem (P). Given $v \in \mathcal{V}_s$, $s \in [1, \infty]$, we consider the *linearized state equation* in \mathcal{Z}_s

$$\dot{z}_t = Df(t, \bar{u}_t, \bar{y}_t)(v_t, z_t) \quad \text{for a.a. } t \in (0, T). \quad (2.70)$$

We call a *linearized trajectory* any $(v, z) \in \mathcal{V}_s \times \mathcal{Z}_s$ such that (2.70) holds. For any $(v, z^0) \in \mathcal{V}_s \times \mathbb{R}^n$, there exists a unique $z \in \mathcal{Z}_s$ such that (2.70) holds and $z_0 = z^0$; we denote it by $z = z[v, z^0]$.

For $1 \leq i \leq n_g$, we define $g_i^{(j)} : [0, T] \times \mathbb{R}^m \times \mathbb{R}^n \rightarrow \mathbb{R}$, $j \in \mathbb{N}$, recursively by

$$g_i^{(j+1)}(t, u, y) := D_t g_i^{(j)}(t, u, y) + D_y g_i^{(j)}(t, u, y) f(t, u, y), \quad g_i^{(0)} := g_i. \quad (2.71)$$

Definition 2.24. *The order of a state constraint g_i is $q_i \in \mathbb{N}$ such that*

$$D_u g_i^{(j)} \equiv 0 \quad \text{for } 0 \leq j \leq q_i - 1, \quad D_u g_i^{(q_i)} \neq 0. \quad (2.72)$$

Remark 2.25. *If g_i is of order q_i , then $t \mapsto g_i(t, \bar{y}_t) \in W^{q_i, \infty}(0, T)$ for any trajectory (\bar{u}, \bar{y}) , and*

$$\frac{d^j}{dt^j} g_i(t, \bar{y}_t) = g_i^{(j)}(t, \bar{y}_t) \quad \text{for } 0 \leq j \leq q_i - 1, \quad (2.73)$$

$$\frac{d^{q_i}}{dt^{q_i}} g_i(t, \bar{y}_t) = g_i^{(q_i)}(t, \bar{u}_t, \bar{y}_t). \quad (2.74)$$

We have the same regularity along linearized trajectories; the proof of the next lemma is classical, see for instance [16, Lemma 9].

Lemma 2.26. *Let (\bar{u}, \bar{y}) be a trajectory and $(v, z) \in \mathcal{V}_s \times \mathcal{Z}_s$ be a linearized trajectory, $s \in [1, \infty]$. Let the constraint g_i be of order q_i . Then*

$$t \mapsto Dg_i(t, \bar{y}_t)z_t \in W^{q_i, s}(0, T), \quad (2.75)$$

and

$$\frac{d^j}{dt^j} Dg_i(t, \bar{y}_t)z_t = Dg_i^{(j)}(t, \bar{y}_t)z_t \quad \text{for } 0 \leq j \leq q_i - 1, \quad (2.76)$$

$$\frac{d^{q_i}}{dt^{q_i}} Dg_i(t, \bar{y}_t)z_t = Dg_i^{(q_i)}(t, \bar{u}_t, \bar{y}_t)(v_t, z_t). \quad (2.77)$$

Definition 2.27. *Let $(\bar{u}, \bar{y}) \in F(P)$. We say that $\tau \in [0, T]$ is a touch point for the constraint g_i iff it is a contact point for g_i , i.e. $g_i(\tau, \bar{y}_\tau) = 0$, isolated in $\{t : g_i(t, \bar{y}_t) = 0\}$. We say that a touch point τ for g_i is reducible iff $\tau \in (0, T)$, $\frac{d^2}{dt^2} g_i(t, \bar{y}_t)$ is defined for t close to τ , continuous at τ , and*

$$\frac{d^2}{dt^2} g_i(t, \bar{y}_t)|_{t=\tau} < 0. \quad (2.78)$$

Remark 2.28. *If g_i is of order at least 2, then by Remark 2.25 a touch point τ for g_i is reducible iff $t \mapsto g_i^{(2)}(t, \bar{u}_t, \bar{y}_t)$ is continuous at τ and $g_i^{(2)}(\tau, \bar{u}_\tau, \bar{y}_\tau) < 0$. The continuity holds if \bar{u} is continuous at τ or if g_i is of order at least 3.*

Let $(\bar{u}, \bar{y}) \in F(P)$. For $1 \leq i \leq n_g$, let

$$\mathcal{T}_{g,i} := \begin{cases} \emptyset & \text{if } g_i \text{ is of order 1,} \\ \{\text{touch points for } g_i\} & \text{if } g_i \text{ is of order at least 2,} \end{cases} \quad (2.79)$$

$$\Delta_{g,i}^0 := \{t \in [0, T] : g_i(t, \bar{y}_t) = 0\} \setminus \mathcal{T}_{g,i}, \quad (2.80)$$

$$\Delta_{g,i}^\varepsilon := \{t \in [0, T] : \text{dist}(t, \Delta_{g,i}^0) \leq \varepsilon\}, \quad (2.81)$$

and for $1 \leq i \leq n_c$, let

$$\Delta_{c,i}^\delta := \{t \in [0, T] : c_i(t, \bar{u}_t, \bar{y}_t) \geq -\delta\}. \quad (2.82)$$

We will need the following two extra assumptions:

Assumption 2.4. *For $1 \leq i \leq n_g$, the set $\mathcal{T}_{g,i}$ is finite and contains only reducible touch points, $\Delta_{g,i}^0$ has finitely many connected components and g_i is of finite order q_i .*

Assumption 2.5. *There exist $\delta', \varepsilon' > 0$ such that the linear mapping from $\mathcal{V}_2 \times \mathbb{R}^n$ to $\prod_{i=1}^{n_c} L^2(\Delta_{c,i}^{\delta'}) \times \prod_{i=1}^{n_g} W^{q_i, 2}(\Delta_{g,i}^{\varepsilon'})$ defined by*

$$(v, z^0) \mapsto \begin{pmatrix} \left(Dc_i(\cdot, \bar{u}, \bar{y})(v, z[v, z^0])|_{\Delta_{c,i}^{\delta'}} \right)_{1 \leq i \leq n_c} \\ \left(Dg_i(\cdot, \bar{y})z[v, z^0]|_{\Delta_{g,i}^{\varepsilon'}} \right)_{1 \leq i \leq n_g} \end{pmatrix} \quad \text{is onto.} \quad (2.83)$$

Remark 2.29. *There exist sufficient conditions, of linear independance type, for Assumption 2.5 to hold. See for instance [17, Lemma 2.3] or [13, Lemma 4.5].*

2.4.1.2 Main result

Let $(\bar{u}, \bar{y}) \in F(P)$. We define the *critical cone* in L^2

$$C_2(\bar{u}, \bar{y}) := \left\{ \begin{array}{l} (v, z) \in \mathcal{V}_2 \times \mathcal{Z}_2 : z = z[v, z_0] \\ D\phi(\bar{y}_0, \bar{y}_T)(z_0, z_T) \leq 0 \\ D\Phi(\bar{y}_0, \bar{y}_T)(z_0, z_T) \in T_{K_\Phi}(\Phi(\bar{y}_0, \bar{y}_T)) \\ Dc(\cdot, \bar{u}, \bar{y})(v, z) \in T_{K_c}(c(\cdot, \bar{u}, \bar{y})) \\ Dg(\cdot, \bar{y})z \in T_{K_g}(g(\cdot, \bar{y})) \end{array} \right\} \quad (2.84)$$

and the *strict critical cone* in L^2

$$C_2^S(\bar{u}, \bar{y}) := \left\{ \begin{array}{l} (v, z) \in C_2(\bar{u}, \bar{y}) : \\ Dc_i(t, \bar{u}_t, \bar{y}_t)(v_t, z_t) = 0 \quad t \in \Delta_{c,i}^0 \quad 1 \leq i \leq n_c \\ Dg_i(t, \bar{y}_t)z_t = 0 \quad t \in \Delta_{g,i}^0 \quad 1 \leq i \leq n_g \end{array} \right\}. \quad (2.85)$$

Remark 2.30. 1. See [21, Examples 2.63 and 2.64] for the description of T_{K_g} and T_{K_c} , respectively.

2. Since by Assumption 2.4 there are finitely many touch points for constraints of order at least 2, $C_2^S(\bar{u}, \bar{y})$ is defined by equality constraints and a finite number of inequality constraints, i.e. the cone $C_2^S(\bar{u}, \bar{y})$ is a polyhedron.

3. The strict critical cone $C_2^S(\bar{u}, \bar{y})$ is a subset of the critical cone $C_2(\bar{u}, \bar{y})$. But if there exists $\lambda = (\bar{\beta}, \bar{\Psi}, \bar{\nu}, \bar{\mu}) \in \Lambda_L(\bar{u}, \bar{y})$ such that

$$\bar{\nu}_i(t) > 0 \quad \text{for a.a. } t \in \Delta_{c,i}^0 \quad 1 \leq i \leq n_c, \quad (2.86)$$

$$\Delta_{g,i}^0 \subset \text{supp}(\bar{\mu}_i) \quad 1 \leq i \leq n_g, \quad (2.87)$$

then $C_2^S(\bar{u}, \bar{y}) = C_2(\bar{u}, \bar{y})$ (see [21, Proposition 3.10]).

For any $\lambda = (\beta, \Psi, \nu, \mu) \in E$, we define a quadratic form, the *Hessian of Lagrangian*, $\Omega[\lambda]: \mathcal{V}_2 \times \mathcal{Z}_2 \rightarrow \mathbb{R}$ by

$$\begin{aligned} \Omega[\lambda](v, z) := & \int_0^T D^2 H^a[p_t^\lambda, \nu_t](t, \bar{u}_t, \bar{y}_t)(v_t, z_t)^2 dt \\ & + D^2 \Phi[\beta, \Psi](\bar{y}_0, \bar{y}_T)(z_0, z_T)^2 \\ & + \int_{[0, T]} d\mu_t D^2 g(t, \bar{y}_t)(z_t)^2 - \sum_{\substack{\tau \in \mathcal{T}_{g,i} \\ 1 \leq i \leq n_g}} \mu_i(\tau) \frac{(Dg_i^{(1)}(\tau, \bar{y}_\tau)z_\tau)^2}{g_i^{(2)}(\tau, \bar{u}_\tau, \bar{y}_\tau)}. \end{aligned} \quad (2.88)$$

We can now state our main result, that will be proved in the next section.

Theorem 2.31. *Let (\bar{u}, \bar{y}) be a Pontryagin minimum for problem (P) and let Assumptions 2.2-2.5 hold. Then for any $(v, z) \in C_2^S(\bar{u}, \bar{y})$, there exists $\lambda \in \Lambda_P(\bar{u}, \bar{y})$ such that*

$$\Omega[\lambda](v, z) \geq 0. \quad (2.89)$$

Remark 2.32. If $\Lambda_P^D(\bar{u}, \bar{y}) \neq \emptyset$ and $\lambda \in \Lambda_P^D(\bar{u}, \bar{y})$, then $-\lambda \in \Lambda_P^D(\bar{u}, \bar{y})$ too. Since $\Omega[-\lambda](v, z) = -\Omega[\lambda](v, z)$ for any $(v, z) \in \mathcal{V}_2 \times \mathcal{Z}_2$, Theorem 2.31 is then pointless. See Corollary 2.22 about the emptiness of $\Lambda_P^D(\bar{u}, \bar{y})$.

2.4.2 Proof of Theorem 2.31

In this section, (\bar{u}, \bar{y}) is a given Pontryagin minimum for problem (P) , and Assumptions 2.2-2.5 hold.

2.4.2.1 Reduction and partial relaxation

The reduction approach [16, section 5] consists in reformulating the state constraint in the neighborhood of a touch point, using its reducibility (Definition 2.27). We apply this approach to the partially relaxed problems (P_N) in order to involve Pontryagin multipliers (see Lemmas 2.15 and 2.20).

Let $N \in \mathbb{N}$. Recall that Γ_N has been defined by (2.51).

Remark 2.33. The result of Remark 2.25 still holds for relaxed trajectories:

$$t \mapsto g_i(t, y_t) \in W^{q_i, \infty}(0, T) \quad \text{for any } y = \Gamma_N(u, \alpha, y^0). \quad (2.90)$$

Let $\tau \in \mathcal{T}_{g,i}$. We define $\Theta_{i,\tau}^{\varepsilon,N} : \mathcal{U} \times \mathcal{A}^N \times \mathbb{R}^n \rightarrow \mathbb{R}$ by

$$\Theta_{i,\tau}^{\varepsilon,N}(u, \alpha, y^0) := \max \{ g_i(t, y_t) : y = \Gamma_N(u, \alpha, y^0), \\ t \in [\tau - \varepsilon, \tau + \varepsilon] \cap [0, T] \}. \quad (2.91)$$

Let $\bar{\Gamma}'_N := D\Gamma_N(\bar{u}, \bar{\alpha}, \bar{y}_0)$ and $\bar{\Gamma}''_N := D^2\Gamma_N(\bar{u}, \bar{\alpha}, \bar{y}_0)$.

Remark 2.34. Let $\bar{\omega} := 0 \in \mathcal{A}^N$. For any $(v, z^0) \in \mathcal{V}_s \times \mathbb{R}^n$, $s \in [1, \infty]$, we have

$$\bar{\Gamma}'_N(v, \bar{\omega}, z^0) = z[v, z^0]. \quad (2.92)$$

Lemma 2.35. There exists $\varepsilon > 0$ independent of N such that for any $\tau \in \mathcal{T}_{g,i}$, $\Theta_{i,\tau}^{\varepsilon,N}$ is C^1 in a neighborhood of $(\bar{u}, \bar{\alpha}, \bar{y}_0)$ and twice Fréchet differentiable at $(\bar{u}, \bar{\alpha}, \bar{y}_0)$, with first and second derivatives given by

$$D\Theta_{i,\tau}^{\varepsilon,N}(\bar{u}, \bar{\alpha}, \bar{y}_0)(v, \omega, z^0) = Dg_i(\tau, \bar{y}_\tau) \bar{\Gamma}'_N(v, \omega, z^0)_\tau \quad (2.93)$$

for any $(v, \omega, z^0) \in \mathcal{V}_1 \times L^1(0, T; \mathbb{R}^N) \times \mathbb{R}^n$, and

$$D^2\Theta_{i,\tau}^{\varepsilon,N}(\bar{u}, \bar{\alpha}, \bar{y}_0)(v, \omega, z^0)^2 = D^2g_i(\tau, \bar{y}_\tau) (\bar{\Gamma}'_N(v, \omega, z^0)_\tau)^2 \\ + Dg_i(\tau, \bar{y}_\tau) \bar{\Gamma}''_N(v, \omega, z^0)_\tau^2 - \frac{\left(\frac{d}{dt} Dg_i(\cdot, \bar{y}) \bar{\Gamma}'_N(v, \omega, z^0) \Big|_\tau \right)^2}{\frac{d^2}{dt^2} g_i(\cdot, \bar{y}) \Big|_\tau} \quad (2.94)$$

for any $(v, \omega, z^0) \in \mathcal{V}_2 \times L^2(0, T; \mathbb{R}^N) \times \mathbb{R}^n$.

Proof. Combine [16, Lemma 23] with Remark 2.33 and Assumption 2.4. \square

The reduced partially relaxed problems The formulation is the same as for problems (P_N) , except that (i) we localize the mixed constraints c and the state constraints g on the domains given by Assumption 2.5, (ii) we replace the state constraints of order at least 2 around their touch points with the mappings $\Theta_{i,\tau}^{\varepsilon',N}$. Without loss of generality we assume that ε' given by Assumption 2.5 is smaller than ε given by Lemma 2.35; δ' is also given by Assumption 2.5.

Let $N \in \mathbb{N}$. Recall that in Section 2.3.2 the partially relaxed problem was

$$\min_{(u,\alpha,y,\theta) \in \mathcal{U} \times \mathcal{A}^N \times \mathcal{Y} \times \mathbb{R}} \theta \quad \text{subject to} \quad (2.43)\text{--}(2.50). \quad (P_N)$$

We consider the following new constraints:

$$c_i(t, u_t, y_t) \leq \theta \quad \text{for a.a. } t \in \Delta_{c,i}^{\delta'} \quad 1 \leq i \leq n_c, \quad (2.95)$$

$$g_i(t, y_t) \leq \theta \quad \text{for a.a. } t \in \Delta_{g,i}^{\varepsilon'} \quad 1 \leq i \leq n_g, \quad (2.96)$$

$$\Theta_{i,\tau}^{\varepsilon',N}(u, \alpha, y_0) \leq \theta \quad \text{for all } \tau \in \mathcal{T}_{g,i} \quad 1 \leq i \leq n_g. \quad (2.97)$$

The *reduced partially relaxed problem* is then

$$\min_{\substack{(u,\alpha,y,\theta) \in \\ \mathcal{U} \times \mathcal{A}^N \times \mathcal{Y} \times \mathbb{R}}} \theta \quad \text{s.t.} \quad (2.43)\text{--}(2.46), (2.49)\text{--}(2.50), (2.95)\text{--}(2.97). \quad (P_N^R)$$

As before, we denote by $F(P_N^R)$ the set of feasible relaxed trajectories.

Remark 2.36. 1. We have $(\bar{u}, \bar{\alpha}, \bar{y}, \bar{\theta}) \in F(P_N^R)$ and, in a neighborhood of $(\bar{u}, \bar{\alpha}, \bar{y}, \bar{\theta})$, $(u, \alpha, y, \theta) \in F(P_N^R)$ iff $(u, \alpha, y, \theta) \in F(P_N)$. In particular, $(\bar{u}, \bar{\alpha}, \bar{y}, \bar{\theta})$ is a weak minimum for problem (P_N^R) iff it is a weak minimum for problem (P_N) .

2. Problem (P_N^R) is qualified at $(\bar{u}, \bar{\alpha}, \bar{y}, \bar{\theta})$ iff problem (P_N) is qualified at $(\bar{u}, \bar{\alpha}, \bar{y}, \bar{\theta})$ (see Remark 2.16.2).

Optimality conditions Again, problem (P_N^R) can be seen as an optimization problem over (u, α, y^0, θ) , via the mapping Γ_N . We denote its Lagrangian by L_N^R , its set of Lagrange multipliers at $(\bar{u}, \bar{\alpha}, \bar{y}_0, \bar{\theta})$ by $\Lambda(P_N^R)$, and its set of quasi radial critical directions in L^2 by $C_2^{QR}(P_N^R)$, as defined in Appendix 2.A.1.

Remark 2.37. By Lemma 2.35, we can identify $\Lambda(P_N^R)$ and $\Lambda(P_N)$ by identifying the scalar components of a multiplier associated to the constraints (2.97) and Dirac measures. See also [16, Lemma 26] or [13, Lemma 3.4].

We have the following second-order necessary conditions:

Lemma 2.38. Let problem (P_N^R) be qualified at $(\bar{u}, \bar{\alpha}, \bar{y}, \bar{\theta})$. Then for any $(v, \omega, z^0, \vartheta) \in \text{cl}(C_2^{QR}(P_N^R))$, there exists $(\lambda, \gamma) \in \Lambda(P_N^R)$ such that

$$D^2 L_N^R[\lambda, \gamma](v, \omega, z^0, \vartheta)^2 \geq 0. \quad (2.98)$$

Here, cl denotes the L^2 closure.

Proof. We apply Theorem 2.48 to $(\bar{u}, \bar{\alpha}, \bar{y}_0, \bar{\theta})$, locally optimal solution of (P_N^R) by Theorem 2.17 and Remark 2.36. The various mappings have the required regularity by Assumption 2.3 and Lemma 2.35. Robinson's constraint qualification and the inward condition for the mixed constraints hold as in the proof of Lemma 2.19. The conclusion follows. \square

2.4.2.2 Proof of the theorem

Let $(\bar{v}, \bar{z}) \in C_2^S(\bar{u}, \bar{y})$. By Lemma 2.15 and since $\lambda \mapsto \Omega[\lambda](\bar{v}, \bar{z})$ is linear continuous, it is enough to show that for all N , there exists $\lambda^N \in \Lambda^N(\bar{u}, \bar{y})$ such that

$$\Omega[\lambda^N](\bar{v}, \bar{z}) \geq 0. \quad (2.99)$$

Let $(\bar{\omega}, \bar{\vartheta}) := (0, 0) \in \mathcal{A}^N \times \mathbb{R}$. The link with the reduced partially relaxed problems (P_N^R) is as follows:

Lemma 2.39. *Let $(\lambda, \gamma) \in \Lambda(P_N^R)$. Then $\lambda \in \Lambda^N(\bar{u}, \bar{y})$ and*

$$D^2 L_N^R[\lambda, \gamma](\bar{v}, \bar{\omega}, \bar{z}_0, \bar{\vartheta})^2 = \Omega[\lambda](\bar{v}, \bar{z}). \quad (2.100)$$

Proof. The first part of the result is known by Lemma 2.20 and Remark 2.37. For the second part, we write L_N^R using H^a and H , as in the expression (2.59) of L_N , and we compute its second derivative. The result follows by Lemma 2.35 and Remark 2.34. See also [16, Lemma 26] or [13, Lemma 3.5]. \square

We also need the following density result, that will be proved in Section 2.4.2.3.

Lemma 2.40. *The direction $(\bar{v}, \bar{\omega}, \bar{z}_0, \bar{\vartheta})$ belongs to $\text{cl}(C_2^{QR}(P_N^R))$, the closure of the set of quasi radial critical directions in L^2 .*

We can now conclude:

Proof of Theorem 2.31 We need $\lambda^N \in \Lambda^N(\bar{u}, \bar{y})$ such that (2.99) holds for all N . If problem (P_N^R) is qualified at $(\bar{u}, \bar{\alpha}, \bar{y}, \bar{\theta})$, then we get λ^N as needed by Lemmas 2.38, 2.39 and 2.40. If problem (P_N^R) is not qualified at $(\bar{u}, \bar{\alpha}, \bar{y}, \bar{\theta})$, then we get λ such that $-\lambda, \lambda \in \Lambda^N(\bar{u}, \bar{y})$ by Remark 2.36.2 and Lemma 2.21. Since $\lambda \mapsto \Omega[\lambda](\bar{v}, \bar{z})$ is linear, (2.99) holds for $\lambda^N = \pm\lambda$. \square

2.4.2.3 A density result

In this section we prove Lemma 2.40. Recall that δ' is given by Assumption 2.5. We define the *strict radial critical cone* in L^2

$$C_2^R(\bar{u}, \bar{y}) := \left\{ \begin{array}{lll} (v, z) \in C_2(\bar{u}, \bar{y}) : \exists \delta > 0, \exists M > 0, \exists \varepsilon > 0, \\ Dc_i(t, \bar{u}_t, \bar{y}_t)(v_t, z_t) = 0 & t \in \Delta_{c,i}^\delta & 1 \leq i \leq n_c \\ |Dc_i(t, \bar{u}_t, \bar{y}_t)(v_t, z_t)| \leq M & t \in \Delta_{c,i}^{\delta'} & 1 \leq i \leq n_c \\ Dg_i(t, \bar{y}_t)z_t = 0 & t \in \Delta_{g,i}^\varepsilon & 1 \leq i \leq n_g \end{array} \right\}. \quad (2.101)$$

Proposition 2.41. *The strict radial critical cone $C_2^R(\bar{u}, \bar{y})$ is a dense subset of the strict critical cone $C_2^S(\bar{u}, \bar{y})$.*

Proof. Touch points for g_i are included in $\Delta_{g,i}^\varepsilon$, $\varepsilon \geq 0$, iff g_i is of order 1.

(a) Let $W^{(q),2}(0, T) := \prod_{i=1}^{n_g} W^{q_i,2}(0, T)$. We claim that the subspace

$$\left\{ \begin{array}{l} (\phi, \psi) \in L^\infty(0, T; \mathbb{R}^{n_c}) \times W^{(q),2}(0, T) : \\ \exists \delta > 0 : \phi_{i,t} = 0 \quad t \in \Delta_{c,i}^\delta \quad 1 \leq i \leq n_c \\ \exists \varepsilon > 0 : \psi_{i,t} = 0 \quad t \in \Delta_{g,i}^\varepsilon \quad 1 \leq i \leq n_g \end{array} \right\} \quad (2.102)$$

is a dense subset of

$$\left\{ \begin{array}{l} (\phi, \psi) \in L^2(0, T; \mathbb{R}^{n_c}) \times W^{(q),2}(0, T) : \\ \phi_{i,t} = 0 \quad t \in \Delta_{c,i}^0 \quad 1 \leq i \leq n_c \\ \psi_{i,t} = 0 \quad t \in \Delta_{g,i}^0 \quad 1 \leq i \leq n_g \end{array} \right\}. \quad (2.103)$$

Indeed, for $\phi_i \in L^2(0, T)$, we consider the sequence

$$\phi_{i,t}^k := \begin{cases} 0 & \text{if } t \in \Delta_{c,i}^{1/k}, \\ \min\{k, |\phi_{i,t}|\} \frac{\phi_{i,t}}{|\phi_{i,t}|} & \text{otherwise.} \end{cases} \quad (2.104)$$

For $\psi_i \in W^{q_i,2}(0, T)$, we use the fact that there is no isolated point in $\Delta_{g,i}^0$ if $q_i \geq 2$, and approximation results in $W^{q_i,2}(0, T)$, e.g. [13, Appendix A.3]. Our claim follows.

(b) By Assumption 2.5 and the open mapping theorem, there exists $C > 0$ such that for all $(\phi, \psi) \in L^2(0, T; \mathbb{R}^{n_c}) \times W^{(q),2}(0, T)$, there exists $(v, z) \in \mathcal{V}_2 \times \mathcal{Z}_2$ such that

$$z = z[v, z_0], \quad \|v\|_2 + |z_0| \leq C (\|\phi\|_2 + \|\psi\|_{(q),2}), \quad (2.105)$$

$$Dc_i(t, \bar{u}_t, \bar{y}_t)(v_t, z_t) = \phi_{i,t} \quad t \in \Delta_{c,i}^{\delta'} \quad 1 \leq i \leq n_c, \quad (2.106)$$

$$Dg_i(t, \bar{y}_t)z_t = \psi_{i,t} \quad t \in \Delta_{g,i}^{\varepsilon'} \quad 1 \leq i \leq n_g.$$

It follows that the subspace

$$\left\{ \begin{array}{l} (v, z) \in \mathcal{V}_2 \times \mathcal{Z}_2 : z = z[v, z_0] \\ \exists \delta > 0 : Dc_i(t, \bar{u}_t, \bar{y}_t)(v_t, z_t) = 0 \quad t \in \Delta_{c,i}^\delta \quad 1 \leq i \leq n_c \\ \exists M > 0 : |Dc_i(t, \bar{u}_t, \bar{y}_t)(v_t, z_t)| \leq M \quad t \in \Delta_{c,i}^{\delta'} \quad 1 \leq i \leq n_c \\ \exists \varepsilon > 0 : Dg_i(t, \bar{y}_t)z_t = 0 \quad t \in \Delta_{g,i}^\varepsilon \quad 1 \leq i \leq n_g \end{array} \right\} \quad (2.107)$$

is a dense subset of

$$\left\{ \begin{array}{l} (v, z) \in \mathcal{V}_2 \times \mathcal{Z}_2 : z = z[v, z_0] \\ Dc_i(t, \bar{u}_t, \bar{y}_t)(v_t, z_t) = 0 \quad t \in \Delta_{c,i}^0 \quad 1 \leq i \leq n_c \\ Dg_i(t, \bar{y}_t)z_t = 0 \quad t \in \Delta_{g,i}^0 \quad 1 \leq i \leq n_g \end{array} \right\}. \quad (2.108)$$

Observe now that $C_2^R(\bar{u}, \bar{v})$ and $C_2^S(\bar{u}, \bar{v})$ are defined by (2.101) and (2.85) respectively as the same polyhedral cone in the previous two vector spaces. See also Remark 2.30.2. Then by [29, Lemma 1], the conclusion of Proposition 2.41 follows. \square

The definition of the set $C_2^{QR}(P_N^R)$ of quasi radial critical directions in L^2 is given in Appendix 2.A.1. Recall that $(\bar{\omega}, \bar{\vartheta}) := (0, 0) \in \mathcal{A}^N \times \mathbb{R}$.

Lemma 2.42. *Let $(v, z) \in C_2^R(\bar{u}, \bar{y})$. Then $(v, \bar{\omega}, z_0, \bar{\vartheta}) \in C_2^{QR}(P_N^R)$.*

Proof. The direction $(v, \bar{\omega}, z_0, \bar{\vartheta})$ is radial [21, Definition 3.52] for the finite dimensional constraints, which are polyhedral, as well as for the constraints on α . Let δ and $M > 0$ be given by definition of $C_2^R(\bar{u}, \bar{y})$. Then for any $\sigma > 0$

$$c_i(t, \bar{u}_t, \bar{y}_t) + \sigma Dc_i(t, \bar{u}_t, \bar{y}_t)(v_t, z_t) \leq \begin{cases} 0 & \text{for a.a. } t \in \Delta_{c,i}^\delta \\ -\delta + \sigma M & \text{for a.a. } t \in \Delta_{c,i}^{\delta'} \setminus \Delta_{c,i}^\delta \end{cases} \quad (2.109)$$

i.e. $(v, \bar{\omega}, z_0, \bar{\vartheta})$ is radial for the constraint (2.95). The same argument holds for constraint (2.96) since there exists $\delta_0 > 0$ such that $g_i(t, \bar{y}_t) \leq -\delta_0$ for all $t \in \Delta_{g,i}^{\epsilon'} \setminus \Delta_{g,i}^\epsilon$. Then $(v, \bar{\omega}, z_0, \bar{\vartheta})$ is radial, and a fortiori quasi radial. \square

Remark 2.43. *To finish this section, let us mention a flaw in the proof of the density result [17, Lemma 6.4 (ii)]. There is no reason that v^n belongs to L^∞ , and not only to L^2 , since $(v^n - v)$ is obtained as a preimage of $(w^n - w, \omega^n - \omega)$. The lemma is actually true but its proof requires some effort, see [13, Lemma 4.5] for the case without mixed constraints. The difficulty is avoided here because we do not have to show the density of a L^∞ cone, thanks to our abstract second-order necessary conditions, Theorem 2.48, that are derived directly in L^2 .*

2.A Appendix

2.A.1 Abstract optimization results

In this section, we recall necessary conditions satisfied by a weak minimum of a general optimal control problem. These conditions have been used in this paper to prove our necessary conditions in Pontryagin form, namely Theorems 2.11 and 2.31, via the partial relaxation, i.e. Lemmas 2.19 and 2.38.

We actually state and prove first- and second-order necessary conditions for a more abstract optimization problem. It has to be noted that our second-order conditions, Theorem 2.48, are obtained directly on a large set of directions in L^2 , thanks to metric regularity result, Lemma 2.50, and a tricky truncation, Lemma 2.51. To our knowledge, this is new.

2.A.1.1 Setting

Let K be a nonempty closed convex subset of a Banach space X and $\Delta_1, \dots, \Delta_M$ be measurable sets of $[0, T]$. For $s \in [1, \infty]$, let

$$\mathcal{U}_s := L^s(0, T; \mathbb{R}^{\bar{m}}), \quad \mathcal{Y}_s := W^{1,s}(0, T; \mathbb{R}^{\bar{n}}), \quad (2.110)$$

$$X_s := X \times \prod_{i=1}^M L^s(\Delta_i), \quad K_s := K \times \prod_{i=1}^M L^s(\Delta_i; \mathbb{R}_-). \quad (2.111)$$

We consider

$$\Gamma: \mathcal{U}_\infty \times \mathbb{R}^{\bar{n}} \rightarrow \mathcal{Y}_\infty, \quad J: \mathcal{U}_\infty \times \mathbb{R}^{\bar{n}} \rightarrow \mathbb{R}, \quad (2.112)$$

$$G_1: \mathcal{U}_\infty \times \mathbb{R}^{\bar{n}} \rightarrow X, \quad G_2^i: \mathcal{U}_\infty \times \mathcal{Y}_\infty \rightarrow L^\infty(\Delta_i), \quad (2.113)$$

the last mappings being defined for $i = 1, \dots, M$ by

$$G_2^i(u, y)_t := m_i(t, u_t, y_t) \quad (2.114)$$

for a.a. $t \in \Delta_i$, where $m_i: [0, T] \times \mathbb{R}^{\bar{m}} \times \mathbb{R}^{\bar{n}} \rightarrow \mathbb{R}$. Let

$$G: \mathcal{U}_\infty \times \mathbb{R}^{\bar{n}} \rightarrow X_\infty, \quad G(u, y^0) := (G_1(u, y^0), G_2(u, \Gamma(u, y^0))). \quad (2.115)$$

The optimization problem we consider is the following:

$$\min_{(u, y^0) \in \mathcal{U}_\infty \times \mathbb{R}^{\bar{n}}} J(u, y^0); \quad G(u, y^0) \in K_\infty. \quad (AP)$$

Remark 2.44. *Optimal control problems fit into this framework as follows: given a uniformly quasi- C^1 mapping $F: \mathbb{R} \times \mathbb{R}^{\bar{m}} \times \mathbb{R}^{\bar{n}} \rightarrow \mathbb{R}^{\bar{n}}$ and the state equation*

$$\dot{y}_t = F(t, u_t, y_t) \quad \text{for a.a. } t \in (0, T), \quad (2.116)$$

we define $\Gamma(u, y^0)$ as the unique $y \in \mathcal{Y}_\infty$ such that (2.116) holds and $y_0 = y^0$, for any $(u, y^0) \in \mathcal{U}_\infty \times \mathbb{R}^{\bar{n}}$; given a cost function $\tilde{J}: \mathcal{Y}_\infty \rightarrow \mathbb{R}$, we define $J := \tilde{J} \circ \Gamma$; given state constraints of any kind (pure, initial-final, ...) $\tilde{G}_1: \mathcal{Y}_\infty \rightarrow X$, with the appropriate space X and convex subset K , we define $G_1 := \tilde{G}_1 \circ \Gamma$; finally, we define G_2 in order to take into account the mixed control-state and control constraints. By definition, a weak minimum of such an optimal control problem is a locally optimal solution of the corresponding optimization problem (AP).

2.A.1.2 Assumptions

Let (\bar{u}, \bar{y}^0) be feasible for (AP) and let $\bar{y} := \Gamma(\bar{u}, \bar{y}^0)$. For various Banach spaces Y and mappings $\mathcal{F}: \mathcal{U}_\infty \times \mathbb{R}^{\bar{n}} \rightarrow Y$, we will require one of the followings:

Property 2.1. *The mapping \mathcal{F} is C^1 in a neighborhood of (\bar{u}, \bar{y}^0) , with continuous extensions $D\mathcal{F}(u, y^0): \mathcal{U}_1 \times \mathbb{R}^{\bar{n}} \rightarrow Y$.*

Property 2.2. *Property 2.1 holds, and \mathcal{F} is twice Fréchet differentiable at (\bar{u}, \bar{y}^0) , with a continuous extension $D^2\mathcal{F}(\bar{u}, \bar{y}^0): (\mathcal{U}_2 \times \mathbb{R}^{\bar{n}})^2 \rightarrow Y$ and the following expansion in Y : for all $(v, z^0) \in \mathcal{U}_\infty \times \mathbb{R}^{\bar{n}}$,*

$$\begin{aligned} \mathcal{F}(\bar{u} + v, \bar{y}^0 + z^0) &= \mathcal{F}(\bar{u}, \bar{y}^0) + D\mathcal{F}(\bar{u}, \bar{y}^0)(v, z^0) + \frac{1}{2}D^2\mathcal{F}(\bar{u}, \bar{y}^0)(v, z^0)^2 \\ &\quad + o_\infty(\|v\|_2^2 + |z^0|^2). \end{aligned} \quad (2.117)$$

Assumption 2.1 (i). *The mappings Γ , J and G_1 satisfy Property 2.1, and the functions m_i are uniformly quasi- C^1 .*

Assumption 2.2 (i'). *The mappings Γ , J and G_1 satisfy Property 2.2, and the functions m_i are uniformly quasi- C^2 .*

Assumption 2.3 (ii). *Robinson's constraint qualification holds:*

$$0 \in \text{int}_{X_\infty} \{G(\bar{u}, \bar{y}^0) + DG(\bar{u}, \bar{y}^0)(\mathcal{U}_\infty \times \mathbb{R}^{\bar{n}}) - K_\infty\}. \quad (2.118)$$

Assumption 2.4 (iii). *The inward condition holds for G_2 : there exists $\gamma > 0$ and $\hat{v} \in \mathcal{U}_\infty$ such that*

$$G_2^i(\bar{u}, \bar{y}) + D_u G_2^i(\bar{u}, \bar{y})\hat{v} \leq -\gamma \quad (2.119)$$

on Δ_i , $i = 1, \dots, M$.

Remark 2.45. *Let us consider the case of an optimal control problem, with Γ , J and G_1 defined as in Remark 2.44. If F , m_i are uniformly quasi- C^1 and \tilde{J} , \tilde{G}_1 are C^1 , then Assumption (i) holds. If F , m_i are uniformly quasi- C^2 and \tilde{J} , \tilde{G}_1 are C^2 , then Assumption (i') holds. See for example [16, Lemmas 19-20] or [64, Theorems 3.3-3.5].*

2.A.1.3 Necessary conditions

We consider the *Lagrangian* $L[\lambda]: \mathcal{U}_\infty \times \mathbb{R}^{\bar{n}} \rightarrow \mathbb{R}$, defined for $\lambda \in X_\infty^*$ by

$$L[\lambda](u, y^0) := J(u, y^0) + \langle \lambda, G(u, y^0) \rangle. \quad (2.120)$$

We define the set of *Lagrange multipliers* as

$$\Lambda(AP) := \{ \lambda \in X_1^* : \lambda \in N_{K_1}(G(\bar{u}, \bar{y}^0)), DL[\lambda](\bar{u}, \bar{y}^0) = 0 \text{ on } \mathcal{U}_1 \times \mathbb{R}^{\bar{n}} \}, \quad (2.121)$$

and the set of *quasi radial critical directions* in L^2 as

$$C_2^{QR}(AP) := \left\{ (v, z^0) \in \mathcal{U}_2 \times \mathbb{R}^{\bar{n}} : DJ(\bar{u}, \bar{y}^0)(v, z^0) \leq 0 \text{ and } \forall \sigma > 0, \right. \\ \left. \text{dist}_{X_1}(G(\bar{u}, \bar{y}^0) + \sigma DG(\bar{u}, \bar{y}^0)(v, z^0), K_1) = o(\sigma^2) \right\}. \quad (2.122)$$

We denote by $\text{cl}(C_2^{QR}(AP))$ its closure in $\mathcal{U}_2 \times \mathbb{R}^{\bar{n}}$.

Remark 2.46. *If $(v, z^0) \in C_2^{QR}(AP)$, then $DG(\bar{u}, \bar{y}^0)(v, z^0) \in T_{K_1}(G(\bar{u}, \bar{y}^0))$. If in addition $\Lambda(AP) \neq \emptyset$, then $DJ(\bar{u}, \bar{y}^0)(v, z^0) = 0$.*

We now state our first- and second-order necessary conditions, in two theorems that will be proved in the next section.

Theorem 2.47. *Let (\bar{u}, \bar{y}^0) be a locally optimal solution of (AP), and let Assumptions (i)-(iii) hold. Then $\Lambda(AP)$ is nonempty, convex, and weakly $*$ compact in X_1^* .*

Theorem 2.48. *Let (\bar{u}, \bar{y}^0) be a locally optimal solution of (AP), and let Assumptions (i')-(iii) hold. Then for any $(v, z^0) \in \text{cl}(C_2^{QR}(AP))$, there exists $\lambda \in \Lambda(AP)$ such that*

$$D^2L[\lambda](\bar{u}, \bar{y}^0)(v, z^0)^2 \geq 0. \quad (2.123)$$

2.A.1.4 Proofs

Proof of Theorem 2.47. Robinson's constraint qualification (2.118) and [74, Theorem 4.1] or [21, Theorem 3.9] give the result in X_∞^* . We derive it in X_1^* with the inward condition (2.119), see e.g. [18, Theorem 3.1]. \square

Proof of Theorem 2.48. (a) Assume first that $(v, z^0) \in C_2^{QR}(AP)$. We consider the following conic linear problem, [21, Section 2.5.6]:

$$\begin{cases} \min_{(w, \xi^0) \in \mathcal{U}_1 \times \mathbb{R}^{\bar{n}}} DJ(\bar{u}, \bar{y}^0)(w, \xi^0) + D^2J(\bar{u}, \bar{y}^0)(v, z^0)^2 ; \\ DG(\bar{u}, \bar{y}^0)(w, \xi^0) + D^2G(\bar{u}, \bar{y}^0)(v, z^0)^2 \in T_{K_1}(G(\bar{u}, \bar{y}^0)). \end{cases} \quad (Q_{(v, z^0)})$$

Robinson's constraint qualification (2.118) for problem (AP) implies that the constraints of $(Q_{(v, z^0)})$ are regular in the sense of [21, Theorem 2.187]. Then by the same theorem, there is no duality gap between $(Q_{(v, z^0)})$ and its dual, which is the following optimization problem:

$$\max_{\lambda \in \Lambda(AP)} D^2L[\lambda](\bar{u}, \bar{y}^0)(v, z^0)^2. \quad (2.124)$$

Observe indeed that the Lagrangian of $(Q_{(v, z^0)})$ is

$$\mathcal{L}[\lambda](w, \xi^0) = DL[\lambda](\bar{u}, \bar{y}^0)(w, \xi^0) + D^2L[\lambda](\bar{u}, \bar{y}^0)(v, z^0)^2, \quad \lambda \in X_1^*. \quad (2.125)$$

The conclusion of the theorem follows when $(v, z^0) \in C_2^{QR}(AP)$ by the following key lemma, that will be proved below.

Lemma 2.49. *The value of $(Q_{(v, z^0)})$ is nonnegative.*

(b) Assume now that $(v, z^0) \in \text{cl}(C_2^{QR}(AP))$. Let $(v^k, z^{0,k}) \in C_2^{QR}(AP)$ converge to (v, z^0) in $\mathcal{U}_2 \times \mathbb{R}^{\bar{n}}$. By step (b), there exists $\lambda^k \in \Lambda$ be such that

$$\begin{aligned} D^2J(\bar{u}, \bar{y}^0)(v^k, z^{0,k})^2 + \left\langle \lambda^k, D^2G(\bar{u}, \bar{y}^0)(v^k, z^{0,k})^2 \right\rangle \\ = D^2L[\lambda^k](\bar{u}, \bar{y}^0)(v^k, z^{0,k})^2 \geq 0. \end{aligned} \quad (2.126)$$

By Theorem 2.47, there exists $\lambda \in \Lambda$ such that, up to a subsequence, $\lambda^k \rightharpoonup \lambda$ for the weak $*$ topology in X_1^* . By Assumption (i'), $D^2J(\bar{u}, \bar{y}^0): \mathcal{U}_2 \times \mathbb{R}^{\bar{n}} \rightarrow \mathbb{R}$ and $D^2G(\bar{u}, \bar{y}^0): \mathcal{U}_2 \times \mathbb{R}^{\bar{n}} \rightarrow X_1$ are continuous. The conclusion follows. \square

Proof of Lemma 2.49. First we prove a metric regularity result, which relies on Assumption (iii). For any $(u, y) \in \mathcal{U}_\infty \times \mathcal{Y}_\infty$, we define $G_2^+(u, y) \in L^\infty(0, T)$ by

$$G_2^+(u, y)_t := \max_{1 \leq i \leq M} (G_2^i(u, y)_t)_+ \quad (2.127)$$

for a.a. $t \in (0, T)$, where

$$(G_2^i(u, y)_t)_+ := \begin{cases} \max\{0, G_2^i(u, y)_t\} & \text{if } t \in \Delta_i, \\ 0 & \text{if } t \notin \Delta_i. \end{cases} \quad (2.128)$$

Lemma 2.50. *There exists $c > 0$ such that, for any $(u, y) \in \mathcal{U}_\infty \times \mathcal{Y}_\infty$ with $y = \Gamma(u, y^0)$ in a neighborhood of (\bar{u}, \bar{y}) , there exists $(\hat{u}, \hat{y}) \in \mathcal{U}_\infty \times \mathcal{Y}_\infty$ with $\hat{y} = \Gamma(\hat{u}, y^0)$ such that*

$$\|\hat{u} - u\|_\infty \leq c \|G_2^+(u, y)\|_\infty, \quad (2.129)$$

$$\|\hat{u} - u\|_1 \leq c \|G_2^+(u, y)\|_1, \quad (2.130)$$

$$\|G_2^+(\hat{u}, \hat{y})\|_\infty \leq c \|G_2^+(u, y)\|_1. \quad (2.131)$$

Proof. Let $\beta \in (0, 1)$ to be fixed later. Since (\bar{u}, \bar{y}^0) is feasible, $G_2^+(\bar{u}, \bar{y}) = 0$, and there exists $\alpha \in (0, \beta)$ such that

$$\|u - \bar{u}\|_\infty + \|y - \bar{y}\|_\infty \leq \alpha \Rightarrow \|G_2^+(u, y)\|_\infty \leq \beta. \quad (2.132)$$

Let (u, y) be such that $\|u - \bar{u}\|_\infty + \|y - \bar{y}\|_\infty \leq \alpha$. We define $\varepsilon \in L^\infty(0, T)$ by

$$\varepsilon_t := \frac{1}{\beta} G_2^+(u, y)_t, \quad (2.133)$$

so that $\varepsilon_t \in [0, 1]$ for a.a. $t \in (0, T)$, and

$$\hat{u} := u + \varepsilon \hat{v} \quad (2.134)$$

where \hat{v} is given by the inward condition (2.119). Once β is fixed, it is clear that (2.129) and (2.130) hold. Let $\hat{y} = \Gamma(\hat{u}, y^0)$.

$$\begin{aligned} G_2^i(\hat{u}, \hat{y}) &= G_2^i(u, y) + DG_2^i(\bar{u}, \bar{y})(\hat{u} - u, \hat{y} - y) \\ &\quad + \int_0^1 (DG_2^i(u + \theta(\hat{u} - u), y + \theta(\hat{y} - y)) - DG_2^i(\bar{u}, \bar{y})) (\hat{u} - u, \hat{y} - y) d\theta \end{aligned} \quad (2.135)$$

a.e. on Δ_i . Since Γ satisfies Property 1, $\|\hat{y} - y\|_\infty = O(\|\hat{u} - u\|_1)$, and then

$$|\hat{u}_t - u_t| = O(\varepsilon_t), \quad |u_t - \bar{u}_t| = O(\alpha) = O(\beta), \quad (2.136)$$

$$|\hat{y}_t - y_t| = O(\|\varepsilon\|_1), \quad |y_t - \bar{y}_t| = O(\alpha) = O(\beta). \quad (2.137)$$

Since m_i is uniformly quasi- C^2 , G_2^i and DG_2^i are Lipschitz in a neighborhood of (\bar{u}, \bar{y}) . Then

$$G_2^i(\hat{u}, \hat{y}) = G_2^i(u, y) + \varepsilon D_u G_2^i(\bar{u}, \bar{y}) \hat{v} + O(\|\varepsilon\|_1 + \varepsilon(\varepsilon + \|\varepsilon\|_1 + \beta)) \quad (2.138)$$

$$= (1 - \varepsilon) G_2^i(u, y) + \varepsilon (G_2^i(u, y) - G_2^i(\bar{u}, \bar{y})) \quad (2.139)$$

$$+ \varepsilon (G_2^i(\bar{u}, \bar{y}) + D_u G_2^i(\bar{u}, \bar{y}) \hat{v}) + O(\|\varepsilon\|_1 + \varepsilon(\varepsilon + \|\varepsilon\|_1 + \beta)).$$

Observe now that

$$(1 - \varepsilon) G_2^i(u, y) \leq G_2^+(u, y^0) = \varepsilon \beta, \quad (2.140)$$

$$\varepsilon (G_2^i(u, y) - G_2^i(\bar{u}, \bar{y})) = O(\alpha \varepsilon) = O(\varepsilon \beta), \quad (2.141)$$

$$\varepsilon (G_2^i(\bar{u}, \bar{y}) + D_u G_2^i(\bar{u}, \bar{y}) \hat{v}) \leq -\varepsilon \gamma. \quad (2.142)$$

Then there exists $C > 0$, independent of u and u' , such that

$$G_2^i(\hat{u}, \hat{y}) \leq C\|\varepsilon\|_1 + \varepsilon[C(\varepsilon + \|\varepsilon\|_1 + \beta) - \gamma] \quad (2.143)$$

on Δ_i , $i = 1, \dots, M$. We fix $\beta \in (0, 1)$ such that $C\beta \leq \gamma/2$ and $\alpha \in (0, \beta)$ such that $C(\varepsilon + \|\varepsilon\|_1) \leq \gamma/2$. The result follows. \square

To prove Lemma 2.49, we also need the following:

Lemma 2.51. *Let $v \in \mathcal{U}_2$ and $w \in \mathcal{U}_1$. Let $v^k := \mathbf{1}_{\{|v| \leq k\}}v$, $w^k := \mathbf{1}_{\{|w| \leq k\}}w$, and $\sigma_k := \frac{\|v^k - v\|_2}{k}$. Then $v^k, w^k \in \mathcal{U}_\infty$, $\sigma_k \rightarrow 0$, and*

$$\|\sigma_k v^k\|_\infty = o(1), \quad \|\sigma_k^2 w^k\|_\infty = o(1), \quad (2.144)$$

$$\|v^k - v\|_2 = o(1), \quad \|w^k - w\|_1 = o(1), \quad (2.145)$$

$$\|v^k - v\|_1 = o(\sigma_k). \quad (2.146)$$

Proof. We first get (2.145) by Lebesgue's dominated convergence theorem. Then $\sigma_k = o(\frac{1}{k})$, and (2.144) follows. Observe that $|v^k - v|^2 \geq k|v^k - v|$, which implies $\|v^k - v\|_1 = O(\frac{1}{k}\|v^k - v\|_2^2)$. (2.146) follows by definition of σ_k and by (2.145). \square

Let us now go back to the proof of Lemma 2.49: let (w, ξ^0) be feasible for problem $(Q_{(v, z^0)})$. We apply Lemma 2.51 to $v \in \mathcal{U}_2$, $w \in \mathcal{U}_1$, and we consider

$$u^k := \bar{u} + \sigma_k v^k + \frac{1}{2}\sigma_k^2 w^k \in \mathcal{U}_\infty, \quad (2.147)$$

$$y^{0,k} := \bar{y}^0 + \sigma_k z^0 + \frac{1}{2}\sigma_k^2 \xi^0 \in \mathbb{R}^{\bar{n}}, \quad (2.148)$$

$$y^k := \Gamma(u^k, y^{0,k}) \in \mathcal{Y}_\infty. \quad (2.149)$$

We have in particular

$$\|u^k - \bar{u}\|_\infty = o(1), \quad \|u^k - \bar{u}\|_2 = O(\sigma_k). \quad (2.150)$$

By analogy with linearized trajectories, we denote

$$z[\tilde{v}, \tilde{z}^0] := D\Gamma(\bar{u}, \bar{y}^0)(\tilde{v}, \tilde{z}^0), \quad z^2[\tilde{v}, \tilde{z}_0] := D^2\Gamma(\bar{u}, \bar{y}^0)(\tilde{v}, \tilde{z}^0)^2 \quad (2.151)$$

for any $(\tilde{v}, \tilde{z}^0) \in \mathcal{U}_\infty \times \mathbb{R}^{\bar{n}}$. Since Γ satisfies Property 2, we have in \mathcal{Y}_∞

$$y^k = \bar{y} + \sigma_k z[v^k, z^0] + \frac{1}{2}\sigma_k^2 \left(z[w^k, \xi^0] + z^2[v^k, z^0] \right) + o(\sigma_k^2), \quad (2.152)$$

and in particular, $\|y^k - \bar{y}\|_\infty = O(\sigma_k)$. Then $(u^k, y^k) \rightarrow (\bar{u}, \bar{y})$ in $\mathcal{U}_\infty \times \mathcal{Y}_\infty$ and

$$\|G_2^+(u^k, y^k)\|_\infty = o(1). \quad (2.153)$$

More precisely, since m_i is uniformly quasi- C^2 , we have

$$\begin{aligned} G_2^i(u^k, y^k) &= G_2^i(\bar{u}, \bar{y}) + DG_2^i(\bar{u}, \bar{y})(u^k - \bar{u}, y^k - \bar{y}) \\ &\quad + \frac{1}{2}D^2G_2^i(\bar{u}, \bar{y})(u^k - \bar{u}, y^k - \bar{y})^2 + o(|u^k - \bar{u}|^2 + |y^k - \bar{y}|^2) \end{aligned} \quad (2.154)$$

a.e. on Δ_i , where $o(\cdot)$ is uniform w.r.t. t . We write

$$G_2^i(u^k, y^k)_t = \frac{1}{2}T_t^{i,k} + \frac{1}{2}Q_t^{i,k} + R_t^{i,k} \quad (2.155)$$

where, omitting the time argument t ,

$$T^{i,k} := G_2^i(\bar{u}, \bar{y}) + 2\sigma_k DG_2^i(\bar{u}, \bar{y})(v^k, z[v^k, z^0]), \quad (2.156)$$

$$Q^{i,k} := G_2^i(\bar{u}, \bar{y}) + \sigma_k^2 (DG_2^i(\bar{u}, \bar{y})(w^k, z[w^k, \xi^0]) + D^2G_2^i(\bar{u}, \bar{y})(v^k, z[v^k, z^0])^2 + D_y G_2^i(\bar{u}, \bar{y})z^2[v^k, z^0]), \quad (2.157)$$

$$R^{i,k} = \frac{1}{2}\sigma_k^3 D^2G_2^i(\bar{u}, \bar{y}) \left[(v^k, z[v^k, z^0]), (w^k, z[w^k, \xi^0] + z^2[v^k, z^0] + o(1)) \right] + \frac{1}{4}\sigma_k^4 D^2G_2^i(\bar{u}, \bar{y})(w^k, z[w^k, \xi^0] + z^2[v^k, z^0] + o(1))^2 + o(|u^k - \bar{u}|^2 + |y^k - \bar{y}|^2) \quad (2.158)$$

We claim that $\|R^{i,k}\|_1 = o(\sigma_k^2)$. Indeed, $z[v^k, z^0]$, $z[w^k, \xi^0]$ and $z^2[v^k, z^0]$ are bounded in \mathcal{Y}_∞ ; the crucial terms are then the following:

$$\|\sigma_k^3 D_{uu}^2 G_2^i(\bar{u}, \bar{y})(v^k, w^k)\|_1 = O\left(\|\sigma_k v^k\|_\infty \cdot \|\sigma_k^2 w^k\|_1\right) = o(\sigma_k^2) \quad (2.159)$$

$$\|\sigma_k^4 D_{uu}^2 G_2^i(\bar{u}, \bar{y})(w^k, w^k)\|_1 = O\left(\|\sigma_k^2 w^k\|_\infty \cdot \|\sigma_k^2 w^k\|_1\right) = o(\sigma_k^2) \quad (2.160)$$

$$\|o(|u^k - \bar{u}|^2 + |y^k - \bar{y}|^2)\|_1 = o\left(\|u^k - \bar{u}\|_2^2 + \|y^k - \bar{y}\|_2^2\right) = o(\sigma_k^2) \quad (2.161)$$

by (2.144),(2.145) and (2.150),(2.152). Recall that $(v, z^0) \in C_2^{QR}(AP)$. Then by (2.146) and Property 1, satisfied by Γ , we have

$$\text{dist}_{L^1} \left(T^{i,k}, L^1(\Delta_i; \mathbb{R}_-) \right) = o(\sigma_k^2). \quad (2.162)$$

Similarly, since (w, ξ^0) is feasible for $(Q_{(v, z^0)})$ and Γ satisfies Property 2,

$$\text{dist}_{L^1} \left(Q^{i,k}, L^1(\Delta_i; \mathbb{R}_-) \right) = o(\sigma_k^2). \quad (2.163)$$

Then, in addition to (2.153), we have proved that

$$\|G_2^+(u^k, y^k)\|_1 = o(\sigma_k^2). \quad (2.164)$$

We apply now Lemma 2.50 to the sequence (u^k, y^k) ; we get a sequence $(\hat{u}^k, \hat{y}^k) \in \mathcal{U}_\infty \times \mathcal{Y}_\infty$ with $\hat{y}^k = \Gamma(\hat{u}^k, y^{0,k})$ and such that

$$\|\hat{u}^k - u^k\|_\infty = o(1), \quad (2.165)$$

$$\|\hat{u}^k - u^k\|_1 = o(\sigma_k^2), \quad (2.166)$$

$$\|G_2^+(\hat{u}^k, \hat{y}^k)\|_\infty = o(\sigma_k^2). \quad (2.167)$$

Since G_1 satisfies Property 2, $(v, z^0) \in C_2^{QR}(AP)$ and (w, ξ^0) is feasible for $(Q_{(v, z^0)})$, we get

$$\text{dist}_X(G_1(\hat{u}^k, y^{0,k}), K) = o(\sigma_k^2), \quad (2.168)$$

and then, together with (2.167),

$$\text{dist}_{X_\infty}(G(\hat{u}^k, y^{0,k}), K_\infty) = o(\sigma_k^2). \quad (2.169)$$

By Robinson's constraint qualification (2.118), G is metric regular at (\bar{u}, \bar{y}^0) w.r.t. K_∞ , [21, Theorem 2.87]. Then there exists $(\tilde{u}^k, \tilde{y}^{0,k}) \in \mathcal{U}_\infty \times \mathbb{R}^{\bar{n}}$ such that

$$\begin{cases} \|\tilde{u}^k - \hat{u}^k\|_\infty + |\tilde{y}^{0,k} - y^{0,k}| = o(\sigma_k^2), \\ G(\tilde{u}^k, \tilde{y}^{0,k}) \in K_\infty. \end{cases} \quad (2.170)$$

Since (\bar{u}, \bar{y}^0) is a locally optimal solution, $J(\tilde{u}^k, \tilde{y}^{0,k}) \geq J(\bar{u}, \bar{y}^0)$ for k big enough. By Property 2, satisfied by J , we have

$$\sigma_k DJ(\bar{u}, \bar{y}^0)(v, z^0) + \frac{1}{2}\sigma_k^2 (DJ(\bar{u}, \bar{y}^0)(w, \xi^0) + D^2J(\bar{u}, \bar{y}^0)(v, z^0)^2) + o(\sigma_k^2) \geq 0. \quad (2.171)$$

The conclusion of Lemma 2.49 follows by Theorem 2.47 and Remark 2.46. \square

2.A.2 Proof of Proposition 2.18

The proof of Proposition 2.18 relies on the following two lemmas, proved at the end of the section. The first one is a consequence of Lyapunov theorem [50] and links relaxed dynamics to classical dynamics.

Lemma 2.52. *Let $F: [0, T] \times \mathbb{R}^m \times \mathbb{R}^n \rightarrow \mathbb{R}^n$ and $G: [0, T] \times \mathbb{R}^n \rightarrow \mathbb{R}^n$ be uniformly quasi- C^1 . Let $(\hat{u}, \hat{\alpha}, \hat{y}) \in \mathcal{U} \times \mathcal{A}^N \times \mathcal{Y}$ such that, for a.a. t , $0 \leq \hat{\alpha}^i \leq 1/N$ and*

$$\dot{\hat{y}}_t = \left(1 - \sum_{i=1}^N \hat{\alpha}_t^i\right) F(t, \hat{u}_t, \hat{y}_t) + \sum_{i=1}^N \hat{\alpha}_t^i F(t, u_t^i, \hat{y}_t) + G(t, \hat{y}_t). \quad (2.172)$$

Then, for any $\varepsilon > 0$, there exists $(u, y) \in \mathcal{U} \times \mathcal{Y}$ such that

$$\dot{y}_t = F(t, u_t, y_t) + G(t, y_t) \quad \text{for a.a. } t, \quad y_0 = \hat{y}_0, \quad (2.173)$$

$$u_t \in \{\hat{u}_t, u_t^1, \dots, u_t^N\} \quad \text{for a.a. } t, \quad (2.174)$$

$$\|u - \hat{u}\|_1 \leq \sum_{i=1}^N \|\hat{\alpha}^i\|_1 \|u^i - \hat{u}\|_\infty, \quad (2.175)$$

$$\|y - \hat{y}\|_\infty \leq \varepsilon. \quad (2.176)$$

The second one is a metric regularity result, consequence of the qualification of problem (P_N) at $(\bar{u}, \bar{\alpha}, \bar{y}, \bar{\theta})$.

Lemma 2.53. *There exists $c > 0$ such that for any relaxed trajectory (u, α, y, θ) with u in a L^1 neighborhood of \bar{u} and (α, y) in a L^∞ neighborhood of $(\bar{\alpha}, \bar{y})$, there exists a relaxed trajectory $(u', \alpha', y', \theta)$ such that*

$$\begin{cases} \|u' - u\|_\infty + \|\alpha' - \alpha\|_\infty + \|y' - y\|_\infty \leq c|\Phi^E(y_0, y_T)|, \\ \Phi^E(y'_0, y'_T) = 0. \end{cases} \quad (2.177)$$

We can now prove the proposition. The idea is to use alternatively Lemma 2.52 to diminish progressively $\hat{\alpha}$, and Lemma 2.53 to restore the equality constraints at each step.

Proof of Proposition 2.18. Let $(\hat{u}, \hat{y}, \hat{\alpha}, \hat{\theta}) \in F(P_N)$, close to $(\bar{u}, \bar{y}, \bar{\alpha}, \bar{\theta})$ and with $\hat{\theta} < 0$. Without loss of generality, we assume that $\hat{\alpha} \neq 0$ and, see Lemma 2.14, that

$$c(t, u_t^i, \hat{y}_t) \leq \hat{\theta} \quad \text{for a.a. } t, \quad 1 \leq i \leq N. \quad (2.178)$$

Let $R := \text{diam}_{L^\infty} \{\hat{u}, u^1, \dots, u^N\}$ and let $\varepsilon > 0$. We claim that there exists a sequence $(\hat{u}^k, \hat{y}^k, \hat{\alpha}^k, \hat{\theta}^k) \in F(P_N)$ such that $(\hat{u}^0, \hat{y}^0, \hat{\alpha}^0, \hat{\theta}^0) = (\hat{u}, \hat{y}, \hat{\alpha}, \hat{\theta})$, and for all k ,

$$\text{diam}_{L^\infty} \{\hat{u}^k, u^1, \dots, u^N\} < 2R, \quad (2.179)$$

$$c(t, u_t^i, \hat{y}_t^k) \leq \hat{\theta}^k \quad \text{for a.a. } t, \quad 1 \leq i \leq N, \quad (2.180)$$

$$\|\hat{u}^{k+1} - \hat{u}^k\|_1 \leq \left(\frac{3}{4}\right)^{k+1} 2RNT\|\hat{\alpha}\|_\infty, \quad (2.181)$$

$$\|\hat{y}^{k+1} - \hat{y}^k\|_\infty \leq \left(\frac{3}{4}\right)^{k+1} \frac{\varepsilon}{4}, \quad (2.182)$$

$$\|\hat{\alpha}^{k+1}\|_\infty \leq \left(\frac{3}{4}\right)^{k+1} \|\hat{\alpha}\|_\infty, \quad (2.183)$$

$$\hat{\theta}^{k+1} = \frac{1}{4}\hat{\theta}^k. \quad (2.184)$$

Suppose for a while that we have such a sequence. By (2.181)-(2.183), there exist $\tilde{u} \in L^1(0, T; \mathbb{R}^m)$ and $\tilde{y} \in C([0, T]; \mathbb{R}^n)$, and $\hat{u}^k \rightarrow \tilde{u}$ in L^1 , $\hat{y}^k \rightarrow \tilde{y}$ in C , and $\hat{\alpha}^k \rightarrow 0$ in L^∞ . By (2.179), $\tilde{u} \in \mathcal{U}$, and since $(\hat{u}^k, \hat{y}^k, \hat{\alpha}^k, \hat{\theta}^k) \in F(P_N)$ and $\hat{\theta}^k < 0$ for all k , we get that $(\tilde{u}, \tilde{y}) \in F(P)$ by doing $k \rightarrow \infty$ in the relaxed dynamics and in the constraints. Finally,

$$\|\tilde{u} - \hat{u}\|_1 \leq 8RNT\|\hat{\alpha} - \bar{\alpha}\|_\infty \quad \text{and} \quad \|\tilde{y} - \hat{y}\|_\infty \leq \varepsilon. \quad (2.185)$$

It remains to prove the existence the sequence. Suppose we have it up to index k and let us get the next term. Let F^k and G^k be defined by

$$F^k(t, u, y) := \left(1 - \sum_{i=1}^N \frac{\hat{\alpha}_t^{i,k}}{2}\right) f(t, u, y), \quad G^k(t, y) := \sum_{i=1}^N \frac{\hat{\alpha}_t^{i,k}}{2} f(t, u_t^i, y). \quad (2.186)$$

Since $(\hat{u}^k, \hat{y}^k, \hat{\alpha}^k, \hat{\theta}^k)$ is a relaxed trajectory, we can write

$$\begin{aligned} \dot{y}_t^k &= \left(1 - \sum_{i=1}^N \frac{\hat{\alpha}_t^{i,k}/2}{1 - \sum_{j=1}^N \hat{\alpha}_t^{j,k}/2}\right) F^k(t, \hat{u}_t^k, \hat{y}_t^k) \\ &\quad + \sum_{i=1}^N \frac{\hat{\alpha}_t^{i,k}/2}{1 - \sum_{j=1}^N \hat{\alpha}_t^{j,k}/2} F^k(t, u_t^i, \hat{y}_t^k) + G^k(t, \hat{y}_t^k). \end{aligned} \quad (2.187)$$

Let $\varepsilon' > 0$. We apply Lemma 2.52 and we get $(u, y) \in \mathcal{U} \times \mathcal{Y}$ such that $(u, y, \hat{\alpha}^k/2, \hat{\theta}^k)$ is a relaxed trajectory, and

$$u_t \in \{\hat{u}_t^k, u_t^1, \dots, u_t^N\} \quad \text{for a.a. } t, \quad (2.188)$$

$$\|u - \hat{u}^k\|_1 \leq \sum_{i=1}^N \left\| \frac{\hat{\alpha}_t^{k,i}/2}{1 - \sum_{j=1}^N \hat{\alpha}_t^{k,j}/2} \right\|_1 \|u^i - \hat{u}^k\|_\infty, \quad (2.189)$$

$$\|y - \hat{y}^k\|_\infty \leq \varepsilon'. \quad (2.190)$$

By (2.188), we have

$$\text{diam}_{L^\infty} \{u, u^1, \dots, u^N\} \leq \text{diam}_{L^\infty} \{\hat{u}^k, u^1, \dots, u^N\} < 2R, \quad (2.191)$$

$$c(t, u_t, \hat{y}_t^k) \leq \hat{\theta}^k \quad \text{for a.a. } t. \quad (2.192)$$

By (2.190), and since $\hat{\theta}^k < 0$, we have for ε' small enough,

$$c(t, u_t, y_t) \leq \frac{1}{2} \hat{\theta}^k \quad \text{for a.a. } t, \quad (2.193)$$

$$g(t, y_t) \leq \frac{1}{2} \hat{\theta}^k \quad \text{for a.a. } t, \quad (2.194)$$

$$\Phi^I(y_0, y_T) \leq \frac{1}{2} \hat{\theta}^k, \quad (2.195)$$

$$\phi(y_0, y_T) - \phi(\bar{y}_0, \bar{y}_T) \leq \frac{1}{2} \hat{\theta}^k, \quad (2.196)$$

$$\Phi^E(y_0, y_T) = O(\varepsilon'). \quad (2.197)$$

Observe that

$$\left|1 - \sum \hat{\alpha}_t^{k,j}/2\right| \geq 1 - N\|\hat{\alpha}\|_\infty \geq \frac{3}{4} \quad (2.198)$$

for $\|\hat{\alpha}\|_\infty$ small enough. Then by (2.183), (2.189) and (2.191),

$$\|u - \hat{u}^k\|_1 \leq \frac{3}{8} \left(\frac{3}{4}\right)^k 2RNT\|\hat{\alpha}\|_\infty. \quad (2.199)$$

We now apply Lemma 2.53 to $(u, y, \hat{\alpha}^k/2)$ and we get $(\hat{u}^{k+1}, \hat{y}^{k+1}, \hat{\alpha}^{k+1})$ such that $\Phi^E(\hat{y}_0^{k+1}, \hat{y}_T^{k+1}) = 0$ and, by (2.197),

$$\|\hat{u}^{k+1} - u\|_\infty + \|\hat{y}^{k+1} - y\|_\infty + \left\| \hat{\alpha}^{k+1} - \frac{\hat{\alpha}^k}{2} \right\|_\infty = O(\varepsilon'). \quad (2.200)$$

Then for $\hat{\theta}^{k+1} := \hat{\theta}^k/4$ and ε' small enough, $(\hat{u}^{k+1}, \hat{y}^{k+1}, \hat{\alpha}^{k+1}, \hat{\theta}^{k+1}) \in F(P_N)$. Moreover,

$$\text{diam}_{L^\infty} \left\{ \hat{u}^{k+1}, u^1, \dots, u^N \right\} < 2R + \left\| \hat{u}^{k+1} - u \right\|_\infty, \quad (2.201)$$

$$\left\| \hat{u}^{k+1} - \hat{u}^k \right\|_1 \leq \frac{3}{8} \left(\frac{3}{4} \right)^k 2RNT \|\hat{\alpha}\|_\infty + T \left\| \hat{u}^{k+1} - u \right\|_\infty, \quad (2.202)$$

$$\left\| \hat{y}^{k+1} - \hat{y}^k \right\|_\infty \leq \varepsilon' + \left\| \hat{y}^{k+1} - y \right\|_\infty, \quad (2.203)$$

$$\left\| \hat{\alpha}^{k+1} \right\|_\infty \leq \frac{1}{2} \left(\frac{3}{4} \right)^k \|\hat{\alpha}\|_\infty + \left\| \hat{\alpha}^{k+1} - \frac{\hat{\alpha}^k}{2} \right\|_\infty \quad (2.204)$$

By (2.200), and since $\|\hat{\alpha}\|_\infty \neq 0$, we get the sequence up to index $k+1$ for ε' small enough. \square

Proof of Lemma 2.52. We need the following consequence of Gronwall's lemma:

Lemma 2.54. *Let $B: [0, T] \times \mathbb{R}^n \rightarrow \mathbb{R}^n$ be uniformly quasi- C^1 . Then there exists $C > 0$ such that, for any $b \in L^\infty(0, T; \mathbb{R}^n)$ and $e^1, e^2 \in \mathcal{Y}$ such that*

$$\begin{cases} \dot{e}_t^2 - \dot{e}_t^1 = B(t, e_t^2) - B(t, e_t^1) + b_t & \text{for a.a. } t, \\ e_0^2 - e_0^1 = 0, \end{cases} \quad (2.205)$$

we have

$$\|e^2 - e^1\|_\infty \leq C \|\hat{b}\|_1, \quad (2.206)$$

where \hat{b} is defined by $\hat{b}_t := \int_0^t b_s ds$.

Proof. Let $w := e^2 - e^1 - \hat{b}$. Then $\dot{w}_t = B(t, e_t^2) - B(t, e_t^1)$, and

$$|\dot{w}_t| \leq C'|e_t^2 - e_t^1| \leq C'(|w_t| + |\hat{b}_t|). \quad (2.207)$$

The result follows by Gronwall's lemma. \square

Let $\varepsilon > 0$, $M \in \mathbb{N}^*$, and $t_j := jT/M$ for $0 \leq j \leq M$. Let us denote by $(e_i)_i$, $1 \leq i \leq N$ the canonical basis of \mathbb{R}^N , and let us define $\tilde{F}^i: [0, T] \rightarrow \mathbb{R}^n \times \mathbb{R}^N$ by

$$\tilde{F}_t^0 := (F(t, \hat{u}_t, \hat{y}_t), 0), \quad \tilde{F}_t^i := (F(t, u_t^i, \hat{y}_t), e_i) \quad 1 \leq i \leq N. \quad (2.208)$$

For $0 \leq j < M$, we apply Lyapunov theorem [50] to the family $(\tilde{F}^i)_i$ with coefficients $(\hat{\alpha}^i)_i$ on $[t_j, t_{j+1}]$. We get the existence of $\alpha \in \mathcal{A}^N$, with values in $\{0, 1\}^N$, and such that for $0 \leq j < M$,

$$\int_{t_j}^{t_{j+1}} \left[\left(1 - \sum_{i=1}^N \alpha_t^i\right) \tilde{F}_t^0 + \sum_{i=1}^N \alpha_t^i \tilde{F}_t^i \right] dt = \int_{t_j}^{t_{j+1}} \left[\left(1 - \sum_{i=1}^N \hat{\alpha}_t^i\right) \tilde{F}_t^0 + \sum_{i=1}^N \hat{\alpha}_t^i \tilde{F}_t^i \right] dt. \quad (2.209)$$

Projecting (2.209) on the first n coordinates, we get that

$$\begin{aligned} & \int_{t_j}^{t_{j+1}} \left[\left(1 - \sum_{i=1}^N \alpha_t^i\right) F(t, \hat{u}_t, \hat{y}_t) + \sum_{i=1}^N \alpha_t^i F(t, u_t^i, \hat{y}_t) \right] dt \\ &= \int_{t_j}^{t_{j+1}} \left[\left(1 - \sum_{i=1}^N \hat{\alpha}_t^i\right) F(t, \hat{u}_t, \hat{y}_t) + \sum_{i=1}^N \hat{\alpha}_t^i F(t, u_t^i, \hat{y}_t) \right] dt. \end{aligned} \quad (2.210)$$

Let $u_t := \hat{u}_t + \sum_{i=1}^N \alpha_t^i (u_t^i - \hat{u}_t)$. Note that for a.a. t , $u_t \in \{\hat{u}_t, \dots, u_t^N\}$. We get by (2.210) that

$$\int_{t_j}^{t_{j+1}} F(t, u_t, \hat{y}_t) dt = \int_{t_j}^{t_{j+1}} \left[\left(1 - \sum_{i=1}^N \hat{\alpha}_t^i\right) F(t, \hat{u}_t, \hat{y}_t) + \sum_{i=1}^N \hat{\alpha}_t^i F(t, u_t^i, \hat{y}_t) \right] dt. \quad (2.211)$$

Projecting (2.209) on the last N coordinates, we get that for $1 \leq i \leq N$,

$$\int_{t_j}^{t_{j+1}} \alpha_t^i dt = \int_{t_j}^{t_{j+1}} \hat{\alpha}_t^i dt. \quad (2.212)$$

Summing (2.212) for $0 \leq j \leq M$, we get that $\|\alpha^i\|_1 = \|\hat{\alpha}^i\|_1$ for $1 \leq i \leq N$. Since

$$\|u - \hat{u}\|_1 \leq \sum_{i=1}^N \|\alpha\|_1 \|u^i - \hat{u}\|_\infty, \quad (2.213)$$

we get (2.175). Let y be the unique solution of (2.173); we estimate $\|y - \hat{y}\|_\infty$ with Lemma 2.54. Let b be defined by

$$b_t := F(t, u_t, \hat{y}_t) - \left(1 - \sum_{i=1}^N \hat{\alpha}_t^i\right) F(t, \hat{u}_t, \hat{y}_t) - \sum_{i=1}^N \hat{\alpha}_t^i F(t, u_t^i, \hat{y}_t), \quad (2.214)$$

and let \hat{b} be defined by $\hat{b}_t := \int_0^t b_s ds$. By (2.211), $\hat{b}_{t_j} = 0$ for $0 \leq j \leq M$. Therefore, $\|\hat{b}\|_\infty = O(1/M)$. Observe now that for a.a. t ,

$$\dot{y}_t - \dot{\hat{y}}_t = F(t, u_t, y_t) + G(t, y_t) - F(t, u_t, \hat{y}_t) - G(t, \hat{y}_t) + b_t. \quad (2.215)$$

By Lemma 2.54, $\|y - \hat{y}\|_\infty = O(1/M)$. For M large enough, we get (2.176), and the proof is completed. \square

Proof of Lemma 2.53. Note that the L^1 -distance is involved for the control. The lemma is obtained with an extension of the nonlinear open mapping theorem [3, Theorem 5]. This result can be applied since the derivative of the mapping defined in (2.52) can be described explicitly with a linearized state equation and therefore, by Gronwall's lemma, is continuous for the L^1 -distance on the control u . \square

2.A.3 A qualification condition

2.A.3.1 Statement

We give here a qualification condition equivalent to the non singularity of generalized Pontryagin multipliers. This qualification condition is expressed with the Pontryagin linearization [55, Proposition 8.1]. In this section, $(\bar{u}, \bar{y}) \in F(P)$ is given. We will always assume that Assumption 2.2 holds.

Definition 2.55. *We say that $\lambda = (\beta, \Psi, \nu, \mu) \in \Lambda_L(\bar{u}, \bar{y})$ is singular iff $\beta = 0$ and that λ is normal iff $\beta = 1$.*

Given $u \in \mathcal{U}$, we define the Pontryagin linearization $\xi[u] \in \mathcal{Y}$ as the unique solution of

$$\begin{cases} \dot{\xi}_t[u] = D_y f(t, \bar{u}_t, \bar{y}_t) \xi_t[u] + f(t, u_t, \bar{y}_t) - f(t, \bar{u}_t, \bar{y}_t), \\ \xi_0[u] = 0. \end{cases} \quad (2.216)$$

Note that $\xi[\bar{u}] = 0$. Recall that U is the set-valued mapping defined by (2.22). We define

$$\mathcal{U}_c := \{u \in \mathcal{U} : u_t \in U(t) \text{ for a.a. } t\}. \quad (2.217)$$

Definition 2.56. *We say that the problem is qualified in the Pontryagin sense (in short P-qualified) at (\bar{u}, \bar{y}) iff*

(i) *the following surjectivity condition holds:*

$$0 \in \text{int} \{D\Phi^E(\bar{y}_0, \bar{y}_T)(z_0, \xi_T[u] + z_T[v, z_0]) : u \in \mathcal{U}_c, v \in \mathcal{U}, z_0 \in \mathbb{R}^n\}, \quad (2.218)$$

(ii) *there exist $\varepsilon > 0$, $\hat{u} \in \mathcal{U}_c$, $\hat{v} \in \mathcal{U}$, and $\hat{z}_0 \in \mathbb{R}^n$ such that*

$$D\Phi^E(\bar{y}_0, \bar{y}_T)(\hat{z}_0, \xi_T[\hat{u}] + z_T[\hat{v}, \hat{z}_0]) = 0, \quad (2.219)$$

and for a.a. t ,

$$\begin{cases} \Phi^I(\bar{y}_0, \bar{y}_T) + D\Phi^I(\bar{y}_0, \bar{y}_T)(\hat{z}_0, \xi_T[\hat{u}] + z_T[\hat{v}, \hat{z}_0]) \leq -\varepsilon, \\ g(t, \bar{y}_t) + Dg(t, \bar{y}_t)(\xi_t[\hat{u}] + z_t[\hat{v}, \hat{z}_0]) \leq -\varepsilon, \\ c(t, \bar{u}_t, \bar{y}_t) + D_y c(t, \bar{u}_t, \bar{y}_t) \xi_t[\hat{u}] + Dc(t, \bar{u}_t, \bar{y}_t)(\hat{v}_t, z_t[\hat{v}_t, \hat{z}_0]) \leq -\varepsilon. \end{cases} \quad (2.220)$$

Note that if we impose $u = \bar{u}$ in the definition of the P-qualification, we obtain the usual qualification conditions, which are equivalent to the normality of Lagrange multipliers. The P-qualification is then weaker, and as proved in the next theorem, it is necessary and sufficient to ensure the non singularity of Pontryagin multipliers.

Theorem 2.57. *Let Assumption 2.2 hold. Then, the set of singular Pontryagin multipliers is empty if and only if the problem is P-qualified.*

We prove this result in the following two paragraphs.

Proposition 2.58. *Let Assumption 2.2 hold. If the set of singular Pontryagin multipliers is empty, then the set of normal Pontryagin multipliers is bounded in E .*

Proof. Remember that the norm of E is defined by (2.11). We prove the result by contraposition and consider a sequence $(\lambda^k)_k$ of normal Pontryagin multipliers which is such that $\|\lambda^k\|_E \rightarrow +\infty$. Then, by Lemma 2.15, the sequence $\lambda^k / \|\lambda^k\|_E$ possesses a weak limit point in $\Lambda_P(\bar{u}, \bar{y})$, say $\lambda = (\beta, \Psi, \nu, \mu)$, which is such that

$$\beta = \lim_k \frac{1}{\|\lambda^k\|_E} = 0. \quad (2.221)$$

Therefore, λ is singular. The proposition is proved. \square

2.A.3.2 Sufficiency of the qualification condition

In this paragraph, we prove by contradiction that the P-qualification implies the non singularity of Pontryagin multipliers. Let us assume that the problem is P-qualified and that there exists $\lambda = (\beta, \Psi, \nu, \mu) \in \Lambda_P(\bar{u}, \bar{y})$ with $\beta = 0$ and $\Psi = (\Psi^E, \Psi^I)$. Let $\hat{u}, \hat{v}, \hat{z}_0$ be such that (2.219)-(2.220) hold. With an integration by parts and using the stationarity of the augmented Hamiltonian, we get that for all $u \in \mathcal{U}_c, v \in \mathcal{U}$, and $z_0 \in \mathbb{R}^n$,

$$\begin{aligned} & \int_0^T \nu_t (Dc(t, \bar{u}_t, \bar{y}_t)(v_t, z_t[v, z_0]) + D_y c(t, \bar{u}_t, \bar{y}_t) \xi_t[u]) dt \\ & + \int_0^T Dg(t, \bar{y}_t)(\xi_t[u] + z_t[v, z_0]) d\mu_t \\ & + D\Phi[0, (\Psi^E, \Psi^I)](\bar{y}_0, \bar{y}_T)(z_0, \xi_T[u] + z_T[v, z_0]) \\ = & \int_0^T H[p_t^\lambda](t, u_t, \bar{y}_t) - H[p_t^\lambda](t, \bar{u}_t, \bar{y}_t) dt \geq 0. \end{aligned} \quad (2.222)$$

By (2.219)-(2.220) and the nonnegativity of Ψ^I, ν , and μ , we obtain that for $u = \hat{u}, v = \hat{v}, z_0 = \hat{z}_0$, the r.h.s. of (2.222) is nonpositive and thus equal to 0. Therefore, Ψ^I, ν , and μ are null and for all $u \in \mathcal{U}_c, v \in \mathcal{U}$, and $z_0 \in \mathbb{R}^n$,

$$\Psi^E D\Phi^E(\bar{y}_0, \bar{y}_T)(z_0, \xi_T[u] + z_T[v, z_0]) \geq 0. \quad (2.223)$$

By (2.218), we can choose u, v , and z_0 so that for $\beta > 0$ sufficiently small,

$$D\Phi^E(\bar{y}_0, \bar{y}_T)(z_0, \xi_T[u] + z_T[v, z_0]) = -\beta(\Psi^E)^T. \quad (2.224)$$

Combined with (2.223), we obtain that $-\beta|\Psi^E|^2 \geq 0$. Then, $\Psi^E = 0$ and finally $\lambda = 0$, in contradiction with $\lambda \in \Lambda_P(\bar{u}, \bar{y})$.

2.A.3.3 Necessity of the qualification condition

We now prove that the P-qualification is necessary to ensure the non singularity of Pontryagin multipliers. In some sense, the approach consists in describing this qualification condition as the limit of the qualification conditions associated with a sequence of partially relaxed problems.

Let us fix a Castaing representation $(u^k)_k$ of U . For all $N \in \mathbb{N}$, we consider a partially relaxed problem (\tilde{P}_N) defined by

$$\min_{u \in \mathcal{U}, \alpha \in \mathcal{A}^N, y \in \mathcal{Y}} \phi(y_0, y_T) \quad \text{s.t. constraints (2.3)-(2.5), } y = y[u, \alpha, y_0], \text{ and } \alpha \geq 0, \quad (\tilde{P}_N)$$

where $y[u, \alpha, y^0]$ is the solution to the partially relaxed state equation (2.43). This problem is the same as problem (P_N) , except that there is no variable θ .

For given $v \in \mathcal{U}, z_0 \in \mathbb{R}^n$ and $\alpha \in \mathcal{A}^N$, we denote by $z[v, z_0]$ the linearized state variable in the direction (v, z_0) , which is the solution to (2.70) and we denote by $\xi[\alpha]$

the linearized state variable in the direction α , which is the solution to

$$\begin{cases} \dot{\xi}_t[\alpha] = D_y f(t, \bar{u}_t, \bar{y}_t) \xi_t[\alpha] + \sum_{i=1}^N \alpha_t^i (f(t, u_t^i, \bar{y}_t) - f(t, \bar{u}_t, \bar{y}_t)), \\ \xi_0[\alpha] = 0. \end{cases} \quad (2.225)$$

The distinction between the Pontryagin linearization $\xi[u]$ and $\xi[\alpha]$ will be clear in the sequel, and we will motivate this choice of notations in Lemma 2.61.

Problem (\tilde{P}_N) is qualified (in the usual sense) iff

(i) the following surjectivity condition holds:

$$0 \in \text{int}\{D\Phi^E(\bar{y}_0, \bar{y}_T)(z_0, \xi_T[\alpha] + z_T[v, z_0]) : \alpha \in \mathcal{A}^N, v \in \mathcal{U}, z_0 \in \mathbb{R}^n\} \quad (2.226)$$

(ii) there exist $\varepsilon > 0$, $\hat{\alpha} \in \mathcal{A}^N$, $\hat{v} \in \mathcal{U}$, $\hat{z}_0 \in \mathbb{R}^n$ such that

$$D\Phi^E(\bar{y}_0, \bar{y}_T)(\hat{z}_0, \xi_T[\hat{\alpha}] + z_T[\hat{v}, \hat{z}_0]) = 0 \quad (2.227)$$

and

$$\begin{cases} \Phi^I(\bar{y}_0, \bar{y}_T) + D\Phi^I(\bar{y}_0, \bar{y}_T)(\hat{z}_0, \xi_T[\hat{\alpha}] + z_T[\hat{v}, \hat{z}_0]) \leq -\varepsilon, \\ g(t, \bar{y}_t) + Dg(t, \bar{y}_t)(\xi_t[\hat{\alpha}] + z_t[\hat{v}, \hat{z}_0]) \leq -\varepsilon, \quad \text{for all } t, \\ c(t, \bar{u}_t, \bar{y}_t) + Dc(t, \bar{u}_t, \bar{y}_t)(\hat{v}_t, \xi_t[\hat{\alpha}] + z_t[\hat{v}, \hat{z}_0]) \leq -\varepsilon, \quad \text{for a.a. } t, \\ \hat{\alpha}_t \geq \varepsilon, \quad \text{for a.a. } t. \end{cases} \quad (2.228)$$

We denote now by $\Lambda(\tilde{P}_N)$ the set of generalized Lagrange multipliers of problem (\tilde{P}_N) at $(\bar{u}, \alpha = 0, \bar{y})$. Following the proof of Lemma 2.20, we easily obtain that

$$\begin{aligned} \Lambda(\tilde{P}_N) &= \{(\lambda, \gamma) \in \Lambda^N(\bar{u}, \bar{y}) \times L^\infty([0, T]; \mathbb{R}_+^k) : \\ &\quad \gamma_t^i = H[p_t^\lambda](t, u_t^i, \bar{y}_t) - H[p_t^\lambda](t, \bar{u}_t, \bar{y}_t), \text{ for } i = 1, \dots, N, \text{ for a.a. } t\}, \end{aligned} \quad (2.229)$$

where $\Lambda^N(\bar{u}, \bar{y})$ is defined by (2.35) and γ is associated with the constraint $\alpha \geq 0$.

Lemma 2.59. *Let $N \in \mathbb{N}$; all multipliers of $\Lambda^N(\bar{u}, \bar{y})$ are non singular if and only if problem (\tilde{P}_N) is qualified.*

Proof. It is known that all multipliers of $\Lambda(\tilde{P}_N)$ are non singular if and only if problem (\tilde{P}_N) is qualified, see e.g. [21, Proposition 3.16]. It follows from (2.229) that all multipliers of $\Lambda^N(\bar{u}, \bar{y})$ are non singular if and only if the multipliers of $\Lambda(\tilde{P}_N)$ are non singular. This proves the lemma. \square

As a corollary, we obtain that if problem (\tilde{P}_N) is qualified at stage N , it is also qualified at stage $N + 1$. Indeed, if none of the multipliers in $\Lambda^N(\bar{u}, \bar{y})$ is singular, *a fortiori*, none of the multipliers in $\Lambda^{N+1}(\bar{u}, \bar{y})$ is singular, since $\Lambda^{N+1}(\bar{u}, \bar{y}) \subset \Lambda^N(\bar{u}, \bar{y})$.

Proposition 2.60. *The set of singular Pontryagin multipliers is empty if and only if there exists $N \in \mathbb{N}$ such that problem (\tilde{P}_N) is qualified.*

Proof. Let $N \in \mathbb{N}$ be such that problem (\tilde{P}_N) is qualified. Then, all multipliers of $\Lambda^N(\bar{u}, \bar{y})$ are non singular, by Lemma 2.59. Since $\Lambda_P(\bar{u}, \bar{y}) \subset \Lambda^N(\bar{u}, \bar{y})$, the Pontryagin multipliers are non singular.

Conversely, assume that for all $N \in \mathbb{N}$, problem (\tilde{P}_N) is not qualified. By Lemma 2.59, we obtain a sequence of singular multipliers $(\lambda^N)_N$ which is such that for all N , $\lambda^N \in \Lambda^N(\bar{u}, \bar{y})$. Normalizing this sequence, we obtain with Lemma 2.15 the existence of a weak limit point in $\Lambda_P(\bar{u}, \bar{y})$, which is necessarily singular. \square

To conclude the proof, we still need a relaxation result, which makes a link between the Pontryagin linearization $\xi[u]$ and the linearization $\xi[\alpha]$.

Lemma 2.61. *Let $N \in \mathbb{N}$; assume that problem (\tilde{P}_N) is qualified. Then, there exists $A > 0$ such that for all $(\alpha, v, z_0) \in \mathcal{A}^N \times \mathcal{U}, \mathbb{R}^n$ with $\|\alpha\|_\infty \leq A$, $\|v\|_\infty \leq A$, $|z_0| \leq A$, for all $\varepsilon > 0$, if α is uniformly positive, then there exists $(u, v', z'_0) \in \mathcal{U}_c \times \mathcal{U} \times \mathbb{R}^n$ such that*

$$D\Phi^E(\bar{y}_0, \bar{y}_T)(z_0, \xi_T[u] + z_T[v, z_0]) = D\Phi^E(\bar{y}_0, \bar{y}_T)(z_0, \xi_T[\alpha] + z_T[v, z_0]), \quad (2.230)$$

$$\|\xi[u] - \xi[\alpha] + z[v' - v, z_0 - z'_0]\|_\infty \leq \varepsilon. \quad (2.231)$$

Proof. We only give some elements of proof. Note that this result is a variant of Proposition 2.18 and can be obtained with Dmitruk's result [28, Theorem 3]. Let us define

$$g(t, u, y) := D_y f(t, \bar{u}_t, \bar{y}_t)y + f(t, u, \bar{y}_t) - f(t, \bar{u}_t, \bar{y}_t). \quad (2.232)$$

Then, for all $u \in \mathcal{U}_c$, $\xi[u]$ is the solution to

$$\dot{\xi}_t[u] = g(t, \xi_t[u], u_t), \quad \xi_0[u] = 0. \quad (2.233)$$

and $\xi[\alpha]$, where $\alpha \in \mathcal{A}^N$ and $\alpha \geq 0$ is the solution to the relaxed system associated with the dynamics g and the Castaing representation. Indeed,

$$\begin{aligned} \dot{\xi}_t[\alpha] &= D_y f(t, \bar{u}_t, \bar{y}_t)\xi_t[\alpha] + \sum_{i=1}^N \alpha_t^i (f(t, u_t^i, \bar{y}_t) - f(t, \bar{u}_t, \bar{y}_t)) \\ &= \left(1 - \sum_{i=1}^N \alpha_t^i\right) g(t, \bar{u}_t, \bar{y}_t) + \sum_{i=1}^N \alpha_t^i (g(t, u_t^i, \bar{y}_t) - g(t, \bar{u}_t, \bar{y}_t)). \end{aligned} \quad (2.234)$$

Finally, we prove the result by building a sequence $(u^k, \alpha^k, v^k, z_0^k)$ which is such that

$$(u^0, \alpha^0, v^0, z_0^0) = (\bar{u}, \alpha, v, z_0), \quad (2.235)$$

$$\begin{aligned} D\Phi^E(\bar{y}_0, \bar{y}_T)(z_0, \xi_T[\alpha] + z_T[v, z_0]) \\ = D\Phi^E(\bar{y}_0, \bar{y}_T)(z_0^k, \xi_T[\alpha^k] + \xi_T[u^k] + z_T[v, z_0]), \end{aligned} \quad (2.236)$$

such that α^k is uniformly positive and finally which is such that $(u^k)_k$ converges to some $u \in \mathcal{U}_c$ in L^1 norm, $(\alpha^k)_k$ converges to 0 in L^∞ norm, and $(v^k, z_0^k)_k$ equally converges to some (v', z'_0) in L^∞ norm. This sequence is built by using Lemma 2.52 and by using the surjectivity condition (2.227). Note that Lemma 2.52 enables to ensure (2.231). \square

Let us conclude the proof of Theorem 2.57. Let us assume that the set of singular Pontryagin multipliers is empty; we already know by Proposition 2.60 that there exists $N \in \mathbb{N}$ such that the MF_N conditions hold. It remains to prove that the problem is P-qualified. Let $(\alpha^k, v^k, z_0^k)_{k=1, \dots, n_{\Phi E} + 1}$ be such that

$$0 \in \text{int} \left\{ \text{conv} \left[D\Phi^E(\bar{y}_0, \bar{y}_T)(z_0^k, z_T[v^k, z_0^k] + \xi_T[\alpha^k]), k = 1, \dots, n_{\Phi E} + 1 \right] \right\}. \quad (2.237)$$

Let $(\hat{\alpha}, \hat{v}, \hat{z}_0)$ be such that (2.228) holds. By (2.227), if we replace (α^k, v^k, z_0^k) by $(\alpha^k + \delta\hat{\alpha}, v^k + \delta\hat{v}, z_0^k + \delta\hat{z}_0)$, for any $\delta > 0$, then (2.237) still holds. Moreover, (2.237) remains true if we multiply this family by a given positive constant. Therefore, since $\hat{\alpha}$ is uniformly positive, we may assume that the family $(\alpha^k, v^k, z_0^k)_{k=1, \dots, n_{\Phi E} + 1}$ is bounded by A and such that for all $k = 1, \dots, n_{\Phi E} + 1$, α^k is uniformly positive. Finally, we can apply Lemma 2.61 to any convex combination of elements of the family. This proves the part of the P-qualification associated with equality constraints. Multiplying $(\hat{\alpha}, \hat{v}, \hat{z}_0)$ by a positive constant, we can assume that it is bounded by A and we can equally approximate it so that (2.219) holds and so that (2.220) holds (if the variable ε of Lemma 2.61 is chosen sufficiently small). We have proved that the problem was P-qualified.

2.A.4 An example about Pontryagin's principle

We give here an example where there exists a multiplier such that the Hamiltonian inequality (2.26) holds for all $u \in U(t)$, but not for all u in

$$\tilde{U}(t) := \{u \in \mathbb{R}^m : c(t, u, \bar{y}_t) \leq 0\}. \quad (2.238)$$

Indeed, $U(t) \subset \tilde{U}(t)$ but it may happen that $U(t) \neq \tilde{U}(t)$.

Consider the optimal control problem

$$\min y_T \quad (2.239)$$

subject to the following state equation with fixed initial state, in \mathbb{R} :

$$\dot{y}_t = u_t, \quad y_0 = y^0, \quad (2.240)$$

and to the following mixed constraint:

$$u_t \geq -y_t, \quad \text{for a.a. } t. \quad (2.241)$$

The optimal control (\bar{u}, \bar{y}) is such that $\bar{u}_t = -\bar{y}_t$ and given an initial state y^0 , the optimal solution is given by:

$$\bar{u}_t = -y^0 e^{-t}, \quad \bar{y}_t = y^0 e^{-t}. \quad (2.242)$$

The problem being qualified, there exists a normal Lagrange multiplier which is determined by ν . Since the augmented Hamiltonian is stationary, we obtain that for a.a. t , $p_t^\nu = \nu_t$, and therefore the costate equation writes

$$-p_t^\nu = -p_t^\nu, \quad p_T^\nu = 1, \quad (2.243)$$

i.e. $p_t = \nu_t = e^{-(T-t)} > 0$. Let us fix $y^0 = 0$, the optimal solution is $(0, 0)$ and $\tilde{U}(t) = U(t) = \mathbb{R}_+$. The Hamiltonian pu is minimized for a.a. t by $\bar{u}_t = 0$ since $p_t > 0$.

Now let us consider a variant of this problem. We replace the previous mixed constraint by the following one:

$$\psi(u_t) \geq -y_t, \quad (2.244)$$

where ψ is a smooth function such that:

$$\begin{cases} \forall u \geq 0, \psi(u) = u, \\ \forall u < 0, \psi(u) \leq 0 \text{ and } \psi(u) = 0 \iff u = -1. \end{cases} \quad (2.245)$$

For $y^0 = 0$, $(0, 0)$ remains a feasible trajectory, since $\tilde{U}(t) = \mathbb{R}_+ \cup \{-1\}$. In this case, $U(t) = \mathbb{R}_+$. Let us check that $(0, 0)$ is still an optimal solution. Let us suppose that there exist a feasible trajectory (u, y) which is such that $y_T < 0$. Then, let $t \in (0, T)$ be such that

$$y_t \in (y_T, 0) \quad \text{and} \quad \forall s \in [t, T], y_s \leq y_t. \quad (2.246)$$

It follows that for a.a. $s \in (t, T)$,

$$\psi(u_s) \geq -y_s > 0. \quad (2.247)$$

Therefore, $u_s > 0$ and y is nondecreasing on $[t, T]$, in contradiction with $y_t > y_T$. We have proved that $(0, 0)$ is an optimal solution, and the multiplier and costate remain unchanged. However, the minimum of the Hamiltonian over $\tilde{U}(t)$ is reached for

$$u = -1 \neq \bar{u}_t. \quad (2.248)$$

Chapter 3

Second-order sufficient conditions for bounded strong solutions

Contents

3.1	Introduction	76
3.2	Setting	78
3.2.1	The optimal control problem	78
3.2.2	Bounded strong optimality and quadratic growth	80
3.2.3	Multipliers	80
3.2.4	Reducible touch points	82
3.2.5	Tools for the second-order analysis	83
3.3	Reduction of touch points	84
3.4	A decomposition principle	86
3.4.1	Notations and first estimates	86
3.4.2	Result	88
3.5	Quadratic growth for bounded strong solutions	92
3.6	Characterization of quadratic growth	97

Abstract

In this chapter, given a reference feasible trajectory of an optimal control problem, we say that the quadratic growth property for bounded strong solutions holds if the cost function of the problem has a quadratic growth over the set of feasible trajectories with a bounded control and with a state variable sufficiently close to the reference state variable. Our sufficient second-order optimality conditions in Pontryagin form ensure this property and ensure *a fortiori* that the reference trajectory is a bounded strong solution. Our proof relies on a decomposition principle, which is a particular second-order expansion of the Lagrangian of the problem.

Résumé

Nous considérons dans ce chapitre une trajectoire admissible d'un problème de commande optimale et disons que la propriété de croissance quadratique pour des solutions fortes est satisfaite si la fonction coût du problème a une croissance quadratique sur l'ensemble des trajectoires dont la commande est bornée et dont la variable d'état est suffisamment proche de la variable d'état de référence. Nos conditions d'optimalité du second ordre sous forme Pontryaguine garantissent cette propriété et *a fortiori* que la trajectoire de référence est une solution forte. Notre preuve s'appuie sur un principe de décomposition, qui est un développement particulier du lagrangien du problème au second ordre.

3.1 Introduction

In this paper, we consider an optimal control problem with final-state constraints, pure state constraints, and mixed control-state constraints. Given a feasible control \bar{u} and its associated state variable \bar{y} , we give second-order conditions ensuring that for all $R > \|\bar{u}\|_\infty$, there exist $\varepsilon > 0$ and $\alpha > 0$ such that for all feasible trajectory (u, y) with $\|u\|_\infty \leq R$ and $\|y - \bar{y}\|_\infty \leq \varepsilon$,

$$J(u, y) - J(\bar{u}, \bar{y}) \geq \alpha(\|u - \bar{u}\|_2^2 + |y_0 - \bar{y}_0|^2), \quad (3.1)$$

where $J(u, y)$ is the cost function to minimize. We call this property *quadratic growth for bounded strong solutions*. Its specificity lies in the fact that the quadratic growth is ensured for controls which may be far from \bar{u} in L^∞ norm.

Our approach is based on the theory of second-order optimality conditions for optimization problems in Banach spaces [26, 47, 53]. A local optimal solution satisfies first- and second-order necessary conditions; denoting by Ω the Hessian of the Lagrangian, these conditions state that under the extended polyhedricity condition [21, Section 3.2], the supremum of Ω over the set of Lagrange multipliers is nonnegative for all critical directions. If the supremum of Ω is positive for nonzero critical directions, we say that the second-order sufficient optimality conditions hold and under some assumptions, a quadratic growth property is then satisfied. This approach can be used for optimal control problems with constraints of any kind. For example, Stefani and Zezza [64] dealt

with problems with mixed control-state equality constraints and Bonnans and Hermant [17] with problems with pure state and mixed control-state constraints. However, the quadratic growth property which is then satisfied holds for controls which are sufficiently close to \bar{u} in uniform norm and only ensures that (\bar{u}, \bar{y}) is a weak solution.

For Pontryagin minima, that is to say minima locally optimal in a L^1 neighborhood of \bar{u} , the necessary conditions can be strengthened. The first-order conditions are nothing but the well-known Pontryagin's principle, historically formulated in [58] and extended to problems with various constraints by many authors, such as Hestenes for problems with mixed control-state constraints [43] Dubovitskii and Milyutin for problems with pure state and mixed control-state constraints in early Russian references [31, 32], as highlighted by Dmitruk [27]. We refer to the survey by Hartl *et al.* for more references on this principle.

We say that the second-order necessary condition are in *Pontryagin form* if the supremum of Ω is taken over the set of Pontryagin multipliers, these multipliers being the Lagrange multipliers for which Pontryagin's principle holds. Maurer and Osmolovskii proved in [56] that the second-order necessary conditions in Pontryagin form were satisfied for Pontryagin minima to optimal control problems with mixed control-state equality constraints. They also proved that if second-order sufficient conditions in Pontryagin form held, then the quadratic growth for bounded strong solutions was satisfied. The sufficient conditions in Pontryagin form are as follows: the supremum of Ω over Pontryagin multipliers only is positive for nonzero critical directions and for all bounded neighborhood of \bar{u} , there exists a Pontryagin multiplier which is such such the Hamiltonian has itself a quadratic growth. The results of Maurer and Osmolovskii are true under a restrictive full-rank condition for the mixed equality constraints, which is not satisfied by pure constraints, and under the Legendre-Clebsch condition, imposing that the Hessian of the augmented Hamiltonian w.r.t. u is positive. The full-rank condition enabled them to reformulate their their problem as a problem with final-state constraints only. Note that these results were first stated by Milyutin and Osmolovskii in [55], without proof.

For problems with pure and mixed inequality constraints, we proved the second-order necessary conditions in Pontryagin form [14]; in the present paper, we prove that the sufficient conditions in Pontryagin form ensure the quadratic growth property for bounded strong solutions under the Legendre-Clebsch condition. Our proof is based on an extension of the decomposition principle of Bonnans and Osmolovskii [18] to the constrained case. This principle is a particular second-order expansion of the Lagrangian, which takes into account the fact that the control may have large perturbations in uniform norm. Note that the difficulties arising in the extension of the principle and the proof of quadratic growth are mainly due to the presence of mixed control-state constraints.

The outline of the paper is as follows. In Section 3.2, we set our optimal control problem. Section 3.3 is devoted to technical aspects related to the reduction of state constraints. We prove the decomposition principle in Section 3.4 (Theorem 3.14) and prove the quadratic growth property for bounded strong solutions in Section 3.5 (Theorem 3.18). In Section 3.6, we prove that under technical assumptions, the sufficient

conditions are not only sufficient but also necessary to ensure the quadratic growth property (Theorem 3.21).

Notations. For a function h that depends only on time t , we denote by h_t its value at time t , by $h_{i,t}$ the value of its i -th component if h is vector-valued, and by \dot{h} its derivative. For a function h that depends on (t, x) , we denote by $D_t h$ and $D_x h$ its partial derivatives. We use the symbol D without any subscript for the differentiation w.r.t. all variables except t , e.g. $Dh = D_{(u,y)}h$ for a function h that depends on (t, u, y) . We use the same convention for higher order derivatives.

We identify the dual space of \mathbb{R}^n with the space \mathbb{R}^{n*} of n -dimensional horizontal vectors. Generally, we denote by X^* the dual space of a topological vector space X . Given a convex subset K of X and a point x of K , we denote by $T_K(x)$ and $N_K(x)$ the tangent and normal cone to K at x , respectively; see [21, Section 2.2.4] for their definition.

We denote by $|\cdot|$ both the Euclidean norm on finite-dimensional vector spaces and the cardinal of finite sets, and by $\|\cdot\|_s$ and $\|\cdot\|_{q,s}$ the standard norms on the Lebesgue spaces L^s and the Sobolev spaces $W^{q,s}$, respectively.

We denote by $BV([0, T])$ the space of functions of bounded variation on the closed interval $[0, T]$. Any $h \in BV([0, T])$ has a derivative dh which is a finite Radon measure on $[0, T]$ and h_0 (resp. h_T) is defined by $h_0 := h_{0+} - dh(0)$ (resp. $h_T := h_{T-} + dh(T)$). Thus $BV([0, T])$ is endowed with the following norm: $\|h\|_{BV} := \|dh\|_{\mathcal{M}} + |h_T|$. See [4, Section 3.2] for a rigorous presentation of BV .

All vector-valued inequalities have to be understood coordinate-wise.

3.2 Setting

3.2.1 The optimal control problem

We formulate in this section the optimal control problem under study and we use the same framework as in [14]. We refer to this article for supplementary comments on the different assumptions made. Consider the *state equation*

$$\dot{y}_t = f(t, u_t, y_t) \quad \text{for a.a. } t \in (0, T). \quad (3.2)$$

Here, u is a *control* which belongs to \mathcal{U} , y is a *state* which belongs to \mathcal{Y} , where

$$\mathcal{U} := L^\infty(0, T; \mathbb{R}^m), \quad \mathcal{Y} := W^{1,\infty}(0, T; \mathbb{R}^n), \quad (3.3)$$

and $f: [0, T] \times \mathbb{R}^m \times \mathbb{R}^n \rightarrow \mathbb{R}^n$ is the *dynamics*. Given $u \in \mathcal{U}$ and $y^0 \in \mathbb{R}^n$, we denote by $y[u, y^0] \in \mathcal{Y}$ the solution to (3.2) with initial state y^0 . Consider constraints of various types on the system: the *mixed control-state constraints*, or mixed constraints

$$c(t, u_t, y_t) \leq 0 \quad \text{for a.a. } t \in (0, T), \quad (3.4)$$

the *pure state constraints*, or state constraints

$$g(t, y_t) \leq 0 \quad \text{for a.a. } t \in (0, T), \quad (3.5)$$

and the *initial-final state constraints*

$$\begin{cases} \Phi^E(y_0, y_T) = 0, \\ \Phi^I(y_0, y_T) \leq 0. \end{cases} \quad (3.6)$$

Here $c: [0, T] \times \mathbb{R}^m \times \mathbb{R}^n \rightarrow \mathbb{R}^{n_c}$, $g: [0, T] \times \mathbb{R}^n \rightarrow \mathbb{R}^{n_g}$, $\Phi^E: \mathbb{R}^n \times \mathbb{R}^n \rightarrow \mathbb{R}^{n_{\Phi^E}}$, $\Phi^I: \mathbb{R}^n \times \mathbb{R}^n \rightarrow \mathbb{R}^{n_{\Phi^I}}$. Finally, consider the *cost function* $\phi: \mathbb{R}^n \times \mathbb{R}^n \rightarrow \mathbb{R}$. The *optimal control problem* is then

$$\min_{(u, y) \in \mathcal{U} \times \mathcal{Y}} \phi(y_0, y_T) \quad \text{subject to} \quad (3.2)-(3.6). \quad (P)$$

We call a *trajectory* any pair $(u, y) \in \mathcal{U} \times \mathcal{Y}$ such that (3.2) holds. We say that a trajectory is *feasible* for problem (P) if it satisfies constraints (3.4)-(3.6), and denote by $F(P)$ the set of feasible trajectories. From now on, we fix a feasible trajectory (\bar{u}, \bar{y}) .

Similarly to [64, Definition 2.1], we introduce the following Carathéodory-type regularity notion:

Definition 3.1. *We say that $\varphi: [0, T] \times \mathbb{R}^m \times \mathbb{R}^n \rightarrow \mathbb{R}^s$ is uniformly quasi- C^k iff*

(i) *for a.a. t , $(u, y) \mapsto \varphi(t, u, y)$ is of class C^k , and the modulus of continuity of $(u, y) \mapsto D^k \varphi(t, u, y)$ on any compact of $\mathbb{R}^m \times \mathbb{R}^n$ is uniform w.r.t. t .*

(ii) *for $j = 0, \dots, k$, for all (u, y) , $t \mapsto D^j \varphi(t, u, y)$ is essentially bounded.*

Remark 3.2. *If φ is uniformly quasi- C^k , then $D^j \varphi$ for $j = 0, \dots, k$ are essentially bounded on any compact, and $(u, y) \mapsto D^j \varphi(t, u, y)$ for $j = 0, \dots, k - 1$ are locally Lipschitz, uniformly w.r.t. t .*

The regularity assumption that we need for the quadratic growth property is the following:

Assumption 3.1. *The mappings f , c and g are uniformly quasi- C^2 , g is differentiable, $D_t g$ is uniformly quasi- C^1 , Φ^E , Φ^I , and ϕ are C^2 .*

Note that this assumption will be strengthened in Section 3.6.

Definition 3.3. *We say that the inward condition for the mixed constraints holds iff there exist $\gamma > 0$ and $\bar{v} \in \mathcal{U}$ such that*

$$c(t, \bar{u}_t, \bar{y}_t) + D_u c(t, \bar{u}_t, \bar{y}_t) \bar{v}_t \leq -\gamma, \quad \text{for a.a. } t. \quad (3.7)$$

In the sequel, we will always make the following assumption:

Assumption 3.2. *The inward condition for the mixed constraints holds.*

Assumption 3.2 ensures that the component of the Lagrange multipliers associated with the mixed constraints belongs to $L^\infty(0, T; \mathbb{R}^{n_{c^*}})$, see e.g. [18, Theorem 3.1]. This assumption will also play a role in the decomposition principle.

3.2.2 Bounded strong optimality and quadratic growth

Let us introduce various notions of minima, following [55].

Definition 3.4. *We say that (\bar{u}, \bar{y}) is a bounded strong minimum iff for any $R > \|\bar{u}\|_\infty$, there exists $\varepsilon > 0$ such that*

$$\begin{aligned} \phi(\bar{y}_0, \bar{y}_T) \leq \phi(y_0, y_T), \quad \text{for all } (u, y) \in F(P) \text{ such that} \\ \|y - \bar{y}\|_\infty \leq \varepsilon \text{ and } \|u\|_\infty \leq R, \end{aligned} \quad (3.8)$$

a Pontryagin minimum iff for any $R > \|\bar{u}\|_\infty$, there exists $\varepsilon > 0$ such that

$$\begin{aligned} \phi(\bar{y}_0, \bar{y}_T) \leq \phi(y_0, y_T), \quad \text{for all } (u, y) \in F(P) \text{ such that} \\ \|u - \bar{u}\|_1 + \|y - \bar{y}\|_\infty \leq \varepsilon \text{ and } \|u\|_\infty \leq R, \end{aligned} \quad (3.9)$$

a weak minimum iff there exists $\varepsilon > 0$ such that

$$\begin{aligned} \phi(\bar{y}_0, \bar{y}_T) \leq \phi(y_0, y_T), \quad \text{for all } (u, y) \in F(P) \text{ such that} \\ \|u - \bar{u}\|_\infty + \|y - \bar{y}\|_\infty \leq \varepsilon. \end{aligned} \quad (3.10)$$

Obviously, (3.8) \Rightarrow (3.9) \Rightarrow (3.10).

Definition 3.5. *We say that the quadratic growth property for bounded strong solutions holds at (\bar{u}, \bar{y}) iff for all $R > \|\bar{u}\|_\infty$, there exist $\varepsilon_R > 0$ and $\alpha_R > 0$ such that for all feasible trajectory (u, y) satisfying $\|u\|_\infty \leq R$ and $\|y - \bar{y}\|_\infty \leq \varepsilon$,*

$$\phi(y_0, y_T) - \phi(\bar{y}_0, \bar{y}_T) \geq \alpha_R(|y_0 - \bar{y}_0|^2 + \|u - \bar{u}\|_2^2). \quad (3.11)$$

The goal of the article is to characterize this property. If it holds at (\bar{u}, \bar{y}) , then (\bar{u}, \bar{y}) is a bounded strong solution to the problem.

3.2.3 Multipliers

We define the *Hamiltonian* and the *augmented Hamiltonian* respectively by

$$H[p](t, u, y) := pf(t, u, y), \quad H^a[p, \nu](t, u, y) := pf(t, u, y) + \nu c(t, u, y), \quad (3.12)$$

for $(p, \nu, t, u, y) \in \mathbb{R}^{n^*} \times \mathbb{R}^{n_{c^*}} \times [0, T] \times \mathbb{R}^m \times \mathbb{R}^n$. We define the *end points Lagrangian* by

$$\Phi[\beta, \Psi](y_0, y_T) := \beta\phi(y_0, y_T) + \Psi\Phi(y_0, y_T), \quad (3.13)$$

for $(\beta, \Psi, y_0, y_T) \in \mathbb{R} \times \mathbb{R}^{n_{\Phi^*}} \times \mathbb{R}^n \times \mathbb{R}^n$, where $n_\Phi = n_{\Phi^E} + n_{\Phi^I}$ and $\Phi = \begin{pmatrix} \Phi^E \\ \Phi^I \end{pmatrix}$.

We set

$$K_c := L^\infty(0, T; \mathbb{R}_-^{n_c}), \quad K_g := C([0, T]; \mathbb{R}_-^{n_g}), \quad K_\Phi := \{0\}_{\mathbb{R}^{n_{\Phi^E}}} \times \mathbb{R}_-^{n_{\Phi^I}}, \quad (3.14)$$

so that the constraints (3.4)-(3.6) can be rewritten as

$$c(\cdot, u, y) \in K_c, \quad g(\cdot, y) \in K_g, \quad \Phi(y_0, y_T) \in K_\Phi. \quad (3.15)$$

Recall that the dual space of $C([0, T]; \mathbb{R}^{n_g})$ is the space $\mathcal{M}([0, T]; \mathbb{R}^{n_g^*})$ of finite vector-valued Radon measures. We denote by $\mathcal{M}([0, T]; \mathbb{R}^{n_g^*})_+$ the cone of positive measures in this dual space. Let

$$E := \mathbb{R} \times \mathbb{R}^{n_{\Phi^*}} \times L^\infty(0, T; \mathbb{R}^{n_{c^*}}) \times \mathcal{M}([0, T]; \mathbb{R}^{n_{g^*}}). \quad (3.16)$$

Let $N_{K_c}(c(\cdot, \bar{u}, \bar{y}))$ be the set of elements in the normal cone to K_c at $c(\cdot, \bar{u}, \bar{y})$ that belong to $L^\infty(0, T; \mathbb{R}^{n_{c^*}})$, i.e.

$$N_{K_c}(c(\cdot, \bar{u}, \bar{y})) := \left\{ \nu \in L^\infty(0, T; \mathbb{R}_+^{n_{c^*}}) : \nu_t c(t, \bar{u}_t, \bar{y}_t) = 0 \text{ for a.a. } t \right\}. \quad (3.17)$$

Let $N_{K_g}(g(\cdot, \bar{y}))$ be the normal cone to K_g at $g(\cdot, \bar{y})$, i.e.

$$N_{K_g}(g(\cdot, \bar{y})) := \left\{ \mu \in \mathcal{M}([0, T]; \mathbb{R}^{n_{g^*}})_+ : \int_{[0, T]} (d\mu_t g(t, \bar{y}_t)) = 0 \right\}. \quad (3.18)$$

Let $N_{K_\Phi}(\Phi(\bar{y}_0, \bar{y}_T))$ be the normal cone to K_Φ at $\Phi(\bar{y}_0, \bar{y}_T)$, i.e.

$$N_{K_\Phi}(\Phi(\bar{y}_0, \bar{y}_T)) := \left\{ \Psi \in \mathbb{R}^{n_{\Phi^*}} : \begin{array}{l} \Psi_i \geq 0 \\ \Psi_i \Phi_i(\bar{y}_0, \bar{y}_T) = 0 \end{array} \text{ for } n_{\Phi^E} < i \leq n_{\Phi} \right\}. \quad (3.19)$$

Finally, let

$$N(\bar{u}, \bar{y}) := \mathbb{R}_+ \times N_{K_\Phi}(\Phi(\bar{y}_0, \bar{y}_T)) \times N_{K_c}(c(\cdot, \bar{u}, \bar{y})) \times N_{K_g}(g(\cdot, \bar{y})) \subset E. \quad (3.20)$$

We define the *costate space*

$$\mathcal{P} := BV([0, T]; \mathbb{R}^{n^*}). \quad (3.21)$$

Given $\lambda = (\beta, \Psi, \nu, \mu) \in E$, we consider the *costate equation* in \mathcal{P}

$$\begin{cases} -dp_t = D_y H^a[p_t, \nu_t](t, \bar{u}_t, \bar{y}_t) dt + d\mu_t Dg(t, \bar{y}_t), \\ p_{T+} = D_{y_T} \Phi[\beta, \Psi](\bar{y}_0, \bar{y}_T). \end{cases} \quad (3.22)$$

Definition 3.6. Let $\lambda = (\beta, \Psi, \nu, \mu) \in E$. We say that the solution of the costate equation (3.22) $p^\lambda \in \mathcal{P}$ is an associated costate iff

$$-p_{0-}^\lambda = D_{y_0} \Phi[\beta, \Psi](\bar{y}_0, \bar{y}_T). \quad (3.23)$$

Let $N_\pi(\bar{u}, \bar{y})$ be the set of nonzero $\lambda \in N(\bar{u}, \bar{y})$ having an associated costate.

We define the set-valued mapping $U: [0, T] \rightrightarrows \mathbb{R}^m$ by

$$U(t) := \text{cl} \{ u \in \mathbb{R}^m : c(t, u, \bar{y}_t) < 0 \} \quad \text{for a.a. } t, \quad (3.24)$$

where cl denotes the closure in \mathbb{R}^m . We can now define two different notions of multipliers.

Definition 3.7. (i) We say that $\lambda \in N_\pi(\bar{u}, \bar{y})$ is a generalized Lagrange multiplier iff

$$D_u H^a[p_t^\lambda, \nu_t](t, \bar{u}_t, \bar{y}_t) = 0 \quad \text{for a.a. } t. \quad (3.25)$$

We denote by $\Lambda_L(\bar{u}, \bar{y})$ the set of generalized Lagrange multipliers.

(ii) We say that $\lambda \in \Lambda_L(\bar{u}, \bar{y})$ is a generalized Pontryagin multiplier iff

$$H[p_t^\lambda](t, \bar{u}_t, \bar{y}_t) \leq H[p_t^\lambda](t, u, \bar{y}_t) \quad \text{for all } u \in U(t), \quad \text{for a.a. } t. \quad (3.26)$$

We denote by $\Lambda_P(\bar{u}, \bar{y})$ the set of generalized Pontryagin multipliers.

Note that even if (\bar{u}, \bar{y}) is a Pontryagin minimum, inequality (3.26) may not be satisfied for some $t \in [0, T]$ and some $u \in \mathbb{R}^m$ for which $c(t, u, \bar{y}_t) = 0$, as we show in [14, Appendix]. Note that the sets $\Lambda_L(\bar{u}, \bar{y})$ and $\Lambda_P(\bar{u}, \bar{y})$ are convex cones.

3.2.4 Reducible touch points

Let us first recall the definition of the order of a state constraint. For $1 \leq i \leq n_g$, assuming that g_i is sufficiently regular, we define by induction $g_i^{(j)} : [0, T] \times \mathbb{R}^m \times \mathbb{R}^n \rightarrow \mathbb{R}$, $j \in \mathbb{N}$, by

$$g_i^{(j+1)}(t, u, y) := D_t g_i^{(j)}(t, u, y) + D_y g_i^{(j)}(t, u, y) f(t, u, y), \quad g_i^{(0)} := g_i. \quad (3.27)$$

Definition 3.8. If g_i and f are C^{q_i} , we say that the state constraint g_i is of order $q_i \in \mathbb{N}$ iff

$$D_u g_i^{(j)} \equiv 0 \quad \text{for } 0 \leq j \leq q_i - 1, \quad D_u g_i^{(q_i)} \neq 0. \quad (3.28)$$

If g_i is of order q_i , then for all $j < q_i$, $g_i^{(j)}$ is independent of u and we do not mention this dependence anymore. Moreover, the mapping $t \mapsto g_i(t, \bar{y}_t)$ belongs to $W^{q_i, \infty}(0, T)$ and

$$\frac{d^j}{dt^j} g_i(t, \bar{y}_t) = g_i^{(j)}(t, \bar{y}_t) \quad \text{for } 0 \leq j < q_i, \quad (3.29)$$

$$\frac{d^j}{dt^j} g_i(t, \bar{y}_t) = g_i^{(j)}(t, \bar{u}_t, \bar{y}_t) \quad \text{for } j = q_i. \quad (3.30)$$

Definition 3.9. We say that $\tau \in [0, T]$ is a touch point for the constraint g_i iff it is a contact point for g_i , i.e. $g_i(\tau, \bar{y}_\tau) = 0$, and τ is isolated in $\{t : g_i(t, \bar{y}_t) = 0\}$. We say that a touch point τ for g_i is reducible iff $\tau \in (0, T)$, $\frac{d^2}{dt^2} g_i(t, \bar{y}_t)$ is defined for t close to τ , continuous at τ , and

$$\frac{d^2}{dt^2} g_i(t, \bar{y}_t)|_{t=\tau} < 0. \quad (3.31)$$

For $1 \leq i \leq n_g$, let us define

$$\mathcal{T}_{g,i} := \begin{cases} \emptyset & \text{if } g_i \text{ is of order 1,} \\ \{\text{touch points for } g_i\} & \text{otherwise.} \end{cases} \quad (3.32)$$

Note that for the moment, we only need to distinguish the constraints of order 1 from the other constraints, for which the order may be undefined if g_i or f is not regular enough.

Assumption 3.3. For $1 \leq i \leq n_g$, the set $\mathcal{T}_{g,i}$ – if nonempty – is finite and only contains reducible touch points.

3.2.5 Tools for the second-order analysis

We define now the linearizations of the system, the critical cone, and the Hessian of the Lagrangian. Let us set

$$\mathcal{V}_2 := L^2(0, T; \mathbb{R}^m), \quad \mathcal{Z}_1 := W^{1,1}(0, T; \mathbb{R}^n), \quad \text{and} \quad \mathcal{Z}_2 := W^{1,2}(0, T; \mathbb{R}^n). \quad (3.33)$$

Given $v \in \mathcal{V}_2$, we consider the *linearized state equation* in \mathcal{Z}_2

$$\dot{z}_t = Df(t, \bar{u}_t, \bar{y}_t)(v_t, z_t) \quad \text{for a.a. } t \in (0, T). \quad (3.34)$$

We call *linearized trajectory* any $(v, z) \in \mathcal{V}_2 \times \mathcal{Z}_2$ such that (3.34) holds. For any $(v, z^0) \in \mathcal{V}_2 \times \mathbb{R}^n$, there exists a unique $z \in \mathcal{Z}_2$ such that (3.34) holds and $z_0 = z^0$; we denote it by $z = z[v, z^0]$. We also consider the *second-order linearized state equation* in \mathcal{Z}_1 , defined by

$$\dot{\zeta}_t = D_y f(t, \bar{u}_t, \bar{y}_t) \zeta_t + D^2 f(t, \bar{u}_t, \bar{y}_t)(v_t, z_t[v, z^0])^2 \quad \text{for a.a. } t \in (0, T). \quad (3.35)$$

We denote by $z^2[v, z^0]$ the unique $\zeta \in \mathcal{Z}_1$ such that (3.35) holds and such that $z_0 = 0$.

The critical cone in L^2 is defined by

$$C_2(\bar{u}, \bar{y}) := \left\{ \begin{array}{l} (v, z) \in \mathcal{V}_2 \times \mathcal{Z}_2 : z = z[v, z_0] \\ D\phi(\bar{y}_0, \bar{y}_T)(z_0, z_T) \leq 0 \\ D\Phi(\bar{y}_0, \bar{y}_T)(z_0, z_T) \in T_{K_\Phi}(\Phi(\bar{y}_0, \bar{y}_T)) \\ Dc(\cdot, \bar{u}, \bar{y})(v, z) \in T_{K_c}(c(\cdot, \bar{u}, \bar{y})) \\ Dg(\cdot, \bar{y})z \in T_{K_g}(g(\cdot, \bar{y})) \end{array} \right\} \quad (3.36)$$

Note that by [21, Examples 2.63 and 2.64], the two tangent cones $T_{K_g}(g(\cdot, \bar{y}))$ and $T_{K_c}(c(\cdot, \bar{u}, \bar{y}))$ are resp. described by

$$T_{K_g} = \{\zeta \in C([0, T]; \mathbb{R}^n) : \forall t, \forall i, g_i(t, \bar{y}_t) = 0 \implies \zeta_{i,t} \leq 0\}, \quad (3.37)$$

$$T_{K_c} = \{w \in L^2([0, T]; \mathbb{R}^m) : \text{for a.a. } t, c_i(t, \bar{u}_t, \bar{y}_t) = 0 \implies w_{i,t} \leq 0\} \quad (3.38)$$

Finally, for any $\lambda = (\beta, \Psi, \nu, \mu) \in E$, we define a quadratic form, the *Hessian of Lagrangian*, $\Omega[\lambda]: \mathcal{V}_2 \times \mathcal{Z}_2 \rightarrow \mathbb{R}$ by

$$\begin{aligned} \Omega[\lambda](v, z) := & \int_0^T D^2 H^a[p_t^\lambda, \nu_t](t, \bar{u}_t, \bar{y}_t)(v_t, z_t)^2 dt + D^2 \Phi[\beta, \Psi](\bar{y}_0, \bar{y}_T)(z_0, z_T)^2 \\ & + \int_{[0, T]} (d\mu_t D^2 g(t, \bar{y}_t)(z_t)^2) - \sum_{\substack{\tau \in \mathcal{T}_{g,i} \\ 1 \leq i \leq n_g}} \mu_i(\tau) \frac{(Dg_i^{(1)}(\tau, \bar{y}_\tau)z_\tau)^2}{g_i^{(2)}(\tau, \bar{u}_\tau, \bar{y}_\tau)}, \end{aligned} \quad (3.39)$$

where $\mu_i(\tau)$ is the measure of the singleton $\{\tau\}$. We justify the terms involving the touch points in $\mathcal{T}_{g,i}$ in the following section.

3.3 Reduction of touch points

We recall in this section the main idea of the reduction technique used for the touch points of state constraints of order greater or equal than 2. Let us mention that this approach was described in [44, Section 3] and used in [52, Section 4] in the case of optimal control problems. As shown in [16], the reduction allows to derive no-gap necessary and sufficient second-order optimality conditions, i.e., the Hessian of the Lagrangian of the reduced problem corresponds to the quadratic form of the necessary conditions. We also prove a strict differentiability property for the mapping associated with the reduction, that will be used in the decomposition principle. Recall that for all $1 \leq i \leq n_g$, all touch points of $\mathcal{T}_{g,i}$ are supposed to be reducible (Assumption 3.3).

Let $\varepsilon > 0$ be sufficiently small so that for all $1 \leq i \leq n_g$, for all $\tau \in \mathcal{T}_{g,i}$, the time function

$$t \in [\tau - \varepsilon, \tau + \varepsilon] \mapsto g(t, \bar{y}_t) \quad (3.40)$$

is C^2 and is such that for some $\beta > 0$, $\frac{d^2}{dt^2} g_i(t, \bar{y}_t) \leq -\beta$, for all t in $[\tau - \varepsilon, \tau + \varepsilon]$. From now on, we set for all i and for all $\tau \in \mathcal{T}_{g,i}$

$$\Delta_\tau^\varepsilon = [\tau - \varepsilon, \tau + \varepsilon] \quad \text{and} \quad \Delta_i^\varepsilon = [0, T] \setminus \{ \cup_{\tau \in \mathcal{T}_{g,i}} \Delta_\tau^\varepsilon \}, \quad (3.41)$$

and we consider the mapping $\Theta_\tau^\varepsilon : \mathcal{U} \times \mathbb{R}^n \rightarrow \mathbb{R}$ defined by

$$\Theta_\tau^\varepsilon(u, y^0) := \max \{ g_i(t, y_t) : y = y[u, y^0], t \in \Delta_\tau^\varepsilon \}. \quad (3.42)$$

We define the reduced pure constraints as follows:

$$\text{for all } i \in \{1, \dots, n_g\}, \quad \begin{cases} g_i(t, y_t) \leq 0, & \text{for all } t \in \Delta_i^\varepsilon, & \text{(i)} \\ \Theta_\tau^\varepsilon(u, y_0) \leq 0, & \text{for all } \tau \in \mathcal{T}_{g,i}. & \text{(ii)} \end{cases} \quad (3.43)$$

Finally, we consider the following *reduced problem*, which is an equivalent reformulation of problem (P), in which the pure constraints are replaced by constraint (3.43):

$$\min_{(u, y) \in \mathcal{U} \times \mathcal{Y}} \phi(y_0, y_T) \quad \text{subject to} \quad (3.2), (3.4), (3.6), \text{ and } (3.43). \quad (P')$$

Now, for all $1 \leq i \leq n_g$, consider the mapping ρ_i defined by

$$\rho_i : \mu \in \mathcal{M}([0, T]; \mathbb{R}_+) \mapsto (\mu|_{\Delta_i^\varepsilon}, (\mu(\tau))_{\tau \in \mathcal{T}_{g,i}}) \in \mathcal{M}(\Delta_i^\varepsilon; \mathbb{R}_+) \times \mathbb{R}^{|\mathcal{T}_{g,i}|}. \quad (3.44)$$

Lemma 3.10. *The mapping Θ_τ^ε is twice Fréchet-differentiable at (\bar{u}, \bar{y}_0) with derivatives*

$$D\Theta_\tau^\varepsilon(\bar{u}, \bar{y}_0)(v, z_0) = Dg_i(\tau, \bar{y}_\tau) z_\tau[v, z_0], \quad (3.45)$$

$$\begin{aligned} D^2\Theta_\tau^\varepsilon(\bar{u}, \bar{y}_0)(v, z_0)^2 &= D^2g_i(\tau, \bar{y}_\tau)(z_\tau[v, z_0])^2 + Dg_i(\tau, \bar{y}_\tau) z_\tau^2[v, z_0] \\ &\quad - \frac{\left(Dg_i^{(1)}(\tau, \bar{y}_\tau) z_\tau \right)^2}{g_i^{(2)}(\tau, \bar{u}_\tau, \bar{y}_\tau)}. \end{aligned} \quad (3.46)$$

and the following mappings define a bijection between $\Lambda_L(\bar{u}, \bar{y})$ and the Lagrange multipliers of problem (P') , resp. between $\Lambda_P(\bar{u}, \bar{y})$ and the Pontryagin multipliers of problem (P') :

$$\lambda = (\beta, \Psi, \nu, \mu) \in \Lambda_L(\bar{u}, \bar{y}) \mapsto (\beta, \Psi, \nu, (\rho_i(\mu^i))_{1 \leq i \leq n_g}) \quad (3.47)$$

$$\lambda = (\beta, \Psi, \nu, \mu) \in \Lambda_P(\bar{u}, \bar{y}) \mapsto (\beta, \Psi, \nu, (\rho_i(\mu^i))_{1 \leq i \leq n_g}). \quad (3.48)$$

See [16, Lemma 26] for a proof of this result. Note that the restriction of μ_i to Δ_i^ε is associated with constraint (3.43(i)) and $(\mu_i(\tau))_{\tau \in \mathcal{T}_{g,i}}$ with constraint (3.43(ii)). The expression of the Hessian of Θ_τ^ε justifies the quadratic form Ω defined in (3.39). Note also that in the sequel, we will work with problem P' and with the original description of the multipliers, using implicitly the bijections (3.47) and (3.48).

Now, let us fix i and $\tau \in \mathcal{T}_{g,i}$. The following lemma is a differentiability property for the mapping Θ_τ^ε , related to the one of strict differentiability, that will be used to prove the decomposition theorem.

Lemma 3.11. *There exists $\varepsilon > 0$ such that for all u_1 and u_2 in \mathcal{U} , for all y^0 in \mathbb{R}^n , if*

$$\|u^1 - \bar{u}\|_1 \leq \varepsilon, \quad \|u^2 - \bar{u}\|_1 \leq \varepsilon, \quad \text{and} \quad |y^0 - \bar{y}_0| \leq \varepsilon, \quad (3.49)$$

then

$$\begin{aligned} \Theta_\tau^\varepsilon(u^2, y^0) - \Theta_\tau^\varepsilon(u^1, y^0) &= g(\tau, y_\tau[u^2, y^0]) - g(\tau, y_\tau[u^1, y^0]) \\ &+ O(\|u^2 - u^1\|_1 (\|u^1 - \bar{u}\|_1 + \|u^2 - \bar{u}\|_1 + |y^0 - \bar{y}_0|)). \end{aligned} \quad (3.50)$$

An intermediate lemma is needed to prove this result. Consider the mapping χ defined as follows:

$$\chi : x \in W^{2,\infty}(\Delta_\tau^\varepsilon) \mapsto \sup_{t \in [\tau - \varepsilon, \tau + \varepsilon]} x_t \in \mathbb{R}. \quad (3.51)$$

Let us set $x^0 = g_i(\cdot, \bar{y})|_{\Delta_\tau^\varepsilon}$. Note that $\dot{x}_\tau^0 = 0$.

Lemma 3.12. *There exists $\alpha' > 0$ such that for all x^1 and x^2 in $W^{2,\infty}(\Delta_\tau)$, if $\|\dot{x}^1 - \dot{x}^0\|_\infty \leq \alpha'$ and $\|\dot{x}^2 - \dot{x}^0\|_\infty \leq \alpha'$, then*

$$\begin{aligned} \chi(x^2) - \chi(x^1) &= x^2(\tau) - x^1(\tau) \\ &+ O(\|\dot{x}^2 - \dot{x}^1\|_\infty (\|\dot{x}^1 - \dot{x}^0\|_\infty + \|\dot{x}^2 - \dot{x}^0\|_\infty)). \end{aligned} \quad (3.52)$$

Proof. Let $0 < \alpha' < \beta\varepsilon$ and x^1, x^2 in $W^{2,\infty}(\Delta_\tau)$ satisfy the assumption of the lemma. Denote by τ_1 (resp. τ_2) a (possibly non-unique) maximizer of $\chi(x^1)$ (resp. $\chi(x^2)$). Since

$$\dot{x}_{\tau-\varepsilon}^1 \geq \dot{x}_{\tau-\varepsilon}^0 - \alpha' \geq \beta\varepsilon - \alpha' > 0 \quad \text{and} \quad \dot{x}_{\tau+\varepsilon}^1 \leq \dot{x}_{\tau+\varepsilon}^0 + \alpha' \leq -\beta\varepsilon + \alpha' < 0, \quad (3.53)$$

we obtain that $\tau_1 \in (\tau - \varepsilon, \tau + \varepsilon)$ and therefore that $\dot{x}_{\tau_1}^1 = 0$. Therefore,

$$\beta|\tau_1 - \tau| \leq |\dot{x}_{\tau_1}^0 - \dot{x}_\tau^0| = |\dot{x}_{\tau_1}^1 - \dot{x}_{\tau_1}^0| \leq \|\dot{x}^1 - \dot{x}^0\|_\infty \quad (3.54)$$

and then, $|\tau_1 - \tau| \leq \|\dot{x}^1 - \dot{x}^0\|_\infty / \beta$. Similarly, $|\tau_2 - \tau| \leq \|\dot{x}^2 - \dot{x}^0\|_\infty / \beta$. Then, by (3.54),

$$\begin{aligned} \chi(x^2) &\geq x^1(\tau_1) + (x^2(\tau_1) - x^1(\tau_1)) \\ &= \chi(x^1) + (x^2(\tau) - x^1(\tau)) + O(\|\dot{x}^2 - \dot{x}^1\|_\infty |\tau_1 - \tau|) \end{aligned} \quad (3.55)$$

and therefore, the l.h.s. of (3.52) is greater than the r.h.s. and by symmetry, the converse inequality holds. The lemma is proved. \square

Proof of Lemma 3.11. Consider the mapping

$$G_\tau : (u, y^0) \in (\mathcal{U} \times \mathbb{R}^n) \mapsto (t \in \Delta_\tau \mapsto g_i(t, y_t[u, y^0])) \in W^{2,\infty}(\Delta_\tau). \quad (3.56)$$

Since g_i is not of order 1 and by Assumption 3.1, the mapping G_τ is Lipschitz in the following sense : there exists $K > 0$ such that for all $(u^1, y^{0,1})$ and $(u^2, y^{0,2})$,

$$\|G_\tau(u^1, y^{0,1}) - G_\tau(u^2, y^{0,2})\|_{1,\infty} \leq K(\|u^2 - u^1\|_1 + |y^{0,2} - y^{0,1}|). \quad (3.57)$$

Set $\alpha = \alpha' / (2K)$. Let u^1 and u^2 in \mathcal{U} , let y^0 in \mathbb{R}^n be such that (3.49) holds. Then by Lemma 3.12 and by (3.57),

$$\begin{aligned} &\Theta_\tau^\varepsilon(u^2, y^0) - \Theta_\tau^\varepsilon(u^1, y^0) \\ &= \chi(G_\tau(u^2, y^0)) - \chi(G_\tau(u^1, y^0)) \\ &= g(y_\tau[u^2, y^0]) - g(y_\tau[u^1, y^0]) \\ &\quad + O(\|u^2 - u^1\|_1 (\|u^2 - \bar{u}\|_1 + \|u^1 - \bar{u}\|_1 + |y^0 - \bar{y}_0|)), \end{aligned} \quad (3.58)$$

as was to be proved. \square

3.4 A decomposition principle

We follow a classical approach by contradiction to prove the quadratic growth property for bounded strong solutions. We assume the existence of a sequence of feasible trajectories $(u^k, y^k)_k$ which is such that u^k is bounded and such that $\|y^k - \bar{y}\|_\infty \rightarrow 0$ and for which the quadratic growth property does not hold. The Lagrangian function first provides a lower estimate of the cost function $\phi(y_0^k, y_T^k)$. The difficulty here is to linearize the Lagrangian, since we must consider large perturbations of the control in L^∞ norm. To that purpose, we extend the decomposition principle of [18, Section 2.4] to our more general framework with pure and mixed constraints. This principle is a partial expansion of the Lagrangian, which is decomposed into two terms: $\Omega[\lambda](v^{A,k}, z[v^{A,k}, y_0^k - \bar{y}_0])$, where $v^{A,k}$ stands for the small perturbations of the optimal control, and a difference of Hamiltonians where the large perturbations occur.

3.4.1 Notations and first estimates

Let $R > \|\bar{u}\|_\infty$, let $(u^k, y^k)_k$ be a sequence of feasible trajectories such that

$$\forall k, \|u^k\|_\infty \leq R, \quad \|u^k - \bar{u}\|_2 \rightarrow 0, \quad \text{and} \quad |y_0^k - \bar{y}_0| \rightarrow 0 \quad (3.59)$$

This sequence will appear in the proof of the quadratic growth property. Note that the convergence of controls and initial values of the state implies that $\|y^k - \bar{y}\|_\infty \rightarrow 0$. We need to build two auxiliary controls \tilde{u}^k and $u^{A,k}$. The first one, \tilde{u}^k , is such that

$$\begin{cases} c(t, \tilde{u}_t^k, y_t^k) \leq 0, \text{ for a.a. } t \in [0, T], \\ \|\tilde{u}^k - \bar{u}\|_\infty = O(\|y^k - \bar{y}\|_\infty). \end{cases} \quad (3.60)$$

The following lemma proves the existence of such a control.

Lemma 3.13. *There exist $\varepsilon > 0$ and $\alpha \geq 0$ such that for all $y \in \mathcal{Y}$ with $\|y - \bar{y}\|_\infty \leq \varepsilon$, there exists $u \in \mathcal{U}$ satisfying*

$$\|u - \bar{u}\|_\infty \leq \alpha \|y - \bar{y}\|_\infty \quad \text{and} \quad c(t, u_t, y_t) \leq 0, \text{ for a.a. } t. \quad (3.61)$$

Proof. For all $y \in \mathcal{Y}$, consider the mapping C_y defined by

$$u \in \mathcal{U} \mapsto C_y(u) = (t \mapsto c(t, u_t, y_t)) \in L^\infty(0, T; \mathbb{R}^{n_g}). \quad (3.62)$$

The inward condition (Assumption 3.2) corresponds to Robinson's constraint qualification for $C_{\bar{y}}$ at \bar{u} with respect to $L^\infty(0, T; \mathbb{R}_-^{n_g})$. Thus, by the Robinson-Ursescu stability theorem [21, Theorem 2.87], there exists $\varepsilon > 0$ such that for all $y \in \mathcal{Y}$ with $\|y - \bar{y}\|_\infty \leq \varepsilon$, C_y is metric regular at \bar{u} with respect to $L^\infty(0, T; \mathbb{R}_-^{n_g})$. Therefore, for all $y \in \mathcal{Y}$ with $\|y - \bar{y}\|_\infty \leq \varepsilon$, there exists a control u such that, for almost all t , $c(t, u_t, y_t) \leq 0$ and

$$\|u - \bar{u}\|_\infty = O(\text{dist}(C_y(\bar{u}), L^\infty(0, T; \mathbb{R}_-^{n_g}))) = O(\|y - \bar{y}\|_\infty).$$

This proves the lemma. \square

Now, let us introduce the second auxiliary control $u^{A,k}$. We say that a partition (A, B) of the interval $[0, T]$ is measurable iff A and B are measurable subset of $[0, T]$. Let us consider a sequence of measurable partitions $(A_k, B_k)_k$ of $[0, T]$. We define $u^{A,k}$ as follows:

$$u_t^{A,k} = \bar{u}_t \mathbf{1}_{\{t \in B^k\}} + u_t^k \mathbf{1}_{\{t \in A_k\}}. \quad (3.63)$$

The idea is to separate, in the perturbation $u^k - \bar{u}$, the small and large perturbations in uniform norm. In the sequel, the letter A will refer to the small perturbations and the letter B to the large ones. The large perturbations will occur on the subset B_k .

For the sake of clarity, we suppose from now that the following holds:

$$\begin{cases} (A_k, B_k)_k \text{ is a sequence of measurable partitions of } [0, T], \\ |y_0^k - \bar{y}_0| + \|u^{A,k} - \bar{u}\|_\infty \rightarrow 0, \\ |B_k| \rightarrow 0, \end{cases} \quad (3.64)$$

where $|B_k|$ is the Lebesgue measure of B_k . We set

$$v^{A,k} := u^{A,k} - \bar{u} \quad \text{and} \quad v^{B,k} := u^k - u^{A,k} \quad (3.65)$$

and we define

$$\delta y^k := y^k - \bar{y}, \quad y^{A,k} := y[u^{A,k}, y_0^k], \quad \text{and} \quad z^{A,k} := z[v^{A,k}, \delta y_0^k]. \quad (3.66)$$

Let us introduce some useful notations for the future estimates:

$$\begin{aligned} R_{1,k} &:= \|u^k - \bar{u}\|_1 + |\delta y_0^k|, & R_{2,k} &:= \|u^k - \bar{u}\|_2 + |\delta y_0^k|, \\ R_{1,A,k} &:= \|v^{A,k}\|_1 + |\delta y_0^k|, & R_{2,A,k} &:= \|v^{A,k}\|_2 + |\delta y_0^k|, \\ R_{1,B,k} &:= \|v^{B,k}\|_1, & R_{2,B,k} &:= \|v^{B,k}\|_2. \end{aligned} \quad (3.67)$$

Combining the Cauchy-Schwarz inequality and assumption (3.64), we obtain that

$$R_{1,B,k} \leq R_{2,B,k} |B_k|^{1/2} = o(R_{2,B,k}). \quad (3.68)$$

Note that by Gronwall's lemma,

$$\|\delta y^k\|_\infty = O(R_{1,k}) = O(R_{2,k}) \quad \text{and} \quad \|z^{A,k}\|_\infty = O(R_{1,A,k}) = O(R_{2,k}). \quad (3.69)$$

Note also that

$$\|\delta y^k - (y^{A,k} - \bar{y})\|_\infty = O(R_{1,B,k}) = o(R_{2,k}) \quad (3.70)$$

and since $\|y^{A,k} - (\bar{y} + z^{A,k})\|_\infty = O(R_{2,k}^2)$,

$$\|\delta y^k - z^{A,k}\|_\infty = o(R_{2,k}). \quad (3.71)$$

3.4.2 Result

We can now state the decomposition principle.

Theorem 3.14. *Suppose that Assumptions 3.1, 3.2, and 3.3 hold. Let $R > \|\bar{u}\|_\infty$, let $(u^k, y^k)_k$ be a sequence of feasible controls satisfying (3.59) and $(A_k, B_k)_k$ satisfy (3.64). Then, for all $\lambda = (\beta, \Psi, \nu, \mu) \in \Lambda_L(\bar{u}, \bar{y})$,*

$$\begin{aligned} \beta(\phi(y_0^k, y_T^k) - \phi(\bar{y}_0, \bar{y}_T)) &\geq \frac{1}{2} \Omega[\lambda](v^{A,k}, z^{A,k}) \\ &+ \int_{B_k} [H[p_t^\lambda](t, u_t^k, \bar{y}_t) - H[p_t^\lambda](t, \tilde{u}_t^k, \bar{y}_t)] dt + o(R_{2,k}^2), \end{aligned} \quad (3.72)$$

where Ω is defined by (3.39).

The proof is given at the end of the section, page 90. The basic idea to obtain a lower estimate of $\beta(\phi(y_0, y_T) - \phi(\bar{y}_0, \bar{y}_T))$ is classical: we dualize the constraints and expand up to the second order the obtained Lagrangian. However, the dualization of the mixed constraint is particular here, in so far as the nonpositive added term is the following:

$$\int_{A_k} \nu_t (c(t, u_t^{A,k}, y_t^k) - c(t, \bar{u}_t, \bar{y}_t)) dt + \int_{B_k} \nu_t (c(t, \tilde{u}_t^k, y_t^k) - c(t, \bar{u}_t, \bar{y}_t)) dt, \quad (3.73)$$

where \tilde{u}^k and $u^{A,k}$ are defined by (3.60) and (3.63). In some sense, we do not dualize the mixed constraint when there are large perturbations of the control. By doing so,

we prove that the contribution of the large perturbations is of the same order as the difference of Hamiltonians appearing in (3.72). If we dualized the mixed constraint with the following term:

$$\int_0^T \nu_t (c(t, u_t^k, y_t^k) - c(t, \bar{u}_t, \bar{y}_t)) dt, \quad (3.74)$$

we would obtain for the contribution of large perturbations a difference of augmented Hamiltonians.

Let us fix $\lambda \in \Lambda_L(\bar{u}, \bar{y})$ and let us consider the following two terms:

$$\begin{aligned} I_1^k &= \int_0^T -H_y^a[p_t^\lambda, \nu_t](t, \bar{u}_t, \bar{y}_t) \delta y_t^k dt \\ &\quad + \int_{A_k} (H^a[p_t^\lambda, \nu_t](t, u_t^{A,k}, y_t^k) - H^a[p_t^\lambda, \nu_t](t, \bar{u}_t, \bar{y}_t)) dt \end{aligned} \quad (3.75a)$$

$$+ \int_{B_k} (H^a[p_t^\lambda, \nu_t](t, \tilde{u}_t^k, y_t^k) - H^a[p_t^\lambda](t, \bar{u}_t, \bar{y}_t)) dt \quad (3.75b)$$

$$+ \int_{B_k} (H[p_t^\lambda, \nu_t](t, u_t^k, y_t^k) - H[p_t^\lambda](t, \tilde{u}_t^k, y_t^k)) dt \quad (3.75c)$$

and

$$I_2^k = - \int_{[0,T]} (d\mu_t Dg(t, \bar{y}_t) \delta y_t^k) + \sum_{i=1}^{n_g} \int_{\Delta_i^\varepsilon} (g_i(t, y_t^k) - g_i(t, \bar{y}_t)) d\mu_{t,i} \quad (3.76a)$$

$$+ \sum_{\substack{\tau \in \mathcal{T}_{g,i} \\ 1 \leq i \leq n_g}} \mu_i(\tau) (\Theta_\tau^\varepsilon(u^k, y_0^k) - \Theta_\tau^\varepsilon(\bar{u}, \bar{y}_0)). \quad (3.76b)$$

Lemma 3.15. *Let $R > \|\bar{u}\|_\infty$, let $(u^k, y^k)_k$ be a sequence of feasible trajectories satisfying (3.59), and let $(A_k, B_k)_k$ satisfy (3.64). Then, for all $\lambda \in \Lambda_L(\bar{u}, \bar{y})$, the following lower estimate holds:*

$$\begin{aligned} &\beta(\phi(y_0^k, y_T^k) - \phi(\bar{y}_0, \bar{y}_T)) \\ &\geq \frac{1}{2} D^2 \Phi[\beta, \Psi](\bar{y}_0, \bar{y}_T) (z_0^{A,k}, z_T^{A,k})^2 + I_1^k + I_2^k + o(R_{2,k}^2). \end{aligned} \quad (3.77)$$

Proof. Let $\lambda \in \Lambda_L(\bar{u}, \bar{y})$. In view of sign conditions for constraints and multipliers, we first obtain that

$$\begin{aligned} &\beta\phi(y_0^k, y_T^k) - \phi(\bar{y}_0, \bar{y}_T) \geq \Phi[\beta, \Psi](y_0^k, y_T^k) - \Phi[\beta, \Psi](\bar{y}_0, \bar{y}_T) \\ &\quad + \sum_{i=1}^{n_g} \int_{\Delta_i^\varepsilon} (g_i(t, y_t^k) - g_i(t, \bar{y}_t)) d\mu_{i,t} + \sum_{\substack{\tau \in \mathcal{T}_{g,i} \\ 1 \leq i \leq n_g}} \mu_i(\tau) (\Theta_\tau^\varepsilon(u^k, y_0^k) - \Theta_\tau^\varepsilon(\bar{u}, \bar{y}_0)) \\ &\quad + \int_{A_k} \nu_t (c(t, u_t^{A,k}, y_t^k) - c(t, \bar{u}_t, \bar{y}_t)) dt + \int_{B_k} \nu_t (c(t, \tilde{u}_t^k, y_t^k) - c(t, \bar{u}_t, \bar{y}_t)) dt. \end{aligned} \quad (3.78)$$

Expanding the end-point Lagrangian up to the second order, and using (3.71), we obtain that

$$\begin{aligned}
& \Phi[\beta, \Psi](y_0^k, y_T^k) - \Phi[\beta, \Psi](\bar{y}_0, \bar{y}_T) \\
&= D\Phi[\beta, \Psi](\bar{y}_0, \bar{y}_T)(\delta y_0^k, \delta y_T^k) + \frac{1}{2}D^2\Phi[\beta, \Psi](\bar{y}_0, \bar{y}_T)(\delta y_0^k, \delta y_T^k)^2 + o(R_{2,k}^2) \\
&= (p_T^\lambda \delta y_T^k - p_0^\lambda \delta y_0^k) + \frac{1}{2}D^2\Phi[\lambda](\bar{y}_0, \bar{y}_T)(z_0^{A,k}, z_T^{A,k})^2 + o(R_{2,k}^2). \tag{3.79}
\end{aligned}$$

Integrating by parts (see [16, Lemma 32]), we obtain that

$$\begin{aligned}
p_T^\lambda \delta y_T^k - p_0^\lambda \delta y_0^k &= \int_{[0,T]} (dp_t^\lambda \delta y_t^k + p_t^\lambda \dot{\delta y}_t^k) dt \\
&= \int_0^T (-H_y^a(t, \bar{u}_t, \bar{y}_t) \delta y_t^k + H(t, u_t^k, y_t^k) - H(t, \bar{u}_t, \bar{y}_t)) dt \\
&\quad - \int_{[0,T]} (d\mu_t Dg(t, \bar{y}_t) \delta y_t^k). \tag{3.80}
\end{aligned}$$

The lemma follows from (3.78), (3.79), and (3.80). \square

A corollary of Lemma 3.15 is the following estimate, obtained with (3.60):

$$\begin{aligned}
& \beta(\phi(y_0^k, y_T^k) - \phi(\bar{y}_0, \bar{y}_T)) \tag{3.81} \\
&\geq \int_0^T [H[p_t^\lambda](t, u_t^k, y_t^k) - H[p_t^\lambda](t, \tilde{u}_t^k, y_t^k)] dt + O(\|\delta y^k\|_\infty) \\
&= \int_0^T [H[p_t^\lambda](t, u_t^k, \bar{y}_t) - H[p_t^\lambda](t, \bar{u}_t, \bar{y}_t)] dt + O(\|\delta y^k\|_\infty). \tag{3.82}
\end{aligned}$$

Proof of the decomposition principle. We prove Theorem 3.14 by estimating the two terms I_1^k and I_2^k obtained in Lemma 3.15.

\triangleright *Estimation of I_1^k .*

Let show that

$$\begin{aligned}
I_1^k &= \frac{1}{2} \int_0^T D^2 H^a[p_t^\lambda \nu_t](t, \bar{u}_t, \bar{y}_t)(v_t^{A,k}, z_t^{A,k})^2 dt \\
&\quad + \int_{B_k} (H[p_t^\lambda](t, u_t^k, \bar{y}_t) - H[p_t^\lambda](t, \tilde{u}_t^k, \bar{y}_t)) dt + o(R_{2,k}^2). \tag{3.83}
\end{aligned}$$

Using (3.71) and the stationarity of the augmented Hamiltonian, we obtain that term (3.75a) is equal to

$$\begin{aligned}
& \int_{A_k} H_y^a[p_t^\lambda, \nu_t](t, \bar{u}_t, \bar{y}_t) \delta y_t^k dt \\
&\quad + \frac{1}{2} \int_{A_k} D^2 H^a[p_t^\lambda, \nu_t](t, \bar{u}_t, \bar{y}_t)(v_t^{A,k}, z_t^{A,k})^2 dt + o(R_{2,k}^2). \tag{3.84}
\end{aligned}$$

Term (3.75b) is negligible compared to $R_{2,k}^2$. Since

$$\begin{aligned} & \int_{B_k} (H[p_t^\lambda](t, u_t^k, y_t^k) - H[p_t^\lambda](t, \tilde{u}_t^k, y_t^k)) dt \\ & - \int_{B_k} (H[p_t^\lambda](t, u_t^k, \bar{y}_t) - H[p_t^\lambda](t, \tilde{u}_t^k, \bar{y}_t)) dt = O(|B_k|R_{1,k}^2) = o(R_{2,k}^2), \end{aligned} \quad (3.85)$$

term (3.75c) is equal to

$$\int_{B_k} (H[p_t^\lambda](t, u_t^k, \bar{y}_t) - H[p_t^\lambda](t, \tilde{u}_t^k, \bar{y}_t)) dt + o(R_{2,k}^2). \quad (3.86)$$

The following term is also negligible:

$$\int_{B_k} D^2 H^a[p_t^\lambda](t, \bar{u}_t, \bar{y}_t)(v_t^{A,k}, z_t^{A,k})^2 dt = o(R_{2,k}^2). \quad (3.87)$$

Finally, combining (3.75), (3.84), (3.86), and (3.87), we obtain (3.83).

▷ *Estimation of I_2^k .*

Let us show that

$$\begin{aligned} I_2^k &= \frac{1}{2} \int_{[0,T]} (d\mu_t D^2 g(t, \bar{y}_t)(z_t^{A,k})^2) \\ & - \frac{1}{2} \sum_{\substack{\tau \in \mathcal{T}_{g,i} \\ 1 \leq i \leq n_g}} \mu_i(\tau) \frac{(Dg_i^{(1)}(\tau, \bar{y}_\tau) z_\tau^{A,k})^2}{g_i^{(2)}(\tau, \bar{u}_\tau, \bar{y}_\tau)}. \end{aligned} \quad (3.88)$$

Using (3.71), we obtain the following estimate of term (3.76a):

$$- \sum_{\substack{\tau \in \mathcal{T}_{g,i} \\ 1 \leq i \leq n_g}} \int_{\Delta_\tau^\varepsilon} Dg_i(t, \bar{y}_t) \delta y_t^k d\mu_{i,t} + \frac{1}{2} \sum_{i=1}^{n_g} \int_{\Delta_\tau^\varepsilon} D^2 g_i(t, \bar{y}_t)(z_t^{A,k})^2 d\mu_t + o(R_{2,k}^2). \quad (3.89)$$

Remember that $z^2[v^{A,k}, \delta y_0^k]$ denotes the second-order linearization (3.35) and that the following holds:

$$\|y^{A,k} - (\bar{y} + z[v^{A,k}, \delta y_0^k]) + z^2[v^{A,k}, \delta y_0^k]\|_\infty = o(R_{2,k}^2). \quad (3.90)$$

Using Lemma 3.11 and estimate (3.71), we obtain that for all i , for all $\tau \in \mathcal{T}_{g,i}$,

$$\begin{aligned} & \Theta_\tau^\varepsilon(u^k, y_0^k) - \Theta_\tau^\varepsilon(u^{A,k}, y_0^k) \\ &= g_i(\tau, y_\tau^k) - g_i(\tau, y_\tau^{A,k}) + O(R_{1,B,k}(R_{1,B,k} + R_{1,k})) \\ &= Dg_i(\tau, \bar{y}_\tau)(y_\tau^k - y_\tau^{A,k}) + o(R_{2,k}^2) \\ &= Dg_i(\tau, \bar{y}_\tau)(\delta y_\tau^k - z_\tau^{A,k} - z_\tau^2[v^{A,k}, \delta y_0^k]) + o(R_{2,k}^2). \end{aligned} \quad (3.91)$$

By Lemma 3.10,

$$\begin{aligned}
& \Theta_\tau^\varepsilon(u^{A,k}, y_0^k) - \Theta_\tau^\varepsilon(\bar{u}, \bar{y}_0) \\
&= Dg_i(\tau, \bar{y}_\tau)(z_\tau^{A,k} + z_\tau^2[v^{A,k}, \delta y_0^k]) \\
&\quad + \frac{1}{2}D^2g_i(\tau, \bar{y}_\tau)(z_\tau^{A,k})^2 - \frac{1}{2}\frac{(D_y g_i^{(1)}(\tau, \bar{y}_\tau)z_\tau^{A,k})^2}{g_i^{(2)}(\tau, \bar{u}_\tau, \bar{y}_\tau)} + o(R_{2,k}^2). \tag{3.92}
\end{aligned}$$

Recall that the restriction of μ_i to Δ_τ^ε is a Dirac measure at τ . Summing (3.91) and (3.92), we obtain the following estimate for (3.76b):

$$\begin{aligned}
& \sum_{\substack{\tau \in \mathcal{T}_{g,i} \\ 1 \leq i \leq n_g}} \left[\int_{\Delta_\tau^\varepsilon} (Dg_i(t, \bar{y}_t)\delta y_t^k + \frac{1}{2}D^2g_i(t, \bar{y}_t)(z_t^{A,k})^2) d\mu_{i,t} \right. \\
& \quad \left. - \frac{1}{2}\frac{(D_y g_i^{(1)}(\tau, \bar{y}_\tau)z_\tau^{A,k})^2}{g_i^{(2)}(\tau, \bar{u}_\tau, \bar{y}_\tau)} \right] + o(R_{2,k}^2). \tag{3.93}
\end{aligned}$$

Combining (3.89) and (3.93), we obtain (3.88). Combining (3.83) and (3.88), we obtain the result. \square

3.5 Quadratic growth for bounded strong solutions

We give in this section sufficient second-order optimality conditions in Pontryagin form ensuring the quadratic growth property for bounded strong solutions. Our main result, Theorem 3.18, is proved with a classical approach by contradiction.

Assumption 3.4. *There exists $\varepsilon > 0$ such that for all feasible trajectories (u, y) in $(\mathcal{U} \times \mathcal{Y})$ with $\|y - \bar{y}\| \leq \varepsilon$, if (u, y) satisfies the mixed constraints, then there exists \hat{u} such that*

$$\hat{u}_t \in U(t), \text{ for a.a. } t \quad \text{and} \quad \|u - \hat{u}\|_\infty = O(\|y - \bar{y}\|_\infty). \tag{3.94}$$

This assumption is a metric regularity property, global in u and local in y . Note that the required property is different from (3.60).

Definition 3.16. *A quadratic form Q on a Hilbert space X is said to be a Legendre form iff it is weakly lower semi-continuous and if it satisfies the following property: if $x^k \rightharpoonup x$ weakly in X and $Q(x^k) \rightarrow Q(x)$, then $x^k \rightarrow x$ strongly in X .*

Assumption 3.5. *For all $\lambda \in \Lambda_P(\bar{u}, \bar{y})$, $\Omega[\lambda]$ is a Legendre form.*

Remark 3.17. *By [16, Lemma 21], this assumption is satisfied if for all $\lambda \in \Lambda_P(\bar{u}, \bar{y})$, there exists $\gamma > 0$ such that for almost all t ,*

$$\gamma I \leq D_{uu}^2 H^a[p_t^\lambda, \nu_t](t, \bar{u}_t, \bar{y}_t), \tag{3.95}$$

where I is the identity matrix of $\mathbb{R}^{m \times m}$. In particular, in the absence of mixed and control constraints, the quadratic growth of the Hamiltonian (3.97) implies (3.95).

For all $R > \|\bar{u}\|_\infty$, we define

$$\Lambda_P^R(\bar{u}, \bar{y}) = \left\{ \lambda \in \Lambda_L(\bar{u}, \bar{y}) : \text{for a.a. } t, \text{ for all } u \in U(t) \text{ with } |u| \leq R, \right. \\ \left. H[p_t^\lambda](t, u, \bar{y}_t) - H[p_t^\lambda](t, \bar{u}_t, \bar{y}_t) \geq 0 \right\}. \quad (3.96)$$

Note that $\Lambda_P(\bar{u}, \bar{y}) = \cap_{R > \|\bar{u}\|_\infty} \Lambda_P^R(\bar{u}, \bar{y})$. Remember that $C_2(\bar{u}, \bar{y})$ is the critical cone in L^2 , defined by (3.36).

Theorem 3.18. *Suppose that Assumptions 3.1-3.5 hold. If the following second-order sufficient conditions hold: for all $R > \|\bar{u}\|_\infty$,*

1. *there exist $\alpha > 0$ and $\lambda^* \in \Lambda_P^R(\bar{u}, \bar{y})$ such that*

$$\begin{cases} \text{for a.a. } t, \text{ for all } u \in U(t) \text{ with } |u| \leq R, \\ H[p_t^{\lambda^*}](t, u, \bar{y}_t) - H[p_t^{\lambda^*}](t, \bar{u}_t, \bar{y}_t) \geq \alpha |u - \bar{u}_t|_2^2, \end{cases} \quad (3.97)$$

2. *for all $(v, z) \in C_2 \setminus \{0\}$, there exists $\lambda \in \Lambda_P^R(\bar{u}, \bar{y})$ such that $\Omega[\lambda](v, z) > 0$,*

then the quadratic growth property for bounded strong solutions holds at (\bar{u}, \bar{y}) .

Proof. We prove this theorem by contradiction. Let $R > \|\bar{u}\|_\infty$, let us suppose that there exists a sequence $(u^k, y^k)_k$ of feasible trajectories such that $\|u^k\|_\infty \leq R$, $\|y^k - \bar{y}\|_\infty \rightarrow 0$ and

$$\phi(y_0^k, y_T^k) - \phi(\bar{y}_0, \bar{y}_T) \leq o(\|u^k - \bar{u}\|_2^2 + |y_0^k - \bar{y}_0|^2). \quad (3.98)$$

We use the notations introduced in (3.67). Let $\lambda^* = (\beta^*, \Psi^*, \nu^*, \mu^*) \in \Lambda_P^R(\bar{u}, \bar{y})$ be such that (3.97) holds.

▷ *First step:* $\|u^k - \bar{u}\|_2 = R_{2,k} \rightarrow 0$.

By Assumption 3.4, there exists a sequence of controls $(\hat{u}^k)_k$ such that

$$\hat{u}_t^k \in U(t), \text{ for a.a. } t \quad \text{and} \quad \|u^k - \hat{u}^k\|_\infty = O(\|\delta y^k\|_\infty) = O(R_{1,k}). \quad (3.99)$$

As a consequence of (3.82), we obtain that

$$\begin{aligned} & \beta^*(\phi(y_0^k, y_T^k) - \phi(\bar{y}_0, \bar{y}_T)) \\ & \geq \int_0^T (H[p_t^{\lambda^*}](t, u_t^k, \bar{y}_t) - H[p_t^{\lambda^*}](t, \hat{u}_t^k, \bar{y}_t)) dt \\ & \quad + \int_0^T (H[p_t^{\lambda^*}](t, \hat{u}_t^k, \bar{y}_t) - H[p_t^{\lambda^*}](t, \bar{u}_t, \bar{y}_t)) dt + o(1) \\ & \geq \alpha \|\hat{u}^k - \bar{u}\|_2^2 + o(1) \\ & = \alpha \|u^k - \bar{u}\|_2^2 + o(1). \end{aligned}$$

Since $\beta^*(\phi(y_0^k, y_T^k) - \phi(\bar{y}_0, \bar{y}_T)) \rightarrow 0$, we obtain that $\|u^k - \bar{u}\|_2 \rightarrow 0$. Therefore, the sequence of trajectories satisfy (3.59) and by the Cauchy-Schwarz inequality, $R_{1,k} \rightarrow 0$.

Now, we can build a sequence of partitions $(A_k, B_k)_k$ which satisfies (3.64). Let us define

$$A_k := \left\{ t \in [0, T], |u_t^k - \bar{u}_t| \leq R_{1,k}^{1/4} \right\} \quad (3.100)$$

and $B_k := [0, T] \setminus A_k$. Then,

$$\|u^k - \bar{u}\|_1 \geq \int_{B_k} (\|u^k - \bar{u}\|_1 + |\delta y_0^k|)^{1/4} dt \geq |B_k| (\|u^k - \bar{u}\|_1)^{1/4}. \quad (3.101)$$

Thus, $|B_k| \leq (\|u^k - \bar{u}\|_1)^{3/4} \rightarrow 0$ and we can construct all the elements useful for the decomposition principle: \tilde{u}^k , $u^{A,k}$, $v^{A,k}$, δy^k , $y^{A,k}$, and $z^{A,k}$.

Let $\bar{\lambda} \in \Lambda_P^R(\bar{u}, \bar{y})$, $\pi \in [0, 1)$ and $\lambda := \pi \bar{\lambda} + (1 - \pi) \lambda^*$. The Hamiltonian depending linearly on the dual variable, the quadratic growth property (3.97) holds for λ (instead of λ^*) with the coefficient $(1 - \pi)\alpha > 0$ (instead of α).

▷ *Second step: we show that $R_{2,B,k} = O(R_{2,A,k})$ and $\Omega[\lambda](v^{A,k}, z^{A,k}) \leq o(R_{2,A,k}^2)$.* By the decomposition principle (Theorem 3.14), we obtain that

$$\begin{aligned} \Omega[\lambda](v^{A,k}, z^{A,k}) + \int_{B_k} [H[p_t^\lambda](t, u_t^k, \bar{y}_t) - H[p_t^\lambda](t, \tilde{u}_t^k, \bar{y}_t)] dt \\ \leq \beta(\phi(y_0^k, y_T^k) - \phi(\bar{y}_0, \bar{y}_T)) + o(R_{2,k}^2) \leq o(R_{2,k}^2). \end{aligned} \quad (3.102)$$

We cannot use directly the quadratic growth of the Hamiltonian, since the control u^k does not satisfy necessarily the mixed constraint $c(t, u_t^k, \bar{y}_t) \leq 0$. Therefore, we decompose the difference of Hamiltonians as follows:

$$\Delta_k = \int_{B_k} [H[p_t^\lambda](t, u_t^k, \bar{y}_t) - H[p_t^\lambda](t, \tilde{u}_t^k, \bar{y}_t)] dt = \Delta_k^a + \Delta_k^b + \Delta_k^c, \quad (3.103)$$

with

$$\begin{aligned} \Delta_k^a &:= \int_{B_k} (H[p_t^\lambda](t, u_t^k, \bar{y}_t) - H[p_t^\lambda](t, \hat{u}_t^k, \bar{y}_t)) dt, \\ \Delta_k^b &:= \int_{B_k} (H[p_t^\lambda](t, \hat{u}_t^k, \bar{y}_t) - H[p_t^\lambda](t, \bar{u}_t, \bar{y}_t)) dt, \\ \Delta_k^c &:= \int_{B_k} (H[p_t^\lambda](t, \bar{u}_t, \bar{y}_t) - H[p_t^\lambda](t, \tilde{u}_t, \bar{y}_t)) dt. \end{aligned}$$

Note first that by (3.102), $\Delta_k \leq O(R_{2,A,k}^2) + o(R_{2,B,k}^2)$. We set

$$\hat{R}_{2,B,k} = \left[\int_{B_k} |\hat{u}_t^k - \bar{u}_t|^2 dt \right]^{1/2}. \quad (3.104)$$

Note that $\Delta_k^b \geq 0$. In order to prove that $R_{2,B,k} = O(R_{2,A,k})$, we need the following two estimates:

$$|\Delta_k^a| + |\Delta_k^c| = o(\Delta_k^b), \quad (3.105)$$

$$|R_{2,B,k}^2 - \hat{R}_{2,B,k}^2| = o(R_{2,B,k}^2). \quad (3.106)$$

Since the control is uniformly bounded, the Hamiltonian is Lipschitz with respect to u and we obtain that

$$|\Delta_k^a| + |\Delta_k^c| = O(|B_k| R_{1,k}), \quad (3.107)$$

while, as a consequence of the quadratic growth of the Hamiltonian,

$$\begin{aligned}\Delta_k^b &\geq \alpha(1-\pi)\hat{R}_{2,B,k}^2 \\ &\geq \alpha(1-\pi)|B_k|(R_{1,k}^{1/4} + O(R_{1,k}))^2 \\ &\geq \alpha(1-\pi)|B_k|R_{1,k}^{1/2}(1 + O(R_{1,k}^{3/4}))^2,\end{aligned}\tag{3.108}$$

which proves (3.105). Combined with (3.102) and $\Omega[\lambda](v^{A,k}, z^{A,k}) = O(R_{2,A,k}^2)$, we obtain that

$$\Delta_k^b = O(\Delta_k^a + \Delta_k^b + \Delta_k^c) = O(\Delta_k) = O(R_{2,A,k}^2) + o(R_{2,B,k}^2)\tag{3.109}$$

and

$$\hat{R}_{2,B,k}^2 \leq \frac{1}{\alpha(1-\pi)}\Delta_k^b = O(\Delta_k) \leq O(R_{2,A,k}^2) + o(R_{2,B,k}^2).\tag{3.110}$$

Let us prove (3.106). For all k , we have

$$\begin{aligned}|R_{2,B,k}^2 - \hat{R}_{2,B,k}^2| &= \left| \int_{B_k} (|u_t^k - \bar{u}_t|^2 - |\hat{u}_t^k - \bar{u}_t^2|) dt \right| \\ &\leq \int_{B_k} |u_t^k - \hat{u}_t^k| (|u_t^k - \hat{u}_t^k| + 2|u_t^k - \bar{u}_t|) dt \\ &\leq \|u^k - \hat{u}^k\|_\infty \left(\int_{B_k} |u_t^k - \hat{u}_t^k| dt + 2 \int_{B_k} |u_t^k - \bar{u}_t| dt \right) \\ &= O(R_{1,k})(O(|B_k|R_{1,k}) + O(R_{1,B,k})) \\ &= o(R_{2,k}^2)\end{aligned}$$

which proves (3.106), by using (3.108). Combined with (3.110), it follows that

$$R_{2,B,k}^2 = \hat{R}_{2,B,k}^2 + o(R_{2,k}^2) = O(R_{2,A,k}^2) + o(R_{2,B,k}^2)\tag{3.111}$$

and finally that

$$R_{2,B,k}^2 = O(R_{2,A,k}^2) \quad \text{and} \quad R_{2,k} = O(R_{2,A,k}).\tag{3.112}$$

Moreover, since $\Delta_k^b \geq 0$ and by (3.105), (3.109), and (3.112),

$$\begin{aligned}\Omega[\lambda](v^{A,k}, z^{A,k}) &\leq o(R_{2,k}^2) - \Delta_k^a - \Delta_k^c \\ &\leq o(R_{2,k}^2) + o(\Delta^k) \leq o(R_{2,A,k}^2).\end{aligned}\tag{3.113}$$

▷ *Third step: contradiction.*

Let us set

$$w^k = \frac{v^{A,k}}{R_{2,A,k}} \quad \text{and} \quad x^k = \frac{z^{A,k}}{R_{2,A,k}} = z[w^k, \delta y_0^k / R_{2,A,k}].\tag{3.114}$$

The sequence $(w^k, x_0^k)_k$ being bounded in $L^2(0, T; \mathbb{R}^m) \times \mathbb{R}^n$, it converges (up to a subsequence) for the weak topology to a limit point, say (w, x_0) . Let us set $x = z[w, x_0]$. Let us prove that $(w, x) \in C_2(\bar{u}, \bar{y})$. It follows from the continuity of the linear mapping

$$z : (v, z_0) \in L^2(0, T; \mathbb{R}^m) \times \mathbb{R}^n \rightarrow z[v, z_0] \in W^{1,2}(0, T; \mathbb{R}^n)\tag{3.115}$$

and the compact imbedding of $W^{1,2}(0, T; \mathbb{R}^n)$ into $C(0, T; \mathbb{R}^n)$ that extracting if necessary, $(x^k)_k$ converges uniformly to x . Using (3.71), we obtain that

$$\begin{aligned} \|\delta y^k - R_{2,A,k}x\|_\infty &= \|z^{A,k} - R_{2,A,k}x\|_\infty + o(R_{2,A,k}) \\ &= R_{2,A,k}(\|x^k - x\|_\infty + o(1)) \\ &= o(R_{2,A,k}). \end{aligned} \quad (3.116)$$

It follows that

$$\phi(y_0^k, y_T^k) - \phi(\bar{y}_0, \bar{y}_T) = R_{2,A,k}D\phi(\bar{y}_0, \bar{y}_T)(x_0, x_T) + o(R_{2,A,k}), \quad (3.117)$$

$$\Phi(y_0^k, y_T^k) - \Phi(\bar{y}_0, \bar{y}_T) = R_{2,A,k}D\Phi(\bar{y}_0, \bar{y}_T)(x_0, x_T) + o(R_{2,A,k}), \quad (3.118)$$

$$\|g(t, y_t^k) - g(t, \bar{y}_t) - R_{2,A,k}Dg(t, \bar{y}_t)x_t\|_\infty = o(R_{2,A,k}). \quad (3.119)$$

This proves that

$$D\phi(\bar{y}_0, \bar{y}_T)(x_0, x_T) = 0, \quad (3.120)$$

$$D\Phi(\bar{y}_0, \bar{y}_T)(x_0, x_T) \in T_{K_\Phi}(\phi(\bar{y}_0, \bar{y}_T)), \quad (3.121)$$

$$Dg(\cdot, \bar{y})x \in T_{K_g}(g(\cdot, \bar{y})). \quad (3.122)$$

Let us set, for a.a. t ,

$$\bar{c}_t = c(t, \bar{u}_t, \bar{y}_t) \quad \text{and} \quad c_t^k = \bar{c}_t \mathbf{1}_{\{t \in B_k\}} + c(t, u^{A,k}, y_t^k) \mathbf{1}_{\{t \in A_k\}}. \quad (3.123)$$

We easily check that

$$\|c_t^k - (\bar{c}_t + R_{2,A,k}Dc(t, \bar{u}_t, \bar{y}_t)(w_t^k, x_t^k))\|_\infty = o(R_{2,A,k}). \quad (3.124)$$

Therefore,

$$\frac{c_t^k - \bar{c}_t}{R_{2,A,k}} \rightharpoonup Dc(t, \bar{u}_t, \bar{y}_t)(w_t, x_t) \quad (3.125)$$

in $L^2(0, T; \mathbb{R}^{n_c})$. Moreover, $c_t^k \leq 0$, for almost all t , therefore the ratio in (3.125) belongs to $T_{K_c}(c(\cdot, \bar{u}, \bar{y}))$. This cone being closed and convex, it is weakly closed and we obtain finally that

$$Dc(t, \bar{u}_t, \bar{y}_t)(w_t, x_t) \in T_{K_c}(c(\cdot, \bar{u}, \bar{y})). \quad (3.126)$$

We have proved that $(w, x) \in C_2(\bar{u}, \bar{y})$. By Assumption 3.5, $\Omega[\lambda]$ is weakly* lower semi-continuous, thus from (3.113) we get

$$\Omega[\lambda](w, x) \leq \liminf_k \Omega[\lambda](w^k, x^k) \leq 0. \quad (3.127)$$

Passing to the limit when $\pi \rightarrow 1$, we find that $\Omega[\bar{\lambda}](w, x) \leq 0$. Since $\bar{\lambda}$ was arbitrary in $\Lambda_P^R(\bar{u}, \bar{y})$, it follows by the sufficient conditions that $(w, x) = 0$ and that for any λ for which the quadratic growth of the Hamiltonian holds,

$$\Omega[\lambda](w, x) = \lim_k \Omega[\lambda](w^k, x^k). \quad (3.128)$$

Since $\Omega[\lambda]$ is a Legendre form, we obtain that $(w^k, z_0^k)_k$ converges strongly to 0, in contradiction with the fact that $\|w^k\|_2 + |x_0^k| = 1$. This concludes the proof of the theorem. \square

3.6 Characterization of quadratic growth

In this section, we prove that the second-order sufficient conditions are also necessary to ensure the quadratic growth property. The proof relies on the necessary second-order optimality conditions in Pontryagin form that we established in [14]. Let us first remember the assumptions required to use these necessary conditions.

Assumption 3.6. *The mappings f and g are C^∞ , c is uniformly quasi- C^2 , Φ and ϕ are C^2 .*

For $\delta' > 0$ and $\varepsilon' > 0$, let us define

$$\Delta_{c,i}^{\delta'} := \{t \in [0, T] : c_i(t, \bar{u}_t, \bar{y}_t) \geq -\delta'\}, \quad (3.129)$$

$$\Delta_{g,i}^0 := \{t \in [0, T] : g_i(t, \bar{y}_t) = 0\} \setminus \mathcal{T}_{g,i}, \quad (3.130)$$

$$\Delta_{g,i}^{\varepsilon'} := \{t \in [0, T] : \text{dist}(t, \Delta_{g,i}^0) \leq \varepsilon'\}. \quad (3.131)$$

Assumption 3.7 is a geometrical assumption on the structure of the control. Assumption 3.8 is related to the controllability of the system, see [17, Lemma 2.3] for conditions ensuring this property.

Assumption 3.7. *For $1 \leq i \leq n_g$, $\Delta_{g,i}^0$ has finitely many connected components and g_i is of finite order q_i .*

Assumption 3.8. *There exist $\delta', \varepsilon' > 0$ such that the linear mapping from $\mathcal{V}_2 \times \mathbb{R}^n$ to $\prod_{i=1}^{n_c} L^2(\Delta_{c,i}^{\delta'}) \times \prod_{i=1}^{n_g} W^{q_i,2}(\Delta_{g,i}^{\varepsilon'})$ defined by*

$$(v, z^0) \mapsto \left(\begin{array}{l} \left(Dc_i(\cdot, \bar{u}, \bar{y})(v, z[v, z^0])|_{\Delta_{c,i}^{\delta'}} \right)_{1 \leq i \leq n_c} \\ \left(Dg_i(\cdot, \bar{y})z[v, z^0]|_{\Delta_{g,i}^{\varepsilon'}} \right)_{1 \leq i \leq n_g} \end{array} \right) \quad \text{is onto.} \quad (3.132)$$

The second-order necessary conditions are satisfied on a subset of the critical cone called *strict critical cone*. The following assumption ensures that the two cones are equal [21, Proposition 3.10].

Assumption 3.9. *There exists $\lambda = (\bar{\beta}, \bar{\Psi}, \bar{\nu}, \bar{\mu}) \in \Lambda_L(\bar{u}, \bar{y})$ such that*

$$\bar{\nu}_i(t) > 0 \quad \text{for a.a. } t \in \Delta_{c,i}^0 \quad 1 \leq i \leq n_c, \quad (3.133)$$

$$\text{supp}(\bar{\mu}_i) \cap \Delta_{g,i}^0 = \Delta_{g,i}^0 \quad 1 \leq i \leq n_g. \quad (3.134)$$

The main result of [14] was the following necessary conditions in Pontryagin form:

Theorem 3.19. *Let Assumptions 3.2, 3.3, and 3.6-3.9 hold. If (\bar{u}, \bar{y}) is a Pontryagin minimum of problem (P), then for any $(v, z) \in C_2(\bar{u}, \bar{y})$, there exists $\lambda \in \Lambda_P(\bar{u}, \bar{y})$ such that*

$$\Omega[\lambda](v, z) \geq 0. \quad (3.135)$$

Assumption 3.10. *All Pontryagin multipliers $\lambda = (\beta, \Psi, \nu, \mu)$ are non singular, that is to say, are such that $\beta > 0$.*

This assumption is satisfied if one of the usual qualification conditions holds since then, all Lagrange multipliers are non singular. In [14, Proposition A.13], we gave a weaker condition ensuring the non singularity of Pontryagin multipliers.

Lemma 3.20. *Let Assumptions 3.2, 3.3, and 3.6-3.10 hold. If the quadratic growth property for bounded strong solutions holds at (\bar{u}, \bar{y}) , then the sufficient second-order conditions are satisfied.*

Proof. Let $R > \|\bar{u}\|_\infty$, let $\alpha > 0$ and $\varepsilon > 0$ be such that for all $(u, y) \in F(P)$ with $\|u\|_\infty \leq R$ and $\|y - \bar{y}\|_\infty \leq \varepsilon$,

$$\phi(y_0, y_T) - \phi(\bar{y}_0, \bar{y}_T) \geq \alpha(\|u - \bar{u}\|_2^2 + |y_0 - \bar{y}_0|^2). \quad (3.136)$$

Then, (\bar{u}, \bar{y}) is a Pontryagin minimum to a new optimal control problem with cost

$$\phi(y_0, y_T) - \alpha(|y_0 - \bar{y}_0|^2 + \|u - \bar{u}\|^2) \quad (3.137)$$

and with the additional constraint $\|u\|_\infty \leq R$. The new Hamiltonian and the new Hessian of the Lagrangian are now given by resp.

$$H[p](t, u, y) - \alpha\beta|u - \bar{u}|^2 \quad \text{and} \quad \Omega[\lambda](v, z) - \alpha\beta(\|v\|^2 + |z_0|^2). \quad (3.138)$$

It is easy to check that the costate equation is unchanged and that the set of Lagrange multipliers of both problems are the same. The set of Pontryagin multipliers to the new problem is the set of Lagrange multipliers λ for which for a.a. t , for all $u \in U(t)$ with $|u| \leq R$,

$$H[p_t^\lambda](t, u, \bar{y}_t) - H[p_t^\lambda](t, \bar{u}_t, \bar{y}_t) \geq \alpha\beta|u - \bar{u}|_2^2, \quad (3.139)$$

it is thus included into $\Lambda_P^R(\bar{u}, \bar{y})$ (which was defined by (3.96)). Let (v, z) in $C_2(\bar{u}, \bar{y}) \setminus \{0\}$, then by Theorem 3.19, there exists a Pontryagin multiplier (to the new problem), belonging to $\Lambda_P^R(\bar{u}, \bar{y})$, which is such that

$$\Omega[\lambda](v, z) \geq \alpha\beta(|z_0|^2 + \|v\|_2^2) > 0. \quad (3.140)$$

The sufficient second-order optimality conditions are satisfied. \square

Finally, combining Theorem 3.18 and Lemma 3.20 we obtain a characterization of the quadratic growth property for bounded strong solutions (under the Legendre-Clebsch assumption).

Theorem 3.21. *Let Assumptions 3.2-3.10 hold. Then, the quadratic growth property for bounded strong solutions holds at (\bar{u}, \bar{y}) if and only if the sufficient second-order conditions are satisfied.*

Chapter 4

Sensitivity analysis for relaxed optimal control problems with final-state constraints

Contents

4.1	Introduction	100
4.2	Formulation of the problem and preliminary results	102
4.2.1	Setting	102
4.2.2	Estimates	104
4.2.3	Metric regularity	105
4.2.4	Optimality conditions	107
4.3	First-order upper estimate of the value function	108
4.4	Second-order upper estimate of the value function	111
4.4.1	Standard linearizations and estimates	111
4.4.2	Second-order upper estimate	114
4.5	Lower estimate of the value function	116
4.5.1	A decomposition principle	116
4.5.2	Study of the rate of convergence of perturbed solutions	118
4.5.3	First- and second-order estimates	121
4.6	Two examples	123
4.6.1	A different value for the linearized problems	123
4.6.2	No classical solutions for the perturbed problems	124
4.A	Appendix	125

Abstract

In this chapter, we compute a second-order expansion of the value function of a family of relaxed optimal control problems with final-state constraints, parameterized by a perturbation variable. In this framework, relaxation with Young measures enables us to consider a wide class of perturbations and therefore to derive sharp estimates of the value function. The sensitivity analysis is performed in a neighborhood of a local optimal solution of a reference problem. The local solution \bar{u} is assumed to be optimal with respect to the set of feasible relaxed controls having their support in a ball of a given radius $R > \|u\|_\infty$ and having an associated trajectory very close to the reference trajectory, for the L^∞ -norm. We call such a solution a relaxed R -strong solution.

Résumé

Dans ce chapitre, nous calculons un développement au second ordre de la fonction valeur d'une famille de problèmes de contrôle optimal avec contraintes sur l'état final, paramétrée par une variable de perturbation. L'analyse de sensibilité est réalisée pour des contrôles nommés *R-strong solutions*. Ce sont des solutions optimales par rapport à l'ensemble des contrôles admissibles de norme infinie inférieure à R ayant une trajectoire associée dans un petit voisinage pour la norme infinie. Dans ce cadre, la relaxation nous permet de considérer une large classe de perturbations et ainsi d'obtenir des estimations précises de la fonction valeur.

4.1 Introduction

We consider a family of relaxed optimal control problems with final-state constraints, parameterized by a perturbation variable θ . The variable θ can perturb the dynamic of the system, the cost function and the final-state constraints. The aim of the article is to compute a second-order expansion of the value $V(\theta)$ of the perturbed problems, in the neighborhood of a reference value of θ , say $\bar{\theta}$. We assume that the reference problem has a classical local solution \bar{u} . The specificity of our work is to consider that this solution is an R -strong solution, a type of solutions that we introduce and which is closely related to the usual bounded strong solutions. We also provide some information on the first-order behavior of perturbed solutions.

There is already an important literature on sensitivity analysis of optimal control problems. By using a shooting formulation of the problems and extensions of the implicit function theorem, Malanowski and Maurer prove the existence of weak solutions to the perturbed problems and their Fréchet-differentiability with respect to the perturbation parameter [55], for optimal control problems with first-order state constraints and mixed constraints. The obtained derivative is itself the solution of a linear quadratic optimal control problem. Then, a second-order expansion of the value function follows. We also refer the reader to [51] (and the references therein) for results on the Lipschitzian behaviour of perturbed solutions of problems with mixed and first-order state constraints and to [42] for the case of problems with second-order (and higher-order) state constraints. Roughly speaking, three kinds of assumptions in all these papers

are considered: a sufficient second-order condition, a qualification condition and strict complementarity conditions (imposing in particular the uniqueness of the multiplier).

In this article, rather than using the implicit function theorem, we follow the methodology described in [21] and originally in [12]. This approach allows to derive a second-order expansion of the value function without the assumptions of strict complementarity. In general, this approach does not ensure differentiability properties of perturbed solutions. The approach is the following: we begin by linearizing the family of optimization problems in the neighborhood of an optimal solution of the reference problem. Under a qualification condition, the first-order and second-order linearizations provide a second-order upper estimate of the value function. The two coefficients involved are the values of two linearized optimization problems, considered in their dual form. Then, a first lower estimate is obtained by expanding the Lagrangian up to the second order. Considering a strong sufficient second-order condition, we show that the distance between the reference solution and solutions to the perturbed problems is of order $|\theta - \bar{\theta}|$. Finally, the lower estimate corresponds to the upper estimate previously obtained.

The sensitivity analysis is performed in the framework of relaxed optimal controls. Roughly speaking, at each time, the control variable is not anymore a vector in a space U , but a probability measure on U , like if we were able to use several controls simultaneously. The new control variable is now a Young measure, in reference to the pioneering work of Young [73]. Relaxation of optimal control problems with Young measures has been much studied, in particular in [33, 54, 71, 72, 73]. Any Young measure is the weak-* limit of a sequence of classical controls, therefore, we expect that a classical optimal control problem and its relaxed version have the same value. This question is studied, for instance, in [8, 35].

Three aspects motivate the use of the relaxation. First, by considering convex combinations of controls in the sense of measures, we manage to describe in a convenient way a large class of tangential directions of the reachable set. This class of tangential directions was called *cone of variations* in the early papers of McShane [54], Gamkrelidze [37] and Warga [70, 71]. It enables to prove Pontryagin's principle with the standard methods used to derive first-order optimality conditions of optimization problems. In our study, we obtain upper estimates expressed with Pontryagin multipliers. More precisely, the two linearized optimization problems that we obtain have a dual form involving multipliers for which Pontryagin's principle holds. Let us mention that Dmitruk used a partial relaxation technique in [27], under the name of *sliding modes*, to prove Pontryagin's principle. His method does not need the use of Young measures, since the relaxation is performed on discrete sets. On the other hand, an infinite sequence of auxiliary problems (justified in [28]) is required to obtain Pontryagin's multipliers. Second, in the framework of relaxation, we can derive a metric regularity theorem for the L^1 -distance using abstract results from [30] and finally, the existence of relaxed solutions for the perturbed problem is guaranteed. Note that such solutions do not always exist in a classical framework.

The sensitivity analysis is realized locally, in a neighborhood of a local optimal solution \bar{u} of the reference problem. In this study, we use the notion of relaxed R -strong optimal controls, for $R > \|\bar{u}\|_\infty$. We say that a control is a relaxed R -strong optimal

solution if it is optimal with respect to the Young measures having their support in a ball of radius R and having a state variable sufficiently close for the uniform norm. This notion is related to the one of bounded strong solutions [55]. In order to obtain a sharp upper estimate of V , we must derive a linearized problem from a wide class of perturbations of the control. More precisely, we must be able to perturb the reference optimal control with close controls for the L^1 -distance, taking into account that they are usually not necessarily close for the L^∞ -distance. For such perturbations of the control, we use a particular linearization of the dynamics of the system, the Pontryagin linearization [55].

We obtain a lower estimate of the value function by assuming a sufficient second-order condition having the same nature as the one in [18]. We assume that a certain quadratic form is positive and that the Hamiltonian satisfies a quadratic growth condition. In order to expand the Lagrangian up to the second-order, we split the controls into two parts, one accounting for the small perturbation of the control in the L^∞ -distance and the other one accounting for the large variations. We obtain an extension of the decomposition principle described in [18] and a lower estimate which corresponds to the upper estimate obtained previously.

The outline of the paper is as follows. In section 4.2, we prove some preliminary results and in particular, a metric regularity theorem. Note that we will always suppose that the associated qualification condition holds. In section 4.3, we obtain a first-order upper estimate of V and in section 4.4 a second-order upper estimate, given in theorem 4.26. In section 4.5, we prove the decomposition principle (theorem 4.28) and we obtain the lower estimate (theorem 4.34). Two examples are discussed in section 4.6. In the appendix, we provide the theoretical material related to Young measures, with precise references from [7, 24, 67, 68]. We also justify the use of relaxation and present some technical proofs for completeness.

4.2 Formulation of the problem and preliminary results

4.2.1 Setting

In this part, we define the family of optimal control problems that we want to study. We also introduce the notion of *relaxed R -strong* solutions.

In the article, the perturbation parameter will be denoted by θ . A reference value of θ , say $\bar{\theta}$ is given. We restrict ourselves to the case where θ is nonnegative and $\bar{\theta} = 0$. We assume that the functions used are defined for $\theta \in [0, 1]$. Consider the control and state spaces

$$\mathcal{U} := L^\infty(0, T; \mathbb{R}^m), \quad \mathcal{Y} := W^{1, \infty}(0, T; \mathbb{R}^n), \quad (4.1)$$

and the state equation, defined in a classical framework, for the moment:

$$\begin{cases} \dot{y}_t = f(u_t, y_t, \theta), & \text{for a.a. } t \in [0, T], \\ y_0 = y^0, \end{cases} \quad (4.2)$$

where $y^0 \in \mathbb{R}^n$ is given and fixed. For a control u in \mathcal{U} and $\theta \geq 0$, we denote by $y[u, \theta]$ the trajectory satisfying the differential system (4.2). We consider the following final

state constraint:

$$\Phi(y_T, \theta) \in K, \quad K := \{0\}^{n_E} \times \mathbb{R}_-^{n_I} \subset \mathbb{R}^{n_C}, \quad (4.3)$$

with $n_C = n_E + n_I$. The general family of optimal control problems that we consider is the following:

$$\text{Min}_{u \in \mathcal{U}} \phi(y_T[u, \theta], \theta), \quad \text{s.t. } \Phi(y_T[u, \theta], \theta) \in K. \quad (4.4)$$

All introduced functions (f , ϕ , and Φ) are supposed to be C^2 (twice differentiable with a continuous second-order derivative).

In this general setting, it is not possible to perform a sensitivity analysis of the global problem. Instead, we are interested in the local behavior of the solutions of the family of problems, in the neighborhood of a local solution of the reference problem (with $\theta = 0$). Let us make clear the notion of local optimality which is used. From now on, we fix a control $\bar{u} \in \mathcal{U}$ and its associated trajectory $\bar{y} = y[\bar{u}, 0]$.

Definition 4.1. Let $R > \|\bar{u}\|_\infty$, the control \bar{u} is said to be an R -strong optimal solution if there exists $\eta > 0$ such that \bar{u} is a solution to the following localized reference problem:

$$\text{Min}_{u \in \mathcal{U}, \|u\|_\infty \leq R} \phi(y_T[u, 0], 0), \quad \text{s.t. } \Phi(y_T[u, 0], 0) \in K, \quad \|y[u, 0] - \bar{y}\|_\infty \leq \eta. \quad (4.5)$$

Note that the control \bar{u} is a *bounded strong* solution if for all $R > \|\bar{u}\|_\infty$, it is an R -strong optimal solution [55, page 291]. If for a given $R > \|\bar{u}\|_\infty$, \bar{u} is an R -strong solution, then it is a weak solution.

Let us consider now a relaxed version of this definition. Let us denote by U_R the closed ball of radius R and center 0 in \mathbb{R}^m . We denote by \mathcal{M}_R^Y the set of Young measures on $[0, T] \times U_R$. Relaxation consists in replacing *classical* controls in \mathcal{U} by Young measures, that we will call *relaxed* controls, like if we were able to take several decisions simultaneously at each time. The basic definitions related to Young measures are recalled in the appendix.

The dynamic associated with a Young measure μ in \mathcal{M}_R^Y is the following:

$$\begin{cases} \dot{y}_t = \int_{U_R} f(u, y_t, \theta) d\mu_t(u), & \text{for a.a. } t \in [0, T], \\ y_0 = y^0. \end{cases} \quad (4.6)$$

This definition is compatible with (4.2) for controls in \mathcal{U} . We extend the mapping $y[u, \theta]$ to Young measures and we say that $\mu \in \mathcal{M}_R^Y$ is *feasible* for the value θ if

$$\Phi(y_T[\mu, \theta], \theta) \in K. \quad (4.7)$$

From now on, we fix $R > \|\bar{u}\|_\infty$ and we denote by $\bar{\mu}$ the Young measure associated with \bar{u} .

Definition 4.2. The relaxed control $\bar{\mu}$ is said to be a relaxed R -strong optimal solution if there exists $\eta > 0$ such that $\bar{\mu}$ is solution to the following relaxed localized reference problem:

$$\text{Min}_{\mu \in \mathcal{M}_R^Y} \phi(y_T[\mu, 0], 0), \quad \text{s.t. } \Phi(y_T[\mu, 0], 0) \in K, \quad \|y[\mu, 0] - \bar{y}\|_\infty \leq \eta. \quad (4.8)$$

Note that if $\bar{\mu}$ is a relaxed R -strong solution, then \bar{u} is an R -strong solution. From now on, we suppose that $\bar{\mu}$ is a relaxed R -strong optimal solution for the value $\bar{\eta}$. The relaxed optimal control problems that we will study are the following:

$$V^\eta(\theta) := \begin{cases} \text{Min}_{\mu \in \mathcal{M}_R^Y} & \phi(y_T[\mu, \theta], \theta), \\ \text{s.t.} & \Phi(y_T[\mu, \theta], \theta) \in K, \quad \|y[\mu, \theta] - \bar{y}\|_\infty \leq \eta. \end{cases} \quad (\mathcal{P}_\theta^{Y, \eta})$$

Remark 4.3. Note that η is not fixed. For all $0 < \eta \leq \eta'$, for all $\theta \geq 0$,

$$V^{\eta'}(\theta) \leq V^\eta(\theta).$$

By assumption, for all $\eta \in (0, \bar{\eta}]$, $V^\eta(0) = V^{\bar{\eta}}(0)$. The role of η in the study is secondary, but it cannot be neglected. Indeed, all the results related to upper estimates (lemma 4.15 and theorem 4.26) are satisfied for all $\eta \in (0, \bar{\eta}]$. In section 4.5, the second-order sufficient condition ensures that for small, positive, and fixed values of η , there exist solutions μ^θ of $(\mathcal{P}_\theta^{Y, \eta})$, converging to $\bar{\mu}$ for the L^2 -distance (theorem 4.33). Thus, the associated trajectories converge uniformly. This proves that for small values of $\eta > 0$, for all $0 < \eta' < \eta$, V^η and $V^{\eta'}$ coincide on a neighborhood of 0.

4.2.2 Estimates

In our study, the addition of Young measures must be understood as the addition of measures on $[0, T] \times U_R$. With this definition of the addition, the set \mathcal{M}_R^Y is convex. The following lemma is a corollary of lemma 4.7. The distance d_1 is the Wasserstein distance, defined by (4.71).

Lemma 4.4. Let μ^0 and μ^1 be in \mathcal{M}_R^Y , and σ in $[0, 1]$. Then,

$$d_1(\mu^0, (1 - \sigma)\mu^0 + \sigma\mu^1) \leq \sigma d_1(\mu^0, \mu^1) \leq 2RT\sigma.$$

In the sequel, we use the notation $g[t] := g(\bar{u}_t, \bar{y}_t, 0)$ for every function g of (u, y, θ) . The following definition of the Pontryagin linearization is a particular linearization of the state equation. Indeed, we only linearize the dynamic with respect to the state variable. We extend the definition of [55, page 40] to Young measures.

Definition 4.5. For a given control μ , we define the Pontryagin linearization $\xi[\mu]$ in \mathcal{Y} as the solution of

$$\begin{cases} \dot{\xi}_t[\mu] = f_y[t]\xi_t[\mu] + \int_{U_R} f(u, \bar{y}_t, 0) d\mu_t(u) - f[t], & \text{for a.a. } t \in [0, T], \\ \xi_0[\mu] = 0. \end{cases}$$

Denote by ξ^θ the solution of the following differential system:

$$\begin{cases} \dot{\xi}_t^\theta = f_y[t]\xi_t^\theta + f_\theta[t], & \text{for a.a. } t \in [0, T], \\ \xi_0^\theta = 0. \end{cases}$$

Lemma 4.6. *The following estimates hold:*

$$\|y[\mu, \theta] - \bar{y}\|_\infty = O(d_1(\mu, \bar{\mu}) + \theta), \quad (4.9)$$

$$\|y[\mu, \theta] - (\bar{y} + \xi[\mu] + \theta\xi^\theta)\|_\infty = O(d_1(\mu, \bar{\mu})^2 + \theta^2), \quad (4.10)$$

where d_1 is the Wasserstein distance (4.71).

This lemma is proved in the appendix, page 130.

4.2.3 Metric regularity

For $q \in \mathbb{N} \setminus \{0\}$, we set $\Delta := \left\{ \gamma \in \mathbb{R}_+^q, \sum_{i=1}^q \gamma_i \leq 1 \right\}$. Given $\mu^1, \dots, \mu^q \in \mathcal{M}_R^Y$, we denote by S the following mapping:

$$S : (\mu^0, \gamma) \in (\mathcal{M}_R^Y \times \Delta) \mapsto \left(1 - \sum_{i=1}^q \gamma_i\right) \mu^0 + \sum_{i=1}^q \gamma_i \mu^i \in \mathcal{M}_R^Y. \quad (4.11)$$

Lemma 4.7. *Let $\gamma, \gamma' \in \Delta$, and let $\mu^0 \in \mathcal{M}_R^Y$. Then,*

$$d_1(S(\mu^0, \gamma), S(\mu^0, \gamma')) \leq \sum_{i=1}^q |\gamma'_i - \gamma_i| d_1(\mu^i, \mu^0) \leq 2RT \sum_{i=1}^q |\gamma'_i - \gamma_i|.$$

This lemma is proved in the appendix, page 131. We introduce the following set:

$$\mathcal{R}_T := \{\xi_T[\mu], \mu \in \mathcal{M}_R^Y\}. \quad (4.12)$$

The Pontryagin linearization being affine with respect to μ , \mathcal{R}_T is clearly convex. We denote by $\mathcal{C}(\mathcal{R}_T)$ the smallest closed cone containing \mathcal{R}_T . Since \mathcal{R}_T is convex, $\mathcal{C}(\mathcal{R}_T)$ is also convex. This set should be understood as a set of tangential directions of the reachable set (at the final time). It is a close object to the cone of variations described in [37, page 121], [71, page 132] and [54, page 457].

Definition 4.8 (Qualification). *The control $\bar{\mu}$ is qualified if there exists $\varepsilon > 0$ such that*

$$\varepsilon B \subset \Phi(\bar{y}_T, 0) + \Phi_{y_T}(\bar{y}_T, 0) \mathcal{C}(\mathcal{R}_T) - K, \quad (4.13)$$

where B is the unit ball of \mathbb{R}^{n_c} and the r.h.s. is understood as

$$\{\Phi(\bar{y}_T, 0) + \Phi_{y_T}(\bar{y}_T, 0)\xi - \zeta, \text{ such that } \xi \in \mathcal{C}(\mathcal{R}_T), \zeta \in K\}.$$

In the sequel, we will always assume that $\bar{\mu}$ is qualified. Note that our qualification condition has the usual form of the Robinson qualification condition and that in remark 4.21, we show that this assumption is weaker than the standard qualification assumption. In general, the Robinson qualification condition allows to compute tangent cones, thanks to a metric regularity property and finally to prove the existence of nondegenerate Lagrange multipliers. In this article, the qualification condition allows to prove a theorem of metric regularity for the relaxed problem. This theorem will be a useful tool to justify the linearized problems. The main elements of the proof of the theorem can be found in [71, lemma 3.1].

Theorem 4.9. *If $\bar{\mu}$ is qualified, then there exist $\delta > 0$, $\sigma > 0$, and $C \geq 0$ such that for all $\theta \in [0, \sigma]$, for all μ satisfying $d_1(\mu, \bar{\mu}) \leq \delta$, there exists a control μ' satisfying*

$$\Phi(y_T[\mu', \theta], \theta) \in K \quad \text{and} \quad d_1(\mu', \mu) \leq C \operatorname{dist}(\Phi(y_T[\mu, \theta], \theta), K). \quad (4.14)$$

Proof. \triangleright *First step: reduction to a finite-dimensional case.*

If (4.13) holds, it can be proved that there exists a family $(\xi^i)_i$, $i = 1, \dots, n_A$ (with $n_A \leq n_C + 1$) in $\mathcal{C}(\mathcal{R}_T)$ such that for some $\varepsilon_1 > 0$,

$$\varepsilon_1 B \subset \Phi(\bar{y}_T, 0) + \Phi_{y_T}(\bar{y}_T, 0) \left(\operatorname{conv}\{\xi_T[\mu^1], \dots, \xi_T[\mu^{n_A}]\} \right) - K.$$

Using the mapping S defined by (4.11), with $q = n_A$, we consider the mapping

$$G_{\mu, \theta} : \gamma \in \Delta \mapsto \Phi(y_T[S(\mu, \gamma), \theta], \theta) \in \mathbb{R}^{n_C}, \quad (4.15)$$

defined for all (μ, θ) in $\mathcal{M}_R^Y \times \mathbb{R}_+$. Note that $G_{\mu, \theta}(0_{n_A}) = \Phi(y_T[\mu, \theta], \theta)$.

Let us fix μ, θ . It can be shown that $\gamma \mapsto G_{\mu, \theta}(\gamma)$ is differentiable on Δ in the following sense: there exists a unique mapping $\gamma \in \Delta \mapsto G'_{\mu, \theta}(\gamma) \in \mathbb{R}^{n_A}$ such that, for all $\gamma, \gamma' \in \Delta$,

$$G_{\mu, \theta}(\gamma') = G_{\mu, \theta}(\gamma) + G'_{\mu, \theta}(\gamma)(\gamma' - \gamma) + o(|\gamma' - \gamma|).$$

An explicit formula for $G'_{\mu, \theta}$ can be obtained with the Pontryagin linearization, see e.g. [71, equation 3.1.6]. By lemma 4.35, the mapping $(\mu, \theta) \in \mathcal{M}_R^Y \times \mathbb{R}_+ \mapsto G'_{\mu, \theta}(\cdot) \in L^\infty(\Delta, \mathbb{R}^{n_A})$ is continuous (for the L^1 -distance of \mathcal{M}_R^Y) and

$$G'_{\bar{\mu}, 0}(0_{n_A})\delta\gamma = \Phi_{y_T}(\bar{y}_T, 0) \left(\sum_{i=1}^{n_A} \xi_T[\mu^i] \delta\gamma_i \right). \quad (4.16)$$

It follows from (4.16) that

$$G_{\bar{\mu}, 0}(0_{n_A}) + G'_{\bar{\mu}, 0}(0_{n_A})\Delta = \Phi(\bar{y}_T, 0) + \Phi_{y_T}(\bar{y}_T, 0) \left(\operatorname{conv}\{\xi_T[\mu^1], \dots, \xi_T[\mu^{n_A}]\} \right).$$

Therefore, by the Robinson-Ursescu stability theorem (see e.g. [61, 66] and also [21, theorem 2.87]), $G_{\bar{\mu}, 0}$ is metric regular with respect to K at 0_{n_A} with a constant $C_1 > 0$ (in the sense of [21, relation (2.165)]).

\triangleright *Second step: metric regularity of $G_{\mu, \theta}$.*

Moreover, there exist a neighborhood \mathcal{O}^μ of $\bar{\mu}$ (for the L^1 -distance), $\sigma > 0$, and a neighborhood \mathcal{O}^γ of 0_{n_A} such that for all (μ, θ, γ) in $\mathcal{O}^\mu \times [0, \sigma] \times (\mathcal{O}^\gamma \cap \Delta)$, $|G'_{\mu, \theta}(\gamma) - G'_{\bar{\mu}, 0}(\gamma)| \leq \frac{C_1}{2}$. By [21, theorem 2.84], the whole family of functions $G_{\mu, \theta}$ is metric regular at 0_{n_A} , for all $\mu \in \mathcal{O}^\mu$ and all $\theta \in [0, \sigma]$. It means in particular that there exists a constant $C_2 \geq 0$ which is such that for all $\mu \in \mathcal{O}^\mu$ and all $\theta \in [0, \sigma]$,

$$\operatorname{dist}(0_{n_A}, G_{\mu, \theta}^{-1}(K)) \leq C_2 \operatorname{dist}(G_{\mu, \theta}(0_{n_A}), K).$$

\triangleright *Third step: conclusion.*

Let (μ, θ) be in $\mathcal{O}^\mu \times [0, \sigma]$, since $G_{\mu, \theta}(0_{n_A}) = \Phi(y_T[\mu, \theta], \theta)$, there exists $\tilde{\gamma}$ in $G_{\mu, \theta}^{-1}(K)$ such that

$$|\tilde{\gamma}| \leq C \operatorname{dist}(G_{\mu, \theta}(0_{n_A}), K) = C \operatorname{dist}(\Phi(y_T[\mu, \theta], \theta), K).$$

Finally, we set $\mu' = S(\mu, \tilde{\gamma})$. This control satisfies the final-state constraint and by lemma 4.7, $d_1(\mu', \mu) \leq 2RT|\tilde{\gamma}|$. Restricting \mathcal{O}^μ to a ball (for the L^1 -distance) of radius $\delta > 0$ and center $\bar{\mu}$, we obtain the theorem with δ , σ , μ' , and $C = 2RTC_2$. \square

Corollary 4.10. *For all $\eta > 0$, there exists $\tilde{\theta} > 0$ such that for all $\theta \in [0, \tilde{\theta}]$, problem $(\mathcal{P}_\theta^{Y,\eta})$ has an optimal solution.*

Proof. Let $\eta > 0$. As a consequence of the compactness of \mathcal{M}_R^Y and the weak-* continuity of $\mu \mapsto y[\mu, \theta]$, every minimizing sequence has a limit point which is a solution to problem $(\mathcal{P}_\theta^{Y,\eta})$. Therefore, for θ sufficiently small, we only need to prove the existence of a feasible control μ satisfying $\|y[\mu, \theta] - \bar{y}\|_\infty \leq \eta$. For all $\theta \in [0, \sigma]$,

$$\text{dist}(\Phi(y_T[\bar{u}, \theta], \theta), K) = O(\theta), \quad (4.17)$$

therefore, by theorem 4.9, there exists a feasible control μ^θ such that $d_1(\bar{\mu}, \mu^\theta) = O(\theta)$. By lemma 4.35, $\|y[\mu^\theta, \theta] - \bar{y}\|_\infty = O(\theta)$, therefore, for θ sufficiently small, $\|y[\mu, \theta] - \bar{y}\|_\infty \leq \eta$. The corollary is now proved. \square

4.2.4 Optimality conditions

We introduce now the *Hamiltonian* function $H : \mathbb{R}^{n^*} \times \mathbb{R}^m \times \mathbb{R}^n \times [0, 1] \rightarrow \mathbb{R}$ defined by

$$H[p](u, y, \theta) := pf(u, y, \theta). \quad (4.18)$$

We also define the *end-point Lagrangian* $\Phi : \mathbb{R}^{n^*} \times \mathbb{R}^n \times [0, 1] \rightarrow \mathbb{R}$ by

$$\Phi[\lambda](y_T, \theta) := \phi(y_T, \theta) + \lambda\Phi(y_T, \theta). \quad (4.19)$$

Definition 4.11. *Let $\lambda \in \mathbb{R}^{n^*}$. We say that p^λ in $W^{1,\infty}(0, T; \mathbb{R}^{n^*})$ is the costate associated with λ if it satisfies the following differential equation:*

$$\begin{cases} -\dot{p}_t^\lambda = H_y[p_t](\bar{u}_t, \bar{y}_t, 0), & \text{for a.a. } t \in [0, T], \\ p_T^\lambda = \Phi'[\lambda](\bar{y}_T, 0). \end{cases} \quad (4.20)$$

Lemma 4.12. *Given $v \in L^\infty(0, T; \mathbb{R}^n)$, let $z \in \mathcal{Y}$ be the solution of*

$$\dot{z}_t = f_y[t]z_t + v_t, \quad z_0 = 0. \quad (4.21)$$

Then, for all λ in \mathbb{R}^{n^} , $\Phi'[\lambda](\bar{y}_T, 0)z_T = \int_0^T p_t^\lambda v_t dt$.*

Proof. The lemma is obtained with an integration by parts:

$$\begin{aligned} \Phi'[\lambda](\bar{y}_T, 0)z_T &= p_T^\lambda z_T - p_0^\lambda z_0 = \int_0^T (\dot{p}_t^\lambda z_t + p_t^\lambda \dot{z}_t) dt \\ &= \int_0^T (-p_t^\lambda f_y[t]z_t + p_t^\lambda f_y[t]z_t + p_t^\lambda v_t) dt = \int_0^T p_t^\lambda v_t dt, \end{aligned}$$

as was to be proved. \square

In the sequel, the notation N and the notation T refer to the normal and the tangent cones.

Definition 4.13. We say that $\lambda \in N_K(\Phi(\bar{y}_T, 0))$ is a Pontryagin multiplier if,

$$H[p_t^\lambda](u, \bar{y}_t, 0) \geq H[p_t^\lambda](\bar{u}_t, \bar{y}_t, 0), \quad \text{for a.a. } t, \forall u \in U_R. \quad (4.22)$$

We denote by Λ^P the set of Pontryagin multipliers.

Note that the existence of Pontryagin multipliers (Pontryagin's principle) is proved at the end of section 4.3.

Remark 4.14. By (4.3), $\lambda \in N_K(\Phi(\bar{y}_T, 0))$ iff for all i in $\{1, \dots, n_I\}$, $\lambda_i \geq 0$ and $\Phi_i(\bar{y}_T, 0) < 0 \implies \lambda_i = 0$. Note also that (4.22) is equivalent to: for all μ in \mathcal{M}_R^Y ,

$$\int_0^T \int_{U_R} (H[p_t^\lambda](u, \bar{y}_t, 0) - H[p_t^\lambda](\bar{u}_t, \bar{y}_t, 0)) d\mu_t(u) dt \geq 0. \quad (4.23)$$

4.3 First-order upper estimate of the value function

In this section, we compute a first-order upper expansion of the value function. As already mentioned, the upper estimate is true for any $\eta \in (0, \bar{\eta}]$.

Consider the Pontryagin linearized problem

$$\begin{cases} \text{Min}_{\xi \in \mathcal{C}(\mathcal{R}_T)} & \phi'(\bar{y}_T, 0)(\xi + \xi_T^\theta, 1), \\ \text{s.t.} & \Phi'(\bar{y}_T, 0)(\xi + \xi_T^\theta, 1) \in T_K(\Phi(\bar{y}_T, 0)). \end{cases} \quad (PL_\theta)$$

Lemma 4.15. For all $\eta \in (0, \bar{\eta}]$, the following upper estimate on the value function holds:

$$\limsup_{\theta \downarrow 0} \frac{V^\eta(\theta) - V^\eta(0)}{\theta} \leq \text{Val}(PL_\theta). \quad (4.24)$$

Proof. Let $\eta \in (0, \bar{\eta}]$ and let $(\theta_k)_k \downarrow 0$ be such that

$$\lim_{k \rightarrow \infty} \frac{V^\eta(\theta_k) - V^\eta(0)}{\theta_k} = \limsup_{\theta \downarrow 0} \frac{V^\eta(\theta) - V^\eta(0)}{\theta}$$

Let $\xi \in F(PL_\theta)$, where $F(PL_\theta)$ is the feasible set of problem (PL_θ) . By definition of $\mathcal{C}(\mathcal{R}_T)$, there exists a sequence $(\alpha_k, \nu^k, \xi^k)_k$ in $\mathbb{R}_+ \times \mathcal{M}_R^Y \times \mathcal{R}_T$ such that $\xi = \lim \alpha_k \xi^k$ and $\xi^k = \xi_T[\nu^k]$, for all k . Note that it may happen that $\alpha_k \rightarrow +\infty$. Extracting if necessary a subsequence of $(\theta_k)_k$, we can suppose that

$$\theta_k \alpha_k \leq 1 \quad \text{and} \quad \alpha_k^2 \leq \frac{1}{k\theta_k}. \quad (4.25)$$

We set

$$\mu^k = (1 - \theta_k \alpha_k) \bar{\mu} + \theta_k \alpha_k \nu^k.$$

Then $(\mu^k)_k$ is a sequence of Young measures and

$$\xi_T[\mu^k] = \theta_k \alpha_k \xi^k = \theta_k \xi + o(\theta_k). \quad (4.26)$$

By (4.25) and lemma 4.4,

$$d_1(\mu^k, \bar{\mu})^2 = O(\theta_k^2 \alpha_k^2) = O\left(\frac{\theta_k}{k}\right) = o(\theta_k). \quad (4.27)$$

By lemma 4.6,

$$\|y[\mu^k, \theta_k] - (\bar{y} + \xi[\mu^k] + \theta_k \xi^\theta)\|_\infty = O(d_1(\mu^k, \bar{\mu})^2 + \theta_k^2),$$

therefore, using (4.26) and (4.27),

$$|y_T[\mu^k, \theta_k] - [\bar{y}_T + \theta_k(\xi + \xi_T^\theta)]|_\infty = o(\theta_k). \quad (4.28)$$

We obtain the two following expansions:

$$\phi(y_T[\mu^k, \theta_k], \theta_k) = \phi(\bar{y}_T, 0) + \theta_k \phi'(\bar{y}_T, 0)(\xi + \xi_T^\theta, 1) + o(\theta_k), \quad (4.29)$$

$$\Phi(y_T[\mu^k, \theta_k], \theta_k) = \Phi(\bar{y}_T, 0) + \theta_k \Phi'(\bar{y}_T, 0)(\xi + \xi_T^\theta, 1) + o(\theta_k). \quad (4.30)$$

Since $\Phi'(\bar{y}_T, 0)(\xi + \xi_T^\theta, 1) \in T_K(\Phi(\bar{y}_T, 0))$, we obtain that $\text{dist}(\Phi(y_T[\mu^k, \theta_k], \theta_k), K) = o(\theta_k)$ and by the metric regularity theorem (theorem 4.9), we obtain the existence of a feasible sequence $\tilde{\mu}^k$ such that $d_1(\tilde{\mu}^k, \mu^k) = o(\theta_k)$. Moreover, by (4.27), for k large enough, $\|y[\mu^k, \theta_k] - \bar{y}\|_\infty \leq \eta$. By lemma 4.35, estimate (4.29) holds for $\tilde{\mu}^k$ and therefore, for k large enough,

$$V^\eta(\theta_k) - V^\eta(0) \leq \phi(y_T[\tilde{\mu}^k, \theta_k], \theta_k) - \phi(\bar{y}_T, 0) = \theta_k \phi'(\bar{y}_T, 0)(\xi + \xi_T^\theta, 1) + o(\theta_k).$$

Finally, minimizing with respect to ξ , we find that

$$\lim_{k \rightarrow \infty} \frac{V^\eta(\theta_k) - V^\eta(0)}{\theta_k} \leq \text{Val}(PL_\theta)$$

and the lemma is now proved. \square

Let us define (formally) the Lagrangian of the problem by

$$\mathcal{L}(u, y, \lambda, \theta) := \int_0^T H[p_t^\lambda](u_t, y_t, \theta) dt + \Phi[\lambda](y_T, \theta) - \int_0^T p_t^\lambda \dot{y}_t dt$$

and the dual linearized problem (DL_θ) by

$$\text{Max}_{\lambda \in \Lambda^P} \mathcal{L}_\theta(\bar{u}, \bar{y}, \lambda, 0), \quad (DL_\theta)$$

with

$$\mathcal{L}_\theta(\bar{u}, \bar{y}, \lambda, 0) := \int_0^T H_\theta[p_t^\lambda][t] dt + \Phi_\theta[\lambda](\bar{y}_T, 0). \quad (4.31)$$

Theorem 4.16. *Problem (DL_θ) is the dual of problem (PL_θ) and has the same value.*

Proof. Let us check that problem (PL_θ) is qualified. Since $K \subset T_K(\Phi(\bar{y}_T, 0))$,

$$\varepsilon B \subset \Phi(\bar{y}_T, 0) + \Phi_{y_T}(\bar{y}_T, 0)\mathcal{C}(\mathcal{R}_T) - T_K(\Phi(\bar{y}_T, 0)). \quad (4.32)$$

It is easy to prove that $\Phi(\bar{y}_T, 0) - T_K(\Phi(\bar{y}_T, 0))$ is a cone. Therefore, the r.h.s. of (4.32) is a cone and contains necessarily the whole space \mathbb{R}^{nc} . Thus,

$$\varepsilon B \subset \mathbb{R}^{nc} = \Phi(\bar{y}_T, 0) + \Phi'(\bar{y}_T, 0)(\xi_T^\theta + \mathcal{C}(\mathcal{R}_T), 1) - T_K(\Phi(\bar{y}_T, 0)),$$

which is the Robinson qualification condition for the linearized problem.

Now, let us study the dual problem, which is:

$$\text{Max}_{\lambda \in N_K(\Phi(\bar{y}_T, 0))} \inf_{\xi \in \mathcal{C}(\mathcal{R}_T)} \Phi'[\lambda](\bar{y}_T, 0)(\xi_T^\theta + \xi, 1). \quad (4.33)$$

By lemma 4.12, we obtain that the dual problem is

$$\text{Max}_{\lambda \in N_K(\Phi(\bar{y}_T, 0))} \inf_{\xi \in \mathcal{C}(\mathcal{R}_T)} \left\{ \Phi_{y_T}[\lambda](\bar{y}_T, 0)\xi + \int_0^T H_\theta[p_t^\lambda][t] dt + \Phi_\theta[\lambda](\bar{y}_T, 0) \right\}. \quad (4.34)$$

We claim that for $\lambda \in N_K(\Phi(\bar{y}_T, 0))$,

$$D(\lambda) := \inf_{\xi \in \mathcal{C}(\mathcal{R}_T)} \Phi_{y_T}[\lambda](\bar{y}_T, 0)\xi = \begin{cases} 0 & \text{if } \lambda \in \Lambda^P, \\ -\infty & \text{otherwise.} \end{cases} \quad (4.35)$$

It is clear that $D(\lambda) \in \{0, -\infty\}$ since $\Phi_{y_T}[\lambda](\bar{y}_T, 0)\xi$ is linear with respect to ξ and $\mathcal{C}(\mathcal{R}_T)$ is a cone. Let $\lambda \in \Lambda^P$. By lemma 4.12, for ξ in \mathcal{R}_T with associated control μ ,

$$\begin{aligned} & \Phi_{y_T}[\lambda](\bar{y}_T, 0)\xi \\ &= \int_0^T \left(-p_t^\lambda f_y[t]\xi_t[\mu] + p_t^\lambda f_y[t]\xi_t[\mu] + \int_{U_R} p_t^\lambda [f(u, \bar{y}_t, 0) - f[t]] d\mu_t(u) \right) dt \\ &= \int_0^T \int_{U_R} (H[p_t^\lambda](u, \bar{y}_t, 0) - H[p_t^\lambda](\bar{u}_t, \bar{y}_t, 0)) d\mu_t(u) dt, \end{aligned} \quad (4.36)$$

and then, $\Phi_{y_T}[\lambda](\bar{y}_T, 0)\xi \geq 0$. Let $\xi \in \mathcal{C}(\mathcal{R}_T)$, then there exists a sequence $(\alpha_k, \xi^k)_k$ in $(\mathbb{R}_+ \times \mathcal{R}_T)$ such that $\xi = \lim_k \alpha_k \xi^k$. By (4.36),

$$\Phi_{y_T}[\lambda](\bar{y}_T, 0)\xi = \lim_k \alpha_k \Phi_{y_T}[\lambda](\bar{y}_T, 0)\xi^k \geq 0,$$

therefore $D(\lambda) \geq 0$ and finally, $D(\lambda) = 0$. Conversely, if λ is not a Pontryagin multiplier, by (4.36), there exists a control μ such that $\Phi_{y_T}[\lambda](\bar{y}_T, 0)\xi_T[\mu] < 0$. Consequently, $D(\lambda) < 0$ and therefore, $D(\lambda) = -\infty$. This proves (4.35). Finally, combining (4.34) and (4.35), we obtain that the dual problem is equivalent to (DL_θ) and has the same value as problem (PL_θ) as a consequence of [21, theorem 2.165]. \square

Consider now the situation where there is no perturbation. The linearized problem (PL_θ) and its dual (DL_θ) become respectively

$$\text{Min}_{\xi \in \mathcal{C}(\mathcal{R}_T)} \phi_{y_T}(\bar{y}_T, 0)\xi, \quad \text{s.t. } \Phi_{y_T}(\bar{y}_T, 0)\xi \in T_K(\Phi(\bar{y}_T, 0)) \quad (PL)$$

and

$$\text{Max}_{\lambda \in \Lambda^P} 0. \quad (DL)$$

By lemma 4.15, we obtain that $0 \leq \text{Val}(PL)$ and since $0 \in F(PL)$, $\text{Val}(PL) = 0$. Since Λ^P is the set of solutions of problem (DL) and since problem (PL) has a finite value, we obtain by [21, theorem 2.165] that Λ^P is nonempty, convex, and compact. Note that Pontryagin's principle follows and can be understood as a first-order necessary optimality condition for relaxed problems. Finally, we obtain that problems (PL_θ) and (DL_θ) have a finite value. Therefore, estimate (4.24) writes

$$V(\theta) \leq V(0) + \theta \text{Val}(DL_\theta) + o(\theta). \quad (4.37)$$

4.4 Second-order upper estimate of the value function

In this section, we obtain a second-order upper estimate of the value function by using a "standard" linearization at the first order and a "Pontryagin" linearization at the second order. Indeed, to obtain a second-order estimate, we need to have a solution to some linearized first-order problem. Unfortunately, problem (PL_θ) is a conic linear problem, thus, it does not have necessarily a solution. This is why we consider now a different kind of linearization, which is such that the associated linearized problem has a solution.

In this section and in the sequel, we use properties of Young measures detailed in the appendix.

4.4.1 Standard linearizations and estimates

We first define some operations on the set of Young measures.

Definition 4.17. *Let $\nu \in \mathcal{M}^Y$, $w \in L^\infty(0, T; \mathbb{R}^m)$, and $\theta \in \mathbb{R}$. We denote by*

$$w \oplus \theta\nu$$

the unique Young measure μ in \mathcal{M}^Y such that for all g in the space of functions vanishing at infinity $C^0([0, T] \times \mathbb{R}^m)$ (see the appendix),

$$\int_0^T \int_{\mathbb{R}^m} g(t, u) d\mu_t(u) dt = \int_0^T \int_{\mathbb{R}^m} g(t, w_t + \theta u) d\nu_t(u).$$

If $\theta \neq 0$, we denote by

$$\frac{\nu \ominus w}{\theta}$$

the unique Young measure μ in \mathcal{M}^Y which is such that for all g in $C^0([0, T] \times \mathbb{R}^m)$,

$$\int_0^T \int_{\mathbb{R}^m} g(t, u) d\mu_t(u) dt = \int_0^T \int_{\mathbb{R}^m} g\left(t, \frac{u - w_t}{\theta}\right) d\nu_t(u).$$

We also denote: $\nu \ominus w = \frac{\nu \ominus w}{1}$.

The addition \oplus (resp. the subtraction \ominus) must be viewed as translations on \mathbb{R}^m of vector w_t (resp. $-w_t$) at each time t . The multiplication (resp. the division) by θ must be viewed as a homothety of ratio θ (resp. $\frac{1}{\theta}$) on \mathbb{R}^m , at each time t . Note that it will always be clear from the context if the multiplication (by constants), or the division, is the operation described in the previous definition or if it the multiplication of measures by constants, which we used up to now. Note that for $\mu \in \mathcal{M}_R^Y$,

$$d_1(\mu, \bar{\mu}) = \|\mu \ominus \bar{\mu}\|_1.$$

We now use the set \mathcal{M}_2^Y defined in the appendix.

Definition 4.18. For a given ν in \mathcal{M}_2^Y , we define the standard linearization $z[\nu]$ by

$$\begin{cases} \dot{z}_t[\nu] = f_y[t]z_t[\nu] + f_u[t]\left(\int_{\mathbb{R}^m} u d\nu_t(u)\right), & \text{for a.a. } t \in [0, T], \\ z_0[\nu] = 0. \end{cases}$$

We also set $z^1[\nu] = z[\nu] + \xi^\theta$, which is the solution of the following system:

$$\begin{cases} \dot{z}_t^1[\nu] = \int_{\mathbb{R}^m} f'[t](z_t^1[\nu], u, 1) d\nu_t(u), & \text{for a.a. } t \in [0, T], \\ z_0^1[\nu] = 0. \end{cases}$$

Although the Pontryagin linearization has been standard for years in the literature, we use the terminology *standard* for the linearization $z[\nu]$ since it corresponds to the most natural way of linearizing a differential system. Note that for $\mu \in \mathcal{M}_R^Y$, $z[\mu \ominus \bar{u}]$ is the solution to

$$\begin{cases} \dot{z}_t = f_y[t]z_t + f_u[t]\left(\int_{U_R} (u - \bar{u}_t) d\mu_t(u)\right), \\ z_0 = 0. \end{cases} \quad (4.38)$$

Lemma 4.19. For μ in \mathcal{M}_R^Y , the following estimates hold:

$$\|z[\mu \ominus \bar{u}] - \xi[\mu]\|_\infty = O(d_2(\bar{\mu}, \mu)^2), \quad (4.39)$$

$$\|y[\mu, \theta] - \bar{y}\|_\infty = O(\|\mu \ominus \bar{u}\|_1 + \theta), \quad (4.40)$$

$$\|y[\mu, \theta] - (\bar{y} + z[\mu \ominus \bar{u}] + \theta\xi^\theta)\|_\infty = O(\|\mu \ominus \bar{u}\|_2^2 + \theta^2). \quad (4.41)$$

The proof is given in the appendix, page 131. The Wasserstein distance and the norm $\|\cdot\|_2$ are also defined in the appendix.

Corollary 4.20. For all ν in \mathcal{M}_∞^Y ,

$$z[\nu] = \lim_{\theta \downarrow 0} \frac{\xi[\bar{u} \oplus \theta\nu]}{\theta}.$$

Proof. By estimate (4.39), for $\theta > 0$ sufficiently small,

$$\|z[\nu] - \frac{\xi[\bar{u} \oplus \theta\nu]}{\theta}\|_\infty = \frac{1}{\theta} \|z[\theta\nu] - \xi[\bar{u} \oplus \theta\nu]\|_\infty = \frac{O(\theta^2)}{\theta} = O(\theta).$$

The corollary is now proved. \square

Remark 4.21. Denoting by \mathcal{C} the smallest closed convex cone containing $\{z[\nu]_T, \nu \in L^\infty(0, T; \mathbb{R}^n)\}$, we obtain by corollary 4.20 that $\mathcal{C} \subset \mathcal{C}(\mathcal{R}_T)$. A standard qualification condition for the problem would have been to assume that for some $\varepsilon' > 0$,

$$\varepsilon' B \subset \Phi(\bar{y}_T, 0) + \Phi_{y_T}(\bar{y}_T, 0)\mathcal{C} - K.$$

This assumption is stronger than the qualification condition (condition (4.13)) that we assumed.

Consider the following standard linearized problem in \mathcal{M}_2^Y .

$$\text{Min}_{\nu \in \mathcal{M}_2^Y} \phi'(\bar{y}_T, 0)(z_T^1[\nu], 1), \quad \text{s.t. } \Phi'(\bar{y}_T, 0)(z_T^1[\nu], 1) \in T_K(\Phi(\bar{y}_T, 0)). \quad (SPL_\theta)$$

and the standard linearized problem in $L^2 := L^2(0, T; \mathbb{R}^m)$ defined by

$$\text{Min}_{v \in L^2} \phi'(\bar{y}_T, 0)(z_T^1[v], 1), \quad \text{s.t. } \Phi'(\bar{y}_T, 0)(z_T^1[v], 1) \in T_K(\Phi(\bar{y}_T, 0)). \quad (SPL'_\theta)$$

Since $L^2 \subset \mathcal{M}_2^Y$, $\text{Val}(SPL_\theta) \leq \text{Val}(SPL'_\theta)$. Moreover, for all $\nu \in \mathcal{M}_2^Y$, we can define $v \in L^2$ by $v_t = \int_{\mathbb{R}^m} u \, d\nu_t(u) \, dt$. Then, $z^1[\nu] = z^1[v]$ and therefore, the two problems have the same value.

Definition 4.22. Let λ in $N_K(\Phi(\bar{y}_T, 0))$, we say that it is a Lagrange multiplier if for almost all t in $[0, T]$, $H_u[p_t^\lambda](\bar{u}_t, \bar{y}_t, 0) = 0$. We denote by Λ^L the set of Lagrange multipliers.

Note that the inclusion $\Lambda^P \subset \Lambda^L$ holds since for a.a. t , \bar{u}_t belongs to the interior of U_R and minimizes $H[p_t^\lambda](\cdot, \bar{y}_t, 0)$ and thus $H_u[p_t^\lambda](\bar{u}_t, \bar{y}_t, 0) = 0$. Under the qualification condition (4.13), Λ^L is nonempty.

Lemma 4.23. The dual of problem (SPL'_θ) is the following problem:

$$\text{Max}_{\lambda \in \Lambda^L} \mathcal{L}_\theta(\bar{u}, \bar{y}, \lambda, 0), \quad (SDL_\theta)$$

and it has the same value as the primal problem. Moreover, problems (SPL_θ) and (SPL'_θ) have solutions and $\text{Val}(PL_\theta) \leq \text{Val}(SPL_\theta)$.

Proof. Remember the definition of the derivative of the Lagrangian, given by (4.31). By lemma 4.12, the dual of problem (SPL_θ) is the following:

$$\begin{aligned} & \text{Max}_{\lambda \in N_K(\Phi(\bar{y}_T, 0))} \inf_{\nu \in L^2} \Phi'[\lambda](\bar{y}_T, 0)(z_T^1[\nu], 1) \\ &= \text{Max}_{\lambda \in N_K(\Phi(\bar{y}_T, 0))} \left\{ \mathcal{L}_\theta(\bar{u}, \bar{y}, \lambda, 0) + \inf_{v \in L^2} \int_0^T H_u[p_t^\lambda][t] v_t \, dt \right\}. \end{aligned}$$

Moreover, for all $\lambda \in N_K(\Phi(\bar{y}_T, 0))$, we easily check that

$$\inf_{v \in L^2} \int_0^T H_u[p_t^\lambda][t]v_t dt = \begin{cases} 0, & \text{if } \lambda \in \Lambda^L, \\ -\infty, & \text{otherwise.} \end{cases}$$

This proves that problem (SDL_θ) is the dual of problem (SPL'_θ) . Moreover, it follows directly from the inclusion $\Lambda^P \subset \Lambda^L$ that

$$-\infty < \text{Val}(PL_\theta) = \text{Val}(DL_\theta) \leq \text{Val}(SDL_\theta) \leq \text{Val}(SPL'_\theta) = \text{Val}(SPL_\theta).$$

We also obtain from the inclusion that problem (SDL_θ) is feasible. Since (SPL'_θ) is linear and since the value of its dual is not $-\infty$, it follows by [21, theorem 2.204] that both problems have the same value. These solutions are also solutions to (SPL_θ) . \square

From now on, we suppose that the following restrictive assumption holds.

Assumption 4.1. *The Pontryagin and classical linearized problems have the same value: $\text{Val}(SPL_\theta) = \text{Val}(PL_\theta)$.*

This hypothesis is satisfied in particular if the set of Lagrange multipliers is a singleton. This hypothesis is also satisfied if the Hamiltonian is convex with respect to u , since then the definitions of Lagrange and Pontryagin multipliers are equivalent.

4.4.2 Second-order upper estimate

Definition 4.24. *For $\nu \in \mathcal{M}_2^Y$, we define the second-order linearization $z^2[\nu]$ by*

$$\begin{cases} \dot{z}_t^2[\nu] = f_y[t]z_t^2[\nu] + \frac{1}{2} \int_{\mathbb{R}^m} f''[t](u, z_t^1[\nu], 1)^2 d\nu_t(u), \\ z_0^2[\nu] = 0. \end{cases}$$

In the following problem, the notation T^2 refers to the second-order tangent set [21, definition 3.28]. Given a solution ν to problem (SPL_θ) , consider the following associated linearized problem:

$$\begin{cases} \text{Min}_{\xi \in \mathcal{C}(\mathcal{R}_T)} & \frac{1}{2}\phi''(\bar{y}_T, 0)(z_T^1[\nu], 1)^2 + \phi_{y_T}(\bar{y}_T, 0)(z_T^2[\nu] + \xi), \\ \text{s.t.} & \frac{1}{2}\Phi''(\bar{y}_T, 0)(z_T^1[\nu], 1)^2 + \Phi_{y_T}(\bar{y}_T, 0)(z_T^2[\nu] + \xi) \\ & \in T_K^2(\Phi(\bar{y}_T, 0), \Phi'(\bar{y}_T, 0)(z_T^1[\nu], 1)). \end{cases} \quad (PQ_\theta(\nu))$$

Observe that in this linearized problem, ν is the first-order direction of perturbation, for which we consider standard linearizations, and ξ is the second-order direction of perturbation, for which we consider a Pontryagin linearization. Let us define the mapping Ω^θ on $\mathbb{R}^{n_C^*} \times \mathcal{M}_2^Y$ as follows:

$$\Omega^\theta[\lambda](\nu) = \int_0^T \int_{\mathbb{R}^m} H''[p_t^\lambda][t](u, z_t^1[\nu], 1)^2 d\nu_t(u) dt + \Phi''[\lambda](\bar{y}_T, 0)(z_T^1[\nu], 1)^2. \quad (4.42)$$

Lemma 4.25. *The dual of problem $(PQ_\theta(\nu))$ is the following problem,*

$$\text{Max}_{\lambda \in S(DL_\theta)} \frac{1}{2} \Omega^\theta[\lambda](\nu), \quad (DQ_\theta(\nu))$$

and it has the same value as $(PQ_\theta(\nu))$.

Proof. It is proved in [21, proposition 3.34, equality 3.64] that since K is polyhedic,

$$T_K^2(\Phi(\bar{y}_T, 0), \Phi'(\bar{y}_T, 0)(z_T^1[\nu], 1)) = T_K(\Phi(\bar{y}_T, 0)) + \Phi'(\bar{y}_T, 0)(z_T^1[\nu], 1)\mathbb{R},$$

where the addition $+$ is the Minkowski sum. Since the second-order tangent set contains the tangent cone, we obtain, like in the proof of theorem 4.16 that

$$\begin{aligned} \varepsilon B \subset \mathbb{R}^{n_C} = & \frac{1}{2} \Phi''(\bar{y}_T, 0)(z_T^1[\nu], 1)^2 + \Phi_{y_T}(\bar{y}_T, 0)(z_T^2[\nu] + \mathcal{C}(\mathcal{R}_T)) \\ & - T_K^2(\Phi(\bar{y}_T, 0), \Phi'(\bar{y}_T, 0)(z_T^1[\nu], 1)), \end{aligned}$$

which is Robinson qualification condition. By [21, theorem 2.165], problem $(PQ_\theta(\nu))$ has the same value as its dual.

Let us denote by N the polar cone of the second-order tangent set. For all λ in $\mathbb{R}^{n_C^*}$, $\lambda \in N$ iff $\lambda \in N_K(\Phi(\bar{y}_T, 0))$ and $\lambda \Phi'(\bar{y}_T, 0)(z_T^1[\nu], 1) = 0$. Following the proof of theorem 4.16, we obtain that the dual of problem $(PQ_\theta(\nu))$ is the following problem:

$$\begin{aligned} \text{Max}_{\lambda \in \Lambda^P,} & \Phi''[\lambda](\bar{y}_T, 0)(z_T^1[\nu], 1)^2 + \Phi_{y_T}[\lambda] z_T^2[\nu]. \\ & \lambda \Phi'(\bar{y}_T, 0)(z_T^1[\nu], 1) = 0, \end{aligned}$$

and using lemma 4.12, we find that

$$\Phi_{y_T}[\lambda] z_T^2[\nu] = \frac{1}{2} \int_0^T \int_{\mathbb{R}^m} H''[p_t^\lambda][t](u, z_t^1[\nu], 1)^2 d\nu_t(u).$$

Moreover, by lemma 4.12 and hypothesis 4.1, for all λ in Λ^P ,

$$\begin{aligned} \lambda \Phi'(\bar{y}_T, 0)(z_T^1[\nu], 1) = 0 & \iff \Phi'[\lambda](\bar{y}_T, 0)(z_T^1[\nu], 1) = \phi'(\bar{y}_T, 0)(z_T^1[\nu], 1) \\ & \iff \int_0^T H_\theta[p_t^\lambda][t] dt + \Phi_\theta[\lambda](\bar{y}_T, 0) = \text{Val}(SPL_\theta) \\ & \iff \mathcal{L}_\theta(\bar{u}, \bar{y}, \lambda, 0) = \text{Val}(PL_\theta) \\ & \iff \lambda \in S(DL_\theta). \end{aligned}$$

The lemma is now proved. □

Consider the problem (PQ_θ) defined by

$$\text{Min}_{\nu \in S(SPL_\theta)} \text{Val}(PQ_\theta(\nu)) = \text{Min}_{\nu \in S(SPL_\theta)} \text{Max}_{\lambda \in S(DL_\theta)} \frac{1}{2} \Omega^\theta[\lambda](\nu). \quad (PQ_\theta)$$

Theorem 4.26. *For all $\eta \in [0, \bar{\eta}]$, the following second-order upper estimate holds:*

$$\limsup_{\theta \downarrow 0} \frac{V^\eta(\theta) - (V^\eta(0) + \theta \text{Val}(SPL_\theta))}{\theta^2} \leq \text{Val}(PQ_\theta). \quad (4.43)$$

This theorem is proved in the appendix, page 132.

4.5 Lower estimate of the value function

4.5.1 A decomposition principle

In the family of optimization problems that we consider, the expression $\Phi[\lambda](y_T, \theta)$ plays the role of a Lagrangian. The basic idea to obtain a lower estimate for the value function is to use a second-order expansion of the right-hand-side of the following inequality:

$$\phi(y_T, \theta) - \phi(\bar{y}_T, 0) \geq \Phi[\lambda](y_T, \theta) - \Phi[\lambda](\bar{y}_T, 0), \quad (4.44)$$

for a feasible trajectory y (for the perturbed problem $(\mathcal{P}_\theta^{Y, \eta})$). This inequality holds since

$$\Phi(y_T, \theta) - \Phi(\bar{y}_T, 0) \in T_K(\Phi(\bar{y}_T, 0)) \quad \text{and} \quad \lambda \in N_K(\Phi(\bar{y}_T, 0)).$$

The main difficulty in computing an expansion of the difference of Lagrangians is that we cannot perform Taylor expansions with respect to the control variable, since we are interested by perturbations of the control which are not small for the L^∞ -norm. The idea to deal with this difficulty is to split the control into two intermediate controls, one accounting for the small perturbations and one accounting for the large perturbations (both for the L^∞ -norm). The decomposition principle that we obtain is an extension of [18, theorem 2.13].

In this part, we fix a sequence $(\theta_k)_k \downarrow 0$ and a sequence $(\mu^k, y^k)_k$ of feasible trajectories for the perturbed problems with $\theta = \theta_k$. We fix $\lambda \in S(DL_\theta)$. In the proofs of lemma 4.27 and theorem 4.28, we omit to mention the dependence of the Hamiltonian with respect to p_t^λ (since the multiplier λ is fixed). For example, we will write $H(u, \bar{y}_t, \theta)$ instead of $H[p_t^\lambda](u, \bar{y}_t, \theta)$.

From now on, we set $R_{1,k} = d_1(\bar{\mu}, \mu^k)$ and $\delta y^k = y^k - \bar{y}$. Note that by lemma 4.6, $\|\delta y^k\|_\infty = O(R_{1,k} + \theta_k)$. We also set $z^k := z[\mu^k \ominus \bar{u}]$ and $z^{1,k} := z^k + \theta_k \xi^\theta$. Note that the dynamic of z^k is given by equation (4.38). Finally, we set

$$\Delta \Phi^k = \Phi[\lambda](y_T^k, \theta_k) - \Phi[\lambda](\bar{y}_T, 0).$$

Lemma 4.27. *The following expansions hold:*

$$\Delta \Phi^k = \text{Val}(PL_\theta)\theta_k + I_1^k + I_2^k + I_3^k + I_4^k + o(\theta_k^2 + R_{1,k}^2), \quad (4.45)$$

where

$$\begin{aligned} I_1^k &= \int_0^T \int_{U_R} (H[p_t^\lambda](u, \bar{y}_t, 0) - H[p_t^\lambda][t]) d\mu_t^k(u) dt, \\ I_2^k &= \int_0^T \int_{U_R} (H_y[p_t^\lambda](u, \bar{y}_t, 0) - H_y[p_t^\lambda][t]) z_t^{1,k} d\mu_t^k(u) dt, \\ I_3^k &= \int_0^T \int_{U_R} (H_\theta[p_t^\lambda](u, \bar{y}_t, 0) - H_\theta[p_t^\lambda][t]) \theta_k d\mu_t^k(u) dt, \\ I_4^k &= \frac{1}{2} \int_0^T H_{(y,\theta)^2}[p_t^\lambda][t](z_t^{1,k}, \theta_k)^2 dt + \frac{1}{2} \Phi''[\lambda](z_T^{1,k}, \theta_k)^2. \end{aligned}$$

and

$$\Delta\Phi^k = \int_0^T \int_{U_R} H[p_t^\lambda](u, \bar{y}_t, 0) - H[p_t^\lambda][t] d\mu_t(u) dt + O(\|\delta y^k\|_\infty) + o(1). \quad (4.46)$$

The proof is given in the appendix, page 134.

In order to go further in the expansions, we need to split the control μ^k into two controls. To that purpose, we consider a sequence $(A^k, B^k)_k$ of measurable subsets of $[0, T] \times U_R$ such that for all k , (A^k, B^k) is a partition of $[0, T] \times U_R$. We consider the Young measures $\mu^{A,k}$ and $\mu^{B,k}$ which are the unique Young measures such that for all g in $C^0([0, T] \times U_R)$,

$$\begin{cases} \int_0^T \int_{U_R} g(t, u) d\mu_t^{A,k}(u) dt = \int_{A^k} g(t, u) d\mu^k(t, u) + \int_{B^k} g(t, \bar{u}_t) d\mu^k(t, u), \\ \int_0^T \int_{U_R} g(t, u) d\mu_t^{B,k}(u) dt = \int_{B^k} g(t, u) d\mu^k(t, u) + \int_{A^k} g(t, \bar{u}_t) d\mu^k(t, u). \end{cases}$$

Note that if g is such that for almost all t in $[0, T]$, $g(t, \bar{u}_t) = 0$, then

$$\int_0^T \int_{U_R} g(t, u) d\mu_t^k(u) dt = \int_0^T \int_{U_R} g(t, u) d\mu_t^{A,k}(u) dt + \int_0^T \int_{U_R} g(t, u) d\mu_t^{B,k}(u) dt.$$

For $i = 1, 2$, we set $R_{i,A,k} := d_i(\bar{\mu}, \mu^{A,k})$ and $R_{i,B,k} := d_i(\bar{\mu}, \mu^{B,k})$. We also set $z^{A,k} := z[\mu^{A,k} \ominus \bar{\mu}]$, and $z^{B,k} := z[\mu^{B,k} \ominus \bar{\mu}]$.

Remember the definition of Ω^θ given by (4.42). For $\lambda \in \mathbb{R}^{n_C^*}$, let us denote by $\Omega[\lambda] : \mathcal{M}_2^Y \rightarrow \mathbb{R}$ the following mapping:

$$\Omega[\lambda](\nu) = \int_0^T \int_{\mathbb{R}^m} H_{(u,y)^2}[p_t^\lambda][t](u, z[\nu])^2 d\nu_t(u) dt + \Phi_{(y_T)^2}[\lambda](\bar{y}_T, 0)(z[\nu]_T)^2. \quad (4.47)$$

Theorem 4.28 (Decomposition principle). *Assume that*

$$\mu^k(B^k) \longrightarrow 0 \quad \text{and} \quad \text{ess sup}_{k \rightarrow \infty} \{|u - \bar{u}_t|, (t, u) \in A^k\} \rightarrow 0. \quad (4.48)$$

Then,

$$z^k = z^{A,k} + o(R_{2,B,k}) \quad (4.49)$$

and the following expansions hold:

$$\begin{aligned} \Delta\Phi^k &= \text{Val}(PL_\theta)\theta_k + \frac{1}{2}\Omega^\theta[\lambda](\mu^{A,k} \ominus \bar{\mu}) \\ &\quad + \int_0^T \int_{U_R} (H[p_t^\lambda](u, \bar{y}_t, 0) - H[p_t^\lambda][t]) d\mu_t^{B,k}(u) dt + o(R_{2,k}^2 + \theta_k^2). \end{aligned} \quad (4.50)$$

and

$$\begin{aligned} \Delta\Phi^k &= \text{Val}(PL_\theta)\theta_k + \frac{1}{2}\Omega[\lambda](\mu^{A,k} \ominus \bar{\mu}) \\ &\quad + \int_0^T \int_{U_R} (H[p_t^\lambda](u, \bar{y}_t, 0) - H[p_t^\lambda][t]) d\mu_t^{B,k}(u) dt \\ &\quad + O(\theta_k(\theta_k + R_{2,A,k})) + o(R_{2,k}^2). \end{aligned} \quad (4.51)$$

Proof. With the Cauchy-Schwarz inequality, we obtain that $R_{1,A,k} = O(R_{2,A,k})$ and since $\mu^k(B^k) \rightarrow 0$,

$$\begin{aligned} R_{1,B,k} &= \int_{B^k} |u - \bar{u}_t| d\mu_t^k(t, u) dt \\ &\leq (\mu^k(B^k))^{1/2} \left[\int_{B^k} |u - \bar{u}_t|^2 d\mu^k(t, u) \right]^{1/2} = o(R_{2,B,k}). \end{aligned} \quad (4.52)$$

Estimate (4.49) follows from (4.52) and $z^k = z^{A,k} + z^{B,k}$. In order to obtain expansion (4.50), we work with the terms of the expansion of lemma 4.27. First,

$$\begin{aligned} I_1^k &= \int_0^T \int_{U_R} (H(u, \bar{y}_t, 0) - H[t])(d\mu_t^{A,k}(u) + d\mu_t^{B,k}(u)) dt \\ &= \frac{1}{2} \int_0^T \int_{U_R} H_{uu}[t](u - \bar{u}_t)^2 d\mu_t^{A,k}(u) dt \\ &\quad + \int_0^T \int_{U_R} (H(u, \bar{y}_t, 0) - H[t]) d\mu_t^{B,k}(u) dt + o(R_{2,A,k}^2) \end{aligned} \quad (4.53)$$

and

$$\begin{aligned} I_2^k &= \int_0^T \int_{U_R} (H_y(u, \bar{y}_t, 0) - H_y[t])(z_t^{A,k} + \theta_k \xi_t^\theta) d\mu_t^{A,k}(u) dt \\ &\quad + \int_0^T \int_{U_R} (H_y(u, \bar{y}_t, 0) - H_y[t]) z_t^{B,k} d\mu_t^{A,k}(u) dt \\ &\quad + \int_0^T \int_{U_R} (H_y(u, \bar{y}_t, 0) - H_y[t]) z_t^{1,k} d\mu_t^{B,k}(u) dt \\ &= \int_0^T \int_{U_R} H_{u,y}[t](u - \bar{u}_t, z_t^{A,k} + \theta_k \xi_t^\theta) d\mu_t^{A,k}(u) dt + o(R_{2,k}^2 + \theta_k^2), \end{aligned} \quad (4.54)$$

Similarly, we prove that

$$I_3^k = \int_0^T \int_{U_R} H_{(u,\theta)}[t](u - \bar{u}_t, \theta_k) d\mu_t^{A,k} dt + o(R_{2,k}^2 + \theta_k^2), \quad (4.55)$$

$$\begin{aligned} I_4^k &= \frac{1}{2} \int_0^T \int_{U_R} H_{(y,\theta)^2}[t](z_t^{A,k} + \theta_k \xi_t^\theta, \theta_k)^2 d\mu_t^{A,k} dt \\ &\quad + \frac{1}{2} \Phi''[\lambda](\bar{y}_T, 0)(z_T^{A,k} + \theta_k \xi_T^\theta, \theta_k)^2 + o(R_{2,k}^2 + \theta_k^2). \end{aligned} \quad (4.56)$$

Finally, combining lemma 4.27 and estimates (4.53-4.56), we obtain expansion (4.50). Expansion (4.51) follows by replacing the second-order terms involving θ_k by the estimate $O(R_{2,A,k}\theta_k)$. \square

4.5.2 Study of the rate of convergence of perturbed solutions

In this part, we give estimates of the L^2 -distance between a solution to the perturbed problem $(\mathcal{P}_\theta^{Y,\eta})$ and $\bar{\mu}$ under a strong second-order sufficient condition. The results will hold for small values of η .

Definition 4.29. We call critical cone C_2 the following set:

$$C_2 := \{\nu \in \mathcal{M}_2^Y, \phi_{y_T}(\bar{y}_T, 0)z[\nu]_T \leq 0, \Phi_{y_T}(\bar{y}_T, 0)z[\nu]_T \in T_K(\Phi(\bar{y}_T, 0))\}. \quad (4.57)$$

In the following assumption, we denote by $\text{ri}(S(DL_\theta))$ the relative interior of $S(DL_\theta)$, which is the interior of $S(DL_\theta)$ for the topology induced by its affine hull.

Assumption 4.2 (Second-order sufficient conditions). *There exists $\alpha > 0$ such that*

1. *for some $\bar{\lambda} \in \text{ri}(S(DL_\theta))$, for almost all t in $[0, T]$,*

$$H[p_t^{\bar{\lambda}}](u, \bar{y}_t, 0) - H[p_t^{\bar{\lambda}}](\bar{u}_t, \bar{y}_t, 0) \geq \alpha|u - \bar{u}_t|^2, \quad \forall u \in U_R,$$

2. *for all ν in $C_2 \setminus \{0\}$, $\max_{\lambda \in S(DL_\theta)} \{\Omega[\lambda](\nu)\} > 0$. Here, 0 is the Young measure which is equal for almost all t to the Dirac measure (centered at 0).*

As a consequence of assumption 4.2.1, for all $\mu \in \mathcal{M}_R^Y$,

$$\int_0^T \int_{U_R} H[p_t^{\bar{\lambda}}](u, \bar{y}_t, 0) - H[p_t^{\bar{\lambda}}](\bar{u}_t, \bar{y}_t, 0) d\mu_t(u) dt \geq \alpha \|\mu \ominus \bar{u}\|_2^2.$$

Remark 4.30. *It is shown in [18, lemma 2.3] that, since $S(DL_\theta)$ is compact, for all $\bar{\lambda} \in \text{ri}(S(DL_\theta))$, there exists $\beta > 0$ such that for almost all t , for all v in U_R ,*

$$H[p_t^{\bar{\lambda}}](v, \bar{y}_t, 0) - H[p_t^{\bar{\lambda}}](\bar{u}_t, \bar{y}_t, 0) \geq \beta \left(\max_{\lambda \in S(DL_\theta)} \{H[p_t^\lambda](v, \bar{y}_t, 0) - H[p_t^\lambda](\bar{u}_t, \bar{y}_t, 0)\} \right).$$

It follows from this result that hypothesis 4.2.1 is equivalent to: there exists $\alpha' > 0$ such that for almost all t , for all $u \in U_R$,

$$\max_{\lambda \in S(DL_\theta)} \{H[p_t^\lambda](u, \bar{y}_t, 0) - H[p_t^\lambda](\bar{u}_t, \bar{y}_t, 0)\} \geq \alpha'|u - \bar{u}_t|^2.$$

The following lemma states some useful semi-continuity properties for Ω and Ω^θ .

Lemma 4.31. *If hypothesis 4.2.1 holds, then for all bounded sequences $(\nu^k)_k$ in \mathcal{M}_2^Y narrowly converging to some $\nu \in \mathcal{M}_2^Y$,*

1. *the sequence $(z[\nu^k])_k$ converges to $z[\nu]$ for the L^∞ -distance*
2. *for all $\lambda \in S(DL_\theta)$, $\Omega[\lambda](\nu) \leq \liminf_{k \rightarrow \infty} \Omega[\lambda](\nu^k)$*
3. *if $\nu = 0$ and $\Omega[\bar{\lambda}](\nu^k) \rightarrow 0$, then $\|\nu^k\|_2 \rightarrow 0$.*

This lemma is proved in the appendix, page 135.

Lemma 4.32. *If $\eta > 0$ is sufficiently small, then for any sequence $(\theta_k)_k \downarrow 0$, for any sequence of solutions $(\mu^k, y^k)_k$ to problems $(\mathcal{P}_\theta^{Y, \eta})$, with $\theta = \theta_k$,*

$$R_{2,k} = d_2(\bar{\mu}, \mu^k) \rightarrow 0. \quad (4.58)$$

Proof. Assume, on the contrary, that there exist two sequences $(\eta_k)_k \downarrow 0$ and $(\theta_k)_k \downarrow 0$ and a sequence of solutions (μ^k, y^k) to $(\mathcal{P}_\theta^{Y,\eta})$ with $\eta = \eta_k$ and $\theta = \theta_k$ such that $R_{2,k} = d_2(\bar{\mu}, \mu^k)$ does not converge to 0. It follows from inequality (4.44) and estimate (4.46) that

$$o(1) = \phi(y_T^k, \theta_k) - \phi(\bar{y}_T, 0) \geq \int_0^T \int_{U_R} (H[p_t^{\bar{\lambda}}](u, \bar{y}_t, 0) - H[p_t^{\bar{\lambda}}][t]) d\mu_t^k(u) dt + o(1),$$

thus, by assumption 4.2.1, $R_{2,k} \rightarrow 0$, in contradiction with the initial assumption. \square

From now on, we fix a parameter $\eta > 0$ sufficiently small so that lemma 4.32 is satisfied. We are now able to build a sequence $(A^k, B^k)_k$ which can be used in the decomposition principle. Let us set

$$A^k := \{ (t, u) \in [0, T] \times U_R, |u - \bar{u}_t| < \sqrt{R_{1,k}} \} \quad \text{and} \quad B^k := (A^k)^c. \quad (4.59)$$

We consider the sequences $(\mu^{A,k})_k$ and $(\mu^{B,k})_k$ associated with $(\mu^k)_k$ and the sequence of partitions $(A^k, B^k)_k$. We still use the notations $z^{A,k}$ and $z^{B,k}$. Then,

$$R_{1,k} = \int_0^T \int_{U_R} |u - \bar{u}_t| d\mu_t^k(u) dt \geq \sqrt{R_{1,k}} \int_0^T \int_{U_R} \mathbf{1}_{B^k}(t, u) d\mu_t^k(u) dt$$

Thus, $\mu^k(B^k) \leq \sqrt{R_{1,k}} = O(\sqrt{R_{2,k}}) \rightarrow 0$, by lemma 4.32. Moreover,

$$\operatorname{ess\,sup}_{k \rightarrow \infty} \{ |u - \bar{u}_t|, (t, u) \in A^k \} \leq \sqrt{R_{1,k}} = O(\sqrt{R_{2,k}}) \rightarrow 0.$$

As a consequence, we can apply the decomposition principle to the partition.

Theorem 4.33. *Under hypotheses 4.1 and 4.2, the following estimates on the rate of convergence of perturbed solutions hold:*

$$R_{2,k} = d_2(\bar{\mu}, \mu^k) = O(\theta_k), \quad \|y^k - \bar{y}\|_\infty = O(\theta_k). \quad (4.60)$$

Proof. \triangleright *First step:* $R_{2,B,k} = O(R_{2,A,k} + \theta_k)$.

With expansion (4.51) and the second-order upper estimate (4.43), we obtain that for all $\lambda \in S(DL_\theta)$,

$$\begin{aligned} \frac{1}{2} \Omega[\lambda](\mu^{A,k} \ominus \bar{\mu}) + \int_0^T \int_{U_R} (H[p_t^\lambda](u, \bar{y}_t, 0) - H[p_t^\lambda][t]) d\mu_t^{B,k}(u) dt \\ \leq o(R_{2,A,k}^2 + R_{2,B,k}^2) + O(\theta_k R_{2,A,k}) + O(\theta_k^2). \end{aligned} \quad (4.61)$$

Specializing (4.61) for $\bar{\lambda}$ and since $\Omega[\bar{\lambda}](\mu^{A,k} \ominus \bar{\mu}) = O(R_{2,A,k}^2)$, we obtain by the second-order sufficient condition hypothesis 4.2.1 that

$$\alpha R_{2,B,k}^2 = O(R_{2,A,k}^2 + \theta_k^2),$$

thus, $R_{2,B,k} = O(R_{2,A,k} + \theta_k)$.

▷ *Second step:* $R_{2,A,k} = O(\theta_k)$.

Let us prove by contradiction that $R_{2,A,k} = O(\theta_k)$. Extracting if necessary a subsequence, we may assume that $\theta_k = o(R_{2,A,k})$. It follows directly that $R_{2,B,k} = O(R_{2,A,k})$. For all $\lambda \in S(DL_\theta)$, the difference of Hamiltonians is nonnegative, thus, by (4.61), for all $\lambda \in S(DL_\theta)$,

$$\Omega[\lambda](\mu^{A,k} \ominus \bar{u}) \leq O(\theta_k^2) + O(\theta_k R_{2,A,k}) + o(R_{2,A,k}^2) = o(R_{2,A,k}^2). \quad (4.62)$$

Using definition 4.17, we set

$$\nu^k = \frac{\mu^{A,k} \ominus \bar{u}}{R_{2,A,k}}.$$

Note that $z[\nu^k] = z^{A,k}/R_{2,A,k}$. For all k , $\|\nu^k\|_2^2 = 1$, therefore, up to a subsequence, we can suppose that $(\nu^k)_k$ converges narrowly to $\bar{\nu} \in \mathcal{M}_2^Y$. By lemma 4.31, $z[\nu^k]$ converges uniformly to $z[\bar{\nu}]$. Let us prove that

$$\phi_{y_T}(\bar{y}_T, 0) z_T[\bar{\nu}] = 0, \quad (4.63)$$

$$\Phi_{y_T}(\bar{y}_T, 0) z_T[\bar{\nu}] \in T_K(\Phi(\bar{y}_T, 0)). \quad (4.64)$$

By lemma 4.19, we obtain that

$$\delta y_T^k = z_T^{A,k} + z_T^{B,k} + \theta_k \xi_T^\theta + O(\theta_k^2 + R_{1,A,k}^2 + R_{1,B,k}^2) = z_T^{A,k} + o(R_{2,A,k}),$$

and finally that $\delta y_T^k = R_{2,A,k}(z[\nu^k] + o(1)) = R_{2,A,k}(z[\bar{\nu}] + o(1))$. As a consequence,

$$\phi(y_T^k, \theta_k) - \phi(\bar{y}_T, 0) = R_{2,A,k}[\phi_{y_T}(\bar{y}_T, 0) z_T[\bar{\nu}] + o(1)], \quad (4.65)$$

$$\Phi(y_T^k, \theta_k) - \Phi(\bar{y}_T, 0) = R_{2,A,k}[\Phi_{y_T}(\bar{y}_T, 0) z_T[\bar{\nu}] + o(1)]. \quad (4.66)$$

We obtain (4.64) directly and (4.63) follows from (4.65) and from the following first-order upper estimate:

$$\phi(y_T^k, \theta_k) - \phi(\bar{y}_T, 0) \leq O(\theta_k) = o(R_{2,A,k}).$$

Therefore, $\nu \in C_2$. We obtain from lemma 4.31 and (4.62) that

$$\sup_{\lambda \in SDL_\theta} \Omega[\lambda](\nu) \leq 0.$$

By the second-order sufficient condition (hypothesis 4.2.2), $\nu = 0$. Applying (4.62) to $\bar{\lambda}$, we obtain by the lower semi-continuity of $\Omega[\bar{\lambda}]$ that $\lim_k \Omega[\bar{\lambda}](\nu^k) = 0$ and thus, by lemma 4.31, $\|\nu^k\|_2 \rightarrow 0$, in contradiction with the fact that $\|\nu^k\|_2 = 1$ for all k . It follows that $R_{2,A,k} = O(\theta_k)$, thus $R_{2,k} = O(R_{2,A,k} + R_{2,B,k}) = \theta_k$ and finally that $\|y^k - \bar{y}\|_\infty = O(\theta_k)$, by lemma 4.35. \square

4.5.3 First- and second-order estimates

In this section, we prove that the first- and the second-order upper estimates that we have computed in section 4.4 are exact expansions, for sufficiently small values of $\eta > 0$ (so that lemma 4.32 holds). The first-order estimate derives directly from inequality (4.44), expansion (4.51), and theorem 4.33 (under hypotheses 4.1 and 4.2):

$$V^\eta(\theta_k) - V^\eta(0) = \text{Val}(PL_\theta)\theta_k + O(\theta_k^2). \quad (4.67)$$

Theorem 4.34. *Under hypotheses 4.1 and 4.2, the following second-order estimate holds:*

$$V^\eta(\theta) = V^\eta(0) + \theta \text{Val}(PL_\theta) + \theta^2 \text{Val}(PQ_\theta) + o(\theta^2). \quad (4.68)$$

Moreover, for any $\theta_k \downarrow 0$, we can extract a subsequence of solutions μ^k to $(\mathcal{P}_\theta^{Y,\eta})$ such that $\frac{\mu^k \ominus \bar{u}}{\theta_k}$ converges narrowly to some $\bar{\nu}$ solution of (PQ_θ) .

Proof. Let $(\theta_k)_k \downarrow 0$. We set

$$\nu^{A,k} = \frac{\mu^{A,k} \ominus \bar{u}}{\theta_k}, \quad \nu^k = \frac{\mu^k \ominus \bar{u}}{\theta_k}.$$

By theorem 4.33, $R_{2,A,k}^2 = O(\theta_k^2)$. Therefore, $(\nu^{A,k})_k$ is bounded for the L^2 -norm and we can extract a subsequence such that $(\nu^{A,k})$ narrowly converges to some $\bar{\nu}$ in \mathcal{M}_2^Y . Moreover, we can show that

$$d_1(\nu^k, \nu^{A,k}) \leq \frac{\|\mu^{B,k} \ominus \bar{u}\|_1}{\theta_k} = o(1),$$

thus, ν^k equally converges to $\bar{\nu}$ for the narrow topology. For all $\lambda \in S(DL_\theta)$,

$$\int_0^T \int_{U_R} (H[p_t^\lambda](u, \bar{y}_t, 0) - H[p_t^\lambda][t]) d\mu_t^{B,k}(u) dt \geq 0,$$

thus, by inequality (4.44), by the decomposition principle (theorem 4.28), and by the lower semi-continuity of Ω^θ (lemma 4.31),

$$\begin{aligned} V^\eta(\theta_k) - V^\eta(0) &\geq \theta_k \text{Val}(PL_\theta) + \frac{\theta_k^2}{2} \Omega^\theta[\lambda](\nu^{A,k}) + o(\theta_k^2) \\ &\geq \theta_k \text{Val}(PL_\theta) + \frac{\theta_k^2}{2} \Omega^\theta[\lambda](\bar{\nu}) + o(\theta_k^2). \end{aligned}$$

Let us prove that $\bar{\nu}$ is a solution to problem (SPL_θ) . Following the proof of theorem 4.33, we obtain that

$$\delta y_T^k = \theta_k (z_T[\bar{\nu}] + \xi_T^\theta + o(1)),$$

and therefore that

$$\phi(y_T^k, \theta_k) - \phi(\bar{y}_T, 0) = \theta_k \phi'(\bar{y}_T, 0)(z_T[\bar{\nu}] + \xi_T^\theta, 1) + o(\theta_k), \quad (4.69)$$

$$\Phi(y_T^k, \theta_k) - \Phi(\bar{y}_T, 0) = \theta_k \Phi'(\bar{y}_T, 0)(z_T[\bar{\nu}] + \xi_T^\theta, 1) + o(\theta_k). \quad (4.70)$$

By (4.37), we obtain that

$$\phi(y_T^k, \theta_k) - \phi(\bar{y}_T, 0) \leq \text{Val}(PL_\theta) \theta_k + o(\theta_k),$$

therefore

$$\phi'(\bar{y}_T, 0)(z_T[\bar{\nu}] + \xi_T^\theta, 1) \leq \text{Val}(PL_\theta).$$

and by (4.70),

$$\Phi'(\bar{y}_T, 0)(z_T[\bar{\nu}] + \xi_T^\theta, 1) \in T_K(\Phi(\bar{y}_T, 0)).$$

This proves that $\bar{\nu}$ is a solution to (SPL_θ) . By lemma 4.25 and theorem 4.26, we obtain that

$$\text{Val}(PQ_\theta(\bar{\nu})) \leq \inf_{\nu \in S(SPL_\theta)} \text{Val}(PQ_\theta(\nu)),$$

thus, $\bar{\nu}$ is a solution to problem (PQ_θ) and the theorem is now proved. It also proves that problem (PQ_θ) has a finite value. \square

4.6 Two examples

4.6.1 A different value for the Pontryagin and the standard linearized problem

Let us consider the following dynamic in \mathbb{R}^2 :

$$\begin{cases} \dot{y}_t = (u_t^3, u_t^2)^T, & \text{for a.a. } t \in [0, T], \\ y_0 = (0, 0)^T. \end{cases}$$

The control u is such that $\|u\|_\infty \leq 1$ and we minimize $y_{2,T}[u]$ under the constraint $y_{1,T}[u] = \theta$, with $\theta \geq 0$ and $\bar{\theta} = 0$. The coordinate y_2 corresponds to the integral which would have been used in a Bolza formulation of the problem. For $\bar{\theta} = 0$, the problem has a unique solution $\bar{u} = 0$, $\bar{y} = (0, 0)^T$. This solution is qualified in the sense of definition 4.8, since for $v = 1$, $\xi_1[v] = T$ and for $v = -1$, $\xi_1[v] = -T$. However, the solution is not qualified in the sense of the standard definition, since the standard linearized dynamic z is equal to 0.

For $\theta \leq T$, the problem has infinitely many solutions, one of them being:

$$u_t^\theta = \begin{cases} 1, & \text{if } t \in (0, \theta), \\ 0, & \text{if } t \in (\theta, T). \end{cases}$$

Indeed, $y_{1,T}[u^\theta] = \theta$, $y_{2,T}[u^\theta] = \theta$ and if v^θ is feasible, then

$$\theta = y_{1,T}[v^\theta] = \int_0^T (v_t^\theta)^3 dt \leq \int_0^T (v_t^\theta)^2 dt = y_{2,T}[v^\theta],$$

which proves that u^θ is optimal. Moreover, if v^θ is optimal, then the previous inequality is an equality and thus, for almost all t , $(v_t^\theta)^3 = (v_t^\theta)^2$, that is to say, $v_t^\theta \in \{0, 1\}$. We also obtain that $\|v^\theta - \bar{u}\|_2 = \sqrt{\theta}$ and $\|v^\theta - \bar{u}\|_\infty = 1$. Note that, in this example, $R = 1$ and $\|u_t^\theta\|_\infty = 1$ for $0 \leq \theta \leq T$, so that u^θ is not an interior point of the ball U_R .

Now, let us compute the sets of multipliers Λ^L and Λ^P (for the reference problem). Since the dynamic does not depend on y , denoting by $\lambda \in \mathbb{R}$ the dual variable associated with the constraint $y_{1,T}[u] - \theta = 0$, the costate p^λ is constant and given by $p_t = (\lambda, 1)$. The Hamiltonian is given by

$$H[\lambda](u) = u^2 + \lambda u^3.$$

As a consequence, we obtain that $\Lambda^L = \mathbb{R} \times \{1\}$ and $\Lambda^P = [-1, 1] \times \{1\}$. The Lagrangian associated with our family of problems is given by

$$\mathcal{L}(u, y, \lambda, \theta) = \int_0^T (u_t^2 + \lambda u_t^3) dt + \lambda(y_{1,\theta} - \theta),$$

therefore, $\mathcal{L}_\theta(\bar{u}, \bar{y}, \lambda, \bar{\theta}) = -\lambda$, $\text{Val}(PL_\theta) = 1$, and $\text{Val}(SPL_\theta) = +\infty$. In this example, the Pontryagin linearized problem enables a more accurate estimation of the value function. Since the solution \bar{u} is not qualified in a standard definition, it is not surprising that the associated linearized problem has a value equal to $+\infty$.

Note that the second-order theory developed in the article cannot be used to study this example, since we do not have the equality of $\text{Val}(PL_\theta)$ and $\text{Val}(SPL_\theta)$. Moreover, observe that for the solution $\lambda = -1$ of (DL_θ) , the Hamiltonian $H[\lambda](u) = u^2 - u^3$ has two minimizers: 0 and 1. The set of minimizers contains the support of the solutions to the perturbed problems.

4.6.2 No classical solutions for the perturbed problems

This second example shows a family of problems for which the perturbed problems do not have a classical solution. This example does not fit to the framework of the study since we consider active control constraints. However, we believe it is interesting since in this case, the ratio $(\mu^\theta \ominus \bar{u})/\theta$ converges to a purely relaxed element of \mathcal{M}_2^Y for the narrow topology. This confirms us in the idea to use relaxation to perform a sensitivity analysis of optimal control problems.

Let us consider the following dynamic in \mathbb{R}^2 :

$$\begin{cases} (\dot{y}_{1,t}, \dot{y}_{2,t})^T = (u_t, y_1^2 + 2(v_t - \theta)^2 - u_t^2)^T, \text{ for a.a. } t \in [0, T], \\ (y_{1,0}, y_{2,0})^T = (0, 0)^T, \end{cases}$$

where for almost all t in $[0, T]$, $v_t \geq u_t$ and $v_t \geq -u_t$. The perturbation parameter θ is nonnegative and $\bar{\theta} = 0$. We minimize $y_{2,T}$. For $\theta = 0$, the problem has a unique solution $\bar{u} = (0, 0)^T$, $\bar{y} = (0, 0)^T$. The associated costate $p = (p_1, p_2)$ is constant, given by $p_1 = 0$ and $p_2 = 1$. Thus,

$$H[p](u, v, \bar{y}_t) = 2(v - \theta)^2 - u^2.$$

This Hamiltonian has been “designed” in a way to have a unique minimizer when $\theta = 0$, but two minimizers $(\pm 2\theta, 2\theta)$ when $\theta > 0$. Let us focus on optimal solutions to the problem when $\theta > 0$. Let $u, v \in L^\infty([0, T], \mathbb{R})$, we have

$$\begin{aligned} y_{2,T}[u, v] &= \int_0^T y_{1,t}[u, v]^2 + 2(v_t - \theta)^2 - u_t^2 dt \\ &= \int_0^T y_{1,t}[u, v]^2 + 2v_t^2 - 4\theta v_t + 2\theta^2 - u_t^2 dt \\ &= \int_0^T y_{1,t}[u, v]^2 + (v_t^2 - u_t^2) + (v_t - 2\theta)^2 - 2\theta^2 dt \geq -2\theta^2 T. \end{aligned}$$

This last inequality is an equality if for almost all t in $[0, T]$, $y_{1,t}[u, v] = 0$, $v_t = 2\theta$, $|u_t| = v_t$. As a consequence, the problem does not have classical solutions, but has a unique relaxed one, $\mu^\theta = ((\delta_{-2\theta} + \delta_{2\theta})/2, 2\theta)$. Moreover,

$$\frac{\mu^\theta \ominus \bar{u}}{\theta} = ((\delta_{-2} + \delta_2)/2, \delta_2).$$

4.A Appendix

Properties of Young measures

First definitions

Weak-* topology on bounded measures Let X be a closed subset of \mathbb{R}^m . We say that a real function ψ on $[0, T] \times X$ vanishes at infinity if for all $\varepsilon > 0$, there exists a compact subset K of X such that for all (t, u) in $[0, T] \times (X \setminus K)$, $|\psi(t, u)| \leq \varepsilon$. We denote by $C^0([0, T] \times X)$ the set of continuous real functions vanishing at infinity. The set $\mathcal{M}_b([0, T] \times X)$ of bounded measures on $[0, T] \times X$ is the topological dual of $C^0([0, T] \times X)$. The associated *weak-* topology* is metrizable since $[0, T] \times X$ is separable.

Young measures Let us denote by P the projection from $[0, T] \times X$ to $[0, T]$. We say that $\mu \in \mathcal{M}_b^+([0, T] \times X)$ is a *Young measure* if $P_{\#}\mu$ is the Lebesgue measure on $[0, T]$. We denote by $\mathcal{M}^Y(X)$ the set of Young measures, which is weakly-* compact [67, theorem 1].

Disintegrability Let us denote by $\mathcal{P}(X)$ the set of probability measures on X . To all measurable mappings $\nu \in L^\infty(0, T; \mathcal{P}(X))$ (see the definition in [67, page 157]), we associate a unique Young measure μ defined by: for all ψ in $C^0([0, T] \times X)$,

$$\int_{[0, T] \times X} \psi(t, u) \, d\mu(t, u) = \int_0^T \int_X \psi(t, u) \, d\nu_t(u) \, dt.$$

This mapping defines a bijection from $L^\infty([0, T]; \mathcal{P}(X))$ to $\mathcal{M}^Y(X)$. This property is called *disintegrability*. Note that $L^\infty([0, T]; \mathcal{P}(X)) \subset L^\infty([0, T]; \mathcal{M}_b(X))$, which is the dual of $L^1(0, T; C^0(X))$ [67, page 179]. On $\mathcal{M}^Y(X)$, the weak-* topology of this dual pair is equivalent to the weak-* topology previously defined [67, theorem 2]. In the article, we always write Young measures in a disintegrated form.

Density To all u in $L([0, T]; X)$, we associate the unique Young measure μ defined by for almost all t in $[0, T]$, $\mu_t = \delta_{u_t}$. The space $L([0, T]; X)$ is dense in $\mathcal{M}^Y(X)$ for the weak-* topology [68, proposition 8].

Lower semi-continuity of integrands We say that $\psi : [0, T] \times X \rightarrow \mathbb{R} \cup \{+\infty\}$ is a *positive normal integrand* if ψ is measurable, $\psi \geq 0$ and if for almost all t in $[0, T]$,

$\psi(t, \cdot)$ is l.s.c. If ψ is a positive normal integrand, then the mapping

$$\mu \in \mathcal{M}^Y(X) \mapsto \int_0^T \int_X \psi(t, u) \, d\mu_t(u) \, dt$$

is l.s.c. for the weak-* topology [67, theorem 4].

Narrow topology We say that the measurable mapping $\psi : [0, T] \times X \rightarrow \mathbb{R}$ is a *bounded Caratheodory integrand* if for almost all t in $[0, T]$, $\psi(t, \cdot)$ is continuous and bounded and if $\|\psi(t, \cdot)\|_\infty$ is integrable. The *narrow topology* on $\mathcal{M}^Y(X)$ is the weakest topology such that for all bounded Caratheodory integrands ψ ,

$$\mu \in \mathcal{M}^Y(X) \mapsto \int_0^T \int_X \psi(t, u) \, d\mu_t(u) \, du$$

is continuous. This topology is finer than the weak-* topology.

Wasserstein distance We denote by P^1 and P^2 the two projections from $[0, T] \times X \times X$ to $[0, T] \times X$ defined by $P^1(t, u, v) = (t, u)$ and $P^2(t, u, v) = (t, v)$. Let μ^1 and μ^2 be in $\mathcal{M}^Y(X)$, then π in $\mathcal{M}_b^+([0, T] \times X \times X)$ is said to be a *transportation plan* between μ^1 and μ^2 if $P_{\#}^1 \pi = \mu^1$ and $P_{\#}^2 \pi = \mu^2$. Note that a transportation plan is disintegrable in time, like Young measures. The set $\Pi(\mu^1, \mu^2)$ of transportation plans between μ^1 and μ^2 is never empty, since it contains the measure π defined by $\pi_t = \mu_t^1 \otimes \mu_t^2$ for a.a. t . For $p \in [1, \infty)$, the L^p -distance between μ^1 and μ^2 is

$$d_p(\mu^1, \mu^2) = \left[\inf_{\pi \in \Pi(\mu^1, \mu^2)} \int_0^T \int_{X \times X} |v - u|^p \, d\pi_t(u, v) \, dt \right]^{1/p}. \quad (4.71)$$

This distance is called the *Wasserstein distance* [24, section 3.4]. The set $\Pi(\mu^1, \mu^2)$ is narrowly closed and if $d_p(\mu^1, \mu^2)$ is finite, any minimizing sequence of the problem associated with (4.71) has a limit point by Prokhorov's theorem [67, theorem 11], thus by lower semi-continuity of the duality product with a positive normal integrand, we obtain the existence of an optimal transportation plan.

If μ^1 is the Young measure associated to $u^1 \in L([0, T]; X)$, then for all μ^2 in $\mathcal{M}^Y(X)$, there is only one transportation plan π in $\Pi(\mu^1, \mu^2)$, which is, for almost all t in $[0, T]$, for all u and v in X , $\pi_t(u, v) = \delta_{u_t^1}(u) \mu_t^2(v)$, therefore, for all $p \in [1, \infty)$,

$$d_p(\mu^1, \mu^2) = \left[\int_0^T \int_{U_R} |v - u_t^1|^p \, d\mu_t^2(v) \, dt \right]^{1/p}. \quad (4.72)$$

Note that in this case, the mapping $\mu^2 \mapsto d_s(\mu^1, \mu^2)$ is weakly-* continuous. If μ^1 and μ^2 are both associated with u_1 and u_2 in $L^p([0, T]; X)$, then $d_p(\mu^1, \mu^2) = \|u_2 - u_1\|_p$.

Young measures on U_R

We suppose here that X is equal to U_R , the ball of \mathbb{R}^m with radius R and center 0. We denote $\mathcal{M}_R^Y = \mathcal{M}^Y(U_R)$. The set U_R being compact, \mathcal{M}_R^Y is weakly-* compact [67, theorem 1]. Moreover, the weak-* topology and the narrow topology are equivalent [67, theorem 4].

Differential systems controlled by Young measures Let $x^0 \in \mathbb{R}^n$, and let $g : [0, T] \times X \rightarrow \mathbb{R}^n$ be Lipschitz continuous (with modulus A), then for all μ in \mathcal{M}_R^Y , the differential system

$$\dot{x}_t = \int_{U_R} f(x_t, u) d\mu_t(u), \quad x_0 = x^0$$

has a unique solution in $C(0, T; \mathbb{R}^n)$, denoted by $x[\mu]$.

Lemma 4.35. *The mapping $\mu \in \mathcal{M}_R^Y \mapsto x[\mu] \in C(0, T; \mathbb{R}^n)$ is weakly-* continuous and Lipschitz continuous for the L^1 -distance of Young measures.*

Proof. \triangleright *Weak-* continuity.*

Let $\mu \in \mathcal{M}_R^Y$, and let $(\mu_k)_k$ converges to $\mu \in \mathcal{M}_R^Y$ for the weak-* topology. The sequence $(g^k)_k$ defined by

$$g_t^k = \int_0^t \int_{U_R} f(x_s[\mu], u) (d\mu_s^k(u) - d\mu_s(u)) ds$$

converges pointwise to 0. We can show with the Arzelà-Ascoli theorem that this convergence is uniform. For all t in $[0, T]$,

$$\begin{aligned} |x_t[\mu^k] - x_t[\mu]| &\leq \int_0^t \int_{U_R} |f(x_s[\mu^k], u) - f(x_s[\mu], u)| d\mu_s^k(u) ds \\ &\quad + \left| \int_0^t \int_{U_R} f(x_s[\mu], u) (d\mu_s^k(u) - d\mu_s(u)) ds \right| \\ &= \int_0^t O(|x_s[\mu^k] - x_s[\mu]|) ds + o(1), \end{aligned}$$

where the estimate $o(1)$ is uniform in time. The uniform convergence of $x[\mu^k]$ follows from Gronwall's lemma.

\triangleright *L^1 -Lipschitz continuity.*

Let μ^1 and μ^2 be in \mathcal{M}_R^Y , and let π be an optimal transportation plan between μ^1 and μ^2 for the L^1 -distance. There exists a constant $A \geq 0$ such that for all t in $[0, T]$,

$$\begin{aligned} |x_t[\mu^2] - x_t[\mu^1]| &\leq \left| \int_0^t \int_{U_R \times U_R} f(x_s[\mu^2], v) - f(x_s[\mu^1], u) d\pi_s(u, v) ds \right| \\ &\leq \int_0^t \int_{U_R \times U_R} A(|x_s[\mu^2] - x_s[\mu^1]| + |v - u|) d\pi_s(u, v) ds \\ &\leq \int_0^t A|x_s[\mu^2] - x_s[\mu^1]| ds + Ad_1(\mu^1, \mu^2). \end{aligned}$$

The Lipschitz continuity follows from Gronwall's lemma. \square

Young measures on \mathbb{R}^m

We suppose here that $X = \mathbb{R}^m$. We equip $\mathcal{M}^Y := \mathcal{M}^Y(\mathbb{R}^m)$ with the narrow topology. In the article, elements of \mathcal{M}^Y are denoted by ν . For p in $[1, \infty)$, we denote by \mathcal{M}_p^Y

the set of Young measures ν in \mathcal{M}^Y with a finite L^p -norm, defined by $\|\nu\|_p = d_p(0, \nu)$, where d_p is the Wasserstein distance. We denote by \mathcal{M}_∞^Y the set of Young measures with bounded support and we define the L^∞ -norm as follows:

$$\|\nu\|_\infty = \inf \{a \in \mathbb{R}, \nu([0, T] \times B(0, a)) = \nu([0, T] \times \mathbb{R}^m)\}.$$

Note the inclusion $\mathcal{M}_\infty^Y \subset \mathcal{M}_2^Y \subset \mathcal{M}_1^Y$.

Lemma 4.36. *The unit ball B_2^Y of \mathcal{M}_2^Y is narrowly compact.*

Proof. By Prokhorov's theorem [67, theorem 11], B_2^Y is precompact. The mapping $(t, u) \mapsto |u|^2$ being a positive normal integrand, the L^2 -norm is l.s.c. and therefore, B_2^Y is closed for the narrow topology. The lemma is proved. \square

Lemma 4.37. *Let $\psi : [0, T] \times X \rightarrow \mathbb{R}^m$ a measurable mapping be such that for almost all t in $[0, T]$, $\psi(t, \cdot)$ is continuous and such that*

$$\operatorname{ess\,sup}_{t \in [0, T]} |\psi(t, u)| = o_{|u| \rightarrow \infty}(|u|^2).$$

Then, for all bounded sequences $(\nu^k)_k$ in \mathcal{M}_2^Y converging narrowly to $\nu \in \mathcal{M}_2^Y$,

$$\int_0^T \int_{\mathbb{R}^m} \psi(t, u) \, d\nu_t^k(u) \, dt \xrightarrow{k \rightarrow \infty} \int_0^T \int_{\mathbb{R}^m} \psi(t, u) \, d\nu_t(u) \, dt \quad (4.73)$$

Proof. The proof is inspired from [7, remark 5.3]. Let $(\nu^k)_k$ be a bounded sequence in \mathcal{M}_2^Y converging narrowly to $\nu \in \mathcal{M}_2^Y$. Let

$$A = \max \{ \|\nu\|_2^2, \sup_k \{\|\nu^k\|_2^2\} \}.$$

Let $\varepsilon > 0$. Let $B \geq 0$ be such that for almost all t in $[0, T]$, for all u in \mathbb{R}^m ,

$$\psi(t, u) \leq \varepsilon|u|^2 + B.$$

Then, $\varepsilon|u|^2 + B - \psi(t, u)$ is a positive normal integrand. Thus,

$$\int_0^T \int_{\mathbb{R}^m} \varepsilon|u|^2 + B - \psi(t, u) \, d\nu_t(u) \, dt \leq \liminf_{k \rightarrow \infty} \int_0^T \int_{\mathbb{R}^m} \varepsilon|u|^2 + B - \psi(t, u) \, d\nu_t^k(u) \, dt.$$

and therefore,

$$\int_0^T \int_{\mathbb{R}^m} -\psi(t, u) \, d\nu_t(u) \, dt \leq \liminf_{k \rightarrow \infty} \int_0^T \int_{\mathbb{R}^m} -\psi(t, u) \, d\nu_t^k(u) \, dt + 2\varepsilon A^2.$$

To the limit when $\varepsilon \downarrow 0$, we obtain that

$$\int_0^T \int_{\mathbb{R}^m} \psi(t, u) \, d\nu_t(u) \, dt \geq \limsup_{k \rightarrow \infty} \int_0^T \int_{\mathbb{R}^m} \psi(t, u) \, d\nu_t^k(u) \, dt,$$

which proves the upper semi-continuity of the mapping (4.73). We prove similarly the lower semi-continuity. \square

Justification of relaxation

This section aims at justifying the use of relaxation in the formulation of the problem. The results that we give are independent of the sensitivity analysis performed in the article. We introduce the value function associated with the notion of classical R -strong optimal solutions, denoted by $\hat{V}^\eta(\theta)$.

$$\hat{V}^\eta(\theta) := \begin{cases} \text{Min}_{u \in \mathcal{U}, \|u\| \leq R} & \phi(y_T[u, \theta], \theta), \\ \text{s.t.} & \Phi(y_T[u, \theta], \theta) \in K, \quad \|y[u, \theta] - \bar{y}\|_\infty \leq \eta. \end{cases} \quad (4.74)$$

Note that for all $\theta \geq 0$, for all $\eta > 0$, $V^\eta(\theta) \leq \hat{V}^\eta(\theta)$, since the set of Young measures contains the classical controls. The converse inequality would be true if there were no constraints. In that case, it would suffice to approximate any Young measure μ with a sequence of classical controls converging to μ for the weak-* topology. In the constrained case, this sequence is not necessarily feasible. We prove in lemma 4.38 that if a given classical control is close in the L^1 -distance from \bar{u} , it can be restored (with another classical control). We obtain as a corollary that any feasible relaxed control close to \bar{u} in the L^1 -distance can be approximated by feasible classical controls. Using the results of convergence of the solutions of perturbed problems obtained in section 4.5, we prove the equality of V and \hat{V} for small values of η and θ .

Lemma 4.38. *If $\bar{\mu}$ is qualified, then there exist $\delta_1 > 0$, $\sigma > 0$, and $C_1 \geq 0$ such that for all classical controls u with $\|u - \bar{u}\|_1 \leq \delta_1$, for all $\theta \in [0, \sigma]$, there exists a classical control u' such that*

$$\Phi(y_T[u', \theta], \theta) \in K \quad \text{and} \quad \|u' - u\|_1 \leq C_1 \text{dist}(\Phi(y_T[u, \theta], \theta), K).$$

Proof. Let δ , σ , and C be the constants given by the metric regularity theorem (theorem 4.9). Let us set $\delta_1 = \frac{\delta}{2C+3}$. Given $\theta \in [0, \sigma]$, let u be a classical control such that $\|u - \bar{u}\|_1 \leq \delta_1$. Set $d = \text{dist}(\Phi(y_T[u, \theta], \theta), K)$. Let us build a sequence $(u^k)_k$ of classical controls with $u^0 = u$ and which is such that for all k ,

$$\|u^{k+1} - u^k\|_1 \leq \frac{(C+1)d}{2^k} \quad \text{and} \quad \Phi(y_T[u^k, \theta], \theta) \leq \frac{d}{2^k}. \quad (4.75)$$

By definition, $\text{dist}(\Phi(y_T[u^0, \theta], \theta), K) \leq d/2^0$. Let k in \mathbb{N} , and let us suppose that we have built u^0, \dots, u^k such that (4.75) holds up to index $k-1$. Thus, $\text{dist}(\Phi(y_T[u^k, \theta], \theta), K) \leq d/2^k$ and $\|u^{j+1} - u^j\|_1 \leq (C+1)d/2^j$ for all j in $\{0, \dots, k-1\}$. Therefore,

$$d_1(u^k, \bar{\mu}) \leq \|u^k - u^0\|_1 + d_1(u^0, \bar{\mu}) \leq \sum_{j=0}^{k-1} \frac{(C+1)d}{2^j} + \delta_1 \leq 2(C+1)\delta_1 + \delta_1 \leq \delta.$$

By the metric regularity theorem, there exists a feasible relaxed control μ such that $d_1(u^k, \mu) \leq Cd/2^k$. By the density of classical controls into \mathcal{M}_R^Y , by the weak-* continuity of $d_1(u^k, \cdot)$, and by lemma 4.35, there exists a classical control u such that

$$\|u - u^k\|_1 \leq \frac{(C+1)d}{2^k} \quad \text{and} \quad \Phi(y_T[u, \theta], \theta) \leq \frac{d}{2^{k+1}}.$$

We set $u^{k+1} = u$. This justifies the existence of a sequence satisfying (4.75). Finally, we have built a sequence $(u^k)_k$ of classical controls which converges for the L^1 -norm. Let us denote by u' its limit, by lemma 4.35, it follows that

$$\text{dist}(\Phi(y_T[u', \theta], \theta), K) \leq \lim_{k \rightarrow \infty} \text{dist}(\Phi(y_T[u^k, \theta], \theta), K) = 0$$

and

$$\|u' - u\|_1 \leq \sum_{k=0}^{\infty} \|u^{k+1} - u^k\|_1 \leq \sum_{k=0}^{\infty} \frac{(C+1)d}{2^k} = 2(C+1)d.$$

The lemma holds with δ_1 , σ , u' , and $C_1 = 2(C+1)$. \square

Corollary 4.39. *Let $\mu \in \mathcal{M}_R^Y$ and $\theta \in [0, \sigma]$ be such that $d_1(\bar{u}, \mu) < \delta_1$ and such that μ is feasible for θ . Then, there exists a feasible sequence of classical controls $(u^k)_k$ converging to μ for the weak-* topology.*

Proof. Let $\mu \in \mathcal{M}_R^Y$ and $\theta \in [0, \sigma]$ be as above. Let $(u^k)_k$ be a sequence of classical controls converging to μ for the weak-* topology. Then, $\text{dist}(\Phi(y_T[u^k, \theta], \theta), K) \rightarrow 0$, by lemma 4.35 and for k large enough, $\|u^k - \bar{u}\|_1 \leq \delta_1$. By lemma 4.38, we obtain a sequence of feasible controls $(\tilde{u}^k)_k$ which is feasible for the value θ and which is such that $\|u^k - \tilde{u}^k\|_1 \rightarrow 0$. Then, it is easy to check that \tilde{u}^k converges to μ for the weak-* topology. This proves the corollary. \square

In theorem 4.33, we have proved that under a second-order sufficient condition, for a small, positive, and fixed value of η , any sequence of solutions to problems $(\mathcal{P}_\theta^{Y, \eta})$ converges to \bar{u} for the L^1 -distance. Therefore, for small values of η and θ , these solutions can be approximated by feasible classical controls and $V^\eta(\theta) = \hat{V}^\eta(\theta)$.

Technical proofs

Lemma 4.6. For all t in $[0, T]$,

$$\begin{aligned} |y[\mu, \theta]_t - \bar{y}_t| &= \left| \int_0^t \int_{U_R} (f(u, y_s[\mu, \theta], \theta) - f(\bar{u}_s, \bar{y}_s, 0)) \, d\mu_s(u) \, ds \right| \\ &= \int_0^t \int_{U_R} O(|u - \bar{u}_t|) + O(|y_s[\mu, \theta] - \bar{y}_s| + \theta) \, d\mu_s(u) \, ds + O(\theta) \\ &= O(d_1(\mu, \bar{\mu})) + O(\theta) + \int_0^t O(|y[\mu, \theta]_s - \bar{y}_s|) \, ds, \end{aligned}$$

whence estimate (4.9) by Gronwall's lemma. Now, set $r = y[\mu, \theta] - (\bar{y} + \xi[\mu] + \theta\xi^\theta)$, then, for all t in $[0, T]$,

$$\begin{aligned} |r_t| &= \left| \int_0^t \int_{U_R} (f(u, y_s[\mu, \theta], \theta) - f(u, \bar{y}_s, 0)) \, d\mu_s(u) - f_{y,\theta}[s](\xi_s[\mu] + \theta\xi_s^\theta, \theta) \, ds \right| \\ &\leq \int_0^t |f(\bar{u}_s, y_s[\mu, \theta], \theta) - f(\bar{u}_s, \bar{y}_s, 0) - [f_y[s]\xi_s[\mu] + f_y[s]\theta\xi_s^\theta + f_\theta[s]]| \, ds \\ &= \int_0^t |f_y[s](y_s[\mu, \theta] - (\bar{y}_s + \xi_s[\mu] + \theta\xi_s^\theta))| \, ds + O(d_1(\mu, \bar{\mu})^2 + \theta^2) \\ &= \int_0^t O(|r_s|) \, ds + O(d_1(\mu, \bar{\mu})^2 + \theta^2), \end{aligned}$$

since

$$\begin{aligned} &\int_0^t \int_{U_R} [f(u, y_s[\mu, \theta], \theta) - f(u, \bar{y}_s, 0)] - [f(\bar{u}_s, y_s[\mu, \theta], \theta) - f(\bar{u}_s, \bar{y}_s, 0)] \, d\mu_s(u) \, ds \\ &= O(d_1(\mu, \bar{\mu})(\|y[\mu] - \bar{y}\|_\infty + \theta)) = O(d_1(\mu, \bar{\mu})^2 + \theta^2). \end{aligned}$$

Estimate (4.10) follows from Gronwall's lemma. \square

Lemma 4.7. The result is a consequence of the dual representation of the L^1 -distance given in [24, theorem 3.4.1]. Let $\psi : [0, T] \times U_R \rightarrow \mathbb{R}$ be a bounded Caratheodory integrand which is such that for almost all t , $u \in U_R \mapsto \psi(t, u)$ is Lipschitz continuous with modulus 1. Then,

$$\begin{aligned} &\int_0^T \int_{U_R} \psi(t, u) (dS_t(\mu^0, \gamma')(u) - dS_t(\mu^0, \gamma)(u)) \, dt \\ &= \sum_{i=1}^q (\gamma'_i - \gamma_i) \int_{U_R} \psi(t, u) (d\mu^i(u) - d\mu^0(u)) \, dt \leq \sum_{i=1}^q |\gamma'_i - \gamma_i| d_1(\mu^0, \mu^i). \end{aligned}$$

The first inequality follows and the second one is obvious. \square

Lemma 4.19. Remember that $\|\mu \ominus \bar{\mu}\|_1 = d_1(\bar{\mu}, \mu)$. Setting $r = \xi[\mu] - z[\mu \ominus \bar{\mu}]$, we obtain that for almost all t in $[0, T]$,

$$\begin{aligned} \dot{r}_t &= f_y[t]r_t + \int_{U_R} [f(\bar{y}_t, u) - (f[t] + f_u[t](u - \bar{u}_t))] \, d\mu_t(u) \\ &= O(|r_t|) + \int_{U_R} O(|u - \bar{u}_t|^2) \, d\mu_t(u), \end{aligned}$$

thus, by Gronwall's lemma, $\|r\|_\infty = O(\|\mu \ominus \bar{\mu}\|_2^2)$, which proves estimate (4.39). Replacing $\xi[\mu]$ by $z[\mu \ominus \bar{\mu}]$ in estimates (4.9) and (4.10) of lemma 4.6, we obtain estimates (4.40) and (4.41). \square

The following lemma will be used in the proof of theorem 4.26.

Lemma 4.40. *Let $(\theta_k)_k \downarrow 0$ and let $f : \mathbb{R}_+ \rightarrow \mathbb{R}_{+*}$ be a non-increasing right-continuous function converging to 0 at infinity. Then, there exists a sequence $(c_k)_k$ of positive real numbers satisfying*

$$c_k \theta_k \rightarrow 0 \quad \text{and} \quad \frac{f(c_k)}{c_k} = o(\theta_k). \quad (4.76)$$

Proof. For all k , set

$$C_k = \{c \geq 0, f(c) \leq (\theta_k c)^2\}.$$

Since f is non-increasing and right-continuous, C_k is a closed interval of \mathbb{R}_{+*} . Set $c_k = \inf C_k$. The sequence $(c_k)_k$ is well-defined and positive. Let $C > 0$, for k large enough, $\theta_k < \sqrt{f(C)}/C$, thus $c_k \geq C$. This proves that $c_k \rightarrow +\infty$ and therefore that $f(c_k) \rightarrow 0$. Since $c_k/2 < c_k$,

$$f(c_k/2) \geq \left(\frac{\theta_k c_k}{2}\right)^2,$$

therefore, $c_k \theta_k \leq 2\sqrt{f(c_k/2)} \rightarrow 0$. As a consequence, by right-continuity of f , $f(c_k)/c_k = \theta_k(\theta_k c_k) = o(\theta_k)$. This proves the lemma. \square

Theorem 4.26. We follow the proof of lemma 4.15. The main difficulty of the proof is that we need to combine the two different kinds of linearizations: the standard one at the first order and the Pontryagin linearization at the second order. A second difficulty arises if ν has a non-bounded support: in this case, a truncation must be realized. In the proof, we consider this case: ν is non-bounded. Let $\nu \in S(SPL_\theta)$, $\xi \in F(PQ_\theta(\nu))$, and $(\theta_k)_k \downarrow 0$ be such that

$$\lim_{k \rightarrow \infty} \frac{V^\eta(\theta_k) - [V^\eta(0) + \theta_k \text{Val}(PL_\theta)]}{\theta_k^2} = \limsup_{\theta \downarrow 0} \frac{V^\eta(\theta) - [V^\eta(0) + \theta \text{Val}(PL_\theta)]}{\theta^2}.$$

Let $(\tilde{\mu}_k, \alpha_k)_k$ be a sequence in $\mathcal{M}_R^Y \times \mathbb{R}_+$ such that $\xi = \lim \alpha_k \xi_T[\tilde{\mu}^k]$. Extracting a subsequence of $(\theta_k)_k$ if necessary, we can suppose that

$$\theta_k \alpha_k = o(1) \quad \text{and} \quad \alpha_k \theta_k^2 \leq 1.$$

For all $c \geq 0$, we define ν^c and ω^c the unique Young measures which are such that for all $g \in C^0([0, T] \times \mathbb{R}^m)$,

$$\begin{cases} \int_0^T \int_{\mathbb{R}^m} g(t, u) d\nu^c dt = \int_0^T \int_{\mathbb{R}^m} \mathbf{1}_{|u-\bar{u}_t|>c} g(t, 0) + \mathbf{1}_{|u-\bar{u}_t|\leq c} g(t, u) d\nu_t^k dt, \\ \int_0^T \int_{\mathbb{R}^m} g(t, u) d\omega^c dt = \int_0^T \int_{\mathbb{R}^m} \mathbf{1}_{|u-\bar{u}_t|>c} g(t, u) + \mathbf{1}_{|u-\bar{u}_t|\leq c} g(t, 0) d\nu_t^k dt. \end{cases}$$

We set $f(c) = \|\omega^c\|_2^2$. It satisfies the assumptions of lemma 4.40. We obtain a sequence $(c_k)_k$ satisfying (4.76) and we set $\nu^k = \nu^{c_k}$ and $\omega^c = \omega^{c_k}$. Note that

$$f(c_k) = \|\omega^k\|_2^2 \geq c_k \|\omega^k\|_1,$$

therefore, by (4.40),

$$\|\omega^k\|_1 = o(\theta_k).$$

Now, in order to realize the first-order perturbation, we consider the measure $\mu^{1,k} = \bar{u} \oplus \theta_k \nu^k$. For almost all t , the support of $\mu_t^{1,k}$ is included into the ball of center \bar{u}_t and radius $c_k \theta_k$. Since $c_k \theta_k \rightarrow 0$, for k large enough $\mu^{1,k} \in \mathcal{M}_R^Y$ and since $\alpha_k \theta_k^2 \leq 1$, we can define

$$\mu^k = (1 - \alpha_k \theta_k^2) \mu^{1,k} + (\alpha_k \theta_k^2) \tilde{\mu}^k \in \mathcal{M}_R^Y.$$

We set $y^k = y[\mu^k, \theta_k]$. Let us show the expansion

$$\|y^k - (\bar{y} + \theta_k z^1[\nu] + \theta_k^2(z^2[\nu] + \xi))\|_\infty = o(\theta_k^2). \quad (4.77)$$

We know that $d_1(\bar{\mu}, \mu^k) = O(\theta_k)$. Moreover,

$$\theta z[\nu] - z[\mu^k \ominus \bar{u}] = \alpha_k \theta_k^3 z[\nu] - \alpha_k \theta_k^2 z[\tilde{\mu}^k] = o(\theta_k),$$

thus, using lemma 4.19, we obtain that

$$\|y^k - (\bar{y} + \theta_k z^1[\nu])\|_\infty = o(\theta_k).$$

Let us set $r^k = y^k - (\bar{y} + \theta_k z^1[\nu] + \theta_k^2(z^2[\nu] + \alpha_k \xi[\tilde{\mu}^k]))$. Then,

$$\begin{aligned} r_t^k &= (1 - \alpha_k \theta_k^2) \int_0^t \int_{\mathbb{R}^m} f(\bar{u}_s + \theta_k u, y_s^k, \theta_k) - f[s] \, d\nu_t^k(u) \, ds \\ &\quad - \int_0^t \int_{\mathbb{R}^m} (\theta_k f'[s](u, z_s^1[\nu], 1) + \frac{1}{2} \theta_k^2 f''[s](u, z_s^1[\nu], 1)^2) \, d\nu_t(u) \, ds \\ &\quad - \theta_k^2 \int_0^t f_y[s](z_s^2[\nu] + \alpha_k \xi[\tilde{\mu}^k]_s) \, ds \\ &\quad + \alpha_k \theta_k^2 \int_0^t \int_{U_R} f(u, y_s^k, \theta_k) - (f(u, \bar{y}_s, 0) - f[s]) - f[s] \, d\tilde{\mu}_s^k(u) \, ds \\ &= \int_0^t \int_{\mathbb{R}^m} \left(f'[s](\theta_k u, (y_s^k - \bar{y}_s), \theta_k) + \frac{1}{2} f''[s](\theta_k u, y_s^k - \bar{y}_s, \theta_k)^2 \right) \, d\nu_t^k(u) \, ds \\ &\quad - \int_0^t \int_{\mathbb{R}^m} \left(f'[s](\theta_k u, \theta_k z_s^1[\nu], \theta_k) + \frac{1}{2} f''[s](\theta_k u, \theta_k z_s^1[\nu], \theta_k)^2 \right) \, d\nu_t(u) \, ds \\ &\quad - \theta_k^2 \int_0^t f_y[s](z_s^2[\nu] + \alpha_k \xi[\tilde{\mu}^k]_s) \, ds \\ &\quad + \alpha_k \theta_k^2 \int_0^t \int_{U_R} (f(u, y_s^k, \theta_k) - f(u, \bar{y}_s, \theta_k)) \, d\tilde{\mu}_s^k(u) \, ds + o(\theta_k^2) \\ &= \int_0^t \int_{\mathbb{R}^m} (\theta_k f u[s] u + \frac{1}{2} \theta_k^2 f''[s](u, z_s^1[\nu], 1)^2) (d\nu_t^k(u) - d\nu_t(u)) \, dt \\ &\quad + \int_0^t f_y[s] r_s^k \, ds + o(\theta_k^2) \\ &= \int_0^t f_y[s] r_s^k \, ds + O(\theta_k \|\omega^k\|_1) + O(\theta_k^2 \|\omega^k\|_2^2) + o(\theta_k^2) \\ &= \int_0^t f_y[s] r_s^k \, ds + o(\theta_k^2). \end{aligned}$$

By Gronwall's lemma, $\|r^k\|_\infty = o(\theta_k^2)$ and since $\alpha_k \xi_T[\mu^k] \rightarrow \xi$, expansion (4.77) holds. As a consequence, the following second-order expansion holds:

$$\begin{aligned} \phi(y_T[\mu^k, \theta_k], \theta_k) &= \phi(\bar{y}_T, 0) + \theta_k \phi'(\bar{y}_T, 0)(z_T^1[\nu], 1) \\ &\quad + \theta_k^2 \left[\frac{1}{2} \phi''(\bar{y}_T, 0)(z_T^1[\nu], 1)^2 + \phi_{y_T}(\bar{y}_T, 0)(z_T^2[\nu] + \xi) \right] + o(\theta_k^2), \end{aligned} \quad (4.78)$$

and the same expansion holds for $\Phi(y_T[\mu^k, \theta_k], \theta_k)$. Therefore, $\text{dist}(\Phi(y_T^k), K) = o(\theta_k^2)$. By the metric regularity theorem (theorem 4.9) and by lemma 4.35, there exists a sequence $\hat{\mu}^k$ of feasible controls such that $d_1(\mu^k, \hat{\mu}^k) = o(\theta_k^2)$ and such that (4.78) holds for $\phi(y_T[\hat{\mu}^k, \theta_k], \theta_k)$. Minimizing with respect to ξ , we obtain that

$$\limsup_{\theta \downarrow 0} \frac{V^\eta(\theta) - [V^\eta(0) + \theta \text{Val}(PL_\theta)]}{\theta^2} \leq \text{Val}(PQ_\theta(\nu)).$$

Minimizing with respect to ν , we obtain the theorem. \square

Lemma 4.27. Expanding the difference of Lagrangians up to the second order, we obtain

$$\Delta \Phi^k = \Phi'[\lambda](\bar{y}_T, 0)(\delta y_T^k, \theta_k) + \frac{1}{2} \Phi''[\lambda](\delta y_T^k, \theta_k)^2 + o(\theta_k^2 + |\delta y_T^k|^2). \quad (4.79)$$

Then,

$$\begin{aligned} \Phi_{y_T}[\lambda](\bar{y}_T, 0) \delta y_T^k &= [p_t^\lambda \delta y_t^k]_0^T = \int_0^T (p_t^\lambda \dot{\delta y}_t^k + \dot{p}_t^\lambda \delta y_t^k) dt \\ &= \int_0^T \left(\int_{U_R} (H(u, y_t^k, \theta_k) - H[t]) d\mu_t^k(u) - H_y[t] \delta y_t^k \right) d\mu_t^k(u) dt. \end{aligned} \quad (4.80)$$

Expanding the difference of Hamiltonians, we obtain that

$$\begin{aligned} &\int_0^T \int_{U_R} (H(u, y_t^k, \theta_k) - H[t]) d\mu_t^k(u) dt \\ &= \int_0^T \int_{U_R} [H(u, y_t^k, \theta_k) - H(u, \bar{y}_t, 0)] + [H(u, \bar{y}_t, 0) - H[t]] d\mu_t^k(u) dt \\ &= \int_0^T \int_{U_R} H_{(y,\theta)}(u, \bar{y}_t, 0)(\delta y_t^k, \theta_k) + \frac{1}{2} H_{(y,\theta)^2}(u, \bar{y}_t, 0)(\delta y_t^k, \theta_k)^2 d\mu_t^k(u) dt \\ &\quad + \int_0^T \int_{U_R} (H(u, \bar{y}_t, 0) - H[t]) d\mu_t^k(u) dt + o(\theta_k^2 + R_{1,k}^2). \end{aligned} \quad (4.81)$$

Moreover,

$$\begin{aligned} &\int_0^T \int_{U_R} |H_{(y,\theta)^2}(u, \bar{y}_t, 0)(\delta y_t^k, \theta_k)^2 - H_{(y,\theta)^2}[t](\delta y_t^k, \theta_k)^2| d\mu_t^k(u) dt \\ &= O(R_{1,k}(R_{1,k}^2 + \theta_k^2)). \end{aligned} \quad (4.82)$$

and

$$R_{1,k}(R_{1,k}^2 + \theta_k^2) \leq R_{1,k}^3 + \frac{1}{2}(R_{1,k}^2 + \theta_k^2)\theta_k = o(R_{1,k}^2 + \theta_k^2). \quad (4.83)$$

Finally, remember that $\text{Val}(PL_\theta) = \int_0^T H_\theta[t] dt + \Phi_\theta[\lambda](\bar{y}_T, 0)$. Combining expansions (4.79-4.83), we obtain that

$$\begin{aligned} \Delta\Phi^k &= \text{Val}(PL_\theta)\theta_k + \int_0^T \int_{U_R} (H[p_t^\lambda](u, \bar{y}_t, 0) - H[p_t^\lambda][t]) d\mu_t(u) dt \\ &+ \int_0^T \int_{U_R} (H_y[p_t^\lambda](u, \bar{y}_t, 0) - H_y[p_t^\lambda][t]) \delta y_t^k d\mu_t^k(u) dt \end{aligned} \quad (4.84a)$$

$$+ \int_0^T \int_{U_R} (H_\theta[p_t^\lambda](u, \bar{y}_t, 0) - H_\theta[p_t^\lambda][t]) \theta_k d\mu_t^k(u) dt \quad (4.84b)$$

$$+ \frac{1}{2} \left[\int_0^T H_{(y,\theta)^2}[p_t^\lambda][t] (\delta y_t^k, \theta_k)^2 dt + \Phi''[\lambda](\delta y_T^k, \theta_k)^2 \right] + o(\theta_k^2 + R_{1,k}^2). \quad (4.84c)$$

We have already proved in lemma 4.19 the following estimate:

$$\|\delta y^k - (z^k + \theta_k \xi^\theta)\|_\infty = O(R_{1,k}^2 + \theta_k^2).$$

Therefore, we can replace δy^k by its standard expansion $z^{1,k}$ in terms (4.84a) and (4.84c). The errors that we make are respectively of order $R_{1,k}(R_{1,k}^2 + \theta_k^2)$ and $R_{1,k}^2(R_{1,k} + \theta_k)$. As we prove in estimate (4.83), the first term is of order $o(R_{1,k}^2 + \theta_k^2)$. The estimate (4.45) holds.

Expansion (4.46) follows from (4.84). We replace respectively terms (4.84a), (4.84b), and (4.84c) by the following estimates: $O(R_{1,k}\|\delta y^k\|_\infty)$, $O(R_{1,k}\theta_k)$, $O(\|\delta y^k\|_\infty^2 + \theta_k^2)$, and the estimate is obtained, since the sequence $(R_{1,k})_k$ is bounded. \square

Lemma 4.31. Let $\nu \in \mathcal{M}_2^Y$ and let $(\nu^k)_k$ be a bounded sequence in \mathcal{M}_2^Y narrowly converging to $\bar{\nu}$.

\triangleright *Narrow continuity of $\nu \mapsto z[\nu]$.*

We set, for almost all t ,

$$v_t^k = \int_{\mathbb{R}^m} u d\nu_t^k(u) \quad \text{and} \quad v_t = \int_{\mathbb{R}^m} u d\nu_t(u).$$

It is easy to check that $\bar{\nu}$ and $v^k \in L^2(0, T; \mathbb{R}^m)$. Moreover, $z[v^k] = z[\nu^k]$ and $z[v] = z[\nu]$. Let us check that v^k converges to $\bar{\nu}$ for the weak topology of L^2 . Let $h \in L^2(0, T; \mathbb{R}^m)$, then by definition of the narrow topology,

$$\int_0^T h_t v_t^k dt = \int_0^T \int_{\mathbb{R}^m} h_t d\nu_t^k(u) dt \rightarrow \int_0^T \int_{\mathbb{R}^m} h_t d\nu_t(u) dt = \int_0^T h_t v_t^k dt. \quad (4.85)$$

This proves the weak convergence of v^k . The mapping $v \in L^2(0, T; \mathbb{R}^m) \mapsto z[v] \in H^1(0, T; \mathbb{R}^n)$ being linear continuous, $z[v^k]$ converges for the weak topology of H^1 . Since $(z[v^k])_k$ is bounded in H^1 and by the compact embedding of this space in $C(0, T; \mathbb{R}^n)$, $z[v^k]$ converges uniformly to $z[v]$.

▷ *Narrow lower semi-continuity of $\Omega[\lambda]$ and $\Omega^\theta[\lambda]$.*

Let $\lambda \in \Lambda^P$. Let us decompose $\Omega^\theta[\lambda]$ into three terms, Q_0 , Q_1 , and Q_2 with

$$\begin{aligned} Q_0[\lambda](\nu) &= \int_0^T H_{y,\theta}[t](z[\nu], 1)^2 dt + \Phi''[\lambda](\bar{y}_T, 0)(z_T[\nu], 1)^2, \\ Q_1[\lambda](\nu) &= 2 \int_0^T \int_{\mathbb{R}^m} H_{u,\theta}[t](u, 1) + H_{u,y}[t](u, z[\nu]) d\nu_t(u) dt, \\ Q_2[\lambda](\nu) &= \int_0^T \int_{\mathbb{R}^m} H_{uu}[t](u)^2 d\nu_t(u) dt. \end{aligned}$$

Since $z[\nu^k]$ converges uniformly to $z[\nu]$ and since the sequence $(\nu^k)_k$ is bounded, we obtain by lemma 4.37 that $Q_0[\lambda](\nu^k)$ and $Q_1[\lambda](\nu^k)$ converge resp. to $Q_0[\lambda](\nu)$ and $Q_1[\lambda](\nu)$. Since $\lambda \in \Lambda^P$, the integrand $H_{uu}[t](u)^2$ of $Q_2[\lambda]$ is nonnegative, $Q_2[\lambda]$ is lower semi-continuous for the narrow topology. Finally, we obtain the lower semi-continuity of $\Omega^\theta[\lambda]$ and similarly, the one of $\Omega[\lambda]$.

▷ *Strong convergence to 0.*

Suppose now that $(\nu^k)_k$ converges narrowly to 0 and that $\Omega[\bar{\lambda}](\nu^k) \rightarrow 0$. Then, necessarily, $Q_2[\bar{\lambda}](\nu^k) \rightarrow 0$. From hypothesis 4.2.1, we obtain the inequality $2\alpha\|\nu\|_2^2 \leq Q_2[\bar{\lambda}](\nu)$ and the lemma is now proved. \square

Chapter 5

Sensitivity analysis for the outages of nuclear power plants

Contents

5.1	Introduction	138
5.2	Study of the reference problem	139
5.2.1	Notations, model and mathematical hypotheses	140
5.2.2	Study of the optimal controls	141
5.3	Sensitivity analysis	146
5.3.1	Theoretical material	146
5.3.2	Expression of the directional derivatives	149
5.3.3	Study of the Lagrange multipliers	155
5.4	Technical aspects	158
5.4.1	Existence of solutions	158
5.4.2	Qualification	159
5.4.3	On convergence of solutions to the perturbed problems	162
5.5	Conclusion	168

Abstract

Nuclear power plants must be regularly shut down in order to perform refueling and maintenance operations. The scheduling of the outages is the first problem to be solved in electricity production management. It is a hard combinatorial problem for which an exact solving is impossible.

Our approach consists in modelling the problem by a two-level problem. First, we fix a feasible schedule of the dates of the outages. Then, we solve a low-level problem of optimization of electricity production, by respecting the initial planning. In our model, the low-level problem is a deterministic convex optimal control problem.

Given the set of solutions and Lagrange multipliers of the low-level problem, we can perform a sensitivity analysis with respect to dates of the outages. The approximation of the value function which is obtained could be used for the optimization of the schedule with a local search algorithm.

Résumé

Les centrales nucléaires sont régulièrement arrêtées afin de réaliser des opérations de maintenance et de rechargement en combustible nucléaire. La planification de ces arrêts constitue le premier problème à résoudre en gestion de la production d'électricité. C'est un problème combinatoire difficile qui ne peut être résolu exactement.

Notre approche consiste à modéliser ce problème par un problème à deux niveaux. Tout d'abord, nous fixons un calendrier admissible des dates des arrêts des centrales. Puis, nous résolvons un sous-problème de production d'électricité, en respectant le calendrier initial. Dans notre modèle, ce sous-problème est un problème de contrôle optimal déterministe et convexe.

Etant donnés les solutions et multiplicateurs de Lagrange du sous-problème, nous pouvons réaliser une analyse de sensibilité par rapport aux dates des arrêts. Nous obtenons une approximation de la fonction valeur qui devrait permettre de mettre en place un algorithme de recherche locale pour l'optimisation de ces dates d'arrêts.

5.1 Introduction

Energy generation in France is a competitive market, whereas transportation and distribution are monopolies. Electric utilities generate electricity from hydro reservoirs, fossil energy (coal, gas), atom (nuclear fission process) and to a small extent from wind farms, solar energy or run of river plant without pondage. This energy mix provides enough power and flexibility to match energy demand in any circumstances. Hydro power stations are managed in order to remove peaks on the load curve during peak-hours, whereas thermal power stations supply base load energy. Due to their capacity generation and their production cost as well, the base load part is mainly supported by nuclear power stations.

Nuclear facilities are subject to various constraints, and this induces a variation of the availability of nuclear energy. Some events may occur randomly during the operating

period and cause forced outages. This is why outages must be planned by the producer in order to perform maintenance and refuelling operations of the fleet of nuclear power stations and in order to avoid a dramatical decrease of the nuclear availability. Thermal power stations, using expensive resources such as coal or gas, enable to compensate a lack of nuclear energy. These supplementary costs, due to the nuclear unavailability must be minimized when a schedule of the outages is planned.

Each power station has its scheduling variables, which are submitted to local and coupling constraints as well. There are different constraints in the scheduling of outages of power plants: on the minimum spacing, on the maximum overlapping between outages, and on the number of outages in parallel. For operating purposes, the decision to stop a power station for maintenance has to be forecast far ahead. As a consequence, scheduling decisions are modelled as “open-loop” decisions, which means that they do not depend on the consumption scenario.

Given the planning of outages, the low-level problem of electricity production can be described by a discrete time dynamic and stochastic optimization problem. The overall optimization problem is a large scale, mixed integer stochastic problem. We refer to [34, 49, 48, 59] for precise descriptions of this problem. At Electricité de France, the numerical resolution of this problem uses local search algorithms in order to improve the current planned program. Numerous slight modifications are performed around the current program and the most profitable determines the next program. The computational burden to solve this problem is heavy, reducing it is a challenging task.

In this paper, we perform a sensitivity analysis of the electricity production problem when the integer parameters defining the scheduling of the outages are set. We provide a first-order expansion of the value of this low-problem, with respect to the dates of the outages. For the sake of simplicity, the low-level problem is a convex deterministic optimal control problem with continuous time. We do not consider the combinatorial side of the problem.

In the first section, we discuss the structure of solutions to the low-level problem, which are not unique in general. In the second section, we realize the sensitivity analysis by using a well suited time reparameterization. We obtain a formula for the directional derivatives of the value function using the opposite of the jumps of the true Hamiltonian at the times of beginning or end of the outages. It is based on the set of Lagrange multipliers, which we describe precisely. The result is an application of a theorem of [21]. The technical aspects related to the theorem such as the proof of qualification or the proof of convergence of the solutions to the perturbed problems are postponed in the third section.

5.2 Study of the reference problem

In this first part, we study the low-level problem of production management and therefore consider that the dates of the outages are fixed. In our model, we only consider one outage for each plant. Applying Pontryagin’s principle, we study the particular structure of the optimal controls, which are not unique in general.

5.2.1 Notations, model and mathematical hypotheses

The main notations for the problem are the following:

$[0, T]$	the time period	
$c(x)$	the cost of production of an amount x with thermal power stations	
$d(t)$	the demand of electricity at time t	
$d(t)$	the demand of electricity at time t	
\mathbb{S}	the set of nuclear power plants	
n	the number of nuclear power plants	
$s^i(t)$	the amount of available fuel of plant i at time t	
s_0^i	the initial level of plant i	
$u^i(t)$	the rate of production of plant i at time t	
\bar{u}^i	the maximum rate of production of plant i at time t	
\mathcal{U}	the set of controls defined by $\{u \in \mathbb{R}^n, \text{ such that } u^i \in [0, \bar{u}^i], \forall i \in \mathbb{S}\}$	(5.1)
τ_b^i	the date of the beginning of the outage of plant i	
τ_e^i	the date of the end of the outage of plant i	
\mathcal{T}	the set of dates defined by $\cup_{i \in \mathbb{S}} \{\tau_b^i, \tau_e^i\}$.	
$W(t)$	the set of working plants at time t , defined by $W(t) = \{i \in \mathbb{S}, t \notin [\tau_b^i, \tau_e^i]\}$	
$a^i(t)$	the rate of refuelling of plant i at time t , with $a^i(t) \geq 0$	
$\phi(s(T))$	a decreasing convex function of the final state	
$V(\tau_b, \tau_e)$	the value of the problem in function of τ_b and τ_e .	

The optimal control problem ($\mathcal{P}(\tau_b, \tau_e)$) is

$$\begin{array}{l}
 V(\tau_b, \tau_e) = \min_{u, s} \int_0^T c\left(d(t) - \sum_{i \in W(t)} u^i(t)\right) dt + \phi(s(T)), \\
 \text{s.t. } \forall i \in \mathbb{S}, \quad \begin{array}{l}
 \dot{s}^i(t) = -u^i(t) + a^i(t)\mathbf{1}_{[\tau_b^i, \tau_e^i]}(t), \quad \text{for a. a. } t, \\
 0 \leq u^i(t) \leq \bar{u}^i, \quad \text{for a. a. } t, \\
 s^i(0) = s_0^i, \\
 s^i(\tau_b^i) = 0, \\
 s^i(T) \geq 0,
 \end{array}
 \end{array}
 \quad (\mathcal{P}(\tau_b, \tau_e))$$

where $u \in L^\infty(0, T; \mathbb{R}^n)$ and $s \in W^{1, \infty}(0, T; \mathbb{R}^n)$.

The dynamic of the stocks of fuel is clear from the differential equation: the stock s^i decreases at rate $u^i(t)$ during the time period and increases at rate $a^i(t)$ during the time of outage. The argument of the cost function c is the amount of energy which is not produced with nuclear power plants in order to satisfy the demand. This energy is

produced with other types of power stations, which are more expensive. In our model, we also allow the total production to be greater than the demand.

Note that for optimal solutions, we will obtain that for all i in \mathbb{S} , for almost all t in $[\tau_b^i, \tau_e^i]$, the control $u^i(t)$ is equal to 0, see lemma 5.2.

Mathematical hypotheses For our study, we suppose that the following hypotheses are satisfied:

- ▷ the cost functions $c(x)$ and $\phi(s)$, the demand $d(t)$ and the rate of refuelling $a(t)$ are continuously differentiable functions,
- ▷ the cost function $c(x)$ is strongly convex with parameter α on \mathbb{R} ,
- ▷ the final cost function $\phi(s)$ is strictly convex on \mathbb{R}_+^n and for all s in \mathbb{R}_+^n , for all i in \mathbb{S} ,

$$D_{s^i} \phi(s) < 0.$$

Feasibility of the problem The problem has a feasible control with a feasible trajectory associated if and only if, for all i in \mathbb{S} ,

$$\tau_b^i \cdot \bar{u}^i \geq s_0^i.$$

Moreover, we can prove the existence of an optimal solution in this case. It follows from the boundedness of the controls and the convexity of the cost functions, see lemma 5.18. In the sequel, we will assume that the following qualification condition is satisfied: for all i in \mathbb{S} ,

$$\tau_b^i > 0, \quad \bar{u}^i > 0, \quad \tau_b^i \cdot \bar{u}^i > s_0^i, \quad \text{and} \quad \int_{\tau_b^i}^{\tau_e^i} a^i(t) dt > 0. \quad (\text{QC})$$

Note that this last integral is equal to $s^i(\tau_e^i)$. This hypothesis will enable us to prove an abstract qualification condition, needed to apply Pontryagin's principle and to realize the sensitivity analysis (see lemma 5.19).

5.2.2 Study of the optimal controls

This subsection is dedicated to the study of an optimal control $u(t)$, which minimizes the Hamiltonian for almost all t . For our problem, the Hamiltonian has the particularity to be independent on the state s .

Let us denote by p the costate associated with s . Given a subset W of \mathbb{S} , we define the Hamiltonian of the system by

$$H_W(t, u, p) = c\left(d(t) - \sum_{i \in W} u^i\right) + \sum_{i \in \mathbb{S}} p^i \left(-u^i + a^i(t) \mathbf{1}_{i \notin W}\right) \quad (5.2)$$

for t in $[0, T]$, u in \mathcal{U} and p in \mathbb{R}^n . The notation \mathcal{U} has been introduced in (5.1). This subscript W will be particularly useful later, since we will consider the Hamiltonian at times τ_b^i and τ_e^i at which there are two sets of working plants of interest (one includes the

plant beginning or ending its outage, the other does not). Notice that the Hamiltonian does not depend on the state s .

Proposition 5.1 (Pontryagin's principle). *If hypothesis (QC) holds, then for all optimal solution (u, s) , there exists a costate $t \mapsto p(t) \in \mathbb{R}^n$ such that for all i in \mathbb{S} ,*

▷ $p^i(t)$ is a step function, taking two values $p^i(0)$ and $p^i(T)$ on the intervals $[0, \tau_b^i)$ and $(\tau_b^i, T]$ respectively

▷ $p^i(T) \leq D_{s^i} \phi(s(T))$ and $p^i(T) = D_{s^i} \phi(s(T))$ if $s^i(T) > 0$

and such that for almost all t in $[0, T]$, the control minimizes the Hamiltonian:

$$H_{W(t)}(t, u(t), p(t)) = \min_{v \in \mathcal{U}} H_{W(t)}(t, v, p(t)). \quad (5.3)$$

Proof. In lemma 5.19, we prove that hypothesis (QC) implies Robinson's qualification condition (RQC). This condition enables us to apply Pontryagin's principle for systems with a final-state constraint, see [46, section 2.4.1, theorem 1] for a proof. For our problem, each state variable s^i can be decomposed into two state variables, one describing the dynamic of the stock before its outage, one describing its dynamic after. This is why we can view the constraint $s(\tau_b^i) = 0$ as a final-state constraint. The costate p is a step function because nor the dynamic, neither the cost function depend on the state. The discontinuity of the coordinate p^i at time τ_b^i is due to the state constraint $s(\tau_b^i) = 0$. \square

In the sequel, we will consider that a costate is an element of \mathbb{R}^{2n} which is characterized by its values $p(0)$ and $p(T)$ at times 0 and T . For all $p = (p_0, p_T)$ in \mathbb{R}^{2n} , we associate the costate function defined by

$$p^i(t) = \begin{cases} p^i(0) & \text{if } t \in [0, \tau_b^i), \\ p^i(T) & \text{if } t \in (\tau_b^i, T], \end{cases} \quad \forall i \in \mathbb{S}.$$

We assign no value to p^i at time τ_b^i . However, we will use the following notation in the sequel: if plant i is the only plant to start an outage at time $t = \tau_b^i$, $p(t^-)$ and $p(t^+)$ are such that for all $j \neq i$,

$$p^j(t^-) = p^j(t^+) = p^j(t) \quad (5.4)$$

and such that

$$p^i(t^-) = p^i(0), \quad \text{and} \quad p^i(t^+) = p^i(T). \quad (5.5)$$

Now, let us study the problem of minimization of the Hamiltonian introduced in (5.3). Let $t \in [0, T] \setminus \mathcal{T}$ (that is to say, t is different from all the dates of beginning or end of outage). Let u be an optimal solution and let $p \in \mathbb{R}^{2n}$ be an associated costate. Since $t \notin \mathcal{T}$, $p(t)$ and $W(t)$ are uniquely defined. Note that if $i \notin W(t)$, then necessarily $t > \tau_b^i$ and thus

$$p^i(t) = p^i(T) \leq D_{s^i} \phi(s(T)) < 0. \quad (5.6)$$

Consider the problem

$$\min_{v \in \mathcal{U}} c \left(d(t) - \sum_{i \in W(t)} v^i \right) + \sum_{i \in \mathbb{S}} p^i(t) \left(-v^i + a^i(t) \mathbf{1}_{[\tau_b^i, \tau_e^i]}(t) \right). \quad (P_t)$$

As we can see, the term $\sum_{i \in \mathbb{S}} p^i(t) a^i(t) \mathbf{1}_{[\tau_i^i, \tau_i^e]}(t)$ does not play any role here. Moreover, we can decompose the problem by introducing an additional variable μ for the total production, the sum $\sum_{i \in W(t)} v^i$. Let us set

$$U_{W(t)} = \sum_{i \in W(t)} \bar{u}^i$$

and let us define, for μ in $[0, U_{W(t)}]$,

$$\xi_t(\mu) = \min_{\substack{v \in \mathcal{U}, \\ \sum_{i \in W(t)} v^i = \mu, \\ v^i = 0, \forall i \notin W(t)}} \sum_{i \in W(t)} -p^i(t) v^i. \quad (5.7)$$

Now, we can focus on the following one-dimensional problem:

$$\min_{0 \leq \mu \leq U_{W(t)}} c(d(t) - \mu) + \xi_t(\mu). \quad (P'_t)$$

The following lemma justifies problem P'_t .

Lemma 5.2. *If u is a solution to problem P_t , then $\sum_{i \in \mathbb{S}} u^i$ is a solution to problem P'_t and $u^i = 0$ for all $i \notin W(t)$. Conversely, if μ is a solution to P'_t , then there exists a solution u to problem P'_t which is such that $\sum_{i \in \mathbb{S}} u^i = \mu$.*

Proof. Let $u \in \mathcal{U}$ be a solution to problem P_t . By (5.6), for all $i \notin W(t)$, $-p^i(t) > 0$ and thus $u^i = 0$. It is then clear that $\mu = \sum_{i \in \mathbb{S}} u^i = \sum_{i \in W(t)} u^i$ is a solution to P'_t . Conversely, let μ be a solution to P'_t . Since $\mu \leq U_{W(t)}$, the optimization problem (5.7) is feasible and has a solution in \mathcal{U} , say u , since \mathcal{U} is compact. Then, $\sum_{i \in \mathbb{S}} u^i = \mu$ and it is easy to check that u is a solution to P'_t . \square

Problem P'_t has an economic interpretation. Producing at time t at a rate u has a consequence on the dynamic of the state after time t . This is represented by the function $\xi_t(\mu)$. In some sense, the real numbers $-p^1(t), \dots, -p^n(t)$ are the marginal prices associated with the production at time t . Problem P'_t takes into account both the cost function $c(d(t) - \mu)$ and the cost of production $\xi_t(\mu)$.

Notations In the next three lemmas, we focus on problem P'_t . We always assume that t is a given time in $[0, T] \setminus \mathcal{T}$, u an optimal solution and p an associated costate. Let us denote by K the cardinal of $\{p^i(t), i \in W(t)\}$. In the sequel, keep in mind that it may be possible that $p^i(t) = p^j(t)$ for some i and j in $W(t)$. In this case, the corresponding value $p^i(t) = p^j(t)$ is counted only once and then $K < |W(t)|$. We consider the mapping σ from $\{1, \dots, K\}$ to $\mathcal{P}(W(t))$ (the power set of $W(t)$) uniquely defined by:

$$(i) \forall k \in \{1, \dots, K\}, \forall i \in \sigma(k), \forall j \in W(t), (p^j(t) = p^i(t)) \Leftrightarrow (j \in \sigma(k)). \quad (5.8)$$

This common value will be denoted by $p_k(t)$.

$$(ii) \forall k, l \in \{1, \dots, K\}, k < l \Rightarrow p_k(t) > p_l(t). \quad (5.9)$$

This mapping is nothing but a decreasing ordering of the coordinates of $p(t)$ involved in the definition of ξ_t . We also set, for k in $\{1, \dots, K\}$,

$$U_k = \sum_{l=1}^k \sum_{i \in \sigma(l)} \bar{u}^i \quad (5.10)$$

and $U_0 = 0$. Note that $U_K = U_{W(t)}$. In the sequel, indexes i and j will be elements of \mathbb{S} and will appear at the top, whereas indexes k and l will be elements of $\{1, \dots, K\}$ and will appear at the bottom.

The function $\mu \mapsto \xi_t(\mu)$ is piecewise affine and convex. We make its value explicit on $[0, U_K]$:

$$\begin{cases} \xi_t(\mu) = -p_1(t)\mu, & \forall \mu \in [0, U_1], \\ \xi_t(\mu) = -p_2(t)(\mu - U_1) + \xi_t(U_1), & \forall \mu \in [U_1, U_2], \\ \dots \\ \xi_t(\mu) = -p_K(t)(\mu - U_{K-1}) + \xi_t(U_{K-1}), & \forall \mu \in [U_{K-1}, U_K]. \end{cases} \quad (5.11)$$

The following lemma shows that there is an ordering in the use of the fuel: we begin by using the power of the plants of greatest costate.

Lemma 5.3. *Let i and j in $W(t)$ be such that $-p^i(t) < -p^j(t)$, if v is a solution to P_t , then*

$$(v^j > 0) \Rightarrow (v^i = \bar{u}^i),$$

or, equivalently,

$$(v^i < \bar{u}^i) \Rightarrow (v^j = 0).$$

Proof. This is a direct consequence of lemma 5.2 and the expression of $\xi_t(\mu)$ given by (5.11). \square

The interpretation of the lemma is the following: if $-p^i(t) < -p^j(t)$, then plant i is cheaper than plant j at time t and should be used first. The next lemma gives the necessary optimality conditions of problem P'_t .

Lemma 5.4. *Problem P'_t has a unique solution on $[0, U_K]$, say μ . The following four cases hold true.*

1. *If there exists k in $\{1, \dots, K\}$ such that $\mu \in]U_{k-1}, U_k[$, then*

$$c'(d(t) - \mu) = -p_k(t). \quad (5.12)$$

2. *If there exists k in $\{0, \dots, K\}$ such that $\mu = U_k$, then*

(a) *if $k \in \{1, \dots, K-1\}$,*

$$-p_k(t) \leq c'(d(t) - U_k) \leq -p_{k+1}(t). \quad (5.13)$$

$$(b) \text{ if } k = 0, \quad c'(d(t) - 0) \leq -p_1(t). \quad (5.14)$$

$$(c) \text{ and if } k = K, \quad -p_K(t) \leq c'(d(t) - U_K). \quad (5.15)$$

Proof. The function $\mu \mapsto c(d(t) - \mu) + \xi_t(\mu)$ is continuous and defined on a compact interval, whence the existence of the solution. Furthermore, this function is strictly convex, since c is so. The uniqueness of the solution follows. For the optimality conditions, we use the assumption of differentiability of c and the explicit formula of $\xi_t(\mu)$ given by (5.11). \square

The goal of the next lemma is to give a characterization of the solutions to problem P'_t in function of $d(t)$. We denote by k^{\min} and k^{\max} the smallest indices such that

$$\lim_{x \rightarrow -\infty} c'(x) < -p_{k^{\min}} \quad \text{and} \quad -p_{k^{\max}} < \lim_{x \rightarrow +\infty} c'(x) \quad \text{respectively.}$$

For all k in $\{k^{\min}, \dots, k^{\max}\}$, we set

$$\begin{cases} d_k^- = c'^{-1}(-p_k(t)) + U_{k-1}, \\ d_k^+ = c'^{-1}(-p_k(t)) + U_k. \end{cases} \quad (5.16)$$

We also set

$$d_{k^{\min}-1}^+ = -\infty \quad \text{and} \quad d_{k^{\max}+1}^- = +\infty.$$

We have

$$d_{k^{\min}-1}^+ < d_{k^{\min}}^- < d_{k^{\min}}^+ < d_{k^{\min}+1}^- < \dots < d_{k^{\max}}^- < d_{k^{\max}}^+ < d_{k^{\max}+1}^-.$$

Now, we can express the optimal solution μ in function of $d(t)$.

Lemma 5.5. *The following two cases hold true.*

1. *If for some k in $\{k^{\min}, \dots, k^{\max}\}$, $d_k^- \leq d(t) \leq d_k^+$, then*

$$\begin{aligned} \mu &= d(t) - c'^{-1}(-p_k(t)), \\ u^i &= \bar{u}^i, \quad \forall i \in \sigma(l), \quad l < k, \\ \sum_{i \in \sigma(k)} u^i &= d(t) - c'^{-1}(-p_k(t)) - U_{k-1}, \\ u^i &= 0, \quad \forall i \in \sigma(l), \quad l > k. \end{aligned}$$

2. *If for some k in $\{k^{\min} - 1, \dots, k^{\max}\}$, $d_k^+ \leq d(t) \leq d_{k+1}^-$, then*

$$\begin{aligned} \mu &= U_k, \\ u^i &= 0, \quad \forall i \in \sigma(l), \quad l > k, \\ u^i &= \bar{u}^i, \quad \forall i \in \sigma(l), \quad l \leq k. \end{aligned}$$

Proof. Since the problem is convex, it suffices to check the necessary optimality conditions detailed in lemma 5.4. For the first case, the condition satisfied is (5.12). In the second case, if $k = 0$, the satisfied condition is (5.14), if $k = K$, the satisfied condition is (5.15), otherwise, the satisfied condition is (5.13). \square

Remark 5.6. *In lemma 5.5, we see that the coefficients $d_k^-/+$ play an important role, since they enable us to compute the optimal solutions to problem P_t . Keep in mind that these coefficients depend on $p(t)$. As a consequence, they have to be viewed as step functions of time.*

We state now a uniqueness property of the optimal controls.

Lemma 5.7. *Let (u_1, s_1) and (u_2, s_2) be two optimal solutions. Then, for almost all t in $[0, T]$, $\sum_{i \in \mathcal{S}} u_1^i(t) = \sum_{i \in \mathcal{S}} u_2^i(t)$ and $s_1(T) = s_2(T)$.*

Proof. It is well-known that for a convex optimization problem, if the cost function is strictly convex with respect to one of the optimization variables, then the value of this variable is unique at the optimum. For our problem, since c and ϕ are strictly convex, we have that $\sum_{i \in W(t)} u_1^i(t) = \sum_{i \in W(t)} u_2^i(t)$ for almost all t in $[0, T]$ and $s_1(T) = s_2(T)$. Since $u_1(t) = u_2(t) = 0$ for almost all t in $[\tau_b^i, \tau_e^i]$, we finally obtain that $\sum_{i \in \mathcal{S}} u_1^i(t) = \sum_{i \in \mathcal{S}} u_2^i(t)$ for almost all t . \square

Remark 5.8. *While the sum of the controls is unique, there may be several different optimal controls. This happens when there are at least two plants i and j for which $p^i(t) = p^j(t)$ on a subinterval of $[0, T]$. If the demand satisfies strictly the inequalities of the first case of lemma 5.5, then the problem of minimization of the Hamiltonian, P_t , has several optimal solutions and the general problem has equally, in general, several solutions.*

5.3 Sensitivity analysis

5.3.1 Theoretical material

In this subsection, we state an abstract general theorem for the sensitivity analysis of a convex problem. Consider the general parameterized problem

$$V(y) = \min_{x \in X} f(x, y), \text{ subject to } G(x, y) \in K, \quad (P_y)$$

in which y stands for the perturbation parameter and belongs to a space Y . The functions f and G are supposed to be continuously differentiable with respect to x and y . K is a closed convex subset of a space Z . The spaces X , Y and Z are Banach spaces. We fix a reference value y_0 for y . Let x be a feasible point of the reference problem with $y = y_0$. We say that Robinson's qualification condition holds at x if there exists $\varepsilon > 0$ such that

$$\varepsilon B_Z \subset G(x, y_0) + D_x G(x, y_0)X - K, \quad (\text{RQC})$$

where B_Z is the unit ball of Z . For λ in Z^* , we define the Lagrangian by

$$L(x, \lambda, y) = f(x, y) + \langle \lambda, G(x, y) \rangle.$$

In a general framework, for a solution x_0 to the optimization problem with $y = y_0$, the set of Lagrange multipliers $\Lambda(x_0, y_0)$ is defined by

$$\Lambda(x_0, y_0) = \{\lambda \in Z^*, D_x L(x_0, \lambda, y_0) = 0, \lambda \in N_K(G(x_0, u_0))\}, \quad (5.17)$$

where $N_K(G(x_0, u_0))$ is the normal cone of K at $G(x_0, u_0)$, defined by

$$N_K(G(x_0, u_0)) = \{\lambda \in Z^*, \langle \lambda, z - G(x_0, u_0) \rangle \leq 0, \forall z \in K\}. \quad (5.18)$$

We suppose now that the reference problem P_{y_0} is convex, following [21, definition 2.163]. Problems, like our application problem, with a convex cost function, linear equality constraints, and finite convex inequality constraints are convex. For a convex problem, the set of Lagrange multipliers is the set of solutions of a dual problem which does not depend on the choice of the (primal) solution x_0 . Therefore, $\Lambda(x_0, y_0)$ does not depend on x_0 and we simply write $\Lambda(y_0)$.

The following theorem establishes a differentiability property of the value function of the problem $V(y)$. See [21, definition 2.45] for a definition of the Hadamard differentiability.

Theorem 5.9. *Consider a reference value y_0 . Suppose that:*

1. *Problem P_{y_0} is convex and has a non-empty set of optimal solutions $S(y_0)$.*
2. *Robinson's qualification condition holds at all x_0 in $S(y_0)$.*
3. *For any sequence $(y_k)_k$ converging to y_0 , for all k , problem P_{y_k} possesses an optimal solution x_k such that, for all λ in $\Lambda(y_0)$, for all sequence $(y'_k)_k$ satisfying $y'_k \in [y_0, y_k]$, one has:*

$$D_y L(x_0, \lambda, y_0) \text{ is a limit point of } D_y L(x_k, \lambda, y'_k).$$

Then the optimal value function V is Hadamard directionally differentiable at y_0 in any direction w and

$$V'(y_0, w) = \inf_{x \in S(y_0)} \sup_{\lambda \in \Lambda(y_0)} D_y L(x, \lambda, y_0)w. \quad (5.19)$$

This theorem is a direct extension of [21, theorem 4.24], which was originally proved in [39]. In the original formulation of the theorem, the third assumption is replaced by the following assumption: for any sequence $(y_k)_k$ converging to y_0 , for all k , problem P_{y_k} possesses an optimal solution x_k such that the sequence $(x_k)_k$ has a limit point in $S(y_0)$. However, this assumption would be rather painful to check for our problem, this is why we prefer weakening it with this new assumption. Note also that the assumption of convexity of the problem is essential for the sensitivity analysis. In a non-convex setting, we would have to assume in addition that a certain sufficient second-order condition holds (see [21, theorems 4.25 and 4.65], for example).

theorem 5.9. Let us adapt the proof given in [21]. Note first that since Robinson's qualification condition holds and since there exist optimal solutions, the set $\Lambda(y_0)$ of Lagrange multipliers is nonempty and thus, the expression of the directional derivative (5.19) is finite. It is proved in [21, proposition 4.22] that under the directional regularity condition, for any mapping $\alpha \in \mathbb{R}_+ \mapsto y(\alpha) \in Y$ defined on a neighborhood of 0 such that $y(\alpha) = y_0 + \alpha w + o(\alpha)$ the following holds:

$$\limsup_{\alpha \downarrow 0} \frac{V(y(\alpha)) - V(y_0)}{\alpha} \leq \inf_{x \in S(y_0)} \sup_{\lambda \in \Lambda(y_0)} D_y L(x, \lambda, y_0)w. \quad (5.20)$$

The directional regularity condition is implied by Robinson's qualification condition, see [21, theorem 4.9].

Let $\alpha_n \downarrow 0$, let $y_n = y_0 + \alpha_n w + o(\alpha_n)$ and let $(x_n)_n$ be the sequence of solutions such that hypothesis (3) of the theorem is satisfied. Extracting a subsequence if necessary, we can suppose that $(x_n)_n$ converges to x_0 in $S(y_0)$. Let λ be in $\Lambda(y_0)$. Since $\Lambda(y_0) \subset N_K(G(x_0, y_0))$, and then

$$\langle \lambda, G(x_n, y_n) - G(x_0, y_0) \rangle \leq 0,$$

we have

$$f(x_n, y_n) - f(x_0, y_0) \geq L(x_n, \lambda, y_n) - L(x_0, \lambda, y_0).$$

By convexity of P_{y_0} , the first order optimality conditions imply that x_0 belongs to $\arg \min_{x \in X} L(x, \lambda, y_0)$, and then

$$L(x_n, \lambda, y_0) \geq L(x_0, \lambda, y_0). \quad (5.21)$$

Since $V(y_n) = f(x_n, y_n)$ and by the mean value theorem and continuity of $L(x, \lambda, y)$, we obtain from (5.21) that, for some y'_n in $[y_0, y_n]$,

$$\begin{aligned} V(y_n) - V(y_0) &\geq L(x_n, \lambda, y_n) - L(x_n, \lambda, y_0) \\ &= \alpha_n D_y L(x_n, \lambda, y'_n)w \\ &= \alpha_n D_y L(x_0, \lambda, y_0)w + o(\alpha_n), \end{aligned}$$

since by assumption,

$$D_y L(x_n, \lambda, y'_n) \rightarrow D_y L(x_0, \lambda, y_0).$$

As a consequence, since λ was arbitrary,

$$\begin{aligned} \liminf_{n \rightarrow \infty} \frac{V(y_n) - V(y_0)}{\alpha_n} &\geq \sup_{\lambda \in \Lambda(y_0)} D_y L(x_0, \lambda, y_0)w \\ &\geq \inf_{x \in S(y_0)} \sup_{\lambda \in \Lambda(y_0)} D_y L(x, \lambda, y_0)w. \end{aligned} \quad (5.22)$$

Combining (5.20) and (5.22), we obtain that for any $y(\alpha) = y_0 + \alpha w + o(\alpha)$,

$$\lim_{\alpha \downarrow 0} \frac{V(y(\alpha)) - V(y_0)}{\alpha} = \inf_{x \in S(y_0)} \sup_{\lambda \in \Lambda(y_0)} D_y L(x, \lambda, y_0) w,$$

as was to be proved. \square

5.3.2 Expression of the directional derivatives

In this subsection, we give a sensitivity formula for problem $(\mathcal{P}(\tau_b, \tau_e))$. We show that the value function is Hadamard directionally differentiable if all the dates of the outages are different. When differentiating the value function with respect to one variable, the result obtained is the jump of the reduced Hamiltonian at the reference time of the variable.

Time reparameterization Theorem 5.9 cannot be applied directly to our application problem. Indeed, in its formulation, the cost function and the dynamic are not continuously differentiable with respect to τ_b and τ_e . For example, if we try to differentiate the cost function with respect to the variable τ_e^j , we obtain the following derivative,

$$c\left(\tau_e^j, d(\tau_e^j) - \sum_{i \in W} u^i(\tau_e^j)\right) - c\left(\tau_e^j, d(\tau_e^j) - \sum_{i \in W \cup \{j\}} u^i(\tau_e^j)\right),$$

where W is the set of working plants at time τ_e^j (j being excluded of W). This expression does not make sense, since the control is only in $L^\infty(0, T; \mathbb{R}^n)$, thus, we cannot define its value at time τ_e^j .

However, if we perform a well suited change of variable in time, we can apply the abstract result. The change of variable that we use can be realized if and only if the following hypothesis holds:

$$\text{For all } i \text{ and } j \text{ in } \mathbb{S} \text{ such that } i \neq j, \tau_b^i \neq \tau_b^j, \tau_e^i \neq \tau_e^j \text{ and } \tau_b^i \neq \tau_e^j. \quad (\text{H})$$

We begin by computing $D_{\tau_e^j} V(\tau_b, \tau_e)$. We consider a nuclear power plant j and we denote by τ_0 the reference value of τ_e^j and by (u, s) a solution with a costate p , for the reference problem with $\tau_e^j = \tau_0$. As a consequence of (H), we get :

None of the plants, except j , begins or ends its outage at time τ_0 .

Let us consider two times t_1 and t_2 such that $t_1 < \tau_0 < t_2$ and such that they are sufficiently close to τ_0 so that none of the plants (except j) begins or ends an outage during $[t_1, t_2]$. The idea of the change of variable is to fix the time of the discontinuity due to the end of the outage. We set, for all t' in $[0, T]$,

$$\theta_{\tau_e^j}(t') = \begin{cases} t_1 + \frac{\tau_e^j - t_1}{\tau_0 - t_1}(t' - t_1), & \text{if } t' \in [t_1, \tau_0] \\ t_2 - \frac{t_2 - \tau_e^j}{t_2 - \tau_0}(t_2 - t'), & \text{if } t' \in [\tau_0, t_2] \\ t', & \text{otherwise.} \end{cases} \quad (5.23)$$

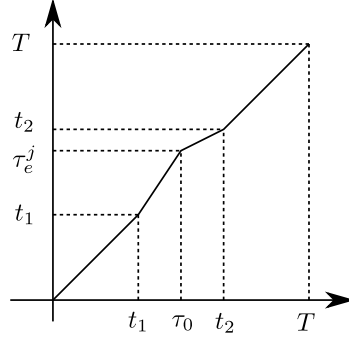

Figure 5.1: Change of variable associated with the perturbation of τ_e^j .

We perform the change of variable $t = \theta_{\tau_e^j}(t')$. See figure 5.1 for an illustration of the change of variable. It is well defined for τ_e^j in (t_1, t_2) . We denote by W the set of working plants on the interval $[t_1, t_2]$. By convention, j does not belong to W . The new optimal control problem $(\mathcal{P}'(\tau_e^j))$ to be solved is

$$\begin{aligned}
 V(\tau_e^j) &= \min_{u,s} \left[\int_0^{t_1} c(d(t') - \sum_{i \in W(t')} u^i(t')) dt' \right. \\
 &\quad + \frac{\tau_e^j - t_1}{\tau_0 - t_1} \int_{t_1}^{\tau_0} c(d \circ \theta_{\tau_e^j}(t') - \sum_{i \in W} u^i(t')) dt' \\
 &\quad + \frac{t_2 - \tau_e^j}{t_2 - \tau_0} \int_{\tau_0}^{t_2} c(d \circ \theta_{\tau_e^j}(t') - \sum_{i \in W \cup \{j\}} u^i(t')) dt' \\
 &\quad \left. + \int_{t_2}^T c(d(t') - \sum_{i \in W(t')} u^i(t')) dt' + \phi(s(T)) \right], \\
 \text{s.t. } \forall i \in \mathbb{S}, \quad &s^i(t') = \dots \\
 &\begin{cases} \frac{\tau_e^j - t_1}{\tau_0 - t_1} [-u^i(t') + a^i \circ \theta_{\tau_e^j}(t') \mathbf{1}_{i \notin W}], & \text{if } t' \in [t_1, \tau_0], \\ \frac{t_2 - \tau_e^j}{t_2 - \tau_0} [-u^i(t') + a^i \circ \theta_{\tau_e^j}(t') \mathbf{1}_{i \notin W \cup \{j\}}], & \text{if } t' \in [\tau_0, t_2], \\ -u^i(t') + a^i(t') \mathbf{1}_{[\tau_b^i, \tau_e^i]}(t'), & \text{otherwise,} \end{cases} \\
 &0 \leq u^i(t') \leq \bar{u}^i, \\
 &s^i(0) = s_0^i, \\
 &s^i(\tau_b^i) = 0, \\
 &s^i(T) \geq 0.
 \end{aligned} \tag{\mathcal{P}'(\tau_e^j)}$$

It is easy to check that problems $(\mathcal{P}(\tau_b, \tau_e))$ and $(\mathcal{P}'(\tau_e^j))$ have the same value when τ_e^j belongs to (t_1, t_2) . Since for all t' in $[0, T]$, $\theta_{\tau_0}(t') = t'$, the original and the reparameterized problems are the same for $\tau_e^j = \tau_0$.

Remark 5.10. Notice that this reparameterization is not correct anymore when another plant begins or ends an outage at time τ_0 . Indeed, in this case, we cannot anymore

identify a constant set of working plants (j let alone) in the neighborhood of time τ_0 .

Remark 5.11. The Hamiltonian H' associated with the reparameterized problem is the following:

$$H'(t', u, p) = \dot{\theta}_{\tau_e^j}(t') H_{W(t')}(\theta_{\tau_e^j}(t'), u, p).$$

Note that the set of working plants $W(t')$ at time t' is defined with respect to the dates of the reference problem. Moreover, (u, s) is an optimal solution to $\mathcal{P}(\tau_b, \tau_e)$ with associated costate p if and only if $(u \circ \theta_{\tau_e^j}, s \circ \theta_{\tau_e^j})$ is an optimal solution to $\mathcal{P}'(\tau_e^j)$ with associated costate $p \circ \theta_{\tau_e^j}$.

Derivation of the Lagrangian Let (u, s) be a solution to the reference problem with $\tau_e^j = \tau_0$, let p be an associated costate. We consider a Lagrangian on the interval $[t_1, t_2]$, where the variable τ_e^j appears. Note that p is constant on this interval. For the sake of simplicity, we write p instead of $p(t')$ and t instead of t' . In the following Lagrangian, we only take into account the part of the cost function and the part of the dynamic associated with the interval $[t_1, t_2]$, where the perturbation happens.

$$\begin{aligned} \mathcal{L}(u, s, p, \tau_e^j) & \tag{5.24} \\ &= \frac{\tau_e^j - t_1}{\tau_0 - t_1} \int_{t_1}^{\tau_0} c\left(d \circ \theta_{\tau_e^j}(t) - \sum_{i \in W} u^i(t)\right) dt \\ & \quad + \frac{t_2 - \tau_e^j}{t_2 - \tau_0} \int_{\tau_0}^{t_2} c\left(d \circ \theta_{\tau_e^j}(t) - \sum_{i \in W \cup \{j\}} u^i(t)\right) dt \\ & \quad + \sum_{i \in \mathbb{S}} p^i \int_{t_1}^{\tau_0} \left(-\dot{s}^i(t) + \frac{\tau - t_1}{\tau_0 - t_1} (-u^i(t) + a^i \circ \theta_{\tau_e^j}(t) \mathbf{1}_{i \notin W})\right) dt \\ & \quad + \sum_{i \in \mathbb{S}} p^i \int_{\tau_0}^{t_2} \left(-\dot{s}^i(t) + \frac{\tau - t_2}{\tau_0 - t_2} (-u^i(t) + a^i \circ \theta_{\tau_e^j}(t) \mathbf{1}_{i \notin (W \cup \{j\})})\right) dt \\ &= \frac{\tau_e^j - t_1}{\tau_0 - t_1} \int_{t_1}^{\tau_0} H_{W(t)}(\theta_{\tau_e^j}(t), u(t), p) dt \\ & \quad + \frac{t_2 - \tau_e^j}{t_2 - \tau_0} \int_{\tau_0}^{t_2} H_{W(t)}(\theta_{\tau_e^j}(t), u(t), p) dt - \sum_{i \in \mathbb{S}} \int_{t_1}^{t_2} p^i \dot{s}^i(t) dt. \end{aligned}$$

Before deriving the Lagrangian, let us introduce some notations. We define the true Hamiltonian by

$$H_W^*(t, p) = \min_{v^i \in [0, \bar{u}^i]} H_W(t, v, p), \quad \forall p \in \mathbb{R}^n. \tag{5.25}$$

Pontryagin's principle states that

$$H_{W(t)}^*(t, p) = H_{W(t)}(t, u(t), p), \quad \text{for a. a. } t \text{ in } [0, T].$$

Note that the function $t \mapsto H_{W(t)}^*(t, u, p)$ is discontinuous at times τ_e^i and τ_b^i , for all i . Indeed, the set of working plants $W(t)$ is changing precisely at these times. The next lemma is a classic useful consequence of Pontryagin's principle. See [46, section 2.4.1, equality (8a)] for a proof.

Lemma 5.12. *Let u be an optimal control, with associated costate p . Consider an interval (t_a, t_b) included in $[0, T]$ on which none of the plants begins or ends an outage. On such an interval, the costate is constant and the set of working plants is constant, equal to say W . The mapping:*

$$h : t \in [t_a, t_b] \rightarrow H_W^*(t, p)$$

is C^1 on $[t_a, t_b]$ and its derivative is given by

$$\dot{h}(t) = D_t H_W^*(t, p_0) = D_t H_W(t, u(t), p), \quad \text{for a. a. } t \text{ in } [t_a, t_b], \quad (5.26)$$

where the notation $D_t H_W$ stands for the partial derivative of H_W with respect to t .

Note that this result can also be obtained by applying theorem 5.9. Indeed, H_W^* is the value of an optimization problem (the minimization of the Hamiltonian), parameterized by t . Since the constraints ($u \in \mathcal{U}$) are unchanged, the derivative of $H_W^*(t, p)$ is the derivative of the cost function, here the Hamiltonian.

Proposition 5.13. *The mapping $\tau_e^j \mapsto \mathcal{L}(u, s, p, \tau_e^j)$ is differentiable on (t_1, t_2) and*

$$D_{\tau_e^j} \mathcal{L}(u, s, p, \tau_0) = H_W^*(\tau_0, p) - H_{W \cup \{j\}}^*(\tau_0, p). \quad (5.27)$$

Proof. We have

$$\begin{aligned} D_{\tau_e^j} \mathcal{L}(u, s, p, \tau_e^j) &= \left[\frac{1}{\tau_0 - t_1} \int_{t_1}^{\tau_0} H_W(\theta_{\tau_e^j}(t), u(t), p) dt \right. \\ &\quad \left. + \frac{\tau_e^j - t_1}{\tau_0 - t_1} \int_{t_1}^{\tau_0} \frac{t - t_1}{\tau_0 - t_1} D_t H_W(\theta_{\tau_e^j}(t), u(t), p) dt \right] \\ &\quad - \left[\frac{1}{t_2 - \tau_0} \int_{\tau_0}^{t_2} H_{W \cup \{j\}}(\theta_{\tau_e^j}(t), u(t), p) dt \right. \\ &\quad \left. - \frac{t_2 - \tau_e^j}{t_2 - \tau_0} \int_{\tau_0}^{t_2} \frac{t_2 - t}{t_2 - \tau_0} H_{W \cup \{j\}}(\theta_{\tau_e^j}(t), u(t), p) dt \right]. \end{aligned}$$

For $\tau_e^j = \tau_0$, we obtain

$$\begin{aligned} &D_{\tau_e^j} \mathcal{L}(u, s, p, \tau_0) \quad (5.28) \\ &= \frac{1}{\tau_0 - t_1} \left[\int_{t_1}^{\tau_0} H_W^*(t, p) dt + \int_{t_1}^{\tau_0} (t - t_1) D_t H_W^*(t, p) dt \right] \\ &\quad - \frac{1}{t_2 - \tau_0} \left[\int_{\tau_0}^{t_2} H_{W \cup \{j\}}^*(t, p) dt - \int_{\tau_0}^{t_2} (t_2 - t) D_t H_{W \cup \{j\}}^*(t, p) dt \right]. \end{aligned}$$

Then, we obtain by integrating by parts (with lemma 5.12)

$$\begin{aligned} &\int_{t_1}^{\tau_0} (t - t_1) D_t H_W^*(t, p) dt \quad (5.29) \\ &= \left[(t - t_1) H_W^*(t, p) \right]_{t_1}^{\tau_0} - \int_{t_1}^{\tau_0} H_W^*(t, p) dt \\ &= (\tau_0 - t_1) H_W^*(\tau_0, p) - \int_{t_1}^{\tau_0} H_W^*(t, p) dt, \end{aligned}$$

and a similar expression holds for the integral on $[\tau_0, t_2]$. Finally, we obtain

$$D_{\tau_0^j} \mathcal{L}(u, s, p, \tau_0) = -[H_{W \cup \{j\}}^*(\tau_0, p) - H_W^*(\tau_0, p)], \quad (5.30)$$

as was to be proved. \square

Remark 5.14. *In general, there are several solutions to the problem. However, the expression obtained for the derivative of the Lagrangian, when p is given, does not depend on the primal solution, for two reasons:*

- \triangleright *the Hamiltonian, and thus the true Hamiltonian, do not depend on the state (and therefore, they do not depend on the past trajectory)*
- \triangleright *by definition, the true Hamiltonian at time t does not depend on the choice of the value of the optimal control at time t .*

Sensitivity with respect to the beginning of outage The above analysis remains true for τ_b^j if hypothesis (H) always holds. In this case, none of the plants (except j) begins or stops its outage at time τ_b^j and we denote by W the set of working plants at the reference time τ_0 (j does not belong to W). The only difference with the previous expression is that the j -th coordinate of p has a jump at time τ_0 . Using the conventions (5.4) and (5.5), we obtain the expression

$$D_{\tau_b^j} \mathcal{L}(u, s, p, \tau_0) = -[H_W^*(\tau_0, p(\tau_0^+)) - H_{W \cup \{j\}}^*(\tau_0, p(\tau_0^-))]. \quad (5.31)$$

Notice that the state constraint $s^j(\tau_b^j) = 0$ has become $s^j(\tau_0) = 0$, as a consequence, it does not depend on τ_b^j anymore and we do not need to take it into account in the Lagrangian.

Sensitivity with respect to an arbitrary direction We compute now the value of the directional derivative of the value function in an arbitrary direction. To this purpose, we must realize a complete reparameterization of the problem and some notations are needed. We fix a reference value $(\tau_{b,0}, \tau_{e,0})$ for the dates of outages and we suppose that hypothesis (H) holds. Then, we can fix dates $t_{b,1}^i, t_{b,2}^i, t_{e,1}^i$ and $t_{e,2}^i$ in $[0, T]$ such that for all i in \mathbb{S} ,

$$t_{b,1}^i < \tau_{b,0}^i < t_{b,2}^i < t_{e,1}^i < \tau_{e,0}^i < t_{e,2}^i$$

and such that on the intervals $[t_{b,1}^i, t_{b,2}^i]$ and $[t_{e,1}^i, t_{e,2}^i]$, plant i is the only one to begin or to end its outage. Therefore, we can define the sets W_b^i and W_e^i of working plants on the intervals $[t_{b,1}^i, t_{b,2}^i]$ and $[t_{e,1}^i, t_{e,2}^i]$ respectively, i being excluded of these sets. The global

change of variable to perform is now the following:

$$\theta_{\tau_b, \tau_e}(t') = \begin{cases} t_{b,1}^i + \frac{\tau_b^i - t_{b,1}^i}{\tau_{b,0}^i - t_{b,1}^i}(t' - t_{b,1}^i), & \text{for } t' \text{ in } [t_{b,1}^i, \tau_{b,0}^i], \\ t_{b,2}^i - \frac{t_{b,2}^i - \tau_b^i}{t_{b,2}^i - \tau_{b,0}^i}(t_{b,2}^i - t'), & \text{for } t' \text{ in } [\tau_{b,0}^i, t_{b,2}^i], \\ t_{e,1}^i + \frac{\tau_e^i - t_{e,1}^i}{\tau_{e,0}^i - t_{e,1}^i}(t' - t_{e,1}^i), & \text{for } t' \text{ in } [t_{e,1}^i, \tau_{e,0}^i], \\ t_{e,2}^i - \frac{t_{e,2}^i - \tau_e^i}{t_{e,2}^i - \tau_{e,0}^i}(t_{e,2}^i - t'), & \text{for } t' \text{ in } [\tau_{e,0}^i, t_{e,2}^i], \\ t', & \text{otherwise.} \end{cases} \quad (5.32)$$

The general reparameterized problem is the following:

$$\begin{aligned} & V(\tau_b, \tau_e) = \\ & \min_{u, s} \left[\int_0^T \dot{\theta}_{\tau_b, \tau_e}(t') c \left(d \circ \theta_{\tau_b, \tau_e}(t') - \sum_{i \in W(t')} u^i(t') \right) dt' + \phi(s(T)) \right], \\ & \text{s.t. } \forall i \in \mathbb{S}, \\ & \quad \dot{s}^i(t') = \dot{\theta}_{\tau_b, \tau_e}(t') (-u^i(t') + a^i \circ \theta_{\tau_b, \tau_e}(t') \mathbf{1}_{[\tau_{b,0}^i, \tau_{e,0}^i]}(t')) \\ & \quad 0 \leq u^i(t') \leq \bar{u}^i, \\ & \quad s^i(0) = s_0^i, \\ & \quad s^i(\tau_{b,0}^i) = 0, \\ & \quad s^i(T) \geq 0. \end{aligned} \quad (\mathcal{P}'(\tau_b, \tau_e))$$

Here, the set of working plants $W(t')$ at time t' is defined by:

$$W(t') = \{i \in \mathbb{S}, t' \notin [\tau_{b,0}^i, \tau_{e,0}^i]\}.$$

Notations Let us introduce some notations in order to simplify our sensitivity formula. First, we denote by $\Pi(\tau_{b,0}, \tau_{e,0})$ the set of costates satisfying Pontryagin's principle (lemma 5.1) for the value $(\tau_{b,0}, \tau_{e,0})$ of the dates of the outages. Recall that it is a subset of \mathbb{R}^{2n} . We also introduce the jumps of the true Hamiltonian, denoted by $\Delta H_b^i(p)$ and $\Delta H_e^i(p)$ and defined by

$$\begin{aligned} \Delta H_b^i(p) &= H_{W_b^i}^*(\tau_{b,0}^i, p(\tau_{b,0}^{i+})) - H_{W_b^i \cup \{i\}}^*(\tau_{b,0}^i, p(\tau_{b,0}^{i-})), \\ \Delta H_e^i(p) &= H_{W_e^i \cup \{i\}}^*(\tau_{e,0}^i, p(\tau_{e,0}^i)) - H_{W_e^i}^*(\tau_{e,0}^i, p(\tau_{e,0}^i)), \end{aligned}$$

for p in $\Pi(\tau_{b,0}, \tau_{e,0})$.

Theorem 5.15. *Consider a direction of perturbation denoted by $(\delta\tau_b, \delta\tau_e)$. If hypothesis (H) holds, then*

$$\begin{aligned} & V'((\tau_{b,0}, \tau_{e,0}), (\delta\tau_b, \delta\tau_e)) \\ &= \sup_{p \in \Pi(\tau_{b,0}, \tau_{e,0})} \left[\sum_{i \in \mathbb{S}} -\delta\tau_b^i \Delta H_b^i(p) + \sum_{i \in \mathbb{S}} -\delta\tau_e^i \Delta H_e^i(p) \right]. \end{aligned} \quad (5.33)$$

Proof. The expression of the derivative of the Lagrangian given in the theorem is a simple extension of expressions (5.27) and (5.31). The theorem is a direct consequence of theorem 5.9. For our application problem, a costate is a Lagrange multiplier if and only if it satisfies Pontryagin's principle, since the Hamiltonian is convex. The three hypotheses of the theorem (existence of solutions, qualification and continuity of the derivative of the Lagrangian) are checked in lemmas 5.18, 5.19, and 5.24. \square

5.3.3 Study of the Lagrange multipliers

In this part, we give a complete description of the set $\Pi(\tau_b, \tau_e)$ of costates satisfying Pontryagin's principle, which is for our application problem the set of Lagrange multipliers introduced in (5.17). Note that the characterization of costates holds even if hypothesis (H) is not satisfied.

Notations Let us consider the smallest sequence of times

$$0 = \tau_0 < \tau_1 < \dots < \tau_M = T$$

such that the outages begin or end only at times $\{\tau_1, \dots, \tau_M\}$. For all integer m with $0 \leq m < M$, the set of working plants is constant on the interval of time (τ_m, τ_{m+1}) .

Let us fix now an optimal control u and its associated trajectory s . Since the set of Lagrange multipliers does not depend on the choice of the optimal solution, it suffices to compute the set of costates associated with the particular solution (u, s) . We have proved in lemma 5.7 that $\mu = \sum_{i \in \mathbb{S}} u^i(t)$ and $s(T)$ are unique. Let us define, for all i in \mathbb{S} ,

$$\begin{cases} \pi_0^{i,\min} = \operatorname{ess\,sup}_{t \in [0, \tau_b^i], u^i(t) > 0} \{-c'(d(t) - \mu(t))\}, \\ \pi_0^{i,\max} = \operatorname{ess\,inf}_{t \in [0, \tau_b^i], u^i(t) < \bar{u}^i} \{-c'(d(t) - \mu(t))\}. \end{cases} \quad (5.34)$$

For all i in \mathbb{S} , if $s^i(T) > 0$, we set

$$\pi_T^{i,\min} = \pi_T^{i,\max} = D_{s^i} \phi(s(T)) \quad (5.35)$$

otherwise, we set

$$\begin{cases} \pi_T^{i,\min} = \operatorname{ess\,sup}_{t \in [\tau_e^i, T], u^i(t) > 0} \{-c'(d(t) - \mu(t))\}, \\ \pi_T^{i,\max} = \min \left\{ \operatorname{ess\,inf}_{t \in [\tau_e^i, T], u^i(t) < \bar{u}^i} \{-c'(d(t) - \mu(t))\}, D_{s^i} \phi(s(T)) \right\}. \end{cases} \quad (5.36)$$

Theorem 5.16. *The set of costates $\Pi(\tau_b, \tau_e)$ is described by*

$$\Pi(\tau_b, \tau_e) = \left(\prod_{i \in \mathbb{S}} [\pi_0^{i, \min}, \pi_0^{i, \max}] \right) \times \left(\prod_{i \in \mathbb{S}} [\pi_T^{i, \min}, \pi_T^{i, \max}] \right). \quad (5.37)$$

Proof. Let t in $[0, T]$, let v in \mathcal{U} be such that for all $i \notin W(t)$, $v^i = 0$. We set $\mu = \sum_{i \in \mathbb{S}} v^i$. Fix q in \mathbb{R}^n . Then v is a solution to the problem of minimization of the Hamiltonian P_t with $p = q$ if and only if for all i in $W(t)$,

$$(v^i > 0 \Rightarrow q^i(t) \geq -c'(d(t) - \mu)), \quad (5.38)$$

$$(v^i < \bar{u}^i \Rightarrow q^i(t) \leq -c'(d(t) - \mu)), \quad (5.39)$$

$$\text{and } i \notin W(t) \Rightarrow q^i \leq 0. \quad (5.40)$$

Therefore, a costate p is such that the Hamiltonian is minimized for almost all t if and only if conditions (5.38) and (5.39) are satisfied for almost all t with $q = p(t)$. These conditions being inequalities, it suffices to consider the essential infimum and supremum as we did in the construction of $\pi_0^{i, \min}$, $\pi_0^{i, \max}$, $\pi_T^{i, \min}$ and $\pi_T^{i, \max}$. Notice that we do not need to impose that $p^i(T) \leq 0$, since we already have that $D_{s^i} \phi(s(T)) \leq 0$. The theorem follows. \square

The following lemma describes situations where the costate is unique.

Lemma 5.17. *Let us consider four different cases.*

1. (a) *If on a non-negligible subset of $[0, \tau_b^i]$, $u^i(t) \in (0, \bar{u}^i)$, then $p^i(0)$ is unique.*
 (b) *If $s^i(T) > 0$ or if on a non-negligible subset of $[\tau_e^i, T]$, $u^i(t) \in (0, \bar{u}^i)$, then $p^i(T)$ is unique.*
2. (a) *If there exist two non-negligible subsets \mathcal{T}_1 and \mathcal{T}_2 of a given interval $[\tau_m, \tau_{m+1}]$ with $\tau_{m+1} \leq \tau_b^i$ such that*

$$\forall t \in \mathcal{T}_1, u^i(t) = 0 \quad \text{and} \quad \forall t \in \mathcal{T}_2, u^i(t) = \bar{u}^i,$$

then, $p^i(0)$ is unique.

- (b) *If the same property holds on an interval $[\tau_m, \tau_{m+1}]$ with $\tau_m \geq \tau_e^i$, then $p^i(T)$ is unique.*

Proof. In cases 1.a and 1.b, it follows from the existence of a non-negligible subset of $[0, \tau_b^i]$ (resp. $[\tau_e^i, T]$) where $0 < u^i(t) < \bar{u}^i$ that $\pi_0^{i, \min} \geq \pi_0^{i, \max}$ (resp. $\pi_T^{i, \min} \geq \pi_T^{i, \max}$), whence the equality of these bounds and the uniqueness of $p^i(0)$ (resp. $p^i(T)$).

For case 2.a, let us define r^{\min} and r^{\max} by

$$r^{\min} = \operatorname{ess\,sup}_{t \in [\tau_m, \tau_{m+1}], u^i(t) > 0} \{-c'(d(t) - \mu(t))\},$$

$$r^{\max} = \operatorname{ess\,inf}_{t \in [\tau_m, \tau_{m+1}], u^i(t) < \bar{u}^i} \{-c'(d(t) - \mu(t))\}.$$

Clearly,

$$-\infty < r^{\min} \leq \pi_0^{i,\min} \leq \pi_0^{i,\max} \leq r^{\max} < +\infty.$$

Let us show the uniqueness by contradiction. We suppose that $\pi_0^{i,\max} - \pi_0^{i,\min} = \varepsilon > 0$. It can be observed from lemma 5.5 that the solution μ of problem P'_t depends continuously on $d(t)$ on the interval $[\tau_m, \tau_{m+1}]$, since the set of working plants remains constant. The demand $d(t)$ being continuous in time, it follows that $c'(d(t) - \mu(t))$ is a continuous function of time. Let t_1 and t_2 be two times such that

$$\begin{aligned} -c'(d(t_1) - \mu(t_1)) &\leq r^{\min} + \frac{\varepsilon}{3}, \\ -c'(d(t_2) - \mu(t_2)) &\geq r^{\max} - \frac{\varepsilon}{3}. \end{aligned}$$

The function $c'(d(t) - \mu(t))$ being continuous, there exists a non-negligible subinterval of $[t_1, t_2]$ (or $[t_2, t_1]$ if $t_2 < t_1$) where $-c'(d(t) - \mu(t))$ belongs to $[r^{\min} + \varepsilon/3, r^{\max} - \varepsilon/3]$. On this subinterval, there exists a non-negligible subset where either $0 < u^i(t) < \bar{u}^i$, either $u^i(t) = 0$ or $u^i(t) = \bar{u}^i$. In the first case, we obtain the uniqueness of $p^i(0)$, which contradicts the statement of non-uniqueness. In the second case, we obtain that

$$\operatorname{ess\,inf}_{t \in [\tau_m, \tau_{m+1}], u^i(t) < \bar{u}^i} \{-c'(d(t) - \mu(t))\} \leq r^{\max} - \frac{\varepsilon}{3}, \quad (5.41)$$

and in the third case, we obtain that

$$\operatorname{ess\,sup}_{t \in [\tau_m, \tau_{m+1}], u^i(t) > 0} \{-c'(d(t) - \mu(t))\} \geq r^{\min} + \frac{\varepsilon}{3}, \quad (5.42)$$

Inequalities (5.41) and (5.42) contradict the definition of r^{\min} and r^{\max} . Thus, $p^i(0)$ is unique. Case 2.b can be treated similarly. \square

It follows from the contraposition of lemma 5.17 that if for some i in \mathbb{S} , $p^i(0)$ is not unique, then the optimal control u^i is constant on each interval (τ_m, τ_{m+1}) with $\tau_{m+1} \leq \tau_b^i$, being equal to 0 or \bar{u}^i . Denoting by M_0 the set of indexes m for which $u^i(t) = \bar{u}^i$ on (τ_m, τ_{m+1}) , we obtain that

$$s_0^i = \bar{u}^i \cdot \sum_{m \in M_0} \tau_{m+1} - \tau_m. \quad (5.43)$$

Similarly, if $p^i(T)$ is not unique, then $s^i(T) = 0$ and the optimal control u^i is constant on each interval (τ_m, τ_{m+1}) with $\tau_m \geq \tau_e^i$, being equal to 0 or \bar{u}^i . Denoting by M_T the set of indexes m for which $u^i(t) = \bar{u}^i$ on (τ_m, τ_{m+1}) , we obtain that

$$\int_{\tau_b^i}^{\tau_e^i} a^i(t) dt = \bar{u}^i \cdot \sum_{m \in M_T} \tau_{m+1} - \tau_m. \quad (5.44)$$

Inequalities (5.43) and (5.44) are, in some sense, unstable.

5.4 Technical aspects

In this part, we adopt some new notations in order to simplify the proofs. We set

$$\ell(t, u) = c \left(d(t) - \sum_{i \in W(t)} u^i \right),$$

and for a sequence of dates $(\tau_{b,k}, \tau_{e,k})_k$, we denote by θ_k the associated changes of variable, defined by (5.32) and we obtain, with the new notations:

$$\begin{aligned} V(\tau_{b,k}, \tau_{e,k}) = & \min_{u,s} \int_0^T \dot{\theta}_k(t) \ell(\theta_k(t), u(t)) dt + \phi(s(T)), \\ \text{s.t. } \forall i \in \mathbb{S}, & \dot{s}^i(t) = \dot{\theta}_k(t) (-u^i(t) + a^i \circ \theta_k(t) \mathbf{1}_{[\tau_{b,0}^i, \tau_{e,0}^i]}(t)), \\ & 0 \leq u^i(t) \leq \bar{u}^i(t), \\ & s^i(0) = s_0^i, \\ & s^i(\tau_{b,0}^i) = 0, \\ & s^i(T) \geq 0. \end{aligned} \quad (\mathcal{P}'(\tau_b, \tau_e))$$

Let us give two elementary properties associated with the changes of variable θ_k . First, it can be easily checked that

$$\theta_k \rightarrow \text{Id} \quad \text{and} \quad \dot{\theta}_k \rightarrow 1, \quad (5.45)$$

for the uniform topology of $L^\infty(0, T; \mathbb{R}^n)$. Moreover, if b is in $L^1(0, T; \mathbb{R}^n)$, then

$$b \circ \theta_k \rightarrow b, \quad (5.46)$$

for the L^1 -topology. This property being easily checked if b is continuous, by density of continuous functions in $L^1(0, T; \mathbb{R}^n)$, we obtain it for all function in $L^1(0, T; \mathbb{R}^n)$.

5.4.1 Existence of solutions

Lemma 5.18. *If condition (QC) is satisfied, the problem has an optimal solution.*

Proof. Consider a minimizing sequence (u_k, s_k) of feasible solutions. Since the controls are bounded and the dynamic is linear, one can easily prove with the Banach-Alaoglu theorem and the Arzelà-Ascoli theorem the existence of a subsequence (u_k, s_k) such that u_k converges to a control u for the weak topology of $L^\infty(0, T; \mathbb{R}^n)$, such that s_k converges to a trajectory s for the strong topology of $L^\infty(0, T; \mathbb{R}^n)$, and such that (u, s) is a feasible trajectory. Moreover, the mapping

$$u \in L^\infty(0, T; \mathbb{R}^n) \mapsto \int_0^T \ell(t, u(t)) dt \quad (5.47)$$

is sequentially lower semi-continuous for the weak-* topology. Indeed, since for all t , $\ell(t, \cdot)$ is differentiable and convex with respect to u ,

$$\int_0^T \ell(t, u_k(t)) dt \geq \int_0^T \ell(t, u(t)) dt + \int_0^T D_u \ell(t, u(t)) (u_k(t) - u(t)) dt,$$

thus, to the limit,

$$\int_0^T \ell(t, u(t)) dt \leq \liminf_{k \rightarrow \infty} \int_0^T \ell(t, u_k(t)) dt. \quad (5.48)$$

Since ϕ is continuous and the cost function is sequentially weakly-* lower semi continuous, the trajectory (u, s) is an optimal solution to the problem. \square

5.4.2 Qualification

Lemma 5.19. *If condition (QC) is satisfied, then Robinson's constraint qualification holds for any feasible trajectory.*

Proof. We must check condition (RQC). We consider that the control u and the trajectory s are the optimization variables, defined on $L^\infty(0, T; \mathbb{R}^n)$ and $W^{1,\infty}(0, T; \mathbb{R}^n)$. For simplicity, we denote by L^∞ , L_+^∞ and $W^{1,\infty}$ the spaces $L^\infty([0, T], \mathbb{R}^n)$, $L^\infty(0, T; \mathbb{R}_+^n)$ and $W^{1,\infty}([0, T], \mathbb{R}^n)$, respectively. The function G describing the constraints is the following:

$$G : (u, s) \in (L^\infty, W^{1,\infty}) \mapsto (G_E(u, s), G_I(u, s)),$$

where

$$G_E(u, s) = \begin{cases} s(0) - s_0 \\ \dot{s}^i(t) + u^i(t) - a^i \mathbf{1}_{[\tau_{b,0}^j, \tau_{e,0}^j]}(t) \\ s^i(\tau_{b,0}^i) \end{cases}$$

and

$$G_I(u, s) = \begin{cases} s^i(T) \\ u^i(t) \\ \bar{u}^i - u^i(t) \end{cases}.$$

The set K is equal to $\{0\}_{\mathbb{R}^n \times L^\infty \times \mathbb{R}^n} \times K_I$ where

$$K_I = \mathbb{R}_+^n \times L_+^\infty \times L_+^\infty.$$

Let us consider a feasible trajectory $x = (u, s)$ of the problem, we denote by $dx = (du, ds)$ a perturbation of the optimization variables u and s . We have to characterize the set:

$$G(x, y_0) + D_x G(x, y_0) dx - K.$$

An element of this set is of the following form:

$$\begin{cases} ds^i(0) \\ \dot{s}^i(t) + du^i(t) \\ ds^i(\tau_{b,0}^i) \\ s^i(T) + ds^i(T) - g \\ u^i(t) + du^i(t) - \check{u}(t) \\ \bar{u}^i - u^i(t) - du^i(t) - \hat{u}(t) \end{cases} \quad (5.49)$$

where \tilde{u} and \hat{u} belongs to L^{∞}_+ , g belongs to \mathbb{R}^n_+ . Note that the expression obtained is decoupled in i . This allows us to study the qualification by examining just one coordinate. Let us show that there exists a constant $\varepsilon > 0$ such that for all

$$dg = (g_1, z, g_2, g_3, \nu_1, \nu_2) \in \mathbb{R}^n \times L^{\infty} \times \mathbb{R}^n \times \mathbb{R}^n \times L^{\infty} \times L^{\infty}$$

with $\|dg\|_{\infty} \leq \varepsilon$, there exists $dx = (du, ds)$ in $L^{\infty} \times W^{1,\infty}$ such that

$$dg \in G(x, y) + DG_x(x, y_0)dx - K.$$

It is easy to check that this last condition is equivalent to the existence of a control du^i in L^{∞} satisfying the bounds

$$\nu_1(t) \leq u^i(t) + du^i(t) \leq \bar{u}^i - \nu_2(t),$$

and such that the associated differential system

$$\begin{cases} \dot{ds}^i(t) = -du^i(t) + z(t) \\ ds^i(0) = g_1 \end{cases}$$

satisfies the following two state constraints:

$$ds^i(\tau_{b,0}^i) = g_2, \quad ds^i(T) \geq -s^i(T) + g_3.$$

Now, we focus on the construction of du^i on $[0, \tau_{b,0}^i]$. The idea is to take for $du^i(t)$ a convex combination of its bounds, $\nu_1(t) - u^i(t)$ and $\bar{u}^i - \nu_2(t) - u^i(t)$. The first state constraint, $ds^i(\tau_{b,0}^i) = g_2$ is equivalent to

$$\int_0^{\tau_{b,0}^i} du^i(t) = g_1 - g_2 + \int_0^{\tau_{b,0}^i} z(t) dt.$$

Hypothesis (QC) states that

$$0 < s_0^i = \int_0^{\tau_{b,0}^i} u^i(t) dt < \tau_{b,0}^i \cdot \bar{u}^i,$$

thus we can set

$$\varepsilon_1 = \min(s_0^i, \tau_{b,0}^i \cdot \bar{u}^i - s_0^i, \bar{u}^i) > 0. \quad (5.50)$$

We assume that

$$\|\nu_1\|_{\infty} \leq \frac{\varepsilon_1}{2} \min(1, (\tau_{b,0}^i)^{-1}) \quad \text{and} \quad \|\nu_2\|_{\infty} \leq \frac{\varepsilon_1}{2} \min(1, (\tau_{b,0}^i)^{-1}). \quad (5.51)$$

It follows that:

$$\int_0^{\tau_{b,0}^i} \bar{u}^i - u^i(t) - \nu_2(t) dt \geq (\tau_{b,0}^i \bar{u}^i - s_0^i) - \tau_{b,0}^i \cdot \|\nu_2\|_{\infty} \geq \varepsilon_1/2, \quad (5.52)$$

$$\int_0^{\tau_{b,0}^i} -u^i(t) - \nu_1(t) dt \leq -s_0^i + \tau_{b,0}^i \cdot \|\nu_1\|_\infty \leq -\varepsilon_1/2, \quad (5.53)$$

and for all t in $[0, \tau_{b,0}^i]$, $\nu_2(t) - \nu_1(t) \leq \bar{u}^i$, thus,

$$-u^i(t) - \nu_1(t) \leq \bar{u}^i - u^i(t) - \nu_2(t). \quad (5.54)$$

We assume that

$$|g_1| \leq \frac{\varepsilon_1}{6}, \quad |g_2| \leq \frac{\varepsilon_1}{6}, \quad \text{and} \quad \|z\|_\infty \leq \frac{\varepsilon_1}{6\tau_{b,0}^i}, \quad (5.55)$$

so that

$$\left| g_1 - g_2 + \int_0^{\tau_{b,0}^i} z(t) dt \right| \leq \frac{\varepsilon_1}{2}. \quad (5.56)$$

Let us set

$$\lambda = \frac{\left(g_1 - g_2 + \int_0^{\tau_{b,0}^i} z(t) dt \right) - \left(\int_0^{\tau_{b,0}^i} -u^i(t) - \nu_1(t) dt \right)}{\int_0^{\tau_{b,0}^i} \bar{u}^i - \nu_2(t) dt - \int_0^{\tau_{b,0}^i} -\nu_1(t) dt}, \quad (5.57)$$

we obtain, combining (5.52), (5.53), and (5.56) that $0 \leq \lambda \leq 1$. Using (5.54) and (5.57), we obtain that the control du^i defined on $[0, \tau_{b,0}^i]$ by

$$du^i(t) = \lambda[-\nu_1(t) - u^i(t)] + (1 - \lambda)[\bar{u}^i - u^i(t) - \nu_2(t)] \quad (5.58)$$

is feasible and that the associated state $ds^i(t)$ satisfies the first state constraint.

Let us focus on the construction of du^i on $[\tau_{b,0}^i, T]$. The final-state constraint on $ds^i(T)$ is satisfied if and only if

$$\int_{\tau_{b,0}^i}^T du^i(t) \leq g_2 - g_3 + s^i(T) + \int_{\tau_{b,0}^i}^T z(t) dt.$$

Hypothesis (QC) states that

$$0 < \int_{\tau_{b,0}^i}^{\tau_{e,0}^i} a^i(t) dt.$$

We set

$$\varepsilon_2 = \min \left(\int_{\tau_{b,0}^i}^{\tau_{e,0}^i} a^i(t) dt, \bar{u}^i \right) > 0. \quad (5.59)$$

We assume now that

$$\|\nu_1\|_\infty \leq \frac{\varepsilon_2}{2} \min(1, (T - \tau_{b,0}^i)^{-1}) \quad \text{and} \quad \|\nu_2\|_\infty \leq \frac{\varepsilon_2}{2}. \quad (5.60)$$

It follows that:

$$\begin{aligned} \int_{\tau_{b,0}^i}^T -u^i(t) - \nu_1(t) dt &= - \int_{\tau_{b,0}^i}^{\tau_{e,0}^i} a^i(t) dt - \int_{\tau_{b,0}^i}^T \nu_1(t) dt + s^i(T) \\ &\leq -\varepsilon_2 + (T - \tau_{b,0}^i) \|\nu_1\|_\infty + s^i(T) \\ &\leq -\frac{\varepsilon_2}{2} + s^i(T) \end{aligned} \quad (5.61)$$

and for all t in $[0, \tau_{b,0}^i]$, $\nu_2(t) - \nu_1(t) \leq \bar{u}^i$, thus

$$-u^i(t) - \nu_1(t) \leq \bar{u}^i - u^i(t) - \nu_2(t).$$

Now, we assume that

$$|g_2| \leq \frac{\varepsilon_2}{6}, \quad |g_3| \leq \frac{\varepsilon_2}{6}, \quad \|z\|_\infty \leq \frac{\varepsilon_2}{6(T - \tau_{b,0}^i)},$$

so that

$$g_2 - g_3 + \int_{\tau_{b,0}^i}^T z(t) dt \geq -\frac{\varepsilon_2}{2}.$$

Now, we can set, for all t in $[\tau_{b,0}^i, T]$,

$$du^i(t) = -u^i(t) - \nu_1(t),$$

It follows from (5.61) that:

$$\begin{aligned} du^i(T) &\leq -\varepsilon_2/2 + s^i(T) \\ &\leq g_2 - g_3 + \int_{\tau_{b,0}^i}^T z(t) dt + s^i(T). \end{aligned}$$

As a consequence, the second state constraint is satisfied. The lemma is proved by taking for the constant ε a positive real number satisfying (5.50), (5.51), (5.55), (5.59), and (5.60). \square

5.4.3 On convergence of solutions to the perturbed problems

The goal of this part is to check the third hypothesis of theorem 5.9 for our application problem. To that purpose, we fix a reference date $(\tau_{b,0}, \tau_{e,0})$ and a sequence $(\tau_{b,k}, \tau_{e,k})$ of dates converging to $(\tau_{b,0}, \tau_{e,0})$. We suppose that hypothesis (H) holds for the reference problem. Thus, it holds for k sufficiently large and there exists a sequence of optimal solutions $(u_k, s_k)_k$ to the perturbed problems (for k sufficiently large). We denote by $(p_k)_k$ a sequence of associated costates.

In lemma 5.20, we obtain the existence of a subsequence of $(u_k, s_k)_k$ such that $(u_k)_k$ converges to an optimal control of the reference problem, u , for the weak-* topology, and such that $(s_k)_k$ converges uniformly to the associated trajectory s . In lemma 5.22, we prove the existence of a subsequence such that $(p_k)_k$ converges to a costate associated with (u, s) and, in lemma 5.23, we prove that the sum of the controls converges uniformly. Finally, we prove the last hypothesis of theorem 5.9.

Note that all the subsequences have the same name as the original sequence, for the sake of simplicity.

Lemma 5.20. *There exists a subsequence of $(u_k, s_k)_k$ such that*

$$\begin{aligned} u_k &\xrightarrow{*} u \text{ in } L^\infty(0, T; \mathbb{R}^n), \\ s_k &\rightarrow s \text{ in } L^\infty(0, T; \mathbb{R}^n), \end{aligned}$$

where (u, s) is a solution to $\mathcal{P}'(\tau_{b,0}, \tau_{e,0})$.

Proof. In this proof we first show the existence of a feasible limit point (u, s) to the sequence $(u_k, s_k)_k$. Then, for any feasible trajectory (\tilde{u}, \tilde{s}) of the reference problem, we show the existence of a sequence $(\tilde{u}_k, \tilde{s}_k)_k$ such that both $(\tilde{u}_k)_k$ and $(\tilde{s}_k)_k$ converges uniformly to (\tilde{u}, \tilde{s}) and such that for k sufficiently large, $(\tilde{u}_k, \tilde{s}_k)$ is a feasible trajectory for the perturbed problem.

For all k , for all i in \mathbb{S} and for all t in $[0, T]$,

$$|\dot{s}_k^i(t)| \leq \bar{u}^i + \|a\|_\infty,$$

$$|s_k^i(t)| \leq |s_0^i| + T(\bar{u}^i + \|a\|_\infty),$$

and

$$\|u_k^i\|_\infty \leq \bar{u}^i.$$

Using the Arzelà-Ascoli theorem and the Banach-Alaoglu theorem, we obtain the existence of a subsequence, still denoted by $(u_k, s_k)_k$ such that s_k converges uniformly to some s in $L^\infty(0, T; \mathbb{R}^n)$, with $s^i(0) = s_0^i$, $s^i(\tau_{b,0}^i) = 0$ and $s^i(T) \geq 0$ and such that u_k converges to some u for the weak-* topology of $L^\infty(0, T; \mathbb{R}^n)$. Necessarily, for almost all t in $[0, T]$, $0 \leq u^i(t) \leq \bar{u}^i$ and, for all k and for all t' ,

$$\begin{aligned} s_k^i(t') &= s_0^i + \int_0^{t'} \dot{\theta}_k(t) (-u_k^i(t) + a^i \circ \theta_k(t) \mathbf{1}_{[\tau_{b,0}^i, \tau_{e,0}^i]}(t)) dt \\ &= s_0^i + \int_0^{t'} -(\dot{\theta}_k(t) - 1) u_k^i(t) dt \\ &\quad + \int_0^{t'} (\dot{\theta}_k(t) - 1) a^i \circ \theta_k(t) \mathbf{1}_{[\tau_{b,0}^i, \tau_{e,0}^i]}(t) dt \\ &\quad + \int_0^{t'} -(u_k^i(t) - u^i(t)) dt + \int_0^{t'} (a^i \circ \theta_k(t) - a^i(t)) \mathbf{1}_{[\tau_{b,0}^i, \tau_{e,0}^i]}(t) dt \\ &\quad + \int_0^{t'} -u^i(t) + a^i(t) \mathbf{1}_{[\tau_{b,0}^i, \tau_{e,0}^i]}(t) dt. \end{aligned} \tag{5.62}$$

Using (5.45), (5.46), and the weak-* convergence of $(u_k)_k$, we obtain, to the limit,

$$s^i(t) = s_0^i + \int_0^{t'} -u^i(t) + a^i(t) \mathbf{1}_{[\tau_{b,0}^i, \tau_{e,0}^i]}(t) dt,$$

which proves that s satisfies the differential equation of the reference problem, hence (u, s) is feasible.

Let (\tilde{u}, \tilde{s}) be a feasible control of the reference problem. It can be proved (with the same kind of estimates as in (5.62)) that

$$\begin{aligned} s_0^i + \int_0^{\tau_{b,0}^i} \dot{\theta}_k(t) (-\tilde{u}^i(t) + a^i \circ \theta_k(t) \mathbf{1}_{[\tau_{b,0}^i, \tau_{e,0}^i]}(t)) dt &= \tilde{s}(\tau_{b,0}^i) + o(1) = o(1), \\ s_0^i + \int_0^T \dot{\theta}_k(t) (-\tilde{u}^i(t) + a^i \circ \theta_k(t) \mathbf{1}_{[\tau_{b,0}^i, \tau_{e,0}^i]}(t)) dt &= \tilde{s}(T) + o(1) = o(1), \end{aligned}$$

Since Robinson's qualification holds for the trajectory (\tilde{u}, \tilde{s}) by lemma 5.19, we obtain, using the stability theorem [21, theorem 2.87] that there exists a sequence of feasible trajectories $(\tilde{u}_k, \tilde{s}_k)$ for the perturbed problems such that $(\tilde{u}_k)_k$ and $(\tilde{s}_k)_k$ converges uniformly to \tilde{u} and \tilde{s} respectively.

Finally, we have that

$$\int_0^T \ell(t, u_k(t)) dt \leq \int_0^T \ell(t, \tilde{u}_k(t)) dt,$$

thus passing to the lim inf in the left-hand-side (like in 5.48) and passing to the limit in the right-hand-side, we obtain that

$$\int_0^T \ell(t, u(t)) dt \leq \int_0^T \ell(t, \tilde{u}(t)) dt,$$

which proves the optimality of (u, s) . The lemma follows. \square

Lemma 5.21. *The sequence (p_k) is bounded.*

Proof. This result derives from the study of $\Pi(\tau_{b,0}, \tau_{e,0})$ conducted in theorem 5.16. The qualification condition (QC) being stable, it is satisfied for k sufficiently large. When the qualification condition is satisfied, it is impossible that $u^i(t) = 0$ for almost all t in $[0, \tau_{b,0}^i]$ or that $u^i(t) = \bar{u}^i$ for almost all t in $[0, \tau_{b,0}^i]$, thus the associated bounds $\pi_0^{i,\min}$ and $\pi_0^{i,\max}$ are finite. More precisely, denoting respectively by d_{\min} and d_{\max} the infimum and the supremum of d over $[0, T]$, we obtain that

$$-c'(d_{\max}) \leq p_k^i(0) \leq -c' \left(d_{\min} - \sum_{i \in \mathcal{S}} \bar{u}^i \right),$$

since $-c'$ is non-increasing. This proves the boundedness of $p_k(0)$. For the study of $p_k(T)$, let us recall first that up to a subsequence, a sequence (u_k, s_k) of optimal solutions to the perturbed problems is such that $s_k(T)$ converges. Let B_T a compact of \mathbb{R}^n be such that $s_k(T)$ belongs to B_T for k big enough. There are two cases: if $s_k^i(T) > 0$, then

$$\inf_{s \in B_T} D_{s^i} \phi(s) \leq D_{s^i} \phi(s_k(T)) = p_k^i(T) \leq \sup_{s \in B_T} D_{s^i} \phi(s)$$

otherwise, $s_k^i(T) = 0$ and by qualification, it is impossible to have $u_k^i(t) = 0$ for all t in $[\tau_{e,0}^i, T]$ in this case, thus

$$-c'(d_{\max}) \leq p_k^i(T) \leq \sup_{s \in B_T} D_{s^i} \phi(s).$$

Finally, we obtain that

$$\min \left\{ -c'(d_{\max}), \inf_{s \in B_T} D_{s^i} \phi(s) \right\} \leq p_k^i(T) \leq \sup_{s \in B_T} D_{s^i} \phi(s),$$

whence the boundedness of $(p_k)_k$. \square

Lemma 5.22. *Up to a subsequence, $(p_k)_k$ converges to some p in $\Pi(\tau_{b,0}, \tau_{e,0})$.*

Proof. Recall that p is viewed as an element of \mathbb{R}^{2n} , therefore we do not need to be precise about the topology involved for the convergence. By lemma 5.20, we can extract from this sequence a sequence of solutions, denoted by (u_k, s_k) such that $u_k \xrightarrow{*} u$ and $s_k \rightarrow s$ (in $L^\infty(0, T; \mathbb{R}^n)$) where (u, s) is a solution to $\mathcal{P}(\tau_{b,0}, \tau_{e,0})$.

By lemma 5.21, the sequences $p_k(0)$ and $p_k(T)$ are bounded, and thus we can extract a subsequence such that these sequences converge to say p_0 and p_T . Let us prove that $p = (p_0, p_T)$ belongs to $\Pi(\tau_{b,0}, \tau_{e,0})$. Recall that the Hamiltonian associated the perturbed problem is

$$\dot{\theta}_k(t) H_{W(t)}(\theta_k(t), u, p).$$

Let a and b be such that $0 \leq a < b \leq T$, let v in $L^\infty(0, T)$ be such that for almost all t in $[0, T]$, for all i in \mathbb{S} , $0 \leq v^i(t) \leq \bar{u}^i$. In order to show that p belongs to $\Pi(\tau_{b,0}, \tau_{e,0})$, it suffices to show that:

$$\int_a^b H_{W(t)}(t, p(t), u(t)) dt \leq \int_a^b H_{W(t)}(t, p(t), v(t)) dt.$$

Applying Pontryagin's principle to the perturbed problem, we obtain directly that

$$\int_a^b H_{W(t)}(\theta_k(t), u_k(t), p_k(t)) dt \leq \int_a^b H_{W(t)}(\theta_k(t), v(t), p_k(t)) dt. \quad (5.63)$$

Let us focus on the integral of the left-hand-side. We have

$$\begin{aligned} & \int_a^b H_{W(t)}(\theta_k(t), u_k(t), p_k(t)) dt \\ &= \int_a^b H_{W(t)}(\theta_k(t), u_k(t), p_k(t)) - H_{W(t)}(t, u_k(t), p_k(t)) dt \\ & \quad + \int_a^b H_{W(t)}(t, u_k(t), p_k(t)) - H_{W(t)}(t, u_k(t), p(t)) dt \\ & \quad + \int_a^b H_{W(t)}(t, u_k(t), p(t)) - H_{W(t)}(t, u(t), p(t)) dt \\ & \quad + \int_a^b H_{W(t)}(t, u(t), p(t)) dt. \end{aligned}$$

Using (5.45), (5.46), the uniform convergence of $(p_k)_k$, the weak-* lower semi-continuity of the integral of the Hamiltonian (see (5.48) for the idea of a proof), we obtain that to the limit,

$$\liminf_{k \rightarrow \infty} \int_a^b \theta'_k(t) H_{W(t)}(\theta_k(t), u_k(t), p_k(t)) dt \leq \int_a^b H_{W(t)}(t, u(t), p(t)) dt.$$

Similarly, we can show that

$$\lim_{k \rightarrow \infty} \int_a^b \theta'_k(t) H_{W(t)}(\theta_k(t), v(t), p_k(t)) dt = \int_a^b H_{W(t)}(t, v(t), p(t)) dt.$$

Thus, passing to the limit in (5.63), we obtain

$$\int_a^b H_{W(t)}(t, u(t), p(t)) dt \leq \int_a^b H_{W(t)}(t, v(t), p(t)) dt,$$

which proves that p belongs to $\Pi(\tau_{b,0}, \tau_{e,0})$, hence the lemma. \square

Lemma 5.23. *Up to a subsequence,*

$$\sum_{i \in \mathbb{S}} u_k^i \longrightarrow \sum_{i \in \mathbb{S}} u^i \text{ in } L^\infty(0, T; \mathbb{R}^n).$$

Proof. As usual, we set $\mu_k(t) = \sum_{i \in \mathbb{S}} u_k^i(t)$. Let us set

$$\begin{aligned} \tilde{H}_W : \mathbb{R} \times \mathbb{R}^n \times \mathbb{R}^n &\rightarrow \mathbb{R} \\ (d, \mu, p) &\mapsto c(d(t) - \mu) + \xi_W(\mu, p), \end{aligned}$$

where W is a given subset of \mathbb{S} . This function looks like a Hamiltonian, however, notice that the demand is viewed as a parameter now. Moreover, the part involving the refuelling $a(t)$ is missing. For almost all t in $[0, T]$,

$$\mu_k(t) = \min_{\mu \in [0, \sum_{i \in W(t)} \bar{u}^i]} \tilde{H}_{W(t)}(d \circ \theta_k(t), \mu, p_k(t)). \quad (5.64)$$

Thanks to the reparameterization, when t is given, $\mu_k(t)$ minimizes a function $\tilde{H}_{W(t)}$ independent on k . Recall that the cost function c is α -convex and so is the function $\mu \mapsto \tilde{H}_W(d, p, \mu)$. Considering that the optimization problem given by (5.64) is a problem parameterized by $d \circ \theta_k$ and p_k , we obtain by a classical property of stability of optimal solutions (see [21, proposition 4.32]) that there exists a constant A independent on time such that for almost all t in $[0, T]$,

$$|\mu_k(t) - \mu(t)| \leq A(|p_k(t) - p(t)| + |d \circ \theta_k(t) - d(t)|), \quad (5.65)$$

By lemma 5.22, we know that up to a subsequence, $(p_k(0), p_k(T))$ converges to some p in $\Pi(\tau_b, \tau_e)$. Since the times of discontinuity of p are fixed, this implies the uniform convergence of the costate, when considered as a time function. Moreover, it is easy to check that the sequence $(d \circ \theta_k(t))_k$ converges uniformly to $d(t)$, since $d(t)$ is Lipschitz and since $(\theta_k)_k$ converges uniformly to the identity function on $[0, T]$. Together with (5.65), we obtain that

$$\|\mu_k - \mu\|_\infty \leq A(\|p_k - p\|_\infty + \|d \circ \theta_k - d\|_\infty) \rightarrow 0.$$

as was to be proved. \square

Lemma 5.24. *If hypotheses (H) and (QC) hold, then hypothesis 3 of theorem 5.9 is satisfied for any direction of perturbation.*

Proof. We know by lemmas 5.20 and 5.23 that up to a subsequence, for all i in \mathbb{S} ,

$$u_k^i \xrightarrow{*} u^i \quad \text{and} \quad \mu_k = \sum_{i \in \mathbb{S}} u_k^i \rightarrow \mu = \sum_{i \in \mathbb{S}} u^i.$$

Consider a sequence of times $(\tilde{\tau}_{b,k}, \tilde{\tau}_{e,k})$ such that for all k ,

$$(\tilde{\tau}_{b,k}, \tilde{\tau}_{e,k}) \in [(\tau_{b,0}, \tau_{e,0}), (\tau_{b,k}, \tau_{e,k})].$$

For simplicity, we consider that the direction of perturbation is a unit basic vector in direction τ_e^j , so that we can refer to expression (5.28) for the derivative of the Lagrangian, and we use the same notations. We have:

$$\begin{aligned} & D_{\tau_e^j} \mathcal{L}(u_k, s, p, (\tilde{\tau}_{b,k}, \tilde{\tau}_{e,k})) \\ = & \left[\frac{1}{\tau_0 - t_1} \int_{t_1}^{\tau_0} H_W(\theta_{\tilde{\tau}_{b,k}, \tilde{\tau}_{e,k}}(t), u_k(t), p) dt \right. \\ & \left. + \frac{\tilde{\tau}_{e,k}^j - t_1}{\tau_0 - t_1} \int_{t_1}^{\tau_0} \frac{t - t_1}{\tau_0 - t_1} D_t H_W(\theta_{\tilde{\tau}_{b,k}, \tilde{\tau}_{e,k}}(t), u_k(t), p) dt \right] \\ - & \left[\frac{1}{t_2 - \tau_0} \int_{\tau_0}^{t_2} H_{W \cup \{j\}}(\theta_{\tilde{\tau}_{b,k}, \tilde{\tau}_{e,k}}(t), u_k(t), p) dt \right. \\ & \left. - \frac{t_2 - \tilde{\tau}_{e,k}^j}{t_2 - \tau_0} \int_{\tau_0}^{t_2} \frac{t_2 - t}{t_2 - \tau_0} D_t H_{W \cup \{j\}}(\theta_{\tilde{\tau}_{b,k}, \tilde{\tau}_{e,k}}(t), u_k(t), p) dt \right]. \end{aligned}$$

Moreover, for all t in $[t_1, \tau_0]$,

$$\begin{aligned} & H_W(\theta_{\tilde{\tau}_{b,k}, \tilde{\tau}_{e,k}}(t), u_k(t), p) \\ = & c \left(d \circ \theta_{\tilde{\tau}_{b,k}, \tilde{\tau}_{e,k}}(t) - \sum_{i \in W} u_k(t) \right) + \sum_{i \in \mathbb{S}} p^i (-u^i(t) + a^i \circ \theta_{\tilde{\tau}_{b,k}, \tilde{\tau}_{e,k}}(t) \mathbf{1}_{i \notin W}), \end{aligned}$$

thus, using the strong convergence of the sum of controls, the weak-* convergence of controls, the strong convergence of $\theta_{\tilde{\tau}_{b,k}, \tilde{\tau}_{e,k}}$ and (5.46), we obtain that

$$\int_0^T H_W(\theta_{\tilde{\tau}_{b,k}, \tilde{\tau}_{e,k}}(t), u_k(t), p) dt \rightarrow \int_0^T H_W(t, u(t), p) dt,$$

and we prove similarly the convergence of the integral of $D_t H_W$, and finally, we obtain that for a subsequence of the original sequence $(\tilde{\tau}_{b,k}, \tilde{\tau}_{e,k})_k$,

$$D_{\tau_e^j} \mathcal{L}(u_k, s, p, (\tilde{\tau}_{b,k}, \tilde{\tau}_{e,k})) \rightarrow D_{\tau_e^j} \mathcal{L}(u, s, p, (\tau_{b,0}, \tau_{e,0})).$$

This property easily extends to any direction of perturbation by linearity of the derivative of the Lagrangian. □

5.5 Conclusion

In this article, we have studied a simplified model for the management of electricity production with nuclear power plants. We have performed a sensitivity analysis of the value of the problem with respect to the dates of the outages of the power plants. With formula (5.33), we obtain an approximation of the value function V by writing a first-order Taylor expansion:

$$\begin{aligned} & V(\tau_{b,0} + \delta\tau_b, \tau_{e,0} + \delta\tau_e) \\ &= V(\tau_{b,0}, \tau_{e,0}) + V'((\tau_{b,0}, \tau_{e,0}), (\delta\tau_b, \delta\tau_e)) + o(\delta\tau_b, \delta\tau_e). \end{aligned} \quad (5.66)$$

In general, there is a unique multiplier and $V'((\tau_{b,0}, \tau_{e,0}), (\delta\tau_b, \delta\tau_e))$ is linear with respect to the perturbation $(\delta\tau_b, \delta\tau_e)$ (see lemma 5.17).

This formula holds if hypothesis H holds and is relevant in a neighborhood of $(\tau_{b,0}, \tau_{e,0})$. More precisely, we must at least ensure that the ordering of the dates is unchanged after the perturbation. The question of differentiability when hypothesis H does not hold is still open. It is difficult to give stability results for the optimal controls, since they are not unique in general. However, as shown in lemma 5.23, the total production is stable.

Part II

Chance-constrained stochastic optimal control

Chapter 6

Stochastic optimal control with a probability constraint

Contents

6.1	Introduction	172
6.2	Discrete-time chance-constrained control problems	173
6.2.1	First properties	173
6.2.2	Relaxation	177
6.2.3	Application	182
6.3	Properties of continuous-time optimal control problems	183
6.3.1	Formulation of the continuous-time problem	183
6.3.2	Convexity	185
6.4	HJB equations	187
6.4.1	HJB equation for the value function	187
6.4.2	HJB equation for the Legendre-Fenchel transform	190
6.4.3	HJB equation for the highest reachable level of probability	191
6.5	Numerical methods	191
6.5.1	Semi-Lagrangian schemes	192
6.5.2	Finite-difference schemes	194
6.5.3	Possible approaches for the dynamic programming method	195
6.6	Numerical tests	196
6.6.1	Description of the problem	196
6.6.2	Results	198
6.7	Study of an asset-liability management problem	204
6.7.1	Setting	204
6.7.2	Properties of the value function	205
6.7.3	HJB equations	206
6.7.4	Numerical results	209

6.1 Introduction

In this chapter, we study stochastic optimal control problems with an expectation constraint. More precisely, we would like that the expectation of a given function g of the final state X_T is greater or equal than a given value z . This framework includes some chance-constrained problems: if g is the indicator function of a subset K , we therefore ensure that the probability for the final state to belong to K is greater than z . We refer to [94] and [104, Section 4] for general references on chance-constrained optimization problems. We start our analysis with discrete-time problems, and then use it for continuous-time problems.

We focus on two possible approaches to solve these problems. The first one consists in adding a supplementary state variable, denoted by Z , which is the conditional expectation of $g(X_T)$. Introducing this variable enables us to transform the problem into a stochastic target problem, that is to say, a problem for which the final-state constraint must be satisfied almost surely. As a consequence, a dynamic programming approach can be developed for the value function $V(t, x, z)$ of the problem, where t is the time, x the initial state, and z the level for the expectation constraint. This approach was used, for example in [84, Section 3], in [86, Section 4] for discrete-time problems (as well as the thesis [91] in French). It was successfully applied in [92, Section 4] to a power management problem for hybrid vehicles. In [83], it is proved that the value function of stochastic target problems (therefore including chance-constrained problems) is the viscosity solution to a certain HJB equation (see also [105, Chapter 8] and the lecture notes [82]).

The second method is the Lagrangian relaxation method [96, Chapter XII], [99]. Instead of dealing directly with the expectation constraint, we add the term $-\lambda\mathbb{E}[g(X_T)]$ to the cost function to be minimized, so that the problem is reduced to a standard unconstrained stochastic optimal control problem. The dual variable $\lambda \geq 0$ ensuring the level z of expectation is unknown and must be found iteratively. This technique is used in [75], for example.

If the dynamic of the system is linear and if g is concave, the expectation constraint is a convex constraint, in so far as for two given controls satisfying the expectation constraint, the average control also satisfies the constraint. In general, this property is not satisfied, therefore, the Lagrange relaxation cannot provide an optimal control for all the values of z . Note that the set of controls satisfying the constraint may even be not connected. These issues are studied in [93, 95]. On the other hand, the dynamic programming method enables us to deal with the apparent nonconvexity, but is more complex, since it requires a supplementary variable, which is a martingale. In the case of continuous-time problems, the volatility of this martingale is unbounded, which is a supplementary difficulty, and the domain of the value function is *a priori* unknown.

In section 6.2, we study a discrete-time optimal control problem. We describe a natural relaxation of the problem, which consists in allowing the player to choose a mixed strategy for the control. In this framework, the (relaxed) value function is convex with respect to z and some links between the two methods that we mentioned appear, thanks to the Legendre-Fenchel transform of the value function. We prove that if λ is the dual

variable associated with our problem, it is a subgradient of the relaxed value function with respect to z , for all t , along any optimal trajectory. In section 6.3, we formulate a continuous-time stochastic optimal control problem with an expectation constraint. We prove that if g is Lipschitz, the value function is convex with respect to z without relaxation. In section 6.4, we state the HJB equations associated with different value functions. Note that we only give a formal derivation of the HJB equation of the value function associated with the original problem. We propose numerical schemes in section 6.5, adapted from classical schemes for stochastic optimal control [97, 98]. These schemes use the analysis of section 6.2. A natural commutativity property between the discretization of the value function and the Legendre-Fenchel transformation appears. Finally, section 6.7 is dedicated to a chance-constrained asset-liability management problem.

6.2 Discrete-time chance-constrained control problems

6.2.1 First properties

Formulation We consider a discrete-time stochastic optimal control problem with an expectation constraint, which is a generalization of probabilistic constraints. Let $T \in \mathbb{N}^*$, let $(\xi_j)_{j=1,\dots,T}$ be T independent random values. For all $j \in \{0, \dots, T\}$, we denote by $\mathcal{F}_{0,j}$ the σ -algebra generated by $\{\xi_1, \dots, \xi_j\}$ and we denote by \mathbb{F}_0 the filtration $(\mathcal{F}_{0,j})_{j=0,\dots,T}$.

To simplify, we assume that the random values ξ_j are independent and identically distributed, with a discrete law. Let $I \in \mathbb{N}^*$ and $(p_i)_{i=1,\dots,I}$ in $[0, 1]^I$ be such that $\sum_{i=1}^I p_i = 1$, we assume that for all $i \in \{1, \dots, I\}$,

$$\mathbb{P}[\xi_j = i] = p_i. \quad (6.1)$$

Now, let us consider a stochastic process $(X_j)_{j=0,\dots,T}$ with values in \mathbb{R}^n , modeled as a controlled Markov chain. The values of the control process $u = (u_j)_{j=0,\dots,T-1}$ belong to a subset U of \mathbb{R}^m . The dynamic of X is given by

$$\begin{cases} X_{j+1} = f(X_j, u_j, \xi_{j+1}), & \forall j = 0, \dots, T-1, \\ X_0 = x_0. \end{cases} \quad (6.2)$$

We consider a non-anticipative constraint: u must be \mathbb{F}_0 -adapted. We denote by \mathcal{U}_0 the set of control processes in U satisfying this constraint. For all $u \in \mathcal{U}_0$, there exists a unique process denoted by $(X_j^{0,x_0,u})_{j=0,\dots,T}$ which is solution to (6.2). Note that $X^{0,x_0,u}$ is \mathbb{F}_0 -adapted. To sum up, the decision process is as follows:

$$\begin{aligned} x_0 &\rightarrow \text{decision of } u_0 \rightarrow \text{observation of } \xi_1 \rightarrow x_1 \rightarrow \dots \rightarrow \\ x_j &\rightarrow \text{decision of } u_j \rightarrow \text{observation of } \xi_{j+1} \rightarrow x_{j+1} \rightarrow \dots \rightarrow x_T. \end{aligned}$$

Let $\phi : \mathbb{R}^n \rightarrow \mathbb{R}$ and $g : \mathbb{R}^n \rightarrow \mathbb{R}$, let $z_0 \in \mathbb{R}$, we consider the following stochastic optimal control problem:

$$\min_{u \in \mathcal{U}_0} \mathbb{E}[\phi(X_T^{0,x_0,u})] \quad (6.3)$$

$$\text{s.t. } \mathbb{E}[g(X_T^{0,x_0,u})] \geq z_0. \quad (6.4)$$

The assumptions on the problem are the following: f is continuous with respect to x and u , g and ϕ are continuous, and U is compact, so that the existence of optimal solutions is ensured (provided that the problem is feasible).

Remark 6.1. *The case of a probabilistic constraint of the following form:*

$$\mathbb{P}[h(X_T^{0;x_0,u}) \geq 0] \geq z \quad (6.5)$$

enters into this framework, by setting

$$g(x) = \mathbf{1}_{\mathbb{R}_+}(h(x)) := \begin{cases} 1 & \text{if } h(x) \geq 0, \\ 0 & \text{otherwise.} \end{cases} \quad (6.6)$$

Of course, g is not continuous in this case, but the existence of optimal solutions is still ensured if the other assumptions on f , ϕ , and U still hold, and provided that the problem is feasible.

Convex analysis tools This paragraph is a very short introduction to some notions of convex analysis [103]. The notations that we will use there are independent of the article. Let $V : z \in \mathbb{R} \mapsto \mathbb{R} \cup \{+\infty\}$. We denote by V^* its Legendre-Fenchel transform, defined for all $\lambda \in \mathbb{R}$ by

$$V^*(\lambda) = \sup_{z \in \mathbb{R}} \{\lambda z - V(z)\}. \quad (6.7)$$

If $z \mapsto V(z)$ is nondecreasing, which will always be the case in the sequel, then

$$V(\lambda) = +\infty, \quad \forall \lambda < 0. \quad (6.8)$$

By definition, for all z and λ ,

$$V(z) + V^*(\lambda) \geq z\lambda. \quad (6.9)$$

The subdifferential ∂V is the multimapping, possibly empty, defined for all $z \in \mathbb{R}$ by

$$\partial V(z) = \{\lambda \in \mathbb{R} : V(z') - V(z) \geq \lambda(z' - z), \forall z' \in \mathbb{R}\}. \quad (6.10)$$

Observe that for all z and λ ,

$$V(z) + V^*(\lambda) = z\lambda \iff \lambda \in \partial V(z). \quad (6.11)$$

Finally, we denote by $\text{conv}(V)$ the convex envelope of V , defined as the greatest convex and lower semi-continuous function which is smaller than V . Note that by the Fenchel-Moreau-Rockafellar Theorem, if $\text{conv}(V)(z) > -\infty$, then

$$\text{conv}(V)(z) = V^{**}(z). \quad (6.12)$$

In this chapter, the functions V that will be used will depend on several variables, but the Legendre-Fenchel transform, the subdifferential, and the convex envelope will be always considered with respect to z only.

Let us introduce the Lagrangian relaxation, for an abstract optimization problem. We consider the following family of problems:

$$V(z) = \operatorname{Min}_{x \in X} f(x) \quad \text{s.t. } g(x) \geq z, \quad (6.13)$$

where the space X is given, $f : X \rightarrow \mathbb{R}$ and $g : X \rightarrow \mathbb{R}$ are also given. Let us compute the Legendre-Fenchel transform of the value function V . Let $\lambda \geq 0$.

$$\begin{aligned} V^*(\lambda) &= \sup_{z \in \mathbb{R}} \left\{ \lambda z - \inf_{x, g(x) \geq z} f(x) \right\} \\ &= \sup_x \sup_{z \leq g(x)} \left\{ \lambda z - f(x) \right\} \\ &= \sup_x \left\{ \lambda g(x) - f(x) \right\} \\ &= - \inf_x \left\{ f(x) - \lambda g(x) \right\}. \end{aligned} \quad (6.14)$$

It can be easily checked that for $\lambda < 0$, $V^*(\lambda) = +\infty$. We call dual problem the minimization problem in 6.14. Observe that V and V^* are both nonincreasing. In the following lemma, we consider that the existence of optimal solutions to problems (6.13) and (6.14) is ensured for all $z \in \mathbb{R}$ and for all $\lambda \geq 0$. We denote by $x(\lambda)$ the solution to (6.14), for a given value of λ .

Lemma 6.2. *Let $\lambda \geq 0$. Then, $x(\lambda)$ is a solution to (6.13), with $z = g(x(\lambda))$. Moreover, the mapping $\lambda \in \mathbb{R}_+ \mapsto g(x(\lambda))$ is nondecreasing.*

Proof. Let $\lambda \geq 0$ and let x be such that $g(x) \geq g(x(\lambda))$. Then,

$$f(x) \geq f(x(\lambda)) + \lambda(g(x) - g(x(\lambda))) \geq f(x(\lambda)), \quad (6.15)$$

which proves the first part of the lemma. Let $0 \leq \lambda_1 < \lambda_2$, let $x_1 = x(\lambda_1)$ and $x_2 = x(\lambda_2)$, then

$$f(x_1) - \lambda_1 g(x_1) \leq f(x_2) - \lambda_1 g(x_2), \quad (6.16)$$

$$f(x_2) - \lambda_2 g(x_2) \leq f(x_1) - \lambda_2 g(x_1), \quad (6.17)$$

and summing these two inequalities, we obtain that

$$(\lambda_2 - \lambda_1)g(x_1) \leq (\lambda_2 - \lambda_1)g(x_2), \quad (6.18)$$

which concludes the lemma. \square

Dynamic programming Let us go back to our stochastic optimal control problem. Let us first introduce some notations. Let $j \in \{0, \dots, T\}$, for all $k \geq j$, we denote by $\mathcal{F}_{j,k}$ the σ -algebra generated by ξ_{j+1}, \dots, ξ_k and we denote by \mathbb{F}_j the associated filtration. We denote by \mathcal{U}_j the set of \mathbb{F}_j -adapted control processes $(u_k)_{k=j, \dots, T}$. Finally, for all $x \in \mathbb{R}^n$, for all $u \in \mathcal{U}_j$, we denote by $(X_k^{j,x,u})_{k=j, \dots, T}$ the solution to

$$\begin{cases} X_{k+1}^{j,x,u} = f(X_k^{j,x,u}, u_k, \xi_{k+1}), & \forall k = j, \dots, T-1, \\ X_j^{j,x,u} = x. \end{cases} \quad (6.19)$$

Note that $X^{j,x,u}$ is \mathbb{F}_j -adapted. For all $j \in \{0, \dots, T\}$, for all $x \in \mathbb{R}^n$, and for all $z \in \mathbb{R}$, we set

$$V_j(x, z) = \min_{u \in \mathcal{U}_j} \mathbb{E}[\phi(X_T^{j,x,u}) | \mathcal{F}_{j,T}], \quad (6.20)$$

$$\text{s.t. } \mathbb{E}[g(X_T^{j,x,u}) | \mathcal{F}_{j,T}] \geq z. \quad (6.21)$$

Note that for all j and all x , $V_j(x, \cdot)$ is nondecreasing.

Lemma 6.3. *Let $z \in \mathbb{R}$, $j \in \{0, \dots, T\}$, $x \in \mathbb{R}^n$ and $u \in \mathcal{U}_j$. Then, the constraint (6.21) holds if and only if there exists an \mathbb{F}_j -adapted martingale $(Z_k)_{k=j, \dots, T}$ satisfying*

$$Z_j = z \quad \text{and} \quad Z_T \leq g(X_T^{j,x,u}). \quad (6.22)$$

Proof. Assume that an \mathbb{F}_j -adapted martingale Z satisfying (6.22) exists. Then,

$$\mathbb{E}[g(X_T^{j,x,u}) | \mathcal{F}_{j,T}] \geq \mathbb{E}[Z_T | \mathcal{F}_{j,T}] = Z_j = z, \quad (6.23)$$

and (6.21) holds. Conversely, assume that (6.21) holds and define

$$Z_k = \mathbb{E}[g(X_T^{j,x,u}) | \mathcal{F}_{j,k}] - (\mathbb{E}[g(X_T^{j,x,u})] - z). \quad (6.24)$$

Clearly, Z is an adapted martingale and (6.22) holds. \square

The following proposition states the dynamic programming principle associated with our problem and shows that the Legendre-Fenchel transform of the value function also satisfies a dynamic programming principle.

Proposition 6.4. *The value function $V_j(x, z)$ satisfies the following relations:*

$$V_T(x, z) = \begin{cases} \phi(x) & \text{if } g(x) \geq z, \\ +\infty & \text{otherwise,} \end{cases} \quad (6.25)$$

$$V_j(x, z) = \inf_{\substack{u \in U, (z_i)_{i=1}^I \in \mathbb{R}^I \\ \sum_{i=1}^I p_i z_i = z}} \sum_{i=1}^I p_i V_{j+1}(f(x, u, i), z_i), \quad \forall j = 0, \dots, T-1. \quad (6.26)$$

Given j and x , for all $u \in \mathcal{U}_j$ and all adapted martingale Z , u is an optimal solution and Z satisfies (6.22) if and only if for all $j \leq k < T$, (u_k, Z_{k+1}) is a solution to (6.26) with probability 1.

Moreover, the Legendre-Fenchel transform of the value function satisfies for all $\lambda \geq 0$

$$V_T^*(x, \lambda) = g(x)\lambda - \phi(x) \quad (6.27)$$

$$V_j^*(x, \lambda) = \sup_{u \in U} \left\{ \sum_{i=1}^I p_i V_{j+1}^*(f(x, u, i), \lambda) \right\}, \quad \forall j = 0, \dots, T-1. \quad (6.28)$$

For all $\lambda < 0$, $V_j(x, \lambda) = +\infty$.

Proof. The first part of the proposition (relations (6.25) and (6.26)) is classical and follows directly from Lemma 6.3. Relation (6.27) follows from the definition. Finally, let us prove (6.28). Let $j \in \{0, \dots, T-1\}$, let $x \in \mathbb{R}^n$. Then,

$$V_j^*(x, \lambda) = \sup_{z \in \mathbb{R}} \left\{ \lambda z - \inf_{\substack{u \in U, (z_i)_{i \in \mathbb{R}^I} \\ \sum_{i=1}^I p_i z_i = z}} \left\{ \sum_{i=1}^I p_i V_{j+1}^*(f(x, u, i), z_i) \right\} \right\} \quad (6.29)$$

$$= \sup_{u \in U, (z_i)_{i \in \mathbb{R}^I}} \left\{ \sum_{i=1}^I p_i (\lambda z_i - V_{j+1}^*(f(x, u, i), z_i)) \right\} \quad (6.30)$$

and relation (6.28) follows. \square

Remark 6.5. 1. Relation (6.28) is an extension of the following well-known property: the Legendre-Fenchel transform of the inf-convolution of two functions is the sum of the transforms of these two functions.

2. By (6.14), $V_j^*(x, \lambda)$ is the value function associated with the following cost (which is maximized):

$$\mathbb{E}[g(X_T^{t,x,u})\lambda - \phi(X_T^{t,x,u})]. \quad (6.31)$$

Relation (6.28) is nothing but the dynamic programming principle associated with this new cost function.

6.2.2 Relaxation

Formulation We consider a relaxed version of the previous problem, which is natural in the framework of stochastic problems with an expectation constraint. The value function that we obtain is the convex envelope (with respect to the variable z) of the value function of the unrelaxed problems. Therefore, the dynamic programming principle satisfied by the Legendre-Fenchel transform of the value function can be used.

Let us consider a supplementary sequence $(\zeta_j)_{j=0, \dots, T-1}$ of i.i.d. variables with common law the uniform law on $[0, 1]$. The dynamic of the state variable X is unchanged. At time j , before taking a decision u_j , the player is allowed to observe ζ_j and its decision may depend on ζ_j . The expectation constraint is now seen in the σ -algebra generated by the random processes $(\xi_j)_j$ and $(\zeta_j)_j$. The new decision process is as follows:

$$\begin{aligned} x_0 &\rightarrow \text{observation of } \zeta_0 \rightarrow \text{decision of } u_0 \rightarrow \text{observation of } \xi_1 \rightarrow x_1 \rightarrow \dots \\ x_j &\rightarrow \text{observation of } \zeta_j \rightarrow \text{decision of } u_j \rightarrow \text{observation of } \xi_{j+1} \rightarrow x_{j+1} \rightarrow \dots \end{aligned}$$

Let us give a more precise description of this process. In this section, the superscript r will stand for “relaxed”. At time j , the “ \sim ” symbol will be used for the mathematical objects defined after the observation of ζ_j . For all $j \in \{1, \dots, T-1\}$ and for all $k \geq j$, we set

$$\begin{cases} \mathcal{F}_{j,k}^r = \sigma(\xi_{j+1}, \dots, \xi_k, \zeta_j, \dots, \zeta_{k-1}), \\ \tilde{\mathcal{F}}_{j,k}^r = \sigma(\xi_{j+1}, \dots, \xi_k, \zeta_j, \dots, \zeta_k). \end{cases} \quad (6.32)$$

and we denote by \mathbb{F}_j^r and $\tilde{\mathbb{F}}_j^r$ the associated filtrations. We introduce a third filtration, defined by

$$\mathbb{G}_j^r = (\mathcal{F}_{j,j}^r, \tilde{\mathcal{F}}_{j,j}^r, \mathcal{F}_{j,j+1}^r, \tilde{\mathcal{F}}_{j,j+1}^r, \dots, \mathcal{F}_{j,T}^r). \quad (6.33)$$

We denote by \mathcal{U}_j^r the set of $\tilde{\mathbb{F}}_j^r$ -adapted control processes $(u_k)_{k=j,\dots,T-1}$ with values in U . For all $u \in \mathcal{U}_j^r$ and all $x \in \mathbb{R}^n$, we still denote by $(X_k^{j,x,u})_{k=j,\dots,T}$ the solution to (6.2), which is an \mathbb{F}_j^r -adapted process.

Dynamic programming We introduce a new value function:

$$V_j^r(x, z) = \min_{u \in \mathcal{U}_j^r} \mathbb{E}[\phi(X_T^{j,x,u}) | \mathcal{F}_{j,T}^r], \quad (6.34)$$

$$\text{s.t. } \mathbb{E}[g(X_T^{j,x,u}) | \mathcal{F}_{j,T}^r] \geq z, \quad (6.35)$$

where the expectancies are considered in $\mathcal{F}_{j,T}^r$.

On figure 6.1, we give an example of a relaxed value function. The shape of this graph is typical of a chance-constrained optimization problem, where the set of random events is discrete. On this figure, the different probabilities that can arise are: 0, 1/3, 2/3 and 1. For the probability 1/2, the optimal control for the unrelaxed problem necessarily ensure a probability of 2/3. The optimal control for the relaxed problem uses the two optimal controls associated with the levels 1/3 and 2/3, both with probability 1/2.

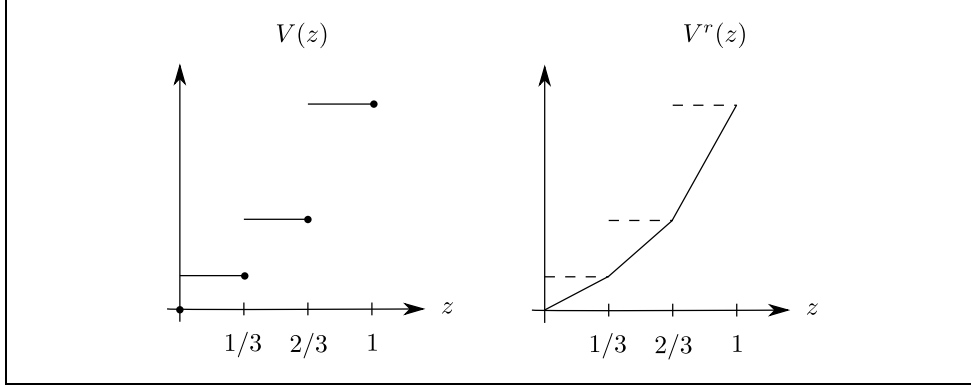

Figure 6.1: Example of a relaxed value function, for a chance-constrained problem.

We also need an intermediate value function, defined for all $x \in \mathbb{R}^n$, $z \in \mathbb{R}$ and $s \in [0, 1]$ by

$$\tilde{V}_j^r(x, z, s) = \begin{cases} \min_{u \in \mathcal{U}^r} \mathbb{E}[\phi(X_T^{j,x,u}) | \zeta_j = s] \\ \text{s.t. } \mathbb{E}[g(X_T^{j,x,u}) | \zeta_j = s] \geq z. \end{cases} \quad (6.36)$$

Actually, this value function does not depend on s , therefore, we will always write $\tilde{V}_j^r(x, z)$ in the sequel. Note that V_j^r and \tilde{V}_j^r are both nondecreasing with respect to z . Moreover, for all j , for all $x \in \mathbb{R}^n$ and all $z \in \mathbb{R}^n$,

$$V_j^r(x, z) \leq \tilde{V}_j^r(x, z) \leq V_j(x, z). \quad (6.37)$$

Lemma 6.6. *Let $j, z \in \mathbb{R}, x \in \mathbb{R}^n, u \in \mathcal{U}_j$. Then, the constraint (6.35) holds if and only if there exists a \mathbb{G}_j^r -adapted martingale $(Z_j, \tilde{Z}_j, Z_{j+1}, \dots, Z_T)$ which is such that*

$$Z_j = z \quad \text{and} \quad Z_T \leq g(X_T^{j,x,u}) \quad \text{a.s.} \quad (6.38)$$

The proof of this lemma is similar to the one of Lemma 6.3. The following lemma is the dynamic programming principle associated with the relaxed problem.

Lemma 6.7. *The value function $V_j^r(x, z)$ satisfies the following relations:*

$$V_T^r(x, z) = \begin{cases} \phi(x) & \text{if } g(x) \geq z, \\ +\infty & \text{otherwise,} \end{cases} \quad (6.39)$$

$$\tilde{V}_j^r(x, z) = \inf_{\substack{u \in U, (z_i)_{i \in \mathbb{R}^I} \\ \sum_{i=1}^I p_i z_i = z}} \left\{ \sum_{i=1}^I p_i V_{j+1}^r(f(x, u, i), z_i) \right\}, \quad (6.40)$$

$$V_j^r(x, z) = \text{conv}(\tilde{V}_j^r)(x, z) \quad (6.41)$$

$\forall j = 0, \dots, T-1.$

Moreover, the Legendre-Fenchel transform of V_j^r satisfies the same relations as V_j^* , for all $\lambda \geq 0$:

$$V_T^{r,*}(x, \lambda) = g(x)\lambda - \phi(x) \quad (6.42)$$

$$V_j^{r,*}(x, \lambda) = \sup_{u \in U} \left\{ \sum_{i=1}^I p_i V_{j+1}^{r,*}(f(x, u, i), \lambda) \right\}, \quad \forall j = 0, \dots, T-1. \quad (6.43)$$

Proof. Let us prove the first part of the lemma. Equations (6.39) and (6.40) are obtained with Lemma 6.6. We also obtain with Lemma 6.6 that

$$V_j^r(x, z) = \inf_{\substack{\tilde{z} \in L^1[0,1] \\ \int_0^1 \tilde{z}(s) ds = z}} \int_0^1 \tilde{V}_j^r(x, \tilde{z}(s)) ds, \quad (6.44)$$

which proves (6.41).

Let us prove the second part of the lemma. Relation (6.42) follows directly from (6.39). Similarly to the proof of Lemma 6.4, we obtain that

$$\tilde{V}_j^{r,*}(x, \lambda) = \sup_{u \in U} \left\{ \sum_{i=1}^I p_i V_{j+1}^{r,*}(f(x, u, i), \lambda) \right\}. \quad (6.45)$$

Since a function and its convex envelope have the same Legendre-Fenchel transform, we obtain (6.43), with (6.41). \square

Remark 6.8. 1. *The dynamic programming principle associated with $V_j^{r,*}(x, \lambda)$ does not involve a dynamic on λ . In other words, for two prescribed $\lambda_1 \geq 0$ and $\lambda_2 \geq 0$, the functions $(j, x) \mapsto V_j^{r,*}(x, \lambda_1)$ and $(j, x) \mapsto V_j^{r,*}(x, \lambda_2)$ can be computed independently. This property is strongly linked with the fact that the sensitivity with respect to the variable z is constant over time, as we show in Proposition 6.11.*

2. As a corollary of Lemma 6.7, we obtain that $V_j^*(x, \lambda)$ and $V_j^{r,*}(x, \lambda)$ are equal. Therefore,

$$V_j^r = \text{conv}(V_j). \quad (6.46)$$

This also means that if the relaxed problem starts at time j , the player can choose a control u which is at any time $k \geq j$ a function of $\zeta_j, \xi_j, \dots, \xi_k$.

Consequences of the dynamic programming principle We study now two important consequences of the dynamic programming principle satisfied by $V_j^{r,*}$. We prove in Proposition 6.11 that the sensitivity of the value function with respect to the level z is in some sense constant over time, for an optimal control. We also prove in Proposition 6.12 that a feedback control obtained by solving the dual problem (6.43) provides an optimal control, for an a priori unknown level z . We start with two technical lemmas.

Lemma 6.9. *Let $j \in \{0, \dots, T-1\}$, $x \in \mathbb{R}^n$, $\lambda \geq 0$, $z \in \mathbb{R}$, and $\tilde{z} \in L^1([0, 1])$ such that $\int_0^1 \tilde{z}(s) ds = z$. Consider the three following statements:*

$$(S1) \lambda \in \partial V_j(x, z), \quad (S2) \tilde{z} \text{ is a solution to (6.44)}, \quad (S3) \lambda \in \partial \tilde{V}_j^r(x, \tilde{z}(s)), \text{ a.s.}$$

Then,

$$(S1) \text{ and } (S2) \iff (S3). \quad (6.47)$$

Proof. Let us set

$$\begin{cases} A = \lambda z - V_j^{r,*}(x, \lambda) = \int_0^1 (\lambda \tilde{z}(s) - V_j^{r,*}(x, \lambda)) ds, \\ B = V_j^r(x, z), \\ C = \int_0^1 \tilde{V}_j^r(x, \tilde{z}(s)) ds. \end{cases} \quad (6.48)$$

Then, by (6.9), $A \leq B \leq C$ and by (6.11),

$$(S1) \iff A = B, \quad (S2) \iff B = C, \quad (S3) \iff A = C. \quad (6.49)$$

The lemma follows. \square

Lemma 6.10. *Let $j \in \{0, \dots, T\}$, $x \in \mathbb{R}^n$, $u \in \mathbb{R}^m$, $\lambda \geq 0$, $z \in \mathbb{R}$, and $(z_i)_{i=1, \dots, I}$ such that $\sum_{i=1}^I p_i z_i = z$. Consider the following four statements:*

$$(S1) \lambda \in \partial \tilde{V}_j^r(x, z)$$

$$(S2) u, z_1, \dots, z_I \text{ is a solution to (6.40)}$$

$$(S3) u \text{ is a solution to (6.43)}$$

$$(S4) \lambda \in \partial V_{j+1}^r(f(x, u, i), z_i), \quad \forall i = 1, \dots, I$$

Then, the following equivalence holds:

$$(S1) \text{ and } (S2) \iff (S3) \text{ and } (S4). \quad (6.50)$$

Proof. Let us set

$$\begin{cases} A = z\lambda - V_j^{r,*}(x, \lambda) = z\lambda - \tilde{V}_j^{r,*}(x, \lambda) \\ B = \tilde{V}_j^r(x, z) \\ C = \sum_{i=1}^I p_i(\lambda z_i - V_{j+1}^{r,*}(f(x, u, i), \lambda)) \\ D = \sum_{i=1}^I p_i V_{j+1}^r(f(x, u, i), z_i). \end{cases} \quad (6.51)$$

It easy to check that

$$A \leq B \leq D \quad \text{and} \quad A \leq C \leq D, \quad (6.52)$$

as a consequence of the general relation (6.9) and of the non-optimality of u, z_1, \dots, z_I in problems (6.40) and (6.43). Moreover, by (6.11), we also obtain that

$$\begin{cases} \text{(S1)} \iff A = B, & \text{(S2)} \iff B = D, \\ \text{(S3)} \iff A = C, & \text{(S4)} \iff C = D. \end{cases} \quad (6.53)$$

Combining (6.51), (6.52), and (6.53), we obtain that

$$\text{(S1) and (S2)} \iff A = B = D \iff A = C = D \iff \text{(S3) and (S4)} \quad (6.54)$$

and the lemma follows. \square

Proposition 6.11. *Let $j \in \{0, \dots, T-1\}$, $x \in \mathbb{R}^n$, $z \in \mathbb{R}$, let $u \in \mathcal{U}_j$ be an optimal solution to problem (6.34)-(6.35), let $(Z_j, \tilde{Z}_j, \dots, Z_T)$ be a \mathbb{G}_j -adapted martingale satisfying (6.38). Finally, let $\lambda \in \partial V_j^r(x, z)$. Then,*

$$\lambda \in \partial \tilde{V}_k^r(X_k^{j,x,u}, \tilde{Z}_k), \text{ a.s.} \quad \text{and} \quad \lambda \in \partial V_{k+1}^r(X_{k+1}^{j,x,u}, Z_{k+1}) \quad \forall k = j, \dots, T-1. \quad (6.55)$$

Proof. Let us prove the property for $k = j$. By Lemma 6.9 and Lemma 6.10 (the \implies of (6.47) and (6.50)), we obtain successively that

$$\lambda \in \partial \tilde{V}_j^r(X_j^{j,x,u}, \tilde{Z}_j) \quad \text{and} \quad \lambda \in \partial V_{j+1}^r(X_{j+1}^{j,x,u}, Z_{j+1}), \text{ a.s.} \quad (6.56)$$

We have proved the lemma for $k = j$. The general result follows by induction. \square

Proposition 6.12. *Let $j \in \{0, \dots, T-1\}$, $x \in \mathbb{R}^n$, let $u \in \mathcal{U}_j$ and let $\lambda \geq 0$. Assume that for all k , u_k is a solution to problem (6.43), where $x = X_k^{j,x,u}$. Let*

$$z = \mathbb{E}[g(X_T^{j,x,u})], \quad (6.57)$$

then u is an optimal solution of problem (6.34)-(6.35), and since it is not relaxed, it is a solution to (6.20)-(6.21).

Proof. Let us define the \mathbb{G}_j -adapted martingale $(Z_j, \tilde{Z}_j, \dots, Z_T)$ as in Lemma 6.6. By (6.39),

$$\partial V_T^r(x, g(x)) = \mathbb{R}_+, \quad (6.58)$$

therefore, by (6.38),

$$\lambda \in \partial V_T^r(X_T^{j,x,u}, Z_T) \quad (6.59)$$

and by Lemma 6.10 (the \Leftarrow part of (6.50)), we obtain that (u_{T-1}, Z_T) is a solution to problem (6.40) and that

$$\lambda \in \tilde{V}_{T-1}^r(X_{T-1}^{j,x,u}, \tilde{Z}_{T-1}). \quad (6.60)$$

By Lemma 6.9 (the \Leftarrow part of (6.47)), we obtain that \tilde{Z}_{T-1} is a solution to problem (6.44) and that

$$\lambda \in V_{T-1}^r(X_{T-1}^{j,x,u}, Z_{T-1}). \quad (6.61)$$

By a backward induction, we obtain that for all $k = T-1, \dots, j$, (u_k, Z_{k+1}) is a solution to problem (6.40), which proves that u is an optimal control. \square

Note that this result is also a consequence of Lemma 6.2, which also implies that if u_1 and u_2 are two optimal strategies for the penalized problems with $0 \leq \lambda_1 < \lambda_2$, then

$$\mathbb{E}[g(X_T^{t,x,u_2})] \geq \mathbb{E}[g(X_T^{t,x,u_1})]. \quad (6.62)$$

6.2.3 Application

Let us go back to the resolution of problem (6.3)-(6.4) and its relaxed version. Consider a mapping $v : \lambda \mapsto v(j, x, \lambda) \in U$ which is such that for all $j, x, \lambda \geq 0$, $v(j, x, \lambda)$ is a solution to (6.43). This mapping may not be uniquely defined. We consider then the mapping $\lambda \mapsto u(\lambda) \in \mathcal{U}$ which is such that for all λ , for all j ,

$$u_j(\lambda) = v(j, X_j^{0,x_0,u(\lambda)}, \lambda). \quad (6.63)$$

It is clear from Proposition 6.12 that for all $\lambda \geq 0$, $u(\lambda)$ is an optimal control for problem (6.3)-(6.4), with an undefined level z . Let us consider this level, that we denote by $Z_0(x_0, \lambda)$ and define by

$$Z_0(x_0, \lambda) = \mathbb{E}[g(X_T^{0,x_0,u(\lambda)})]. \quad (6.64)$$

This level can be computed with a dynamic programming approach, by introducing the function $Z_j(x, \lambda)$, solution to:

$$Z_T(x, \lambda) = g(x) \quad (6.65)$$

$$Z_j(x, \lambda) = \sum_{i=1}^I p_i Z_{j+1}(f(x, v(j, x, \lambda), i), \lambda). \quad (6.66)$$

As we already mentioned, the mapping $\lambda \mapsto Z_j(x, \lambda)$ is non-decreasing.

To sum up, we are able, for all λ , to compute $V^*(0, x_0, \lambda)$ and to compute an optimal control associated, which is optimal for a certain level $Z(0, x_0, \lambda)$, which is a non-decreasing function of λ . Therefore, to solve the problem for a given level z , it suffices to solve the equation:

$$Z_0(x_0, \lambda) = z, \quad (6.67)$$

with unknown variable λ , with a dichotomy method (for example). Of course, this equation does not have solutions if there is a duality gap, that is to say, if $V_0(x_0, z) > V_0^r(x_0, z)$. Indeed, in this case, there will exist a value of λ , say $\bar{\lambda}$, which is such that

$$\lim_{\lambda \uparrow \bar{\lambda}} Z_0(x_0, \lambda) < z < \lim_{\lambda \downarrow \bar{\lambda}} Z(0, x_0, \lambda). \quad (6.68)$$

Let us denote by z^- and z^+ the two limits and by u^- and u^+ two optimal control strategies associated. In this situation, a relaxed optimal control for the value z by using u^- with probability $(z^+ - z)/(z^+ - z^-)$ and by using u^+ with probability $(z - z^-)/(z^+ - z^-)$.

Let us examine the advantages and drawbacks of this method.

- ▷ The computation of $V_j^*(x, \lambda)$ is simpler than $V_j(x, z)$, since it is associated with a standard optimal control problem, and since the dimension of the state variable is smaller. Of course, a certain number of iterations on λ is required.
- ▷ This method cannot compute an optimal control for the unrelaxed problem.

6.3 Properties of continuous-time optimal control problems

6.3.1 Formulation of the continuous-time problem

Setting Let n, m, d in \mathbb{N}^* , let $T > 0$, let W be a d -dimensional Brownian motion. We denote by $\mathbb{F} = (\mathcal{F}_t)_{t \in [0, T]}$ the filtration generated by W . Note that in the sequel, all the statements concerning random values are valid almost surely, unless otherwise specified. Consider the following dynamic for the state variable $X \in \mathbb{R}^n$ on $[0, T]$:

$$\begin{cases} dX_t = f(X_t, u_t) dt + \sigma(X_t, u_t) dW_t, \\ X_0 = x \end{cases} \quad (6.69)$$

where u_s is progressively measurable and belongs to a given compact U of \mathbb{R}^m . The unique solution to (6.69) is denoted $(X_t^{0, x, u})_{t \in [0, T]}$. We denote by \mathcal{U} the set of measurable controls in U and we aim at minimizing the following cost function:

$$\mathbb{E}[\phi(X_T^{0, x, u})]. \quad (6.70)$$

We consider now an expectation constraint:

$$\mathbb{E}[g(X_T) \geq 0] \geq z, \quad (6.71)$$

where $g : \mathbb{R}^n \rightarrow \mathbb{R}$ is a given mapping. Like before, this constraint contains the case of chance-constrained optimal control problems of the form:

$$\mathbb{P}[h(X_T) \geq 0] \geq z, \quad (6.72)$$

that can be obtained by setting $g = \mathbf{1}_{\mathbb{R}_+} \circ h$.

The mappings $f : \mathbb{R}^n \times \mathbb{R}^m \rightarrow \mathbb{R}^n$, $\sigma : \mathbb{R}^n \times \mathbb{R}^m \rightarrow \mathbb{R}^n \times \mathbb{R}^k$, $\phi : \mathbb{R}^n \rightarrow \mathbb{R}$ satisfy the classical regularity assumptions: there exists $L > 0$ such that for all $x, y \in \mathbb{R}^n$, for all $u \in U$,

$$|f(x, u)| + |\sigma(x, u)| + |\phi(x)| \leq L(1 + |x|), \quad (6.73)$$

$$|f(x, u) - f(y, u)| + |\sigma(x, u) - \sigma(y, u)| + |\phi(x) - \phi(y)| \leq L|y - x|, \quad (6.74)$$

so that the stochastic differential equation is well-posed [101, Section 5]. We assume that for all $x \in \mathbb{R}^n$,

$$|g(x)| \leq L(1 + |x|). \quad (6.75)$$

For the moment, we do not suppose that g is Lipschitz (or even continuous), so that we do not exclude the case of chance-constrained optimal control problems. However, we will need this assumption in Theorem 6.14.

Dynamic programming Let \mathcal{A} be the space of square-integrable measurable processes of dimension d . For $z \in [0, 1]$, $\alpha \in \mathcal{A}$, we denote by $(Z_t^{0,z,\alpha})_{t \in [0,T]}$ the solution to

$$\begin{cases} dZ_t = \alpha_t dW_t \quad (:= \sum_{i=1}^d \alpha_t^i dW_t^i), \\ Z_0 = z. \end{cases} \quad (6.76)$$

where α is seen as a row vector in \mathbb{R}^{d*} . Note that $Z^{0,z,\alpha}$ is a martingale.

Lemma 6.13. *Let $u \in \mathcal{U}$. Then, the probability constraint (6.71) holds if and only if there exists $\alpha \in \mathcal{A}$ such that the martingale $Z^{0,z,\alpha}$ satisfies*

$$Z_T^{0,z,\alpha} \leq g(X_T^{0,x,u}). \quad (6.77)$$

Moreover, if g is lower bounded by say \underline{g} (resp. upper bounded by say \bar{g}), and if $z \geq \underline{g}$ (resp. $z \leq \bar{g}$), we can impose that

$$Z_t^{0,z,\alpha} \geq \underline{g}, \quad (\text{resp. } Z_t^{0,z,\alpha} \leq \bar{g}). \quad (6.78)$$

Proof. Let α be such that (6.77) hold. Then, since Z is a martingale,

$$\mathbb{E}[g(X_T^{0,x,u})] \geq \mathbb{E}[Z_T^{z,\alpha}] = z. \quad (6.79)$$

Conversly, assume that expectation constraint (6.71) holds, set

$$z_0 = \mathbb{E}[g(X_T^{0,x,u})]. \quad (6.80)$$

Note that $z \leq z_0$. Define the martingale

$$Z_t = \mathbb{E}[g(X_T)|\mathcal{F}_t] - (z - z_0), \quad (6.81)$$

it satisfies (6.77). Let us suppose that g is lower bounded by \underline{g} . Let us defined the stopping time

$$\tau = \inf_t \{t : Z_t < \underline{g}\} \quad (6.82)$$

and let us set:

$$Z'_t = Z_{\min(t,\tau)}. \quad (6.83)$$

It is known that Z' is well-defined and is still a martingale (a *stopped* martingale). Moreover, it is easy to check that

$$Z'_t \leq \max(Z_t, \underline{g}), \quad (6.84)$$

therefore, (6.77) still holds for Z' . The proof is the same when g is upper bounded. Finally, the control α is obtained by the martingale representation problem [101, Theorem 4.3.4]. \square

This lemma allows to reformulate the problem of minimization of (6.70) under (6.71) as an optimal control problem with a stochastic target. For t , we denote by \mathcal{U}_t and \mathcal{A}_t the subsets of \mathcal{U} and \mathcal{A} of controls which are independent of \mathcal{F}_t . For x and z , for $u \in \mathcal{U}_t$, we denote resp. by $(X_s^{t,x,u})_{s \in [t,T]}$ and $(Z_s^{t,z,\alpha})_{s \in [t,T]}$ the solutions to (6.69) and (6.76), but with initial conditions $X_t^{t,x,u} = x$ and $Z_t^{t,z,\alpha} = z$. We introduce the value function V , defined by

$$V(t, x, z) = \inf_{u \in \mathcal{U}_t} \mathbb{E}[\phi(X_T^{t,x,u})] \quad \text{s.t.} \quad \mathbb{E}[g(X_T^{t,x,u})] \geq z \quad (6.85)$$

$$= \inf_{u \in \mathcal{U}_t, \alpha \in \mathcal{A}_t} \mathbb{E}[\phi(X_T^{t,x,u})] \quad \text{s.t.} \quad g(X_T^{t,x,u}) \geq Z_T^{t,z,\alpha}. \quad (6.86)$$

Observe that $z \mapsto V(t, x, z)$ is a nondecreasing function. Observe also that V may be infinite and that for all z , if $V(t, x, z) < +\infty$, then for all $z' \leq z$, $V(t, x, z') < +\infty$.

6.3.2 Convexity

In this subsection, we prove that the value function is convex with respect to z , if g is Lipschitz. This property is strongly linked to the relaxation technique studied in section 6.2. Let us give the main idea. Let us fix (t, x) , let u_1 and u_2 be two controls ensuring the levels $z_1 < z_2$. In a relaxed framework, we would prove the convexity by using the two controls u_1 and u_2 with probability 1/2. In an unrelaxed framework, the idea consists in observing the Brownian motion during a very short time, in order to decide which control should be used.

Theorem 6.14. *If g is uniformly Lipschitz, then for all $(t, x) \in [0, T]$, the mapping $z \mapsto V(t, x, z)$ is convex.*

Proof. Let $t \in [0, T]$, let $x \in \mathbb{R}^n$, let z_1 and z_2 be such that $V(t, x, z_1) < +\infty$, $V(t, x, z_2) < +\infty$, let $z = (z_1 + z_2)/2$. Let u^1 and u^2 in \mathcal{U}_t be such that

$$\mathbb{E}[g(X_T^{t,x,u^1})] \geq z_1 \quad \text{and} \quad \mathbb{E}[g(X_T^{t,x,u^2})] \geq z_2. \quad (6.87)$$

Let $\varepsilon > 0$. Let $\tilde{u}^1 \in \mathcal{U}_{t+\varepsilon}$ be such that the two following processes:

$$(u_{t+s}^1)_{s \in [0, T-(t+\varepsilon)]} \quad \text{and} \quad (\tilde{u}_{t+\varepsilon+s}^1)_{s \in [0, T-(t+\varepsilon)]} \quad (6.88)$$

have the same law. In other words, \tilde{u}^1 is obtained by delaying u^1 of ε . We similarly define \tilde{u}^2 . Let $p \in [0, 1]$, let $w(p)$ be such that $\frac{1}{\sqrt{2\pi}} \int_{-\infty}^{w(p)} e^{-\theta^2/2} d\theta = p$, let A_p be the following event:

$$W_{t+\varepsilon}^1 - W_t^1 \leq \sqrt{\varepsilon}w(p), \quad (6.89)$$

so that

$$\mathbb{P}[A_p] = p. \quad (6.90)$$

Finally, let $u^0 \in U$ and let $u(p) \in \mathcal{U}_t$ be such that

$$u_t(p) = u^0, \quad \forall t \in (t, t + \varepsilon), \quad u_t(p) = \begin{cases} \tilde{u}_t^1 & \text{if } A(p) \text{ is realized} \\ \tilde{u}_t^2 & \text{otherwise.} \end{cases} \quad (6.91)$$

In short, we use control u^1 with probability p and control u^2 with probability $(1 - p)$, after a small delay during which we observe the Brownian motion, in order to decide which control to use. We claim that there exists a constant $C > 0$ independent of p which is such that:

$$\mathbb{E}[g(X_T^{t,x,u(p)})] \geq pz_1 + (1 - p)z_2 - C\sqrt{\varepsilon}, \quad (6.92)$$

$$\mathbb{E}[\phi(X_T^{t,x,u(p)})] \leq p\mathbb{E}[\phi(X_T^{t,x,u^1})] + (1 - p)\mathbb{E}[\phi(X_T^{t,x,u^2})] + C\sqrt{\varepsilon}. \quad (6.93)$$

We will prove these estimates later. Let us suppose that $z_2 > z_1$, and let us set $p_\varepsilon = \frac{1}{2} - C\sqrt{\varepsilon}/(z_2 - z_1)$. It follows that

$$\mathbb{E}[g(X_T^{t,x,u(p_\varepsilon)})] \geq \frac{1}{2}(z_1 + z_2), \quad (6.94)$$

$$\mathbb{E}[\phi(X_T^{t,x,u(p_\varepsilon)})] \leq \frac{1}{2}(\mathbb{E}[\phi(X_T^{t,x,u^1})] + \mathbb{E}[\phi(X_T^{t,x,u^2})]) + O(\sqrt{\varepsilon}). \quad (6.95)$$

To the limit when $\varepsilon \downarrow 0$, we obtain that

$$V(t, x, z) \leq \frac{1}{2}(\mathbb{E}[\phi(X_T^{t,x,u^1})] + \mathbb{E}[\phi(X_T^{t,x,u^2})]), \quad (6.96)$$

and the result follows by minimizing the r.h.s. of the previous inequality.

Now, let us prove estimate (6.92), the proof of (6.93) being similar. First,

$$\mathbb{E}[g(X_T^{t,x,u(p)})] = p\mathbb{E}\left[g\left(X_T^{t+\varepsilon, X_{t+\varepsilon}^{t,x,u^0}, \tilde{u}^1}\right) \middle| A_p\right] + (1-p)\mathbb{E}\left[g\left(X_T^{t+\varepsilon, X_{t+\varepsilon}^{t,x,u^0}, \tilde{u}^2}\right) \middle| \bar{A}_p\right]. \quad (6.97)$$

Then, since g is Lipschitz,

$$\begin{aligned} \mathbb{E}\left[g\left(X_T^{t+\varepsilon, X_{t+\varepsilon}^{t,x,u^0}, \tilde{u}^1}\right) \middle| A_p\right] &= \mathbb{E}[g(X_T^{t+\varepsilon, x, \tilde{u}^1}) \middle| A_p] + O(\mathbb{E}[|X_{t+\varepsilon}^{t,x,u^0} - x|]) \\ &= \mathbb{E}[g(X_{T-\varepsilon}^{t,x,u^1})] + O(\sqrt{\varepsilon}) \\ &= \mathbb{E}[g(X_T^{t,x,u^1})] + O(\sqrt{\varepsilon}). \end{aligned} \quad (6.98)$$

These last estimates follow from classical a priori estimates for stochastic differential equations, themselves consequences of Gronwall's lemma and Itô's isometry. A similar estimate holds for u^2 and (6.92) follows. \square

Remark 6.15. 1. This result does not cover the case of chance-constrained problems when $g = \mathbf{1}_{\mathbb{R}_+} \circ h$. Proving the convexity (or the non-convexity) in this case is still an open question to us.

2. The notion of relaxed controls can naturally be defined for continuous-time problems. If g is Lipschitz, relaxing does not modify the value function.

6.4 HJB equations

In this section, we give three HJB equations that are satisfied by V , its Legendre-Fenchel transform, and by the boundary of the domain of V . Note that we only provide a formal derivation of the equation satisfied by V , which is different from the equation provided in [83] (for which a complete justification is provided). The control α , associated with the martingale Z is unbounded and therefore the (true) Hamiltonian may be infinite. The theory of discontinuous viscosity solutions enables to treat the case, but it is possible to reformulate the problem of minimization of the Hamiltonian so that it only involves bounded controls, as shown in [85]. This technique was also used in [79] and enabled the authors to derive a numerical scheme.

Note that in this section, the partial derivative with respect to time is denoted by $\partial_t V$ and the first- and second-order partial derivatives with respect to x are simply denoted by DV and D^2V . We never differentiate the Legendre-Fenchel transform V^* with respect to λ .

6.4.1 HJB equation for the value function

We denote by M_j the set of symmetric matrices of order j . For $p \in \mathbb{R}^{n^*}$ and $Q \in M_{n+1}$, with

$$Q = \begin{pmatrix} Q_{xx} & Q_{xz} \\ Q_{xz}^T & Q_{zz} \end{pmatrix}, \quad (6.99)$$

where $Q_{xx} \in M_n$, $Q_{xz} \in \mathbb{R}^n$, $Q_{zz} \in \mathbb{R}$, we define the *physical Hamiltonian* of the problem by

$$H^X(u, x, p, Q_{xx}) = pf(x, u) + \frac{1}{2} \text{tr} [\sigma(x, u) \sigma(x, u)^\top Q_{xx}] \quad (6.100)$$

and the *Hamiltonian* by

$$\begin{aligned} & H(u, \alpha, x, p, Q) \\ &= pf(x, u) + \frac{1}{2} \text{tr} \left[\begin{pmatrix} \sigma(x, u) \sigma(x, u)^\top & \sigma(x, u) \alpha^\top \\ \alpha \sigma(x, u)^\top & \alpha \alpha^\top \end{pmatrix} Q \right], \end{aligned} \quad (6.101)$$

where tr is the trace of a matrix. Observe that the two Hamiltonian are independent of z . We use the terminology *physical Hamiltonian* to emphasize the fact that H^X is the Hamiltonian associated with the physical variable X which would have been used in the absence of probability constraint. Finally, we define the true Hamiltonian by

$$H^*(x, p, Q) = \inf_{u \in U} \inf_{\alpha \in \mathbb{R}^{d^*}} H(u, \alpha, x, p, Q) \quad (6.102)$$

We also define for future reference the true physical Hamiltonian

$$H^{X,*}(x, p, Q_{xx}) = \inf_{u \in U} H^X(u, x, p, Q_{zz}). \quad (6.103)$$

We can write the Hamiltonian as follows:

$$H(u, \alpha, x, p, Q) = P_{u,x,p,Q}(\alpha), \quad (6.104)$$

where

$$P_{(u,x,p,Q)}(\alpha) := A + \alpha B + |\alpha|^2 C / 2 \quad (6.105)$$

is a polynomial of degree 2 with coefficients $A \in \mathbb{R}$, $B \in \mathbb{R}^d$, $C \in \mathbb{R}$ depending on (u, x, z, p, Q) and defined by

$$A := H^X(u, x, p, Q_{xx}), \quad B := \sigma(x, u)^\top Q_{xz}, \quad \text{and} \quad C := Q_{zz}. \quad (6.106)$$

Given (u, x, p, Q) , the infimum of $P_{(u,x,p,Q)}$ with respect to $\alpha \in \mathbb{R}^{d*}$ is given by

$$\frac{AC - |B|^2/2}{C} \text{ if } C > 0, \quad A \text{ if } C = 0 \text{ and } B = 0, \quad -\infty \text{ otherwise.} \quad (6.107)$$

Therefore, given (u, x, p, Q) , the minimum of the Hamiltonian w.r.t. α is given by

$$\left\{ \begin{array}{ll} \frac{H^X(u, x, p, Q_{xx})Q_{zz} - |\sigma(x, u)^\top Q_{xz}|^2/2}{Q_{zz}} & \text{if } Q_{zz} > 0, \\ H^X(u, x, p, Q_{xx}) & \text{if } Q_{zz} = 0 \text{ and } \sigma(x, u)^\top Q_{xz} = 0, \\ -\infty & \text{otherwise.} \end{array} \right. \quad (6.108)$$

The approach of [102] consists in describing the domain of the true Hamiltonian H^* with a nonnegative continuous function $G(x, p, Q)$ which is such that

$$\{H^*(x, p, Q) > -\infty\} \iff \{G(x, p, Q) > 0\}. \quad (6.109)$$

Then, the HJB equation is given by

$$\min \{H^*(x, DV, D^2V); G(x, DV, D^2V)\} = 0.$$

For the problem with an expectation constraint, there does not exist (in general) any continuous function describing the domain of the Hamiltonian and therefore, this approach cannot be adopted. However, it seems reasonable to impose the convexity with respect to z of the value function in the HJB equation, in view of Theorem 6.14.

We denote by \mathcal{S}_d the unit sphere of \mathbb{R}^{d+1} and we set

$$\mathcal{S}_d^+ = \{\beta \in \mathcal{S}_d : \beta_1 \geq 0\}. \quad (6.110)$$

Let us denote by \mathcal{P}_d and $\bar{\mathcal{P}}_d$ the following subsets of \mathbb{R}^{d+1} :

$$\mathcal{P}_d = \{\beta \in \mathbb{R}^{d+1} : \beta_1 = 1\}, \quad \bar{\mathcal{P}}_d = \mathcal{P}_d \cup \{\beta \in \mathcal{S}_d : \beta_1 = 0\}. \quad (6.111)$$

Recall the definition of the coefficients A , B , and C , given by (6.106). For $\zeta \in \mathbb{R}$, consider the $(d+1)$ -dimensional symmetric matrix $M(\zeta, u, x, p, Q)$ defined by

$$\begin{aligned} M(\zeta, u, x, p, Q) &= \left(\begin{array}{c|ccc} \zeta + A & B_1/2 & \dots & B_d/2 \\ \hline B_1/2 & & & \\ \vdots & & (C/2)\text{Id}_d & \\ B_d/2 & & & \end{array} \right) \\ &= \left(\begin{array}{c|c} \zeta + H^X(u, x, p, Q_{xx}) & \sigma(x, u)^\top Q_{xz}/2 \\ \hline \sigma(x, u)^\top Q_{xz}/2 & (Q_{zz}/2)\text{Id}_d \end{array} \right), \end{aligned} \quad (6.112)$$

where Id_d is the identity matrix of size d . Observe that for all $\alpha \in \mathbb{R}^{d*}$, setting $\beta = (1, \alpha)^\top \in \mathcal{P}_d$,

$$\zeta + P_{(u,x,p,Q)}(\alpha) = \beta^\top M(\zeta, u, x, p, Q)\beta. \quad (6.113)$$

Note also that if $Q_{zz} > 0$,

$$\begin{aligned} \det(M(\zeta, u, x, p, Q)) &= \frac{2(\zeta + H^X(u, x, p, Q_{xx}))Q_{zz} - |\sigma(x, u)^\top Q_{xz}|^2}{4} \\ &= \frac{Q_{zz}}{2} \left[\min_{\alpha \in \mathbb{R}^{d*}} \{ \zeta + P_{(u,x,p,Q)}(\alpha) \} \right]. \end{aligned} \quad (6.114)$$

For $M \in M_{d+1}$, we denote by $\Lambda^-(M)$ its smallest eigenvalue. Note that

$$\Lambda^-(M) = \min_{\beta \in \mathcal{S}_d^+} \{ \beta^\top M\beta \}. \quad (6.115)$$

For the HJB equation, we propose, following Bruder:

$$\left\{ \begin{array}{l} \min_{u \in U} \left\{ \Lambda^- \left(\begin{array}{c|c} \partial_t V + H^X(u, x, p, V_{xx}) & \sigma(x, u)^\top V_{xz}/2 \\ \hline \sigma(x, u)^\top V_{xz}/2 & (V_{zz}/2)\text{Id}_d \end{array} \right) \right\} = 0, \\ V(T, x, z) = \begin{cases} \phi(x), & \text{if } z \leq g(x), \\ +\infty, & \text{otherwise.} \end{cases} \end{array} \right. \quad (6.116)$$

This formulation of the HJB equation is motivated by the following lemma.

Lemma 6.16. *Let $\zeta \in \mathbb{R}$ and (u, x, p, Q) . Set*

$$K = \min \left\{ \min_{\alpha \in \mathbb{R}^{d*}} \{ H(u, \alpha, x, p, Q); Q_{zz} \} \right\}, \quad (6.117)$$

the following equivalence holds:

$$K = 0 \iff \Lambda^-(M(\zeta, u, x, p, Q)) = 0. \quad (6.118)$$

Proof. Let us fix ζ and (u, x, p, Q) . For simplicity, we write $M = M(\zeta, u, x, p, Q)$. The mapping $\rho : \beta \in \bar{\mathcal{P}}_d^+ \mapsto \rho(\beta) = \beta/|\beta| \in \mathcal{S}_d^+$ is a bijection which is such that for all $\beta \in \bar{\mathcal{P}}_d^+$,

$$\beta^\top M \beta \geq 0 \iff \rho(\beta)^\top M \rho(\beta). \quad (6.119)$$

Moreover, by (6.104) and (6.113),

$$\min_{\alpha \in \mathbb{R}^{d^*}} \{\zeta + H(u, \alpha, x, p, Q)\} = \min_{\beta \in \bar{\mathcal{P}}_d^+} \{\beta^\top M \beta\} \quad \text{and} \quad Q_{zz} = \min_{\substack{\beta \in \mathcal{S}_d, \\ \beta_1 = 0}} \{\beta^\top M \beta\}. \quad (6.120)$$

It follows that

$$K = \min_{\beta \in \bar{\mathcal{P}}_d^+} \{\beta^\top M \beta\} \quad (6.121)$$

Combining (6.115), (6.119), and (6.121) and using the fact that ρ is a bijection, we obtain that

$$K \geq 0 \iff \Lambda^-(M) \geq 0. \quad (6.122)$$

Now, if $K = 0$ and $Q_{zz} = 0$, then any $\beta \in \mathcal{S}_d$ with $\beta_1 = 0$ belongs to the kernel of M . Assume that $K = 0$ and $Q_{zz} > 0$, then $\zeta + P_{(u,x,p,Q)}(\alpha)$ reaches its minimum, thus equal to 0, at say $\bar{\alpha}$ and therefore, by (6.113), $(1, \bar{\alpha})$ belongs to the kernel of M . Using (6.122), we obtain that

$$K = 0 \implies \Lambda^-(M). \quad (6.123)$$

Conversely, assume that $\Lambda^-(M) = 0$. Let $\bar{\beta} = (\bar{\beta}_1, \bar{\beta}_2)^\top$ be a nonzero element of the kernel of M . If $\bar{\beta}_1 = 0$, then $Q_{zz} = 0$ and $K = 0$. If $\bar{\beta}_1 \neq 0$, then $\bar{\alpha} = \bar{\beta}_2/\bar{\beta}_1$ is such that $\zeta + P_{(u,x,p,Q)}(\bar{\alpha}) = 0$ and thus $K = 0$. We have proved that

$$\Lambda^-(M) = 0 \implies K = 0. \quad (6.124)$$

The lemma is now proved. \square

6.4.2 HJB equation for the Legendre-Fenchel transform

We give here the HJB equation satisfied by $V^*(t, x, \lambda)$, the Legendre-Fenchel transform of V with respect to λ , for $\lambda \geq 0$. As we explained in Section 6.2, $V^*(t, x, \lambda)$ is the value function associated with the unconstrained maximization of

$$\mathbb{E}[g(X_T^{t,x,u})\lambda - \phi(X_T^{t,x,u})]. \quad (6.125)$$

Therefore, the HJB equation is the following:

$$\begin{cases} V^*(T, x, \lambda) = g(x)\lambda - \phi(x) \\ \partial_t V^*(t, x, \lambda) = H^{X,*}(x, -DV^*(t, x, \lambda), -D^2V^*(t, x, \lambda)). \end{cases} \quad (6.126)$$

6.4.3 HJB equation for the highest reachable level of probability

A possible approach for computing the boundary of the domain of $V(t, x, z)$ consists in computing the highest reachable level, denoted by $\Psi(t, x)$ and defined by

$$\begin{aligned}\Psi(t, x) &= \sup_{z \in \mathbb{R}} \{z : V(t, x, z) < +\infty\} \\ &= \sup_{u \in \mathcal{U}_t} \{\mathbb{E}[g(X_T^{t,x,u})]\}.\end{aligned}\tag{6.127}$$

The HJB equation satisfied by $\Psi(t, x)$ is the following:

$$\begin{cases} \Psi(T, x) = g(x) \\ \partial_t \Psi(t, x) = H^{X,*}(x, -D\Psi(t, x), -D^2\Psi(t, x)). \end{cases}\tag{6.128}$$

Lemma 6.17. *Let $t < T$, let $x \in \mathbb{R}^n$ and $z = \Psi(t, x)$. Let $u \in \mathcal{U}_t$ and $\alpha \in \mathcal{A}_t$ be such that*

$$\mathbb{E}[g(X_T^{t,x,u})] = z \quad \text{and} \quad Z_T^{t,z,\alpha} \leq g(X_T^{t,x,u}).\tag{6.129}$$

Then, for all $s \geq t$,

$$Z_s^{t,z,\alpha} = \Psi(s, X_s^{t,x,u}).\tag{6.130}$$

Proof. We only give some elements of proof. Note first that (6.129) must necessarily be an equality. The dynamic programming principle satisfied by $\Psi(t, x)$ is the following: for all stopping time $\tau \geq t$,

$$\Psi(t, x) = \sup_{v \in \mathcal{U}} \left\{ \mathbb{E}[\Psi(\tau, X_\tau^{t,x,v})] \right\}.\tag{6.131}$$

Then, u is optimal for (6.131), therefore $\Psi(s, X_s^{t,x,u})$ is a martingale. Combined with the equality in (6.129), we get the result. \square

6.5 Numerical methods

In this section, we propose some numerical schemes for the resolution of stochastic optimal control problems with an expectation constraint. Our approach consists in discretizing the dynamic of the physical state variable X with a controlled Markov chain, as it is usually done for the semi-Lagrangian scheme and the finite-difference scheme, and to solve the constrained problem associated. For each type of discretization, two approaches are possible: one based on dynamic programming, the other one based on Lagrangian relaxation. The approach using Lagrangian relaxation is of course justified in so far as the initial continuous-time problem is convex with respect to z (at least if g is Lipschitz).

To simplify the presentation of the schemes, we suppose that x is of dimension 1. Let us introduce some notations:

\triangleright $K > 0$, so that the state space is reduced to $[-K, K]$

- ▷ $M_t + 1$, the number of discretization points for the time variable
- ▷ $\delta t = T/M_t$
- ▷ $2M_x + 1$, the number of discretization points for the space variable
- ▷ $\delta x = K/M_x$
- ▷ $M_z + 1$, the number of discretization points for the variable z .

We use the following discretized variables:

- ▷ $j \in \{0, \dots, M_t\}$, the variable associated with the time variable t
- ▷ $k \in \{-M_x, \dots, M_x\}$, the variable associated with the space variable x .

We will sometimes write $f(u, k)$ instead of $f(u, k\delta x)$ and we will use the same convention for σ , ϕ and g .

6.5.1 Semi-Lagrangian schemes

Discretization of the problem The discretization of X is naturally obtained by discretizing the Brownian motion. Let $(\xi^i)_{i=1, \dots, d+1}$ be a family of \mathbb{R}^d and $(p_i)_{i=1, \dots, d+1}$ be a family of $[0, 1]$ such that

$$\sum_{k=1}^{d+1} p_i = 1, \quad \sum_{k=1}^{d+1} p_i \xi^i = 0, \quad \text{and} \quad \sum_{k=1}^{d+1} p_i \xi^i (\xi^i)^\top = \text{Id}_d. \quad (6.132)$$

For $d = 1$, we can take $p_1 = p_2 = 1/2$ and $\xi^1 = 1$, $\xi^2 = -1$. For $k = 2$, we can take $p_1 = p_2 = p_3 = 1/3$ and

$$\xi^1 = (0, \sqrt{2})^\top, \quad \xi^2 = (-\sqrt{2}/2, \sqrt{6}/2)^\top, \quad \text{and} \quad \xi^3 = (-\sqrt{2}/2, -\sqrt{6}/2)^\top. \quad (6.133)$$

We consider now M_t i.i.d. random variables in \mathbb{R}^d , $(\xi_j)_{j=1, \dots, M_t}$, with the following law:

$$\mathbb{P}[\xi_j = \xi^i] = p_i, \quad \forall j \in \{1, \dots, M_t\}, \quad \forall i \in \{1, \dots, d+1\}. \quad (6.134)$$

We consider the same filtrations as in Section 6.2 and for all j , we define the space \mathcal{U}_j of \mathbb{F}_j -adapted controls. A first level of discretization of X is given by:

$$X_{j+1}^u = X_j^u + f(u_j, X_j)\delta t + \sigma(u_j, X_j)\xi_j\sqrt{\delta t}. \quad (6.135)$$

However, the variable X is still continuous on \mathbb{R} and we would like to ensure that the approximating Markov chain evolves on a countable subset of \mathbb{R} . We consider here: $\delta x\mathbb{Z} = \{k\delta x : k \in \mathbb{Z}\}$. If after the first step, the state takes the value x , we consider that it goes to the states

$$\begin{aligned} & \left\lfloor \frac{x}{\delta x} \right\rfloor \delta x \text{ with probability } 1 - \left\{ \frac{x}{\delta x} \right\}, \\ & \left(\left\lfloor \frac{x}{\delta x} \right\rfloor + 1 \right) \delta x \text{ with probability } \left\{ \frac{x}{\delta x} \right\}, \end{aligned} \quad (6.136)$$

where $\{y\}$ is the decimal part of y and where $y = \lfloor y \rfloor + \{y\}$. Finally, the discretization of the state variable is given for all $i = 1, \dots, d$ by

$$\begin{aligned}\mathbb{P}[X_{j+1}^u = \lfloor k_i \rfloor \delta x \mid X_j^u = k \delta x] &= p_i(1 - \{k_i\}), \\ \mathbb{P}[X_{j+1}^u = (\lfloor k_i \rfloor + 1) \delta x \mid X_j^u = k \delta x] &= p_i \{k_i\},\end{aligned}\quad (6.137)$$

where

$$k_i = k + \frac{f(u_j, k) \delta t + \sigma(u_j, k) \xi^i \sqrt{\delta t}}{\delta x}.\quad (6.138)$$

We let the reader check with (6.132) that

$$\mathbb{E}[X_{j+1}^u - X_j^u \mid X_j^u] = f(u_j, X_j^u) \delta t, \quad (6.139)$$

$$\text{Var}[X_{j+1}^u - X_j^u \mid X_j^u] = \sigma(u_j, X_j^u) \sigma(u_j, X_j^u)^\top \delta t + O(\delta x^2), \quad (6.140)$$

which proves the consistency of the approximation.

We can now define the discretized value function:

$$V_{j,k}(z) = \begin{cases} \text{Min}_{u \in \mathcal{U}_j} \mathbb{E}[\phi(X_{M_t}^{j,k\delta x,u})] \\ \text{s.t. } \mathbb{E}[g(X_{M_t}^{j,k\delta x,u})] \geq z. \end{cases} \quad (6.141)$$

The associated dynamic programming principle is given by

$$\left\{ \begin{array}{l} V_{M_t,k}(z) = \begin{cases} \phi(k) & \text{if } g(k) \geq z, \\ +\infty & \text{otherwise,} \end{cases} \\ V_{j,k}(z) = \inf_{u \in U, \substack{(z_i^+)_{i \in \mathbb{R}^{d+1}}, \\ (z_i^-)_{i \in \mathbb{R}^{d+1}},}} \left\{ \sum_{i=1}^{d+1} p_i \left((1 - \{k_i\}) V_{j+1, \lfloor k_i \rfloor} (z_i^-) + \{k_i\} V_{j+1, \lfloor k_i \rfloor + 1} (z_i^+) \right) \right\}, \\ \text{where } k_i = k + (f(u_j, k) \delta t + \sigma(u_j, k) \xi^i \sqrt{\delta t}) / \delta x, \\ \text{s.t. } \sum_{i=1}^{d+1} p_i ((1 - \{k_i\}) z_i^- + \{k_i\} z_i^+) = z. \end{array} \right. \quad (6.142)$$

The dynamic programming principle associated with the Legendre-Fenchel transform $V_{j,k}^*(\lambda)$ is given for all $\lambda \geq 0$ by

$$\left\{ \begin{array}{l} V_{M_t,k}^*(\lambda) = g(k) \lambda - \phi(k) \\ V_{j,k}^*(\lambda) = \sup_{u \in U} \left\{ \sum_{i=1}^{d+1} p_i \left((1 - \{k_i\}) V_{j+1, \lfloor k_i \rfloor}(\lambda) + \{k_i\} V_{j+1, \lfloor k_i \rfloor + 1}(\lambda) \right) \right\}, \\ \text{where } k_i = k + (f(u_j, k) \delta t + \sigma(u_j, k) \xi^i \sqrt{\delta t}) / \delta x. \end{array} \right. \quad (6.143)$$

Note that the dynamic programming principle satisfied by $V_{j,k}^*(\lambda)$ corresponds to the one that we would have obtained by writing the semi-Lagrangian scheme associated with $V^*(t, x, \lambda)$, we observe a commutativity property between the discretization and the Legendre-Fenchel transformation.

Application Two approaches can be used to solve the problem, as we mentioned : the first one consists in computing $V_{j,k}(z)$, the second one in computing $V_{j,k}^*(\lambda)$ for a certain number of values of λ , so that we find an optimal strategy for the required level z . Let us make a few comments on these approaches.

- ▷ The method can be extended to the case when x is multi-dimensional.
- ▷ Both approaches suffer from the curse of dimensionality: the complexity of the algorithm increases exponentially with n .
- ▷ We must bound the state space. A simple approach consists in projecting the coefficient k_i on $[-M_x, M_x]$ in the dynamic programming principles.
- ▷ For the computation of $V_{j,k}(z)$, we must discretize the variable z and we must ensure the constraint:

$$\sum_{i=1}^{d+1} p_i((1 - \{k_i\})z_i^- + \{k_i\}z_i^+) = z \quad (6.144)$$

in a consistent way. Moreover, we must take into account the fact the value function can take the value $+\infty$. We discuss this specific point in subsection 6.5.3.

- ▷ The set of controls, U must be discretized, and the minimization problem in the dynamic programming principles can be solved by enumeration.

6.5.2 Finite-difference schemes

Discretization of the problem Like previously, we discretize the dynamic of the variable X with a controlled Markov chain. The discretization is obtained by discretizing the Hamiltonian of the system. Let us define

$$\begin{aligned} p(u, k, 0) &= 1 - \frac{|f(u, k)|\delta t}{\delta x} - \frac{|\sigma(u, k)|^2\delta t}{\delta x^2} \\ p(u, k, 1) &= \frac{f^+(u, k)\delta t}{\delta x} + \frac{|\sigma(u, k)|^2\delta t}{2\delta x^2} \\ p(u, k, -1) &= \frac{-f^-(u, k)\delta t}{\delta x} + \frac{|\sigma(u, k)|^2\delta t}{2\delta x^2}, \end{aligned}$$

where $x^+ = \max(x, 0)$ and $x^- = \min(x, 0)$, so that $x = x^+ + x^-$ and $|x| = x^+ - x^-$. The controlled Markov chain is defined by

$$\mathbb{P}[X_{j+1}^u - X_j^u = q\delta x \mid X_j^u = k\delta x] = p(u_j, k, q), \quad \forall q \in \{-1, 0, 1\}. \quad (6.145)$$

This chain is well-posed if the following CFL condition holds true:

$$\|f\|_\infty\delta t \leq \frac{1}{2}\delta x \quad \text{and} \quad \|\sigma\|_\infty\delta t \leq \frac{1}{2}\delta x^2, \quad (6.146)$$

where $\|f\|_\infty = \sup_{u,x} |f(u,x)|$ and $\|\sigma\|_\infty = \sup_{u,x} |\sigma(u,x)|$. Observe that the approximation is consistent in so far as

$$\mathbb{E}[X_{j+1}^u - X_j^u | X_j^u = k\delta x] = f(u_j, k)\delta t \quad (6.147)$$

$$\text{Var}[X_{j+1}^u - X_j^u | X_j^u = k\delta x] = \sigma(u_j, k)\sigma(u_j, k)^\top \delta t + o(\delta t). \quad (6.148)$$

We can now define the discretized value function:

$$V_{j,k}(z) = \begin{cases} \text{Min}_{u \in \mathcal{U}_j} \mathbb{E}[\phi(X_{M_t}^{j,k\delta x,u})] \\ \text{s.t. } \mathbb{E}[g(X_{M_t}^{j,k\delta x,u})] \geq z. \end{cases} \quad (6.149)$$

The associated dynamic programming principle is given by

$$\left\{ \begin{array}{l} V_{M_t,k}(z) = \begin{cases} \phi(k) & \text{if } g(k) \geq z, \\ +\infty & \text{otherwise,} \end{cases} \\ V_{j,k}(z) = \inf_{\substack{u \in \mathcal{U}, \\ z_{-1}, z_0, z_1 \in [0,1]^3, \\ \sum_{q=-1}^1 p(u,k,q)z_q = z}} \left\{ \sum_{q=-1}^1 p(u,k,q)V_{j+1,k+q}(z_q) \right\}, \\ \forall j \in \{0, \dots, M_t - 1\}. \end{array} \right. \quad (6.150)$$

The dynamic programming principle associated with the Legendre-Fenchel transform $V_{j,k}^*(\lambda)$ is given for all $\lambda \geq 0$ by

$$\left\{ \begin{array}{l} V_{M_t,k}^*(\lambda) = g(k)\lambda - \phi(k) \\ V_{j,k}^*(\lambda) = \sup_{u \in \mathcal{U}} \left\{ \sum_{q=-1}^1 p(u,k,q)V_{j+1,k+q}^*(\lambda) \right\}, \\ \forall j \in \{0, \dots, M_t - 1\}. \end{array} \right. \quad (6.151)$$

Note that the dynamic programming principle satisfied by $V_{j,k}^*(\lambda)$ corresponds to the one that we would have obtained by writing the finite-difference scheme associated with $V^*(t, x, \lambda)$.

Application The same remarks as for the semi-Lagrangian scheme can be made. Note however that the extension to the multi-dimensional case is more complex: let us mention the generalized finite-difference approach of [80, 81].

6.5.3 Possible approaches for the dynamic programming method

We discuss now some possible approaches for the discretization of the variable z in $V_{j,k}(z)$. The semi-Lagrangian scheme and the finite-difference scheme can be summarized as follows:

$$V_{j,k}(z) = \inf_{u \in \mathcal{U}} W_{j,k}(z, u), \quad (6.152)$$

where

$$W_{j,k}(z, u) = \inf_{\substack{(z_i)_{i=1, \dots, N} \in [0, 1]^N, \\ \sum_{i=1}^N p_i(u) z^i = z}} \sum_{i=1}^N p_i W_{j,k}(z_i, u, i). \quad (6.153)$$

Let us fix j, k, u , and let us focus on the solving of problem (6.153). We do not mention anymore the dependence with respect to j, k , and u and write $W(z)$ and $W(z_i, i)$ instead of $W_{j,k}(z, u)$ and $W_{j,k}(z_i, u, i)$.

The mapping $W(z)$ can be computed recursively. For all $r \in \{1, \dots, N\}$, we set:

$$P_r = \sum_{i=1}^r p_i \quad \text{and} \quad W_r(z) = \inf_{\substack{(z_i)_{i=1, \dots, r} \in [0, 1]^r, \\ \frac{1}{P_r} \sum_{i=1}^r p_i z_i = z}} \frac{1}{P_r} \sum_{i=1}^r p_i W(z_i, i). \quad (6.154)$$

Note that $P_N = 1$ and $W_N(z) = W(z)$. Moreover, for all $r \in \{1, \dots, N\}$,

$$W_{r+1}(z) = \inf_{\substack{z^-, z^+ \in [0, 1] \\ P_r z^- + p_{r+1} z^+ = z}} \left\{ P_r W_r(z^-) + p_{r+1} W(z^+, r+1) \right\} \quad (6.155)$$

$$= \inf_{z^- \in [0, 1]} \left\{ P_r W_r(z^-) + p_{r+1} W\left(\frac{z - P_r z^-}{p_r}, r+1\right) \right\}. \quad (6.156)$$

Let us consider a discretization of $[0, 1]$: $\mathcal{Z} = \{0, 1/M_z, 2/M_z, \dots, 1\}$, where M_z is a given integer. Let r , let us suppose to have computed an approximation of $W_r(z)$ for all $z \in \mathcal{Z}$. We compute an affine interpolation of $W_r(z)$ on $[0, 1]$. Note that for the highest values of z , the problem may be infeasible. We can compute then an approximation of W_{r+1} with (6.156), by enumerating all the values of z^- and z in \mathcal{Z} . Finally, we obtain an approximation of $W(z)$ with $O(NM_z^2)$ operations. Of course, many variants can be considered and we do not give a more complete justification of this approach.

6.6 Numerical tests

In this section, we present numerical results for a simple chance-constrained stochastic optimal control problem, for the semi-Lagrangian method.

6.6.1 Description of the problem

Setting We consider the dynamic:

$$dX_t = u_t dt + dW_t \quad (6.157)$$

where the control u_t belongs to $U := [0, 1]$ for a.a. t . The value function is

$$V(t, x, z) = \text{Min}_{u \in \mathcal{U}_t} \mathbb{E} \left[\int_t^T u_s^2 dt \right] \quad \text{s.t.} \quad \mathbb{P}[X_T^{t, x, u} \geq 0] \geq z. \quad (6.158)$$

Boundary The boundary is described by the highest reachable probability

$$\begin{aligned}\Psi(t, x) &= \sup_{z \in [0,1]} \{z : V(t, x, z) < +\infty\} \\ &= \sup_{u \in \mathcal{U}_t} \{\mathbb{P}[X_T^{t,x,u} \geq 0]\}.\end{aligned}\quad (6.159)$$

For this simple example, we can compute explicitly Ψ , since this highest probability is reached with a constant control equal to 1. Therefore,

$$\Psi(t, x) = \mathbb{P}[W_{T-t} \geq -(x + (T - t))] = \frac{1}{\sqrt{2\pi}} \int_{-\infty}^{(x+T-t)/\sqrt{T-t}} e^{-\theta^2/2} d\theta. \quad (6.160)$$

The HJB equation is the following:

$$\begin{cases} \Psi(T, x) = \mathbf{1}_{\mathbb{R}_+}(x) \\ -\partial_t \Psi(t, x) = D\Psi(t, x) + \frac{1}{2}D^2\Psi(t, x). \end{cases} \quad (6.161)$$

Note that

$$V(t, x, Z(t, x)) = T - t. \quad (6.162)$$

The semi-Lagrangian scheme is given by

$$\left\{ \begin{array}{l} \Psi_{M_t, k} = \begin{cases} 1 & \text{if } k \geq 0 \\ 0 & \text{otherwise,} \end{cases} \\ \Psi_{j, k} = \left\{ \frac{1}{2}[(1 - \{k_1\})\Psi_{j+1, [k_1]} + \{k_1\}\Psi_{j+1, [k_1]+1}] \right. \\ \quad \left. + \frac{1}{2}[(1 - \{k_2\})\Psi_{j+1, [k_2]} + \{k_2\}\Psi_{j+1, [k_2]+1}] \right\}, \\ \text{where: } k_1 = k + (\delta t + \sqrt{\delta t})/\delta x, \\ \quad k_2 = k + (\delta t - \sqrt{\delta t})/\delta x. \end{array} \right. \quad (6.163)$$

For this example, we are also interested in:

$$\begin{aligned}\Psi_0(t, x) &= \sup_{z \in [0,1]} \{z : V(t, x, z) = 0\} \\ &= \mathbb{P}[X_T^{t,x,u_0} \geq 0],\end{aligned}\quad (6.164)$$

where u_0 is the control process constant and equal to 0. The explicit value is

$$\Psi_0(t, x) = \mathbb{P}[W_{T-t} \geq -x] = \frac{1}{\sqrt{2\pi}} \int_{-\infty}^{x/\sqrt{T-t}} e^{-\theta^2/2} d\theta. \quad (6.165)$$

Discretized value function The discretized value function, with the semi-Lagrangian scheme, is given by

$$\left\{ \begin{array}{l} V_{M_t, k}(z) = \begin{cases} 0 & \text{if } k \geq \mathbf{1}_{\mathbb{R}_+}(k) \\ +\infty & \text{otherwise,} \end{cases} \\ V_{j, k}(z) = \inf_{u \in [0, 1], z_1^- / z_1^+} \left\{ \frac{1}{2} [(1 - \{k_1\})V_{j+1, [k_1]}(z_1^-) + \{k_1\}V_{j+1, [k_1]+1}(z_1^+)] \right. \\ \left. + \frac{1}{2} [(1 - \{k_2\})V_{j+1, [k_2]}(z_2^-) + \{k_2\}V_{j+1, [k_2]+1}(z_2^+)] \right\}, \\ \text{where: } k_1 = k + (u\delta t + \sqrt{\delta t})/\delta x, \\ k_2 = k + (u\delta t - \sqrt{\delta t})/\delta x, \\ \text{s.t. } \frac{1}{2}((1 - \{k_1\})z_1^- + \{k_1\}z_1^+ + (1 - \{k_2\})z_2^- + \{k_2\}z_2^+) = z. \end{array} \right. \quad (6.166)$$

Legendre-Fenchel transform The Legendre-Fenchel transform is given by

$$\begin{aligned} V^*(t, x, \lambda) &= \sup_{z \in [0, 1]} (\lambda z - V(t, x, z)) \\ &= \text{Min}_{u \in \mathcal{U}_t} \mathbb{E} \left[\int_t^T u_t^2 dt - \mathbf{1}_{\mathbb{R}_+}(X_T^{t, x, u}) \right]. \end{aligned} \quad (6.167)$$

The HJB equation is the following:

$$\left\{ \begin{array}{l} V^*(T, x, \lambda) = \lambda \mathbf{1}_{\mathbb{R}_+}(x) \\ -\partial_t V^*(t, x) = \sup_{u \in [0, 1]} \{uDV^*(t, x, \lambda) + \frac{1}{2}D^2V^*(t, x, \lambda)\}. \end{array} \right. \quad (6.168)$$

The semi-Lagrangian scheme is given by

$$\left\{ \begin{array}{l} V_{M_t, k}^*(\lambda) = \begin{cases} \lambda & \text{if } k \geq 0 \\ 0 & \text{otherwise,} \end{cases} \\ V_{j, k}^*(\lambda) = \sup_{u \in [0, 1]} \left\{ \frac{1}{2} [(1 - \{k_1\})V_{j+1, [k_1]}^*(\lambda) + \{k_1\}V_{j+1, [k_1]+1}^*(\lambda)] \right. \\ \left. + \frac{1}{2} [(1 - \{k_2\})V_{j+1, [k_2]}^*(\lambda) + \{k_2\}V_{j+1, [k_2]+1}^*(\lambda)] \right\}, \\ \text{where: } k_1 = k + (u\delta t + \sqrt{\delta t})/\delta x, \\ k_2 = k + (u\delta t - \sqrt{\delta t})/\delta x. \end{array} \right. \quad (6.169)$$

6.6.2 Results

Parameters We present in this part some numerical results for the simplified model. The discretization parameters that were used are the following:

- ▷ Number of times steps: 20; $T = 10$
- ▷ Discretized control space: $\{0, 1/5, \dots, 1\}$
- ▷ Number of space steps: 40; state space: $[-20, 20]$
- ▷ Number of probability steps: 40.

Boundaries Figures 6.2 and 6.3 show a representation of $\Psi(t, x)$ and $\Psi_0(t, x)$, obtained with a semi-Lagrangian scheme.

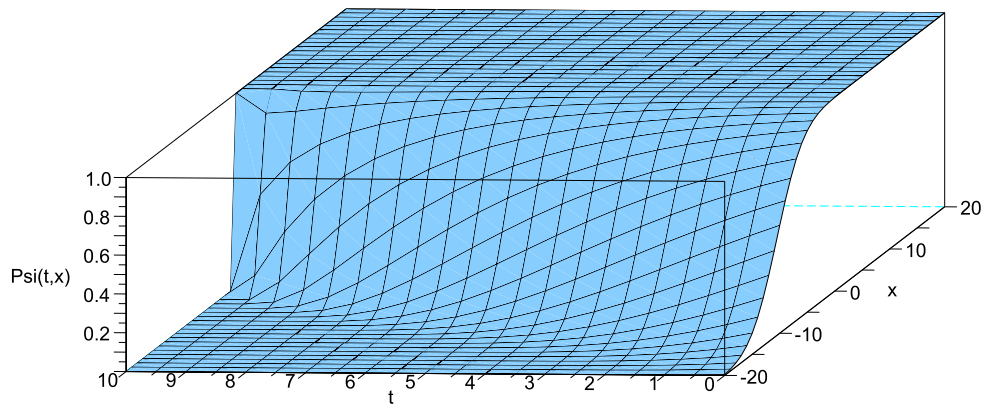

Figure 6.2: Graph of $\Psi(t, x)$

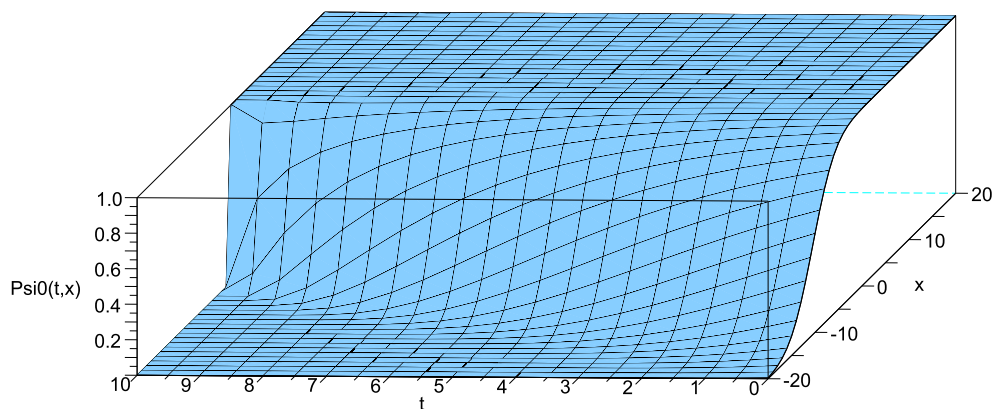
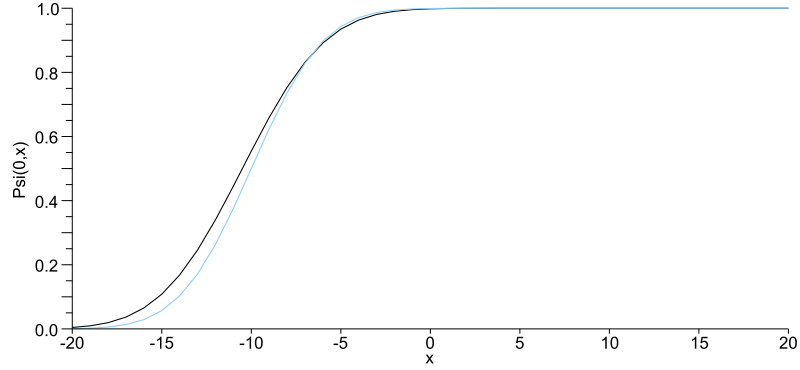
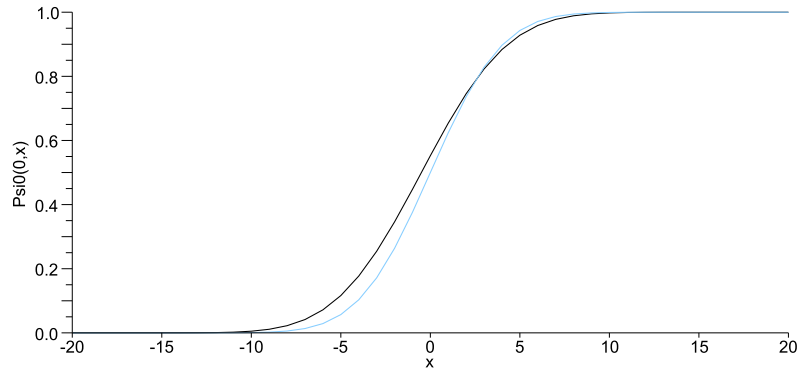

Figure 6.3: Graph of $\Psi_0(t, x)$

Figures 6.4 and 6.5 show a representation of the same functions, for $t = 0$. The approximation (in black) and the exact value (in clear) are compared.

Figure 6.4: Graph of $\Psi(0, x)$ Figure 6.5: Graph of $\Psi_0(0, x)$

Value function with Lagrange relaxation In figure 6.6, we show an approximation of $V^{**}(t, x, z)$ (at time $t = 0$) obtained as follows:

$$\sup_{\lambda \in \Lambda} \{\lambda z - V^*(t, x, \lambda)\}, \quad (6.170)$$

where Λ is a sampling of values of λ . We chose: $\Lambda = \{0, 1, 2, \dots, 100\}$.

Let us comment this graph. Three distinct zones, separated by the two bold lines, can be distinguished. The projections of these lines on the plan (x, z) are described by

$$z = \Psi_0(0, x), \quad \text{and} \quad z = \Psi(0, x). \quad (6.171)$$

On the first zone, for $z \leq \Psi_0(0, x)$, we have that $V(0, x, z) = 0$. The second zone, where $\Psi_0(0, x) \leq z \leq \Psi(0, x)$, is the most interesting since the problem is feasible and does not have a trivial solution. Finally, the last zone (in dark on the graph) corresponds to

the zone of infeasibility for the problem. It is easy to check that for $z = \Psi(0, x)$, we have $V(0, x, z) = T$, therefore, in order to represent the graph in a convenient way, we adopted the following rules:

- ▷ We computed first the boundaries Ψ and Ψ_0 .
- ▷ On the graph, the value function is equal to T in the infeasibility zone.
- ▷ For the first two zones, we used (6.170).

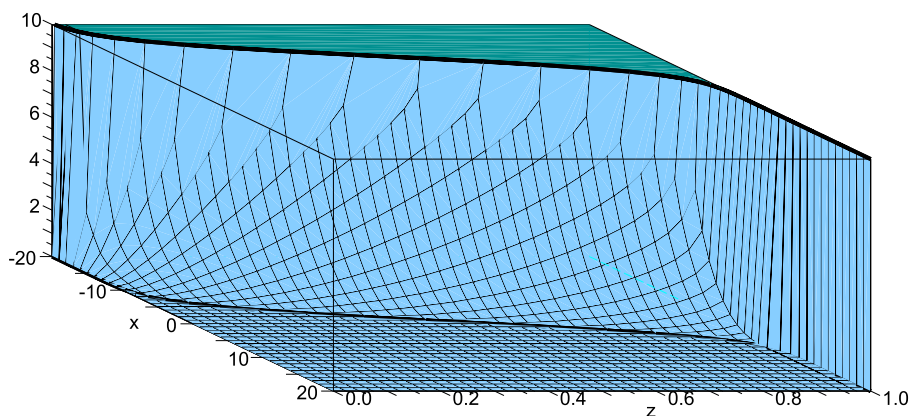

Figure 6.6: Estimation of $(x, z) \mapsto V(0, x, z)$ with Lagrange relaxation

Figure 6.7 shows, for all (x, z) , the value of λ which is optimal in (6.170). This value of λ provides an estimate of $D_z V(t, x, z)$ (at time 0). This figure justifies *a posteriori* the choice of the sampling Λ .

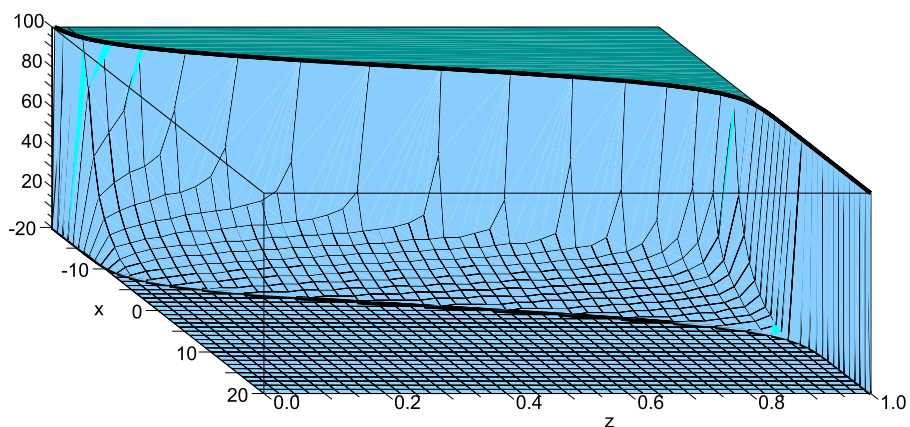

Figure 6.7: Estimation of $(x, z) \mapsto D_z V(t, x, z)$

An optimal control is associated with all $\lambda \geq 0$, for an *a priori* unknown level of probability, that can be computed by dynamic programming. Let (x, z) , we denote by $Z(0, x, z)$ the level ensured by the value of λ which is optimal in (6.170). In figure (6.8), we represent $(x, z) \mapsto Z(0, x, z) - z$. Let us analyse this graph.

- ▷ In the first zone (in which the optimal control is equal to 0), $Z(0, x, z) - z = \Psi_0(0, x, z) - z$.
- ▷ In the second zone, $Z(0, x, z) - z \approx 0$.
- ▷ In the third zone (the infeasibility zone), $Z(0, x, z) - z = \Psi(0, x, z) - z$.

Figure 6.9 is another view of the same function, in the plan (x, z) .

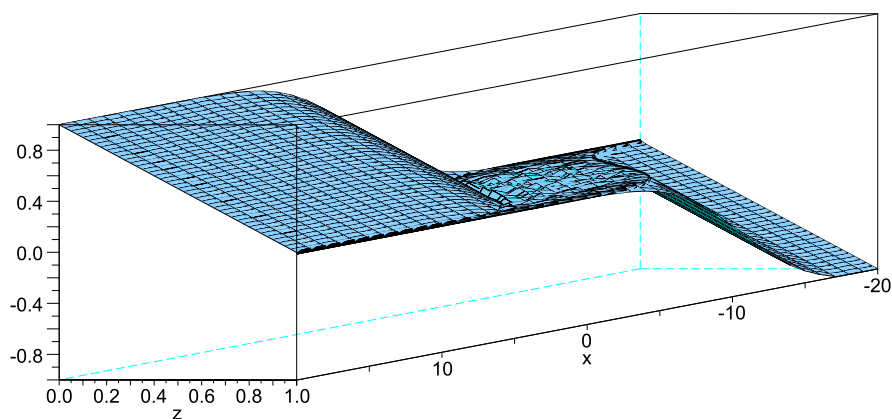

Figure 6.8: Representation of $(x, z) \mapsto Z(0, x, z) - z$

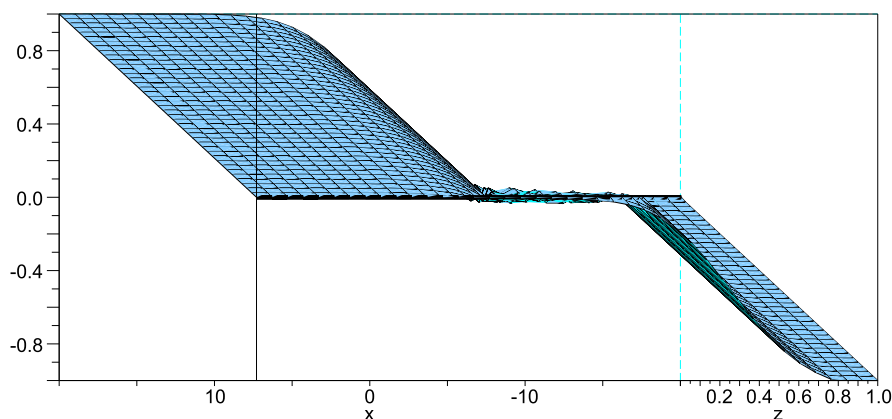

Figure 6.9: Another view of $(x, z) \mapsto Z(0, x, z) - z$

Dynamic programming We also implemented the method by dynamic programming, in which z is seen as a supplementary state variable. We follow the approach described in subsection 6.5.3 for the discretization of z . The discretization of $[0, 1]$ that we chose is: $\{0, 1/40, \dots, 1\}$. We tested two variants.

- ▷ The first one corresponds to the one described in subsection 6.5.3. In figure 6.10, we show the difference between the obtained result and the evaluation of V^{**} computed before. Unsurprisingly, the error is the highest when z is close to the highest reachable probability, because the discretization may prevent from attaining this highest level. Moreover, the derivative of V with respect to z is the highest there, by convexity.
- ▷ The second one consists in a refinement of the discretization of the interval $[0, 1]$. We add a supplementary value, the highest reachable probability, that we have to compute before. In this simple example, the value on the boundary is known and equal to $T - t$. The approximation is much better as one can see on figure 6.11.

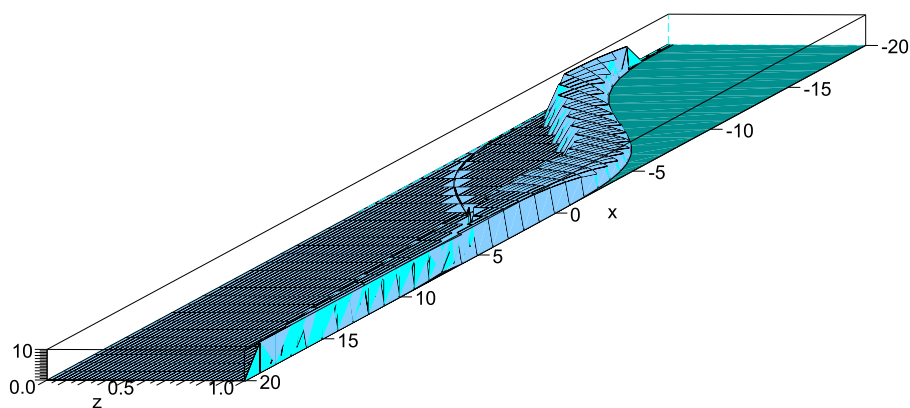

Figure 6.10: Difference between dynamic programming and relaxation (with the first method)

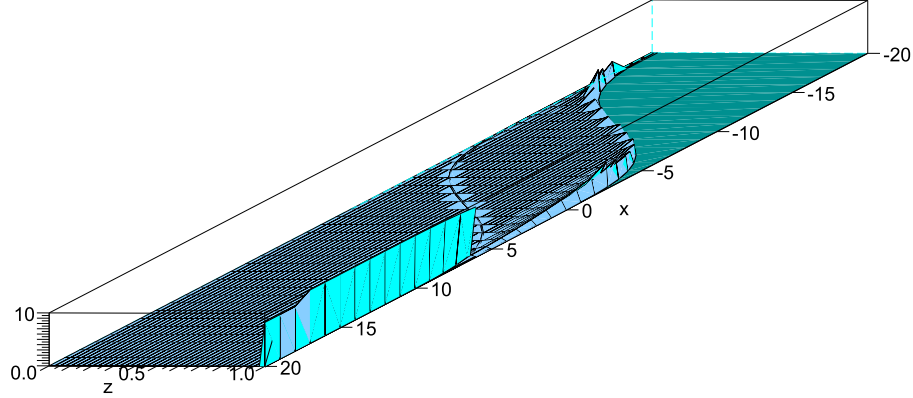

Figure 6.11: Difference between dynamic programming and relaxation (with the second method)

6.7 Study of an asset-liability management problem

We describe in this section an asset-liability management problem proposed by our partners at EDF (Electricité de France). The goal of this problem is to constitute an asset fund dedicated to future decommissioning and long-term radioactive waste management. In this model, our portfolio (modeled by the variable A_t) is composed of a risky asset and a non-risky. The value of the portfolio must be greater (with a certain probability) than the expected costs of nuclear decommissioning, the liability L_t . The model that we present is inspired of [106], see the seminal paper [100] about asset-liability management.

6.7.1 Setting

Asset portfolio We consider a 2-dimensional Brownian motion. Let us denote by A_t the value of the asset portfolio at time t . This portfolio can be invested in two assets:

- ▷ a risk-free asset of value B_t and return $dB_t = rB_t$,
- ▷ a risky one of value S_t and return $dS_t = S_t(\mu dt + \sigma dW_t^1)$.

We consider a two-dimensional control variable $\theta = (\theta^B, \theta^S)$, standing for the respective portfolio proportions invested in both assets. It satisfies $\theta \in \Theta$, where

$$\Theta := \{\theta \in \mathbb{R}^2 : \theta^B \geq 0, \theta^S \geq 0, \theta^B + \theta^S \geq 1, \theta^B \leq \bar{\theta}^B, \theta^S \leq \bar{\theta}^S\}. \quad (6.172)$$

The variables are nonnegative since leverage is forbidden. The dynamic of the asset portfolio is given by

$$dA_t = A_t \left(\theta_t^B \frac{dB_t}{B_t} + \theta_t^S \frac{dS_t}{S_t} \right) = A_t ([\theta_t^B r + \theta_t^S \mu] dt + \theta_t^S \sigma dW_t^1). \quad (6.173)$$

The liability value L_t is also modeled with a geometric brownian motion:

$$dL_t = L_t(\tilde{\mu} dt + \tilde{\sigma}[\rho_1 dW_t^1 + \rho_2 dW_t^2]), \quad (6.174)$$

where $\rho_1^2 + \rho_2^2 = 1$.

Constraint Let us denote by $F_t := A_t/L_t$ the funding ratio. The regulatory authority imposes that the funding ratio remains above 1 at all time. As the market is incomplete, this constraint can only be ensured in a probabilistic manner. This leads to consider the following constraint on the asset-liability management optimization:

$$\mathbb{P}\left(\min_{t \in [0, T]} F_t \geq 1\right) \geq 1 - \varepsilon, \quad (6.175)$$

where $\varepsilon > 0$ is close to 0 (typically, $\varepsilon = 1\%$), but for simplicity, we consider the constraint

$$\mathbb{P}[F_T \geq 1] \geq 1 - \varepsilon. \quad (6.176)$$

Problem The objective is to minimize the expected portfolio management cost:

$$\mathbb{E}\left[\int_0^T e^{-\beta t} A_t(\theta_t^B + \theta_t^S - 1)r dt\right], \quad (6.177)$$

where $\beta \in (0, 1)$ is the manager discount factor.

We denote by \mathcal{U} the space of \mathcal{F}_t -measurable controls a.s. bounded in \mathbb{R}^2 . For $(a, l) \in \mathbb{R}_{+*}^2$, for $\theta = (\theta^B, \theta^S) \in \mathcal{U}$ we denote resp. by $A_t^{s, a, \theta}$ and $L_t^{s, l}$ the solutions to (6.173) and (6.174), starting at a and l respectively at time s , with the control θ .

The problem that we consider is the following:

$$V(t, a, l, z) = \min_{\theta \in \mathcal{U}} \mathbb{E}\left[\int_t^T e^{-\beta s} A_s^{t, a, \theta}(\theta_s^B + \theta_s^S - 1)r ds\right], \quad (6.178)$$

$$\text{s.t. } \begin{cases} \mathbb{P}[A_T^{t, a, \theta}/L_T^{t, l, \theta} \geq 1] \geq z \\ \theta_s^B + \theta_s^S \geq 1, \\ 0 \leq \theta_s^B \leq \bar{\theta}^B, 0 \leq \theta_s^S \leq \bar{\theta}^S. \end{cases}$$

6.7.2 Properties of the value function

We discuss some basic properties of the value function V . Note first that $V \geq 0$ and may be equal to $+\infty$. The value function is

- ▷ nonincreasing with respect to a
- ▷ nondecreasing with respect to l
- ▷ nondecreasing with respect to z .

Moreover, for all $\mu > 0$, for all (t, a, l, z) ,

$$V(t, \mu a, \mu l, p) = \mu V(t, a, l, p). \quad (6.179)$$

Indeed, for any control θ , for all (t, a, l) and $\lambda > 0$,

$$A_s^{t, \mu a, \theta} = \mu A_s^{t, a, \theta}, \quad \text{and} \quad L_s^{t, \mu l} = \mu L_s^{t, l} \quad (6.180)$$

and therefore

$$A_s^{t, \mu a, \theta} / L_s^{t, \mu a, \theta} = A_s^{t, a, \theta} / L_s^{t, a, \theta}. \quad (6.181)$$

6.7.3 HJB equations

HJB equation of the value function In this section, we explicit the HJB equation satisfied by $V(t, a, l, z)$. We first make the following changes of variables : $\tilde{a} = \ln(a)$ and $\tilde{l} = \ln(l)$, and we set

$$\tilde{V}(t, \tilde{a}, \tilde{l}, z) = V(t, e^{\tilde{a}}, e^{\tilde{l}}, z). \quad (6.182)$$

The dynamic of the state variables is given by

$$d \ln(A_t) = \left((\theta_t^B r + \theta_t^S \mu) - \frac{1}{2} (\theta_t^S \sigma)^2 \right) dt + (\theta_t^S \sigma) dW_t^1, \quad (6.183)$$

$$d \ln(L_t) = \left(\tilde{\mu} - \frac{1}{2} \tilde{\sigma}^2 \right) dt + \tilde{\sigma} (\rho_1 dW_t^1 + \rho_2 dW_t^2). \quad (6.184)$$

The physical Hamiltonian \tilde{H}^X is given by

$$\begin{aligned} \tilde{H}^X(t, \theta, \tilde{a}, D\tilde{V}, D^2\tilde{V}) &= e^{-\beta t + \tilde{a}} (\theta^B + \theta^S - 1) \\ &\quad + \left((\theta^B r + \theta^S \mu) - \frac{1}{2} (\theta^S \sigma)^2 \right) \tilde{V}_{\tilde{a}} + \left(\tilde{\mu} - \frac{1}{2} \tilde{\sigma}^2 \right) \tilde{V}_{\tilde{l}} \\ &\quad + \frac{1}{2} \left[(\theta^S \sigma)^2 \tilde{V}_{\tilde{a}\tilde{a}} + 2\theta^S \sigma \tilde{\sigma} \rho_1 \tilde{V}_{\tilde{a}\tilde{l}} + \tilde{\sigma}^2 \tilde{V}_{\tilde{l}\tilde{l}} \right]. \end{aligned} \quad (6.185)$$

and the term $\tilde{B}(\theta, V_{\tilde{a}z}, \tilde{V}_{\tilde{l}z}) = \sigma^\top(\theta) (\tilde{V}_{\tilde{a}z}, \tilde{V}_{\tilde{l}z})^\top$ involving the cross derivatives is given by

$$B(\theta, V_{\tilde{a}z}, \tilde{V}_{\tilde{l}z}) = \begin{pmatrix} \theta^S \sigma & \tilde{\sigma} \rho_1 \\ 0 & \tilde{\sigma} \rho_2 \end{pmatrix} \begin{pmatrix} \tilde{V}_{\tilde{a}z} \\ \tilde{V}_{\tilde{l}z} \end{pmatrix} = \begin{pmatrix} \theta^S \sigma V_{\tilde{a}z} + \tilde{\sigma} \rho_1 V_{\tilde{l}z} \\ \tilde{\sigma} \rho_2 V_{\tilde{l}z} \end{pmatrix}. \quad (6.186)$$

The value function V is a solution to the HJB equation on $[0, T] \times \mathbb{R} \times \mathbb{R} \times [0, 1]$

$$\begin{cases} \min_{\theta \in \Theta} \left\{ \Lambda^- \begin{pmatrix} \partial_t \tilde{V} + \tilde{H}^X(t, \theta, \tilde{a}, D\tilde{V}, D^2\tilde{V}) & \tilde{B}(\theta, \tilde{V}_{\tilde{a}z}, \tilde{V}_{\tilde{l}z})^\top / 2 \\ \tilde{B}(\theta, \tilde{V}_{\tilde{a}z}, \tilde{V}_{\tilde{l}z})^\top / 2 & (\tilde{V}_{zz} / 2) \text{Id}_2 \end{pmatrix} \right\} = 0, \\ \tilde{V}(T, \tilde{a}, \tilde{l}, z) = \begin{cases} 0, & \text{if } z \leq \mathbf{1}_{\mathbb{R}_+} (\tilde{a} - \tilde{l}), \\ +\infty, & \text{otherwise.} \end{cases} \end{cases} \quad (6.187)$$

From (6.179), we obtain that for all $\mu \in \mathbb{R}$,

$$\tilde{V}(t, \tilde{a} + \mu, \tilde{l} + \mu, z) = e^\mu \tilde{V}(t, \tilde{a}, \tilde{l}, z). \quad (6.188)$$

Taking $\mu = -\tilde{l}$, we obtain that

$$\tilde{V}(t, \tilde{a}, \tilde{l}, z) = e^{\tilde{l}} V(t, \tilde{a} - \tilde{l}, 0, z) =: \hat{V}(t, \tilde{a} - \tilde{l}, z). \quad (6.189)$$

We denote by x the second argument of \hat{V} . The relations between the partial derivatives of \tilde{V} and \hat{V} are given by

$$\partial_t \tilde{V} = e^{\tilde{l}} \partial_t V, \quad \tilde{V}_{\tilde{a}} = e^{\tilde{l}} \hat{V}_x, \quad \text{and} \quad \tilde{V}_{\tilde{l}} = e^{\tilde{l}} (\hat{V} - \hat{V}_x). \quad (6.190)$$

and

$$\tilde{V}_{\tilde{a}\tilde{a}} = e^{\tilde{l}} \hat{V}_{xx}, \quad \tilde{V}_{\tilde{a}\tilde{l}} = e^{\tilde{l}} (\hat{V}_x - \hat{V}_{xx}), \quad \text{and} \quad \tilde{V}_{\tilde{l}\tilde{l}} = e^{\tilde{l}} (\hat{V} - 2\hat{V}_x + \hat{V}_{xx}). \quad (6.191)$$

Therefore, we obtain that

$$\begin{aligned} & e^{-\tilde{l}} \tilde{H}^X(t, \theta, \tilde{a}, D\tilde{V}, D^2\tilde{V}) \\ &= e^{-\beta t + x} (\theta^B + \theta^S - 1) + \tilde{\mu} \hat{V} \\ & \quad + [(\theta^B r + \theta^S \mu - \tilde{\mu}) - \frac{1}{2}((\theta^S \sigma)^2 - 2\theta^S \sigma \tilde{\sigma} \rho_1 + \tilde{\sigma}^2)] \hat{V}_x \\ & \quad + \frac{1}{2}[(\theta^S \sigma)^2 - 2\theta^S \sigma \tilde{\sigma} \rho_1 + \tilde{\sigma}^2] \hat{V}_{xx} \\ &=: \hat{H}^X(t, \theta, x, D\hat{V}, D^2\hat{V}) \end{aligned} \quad (6.192)$$

and

$$\tilde{B}(\theta, \tilde{V}_{\tilde{a}z}, \tilde{V}_{\tilde{l}z}) = \begin{pmatrix} \theta^S \sigma \hat{V}_{xz} + \tilde{\sigma} \rho_1 \hat{V}_z - \tilde{\sigma} \rho_1 \hat{V}_{xz} \\ \tilde{\sigma} \rho_2 \hat{V}_z - \tilde{\sigma} \rho_2 \hat{V}_{xz} \end{pmatrix} =: \hat{B}(\theta, x, \hat{V}_z, \hat{V}_{xz}). \quad (6.193)$$

Note that

$$(\theta^S \sigma)^2 - 2\theta^S \sigma \tilde{\sigma} \rho_1 + \tilde{\sigma}^2 = (\theta^S \sigma - \tilde{\sigma})^2 + 2\theta^S \sigma \tilde{\sigma} (1 - \rho_1) \geq 0. \quad (6.194)$$

The value function \hat{V} is a solution the HJB equation on $[0, T] \times \mathbb{R} \times [0, 1]$

$$\begin{cases} \min_{\theta \in \Theta} \{ \Lambda^-(M(\partial_t V, \theta, x, D\hat{v}, D^2\hat{v})) \} = 0, \\ \hat{V}(T, x, z) = \begin{cases} 0, & \text{if } z \leq \mathbf{1}_{\mathbb{R}_+}(g), \\ +\infty, & \text{otherwise,} \end{cases} \end{cases} \quad (6.195)$$

where

$$M(\partial_t V, \theta, x, \hat{V}, D\hat{v}, D^2\hat{v}) = \begin{pmatrix} \partial_t \hat{V} + \hat{H}^X(t, \theta, x, \hat{V}_x, \hat{V}_{xx}) & \hat{B}(\theta, \hat{V}_z, \hat{V}_{xz})^\top / 2 \\ \hat{B}(\theta, \hat{V}_z, \hat{V}_{xz}) / 2 & (\hat{V}_{zz} / 2) \text{Id}_2 \end{pmatrix}. \quad (6.196)$$

HJB equation of the Legendre-Fenchel transform The Legendre-Fenchel transform of $\tilde{V}(t, \tilde{a}, \tilde{l}, z)$, denoted $\tilde{V}^*(t, \tilde{a}, \tilde{l}, \lambda)$ satisfies the following HJB equation:

$$\begin{cases} \partial_t \tilde{V}^* = \tilde{H}^{X,*}(t, \tilde{a}, -D\tilde{V}^*, -D^2\tilde{V}^*) \\ \tilde{V}^*(T, \tilde{a}, \tilde{l}, \lambda) = \lambda \mathbf{1}_{\mathbb{R}_+}(\tilde{a} - \tilde{l}). \end{cases} \quad (6.197)$$

For all $\mu \in \mathbb{R}$,

$$\begin{aligned}\tilde{V}^*(t, \tilde{a} + \mu, \tilde{l} + \mu, \lambda) &= \sup_{z \in [0,1]} \{ \lambda z - e^\mu \tilde{V}(t, \tilde{a}, \tilde{l}, z) \} \\ &= e^\mu \sup_{z \in [0,1]} \{ e^{-\mu} \lambda z - V(t, \tilde{a}, \tilde{l}, z) \} \\ &= e^\mu \tilde{V}^*(t, \tilde{a}, \tilde{l}, \lambda e^{-\mu}).\end{aligned}\quad (6.198)$$

Let λ and λ' , taking $\mu = \ln(\lambda/\lambda')$ in the previous formula, we get

$$\tilde{V}^*(t, \tilde{a}, \tilde{l}, \lambda') = \frac{\lambda'}{\lambda} \tilde{V}^*(t, \tilde{a} + \ln(\lambda/\lambda'), \tilde{l} + \ln(\lambda/\lambda'), \lambda). \quad (6.199)$$

HJB equation of the boundary We describe here the HJB equation satisfied by the highest reachable probability associated with the problem, defined by

$$\tilde{\Psi}(t, \tilde{a}, \tilde{l}) = \sup_{z \in [0,1]} \{ \tilde{V}(t, \tilde{a}, \tilde{l}, z) < +\infty \}. \quad (6.200)$$

We also define the highest reachable probability without adding money,

$$\tilde{\Psi}_0(t, \tilde{a}, \tilde{l}) = \sup_{z \in [0,1]} \{ \tilde{V}(t, \tilde{a}, \tilde{l}, z) = 0 \}. \quad (6.201)$$

Note that

$$\tilde{\Phi}_0(t, \tilde{a}, \tilde{l}) \leq \tilde{\Psi}(t, \tilde{a}, \tilde{l}). \quad (6.202)$$

Let us start with $\tilde{\Psi}(t, a, l)$. The Hamiltonian is given by

$$\begin{aligned}\tilde{h}(\theta, D\tilde{\Phi}, D^2\tilde{\Phi}) &= (\theta^B r + \theta^S \mu - \frac{1}{2}(\theta^S \sigma)^2) \tilde{\Phi}_{\tilde{a}} + (\tilde{\mu} - \frac{1}{2}\tilde{\sigma}^2) \tilde{\Phi}_{\tilde{l}} \\ &\quad + \frac{1}{2} [(\theta^S \sigma)^2 \tilde{\Phi}_{\tilde{a}\tilde{a}} + 2\theta^S \sigma \tilde{\sigma} \rho_1 \tilde{\Phi}_{\tilde{a}\tilde{l}} + \tilde{\sigma}^2 \tilde{\Phi}_{\tilde{l}\tilde{l}}].\end{aligned}\quad (6.203)$$

We then set

$$\tilde{h}^*(D\tilde{\Psi}, D^2\tilde{\Psi}) := \sup_{\theta \in \Theta} \tilde{h}(\theta, D\tilde{\Psi}, D^2\tilde{\Psi}). \quad (6.204)$$

The HJB equation satisfied by $\tilde{\Psi}(t, \tilde{a}, \tilde{l})$ is

$$\begin{cases} \tilde{\Psi}(T, \tilde{a}, \tilde{l}) = \begin{cases} 1 & \text{if } \tilde{a} - \tilde{l} \geq 0, \\ 0 & \text{otherwise,} \end{cases} \\ -\partial_t \tilde{\Psi} = \tilde{h}^*(D\tilde{\Psi}, D^2\tilde{\Psi}). \end{cases} \quad (6.205)$$

Then, observe that

$$\tilde{\Psi}(t, \tilde{a}, \tilde{l}) = \tilde{\Psi}(t, \tilde{a} - \tilde{l}, 0) =: \hat{\Psi}(t, \tilde{a} - \tilde{l}). \quad (6.206)$$

Like before, we denote by x the second argument of $\hat{\Psi}$. The relations between the partial derivatives of $\tilde{\Psi}$ and $\hat{\Psi}$ are given by

$$\partial_t \tilde{\Psi} = \partial_t \hat{\Psi}, \quad \tilde{\Psi}_{\tilde{a}} = \hat{\Psi}_x, \quad \text{and} \quad \tilde{\Psi}_{\tilde{l}} = -\hat{\Psi}_x. \quad (6.207)$$

and

$$\tilde{\Psi}_{\tilde{a}\tilde{a}} = \hat{\Psi}_{xx}, \quad \tilde{\Psi}_{\tilde{a}\tilde{l}} = -\hat{\Psi}_{xx}, \quad \text{and} \quad \tilde{\Psi}_{\tilde{l}\tilde{l}} = \hat{\Psi}_{xx}. \quad (6.208)$$

We obtain that

$$\begin{aligned} \tilde{h}(\theta, D\tilde{\Psi}, D^2\tilde{\Psi}) &= [(\theta^B r + \theta^S \mu - \tilde{\mu}) - \frac{1}{2}((\theta^S \sigma)^2 - \tilde{\sigma}^2)] \hat{\Psi}_x \\ &\quad + \frac{1}{2}[(\theta^S \sigma)^2 - 2\theta^S \sigma \tilde{\sigma} \rho_1 + \tilde{\sigma}^2] \hat{\Psi}_{xx}/2 \\ &=: \hat{h}(\theta, \hat{\Psi}_x, \hat{\Psi}_{xx}). \end{aligned} \quad (6.209)$$

and we set

$$\tilde{h}^*(D\hat{\Psi}, D^2\hat{\Psi}) := \sup_{\theta \in \Theta} \hat{h}(\theta, D\hat{\Psi}, D^2\hat{\Psi}). \quad (6.210)$$

The HJB equation satisfied by $\hat{\Psi}(t, x)$ is

$$\begin{cases} \hat{\Psi}(T, x) = \begin{cases} 1 & \text{if } x \geq 0, \\ 0 & \text{otherwise,} \end{cases} \\ -\partial_t \hat{\Psi} = \tilde{h}^*(D\hat{\Psi}, D^2\hat{\Psi}). \end{cases} \quad (6.211)$$

Similarly, we obtain the equation satisfied by $\hat{\Psi}_0$. It suffices to change the set of controls Θ in the Hamiltonian by

$$\Theta_0 = \{\theta = (\theta^B, \theta^S) : \theta^B + \theta^S = 1\}. \quad (6.212)$$

6.7.4 Numerical results

We have computed the value function with the Lagrange relaxation method, with the following parameters:

- ▷ $T = 2$
- ▷ $r = 0.03$
- ▷ $\mu = 0.07, \sigma = 0.2$
- ▷ $\tilde{\mu} = 0.05, \tilde{\sigma} = 0.005$
- ▷ $\rho_1 = 0, \rho_2 = 1$
- ▷ $\beta = 0.05$
- ▷ $\bar{\theta}^B = 2, \bar{\theta}^S = 2$.

The parameters for the discretization are the following:

- ▷ Number of times steps: 10
- ▷ Number of space steps: 50×50
- ▷ Discretization of the control space: $\{0, 1/2, 1, 3/2, 2\} \times \{0, 1/2, 1, 3/2, 2\}$

▷ Sampling for the dual value: $\{0, 1, 2, \dots, 50\}$.

Figure (6.12) shows a representation of the value function for $l = 1$ at $t = 0$. The value of V on the boundary Ψ has been taken into account to draw the graph.

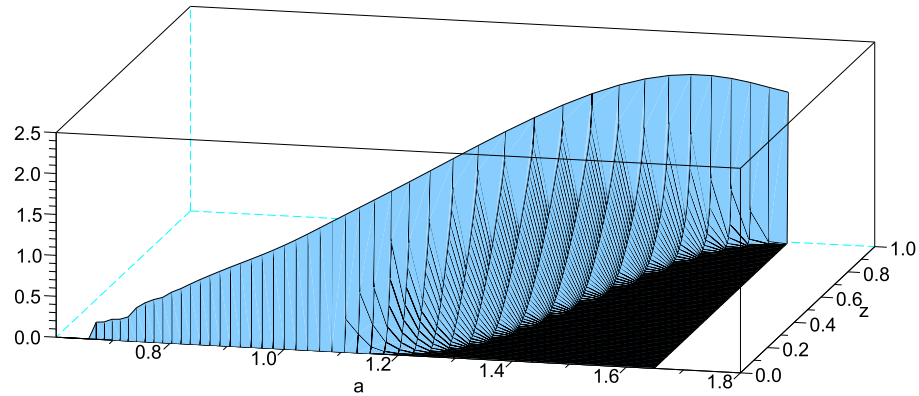

Figure 6.12: Value function at $l = 1$, $t = 0$

Figure (6.13) shows a representation of the highest reachable probability for $l = 1$ and $t = 0$.

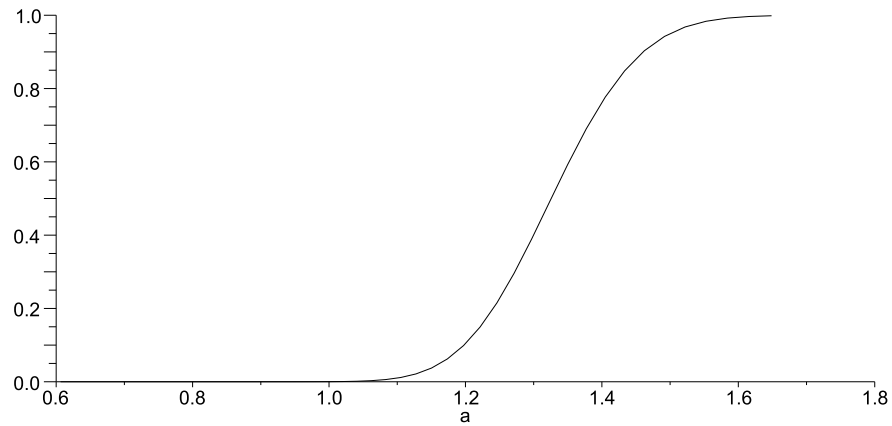

Figure 6.13: Highest reachable probability for $l = 1$ and $t = 0$

Bibliography of Part I

- [1] A. A. Agrachev and Y. Sachkov. *Control Theory from the Geometric Viewpoint*. Control theory and optimization. Springer, 2004.
- [2] E. L. Allgower and K. Georg. *Introduction to Numerical Continuation Methods*. Society for Industrial and Applied Mathematics, Philadelphia, PA, USA, 2003.
- [3] F. Álvarez, J. Bolte, J. F. Bonnans, and F. J. Silva. Asymptotic expansions for interior penalty solutions of control constrained linear-quadratic problems. *Math. Program.*, 135(1-2, Ser. A):473–507, 2012.
- [4] L. Ambrosio, N. Fusco, and D. Pallara. *Functions of bounded variation and free discontinuity problems*. Oxford Mathematical Monographs. The Clarendon Press Oxford University Press, New York, 2000.
- [5] M. S. Aronna. *Second order analysis of optimal control problems with singular arcs*. PhD thesis, Ecole Polytechnique, 2011.
- [6] J. P. Aubin and H. Frankowska. *Set-Valued Analysis*. Systems & Control. Birkhäuser, 1990.
- [7] E. J. Balder. Lectures on Young measure theory and its applications in economics. 1998.
- [8] E. N. Barron and R. Jensen. Relaxation of constrained control problems. *SIAM J. Control Optim.*, 34(6):2077–2091, 1996.
- [9] K. Barty, J. F. Bonnans, and L. Pfeiffer. Sensitivity analysis for the outages of nuclear power plants. Rapport de recherche RR-7884, INRIA, February 2012.
- [10] J. T. Betts. Survey of Numerical Methods for Trajectory Optimization. *AIAA J. of Guidance, Control and Dynamics*, 21:193–207, 1998.
- [11] J. F. Bonnans. The shooting approach to optimal control problems. In *Proc. IFAC International Workshop on Adaptation and Learning in Control and Signal Processing, Caen*, 2013.
- [12] J. F. Bonnans and R. Cominetti. Perturbed optimization in Banach spaces. I. A general theory based on a weak directional constraint qualification. *SIAM J. Control Optim.*, 34(4):1151–1171, 1996.

-
- [13] J. F. Bonnans, C. de la Vega, and X. Dupuis. First- and second-order optimality conditions for optimal control problems of state constrained integral equations. *Journal of Optimization Theory and Applications*, Online First, 2013.
- [14] J. F. Bonnans, X. Dupuis, and L. Pfeiffer. Second-order necessary conditions in Pontryagin form for optimal control problems. Inria Research Report RR-3806, INRIA, May 2013.
- [15] J. F. Bonnans, X. Dupuis, and L. Pfeiffer. Second-order sufficient conditions for strong solutions to optimal control problems. Inria Research Report RR-3807, INRIA, May 2013.
- [16] J. F. Bonnans and A. Hermant. No-gap second-order optimality conditions for optimal control problems with a single state constraint and control. *Math. Program.*, 117(1-2, Ser. B):21–50, 2009.
- [17] J. F. Bonnans and A. Hermant. Second-order analysis for optimal control problems with pure state constraints and mixed control-state constraints. *Ann. Inst. H. Poincaré Anal. Non Linéaire*, 26(2):561–598, 2009.
- [18] J. F. Bonnans and N. P. Osmolovskii. Second-order analysis of optimal control problems with control and initial-final state constraints. *J. Convex Anal.*, 17(3-4):885–913, 2010.
- [19] J. F. Bonnans, L. Pfeiffer, and O. S. Serea. Sensitivity analysis for relaxed optimal control problems with final-state constraints. *Nonlinear Analysis: Theory, Methods & Applications*, 89(0):55 – 80, 2013.
- [20] J. F. Bonnans and A. Shapiro. Optimization problems with perturbations: A guided tour. *SIAM Review*, 40(2):228–264, 1998.
- [21] J. F. Bonnans and A. Shapiro. *Perturbation analysis of optimization problems*. Springer Series in Operations Research. Springer-Verlag, New York, 2000.
- [22] A. E. Bryson and Y. C. Ho. *Applied Optimal Control*. Blaisdell, New York, 1969.
- [23] C. Castaing. Sur les multi-applications mesurables. *Rev. Française Informat. Recherche Opérationnelle*, 1(1):91–126, 1967.
- [24] C. Castaing, P. Raynaud de Fitte, and M. Valadier. *Young measures on topological spaces*, volume 571 of *Mathematics and its Applications*. Kluwer Academic Publishers, Dordrecht, 2004. With applications in control theory and probability theory.
- [25] C. Castaing and M. Valadier. *Convex analysis and measurable multifunctions*. Lecture Notes in Mathematics, Vol. 580. Springer-Verlag, Berlin, 1977.
- [26] R. Cominetti. Metric regularity, tangent sets, and second-order optimality conditions. *Appl. Math. Optim.*, 21(3):265–287, 1990.

-
- [27] A. V. Dmitruk. Maximum principle for the general optimal control problem with phase and regular mixed constraints. *Comput. Math. Model.*, 4(4):364–377, 1993. Software and models of systems analysis. Optimal control of dynamical systems.
- [28] A. V. Dmitruk. An approximation theorem for a nonlinear control system with sliding modes. *Tr. Mat. Inst. Steklova*, 256 (Din. Sist. i Optim.):102–114, 2007.
- [29] A. V. Dmitruk. Jacobi type conditions for singular extremals. *Control Cybernet.*, 37(2):285–306, 2008.
- [30] A. L. Dontchev and R. T. Rockafellar. *Implicit functions and solution mappings*. Springer Monographs in Mathematics. Springer, Dordrecht, 2009. A view from variational analysis.
- [31] A. Ja. Dubovickiĭ and A. A. Miljutin. Extremal problems with constraints. *Ž. Vyčisl. Mat. i Mat. Fiz.*, 5:395–453, 1965.
- [32] A. Ja. Dubovickiĭ and A. A. Miljutin. Necessary conditions for a weak extremum in optimal control problems with mixed constraints of inequality type. *Ž. Vyčisl. Mat. i Mat. Fiz.*, 8:725–779, 1968.
- [33] I. Ekeland and R. Temam. *Convex analysis and variational problems*. North-Holland Publishing Co., Amsterdam, 1976. Translated from the French, Studies in Mathematics and its Applications, Vol. 1.
- [34] F. Fourcade, E. Johnson, M. Bara, and P. Cortey-Dumont. Optimizing nuclear power plant refueling with mixed-integer programming. *European Journal of Operational Research*, 97(2):269 – 280, 1997.
- [35] H. Frankowska and F. Rampazzo. Relaxation of control systems under state constraints. *SIAM J. Control Optim.*, 37(4):1291–1309 (electronic), 1999.
- [36] R. V. Gamkrelidze. On sliding optimal states. *Dokl. Akad. Nauk SSSR*, 143:1243–1245, 1962.
- [37] R. V. Gamkrelidze. *Principles of optimal control theory*. Plenum Press, New York, revised edition, 1978. Translated from the Russian by Karol Malowski, Translation edited by and with a foreword by Leonard D. Berkovitz, Mathematical Concepts and Methods in Science and Engineering, Vol. 7.
- [38] M. Gerds. *Optimal Control of ODEs and DAEs*. De Gruyter Textbook. De Gruyter, 2012.
- [39] E. G. Gol’šteĭn. *Theory of convex programming*. American Mathematical Society, Providence, R.I., 1972. Translated from the Russian by K. Makowski, Translations of Mathematical Monographs, Vol. 36.
- [40] R. F. Hartl, S. P. Sethi, and R. G. Vickson. A survey of the maximum principles for optimal control problems with state constraints. *SIAM Rev.*, 37(2):181–218, 1995.

-
- [41] A. Hermant. *Sur l'algorithme de tir pour les problèmes de commande optimale avec contraintes sur l'état*. PhD thesis, Ecole Polytechnique, 2008.
- [42] A. Hermant. Stability analysis of optimal control problems with a second-order state constraint. *SIAM Journal on Optimization*, 20(1):104–129, 2009.
- [43] M. R. Hestenes. *Calculus of variations and optimal control theory*. John Wiley & Sons Inc., New York, 1966.
- [44] R. P. Hettich and H. Th. Jongen. Semi-infinite programming: conditions of optimality and applications. In *Optimization techniques (Proc. 8th IFIP Conf., Würzburg, 1977), Part 2*, pages 1–11. Lecture Notes in Control and Information Sci., Vol. 7. Springer, Berlin, 1978.
- [45] D. Hoehener. Variational approach to second-order optimality conditions for control problems with pure state constraints. *SIAM J. Control Optim.*, 50:1139–1173, 2012.
- [46] A. D. Ioffe and V. M. Tihomirov. *Theory of extremal problems*, volume 6 of *Studies in Mathematics and its Applications*. North-Holland Publishing Co., Amsterdam, 1979. Translated from the Russian by Karol Makowski.
- [47] H. Kawasaki. An envelope-like effect of infinitely many inequality constraints on second-order necessary conditions for minimization problems. *Math. Programming*, 41(1, (Ser. A)):73–96, 1988.
- [48] M. Khemmoudj. Modélisation et résolution de systèmes de contraintes : Application au problème de placement des arrêts et de la production des réacteurs nucléaires d'EDF. *PhD Thesis*, Avril 2007.
- [49] M. Khemmoudj, M. Porcheron, and H. Bennaceur. When constraint programming and local search solve the scheduling problem of Electricité de France nuclear power plant outages. In Frédéric Benhamou, editor, *Principles and Practice of Constraint Programming - CP 2006*, volume 4204 of *Lecture Notes in Computer Science*, pages 271–283. Springer Berlin / Heidelberg, 2006.
- [50] A. Liapounoff. Sur les fonctions-vecteurs complètement additives. *Bull. Acad. Sci. URSS. Sér. Math. [Izvestia Akad. Nauk SSSR]*, 4:465–478, 1940.
- [51] K. Malanowski. Second-order conditions in stability analysis for state constrained optimal control. *Journal of Global Optimization*, 40(1-3):161–168, 2008.
- [52] K. Malanowski and H. Maurer. Sensitivity analysis for optimal control problems subject to higher order state constraints. *Ann. Oper. Res.*, 101:43–73, 2001. Optimization with data perturbations, II.
- [53] H. Maurer. First and second order sufficient optimality conditions in mathematical programming and optimal control. *Math. Programming Stud.*, (14):163–177, 1981. Mathematical programming at Oberwolfach (Proc. Conf., Math. Forschungsinstitut, Oberwolfach, 1979).

-
- [54] E. J. McShane. Relaxed controls and variational problems. *SIAM J. Control*, 5:438–485, 1967.
- [55] A. A. Milyutin and N. P. Osmolovskii. *Calculus of variations and optimal control*, volume 180 of *Translations of Mathematical Monographs*. American Mathematical Society, Providence, RI, 1998.
- [56] N. P. Osmolovskii and H. Maurer. *Applications to regular and bang-bang control*, volume 24 of *Advances in Design and Control*. Society for Industrial and Applied Mathematics (SIAM), Philadelphia, PA, 2012.
- [57] H. J. Pesch. A practical guide to the solution of real-life optimal control problems. *Control and Cybernetics*, 23:7–60, 1994.
- [58] L. S. Pontryagin, V. G. Boltyanskii, R. V. Gamkrelidze, and E. F. Mishchenko. *The mathematical theory of optimal processes*. Translated from the Russian by K. N. Trirogoff; edited by L. W. Neustadt. Interscience Publishers John Wiley & Sons, Inc. New York-London, 1962.
- [59] M. Porcheron, A. Gorge, O. Juan, T. Simovic, and G. Dereu. Challenge ROADEF/EURO 2010: A large-scale energy management problem with varied constraints.
<http://challenge.roadef.org/2010/files/sujetEDFv22.pdf>. Février 2010.
- [60] S. M. Robinson. First order conditions for general nonlinear optimization. *SIAM J. Appl. Math.*, 30(4):597–607, 1976.
- [61] S. M. Robinson. Regularity and stability for convex multivalued functions. *Math. Oper. Res.*, 1(2):130–143, 1976.
- [62] R. T. Rockafellar. Integral functionals, normal integrands and measurable selections. In *Nonlinear operators and the calculus of variations (Summer School, Univ. Libre Bruxelles, Brussels, 1975)*, pages 157–207. Lecture Notes in Math., Vol. 543. Springer, Berlin, 1976.
- [63] E. D. Sontag. *Mathematical Control Theory: Deterministic Finite Dimensional Systems*. Texts in Applied Mathematics. Springer, 1998.
- [64] G. Stefani and P. Zezza. Optimality conditions for a constrained control problem. *SIAM J. Control Optim.*, 34(2):635–659, 1996.
- [65] E. Trélat. *Contrôle optimal: théorie et applications*. Collection Mathématiques Concrètes. Vuibert, 2005.
- [66] C. Ursescu. Multifunctions with convex closed graph. *Czechoslovak Math. J.*, 25(100)(3):438–441, 1975.
- [67] M. Valadier. Young measures. In *Methods of nonconvex analysis (Varenna, 1989)*, volume 1446 of *Lecture Notes in Math.*, pages 152–188. Springer, Berlin, 1990.

-
- [68] M. Valadier. A course on Young measures. *Rend. Istit. Mat. Univ. Trieste*, 26(suppl.):349–394 (1995), 1994. Workshop on Measure Theory and Real Analysis (Italian) (Grado, 1993).
- [69] R. B. Vinter. *Optimal Control*. Modern Birkhäuser classics. Birkhauser Verlag AG, 2000.
- [70] J. Warga. Necessary conditions for minimum in relaxed variational problems. *J. Math. Anal. Appl.*, 4:129–145, 1962.
- [71] J. Warga. Relaxed variational problems. *J. Math. Anal. Appl.*, 4:111–128, 1962.
- [72] J. Warga. *Optimal control of differential and functional equations*. Academic Press, New York, 1972.
- [73] L. C. Young. *Lectures on the calculus of variations and optimal control theory*. Foreword by Wendell H. Fleming. W. B. Saunders Co., Philadelphia, 1969.
- [74] J. Zowe and S. Kurcyusz. Regularity and stability for the mathematical programming problem in Banach spaces. *Appl. Math. Optim.*, 5(1):49–62, 1979.

Bibliography of Part II

- [75] L. Andrieu, G. Cohen, and F. J. Vázquez-Abad. Gradient-based simulation optimization under probability constraints. *European J. Oper. Res.*, 212(2):345–351, 2011.
- [76] M. Bardi and I. Capuzzo-Dolcetta. *Optimal Control and Viscosity Solutions of Hamilton-Jacobi-Bellman Equations*. Modern Birkhäuser Classics. Birkhäuser Boston, 2008.
- [77] G. Barles and P. E. Souganidis. Convergence of approximation schemes for fully nonlinear second order equations. 1990.
- [78] R. Bellman. *Dynamic Programming*. Princeton University Press, Princeton, NJ, 1957.
- [79] O. Bokanowski, B. Bruder, S. Maroso, and Z. Zidani. Numerical approximation for a superreplication problem under gamma constraints. *SIAM. Num. Analysis.*, 47(3):2289–2320, 2009.
- [80] J. F. Bonnans, E. Ottenwaelter, and H. Zidani. A fast algorithm for the two dimensional HJB equation of stochastic control. *ESAIM: Mathematical Modelling and Numerical Analysis*, 38(4):723–735, 3 2010.
- [81] J. F. Bonnans and H. Zidani. Consistency of generalized finite difference schemes for the stochastic HJB equation. *SIAM J. Numerical Analysis*, 41:1008–1021, 2003.
- [82] B. Bouchard. Portfolio management under risk constraints. Lecture notes, 2010.
- [83] B. Bouchard, R. Elie, and C. Imbert. Optimal control under stochastic target constraints. *SIAM Journal on Control and Optimization*, 48(5):3501–3531, 2010.
- [84] B. Bouchard, R. Elie, and N. Touzi. Stochastic target problems with controlled loss. *SIAM Journal on Control and Optimization*, 48(5):3123–3150, 2010.
- [85] B. Bruder. Super-replication of European options with a derivative asset under constrained finite variation strategies.
- [86] P. Carpentier, J. P. Chancelier, G. Cohen, M. De Lara, and P. Girardeau. Dynamic consistency for stochastic optimal control problems. *Annals of Operations Research*, 200(1):247–263, 2012.

-
- [87] M. G. Crandall, L. C. Evans, and P. L. Lions. Some properties of viscosity solutions of hamilton-jacobi equations. *American Mathematical Society*, 282(2), 1984.
- [88] M. G. Crandall, H. Ishii, and P. L. Lions. User's guide to viscosity solutions of second order partial differential equations. *Bull. Amer. Math. Soc.*, 27(1):1–67, July 1992.
- [89] M. G. Crandall and P. L. Lions. Viscosity solutions of hamilton-jacobi equations. *Transactions of the American Mathematical Society*, pages 1–42, 1983.
- [90] W. H. Fleming and H. M. Soner. *Controlled Markov Processes and Viscosity Solutions*. Applications of Mathematics Series. Springer-Verlag, 1993.
- [91] P. Girardeau. *Résolution de grands problèmes en optimisation stochastique dynamique et synthèse de lois de commande*. PhD thesis, Université Paris-Est, 2010.
- [92] G. Granato. *Optimisation de lois de gestion énergétique des véhicules hybrides*. PhD thesis, Ecole Polytechnique, 2012.
- [93] R. Henrion. On the connectedness of probabilistic constraint sets. *Journal of Optimization Theory and Applications*, 112(3):657–663, 2002.
- [94] R. Henrion. Introduction to chance-constrained programming. 2004.
- [95] R. Henrion and C. Strugarek. Convexity of chance constraints with independent random variables. 2007.
- [96] J. B. Hiriart-Urruty and C. Lemarechal. *Convex Analysis and Minimization Algorithms: Part 2: Advanced Theory and Bundle Methods*. Convex Analysis and Minimization Algorithms. Springer, 1993.
- [97] H. J. Kushner. Numerical methods for stochastic control problems in continuous time. *SIAM J. Control Optim.*, 28(5):999–1048, 1990.
- [98] H. J. Kushner and P. Dupuis. *Numerical Methods for Stochastic Control Problems in Continuous Time*. Applications of mathematics. Springer, 2001.
- [99] C. Lemaréchal. Lagrangian relaxation. In Michael Junger and Denis Naddef, editors, *Computational Combinatorial Optimization*, volume 2241 of *Lecture Notes in Computer Science*, pages 112–156. Springer Berlin Heidelberg, 2001.
- [100] R. C. Merton. Optimum consumption and portfolio rules in a continuous-time model. *J. Econom. Theory*, 3(4):373–413, 1971.
- [101] B. Øksendal. *Stochastic Differential Equations: An Introduction with Applications*. Hochschultext / Universitext. Springer, 2003.
- [102] H. Pham. *Continuous-time stochastic control and optimization with financial applications*, volume 61 of *Stochastic Modelling and Applied Probability*. Springer-Verlag, Berlin, 2009.

-
- [103] R. T. Rockafellar. *Convex Analysis*. Princeton mathematical series. Princeton University Press, 1970.
- [104] A. Shapiro, D. Dentcheva, and A. P. Ruszczyński. *Lectures on Stochastic Programming: Modeling and Theory*. MPS-SIAM series on optimization. Society for Industrial and Applied Mathematics (SIAM, 3600 Market Street, Floor 6, Philadelphia, PA 19104), 2009.
- [105] N. Touzi. *Optimal Stochastic Control, Stochastic Target Problems, and Backward SDE*. Fields Institute Monographs. Springer, 2012.
- [106] J. H. van Binsbergen and M. W. Brandt. Optimal asset allocation in asset liability management. Working Paper 12970, National Bureau of Economic Research, March 2007.

Résumé

Cette thèse est divisée en deux parties. Dans la première partie, nous étudions des problèmes de contrôle optimal déterministes avec contraintes et nous nous intéressons à des questions d'analyse de sensibilité. Le point de vue que nous adoptons est celui de l'optimisation abstraite; les conditions d'optimalité nécessaires et suffisantes du second ordre jouent alors un rôle crucial et sont également étudiées en tant que telles. Dans cette thèse, nous nous intéressons à des solutions fortes. De façon générale, nous employons ce terme générique pour désigner des contrôles localement optimaux pour la norme L^1 . En renforçant la notion d'optimalité locale utilisée, nous nous attendons à obtenir des résultats plus forts. Deux outils sont utilisés de façon essentielle : une technique de relaxation, qui consiste à utiliser plusieurs contrôles simultanément, ainsi qu'un principe de décomposition, qui est un développement de Taylor au second ordre particulier du lagrangien.

Les chapitres 2 et 3 portent sur les conditions d'optimalité nécessaires et suffisantes du second ordre pour des solutions fortes de problèmes avec contraintes pures, mixtes et sur l'état final. Dans le chapitre 4, nous réalisons une analyse de sensibilité pour des problèmes relaxés avec des contraintes sur l'état final. Dans le chapitre 5, nous réalisons une analyse de sensibilité pour un problème de production d'énergie nucléaire.

Dans la deuxième partie, nous étudions des problèmes de contrôle optimal stochastique sous contrainte en probabilité. Nous étudions une approche par programmation dynamique, dans laquelle le niveau de probabilité est vu comme une variable d'état supplémentaire. Dans ce cadre, nous montrons que la sensibilité de la fonction valeur par rapport au niveau de probabilité est constante le long des trajectoires optimales. Cette analyse nous permet de développer des méthodes numériques pour des problèmes en temps continu. Ces résultats sont présentés dans le chapitre 6, dans lequel nous étudions également une application à la gestion actif-passif.

