



HAL
open science

Risk management in double unknown: theory, model and organization for the design of generic technologies

Olga Kokshagina

► **To cite this version:**

Olga Kokshagina. Risk management in double unknown: theory, model and organization for the design of generic technologies. Business administration. Ecole Nationale Supérieure des Mines de Paris, 2014. English. NNT: 2014ENMP0009 . pastel-01038009

HAL Id: pastel-01038009

<https://pastel.hal.science/pastel-01038009>

Submitted on 23 Jul 2014

HAL is a multi-disciplinary open access archive for the deposit and dissemination of scientific research documents, whether they are published or not. The documents may come from teaching and research institutions in France or abroad, or from public or private research centers.

L'archive ouverte pluridisciplinaire **HAL**, est destinée au dépôt et à la diffusion de documents scientifiques de niveau recherche, publiés ou non, émanant des établissements d'enseignement et de recherche français ou étrangers, des laboratoires publics ou privés.

ParisTech

INSTITUT DES SCIENCES ET TECHNOLOGIES
PARIS INSTITUTE OF TECHNOLOGY



École doctorale n° 396 : Économie, Organisations & Société

Doctorat ParisTech

T H È S E

pour obtenir le grade de docteur délivré par

l'École nationale supérieure des mines de Paris

Spécialité “ Sciences de Gestion ”

présentée et soutenue publiquement par

Olga KOKSHAGINA

le 29 janvier 2014

Risk Management in double unknown :

Theory, Model and Organization for the design of Generic Technologies

Directeurs de thèse : **Pascal LE MASSON** et **Benoit WEIL**

Jury

Mme Carliss Y. BALDWIN, Professeur, Finance, Harvard Business School

M. Jean-François BOUJUT, Professeur, G-SCOP, Grenoble INP

M. Patrick COGEZ, Directeur Innovation/Recherche externe, STMicroelectronics

M. Olivier L. DE WECK, Professeur, Engineering Systems Division, MIT

M. Sylvain LENFLE, Maître de conférence - HDR, THEMA, Université de Cergy-Pontoise

Suffragant

Rapporteur

Suffragant

Suffragant

Rapporteur

M. Pascal LE MASSON, Professeur, Centre de Gestion Scientifique, Mines ParisTech

M. Benoit WEIL, Professeur, Centre de Gestion Scientifique, Mines ParisTech

Directeur de thèse

Directeur de thèse

MINES ParisTech
Centre de Gestion Scientifique
60 Boulevard Saint-Michel, 75006

**T
H
È
S
E**

Mines ParisTech n'entend donner aucune approbation ni improbation aux opinions émises dans cette thèse. Ces opinions doivent être considérées comme propres à l'auteur

*“Рукописи не горят” -
“Manuscripts don't burn”*

Mikhail Bulgakov, *The Master and Margarita*

Remerciements

A l'issue de cette thèse, j'aimerais tout d'abord remercier mes directeurs de thèse, Professeurs Pascal Le Masson et Benoit Weil, d'avoir accepté ma candidature et de m'avoir guidé lors de ce parcours riche d'expériences et de réflexions. Vous m'avez apporté beaucoup aussi bien dans l'accompagnement de ce travail que dans le développement de ma curiosité et de mon esprit critique.

Je tiens à remercier mon tuteur industriel Patrick Cogez pour sa confiance, ses précieux conseils et pour son soutien lors des nombreuses initiatives chez STMicroelectronics. Ensuite je ne pourrais pas oublier Pascal Ancey, même s'il m'est très difficile de trouver les mots pour lui exprimer ma gratitude maintenant qu'il nous a quitté. Son courage et sa détermination, mais aussi ces encouragements, son écoute, sa disponibilité, sa créativité m'ont aidé à trouver le courage nécessaire et ont été pour moi une source de motivation majeure.

Je souhaite aussi remercier les membres du jury qui ont apporté leur expérience et un regard extérieur de grande grande qualité. Un grand merci à Pr. Carliss Baldwin qui a accepté a participé et présidé mon jury de thèse. Carliss, it was a great honor to have you in the committee. Thank you for your evaluation and valuable inputs for my work. Je remercie les rapporteurs de thèse Prs. Jean-François Boujut et Sylvain Lenfle qui ont examiné ce travail et leur intérêt qu'ils ont porté à mon sujet de recherche. Merci à Pr. Olivier de Weck pour avoir bien voulu évaluer ce travail dans des délais très courts et d'avoir apporté des éléments de réflexions importants et originaux.

La richesse de données empiriques et l'analyse effectuée lors de mes travaux sont aussi le résultat de la précieuse contribution des nombreux experts et managers chez ST. Je voudrais vous remercier pour votre temps, vos inputs et votre enthousiasme qui m'ont beaucoup guidée lors de ces trois années passées au sein de STMicroelectronics. En particulier, j'aimerais remercier chaleureusement Eric Balossier, Patrick Blouet, Najet Chakroun, Patrick Dureault, Yacine Felk, Bernard Fontan, Richard Fournel, Eric Flamand, Yves Gilot, Dominique Henoff, Jean-Luc Jaffard, Loic Lietar, Gerard Matheron, Diego Melpignano, Sylvie Phelpun, Bernard Sautreuil, et Dominique Thomas.

J'ai eu la chance de suivre les travaux sur les "Business Innovation Challenge" chez ST et d'assister aux nombreuses réunions de réflexions avec le "Core Innovation Team" que je tiens également à remercier. En particulier merci à Michel Bendredi, Cedrick Chappaz, Mario Diaznavia, Olivier Le-Briz, Pascale Mazoyer, Stéphane Monfray, Thomas Skotnicki, Pascal Urard qui ont largement contribué aux réflexions effectuées lors de cette thèse. Merci à ceux qui ont accepté d'être interviewés. J'ai beaucoup appris de vos passionnantes expériences sur des projets innovants.

Je tiens à remercier les nombreux experts, doctorants, stagiaires qui ont accepté de participer aux sessions de conception en propriété intellectuelle. Merci de m'avoir donné cette opportunité de vous guider dans cette exploration, d'apprendre beaucoup de choses avec vous et surtout passer des moments extraordinaires ensemble. Merci beaucoup aux teams créatifs et spécialement à Pierre Bar, Yann Beilliard,

François Bernard, Laurent-Luc Chapelon, Cedrick Chappaz, Romain Girard Desprolet, Simon Gousseau, Sandrine Lhostis, Christophe Maitre, Stéphane Monfray, Sylvain Joblot, Onoriu Puscasu, Alisee Taluy, et Benjamin Vianne.

Un grand merci à l'équipe 3D Intégration pour votre accueil à ST Crolles, pour les pauses cafés amusantes, pour votre passion et pour m'avoir offert l'opportunité de faire mes premiers pas dans le monde fascinant de la micro-électronique : Jean Michailos, Nicolas Hotellier, Alexis Farcy, Fabrice Casset, Fabienne Ponthenier, Perceval Coudrain, Jean-François Carpentier, Mélanie Brocard, Sébastien Mermoz, Emelie Trioux. Lionel Cadix, David Petit, et Yoann Civet.

Cette recherche a été aussi l'opportunité de partager mes réflexions et résultats avec les étudiants de 2A et 3A de l'ENSTA et des Mines en stage chez ST et au Centre de Gestion Scientifique : Hassen, Arnaud, David, Maxime et Adrien. Merci pour votre enthousiasme et pour la qualité de vos travaux.

Je remercie Prs. Armand Hatchuel, Blanche Segrestin et Eva Boxenbaum pour leurs remarques stimulantes. Un grand merci à l'ensemble des doctorants et post-docs qui m'ont toujours témoigné sympathie et encouragements. Merci à Pierre-Antoine, Fred et Fred, Akin, Olga, Lucie, Elvira, Elsa, Milena, Kenza, Fabien, Paris pour tout les moments passés ensemble. En particulier, merci à Kevin Levillain, Sophie Hooge, Marine Agogué, Ingi Brown, Aurélie Sara Cognat, Jeanne Riot et Mélodie Cartel pour les relectures de mon mémoire.

Je n'oublierais pas les aides permanentes reçues du personnel administratif du STMicroelectronics et du Centre de Gestion Scientifique: Catherine Soullignac, Evelyne Montmayeul, Stéphanie Brunet, Céline Bourdon et Martine Jouanon pour leur support administratif pendant ces trois dernières années.

Enfin merci à mes proches pour leur soutien permanent durant ces années. Merci à ma famille : Мамочка и Наташа, спасибо за вашу поддержку, за ваше понимание и постоянное присутствие даже за 3000 км. Спасибо моим друзьям и особенно тебе, Катя. Спасибо родная за то что приехала на защиту, за твою помощь и понимание. Спасибо за то, что ты всегда видишь хорошее даже в самые трудные моменты.

Finalmente, vorrei ringraziare particolarmente Jacopo. La mia tesa è un po' la tua tesi. Hai superato i momenti diversi con me et eri sempre disponibile. Grazie per la tua pazienza. Per aver avuto fiducia in me anche quando io non ero più disposta ad averne, per avermi sempre ripetuto di crederci e per aver aiutarmi durante tutte le ore che ho dedicato a questo lavoro. Per questi 5 anni che ci hanno visti crescere, per mi vuole bene....

Résumé de la thèse: “Gestion de risque en situation de double inconnu: théorie, modèle et l’organisation pour la conception de technologies génériques”

1. Gestion de risques en double inconnu : du paradigme décisionnel a la conception.....	11
2. La problématique et les questions de recherche.....	15
3. Approche méthodologique : vers un double inconnu « gérable ».....	17
4. Résultats : la conception de technologies génériques en double inconnu	19

Résumé de la thèse

Nous proposons ici un résumé en français de la thèse. Dans une première section, nous procédons au positionnement théorique de notre travail : nous analysons la littérature en gestion des risques et incertitudes ainsi que la littérature sur les technologies génériques. Cette analyse révèle la limite des stratégies de gestion de risques traditionnelles face à un double inconnu. Pourtant certaines industries, comme celles de semi-conducteurs, télécommunication, bio- et nanotechnologies, doivent organiser des développements technologiques à coûts et risques contrôlés, alors que les dimensions techniques et commerciales sont sujettes à des incertitudes majeures. Une motivation supplémentaire pour gérer la conception en double inconnu est la possibilité de surmonter les risques technologiques et de marché par la conception de technologies génériques qui adressent plusieurs marchés différents. Pour étudier la conception de technologies génériques en double inconnu cette thèse définit quatre questions de recherche : Quelles sont les stratégies pour gérer le processus de conception en double inconnu ? Quel est le domaine de validité de ces différentes stratégies de gestion de risque ? Quel est le processus de conception de technologies génériques? Quels sont les compétences et les acteurs indispensables pour piloter ce type de processus? (Deuxième section). **Ce travail de thèse montre que la situation de double inconnu est « gérable ». Nous proposons une méthode pour l'entreprise à travers l'identification et le pilotage de concepts techniques génériques capables de traiter plusieurs marchés émergents.** Dans la troisième section, nous présentons quelques éléments de méthode et justifions la pertinence de l'industrie des semi-conducteurs pour étudier notre problématique. Cette thèse mobilise un ensemble très riche de cas empiriques effectués chez STMicroelectronics. Enfin, nous synthétisons les apports théoriques et managériaux de nos recherches.

1. GESTION DE RISQUES EN DOUBLE INCONNU : DU PARADIGME DECISIONNEL A LA CONCEPTION

1.1. Risque, incertitude et inconnu : nécessité de gestion en double inconnu

L'augmentation des coûts des investissements en R&D, le rythme de l'innovation soutenue et intensive qui nécessite un investissement de R&D de plus en plus coûteux et fréquent, amène les entreprises à dépasser les stratégies traditionnelles de conception et de gestion de risque ».

Pour demeurer un des leaders du marché, il faut néanmoins savoir apporter des produits différenciés, à forte marge, au bon moment. Ceci n'est possible qu'en restant à la pointe de la technologie, au meilleur coût, ce qui implique de maintenir une R&D avancée, tout en accroissant son efficacité économique. Les moyens classiques dont disposent les entreprises qui cherchent à développer des technologies radicales et proposer des produits « disruptifs » sont l'externalisation de la R&D avancée, la création de partenariats pour piloter les activités exploratoires, le lancement de concours à idées et le développement de méthodes créatives pour gérer les processus en inconnu tout en contrôlant le coût de l'exploration. Ces méthodes visent à explorer l'inconnu tout en contrôlant les ressources investies.

Que prédisent les modèles sur l'efficacité de telles méthodes ? Les modèles traditionnels de gestion du risque considèrent que les espérances de gain sont inversement proportionnelles aux incertitudes initiales sur la technique et (ou) sur le marché (Chapman, 1990, Lipshitz and Strauss, 1997). Plusieurs modèles ont été développés, correspondant à des types d'incertitude. Lorsqu'en fait l'hypothèse que les couples technologies-marchés sont déjà établis, il est possible d'utiliser des critères classiques comme la valeur actuelle nette (VAN), le Discounted Cash Flow (DCF). Ces critères permettent le choix de la meilleure solution parmi un ensemble d'options prédéterminées en utilisant les critères de gestion des risques.

Si le niveau d'incertitude est plus élevé, on introduit une liste fixée d'états de la nature et une probabilité associée à chaque état. Ce modèle correspond à la théorie de la décision dans l'incertain, développée par Savage (Savage, 1972) et Raïffa (Raïffa, 1968). Dans cette situation la prise de décision est possible et tient compte de forme de minimisation de l'incertitude. Ces approches théoriques sous-tendent les modèles classiques comme le *techno push* (réduire les risques en partant d'une proposition technique maîtrisée) et le *market pull* (réduire les risques marché en explicitant une demande), qui sont utilisées pour choisir soit une « meilleure » technologie (quand le marché est inconnu) soit un besoin de marché fort (quand la technologie est indéterminée) (Coombs, 2007, Hauser and Clausing, 1988).

Grâce à la théorie de la décision dans l'incertain il est impossible de calculer la valeur d'un « essai » qui permettrait de diminuer l'incertitude sur les états de la nature. Cette stratégie s'appelle « trial and learning » et elle est souvent utilisée pour gérer l'exploration dans les situations de haute incertitude (Lynn, 1998, Loch, 2008). Ce cadre théorique a permis le développement d'*options réelles* qui permettent de calculer la valeur d'une expérience ou d'une étude supplémentaire et de diminuer les incertitudes (Huchzermeier and Loch, 2001).

Ces méthodes présentent leurs limites lorsque la liste de solutions possibles est encore inconnue ; typiquement lorsque ni le marché ni les technologies ne sont déterminés. Dans ce cas ce n'est pas la probabilité qu'est en jeu mais la nature même de l'état.

Néanmoins, ces situations sont déjà envisagées dans la littérature (voir notions d'incertitude selon Knight (Knight, 1921) ; ou plus récemment les analyses d'innovation disruptive (marché inconnu) (Christensen, 1996) et l'innovation de rupture (innovation technologique) (Abernathy and Clark, 1985)) ; le résultat majeur de ces travaux est que les situations de double inconnu ne peuvent pas être gérées dans des logiques de « technology push » ou de « market pull ». Et les travaux ont souvent conduit à penser que ce type de projet supposait une prise de risque inévitable, plus importante et moins gérable que les projets classiques.

De telles situations sont pourtant la règle dans certaines industries comme les semi-conducteurs, où les inconnues techniques et commerciales sont très importantes. Prenons un exemple : il paraît évident que les téléphones intelligents complètement flexibles vont se développer, mais l'existence et la nature de marchés auxquels ils s'adresseront n'est pas déterminée. Donc, nous pouvons déjà nous demander quels sont les besoins futurs et les fonctions futures auxquels cette solution va s'adresser. De même pour les

technologies : on anticipe des besoins émergents en utilisant les compétences techniques existantes et en explorant de nouvelles technologies, mais sans connaître à l'avance les technologies les plus prometteuses ». La gestion du risque sur les projets en double inconnu apparaît nécessaire mais il n'existe pas à l'heure actuelle des modèles adaptés. Peut-on assurer un développement à risques limités alors que marchés et technologies sont encore inconnus ?

De Neufville et al. (2004) montrent que l'incertitude pourrait être considérée comme une opportunité et que les concepteurs devraient s'appropriier la gestion en inconnu pour proposer des séries de solutions originales. Cette alternative est une invitation à « profiter » des inconnues technologiques et de marché pour concevoir des solutions qui permettent de structurer l'inconnu et de poursuivre l'exploration technologique.

Dans cette perspective la gestion de l'inconnu se renverse et il ne s'agit plus de décider entre des alternatives incertaines mais de concevoir des nouvelles alternatives ayant une forte probabilité de succès. Les questions deviennent: Peut-on élaborer des modèles de gestion du risque en double inconnu qui fassent mieux que le hasard ? Comment conjuguer projet de R&D en double inconnu (innovation radicale sur la technique et disruptive sur le marché) et risques limités ? Est-il possible de gérer une telle situation et contrôler les risques en double inconnu ?

1.2. Comment gérer l'exploration en double inconnu ?

Les stratégies d'exploration de double inconnu ne sont pas nouvelles. En particulier les stratégies type « *trial and learning* » peuvent être interprétées comme des stratégies de conception. Néanmoins, il faudrait préciser les limites en terme de conception. Dans la littérature sur la gestion de risque, d'incertitude, les stratégies existantes nous montrent qu'en cas de situation à double inconnu, il est possible d'utiliser un « *trial and learning* » (essai et apprentissage ou « *probe and learning* ») (Lynn, 1998, Loch, 2008) Il s'agit d'identifier un *trial* de marché, de développer une technologie pour ce marché et d'augmenter la probabilité d'existence de ce « marché essayé » en fonction de l'apprentissage. Cette stratégie a pour objectif d'augmenter la probabilité de succès sur le premier marché et ne cherche pas directement à contrôler le nombre de marchés que la nouvelle technologie peut intéresser. Quand cette stratégie considère la pénétration d'une technologie au sein de marchés différents, l'apprentissage porte sur des marchés multiples, mais uniquement sur les probabilités subjectives associées aux états de la nature. Les états de la nature et les solutions émergentes restent indépendants et la stratégie reste dépendante du premier choix effectué (Danneels, 2007).

Les travaux académiques en économie, histoire, sociologie nous laissent penser qu'il existe d'autres stratégies d'exploration de l'incertitude qui peuvent être plus performantes que le « *trial and learning* ». Il s'agit de développer des technologies génériques (general-purpose technologies) (Cantwell and Qui, 2009, Maine and Garnsey, 2006). Les technologies génériques sont alors envisagées comme des plateformes qui sont capables de répondre à des besoins présents sur *plusieurs* marchés existants ou émergents. Autrement dit, les technologies génériques permettent, une fois développées, de résister aux situations de forte incertitude. Par exemple, supposons qu'il existe une technologie émergente qui, à un faible effort de

Résumé de la thèse

R&D près, adresse des marchés potentiels tous très improbables mais en assez grand nombre, disons 20 marchés ayant chacun une probabilité de succès de 20%. La probabilité qu'il existe au moins un marché qui émerge devient très élevée : $1 - (1 - 0.2)^{20} \sim 0.98$. Dans cette perspective en double inconnu, le projet de R&D pourrait être un projet à forte probabilité de succès, s'il propose une solution générique permettant d'adresser plusieurs marchés ne demandant qu'un effort d'adaptation marginal. En explorant la trajectoire «générique», les entreprises pourront profiter de cette situation de double inconnu pour proposer une solution générique capable d'adresser plusieurs marchés émergents.

La performance des TG pour la gestion en double inconnu tient aux interdépendances entre alternatives. Les plateformes technologiques sont souvent représentées comme un ensemble de composants standards autour desquels les acheteurs et les vendeurs coordonnent leurs efforts et donc construisent des nouveaux modules (Bresnahan and Greenstein, 1999). Les approches de type plateforme permettent aujourd'hui d'évaluer le potentiel de plateformes technologiques plus ou moins modulaires (Baldwin and Clark, 2006, Gawer, 2009), c'est-à-dire permettant d'adresser plusieurs configurations potentielles de marchés. En assimilant une TG à une plateforme, on comprend la valeur de la généralité d'une technologie.

Ces méthodes traitent principalement des plateformes connues et ne formulent pas de recommandations sur les interdépendances qui doivent être privilégiées afin de développer des plateformes génériques flexibles. **Comment concevoir une plateforme ? On peut penser que dans une situation donnée plusieurs plateformes peuvent être conçues. Laquelle donc valoriser en fonction de la structure des indépendances et interdépendances entre les technologies et les marchés ?**

Notre analyse nous conduit à identifier deux approches possibles pour l'exploration de l'inconnu :

- Un **Trial and Learning** qui tire parti de l'apprentissage afin d'augmenter la probabilité d'existence d'un marché.
- Ou au contraire une stratégie visant à tirer parti du nombre de marchés que les technologies pourrait adresser, une possibilité que le modèle des General-Purpose Technologies semble indiquer. D'habitude, le nombre de marchés n'est pas pris en compte et les stratégies visent plutôt à travailler sur l'augmentation de la probabilité d'un de ces marchés. Existe-t-il une stratégie qui tire partie du nombre de marchés émergents adressable par une technologie?

Enfin, est-il possible de construire une stratégie de développement de technologies génériques différente du *trial and learning* et qui permettrait de traiter le double inconnu? Comment le processus de conception pourrait-il être organisé pour concevoir des technologies génériques? Comment peut-on alors rendre la technologie générique et quelles sont les méthodes de construction de la généralité?

2. LA PROBLEMATIQUE ET LES QUESTIONS DE RECHERCHE

2.1. La problématique de recherche : la conception de technologies génériques pour gérer les risques en double inconnu

Dans un premier temps, nous avons montré que la situation de double inconnu est souvent considérée comme ingérable. Nous proposons de renverser l'analyse traditionnelle et de considérer ce même « double inconnu » comme une opportunité : celle de proposer une nouvelle solution qui structurera l'inconnu et rendra possible la gestion des risques. Dans un second temps, nous avons indiqué que les technologies génériques, qui adressent de nombreux marchés potentiels, constituent une opportunité pour gérer les risques en univers inconnu et assurer le succès de l'investissement technologique. Mais comment construire la généricité que dans la littérature n'apparaît qu'une fois la technologie développée (l'effort porte alors sur les stratégies et les modèles d'affaires pour leur commercialisation)? A l'heure actuelle, il n'existe pas de méthode de conception et de gestion de technologies génériques en double inconnu. Pourrait-on imaginer soit une technologie créant les interdépendances pour des marchés futurs soit une technologie qui adresse directement plusieurs marchés à la fois ?

Dans cette thèse nous mobilisons des théories de conception innovante afin d'intégrer la capacité de conception au champ de la gestion de risque par la réduction de l'incertitude. **La problématique de cette thèse peut alors être posée de la manière suivante : Comment concevoir une technologie générique qui réduise les risques en double inconnu? L'objectif de cette recherche est de proposer une conception de la technologie générique qui articule des explorations technologiques et commerciales avancées.**

2.2. Les questions de recherche : vers une nouvelle logique d'action pour la conception de technologies génériques

Afin de travailler sur la conception de technologies génériques, l'objet de gestion en double inconnu doit être précisé. Ayant exposé deux types de stratégies de gestion de risque dans l'inconnu (une stratégie de gestion du risque par réduction d'incertitude comme le trial and learning, et une stratégie de type plateforme qui vise à accroître la généricité par la conception de modules) nous montrons que le niveau d'analyse, les critères de contingence associés, les objets de l'exploration, et les acteurs mobilisés sont différents dans ces deux cas. C'est pourquoi il faudrait d'abord avoir un cadre pour comparer ces stratégies afin d'identifier une stratégie de gestion en double inconnu. **D'où la première question : comment caractériser les différentes stratégies mobilisées par les entreprises et le faire face aux situations de double inconnu ? En particulier, les stratégies type « trial and learning » sont largement connus mais peut-on mettre en évidence les « anomalies de déviance » par rapport à ces stratégies ?**

Ensuite, si une telle stratégie existe, dans quel domaine est-elle pertinente? Quel est le domaine de validité de ces différentes stratégies de gestion du risque ? Est-ce que les critères d'évaluation des

stratégies innovantes ne doivent pas tenir compte du type de domaine technico-économique, et de la variété des dynamiques industrielles ? **Quelle stratégie adopter en fonction des dynamiques des marchés et des techniques ?** Gambardella and McGahan (2010) ont montré que les logiques business classiques sont limitées en cas de technologies génériques qui cherchent à adresser plusieurs marchés et donc la commercialisation de **TGs** nécessite des modèles de « business plans » différents. Ne devrait-on pas introduire des nouveaux critères de description de la situation technico-économique qui permettent de distinguer les cas où les TGs deviendraient intéressantes? Dans quel contexte le business plan orienté par la conception de technologies génériques devient-t-il intéressant?

Le développement de technologies génériques est souvent considéré comme un processus de « trial and learning ». L'essai est en général choisi parmi une liste de choix connus (Miyazaki, 1994). Ce processus consiste à développer une technologie générique suite à la généralisation consécutive des marchés considérés. Il correspond à un modèle évolutionniste aléatoire au sein duquel la technologie générique apparaît comme une forme émergente qui est par la suite destinée à plusieurs applications. Or, le modèle évolutionniste fournit juste une façon de concevoir les TGs et il n'est pas impossible d'avoir des approches plus intentionnelles pour développer la généricité et atteindre un domaine d'application plus grand.

En outre, De Neufville et al. (2004) ont montré que l'incertitude pourrait être considérée comme une opportunité pour les concepteurs de systèmes en ingénierie. Le Masson et al. (2013) démontrent que les risques peuvent être considérés comme des relations entre les espaces de conception et les environnements extérieurs. Le dialogue est établi entre ces deux champs de littérature, la conception et la gestion du risque, en élargissant cette dernière et en considérant l'action de conception comme une possibilité de réduire les risques. Les théories de la conception (par ex. (Hatchuel and Weil, 2009, Shai and Reich, 2004)) pourraient nous proposer une meilleure façon de traiter l'inconnu que le processus évolutif et apporter des nouveaux éclairages sur la conception de TGs. **Comment concevoir des technologies génériques ex ante ? Qu'est-ce la généricité en théories de la conception?**

Ce processus de conception des technologies génériques nécessite de définir les formes organisationnelles et d'identifier les acteurs qui sont capable de conduire ce type de raisonnement. Il apparaît indispensable d'étudier ces aspects organisationnels de pilotage des TGs. **Par conséquent, quelles formes organisationnelles faudrait-t-il développer pour concevoir des technologies génériques ?** O'Connor (2008) met en lumière une nouvelle fonction de l'innovation, appelée « major innovation ». Elle propose d'utiliser le langage des options réelles face aux incertitudes et à la dynamique des environnements. Cependant, les méthodes des options réelles ne considèrent pas la création des interdépendances nouvelles, ce qui est critique pour la conception des technologies génériques. Existe-il des organisations de l'innovation construite sur un nouveau langage de généricité? Si oui, comment cela se traduit-il dans le langage organisationnel ? Par exemple, comment la gestion des TGs s'inscrit-elle dans les nouveaux cadres organisationnels, et notamment dans le modèle « Recherche – Innovation – Développement » ? (Hatchuel et al., 2005)?

Pour résumer, ce travail se construit sur **quatre principales questions de recherche:**

Question de recherche 1 : Existe-il un modèle mettant en équation marchés et techniques en double inconnu? Si oui, quelles sont les stratégies pour gérer le processus en double inconnu ?

Question de recherche 2 : Quel est le domaine de validité de ces différentes stratégies de gestion de risque ?

Question de recherche 3 : Quel est le processus de conception de technologies génériques?

Question de recherche 4 : Quels sont les compétences et les acteurs indispensables pour piloter ce type de processus?

Ces quatre questions correspondent aux dimensions qui permettent de définir une logique d'action collective selon (Hatchuel and Weil, 1995, Hatchuel, 2005). Dans l'ensemble, ces questions de recherche permettront donc de constituer le modèle d'action collective adapté à un phénomène émergent nouveau qu'est la conception de technologies génériques.

3. APPROCHE METHODOLOGIQUE : VERS UN DOUBLE INCONNU « GERABLE »

Une variété d'approches a été adoptée pour définir un nouveau modèle d'action collective pour la conception de technologies génériques. Diverses méthodes, comprenant des études de cas empiriques, la modélisation formelle et la simulation, et des expérimentations, ont été mobilisées pour découvrir les blocs de construction nécessaires de modèle d'action: objet, contexte et de performance, les méthodes et les processus, les acteurs et l'organisation. Les méthodes choisies réunissent les conditions de recherche intervention (Hatchuel, 2001) et plus généralement de la recherche collaborative (Shani et al., 2008). La recherche a été conduite dans le cadre d'une Convention Industrielle de Formation par la Recherche (CIFRE) à STMicroelectronics où le doctorant a pu travailler pendant la période (2010 - 2013). Ce statut offre un intérêt particulier pour la recherche-intervention : il facilite l'accès à l'ensemble de données d'entreprise et offre une possibilité d'appliquer l'ensemble des résultats théoriques aux problèmes empiriques concernées.

1) Révéler l'anomalie de gestion de risque en double inconnu : l'analyse ex post des portefeuilles de projets de recherche

Pour révéler un nouvel objet qui n'est pas encore étudié dans la littérature, la recherche suit un processus d'identification et la caractérisation de phénomène (Siggelkow, 2007).

Cette approche comprend: 1) la caractérisation et l'identification des modèles existant dans la littérature; 2) la définition de descripteurs qui permettront de déterminer l'anomalie, la modélisation de cette anomalie et la construction d'un instrument pour décrire le phénomène de recherche correspondant; 3) la caractérisation des anomalies et définition des actions correspondantes et leurs implications.

2) Contexte technico-économique de validité de différentes stratégies de gestion de risques

Avec l'objectif de tester les conditions économiques de différentes stratégies de gestion de risques en conception nous avons choisi de poursuivre l'axe de modélisation et simulation. Le modèle est basé sur la simulation des marchés existants et de l'émergence des nouveaux marchés sous forme de combinaisons fonctionnelles suivant les théories de (Lancaster, 1966); sur la modélisation de technologies existantes et de technologies encore inconnues sous forme de graphes entités-relation; sur la modélisation des stratégies de gestion de risque et des environnements économiques. Ce modèle permettra de simuler différentes stratégies de gestion de risque et d'étudier les stratégies dominantes en fonction des modèles des dynamiques de marchés et de technologies. Les travaux d'élaboration du modèle ont été réalisés en collaboration avec un élève de l'ENSTA en stage de 2ème année qui a travaillé sur la « simulation de stratégies de gestion de risque en double inconnus, technique et marché » (voir Hassen Ahmed). Ce modèle permet d'aller au delà des modèles décisionnels traditionnels, et se définit comme un hybride entre deux classes de modèles:

1. Les modèles décisionnels, de type options réelles, qui négligent les interdépendances et considèrent que les projets n'interagissent pas entre eux (Camerer and Weber, 1992, Huchzermeier and Loch, 2001)
2. Les modèles d'interdépendances, plutôt de type chaotique ou « search », dont, notamment l'algorithme NK (Caldart and Ricart, 2004, Gavetti et al., 2005, Rivkin, 2000, Sommer and Loch, 2004).

La nécessité de développer un nouveau modèle se justifie par l'intérêt de traiter les situations où le temps de développement technique devient du même ordre de grandeur que la dynamique industrielle. Dans ces situations, les modèles complexes ne sont plus adaptés puisque leur cadre d'analyse est fixe, et ne prend pas en compte l'évolution de l'environnement.

3) Méthode et processus pour la conception de technologies génériques dans l'inconnu

Pour poursuivre l'exploration de la conception de TG, le processus et les méthodes qui conduisent à la conception de généricité doivent être établis. La méthodologie comprend l'élaboration d'un modèle basé sur une revue de la littérature sur les théories de conception.

Pour déterminer la logique derrière la conception de technologies génériques, la théorie C-K (Concept – Knowledge) de la conception (Hatchuel and Weil, 2009) a été mobilisée car elle est indépendante d'un domaine particulier de l'ingénierie et invariante par rapport au contexte. L'étude d'exemples historiques et mathématiques permet notamment de construire un modèle de conception de technologies génériques.

Ensuite nous nous sommes appuyés sur l'analyse de projets de l'initiative «*Business Innovation Process (BIP)*», qui est un processus de collecte et développement des suggestions d'innovation au sein des collaborateurs de STMicroelectronics. Les premiers résultats de modélisation de processus BIP ont été obtenus en collaboration avec deux élèves-ingénieurs de l'Ecole de Mines en stage de fin d'étude chez STMicroelectronics.

4) Plusieurs études de cas de formes organisationnelles pour identifier une figure de gestion adéquate et des structures organisationnelles pour la conception de technologies génériques

Comment montre-t-on que cet acteur est indispensable, que c'est lui qui est capable de porter le raisonnement sur les TG ? Pour définir les compétences nécessaires, nous avons utilisé la méthodologie de l'étude de cas multiples (Eisenhardt, 1989, Yin, 2003). L'étude de cas multiples est particulièrement pertinente pour valider expérimentalement les résultats (Eisenhardt, 1989).

La pertinence de l'industrie des semi-conducteurs pour l'exploration du double inconnu et son caractère générique

La pertinence de l'industrie de semi-conducteur pour les questions de généricité est déjà soulignée par la littérature, notamment Bresnahan and Trajtenberg (1995), qui montrent que le transistor est un cas de Generic-Purpose Technology, ou (Novelli, 2010), qui utilise la photonique comme un exemple de TG. L'industrie des semi-conducteurs est souvent confrontée à une situation de double inconnu, d'où l'existence des entités comme « More than Moore » de l'ITRS ou iNEMI dont l'objectif est de structurer la connaissance afin d'organiser le processus d'exploration et proposer des solutions innovantes.

L'ensemble des études de cas effectuées pendant cette thèse ont été effectués au sein de STMicroelectronics (ST). ST est un leader européen en semi-conducteurs, l'entreprise fait partie des 100 premières entreprises les plus innovantes dans le monde selon le classement de Thomson Reuters, son portefeuille comprend 16 000 brevets et environ 9 000 familles de brevets.

D'une part, STMicroelectronics est à l'origine de plusieurs exemples de conception réussie de TG : notamment MEMS, transistors bipolaires, microcontrôleurs. De l'autre, des explorations très avancées sont souvent organisées en double inconnu quand ni les technologies sont encore choisies, ni les marchés sont définis. Ainsi, ST est un acteur particulièrement intéressé par nos questions de recherche et nous effectuons un travail empirique dans le cadre de la thèse CIFRE (2010 - 2013).

4. RESULTATS : LA CONCEPTION DE TECHNOLOGIES GENERIQUES EN DOUBLE INCONNU

4.1. Le "common unknown" comme une nouvelle stratégie de gestion des interdépendances en double inconnu

A partir des différents cas étudiés et des travaux bibliographiques sur l'évaluation économique des projets et la gestion des risques dans l'inconnu, nous avons mis en évidence un modèle de gestion de risque original, fondé sur une logique d'inconnu technique commun à plusieurs marchés potentiels.

Afin de définir un cadre théorique de référence, nous clarifions ce que prédit la théorie de gestion de l'incertitude. Ce cadre théorique montre que ce n'est pas impossible qu'il existe une voie dite « common unknown » qui n'était pas considérée par les stratégies habituelles de gestion des risques. Dans l'optique

de révéler cette anomalie, un modèle visant à analyser les relations entre technologies et marchés sans considérer leurs relations les plus directes a été proposé. La notion de fonctions a été mobilisée pour définir un cadre intermédiaire qui montre les déformations dans les interdépendances directes entre technologies et marchés. En utilisant le cadre proposé, nous avons analysé un certain nombre de technologies développées par ST et nous avons cherché à déterminer s'il existe une correspondance stricte entre les technologies et les marchés via les fonctions.

Nous avons pu repérer une anomalie intéressante : un ensemble de cas où la technologie se développe indépendamment des marchés. Notamment dans le cadre du développement de la technologie BiCMOS, ST a développé une technologie qui n'adresse aucun marché directement. Mais une fois développée, cette technologie a attiré un grand nombre de marchés émergents. Ce cas est étonnant : d'un côté la technologie développée n'était pas une technologie aléatoire, et son succès était prémédité, mais de l'autre ce n'est pas un marché existant qui a tiré cette exploration. Il y a un donc couplage T-M qui ne s'est réalisé ni sur une technologie connue, ni sur un marché identifié.

Nous avons appelé cette stratégie « common unknown », c'est-à-dire une stratégie qui crée une plateforme technologique pour plusieurs marchés émergents (plus exactement pour les fonctions communes que ces marchés recherchent). Cette stratégie propose un modèle de gestion de risque original, fondé sur une logique d'inconnu technique commun à plusieurs marchés potentiels. Empiriquement, ce modèle appliqué au projet « Bulk Acoustic Wave » (BAW) chez ST nous a permis de démontrer que le processus type « trial and learning » s'avère plus risqué quand il conduit à développer un « mauvais » premier essai, c'est-à-dire un essai qui ne sera pas une bonne plateforme pour répondre aux marchés émergents et ne conduit pas à développer un marché gagnant. Nous avons montré que privilégier un premier projet d'exploration (phase « essai ») avant de formuler la plate-forme robuste pourrait effectivement conduire à une augmentation des risques globaux et une limitation de l'espace d'exploration. Néanmoins, cette stratégie reste gagnante quand il existe une application dominante, qui peut être adressée par le développement d'essais et du processus d'apprentissage associé.

Ensuite, nous avons précisé quels critères de pilotage sont considérés par ces différentes stratégies de gestion des risques, et les aspects organisationnels de leur implémentation. Enfin, nous avons montré l'intérêt et la possibilité de supporter le développement de «*General Purpose Technologies*» (GPT) en double inconnu (c'est à dire un concept technique générique commun à plusieurs marchés).

4.2. Le critères de contingence : vers la notion d'« aggrégativité »

La partie précédente nous a permis de constater une voie originale pour la gestion en double inconnu. **Pouvons nous créer la grille d'analyse pour ce type de stratégies?**

Concernant l'axe de l'analyse économique de technologies génériques, nous avons développé un modèle de simulation qui intègre les logiques de la décision dans l'incertain et les logiques de structures de l'inconnu permettant d'identifier et d'accroître la généralité des techniques. Ce travail de modélisation

nous a permis de définir les critères technico-économiques qui clarifient les variables les plus déterminantes de chacun des modèles de gestion des risques.

Ce modèle nous a permis de tracer la frontière entre le domaine où les anciennes méthodes sont toujours valables et celui dans lequel on peut espérer mieux. Par exemple, si les besoins sont clairs, le market pull est la solution la plus indiquée. Mais même dans les cas où les besoins sont très clairs et les techniques elles-mêmes semblent être très flexibles, alors ce n'est plus certain que la stratégie de type market pull est dominante.

Notre travail de simulation montre que la conception de technologies génériques est pertinente lorsqu'il existe des signaux de marchés multiples avec des probabilités d'existence très faibles mais avec des taux de changement dynamiques, et lorsque les principes technologiques ont un caractère agrégatif, c'est-à-dire dont le coût de la création de nouvelles interdépendances est faible. La notion d'agrégativité signifie que les technologies déjà combinées rendent plus facile la combinaison ultérieure avec d'autres technologies. Deux critères apparaissent donc comme critiques pour définir les zones de validité de chaque stratégie : agrégativité et stabilité des signaux du marché technologique.

4.3. Le processus de conception : la notion de concept générique

Ayant défini les critères de contingence pour les stratégies type TG, il apparaît nécessaire de travailler sur le processus lui-même de conception de technologies génériques.

Notre travail empirique en conception de technologies génériques et des stratégies d'augmentation de la généralité de technologies nous a permis de développer une méthode théorique de conception de technologies génériques et de discuter la généralité des théories de conception. Nous nous sommes appuyés sur l'analyse de cas historiques (comme les machines à vapeur), mathématiques ou plus récents comme celui des microsystèmes électromécaniques (MEMS) à ST, pour montrer que la gestion de la généralité est faite par le pilotage d'un « **concept générique** » qui a une structure d'un concept x avec les propriétés $P(x)$, auquel on ajoute un domaine de validité large – **Domaine d'existence $D(x)$: $x \in D$** . Nous avons montré que la conception de technologies génériques se fait par la constitution de domaine d'existence $D(x)$. Ceci a permis de montrer que **la généralité dépend des descripteurs du domaine d'existence et commence par la construction d'un concept générique**. Le concept générique permet d'obtenir, à partir d'un exercice de conception, non pas une solution singulière mais un très grand nombre de solutions. Pour accroître le niveau de la généralité, le domaine de validité doit être plus grand, ce qui signifie qu'il doit incarner divers domaines d'applications connus et encore inconnus, donc être flexible vers des nouveaux environnements. Le modèle construit est fondé sur des exemples de succès historiques (notamment les machines à vapeur) et le cas des extensions algébriques. L'objet de la stratégie de conception des TG devient alors la conception de ce domaine D lui-même, qui doit à la fois assurer que le concept générique adresse le plus grand nombre d'applications possibles sans dépasser le budget alloué, c'est-à-dire sans exiger un maximum de connaissances nouvelles »

Une fois ce modèle établi, il devient souhaitable de dégager des stratégies d'accroissement de la généricité qui soient mobilisables par l'entreprise. Le travail de l'analyse de différents projets issue de BIP à ST nous a servi pour formuler des stratégies d'augmentation de la généricité des technologies dans les semi-conducteurs. Ces stratégies portent sur la superposition, l'attraction et le renversement des « environnements » associés. Un niveau d'aggrégativité technologique supérieur facilite la conception des descripteurs du domaine D et permet d'atteindre un domaine de la validité plus large. Ce travail permet de beaucoup mieux comprendre certains succès de ST.

4.4. Définition d'une nouvelle figure managériale : « cross-application manager » pour la conception des technologies génériques

Ces avancées théoriques nécessitent d'explorer les formes organisationnelles qui sont capables de porter ce type de raisonnement. Il devrait y avoir un acteur qui prend en charge le développement de concept générique! S'il existe, quelles compétences sont indispensables pour porter le raisonnement sur les TGs? Où se trouve cette figure managériale dans l'organisation? Pour répondre à cette problématique, nous avons analysé certain nombre de situation de développement technique où il y a besoin de développement de la généricité.

Notre étude nous a conduit à définir que l'inscription de ce type de raisonnement dans l'organisation pourrait être faite avec l'aide d'une figure comme le « **cross-application manager (CAM)** ». C'est une figure peu vue. Elle a apparue nécessaire dans un certain nombre de processus. Signalons à ce propos que le processus come BIP fonctionnera s'il y a un cross-application manager (étude de cas 1) ; l'exploration de propositions pour les futurs inventions est piloté par le coordinateur qui remplit la fonction de CAM temporairement et qui conduit les équipes à protéger des technologies génériques par la conception des portefeuilles des futures inventions. Dans certains contextes à ST comme le pilotage de portefeuille de projets de recherche, l'appropriation de brevets, le lancement de challenge à l'idées ou les autres contextes où le développement technique est plus ou moins collectives et orienté vers l'exploration des technologies génériques, nous retrouvons chaque fois cet acteur, qu'il est plutôt critique, qui porte ces cas et gère la généricité de futurs solutions. Cette figure managériale qui nous appelons TAM apparait indispensable dans le processus de l'organisation d'exploration des TG. Cette figure managériale doit être capable de mettre en interaction différents concepts innovants et de guider l'exploration en double inconnu vers la conception de technologies génériques. De plus, il a une double expertise qu'intègre d'une part une grande connaissance des techniques disponibles et d'autre part une connaissance des marchés différents et besoins concernées.

En outre, basée sur l'analyse du portefeuille de projets de recherche, cette partie présente une nouvelle notion de développement conceptif pour la conception de TG. Le développement conceptif vise à explorer l'inconnu et proposer des solutions innovantes tout en gardant les coûts sous contrôle et en intégrant les caractéristiques des projets de développement dans les domaines d'exploration qui consiste à obtenir la même fiabilité (coût, délai, risque) que le développement alors qu'il n'y a pas de demande claire du

marché. Ce type de projet explore l'inconnu mais doit rester prédictible et réutiliser au maximum la connaissance disponible. Le *développement conceptif* suppose un travail sur les attributs de type $D(x)$.

4.5. Modèle d'action : conception de technologies génériques en double inconnu et les apports de recherche

Quatre résultats principaux de cette thèse qui correspondent aux questions de recherche, permettent de déterminer le modèle de conception de technologies génériques en double inconnu. Pris ensemble, ce modèle d'action est basée sur les principaux éléments suivants: objet de gestion, la performance et le contexte, la méthode et de l'organisation.

Ce modèle d'action de conception des technologies génériques propose de perspectives d'extension de modèle de conception innovante (R-I-D) vers l'ingénierie conceptive. L'ingénierie conceptive apparaisse comme une forme de spécialisation du travail en conception innovante (de la fonction I) qui reverse le raisonnement derrière les activités de recherches et développement pour l'objectif d'organiser l'exploration en inconnu. En particulier, cette thèse propose une nouvelle forme de gestion des risques qui rend possible un nouveau type de développement que nous appelons le *développement conceptif*. Il cherche d'un côté à contrôler les coûts et de l'autre à maximiser la probabilité d'être pertinent pour les marchés futurs.

Ce travail montre le pouvoir de gérer les concepts techniques génériques. On s'aperçoit que cela nécessite un mode de raisonnement orienté vers la conception qui n'est plus dans le paradigme décisionnel.

L'apport théorique majeur est une nouvelle perspective de gestion de risque qui consiste à ajouter une capacité de conception pour réduire les inconnues. Cette capacité de conception consiste à structurer l'inconnu en proposant un concept générique qui conduit à concevoir les technologies génériques applicable au plus grand nombre de marchés émergents.

La conception des technologies génériques apparaisse comme un enjeu majeur contemporain pas seulement dans l'industrie de semi-conducteurs mais ainsi dans les domaines des hautes technologies comme télécommunication, biotechnologies, IT et même les secteurs type « low cost » où les usages de produits deviennent plus génératifs. Ces derniers suscitent une large exploration d'usages nouveaux et inconnus qu'enrichit la conception des technologies génériques.

Les technologies génériques sont considérées comme un instrument de la politique publique. L'état cherche à déterminer les nouvelles opportunités européennes pour la recherche et l'innovation. Dans cette optique, le modèle de conception des technologies génériques développées par cette thèse ouvre une perspective stimulante d'aborder ce sujet avec l'efficacité économique tout en restent dans une situation de double inconnu.

Résumé de la thèse

Table of contents

Introduction: Generic technology as an opportunity to manage risks in double unknown	29
Chapter 1 Context and research problem: from decision-making to design paradigm ..	35
1. Risk management in double unknown: can we afford to be certain?	35
2. Theoretical background: on the design of generic technologies.....	42
Chapter 2 Theoretical constructs of double unknown management: setting the issue	47
1. On manageability of double unknown: a need for research object clarification.....	47
2. Techno-economic conditions and validity of strategies for generic technologies design.....	51
3. Methods and process of design for generic technologies.....	53
4. Organizational structure and actors for generic technology exploration	55
5. Research questions: Towards a new action logic of generic technologies design.....	57
Chapter 3 Research methodology and the corresponding itinerary: Making double unknown “manageable”	61
1. Building a model of collective action for the design of generic technologies: chosen research methods	62
2. Validity of chosen industrial background for research problem and questions: the knowledge-intensive semiconductor industry	66
3. Synthesis of research path and chosen methods	70
Dissertation Structure and Research outline	73
Part I Common unknown as a new strategy for double unknown management: a research anomaly analysis.....	77
Chapter 4 Strategy for GT design: creating interdependencies between technologies and markets or gambling on markets	83
1. Research anomaly in managing double unknown: building interdependencies between technologies and markets	83
2. Mechanism to reveal the anomaly: proposition of the analytical framework.....	87
3. Strategies comparison in double unknown: trial and learning <i>versus</i> new “common unknown” strategy	90

Chapter 5 Managerial implications for the situation of double unknown management and structure of “common unknown”	99
1. Generic <i>versus</i> common, universal and specific technologies	100
2. A study of many-core computing acceleration from generic technology design perspective – STHORM project at STMicroelectronics	102
 Part II The impact of sector dynamic rules on the choice of risk management strategy in double unknown: contingent criteria	109
 Chapter 6 Supporting the design of generic technologies: techno-economic conditions to account for higher performance	115
1. Characterization of techno-economic environment.....	115
2. Techno-economic contingent criteria for strategies validity	123
 Chapter 7 Managerial implications: the investment logic faced with uncertain and dynamic environments	129
1. “Genericity building” business plans: multi-markets logic.....	129
2. The notions of aggregativity and segregativity	131
3. Illustration of market opportunities creation through functional combination: the case of Yole Developpement	133
 Part III Methods and process for generic technologies design: the notion of generic concept and genericity improvement.....	137
 Chapter 8 Method of engineering design and theoretical basis behind the design of generic technologies: The new notion of generic concept.....	143
1. Design of generic technologies: genericity and genericity Building.....	143
2. The new notion of generic concept.....	152
 Chapter 9 Strategies to acquire genericity: strategies of validity domain $D(x)$ design ...	163
1. Strategy of domain design creation by environment superposition.....	163
2. Strategy of domain design creation by environment projection	167
3. Strategy of domain design creation by designers attraction – “genericity co-design”	170
4. Conclusion: towards higher “genericity building”	172
4. Conclusion: towards higher “genericity building”	172

Part IV Organizing the process of double unknown exploration: Cross-application manager, a necessary figure for successful generic technology design	177
Chapter 10 New action logic for generic technology design: the role of the Cross-Application Manager.....	183
1. Elaboration of an action logic for generic technology design.....	183
2. Managerial role and organizational structures for generic technologies	185
3. Cross-application manager – a new managerial figure to ensure the successful implementation of generic technology design action logic	191
Chapter 11 Managerial implications: The role of the cross-application manager in project portfolio's constitution and management	197
1. Research-Innovation-Development (RID) model for generic technology design.....	197
2. Conceptive development for generic technologies design	201
3. Conceptive engineering: conceptive research and a new conceptive development activity.....	205
General conclusion: Generic technology design in double unknown	209
1. Principal positioning of the thesis: the issue of double unknown management for generic technologies design perspective.....	213
2. Main results: managerial and organizational patterns for double unknown management and a new action logic for generic technology design	214
3. Theoretical implications: design as a new action possibility for risk management in unknown situations?.....	217
4. Managerial implications: transversal technology and markets exploration in the unknown....	219
5. Further work: dissemination of the logic behind generic technologies design and its validity	220
Key references.....	223
References	225
List of corresponding appendices	235
Appendix 1 Industrial background: Knowledge-intensive Semiconductor industry and its pertinence for double unknown exploration.....	237

Appendix 2 Case study: Research anomaly identification: SiGe Bipolar technological platform for mmWave applications (BICMOS9MW) at STMicroelectronics	249
Appendix 3 R&D Project Portfolio analysis: the example of etching process step	263
Appendix 4 Generic Technology in patent portfolio design: designing technological patents in high uncertainty	273
List of figures	280
List of tables	283
List of corresponding papers	284

Introduction:

Generic technology as an opportunity to manage risks in double unknown

*“Exploring the unknown requires tolerating
uncertainty”*

Brian Greene

Introduction: Generic technology as an opportunity to manage risks in double unknown

Introduction: Generic technology as an opportunity to manage risks in double unknown

Chapter 1 Context and research problem: from decision-making to design paradigm ..	35
1. Risk management in double unknown: can we afford to be certain?	35
1.1. Innovation management: towards exploration of the unknown.....	35
1.2. Dealing with risks, uncertainties and unknowns: necessity of double unknown management.....	37
1.3. From decision-making to design: From uncertainty reduction to design of generic technologies	40
2. Theoretical background: on the design of generic technologies.....	42
2.1. The advantages of generic and general purpose technologies.....	42
2.2. Research problem: Risk management in unknown by generic technologies design.....	44
Chapter 2 Theoretical constructs of double unknown management: setting the issue	47
1. On manageability of double unknown: a need for research object clarification.....	47
2. Techno-economic conditions and validity of strategies for generic technologies design.....	51
3. Methods and process of design for generic technologies.....	53
4. Organizational structure and actors for generic technology exploration	55
5. Research questions: Towards a new action logic of generic technologies design.....	57
Chapter 3 Research methodology and the corresponding itinerary: Making double unknown “manageable”	61
1. Building a model of collective action for the design of generic technologies: chosen research methods	62
1.1. Revealing the anomaly of double unknown management: <i>ex post</i> analysis of research projects portfolio	63
1.2. Techno-economic context of strategies applicability: in which conditions new object accounts for higher performance?	63
1.3. Method and Process for the design of generic technologies in unknown	65
1.4. Multiple cases studies of organizational forms to identify a suitable managerial figure and organizational structures for generic technologies design	65
2. Validity of chosen industrial background for research problem and questions: the knowledge-intensive semiconductor industry	66
2.1. The pertinence of the semiconductor industry for double unknown exploration and its generic character	66
2.2. STMicroelectronics is looking how to organize the process of generic technologies design in double unknown	69
3. Synthesis of research path and chosen methods	70
Dissertation Structure and Research outline	73

Introduction: Generic technology as an opportunity to manage risks in double unknown

To survive in a competitive environment while dealing with tight schedules and high penetration rates, companies constantly pursue the development of breakthrough innovations that change the fundamentals of business and create new avenues for extensive wealth. Organizations face highly turbulent and uncertain environments and are obliged to reconsider their business models, strategies, and the underlying object identities. In the semiconductor industry, these challenges are not rare. For instance, the rise of embedded computing changed the modular architecture established by IBM and used up to now as a reference in a wide variety of applications such as laptops, PCs or servers. Nowadays, the industrial trend is shifting from PCs to mobile devices like goggles, smartphones and tablets with cloud-based services, which require more modular chip designs that provide an extended functionality to consider a wide variety of applications and flexibility to optimize solutions for specific applications. Even the semiconductor giant Intel Corporation wonders whether it can survive the future it has built for itself. Intel is striving to gain a stable market place for its processors in mobile platforms. Undoubtedly, other examples can be cited. For instance, Apple's market share has been deteriorating since June 2012¹, Nokia is trying to change its business model by recently selling out its mobile business to Microsoft, STMicroelectronics just completed the split-up of its joint venture with Ericsson, and the smartphone pioneer BlackBerry constantly seeks ways of fighting their declining market shares. Faced with business models transformation, these companies have to adapt to unconventional forms of reasoning to maintain their market position and create new radically innovative products while keeping R&D costs low. To survive and ensure benefits in these changing environments, innovative forms of risk management that deal with yet unknown products and technologies become indispensable.

Traditional methods of risk management consider that the chance of success is inversely proportional to initial uncertainty, which often leads to the rejection of projects that cope with high level of unknowns. Yet, when multiple unknowns are present, plenty of technological candidates and market applications might still be imagined. The problem is that these solutions are all highly uncertain and it is impossible to list the risks and evaluate their probability of occurrence when the level of unknown is high. Companies are confronted with an enormous amount of uncertainties, which can interact in ways so unpredictable that no plausible range of management scenarios can be identified². The question occurs whether these situations could be somehow managed.

The technology management literature stresses the importance of generic (known as general-purpose) technology development. Among the successful examples of generic technologies (GTs) exploration are widely used technologies such as: electricity, semiconductors, steam engines, and nanotechnologies. By definition GTs are capable of addressing sets of emerging markets, mobilizing various technological alternatives, and supporting economic growth and development. The literature

¹ For a description see: "[Apple Losing Tablet Market Share but still dominates north America Usage](#)", Forbes,

² For a description see: Courtney H., Kirkland J., Vignier P. (2000) "[Strategy under uncertainty](#)", McKinsey Quarterly, accessed September 30, 2013

mostly deals with already existing GTs and prior research mostly focuses on their dissemination and commercialization. Considering their potential for pervasive use in a variety of applications and high technological velocity, this research proposes to investigate the possibility of designing GTs. Unknown environments can be seen as an opportunity, which opens the possibility for the successful design of general-purpose technologies. Thus, is it possible to benefit from technological and market unknowns to develop GTs? Is there a process of “unknown management” that can lead to the design of GTs?

In order to account for GTs, both markets and technologies have to be explored. Yet, existing methods tend to deal with market signals or technological opportunities, but consider that in double unknown situations, risks are difficult to manage. However, when both commercial and technological uncertainties are regular, companies have to organize exploration while controlling costs and risks in « double unknown » contexts. There is a need for new tools to guide the development in such situations. The attention should be drawn on the paradox that exists between the difficulty of unknown management on the one side, and the opportunity that unknowns might offer for highly beneficial GTs development on the other side. For instance, while dealing with a high number of volatile markets with very low probability of success, GTs attain high probability of succeeding in one of these markets at least.

This thesis strives to answer the question of what the design of GTs should be. The aim is to present a winning solution for managing double unknown situation, in particular the identification and management of generic technological concepts capable of addressing multiple emerging markets. We deal with the problem of double unknown management from a micro-managerial perspective. We attempt to clarify what practices should be employed to design successful GTs. This requires clarifying the associated model of collective action that determines a managerial object, measures of performance in double unknown situations, appropriate organizational forms and actors with suitable competence and methods capable of identifying opportunities in double unknown contexts. The introduction part of the thesis starts by underlying the necessity to deal with the increasing level of unknowns. The possibility of double unknown management by designing GTs is described in the Section 1 of **Chapter 1**. Section 2 of this chapter demonstrates the features of GTs development in double unknown situation and underlines the importance of GTs design. **Chapter 2** shapes the theoretical building blocks, defines the knowledge gaps and the corresponding research questions. This chapter serves as a summary of the academic background, which is used to identify knowledge gaps and position this research. It justifies how different fields of literature were used and how they were mobilized by this work. **Chapter 3** defines the chosen methodology, justifies the methods used for each research question and constructs the research itinerary (Section 1). It continues by justifying the choice of the semiconductor industry as a relevant field for our research because it is often exposed to double unknown situations and provides examples of GTs (Section 2). Finally, synthesis of research itinerary and chosen methods is provided (Section 3). This part concludes with the overview of the corresponding document.

Chapter 1

Context and research problem: from decision-making to design paradigm

“You have to make the right choice. As long as you don't choose, everything remains possible”

Jaco Van Dormael

The purpose of this chapter is to reveal contemporary issues that companies are facing while coping with the increasing innovation dynamics and the increasing level of uncertainty. Section 1 defines the “double unknown” situation and draws on the idea that to manage effectively innovative projects and deal with novelty and uncertainties, it is necessary to consider the engineering design approach. The main thesis is to go beyond the decision making to design paradigm that reduces risks by designing a new attractive solution – generic technology (GT). Section 2 demonstrates that GT proposes an interesting alternative to handle the double unknown situation and defines the research problem.

1. RISK MANAGEMENT IN DOUBLE UNKNOWN: CAN WE AFFORD TO BE CERTAIN?

1.1. Innovation management: towards exploration of the unknown

The importance of innovation is widely recognized by practitioners and academics. While pursuing innovative exploration, companies deal with an increasing level of uncertainties and novelty. It is becoming evident nowadays that firms' strategic decisions have to be tailored according to the surrounding uncertainty levels. As pointed by Freeman and Soete (1997), the concept of technological innovation can be seen as a technology and market matching process that evolves during the exploration process. Traditionally, the innovation dynamic is considered to follow an S-curve that comprises fluid, transitional and specific phases (Abernathy and Utterback, 1978). A fluid phase is characterized by a high level of unknown. Firms often compete in new market places by offering new products obtained through radical innovation, product differentiation, and consequently leadership position on the market changes. The transition phase includes consolidation that often requires process innovations. According to Abernathy and Utterback (1978), transition occurs once a dominant design solution emerges on the market. The dominant design is the one that the market players have to appropriate if they want to compete on the marketplace. The specific phase appears after the dominant solution is established. It focuses on the solution's performance and costs.

S-curve requires companies to implement different tools suitable to manage and evaluate product performance within each phase. This thesis mostly focuses on the fluid phase that copes with novelty and unknowns. Under this phase technological and market unknowns prevail. The evaluation of R&D efficiency embodied the extreme positions that use either market pull or technology push strategies which deal with singular forms of unknowns (consequently technological- or market-based unknowns). Market pull reduces market risks by defining particular needs or the voice of the customer (Coombs, 2007, Hauser and Clausing, 1988) followed by a suitable technology design, (III, Figure 1). Technology push manages risks by seeking potential applications for new technical invention through R&D, production and sales centers (Linton and Walsh, 2008b, Morone, 1993)(II, Figure 1). These strategies assume existence of market needs or dominant technology candidates consequently.

Disruptive innovation approaches propose ways to deal with unknown markets (Christensen and Bower, 1996). Disruption is associated with the idea that technologies have performance trajectories. Disruptive products often prevail over traditional ones by offering improvement in new dimensions and thus, disrupt the traditional ways of competition. Radical innovation approaches normally deal with technological innovations (Abernathy and Clark, 1985). Yet, it was shown that breakthrough or radical innovations, require a combination of both market and technology R&D exploration (R&D type 2 and marketing type 2 (Miller and Morris, 2008, Roussel et al., 1991)). Moreover, the notion of major innovation is used when dealing with high technological and/or market uncertainty (Garcia and Calantone, 2002). Through the analysis of industrial examples, Lynn et al. (1996) demonstrate that discontinuous forms of innovations are critical in competitive, technology-intensive markets; the advantages are created not from the continuous improvement in technology but from creation of entirely new families of products and business. In these cases, market probability distributions are unknown and the exploration is considered to be under ambiguity (Knight, 1921). As pointed to by Courtney et al. (1997), companies under ambiguity are confronted with multiple unknowns concerning technology, demand, and relations between various partners in a value chain which may interact in such unpredictable ways that no plausible scenarios can be identified. **Breakthrough situations require developing both new technologies for new uses and new markets** (Chesbrough, 2006, Danneels, 2004, O'Connor and Veryzer, 2001) or deal with double unknown. The attempts to explore unknown are numerous. For instance, Mullins (2007) deals with so-called "unk unks" that define the situations where we do not know that we do not know. The presence of unknown unknowns is explicitly acknowledged and the discovery-driven approach is proposed to uncover them in (McGrath and MacMillan, 2009). Defined as unforeseeable uncertainty (Loch, 2006, Loch et al., 2008), this situation is characterized by the team unawareness of the event existence or its unlikeness to happen. The difference with chaos is that under unforeseeable uncertainty the team begins with reasonable assumptions and goals. (IV, Figure 1).

There is an increasing concern in **managing double technological and market unknown**, though it is considered that in this case the projects are confronted with a high level of hardly manageable

risks. Moreover, the resources allocated to the R&D projects are limited and controlled. One needs to guide the development in the situation of double unknowns to capacitate breakthrough innovation in technological expertise and market place. Therefore, to pursue the exploration of projects in double unknown, there should be a way to evaluate and manage risks. Unknowns have to be assessed in more creative ways while keeping the resources under constraints and minimizing risks.

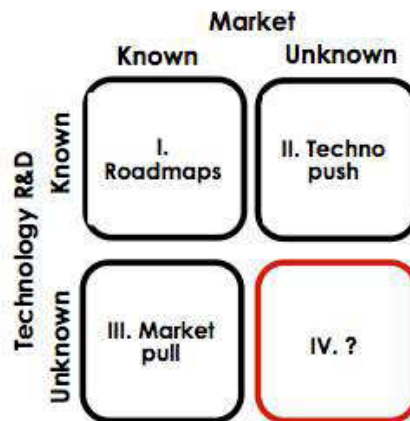

Figure 1 - Double unknown phenomenon: technologies and markets are ill-defined and yet-unknown

1.2. Dealing with risks, uncertainties and unknowns: necessity of double unknown management

The chances to succeed are inversely proportional to the initial technological and marketing uncertainties. When the uncertainties are low, the nature of technologies and markets and the associated project alternatives might be determined. In this case the market values can be estimated and their volatility is low. When a manager can make a list of all possible outcomes associated with a decision and assign a probability of occurrence to each one of the outcomes, **a decision is made under risk** (Chapman, 1990, Lipshitz and Strauss, 1997). The probabilities assigned to the outcomes can be objective and subjective (based on rather personal experiences than on scientific data). This situation corresponds to the “variation type” of uncertainty according to De Meyer et al. (2002). Trajectories of techno-economic development differ significantly based on chosen strategies, criteria of their evaluation and industrial environment (Chandler et al., 1999). When coping with risks, managers are capable of establishing the list of alternatives and their level of risks. In this case, technological and market alternatives (states of nature) are identified in advance. In this situation, the goal consists of choosing the most promising technological candidate that corresponds to the identified market using classical tools of risk management to make a better decision. The performance can be evaluated using various criteria like subjective net present value (NPV), discounted cash flow or probability of market emergence whose distribution has rather low volatility.

When a decision maker cannot list all the possible outcomes and probabilities cannot be assigned, the projects **cope with uncertainty**. In this case managers only know the different options available and their possible states. The models of uncertainty reduction correspond to the theory of decision making under uncertainty (Savage, 1972, Raiffa, 1968). The choice under uncertainty is often characterized as the **maximization of expected utility**. Utility is defined as a function of profit that comprises the value of benefits associated to each state of nature weighted by its probability and by the utility character of the decision maker. It leads to the selection of the most promising alternatives (maximal utility) for the predefined list. This theory lies upon various derived techniques to deal with uncertainty management. For instance, **real option valuation methods** enable the calculation of the value of a test or an option that allows decreasing uncertainties. Real options are defined as opportunities to respond to changing circumstances of a project by management (Dixit and Pindyck, 1994). Real options are derived from financial options. Built on the critics of the classical NPV “now-or-never” decisions, options in finance simply define the right, but not the obligation, to buy or sell financial assets (stocks/bonds), or real assets (projects and business): the former are financial options and the latter are real options (Trigeorgis, 1996, Abel et al., 1996). The quantitative methods for valuing real options are derived from Black-Scholes option model (Black and Scholes, 1973). For instance, Raiffa (1968) estimates the value of options by studying the evolution of subjective probabilities and learning. Real options are rather calculated based on the underlying assets to reflect the probability distribution of the states of nature (Trigeorgis, 1993).

When the decision has to be made under uncertainty, the volatility of distributions are high, their values can be estimated but it can also change through time. In this case the uncertainty might be reduced following methods like real option valuation. To apply real options, the decision maker has to know the project’s potential, underlying assets, potential states of nature. Moreover, the estimated option value should indicate the reliable actions to follow. The managerial flexibility is incorporated through “defer, abandonment, expansion, contraction or switching” (Trigeorgis, 1996) and improvement options (added by (Huchzermeier and Loch, 2001) and their combinations. When uncertainty is high, these conditions are hardly met. Moreover, new alternatives and unexpected results could emerge throughout the time of exploration.

The notion of uncertainty is often broader than we believe it to be. As shown by Langlois and Cosgel (1993), Knight's distinction between risk and uncertainty goes beyond a distinction between insurable and uninsurable risk. Uncertainty covers two aspects. The first type of situations occurs when project alternatives can be identified and when managing uncertainty consists of making the optimal choice between given possible decisions and probable states of nature. However, when the uncertainties are high, probabilistic approaches are limited because the probabilities evolve during the process of exploration and cannot be correctly estimated initially. In this case, uncertainty reduction approaches are mobilized to reduce these uncertainties. This is the case described previously. The second type includes cases that are called “unk-unk”, where the level of unknownness is so high that neither the level of risks nor the list of risks is known. In R&D contexts, this scenario

often corresponds to “**double unknown**” situations in which neither technologies, nor markets are known. In this situation the alternatives are not yet determined and can emerge during the exploration. These situations are often considered simply unmanageable and the idea is often to wait until the unknown aspects of projects are reduced.

Still while dealing with breakthrough innovation, we aim to explore unknown technologies and unknown markets to propose new alternatives. In this case project managers are confronted with the situation of **double unknown**. Markets are considered to be unknown since the product features that might make them successful are unknown at the beginning (O'Connor and Rice, 2012). Technologies are unknown, which means that for some features, a large variety of solutions might be designed, but none of them exist at the moment. It is important to mention that emerging technologies are not necessarily the radically new ones. Martinez (2013) underlined that emerging technologies can be old, new or a different combination of existing technologies. Though, they generate products that are radically superior and different from the traditional familiar products to customers' ones (Walsh et al., 2005). In these situations technologies are still evolving, markets are “ill-defined”, moreover the environment and organizational structures for developing these technologies and yet-undefined markets do not exist. The value distributions of various alternatives appear to be flat, their mean value close to zero and their deviation seems to be infinite. It is ambiguous which emerging markets will succeed and which technological forms will be more advantageous. The projects are associated with highly volatile probability distributions. Because of the presence of pervasive uncertainties (Lynn et al., 1996), the majority of conventional market approaches for new product development fall short if applied to breakthrough and radical innovation explorations.

In this case both market pull and technology push are limited since there are no markets to pull or no technologies to push. Both market pull and technology push strategies take uncertainty into account (Rothwell, 1992, Barclay, 1992). Albeit the level of uncertainty is controlled to enable selection, these strategies do not integrate uncertainty reduction. If uncertainty is higher, then the selection criteria will normally take it into consideration and the consequent technologies or markets will be lounged at a lower level, no learning process will occur. In addition, firm diversification depends on both the uncertain attractiveness of emerging markets and current firm technological success (Kim and Kogut, 1996), which requires double facets of market and technological exploration and thus, limits the use of these two strategies in the case of double unknown. The real options approaches are limited as well since the learning considered in these techniques is based on the subjective probabilities distributions associated with the states of nature (the option itself). The learning process does not affect states and decisions, which is critical in double unknown since new technological alternatives can emerge and new markets be created during the exploration. Moreover, the real options consider that the decisions and the states of nature are independent.

From dealing with risk management in uncertainty, we move towards risk management in double unknown. Since in double unknown the list of market and technological alternatives is not fixed, the most common strategies for innovation management (like real options, market pull, technology push)

are not valid. The costs of development are hard to estimate and generally, this situation is considered as being unmanageable. Paradoxically, even if double unknown is challenging from the management point of view and the preference is to wait until the uncertainty is reduced, this situation can offer a freedom and lower risks for companies that attempt to shape the future market situation (Courtney et al., 1997). Engineering design perspective suggests seeing high uncertainties as an opportunity (De Neufville et al., 2004).

This perspective might add a new action possibility: designing a new alternative that copes with the probable states of nature and reduces the unknown risks. The idea behind is to profit from the double technological and market unknowns to design the alternatives that reduce the latter and enable to structure and effectively pursue technological exploration. What could be the strategies to profit from double unknown? Which alternatives need to be pursued? More generally, how can decisions be made when unknowns are so high?

1.3. From decision-making to design: From uncertainty reduction to design of generic technologies

There exist attempts to organize exploration in high uncertainty. Innovation journeys (Van de Ven et al., 1999), discovery-driven planning (McGrath and MacMillan, 2009), information gap decision theory (Ben-Haim, 2006), diagnosis of unforeseeable uncertainties through trial and learning (Loch et al., 2008, Sommer et al., 2009) propose ways to address them. Discovery-Driven Planning offers an effective way to plan investments in ambiguous and uncertain environments; it recognizes the unpredictable character of outcomes and privilege discovery and reorientation approach through exploration process. According to McGrath and MacMillan (2009) discovery-driven planning can be effectively combined with real options to avoid rejecting investments with high potential but yet unknown outcomes. Cheng and Van de Ven (1996) have pointed out that learning in unknown (chaotic) conditions can be viewed as an expanding and divergent process of discovery which differs from a more narrowing and converging process of experimentation once the uncertainties are reduced. Information gap decision theory proposes to model uncertainty as an information gap rather than probability (Ben-Haim, 2006). This theory measures the deviation of errors (differences between the parameter and the estimate), but not the probability of outcomes to identify the potential knowledge gaps.

The work on the process of new product development (NPD) has progressively led to structure an integrative process including technological and/or market breakthroughs (for more information see flexible product development, fuzzy front end) (Eisenhardt and Tabrizi, 1995, Iansiti and MacCormack, 1997, Koen et al., 2001, Reid and De Brentani, 2004) and the rapid assimilation of knowledge and new ideas (open innovation) (Chesbrough et al., 2008, West and Gallagher, 2006). **These studies most often consider disruptive innovation as a random evolutionary process that requires making multiple consequent or parallel trials while reducing costs and incorporating learning.**

One of the most advanced strategy proposed is to select a trial and reduce unknowns through the process of learning – Trial and learning (Lynn, 1998, Loch, 2008). It attempts to maximize the probability of trial existence and minimize unknowns through the process of sequential learning. Trial project’s selection appears to be challenging due to the high level of unknown. By dealing with the *unforeseen* type of uncertainty, this type of strategy recognizes “unforeseen chance nodes” that lead to redefining contingent plans during the exploration. When this strategy considers reuse of the acquainted learning to develop other market alternatives, it might result in a platform creation based on the dependencies created during trial exploration and consequent learning process. The success in this case highly depends on the results of the trial.

There exist alternative strategies whose success in double unknown is strongly based on the design of dependencies. The literature on the history of the economics suggests different forms of dependencies management through the development of GTs (Rosenberg, 1994). **GTs are technological platforms capable of addressing multiple emerging and existing markets.** GTs, once developed, permit to resolve the problem of double unknown and enable the reduction of unknowns. They increase benefits, encourage growth and reduce the risk of failure by ensuring technology reuse in various markets. For instance, suppose there is an emerging technology that by using relatively small R&D budget can consider a high number of niche markets with a probability of occurrence of about 20% each. The probability that at least one market from the considered 20 emerges at the end is equal to $1 - (1 - 0.2)^{20} \sim 0.98$. Thus, in double unknown, the R&D projects might be highly successful if it is possible to propose a generic solution for a wide number of market applications meaning that the project comprises generic core that can be easily reused to address larger number of markets. By exploring this “generic” trajectory, companies could profit from double unknown to design a solution suitable for several uses and increase company benefits, which make **GTs development and diffusion as one of a key interest for company strategy.**

To account for GTs in double unknown, we have to establish multiple technological and market dependencies. So suitable strategies have to deal with markets, technologies exploration and creation of the dependencies between them. It is assumed that strategies like trial and learning, or probe and learning, enable unknown exploration and lead to generic technologies development through the consequent process of selection and mutation of trials. For instance, in the trial and learning strategy, the trial might result in platform design, which does not address only the trial application but can be generalized for other contexts. This offers some kind of evolutionary path for GT design. But is this the only way? **This work aims to demonstrate that there exist a more intentional way of designing GT that can result in developing more “generic” solutions.**

What does stand behind our motivation of dealing with the intentional direct approaches for generic technologies design in double unknown? First, GTs are highly desirable for a wide range of sectors of the economy and society and therefore both national governments and firms seek to develop them to sustain their growth and profit (Keenan, 2003) (see Section 2). Yet, neither random sequences of

chance events, nor trial and learning strategies guarantee to companies the successful results and allow the controlling of the costs of exploration. The issue of double unknown management for the design of GTs becomes critical. Second, the recent advancements in innovative design research perspective enable us to treat the question of GT design more precisely and independently from the evolutionary models. For instance, the models of unknown exploration issued from the design theories propose to interpret the “unknowns” as an opportunity to generate more possibilities and explore new alternatives (Hatchuel et al., 2010). The design theories could enable to simultaneously deal with the probable states of the nature to design new alternatives for GTs.

2. THEORETICAL BACKGROUND: ON THE DESIGN OF GENERIC TECHNOLOGIES

2.1. The advantages of generic and general purpose technologies

General purpose technologies (GPTs) play an important role in the economic growth (Keenan, 2003). They offer key mechanisms of transformation in the way industry works and in the way firms conduct their business (Jovanovic and Rousseau, 2005). Steam, electricity, semiconductors, nanotechnology and information technology are often classified as GPTs based on their potential to boost productivity across different industrial areas and even to create new markets. For instance, the steam engines of Watt and Boulton were not designed solely for water extraction in mining applications (which was a design reference at the beginning of 18th century) but they were also used as power sources for textile fabrics, trains, boats, driving machinery in factories, mills, mines, propelling transports (Rosenberg and Trajtenberg, 2004).

While GPTs are characterized by their pervasiveness for the whole economy, GTs are less prevalent and attempt to address and provoke the creation of a variety of applications (Cantwell and Qui, 2009, Maine and Garnsey, 2006). **By GT we define a technology that is capable of addressing multiple emerging markets or even to provoke a creation of new markets, which all share the same technological core and provoke exploration of options.** A technological platform constitutes the independent technological core of GTs. GTs, once developed, permit to resolve challenges associated with double unknown exploration when markets and technologies are unknown. GTs increase benefits, ensure growth and reduce risks of failure by ensuring technology reuse by various markets (Miyazaki, 1994a).

The value of GTs is demonstrated from historical (Landes, 1990, Moser and Nicholas, 2004), economic (Bresnahan and Trajtenberg, 1995), and sociological perspectives (Powell, 1987). As pointed out by Bresnahan and Trajtenberg (1995), most GTs play the role of enabling technologies which provide plenty of new opportunities rather than offering complete solutions. As such, the introduction of electric motors enabled the industry not only to reduce energy consumption, but also to provoke the complete redesign of factories. This process is twofold: on one side, GTs provoke further innovations in a variety of industrial applications and on the other side, the genericity itself can be improved through their propagation as well. In the first case, the generic technology attempts

to further disseminate the innovative solution for the industrial applications. In the second case, the propagation and further improvement of genericity provokes the emergence of completely new sectors, and the creation of new needs.

Obviously, by building GTs, issues are raised not just from their underlying approaches of managing unknowns but also the necessity of overcoming technological lock-ins with the advancements in time (*i.e.*, transistors appeared after electricity was developed), and organizational conditions. There exists a lot of debates whether some technological innovations are GPTs. Various scholars examine whether nanotechnology is emerging as GPT (Shea et al., 2011, Youtie et al., 2008). Even electricity was challenged initially on its GPT character. For instance, Moser and Nicholas (2004) examined GPT's characteristics of electricity based on patent citation analysis. The authors suggest using forward patent citations as a measure of genericity, especially when these citations occur within various sectors. By comparing patent citations, they show that electricity could not qualify as GPT more than, for instance, chemicals. They state that it is not electricity itself but the general scientific advances that cause productivity gains in 1920s. Built on the example of electricity Kander et al. (2007) demonstrate the limits of patent citations approach to test whether a technology is generic. The authors underline that electricity is deeply embedded in everyday life, all machines use electricity as a power source, lighting equipment or for heating reasons without actually citing patents that belong to the electricity domain. For instance, the patents protecting integrated circuits that make use of low current electricity do not make references to underlying electricity patents. Therefore only by quantifying the underlying productivity effects, the GPTs role of electricity becomes clear.

The penetration rate of the GT's families is high. For example, smartphones are considered as generic products of well-known GPTs such as information and communication technologies. The analysis of penetration rates for various modern technologies demonstrates that smartphones have achieved 50% of penetration of the American consumer markets (The economist 2012). Figure 2 below shows that smartphone penetration is two times faster than that of computers and much faster than cars. Their generic potential is enormous. These powerful mini-computers do not just facilitate the ways people interact and access data, but they also provoke revolutionary uses in many areas such as medical, tracking, entertainment, and safety.

The various benefits to design GTs have been underlined. Among them: flexibility to extend the scope of initially considered market applications, including markets with various maturity level, various domains, share risks and decreased R&D costs among several applications (Shane, 2004), attract venture capital and large corporate investments (Maine and Garnsey, 2006). GTs appear to have higher probability of existence in companies with advanced external and internal R&D centers, fragmented market landscapes and diversified technological portfolio, which are more exposed to the nature of unknown exploration. For example, semiconductors, biotechnology and nanotechnology domains are *a priori* well positioned given their wide industrial application area, technological diversity and the rate of scientific breakthroughs.

Surveys of the GPTs *ex post* demonstrate that they contain an underlying generic function (or concept), which is independent and can be applied in many industries such as the “continuous rotary motion” of steam engines or the “transistorized binary logic” of integrated circuits. Yet, while *ex post* generic functions are possible to identify, *ex ante* their definition is less obvious. Such as, it is ambiguous to confirm that by privileging continuous rotary motion, the price of stewing will decrease and the steam power will be used in plenty of application areas. Moreover, it is impossible to predict the complementary effort necessary for further diffusion of generic concepts, which explain the existence of steam engines designs that were powerful for singular applications and did not make use of rotary motion for energy transmission.

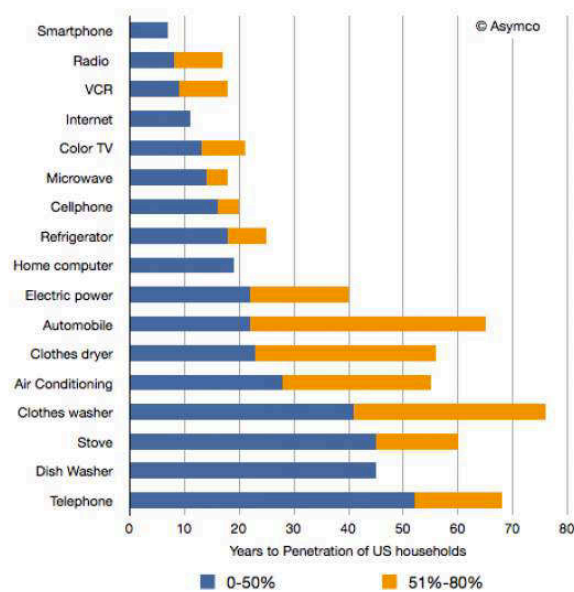

Figure 2 - Fastest Growing Consumer Technologies³. For instance, It shows how much more rapid cellphone adoption has been than home computer adoption. The raised question is how long will it take for smartphones to reach saturation in the US.

2.2. Research problem: Risk management in unknown by generic technologies design

Despite the proven interest in developing GT and the increasing number of studies that demonstrate their value, genericity appears mostly as a result of an exploration or as an evaluation criterion. **Prior research mostly focuses on the challenges of dissemination and commercialization of GTs. However, little attention has been paid to the patterns underlying the design of GTs.**

To the best of our knowledge, there are no methods that target GTs' design. Given the benefits genericity creates, is it possible to identify, pilot and control the projects that lead to genericity

³ For a description see: “[General purpose technologies: the revolution to come](#)”, The Economist, 2012, accessed September 15, 2013

building *ex ante*? Due to their double disruptive nature in both technological and marketing domains, GTs can provide a powerful solution for double unknown management. They lead to organizing exploration in both technologies and markets, to build their interdependencies. **Then how is it possible to recognize a project *ex ante* that will enable genericity exploration?** Which model of risk management can support the design of GTs?

Insights on the GT's design for double unknown management might be gained from the literature on technological platforms and modularity. Technological platforms are defined "as sets of subsystems and interfaces developed to form a common structure from which a derivative product can be efficiently developed and produced" (Gawer, 2010, McGraph, 1995, Muffatto and Roveda, 2002). The platforms represent a core element of the technological system. For instance, Bresnahan and Greenstein (1999) analyze platforms as a bundle of standard components around which buyers and sellers coordinate their efforts and therefore build new modules. The platform approaches nowadays allow evaluating the modularity level of platforms and the techniques are based on how to better commercialize the platform by addressing more market complementarities (Gawer, 2008, Gawer, 2009, Baldwin and Clark, 1997, Baldwin, 2008) through the process of dependencies creation between platform and modules. Generally, the modularity concept defines three purposes: to make complexity manageable, to enable parallel work, and to accommodate future uncertainty (Baldwin and Clark, 1997). Thus, the success can be explained not only by matching technology and its application (corresponding market), but more so by the plasticity of a technological core that is flexible for design and can be used to build several technology-market couples.

These approaches help to valorize generic character of platforms based on the structure of associated dependencies management to address client demands through module development. Still, these methods mostly deal with known platforms and do not provide recommendations on which dependencies are better to privilege in order to account for flexible generic platform. **Given several emerging technologies or platforms, which one should be chosen to increase genericity (to penetrate larger amount of markets areas)? How to evaluate possible structure of interdependencies?**

GTs drive successful development by proposing a flexible generic core that can be used to address several market applications, and support several products and business models. What does make us think that designing the right generic technological structure would justify the technological investments and address a range of attractive markets faced with high uncertainties? Figure 3 demonstrates that emblematic technological families like Internet or telephone allowed for breakouts even during recession times. Generally, their trajectories of technological development do not change with market recession; the exploration continues independently and just re-attacks the markets once the crises is over. It is shown that innovative technologies that have potential of being generic are independent in broad terms of consumption factors. This means, that if we are able to design GTs that are from one side independent from market situations, and from the other side lead

to use-generative products in various market segments, we enable **risk management in unknown by GTs design.**

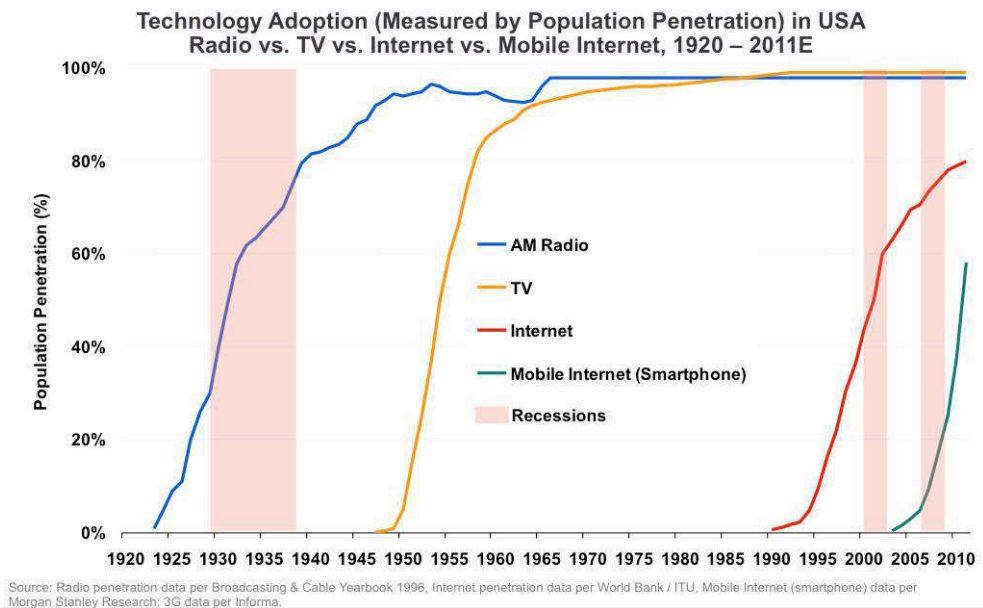

Figure 3 - Technology adoption. Breakthrough Communication Technologies⁴

Taken together, risk management is based on the uncertainties reduction associated to a set of initially defined alternatives, be it technological or market risks. Traditional management approaches of risk reduction don't deal with the situation where the level of unknown is high. The option of designing new alternatives to reduce unknowns is neglected. Yet, there is a clear need to manage the situations of high uncertainties or "unk-unk", where the level of unknownness is so high that neither the level of risks nor even the list of risks are known. In this situation of double market and technological unknowns a design perspective might lead to add a new action possibility in the model: designing a new alternative that modifies the probable states of nature and reduces the level of unknown.

GT design appears as a powerful alternative to structure and reduce technological and market unknowns. The GT design might lead to the original ways of dealing with risks be it known or still unknown risks. **How to design GT in double unknown that reduces the risks?** So far there has been little discussion about the design of GT. In broader terms, the objective of this research is to give insights on the **design of GT** that articulates advanced technological and business explorations.

⁴ Source: [KPCB Internet Trends](#), accessed September 20, 2013

Chapter 2

Theoretical constructs of double unknown management: setting the issue

“Only the unknown frightens men. But once a man has faced the unknown, that terror becomes the known”

Antoine de Saint-Exupery

The present chapter describes the theoretical background and underlines the importance of the chosen research questions. The theoretical background is built upon the fields of innovation management, uncertainty, risk and technology management, platforms and modularity and organizational capabilities literature. Moreover, the design theories are mobilized to provide insights into the issues of generic technology design.

The present chapter starts with defining the double unknown situation as an anomaly to be managed that from one side is challenging and risky and from the other side gives a possibility of GT design (Section 1). Section 2 continues by challenging the performance and the applicability conditions of considered strategies. It builds on the business evaluation logics suitable to GT and the situations where the design of GT might be relevant. Section 3 determines the research gap in the process of genericity building in unknown. Section 4 underlines the needs for the organizational structures and the competent actors for GTs exploration. It highlights which organizational entities identified by the literature for radical, breakthrough, and major innovations can be suitable for GT design and which competences and actors are required for double unknown management.

The sections 1, 2, 3, and 4 comprise the main literature positioning used to determine the research gaps and shape the corresponding research. Each section just indicates the main hypothesis, which will be developed further in the corresponding parts (I, II, III, IV accordingly).

Section 5 presents the corresponding research questions and indicates the possibility of defining a new action logic for the design of GT.

1. ON MANAGEABILITY OF DOUBLE UNKNOWN: A NEED FOR RESEARCH OBJECT CLARIFICATION

Risk reduction is associated with a set of alternatives comprising technological or market risks. Being driven by decision-making theory, risk management methods attempt to find the most promising solution from the already predefined list of decisions and their states of nature. Among the most

common criteria are: subjective probabilities estimation (Chapman and Ward, 2003), project losses definition (Jaafari, 2001), variations (De Meyer et al., 2002), project outcomes estimations and scenario planning. While coping with risks, the effort focuses on the downside of unexpected outcomes and risk management seeks to avoid these negative effects. Yet, external changes are not necessarily harmful and should not always be avoided, as they can yield opportunities for companies. Jaafari (2001) suggests that risks and opportunity management should be considered together to permeate the entire spectrum of project activities.

As demonstrated in Chapter 1, under conditions of uncertainty, the real options approaches might be used to estimate risks and uncertainties and to take the right decision consequently. Besides that, the real options provide recommendations on technology positioning that change boundaries and thus future option value (McGrath, 1997). Huchzermeier and Loch (2001) show various types of uncertainties that influence the value of real options and permit to better understand the effects of operational variability on the value of managerial flexibility.

When dealing with unknown, classical risk management approaches appear to be limited since they consider that the alternatives, their level of estimated risks and probability of occurrence to be known in advance. Moreover, the real option approaches might fail to demonstrate the exploration activities of firms that can lead to unexpected results while coping with multiple unknowns. The notion of real options is hardly distinguishable from that of path dependency and hence the option might simply fail to incorporate the potential of new discoveries (Adner and Levinthal, 2004). Faced with double uncertainty, technologies and markets are weighted with twice the amount of uncertainty, and classical risk management criteria will definitely reject this kind of exploration. **Intuitively, the approach of double unknown management with controlled risks appears impenetrable.**

Still, as indicated previously, the unknowns can be interpreted as possibilities, which, by adopting appropriate management strategies, can generate the opportunities for successful GT design. **Do GTs emerge as the result of a random or gambling process or do some strategies exist that attempt to profit efficiently from the unknown?**

Some insights on the management of highly exploratory projects might be found in the fields of management, entrepreneurship, and marketing. Innovative projects come along with high degrees of ambiguity (Morone, 1993), where learning-oriented and discovery driven exploration to design the dependencies between the alternatives, and consequently commercialize them, can be used (O'Connor and Rice, 2012, McGrath and MacMillan, 1995). By designing the dependencies we mean to establish new relations between previously independent technologies and markets, or within the technologies and markets (*i.e.*, incorporating a new feature that one technology accomplishes to another one, which designs the interdependency between these two technologies and might attract new markets).

To better deal with the exploration of unfamiliar concepts, firms might prioritize experimental learning. Exploratory learning theory underlines that the firms that heavily rely on the existing expertise limit the initial choice and therefore create the issues of path dependencies (Gruber, 2010). There exist various attempts to deal with it. For instance, it is suggested that the best learning can occur in the least familiar domains (Miller et al., 2007). Companies have to work outside the boundaries of their own strategy (Zahra, 2008) or even adopt random distant searches to avoid cognitive traps (Bhardwaj et al., 2006).

Trial and Error strategy is suggested to tackle uncertain explorations (Lynn et al., 1996, Chew et al., 1991). According to this strategy when the individual faces a new situation, he makes a number of random movements: then, a first trial is chosen. If it leads to a failure, the strategies switch to another trial and no learning is incorporated. Out of the number of trials or movements, unsuccessful trials are eliminated and the successful ones are retained. This process could be long and expensive and learning is rather restricted.

Exploratory learning theory and risk management suggest more advanced **trial and learning** (or “**probe and learn**”) strategies to explore new technologies and markets (Lynn et al., 1996, Loch, 2008, Danneels, 2002). Trial and learning strategy takes advantage of learning through selection of a particular development trajectory. The goal is to identify a trial with higher chances of succeeding and increase its probability of success during the process of consequent trial exploration, the series of probes that enable the introduction of prototypes and solutions into a variety of market segments. This type of strategy integrates learning, which consists of reducing market or technological uncertainty and leads to technological reconfiguration and redirects it to a new business orientation during the process of exploration. When this strategy considers “reuse”, it might lead to a whole new platform creation for novel business opportunities. It can be considered as a consequent process of platform generalization. It means that technology is becoming a platform for the different contexts. It creates interdependencies between several previously independent markets through the process of consequent learning and reuse (Loch et al., 2008). By interdependent we define the situation in which the same technological elements are valid for different markets. By independent we define the elements that contribute to a particular function in its own way (Baldwin and Clark, 2000).

It is reckoned that the probing step that consists of introducing a product to a “plausible initial market” is less important than the learning and subsequent steps which take place later (Lynn et al., 1996). Still, the choice of the first trial defines the learning direction, determines the interdependencies amidst all the subsequent tests and thus the success highly depends on the results of this trial and generally the indications on how to choose it are absent. The choice of the first trial constitutes the dependencies between all the subsequent tests and defines the learning direction. Due to the high level of unknown, trial selection might be misleading. Moreover, the effectuation theory points out that the exploration presumes knowledge and existing marketing and technological competence to build a trial (Sarasvathy and Dew, 2005). This process can result in a too narrow

exploration area when new markets and technological opportunities are not presumed within a first trial exploration.

The effectuation theory suggests starting with the available actors and institutional resources to see what they can afford to build in order to find an opportunity. The opportunity in the effectuation theory represents an outcome of the interaction between network actors (O'Connor and Rice, 2012). Although, these approaches provide possibilities to deal with unknown, their performance is not clear. The literature recognizes traps of explorative learning and describes organizational routines (Danneels, 2007); although, it is not clear how to overcome these traps yet. For instance, effectuation theory does not measure the performance of an opportunity and does not clarify how the network of actors can make better decisions. This effectuation theory provides useful insights in designing an opportunity for unknown exploration through the network of actors. But its application for GT design and strategies behind it are not clear.

While dealing with unknown, the nature of technologies needs to be understood and the critical objects revealed to enable exploration and introduce the appropriate strategies. To design GT and increase the variety of considered options, the structure of interdependencies has to be developed between yet unknown markets and technologies. Trial and learning can implicitly lead to GT development but its performance needs to be specified. In trial and learning strategy the first trial has to build a platform that is then useful for other applications.

The logic of technological platforms incorporates interdependencies management (Kim and Kogut, 1996) and appears to be consistent with that of GT. The theory of technological platform provides the insights on, firstly, how to build value by growing the ecosystem of platform users, and secondly, how to profit from an existing platform to provide complementary innovations built on platform cores and orchestrate the ecosystem of players by taking a function of platform leader (Baldwin and Clark, 2006, Gawer, 2009, Schilling, 2002). The platform is considered independent from the specific market needs but still provides access to them by interdependencies creation through complementary market exploration. Platforms attempt to address various market configurations through modules development. Still, contrary to the decision-making approaches, the effect of learning when dealing with platforms is hard to evaluate. In double unknown, it is not know which dependencies need to be built to develop a successful platform. The criteria of platform success in unknown need to be established.

On the one side there exist widely deployed strategies of decision-making that enable incorporation of learning on the states of pre-defined options but fail to integrate the emerging opportunities and interdependencies. Trial and learning strategies provide powerful techniques for experimental learning in unknown, incorporate new alternatives and consider successive interdependencies exploration but their performance is defined by the first trial selection. On the other side, platforms enable to account for multiple market exploration; they are driven by interdependencies and independencies building within platforms and modules. Though, the approaches to evaluate learning

effects in platforms are still missing. For instance, it is unclear which dependencies to privilege in yet unknown technologies and markets to account for better performance. The managerial unit of analysis needs to be clarified.

What is an object of management in unknown situation that incorporates the logic of unknown reduction and learning and enables the design of multiple technological and market interdependencies? Are there strategies that overcome the risks of trial and learning and attempt to maximize the number of emerging markets that technology can address or create? Or more precisely, is there a strategy of GT development that allows overcoming the risks of double unknown and results in a winning GT?

Based on the empirical cases of advanced technologies development, this work evidences a new strategy that corresponds to the anomaly in risk management and defines its place within the risk management framework. This strategy is not based on the logic of risk and uncertainty reduction but rather shows that the reasoning based on the design of GTs offers an interesting perspective for double unknown management. Further, the revealed phenomenon obliges to determine the contingency criteria suitable for GT design.

2. TECHNO-ECONOMIC CONDITIONS AND VALIDITY OF STRATEGIES FOR GENERIC TECHNOLOGIES DESIGN

The characterization of the double unknown situation and the identification of strategies that enable the successful management of double unknown and lead to GTs give the indications on the managerial processes that are far more experimental than conventional methods. To successfully implement and account for GT design in double unknown, the performance of the underlying strategies needs to be clarified. They need to be compared to reveal the contingent criteria of their applicability and conditions that permit decision makers to estimate the validity zones of the corresponding strategies. So what are the contingency criteria? On which grounds can one compare these strategies?

The insights on the nature of the evaluation criteria suitable in various techno-economic contexts could be gained from the financial perspective. While deciding whether or not to invest, the majority of potential funders wish to see a business plan at first. In general terms, a business plan is a strategy to manage risks implied by technology development (Mason and Stark, 2004). The most traditional business plan considers that a couple (technology; market) will be developed and risk management consists of reducing the risks of technological or market failure. Thus, in order to obtain investments, each company or public organization attempts to define their formal market goals, justify the promising market (high volume, low risk) and the reasons why these goals are technologically achievable. Such risk reduction types of business plans are constructed under the assumption that markets and technologies are known. The business logic is then driven by market notions (such as potential benefits, costs, probabilities of success), or technological conditions (performance, cost of

development). The contingency criteria that are commonly used to choose the leading strategies depend on the market or technological conditions. Are these the only type of criteria? Which criteria could be used while dealing with strategies selection in unknown?

The number of different factors normally justifies strategies' choice. For instance, driven by the idea of choosing the strategy that requires less investment for satisfactory results, (Beach and Mitchell, 1978) demonstrate that strategies selection is based on the type of problem, the surrounding environment and the characteristics of a decision makers involved. When only technology is unknown, this is often considered as a market pull oriented business plan where technological uncertainty has to be reduced to obtain forecasted revenue flows (Brem and Voigt, 2009). Conversely, there are business plans that tend to reduce the market risks associated with the commercialization of a known technology (technology push type) (Caetano and Amaral, 2011, Linton and Walsh, 2008a).

Do we evaluate double unknown as double uncertainty? Following this assumption leads to a clear consequence: the common criteria of expected profitability and return on investment are weighted by twice the amount of uncertainty (uncertain market and uncertain technology). So using classical criteria, projects in double unknown never appear to be profitable and the logic of the classical business plan leads then to stop such explorations. In double unknown the list of candidates is infinite and their probability distributions are equally volatile. The rate of new applications' creation and even new markets is high and market signals are dynamic (Hill and Jones, 2007). Moreover, the speed of markets renewal and the success rates of radical innovation are positively influenced by the innovation speed (Goktan and Miles, 2011) and should be taken into consideration while dealing with double unknown. There exist strategies to deal with multiple technological and market exploration in unknown (e.g., trial and learning) (Loch, 2008, Lynn et al., 1996, Sommer et al., 2009). **Though, the criteria for projects selection and evaluation implied by different strategies differ significantly.**

Tidd (2001) stresses the need to better characterize the technological and market contingencies which affect the opportunity for, and constraints on, innovation. Moreover, strategies performance and their validity are influenced by technological and marketing dynamics by the speed of industrial renewal. The investment decisions on whether to launch a particular development using a certain strategy need to be made by taking into account techno-economic situation. The performance and conditions of strategies implementation faced with various industrial dynamics and their validity domains need to be investigated. Driven by the idea of choosing the strategy that requires less investments for satisfactory results, Beach and Mitchell (1978) demonstrate that the choice of strategy depends on the type of problem, the surrounding environment and the characteristics of decision makers. Moreover, Gambardella and McGahan (2010) stress that nowadays products and services are not focalized on customer defined problems but rather they are driven by "scientific and technological breakthroughs that are provoked by design or simulation-based visions about possible applications". There must be a way to deal with "unknownness" by increasing genericity, and a

“genericity-oriented” business plan should help to manage such developments (Bresnahan & Gambardella, 1998). Hence, the following research gap is designated: **it seems that the “risk reduction” logic, based on the evaluation of the probability of a certain (technology, market) couple is misleading in highly volatile environment.**

In order to deal with the investment decisions in unknown and high velocity environments, firms should probably seek for different performance criteria in various stages of development and try to better understand what are the right strategies and policies to adapt according to the initial situation. We aim to clarify these criteria for the firms under high velocity unknown environments and provide some insights for the investment decision making in uncertainty. Hence these new corresponding questions: **What are the criteria that enable to detect which strategy ought to be used for projects exploration? Which criteria facilitate the choice between strategies?**

While dealing with GTs, the criteria of the strategies success differ from the classical ones driven by “technology-market” couples’ assessment to adapt “risk reduction” business plans. The descriptors of techno-economic domain are significantly different. We show that there are two main contingent variables: the existence of a clear market signal and the question of whether technological systems are more or less “segregative”⁵. Our model confirms that market pull is relevant for the environments with reliable market signal (and “segregative” technological systems), and we show that the design of generic technology is relevant for the environments where reliable market signals are absent and technological systems are aggregative. This enables the predetermination of conditions when the design of GT is relevant.

3. METHODS AND PROCESS OF DESIGN FOR GENERIC TECHNOLOGIES

Having defined the techno-economic conditions relevant for GTs design, one has to deal with methods to actually conduct this reasoning. Is it possible to account for generic technology design in unknown? Can the intention to build genericity be expressed *ex ante*? Generic technology development can be built upon a trial, where the latest is often selected from the known list of alternatives (Miyazaki, 1994b). This sequential process corresponds to the evolutionary mechanism where GT appears as an emerging design that is consequently applied to address several emerging markets. In this perspective the technology is first designed for a first market and then, progressively reused to address the other ones. This process depends on the choice of the first applications (market trial). Is it possible to avoid predetermining the exploration space by the initial trial choice (like in evolutionary strategies)? The evolutionary model provides just one way of designing GT and our general hypothesis is that there might be more intentional approaches to deal with genericity and design of larger application domains.

⁵ By “segregative” we define the technologies that are not easily compatible, which means that they cannot easily incorporate new functions and be combined with other technologies (interdependencies are expensive to design) - for more details see Part II.

A design perspective leads to add a new action possibility to risk management: a possibility to design a new alternative that might change completely the probabilistic states of nature. For instance, a designed alternative could drastically increase risks followed by radically new design ideas or even lower risks. In this way, the high uncertainty is regarded as an occasion to create unexpected opportunities and, as pointed by (De Neufville et al., 2004), uncertainty needs to be treated as a core element for the design of engineering systems. **Could one actually propose new designs that lower risks and lead to the building generic technology?**

Gero and Kazakov (1996) who define the design as an activity that changes the physical world, propose that it can be viewed as a decision making activity. In the decision making perspective the purpose is to identify the alternative that best fits a set of probable states of nature. The underlying hypothesis is that the states are predefined to enable better choice. The strategy in this case appears as a search strategy that finds a better design, given the design space. In this perspective evolutionary strategies incorporate learning to improve the design solution through a series of consequent trials.

Le Masson et al. (2013) demonstrate that risks can be seen as relations between design spaces and external environments. As pointed out by Alexander (1964), design can be considered as a dynamic process of problem setting and problem solving that leads to the determination of how the context is defined in design spaces. The external world is invariant for design (Hatchuel et al., 2013) and thus, plays a critical role by influencing the choice of underlying strategies and design dynamics. On the contrary, the design space aims to modify and transform propositions. Design perspective, when considered together with risk management, enables the extension of the classical framework of risk management by adding a possibility of new alternative designs, emerging during the exploration process, which can influence the design process by lowering or increasing risks.

The decision-making perspective offers a general way to deal with risks but it enables only a limited form of action. Design perspective enables the creation of new alternatives to deal with probable states of nature within the predefined design space or even by avoiding fixing the set of alternatives initially. **The design theories might propose a better process for dealing with unknown while designing GTs than the evolutionary process; and provide new insights on GTs design.**

As with any other design process, a generic technology design starts with an initial concept. **Which type of concept leads to genericity creation? What are the associated operators, knowledge structure and reasoning associated with genericity design?**

By analyzing the formal design theories, we demonstrate that they provide powerful mechanisms for genericity construction when the environments are initially fixed and partially unknown. Moreover, based on the most recent design theory formalism, we identify a new type of concept, namely “generic concept” that appears to be crucial for genericity design and determine the specificity of the design of these generic concepts to acquire higher genericity in unknown.

4. ORGANIZATIONAL STRUCTURE AND ACTORS FOR GENERIC TECHNOLOGY EXPLORATION

The design of generic technologies appears to be advantageous to deal with double unknown. Still, the scientific and organizational efforts to identify concepts that lead to GTs and to build interdependencies in unknown situation appear to be challenging. It requires particular governance forms to structure yet-unknown domains and gain flexibility to incorporate and recognize new opportunities. **Which organizational structures can facilitate the management of multiple projects to meet the goal of successful technology development for several markets under high uncertainty? Who are these actors that are capable of managing generic technologies and what are their necessary competences?**

The literature provides various reasons to enable the successful exploration of innovative projects. Among these reasons, the “human side of radical innovation” appears to be particularly important for obtaining desired outcomes (O’Connor and McDermott, 2004). The authors revealed that radical innovation requires a multiplicity of roles, although there is a lack of connectivity and continuity between them. Their work underlined that the teams that are involved in breakthrough innovation exploration differ from those involved in incremental innovation. The teams dealing with breakthrough innovations are driven by their volunteerism, informal recruitment and expertise levels rather than by clarified sets of goals (Howell and Higgins, 1990). Both external and internal networks appear to thrive in radical innovation projects. Confronting exploration in multiple innovative projects, firms rely on organizational learning capability and dynamic capability development (O’Connor, 2006, King and Tucci, 2002).

Then, what are the capabilities that are important while dealing with exploration in unknown? Which organizational assets might be used to succeed? The role of culture of an organization’s ability to change appears to be critical for its success. For instance, IBM gives interesting examples on how change in management culture can reform the companies’ strategy and ensure its survival (Davila et al., 2012). On the contrary, companies that are not able to adapt to the external challenges and transform their business strategy could fail, even down to bankruptcy, as what happened with Polaroid, which was not capable of ensuring the transition from analog to digital photography and failed in 2001 despite being a leader in early digital technology (Tripsas and Gavetti, 2000). A similar example offers Nokia, who was a leader on the mobile phone market. Its operational system Symbian was an international design reference; however, the company failed to recognize the potential value of smartphones initially and its continuous efforts to position on smartphone markets and gain bigger market share failed. As a result, Nokia sold out its mobile activity to Microsoft by giving them non-exclusive licensing rights for their large patent portfolio. How can it be explained why IBM survived, Polaroid failed and Nokia changed drastically its business model from phone manufacturer to patent licensee? How can companies prevent themselves from failing?

Organizational structures comprise the ways companies arrange communication, align and harness effort from their members (Hamel, 2006, Birkinshaw et al., 2008). There exist various governance models for organizations that confront high levels of uncertainty. One approach consists of leveraging new capabilities by other more advanced companies' acquisitions that offer competitive solutions. This approach is widely adopted by the market leaders in the information and communication technology (ICT) industry, which constantly enlarge their portfolios and competences through start-up acquisitions. A second approach would involve ensuring growth and developing competencies through internal or collaborative innovation exploration. Descriptive approaches of "innovation journeys" within ecosystems or within companies (Veryzer, 1998, Van de Ven et al., 1999, Garud and Karnøe, 2003) are conducted gradually to identify organizational structures that enable disruptive innovation (see (O'Connor, 2008, O'Connor, 2006, Le Masson et al., 2010b, Hatchuel et al., 2005, Hatchuel et al., 2001).

To go a bit further, major innovations (MI) are considered as important mechanisms to support growth and renewal of an enterprise (O'Connor, 2008). By demonstrating that major innovation exceeds the level of complexity of simple dynamic capabilities, the authors propose a definition of major innovation (MI) capability through several elements. Among them, MI requires an identifiable group responsible for the firms major innovation activities; the role of MI has to be communicated within the organization and the objectives coupled with companies strategic intent; the management process should be learning and exploration oriented; the leveraging and developing of appropriate skills and models for MI portfolio management are important; and an option mentality is necessary for project evaluation and mechanisms for constant reflection and reconfiguration. The real-options theory is suggested to guide investment decisions under uncertainty (McGrath, 1997, Dixit and Pindyck, 1994) by estimating whether the option of investing in a new technology is worth taking, depending on how the learning process influences the option value. As was shown previously, the real options provide powerful tools that take into account dynamic environments. Though, they neglect the interdependencies creation, which is crucial for generic technologies exploration.

Various organizational processes require diverse organizational capabilities that are difficult to implement and adapt (Nelson and Sidney, 1982). Moreover, the ability to link advanced technologies to market opportunities, where most of them do not yet exist, is difficult to maintain, given organizational pressures to attain immediate profit (O'Connor and Veryzer, 2001). The variety of existing organizational structures for innovation management can be appropriated for GT exploration. **Can the existing organizational structures succeed in building GTs? If yes, what are the necessary capabilities involved in genericity building?**

In high-tech companies, the need of special know-how and dynamic marketing activities to cope with uncertainty requires more flexible approaches, temporary organizational structures and acute actors vision. Managerial competence and governance forms to guide exploration in double unknown need to be defined. For example, the design of a technology that is capable of addressing several markets requires cross-learning collaboration. The latter requires the implication of various groups of

specialists with different backgrounds that are capable of mobilizing their knowledge and articulating different concepts, methods and visions among each other. Both technologies and markets need to be explored. We know that R&D oriented firms are capable of setting up suitable forms of innovation organizations (Le Masson et al., 2010b). Yet, are they capable of designing technologies and markets in unknown? Could the corporate R&D manage the design of GT in unknown? Otherwise, can it be the responsibility of the entrepreneurs or even intrapreneurs to account for genericity?

By its very definition, GTs require multi-market approaches to design a technology that is suitable for market needs that have only partly emerged. The actors capable of designing GTs have to account both for entrepreneurship creativity and resources within the organizations. Who are these actors and which level of knowledge and expertise is required to conduct the design of GTs? How to differentiate managers who are capable of appropriating and successfully executing strategies of GT design? Do they need to have an entrepreneurship background or an expert role within a company? Should the external actors be involved? **Is it possible to identify actor(s) having the necessary competences for double unknown management within the organization? What are the new managerial forms suitable for genericity design?**

Through the analysis of several empirical cases of GT design, we define a new managerial figure, cross-application manager, who is primarily responsible for defining generic concepts and articulating the design of GT within various organizational structures. We show that when the manager who is capable of playing this role is at least temporarily present, the performance of GT design is higher.

5. RESEARCH QUESTIONS: TOWARDS A NEW ACTION LOGIC OF GENERIC TECHNOLOGIES DESIGN

To date there has been little agreement on what the design of generic technologies is. Yet, GTs are considered as being highly beneficial for science-based companies to deal with unknown and create benefits across various application areas.

Based on the determined lenses of four parameters that appear to be critical for the design of GT the following research gaps to need be handled.

First, the design of GT in double unknown situation requires dealing with the new structures of interdependencies that have to be conceived amidst yet unknown markets and technologies. The literature highlights the strategies that involve dependencies creation by consequent platform generalization (trial and learning strategy). However, our analyses indicate the risks of trial and learning strategies to stack in only local optimum and fail to develop technological platforms. It is not sure that these are the only strategies that allow designing GTs. This frames the following **Research Question 1** (Figure 4): are there new strategies that effectively build the dependencies between various technologies and emerging markets in unknown and how can these strategies maximize the

number of emerging markets that technology can address or create? Or more generally, **is there a strategy of GT development that enables resolving the problem of double unknown and design a winning GT?**

Second, it is shown that the conditions, the logic of business plan and the strategies' performance change in accordance with the corresponding industrial environment and therefore they need to be clarified. Moreover, it is unclear in which conditions these strategies would lead to a GT emergence. To successfully conduct the design of GT, the contingency criteria, which define the domain where the design of GT appears to be relevant, should be determined. Hence the **Research question 2: What are the techno-economic criteria that allow detecting which strategy ought to be used for projects exploration in different environmental contexts? Which criteria facilitate the choice between strategies and what are the corresponding business models?**

Third, the design theories might offer powerful mechanisms to build genericity that are different from the evolutionary process. Yet, it is unclear how genericity could be acquired. Should it be identified at the beginning of design process? How to define the initial concepts to account for higher genericity? **Research question 3: how is it possible to conceive GT with the help of design theories? What are the strategies to increase genericity?**

Finally, drawing on the transversal character of GTs and the necessity to explore technologies and markets, the organizational forms suitable to explore GT have to be investigated. The managerial role and the necessary competence to be able to drive the GT design ought to be determined. Hence, **Research question 4: Who is capable of conducting the reasoning based on the design of GT? What are the required competences of these actors and the relevant organizational structures?** (Figure 4)

These identified research questions are coherent with the elements required to define new action logic. Hatchuel and Weil (1995) and Hatchuel (2005) have shown that building an action logic relies on 4 dimensions. They identify *a technical substratum* as the modeling technique required for the research objects; *a management philosophy* as the system of concepts that describe the objects and its performance; *a form of organization* that indicates collective roles and situations and finally, the *model of reasoning* which unifies the other elements and helps to deploy the action logic.

Innovation management in double unknown: Designing generic technologies

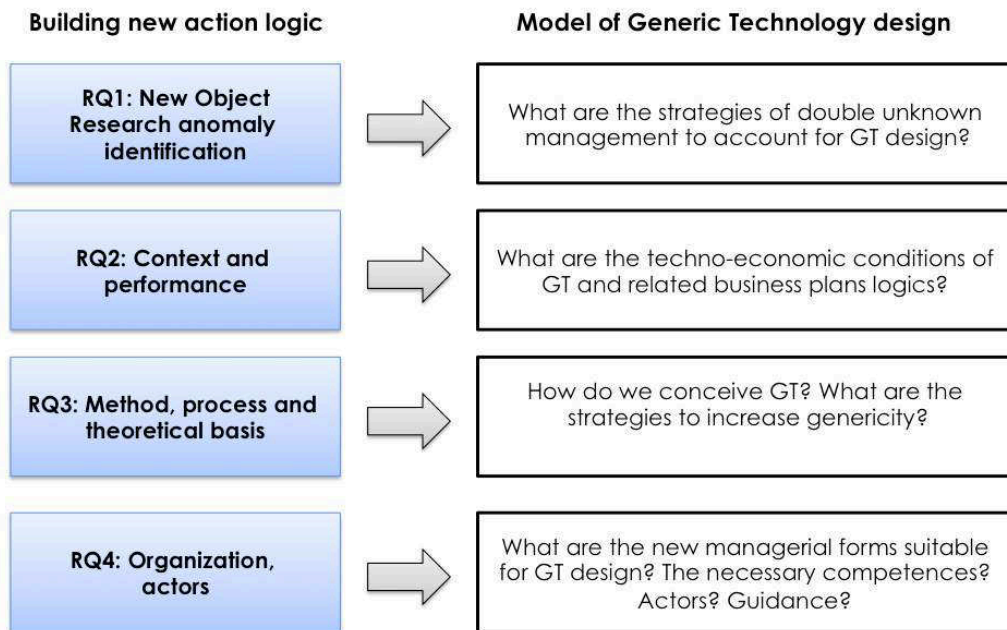

Figure 4 - Principal Research questions

Respecting these findings, in the current work RQ1 corresponds to the **technical substratum** and aims to define the new research object. This new object would enable the definition of management strategies for generic technology exploration in double unknown that attempt to maximize benefits through an identification of one technology that provokes multiple markets creation. RQ2 deals with the **conditions** when the new logic can be applied and the criteria of performance that need to be established. RQ4 aims to determine the **organizational forms**, the **actors** and their relevant competence and expertise to guide the design of GTs. Finally, RQ3 leads to define the underlying methods and process to design GT. **Overall, this research questions will lead to constitute the model of collective action adapted to an emerging new phenomenon, which corresponds to the design of GTs.**

Chapter 3

Research methodology and the corresponding itinerary: Making double unknown “manageable”

“Measure what is measurable, and make measurable what is not so”

Galileo Galilei

The intervention research approach helps to provide important practical insights to the practical issues of GTs design and proposes a new collective action model. Intervention research is possible only when the companies are opened for internal debates regarding their managerial issues (Hatchuel, 2001). This research is designed as collaborative management research (Shani et al., 2008), which has been conducted as a part of “Conventions Industrielles de Formation par la REcherche” CIFRE project at STMicroelectronics. Compliant with the default definitions of CIFRE projects as a joint research project between an industrial firm and scientific entity, our research setting frames the conducted work as both academic and practical. Conducted in collaboration with the semiconductor industry, the nature of this dissertation aims to deal with the issues faced by practitioners. The researcher role comprises direct involvement in academia and a professional role in the company. As defined in Shani et al. (2008), collaborative management research is an *“effort by two or more parties (from both industrial and academic sides) to work together in learning about how the behavior of managers, management methods, or organizational arrangements affect outcomes in the system or systems under study, using methods that are scientifically based and intended to reduce the likelihood of drawing false conclusions from the data collected, with the intent of both improving performance of the system and adding to the broader body of knowledge in the field of management”*. Management science deals with models of collective action that requires both the clarification of scientific object and design of research-oriented partnerships.

To investigate the design of GTs, this research uses the logic of discovery and codification of a new model of collective action through theoretical and empirical work (David et al., 2012, Radaelli et al., 2012). Conducted intervention research at STMicroelectronics during the period 01.11.2010 - 31.10.2013 increases our understanding of management practices in double unknown and provides useful practical insights. Following the pre-requisites of intervention research the research team was monitored by the special committee that looked for creative commons between research goals and the company’s interest – a steering committee of the Ph.D. thesis that involved experts from R&D and

business units of ST. This enabled enrichment of the empirical work, validated certain hypotheses and verified the pertinence of the results for the company.

Data collection is based on semi-structured interviews, direct project participation, analysis of various types of documentation, and simulation data. Theoretical background is mostly based on the risk, uncertainty, innovation management, design theories and modeling. A variety of methods are chosen to address the research questions. Section 1 of this chapter will display the chosen research methods. Section 2 will present the pertinence of the semiconductor industry for the chosen research questions. Section 3 will provide a summary of research itinerary.

1. BUILDING A MODEL OF COLLECTIVE ACTION FOR THE DESIGN OF GENERIC TECHNOLOGIES: CHOSEN RESEARCH METHODS

A variety of approaches were selected to define a new collective action model for GT design. The diverse methods including empirical case studies, formal modeling, corresponding simulation, and experimentations, were mobilized to introduce the necessary building blocks of an action model: object, context and performance, methods and process, actors and organization (Figure 5). In the following, each method is presented in relation with the identified research questions:

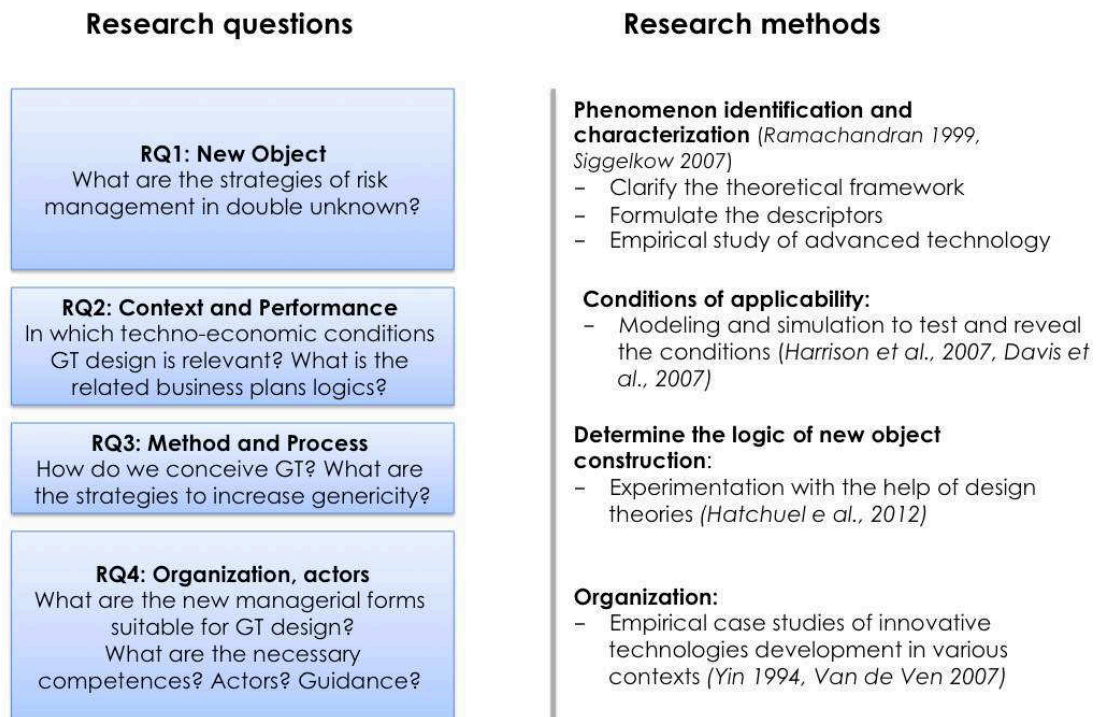

Figure 5 - Research methodology

1.1. Revealing the anomaly of double unknown management: ex post analysis of research projects portfolio

To reveal a new object which is not studied yet in the literature, the research follows a process of phenomenon identification and characterization (Siggelkow, 2007). This approach comprises: 1) the characterization and identification of the existing literature's models; 2) the definition of descriptors that helps to specify the anomaly, their modeling and building an instrument to describe the corresponding research phenomenon; 3) the anomaly characterization and definition of the corresponding actions and their implications.

Following this logic, 1) a theoretical framework driven on risk and interdependency management literature is formulated to reveal the anomaly that is not covered by the well-referred strategies. This framework is based on the contemporary models of uncertainty and interdependencies management and aims to reveal under-investigated alternatives in case of double unknown management. To examine research anomalies and clarify strategies performance, 2) an analytical framework for data analysis is built to identify and clarify the anomaly. The aim of the analytical framework is to enlighten more intentional strategies that deal with markets before their transaction and therefore, to recover an anomaly in interdependencies design. The proposed framework is based on technologies and markets matching using the notion of functions. The notion of functions gives the possibility of working on technologies and markets without directly considering technology/market couples. The general framing based on the distinction among technologies, markets and functions (see Part I, Chapter 4) is used to verify the correspondence among technologies and markets that they develop. In order to analyze strategies that deal with interdependencies creation, it is necessary to detect and examine how the interdependencies between technologies and markets were designed.

The anomaly is observed when direct technology-market matching is absent, which means that in this case the classical strategies are limited and these situations might reveal new ways of dealing with unknown and interdependencies. This model for data analysis is rather general since it explains classical strategies such as technology push, market pull, and selectionism and enables imagining of plenty of other strategies. The formulated analytical framework was applied to review the empirical cases of advanced technologies development in the semiconductor industry and it enabled the finding of cases that did not follow classical RM strategies.

1.2. Techno-economic context of strategies applicability: in which conditions new object accounts for higher performance?

While dealing with the new strategies for generic technology design in double unknown, it is necessary to precisely determine their validity domain and pertinence for the variety of techno-economic situations. To highlight the economic conditions of identified strategies and criteria of their applicability, we attempt to address our research questions by formally describing each method and comparing them using a developed simulation model of techno-economic environments.

Since GTs are more probable to emerge in dynamic, unknown environments, the primary interest is to apprehend the relevant strategies behavior in the environments where the time of technological development has the same order of magnitude as the rate of industrial renewal. Thus, the underlying model is positioned as a hybrid of two classes of models: 1) models that are based on uncertainty management techniques including real options (Camerer and Weber, 1992, Huchzermeier and Loch, 2001); 2) models that incorporate complexity and represent innovative projects as local search on rugged landscapes. This class of models is mostly based on Kauffman NK⁶ model for interactions dimensions and is broadly applied to strategic decision-making (Caldart and Ricart, 2004, Gavetti et al., 2005, Rivkin, 2000, Sommer and Loch, 2004). In case of high turbulence, complex search models become irrelevant since they do not consider environment evolution and therefore they deal only with fixed landscapes. The evolution of the landscape should be considered as incorporating alternatives that were not considered initially or emerged during the exploration process. The proposal in this work model is based on the landscape reconfiguration.

The goal is to test how the strategies performance and their applicability change with reference to the industrial dynamic in time. The model pursues taking into account dynamic environments, as in the first class of models, and interdependencies, as in the second class, and enlarge them to the cases of double unknown management. **The contribution of the proposed model is the configuration of the environmental dynamic landscape that influences the strategies performance and their applicability.**

To test the performance of various strategies, the model characterizing industrial environments was defined as a landscape of technologies, markets, functions and their underlying relationships (*e.g.*, offer - demand) in time. Based on the literature review, we seek to progressively integrate the number of variables that were considered critical (such as, market probabilities, dynamics, path dependencies, and technology compatibility) and enable the modeling of various characters of industrial dynamics, including highly unknown turbulent situations. Strategies in this model are heuristic algorithms that seek to develop more profitable connections between corresponding technologies, functions, and markets (which edges to develop to have an access for a larger amount of markets?). The model attempts to determine the relations between identified variables and compare management strategies in a large variety of techno-economic environments. Both classical strategies of innovation management (market pull, technology push) and the emergent strategies that enable to increase genericity are taken into account.

It is important to underline that the model does not aim to create a robust and exhaustive model of decision-making in situations faced with high uncertainty and interdependency. The goal is to

⁶ Kauffman's NK model proposes originally a means of exploring through parameter variation, the correlation of fitness landscapes in biological evolution and speciation. It uses an idea of a fitness landscape in which agents seek to move from "fitness valleys" to higher "fitness peaks". Kauffman, S. (1993) *The origins of order: Self organization and selection in evolution*, Oxford University Press.

account for simple economic model that helps to gain some insights on the strategies behavior in a variety of industrial situations. The model characterizes the strategies of risk management by identifying their performance, the nature of risks, and the characteristics of the techno-economic environments.

1.3. Method and Process for the design of generic technologies in unknown

To continue exploration of GT design, the process and methods that lead to genericity design need to be established. The methodology comprises model elaboration based on the literature review on design theories. **The study shows that formal design theories provide powerful mechanisms of genericity building when the environments are initially fixed or still unknown and propose the promising ways to deal with the interdependencies evolution.** For instance, the similarities between the techniques and the interdependencies theorems in mathematics forcing, (Cohen, 2002, Cohen, 1963, Cohen, 1964) and the formal design theories (Hatchuel and Weil, 2007, Hatchuel et al., 2012b) demonstrate that the design process consists of designing new objects. These objects are designed based on the existing interdependencies structures and establish the compatibility between the interdependent properties. To determine the logic of new object design experimentation and associated methods, the Concept - Knowledge Design theory (Hatchuel and Weil, 2009) is applied since it is independent from a particular engineering domain and invariant from the particular exploration context. Historical, mathematical and engineering examples of generic technologies development are used to build a model of generic technology design. Building upon the introduced method of GT design, the practical methods of genericity building were deduced through a multiple case study of innovative generic technologies exploration at STMicroelectronics.

1.4. Multiple cases studies of organizational forms to identify a suitable managerial figure and organizational structures for generic technologies design

Concerning the logic of organization and the managerial role, the study comprises four different empirical settings. The characterization of new managerial function is based on the intervention research conducted with the semiconductor industry (David et al., 2012; Radaelli et al., 2012) using multiple case study methodology (Eisenhardt, 1989a, Yin, 2003). The intervention research approach is relevant since it aims to provide an understanding of how to develop innovation capabilities within the organizations and it supports multi-level analysis of the investigated phenomenon (Radaelli et al., 2012).

First, by cross comparison of various organizational settings we analyze the managerial role and organizational structure of the entities capable of conducting exploration of double unknown situations. The purpose of this multiple analyses was to propose new actions and reveal the new managerial roles for GT exploration. The multiple case study approach is particularly relevant to

experimentally validate the findings and lead to more robust results (Eisenhardt, 1989a). The chosen cases represent separate experiments in which patterns were identified and tested. Multiple cases enable accounting for a more accurate level of abstraction and helps to achieve better generalizability. The rather various situations in different organizational contexts were selected to better reveal the phenomenon. Second, by conducting *ex post* analysis of the research project portfolio at STMicroelectronics, we examine different types of projects and the role of the projects interdependencies in overall project portfolio management.

2. VALIDITY OF CHOSEN INDUSTRIAL BACKGROUND FOR RESEARCH PROBLEM AND QUESTIONS: THE KNOWLEDGE-INTENSIVE SEMICONDUCTOR INDUSTRY

This dissertation is mainly based on the in-depth empirical study at the largest European semiconductor company: STMicroelectronics (ST). Semiconductors are fundamental elements of all modern electronic systems and computers such as smartphones, tablets, personal computers, and consumer electronics, telecommunication equipment. The growth in the demand for electronic components increased drastically the demand for semiconductor devices. In order to ensure growth, support the demand and be at the leading edge of competition, industrial players have to be ready for huge capital investment and R&D developments into rapidly changing technological generations. Yet, the risks are high and companies seek ways to analyze the corresponding market structure and more reliable manufacturing strategies to secure their investment. As a result, the science-based semiconductor industry constantly looks for breakthrough innovations and double unknown situations are common. For more detailed analysis of the semiconductor industry see Appendix 1.

2.1. The pertinence of the semiconductor industry for double unknown exploration and its generic character

General-purpose technologies (GPTs) drive the technological and economical progress. Semiconductors are considered as one of the emblematic examples of GPT. As shown by Bresnahan and Trajtenberg (1995), beyond pervasive GPTs often lie generic functions or concepts. For example, the generic function of integrated circuit (IC) (“transistorized binary logic”) was applied in many sectors. The transistor is the fundamental building block of modern electronic devices, it is embedded within ICs, and is ubiquitous in modern electronic systems. Following its development in the early 1950s, the transistor revolutionized the field of electronics, and paved the way for smaller and cheaper radios, calculators, and computers, among other things. Still, the integration of these technologies within emerging objects poses great challenges itself (Bresnahan and Trajtenberg, 1995). For instance, each generation of photolithography equipment designed for a new generation of transistors in semiconductor manufacturing provoked the change in the leadership position within the industry (Henderson and Clark, 1990). Only when the road mapping activity within the International Technology Roadmap for Semiconductors (ITRS) emerged, did the processes become standardized and the scientific efforts coordinated within various industrial players (Walsh, 2004).

As Maine and Garsney (2006) pointed, generic technologies may face high barriers for commercialization despite their potential for value creation. Thus, effective management and coordination process for GTs are necessary to ensure their successful implementation and complementary innovation guidance.

Pervasive technologies have little visibility in the dynamics of the economy unless they foster new inventions that directly or indirectly result from the early major invention (Youtie et al., 2008). It is shown that the widespread adoption of a core technology occurs thanks to the actors that are capable of coordinating their beliefs across the generic technology. The heavily research driven semiconductor industry is strongly coordinated by Moore's law, which reflects the exponential growth in transistor density on a single chip. The ITRS for semiconductors was created to support this growth and coordinate the activities of various actors through the complex supply chain. The ITRS appears as an institution that organizes the externalities from learning during the unknown exploration and attempting to control the "novelty" effort of semiconductors by proposing technology-oriented workshops (Le Masson et al., 2010a). Practically all the research projects launched in the semiconductor domain define the research problem and the goals of the corresponding work, while referring to the associated ITRS roadmap. The ITRS community provides the example of the ecosystem of actors that was able to jointly improve digital technology.

Albeit that transistors are recognized as GPTs, semiconductors do provide other examples of GTs. Among them, silicon photonics is a promising generic technology, which can be used in a large number of applications. Optical interconnects enable chip designers to overcome the problem of classic metal interconnects. Among other actors, the Interuniversity Microelectronics Centre (IMEC), which is known to perform world-leading research in nano-electronics, is pursuing a "general purpose photonics platform, consisting of pluggable process modules that can be added or removed from the flow at the end"⁷. They orientate the exploration towards the development of a flexible generic platform. Silicon photonics is the science and engineering of optical (photonics) functions on the surface of a chip using silicon as a base material. This includes various passive functions, such as routing and wavelength filtering, as well as active functions, such as switching, signal modulation, light detection, and light generation.

The collective R&D efforts of suppliers, users and research organizations have made possible the technological progress within the semiconductor industry. Cohen and Levinthal (1989) argue that the role of R&D is twofold. They show that R&D 1) generates innovations and 2) develops the firm's ability to identify, assimilate, and exploit external knowledge. The semiconductor industry provokes and further facilitates multi-product innovation diffusion to the various sectors (Eisenhardt and Brown, 1998).

⁷ « Silicon Photonics » poster, University of Ghent, can be downloaded: <http://photonics.intec.ugent.be/download/>

The relevance of the semiconductor industry to explore breakthrough innovations was shown by various researchers (Cohen and Levinthal, 1989, Tilton, 1971, Weber, 2003), especially for knowledge creation methods in science-based environments. As shown in Le Masson et al. (2012a) teams were capable of developing a novel type of “absorptive capacity” to make use of external knowledge sources and avoid fixation effects, by working on radical innovation in the field of image sensors. At the ecosystem level, Le Masson et al. (2012b) demonstrate how mapping the ecosystem of technological concepts facilitates the structure of collective exploration process towards breakthroughs and avoids fixation effects. Strong competition and fast changing environments that characterize the semiconductor industry lead to exploring not only new technologies, but also new functionalities and new products, while coping with the unknowns.

It becomes clear that the pace of innovation in semiconductors is extremely high, and in order to develop successful innovation, companies have to incorporate market dimensions along with technical ones, which requires double unknown exploration. In double unknown, markets are unknown, which means that there is a constant variety of emerging applications, which lack structure and segmentation. Market volatility makes it impossible to estimate costs and volumes using traditional techniques. The unknown character of technologies is predefined by the variety of technological possibilities driven by scientific discoveries, by their disruptive nature and by the lack of feasibility and standards to clearly evaluate advancements. These changes brought the ITRS community to create a new technology-working group (TWG) to include significant parts of the “More-than-Moore” domain in its work and pursue roadmap exploration in double unknown. The “More than Moore” (MtM) trend is characterized by functional diversification of semiconductor-based devices and technologies that cover a wide range of fields.

The constantly increasing costs of R&D investments to support new technological generations and a reduction in the annual growth rate clearly outline that the industry cannot simply follow the R&D needs. Therefore, to be able to keep technological leadership, companies then have to be ready for breakthroughs in their expertise, architecture, functionality and the chosen forms of business models. The role of the “More than Moore” TWG is to structure the exploration activity in double unknown to deliver innovative solutions to the markets. There is a double challenge: 1) the increasing need in exploring the unknown technologies and unknown markets, which provokes the expertise disruption and constant new knowledge generation; 2) limited capacity to finance R&D activities. To keep market leadership, semiconductor companies should be able to deliver highly performing, differentiated products at the right time. **It is not possible by just cutting down the costs of technology development and R&D exploration; companies have to enhance their economic efficiency and gain competitive advantage by developing successful products through double unknown explorations.**

To summarize, the need for high degrees of flexibility and innovation in order to constantly adjust to the rapid pace of change in the market makes the semiconductor industry relevant for generic technology exploration in double unknown.

2.2. STMicroelectronics is looking how to organize the process of generic technologies design in double unknown

STMicroelectronics (ST), which was formed by the merger, in 1987, of Thomson Semiconductors and SGS Microelettronica, is the largest European semiconductor company. Having a large product portfolio, ST nowadays focuses its product strategy on sense and power technologies, automotive products and embedded-processing solutions. From its creation, ST has remained a heavily research-driven company: in 2012 the company spent about 28% of its revenue in R&D. It is included in top 100 the most innovative companies in the world⁸ according to the Thomson Reuters classification, its portfolio comprises 16000 patents and about 9000 patent families. At STMicroelectronics, the identification and the development of new technologies is primarily the responsibility of research teams within Technology R&D groups. The new organizational structure (update from June 2013) is divided in two segments: 1) sense, power and automotive products 2) embedded processing solutions, packaging, test manufacturing and product quality excellence. Under each segment there are R&D centers and associated business divisions, which potentially simplify coordination of technologies common to several markets and thus facilitate exploration of GTs.

Dealing with high costs of R&D investment, ST pursues a collaborative perspective to develop its future technologies. The company is involved in a great number of the International, European collaborative research projects, which seek to provide new revolutionary approaches and bring new technologies to the evolving market landscapes. For instance, strong cooperation with CEA Leti is based on key research programs; some of the engineers and Ph.D. students of ST are directly integrated to the work environment with CEA.

The fast pace, high level of competition, increasing costs of R&D and emerging trend of “More than Moore” oblige ST to pursue unconventional management ways for research evaluation and monitoring. For instance, the Advanced R&D groups in ST are subscribed to a diversification approach that is identified by ITRS as “More than Moore” (Hoefflinger, 2012, ITRS, 2011). There is neither a clear scientific question, nor a well-defined decision to develop new products based on exploration and targeted markets: rather, there is a high level of uncertainty both at the level of technology and future markets.

ST succeeded in developing some emblematic examples of generic technologies. Among them, as micro-electro-mechanical systems (MEMS), non-volatile memories, power technologies and microcontrollers. For instance, MEMS technology provoked revolutions in several industries: 1) arrays of micro-mirrors enabled digital film projectors; 2) accelerometers like those in Nintendo Wii controller have changed gaming; 3) the iPhone 4 became the first portable consumer device to incorporate a three-axis accelerometer, three-axis gyroscope, and three-axis electronic compass. A

⁸ Full list of Global 100 Innovators can be viewed: <http://top100innovators.com/>, Accessed September 15, 2013

high variety of industrial applications widely deployed in mobile, consumer, medical, automobile, military and other industries were addressed by MEMS and their derivatives. This technology triggered the creation of completely new uses unanticipated at the beginning (Groen and Walsh, 2013). The market penetration of different MEMS devices is still growing.

Emerging non-volatile memory (eNVM) technologies, 3D integration or optical interconnects are envisioned as promising future memory and interconnect technologies that can fundamentally change the landscape of the future designs (Xie, 2013). These technologies are potentially highly generic and attempt to explore both unknown technologies and yet-unknown markets. Still, there remains a lot of unknowns in terms of market and technology feasibility and the tools to build genericity remain undefined.

The semiconductor industry that provides some emblematic examples of generic technology and is constantly confronting on how to deal with the increasing speed of industrial renewal, pursues original ways of managing the technological and economic unknown. It appears as a pertinent environment to investigate the design of generic technologies. Yet, the methods on how to pursue the genericity remain unclear. **How should technology-market exploration be oriented in order to acquire higher genericity and recognize the future market value? Which business models and strategies are able to support generic technology commercialization and manage double unknowns?**

3. SYNTHESIS OF RESEARCH PATH AND CHOSEN METHODS

This part presents the synthesis of research itinerary by chosen methods. As depicted in Figure 6, this work falls into the empirical settings investigation and experimentation at STMicroelectronics (mostly parts I, III, IV). Moreover, the simulation data was used in Part II and the analyses of historical data and theoretical investigations relevant to the formal design theories were used in Part III. For a description of each case see the corresponding part of the dissertation and the appended research papers. According to the each research question, the relevant methodology and data were used. Figure 6 indicates the methods mobilized, the way the data was collected and finally, the empirical settings used in each case. Further we briefly indicate the empirical basis used in each case (for more details see corresponding parts).

This thesis starts by revealing the research anomaly through the clarification of theoretical framework. To reveal the anomaly, the data was extracted from the Ph.D. projects portfolio at STMicroelectronics, Crolles site, and was analyzed using the defined analytical framework for data analysis. The data was collected through the Ph.D. projects description analysis and semi-structured interviews. This *ex post* analysis was conducted in 2010 – 2011 and resulted in narrowing the data in two cases of advanced technological development that corresponded to the anomaly. These two cases (Bipolar portfolio development and Bulk Acoustic Wave technologies development) were analyzed in collaboration with two intern students from Mines ParisTech, who conducted their graduation

project at ST under our supervision (6 month projects). The case of Bipolar technology serves as an emblematic example that allowed revelation of the research anomaly. This data was used mainly in Parts I and IV of this thesis.

The second principal data source used throughout this thesis is based on the innovation challenges organized by ST, called the Business Innovation Process. The data on this case was collected and elaborated through 3 years of this thesis (2010 - 2013). The author was directly involved as a participant in some projects issued from this context to understand better their technological, economic and organizational challenges. In total there were three contexts organized in a variety of different themes looking to explore both technology and markets. We had the access to the data through all the phases of the organizational challenge (including ideas submissions, the comments of the evaluation committee). Moreover, the interviews were conducted with people from various organizational units. BIP case analysis and the projects issued from it were used as a primarily material in Parts III and IV of this work.

Other empirical contexts at ST (such as STHORM multi-core platform projects analysis and sessions for patent portfolio design with 3DIntegration, energy harvesting and other research groups) were used to illustrate some propositions of this thesis and propose new ideas (*e.g.*, in Part I and IV). The insights on the STHORM were gained through the direct project participation in order to test the emerging results of this thesis and the interviews. The author participation took place in 2012 during 6 months through project analysis, meetings and conference calls attendance. The sessions for patent portfolio exploration were designed in order to valorize the future technological advances and protect them. The author directly organized and conducted the explorative sessions during the 2012 - 2013 time period. More than 30 people were involved in various explorations.

In addition to the empirical insights gained at ST, the data was completed with the simulations. This was the main data source for the Part II, where in order to statistically prove our findings, randomly generated data was used.

Overall, this research attempted to primarily test the propositions within the semiconductor industry but also to gain some insights from the historical, mathematical cases and the examples from the other industries (*e.g.*, automotive).

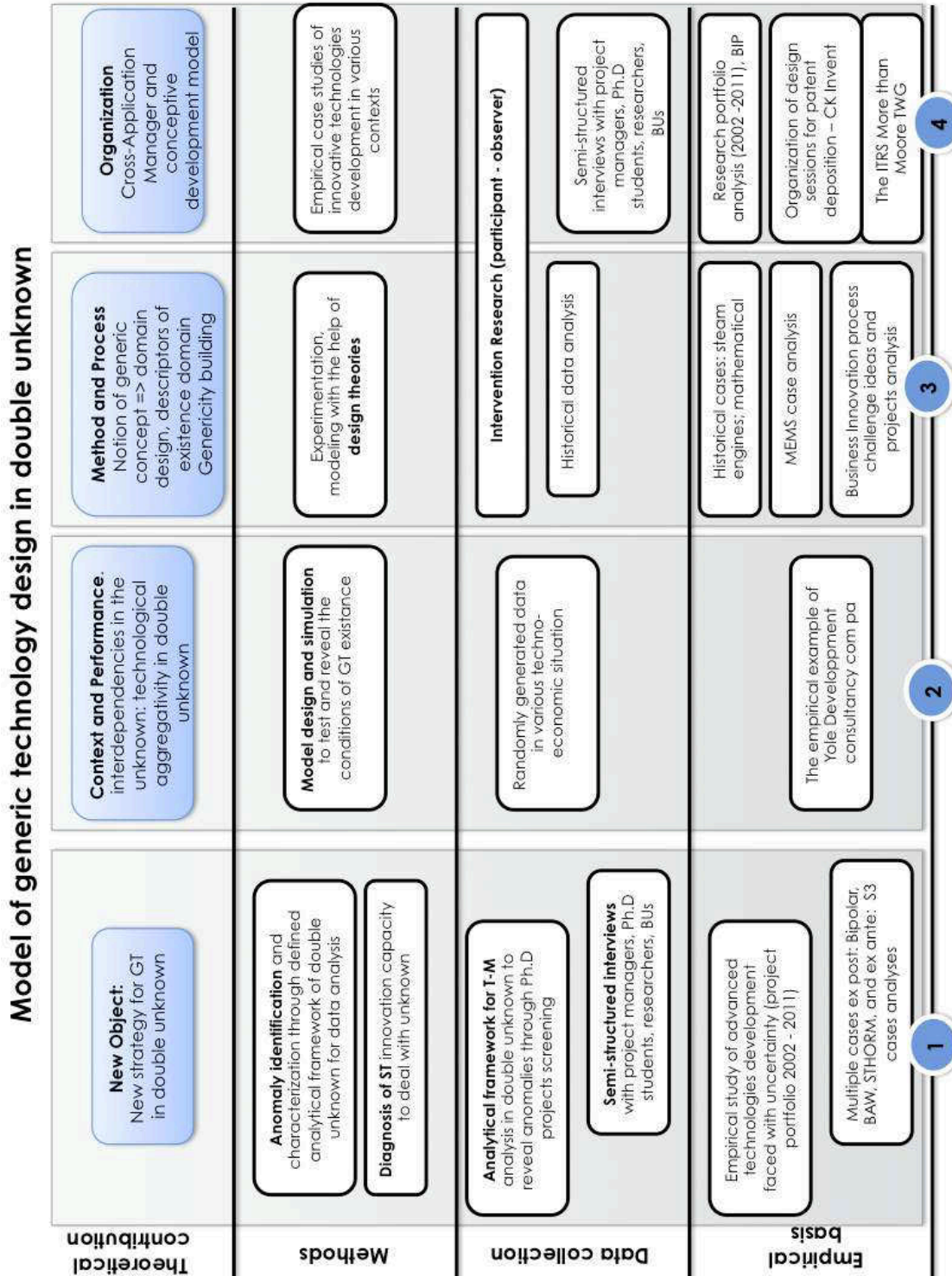

Figure 6 - Research itinerary synthesis: theoretical, contributions, methods and empirical basis

Dissertation Structure and Research outline

In order to achieve the twofold theoretical and academic objectives, this work intends to investigate the possibility of GT design in unknown environments by building on the literature review and the empirical, theoretical and modeling studies. We then apply the notions we introduced to the other empirical settings allowing the demonstration of the empirical evidence and gaining further insights on the issue of GT design. The document's organization and its corresponding structure are synthesized below (Figure 7).

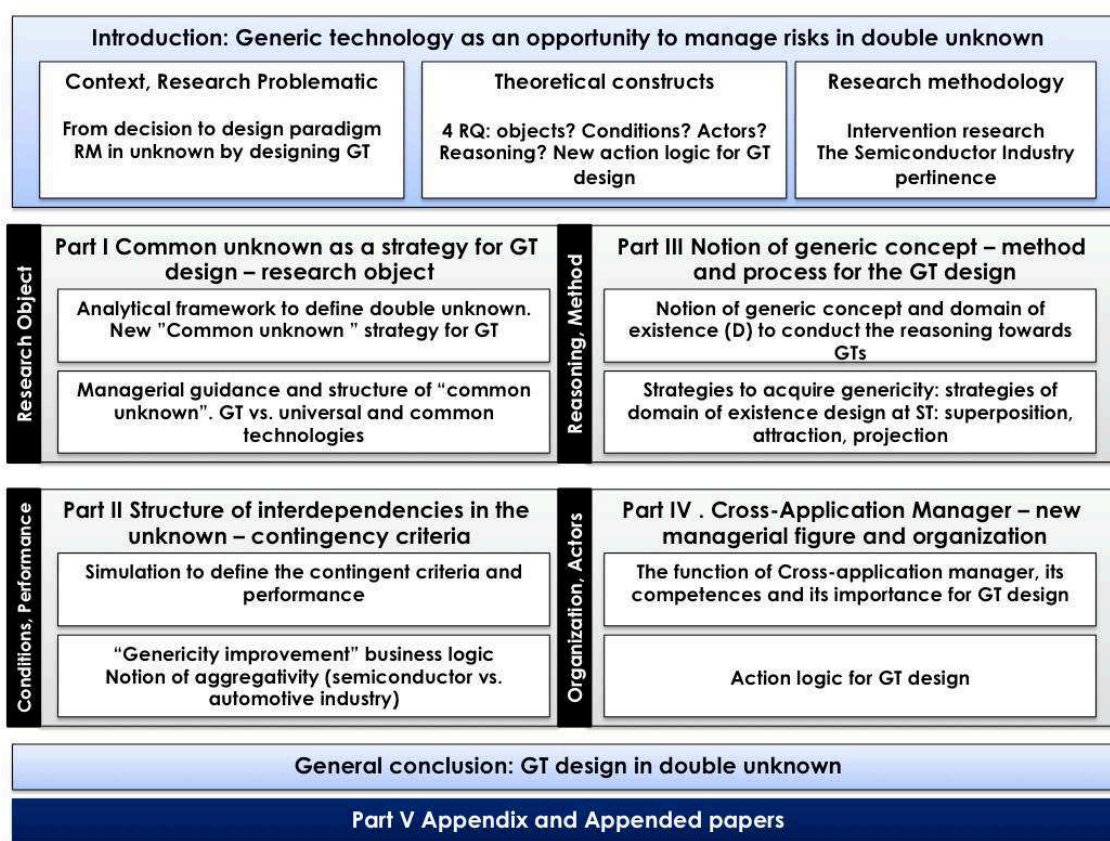

Figure 7 - Research synopsis

Parts I, II, III, IV exhibit the results driven on the appended papers and their industrial implications. Each part begins by demonstrating the main theoretical results and continues by defining their theoretical and empirical implications (see Table 1 for the list of papers).

Part I, spanning **chapters 4 and 5**, builds on risk management, platform emergence and GT management literature to reveal the research anomaly and by its characterization introduce a new object to manage – the “common unknown”. The introduced strategy of common unknown facilitates GT design and further market modules exploration using the proposed model of double unknown

exploration. The findings provide managerial guidance and clarify risks of commonly used strategies in double unknown. Moreover, the particularity of generic technologies design *ex ante* is demonstrated through the empirical cases of GT exploration in the semiconductor industry.

Part II models the techno-economic environment in order to investigate how the strategies' behaviors change with the industrial dynamic and determine the contingent criteria where the previously defined strategies in double unknown are more advantageous. It reveals two main contingent variables that influence the choice of the strategies: the existence of a clear market signal and technological systems that are segregative or aggregative (**Chapter 6**). The importance of the notion of technological aggregativity is discussed using examples and the indications on the business investment logic for generic technologies are formulated (**Chapter 7**).

Part III attempts to investigate whether the design theories facilitate the design of GTs and identifies what constitutes genericity. This work enables us to define the notion of generic concept and highlight the importance of descriptors of the existence domain to construct genericity. The recent C-K Design Theory is used to illustrate genericity building when the knowledge structure has a mathematical or engineering nature. The results reveal genericity measures associated to the generic concept and demonstrate how to account for higher genericity (**Chapter 8**). Through the examination of three innovative generic projects at ST, **Chapter 9** formulates several strategies for genericity design in situations where the domain is still unknown.

Finally, when the nature of GT design is established and the conditions of its applications are defined, the managerial consequences and the enabling roles of managers need to be explored. This is the objective of **Part IV** that defines a new managerial figure – cross-application manager, whose role appears to be critical for successful GT design. The new action logic for generic technology is introduced, based on the definition of the object, the techno-economic conditions, the performance, methods, processes and responsible actors for genericity building (**Chapter 10**). **Chapter 11** exhibits the consequences of these results on the management and constitution of projects portfolios. It attempts to recognize the patterns of GTs development by an *ex post* analysis of research project portfolios. It provides important insights on the problem of corporate governance in highly uncertain transversal projects within operational firms.

These parts are built on the theoretical findings associated with the research papers (see Table 1). The importance of these findings for the design of GT, their originality, and their managerial and theoretical implications are stressed. The validity of our proposals is tested through various organizational structures. The aim is to contextualize new action logic and diffuse the proposed concepts.

General conclusion reviews the major results of the dissertation and gives the policy implications of these findings. It concludes this dissertation by acknowledging its limitation and highlighting potential areas for future works.

Appendix encloses the corresponding papers. Table 1 below provides the list of the papers and the relevant conference proceedings associated with this dissertation according to the research findings. Moreover, a detailed case analysis of the advanced technologies is given. The analysis of the semiconductor industry and the case analysis of BICMOS technology development are provided in the appendix.

Table 1 Corresponding papers

Part III Research Findings	Corresponding papers
<p>Part I. Common unknown as a new strategy for generic technologies design: a research phenomenon analysis</p>	<ol style="list-style-type: none"> 1. Kokshagina, O., Le Masson, P., Weil, B., Cogeze, P. (2013) Risk management strategies in double unknown: Gambling on markets or designing interdependencies. - under review, The R&D Management 2. Kokshagina, O., Le Masson, P., Weil, B., Cogeze, P. (2013). Platform emergence in double unknown (technology, markets): common unknown strategy. <i>In: Çetindamar, D., Daim, T., Başoğlu, N. & Beyhan, B. (eds.) Strategic planning decisions in the high tech industry.</i> London: Springer.
<p>Part II. The impact of sector dynamic rules on the choice of risk management strategy in double unknown (market and technology) situation: contingent criteria</p>	<ol style="list-style-type: none"> 3. Kokshagina, O., Hassen, A., Le Masson, P., Weil, B., Cogeze, P. (2013) Supporting or killing the design of generic technologies? Towards a new model of business plan – working paper
<p>Part III. Methods and process for generic technologies design: notion of generic concept and genericity improvement</p>	<ol style="list-style-type: none"> 4. Kokshagina, O., Le Masson, P., Weil, B., Cogeze, P. (2013) How design theories enable the design of generic technologies: notion of generic concepts and genericity improvement. ICED 2013, August 19-22, Seoul, Korea
<p>Part IV. Organizing the process of double unknown exploration: Cross-application manager, the necessary figure for successful GT design</p>	<ol style="list-style-type: none"> 5. Kokshagina, O., Gillier, T., Le Masson, P., Weil, B., Cogeze, P., Rethinking the management of ideas contests in high-tech environment: the case of generic technology – under submission 6. Cogeze, P., Kokshagina, O., Le Masson, P. & Weil, B. (2013) Industry-Wide Technology Road Mapping in Double Unknown – The Case of the Semiconductor Industry. ICE & IEEE – ITMC Conference Hague 7. Kokshagina, O., Le Masson, P., Weil, B., Cogeze, P. 2013. Portfolio management in high uncertainty: the role of cross-application manager – under review, Creativity and Innovation management

Part I

Common unknown as a new strategy for double unknown management: a research anomaly analysis

*“Strategy is about making choices, trade-offs; it’s
deliberately choosing to be different”*

Michael Porter

Part I: Common unknown as a new strategy for double unknown management

Part I: Common unknown as a new strategy for double unknown management: a research anomaly analysis

Chapter 4 Strategy for GT design: creating interdependencies between technologies and markets or gambling on markets	83
1. Research anomaly in managing double unknown: building interdependencies between technologies and markets	83
2. Mechanism to reveal the anomaly: proposition of the analytical framework.....	87
2.1. The notion of functions to analyze technologies and markets relations.....	87
2.2. Strategies characterization using the analytical framework.....	88
3. Strategies comparison in double unknown: trial and learning <i>versus</i> new “common unknown” strategy	90
3.1. Research anomaly characterization – a study of Advanced R&D projects at STMicroelectronics	90
3.1.1. Data collection and analysis.....	90
3.1.2. Trial and learning strategy: Bulk Acoustic wave for the Integrated Radiofrequency Front-End Module for Mobile phones.....	91
3.1.3. “Common unknown” strategy: Bipolar technological platform for mmWave applications.....	93
3.2. Performance of strategies in double unknown: development costs and nature of risks.....	95
Chapter 5 Managerial implications for the situation of double unknown management and structure of “common unknown”	99
1. Generic <i>versus</i> common, universal and specific technologies	100
2. A study of many-core computing acceleration from generic technology design perspective – STHORM project at STMicroelectronics	102

Part I: Common unknown as a new strategy for double unknown management

This part builds on new object discovery for GT design. A research gap is defined based on the literature review as an absence of strategies to deal with both unknown and interdependencies design. In order to investigate this phenomenon of double unknown management, we have followed the approach of discovery and analyses of the empirical cases at STMicroelectronics that did not fit and could not be explained by traditional risk and uncertainty management strategies. Building on the two in-depth case analyses of the identified in practice anomalies, we demonstrate that they correspond to the design of generic technology. As a result, a new strategy that we call “common unknown” that attempts to intentionally design technological and market dependencies and deal with unknown is defined in **Chapter 4**. It offers an efficient way of managing double unknown situation. Chapter 4 provides the first characterization of this strategy according to its management unit, actors involved, criteria of selection and the necessary resources for the efficient execution of this strategy. Moreover, the risks of more traditional trial and learning strategy that consequently builds interdependencies through trial exploration are determined.

The research follows with the discussion on how the introduced “common unknown” strategy contributes to the GT design (**Chapter 5**). The notion of GT design is discussed and the difference with specific, universal and common technologies is determined. Finally, the empirical implications of these findings are given through the insights gained on the exploration of many-core computing accelerator based on multiple globally asynchronous, locally synchronous processor clusters (STHORM project) at STMicroelectronics that aims to be a GTs.

Part I: Common unknown as a new strategy for double unknown management

Chapter 4

Strategy for GT design: creating interdependencies between technologies and markets or gambling on markets

"Future orientation is combined with a notion and expectation of progress, and nothing is impossible"

Alan Dundes

1. RESEARCH ANOMALY IN MANAGING DOUBLE UNKNOWN: BUILDING INTERDEPENDENCIES BETWEEN TECHNOLOGIES AND MARKETS

Double unknown management requires multiple technological and marketing explorations. To reveal and compare strategies of double unknown management, a comparative framework, driven on risk and interdependency management literature, is formulated. This framework structures the existing risk and uncertainty management strategies as to: 1) strategies that deal with independent alternatives (such as risk minimization at the level of singular project, selectionism) or consider interdependencies between alternatives; 2) strategies that deal with known, already established (*i.e.* platform commercialization) or still unknown interdependencies 3) strategies that deal with interdependencies creation through their emergence (trial and learning) or design (revealed research anomaly) (Figure 8).

When uncertainties are low, the possible alternatives are known and their values can be determined, risk minimization at the level of singular project occurs (S_1 strategy). S_1 provides methods to help decision makers cope with uncertainties (Chapman, 1990, Lipshitz and Strauss, 1997). These methods seek to find favorable technology T_i - market M_i couples from the list of predefined candidates. The probability of success of S_1 is equivalent to the probability of the chosen technology-market couple:

$$p(S_1) = \max_{i=1}^n (p(T_i, M_i)), \text{ where } n \text{ is the number of considered alternatives.}$$

When the uncertainties are too high, selectionism is suggested to choose a most promising technology-market couple. Selectionism (S_2) consists of launching multiple trials in parallel and then

selecting the most favorable approach (Lenfle, 2011, Loch et al., 2008, Leonard-Barton and Doyle, 1996, McGrath, 2001, Lenfle and Loch, 2010). In this case the aim is to select a T_i, M_i couple with higher probability from the launched set of trials N :

$$p(S_2) = 1 - \prod_{i=1}^n p(M_i T_i)$$

S_1 and S_2 deal with projects independently (Table 2). When the structure of interdependencies is known, a platform strategy (S_3) can be used. For instance, in the case of modularization, market options might be built while reusing platform core (Baldwin and Clark, 1997, Baldwin and Clark, 2006). Baldwin and Clark (2006) demonstrated how to obtain several options thanks to a known platform. They showed that total economic value of the system can be expressed as the sum of a minimal system value V (platform core) plus the incremental value V_i added by the performance of each of module: $V_0 + \sum V_i^N$. Expected value of the system is the aggregated portfolio profitability. Platforms represent a core of technological system and have to be interdependent with the other parts of the system. It is shown that to have a platform potential, a technology or a product needs to perform a function that is essential to a technological system and solve a business problem for many firms in the industry (Gawer and Cusumano, 2008). The reuse of platform core permits minimizing risks by constructing several options of multiple markets. The probability of S_3 success is defined by the probability of success of all the market modules M_i that were made accessible by the platform T_0 :

$$p(S_3) = 1 - (1 - p_{M_1 T_1 | T_0})(1 - p_{M_2 T_2 | T_0}) \dots (1 - p_{M_N T_N | T_0}),$$

where N is the number of market options. In S_3 the platform is given. There is a possibility to choose from different available platforms k and the goal is to identify a T_0 that maximizes system value through interdependencies construction between platform and market options. The platform with higher probability is chosen: $p(T_0) = \max_{k=1}^n T_k$. S_3 is not usually related to risk management techniques but it gives an efficient mechanism to reduce uncertainty. In S_3 the reasoning is not based on the success of a particular “technology – market” couple but on a technological platform capability to address multiple markets.

With respect to highly uncertain situations, like unforeseeable uncertainties, chaos (Pich, 2002), S_1 might be impossible because all the projects are too risky. One still might hypothesize based on the estimated probabilities of success, but this assessment would change significantly at the end of the exploration phase due to the existence of the unexpected uncertainties. S_3 strategy might be impossible because there is no platform available to play several times with limited costs. In addition, the existing literature on product platforms assumes that the platform leader understands the final use of products and is capable to develop these new products (Gawer, 2010). This is certainly not valid in the context of high uncertainty, when platform core, market options and therefore, interdependencies are unknown.

When interdependencies are unknown, Kokshagina et al., (2013) show that they can be achieved through their consequent discovery or through more intentional approaches. There are strategies where interdependencies management comprises accumulated learning. A trial and learning approach (Van de Ven et al., 1999, Pich et al., 2002, Lynn, 1998) is based on iterative, selected trials that are coupled with the trial flexible changes in the course of action. This strategy provides a certain transformation of the initial situation of high uncertainty by formulating the problem and integrating the knowledge. This sequential development of trial project and associated learning enables gain of expertise through exploration projects. It can decrease both market and technological uncertainties; therefore, it is adapted to double unknown. It corresponds to a particular project selection and consequent generalization to develop additional applications (trial and learning strategy - SU_1). SU_1 enables the organization of exploration in unknown through trials and its consequent development. The goal of learning is to increase the probability of market existence and technology feasibility. The developed technology could serve as a platform for other market applications.

Table 2 - Risk management strategies

Level of analysis	Probability of success
Risk Minimization at the level of project: Select a more probable T_i, M_i from n identified alternatives	$p(S_1) = \max_{i=1}^n (p(T_i, M_i))$
Selectionism: Select a T_k, M_k couple with higher probability from the launched set of trials N	$p(S_2) = 1 - \prod_{i=1}^n p(M_i T_i, M_2 T_2, \dots, M_N T_N)$
Platform driven strategies: Probability of success of all the market modules M_i knowing the platform T_0	$p(S_3) = 1 - (1 - p_{M_1 T_1 T_0})(1 - p_{M_2 T_2 T_0}) \dots (1 - p_{M_N T_N T_0})$
Trial and Learning: Probability of success of strategy comprising an initial M_0, T_0 trial and the consequent M_i, T_i that depend on M_0, T_0	$p(SU_1) = 1 - p_{M_0 T_0} (1 - p_{M_1 T_1 M_0 T_0})(1 - p_{M_2 T_2 M_0 T_0}) \dots (1 - p_{M_N T_N M_0 \dots T_0 \dots})$
Common unknown: Probability of success is technological platform T_0^* , which can address several market applications $M_i \dots M_N$	$p(SU_2) = 1 - p_{T_0^*} (1 - p_{M_1 T_0^*})(1 - p_{M_2 T_0^*}) \dots (1 - p_{M_N T_0^*})$

The probability of winning highly depends on the choice of the first market trial M_0 with probability p_0 , which attempted to be increased through the learning process and development of a technology

T_0 . When this strategy considers reuse of the acquainted learning to develop other market alternatives, the market success highly depends on the results of the trial. The joint Bayesian probability of success could be defined as

$$p(SU_1) = 1 - p_{M_0|T_0}(1 - p_{M_1|T_1|M_0|T_0})(1 - p_{M_2|T_2|M_0|T_0}) \dots (1 - p_{M_N|T_N|M_{0..N}|T_{0..N}})$$

In case of reuse the interdependencies are managed through consequent learning. This strategy does not seek to increase the number of markets N directly but rather to increase the probability of success of at least one market. This strategy is not based on T_0 that addresses several markets M_i as S_3 but on complex relations among multiple $M_i - T_i$ couples.

Trial and learning allows accounting for consequent GT design. Yet, the more intentional design driven approach is suggested when the goal is not to choose the more powerful alternative but generate options, transform local possibilities into new opportunities through collective reflection (Sarasvathy, 2001). Is it possible to identify a strategy of technological development that maximizes the number of markets that technology will address or create (*max N*)? If one can design a technological platform T_0^* , which can address several market applications $M_i \dots M_N$, the probability of success is:

$$p(SU_2) = 1 - p_{T_0^*}(1 - p_{M_1|T_0^*})(1 - p_{M_2|T_0^*}) \dots (1 - p_{M_N|T_0^*})$$

Trial and learning strategy is a pertinent strategy for double unknown management but there is a possibility to find others that might offer better performance. As illustrated in (Figure 8), these strategies can deal with platforms as a target of the exploration activity. This way proposes to reconsider traditional risk management approaches of the uncertainties reduction among the alternatives and add a new action possibility (*e.g.*, a new solution) that reduces the unknowns. Still, these strategies are not evident to identify because the reasoning is often trapped in the classical market or technology driven strategies of $T-M$ couples' development by dealing with the emerging uncertainties. Therefore, the research anomaly appears when we intend to design both technological core and build multiple interdependencies with markets in unknown to account for GT. **There is a need for a new analytical framework to better follow the interdependencies and reveal the anomaly.** Moreover, the performance of trial and learning needs to be clarified.

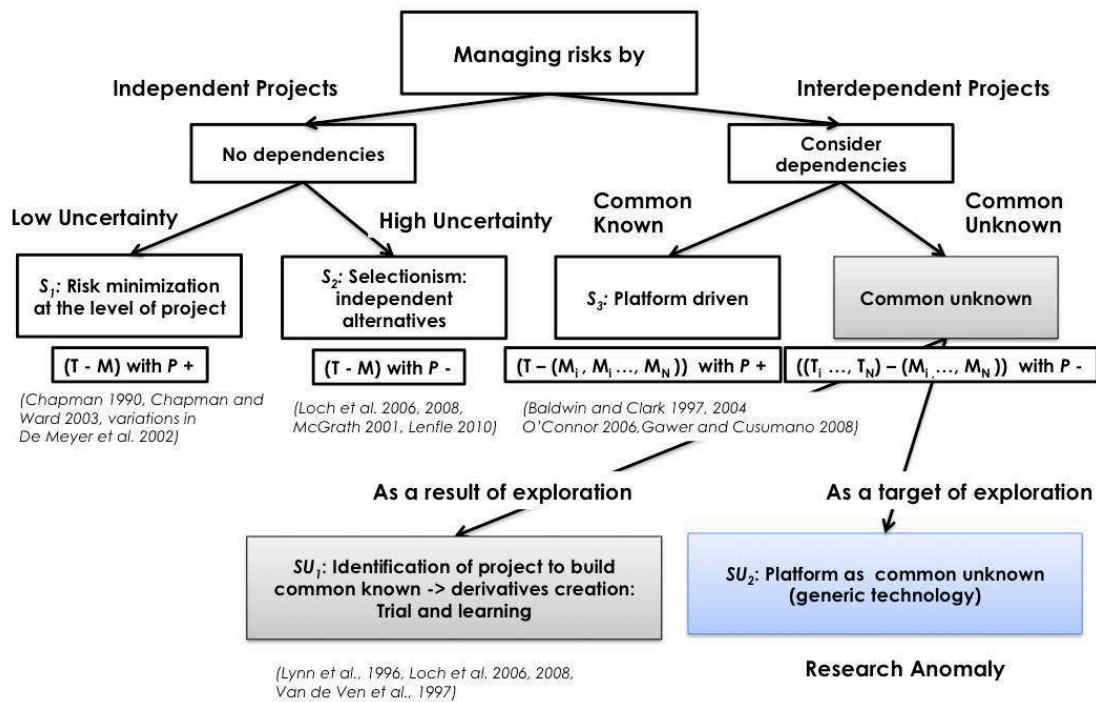

Figure 8 - Comparative Framework - Risk management strategies

2. MECHANISM TO REVEAL THE ANOMALY: PROPOSITION OF THE ANALYTICAL FRAMEWORK

2.1. The notion of functions to analyze technologies and markets relations

To analyze strategies that deal with interdependencies creation, it is necessary to detect and examine how the interdependencies between technologies (T) and market (M) were designed. By verifying *ex post* the list of developed technologies and obtained markets, it is possible to analyze how the markets that succeeded and emerged through exploration were built. It remains unclear how the technological and market relations were established and what has driven the exploration in each case. *Ex post* analysis does not enlighten more intentional strategies that deal with markets before their transaction and therefore, enable to recover the anomaly in interdependencies design, a **new data analysis instrument that avoids direct consideration of T-M couples is needed.**

In order to do that markets need to be described independently from their derived products and the corresponding technologies. The issue has long been addressed in consumer behavior theory (Lancaster, 1966). Since the 1960s, goods can be characterized by functions. The new market applications can be assimilated as a set of functions F_1, F_2, \dots, F_n addressed by goods. Each market M_i can be described as a set of functional elements F_1, F_2, \dots, F_n it targets.

Similarly, technologies have to be described independently from the products and the markets that they accomplished. In the engineering design and technology management literature, the value of

technology is assimilated to functions that each technology addresses (Akao, 1990). To develop a technology to a chosen market means precisely to address its functions. Technology is considered advantageous if it addresses powerful functions that lead to winning markets.

To understand the logic of interdependencies in unknown, the notion of functions is used to verify and characterize technologies by the functions they address and the markets by the functions they seek. It appears that the notion of functions is used to attract stakeholders and markets on the technological concepts without necessarily describing technology. According to the functional analysis of systematic design, points that when the goal is to create a design solution that has not existed before, functions have to be defined in a “solution-neutral” environment without interaction with the physical domain (Suh, 1990). Functions propose an intermediate space when designers are capable of working on still unknown technologies and markets without fixing them yet.

How does the notion of functions enable working on strategies in double unknown? How classical strategies of dealing with innovation exploration can be described with the *T-F-M* framework?

2.2. Strategies characterization using the analytical framework

Following the technology push definition, a chosen technology T_k can address multiple functions and hence, all the markets M_1, M_2, M_l that require the subset of these functions. Successfully developed technology T_k pushes solution to search for promising markets M_l . Conversely needs that are predefined by markets M_k are pulled to seek for a better in terms of performance technology T_l (Figure 9).

Following the “trial and learning”, the goal is to identify a market alternative M_K that has higher probability of success. Despite the high level of uncertainty, the aim is to prescribe subjective probabilities in order to define a trial project and to estimate which market has higher potential of gaining. For example, there is a volatile market M_K (still uncertain but has higher potential than the others) that seeks three key functions F_1, F_2, F_3 . The exploration consists in designing a technology T_1 to address these functions and increase the probability of trial existence P_K . Once T_1 is developed, M_L might be realized by integrating a new functions F_3 and thus, extending technology T_1 to T_{1L} . Technology T_1 is progressively extended to build a platform that addresses several markets.

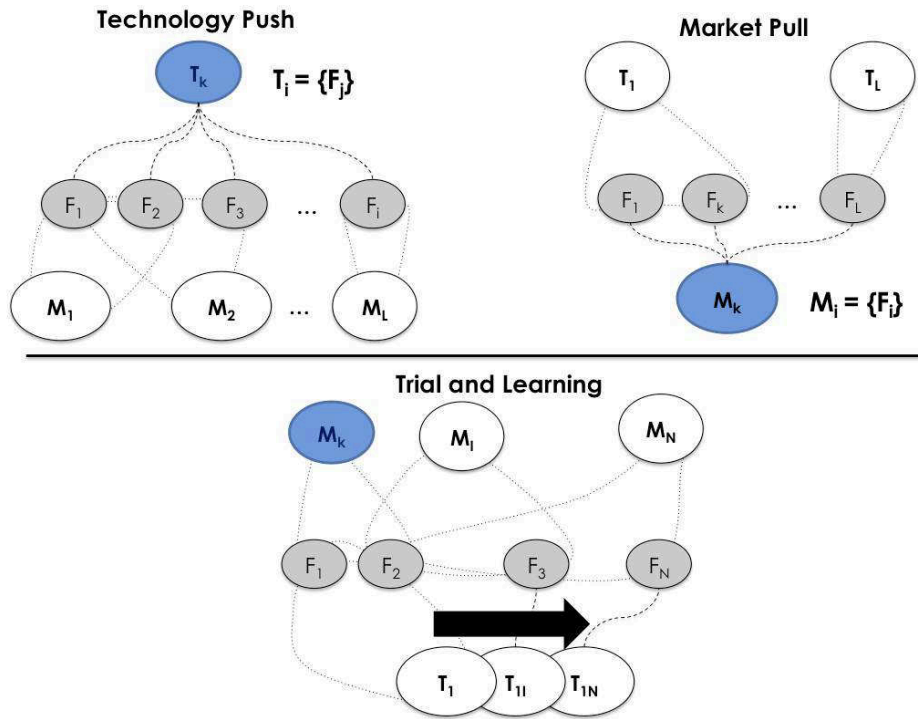

Figure 9 - Technology-Market matching: Technology Push and Market Pull

In double unknown there might be technologies T_i that address the series of functions F_j and some known and yet undefined markets M_i that seek the series of functions F_i (Figure 10). Each new subset of functions that is generated from the combination of F_j and F_i can be seen as unknown markets (markets with very low probability) or can be seen as unknown technologies. Thus, the exploration can be seen as a matching of potential functions that markets seek and that technologies accomplish. A new couple of $T - M$ exists when a new technology addresses unrelated subsets of functions F_i and this subset corresponds to a new realized market. **The notion of functions enables to having a minimal logic to follow technologies and markets exploration.**

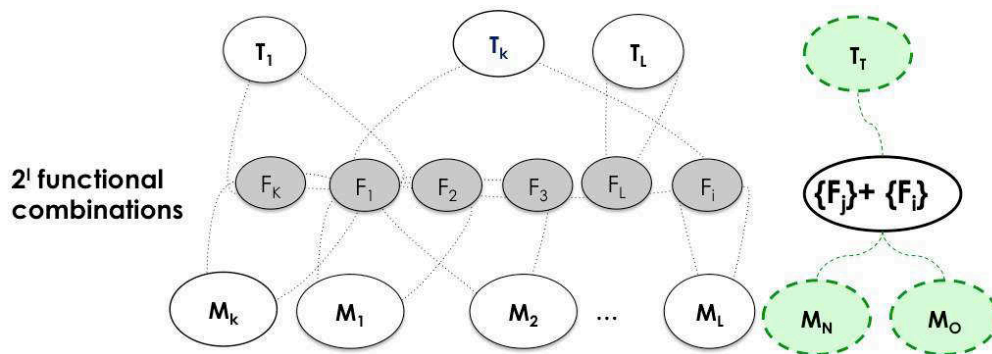

Figure 10 - Double unknown characterization

Following the $T-F-M$ framework, it is possible to image a variety of ways to link the set of functions that markets seek and technologies address and they might bring to define new strategies. But how could these strategies be evaluated from the cost, nature of risks and organizations implied?

3. STRATEGIES COMPARISON IN DOUBLE UNKNOWN: TRIAL AND LEARNING VERSUS NEW “COMMON UNKNOWN” STRATEGY

3.1. Research anomaly characterization – a study of Advanced R&D projects at STMicroelectronics

To enlighten the defined based on the literature review research anomaly, the analytical framework for data analysis was applied to the set of the research projects at STMicroelectronics. The purpose was to identify abnormal strategies of technology and market matching by using the elaborated framework and characterize their performance.

3.1.1. Data collection and analysis

To reveal an anomaly, the formulated instrument of discovery was applied to the portfolio of research projects at STMicroelectronics (more than 400 projects clustered by 14 research group). The portfolio of research projects was chosen thanks to the variety of technological exploration and potentially various application areas that provide an important ground to test and evidence new forms of building technological and market correspondence. Mainly clusters are established according to the axis of technological development. Each cluster comprises a portfolio of collaborative R&D projects, Ph.D. thesis, and even business units' development projects.

The data was collected over an 8 months period from November 2010 till June 2011 following the exploratory case studies (Eisenhardt, 1989a, Yin, 2003). For this study the primary source of data was regular and frequent semi-structured interviews. The interviews were conducted with specialists participating or leading technology development from the Advanced R&D technology and design groups, business divisions, former Ph.D. students and some of the associated external research centers. Approximately 40 interviews were conducted over 8 months. In addition to data collection through the performed interviews, review of secondary sources was conducted. These supporting documents include the European projects reports, presentations, thesis manuscripts, databases of thesis project descriptions and mails. The internal validity and reliability of chosen methodology was achieved by triangulation among projects documentation and conducted case studies examination. The triangulation was continued between derived analysis and feedback seminar sessions with company managers to discuss and test the validity of hypothesis. This enabled continuous involvement of ST according to the guidelines of engaged scholarship (Van de Ven, 2007) and collaborative research (Shani et al., 2008).

The existence of strategies to deal with anomaly and their pertinence for double unknown management were tested on the empirical cases of advanced technologies exploration and their performance defined based on 1) the nature of risks to manage and 2) the development cost of each approach. The first project portfolio screening enabled selection of two cases that were examined in detail further. The first one demonstrates the case when trial and learning paradoxically resulted in a

failure of technological development and the second represents a case of a portfolio whose success is impossible to interpret using classical RM techniques and which led to a successful development. This case enabled the introduction of a new strategy for GT design and the strategies comparison helps to understand in which conditions it can be superior to classical trial and learning.

The first case study investigated is the advanced Bulk Acoustic Wave (BAW) technology development targeting mobile consumer market. The development of this technology was initially managed as an exploration project to increase the probability of gaining selected markets. The developed technology attracted the interest of another market application and the team attempted to reuse acquainted learning to address it. Though, extending progressively the list of functions by technology development following the process of trial and learning, they did not succeed in introducing the solution to the targeted markets. This cases helps to comprehend the risks of a trial and learning strategy faced with unknown situation.

The second portfolio of generic technology development is drawn from the semiconductor industry where high-frequency bipolar transistor with ameliorated back-end (Chevalier, 2007) was designed to address all the environment constraints and win several market applications with low adaptation cost (such as automotive radar, fast download applications, medical, non-invasive imaging, optical communication). The project team that worked on the technology exploration at STMicroelectronics reconstructed a sort of artificial market space « Wi-Fi to enable high device connectivity » with wider genericity scope than the alternatives that facilitated technology adoption by derivative markets later. The genericity design enables maximization of the list of functions by superposing several applications. Instead of fixing the set of markets applications and organizing exploration by minimizing resources spent, they inverted the reasoning by fixing the resources and maximizing the scope of considered applications for genericity building. This case helped to reveal a new strategy that corresponds to the design of GT. The short summary of these cases is provided below and the details of the second case analysis could be found in Appendix 2.

3.1.2. Trial and learning strategy: Bulk Acoustic wave for the Integrated Radiofrequency Front-End Module for Mobile phones

The current study found out that in the case of trial and learning identified technologies and markets are deformed by trial exploration. The resulted from trial exploration technology often evolves to incorporate new functions in the process of learning. Each new market exploration is based on the technology enrichment developed through the trial phase. New markets are always the extensions of trials and the performance of trial and learning highly depends on the choice of the first trial.

The trial and learning strategy was investigated through a case study of the advanced technology development at STMicroelectronics – Bulk Acoustic Wave (BAW) Front-End module (FEM). BAW technology development initially targeted the mobile consumer market (M_1 – FEM filter application, Figure 11 - Trial and learning strategy – BAW FEM case). The development of this technology was

primarily managed as an exploration project to increase the probability of gaining selected RF filter application. The common discrete filter solution was a Surface Acoustic Waves (SAW) filter ensuring F_1 and F_2 , but did not allow integrating the filters directly in FEM F_3 and miniaturization F_4 . The developed Bulk Acoustic Wave (BAW) technology T_2 enabled the obtainment of an integrated, multi-synchronized Front-End Module, which significantly reduced the size (4 times smaller than the deployed at that time SAW technology). The newly developed technology attracted the interest of a time-reference application M_2 and the team attempted to reuse acquainted learning to address it. There is a consequent technological platform creation through the trial and learning process. Though, by extending progressively the list of functions by technology development following the process of trial and learning, they did not succeed in introducing the solution to the targeted markets. This case indicates **the existence of the uncontrolled residual risks based on trial selection**. The trial and learning strategy primarily seeks to increase the probability of the selected trial through the process of learning. However, due to the high market uncertainty, the choice of the first market trial could be misleading. It could result in a rigid common core where the evolutionary path fails to integrate exploration to relevant market areas. Moreover, there is a risk that trial exploration will not pay for the exploration of technology and the development will be considered as a failure.

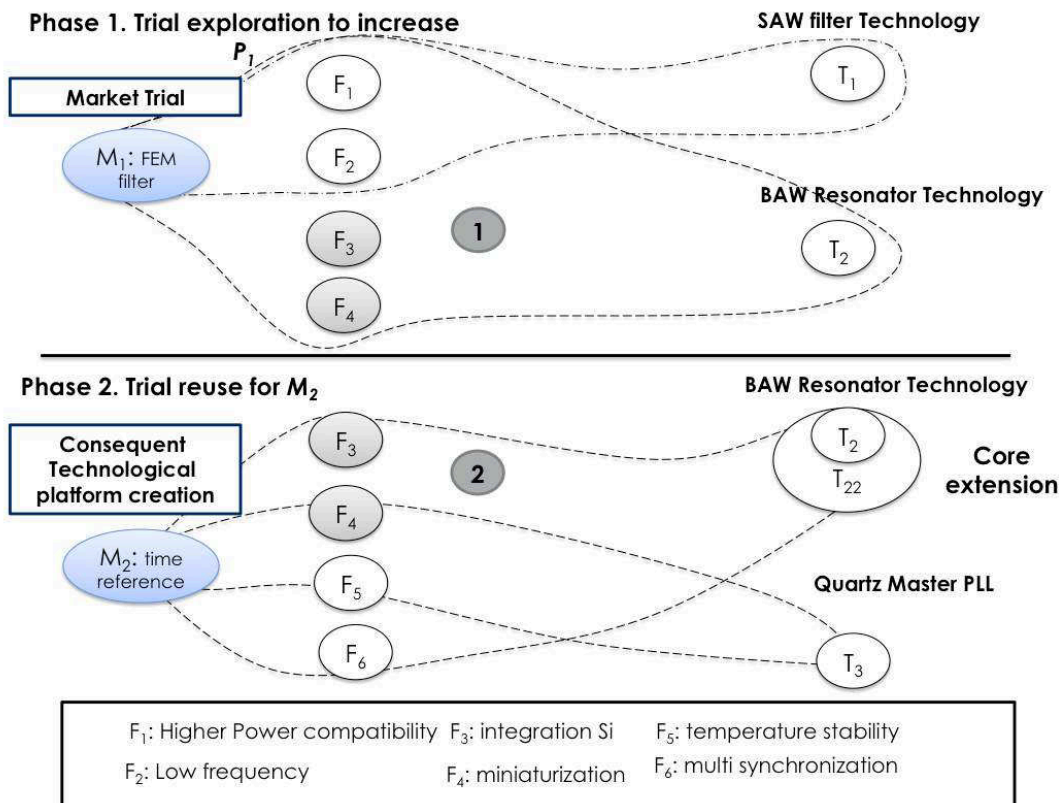

Figure 11 - Trial and learning strategy – BAW FEM case

3.1.3. “Common unknown” strategy: *Bipolar technological platform for mmWave applications*

The anomaly was identified when technology was developed independently from the identified markets, which signifies that none of the primarily identified markets selected is promising. For instance, given the case of BICMOS technology development, initially elaborated technology did not address any markets directly. At the same time, it was neither a technology that was developed randomly, nor the existing markets required its development. There were 5 initially identified emerging markets that seek for certain functions that some of the existing technologies can address (Figure 12).

The technological exploration attempted to mobilize the existing knowledge to maximize the number of common functions that the future technology could accomplish. The goal was to formulate a common core, which maximizes the variability of future compatible market derivatives. The resulting platform, whose development was justified as an exploration of devices to ensure “WI-FI in public places with high connectivity”, was re-used to develop complementary modules for the remaining functions and therefore, propose a solution for all 5 markets. The observed phenomenon shows that a strategy that we call **common unknown** attempts to create a technological platform for several emerging markets (for the common functions that markets seek). To organize an exploration, it is necessary to pay a preliminary exploration cost to design a common core that decreases the cost of adaptation for future market derivatives. This strategy enables the designing of several market options with a fixed R&D budget.

The conducted work highlights that to manage risks in a double unknown situation, one has to consider the common core (knowledge basis common to several projects). Based on the mode the common core is treated in the situation of radical innovation, we distinguished two types of risk management strategies suitable to double unknown:

- **Trial and learning** that develops a common core as a result of trial project exploration. This trial project initially leads to the development of a predefined promising market application and extends this technology to a platform that addresses several market derivatives by incorporating new knowledge consequently.
- **Common unknown** that develops a common core as a result of working directly on common challenge for several markets. This common challenge is identified as common functions and needs that these market derivatives are willing to address. In this strategy the common core is not an existing one, it is still a concept and an object of exploration itself.

1. Initial technology – markets evaluation

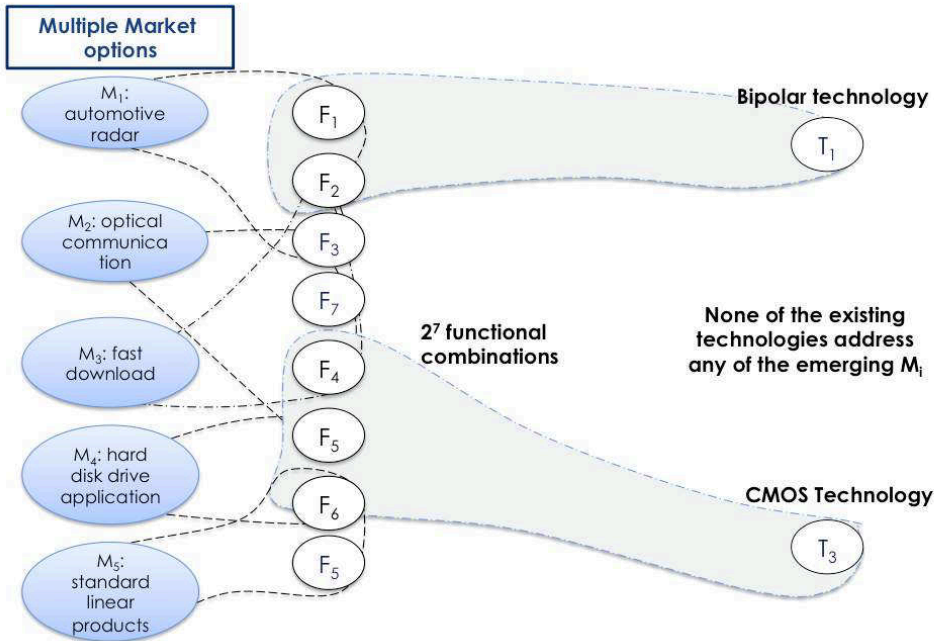

2. Generic core development for essential functions and adaptation

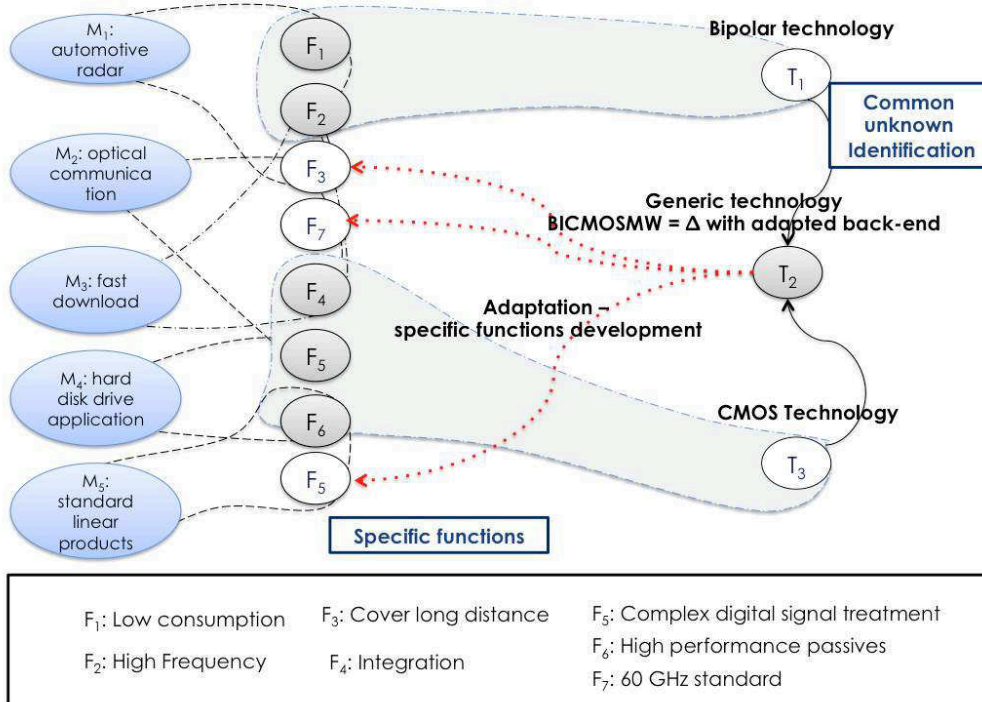

Figure 12 - Initial technology-market evaluation. BICMOS case

3.2. Performance of strategies in double unknown: development costs and nature of risks

In terms of performance the examples reveal that trial and learning contains residual risks that are not controlled by strategy. These risks are based on the trial project selection that might result in inadequate technology exploration. This is precisely what happened in the first case study. The chosen trial did not decrease uncertainties relevant to future market derivatives because exploration was limited to a particular identified market. Instead, it required expensive adaptation to address future options. While initiating the development, the risk manager normally does not take into account future market options that may be addressed because his primary goal is the success of the chosen exploration project. This could result in a rigid common core that is rarely reused by other market derivatives (Table 3).

Table 3 - Strategies characterization

Strategies	Objects	Criteria	Actors	Resources
Project driven strategy	Project	High probability of success of identified project Expected Project Value	Project manager capable to evaluate potential value, has marketing and technological expertise	Information based on: projects functionality, technological principles and future uses
Platform driven strategy	Portfolio of projects (derivatives created by platform core)	Aggregated expected value of portfolio (utility)	Portfolio manager that knows common core and able to define options and test them with low cost	Platform core and cost of associated options
Trial and learning	Phase 1. Project used as common unknown Phase 2 (in case trial leads to a platform) Platform derivatives	Phase 1. Expected utility of project exploration/ Probability of project success Phase 2. Aggregated utility of expected value of portfolio derivatives	Project and portfolio managers	Phase 1. Prioritized list of projects/markets to identify trial project. Phase 2. Identification of future market derivatives
Common unknown	Common Unknown	Probability of at least one market emergence	Expert in both technical and economic domains capable to identify knowledge gaps	Reasoning on concept space. Innovative path identification and accessible common unknown with low resources

The conducted analyses demonstrate that the **common unknown** which typically appears to be costly and risky, leads to successful development, whereas **trial and learning**, which appears as a

natural passage between project-driven exploration and derivatives creation, failed to address identified market options.

In terms of performance the examples reveal that trial and learning contains residual risks that are not controlled by strategy. These risks are based on the trial project selection that might result in inadequate technology exploration. This is precisely what happened in the first case study. The chosen trial didn't decrease uncertainties relevant to future market derivatives because exploration was limited to a particular identified market. Instead, it required expensive adaptation to address future options. While initiating the development, the risk manager normally does not take into account future market options that may be addressed because his primary goal is the success of the chosen exploration project. This could result in rigid common core that is rarely reused by other market derivatives (Table 4). In SU_1 strategy, the cost of trial project exploration must be paid $C(M_0, T_0)$. Depending on the trial results, the cost of market modules $\sum_{i=1}^n C(M_i, T_i)$ may be smaller or it may require significant adaptation and additional resources (Figure 13). The probability of success highly depends on the first trial exploration: $1 - P_{M_0 T_0} (1 - P_{M_1 T_1 | M_0 T_0}) (1 - P_{M_2 T_2 | M_0 T_0}) \dots (1 - P_{M_N T_N | M_{0...N} T_{0...N}})$. Such as in BAW technology, the development of the time reference option required additional resources to customize developed technology for this application and the company was not ready to pay.

Table 4 - Strategies comparison

	Nature of risks	Development cost
SU_1	Uncontrolled residual risks due to the preliminary trial selection could result in rigid common core that might be inflexible for market derivatives. The inflexibility of the common core is due to the primarily goal of the strategy which is to increase the probability of trial market and not to develop various market options	Aggregated cost of options development and cost of selected market exploration to construct platform core
SU_2	In order to formulate common core, not just to minimize uncertainties but maximize the variability of future compatible options. The primarily goals is to address various market options (increase N).	Preliminary exploration cost to design common core, ensure low adaptation derivatives cost

In SU_2 there is a risk of common unknown identification. The common unknown strategy attempts to avoid hypothesis on the associated context. Still, SU_2 requires the payment of preliminary exploration costs to construct the common unknown $C(T_0^*)$ that has a probability of existence $p(T_0^*)$. This investment does not give access to any of the other markets directly but should significantly minimize the costs to address multiple markets once the platform is developed. The cost of adaptation has to be lower to ensure the success of the portfolio $G_i \sim \epsilon$. The probability of T_0^* existence can be low, but once it is designed, it increases the probability of markets success:

$1 - p_{T_0^*}(1 - p_{M_1|T_0^*})(1 - p_{M_2|T_0^*}) \dots (1 - p_{M_N|T_0^*})$ (Figure 13). The probability and cost of common unknown T_0^* design can be higher than that of a trial project but it ensures smaller cost of derivatives development. In the case of BICMOS we learned that it is possible to keep costs under control and SU_2 strategy of common unknown might lead to successful development.

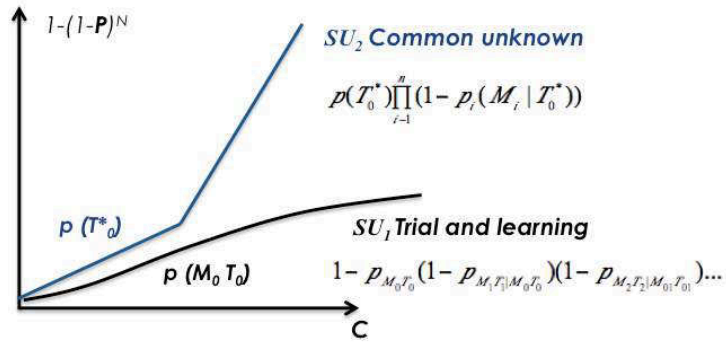

Figure 13 - Costs and probabilities SU_1 and SU_2

Chapter 4 shows that the initially identified anomalies in risk management framework correspond to the cases of generic technology design. **Common unknown intentionally and Trial and Learning intrinsically support the design of GTs. The proposed strategy of working on common unknown opens a new way to portfolio risk management in the context of radical innovation.** This aim of this strategy is knowledge creation but keeps costs under control and maximizes the likelihood of being relevant for future markets. The study demonstrates that the “common unknown” is particularly relevant when the market signals are equally weak and multiple. The interdependencies are built based on technological anticipation and simultaneous multi-market analysis.

The study reveals that the evolutionary trial and learning strategy is risky when it leads to development of a first trial that will not be a good platform to fulfill the following markets. The choice of the first trial defines a future direction of the exploration, orientates learning and decreases the exploration space. So the probe phase determines the success of future exploration.

Chapter 5

Managerial implications for the situation of double unknown management and structure of “common unknown”

“Take calculated risks. That is quite different from being rash”

George S. Patton

Both trial and learning and common unknown strategies require different vision and lead to quite different organizational consequences. The common unknown strategy calls for a coordinator that interacts with all BUs and R&D centers and is capable of identifying emerging industrial trends. The manager of common unknown strategy should be able to coordinate simultaneously existing learning dependencies between different alternatives and account for the possibly new interdependences design, using model of double unknown exploration. It is a manager that coordinates a round table of the potential partners. On the contrary, in case of trial and learning there is an entrepreneur looking for one blockbuster. It is shown that the design of GT deals with both unknown management and effective interdependencies establishment. Still, the notion of GT design and its specificity needs to be established.

Ex post the notion of GT is confound with the notion of **common** and **universal** technologies. All of them could lead to develop technological platforms for several market needs. They appear to be synonymous *ex post* but *ex ante* differ significantly. The difference between generic, common and universal technologies is shown. The principal differences are given using the elements of the previously introduced analytical framework. We distinguish how they deal with technological expertise, market knowledge, functions (common elements of analytical framework) and cost of adaptations and risks (criteria of performance). Further, the insights on GTs development through “common unknown” and the contextualization of the obtained findings were achieved through the analysis of a heterogeneous multi-core platform - STHORM project at STMicroelectronics. STHORM was an ongoing case that allowed confirming the usefulness of common unknown strategy for the situation of double unknown management and provide new insights to the issue of GT design.

1. GENERIC VERSUS COMMON, UNIVERSAL AND SPECIFIC TECHNOLOGIES

A common technology is a technology that accumulates all the functions and constraints of targeted known environments (Figure 14). We refer to a common technology design as a design of technology for several identified environments that are known. It should lead to obtainment of a common platform that addresses previously identified known markets (environments) and their derivatives as well.



Figure 14 - Common technology

A universal technology is a technology that can be used in existing, future and even unknown environments without additional adaptation. It ignores the specifics of each environment (Figure 15).

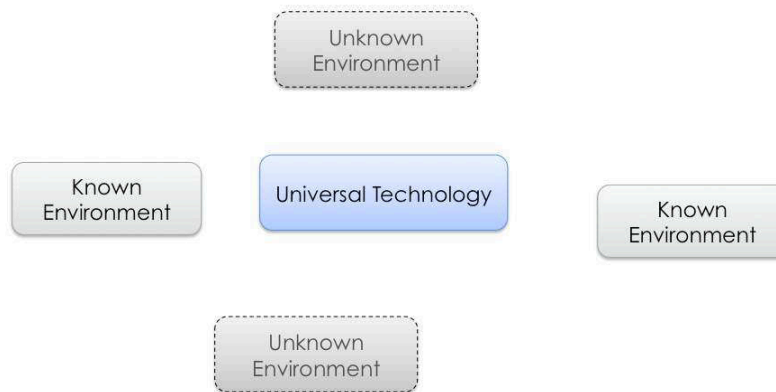

Figure 15 - Universal technology

The development of both common and universal technologies induces implicitly the design of generic technologies. For instance, fuel cells offer devices to convert chemical energy from a fuel into electricity through a chemical reaction. There are a variety of technological principles behind it. If there exists a technology that can be applied to the Auxiliary Power Unit (APU) of cars, planes and energy systems in consumer mobile environments, it appears as a common technology. This common technology targets predefined application areas (known environments). Besides the already addressed applications, for each new environment considered, it is necessary to verify compatibility of a common technology to develop a new market application and complementary modules according to the requirements of these environments. Universal technology development does not incorporate market knowledge initially. For instance, suppose that a fuel cells supplier claims the universal fuel cell technology with increased yield and lifecycle. The technology is intrinsically assumed to be suitable for all the existing and emerging environments. The common strategy builds genericity based on the common functions that belong to the known environments and the universal strategy –

based on the abstraction from any environments. **Both common and universal technologies are generic, yet, the levels of acquainted genericity are obviously different.**

In case of generic technology design (Figure 16) the goal is not to develop a technology that fulfills a predefined list of already known environments (it is not a technology common to several markets), but a technology that has a potential to address (with the effort of knowledge propagation and specific modules/functions design) known environments and provoke further knowledge exploration towards the unknown environments. This propagation towards the unknown set of environments improves the capacity of knowledge expansions while taking into account the existing application areas and makes the design generic. The distinction between generic and specific technologies can be paralleled to the distinction between the usage-flexible and usage-specific resources (Table 5).

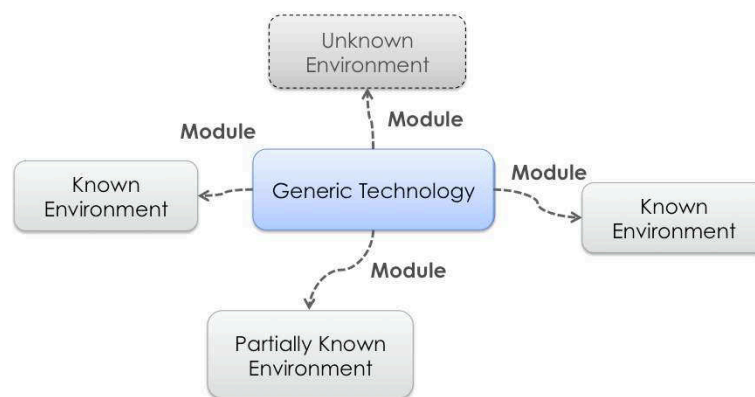

Figure 16 - Generic technology

Ergo, *ex ante* genericity can have various forms and by applying different design and exploration methods could bring various genericity levels. The performance, the applicability conditions of GT design strategies and methods to account for higher genericity need to be clarified. **The process of GT design itself and the definition of genericity *ex ante* remain unclear** (see Part III).

Table 5 Type of technologies

Techno type		General/Generic Technology	Common	Specific/Dedicated	Universal
Properties	Market Environment	Known and unknown Multi-environment (distinct search, diversified markets and technologies portfolios)	Known multiple environments	Well defined application domain (single-market)	Application domain is not defined
	Technological Knowledge	Broad scientific knowledge	Relevant knowledge and expertise for the identified environments	Unique expertise	Broad scientific knowledge
	Functions	General Functional parameters (<i>e.g.</i> , high frequency) that are common to all the applications	Common functions	Key functions to a concrete market (application specific)	Target maximum functions to cover a lot of market areas in the following
	Cost of adaptation	Low cost of technological re-adaptation	Low cost of technological adaptation	High	--
	Risks	Costly preliminary exploration to design generic technology basis	Technology appropriation by the chosen initially market environments	Too specific to a concrete market application and targeted market failure, etc.	Overdesign

2. A STUDY OF MANY-CORE COMPUTING ACCELERATION FROM GENERIC TECHNOLOGY DESIGN PERSPECTIVE –STHORM PROJECT AT STMICROELECTRONICS

STHORM is an area- and power-efficient many-core computing accelerator based on multiple globally asynchronous, locally synchronous processor clusters. The project’s aim is to move a significant step forward in programmable accelerator architectures for next generation data-intensive embedded applications such as multimodal sensor fusion, image understanding, and mobile augmented reality (Melpignano et al., 2012). It is an industrial quality platform that is available for university research and the ecosystem of developers contains more than 50 specialists (in Europe and Canada). The project initially started by STMicroelectronics who ensured its coordination.

The STHORM computing fabric is highly modular and scalable, it is based on multiple processor clusters implemented with independent power and clock domains, enabling aggressive fine-grained power, reliability and variability management. As Melpignano et al. (2012) demonstrated, the STHORM project provides a competitive architecture for the embedded computing with more architectural flexibility than current general purpose programmable graphic units (GP - GPUs); and higher power and area efficiency than both GPUs and general purpose shared memory multi-cores (GP - SMP). This many-core architecture is designed to provide flexibility on top of high performance

to support multiple application domains. For instance, from the software point of view platform supports a wide-range of performance and parallelism exploitation objectives. Hardware acceleration is designed to be shared among multiple programming models (Ojail et al., 2011), which orientates the exploration towards flexible generic technology.

By targeting high flexibility and modularity, and taking into account the diversity of the existing and emerging application areas, STHORM can be classed as a generic multimarket technological platform. Its embedded vision comprises a high number of potential emerging applications like automotive, urban security area, mobile, gaming, medical, consumer and building automation. Though a lot of applications can be possibly identified, still there is a high degree of uncertainty on which model to choose and which application will be the first to be adopted by the market and create benefits. At the same time it appears too consuming to consider all the identified application due to resources limits. One of the biggest challenges for embedded vision processors is “extremely diverse applications” to address⁹. Considering the high technical and marketing uncertainties there is a high level of uncertainty on which model to choose and which applications are worth investigating. In order to be successful in the consumer-driven System-on-Chip (SoC) market, the platform has to respond to rapidly evolving consumer-markets. Moreover, feature-rich products require significant investment and longer time-to-market which determines the necessity to amortize the investments over more product variants and market niches. To compete on the tight markets, OEMs seek to differentiate by adding their own features to the platform, which requires high flexibility, adaptability and extended programmable logic support from the solution (Paulin, 2011).

Considering high degrees of both technical and marketing uncertainties of an investigated case and various emerging market opportunities in line with high level of technological competition, the common unknown strategy was used to gain some insights on the strategic positioning of STHORM project. The following question was formulated: **given the highly competitive unknown environment of STHORM, do the project leaders have to follow common unknown strategy or privilege dominant market exploration?**

Initially, STHORM project leaders identified three possible scenarios for possible technology commercialization:

1. Release of the generic core (cluster) solutions provided primarily for the technological partners where the latter can further develop complementary modules. This architecture offers good time to market, but lower margins for ST.
2. Development of the final applications dedicated to reuse existing technology in ST to address already known market applications. For example, an information appliance device – set-top

⁹.Talk “What Can you Do With Embedded Vision” given by Jeff Bier, Founder of the Embedded Vision Alliance, October 2013 at the Embedded Vision Summit East Presentations, Westford Regency Inn and Conference Center.

box that uses STHORM generic core to improve existing solutions (each BU develops its own application layer independently from the others).

- Development of both new market-based solutions and new technologies, which are explored with the help of a platform developers (both internal and external) and business units (*e.g.*, imaging). This collaboration will facilitate proposing a solution that comprises a platform itself (generic core) and highly-modular application-oriented derivatives (including accelerator, sensor fusions, cloud computing and application specific features like game and video processing, face, gesture tracking,...) that can be associated with the emerging market needs.

The third scenario highly correlates with common unknown strategy. In this case, what are the functions that are application-specific and the generic functions that build interdependencies between various applications? It is possible to identify generic function associated to the hardware and software, which can be generic in their support of many core computing fabrics (Figure 17).

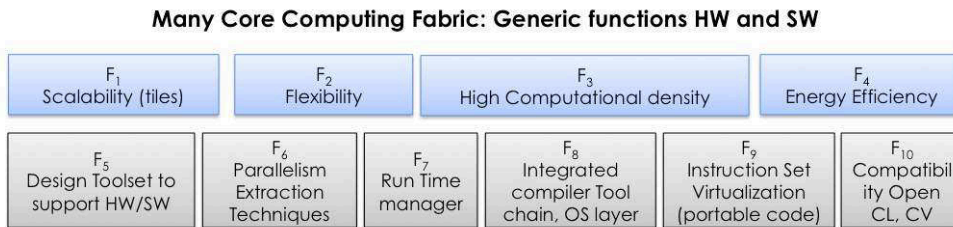

Figure 17 - Generic hardware and software layer

Our initial analysis consisted of applying the *T-F-M* framework (see 3.1 of Chapter 4) by listing all the functions that the platform seeks to offer (both at the generic core and modules level, *e.g.* power- and area- efficiency, high-computational density, virtualization,...) and comparing them with the lists of functions that emerging applications aim to offer. Once the lists were established, we associated them with the emerging Open CV standard (issued in 2013). OpenCV was designed for computational efficiency and with a strong focus on real-time applications. According to the standard and the conducted technology and market analyses, the necessary functions for home automation domain were structured based on user needs, activity and environment management. For instance, concerning the required analytics functions for the environment, lighting control, heating/cooling, leak detection, remote control appliances, energy and water use supply consumption, immersive techniques for social iteration were identified. The more specialized functions for user are statistical behavior, targeted advertising, presence detection, realistic avatar creation, and view optimization. Generally, for an analytics domain that includes home automation, surveillance and gaming (Figure 18), we aimed to list and regroup different functions in modules (*e.g.*, face recognition, gesture tracking). For instance, the **gesture-tracking function** appears to be one of the generic functions at the application level. It means it will be likely incorporated in any of the applications of the embedded vision analytics. Besides, these functions correspond in general to the Open CV standard specification.

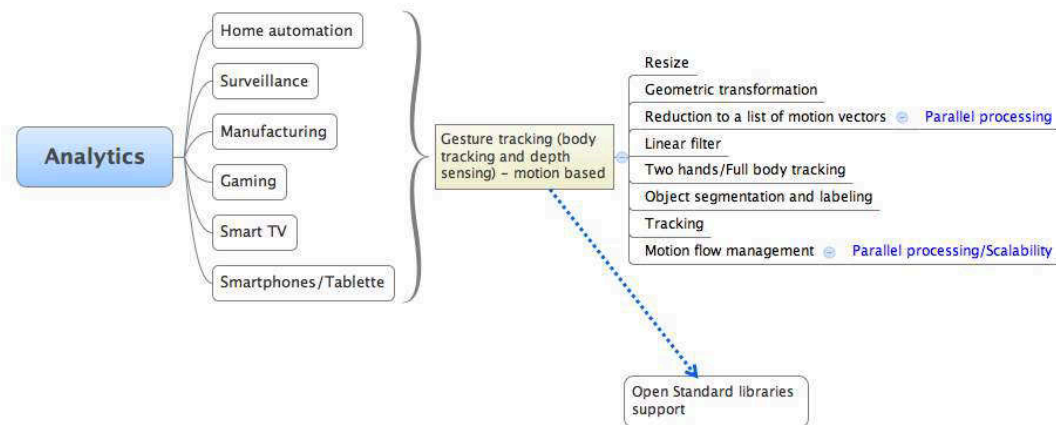

Figure 18 - Generic function identification

This functional cross-analysis that includes the needs of applications, standard and the emergent platform characteristics helped us to establish the list of generic functions that the technological core offers. We have not provided here the analysis of all the functions and applications. **The purpose of this analysis was to show how common unknown framework permits the clarification of the strategy of multiple technological and markets exploration in unknown by controlling genericity of the core and its scalability and flexibility with the application layers.** Table 6 provides the characteristics of the STHORM project according to the definition of GTs properties in the previous section. It is important to underline that application layer in STHORM contains generic function that could be shared among applications.

Table 6 - STHORM project characterization

Techno type	General/Generic Technology	STHORM
Properties	Market Environment	Multi-environment (distinct search, diversified markets and technologies portfolios)
	Knowledge	Broad scientific knowledge
	Functionality	Generic functional parameters (e.g., high frequency) that are common to all the applications
	Cost of adaptation	Low cost of technological re-adaptation
	Risk	Costly preliminary exploration to design generic technology basis
		Set Top Box, Imaging for face detection, gesture tracking, cognitive radio, scalable video coding, etc.
		Broad scientific knowledge
		Generic functions: Scalability (due to tiles), flexibility and high computational density due to Network-on-Chip and symmetric multiprocessing clusters, programmability and instruction set virtualization, open platform
		Easily scalable system, apps development could be done by clients and partners due to open standard platform
		High level of competition, New to the company product at the system level, various market alternatives

Chapter 5: Managerial implications for the process of double unknown management

STHORM represents an example of GT with high potential among emerging applications. Compliant with the analysis of BICMOS project, its successful implementation requires careful design of a scalable system that could be easily shared among clients and partners to reduce the costs of platform redesign. Apart from the internal platform exploration risks (Table 6), the platform should manage well specific vs. generic context. It has to provide sufficient added-value *vis-à-vis* the external competition.

Overall, this chapter indicates the commonalities of the reasoning behind the two different cases of GT design. It demonstrates the pertinence of the “common unknown” strategy for GTs exploration.

Part I Outline

Driven by the analysis of risk, uncertainty management and platform literature, this chapter builds the theoretical framework of risk management strategies based on the necessity to deal with double unknown situations and dependencies management. This framework goes beyond the classical decision making approach and reveals a new strategy that is not covered by the existing risk management. This anomaly consists of proposing a new alternative that reduces the unknowns and builds interdependencies between technologies and markets. By showing that there exist empirical cases that constitute generic technology by successful design of dependencies and dealing with double unknown situation, we introduce a new strategy of “common unknown” management. The introduced common unknown is characterized using a deduced managerial framework based on actors, objects, criteria and resources. It facilitates generic technology design and further market modules exploration. The adopted methodology in this chapter is an exploratory case study of advanced technologies portfolio analysis to reveal the anomaly and characterize it. This leads the definition of the **object of “double unknown” management** that is derived thanks to the capacity of designing common unknown for several emerging markets. **The common unknown strategy consists of interdependencies design based on technological anticipation and simultaneous multi-market analysis.** So to account for risk management in double unknown situation both gambling logic of decision-making and evolutionary process of interdependencies creation is enriched by intentional interdependencies design to reduce the level of unknown and ensure future success. We show that double unknown is manageable and GTs do not appear as a result of a random or evolutionary process. “Common unknown” strategy proposes a new way to increase and manage genericity in unknown. Moreover, it is shown that the attractive **Trial and Learning strategy** is potentially risky when it leads to the development of a first trial that will not be a good platform to fulfill the following markets. Favoring a first exploration project primarily to formulate a platform core might actually lead to increasing the global risks instead of decreasing them and limit the exploration space.

This part leads to formal grounding of the following research concepts: **generic technology, common unknown, and double unknown.** The empirical application of these findings on the ongoing case of multi-core computing fabric – STHORM confirms the validity of the usefulness of common unknown strategy and enables gain of some insights on the governance of highly transversal challenging in unknown.

Corresponding papers:

Kokshagina, O., Le Masson, P., Weil, B., Copez, P. 2013. Platform emergence in double unknown (technology, markets): common unknown strategy. In: Çetindamar, D., Daim, T., Başoğlu, N. & Beyhan, B. (eds.) *Strategic planning decisions in the high tech industry*. London: Springer.

Kokshagina, O., Le Masson, P., Weil, B., Copez, P. 2013 Risk management strategies in double unknown: Gambling on markets or designing interdependencies. Towards generic technology development – under submission, the R&D Management Journal

Part II

The impact of sector dynamic rules on the choice of risk management strategy in double unknown: contingent criteria

*"The real voyage of discovery consists not in
seeking new landscapes, but in having new eyes"*

Marcel Proust

Part II: The impact of sector dynamic rules on the choice of risk management strategy in double unknown: contingent criteria

Chapter 6 Supporting the design of generic technologies: techno-economic conditions to account for higher performance.....	115
1. Characterization of techno-economic environment	115
1.1. Modeling approach: In which conditions do new strategies account for higher performance?.....	115
1.2. Model design to account for unknown situations and interdependencies management ..	116
1.3. Strategies in unknown and contingent criteria for strategies selection.....	117
1.4. Principles of modeling “unknown” technological and market structures.....	120
1.5. Strategies choice in unknown exploration	122
1.5.1. Ideal strategy – no budget restriction.....	122
1.5.2. Strategies under constraints.....	123
2. Techno-economic contingent criteria for strategies validity.....	123
2.1 Simulation results: defining contingent criteria	123
2.2. The importance of interdependencies and market signals stability in the unknown: the introduction of technological aggregativity	127
Chapter 7 Managerial implications: the investment logic faced with uncertain and dynamic environments	129
1. “Genericity building” business plans: multi-markets logic.....	129
1.1. From “risk reduction” to “genericity building” business plans: contingent criteria	129
1.2. The innovation contest for “genericity building” at STMicroelectronics.....	130
2. The notions of aggregativity and segregativity.....	131
3. Illustration of market opportunities creation through functional combination: the case of Yole Developpement.....	133

The empirical study of the Advanced R&D projects in double unknown situations showed the possibility of designing generic solutions and allowed the introduction of an original model of risk management. This model is based on the logic of technology exploration that is common to several potential markets and appears to be highly beneficial for a company's success. Meanwhile, traditional approaches of strategic planning can be risky under uncertainty, postponing the investments till the unknowns are reduced (Courtney et al., 1997). Taking into account various existing strategies, how can the executives faced with double unknown situation decide whether to invest in technological development or wait till the unknowns are reduced? Moreover, which strategy to prioritize regarding the type of industrial environment? The strategies need to be tested in different contexts and their validity domain should be defined and compared.

This part aims to develop a simulation model to understand in which techno-economic conditions the "common unknown", and more generally GTs design strategies, are more relevant than market pull, technology push and trial and learning. By using a previously derived framework that uses the notion of functions, this model integrated the emergency of new markets based on the combination of different functions, modeling the existing technologies and yet unknown technologies. A simulation model is built to further compare these management strategies in a large variety of environments (**Chapter 6**). **Section 1** justifies the need of model design and presents the underlying principles of the model. Based on in-depth literature review, we identify contingent criteria for these strategies. This section concludes with the description of techno-economic environments characterized by the speed of market renewal, the predictability of markets, the compatibility of new technologies to test strategies performance; and strategies definition within these environments. **Section 2** aims to define contingent criteria that determine strategies dominance in various industrial environments.

Chapter 7 provides managerial implications. It demonstrates the existence of the innovation contest at STMicroelectronics – Business Innovation Process that was launched in the techno-economic conditions favorable to the development of GTs. The outcomes of this process demonstrate that the projects that are considered as successful appeared to be generic. Moreover, the importance of the defined notion of aggregativity is indicated and the differences between aggregativity and segregativity are designated across the semiconductor and automotive industries. To conclude, an illustration of new market opportunities creation through functional combination is provided using the case of market ideas exploration conducted by Yole Developpement.

Chapter 6

Supporting the design of generic technologies: techno-economic conditions to account for higher performance

“What makes a specific quality or quantity of innovation retain its intense newness over the years?”

Brian Ferneyhough

1. CHARACTERIZATION OF TECHNO-ECONOMIC ENVIRONMENT

1.1. Modeling approach: In which conditions do new strategies account for higher performance?

The stochastic simulation intends to reveal the relations between types of environments and strategies performance. By simulating a high variety of techno-economic scenarios, the model aims to deduce the conditions that most influence the performance of strategies. The data generated through simulation allows achieving a similar order of statistical significance. The simulation study therefore was chosen over the quantitative methods to compare performance of identified strategies in the various industrial environments.

The simulation model proposes a powerful methodology for advancing theory and research on complex behaviors and system (Harrison et al., 2007), it leads to produce novel theoretical insights (Davis et al., 2007). Simulation tools enable analysis of multiple interdependent processes simultaneously, which appears necessary in order to establish the relations between multiple criteria and strategies performance. Moreover, it is considered as a good exploration strategy to examine the relations within the variables and determine criteria. The data to compare strategies performance and their conditions was generated using stochastic simulation model. By taking into account specifics of real management situations, the criteria for simulation and the description of techno-economic environment were chosen based on the literature review. The scenarios where each strategy accounts for higher performance were formulated based on the set of the initial simulation results. Each scenario represents the list of criteria that correspond to the techno-economic domain and their values. Once the scenarios were defined for each strategy, the simulation was repeated

using newly generated data sets and the statistical tests (in particularly *t-tests*) were performed to analyze the significance of the obtained results.

1.2. Model design to account for unknown situations and interdependencies management

There exist two principal classes of models to account for unknown: 1) **models that are based on uncertainty management techniques including real options** (Camerer and Weber, 1992, Huchzermeier and Loch, 2001); 2) **models that incorporate complexity and represent innovative projects as local searches on rugged landscapes**.

Decision-making models that include real options consider uncertain environments and incorporate environmental dynamics (McGrath, 1997). Typically these models use Bayesian logic that considers sets of random alternatives that evolve in time. McGrath (2001) demonstrates that given the same initial investment in exploration, the opportunities that have higher variance will most probably have bigger option value under uncertainty leading potentially to higher returns for the same probability of loss. The real options methods permit to adjust decisions in a dynamic and competitive environment. Though, they ignore the interdependencies among variables and consider rather simple landscapes.

While pursuing innovation exploration, firms have to deal with complex and unknown environments. Complexity is defined as a large number of parts that interact in a non-trivial way within each other and external systems (Caldart and Ricart, 2004, Sommer and Loch, 2004). A high level of complexity challenges companies' ability to make optimal decisions. Complexity type of models deals with systems that comprise multiple interacting entities. It is considered that organizations adapt by modifying their existing forms in an attempt to enhance their fitness value in a payoff surface (Levinthal, 1997). This class of models is mostly based on Kauffman *NK* model for interactions dimensions and is broadly applied to strategic decision-making (Caldart and Ricart, 2004, Gavetti et al., 2005, Rivkin, 2000, Sommer and Loch, 2004). *NK* model permits dealing with rather rugged landscapes where interdependencies shape complex environments (Kauffman, 1993). Though in *NK* the system size (number of variables) *N* is fixed at the beginning and does not evolve in time (Sting et al., 2011). Only *K*, which is the number of elements of *N*, within which given attributes *K* interact, is changing. *NK* considers rather complex but stable environments. Strategies are modeled as search strategies to maximize the fitness value on the landscape. The simplest ones are strategies of local search, which are highly efficient when companies' business attributes vary incrementally (Caldart and Ricart, 2004, Rivkin, 2000). In addition to the local search, Caldart and Ricart (2004) enlighten strategies of search that 1) involve the adaptation of new corporate business models or simultaneous alteration of many elements *N* in the case of explorative activities with low exploitation level; 2) deal

with explorative nature of activities without losing the benefits of exploitation by manipulating the interdependencies K between different elements of N . In this case the goal is to find new unforeseen combinations of known but previously distant parameters. Global search models take into account the interdependencies and model complex strategies to achieve higher performance: trial and learning and selectionism (Sommer and Loch, 2004, Sommer et al., 2009). These strategies deal with complex landscapes. Though, the NK model behind does not consider the landscape evolution in time and the strategies' visibility is then defined by initial configurations.

Subject to high turbulence, complex search models become irrelevant since their landscape is fixed and they do not consider the environments' evolution. Since GTs are more probable to emerge in dynamic and unknown environments, the primary interest of this study is to apprehend the relevant strategies behavior in the environments where the time of technological development has the same order of magnitude as industrial dynamism. The evolution of the landscape should be considered to incorporate alternatives that were not taken into account initially or emerged during the exploration process. **The model proposed here is positioned as a hybrid of two classes: decision-making and complexity models** and it is based on the landscape reconfiguration. The goal is to test how strategies' performance and their applicability change with reference to the industrial dynamism in time. **The model pursues to take into account dynamic environments as in the first class of models, interdependencies as in the second class, and enlarge it to the cases of double unknown management while integrating emergence of new functions in time.** Next, the main principles and notions of the simulation model are described to characterize identified strategies and simulation environment.

1.3. Strategies in unknown and contingent criteria for strategies selection

There exist several strategies that deal with multiple technologies and markets exploration. It was demonstrated in the previous chapter that **trial and learning** and **common unknown** strategies are suitable for explorations in high uncertainty. The **techno push** and **market pull** deal with singular unknowns: technologies and markets, respectively.

Each of the presented strategies provides powerful mechanism for dealing with the unknown situation, though the criteria and the methods they use differ significantly. Moreover, their performance is highly dependent on the external techno-economic conditions, and on the nature of the firm's knowledge environment (Pisano, 1994). While attempting to launch a new exploration, a strategy has to be chosen according to the initial conditions. ***What are the techno-economic conditions that enable detection of which strategy ought to be used for projects exploration?*** The conducted literature review permits definition of the list of the main criteria (C_i) that possibly influence strategies' performances.

Conventional management strategies handle mostly fixed at the beginning sets of alternatives and their associated probabilities. Their goal is to choose a best alternative using Bayesian probability distribution and reduce the corresponding uncertainties. These strategies deal with market knowledge that usually considers market success and probability of market existence along with the required technological knowledge (i.e., in terms of development cost and probability of technology existence). Though these methods neglect the emergence of new alternatives in time.

When the level of uncertainty is high, the selection of relevant strategy is influenced by the associated market and technological dynamics, and their speed of renewal. Moreover, the various types of uncertainty have to be taken into account: market uncertainty, technological uncertainty, environmental and organizational uncertainty (Mu et al., 2009). Withal, the level of uncertainties differs as well. For instance, markets and technologies might be unknown (McGrath, 2001, McGrath and MacMillan, 1995, O'Connor, 2006). Contingent upon highly volatile and dynamic environments, the rate of new applications and even new markets creation is high and market signals are dynamic (Hill and Jones, 2007). On the contrary, when the dominant market can be identified and the industry is stable, market signals are rather invariable (the criterion called the **nature of markets - C₁** and its **dynamics - C₂**). The strategies choice depends on the **speed of markets renewal (C₃)**, the **success rate of radical innovation (C₄)** is positively influenced by innovation speed (Goktan and Miles, 2011). Whereas the literature provides the evidence on the relations between the market orientation and new product performance, its connection with various market conditions remain unclear (Grinstein, 2008).

Moreover, Das and Van de Ven (2000) indicate that the nature of technology can differ from novel to established and the nature of markets can be concentrated or dispersed. The nature of technologies and markets under question definitely influence the firms' selection of consequent strategies. Vergne and Durand (2010) state that the way path dependencies are created and sustained implies different mechanisms. They demonstrate that the path dependence occurs when the initial conditions are followed by a series of contingent (or chance) events whose influence on the path taken is larger than that of the initial conditions. Still, it remains unclear why **path dependence (C₅)** occurs and how it influences strategies success. When the level of corresponding unknowns is high, it is important to take into account the logic of learning, and incorporate new alternatives. Firms should integrate strategic flexibilities that allow for spontaneous reaction for changing environments (Zhou and Wu, 2010). Moreover, under uncertainty *"variance-creating strategies are more valuable than mean-enhancing ones"* (McGrath, 2001).

From the insights in generic technology development, it is evident that certain technologies are more flexible and can be compatible with higher number of markets (Maine and Garnsey, 2006). This means that the complementary modules can be easily incorporated with the core technology to

address these markets. Conversely, Christensen (1997) indicates that the technologies are becoming more complex and the integration of new functions could be costly and challenging. Consequently the complexity might pose some issues of technology appropriation by the emerging markets. For this reason the criterion that defines the **level of technological adaptation** appears to be critical (**C₆**). The environment itself can be **dominant design type or unknown (C₇)** (Christensen et al., 1998). In the case of dominant design, there are leading technologies and actors that guide further explorations and predefine industrial dynamics. The unknown environments are more competitive, there are various technological candidates and the product portfolios are much more diversified (Kaplan and Tripsas, 2008).

Overall the following techno-economic criteria appears to be important to determine the relevant strategy: nature of markets (C₁), market signals dynamics (C₂), market renewal (C₃), ratio of existing vs. unknown markets (C₄), type of environment (C₅), path dependency (C₆), technology reconfiguration (C₇). Obviously, budget, investment constraints, various technological and marketing risks influence strategies choice and their performance. In addition, Carbonell and Rodríguez-Escudero (2009) demonstrated that management support has a positive effect on the innovation speed under conditions of high technology novelty and high technological turbulence.

Which criteria from the established list facilitate the choice among Market Pull (MP), Technology Push (TP), Trial and learning (TL) and common unknown (CU)? The goal is to reveal the contingent criteria that influence strategies performance and enable the achievement of higher results. The way certain criteria influence the strategies success can be disclosed from the literature review (see Table 7). Mainly, the importance of market signals (C₁) and the uncertainty levels (type of the environment – C₅) are indicated. Though, other criteria appeared to be important as well (*i.e.* the industry is turbulent or stable; the speed of renewal could influence the criteria of strategies' adoption; path dependency that influences the character of technological exploration and strategy).

Table 7 - Criteria of strategies dominance

	MP	TP	TL	CU
Conditions	Market Pull is relevant when market signals are high (C ₁) and stable (C ₂) (Das and Van de Ven, 2000). It is primarily used to commercialize technologies and replace the existing applications, markets (Walsh et al., 2002)	Technology push is relevant in case market signals are absent (C ₁), the suppliers are involved in the strategies determination (Walsh and Linton, 2011)	Trial-and-error learning promises the highest potential when unforeseeable uncertainty is high (C ₁ , C ₇) (Sommer and Loch, 2004)	Common unknown performs better while targeting interdependencies creation in multi-market, multi-technological environments (C ₁ , C ₅) (Kokshagina et al., 2013)

Different management strategies are required to diffuse discoveries and successfully incorporate new knowledge to the operational profit of the firms. The performance and conditions of strategies implementation faced with various industrial dynamics need to be clarified. Besides, it is unclear in which conditions these strategies would lead to a GT emergence. ***What are the relevant contingent criteria to detect reliable strategies based on the industrial dynamics?***

1.4. Principles of modeling “unknown” technological and market structures

The simulation model aims to introduce the dynamic technologies and markets and test management strategies performance in high-velocity environments. These environments are characterized by their dynamism, uncertainty and complexity (Eisenhardt, 1989b, Wirtz et al., 2007). The techno-economic environments' modeling is based on technologies, markets and their interaction. Normally, a winning solution is described as a technology-market (T - M) couple with various probability of success. We keep the traditional T - M matching (Schumpeter, 1961), but as was shown in Chapter 6, there are cases when the direct correspondence in between technologies and markets is not valid (see BiCMOS, BAW, STHORM cases examples, Chapter 6) and moreover, the coupling between technologies and markets cannot be decided initially (due to high unknowns).

Similar to Part I, we use the notion of functions to establish the relations between technologies and markets. The functional combinations correspond either to certain technologies and/or certain markets. In this perspective technology appears as an opportunity to combine different functional combinations by designing interdependencies among technologies that address these functions. The functions are defined as the sets of entities – F_i that create the value to the market. Technologies represent firm capabilities to address (or not) the desired functions (to fulfill the desired specification). In some cases these two dimensions are quite distant (functions related to markets and functions that technologies are offering). In double unknown we deal with still unknown technologies and markets. As indicated in Chapter 6, **unknown markets M_i are modeled as functional combinations with associated volatile probability distribution**. Each market M_i can be described as a set of functional elements F_1, F_2, \dots, F_n it targets. Both dominant and unknown markets are considered in the model and they are characterized by predictability or volatility of market signals accordingly. Market represents the set of needs (functions (F_i)) with the associated potential benefit, probability of existence, and development costs. New functions generation could bring creation of new market needs and even result in new markets. In the model the set of markets is represented as a set of F_i linked by the market constraints (Figure 19).

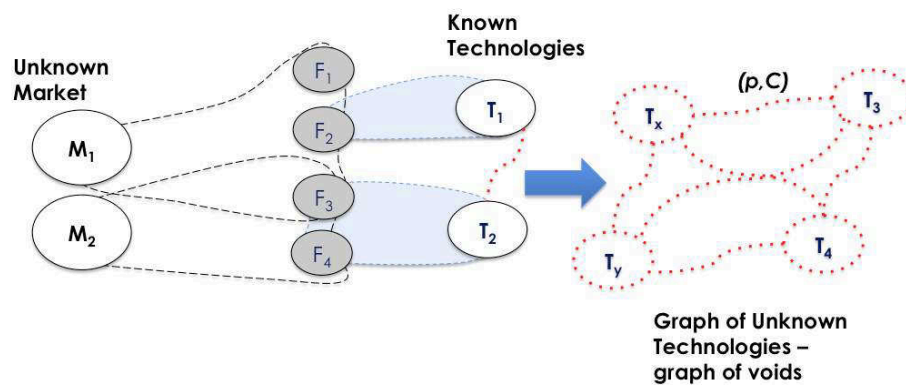

Figure 19 - Technology-Market modeling

Through the time the number of functions evolves, therefore, the number of markets (designed as functional combinations) and the corresponding values change. For instance, if a new function F_5 appears we might imagine 2^5 functional combinations that this new function creates with the already existing 4. The evolution of functions modifies the technological and market landscape itself.

Similarly, technologies have to be described independently from products and markets. To find a technology for a chosen market means precisely to address the market's functions. Technology is considered advantageous if it addresses powerful functions that lead to winning markets. Technology is a set of physical elements (T_i) that ensures certain functions (F_i) with associated development cost c_i and probability of existence p_i . Technologies can be characterized by their complexity and technological systems dynamics. It is considered that all technologies are linked to each other with "unknown edges" (Figure 20). An "unknown edge" between two technological principles is considered as a new technology to develop: an unknown technology (*i.e.*, the new interdependence that has to be built). When the "unknown edge" is successfully established between two existing technologies, it means that a new technology capable of ensuring certain functions is developed. Every unknown edge has a cost c_i , a probability of existence p_i , and an associated weight of its development is estimated as $c_i \cdot (1 - p_i)$ (further defined as the risk of the corresponding edge).

A graph of these "unknown edges" represents a graph of unknown technologies. Once a new edge is developed, the relations between the existing and emerging technologies change. For example, once the interdependencies between T_x and T_y are built (Figure 20), the new technology T_n is created. It changes the graph itself since the relations between the new T_n and the remaining technologies have to be reestablished and, thus, the values of previously defined weights of edges (T_x and T_3) and (T_y and T_3) reconsidered. The configuration criteria of new technologies with the existing ones need to be defined. They depend on the environment and type of technologies. For the current version of the simulation model, various compatibility criteria were chosen (see Paper II). Besides, when path dependency among various technologies is present, it influences the costs of technological

exploration. In the current version of the model, the functional emergence does not depend on the firm strategy from the technological point of view.

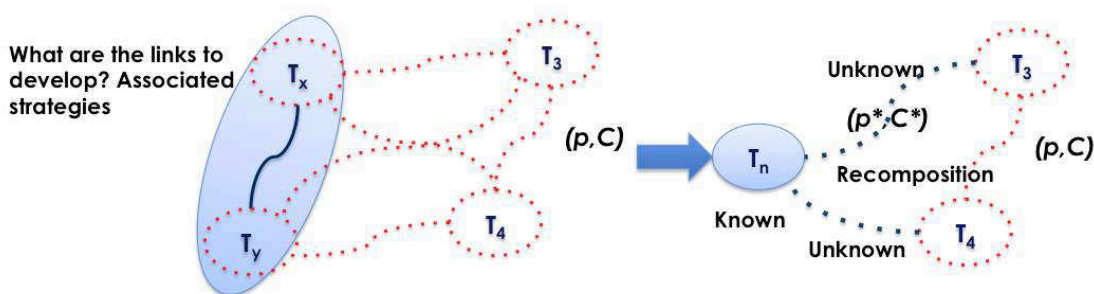

Figure 20 - Unknown technologies graph

Defining the environment in the model consists of setting up the rules that guide the interaction and the evolution of the model’s objects: markets, technologies and functions. The notion of the environment includes all elements, factors, and conditions that have an impact on the choices made, when applying for a management strategy.

1.5. Strategies choice in unknown exploration

In this perspective, the strategies establish the relations between multiple technological and markets alternatives by the efficient interdependencies creation. The model therefore implies strategies as efficient mechanisms to establish the links between technological solutions and promising markets given the techno-economic constraints of the underlying environment.

1.5.1. Ideal strategy – no budget restriction

There are endogenous and exogenous criteria that influence market evolution and various forms of management are possible. The initial landscape of existing technologies and markets is rugged and plenty of local optima can be defined at time t using various strategies. In the proposed model the goal is to develop technologies to fulfill the unknown edges in a graph. In the model, to develop the particular edge requires paying the costs required to deliver the final solutions (e.g., costs of R&D exploration, commercialization, production). If the initial budget is infinite, then the goal is to find an optimal path to develop all the edges. For this reason the widely deployed in graph theory Kruskal algorithm can be used. It finds a minimum-spanning tree for a connected weighted graph. It determines a subset of the edges that forms a tree that includes every vertex (*i.e.* every technology), where the total weight of all the edges (*i.e.* the total risk of the unknown technologies) in the tree is minimized. Though, the budget is limited, new knowledge emerges in time and the residual unknowns exist.

1.5.2. Strategies under constraints

Given the budget constraints, search algorithms to develop all the connections are too costly. Besides, the graph of markets and unknown technological voids evolves in time. This topology change due to the environmental dynamism has to be incorporated in the model. The goal is: **given a budget of R&D and commercialization, which “unknown edges” should be developed to have access to a larger amount of markets?** The strategies represent the identification of innovative projects to launch under the budget constraints. The following strategies were modeled: market pull, technology push, trial and learning, common unknown and random. The principles of strategies modeling are described in the appended paper (see Paper II).

To summarize, there exist various techno-economic environments, which are defined using associated criteria C_i . Each environment contains N technologies T_i and there is a capability to develop new technologies T_i through the combination of existing and emerging ones. The technological portfolio targets known markets M_i , attracts and can lead to a creation of new markets M_L . There is a list of strategies that companies can pursue to account for higher performance in these environments (Techno Push, Market Pull, Common unknown, Trial and Learning, Random).

Given the budget constraints, existing and emerging T_i and M_i , and given the set of strategies, which strategy and relevant business plan logic should the company choose to obtain higher performance in terms of benefits and design generic technologies?

2. TECHNO-ECONOMIC CONTINGENT CRITERIA FOR STRATEGIES VALIDITY

2.1 Simulation results: defining contingent criteria

A simulation plan comprises different experiments to be run to identify the environments in which each strategy is dominant. By using a techno-economic model each strategy is tested with various criteria in order to reveal favorable conditions. The simulation begins with the object definition. After each strategy run, market and technology lotteries are performed to determine whether the development was successful or no. This phase conveys to the automatic update in the market – technology initial graph and recalculates the corresponding values of technologies and market.

Regarding the environment conditions at each time period, new functions and technologies were added randomly or considered path dependency effects to ensure the landscape evolution in time. The simulation run is repeated for a variety of environment conditions and knowledge depth combinations. The initial experiment enabled definition of the criteria configurations when strategies account for higher performance (in terms of profit). These configurations were used to determine 4 scenarios where each strategy is potentially dominant (Table 8).

Table 8 – Scenarios definition

Criteria	Scenario 1: where Market Pull is superior	Scenario 2: where Technology Push is superior	Scenario 3: where Trial and Learning is superior	Scenario 4: where Common unknown is superior
Probability of markets (C ₁)	High	Low	Low	Low
Market signals dynamism (C ₂)	Stable	Dynamic	Dynamic	Dynamic
Market Renewal (C ₃)	Fast	Slow	Stable	Stable
Ration of dominant markets vs. unknown (C ₄)	Dominant environment type (at least 10% of dominant markets)	Unknown environment type (UE) (less than 1% of dominant markets)	UE (less than 10% of dominant markets)	UE (less than 10% of dominant markets)
Path Dependency (C ₅)	N.A	N.A	High	Low
Reconfiguration Criteria (C ₆)	Low	Average	Less than average	High
Type of environment (C ₇)	Dominant	Unknown	Unknown	Unknown

To confirm the validity of the established scenarios and their statistical significance, the tests were conducted on larger sets of data. For each scenario 40 (Scenario 1) or 100 (Scenario 2, 3 and 4) trials were performed. Scenario 1 contains only 40 trials because its statistical significance was achieved on the smaller data set. Each strategy behavior was observed through 5 time periods. By time period we define an interval in time that corresponds to the phases of the decision-making (i.e., from the time project is launched till its delivery through the markets, or simply till the end of the financial year). The constructed simulation model leads to a variety of results. This variety is explained by diversified performance of tested strategies. The simulation results enabled definition of the conditions when each strategy accounts for higher performance. The two-sample *t*-test was used to analyze two population means based on independent samples from the two populations or groups (Table 9).

Table 9 - Simulation Results

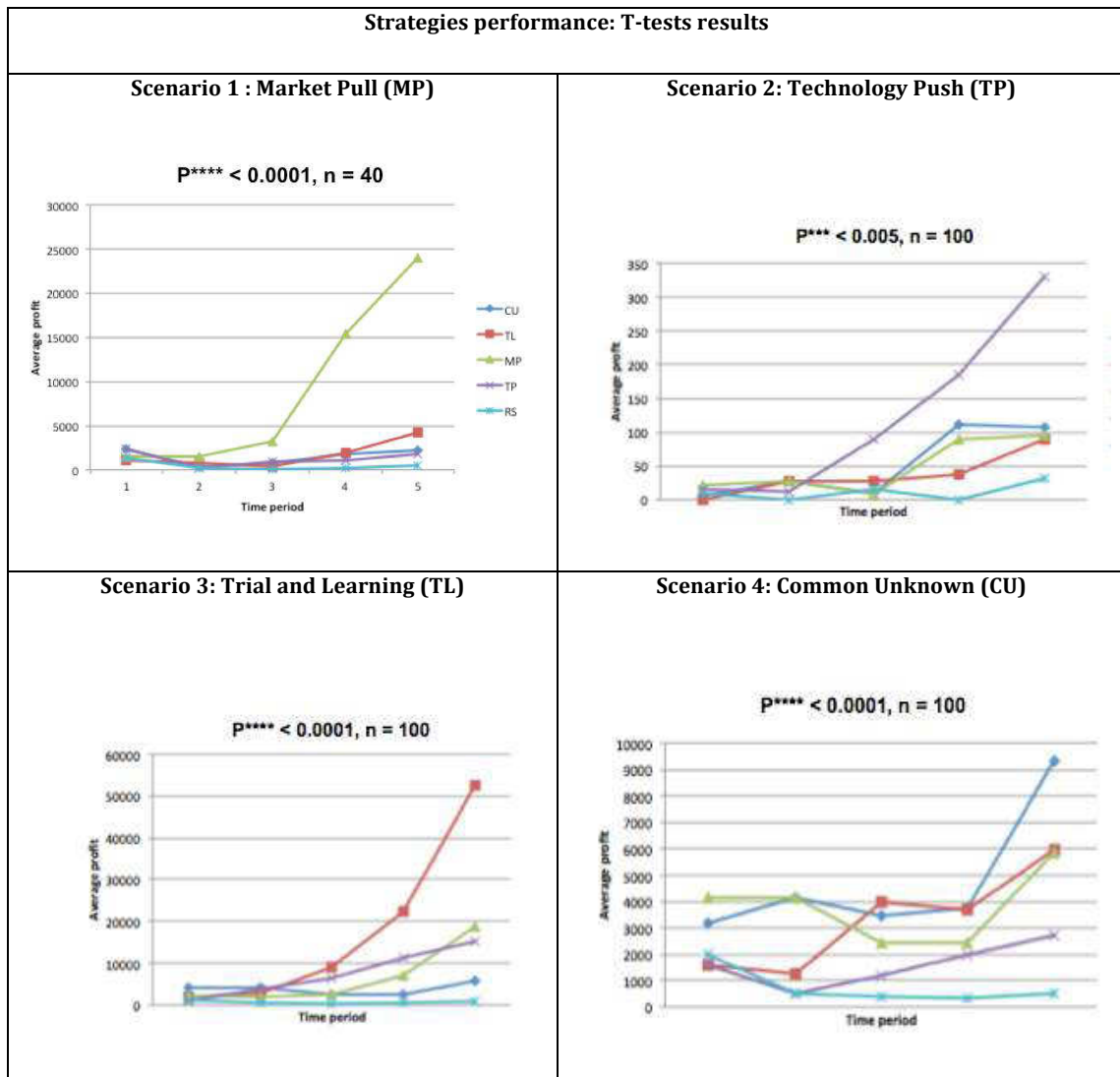

The simulation results and *t*-tests findings confirm that in scarcely innovative environments the market pull strategy (Scenario 1) is superior when there are dominant markets. This model is compliant with the literature findings and confirms that market pull is relevant for the environment with reliable, high market signals. The technological compatibility is less important meaning that the reconfiguration criteria are low. In this case technological systems have “segregative” character, which indicates that the technologies are not easily compatible and flexible, the learning among time periods do not occur (Table 10). A similar trend is observed in trial and learning strategy (Scenario 3), which is based on the presence of market signals as well. Though, in more dynamic environments market signals are weaker, learning process and path dependencies are becoming more important and trial and learning strategy dominates market pull. This strategy seeks to reuse the developed

learning to achieve remaining functions; technology has to be more flexible to easily integrate new functions. It has to be “aggregative”. Once the technology is aggregative, trial and learning dominates market pull, which is compliant with the existing literature. The criterion of technological aggregativity was revealed as an important one for strategies selection in dynamic unknown environments. The principles of “aggregativity” signify that is accounts for the compatible technologies and for smaller costs of the interdependencies design. For instance, technology push (Scenario 2) confronted with dynamic environments seeks for higher technological compatibility and its value but does not include market signals at the beginning of exploration. Common unknown strategy (Scenario 4) appears to be beneficial once the markets signals are weak but multiple and dynamic, technologies are aggregative meaning that they are flexible and can easily incorporate new functions. It is found that two contingent variables are important: the existence of market signals, their strength and the technological systems that are more or less segregative. The two contingent criteria of “market signals stability” and the degree of “technological aggregativity” are formulated as the combinations of the most important criteria from strategies scenarios (Table 10).

Table 10 Conditions of strategies higher performance

		Type of Environment C ₅	
		Markets C ₁ & C ₂ & C ₃	Unknown
Strong	High, stable market signals with high speed of market renewal		Market Pull Technological compatibility is low C ₇ , path dependence – no relevant C ₆
	Average, multiple market signals with average speed of market renewal	Trial and learning Technological compatibility is average C ₇ and strong path dependency C ₆	
	Low, multiple market signals in average speed of market renewal	Common Unknown Technological compatibility is high C ₇ and average path dependency C ₆	
Weak	Weak market signals and low market speed renewal	Technology Push Technological compatibility is average, path dependence – no relevant C ₆	
		Aggregative Technologies	Segregative Technologies

It is important to underline that statistically test significance was measured at the 5th time period. The graphs in (Table 9) demonstrate that strategies’ performances change significantly in time,

depending on the remaining budget constraints, and changes in industrial dynamics (such as, creation of new functions, markets, competition, market saturation, the level of unknown,...). For instance, the common unknown strategy (in Scenario 4) does not dominate until the 3-4th time periods, which signifies that the strategy of generic technology design becomes interesting when the company pursues a long-term development perspective. It is explained by the existence of multiple unknown markets that dynamically change in time.

2.2. The importance of interdependencies and market signals stability in the unknown: the introduction of technological aggregativity

The proposed model investigates performance and conditions of different strategies in the situations where the industrial dynamic has the same order of magnitude as the time of development. **The findings reveal that the design of generic technology is relevant for the environments where reliable market signals are absent and technological systems are aggregative** (Figure 21). Besides market signals should be multiple.

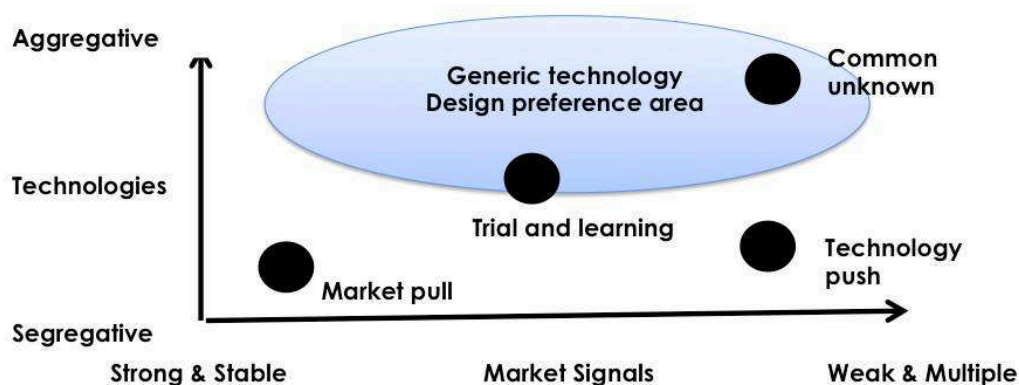

Figure 21 - Conditions of strategies applicability

The trial and learning process is relevant for GT design if a trial market can be identified and the designed path dependent technology can be flexible to “aggregate” emerging markets’ complementarities. Common unknown is advantageous for genericity building when multiple market signals cause the aggregative technologies exploration through interdependencies creation. These strategies of generic technology design do not simply deploy “risk reduction” business plans to capture value.

Both common unknown and trial and learning strategies lead to development of a technological platform that addresses variability of market complementarities and need to incorporate the logic of multiple technologies and markets exploration business evaluation when uncertainty is high. This

development cannot apply the logic of more profitable markets or highly performing technology since it seeks for a technological core suitable for newly emerging markets and the level of unknown is high. The goal of common unknown is therefore to establish various interdependencies between technological principles and markets in order to attain various markets and build a larger validity domain. On the contrary, trial and learning strategy does not aim to increase the validity domain of future technological solutions, but to increase the probability of targeted market acceptance. **Overall, the elaborated model demonstrates the deep relationship between generic technologies and the aggregative character of the emerging technologies. The strategies of GT design become dominant when aggregative technologies are present.**

Chapter 7

Managerial implications: the investment logic faced with uncertain and dynamic environments

“Uncertainty is a permanent part of the leadership landscape. It never goes away”

Andy Stanley

1. “GENERICITY BUILDING” BUSINESS PLANS: MULTI-MARKETS LOGIC

These results provide insights on how to pursue the investments for companies who seek to valorize the exploration of multiple markets.

1.1. From “risk reduction” to “genericity building” business plans: contingent criteria

“Risk reduction” business plans account for higher results when the demand is stable and the technological aggregativity is low. These contingent criteria indicate that in this case the classical (technology, market) couples development is more advantageous and technology specifically designed to address a promising market will lead to higher benefits. This logic works well in rather stable business domains when the technological maturity and the market demand are stable.

The design of generic technology offers an original way to deal with unknown by avoiding binary ways for decision making. The simulation results show that the design of GT is pertinent when dominant market signals are absent, but they are multiple and dynamically evolve and change in time; technologies are aggregative meaning that the interdependencies between different technologies can be easily built and new functions integrated with smaller costs. By prioritizing this approach companies have to follow business logics that are oriented to explore multiple markets and valorize their transversal character. Thus, in order to account for generic technology development, the business plans that have the “genericity improvement” character should be pursued when the

uncertain environments are characterized not only by the absence of reliable market signals but the high probability of their emergence in the future (multiple signals). The crucial parameter for “genericity improvement” business logic is the aggregativity of technological systems, which ensures penetration of GT for various application areas with relatively small costs of adaptation (Figure 21). This notion signifies that the design activity of generic technology should be pursued when the objective is to create new relations between various technological principles.

1.2. The innovation contest for “genericity building” at STMicroelectronics

The R&D centers and business units of STMicroelectronics are leading many innovative activities to explore various new products development and technologies for the markets that they address. It was felt, however, that these innovation processes were leaving out innovations which could deliver potential solutions for several market areas, but which would not promise to involve volumes big enough to be financed by individual business units. To allow for the development of such transversal innovations, two French STMicroelectronics sites - at Crolles and Grenoble in the Rhone-Alpes region (known as the ‘French Silicon Valley’, specializing in microelectronics and nanotechnologies) employing between them over 6400 people – decided in 2009 to develop a unique ideas contest named Business Innovation Process (BIP). BIP aimed to run a series of challenges which would target transversality, ecosystem development and value for users (and benefits for ST) by developing future innovative solutions designed to address several business areas.

These contests aimed to deal with the situation when both future technologies and application are not fixed initially and require exploration on the unknown. The contests did not prefix any initial technologies or markets to be developed but defined them in rather broad terms. For instance, the 2011 “Make life easier and better for everybody” contest targeted ideas to:

“help people who are fragile in the face of their environments...by developing solutions that allow them to live easier and better. These solutions should have a potential to apply to everybody”. (LeServiceCommunication, 2011)

The BIP process was launched to actually overcome direct creation of technology - market couples but to account for more transversal ideas exploration. The participants from the various technological and Business Units groups were brought together to create teams and jointly develop new expertise. The ideas and the latter projects issued from all the challenges embraced a great variety of technologies and markets that already exist and are still unknown. For instance, the “Make life easier and better” challenge proposals were dealing with sensors, radars, LCD, organic solar cells, detectors, audio-video transmission, etc. and from the technological perspective; health, robotics, security, sport, entertainment, smart building, haptic etc. from the application domain perspectives. The number of ideas submitted for this challenge was 128.

The BIP appeared as a structure within the company that did not belong to any particular division or a research group. Instead, participants came from the various organization entities to work together on the innovative challenges. This permitted the development of highly transversal projects that created breakthroughs both in market and technological areas. They have even created new technologies to address emerging and the existing markets. Our analysis of this challenge (see Paper V) shows that the only projects that were considered as successful (and there were very few of them), by the evaluation committee, appeared to be generic.

The conducted study shows that this contest was built to explore transversal innovation, the organizing committee explicitly aimed to valorize the ecosystem creation and push participants to develop innovative approaches together. There were no clients initially in the process and no clear “accessible” market value. **Instead, the varieties of dynamic market signals with rather low probability of existence were identified.** Concerning the technological side, the contests seek to reuse the already existing technological expertise within ST and to develop new richer in functionality and more flexible technologies that address several markets. **The nature of technology appears to be aggregative.**

The traditional “risk reduction” logic is limited to account for more innovative transversal ideas and highly uncertain environments exploration. The BIP was launched in the case that corresponds to the contingent criteria relevant for the generic technology design. Even if the goal to develop generic technologies was not stated initially by BIP organizers, as a result, the process coped with double uncertainty and the conditions to explore genericity, defined in Chapter 6, were met. This contest led to highly generic technologies (for their analysis see Chapter 9) and applied the “genericity oriented” business logic.

The importance of the technological aggregativity for the design of GTs is evident. Yet, the notion of aggregativity itself and its characteristics need to be determined.

2. THE NOTIONS OF AGGREGATIVITY AND SEGREGATIVITY

Our definition of **aggregativity** corresponds somehow to the definition of Wimsatt (2000), who determines aggregativity as non-emergence of a system property relative to properties of its parts. **Aggregativity thus attempts to “bring different things together into total, whole mass or sub-total, forming a total”. In a technological context, aggregativity corresponds to the technological ability to integrate new features by combining technological building blocks with lower resources.**

The automotive industry gives a perception of being slow-paced, driven by the client needs and privileging incremental innovations. As pointed by Elmquist (2007), highly structured product

development processes in the automotive industry “leave little room for experimentation and learning”. The R&D efforts of the automotive suppliers are mostly based on improving the quality of underlying products and business; competition is based on classical Quality-Cost-Delay criteria. Mostly suppliers in the automotive industry prefer to stay in the main niches; they do not seek to diversify their product portfolio. Products appear to be specific for the needs of established customers. The transactional links between component manufacturers, assemblers, and customers appear to be well established and mature. New markets integration is limited and the established system redesign requires high investment and extensive technical efforts. Overall, the automotive industry appears to be segregative.

On the contrary the industrial environment of the electronic industry appears to be fast-paced, highly dynamic, attempts to propose new radical innovation and creates new technologies, and new products to ensure its long-term growth. This industry is driven by high competition, explicit need for technological innovations and cost reduction. To pursue easier integration and design flexibility within complicated supply chain and product generation change, industry is becoming more modular and standardized. The industry aims to preserve its capacity to mix and match new knowledge areas and technologies to diversify their portfolios and thus, preserve their aggregativity level. In the electronic sector competitive advantages within various industrial players could be achieved at the various dispersed levels (Luo et al., 2012). Conducting formal cross-sector comparative analysis of transaction networks the authors indicate that these sectors have quite different horizontal and vertical boundary strategies: 1) on the vertical boundaries, electronic firms operate in the intermediate industrial markets; such transaction are rare in the automotive industry; 2) on the horizontal boundaries, automotive manufacturers are specialized in final products delivery and their suppliers on automotive-related products. Contrarily to this domain-dedicated industry, electronics manufacturers operate in quite diversified lines of productions offering products for various areas of computing, communication and consumer electronics.

The industrial structure of semiconductors permits them to account for highly modular technologies, which could appropriate the increasing number of functions with controlled costs. On the contrary, the segregative industries, like the traditional automotive sector, are limited in their way of incorporating new functions and easily positioning on new markets. The aggregative character appears to be crucial to account for higher genericity. When the industry appears to be segregative, the design of GT appears to be more challenging and often not pertinent.

The defined contingent criteria for the “genericity building” business logic are not just the evaluation criteria on whether the generic technology design can be pursued. They can be considered as an opportunity for action: *i.e.*, certain technological characteristics are more segregative than others, so maybe one can consider how to change them. In this perspective, there exist more explorations of the

aggregative nature within the semiconductor industry. The technological components became cheaper, more compatible and the interdependencies are easier to design. The companies are even proposing to the customers to build their own electric vehicles in a couple of hours, which completely changes the nature of the technological development within the industry.

3. ILLUSTRATION OF MARKET OPPORTUNITIES CREATION THROUGH FUNCTIONAL COMBINATION: THE CASE OF YOLE DEVELOPPEMENT

The generic approach appears to be relevant when there exist multiple market signals and they are dynamically changing in time. It reconfigures the landscape of the promising markets rapidly and brings to create new market opportunities. The generic technologies even create new markets. This process of new applications, functionalities, markets creation by the generic technologies has attracted the interest of Yole Developpement. The latter is a reference company providing marketing, technology and strategy consulting, media in addition to corporate finance services¹⁰.

In 2012, Yole mobilized design formalisms (the C-K design theory (Hatchuel and Weil, 2009)) to conceive markets that do not exist yet and they applied the proposed framework of functions characterization to deal with yet unknown technologies and markets. The study was done to understand the long-term impact of MEMS industry evolution using high-voltage (HV) drivers. Initially, they listed existing MEMS applications and identified functions that each application offers using micro-electro-mechanical systems (MEMS). From 8 functions identified (power, analog/digital, signal frequency,...), 2⁸ functional combinations could be explored. Though, their analysis demonstrated that only 7 functional combinations were used by the existing applications (e.g., single micro mirrors, micro pumps, inkjet heads,...), which opens plenty of possibilities of new functional combinations that can lead to new market creation.

For simplicity reasons, from 8 initially identified functions they chose 3 essential ones comprising voltage, number of outputs and size. By combining the existing functions, they succeeded in identifying new market opportunities. For example, by combining low voltage (<5V) with medium outputs number (6 - 100) and relatively small size (<1 cm²), mobile devices for large data transfers through optical ports could be considered. In addition, this approach enabled the creation of radically new functions by combination of the existing ones: combination of low and medium voltage (called combo-voltage) is a new function that opens up radically new opportunities for multiple MEMS management from one ASIC and shares resources in terms of size, cost, and power.

¹⁰ Source: <http://www.yole.fr/>

The approach of function evolution with the corresponding technologies and markets enable to the identification of knowledge gaps, areas that are unexplored and lead to the creation of new markets and even new functions. The *T-F-M* framework enables the management of double unknown and accounting for the new opportunities. This example illustrates how the underlying principles of the model based on the function description allow the characterization of the evolution of markets and technologies and generating new market needs.

Part II Outline

The model of techno-economic environments has been developed and simulation analysis has been conducted to determine the contingent criteria that influence strategies success. This model enables the characterization of the techno-economic environment beyond the variables that are treated by the classical decision making tools (*e.g.*, costs, probabilities...). The proposed model incorporates the evolving in time environments by adding a possibility of new functions appearance and their evolution, and deals with interdependencies among technologies and markets. Moreover, it enables the consideration of different types of technologies according to their level of compatibility, flexibility and adaptability. The model aims to investigate the performance and conditions of different strategies in the situation where the industrial dynamic has the same order of magnitude as the time of development. The findings reveal the contingent criteria that determine strategies applicability in highly uncertain environments.

The results indicate that there are two main contingent variables: the existence of a clear market signal and the technological systems that are more or less segregative. The analysis confirms that in scarcely innovative environments market pull is relevant for the environments with reliable market signal (dominant markets). The technological compatibility is not important in this case and one can account for “segregative” technological system since learning and path dependency are not taken into account by this strategy. We show that the design of generic technology is relevant for the environments where reliable market signals are absent and technological systems are aggregative.

This work provides important indications for decision makers faced with the unknown situation. The areas in which the classical business logic of finding profitable solutions for promising markets by managing and reducing risks is not valid are indicated. In these situations the importance of criteria to valorize multi-market explorations appeared to be necessary. This leads to the identification of the contingent variables for different, contrasted, business plan models, from the risk reduction ones to the **genericity building** one.

This part demonstrates that management of double unknown situation occurs through the exploration of technological and market structures, interdependencies and dependencies elaboration within multiples functions, technologies and markets. These structures evolve faced with external environments. The introduced techno-economic conditions help to define pertinence of the corresponding strategies for the design of generic technologies. Yet, the process itself and methods for genericity exploration remain unclear. The following part aims to clarify the process of GT design.

Corresponding paper: Kokshagina, O., Le Masson, P., Weil, B., Hassen. A., Cogeze, P. 2013 Supporting or killing the design of generic technologies? Towards a new model of business plan. – working paper

Part III

Methods and process for generic technologies design: the notion of generic concept and genericity improvement

"It is the framework which changes with each new technology and not just the picture within the frame"

Marshall McLuhan

Part III: Methods and process for generic technologies design: the notion of generic concept and genericity improvement

Chapter 8 Method of engineering design and theoretical basis behind the design of generic technologies: The new notion of generic concept 143

1. Design of generic technologies: genericity and genericity Building.....	143
1.1. On the notions of generativity and genericity	143
1.2. Formal design theories on their way to account for various genericity forms	145
2. The new notion of generic concept.....	152
2.1. Generic technologies design using C-K design theory formalism	152
2.2. Research approach	153
2.3. On the genericity of steam engines.....	154
2.4. Do Micro-Electro-Mechanical Systems (MEMS) attempt to become generic?.....	157
2.5. Genericity improvement at the core of the engineering design.....	160

Chapter 9 Strategies to acquire genericity: strategies of validity domain $D(x)$ design... 163

1. Strategy of domain design creation by environment superposition.....	163
1.1. Method for generic technology design through the environments superposition	164
1.2. Empirical case: 3DTouch haptic solution at STMicroelectronics	164
2. Strategy of domain design creation by environment projection	167
2.1. Method for generic technology design through environment projection	167
2.2. Empirical case: HEATec project exploration at STMicroelectronics.....	168
3. Strategy of domain design creation by designers attraction – “genericity co-design”	170
3.1. Design method for generic technology design by participants attraction	170
3.2. Empirical case: GreenNET project exploration at STMicroelectronics.....	171
4. Conclusion: towards higher “genericity building”	172
4. Conclusion: towards higher “genericity building”	172

GT is a technological platform, which contains a core that is independent from market applications. The literature mostly focalizes in the dissemination and commercialization of the technological platforms and assumes that platform is given in advance. Though, in double unknown neither core nor the corresponding market modules are determined. *Ex ante*, which model can be used for the design of the GTs?

With the help of the formal design theories, **Chapter 8** aims to define what is generic concept and what are its corresponding properties, specificity and the methods of GT design. This chapter models the design of GT with the help of the C-K design theory. To demonstrate the possible extensions of applications range, different forms of domain of existence are used: formal mathematical models and engineering models. The notion of generic concept is defined. The introduced generic concept targets the creation of domains of existence that are not reduced to one solution but several of them that can be known or partially unknown. The importance of the existence domain for genericity building in unknown is stressed. The examples of genericity building are shown in the case of the steam engine and the micro-electro-mechanical systems (MEMS) technologies design.

To further investigate the genericity building, **Chapter 9** continues by applying the derived methods to the empirical study of advanced technologies development at STMicroelectronics. This enables the introduction of three strategies of the creation of domains of existence to account for higher genericity building.

Chapter 8

Method of engineering design and theoretical basis behind the design of generic technologies: The new notion of generic concept

“The march of science and technology does not imply growing intellectual complexity in the lives of most people. It often means the opposite”

Thomas Sowell

1. DESIGN OF GENERIC TECHNOLOGIES: GENERICITY AND GENERICITY BUILDING

1.1. On the notions of generativity and genericity

Design science can be seen as science of **generativity** (Hatchuel et al., 2011). *Generativity* is defined as a capacity to generate the set of various alternatives; it is an “ability to produce novel design proposals”. By comparing generativity and robustness¹¹ it is shown that the design theories become more generative and less dependent on predefined objects while keeping the level of robustness. According to the authors, the evolution of design theories establishes that generativity can be seen as a “*systematic model of thought that both creates new objects with desired properties and provides the new knowledge necessary to warrant their existence*”, which distinguishes generativity from a “natural” capacity of the mind to produce novel ideas, meaning creativity. By its definition generativity is relevant for the exploration of double unknown situations, as it can provide some insights on the process of the controlled exploration of new objects comprising technologies and market. What is the relation between genericity and generativity?

¹¹ Robustness is defined as an ability to produce design proposals that resist variations of the context Hatchuel, A., Le Masson, P., Reich, Y. & Weil, B. (2011) A systematic approach of design theories using generativeness and robustness. Proceedings of the 18th International Conference on Engineering Design (ICED11), Vol. 2..

The formalism stemming from the most recent design theory – C-K design theory formalism (Hatchuel and Weil, 2003, Hatchuel and Weil, 2009) – increases the capacity to control a design process and augment its expansion power. C-K stands for the propositions that the design can be represented as the interplay between two interdependent spaces: the space of Concepts (C) and the space of Knowledge (K). The space of knowledge contains propositions that could be assigned with a logical status, which means that they can be considered true or false. The space of concepts represents the desired unknown, a set of propositions, which are still undecidable relatively to current knowledge. The notion of concept appears as an initial brief. It is formalized in the theory as « *There exists some object x for which a group of properties P_1, P_2, \dots, P_n are true in K* » (Hatchuel and Weil, 2009), so that a concept remains undecidable with respect to current K . Generativeness of the C-K theory is driven by both new objects and new knowledge creation from the design process, it often brings revision of an object’s identity (Hatchuel et al., 2011). A design process mobilizes the initial knowledge to formulate the initial concept and organize a design process to transform this undecidable yet proposition into a true proposition in K . During this process of collective C and K spaces enrichment, a variety of solutions are explored through various partitioning and therefore increase generativity. It aims to create objects with desired properties and ensures new knowledge exploration for their existence (Figure 22).

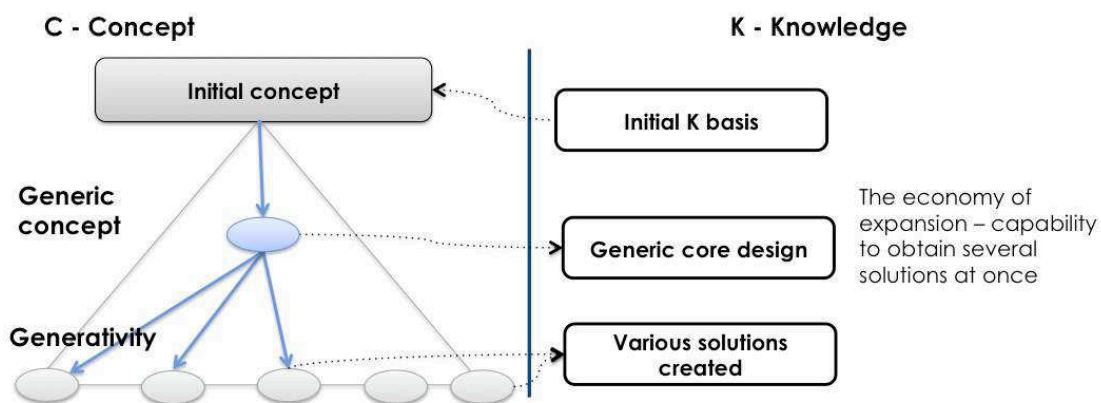

Figure 22 - Generativity and genericity

Targeting generic technology design, **genericity** can be defined as a capacity to generate a common core that addresses sets of emerging applications. Genericity seeks to integrate economic reasoning, by taking into account the economy of knowledge expansions for new objects creation. It aims to obtain several solutions at once (Figure 11).

1.2. Formal design theories on their way to account for various genericity forms

How has genericity been tackled by design theories so far? Formal design theories aim to reach mathematical and logical rigor to formulate hypotheses and prove their findings (Hatchuel et al., 2011). The following formal design theories were chosen for the study: General Design Theory (GDT) (Yoshikawa, 1985), Axiomatic Design (AD) (Suh, 1999), Coupled Design Process (CDP) (Braha and Reich, 2003), Infused Design (ID) (Shai and Reich, 2004), and Concept-Knowledge (C-K) design theory (Hatchuel and Weil, 2009). The design theories do not explicitly discuss technologies and genericity, but rather design solutions (Pahl and Beitz, 1995).

According to the design theories formalisms, a design solution has to be robust at least to one or environment. The set of environments, for which a solution has to be validated, is called here a *domain of existence*. The domain of existence comprises known and yet-unknown environments. To deal with GT building, the forms of genericity and technology should be distinguished within the design theories (Table 11). We attempt to examine formal models and demonstrate their corresponding forms of genericity.

The first design theory that is based on design formalism with rich mathematical foundation is the **General Design Theory (GDT)** (Yoshikawa, 1985) which “clarifies the human ability of designing in a scientific way and producing the practical knowledge on design methodology”. In GDT a design solution is an entity included in specifications and contains necessary manufacturing information (Reich, 1995). Entities are characterized through subsets that are either functions or attributes. The design process consists of determining a domain on the attribute concept space which addresses the specification defined by a concept function space. The design process is limited to the combination of prescribed functions and structures following axioms of GDT. According to the theory, if the entity space has Hausdorff structure¹², we can address all the functional combinations, which mean that all the entity sets are known and each element can be described by abstract concepts. This defines ideal knowledge when the solution might be obtained once the specifications are defined. The problem appears when the space of attributes does not cover completely the set of functional combinations. Hausdorff correspondence is impossible to construct and all the functional combinations cannot be addressed. This is the case of real knowledge where the future design solutions depends on how the design rules will be established to define the correspondence between the spaces (for more details see Kikuchi and Nagasaka (2002)).

¹² Hausdorff distance is defined as the «maximum distance of a set to the nearest point in the other set». It is the greatest of all the distances from a point in one set to the closest point in the other set.

This theory enables building a form of genericity associated to the set of functional combinations. Functions influence the context of the design space, since they define the input for the design specifications. The structure of entity space defines genericity. According to genericity building, Hausdorff distance enables the estimation of the maximal effort to link functions with the corresponding attributes. When the structure of entity space has Hausdorff structure (ideal knowledge), maximum genericity can be obtained. Following the Table 12, once 2^7 combinations are covered, the highest genericity is built. If not, genericity can be conceived only according to certain subset of functions. Genericity can be analyzed as a Hausdorff measure of an entity space. The technology can be considered as the structure of attribute space available to address the function space in (Table 12).

In **Axiomatic Design (AD)** (Suh, 1999) the design process occurs in the physical domain and functional domain. The goal of the designer is to build mapping between functional requirements (FRs) in the functional domain and design parameters (DPs) of the physical domain by selecting proper DPs to ensure FRs. In the axiomatic approach design is controlled by two axioms of Suh: the independence and information axiom¹³. By obtaining the decoupled diagonal matrix of FRs and DPs, one can address each function separately or developed DPs can be changed according to each function independently. If a matrix is decoupled then the designers will be able to reach all the functional combinations.

Genericity is based on the range of FRs achievable by DPs (where FRs and DPs can be mathematically represented as a vector and the relations between them as a matrix). The higher genericity is obtained when the relations in between DPs and FRs are ensured by the independency axiom and the matrix is diagonal. For instance, if FR_1 and FR_2 are independent and the matrix is decoupled, all the functional combinations including these functions can be achieved. Otherwise, if the functions are dependent and the matrix is coupled, a generic solution is not available. So genericity can be seen as a hypercube structure that defines the relations in vector space of FRs (Table 12). Although, AD provides a powerful and robust method to construct genericity, the latter can be built knowing the environments. The technology can be defined as the set of FRs and DPs relations in (Table 11).

This theory is indifferent to knowledge expansions and as in GDT genericity is constructed by a reference to fixed referential. Both AD and GDT propose ways to deal with complete functional spaces when the design space has a particular structure (Hausdorff space in GDT and axiom of

¹³ The Independence Axiom: an optimal design always maintains the independence of FRs.

The Information Axiom: The best design is a functionally uncoupled design that has the minimum information content Suh, N. P. (1999) A theory of complexity, periodicity and the design axioms. Research in Engineering Design, 11, 116-132.

interdependence between FR and DP in AD). The design is possible when the context is described through these particular structures. We see truly that if the environmental context is “invariant” (like FR – DP relations defining a structure of design space), the design is possible.

The **Coupled design theory (CDP)** captures the interplay between the design descriptions, which are defined by a pair of functional and structural descriptions (Braha and Reich, 2003). This theory offers a way to organize the design process of functions and descriptions co-evolution by transition in ‘closure’ spaces. Creating functional or structural closures at each design step enables the integration of new knowledge and consider functions emergence from ‘closure’ spaces. It means that between functions there are order relations. This theory formalizes exploration in partially unknown spaces and closure operators lead to conceive not just existing functions but also their proximal refinement. CDP enables the treatment of genericity beyond initial functional combinations. Genericity can be explained as a set of closure operators - future functions. The higher genericity could be achieved thanks to the closure operators, which allow the modeling of the emergence of new functions and aims to design generic solution to account for these functions.

CDP enables *genericity building in unknown* by integrating new words, by building the set of design requirements during the process. Technology is described as functional and structural descriptions.

Infused design (ID) enables bringing the design problem representation up to a mathematical meta-level (Shai and Reich, 2004). This permits not only the creation of functions and organizing explorations in closed space proximity like CDP, but also the integration of new knowledge from other disciplines. In ID, instead of looking for closure functions, the goal is the common representation composed of model type M and associated terminology $T - (M, T)$ that accommodates all the original ones. The (M, T) defines the problem and the ID privileges transformations of original into reference problems. These transformations are based on mathematical operations of duality, generality, and equivalence.

In ID the genericity can be defined as the combination of classical genericity inside each problem and the form of genericity between them. The first type of genericity is similar to the ones in CDP, AD and GDT. The second is ensured by transformation operators and brings the power of knowledge generation. This is a form of genericity induced by unknown that relies on several knowledge domains. Genericity construction is based on the operators and not defined over space. ID explains how to design by making use of structures in multiple domains.

Concept – Knowledge (C-K) design theory (Hatchuel and Weil, 2009) does not use mapping in between functions and attributes. It defines the design process as a continuous refinement of a concept described by various properties P_i that need to be met based on existing knowledge, and producing new ones. According to C-K theory, creative design requires an expansive partition. This

partition will enable creation of new attribute(s) P' that was not initially an attribute of x in K . This theory models the integration of new knowledge and connections amidst knowledge disciplines using operators of knowledge disjunction ($K \rightarrow C$), conjunction ($C \rightarrow K$), and expansion ($C \rightarrow C, K \rightarrow K$). In C-K, genericity goes beyond the validation of *ex ante* targeted sets of specifications. It includes all the new objects generated by K-reordering (as well as new concepts), *i.e.* by combination of the newly designed object with the previously known objects, the combination of the new and the old knowledge. This is the effect of the newly generated knowledge coming from the exploration of previously unknown concepts on the K space. Genericity improvement in C-K appears to be linked to the expansion strategy: there is a certain anisotropy in expansions to improve K-reordering in order to obtain higher genericity. For example certain designs may only enable limited K-reordering – object identity preservation (in case of ASIT see (Reich et al., 2012)) – or the complete object recomposition – object identity discussion (Hooge et al., 2012). Besides in C-K formalism, technology is defined using the initial K space (Table 11). Contrary to the other theories C-K does not make any hypothesis on the structure of “invariance” and thus, by using C-K we could examine the influence of various knowledge structures on the genericity design in unknown.

Table 11 - Genericity and Technology in Design Theories

	GDT	AD	CDP	ID	C-K
Technology	Structure of entity space	Set of FRs and DPs relations	Functional and structural descriptions	Set of models and terminology in each and across domains	Initial knowledge (K-space)
Genericity defined over extension domain	Functional combinations	Range of functional requirements	Functional combinations and new words	Within problems (discrete models) and duality across problems	K-reordering, Concepts
Genericity Improvement	Hausdorff measure	Diagonal matrix (independency)	Closure operations	Transformation operations	<i>Descriptors of existence domain</i>
Genericity by reference to a fixed referential			Genericity induced by unknown		
Defined over Space				Genericity operators	

On the whole, the existing formal design theories give a tendency to predefine generic space that can be constructed through combination of known and unknown. Based on the literature review of the design theories, different types of genericity were identified: **genericity by reference to a fixed referential in known environments** and **genericity induced by yet unknown ones**. In case of known environments, GDT and AD provide powerful solutions. Regarding *genericity in unknown*, it has been demonstrated that the design theories evolution brings the possibility to reason on yet unknown environments (CDP, ID and C-K). There are various forms of descriptors of existence

domain for genericity building. The most generative formal models lead to distinguish *genericity defined over a fixed referential* (entity space, functional space, closure space) and *genericity obtained by descriptors that help to propagate and hybridize the new into the old*, beyond the new validated conjunction (Table 11). These descriptors can be 1) deduced from existing knowledge (as in case of duality operator in ID), meaning that the rules of propagation exist and are used for knowledge propagation or 2) can be conceived during the exploration.

The literature review reveals different genericity building operators but their contribution to acquired genericity can be demonstrated only when the results are achieved. How can these operators be identified at the beginning of the design process and how to account for *higher genericity in unknown*? As with any other design process, a generic technology design starts with an initial concept. **Which type of concept leads to genericity creation? What are the associated operators, knowledge structure and reasoning associated with genericity design?**

Table 12 - Genericity in design theories

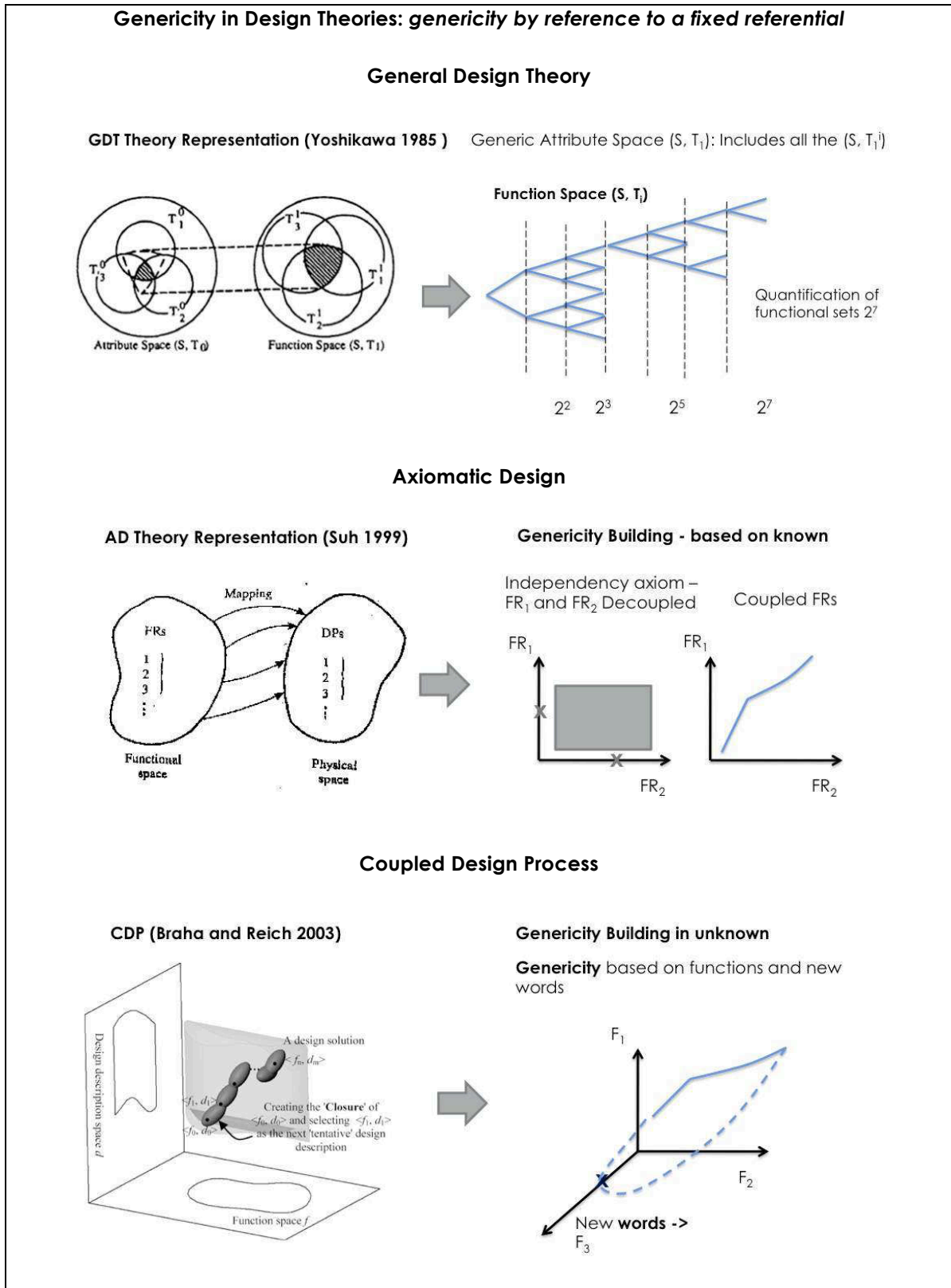

Genericity in Design Theories: genericity induced by unknown

Infused Design

ID Theory Representation (Shai an Reich 2004)

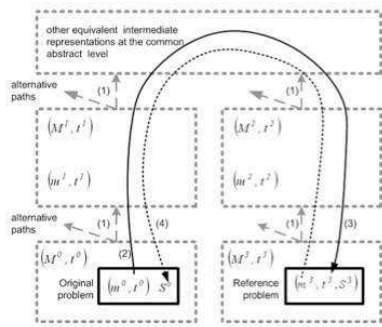

Genericity Building induced by unknown - operators

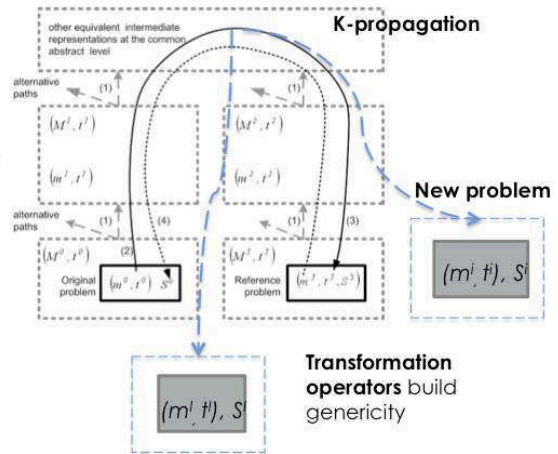

Concept – Knowledge Design Theory

C-K Theory Representation (Hatchuel and Weil 2003, 2009)

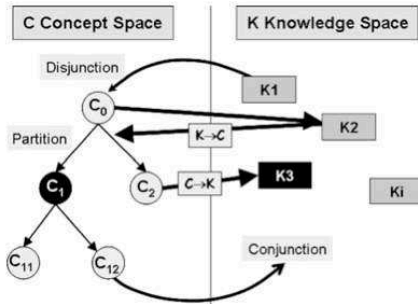

Genericity Building induced by unknown - operators

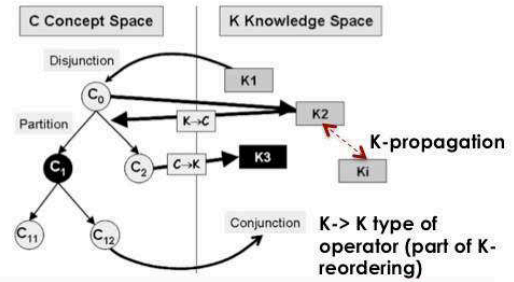

How to design a **domain** ≠ a single solution?
Which operators to design genericity?

2. THE NEW NOTION OF GENERIC CONCEPT

2.1. Generic technologies design using C-K design theory formalism

From the C-K theory design perspective, generic technology attempts to mobilize the available or easily accessible knowledge but still looks for radical knowledge disruption in C space. Given the practical constraints (fixed R&D budget), the goal is a disruption that maximizes the value of the future solution but minimizes the distance between knowledge domains in terms of effort to achieve this disruption. The objective is to identify the minimal partition that provokes maximum expansion (dK, DC), a **powerful expansive partition to obtain generic technology**.

Compared with the classical design process modeled with C-K formalisms, the objective of genericity building is not to generate a single solution through the appropriate connection between knowledge structure (C-K conjunction). As seen in the Section 1, the objective is on the contrary to preserve a diversity of initially independent knowledge structures and to create propagation effects between these structures thanks to a “generic concept”.

This generic concept should be created through the design of **interdependencies** between some of the initial knowledge structures (which we will call the “**connectivity**” operation). The concept in C-K is defined as “*x such that $P(x)$* ”, where $P(x)$ – are properties of the knowledge structures. The goal is to find a “void” in knowledge space that could lead to the creation of generic concept, which in turn extends the knowledge basis and redefines the **domain of existence**.

The expansion generated thanks to the generic concept provokes a K-reordering, which in turn changes the space of possible designs associated with the initial structures in K. The latter is called **domain of existence D**. Indeed, this process is similar to scientific discovery that pushes the boundaries of the existing limits, opens up new possibilities and thus, extends domain of validity of scientific theories. This operation leads to associate this new **domain of existence D**, where the existing structures evolve and create new opportunities to the generic concept itself: the domain is dependent on the first connection that was realized through the generic concept. It is important to underline that the notion of domain is incorporated within the existing knowledge structures. The idea behind the genericity building consists of seeing how the domain can be extended or organized to account for higher genericity.

Finally, **the design of interdependencies** and the **construction of the domain of existence** lead to define **generic concept “*x such as $P(x)$ over D*”, or directly $x, P(x), D$** . Once generic concept is established, the process follows by **densification** operation that is based on the interaction of generic concept and domain of existence to build new rules and extend the solution to other application

areas. Based on the process of generic technology design, the generic concept capacitates the elaboration of a new domain of multiple solutions and not just a single one.

Definition: The **generic concept** targets the existence domains that are not reduced to one solution but several of them, both known and partially unknown. The several environments for which a solution has to be validated are called here **domain of existence D** . Genericity is based on the existence domain. A generic concept can be presented as $xP(x)$ over the domain D . In C-K theory when one particular conjunction in space C is achieved, a new entity can be created P' . In K space propagation operators need to establish the relations between P' and all the other knowledge entities K_1, K_2, \dots, K_n using the descriptors of existence domain d_1, d_2, \dots, d_n included in D . Once a conjunction based on the generic concept is obtained, a new object X is designed with all the corresponding properties $P(x)$, and D enables its propagation for all the relevant and emerging knowledge entities, establish new interdependencies and increase genericity (Figure 23).

D ensures the compatibility among x and all the knowledge basis of existing solutions K_1, K_2, \dots, K_n . Once $xP(x)D$ is defined, new objects may be formed in K that are created from a combination of X and K_1, K_2, \dots, K_n . D allows the creation of interdependencies between previously independent fields. The conducted work reveals that the descriptors of existence domain D could be identified from the initial knowledge ($D \in K$) or conceived during the design process ($D \notin K$) (for a detailed description see Appendix).

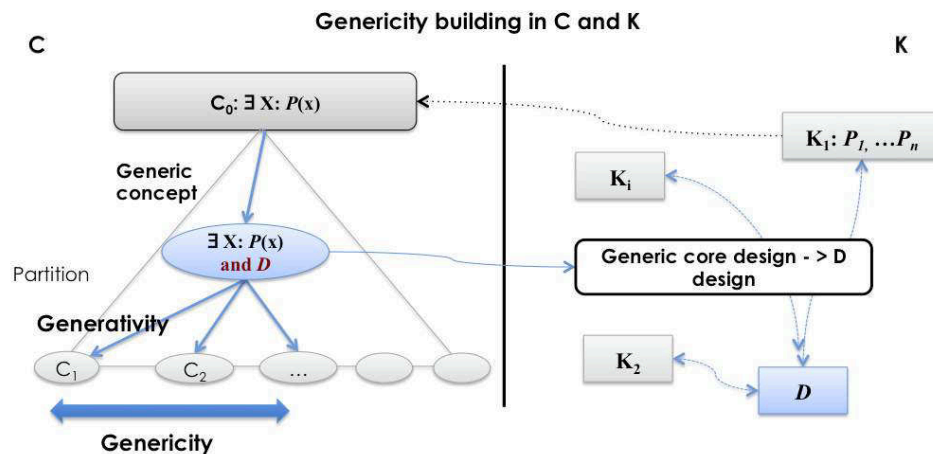

Figure 23 - Generic concept definition

2.2. Research approach

Still, the notion of generic concept with the form $xP(x)D$ is not evident to ensure in practice. The design of generic technologies depends on the nature of knowledge used in the process. The

probability that Watt and Boulton will prioritize the use of rotary motion to construct D is implausible (see **section 2.3**). The construction or identification of the existence domain appears to be crucial for success of GT design. Still, it requires a particular scientific effort to manage the design of GT. How does D evolve over a design process and how can one improve the design of D ?

First of all, for the theory building different examples of genericity construction were used, drawing on the historical, engineering and mathematical examples. This work accounts for well-known example of GPT - steam engines and MEMS technology development.

To demonstrate the possible extensions of applications range, different forms of existence domain are used: the formal mathematical knowledge structure using the examples of algebraic field extension (see (Kokshagina et al., 2013)) and engineering models using steam engines (2.3) and MEMS technology development (2.4). The aim is to understand the underlying processes that lead to genericity construction in the cases where there are various knowledge structures. The forms of genericity when a domain D is known differ from the cases where it is designed through the process of exploration itself.

The generic extension mechanisms are investigated on the cases of mathematical knowledge structure: algebraic and complex field extension. In mathematics various extension operators could be interpreted as design (Hatchuel et al., 2012a). The main idea of field extensions is to start with a base field and construct a larger field that contains the base field and satisfies additional properties. In case of algebraic extensions knowledge basis K is defined and propagation rules are ensured by mathematical operations of addition and multiplication. Using mathematical knowledge structure, we analyze how to account for a larger field and to obtain the set of solutions and not just a new number by starting from the initial concept.

By analyzing historical examples of Watt and Boulton generic design of steam engines and MEMS technology development, the underlying principles of genericity design were revealed. These cases were used to understand different mechanisms of genericity construction.

2.3. On the genericity of steam engines

The descriptors of existence domain D can be identified from the initial knowledge or conceived during the design process. Based on the knowledge structure they can take various forms. When we deal with engineering design, D has to ensure the compatibility of an object and associated environments. To study the particularity of generic concept identification and D formation, the steam engine example is chosen. The steam engine is recognized as a general purpose technology (Rosenberg and Trajtenberg, 2004) used in various domains as reciprocating pumps, spinning mules, driving machinery in factories, mines, and propelling transports. The story of the steam engine's development is often interpreted using the evolutionary model of a successful trial applied

consequently on a sequence of applications. According to this model, Watt designed a steam engine and progressively applications appeared to use this generic technology. Based on the analysis of historical literature of the early development of steam engines (Dickinson, 2010) we aim to investigate whether the genericity of steam engines was achieved following evolutionary trial and learning process or more intentional design driven strategy.

In the late 17th century flooding problems challenged mining activities in Britain. The pumping solutions to lift water out of mines were actively explored. The first successful design is known as Savery engine (1695 - 1702), where steam was first admitted and then condensed inside a vessel by pouring cold water outside and following steam condensation, atmospheric pressure drives the water to be pumped up into the vessel (Frenken and Nuvolari, 2004). Yet, the engine enabled the demonstration of the potential of steam power, rather than how it was really used in practice due to its height limitations in raising water (around 6 m), and its high power consumption to recreate steam inside the vessel at each stroke.

In 1712, Thomas Newcomen, dealing with the increasing need in energy, developed atmospheric engines that brought benefits to mills, but they were inefficient in terms of the energy use to power them. Handling this problem of energy loss in both Savery and Newcomen's designs, James Watt developed a steam engine with a separate condensation chamber (1763). The main use of these designs was to pump water out of mills (Figure 24).

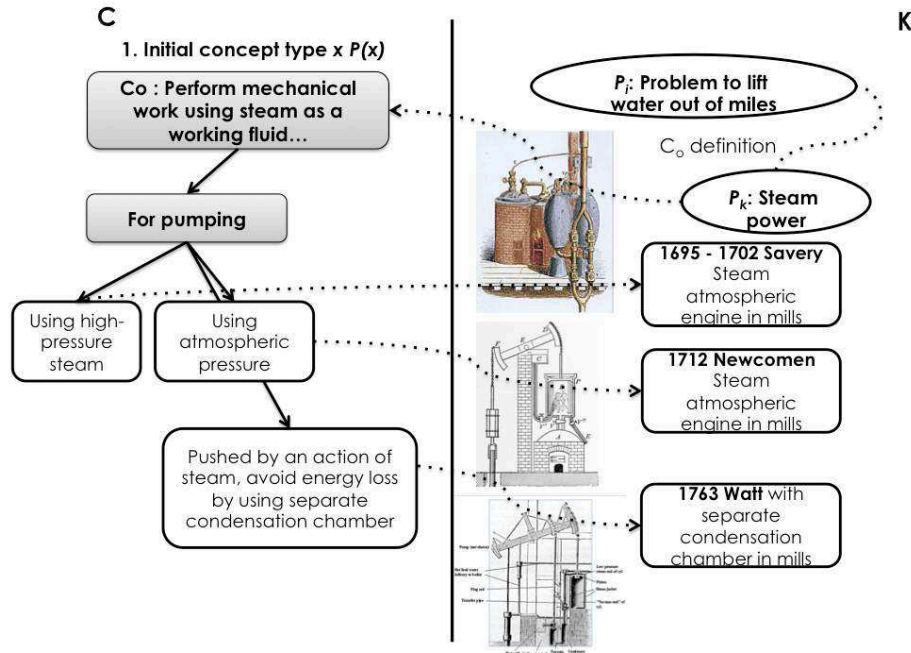

Figure 24 - Early steam engines design in C-K-theory

In 1780s Watt's business partner, Matthew Boulton, an entrepreneur aware of the issues of the newly emergent industry (in particular iron work, through his collaboration with Wilkinson), had an idea to develop an energy source compatible with industrial systems like textile factories, driving machinery. According to Dickinson (2010),

"Boulton created the environment which enabled Watt to work on the further instrument that brought steam engines from an apparatus for lifting water into the one with an immensely larger field of application to general power purposes".

He built existing knowledge on commonly deployed water wheel energy sources to ensure rotary motion between energetic source and the mechanism that uses this motion. In 1781 Boulton wrote to Watt:

"We should determine to take out a patent for certain methods of producing rotary motion" (Dickinson, 2010).

Watt's development of double acting engine converted reciprocating into rotary motion which resulted in a more uniform movement of the piston (Frenken and Nuvolari, 2004). The double acting engine became state of the art for applications with rotary motions

The generic concept is based on the domain building by preserving the system of water wheels energy transmission (Figure 25). The generic concept emerged through the connectivity of two distinct knowledge bases: steam power and a water wheel that uses rotary motion. The design of a set of entities was achieved through the identification of one descriptor of existence domain – rotary motion (*D*). This concept is generic since it is compatible both with known environments, where the energetic source can be transferred by rotary motion, and with the extensive number of initially unknown environments. It is shown that the key challenge to design genericity was not underlying technology but a new method compatible with the existing systems, a method to convert the steam energy to rotary motion to drive a generator.

Furthermore, Boulton and Watt established standard units of measure for both the fuel efficiency (duty) and the power (horsepower), which lead to further diffusion and economic significance of engines. It is important to underline the effort on genericity appropriation. Once a steam engine with rotary motion was designed, it took years to improve and disseminate them to the markets. For instance, the first locomotive with steam power was introduced in 1804, 20 years after the invention of the first rotary engine. It was possible thanks to a Trevithick's improved high-pressure engines, which discharged exhaust steam directly into the atmosphere.

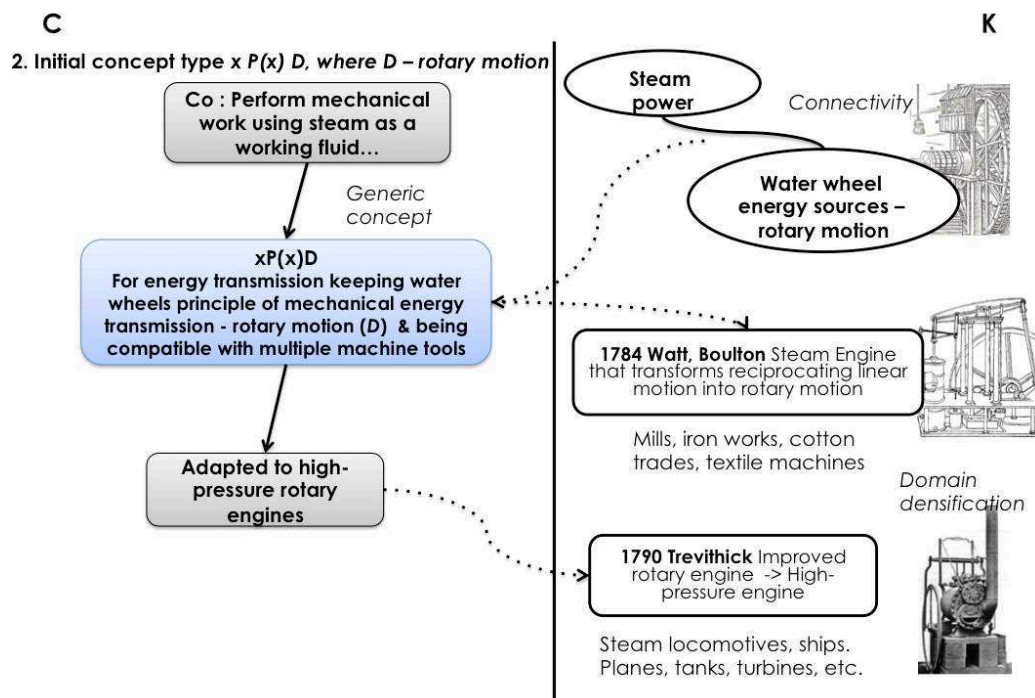

Figure 25 - Generic concept of steam engines

This example demonstrates that what counts is the capacity to enable propagation, and fabricate sets of the relations between objects. Rotary steam engines use existing descriptors of existence domain to design new objects. **It is shown that D is a shared property (rotary motion) that guides the design process and is used in every application through further domain densification.** The generic character of steam engines was not obtained thanks to the evolutionary market exploration process, Watt and Boulton engines were not just a generalization of already existing steam engines. It was an intentional genericity design process, which did not result in a completely original solution, but on an enabling principle of movement transformation and a continuous effort of validity domain design. In this respect, Boulton ensured constantly growing interest in steam power from the unusual market areas (like breweries, textiles) by exposing success market stories of already implemented design (e.g. the famous Albion Mills in London), by publishing technical booklets that facilitate the use and maintenance of engines by their owners directly (Pyka and Hanusch, 2006).

2.4. Do Micro-Electro-Mechanical Systems (MEMS) attempt to become generic?

Micro Electro Mechanical System (MEMS), micron-size devices that can sense or manipulate the physical world, are exceptionally diversified. MEMS encompass the process-based technologies used to fabricate tiny integrated devices and systems that incorporate functionalities from different physical domains into one device. MEMS revolutionized various product domains and created new

ones by bringing together silicon-based microelectronics and micromachining technology (Bryzek, 1996).

In the last decade, MEMS have provoked revolutions in several industries. Just to cite some of them: arrays of micro mirrors enabled digital film projectors, accelerometers like those in Wii controller have changed gaming, the iPhone 4 became the first portable consumer device to incorporate a three-axis accelerometer, three-axis gyroscope, and three-axis electronic compass. MEMS became a generic technological platform that enables the development of products, augmenting the computational ability of microelectronics with the perception and control capabilities of micro sensors and micro actuators, expanding the space of possible designs and applications. MEMS technology is the integration of mechanical elements, sensors, actuators, and electronics on a common substrate through micro fabrication technology (*D*). MEMS appear as a set of technologies, a group of manufacturing processes that comprise the second micromanufacturing revolution (Walsh, 2004). (Figure 26).

MEMS development started in the 1950s when silicon strain gauges became commercially available. Not long after this, Dr. Richard Feynman, in his famous talk “There’s plenty of room at the bottom”, described the tremendous potentials in the micro technology field. After the invention in 1967 of surface machining of the first silicon accelerometer, micro machined inkjet nozzles were developed (Heeren and Salomon, 2007). Yet, genericity was not acquired at that moment.

In the mid 1990s two MEMS enabling technologies appeared. First, the deep reactive ion etching of silicon made possible to etch deep high aspect ration trenches into silicon. Second, the development of silicon on insulator wafers enabled high quality silicon layers for micromechanical structure. Thanks to these technologies, the micromechanical components were fabricated using compatible micromachining processes to selectively etch away parts of the silicon wafer or add new structural layers to form the mechanical and electromechanical devices (*D* design). Through these innovative processes MEMS became a true GT and manufacturing platform. Taking into account the complexity and variety of different technological phenomena involved, MEMS did not have a unit cell like a transistor to progress (Tierney et al., 2013). By using batch process as in semiconductors manufacturing, MEMS manufacturing differs significantly by combining electrical and mechanical processes (Walsh, 2004). MEMS appeared to be truly generic when new descriptor *D* that ensures the propagation and connection within the MEMS-related various technological families emerged.

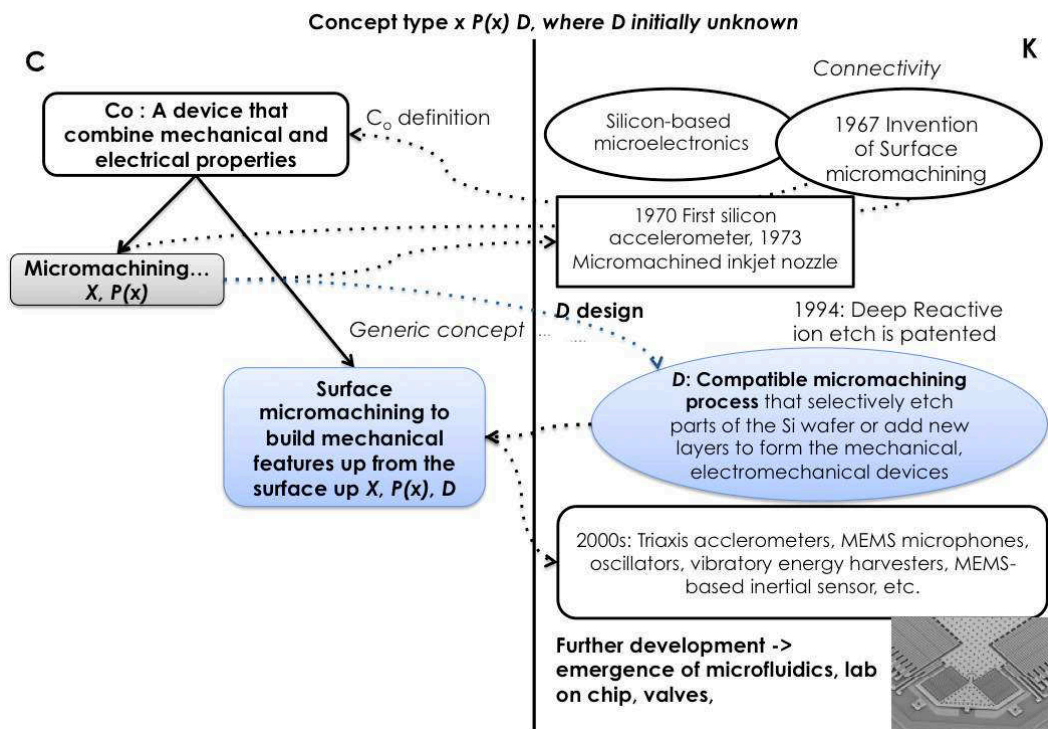

Figure 26 - Generic MEMS technology and D design in C-K-theory

The genericity continues to be built. For instance, the emergence of microfluidics in the medical applications opens a lot of possibilities for MEMS in the drug delivery in Figure 4. Electronic nose applications that use MEMS principles are being developed for a wide range of healthcare and biomedicine sectors and revolutionize the way this traditional sector operates. The further design domain densification is expected once MEMS product adoption finds its way into watches, refrigerators, beds, toys, and clothes, among other everyday things (Lee, 2013).

These two examples demonstrate the importance of validity domain D design to account for successful generic technology design. In the case of steam engines the descriptors that enabled the building of D , were revealed using the existing knowledge on water wheels rotary movement. Conversely, MEMS illustrate the case when the descriptors were unknown initially and were designed. Through the analysis of these two cases, the similar pattern of D definition could be observed. First, it structures the knowledge space by connecting initially independent knowledge bases (including technological phenomena, application domains, etc.) to define generic concept and form an existence domain. Second, once the domain is designed, the connections tend to multiply, new relevant knowledge emerges, independent generic core is formed and new interdependencies could be built to account for higher genericity. Here the more aggregative technologies are, the higher are the chances to build a large validity domain and connect distinct knowledge bases.

There might be a variety of processes to design validity domain for generic technologies. The following part attempts to explore possible ways of acquiring genericity and build existence domains for GTs.

2.5. Genericity improvement at the core of the engineering design

The acquired genericity can be “improved” through further D extension. Drawing on the principles of engineering design, the design process can be accomplished through: planning and clarifying the task, conceptual design, embodiment design, detail design (Pahl and Beitz, 1995). Theoretically, it is possible to account for genericity improvement at each phase until the detailed stage of design is achieved. Embodiment keeps technical specification and the goal is to ensure predefined volumes, which means to ensure compatibility with the identified environments. These are descriptors (D) defined at the level of embodiment (based on design parameters).

In the case of steam engines the compatibility with factory machinery was achieved through rotary motion preservation. Using the principles of engineering design language, the descriptors are defined at the **embodiment level**. Although the existence domain can be defined at the conceptual or functional level as well. For instance, one could think of designing steam engines compatible with various forms of energy transmission. On these terms, descriptors should be defined at the functional level. More generally, genericity improvement is often at the core of engineering science.

Following the axiomatic design axioms (Suh, 1999) the goal is to decouple functional requirements (FRs) and design parameters (DPs), Thus, the engineers seek to combine the right skills to fabricate not only the relations between FRs and DPs, but also to preserve the independence of DPs from other functional requirements (independence axiom). The engineering design approaches allow managing the interdependencies as well as independencies, which is critical for designing generic technologies. From this perspective, any technology already has generic properties.

The design approaches (*i.e.* robust design which is defined as a « set of methods which deal with a consistency of a system functions across a wide range of conditions » (De Neufville et al., 2004)) seek to reduce the uncertainty effects during the design process. For instance, Taguchi methods help to analyze what is the best alternative to meet with varied external contexts. Or other work (de Weck et al., 2003, De Weck et al., 2004) demonstrates how to incorporate flexibility in the design process while dealing with uncertainty and stress the necessity to incorporate market-based risks that are often neglected within the technological design process.

Moreover, the design of genericity presumes the involvement of various experts, and their effective collaboration in order to account for the larger domain of existence. Boujut and Laureillard (2002) point out the importance of tools to organize the effective co-operation and offer a conceptual framework for the development of design co-operation at actor, product and organizational level

within design organizations. The intermediary objects are proposed to facilitate the modeling of the design situations and encourage the co-operation (Boujut and Blanco, 2003). This intermediary objects might be used as a means to work on generic concepts and foster transversal exploration to attain higher levels of genericity. Besides, the design of generic technologies occurs when the level of maturity is not relevant. These early phases of exploration (as indicated in (Legardeur et al., 2010)) are not evident and require collaborative innovation process within and outside company's framework, which calls to investigate the organizational issues and define the actors involved in the process of the design of generic technologies (see Part IV).

The economic reasoning behind the genericity building provides the important insights on the dynamics of engineering systems and the problem of the design of generic technology is at the heart of the engineering systems planning and design.

Chapter 9

Strategies to acquire genericity: strategies of validity domain $D(x)$ design

“One man's 'magic' is another man's engineering”

Robert A. Heinlein

The construction of the validity domain $D(x)$ appears to be crucial for genericity building. What could be the methods to design $D(x)$ in order to attain higher genericity? Chapter 7 indicated that the design of GTs is particularly relevant when the technologies are aggregative. The more flexible and aggregative technologies are, the less-resource consuming (in terms of cost and technological effort) the process of interdependencies building within different knowledge domains is, and thus, it is possible to account for larger D .

The operation of building D is critical for the success of GTs design. The previous section enables to identify the patterns of D creation. Yet, how to build D in unknown to define generic concept? Through the empirical study of advanced technologies development at STMicroelectronics, three strategies of domain design were identified: strategy of environment superposition, of environment projection and environment attraction. Further, each method is formulated and presented using the associated empirical cases at ST.

1. STRATEGY OF DOMAIN DESIGN CREATION BY ENVIRONMENT SUPERPOSITION

The strategies for genericity building were investigated using the projects issued from the internal innovation challenge launched at ST in 2009. This initiative is called the Business Innovation Process (BIP). It was launched between two geographical sites of STMicroelectronics in France (Crolles and Grenoble), and open for all the 6400 employees. These two sites are located in the Rhone Alpes region, known as the “French silicon valley” in microelectronics and nanotechnology. The goal of this process was to develop innovation initiatives that enable potential innovators to address new markets that were outside of the domain of the existing business units, and to deliver solutions for several market areas, but that did not provide volumes big enough to be financed by particular business units. The contest targeted transversality, ecosystem development and value for users and for ST. BIP appeared as a relevant hub for designing generic technology and through detailed

empirical analysis of 3 successful explorations issued from BIP, several strategies of genericity improvement were analyzed

1.1. Method for generic technology design through the environments superposition

This first strategy, which we called “Method of Superposition”, starts by identifying relevant market domains. Market environment superposition enables the identification of common properties that these environments seek. It thus starts from the identification of a conceived concept that addresses market environments E_1, E_2 and all combinations generated from the superposition in between these environments. During the exploration process a descriptor of the existence domain $D(X)$ is progressively built. $D(X)$ is common to E_1, E_2 and all the emerging still unknown environments generated from their combinations. $D(X)$ leads to reusing knowledge associated to an initial technological concept and E_1, E_2 . This method is therefore based on the concept “a T for the identified environments E_1, \dots, E_N and their linear combinations” (Figure 27). It is important to underline that in this case possible market areas drive the reasoning and define the connections to build to address all of them through genericity exploration. Further, the obtained genericity attracts new market areas that seek for similar solutions or even lead to create new applications.

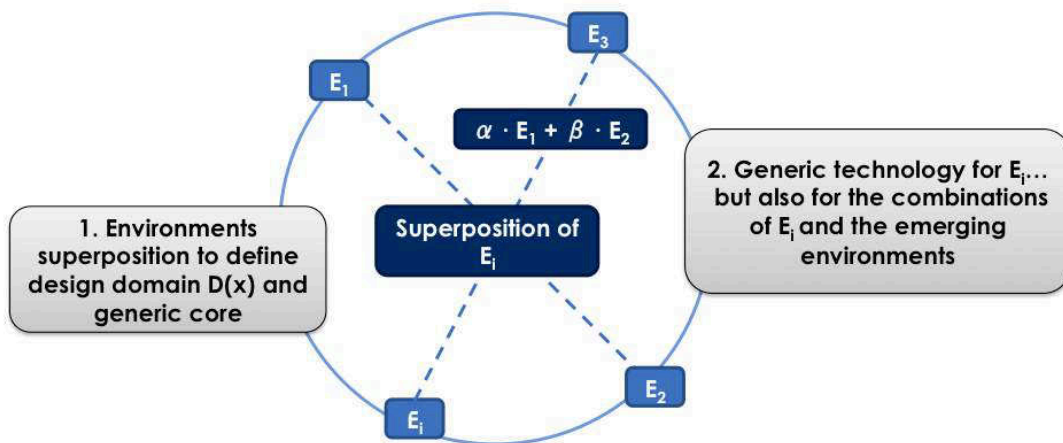

Figure 27 - Principle of superposition

1.2. Empirical case: 3DTouch haptic solution at STMicroelectronics

At ST the 3DTouch project was created with an objective to use an active surface to simulate the haptic touch sensations. Haptic technology is a tactile feedback technology, which takes advantage of the human sense of touch by applying forces, vibrations, or motions to the user to give a “feeling of reality” on touch screens, game consoles, etc. The key proposal of the 3DTouch project is based on the ability to physically sense the texture of an interactive device. The 3DTouch idea aims to transmit to

the user more complex information than the simple acknowledgement of a command through vibration by using the high tactile sensitivity of the fingers. It attempts to develop a technology that provides rich haptic feedback comprising one or more vibratory actuators, which are excited by an electrical signal. ST attempted to develop a haptic multi touch capacitive technology to enable tissue simulation on the screens of smartphones, tablets and PC both using external devices or incorporated directly on the screen for retail e-commerce applications like e-shopping (E_1). The applicative examples could be numerous; for example, hands feeling while touching the sofa material, probing the resistance of leather skin, sensing the texture of clothes will be more convincing to advance e-commerce applications¹⁴. The second type of the considered environment was an eye-less solution that ensures tactile rendering of the "relief" on a keyboard, on a touch screen or even the reverse side of mobile phone and other applications where vision is limited and blindness typing becomes possible. We call this environment a consumer back-typing application (E_2). Moreover, they seek ways to enhance perception in the medical diagnostics domain (E_3). The initial concept was "An active haptic surface to simulate the haptic touch sensations for E_1 E_2 , E_3 (Figure 29)" that aimed to use the active surface to simulate touch by integrating vibratory actuators into various objects comprising a part provided to be handheld.

Each considered environment imposed its functional requirement and constraints. For example, to enable different sensations effects on the tactile screens vibration effects should be integrated by using piezoelectricity principles. Moreover, a database of various vibration simulations according to the tissue properties should be built; actuators should be integrated and controlled. Even if all these market domains search for haptic multitouch technology, some of the functions are specific to each application and even appear to be mutually exclusive (i.e, screen transparency management and actuators management). A technology that would explicitly address functions required by all identified applications requires a complicated and most probably expensive technological exploration. So they seek to superpose these environments to reveal common properties that are essential to each application and are independent from specific environment constraints. Through functional analyses of each environment, the generic concept was defined: "*Notch texture feeling through friction modulation for E_i* ". This exploration enabled to define progressively $D(X)$ through environment superposition. Playing with the resonant frequency of the top glass, they have reduced the friction felt by the user and so produced a texture sensation below the finger. The superposition enabled to build the interdependencies between these areas and create an existence domain that involves all the initially considered E_i .

¹⁴ Source: http://lexpansion.lexpress.fr/entreprise/neuromarketing-et-design-sensoriel-a-l-affut-du-client_379707.html?p=2

Once the genericity was built, it became possible to enlarge the domain by considering and even creating new market applications. For instance, e-books, educational, social networks, gaming solutions through enhanced immersion, gesture learning and object customization, and security. Haptic scrolls emerged as well. The genericity was acquired. Though, the genericity building is still ongoing. Not just new applications could enlarge the design domain $D(x)$, but the generic concept itself can be improved to “consider precise multitouch haptic feedback and volume rendering on flexible displays”. Indeed, the group is working now on how to incorporate haptic feedback and volume rendering in the case of flexible and transparent displays. These could be realized through graphene deposition on organic materials (transparent & flexible material), and integration of electro-active polymers compliant with flexible displays.

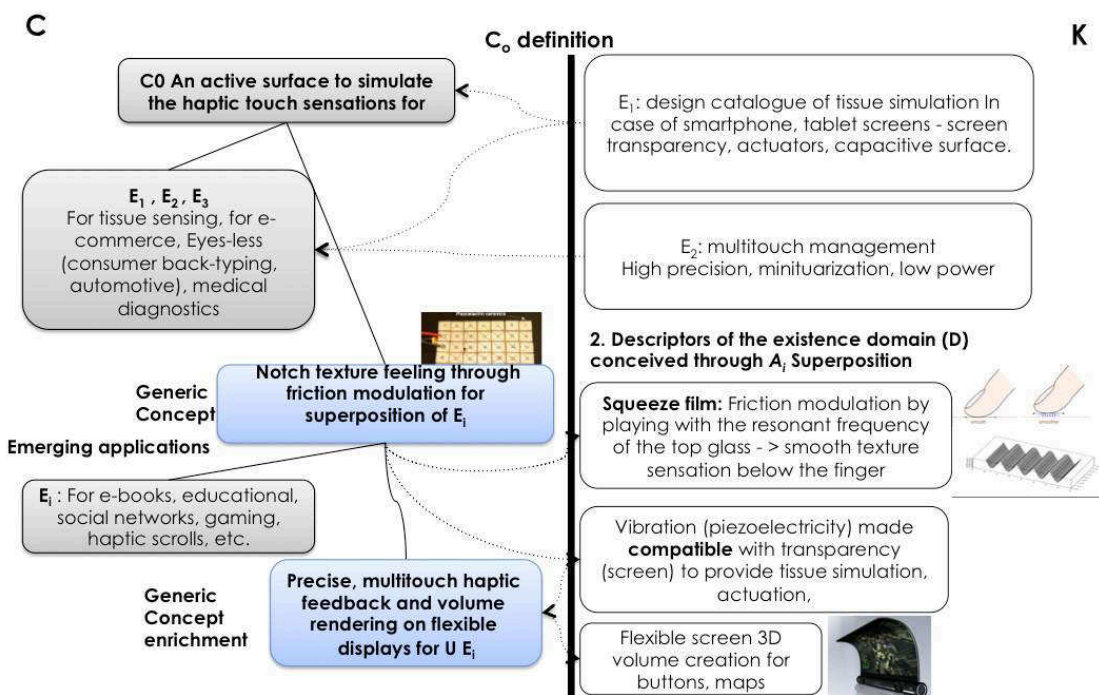

Figure 28 - Superposition strategy “3DTouch” project exploration

The force of 3DTouch was in its capability to maximize the compatibility and the interdependencies creation between various properties and to group common functions in a generic technological core and exclusive functions in specific modules. The objective was to limit project risks by increasing the number of potential markets and their applications. This approach seems to be logical for generic technology design. But it is counterintuitive since intuitively we tend to optimize projects to existing less risky applications (*i.e.*, just develop a back-typing solution for which the market was clearly identified by existing ST clients). It is necessary to underline the essential role of project manager that was constantly seeking for new exploration environments to determine which functions have to be included in a generic core. For example, since the back typing application was the most promising,

he could target the integration of the property of screen transparency in a generic technologic core and it would make it impossible to consider a cheaper tactile back typing solution and other market applications. Thus, the project leader has to prioritize genericity to optimization, which brings about consideration of larger application areas.

2. STRATEGY OF DOMAIN DESIGN CREATION BY ENVIRONMENT PROJECTION

2.1. Method for generic technology design through environment projection

The second strategy, called “Method of projection”, does not seek to superimpose the various market environments. It builds $D(x)$ by seeking for a technology that maximizes the number of markets that this technology attracts. The projection starts with a technological concept definition, whose goal is to develop a solution for an original, specific environment E^* . This environment plays the role of “projector” to learn more on the genericity of proposal and potential existence domains. This environment could be market related or technology related. The exploration of this challenging environment reveals yet-unknown properties of technology T and permits to formulate $D(X)$. The $D(X)$ leads to the opening up of new domains for an identified generic technological solution T' . The creation of new environments conceived with such properties enables birth of a generic technology and multiple applications (Figure 29).

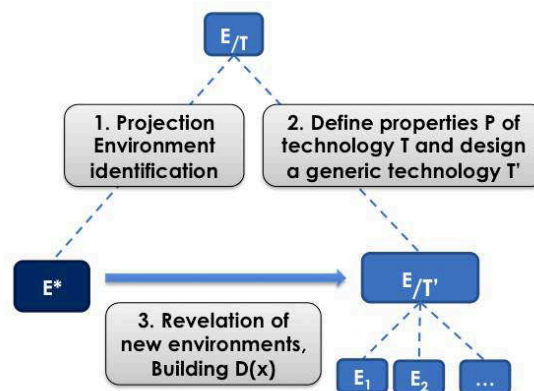

Figure 29 - Principle of Environment Projection

The first targeted environment does not necessary lead to a reliable market but it allows the development of the technological building blocks that provoke new environments emergence and increased technology genericity. Projection initiates with technological knowledge and expertise and therefore, differs significantly from superposition strategy. In this case genericity is not defined through emerging market analysis but thanks to a technology design that conveys the existence

domain creation. Initially this strategy could be confounded with the trial and learning one. This perception is based on the fact that it starts with disruptive technological concept that was pushed to explore market applications. Yet, the exploration does not converge towards an initially defined technology, but both technologies and markets are explored simultaneously to diverge towards a larger market area. The technological concept is projected to the exploration space in order to enrich technology and markets.

2.2. Empirical case: HEATec project exploration at STMicroelectronics

HEATec aims to develop innovative solutions for thermal energy recuperation. At ST the HEATec started based on a particular idea to recuperate energy from the sources that are unexploited today and where thermal gradients are present (E^*) (e.g., electronic equipment, building automation area). The motivation point behind this project is rather classical: it aimed to develop an advanced technology for the emerging needs of energy harvesting (e.g., autonomous wireless networks) that would provide solutions with smaller costs and enable ST to ensure its growth and fab overload. So first a technological principle was determined, a patent of energy harvesting principles was filed and a projection environment was identified E^* . Two technological principles of thermal – mechanical energy conversion were patented. The idea was to initiate an exploration that would push these two concepts towards a reliable technology and develop market applications.

The starting point was to conceive the first targeted environment of non-solar power energy recuperation where a thermal gradient is present. The aim was to make use of the lost energy to power autonomous systems when the amount of converted energy is low or even to create power systems when the conversion efficiency is high. The sources of heat do not have planar forms and thus, the creation of flexible and thin energy harvesters to maximize system efficiency and the amount of recuperated energy would definitely find its uses. Thus, the project team aimed to increase the total efficiency of energy generation through the use of several technological approaches. By working on new forms of electronics that need far less power they aimed to develop a new approach for energy harvesting that generates electricity from a small temperature gradient (Monfray, 2012).

The HEATec searched for a technology that could potentially solve this problem. Initially, they intended to recuperate losses of thermal energy given the importance of the Joule effect in semiconductors. Logically, market areas of mobile consumer market were rapidly considered first due to the importance of energy autonomy, overheating problems and potentially high application volume. The definition of this first technical solution was specific to the constraints of the considered environment. The initial strategic objective was to recuperate thermal energy losses of electronic chips and the technology had to respect a reduced footprint to be integrated in mobile phones. They used first of all the existing Seebeck effect of direct conversion based on the temperature differences to electric voltage and vice-versa that permitted avoiding using commonly deployed radiators.

However, the materials that allow implementation of this effect had to be supplied with bulky radiators that are impossible to integrate in mobile phones. Thus, the project team searched for a new device for thermal – mechanical energy conversion with a small footprint. The solution came with energy transformation in two steps: first, thermal – mechanical and second, from mechanical to electrical knowing that the principle of mechanical – electrical energy conversion is based on a known phenomenon of piezoelectricity (Figure 30).

The innovation of HEATec consists in developing a solution of constant energy conversion from thermal to mechanical impulses. A new technology principle was identified and allowed the development of a prototype. However, the team found out that the orders of magnitude of this technology is nowadays incompatible with mobile phones. Nevertheless, the created technology enabled them to activate new environments. The developed energy harvesting solution could be applied in the various systems with important thermal gradients. The following applications emerged: an autonomous sensor installed close to hot water canalization, smart grids, wall thermal management (building automation area), autonomous healthcare, industrial monitoring, industrial automation, the “internet of things” concepts, etc.

This new principles of energy conversion obtained from the projection allowed formulation of the existence domain and work on genericity. The new principles of energy conversion for E^* convey to design a technology for a large application area and enlarge a spectrum of validity domain. The developed system of energy conversion is compatible with large-scale objects, flexible to adapt to the various systems size and their power and efficiency requirements attract new application domains and thus, increase D and strength genericity.

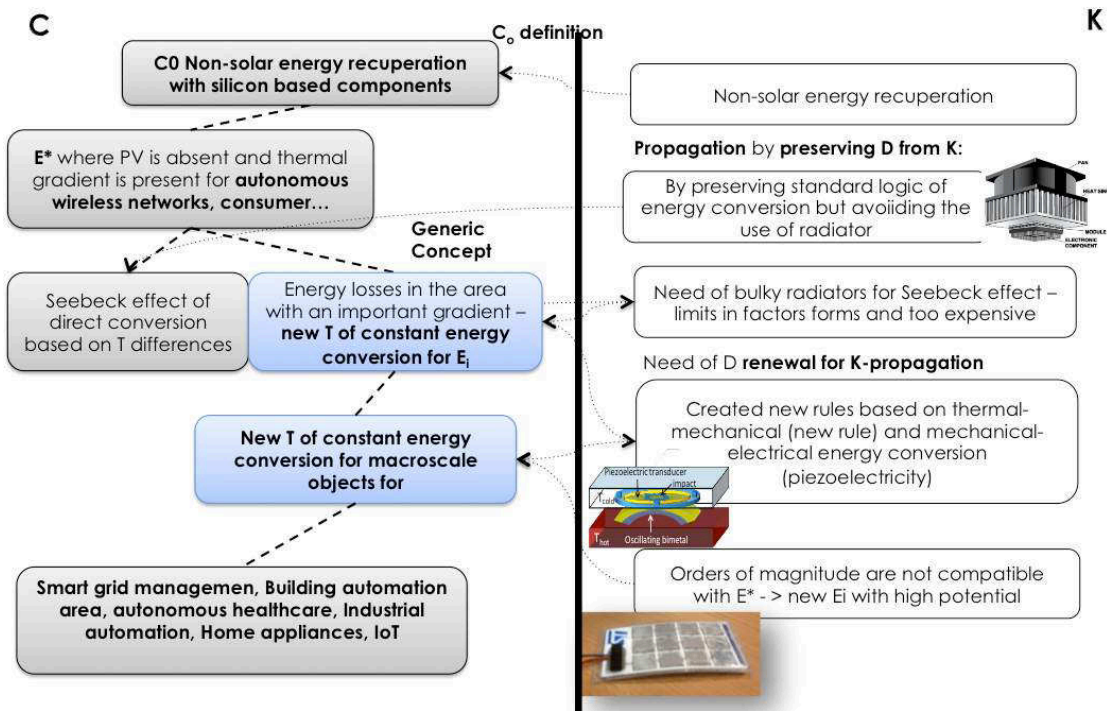

Figure 30 - Environment projection strategy "HEATec" project exploration

3. STRATEGY OF DOMAIN DESIGN CREATION BY DESIGNERS ATTRACTION – "GENERICITY CO-DESIGN"

3.1. Design method for generic technology design by participants attraction

The last strategy identified, which we call "Method of Attraction", starts with a technological concept: the goal is to find a number of actors that are interested to explore emerging environments associated to a potentially generic technology. These actors through the process of co-design enable the identification of the descriptors of the existence domain $D(X)$ that unify these domains of exploration and separate the list of parameters specific to the domain of interest of each involved actor. The genericity in this case depends on the experts of the ecosystem itself, on their capacity to decrease the costs of exploration and integrate the acquired learning. The co-design of the platform within the set of actors enables joining of the effort and allows access to the clients' knowledge databases and their expertise (Figure 31). In this strategy the design domain $D(x)$ is built through the collaborative effort of multiple actors where each one is responsible for the design of a subset of functions that define a part of the domain. This strategy demonstrates the importance of co-development to design validity domain.

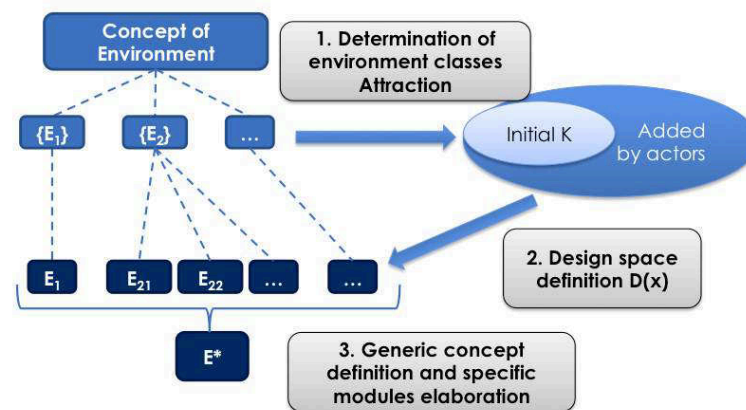

Figure 31 - Principle of Environment Attraction

3.2. Empirical case: GreenNET project exploration at STMicroelectronics

The GreenNET project incorporates the network of autonomous wireless sensors. Wireless sensor network appears as a great opportunity that represents a future of billions of information devices embedded in the physical world and ST searched to position in this emergent area. GreenNet is an autonomous, scalable wireless sensing and computing network. It comprises wireless autonomous sensors available through the merging of existing technological principles to build sensor tags. A set of tags builds a network of sensing, computing and communication nodes and in addition with STAppStore software platform all the applications of the famous Internet of things concepts becomes possible. The project started as a technical solution to monitor vibrations. This environment specifies certain technical principles of future solutions including utilization of photovoltaic cells to enable autonomy and protocol for wireless communication. The platform makes use of set top boxes and mobile phones to manage self-power nodes positioned in various places for temperature controlling, CO emissions, movement sensing, relaying data wirelessly to enable monitoring and control for home surveillance, medical reasons, and industrial control.

As shown in (Figure 32) the solution was already positioned as generic driven by the interest of various markets. Yet, the exact design domain and generic technology behind were not evident. Besides, the design of a complete solution for all the markets including software, hardware, tags, network, sensors, software libraries and system support appeared to be expensive and out of the core ST competence (especially for software part involving B2C). In order to refine genericity and structure propositions, the project leader prioritized co-design by opening exploration to partners and potential clients of ST. This joint work enabled the identification of commonalities among various environments, enrichment of the proposal, and consideration of new applications. It structured the domain D and enabled ST to define its own GreenNet proposal. The developed generic core represents a so-called GreenNet node, which “utilizes core ST technologies in energy management,

silicon-based and embedded wireless sensors to create the network node free of wires or any need to change batteries”¹⁵. This node makes use of both a rechargeable battery and solar cell with an on-chip sensor, wireless microcontroller and 3D System in Package to consume less and operate only by ambient light energy. The partners on their side were then building their own application modules based on those conceived by ST generic core including sensors incorporation, various forms of packaging, software libraries and software specific for each application to conceive the particular environment. The use of open standard enables independent developers to create their own applications and make better use of acquired genericity. The co-design of generic core and applications enabled to decrease risks and costs of platform adaptation, ensuring platform use by at least attracted partners that participated during the technology development phase. The involvement of potential clients at the beginning permitted to share the design effort in double unknown and create new environments.

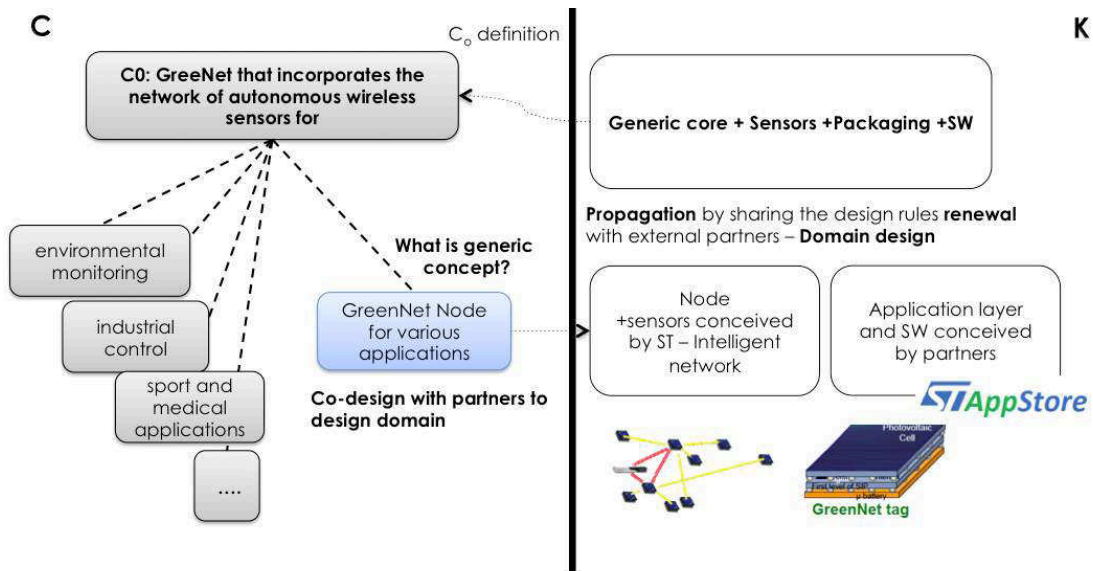

Figure 32 - The strategy of Environment attraction - “GreeNet” project exploration

4. CONCLUSION: TOWARDS HIGHER “GENERICITY BUILDING”

4. CONCLUSION: TOWARDS HIGHER “GENERICITY BUILDING”

To enrich the generic technological core one needs to account for the environments exploration. To take into account emerging functions in the process of environment exploration, we could use the

¹⁵For more details see: “[ST to launch GreenNET Wireless Sensor Networking platform](#)”. Telecompaper, January 16, 2012. Accessed on September 12, 2013.

mechanisms of environment generation. By questioning the predefined market environments and their position could push designers to explore the unusual and yet unknown environments.

The identified strategies affect knowledge reorganization, enable to conceive generic technologies and determine generic concepts through the design of the domain of existence *ex ante*. They provide rather different approaches to build generic technologies (Table 13) by putting an accent on the environments superposition to design robust and flexible generic platform in the case of 3DTouch, and by starting with rather classical approach of concept push for a predefined “projection” to decrease unknowns and collectively explore both technologies and markets in the case of HEATec. Besides, GreenNet begins as an already generic technology, whose development appeared to be expensive, and thus, finds a way to attract partners and collectively explore GTs by decreasing the costs of ownership for ST.

Table 13 - Strategies of existence domain design

Strategy	Description
Superposition	Starts with $E_1, E_2 \dots E_N$ identification and their superposition to refine generic core and build associated to each market modules
Projection	Starts with an original technological concept T^* for E^* a predefined projection environment. Projection appears as a context of exploration. It enables to enrich T^* and reveal new E_1, E_2, E_3, \dots and design modules
Attraction	Starts with predefined generic technology T –and definition of desired environments E_i as a generic platform and the strategy proposed an efficient way to share costs C_i with players in M_i to build modules and refine generic core: $C_{GT} = C_{CG} + \sum C_i < \text{Potential Benefits}$

The findings demonstrate that the elaboration of the domain of existence in order to build generic technologies allows accounting for the larger amount of applications and manages costs of exploration by producing new breakthroughs. The examples demonstrated that D could be deduced from the knowledge basis or designed through the exploration process. The defined strategies facilitate the design of the domain of existence.

Part III Outline

The design of GT is managed by generic concepts that has a structure of a concept x with the associated properties $P(x)$ and the added notion of the validity domain – D . The generic concept $xP(x)D$ targets the existence domains that are not reduced to one solution but comprise several of them both known or partially unknown. The descriptors of the domain of existence are crucial for successful GT design. As our work demonstrated they could be identified from the existing knowledge base (like rotary motion in water wheels) or could be designed (like, micromachining process in MEMS). The descriptors enable the formulation of the existence domain and build genericity on the set of solutions. To design generic concepts and associated domain of existence, the two operators appear to be critical: 1) the design of interdependencies between initially independent areas, or connectivity operation, which leads to formulate generic concept; 2) the densification of rules to ensure genericity propagation in unknown and account for larger domain of validity. Having defined a form of D imposes a certain structure of future knowledge and controls the operation of K-reordering, which brings interesting theoretical perspective to C-K theory. In the C-K theory concept is formulated as "There exists some object x for which a group of properties P_1, P_2, \dots, P_n are true in K " (Hatchuel and Weil, 2009) such that a concept is undecidable with respect to current K . The introduced operator of the existence domain does not discuss the relation amidst the existing K but with an emerging future K' that has not only new object X but as well its relations with the actual knowledge basis imposed by D . The role of descriptors of existence domain D is to impose a structure of future knowledge K' . D controls the K-reordering operation. D uses the knowledge of the domain in K or requires a design process. It is important to underline that D provokes the emergence of different concepts. As regards to steam engines, it is not the engine itself that is particularly generic, but the coupling principle that enables steam engines to penetrate various market fields.

Moreover, it is demonstrated that the activity of D identification and creation to design generic concept $xP(x)D$ is not evident, it requires deep scientific and business expertise in various domains. Thus, the organizational structures to design and explore the infrastructure of domains of validity, where the actors could jointly explore these domains, are necessary. Several strategies of domain design are formulated based on the empirical case studies of innovative generic technologies development in the semiconductor industry. They provide rather different perspectives on the way of genericity building through market environment superposition, technological environment projection and partners' attraction to design D . It is demonstrated that different descriptors of existence domain can lead to various genericity levels. The economic reasoning behind the genericity building provides insights on the dynamics of engineering systems.

Corresponding paper: Kokshagina O., Le Masson, P., Weil, B., Coge, P. 2013. *How design theories enable the design of generic technologies: notion of generic concept and genericity improvement*. ICED 2013, August 19-22, Seoul, Korea

Part IV

**Organizing the process of
double unknown
exploration:
Cross-application
manager, a necessary
figure for successful
generic technology design**

*“Great discoveries and improvements invariably
involve the cooperation of many minds”*

Alexander Graham Bell

Part IV: Organizing the process of double unknown exploration: Cross-application manager, a necessary figure for successful generic technology design

Chapter 10 New action logic for generic technology design: the role of the Cross-Application Manager.....	183
1. Elaboration of an action logic for generic technology design.....	183
2. Managerial role and organizational structures for generic technologies	185
2.1. Managerial principles at STMicroelectronics: research organization.....	185
2.2. Multiple case analysis: insights from four organizational contexts	187
2.2.1. Case 1: Business Innovation Process	187
2.2.2. Case 2: The “More than Moore” group of the ITRS community.....	188
2.2.3. Case 3: Patent portfolio design	189
2.2.4. Case 4: Ph.D. portfolio management.....	189
2.3. Insights gained from the multiple GTs exploration cases.....	190
3. Cross-application manager – a new managerial figure to ensure the successful implementation of generic technology design action logic	191
3.1. Role of the Cross-Application Manager	191
3.2. Illustration of action logic of generic technology design through the 3DTouch case at ST	193
Chapter 11 Managerial implications: The role of the cross-application manager in project portfolio's constitution and management	197
1. Research-Innovation-Development (RID) model for generic technology design.....	197
1.1. Action model for RID	197
1.2. Possible forms of the “Innovative design”	199
1.2.1. Emerging form of the innovative design – a “conceptive research”	199
1.2.2. Forms of innovative design for GT design	200
2. Conceptive development for generic technologies design	201
2.1. BICMOS portfolio at STMicroelectronics – project portfolio structure driven by generic technology design.....	201
2.2. New form of project dealing with generic technology design – a Conceptive development	204
3. Conceptive engineering: conceptive research and a new conceptive development activity.....	205

The theoretical model we introduced for the design of GTs offers considerable means to manage double unknown situation. It encompasses a managerial logic (new strategy for GT in double unknown contexts based on the capability to identify common unknown for several markets in Chapter 6, structure of unknown, technological aggregativity in double unknown in Chapter 7). Moreover, it comprises a design reasoning (notion of generic concept, descriptors of existence domain in Chapter 8). These findings demonstrate the conditions in which GT design is applicable, while providing the instruments to guide and manage the design of GTs. It is shown that to design GTs both engineering design and economic decision making reasoning has to be applied. The unknown structures, their evolution and interdependencies design are at the core of the design theories. These elements lead to determine the action logic for GT design (Chapter 10).

The elaboration of this model demonstrates that the reasoning associated with the design of GT requires a significant scientific effort to construct the domain of existence and the governance of this design process appears critical for the successful design of GTs. The model identifies the necessary competences of the actor capable to manage the design of GTs. The second section of Chapter 10 examines the presence of this type of actor within four diverse cases in the semiconductor industry. The transversal case analysis illustrates that the design of GT requires a new actor in organizations, a “cross-application” manager, capable of creating innovative concepts developed in different business lines, creating interdependences and supporting the balance within project portfolio. The empirical investigations we conducted enabled us to prove that the success of generic technologies was correlated with the existence of an actor playing this role at least temporarily.

Once the new managerial figure is defined, we aim to define its relation with the other organizational structures of the company. More particularly, we attempt to investigate how the figure of “Cross-application manager” interacts with the actors and organizational structures predefined by the Research-Innovation-Development (RID). This is comprised in Chapter 11 whose focus is to present the patterns of GT development and the role of project managers while analyzing research portfolio and more particularly its innovation function in case of genericity exploration.

Chapter 10

New action logic for generic technology design: the role of the Cross-Application Manager

"It is not enough to have great qualities; We should also have the management of them"

Francois de La Rochefoucauld

The results developed in the previous parts lead to the definition of the principal elements of the generic technology design action logic. This chapter starts by defining this logic. Elements defining this logic draw the necessary competences of actors involved in the management of GT design and therefore, formulate the managerial figure able to guide the design of generic technology.

The second part of this chapter aims to investigate the presence of this actor, which we name Cross-Application Manager (CAM); through the analysis of four multiple case studies of GTs design. Finally, the new managerial figure of cross-application manager is defined and the action logic for the design of GTs is demonstrated using the case of the 3DTouch project at STMicroelectronics.

1. ELABORATION OF AN ACTION LOGIC FOR GENERIC TECHNOLOGY DESIGN

As was indicated in Chapter 2, the present thesis determines the generic technology design action logic based on the following principal elements: the managerial object, the performance and context, the method and theoretical basis and the organization.

The thesis results reveal that the design of generic technology (Figure 33) is driven by the interdependencies creation within multiple technological and market alternatives in double unknown. Following the introduction of the "common unknown" strategy, the goal is to prioritize interdependencies that increase the probability of attaining larger amount of markets even if they are still unknown (1). In order to account for highly generic technology that addresses a larger amount of markets the notion of generic concept is introduced. Built on the design perspective generic concept that have the form " $x P(x)$ over the domain of existence D " and aims to attain a larger domain of existence that we define as D (2). The results indicate that D can be created during the process or identified from the knowledge basis. Yet, starting in double unknown the design of existence domain seems to be ambiguous. Following the process of design reasoning associated with the generic projects *ex post*, we have analyzed the principles of genericity building and introduced three

strategies of existence domain construction: superposition, attraction and projection (3). Further, the conditions of generic technology design relevance were investigated. The findings reveal that GT design is relevant when multiple market alternatives emerge and change dynamically. Technologies have an aggregative character, which presumes that the cost of new functions integration to the established technological platforms is low (4). This reasoning is oriented towards multiple market exploration logic and applies the “genericity building” business logic.

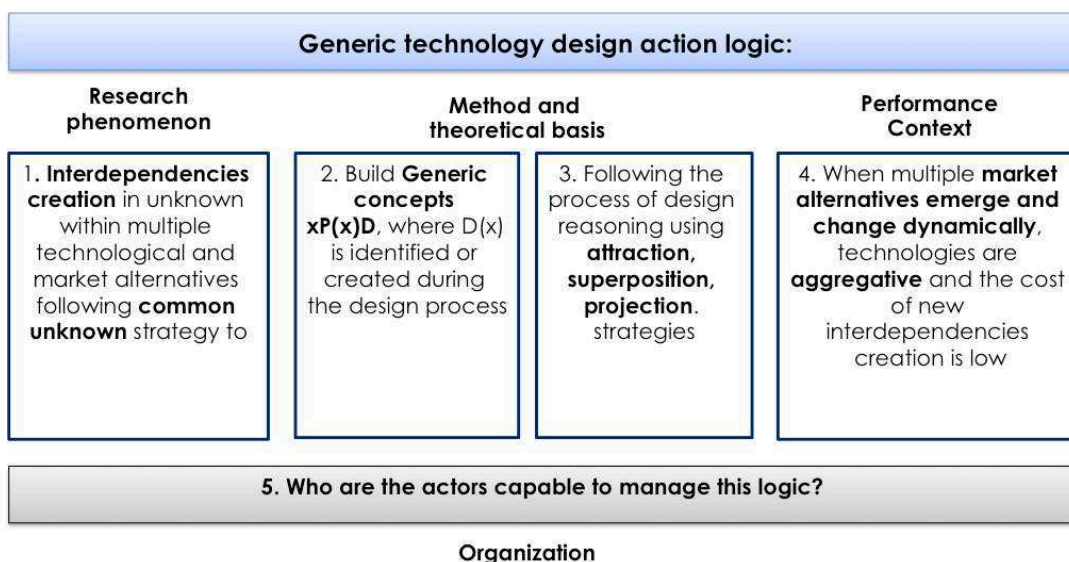

Figure 33 - Generic Technology Design action logic

This process requires a presence of managerial figure(s) capable of managing this logic and conducting the reasoning in unknown. Hence, who are these actors? What is their place within the organization? According to the defined action model, this actor should be capable of 1) managing simultaneously multiple technologies and market exploration in double unknown; 2) knowing the functional structure of emerging and existing markets within various business units and their existing technological portfolio; 3) evaluating the external and internal R&D technological portfolio and revealing segregative or aggregative character of technologies; 4) identifying and formulating generic concepts. **Does this actor exist? Where can it be found within the organization?**

As indicated in Chapter 2, the successful implementation of generic technologies might require multiple roles that ensure both the technology and market exploration phases, along with their propagation, appropriation, communication, and management. This requires a certain level of expertise in both technological and market domains. The corporate R&D units of Strategy and Innovation Departments often address these functions. Yet, while exploring the unknown and designing GTs, it is necessary to reason based on the future market needs and on the most promising technological opportunities, This requires vision, creativity and entrepreneurial spirit. The actors

that are capable of managing the design of GTs cannot be pure entrepreneurs or managers of the particular R&D or BUs departments. They have to combine these skills in order to pursue genericity and account for disruption in unknown.

The design of generic technology within a complex organizational structure is not evident. **In this perspective how can the design of GTs be organized? What are the managerial functions capable of conducting this reasoning?**

For this investigation, a multiple case study approach was deployed to provide insights on the organizational and managerial logic behind the GTs. The four cases chosen are examples of generic technologies exploration in the various organization contexts at STMicroelectronics and within the ITRS community.

2. MANAGERIAL ROLE AND ORGANIZATIONAL STRUCTURES FOR GENERIC TECHNOLOGIES

2.1. Managerial principles at STMicroelectronics: research organization

At STMicroelectronics, Project Managers ensure the collaboration within R&D and Business units (Figure 34). The projects are regularly launched between particular R&D teams and Business Units (BUs), the latter playing the role of internal clients. Traditionally, R&D teams do not have direct access to the final client. The majority of ST's BUs have their own R&D functions that are more oriented towards a BU specific exploration. This exploration could be a development of a particular technology building block for a specific design or platform adaptation to a particular client (mostly D type projects).

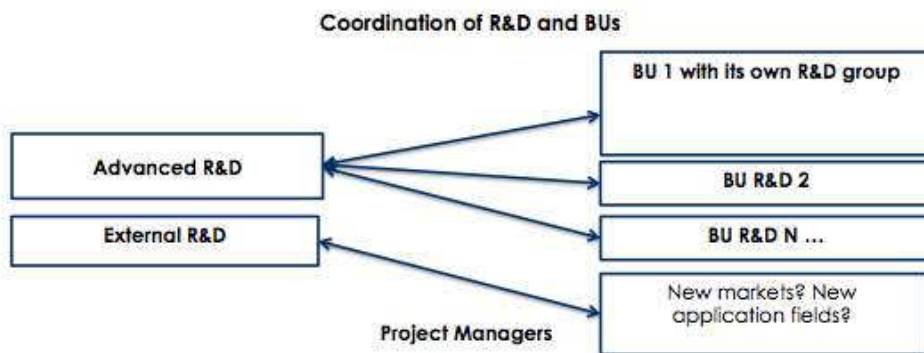

Figure 34 - R&D and Business Units collaboration

The central R&D comprises R&D teams responsible for a particular area of technological exploration (e.g., MEMS, 3D Integration, Bipolar, Photonics,...) or for the design part. Each group has development

and process integration projects with the assigned maturity level. The maturity level is attributed to each project according to the internal company's procedure (similar to the well-known Technology Readiness Level). Projects below level 5 of maturity are considered as "Advanced R&D". Most of the Advanced R&D projects that are considered as highly explorative are pursued with external labs and research centers (*e.g.*, IMEC, CEA LETI, Berkley, Stanford, IBM) and the costs of their developments are shared. Additionally, ST finances external exploration projects, which are often orientated towards immature unknown explorations pursued with highly skilled research centers. This structure mostly prioritizes the one-to-one relations between technologies (provided by the R&D groups) and markets (defined by the Business Units). **How were the more transversal, generic technologies explored within this process?**

To understand the particularity of GT management, we have conducted multiple case studies of innovative technologies development in various contexts at ST. The four identified cases that we have chosen offer rather different frameworks and units of analysis, which permit different perspectives on the research questions: 1) **Case 1:** BIP innovation contests designed for generic technologies at ST including *ex post* projects analysis and ongoing experimentations; 2) **Case 2:** Ecosystem exploration of technologies and markets in the case of "More than Moore" technological working group within the ITRS; 3) **Case 3:** Generic patent design with various advanced technological groups by using "C-K Invent" method patent design; 4) **Case 4:** *ex post* analysis of a research project portfolio (Table 15). Still, all of them pursue GTs development. These cases uncover how genericity was acquired, which organizational capabilities were mobilized, and how and by whom they were managed (for detailed analysis see Paper IV).

Within all these studies, researchers played the role of observers in case 4 or were directly involved in the process comprising the roles of participant in case, coordinator in case 1 and 2 or facilitator in case 3. Information gathering techniques included in-depth interviews with a variety of company representatives and external collaborators associated to each portfolio from a variety of functional perspectives. Experts with commercial, marketing, financial, technological, research, development, and operational backgrounds were involved. They were directly involved in executing, organizing, participating, managing, supporting or decision-making roles within a portfolio.

Table 14 Multiple Organizational contexts for GTs exploration

	Case 1	Case 2	Case 3	Case 4
Description	Open Innovation contests – Business Innovation Process (3 consequent innovation challenges)	The International Technology Roadmap for Semiconductors (ITRS) Technology working group “More than Moore (MtM)”	Generic patent design with various advanced technological groups	Ex-post analysis of research project portfolio
Time period	2009 - 2012	2005 - 2013	2008 - 2013	2003 - 2010
Unit of analysis	Innovation exploration projects accepted after the ideas collection phase – 20 projects in 3 years	The working group composed by actors from the various semiconductor companies	5 exploration groups	10 research projects clusters (~400 thesis projects)
Involved organizational entities	Business Units, Strategy, Marketing, R&D groups	Companies representatives, MtM TWG leaders	Business units, R&D groups	R&D groups

2.2. Multiple case analysis: insights from four organizational contexts

2.2.1. Case 1: Business Innovation Process

An innovation contest called “Business Innovation Process” (BIP) (**Case 1**) targeted transversality, ecosystem development and value for users and for ST of future innovative solutions to address several business areas. The process was launched with the goal

“to boost Grenoble and Crolles sites contribution to ST value creation through better innovation and better use of local clusters” (BIP, 2009).

On the technology side, the contest allowed the open participation of any employee of these groups. Likewise, the wording regarding the targeted uses and markets allowed for a wide variety of solutions involving open participation of all business units and strategy & marketing units. Hence, this process was clearly positioned in a situation of double unknown and privileged open collaboration and learning. From 20 accepted projects within BIP, 4 of them are still ongoing and appear to be generic technologies. Despite classical technology – market couple criteria, the successful projects issued from this process were generic (e.g., projects in part III).

The example of the 3DTouch project from **Case 1** (see Part III) demonstrates that the manager role appears to be critical to privilege generic aspects of the solution instead of a specialization in more promising markets. For instance, one of the potential customers was interested in using haptic

technology for eye-less keyboard application and eye-less haptic mouse. If a manager chooses to address only these promising markets, then the transparency of a multi-touch capacitive solution required for smartphones and tablets would be difficult to even consider. In this case, the manager was able to design a portfolio in which functions specific to the market were managed in the separate projects and in which the generic core was a common project that facilitates its reuse by the emerging market areas. The manager, which we propose to call **cross-application manager (CAM)**, was able to manage the links between technological requirements and market needs. On the contrary, the lack of collaboration within these roles and insufficient management of learning interdependencies might consequently lead to the failure in GT exploration. Moreover, it is important to mention the key role of the organizing committee that did not seek to select the winner of the challenge but prioritizes the accumulation of joint expertise within participants from different backgrounds. This committee – Core Innovation Team - prioritized multi-market exploration and helped project leaders build their network both internally and externally, and the team played the role of the interface between various technological and business groups. This team involved people from the R&D, BUs and strategic departments (overall around 15 specialists) and played the role of CAM during the business innovation process (for more details on business innovation process description see (Paper V)). While dealing with GT design, the seekers and solvers need to question the problem, find or even construct it collectively.

2.2.2. Case 2: The “More than Moore” group of the ITRS community

Case 2 is an empirical study of the **International Technology Roadmap for Semiconductors (ITRS) “More than Moore” working group**. The goal of this group is to build a roadmap in the situations when both markets and technologies are yet unknown. The “More than Moore” (MtM) community deals with the situations when the figure of merit is no longer miniaturization; the exploration is thus exposed to various emerging markets and technologies that involve various parameters management. The decoupling between market and technology commons for the semiconductor industry could not longer be supported; companies are now truly in double unknown situations comprising many potential markets with high uncertainty regarding sizes, timings, and needs and many potential technologies. **Case 2** demonstrates that highly coordinated activities of individuals leading the MtM trend have increased its importance within the community. From its first mention in 2005, the citations of MtM in 2011 reached 79 and from 18 technology working groups within the ITRS 11 groups cite MtM. Additionally, a purely MtM-oriented group was created in 2011 for MEMS portfolio exploration. Coordinators of the MtM group play a crucial role for both the existence of this group within the ITRS and its increasing popularity within the community. It is demonstrated that the group exists thanks to a group coordinator(s) who is (are) capable of guiding the group at the level of the ecosystem. These actors search for the existing knowledge gaps within the landscape of technologies and markets in order to define the direction of technological

development and identify interdependencies that can be built to acquire generic technology. Their position within the ecosystem of the major industrial players of the semiconductor industry facilitates their access to necessary information and enables them to test the relevance of their propositions (for more details see (Cogez et al., 2013), or Paper VI).

2.2.3. Case 3: Patent portfolio design

Case 3 represents an exploration activity for patent portfolio design (Felk et al., 2011). At ST the C-K based approach was adapted for the patent portfolio design in the case of disruptive technologies exploration. The joint exploration session enabled better positioning of patent propositions, defining their interdependencies and therefore, enabled the design of a stronger patent portfolio to protect a GT. Overall, five explorations of patent portfolio design within ST were launched from 2009 involving various R&D groups. The results demonstrate the possibility of obtaining larger patent propositions that are generic and propose powerful solutions for identified market challenges as well (see Chapter 11). Each group of ideas' exploration included participants mostly from technological background together with participants coming from the business units that were interested in particular technological exploration. The working sessions were organized and conducted by a coordinator – animator who managed the group and directed them towards the exploration of new concepts to achieve higher genericity. All the participants contributed to the elaboration of ideas and formulation of invention proposals. At the end, the list of inventions is established and presented to the committee. Each proposition has a number of authors assigned to it, they are responsible for deepening technological proposition and developing it once the idea is issued through the process. It is important to underline the role of coordinators – animators of these sessions that play the role of cross-application manager temporarily during each transversal exploration. As a result, portfolios of inventions were established that help to better valorize and protect the emerging GTs. For more information about the process of ideas exploration and our reflections on how to valorize and protect generic technology through patent portfolio design see Appendix 4.

2.2.4. Case 4: Ph.D. portfolio management

The fourth case is a **Ph.D. research portfolio management**. We conducted an *ex post* analysis of 400 Ph.D. thesis projects from 2002 to 2010. The study contained an analysis of the thesis projects portfolio of ST Crolles and positioned these projects vis-à-vis with the major technological challenges. Initially the work consisted of screening of Ph.D. projects portfolios in STMicroelectronics. Besides the classical research projects portfolio exploration that deliver solutions to particular business unit, the analysis enabled the revealing of different types of project clusters (mostly within Advanced R&D groups) that attempt to incorporate the recent advancement of each research portfolio and seek to integrate the notion of market value directly into the research projects. This type of portfolio (4 from a total 10) directly incorporated market knowledge and thus, leads to faster market disruption and

elaboration of generic technologies. The clusters were considered generic if they had succeeded in introducing technology across various market areas. Among them, the bipolar project portfolio (10 Ph.D. projects involved) that allowed the development of generic technology and its corresponding roadmap were both driven by the increase in the optical communications data rate and by the emergence of applications at higher frequencies (Chevalier et al., 2007) (see Appendices 2 and 4 for further analysis). The portfolio was structured along the bipolar technology adapted for millimeter-Wave applications. It is a technological platform based on a Heterojunction Bipolar Transistor (HBT), whose features include many advantages compared to CMOS devices like their low noise factor, higher voltage and higher resistance for the same speed. The co-exploration of technology and markets in this case enabled the introduction of this technology to various markets, such as the rapid download, optical communication, medical, and high-frequency markets.

Moreover, there are groups that efficiently establish technology – market relation. In this case, there is no need of transversal exploration towards the GTs. These portfolios aim to reduce technological uncertainty and to deliver the best solutions in terms of performance to attain higher benefits and help preparing for the next technological generation. Normally, they do not lead to the creation of new markets and uses. As an example, an analysis of the etching project portfolio at ST was provided. The portfolio contains 21 projects (over an 8 years period) whose main goal was to ensure the successful implementation of the next CMOS generations.

When the level of uncertainty is higher, the technology under question has the premises of being generic; the role of clusters for GT exploration becomes advantageous. The presence of managers (team coordinator, technology line managers) playing the role of transversal managers enabled the company to build the interface within various BUs and R&D centers and to position technologies as generic earlier, which in turn allowed for more rapid technology appropriation by the market through the construction of interdependencies. For instance, as our analysis revealed (see Appendix 2), the success of the bipolar project portfolio was not obtained thanks to its technological advancements, but thanks to the manager capable of designing the exploration area that led to a larger application area.

2.3. Insights gained from the multiple GTs exploration cases

The exposure to the unknown markets and technological structures gives an opportunity for some project leaders to proceed towards GT development to address multiple markets. Though, these transversal projects offer solutions for several BUs, they often pose challenges in terms of the BUs' investments for technology development, managerial responsibility, technology ownership, and time-to-market. For instance, BUs need to decide how they will share costs of platform development, and which remaining costs do they need to pay for market complementarities. To ensure platform adaption by various markets, GT managers need to control these organizational risks. Additionally,

GT managers have to be able to ensure the platform insertion to both the existing markets that can generate profit in the short-term and the emerging markets to ensure the long-term growth for GT.

GT exploration motivates managers to seek for transversal ideas to address several market areas (existing and new ones) and for new original technological solutions, which are flexible and robust to address several environments. They should privilege a variety of market applications while reusing the existing technological competences and developing new ones with minimal cost of re-adaptation in between future modules. These results indicate the existence of an actor(s) who has an expertise in identifying missing technologies and markets and interdependencies yet to be constructed. We call this actor the cross-application manager (CAM). The role of the CAM appears to be a pivotal one while pursuing GT design (Table 15).

Table 15 Cross-application manager

	Case 1	Case 2	Case 3	Case 4
Results of GT portfolio	4/20 (+/-)	(+)	(+)	4/10 (+/-)
The role of CAM	4 GT projects (from 20) lead to successful generic portfolio creation. The managers performed the role of CAM by preventing the exploration of a singular market solutions	The coordinator of TWG “More than Moore” holds group together and pursues the exploration of generic functions for both technologies and key application domains	The animator role of patent exploration sessions appears to be critical to refine and organize patent portfolio around generic technology	For each portfolio resulted in generic technology – a technology leader performs a function of technology line manager (CAM) who coordinates R&D groups and BUs and orientates the technology exploration transversally within the organization

3. CROSS-APPLICATION MANAGER – A NEW MANAGERIAL FIGURE TO ENSURE THE SUCCESSFUL IMPLEMENTATION OF GENERIC TECHNOLOGY DESIGN ACTION LOGIC

3.1. Role of the Cross-Application Manager

These cases demonstrated that the design of generic technology requires "**cross-application**" **managers**, who are able to put into interaction the innovative concepts developed in different business and research groups, and are responsible for creating and managing technological and marketing exploration portfolios within various organizational structures of the company. Contrarily

to actors that contribute essentially to knowledge management and circulation, “cross-application” managers work on concepts. They take the lead when the problem is not well structured, when the common interests and purposes are not established yet, when the products itself and their potential benefits are not determined.

To successfully implement the action logic for GT design, the CAM has to coordinate the exploration between various technological and market groups whose participation can enrich the design of GTs. As (Figure 35) demonstrates this actor ensures both the vertical collaboration between various R&D groups and between Business Units and horizontal relations between the research and business units. He has to be able to mobilize the knowledge and expertise acquired in each group. His role is primarily the responsibility for the identification of opportunities within portfolio, the creation of future interdependencies among various technological explorations and marketing opportunities. He should be able to mobilize the technical experts to assess the technological character, and to estimate if the emerging technology has a potential in addressing an emerging market need. So he should mobilize enabling GTs and organize their exploration in the way that they are able to attract market functionality and even provoke further market exploration (Figure 35)

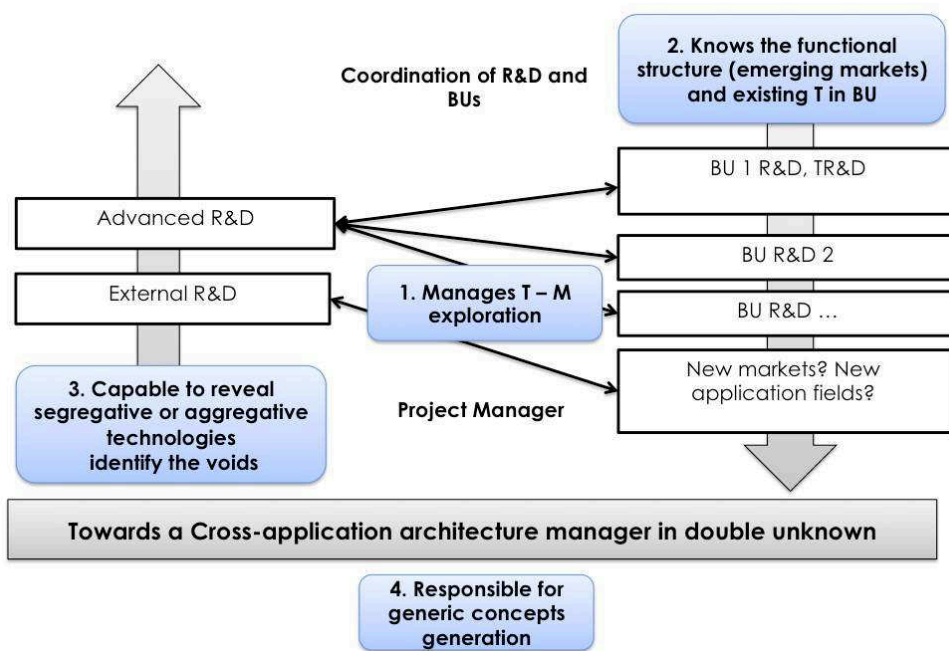

Figure 35 - Cross-application manager expertise

The CAM figure is challenging to identify and the necessary level of expertise is hardly achievable without the relevant experience but it appears to be necessary in order to guide a processes of genericity building. The multiple case analyses reveals that the GT is successful when a managerial support is present and pilots the transversal technological and markets exploration. For instance,

192

within BIP, project leaders that prioritized genericity succeeded in developing a generic platform for several markets. More importantly, these are the only projects that were considered successful within the challenge (see Appendix, Paper 5). The existence of the technology working group “More than Moore” and its accomplishments, oriented towards exploration of double unknown, highly relies upon the involvement of its coordinator. He prioritizes the roadmaps construction in double unknown based on the generic functions identification. The work on patent design with various research groups demonstrates that the animator could play an important role in the process of generic technology valorization. By targeting genericity, the groups obtain larger patent propositions that are generic and propose powerful solutions for identified market challenges as well. It is important to mention that the CAM is not necessary a single managerial actor within the organization; it could be a pool of managers or even a particular organizational structure.

3.2. Illustration of action logic of generic technology design through the 3DTouch case at ST

This section demonstrates the introduced action logic using the example of the 3DTouch generic technology platform at ST. It was shown previously that 3DTouch is a generic technological platform that led to the creation of various market applications (Figure 37). Taking our findings together, we would like to provide the elements of GT behind the multitouch haptic technological platform.

The technology behind the 3DTouch proposition initially was to develop an active surface to simulate the haptic touch sensations for various emerging market applications (*e.g.*, for tissue sensing, for e-commerce, Eyes-less (consumer back-typing, automotive), medical diagnostics). Initially market signals were multiple, dynamic and the probability of these markets’ existence was low. The initial technological idea behind aimed to reuse the existing knowledge expertise in MEMS, piezoelectricity in order to enhance the “touch” perception. So the exploration aimed to encourage the “aggregative” character of the technology, to minimize its future cost and incorporate richer functionality. These two criteria indicate, according to the findings in part II, that the conditions to prioritize “genericity oriented” business logic are unified.

The generic concept was defined and the domain of existence was built using the environment superposition strategy. The generic concept was defined as **“Notch texture feeling through friction modulation for superposition of the emerging market environments to design an active surface for haptic touch of various emerging markets” (Part I, III)**. This strategy permitted the development of the generic core, to attract new markets and even to pursue further genericity building.

The superposition strategy and the whole process of the 3DTouch development were managed by an actor who prioritized unknown multi-market exploration to more promising singular markets. He

was the technological leader of the project, its creator and the direct interface with the business units and the clients directly. It is important to underline that in this case the transversal character of the exploration, enabled the CAM to build a new community of actors to facilitate the technology development. The whole ecosystem comprising the external partners, BUs, and research centers was created as well. Moreover, the Core Innovation Team (CIT) played an important role in building the community of experts to explore the unknown and build partnership in this case. The CAM constituted a portfolio of various projects in order to further build this generic technology. The portfolio comprised projects seeking for disruption, exploring the unknown and development and research projects aiming to incorporate new knowledge and demonstrate technology feasibility. The CAM is responsible for the articulation of these projects.

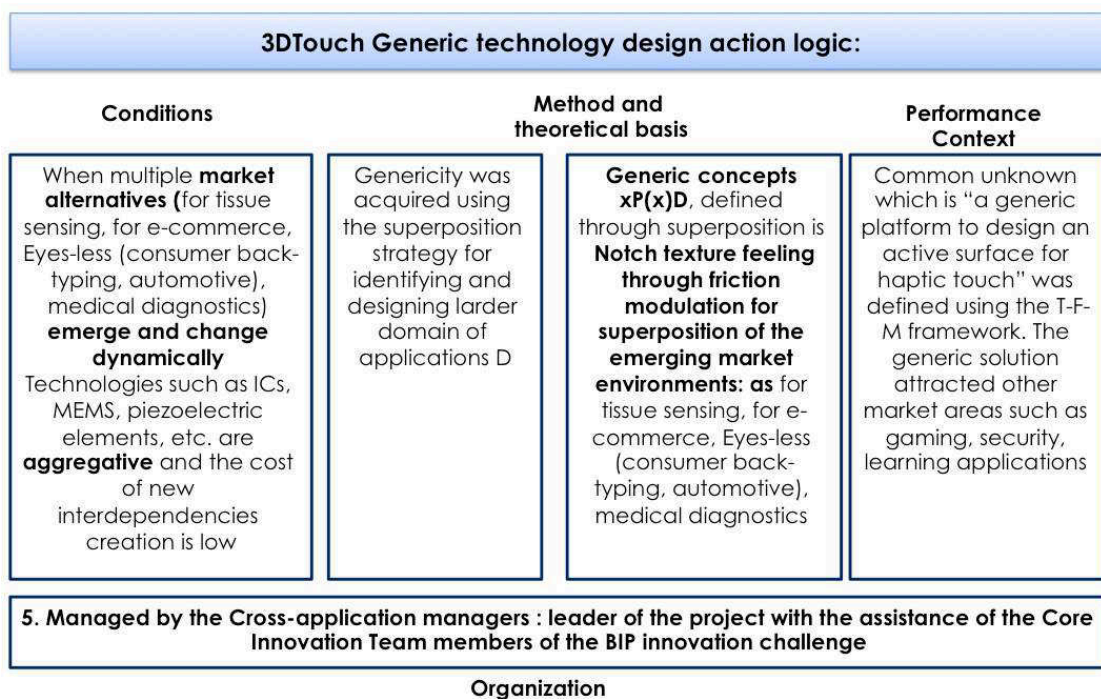

Figure 36 - 3DTouch Generic Technology Design action logic

The CAM and the design action logic allow accounting for the GT design. How is this logic articulated within other innovation functions within the company? How does this new managerial figure of the CAM interact with other actors? Le Masson et al. (2010b) demonstrate that the innovation function aims to organize collective innovative design and appears as a conceptual core that activates both research and development and extensively mobilize the knowledge and competences obtained from them. The authors define the innovation function as an action model coherent with the mission of the innovation function within the organization. This action model is managed through the co-evolution of competences and products. The managerial objects are the innovative fields themselves and the type of performance is managed through the

maximal knowledge reuse while avoiding stabilizing the object identities. Given this action model, what is the place of GTs? Further, we present the RID model and try to gain insights on how to deal with genericity in the case of R&D research portfolio at ST.

Chapter 11

Managerial implications: The role of the cross-application manager in project portfolio's constitution and management

"Exploration is the engine that drives innovation. Innovation drives economic growth. So let's all go exploring"

Edith Widder

This chapter aims to discuss the relation between the RID action logic and the GT design logic and more precisely define how the cross-application manager figure influences the activity of innovative design. This study demonstrated the interaction between various projects in the case of GT design using a case of research project portfolio management at STMicroelectronics. First, we present the RID action model and the conceptive research form of the RID model. Second, we analyze the example of projects portfolio in case of generic technology. This case demonstrates how the actors like CAM, who managed the reasoning towards the design of generic technologies, interacted with the team leaders of technology development and how the portfolio of projects was structured. This analysis permitted the definition of a new form of project that we call conceptive development that is defined as a production of controlled knowledge where the level of unknown remains high.

1. RESEARCH-INNOVATION-DEVELOPMENT (RID) MODEL FOR GENERIC TECHNOLOGY DESIGN

1.1. Action model for RID

It has been shown that the R&D based firms are capable of setting up suitable forms of innovation organizations (Le Masson et al., 2010b). By showing that research (R) and development (D) functions are both effective for certain types of design, the authors extend these functions. **They propose to add a new function to the R&D Model – "innovative design" or 'I' function.**

Hatchuel et al. (2005) demonstrated that by adding an Innovation function to the classical R&D model, it is possible to increase the generativity of the proposed solutions. By exploring the

innovation fields, the innovation design (or I) function proposes to “break” and revisit the existing object identities.

The mission of R is to resolve clearly defined questions by applying a rigorous methodology and by managing a controlled process of research production; but research is not responsible for value definition. The goal of D comprises proposing products and rules that allow the fabrication of product families that fulfill precise development specifications and mobilize available resources. Yet, development starts with already predefined notions of value and required competences. The goal of I is thus to structure the innovative fields, prepare potential specifications, define value and identify necessary competences for the concepts considered as strategic for a company. This innovation function is in charge of formulating research questions and specifications of future explorations. As a result, I is enriched by knowledge produced by research and by challenges that the development projects bring when they are confronted with the lack of necessary competence (Figure 37).

The outputs of the RID model are: validated scientific knowledge (for R projects), definition and fabrication rules of product fabrication (for D projects) and new rules for dominant design projects like R and D (for I projects) (for further details of RID definition see (Le Masson et al., 2010b). Appendix 3 provides an example of a research project portfolio at STMicroelectronics. First, the examples of research, development and innovation (brief) projects are given. Second, the etching process step example is analyzed to demonstrate the particularity of the R&D type of portfolio at ST.

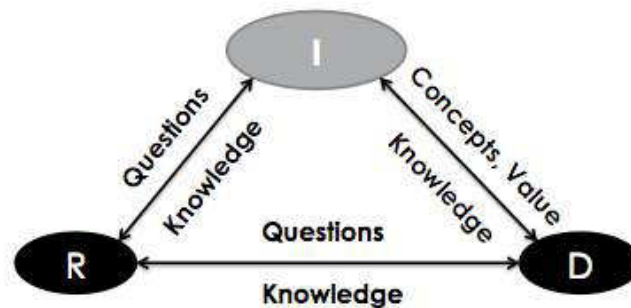

Figure 37 - RID model (adapted from (Hatchuel et al., 2001))

Based on the definition of the Research and Development type of projects, the probability that they will lead to generic technologies design is quite low. The research types of projects are normally initiated by clear research questions, which are absent at the initial phase of GT design and are created once the generic concept is formulated. The development projects are guided by the defined product specifications, which appear possible in case of GTs only when the list of markets and technology itself are defined, the unknowns are reduced and thus, the phase of design itself is finished. On the contrary, the Innovation is driven by the concepts elaboration for a new field of

exploration. Within the function I the concepts could be generic and therefore, it might be possible to investigate genericity within the innovative design functions and account for the relations that the I function build with R and D projects. **How are GTs managed within the RID?**

1.2. Possible forms of the “Innovative design”

The innovative design functions are gaining increasing interest within the companies and their applications to the different organizational contexts allow the proposal of new forms and enriching the model itself. This activity contributes to redefining the strategy and redesigning the common purpose. The innovation function can take various forms.

In this perspective, Felk (2011) introduced a new form – conceptive research – by the exploration of the Advanced R&D processes of the semiconductor industry. **Conceptive research (Rc) seeks to structure unknowns by exploring fundamental concepts, looking for rule breaking in accepted technical principles.**

1.2.1. Emerging form of the innovative design – a “conceptive research”

Conceptive Research (Rc) is a controlled activity of concepts creation including the identification and expansion of associated concepts (corresponds to the expansion of concepts and knowledge in C-K design formalism). *Rc* proposes methods for better structuring the space of concepts and avoids fixation effects. *Rc* aims to structure the unknown. For instance, Felk (2011) showed how the *Rc* approach through unknown exploration enabled the proposal of a new type of architecture based on 3D back-side integration for the image sensors that were classically based on planar CMOS architecture. The goal of *Rc* is to propose a complete cartography of concepts independently from the accepted company strategy to revise and challenge the existing models and reveal appealing alternatives.

As demonstrated by Felk (2011), at STMicroelectronics, the Advanced R&D groups are capable to structure and support the exploration of conceptive research projects. On his study of the CMOS imager, the author showed that the research group worked on the concept of “*new non-CMOS imagers generation*”, sensors for new digital photo devices integrated within mobile phones. The direct aim of this exploration was to work on the concepts, on which the other companies’ designers did not work at that time. The classical research approach would be to work on the new generations of imagers based on traditional silicon technologies (CMOS) from the design perspective (D type of projects) or modeling the photons trajectories and the signals losses through successive layers deposited on silicon from the research perspective (R project modeling type).

Yet, they wanted to explore new disruptive solutions and search for alternatives technologies. The results of this process are not a particular product or a technology, but a **number of new concepts**

and associated knowledge that structure unknown and open up new possibilities for breakthroughs. Starting with the initial concept, the goal is to produce the complete panorama of alternative solutions independently from the companies' core strategy and the existing models. The process is guided through the control of rigorous partitioning and new models that emerge in K. This example demonstrates the conceptive research role of Advanced R&D projects.

As R and D, Rc activities contribute to the coordination of projects and by their exploration nature ensure the external knowledge coordination. By structuring the alternatives, Rc creates interdependencies and decreases unknowns. It contributes to the creation of an external ecosystem for innovative fields exploration. New type of innovation - Rc allows structuring unknown but does not take into account potential market applications, which is crucial to account for GT success. How can future market value in double unknown be taken into account?

1.2.2. Forms of innovative design for GT design

Rc projects effectively structure the unknown and prepare for the future disruption. Yet, the Rc function and the RID model itself do not integrate the economic reasoning directly. The market and clients notions appear to be missing. Yet, the activity of innovative design is not limited to the discussion of the technological feasibility but also deals with the market notions.

From this perspective, Pointet (2011) proposes to add the marketing function to the RID model in order to integrate the notions of the value that clients are looking for and obtain the knowledge in terms of potential uses that can be used as an input to the innovative design activity.

As was shown previously, the design of generic technologies requires the input and the involvement of both business and technological sides. The input from the market side should have the "imaginative" character comprising market visions, possibilities of future orientation and the emerging market signals. The conceptive research appears as an important source of information regarding the new technological concepts and technological expertise. These two forms (as well as classical research and development once) appear necessary to manage generic technologies. **Yet, they are not directly oriented and by their definition are not capable of formulating the generic concepts and thus, to design the GTs. So which forms of Innovation design could be used and how to work on GTs?**

2. CONCEPTIVE DEVELOPMENT FOR GENERIC TECHNOLOGIES DESIGN

2.1. BICMOS portfolio at STMicroelectronics – project portfolio structure driven by generic technology design

To gain insights on projects portfolio structuring in the case of generic technology, we take the case of the BICMOS technological portfolio. The analysis of this technology was used to reveal the “common unknown” strategy (Part I). BiCMOS appeared to be a generic technology and the role of the Technology Line Manager who was responsible for this exploration appeared to be crucial for the technology’s success (see Appendix 2).

This exploration belongs to the area of radio frequency and analog/mixed signals for wireless communication. According to the ITRS (2008) the drivers for wireless communication systems are cost, available frequency bands, power consumption, functionality, size of mobile units, appropriate performance requirements, as well standards and protocols that define the allowed bandwidths, and transmit power for particular applications.

From 2000 to 2002 the R&D group was working on the optimization of bipolar transistor for analog signal processing to address 60GHz frequency. Initially, three building blocks were developed at ST, which ensured: complex digital signal treatment, high-frequency emission and low power. Each technological block was independent, but the applications that seek for two or even three of these functions were identified. For instance, a technology line manager, in this case the CAM, stated that **by combining these independent functions, a new Wi-Fi hub solution could be created for large public spaces like airports**. Defining a validity domain D enabling connectivity in large public spaces like airports enabled ST to work on a solution that combines complex digital signal treatment, high-frequency emission and low power by maximally reusing already existing knowledge. This occurs as an initial generic concept.

The various combinations of building blocks opened up applications, like automotive radar, fast download applications, optical communications, and new active interfaces. Initially, the principle of combining these blocks by preserving their functionalities did not exist. The generic concept aimed precisely to design a technology that would address all these functional combinations based on the existing technological blocks.

For successful conceptive development implementation in unknown, two pre-requisites look necessary:

1. The probability of common core existence does not depend on the number of market alternatives that GT aims to address, but on the high probability of finding compatible generic functions that these markets seek.
2. One pays for the technological common core development if it allows addressing of all the identified options with the aggregated cost inferior to the budget of R&D

So the cost of generic technology development that gives access to all the functional combinations should be inferior to the sum of the costs of specific technologies development that give access directly to the market. It is important to underline that the cost of BiCMOS technology development is not equal to the cost of a technology that addresses three functions, since the technology should keep the modular principle of being able to dissociate each functional combination to address a particular application (for more details on BiCMOS9MW project analysis see Appendix 2).

Regarding the Ph.D. projects analysis, bipolar portfolio consists of 12 projects (2002 - 2010). There were projects before 2002 and after 2010 that were not included in our analysis and this might lead to the inconsistency of our results. As indicated in Appendix 1, the validity domain D to enable connectivity in large public spaces like airports was determined before 2002. Therefore, the projects launched from 2002 contribute to the genericity building by designing particular technological features for specific applications or optimizing technology to obtain desired properties.

The initial concept identified through project analysis is “**heterogeneous bipolar transistor (HBTs) for millimeter-wave applications**”. HBTs are composed of at least two different semiconductors which provide an additional degree of freedom and leads to the obtaining of improvements in terms of performance devices. The two frequencies of transistor and their trade-offs are used to measure device performance. f_{max} is a maximum frequency, which is more useful in a high-speed large-signal applications. f_t is a maximum effective frequency of a transistor.

This portfolio comprises R&D projects to optimize HBTs SiGe technology using bulk substrates and developing new procedures by using SOI substrates (Figure 38). For instance, an optimization Project 3 launched in 2003 aimed to optimize technology and physics of ultra-high speed self-aligned HBTs SiGe. Project 6 launched in 2005 aimed to study and develop self-aligned Si/SiGe:C HBTs with the objective to improve f_T of SiGe HBTs in order to address new emerging applications (communications, security, medical...). Project 7 (2005 - 2008) attempted to optimize the processes of bipolar heterogeneous transistor for 0.25 μm BiCMOS technology for high voltages or Project 8 (2006 - 2009) for low-frequency noise. It is important to underline that both modeling and optimization projects that pursue the axis of “radio-frequency for wireless communication” integrate the notion of market knowledge while pursuing technological development. This notion of market was established by the generic concept that was defined by a technology line manager.

The analysis shows that the bipolar project portfolio contains R, D and also Rc type of projects. For instance, in 2003 Project 1 attempted to explore the advantages of thin Silicon on Insulator (SOI) properties for RF design (e.g., for low substrate losses, high-Q passives). Though, the SiGe NPN bipolar transistor that is a key component for RF design was not compatible with thin-film SOI. This thesis proposed an HBT structure that is compatible with thin SOI substrates. It is an Rc project that aimed to structure unknown and gain new knowledge in the benefits of using thin SOI for HBT. In the same area Project 4 launched in 2004 aimed to development HBT Si/SiGeC PNP auto-aligned process for SOI BICMOS complementary process. This project is derived from Rc and resulted in developing a new procedure based on SOI.

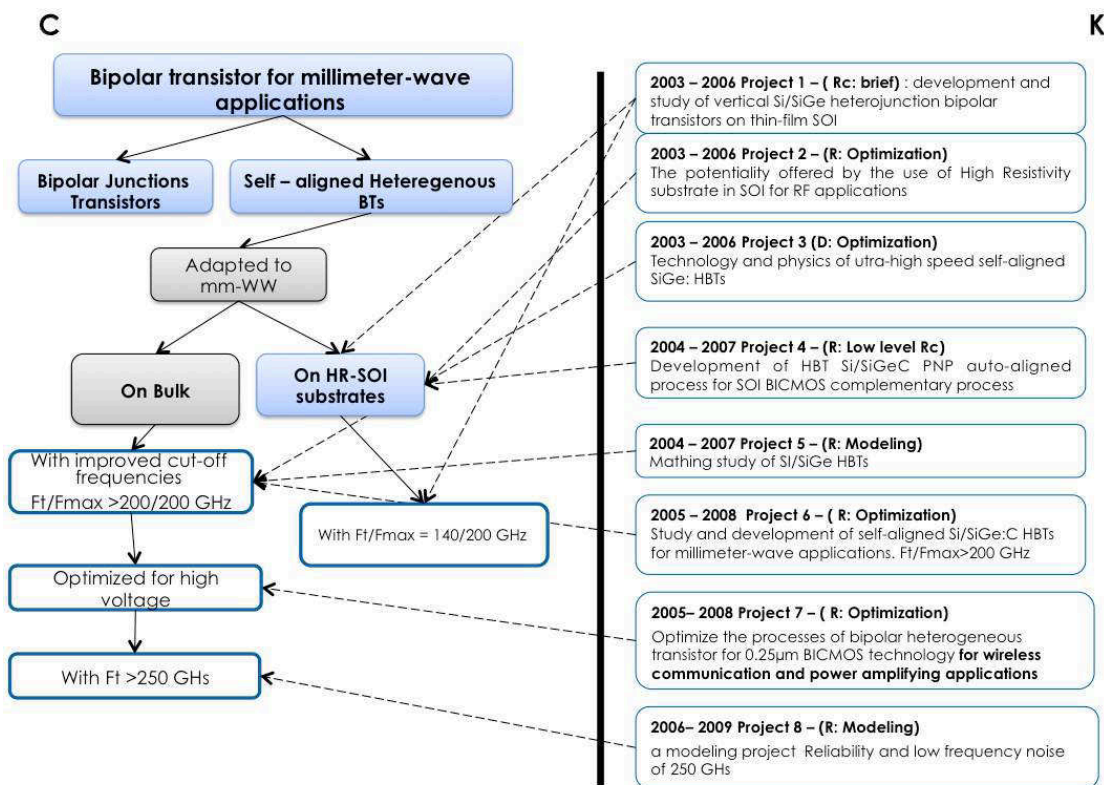

Figure 38 - Bipolar Ph.D projects portfolio (2002 - 2006)

The generic concept that orientates exploration of this generic portfolio was not defined at the Ph.D. thesis level. The research projects appeared to be decoupled according to their goals defined by a generic portfolio (R, D, Rc type of projects). Still, they appear as necessary building blocks to ensure the technical features of GTs and its adaptation to specific market properties. It is at the level of technology line manager that the concept of generic approach for WI-FI systems was created and exploration is then organized within portfolio. Even if generic potential of the technology could be revealed from the single project analysis, in this portfolio the generic concept leading to genericity was defined in advance (before the launch of Project 1 in 2002).

The interactions between a technology line manager (CAM, see Appendix 2) and other actors within the organization are quite close. The team leaders of the BUs provide knowledge and share their expertise and the current challenges they are facing. This information is used as an input to define what could be a more generic challenge and how to deal with it. **This is the role of the CAM who defines the generic concept to build and facilitates portfolio constitution and its organization with direct R&D groups, program and project managers who execute and further explore this concept.**

The portfolio is decomposed in projects that face research, development or a more conceptive research approach. The design of generic concepts occurs more at the level of the technology line manager. We call it conceptive development since it incorporates the features of the development projects by aiming to reduce risks, using the existing expertise, and minimizing the costs of exploration. It has a conceptive nature because it looks for a breakthrough and explores the unknown.

2.2. New form of project dealing with generic technology design – a Conceptive development

The notion of generic concepts aims to design a wide range of potential applications and not just one solution. This represents in the C-K theory an expansive partition that enables to prepare disruption while controlling risks and costs of development. It leads to the elaboration of a new form of project that we call **“conceptive development” (Dc)**. The generic concept behind conceptive development supposes to work on the identification or creation of descriptors of the existence domain *D*. **Conceptive development aims to manage unknown by designing technological building blocks with controlled costs and to produce maximal value.** Conceptive development consists of advanced technology development for multiple emerging markets with fixed pre-defined budget of R&D. From the engineering design point of view conceptive development determines the topology of relations between functional requirements and technological attributes.

The **Conceptive development Dc** type of exploration is particularly interesting because it consists in reaching the same reliability (e.g., Quality, Cost, Delay) of classical development projects even if market demands are not explicit yet and the level of unknown is high. Dc explores unknown but attempts to keep costs under control, ensure predictability and maximally reuse the existing knowledge and expertise.

The required expertise for successful Dc implementation is twofold. First of all, the available techniques need to be analyzed. For instance, CAMs need to evaluate the existing business expertise, reveal knowledge about possible lock-ins and critical points regarding application areas. Second, the market areas, various applications need to be examined from the functional knowledge point of view.

Since, we are dealing with unknown environment, the notion of probability and costs are less important initially due to their changing nature. In order to account for higher D design, conceptive development's goal is to reach a higher number of applications with controlled costs and controlled knowledge production (just to enable disruption).

3. CONCEPTIVE ENGINEERING: CONCEPTIVE RESEARCH AND A NEW CONCEPTIVE DEVELOPMENT ACTIVITY

Exploration of highly uncertain projects at STMicroelectronics allows introducing a new form of RID – **conceptive engineering**. **Conceptive engineering** includes both conceptive research and conceptive development. It reverses the Research and Development activities and changes their nature from the rule-breaking design towards the innovative design. Conceptive development is defined as a production of controlled knowledge in unknown space. Conceptive research seeks to structure unknown by exploring general concepts, and looking for rule breaking in research principles (Figure 39). Moreover, market function could provide new inputs to the orientation of the innovative design activity.

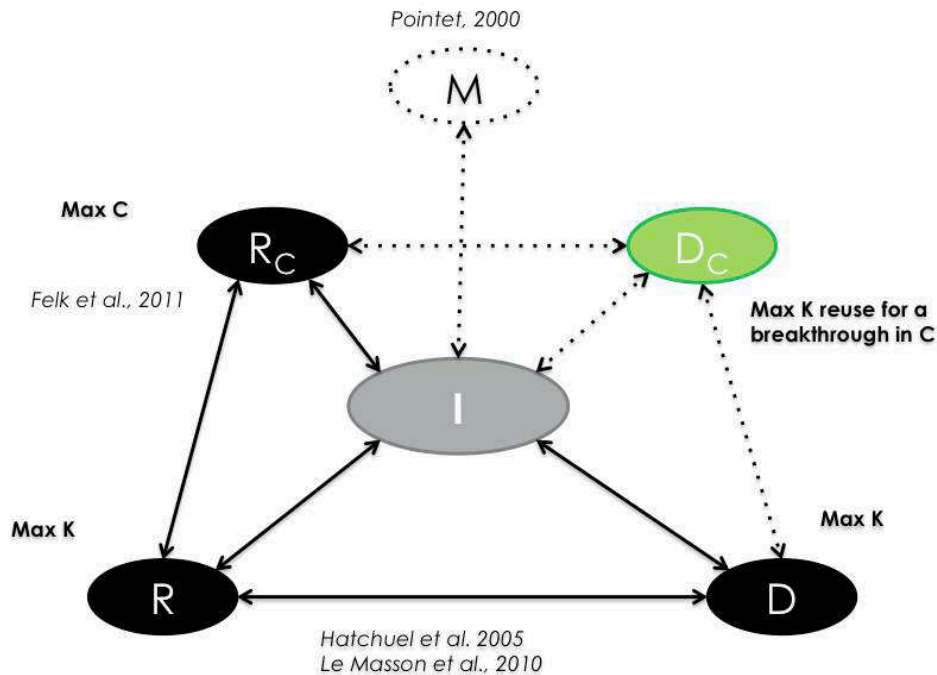

Figure 39 - RID and conceptive engineering

The innovative design function in this case plays the coordination role to articulate effective interdependencies management between conceptive research and conceptive development, research and development projects. It ensures maximal knowledge reuse and information flow within

portfolios. As shown by Felk (2011), conceptive research implies collective exploration and collaboration with other domains of expertise both external and internal to the company to enlarge the scope of solution and think “out of the box”. At the same time, Rc seeks to structure and evaluate emerging alternatives, find more original and advantageous concepts and thus, integrates evaluation adapted to unknown. Conceptive research contributes to the cohesion activity of the company but exploring the concepts externally and internally and appropriating them by the working groups. It constitutes the cartography of new possibilities that also contribute to attract specialists according to their group of interest and competences.

Conceptive development contributes to the generic concept definition to successfully account for the GT design. They presume to conduct the effort on building the larger domain of existence D (see Part III) and are responsible for the preliminary phases of design. For instance, in case of Bipolar the role of conceptive development appears to be crucial to define the generic concept and structure the portfolio of projects towards this concept exploration. After this phase leads to the classical project portfolio management that involves mostly Research and Development types of projects. In order to manage and define conceptive development, the role of the CAM appears to be compulsory. Moreover, this actor cannot succeed in developing these technologies solely. It necessitates the participation of various actors who inject knowledge to formulate the generic concepts and build a larger domain of existence; develop the technologies and specific market modules, and manage risks of technology appropriation. Moreover, being a part of the innovation design activity, the CAM contributes to the cohesion activity by proposing the generic concepts that are shared within the ecosystem of actors within the company. Conceptive development requires knowledge related to the existing and emerging fields, expertise in the already existing technologies and their lock-ins. Moreover, knowledge related to the functional needs of various application areas, industrial trends and market vision appear to be indispensable to identify generic concepts for emerging market areas and design the existence domain. The variety of existing organizational structures for innovation management could potentially be appropriated for GT exploration.

This chapter provides an example of how the activity of generic technology design can be articulated within the R&D project portfolio exploration. It demonstrates the close relations between the CAM and other actors within the organizations and indicates the particularity of this role, which requires capabilities to deal with the coordination and cohesion of the teams in order to account for highly generic technological propositions. Definitely, the study of other organizational contexts will provide more insights in the role of the cross-application manager and might lead to the definition of new forms of the innovative design functions. In this perspective, Appendix 4 exhibits the consequences of these results to the intellectual property activity and aims to further animate discussion on the issue of generic technology valorization and the design of patent portfolio.

Part IV Outline

The outlined part (Chapter 10, section 1) assembles the necessary elements to define the action model of GT design where 1) the objects to be managed are generic concepts that drive the design of generic technologies in double unknown; 2) a model of activity and reasoning is based on the identification and formulation of the generic concepts that aim to design a larger application area through the creation of a new existence domain; the identities are often unstable in unknown. 3) The performance could be significant when technologies have the aggregative character (capable of incorporating new functions) and there exist a variety of market signals even if their probability is low and distributions are volatile; the signals are dynamic in time. These elements determine the necessary competences and expertise that the manager who is able to manage this action logic of GT design should require. This draws a new managerial figure that we call a cross-application manager (CAM), who is capable of managing multiple technological and marketing explorations, who knows the functional structure of the company and is capable of revealing segregative or aggregative nature of technologies and identify corresponding voids. The CAM is responsible for defining generic concepts, creating, structuring and leading projects portfolio exploration to build a larger existence domain. His role is to ensure genericity dissemination and relevance of the GT exploration.

Section 2 of Chapter 10 examines the 4 cases of GT design to reveal the required expertise and understand whether the manager who has all the previously defined competences exists within the organization and where. These cases reveal that in the case where GT design is successful, the CAM is present. Moreover, the role of the CAM appears to be crucial while pursuing GT design.

Chapter 11 provides the consequences of the new managerial role and the emerging action model drawn on the empirical cases at ST: research project portfolio analysis. First, through the analysis of portfolio of research projects at ST we examine the particularity of innovation function and the corresponding forms of conceptive engineering. Conceptive engineering comprises conceptive research and conceptive development parts. Conceptive research seeks to structure unknown by exploring general concepts, looking for rule breaking in research principles. Conceptive development is defined as production of controlled knowledge in unknown space. We demonstrate that conceptive development is a function of I responsible for the design of generic technologies. The RID model analyzed here offers the organizational context for portfolio management and building in unknown. The study shows that the CAM closely interacts with portfolio and project managers and the design of GT appears as a process of joint expertise development.

The introduced model of collection action for GT design allows managing double unknown situation by going beyond the classical decision making paradigms towards and proposing an original way of dealing with risks by designing new alternatives.

Corresponding papers:

Kokshagina, O., Gillier, T., Le Masson, P., Weil, B., Cogez, P., Rethinking the management of ideas contests in high-tech environment: the case of generic technology – under submission

Cogez, P., Kokshagina, O., Le Masson, P. & Weil, B. (2013) Industry-Wide Technology Road Mapping in Double Unknown – The Case of the Semiconductor Industry. ICE & IEEE – ITMC Conference Hague

Kokshagina, O., Le Masson, P., Weil, B., Cogez, P. 2013. Portfolio management in high uncertainty: the role of cross-application manager – under review, Creativity and Innovation management

General conclusion:

**Generic technology design
in double unknown**

*“Everybody has to be able to participate in a future
that they want to live for. That’s what technology
can do”*

Dean Kamen

Conclusion: Generic technology design in double unknown

General conclusion:

Generic technology design in double unknown

1. Principal positioning of the thesis: the issue of double unknown management for generic technologies design perspective	213
2. Main results: managerial and organizational patterns for double unknown management and a new action logic for generic technology design	214
3. Theoretical implications: design as a new action possibility for risk management in unknown situations?	217
4. Managerial implications: transversal technology and markets exploration in the unknown....	219
5. Further work: dissemination of the logic behind generic technologies design and its validity	220

Conclusion: Generic technology design in double unknown

This dissertation proposes innovative ways to design GTs and to deal with the situation of “double unknown”. In this concluding part, we summarize the principal findings of the thesis starting from the anomaly identification to the introduction of a new model of collective action for the design of GTs. We then present the industrial and academic perspectives and limits of the undertaken work. Finally, we demonstrate the managerial implications and the questions raised by the present exploration through various theoretical perspectives.

1. PRINCIPAL POSITIONING OF THE THESIS: THE ISSUE OF DOUBLE UNKNOWN MANAGEMENT FOR GENERIC TECHNOLOGIES DESIGN PERSPECTIVE

The increasing costs of R&D investments in a competitive environment have caused established firms to reconsider their strategy. To maintain their competitive advantage, these companies attempt to develop radically innovative technologies and breakthrough products by externalizing their R&D, developing partnerships, pursuing innovation contests and developing creative tools to deal with the unknown while controlling the costs of exploration. This is the starting point of this thesis: from one side there is a motivation to deal with the unknown in order to propose innovative solutions ahead of competitors and from the other side, there is an increasing pressure to control the costs of R&D exploration, to ensure market acceptance by new forms of risk management in the unknown. Dealing mostly with the fast paced semiconductors industry, we are driven by the fact that semiconductors appear to be capable of developing GTs, which ensure the technical progress and growth across various sectors. By developing generic technologies that address several markets it is possible to reduce the risks of technology acceptance and its appropriation. Our research focused upon the role of GT design for companies’ growth and double unknown management.

In a double unknown situation, neither technologies nor markets are fixed. Markets are considered unknown since the probability of their existence is really low and market signals are highly dynamic. Technological performance and its maturity is yet undetermined and there usually exist many technological alternatives. In this case, traditional risk management strategies considering decision states are independent. They do not take into account emergence of new alternatives and are thus limited in how they are able to deal with the double unknown situation. The literature relevant to technological platforms development proposes ways to deal with interdependencies by proposing a platform with several modules. Built upon the underlying platform, the modules address multiple markets and reduce risks of unknown exploration by ensuring the platform’s reuse. It is unclear how to build a successful platform core in unknown situations (*i.e.*, which independence/interdependencies structures to privilege) and how to evaluate more successful platforms. How is it possible to account for successful exploration by preserving the unknown character of associated technologies and markets? In double unknown situations, the management object itself remains to be defined. It appears as a research anomaly, since there is a lack of strategies to conduct exploration in the double unknown situations that structure unknown and manage the dependencies. However, in practice the ability of dealing with double unknown situations by GT

design is highly interesting as it would open numerous perspectives for high-tech companies and is of high interest. Yet, genericity appears *ex post* as a result of exploration. Can we deduce that genericity appears as the result of a random process? Or is it an evolutionary trial? Does genericity depend on the vision of a particular entrepreneur or is it possible to actually define repeatable methods and strategies to intentionally design GT?

This is why the goal of this thesis is to examine the anomaly and develop a new action logic for GT design by answering the following research questions: 1) What are the strategies of risk management in double unknown that lead to the design of GT? 2) What are the techno-economic conditions and contingent criteria that define strategies performance and their validity? 3) How to conceive GT? What are the methods, processes and strategies to increase and design genericity? 4) What are the necessary organizational structure and actors capable of managing this genericity? These four principal questions enable us to determine the underlying aspects of the new action model: the management object, the performance and context, the methods and theoretical basis and the corresponding organization structure and governance models.

This research is conducted mainly at STMicroelectronics, one of the biggest semiconductor manufacturers. Faced with high levels of competition and high needs in R&D investment to support “Moore’s Law”, the industry is turning towards more disruptive innovation and unconventional forms of unknown exploration that integrate market knowledge from the very beginning of technology development. The necessity to control the costs of exploration in unknown situations and to benefit from it in order to propose radically new products, prompts ST to look for methods to manage double unknown situations. Moreover, semiconductors provide emblematic examples of GTs and therefore appear relevant to explore both double unknown and the methods for GTs design. Given the exploratory nature of this work, an intervention research approach was mobilized. The work was conducted from 2010 to 2013 based on 1) the *ex post* analysis of various contexts to collect and analyze the data following a semi-structured method, documentation analysis and data triangulation to ensure the pertinence of the drawn conclusions; 2) *ex ante* projects participation to test emerging concepts and gain further insights into the processes of GT design and unknown exploration within the company.

2. MAIN RESULTS: MANAGERIAL AND ORGANIZATIONAL PATTERNS FOR DOUBLE UNKNOWN MANAGEMENT AND A NEW ACTION LOGIC FOR GENERIC TECHNOLOGY DESIGN

The exploration of the design of generic technologies in double unknown as a new and original anomaly enabled us to implement the analytical framework of a new phenomenon discovery. By “anomaly”, we define a situation that has not yet been investigated in the current literature but can be observed in practice. The approach used for anomaly identification and characterization is similar to the “talking pig” of Siggelkow (2007). First, we compare various theoretical perspectives in order to

identify the anomaly and clarify the descriptors to reveal them. Second, we construct the instruments for data analysis to identify the anomalies following the empirical cases, and characterize the underlying research phenomenon. This approach enabled us to build a new action logic for generic technology design based on: object definition, techno-economic conditions, performance, methods, processes and the actors responsible for genericity building.

Four principal results that correspond to initially defined research questions determine the model of GT design in double unknown. This model is driven by **1) a strategy for GT design in double unknown: common unknown**, which is based on the capability to identify and design a common core for various known and yet unknown markets. This strategy was witnessed through the comparative framework of risk management that takes into account uncertainty and interdependencies management. The strategy was characterized through the analytical model of data analysis applied to the empirical cases of technology development. This model allowed us to analyze the interdependencies creation, new technologies and markets exploration in double unknown situations. It argues that in double unknown one can organize exploration using the mapping between functions that technologies will be able to address and functions, that markets seek to fulfill. It is shown that the trial and learning strategy is potentially risky. Indeed, it occasionally leads to the development of a first trial that does not result in platform development. Favoring a first exploration project before formulating a platform core might actually lead to an increase in the global risks instead of decreasing it and limiting the exploration space. This evolutionary strategy is preferable when there is a dominant application which can be addressed through consequent trial development.

2) Contingent techno-economic criteria determine the conditions when the strategies of GT design are more advantageous to develop than more classical ones like market pull, technology push or evolutionary approaches such as trial and learning. It is shown that the design of GT is pertinent when multiple market alternatives emerge and change dynamically, technologies are aggregative and the cost of new interdependencies creation is low. Two contingent criteria: technological aggregativity and stability of market signals appear to be crucial to define validity zones for each strategy. These criteria were established based on the developed simulation model of techno-economic environments. The proposed model incorporates the evolution in time environments and deals with interdependencies. It aims to investigate the performance and conditions of different strategies in the situation where the industrial dynamic has the same order of magnitude as the time of development.

To design a GT, **3)** one has to define and manage **generic concepts** that lead to genericity exploration through the design of larger validity domain. The generic concept is a starting point in the design of a generic technology. Each generic concept is built on the associated domain of existence. The generic concept targets the existence domains that are not reduced to one solution but several of them, either known or partially unknown. To account for higher genericity, the validity domain should be larger, meaning that it has to embody various application areas and be flexible towards new environments. Three strategies to design existence domain in unknown were defined, based on the empirical

analysis of GTs development at ST: attraction, superposition and projection. These strategies provide different ways of building validity domains to account for successful GTs. Higher technological aggregativity facilitates the domain design and leads to the attainment of a larger existence domain. The economic reasoning behind the genericity building provides insights on the dynamics of engineering systems.

Finally, managerial and organizational needs are defined in order to account for GTs. **4) A new role of cross-application manager**, who is capable to put in interaction between various innovative concepts and guide the exploration of double unknown towards generic technology design, is defined. Through the investigation of four empirical contexts of GT design, it is shown that the success of GT development is highly correlated to the presence of a managerial figure that plays the role of the cross-application manager. Moreover, a new notion of conceptive development for GT design is introduced. Conceptive development aims to explore unknowns and account for breakthrough by keeping costs under control and integrating the characteristics of development projects in highly disruptive fields of exploration.

The design of generic technologies in double unknown is driven by **generic concepts** that are responsible for designing a larger application area through the creation or identification of a new existence domain. The interdependencies structure creation within various independent domains with controlled costs become crucial to attain a larger application area. The multi-market application valorization and technology capable of incorporating new functions (aggregative character) prevail over the reasoning of technology-market couples' development. The design of GT appears to be relevant when a variety of market signals exist even if their probability is low and distributions are volatile; these signals are dynamic in time. Moreover, technology should be aggregative, which ensures their adaptation to the new needs and their modularization for various market needs. The scientific and managerial effort associated with GT design requires a manager capable of managing multiple technological and marketing explorations, who knows the functional structure of the company and is capable of revealing the segregative or aggregative nature of technologies and identifying corresponding voids. The empirical analysis revealed the figure of a manager who is capable to manage generic concept generation while mobilizing the required expertise. Through the detailed analysis of four dimensions (object, conditions, process, actors) we have introduced the model of generic technology design (Figure 40)

	Academic contribution	Industrial contributions
Research phenomenon	New Object: New strategy for GT in double unknown based on the capability to identify common unknown for several markets	Managerial guidance and structure of common unknown in semiconductor industry
Performance Context	Context and Performance. Importance of interdependencies in the unknown: technological aggregativity in double unknown	New logic of "genericity improvement" business plan and applicability conditions of double unknown strategies
Method and theoretical basis	Method and Process Notion of generic concept => domain design, descriptors of existence domain (D)	Fabrication of D structure, strategies to improve genericity deployed at ST. Demonstrated design of G in open innovation process
Organization	Model of GTD: Modeling new action logic Cross-Application Manager and conceptive development model for GT design	Managerial guidance, method and governance of GT

Figure 40 - Results summary

3. THEORETICAL IMPLICATIONS: DESIGN AS A NEW ACTION POSSIBILITY FOR RISK MANAGEMENT IN UNKNOWN SITUATIONS?

In this section we discuss the theoretical implications of our research. The first principal thesis of this dissertation posits that situations of double unknown, normally considered as being unmanageable, are advantageous for the design of generic technologies. By their definition, GTs are capable of provoking technology dissemination in various market areas as well as of creating new uses. Still, the reasoning behind appeared to be challenging. By admitting the interest in developing pervasive GTs, the second principal thesis shows that even though the current literature shows the advantages of these technologies, there is a lack of techniques to actually design genericity. Thus, the main contribution of this thesis is a new action logic that facilitates the design of generic technologies. This action model of GT design engenders the range of the following theoretical implications.

First, this work opens further research streams on the governance of projects under uncertainty (Enkel et al., 2009, Gassmann, 2006). In the situation of high uncertainty there is a tendency to privilege more emergent and evolutionary strategies like trial and learning. They are based on injecting learning processes into so-called emergent strategies (Mintzberg, 1990)(e.g. logical incrementalism (Quinn, 1978), incorporating logic of action (Starbuck, 1992)). Surprisingly, the "common unknown" strategy, introduced in this work, belongs to a more deterministic class of strategies which allows managing double unknown in a more predictable way. The "common unknown" rather corresponds to the old classical strategy of "design school" where the challenge is not about choosing among alternatives, but rather in "generating options via collective reflection-in-

action” (Garud and Karunakaran, 2013). The introduced common unknown strategy has gone some way towards enhancing our understanding of unknown management. Dealing with the unknown management through interdependencies creation, is compliant with the advances that have demonstrated the importance of projects evaluation in relation to each other and interdependencies management (Elmqvist and Le Masson, 2009). **This research expands the classical definition of risk management dealing with uncertainty reduction by adding a new perspective on designing alternatives.** The design perspective shifts from dealing with uncertainty to exploring the unknown. This research demonstrates that the commonly deployed evolutionary models of risk management (*e.g.* trial and learning) appear to be risky while dealing with double unknown. Trial and learning conducts exploration in unknown through market trials. These trials provide limited access to knowledge with controlled costs. The associated learning process shapes path dependency and could incorporate new knowledge that leads to change in the path of exploration. Yet, the leaning course is predefined by the choice of the first trial, which could lead to a wrong direction in double unknown.

Second, by working on genericity building with the help of design theories, we were able to provide some theoretical insights to the field of design engineering as well. The analysis reveals that formal design theories provide powerful ways of designing genericity. Though, the level of genericity that each theory could attain and the mechanisms of its construction differ significantly. The introduced notion of generic concept and more importantly the validity domain impose a certain structure of future knowledge, which brings a new theoretical perspective to the Concept-Knowledge theory. The structure of the validity domain controls the operation of K-reordering, which is defined as the operation of propagation that follows the conjunction’s emergence: this is the effect of the newly generated knowledge, coming from the unknown, on the K space.

Third, by acknowledging the importance of techno-economic environments for strategies selection, we attempted to define contingent criteria that facilitate strategic choices in double unknown, with respect to the various industrial dynamics (Farr and Fischer, 2007). For instance, the results help to distinguish strategies relevant to a turbulent environment with a high rate of competition in high tech industries (Duysters and Man, 2003, Tierney et al., 2012) from the more traditional stable industries with the presence of dominant markets. These results bring new insights to the criteria used to evaluate the potential of innovative exploration in unknown situations and the models of resources allocation for investigations that target generic technologies design.

Additionally, the developed simulation model deals with the notion of complexity and interdependencies management as in NK Models (Gavetti et al., 2005, Rivkin and Siggelkow, 2003) and learning and uncertainty management as in decision-making models (*e.g.*, real options). By dealing with fast paced industries with high rate of innovation, we have built a simulation model that proposes to analyze situations that are evolving through time (by adding new functions, market signals, etc.).

Finally, our work regarding the necessary managerial and organizational capabilities to build transversal innovation projects is highly correlated with several other studies (Hatchuel et al., 2005, Hatchuel et al., 2006, Le Masson et al., 2010b, Lenfle and Midler, 2002) that deal with design-based organizations to prepare and manage the disruptions. The authors mobilize the design and organizational theory and propose a Research-Innovation-Development (RID) model to orientate the classical R&D structures towards the innovation design stressing the importance of an Innovation function. Dealing with the Advanced R&D exploration, Felk (2011) proposes a new form of innovation – conceptive development, that enables firms to manage radical concepts, identify new possibilities and manage the unknown. In the favor of GTs design, we have enriched the RID model by adding a new form of Innovation (I) – **Conceptive Development**. As conceptive research, conceptive development aims to deal with unknown in order not to explore all the possible alternatives, but to propose an original generic solution, which controls the risks in unknown. Conceptive development adds new perspectives on managing firms' innovative capabilities by targeting a high number of applications and control costs and knowledge production.

The present study provides additional evidence with respect to the managerial capabilities to work on transversal exploration and enable organizational creativity as an actionable concept to support innovation. We defined the role of the **cross-application manager**, who is responsible for the creation and management of generic concepts, and the enlargement of the innovative design capacity. This actor is also able to put into interaction innovative concepts developed by different business and research groups. He is responsible for creating and managing technological and marketing exploration portfolios within various organizational structures of the company. Agogue et al. (2013) demonstrated that these intermediaries could play an important role in structuring collective exploration activities. Faced with double unknown, the Cross-application manager appears to be an important innovation intermediary that brings together the range of different business units and knowledge needed to create successful generic technologies.

Finally, the proposed model of action logic for the GTs' design improves the understanding and management of the *ex ante* processes of innovation and generates new concepts while integrating economic reasoning adapted to unknown exploration. The elaborated model aims to exploit the firm's existing opportunities and generate entirely new ones.

4. MANAGERIAL IMPLICATIONS: TRANSVERSAL TECHNOLOGY AND MARKETS EXPLORATION IN THE UNKNOWN

The current findings substantially add to our understanding of the issues of double unknown management and the challenges of GT design in practice. The intervention research approach conducted at STMicroelectronics, based on the *ex post* case analyses of generic technology development and *ex ante* cases assessment in double unknown and their guidance, underlines that this work is highly pertinent for practitioners attempting to explore both new uses and technological phenomena.

The results of this work are especially relevant for high-tech industries characterized by the high rate of competition, disruption and fast renewal. The implications given for semiconductors within this work could be extended for the other high-tech domains. For instance, the results of this work are already mobilized in the energy sector through a project financed by the French Energy Counsel to explore double unknown situations and gain further insights on the management of GTs in the energy domain. This project is conducted by the Center of Management Science (CGS) in collaboration with CEA (2012 - 2014). In addition, the developed reasoning of generic technologies design was mobilized by intern students (2012 - 2013) of the CGS who conducted their master thesis project at EADS innovation works. They have applied the insights gained on GTs for the generation of architectural alternatives to the hypersonic aircraft in aerospace industry. Further studies could provide a number of important implications for future practices in telecommunication, biotechnology and nanotechnology.

The conducted simulation to reveal techno-economic conditions that define the strategies performance lead to revisiting the types of business plans to help investors in their decision-making. We showed that traditional business plans are driven by the logic of finding the best, which in terms of future benefits technology-market couple is misleading in double unknown situations. We have given important indications on the necessary investment logic. It was demonstrated that projects attempting to address multiple markets by developing generic technologies or even more classical explorations that follow technology push, should be driven by multi-market evaluation business reasoning. This work defines the pertinence zone for each type of business logics and demonstrates a new form of “genericity improvement” business plans.

Our empirical work based on business innovation processes analyses demonstrated strategies to improve genericity and elaborates on how genericity could be developed within innovation contests.

The examination of project portfolios faced with double unknown at STMicroelectronics allowed us to determine the managerial guidance and structure of common unknown in the semiconductor industry. Moreover, the new role of cross-application manager challenges the existing organizational structure of the companies that privilege exploration based on an R&D group providing a solution for a singular business unit.

5. FURTHER WORK: DISSEMINATION OF THE LOGIC BEHIND GENERIC TECHNOLOGIES DESIGN AND ITS VALIDITY

This thesis may serve as a beginning to understanding the complex process that precedes the design of competitive solution in double unknown. Through our investigation we addressed a range of questions and obtained some significant results whose importance is shown by their deployment in the semiconductors and in other domains. To conclude, some directions for further research are given. This research can proceed following three main directions: 1) generalizing the results of this research; 2) addressing the remaining questions; 3) widening both the scope and level of analysis.

Generalization of the obtained results

The dimensions of the proposed new action logic could be enriched. From a methodological perspective, further enhancement of the simulation model could be beneficial. The current version only comprises new market generation and their extinction when the market draw is unfavorable. The existing markets updates, including their type, the level of uncertainty and the associated costs could be considered after each time period to account for a more realistic environment. In addition, the competing technologies could be added. Further research will attempt to overcome the main limitations of the model by using larger samples. Using data corresponding to the practical cases could provide important insights to practitioners dealing with investment decisions in unknown and enrich the prerequisites of strategies success.

The notion of generic concept and the domain of existence were examined and introduced based on two forms of genericity: algebraic field extensions and selected engineering knowledge structures. Other knowledge topologies could enable the identification of new powerful forms of genericity. In models of the K-space, for instance, Hendriks and Kazakci (2010) underlined that different structures to model knowledge yield different conceptive power and degrees of flexibility.

The thesis highlights new forms of conceptive engineering, *i.e.* conceptive development, and demonstrates how the projects could be organized within the model of innovation design *ex post*. Further research should examine more precisely the issues of portfolio organization and management in the unknown situation, provide indications on how to structure portfolio around generic technologies and account for faster knowledge production and reuse, how to balance the portfolios of existing and new opportunities over time.

Addressing the remaining questions

Unexamined in this work, social and psychological design approaches could provide new perspectives on the process of GT design. The fixation effects associated with genericity reasoning should be investigated. How can we stimulate innovative thinking on double unknown in cases where the target is a genericity creation? There are methods which, in order to overcome fixation effects (Purcell and Gero, 1996), suggest enhancing social interaction through communication, boundary spanning (Rapp et al., 2013) or enhancing cognition (Agogué et al., 2012). Can these techniques be useful to enhance the degree of genericity of exploration? How can we stimulate participants to build genericity? What is the nature of this stimulus?

The obtained empirical results on patent portfolio design around generic technologies and four explorations at STMicroelectronics show the interest to further continue this direction and, based on the preliminary theoretical model developed in (Felk, 2011), conduct rigorous theoretical model for intellectual property design and the various forms of its valorization. Further research could focus more closely on the challenges associated with patent portfolio protection in case of generic

technologies, on the definition of a generic patent portfolio and even on the alternative forms of genericity protection.

Extending the scope and level of analysis

Once the new action logic is introduced, it needs to be tested on other empirical settings *ex post* and provide further insights for ongoing and future explorations. The further research should contextualize this model to the contexts of other companies and industries.

We have built a new model of collective action based on the industrial dynamics of the semiconductor industry choosing one company as a unit of analysis. Yet, the importance of transversal explorations at the ecosystem level of different actors is stressed by the literature. Our research proved some insights on the double unknown exploration through collective action within “More than Moore” community of the ITRS (Cogez et al., 2013). This analysis demonstrates that the design of generic technologies appears to be pertinent to explore unknown at the level of the ecosystem in semiconductor industry. Still, effective governance forms and business investment models adapted to co-develop generic technologies at the level of the ecosystem should be further investigated. The role of different stakeholders needs to be considered in order to clarify the form of business model innovation suitable for generic technologies exploration.

In future investigations it might be possible to gain new insights by conducting experiments within other intensive innovation-based industries. These research avenues should lead to larger application areas of generic technology design and adjust the corresponding action model.

Key references

Research area	Key references
Generic technologies	<p>Bresnahan, T. F. & Trajtenberg, M. (1995) General purpose technologies 'Engines of growth'? <i>Journal of econometrics</i>, 65, 83-108.</p> <p>Maine, E. & Garnsey, E. (2006) Commercializing generic technology: The case of advanced materials ventures. <i>Research Policy</i>, 35, 375-393.</p> <p>Youtie, J., Iacopetta, M. & Graham, S. (2008) Assessing the nature of nanotechnology: can we uncover an emerging general purpose technology? <i>The Journal of Technology Transfer</i>, 33, 315-329.</p> <p>Miyazaki, K. (1994) Interlinkages between systems, key components and component generic technologies in building competencies. <i>Technology Analysis & Strategic Management</i>, 6, 107-120.</p>
1. Risk management in unknown, platforms	<p>- Trial and learning strategies</p> <p>Loch, C. L., Solt, M. E., Bailey E. M. . (2008) Diagnosing unforeseeable uncertainty in a new venture. <i>The Journal of Product Innovation Management</i>, 25.</p> <p>Sommer, S. C. & Loch, C. H. (2004) Selectionism and learning in projects with complexity and unforeseeable uncertainty. <i>Management Science</i>, 50, 1334-1347.</p> <p>- Platforms and modularity</p> <p>Baldwin, Y. C. (2008) Where Do Transactions Come From? Modularity, Transactions, and the Boundaries of Firms. . <i>Industrial and Corporate Change</i>, 17, 155-195.</p> <p>Gawer, A. (2009) <i>Platforms, Markets and Innovation</i>, Edward Elgar Publishing.</p> <p>Kim, D.-J. & Kogut, B. (1996) Technological platforms and diversification. <i>Organization Science</i>, 7, 283-301.</p>
2. Criteria and Business models	<p>- Business model innovation for generic technologies</p> <p>Gambardella, A. & Mcgahan, A. M. (2010) Business-model innovation: General purpose technologies and their implications for industry structure. <i>Long Range Planning</i>, 43, 262-271.</p> <p>- Real options</p> <p>Huchzermeier, A. & Loch, C. H. (2001) Project Management Under Risk: Using the Real Options Approach to Evaluate Flexibility in R... <i>D. Management Science</i>, 47, 85-101.</p> <p>Kogut, B. & Kulatilaka, N. (2001) Capabilities as real options. <i>Organization Science</i>, 12, 744-758.</p> <p>- NK type of models</p> <p>Rivkin, J. W. (2000) Imitation of complex strategies. <i>Management Science</i>, 46, 824-844.</p> <p>Gavetti, G., Levinthal, D. A. & Rivkin, J. W. (2005) Strategy making in novel and complex worlds: the power of analogy. <i>Strategic Management Journal</i>, 26, 691-712.</p>
3. Design theories and genericity	<p>- Generativity in design theories</p> <p>Hatchuel, A., Weil, B. & Le Masson, P. (2013) Towards an ontology of design: lessons from C-K design theory and Forcing. <i>Research in Engineering Design</i>, 1-17.</p> <p>Hatchuel, A., Le Masson, P., Reich, Y. & Weil, B. (Year) Published. A systematic approach of design theories using generativeness and robustness. <i>Proceedings of the 18th International Conference on Engineering Design (ICED11)</i>, Vol. 2, 2011. 87-97.</p> <p>Otherwise: papers corresponding to the formal design theory</p>
4. Organization and cross-application	<p>- Organizational forms and the rols of management for unknown exploration</p> <p>O'connor, G. C. (2008b) Major Innovation as a Dynamic Capability: A Systems Approach*. <i>Journal of product innovation management</i>, 25, 313-330.</p> <p>O'connor, C. G. (2006) <i>Organizing for Radical Innovation: An Exploratory Study of the</i></p>

<p>manager</p>	<p>Struc-tural Aspect of RI Management Systems in Large Established Firms. The Journal of product innovation management, 23, 475-497.</p> <p>O'connor, G. C. & Rice, M. P. (2012) New Market Creation for Breakthrough Innovations: Enabling and Constraining Mechanisms. Journal of Product Innovation Management.</p> <p>- RID</p> <p>Hatchuel, A., Le Masson, P. & Weil, B. (2007) Published. From R&D to RID: Design strategies and the management of innovation fields. 8th international product development management conference, 2001. 415-430.</p>
-----------------------	---

References

- Abel, A. B., Dixit, A. K., Eberly, J. C. & Pindyck, R. S. (1996) Options, the value of capital, and investment. *The quarterly Journal of economics*, 111, 753-777.
- Abernathy, W. J. & Clark, K. B. (1985) Innovation: Mapping the Winds of Creative Destruction. *Research Policy*, 14, 3-22.
- Abernathy, W. J. & Utterback, J. M. (1978) Patterns of innovation in technology. *Technology review*, 80, 40-47.
- Adner, R. & Levinthal, D. A. (2004) What is not a real option: Considering boundaries for the application of real options to business strategy. *Academy of Management Review*, 29, 74-85.
- Agogu , M., Le Masson, P. & Robinson, D. K. (2012) Orphan innovation, or when path-creation goes stale: a design framework to characterise path-dependence in real time. *Technology Analysis & Strategic Management*, 24, 603-616.
- Agogue, M., Ystr m, A. & Le Masson, P. (2013) Rethinking the role of intermediaries as an architect of collective exploration and creation of knowledge in open innovation. *International Journal of Innovation Management*, 17.
- Akao, Y. (1990) *Quality function deployment: integrating customer requirements into product design*, Productivity Press.
- Alexander, C. (1964) *Notes on the Synthesis of Form*, Harvard University Press.
- Arden, W., Brillou t, M., Cogez, P., Graef, M., Huizing, B. & Mahnkopf, R. (2010) More-than-Moore white paper. Version, 2, 14.
- Baldwin, C. & Clark, K. (1997) *Managing in an Age of Modularity*. Harvard Business Review.
- Baldwin, C. & Clark, K. (2006). Modularity in the design of complex engineering systems. Book chapter in *Complex Engineering systems: Science meets technology*. In: Ali Minai, D. B. a. Y. B. Y. (ed.) *New England Complex System Institute Series on Com-plexity*. New York: Springer-Verlag.
- Baldwin, C. Y. & Clark, K. B. (2000) *Design rules: The power of modularity*, Mit Press.
- Baldwin, Y. C. (2008) Where Do Transactions Come From? Modularity, Transactions, and the Boundaries of Firms. *Industrial and Corporate Change*, 17, 155-195.
- Barclay, I. (1992) The new product development process: past evidence and future practical application, Part 1. *R&D Management*, 22, 255-264.
- Beach, L. R. & Mitchell, T. R. (1978) A contingency model for the selection of decision strategies. *Academy of Management Review*, 3, 439-449.
- Ben-Haim, Y. (2006) *Info-gap decision theory: decisions under severe uncertainty*, Academic Press.
- Bensahel, D. (2012) Laboratoire commun LTM STMicron lectronique.
- Bhardwaj, G., Camillus, J. C. & Hounshell, D. A. (2006) Continual corporate entrepreneurial search for long-term growth. *Management Science*, 52, 248-261.
- Bip. (2009) *Business Innovation Process*. Lancement BIP Grenoble.
- Birkinshaw, J., Hamel, G. & Mol, M. J. (2008) Management innovation. *Academy of management Review*, 33, 825-845.
- Black, F. & Scholes, M. (1973) The pricing of options and corporate liabilities. *The journal of political economy*, 637-654.
- Bohr, M. (2009) The new era of scaling in an SoC world. *Solid-State Circuits Conference-Digest of Technical Papers, 2009. ISSCC 2009. IEEE International*. IEEE.
- Boujut, J.-F. & Blanco, E. (2003) Intermediary objects as a means to foster co-operation in engineering design. *Computer Supported Cooperative Work (CSCW)*, 12, 205-219.
- Boujut, J.-F. & Laureillard, P. (2002) A co-operation framework for product-process integration in engineering design. *Design studies*, 23, 497-513.
- Braha, D. & Reich, Y. (2003) Topological structures for modeling engineering design processes. *Research in Engineering Design*, 14, 185-199.
- Brem, A. & Voigt, K. I. (2009) Integration of market pull and technology push in the corporate front end and innovation management—Insights from the German software industry. *Technovation*, 29, 351-367.
- Bresnahan, T. F. & Greenstein, S. (1999) Technological competition and the structure of the computer industry. *The Journal of Industrial Economics*, 47, 1-40.
- Bresnahan, T. F. & Trajtenberg, M. (1995) General purpose technologies ‘Engines of growth’? *Journal of econometrics*, 65, 83-108.
- Bryzek, J. (1996) Impact of MEMS technology on society. *Sensors and Actuators A: Physical*, 56, 1-9.

- Caetano, M. & Amaral, D. C. (2011) Roadmapping for technology push and partnership: a contribution for open innovation environments. *Technovation*, 31, 320-335.
- Caldart, A. A. & Ricart, J. E. (2004) Corporate strategy revisited: a view from complexity theory. *European Management Review*, 1, 96-104.
- Camerer, C. & Weber, M. (1992) Recent developments in modeling preferences: Uncertainty and ambiguity. *Journal of risk and uncertainty*, 5, 325-370.
- Cantwell, J. & Qui, R. (2009) General Purpose Technology (GPT), firm technological diversification and the re-structure of MNC international innovation networks. *Druid conference summer conference*.
- Carbonell, P. & Rodríguez-Escudero, A. I. (2009) Relationships among team's organizational context, innovation speed, and technological uncertainty: An empirical analysis. *Journal of Engineering and Technology Management*, 26, 28-45.
- Cathelin, A., Martineau, B., Seller, N., Giancesello, F., Raynaud, C. & Belot, D. (Year) Published. (INVITED) Deep-submicron digital CMOS potentialities for millimeter-wave applications. *Radio Frequency Integrated Circuits Symposium, 2008. RFIC 2008. IEEE, 2008. IEEE*, 53-56.
- Chandler, A. D., Hagstrom, P. & Solvell, O. (1999) *The dynamic firm: the role of technology, strategy, organization, and regions*, Oxford University Press.
- Chantre, A., Chevalier, P., Lacave, T., Avenier, G., Buczko, M., Campidelli, Y., Depoyan, L., Berthier, L. And Gacquièrè, C. . (2010) Pushing conventional SiGe HBT Technology Towards "Dotfive" Terahertz. *EuMA*.
- Chapman, C. (1990) A risk engineering approach to project risk management. *International Journal of Project Management*, 8, 5-16.
- Chapman, C. & Ward, S. (2003) *Project risk management: processes, techniques and insights*, Wiley.
- Cheng, Y.-T. & Van De Ven, A. H. (1996) Learning the innovation journey: order out of chaos? *Organization Science*, 7, 593-614.
- Chesbrough, H., Vanhaverbeke, W. & West, J. (2008) *Open Innovation: Researching a New Paradigm: Researching a New Paradigm*, Oxford university press.
- Chesbrough, H. W. (2006) The era of open innovation. *Managing innovation and change*, 127, 34-41.
- Chevalier, P., Gloria, D., Scheer, P., Pruvost, S., Giancesello, F., Pourchon, F., Garcia, P., Vildeuil, J.-C., Chantre, A. & Garnier, C. (2006) Advanced SiGe BiCMOS and CMOS platforms for optical and millimeter-wave integrated circuits. *Compound Semiconductor Integrated Circuit Symposium, 2006. CSIC 2006. IEEE. IEEE*.
- Chevalier, P., Szelag, B., Boissonnet, L., Cremer, S., Chantre, A. & Granger, E. (Year) Published. Advanced silicon technologies for wireless communications. *Research in Microelectronics and Electronics Conference, 2007. PRIME 2007. Ph. D., 2007. IEEE*, 291-297.
- Chevalier, P. H. (2007) *High-Speed SiGe BiCMOS Technologies: 120-nm Status and End-of-Roadmap Challenges*. SiRF.
- Chew, W. B., Leonard-Barton, D. & Bohn, R. E. (1991) Beating Murphy's law. *Shan Management Rev.*
- Christensen, C. M. (1997) *The innovator's dilemma: when new technologies cause great firms to fail*, Harvard Business Press.
- Christensen, C. M. & Bower, J. L. (1996) Customer power, strategic investment, and the failure of leading firms. *Strategic management journal*, 17, 197-218.
- Christensen, C. M., Suárez, F. F. & Utterback, J. M. (1998) Strategies for survival in fast-changing industries. *Management science*, 44, S207-S220.
- Cogez, P., Kokshagina, O., Le Masson, P. & Weil, B. (2013) Industry-Wide Technology Road Mapping in Double Unknown – The Case of the Semiconductor Industry. *ICE & IEEE – ITMC Conference Hague*.
- Cohen, P. (2002) The discovery of Forcing. *Rocky Mountain Journal of Mathematics*, 32, 1071-1100.
- Cohen, P. J. (1963) The independence of the Continuum Hypothesis. *Proceedings of the National Academy of Science*, 50, 1143-1148.
- Cohen, P. J. (1964) The independence of the Continuum Hypothesis II. *Proceedings of the National Academy of Science*, 51, 105-110.
- Cohen, W. M. & Levinthal, D. A. (1989) Innovation and learning: the two faces of R & D. *The economic journal*, 99, 569-596.
- Coombs, R. (2007) Core competencies and the strategic management of R&D. *R&D Management*, 26, 345-355.
- Courtney, H., Kirkland, J. & Viguerie, P. (1997) Strategy under uncertainty. *Harvard business review*, 75, 67-79.
- Danneels, E. (2002) The dynamics of product innovation and firm competences. *Strategic management journal*, 23, 1095-1121.
- Danneels, E. (2004) Disruptive technology reconsidered: A critique and research agenda. *Journal of product innovation management*, 21, 246-258.

- Danneels, E. (2007) The process of technological competence leveraging. *Strategic Management Journal*, 28, 511-533.
- Das, S. S. & Van De Ven, A. H. (2000) Competing with new product technologies: a process model of strategy. *Management Science*, 46, 1300-1316.
- David, A., Hatchuel, A. & Laufer, R. (2012) *Les nouvelles fondations des sciences de gestion*, Presses des Mines.
- Davila, T., Epstein, M. & Shelton, R. (2012) *Making innovation work: How to manage it, measure it, and profit from it*, FT Press.
- Davis, J. P., Eisenhardt, K. M. & Bingham, C. B. (2007) Developing theory through simulation methods. *Academy of Management Review*, 32, 480-499.
- De Meyer, A., Loch, H. C. & Pitch, T. M. (2002) Managing project uncertainty: From Variation to Chaos. *MIT Sloan Management Review*, 43, 60-67.
- De Neufville, R., De Weck, O., Frey, D., Hastings, D., Larson, R., Simchi-Levi, D., Oye, K., Weigel, A. & Welsch, R. (Year) Published. *Uncertainty management for engineering systems planning and design*. Engineering Systems Symposium, MIT, Cambridge, MA, 2004.
- De Weck, O., De Neufville, R. & Chaize, M. (2003) Enhancing the economics of communications satellites via orbital reconfigurations and staged deployment. *American Institute of Aeronautics and Astronautics*.
- De Weck, O. L., Neufville, R. D. & Chaize, M. (2004) Staged deployment of communications satellite constellations in low earth orbit. *Journal of Aerospace Computing, Information, and Communication*, 1, 119-136.
- Dickinson, H. W. (2010) *Matthew Boulton*, Cambridge University Press.
- Dixit, A. K. & Pindyck, R. S. (1994) *Investment under uncertainty*, 1994. Princeton UP, Princeton.
- Duysters, G. & Man, A. P. (2003) Transitory alliances: an instrument for surviving turbulent industries? *R&D Management*, 33, 49-58.
- Eisenhardt, K. (1989a) Building Theories from Case Study Research. *The Academy of Management Review*, 14, 532-550.
- Eisenhardt, K. M. (1989b) Making fast strategic decisions in high-velocity environments. *Academy of Management journal*, 32, 543-576.
- Eisenhardt, K. M. & Brown, S. L. (1998) Time pacing: Competing in markets that won't stand still. *Harvard business review*, 76, 59-71.
- Eisenhardt, K. M. & Tabrizi, B. N. (1995) Accelerating adaptive processes: Product innovation in the global computer industry. *Administrative Science Quarterly*, 84-110.
- Elmquist, M. (2007) Vehicles for innovation and learning: the case of a neglected concept car project. *Knowledge and Process Management*, 14, 1-14.
- Elmquist, M. & Le Masson, P. (2009) The value of a 'failed'R&D project: an emerging evaluation framework for building innovative capabilities1. *R&d Management*, 39, 136-152.
- Eniac. (2012) Annual Work program.
- Enkel, E., Gassmann, O. & Chesbrough, H. (2009) Open R&D and open innovation: exploring the phenomenon. *R&d Management*, 39, 311-316.
- Farr, C. M. & Fischer, W. A. (2007) Managing international high technology cooperative projects. *R&D Management*, 22, 055-068.
- Feldman, M. P. & Yoon, J. W. (2012) An empirical test for general purpose technology: an examination of the Cohen-Boyer rDNA technology. *Industrial and Corporate Change*, 21, 249-275.
- Felk, Y. (2011) *Evaluation et pilotage des activités de recherche dans la R&D centrale de STMicroelectronics. Nouveaux principes de management de la recherche industrielle pour l'innovation de rupture* Doctorat en Sciences de Gestion, Mines ParisTech.
- Felk, Y., Le Masson, P., Weil, B., Cogez, P. & Hatchuel, A. (Year) Published. *Designing patent portfolio for disruptive innovation - a new methodology based on CK theory* Proceedings of the 18th International Conference on Engineering Design (ICED11), Vol. 2, 2011. 214-225.
- Field, A. J. (2008) *Does Economic History Need GPTs?* Available at SSRN 1275023.
- Freeman, C. & Soete, L. L. (1997) *The economics of industrial innovation*, Psychology Press.
- Frenken, K. & Nuvolari, A. (2004) The early development of the steam engine: an evolutionary interpretation using complexity theory. *Industrial and Corporate Change*, 13, 419-450.
- Gambardella, A. & Mcgahan, A. M. (2010) Business-model innovation: General purpose technologies and their implications for industry structure. *Long Range Planning*, 43, 262-271.
- Garcia, R. & Calantone, R. (2002) A critical look at technological innovation typology and innovativeness terminology: a literature review. *Journal of product innovation management*, 19, 110-132.
- Garud, R. & Karnøe, P. (2003) Bricolage versus breakthrough: distributed and embedded agency in technology entrepreneurship. *Research policy*, 32, 277-300.

- Garud, R. & Karunakaran, A. (2013) A Design approach to navigating cognitive traps: the case of google inc. . EURAM 2013 (European Academy of Management) Conference. Istanbul.
- Gassmann, O. (2006) Opening up the innovation process: towards an agenda. *R&D Management*, 36, 223-228.
- Gavetti, G., Levinthal, D. A. & Rivkin, J. W. (2005) Strategy making in novel and complex worlds: the power of analogy. *Strategic Management Journal*, 26, 691-712.
- Gawer, A. (2009) *Platforms, Markets and Innovation*, Edward Elgar Publishing.
- Gawer, A. (2010). The organization of technological platforms. In: Nelson Phillips, G. S., Dorothy Griffiths (ed.) *Technology and Organization: Essays in Honour of Joan Woodward in Research in the Sociology of Organizations*. Emerald Group Publishing Limited.
- Gawer, A. & Cusumano, M. A. (2008) How companies become platform leaders. *MIT Sloan Management Review*, 49, 28-35.
- Gawer, A. a. C., M. A. . (2008) How companies become platform leaders. *MIT Sloan Management Review*, 49, 28-35.
- Gero, J. S. & Kazakov, V. A. (1996) An Exploration-Based Evolutionary Model of a Generative Design Process. *Computer-Aided Civil and Infrastructure Engineering*, 11, 211-218.
- Goktan, A. B. & Miles, G. (2011) Innovation speed and radicalness: are they inversely related? *Management Decision*, 49, 533-547.
- Granstrand, O. (1999) *The economics and management of intellectual property: Towards intellectual capitalism*, Edward Elgar Cheltenham, UK.
- Grinstein, A. (2008) The effect of market orientation and its components on innovation consequences: a meta-analysis. *Journal of the Academy of Marketing Science*, 36, 166-173.
- Groen, A. & Walsh, S. (2013) Introduction to the Field of Emerging Technology Management. *Creativity and Innovation Management*, 22, 1-5.
- Gruber, M. (2010) Exploring the origins of organizational paths: Empirical evidence from newly founded firms. *Journal of Management*, 36, 1143-1167.
- Hall, B. H. & Trajtenberg, M. (2004) Uncovering GPTs with patent data. National Bureau of Economic Research.
- Hamel, G. (2006) The why, what, and how of management innovation. *Harvard business review*, 84, 72.
- Harrison, J. R., Lin, Z., Carroll, G. R. & Carley, K. M. (2007) Simulation modeling in organizational and management research. *Academy of Management Review*, 32, 1229-1245.
- Hatchuel, A. (2001) The two pillars of new management research. *British Journal of Management*, 12, S33-S39.
- Hatchuel, A. (2005) Towards an epistemology of collective action: management research as a responsive and actionable discipline. *European Management Review*, 2, 36-47.
- Hatchuel, A., Le Masson, P., Reich, Y. & Weil, B. (2011) A systematic approach of design theories using generativeness and robustness. *Proceedings of the 18th International Conference on Engineering Design (ICED11)*, Vol. 2.
- Hatchuel, A., Le Masson, P. & Weil, B. (2001) From R&D to RID: Design strategies and the management of innovation fields. 8th international product development management conference.
- Hatchuel, A., Le Masson, P. & Weil, B. (2005) The Development of Science-Based Products: Managing by Design Spaces. *Creativity and innovation management*, 14, 345-354.
- Hatchuel, A., Le Masson, P. & Weil, B. (2006) Building innovation capabilities: the development of design-oriented organizations. *Innovation, Science, and Institutional Change*. (MMJ Hage, Éd.), 295-312.
- Hatchuel, A., Starkey, K., Tempest, S. & Le Masson, P. (2010) Strategy as innovative design: An emerging perspective. *Advances in Strategic Management*, 27, 3-28.
- Hatchuel, A. & Weil, B. (1995) Experts in organizations: a knowledge-based perspective on organizational change, Walter de Gruyter.
- Hatchuel, A. & Weil, B. (Year) Published. A new approach of innovative design: an introduction to CK theory. *Proceedings, International Conference on Engineering Design, 2003*. Citeseer.
- Hatchuel, A. & Weil, B. (Year) Published. Design as Forcing: deepening the foundations of C-K theory. *International Conference on Engineering Design, 2007 Paris*. 12.
- Hatchuel, A. & Weil, B. (2009) CK design theory: an advanced formulation. *Research in Engineering Design*, 19, 181-192.
- Hatchuel, A., Weil, B. & Le Masson, P. (2012a) Towards an ontology of design: lessons from C-K design theory and Forcing. *Research in Engineering Design*, 1-17.
- Hatchuel, A., Weil, B. & Le Masson, P. (2012b) Towards an ontology of expansion: lessons from C-K Design theory and Forcing. *Research in Engineering Design*, (accepted).
- Hatchuel, A., Weil, B. & Le Masson, P. (2013) Towards an ontology of design: lessons from C-K design theory and Forcing. *Research in Engineering Design*, 1-17.
- Hauser, J. R. & Clausing, D. (1988) The house of quality.

- Heeren, V. H. & Salomon, P. (2007) MEMS Recent Developments, Future Directions. Loughborough University.
- Henderson, R. M. & Clark, K. B. (1990) Architectural innovation: the reconfiguration of existing product technologies and the failure of established firms. *Administrative science quarterly*, 9-30.
- Hendriks, L. & Kazakci, A. (2010). Design as imagining the future: a formal account. *Logic and Interactive Rationality*. In: Grossi, D., Minica, S., Rodenhauer, B. & Smets, S. (eds.) *Logic and Interactive Rationality*. Yearbook2010.
- Hill, C. W. & Jones, G. R. (2007) Strategic Management: An Intergrated Approach, CengageBrain. com.
- Hoefflinger, B. (2012). ITRS: The International Technology Roadmap for Semiconductors. *Chips 2020*. Springer.
- Hooge, S., Agogu , M. & Gillier, T. (Year) Published. A new methodology for advanced engineering design: Lessons from experimenting CK Theory driven tools. *Proceedings of International Design Conference-Design*, 2012.
- Howell, J. M. & Higgins, C. A. (1990) Champions of technological innovation. *Administrative science quarterly*, 317-341.
- Huchzermeier, A. & Loch, C. H. (2001) Project Management Under Risk: Using the Real Options Approach to Evaluate Flexibility in R... *D. Management Science*, 47, 85-101.
- Iansiti, M. & MacCormack, A. (1997) Developing products on Internet time. *Harvard business review*, 75, 108.
- Itrs. (2011) The International Technology Roadmap for Semiconductors.
- Jaafari, A. (2001) Management of risks, uncertainties and opportunities on projects: time for a fundamental shift. *International journal of project management*, 19, 89-101.
- Jovanovic, B. & Rousseau, P. L. (2005) General purpose technologies. *Handbook of economic growth*, 1, 1181-1224.
- Kander, A., Enflo, K. & Sch n, L. (2007) In Defense of Electricity as a General Purpose Technology. CIRCLE Electronic Working Paper Series.
- Kaplan, S. & Tripsas, M. (2008) Thinking about technology: Applying a cognitive lens to technical change. *Research Policy*, 37, 790-805.
- Kauffman, S. (1993) *The origins of order: Self organization and selection in evolution*, Oxford University Press.
- Keenan, M. (2003) Identifying emerging generic technologies at the national level: the UK experience. *Journal of Forecasting*, 22, 129-160.
- Kikuchi, M. & Nagasaka, I. (2002) On the Three Axioms of General Design Theory. *Proceedings of IWES*, 2, 69.
- Kim, D.-J. & Kogut, B. (1996) Technological platforms and diversification. *Organization Science*, 7, 283-301.
- King, A. A. & Tucci, C. L. (2002) Incumbent entry into new market niches: The role of experience and managerial choice in the creation of dynamic capabilities. *Management Science*, 48, 171-186.
- Knight, F. H. (1921) *Risk, uncertainty and profit*. New York: Hart, Schaffner and Marx.
- Koen, P., Ajamian, G., Burkart, R., Clamen, A., Davidson, J., D'amore, R., Elkins, C., Herald, K., Incorvia, M. & Johnson, A. (2001) Providing clarity and a common language to the" fuzzy front end". *Research-Technology Management*, 44, 46-55.
- Koh, E. C. (2013) Engineering design and intellectual property: where do they meet? *Research in Engineering Design*, 1-5.
- Kokshagina, O., Le Masson, P., Weil, B. & Coge , P. (2013). Platform emergence in double unknown (technology, markets): common unknown strategy. In:  etindamar, D., Daim, T., Ba o lu, N. & Beyhan, B. (eds.) *Strategic planning decisions in the high tech industry*. London: Springer.
- Landes, D. S. (1990) Why are we so rich and they so poor? *The American Economic Review*, 80, 1-13.
- Langlois, R. N. & Cosgel, M. M. (1993) Frank Knight on risk, uncertainty, and the firm: a new interpretation. *Economic Inquiry*, 31, 456-465.
- Le Masson, P., Coge , P., Felk, Y. & Weil, B. (2012a) Revisiting absorptive capacity from a design perspective. *International Journal of Knowledge Management Studies*, 5, 10-44.
- Le Masson, P., Hatchuel, A. & Weil, B. (2010a) Modeling novelty-driven industrial dynamics with design functions: understanding the role of learning from the unknown. *International Schumpeter Societe Conference on Innovation, Organization, Sustainability and Crises*. Aalborg.
- Le Masson, P., Weil, B. & Hatchuel, A. (2010b) Strategic management of design and innovation.
- Le Masson, P., Weil, B., Hatchuel, A. & Coge , P. (2012b) Why are they not locked in waiting games? Unlocking rules and the ecology of concepts in the semiconductor industry. *Technology Analysis & Strategic Management*, 24, 617-630.
- Le Masson, P., Weil, B. & Kokshagina, O. (2013) A new perspective for risk management: independence structures and the design of generic technologies. *NARA workshop*.
- Legardeur, J., Boujut, J. F. & Tiger, H. (2010) Lessons learned from an empirical study of the early design phases of an unfulfilled innovation. *Research in Engineering Design*, 21, 249-262.

- Lenfle, S. (2011) The strategy of parallel approaches in projects with unforeseeable uncertainty: The Manhattan case in retrospect. *International Journal of Project Management*, 29, 359 – 373.
- Lenfle, S. & Loch, C. (2010) Lost roots: how project management came to emphasize control over flexibility and novelty. *California Management Review*, 53.
- Lenfle, S. & Midler, C. (2002) Stratégie d'innovation et organisation de la conception dans les entreprises amont. *Revue française de gestion*, 28, 89-105.
- Leonard-Barton, D. & Doyle, J. L. (1996) Commercializing technology: imaginative understanding of user needs. *Engines of innovation*, Harvard Business School Press, Boston, MA, 177-208.
- Leservicecommunication. 2011. RE: Plus qu'un mois pour participez au challenge à idées: "Make life easier and better for Everybody! ".
- Levinthal, D. A. (1997) Adaptation on rugged landscapes. *Management science*, 43, 934-950.
- Linton, J. D. & Walsh, S. T. (2008a) Acceleration and extension of opportunity recognition for nanotechnologies and other emerging technologies. *International Small Business Journal*, 26, 83-99.
- Linton, J. D. & Walsh, S. T. (2008b) A theory of innovation for process-based innovations such as nanotechnology. *Technological Forecasting and Social Change*, 75, 583-594.
- Lipshitz, R. & Strauss, O. (1997) Coping with uncertainty: A naturalistic decision-making analysis. *Organizational Behavior and Human Decision Processes*, 69, 149-163.
- Loch, C. H., Solt, M. E. & Bailey, E. M. (2008) Diagnosing Unforeseeable Uncertainty in a New Venture*. *Journal of Product Innovation Management*, 25, 28-46.
- Loch, C. L., De Meyer, A. And Pitch, M. T. (2006) Managing the unknown: A new approach to managing high uncertainty in projects, New York: Wiley.
- Loch, C. L., Solt, M. E., Bailey E. M. . (2008) Diagnosing unforeseeable uncertainty in a new venture. *The Journal of Product Innovation Management*, 25.
- Luo, J., Baldwin, C. Y., Whitney, D. E. & Magee, C. L. (2012) The architecture of transaction networks: a comparative analysis of hierarchy in two sectors. *Industrial and Corporate Change*, 21, 1307-1335.
- Lynn, G., Morone, J. & Paulson, A. (1996) Marketing and discontinuous innovation: the probe and learn process. *California management review*, 38.
- Lynn, S. G., Akgun, E. A. . (1998) Innovation strategies under uncertainty: a contingency approach for new products development. *Engineering Management Journal*, 10, 11-17.
- Maine, E. & Garnsey, E. (2006) Commercializing generic technology: The case of advanced materials ventures. *Research Policy*, 35, 375-393.
- Maine, E. & Garsney, E. (2006) Commercializing generic technology : The case of advanced material ventures. *Research Policy*, 35, 375-393.
- Mansfield, E. (1986) Patents and innovation: an empirical study. *Management science*, 32, 173-181.
- Martinez, J. L. (2013) Practitioner's Insight: Learning to Manage Emerging Technologies. *Creativity and Innovation Management*, 22, 6-9.
- Mason, C. & Stark, M. (2004) What do investors look for in a business plan? A comparison of the investment criteria of bankers, venture capitalists and business angels. *International Small Business Journal*, 22, 227-248.
- Mcgrath, M. E. (1995) *Product Strategy for high-technologies companies*, New York, Irwin professional publishing.
- Mcgrath, R. G. (1997) A real options logic for initiating technology positioning investments *Academy of management review*, 22, 974-996.
- Mcgrath, R. G. (2001) Exploratory learning, innovative capacity, and managerial oversight *Academy of Management Journal*, 44, 118-131.
- Mcgrath, R. G. & Macmillan, I. C. (1995) *Discovery driven planning*, Wharton School, Snider Entrepreneurial Center.
- Mcgrath, R. G. & Macmillan, I. C. (2009) *Discovery-driven growth: A breakthrough process to reduce risk and seize opportunity*, Harvard Business Press.
- Meindl, J. D., Chen, Q. & Davis, J. A. (2001) Limits on silicon nanoelectronics for terascale integration. *Science*, 293, 2044-2049.
- Melpignano, D., Benini, L., Flamand, E., Jegou, B., Lepley, T., Haugou, G., Clermidy, F. & Dutoit, D. (2012) Platform 2012, a many-core computing accelerator for embedded SoCs: performance evaluation of visual analytics applications. *Proceedings of the 49th Annual Design Automation Conference*. ACM.
- Miller, D. J., Fern, M. J. & Cardinal, L. B. (2007) The use of knowledge for technological innovation within diversified firms. *Academy of Management Journal*, 50, 307-325.
- Miller, W. L. & Morris, L. (2008) *Fourth generation R&D: Managing knowledge, technology, and innovation*, Wiley.com.

- Mintzberg, H. (1990) The design school: reconsidering the basic premises of strategic management. *Strategic management journal*, 11, 171-195.
- Miyazaki, K. (1994a) Interlinkages between systems, key components and component generic technologies in building competencies. *Technology Analysis & Strategic Management*, 6, 107-120.
- Miyazaki, K. (1994b) Search, learning and accumulation of technological competences; the case of optoelectronics. *Industrial and Corporate Change*, 3, 631-654.
- Monfray. (2012) To check. Silicon Nano workshop
- Moore, G. E. (1965) Cramming more components onto integrated circuits. *Electronics Magazine*, 4.
- Morone, J. (1993) Winning in high tech markets: the role of general management.
- Moroz, V. (2011) Transition from Planar MOSFETs to FinFETs and its Impact on Design and Variability. Berkley Seminar.
- Moser, P. & Nicholas, T. (2004) Was electricity a general purpose technology? Evidence from historical patent citations. *American Economic Review*, 388-394.
- Mu, J., Peng, G. & Maclachlan, D. L. (2009) Effect of risk management strategy on NPD performance. *Technovation*, 29, 170-180.
- Muffatto, M. & Roveda, M. (2002) Product architecture and platforms: a conceptual framework. *International Journal of Technology Management*, 24, 1-16.
- Mullins, J. W. (2007) Discovering "unk-unks". *MIT Sloan Management Review*, 48, 17-21.
- Nelson, R. R. (1989) What is private and what is public about technology? *Science, Technology & Human Values*, 14, 229-241.
- Nelson, R. R. & Sidney, G. (1982) Winter. 1982. An evolutionary theory of economic change, 929-964.
- Novelli, E. (2010) as you sow, so shall you reap: general technologies and entry into the product subfields in the face of technological uncertainty
- O'Connor, C. G. (2006) Organizing for Radical Innovation: An Exploratory Study of the Structural Aspect of RI Management Systems in Large Established Firms. *The Journal of product innovation management*, 23, 475-497.
- O'Connor, G. C. (2008) Major Innovation as a Dynamic Capability: A Systems Approach*. *Journal of product innovation management*, 25, 313-330.
- O'Connor, G. C. & Rice, M. P. (2012) New Market Creation for Breakthrough Innovations: Enabling and Constraining Mechanisms. *Journal of Product Innovation Management*.
- O'Connor, G. C. & Veryzer, R. W. (2001) The nature of market visioning for technology-based radical innovation. *Journal of Product Innovation Management*, 18, 231-246.
- O'Connor, G. C. & McDermott, C. M. (2004) The human side of radical innovation. *Journal of Engineering and Technology Management*, 21, 11-30.
- Ojail, M., David, R., Chehida, K. B., Lhuillier, Y. & Benini, L. (2011) Synchronous reactive fine grain tasks management for homogeneous many-core architectures. ARCS 2011.
- Pahl, G. & Beitz, W. (1995) *Engineering design: a systematic approach*, Springer.
- Paulin, P. (2011) Programming challenges & solutions for multi-processor SoCs: an industrial perspective. *Design Automation Conference (DAC), 2011 48th ACM/EDAC/IEEE. IEEE*.
- Pich, M. T., Loch, C. H. & De Meyer, A. (2002) On uncertainty, ambiguity, and complexity in project management. *Management Science*, 48, 1008-1023.
- Pisano, G. P. (1994) Knowledge, integration, and the locus of learning: An empirical analysis of process development. *Strategic management journal*, 15, 85-100.
- Pointet, J.-M. (2011) Rôle du marketing en conception innovante: les leçons du cas Axane. *Gestion 2000*, 28.
- Powell, W. W. (1987) Explaining technological change. JSTOR.
- Purcell, A. T. & Gero, J. S. (1996) Design and other types of fixation. *Design Studies*, 17, 363-383.
- Pyka, A. & Hanusch, H. (2006) *Applied evolutionary economics and the knowledge-based economy*, Edward Elgar Publishing.
- Quinn, J. B. (1978) Strategic Change: "Logical Incrementalism.". *Sloan management review*, 20, 7-19.
- Radaelli, G., Guerci, M., Cirella, S. & Shani, A. B. R. (2012) Intervention Research as Management Research in Practice: Learning from a Case in the Fashion Design Industry. *British Journal of Management*.
- Raiffa, H. (1968) *Decision analysis: introductory lectures on choices under uncertainty*.
- Rapp, A., Beitelspacher, L. S., Grewal, D. & Hughes, D. E. (2013) Understanding social media effects across seller, retailer, and consumer interactions. *Journal of the Academy of Marketing Science*, 1-20.
- Reich, Y. (1995) A critical review of general design theory. *Research in Engineering Design*, 7, 1-18.
- Reich, Y., Hatchuel, A., Shai, O. & Subrahmanian, E. (2012) A theoretical analysis of creativity methods in engineering design: casting and improving ASIT within C-K theory. *Journal of Engineering Design*, 23, 137-158.

- Reich, Y. & Shai, O. (2012) The interdisciplinary engineering knowledge genome. *Research in Engineering Design*, 23, 251-264.
- Reid, S. E. & De Brentani, U. (2004) The fuzzy front end of new product development for discontinuous innovations: a theoretical model. *Journal of Product Innovation Management*, 21, 170-184.
- Rivkin, J. W. (2000) Imitation of complex strategies. *Management Science*, 46, 824-844.
- Rivkin, J. W. & Siggelkow, N. (2003) Balancing search and stability: Interdependencies among elements of organizational design. *Management Science*, 49, 290-311.
- Rosenberg, N. (1994) *Exploring the black box: Technology, economics, and history*, Cambridge University Press.
- Rosenberg, N. & Trajtenberg, M. (2004) A general-purpose technology at work: The Corliss steam engine in the late 19th century United States. *The Journal of Economic History*, 64, 61-99.
- Rothwell, R. (1992) Successful industrial innovation: critical factors for the 1990s. *R&D Management*, 22, 221-240.
- Roussel, P. A., Saad, K. N., Erickson, T. J. & Little, A. D. (1991) *Third generation R&D: managing the link to corporate strategy*, Harvard Business School Press Boston.
- Sarasvathy, S. D. (2001) Causation and effectuation: Toward a theoretical shift from economic inevitability to entrepreneurial contingency. *Academy of management Review*, 243-263.
- Sarasvathy, S. D. & Dew, N. (2005) New market creation through transformation. *Journal of Evolutionary Economics*, 15, 533-565.
- Savage, L. (1972) *The foundations of statistics*, DoverPublications.com.
- Schilling, M. A. (2002) Technology success and failure in winner-take-all markets: The impact of learning orientation, timing, and network externalities. *Academy of Management Journal*, 45, 387-398.
- Schmookler, J. (1966) *Invention and economic growth*, Harvard University Press Cambridge, MA.
- Schumpeter, J. A. (1961) *The theory of economic development: An inquiry into profits, capital, credit, interest, and the business cycle*, Transaction Books.
- Shai, O. & Reich, Y. (2004) Infused design. I. Theory. *Research in Engineering Design*, 15, 93-107.
- Shane, S. A. (2004) *Academic entrepreneurship: University spinoffs and wealth creation*, Edward Elgar Publishing.
- Shani, A. B., Coghlan, D. & Coughlan, P. (2008) *Handbook of collaborative management research*, Sage Publications Thousand Oaks, CA.
- Shea, C. M., Grinde, R. & Elmslie, B. (2011) Nanotechnology as general-purpose technology: empirical evidence and implications. *Technology Analysis & Strategic Management*, 23, 175-192.
- Siggelkow, N. (2007) Persuasion with case studies *Academy of Management Journal*, 50, 20-24.
- Sincholle, V. (2009) *De la gestion des brevets d'invention au pilotage de l'innovation: le cas d'un centre de recherche de haute technologie*. Ecole Polytechnique X.
- Site, O. 1st of July 2013 2013. RE: Operational Review STMicroelectronics Crolles Site.
- Sommer, S. C. & Loch, C. H. (2004) Selectionism and learning in projects with complexity and unforeseeable uncertainty. *Management Science*, 50, 1334-1347.
- Sommer, S. C., Loch, C. H. & Dong, J. (2009) Managing complexity and unforeseeable uncertainty in startup companies: An empirical study. *Organization Science*, 20, 118-133.
- Starbuck, W. H. (1992) Learning by knowledge-intensive firms *Journal of management Studies*, 29, 713-740.
- Sting, F., Mihm, J. & Loch, C. (2011) Collaborative search.
- Suh, N. P. (1990) *The principles of design*, Oxford University Press New York.
- Suh, N. P. (1999) A theory of complexity, periodicity and the design axioms. *Research in Engineering Design*, 11, 116-132.
- Tidd, J. (2001) Innovation management in context: environment, organization and performance. *International Journal of Management Reviews*, 3, 169-183.
- Tierney, R., Hermina, W. & Walsh, S. (2012) The pharmaceutical technology landscape: A new form of technology roadmapping. *Technological Forecasting and Social Change*.
- Tilton, J. E. (1971) *Semiconductors and the worldwide spread of technology: Highlights of International diffusion of technology; the case of semiconductors*, Brookings Institution (Washington).
- Trigeorgis, L. (1993) Real options and interactions with financial flexibility. *Financial Management*, 202-224.
- Trigeorgis, L. (1996) *Real Options: Managerial flexibility and Strategy Inresource Allocation*, the MIT Press.
- Tripsas, M. & Gavetti, G. (2000) Capabilities, cognition, and inertia: Evidence from digital imaging. *Strategic Management Journal*, 21, 1147-1161.
- Van De Ven, A. H. (2007) *Engaged scholarship: A guide for organizational and social research*, OUP Oxford.
- Van De Ven, A. H., Polley, D. E., Garud, R. & Venkataraman, S. (1999) *The innovation journey*, Oxford University Press, USA.

- Vergne, J. P. & Durand, R. (2010) The missing link between the theory and empirics of path dependence: conceptual clarification, testability issue, and methodological implications. *Journal of Management Studies*, 47, 736-759.
- Veryzer, R. W. (1998) Discontinuous innovation and the new product development process. *Journal of product innovation management*, 15, 304-321.
- Walsh, S. T. (2004) Roadmapping a disruptive technology: A case study: The emerging microsystems and top-down nanosystems industry. *Technological Forecasting and Social Change*, 71, 161-185.
- Walsh, S. T., Boylan, R. L., Mcdermott, C. & Paulson, A. (2005) The semiconductor silicon industry roadmap: epochs driven by the dynamics between disruptive technologies and core competencies. *Technological Forecasting and Social Change*, 72, 213-236.
- Walsh, S. T., Kirchhoff, B. A. & Newbert, S. (2002) Differentiating market strategies for disruptive technologies. *Engineering Management, IEEE Transactions on*, 49, 341-351.
- Walsh, S. T. & Linton, J. D. (2011) The strategy-technology firm fit audit: a guide to opportunity assessment and selection. *Technological Forecasting and Social Change*, 78, 199-216.
- Weber, A. (2003) Semiconductor developments in the Dresden region. Institute for Prospective Technological Studies (ipts)(Hrsg.): Identifying factors of success and failure in European IST-related national/regional developments. Sevilla: European Communities, 122-179.
- West, J. & Gallagher, S. (2006) Challenges of open innovation: the paradox of firm investment in open-source software. *R&D Management*, 36, 319-331.
- Wimsatt, W. C. (2000) Emergence as non-aggregativity and the biases of reductionisms. *Foundations of Science*, 5, 269-297.
- Wirtz, B. W., Mathieu, A. & Schilke, O. (2007) Strategy in high-velocity environments. *Long Range Planning*, 40, 295-313.
- Xie, Y. (2013) Future memory and interconnect technologies. *Design, Automation & Test in Europe Conference. IEEE*.
- Yin, R. (2003) *Case Study Research: Design and Methods*, Thousand Oaks, California: Sage Publications, Inc.
- Yole. (2013) *MEMS Trends*.
- Yoshikawa, H. (1985) Design theory for CAD/CAM integration. *CIRP Annals-Manufacturing Technology*, 34, 173-178.
- Youtie, J., Iacopetta, M. & Graham, S. (2008) Assessing the nature of nanotechnology: can we uncover an emerging general purpose technology? *The Journal of Technology Transfer*, 33, 315-329.
- Zahra, S. A. (2008) The virtuous cycle of discovery and creation of entrepreneurial opportunities. *Strategic Entrepreneurship Journal*, 2, 243-257.
- Zhou, K. Z. & Wu, F. (2010) Technological capability, strategic flexibility, and product innovation. *Strategic Management Journal*, 31, 547-561.

List of corresponding appendices

Appendix 1	Industrial background: Knowledge-intensive Semiconductor industry and its pertinence for double unknown exploration
Appendix 2	Case study: Research anomaly identification: SiGe Bipolar technological platform for mmWave applications (BICMOS9MW) at STMicroelectronics
Appendix 3	R&D Project Portfolio analysis at STMicroelectronics
Appendix 4	Generic Technology in patent portfolio design: designing technological patents in high uncertainty

Appendix 1

Industrial background: Knowledge-intensive Semiconductor industry and its pertinence for double unknown exploration

*“At the end of the day the best transistors win,
no matter what you are building: a server or a
phone”*

Paul Otellini, former CEO of Intel, 2013

Semiconductors are fundamental elements of all modern electronic systems and computers such as smartphones, tablets, personal computers, and consumer electronics, telecommunication equipment. The growth in the demand for electronic components has increased drastically the demand for semiconductor devices. In order to ensure growth, support the demand and be at the leading edge of competition, industrial players have to be ready for huge capital investment and R&D developments into rapidly changing technological generations. Yet, the risks are high and companies seek ways to analyze the corresponding market structure and more reliable manufacturing strategies to secure their investment. As a result, a science-based semiconductor industry constantly looks for breakthrough innovations and double unknown situations are common. This chapter begins by identifying the particularity of semiconductor industries that face double unknown situations (Section 1). It posits the generic character of semiconductor industry (Section 2).

This dissertation is mainly based on the in-depth empirical study at the largest European semiconductor company: STMicroelectronics (ST). In section 3, characteristics and challenges that ST faces to keep its market position and survive despite the escalating costs of building and supporting foundries will be described in more detail.

1. SEMICONDUCTOR INDUSTRY IN DOUBLE UNKNOWN

1.1. Intensive and research driven R&D – Moore's Law approach and its limits

The semiconductor industry dynamic is based on rapid product renewal, skill acquisition and competence development to follow and empower its strategic positioning. The coordination of this activity is facilitated and organized by the law known as “Moore's Law”. This trend indicates that the

and control the technological needs of ICs production. Initially, the roadmaps within the semiconductor industry appeared at the Semiconductor Industry Association (SIA), which led to the creation of an American style roadmap named the National Technology Roadmap for Semiconductors (NTRS). In 1998, the SIA became closer to its European, Japanese, Korean and Taiwanese counterparts by creating the first global roadmap: The International Technology Roadmap for Semiconductors (ITRS). This international group is composed of 936 companies (as of the 2003 edition), which were affiliated with working groups within the ITRS (Arden et al., 2010).

Nowadays, the primarily role of the ITRS consists of defining and coordinating roadmaps for disruptive technologies exploration within the rather complex semiconductors supply chain. Le Masson et al. (2012b) demonstrate that the ITRS members coordinate industrial players in a single planning process, they organize technology suppliers' commitment to exploration and learning; maximize divergence to minimize the risks of technological gaps, minimize the costs of collective exploration and map an ecosystem of alternative technological concepts.



Figure 42 - Semiconductor value chain

Yet, this scaling law is approaching its limits and there exist technologies that do not necessarily follow Moore's Law. According to Morris Chang, CEO of TSMC, in April 2011 "Moore's law won't hold true in 6-8 years"¹⁸. For instance, one of the bottlenecks of Moore's law is the metal interconnects that are used to connect elements of integrated circuits. As metal wires scale down, the resistance-capacitance (RC) product of interconnects increases the time delay in crosstalk of signals and finally increases the consumption and reduces the computing speed of IC (Meindl et al., 2001). Additionally, current leakage, power consumption and heat sink¹⁹ also pose problems to keep up with Moore's Law.

It became evident that to deal with these issues, the efforts of dimensional scaling should be combined with innovations in materials and device structures. The research advances have permitted the use of new materials and substrates such as high-k, low-k, dielectrics, copper, SiGe, SOI, graphène; and to design new performing architectures such as double gates, FDSOI, and 3D FinFet. Moreover, the advances in System-on-a-chip (SoC) approaches drive us towards a new era of microprocessor scaling that combines a diverse set of components using adaptive circuits, integrated

¹⁸ For a description see: "[Moore's Law won't hold true in 6-8 years: Chang](#)", The China Post news staff, 2011, accessed September 15, 2013

¹⁹ Heat sink is a passive heat exchanger that cools a device by dissipating heat into the surrounding medium (Source: [Wikipedia](#))

Appendix 1: Industrial background

sensors, sophisticated power-management techniques, and increased parallelism to build products that are many-core, multi-core, clusters, and multi-function (Bohr, 2009).

Taking into account the increasing difficulty and complexity to keep up with Moore's Law, the derived "More Moore's" approach was formulated. "More Moore's" approach assumes the validity of a Moore's Law and a technology push strategy was adopted by the ITRS in order to design roadmaps. For instance, the "More Moore" approach is used to define imaging signal processing roadmaps, memories, digital processing and storage. This approach is adapted mostly by technologies that can progress independently from the corresponding design and market knowledge and the products are mostly driven by mass production and customization. Yet, market is drifting towards mobile applications, dominated by ARM and low-power microcontrollers. Moore's Law or "More Moore's" approaches do not drive this evolution. In the absence of a law to coordinate exploration, a different methodology is needed to identify and guide roadmap efforts. Today the new approach for the design coordination, where scaling is not a key factor for performance improvement, and which allows non-digital functionalities to migrate from the system board-level into the package (SiP) or onto the chip (SoC), is called "More than Moore".

1.2. Towards "More than Moore" double unknown exploration: the ITRS and INEMI

Traditionally manufacturers kept up with requirements predefined by constructed roadmaps. The changes in objects' identity towards heterogeneous systems, emerging user requests are not taken into account by technological specifications, which require new mechanisms for R&D management. After having experienced an exponential growth, the semiconductors industry is now entering a phase of consolidation with a reduction in the rate of annual growth. The budget allocated to R&D cannot simply follow the explosion of the needs. Therefore, the companies are facing a double challenge: the increasing needs in knowledge, expertise to cover and limited capacity to finance R&D. This brought the ITRS community to create a new technology-working group (TWG) to include significant parts of the "More-than-Moore" domain in its work and pursue roadmap exploration in double unknown.

The "More than Moore" (MtM) trend is characterized by functional diversification of semiconductor-based devices and technologies that cover a wide range of fields. This is achieved through an extension of the CMOS functionality with its combination other technologies (on Figure 43 – horizontal axis correspond to MtM diversification approach, vertical axis to the classical Moore's Law). This figure demonstrates the examples of MtM technologies. For instance, MEMS applications include sensors, actuators and ink jet printers. Radiofrequency CMOS applications include Bluetooth, GPS and Wi-Fi. CMOS image sensors are found in most digital cameras. High voltage drivers are used to power LED lights. These applications add value to computing and memory devices that are made from the traditional Moore's Law technology. As a result, more heterogeneous systems are aimed to be developed. Just to cite some of them: the "Above IC" approaches extend the ICs by adding

supplementary functional layers. In “Above IC”, imaging technology starts out with a conventional CMOS circuits but the sensor is built on the top of CMOS logic, which simplifies integration and fabrication. New methods of information transportation (using optoelectronic, radiofrequency, photonic systems), of assembly of several chips in the same package (“system-in-package” - SiP), or direct chip-to-chip assembly - 3D Integration approach through TSV or through electric or optical interposers, direct package and board integration (iPAD system) provide powerful technologies to capture markets interests. These non-digital technologies contribute to the miniaturization of electronic systems, although they do not necessarily scale at the same rate as the one that describes the development of digital functionality (Figure 43).

To be able to keep technological leadership, companies then have to be ready for breakthroughs in their expertise, architecture, functionality and the chosen forms of business models. The role of the “More than Moore” TWG is to structure the exploration activity in double unknown to deliver innovative solutions to the markets.

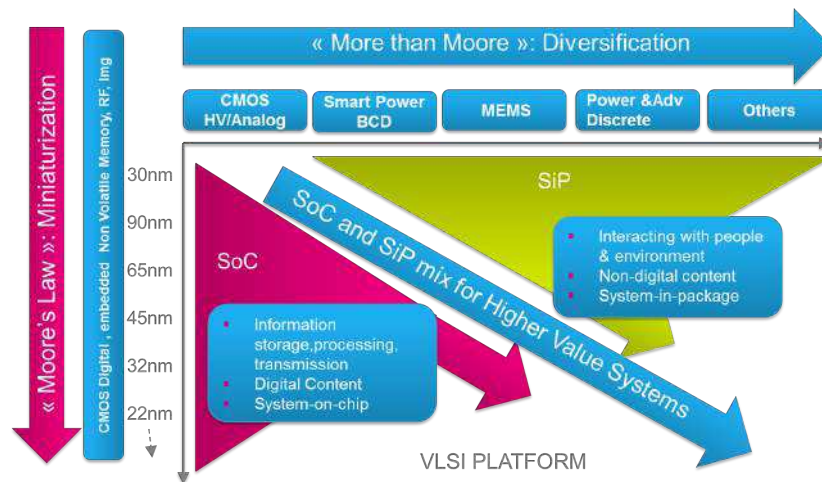

Figure 43 - Towards More than Moore (Source: STMicroelectronics)

In addition to the ITRS “More than Moore” TWG, there exist other organizations that attempt to construct roadmaps for semiconductor industry guidance while taking into account market value. The International Electronic Manufacturing Initiative (iNEMI) is based on established proactive programs. The organization proposes roadmaps for identified marketing trends. iNEMI roadmaps the future technology requirements of the global electronics industry, identifies and prioritizes technology and infrastructure gaps, and helps to eliminate those gaps through timely and high-impact deployment projects. They mostly followed a market pull trend to design the roadmaps. In September 2013 for instance, iNEMI organized a workshop to focus on future technology challenges in electronics manufacturing for automotive applications. This workshop attempted to “review roadmap information on the trends and drivers in automotive electronics; feature speakers from

Appendix 1: Industrial background

automotive OEMs, suppliers, and research institutions; identify technology challenges and gaps that benefit from a collaborative approach”²⁰

Through MtM technology working group creation, the exploration of highly innovative technology concepts on double unknown is encouraged. The organizations such as ITRS or iNEMI attempt to guide companies in the exploration of both unknown technologies and unknown markets.

It becomes clear that the pace of innovation in semiconductors is extremely high, and in order to develop successful innovation, companies have to incorporate market dimensions along with the technical ones, which requires double unknown exploration. In double unknown, markets are unknown meaning that there is a constant variety of emerging applications, which lack structure and segmentation. Market volatility makes it impossible to estimate costs and volumes using traditional techniques. The unknown character of technologies is predefined by the variety of technological possibilities driven by scientific discoveries, by their disruptive nature and by the lack of feasibility and standards to clearly evaluate advancements.

The constantly increasing costs of R&D to investments to support new technological generations and a reduction in the annual growth rate clearly outline that the industry cannot simply follow the R&D needs. There is a double challenge: 1) the increasing need in exploring the unknown technologies and unknown markets, which provokes the expertise disruption and constant new knowledge generation; 2) limited capacity to finance R&D activities. To remain in market leadership, semiconductor companies should be able to deliver highly performing, differentiated products at the right time. **It is not possible by just cutting down the costs of technology development and R&D exploration; companies have to enhance their economic efficiency and gain competitive advantage by developing successful products through double unknown explorations.**

2. THE SEMICONDUCTOR INDUSTRY AND GENERIC TECHNOLOGIES

General-purpose technologies drive the technological and economical progress. Semiconductors are considered as one of the emblematic examples of GPT. As shown by Bresnahan and Trajtenberg (1995), beyond pervasive GPTs often lie generic functions or concepts. For example, the generic function of integrated circuit (IC) (“transistorized binary logic”) was applied in many sectors. The transistor is the fundamental building block of modern electronic devices, which is embedded within ICs, and is ubiquitous in modern electronic systems. Following its development in the early 1950s, the transistor revolutionized the field of electronics, and paved the way for smaller and cheaper radios, calculators, and computers, among other things. Still, the integration of these technologies within emerging objects poses great challenges itself (Bresnahan and Trajtenberg,

²⁰ For further details see : « [What down the rode for automotive electronics manufacturers](#) ». iNEMI. September 9th, 2013.

1995). Advanced ICs require complementary innovations in photolithography and other manufacturing processes. For instance, each generation of photolithography equipment designed for a new generation of transistors in semiconductor manufacturing provoked the change in the leadership position within the industry (Henderson and Clark, 1990). Only when the road mapping activity within the International Technology roadmap for Semiconductors (ITRS) emerged, did the processes become standardized and the scientific efforts coordinated within various industrial players (Walsh, 2004). As pointed by Maine and Garsney (2006) generic technologies may face high barriers for commercialization despite their potential for value creation. Thus, effective management and coordination process for GTs are necessary to ensure their successful implementation and complementary innovation guidance.

Pervasive technologies have little visibility in the dynamics of the economy unless they foster new inventions that directly or indirectly result from the early major invention (Youtie et al., 2008). It is shown that the widespread adoption of a core technology occurs thanks to the actors that are capable to coordinate their beliefs across the generic technology. This can be evidenced at the ITRS community where the ecosystem of actors was able to jointly improve digital technology. In order to maintain their position as technological leaders, companies that pursue the design of GTs have to be ready for some radical breaks with the expertise, architectures, features, or even with conventional forms of marketing.

Albeit that transistors are recognized as GPTs, semiconductors provide other examples of GTs. Among them, silicon photonics is a promising generic technology, which can be used in a large number of applications. Optical interconnects enable chip designers to overcome the problem of classic metal interconnects. Among other actors, IMEC, who is known to perform world-leading research in nano-electronics, is pursuing a “general purpose photonics platform, consisting of pluggable process modules that can be added or removed from the flow at the end”²¹. They orientate the exploration towards the development of a flexible generic platform. Silicon photonics is the science and engineering of optical (photonics) functions on the surface of a chip using silicon as a base material. This includes various passive functions, such as routing and wavelength filtering, as well as active functions, such as switching, signal modulation, light detection and light generation. The European Commission recognizes silicon photonics as one of the Key enabling technologies (KET). This initiative was launched in 2010 to support the development of KET that “play an important role in the R&D, innovation and cluster strategies of many industries and are regarded as crucial for ensuring the competitiveness of European industries in the knowledge economy”²². This group consists of representatives from European Member states, relevant European industries

²¹ « Silicon Photonics » poster, University of Ghent, can be downloaded:

<http://photonics.intec.ugent.be/download/>

²² More information on Key Enabling Technologies initiative is available:

http://ec.europa.eu/enterprise/sectors/ict/key_technologies/, accessed October 5, 2013

Appendix 1: Industrial background

including small and medium enterprises, research technology organizations, academia, and the European Investment Bank. They define nanotechnology, micro and nano-electronics, industrial biotechnology, photonics, advanced materials and advanced manufacturing as KETs. The goal is to build pilot lines where “innovative technology can be used to develop innovative products, meeting social challenges and establishing a new realistic R&D environment...”(ENIAC, 2012). These pilot lines target to cross the well-known “valley of death” between innovation and market and thus, providing a perfect place for generic technologies exploration and design. The concept of KET pilot lines will contribute to further GT appropriation, enable companies to test their feasibility and coordinate efforts within industrial partners while reducing risks.

To summarize, the need for high degrees of flexibility and innovation in order to constantly adjust to the rapid pace of change in the market makes the semiconductor industry relevant for generic technology exploration in double unknown.

3. STMICROELECTRONICS: A KNOWLEDGE INTENSIVE COMPANY

STMicroelectronics (ST), which was formed by the merger, in 1987, of Thomson Semiconductors and SGS Microelettronica, is the largest European semiconductor company. Having a large product portfolio, ST nowadays focuses its product strategy on sense and power technologies, automotive products and embedded-processing solutions.

From its creation, ST has remained a heavily research-driven company: in 2012 the company spent about 28% of its revenue in R&D. It is included in the top 100 most innovative companies in the world²³ according to Thomson Reuters classification, its portfolio comprises 16000 patents and about 9000 patent families.

At STMicroelectronics, the identification and the development of new technologies is primarily the responsibility of research teams within Technology R&D groups. Primarily these groups were responsible for the development of technology platforms for the divisions organized by market segments (“Automotive”, “Computer and Communication infrastructure”, « Home Entertainment & Displays », «Industrial & Multisegment sector ») to design and develop new products. The new organizational structure (update from June 2013) is divided in two segments: 1) sense & power & automotive products and 2) embedded processing solutions, packaging & test manufacturing and product quality excellence. Under each segment there are R&D centers and associated business divisions, which potentially simplify coordination of technologies common to several markets and thus facilitate exploration of GTs.

²³ Full list of Global 100 Innovators can be viewed: <http://top100innovators.com/> , Accessed September 15, 2013

Dealing with high costs of R&D investment, ST pursues a collaborative perspective to develop its future technologies. The company is involved in a great number of the International, European collaborative research projects, which seek to provide new revolutionary approaches and bring new technologies to the evolving market landscapes. For instance, strong cooperation with CEA Leti is based on key research programs; some of the engineers and Ph.D. students of ST are directly integrated to the work environment with CEA.

The fast pace, high level of competition, increasing costs of R&D and emerging trend of “More than Moore” oblige ST to pursue unconventional management tools for research evaluation and monitoring. For instance, Advanced R&D groups in ST are subscribed to a diversification approach that is identified by ITRS as “More than Moore” (Hoefflinger, 2012, ITRS, 2011). There is neither a clear scientific question, nor a well-defined decision to develop new products based on exploration and targeted markets: rather, there is a high level of uncertainty both at the level of technology and future markets.

In his research work at STMicroelectronics, Felk (2011) demonstrates that classical research evaluation tools should be extended while applied for advanced and explorative research activities. The author indicated that advanced research at ST improves the “conceptual absorptive capacity”: it prepares future product generation, renews design rule assets and enables both to account for patent design capabilities and enhance the intellectual property. The work of (Felk, 2011) on the management of advanced research activities led to the introduction of new forms of projects that enable the management of unknown by structuring it, creating a panorama of alternatives and challenging the existing fixation effects. Still, the notion of learning by interdependencies management within project portfolio and the notion of market knowledge, which appear to be critical while dealing with double unknown, seem to be understudied.

3.1. STMicroelectronics in the process of generic technology design in double unknown

ST developed successful innovative products such as micro-electro-mechanical systems (MEMS), non-volatile memories, power technologies and microcontrollers. MEMS technology provoked revolutions in several industries: 1) arrays of micro-mirrors enabled digital film projectors; 2) accelerometers like those in Nintendo Wii controller have changed gaming; 3) the iPhone 4 became the first portable consumer device to incorporate a three-axis accelerometer, three-axis gyroscope, and three-axis electronic compass. High variety of industrial applications widely deployed in mobile, consumer, medical, automobile, military and other industries were addressed by MEMS and their derivatives (see Figure 44). This technology triggered the creation of completely new uses unanticipated at the beginning (Groen and Walsh, 2013). The market penetration of different MEMS devices is still growing.

Appendix 1: Industrial background

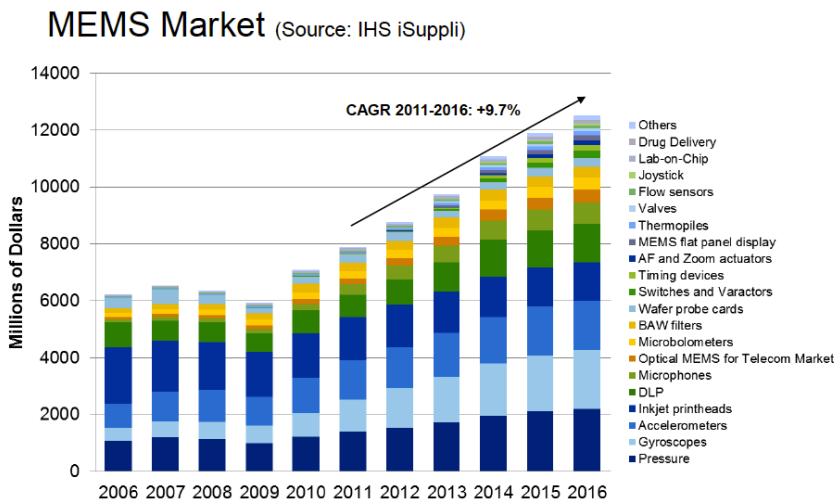

Figure 44 - MEMS market

In February 2013, Yole Développement recognized STMicroelectronics as the first \$1 billion MEMS company (Yole, 2013). ST is now churning out some 4 million MEMS devices a day, offering not only inertial sensors but also consumer pressure sensors, microphones, and e-compasses. ST promotes that the integration of multi-axis sensor technology to the growing number of multi-platform devices enables innovative MEMS applications.

At ST, MEMS started in 1996 when the MEMS Business Unit was created. Primarily they analyzed what the state of the art on the market was. B. Vigna who was a project leader of MEMS development at ST pointed out:

“It was 2000, and there was no market or any customers yet! We had to create them, so we started by looking at what already existed.” (Internal ST Document)

The devices existing at that time were 2-dimensional motion detectors that can be produced at a low price, such as the ones that caused the airbags in cars to come out during a crash. There were also larger expensive sensors used in aircrafts. There were no 3-axis accelerometers on the market so:

“we knew that if we were successful in creating these at a cheap price and small in size, it would be an extremely powerful progression” (Internal ST Document).

According to Chiung Lee, senior technical marketing engineer of analog, MEMS and sensors at ST:

“ST’s introduction of its iNEMO-architecture solutions integrating a 3-axis gyroscope, a 3-axis accelerometer and a 3-axis magnetometer has been further extended to sensing applications to

*include image stabilization, remote-control, augmented reality, sports activities, navigation and location based service*²⁴

ST succeeded in developing a generic platform based on MEMS and obtain the largest MEMS based product portfolio.

Besides MEMS, ST, being involved in KET initiative, is engaged to build pilot lines to industrialize other generic technologies. A new pilot line named Places2Be attempts to federate all forces of the European semiconductor ecosystem willing to industrialize circuits using advanced 28/20 nm digital CMOS technology based on FDSOI transistors²⁵. FDSOI generic technology is up to 30% faster than bulk CMOS enabling faster processors, which brings more powerful devices. They are significantly more power-efficient than bulk CMOS devices, and have lower leakage and a much wider range of operation points down to lower voltage, which allow the devices to run cooler and last for longer. Finally, the manufacturing process is simpler and makes extensive use of existing fab facilities (Site, 2013).

Another pilot line envisaged advanced non-volatile memory technologies for automotive microcontrollers, high security applications and general electronics. An Embedded Non-Volatile Memory (eNVM) is an important component of almost all systems-on-chips. The eNVM operates as an on-chip program or data storage locker, where the system can safely store firmware, security-code, calibration data, and other application-critical information, even when the system is not being powered. This project attempts to consolidate the existing 55nm embedded flash technology platforms to build a solid manufacturing platform in Europe, set up of a complete 40nm eNVM platform in order to achieve a prototyping maturity for an innovative eNVM technology suitable for 28nm node (Site, 2013). They attempt to reuse existing technology competences to explore a disruptive generic technology, which will open up new applications in automotive, consumer/industrial, secure and medical applications.

Moreover, the Nano 2017 ST R&D program, announced in July 2013, has the aim of further advancing the company's leadership in key embedded processing solutions and technologies that will lead to improve ST's position in the following generic technologies: Fully-Depleted Silicon on Insulator Technology (FD-SOI), next-generation imaging and next-generation embedded non-volatile memories²⁶.

²⁴For a description see: "[Enriching multiple MEMS applications for mobile devices](#)", Digitimes, May 2, 2013. Accessed August 29, 2013.

²⁵More information on Places2Be project is available: "[Places2Be: la grabure 28 nm FD-SOI prend forme avec ST en Europe](#)", May 21, 2013. Accessed August 29, 2013

²⁶ For a description see: "[Nano 2017 R&D program announced at STMicroelectronics Crolles Site](#)", Accessed October 10, 2013

Appendix 1: Industrial background

These technologies are potentially highly generic and attempt to explore both unknown technologies and yet-unknown markets. Emerging non-volatile memory (eNVM) technologies, 3D integration or optical interconnects are envisioned as promising future memory and interconnect technologies that can fundamentally change the landscape of the future computer architecture design with profound impact (Xie, 2013). Still, there remains a lot of unknowns in terms of market and technology feasibility and the tools to build genericity remain undefined.

How can these technologies acquire similar level of success as that of MEMS? Which strategy do they have to follow? MEMS represent a successful case of dealing with double unknown but how was genericity acquired? Did they follow an evolutionary process of successive market exploration or was MEMS initially designed as a highly generic technologies?

There are a lot examples when technologies were primarily developed or announced by R&D teams but were never translated into final products. In the meanwhile, the competitors have introduced products in the market based on the same technological basis. **How should technology-market exploration be oriented in order to acquire higher genericity and recognize the future market value? Which business models and strategies are able to support generic technology commercialization and manage double unknowns?**

Appendix 2

Case study:

Research anomaly identification:

SiGe Bipolar technological

platform for mmWave

applications (BICMOS9MW) at

STMicroelectronics

The following case analysis is based on BiCMOS9MW (abbreviation used internally at ST) platform development at STMicroelectronics Crolles TR&D. The objective of the study is to identify how the technology was developed, how the relations with markets were established, to analyze the decision making process behind this platform and the role of actors involved in the exploration. The insights gained from this case study led to reveal and analyze research anomaly (Part I), where the latter determined a new “common unknown “strategy for generic technologies (GT) design. Moreover, this case was used to demonstrate the features of Ph.D. projects portfolio organization leading to GT (Part IV).

1. CASE BACKGROUND

The idea of Si-based BICMOS technology was to combine the advantages of two types of transistors: the bipolar transistor and the CMOS transistor. Analog bipolar transistors offered higher gain, higher switching speed, better noise performance, low consumption, high-frequency RF applications. Digital CMOS transistors offered higher density, low consumption and better performance for logic operations, lower speed blocks, control functions.

At STMicroelectronics, BISMOS9MW platform has evolved after several generations of technical solutions. Started with bipolar based BiPx project it lead to BICMOS9MW (specifically designed to address emerging millimeter-wave applications) and beyond.

This case was chosen to investigate the reasoning behind double unknown management for the following reasons: 1) it belongs to the family of “More than Moore” projects; 2) developed technological platform enabled to address several markets which were still unknown at the moment of technological development; 3) the reason of pursuing the early development of this project was not possible to explain or justify following classical decision making criteria (as probability of

Appendix 2: Case study: Research anomaly identification:

technology and future market success); 4) it did not follow neither market pull or technology push approaches.

The case study analysis was carried out in 2010-2011 taking into consideration project documentation and market studies. The interviews were performed with people responsible for the technology development, the Ph.D. students, researchers involved, business units involved, project management office. This case analysis was conducted in collaboration with 2 intern students from Mines ParisTech. The main research was done at ST Crolles (large R&D center and manufacturer of electronic circuits) and Grenoble area. Overall, 20 semi-structured interviews were conducted and the secondary sources of data were collected and analyzed. The data was triangulated with company's representatives to gain new insights and discuss the findings. Throughout the time around 20 people from various organizational entities were involved in this technology development. Our analysis revealed the important discrepancies on the earlier history of technology development. The major disagreement was found in the initial positioning of applications that technology aimed to address. Generally, the one version was presenting the technology development following a trial and learning process where the technology developed for the first market trial was generalized to address the other emerging applications. The second version has demonstrated a more intentional strategy of generic technology development where the initial context was predefined to conduct multi-market exploration. Further, we analyzed how this technology was developed and how genericity was acquired.

In the following we provide a history of technology development at ST and its overview and the case analyses to understand how this technological platform was developed.

2. THE HISTORY OF TECHNOLOGY DEVELOPMENT AT STMICROELECTRONICS AND ITS OVERVIEW

2.1. BICMOS9MW platform design

At STMicroelectronics the history of bipolar transistor (BiPx project) technology based on SiGe started in 1998 with 0.35 μm technology for wireless communication. It is based on a Heterojunction Bipolar Transistor (HBT), which features include many advantages comparing to CMOS devices like their low noise factor, higher voltage and higher resistance for the same speed. The success of the SiGe Heterojunction Bipolar Transistor (HBT) has come mainly from its compatibility with silicon technology allowing both low-cost and high yield.

BICMOS9MW technology is a platform which can be used in analogical signal processing. The alternative technologies are platforms based in CMOS or and III-V materials platforms (AsGa, InP, etc.). BICMOS9MW addresses high frequencies applications, thanks to its good reliability and

performance for these applications, and its lower cost compared with III-V materials. A lot of studies have been made to compare the different platform characteristics in terms of cost, integration, operating frequencies, noise performance, etc. However, it was rather difficult to conclude which technology is better. It depends mainly on the type of application and the type of market addressed.

Globally, there existed a need to increase the operating frequencies of utilization in order to attain higher speed required for systems (communications, calculation...), and allow bigger file transfers (DVD, Blue Ray, 3D,...). Additionally, there is a constant need to cover new areas for wireless communication: this point is related to the communication standards.

The first identified platforms which were able to reach the higher frequencies were the AsGa (or other III-V materials), followed by BiCMOS, and finally CMOS. For a long time the only technologies capable of addressing high-speed optical communications and millimeter-wave (mm-waves) applications were III-V technologies. This situation changed once Si-based technologies emerged and offered competitive advantage to address applications such as 60-GHz WLAN and 77-GHz automotive radar for which large volumes can be expected. Si-based technologies offer indeed lower cost, which is reinforced by their high integration capabilities. Concerning the application related to the 60 GHz there were companies already announcing products based on CMOS and BiCMOS platforms. However there existed challenges related to the technological design like lower voltage tolerance of Silicon, metal pattern density. The extent to which the design community can overcome these challenges will determine the degree to which silicon dominates the emerging millimeter wave market (Cathelin et al., 2008)

While bipolar-only technologies are attractive to replace III-V technologies, full benefit is obtained by using heterogeneous solution of BiCMOS + CMOS devices. In spite of the ever-increasing constraints brought by integration with CMOS (thermal budget, structural issues, etc.), HBT performance has dramatically increased over the past 10 years (Figure 45).

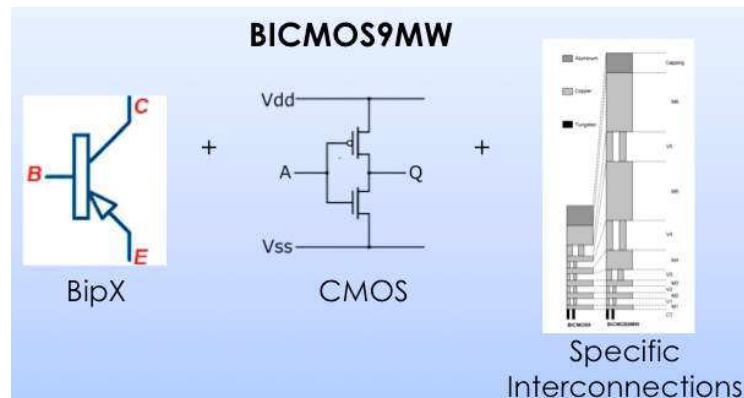

Figure 45 - BiCMOS Platform underlying technologies

Appendix 2: Case study: Research anomaly identification:

Until 2002 the group was working on the optimization of bipolar transistor for analog signal processing to address emerging standard of 60 GHz. There was no particular client demand at the beginning. The technological basis that was developed was not ready to address any market at that time and the key technology was based on CMOS. **In the following 2002 the group was analyzing which potential high-volume market and technological effort needed to develop to address it while reusing the previous research results on bipolar transistor.**

The expert (Technology Line Manager) that initiated technology development was looking for emerging markets with potentially huge volume to ensure return on investment. He determined a particular system issue: **the Wi-Fi connections in the big public systems like airports, train stations, and more generally high-density places with a lot of connectivity devices.** The currently used standard for Wi-Fi communication (2.5 to 5 GHz) processed information too slowly with the low frequency of processing information, which was not enough to ensure connectivity substantial debit with the increasing number of devices.

Initially the BiCMOS9 platform was designed to address optical networking and wireless applications up to 40 Gb/s – 40 GHz. Yet, BiCMOS9 could not address emerging applications such as 60-GHz WLAN, 77-GHz automotive radars and 80-Gb/s optical communications due to its limitation in the HBT performance and the back-end of line (BEOL) limitations to support high current densities and minimize signal attenuation²⁷.

By dealing with these problems, the BiCMOS9MW platform has been developed to reach higher frequencies for optical communications and RF Wireless communications, with low price components (lower than III/V components costs). BiCMOS9MW was built upon BiCMOS9. The team demonstrated that the main limitation was the quality of passives, such as transmission lines and inductors. Therefore, the choice of BEOL cannot be separated from the substrate choice, *i.e.*, bulk or silicon-on-insulator (SOI) substrates. In fact it is not the SOI that is important but the high-resistivity substrate lying underneath the buried oxide. The next generation of CMOS node implied the vertical shrink of the BEOL together with the decrease of the metal and dielectric thicknesses and of the metal pitch in order to increase integration density. The solution chosen consisted of adopting a few thick metal layers. The new copper metallization scheme was developed.

In the meanwhile, the European commission announced an objective to improve automotive security. They started a project called eSafety with the goal to enhance and implement new communication technologies like radar systems. The project committee announced that the frequency 79 GHz should be available in 2005 for this application. The choice of the 60 GHz frequency was based on the

²⁷ Source: STMicroelectronics internal document: presentation “BiCMOS9MW and beyond”, 2009

frequency standards that are managed by the European commission. In 2005, new standards appeared on frequencies: 60 GHz for Wireless communications and 77 GHz for automotive radars. This played as a positive factor that pushed the development of a RF system, which could be able to reach those frequencies, based on the BiCMOS9MW HBT. A 77 GHz radar system was considered as an opportunity to introduce the technology to the market.

The BiCMOS9MW platform emerged in 2005 and was optimized for very high frequency applications (Chantre, 2010). BiCMOS9MW platform represents an integration of three principal components (previously independent): **0.13 μm front-end of line, SiGe HBT and thick metallization schemes of BEOL** (Figure 46) (Chevalier, 2007) showed that high-speed BiCMOS roadmap is driven on the one hand by the increase of the optical communications data rate, and on the other hand by the emergence of applications at higher frequencies. It does not follow classical Moore. “BiCMOS roadmap does not follow Moore’s law, whose driver is the shrink of digital functions [...] high-speed BiCMOS roadmap is driven by, on the one hand the increase of the optical communications data rate, and on the other hand the emergence of applications towards higher frequencies” according to (Chevalier et al., 2006).

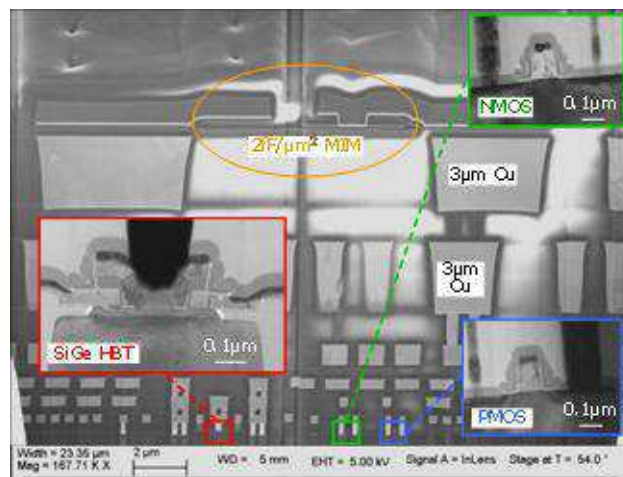

Figure 46 - BiCMOS9MW technology

The purpose of Si-based BiCMOS9MW technology is to combine the advantages of two types of transistors: the bipolar transistor for higher gain, higher switching speed, better noise performance, low consumption and the CMOS (Complementary Metal Oxide Semiconductor) transistor for higher density, better performance for logic operations, lower speed blocks, control functions.

Yet, to address each of the identified application, the system had to incorporate additional properties. For instance, to account for a solution that uses a 60 GHz Wi-Fi system with a long range (>10 m) to limit the number of base stations and system complexity, the following properties appeared critical:

- 1) The platform must be adapted to mm-Wave and should allow having high Q factors for the passive

Appendix 2: Case study: Research anomaly identification:

elements; 2) to obtain high-emission power for long range, the current intensity in power amplifiers must be high enough; 3) the base station system must be compatible with the mobile device Tx/Rx system: thus, it must be an integrated system for mobile devices and a power efficient system.

To conclude, the developed technology relies on the n -2 CMOS generation, has a significant cost advantage especially for applications that do not require very high density of digital functions. As a consequence, optical communications circuits, with the exception of modulator/laser drivers, are more suitable for implementation in CMOS technologies even if BiCMOS still has an edge at 80 Gb/s and above. CMOS may only emerge as a competing technology for mm-waves SoC, while BiCMOS appears more favorable for mm-waves SiP (Chevalier et al., 2006).

2.2. Further development: Platform commercialization – modules development

The number of factors helped to further disseminate and valorize the platform. In 2007, a first prototype of 77 GHz radar in BiCMOS was made in collaboration with the University of Toronto. This allowed the demonstration of the potential value of highly integrated broadband circuits with true BiCMOS9MW high-speed logic topology. Generally for radar systems, even if CMOS devices were competing with bipolar devices and could give design advantages (power consumption for instance), on the whole, Si/SiGeC HBTs were able to ensure more design margin since they provide higher gain and higher voltage swing, which are important criteria for critical blocks such as voltage-controlled oscillators or power-amplifiers, especially in harsh environments (high-temperature in automotive) (Chevalier et al., 2006).

The developed demonstrator helped the research team to promote technology. For instance, Bosch seemed to be interested by this demonstrator, which in turn attracted the ST's Automotive Business Division and finally, they supported the further R&D development for automotive radars application. However in 2008, Bosch, which was involved with Infineon in a collaborative project (2004-2007: 79 GHz radar research), chose the Infineon solution for its radar application, which slowed down the interest of the automotive division in the BiCMOS9MW.

In the meanwhile in 2008, ST joined the European project, which was led by a concept stemming “from the competitive race existing in the semiconductor research to achieve individual devices and integrated circuits with higher operating speed allowing realization of new applications in new regions of the electromagnetic spectrum” (according to DotFIVE website <http://www.dotfive.eu/>). The goal of the project was to experimentally demonstrate the possibility to increase the frequency performances of SiGe HBTs, from an initial state-of-the-art value of the maximum oscillation frequency F_{max} at ~ 300 GHz, towards a final goal at ~ 500 GHz (Chantre et al. 2010).

Moreover, Finisar, a partner working with ST technologies since 1999 showed his interest for the BiCMOS9MW in order to use it in its optical interface with high Frequencies. Thus, ST decided to support financially the BiCMOS9MW project, and its maturity 5 development phase started in 2008 (technology needs to reach maturity 5 in order to go from purely research to development stage).

In 2009, the automotive division as reorganized and the new management team provided sponsorship for a BiCMOS9MW. As a consequence, 77 GHz radar developed was launched and several potential clients were identified (*i.e.*, Magna was interested by this platform in order to use ST as a second source of its current Freescale based 77 GHz radar chipset).

As well, PERASO, a spin-off of the University of Toronto used the BiCMOS9MW platform to develop a 60 GHz transceiver for mobile phone fast downloading applications. Several customers were identified. Another type of application was developed within the frame of the collaborative project called VéLO (“Communication Inter Véhicules et Localisation Relative Précise” – “Vehicule-2-Vehicule communication and relatively precise location”(translated by the author)) in order to study the possibility to make antenna for Short Range Radar in 79 GHz. The ST technology review that was held on the 21st January 2010 announced several prototypes: fiber optics communications with Finisar and Nortel; 60 GHz W-HDMI for video streaming with Peraso, 77 GHz automotive radar with Magna, Bosch, High speed instrumentation with Agilent, and 100 Gbs Ethernet prototype with Finisar.

The technological development continued to push technologies to TeraHertz frequencies. In 2011, a new project started with ST to integrate previous results from Dotfive Bipolar transistor into an advanced CMOS node like Cmos055 (project called “RF to TeraHertz”). The terahertz band, which falls roughly between the traditional microwave and optical bands, is typically defined as the frequency range of 0.1 – 10 THz. In terms of the wavelength in free space, it corresponds to the range of 3 mm – 0.03 mm. With these distinguishing properties, the TeraHertz band retains a great potential for applications that range from security and bio imaging, spectroscopy, sensors, to astronomy and atmospheric studies. Another advantage of the terahertz band is its immense bandwidth available for broadband wireless communication.

3. ACTORS AND THE KEY ROLE OF R&D CUSTOMER INTERACTIONS ROLE

The ecosystem of actors involved in this technology development comprised the internal, external specialists and market players. (Figure 47). The figure below presents the role that various experts play (*e.g.*, technology design, development, marketing, coordination...). The technology was developed thanks to a tight cooperation among these actors. For instance, technological know how was acquired through the collaboration with ST R&D devices development team, university of Toronto and CEA LETI laboratory. Moreover, the role of R&D Customer interactions role that comprised two managers (where the development was started by the first one and continued by the

second) appeared to be a key element leading to the technological success. This function was in contact with all the other players within the ecosystem, and enabled knowledge flow and coordinated technology platform design.

4. TOWARDS GENERIC TECHNOLOGY DESIGN: ANALYSIS AND HYPOTHESIS

4.1. Analysis: the discrepancies in case description

Development of the platform followed at the beginning the logic of technology push. The exploration resulted in BICMOC9MW cost effective platform offering higher frequencies for the analogical signal processing. The development did follow neither technology push, nor market pull strategy. There was no clear demand for this technology from the market side. From the perspective of the classical management criteria, this project appears to be unattractive. Moreover, the CMOS digital platform prevailed in the company. Still BICMOS9MW development seems to be a rational choice to maximize the possibilities to conquer the future market of high frequency analogical processing. Despite the difficulties in defining both future technology and designing market, the R&D devices team managed by the associated Technology Line Manager (“R&D Customer interaction role”)(See Figure 47) in succeeding to address several markets simultaneously. **The platform was positioned in automotive, fast download, optical communication application areas and resulted in being a generic technology.** Then, what was the logic behind it? How was the genericity acquired?

The choice of this case is based on the discrepancies identified through case studies interviews. The first group of interviewers presented the case as a management of exploration project where BISMOS9MW appeared as technology development for singular radar application development and its consequent development for fast download and optical communication. From this perspective this thesis corresponds to the trial and learning strategy where generic technology was built through consequent technology generalization to a set of different markets. This story was revealed mostly after interviews with specialists from ST Devices Development team and R&D design team – actors who were responsible for direct execution and technological development.

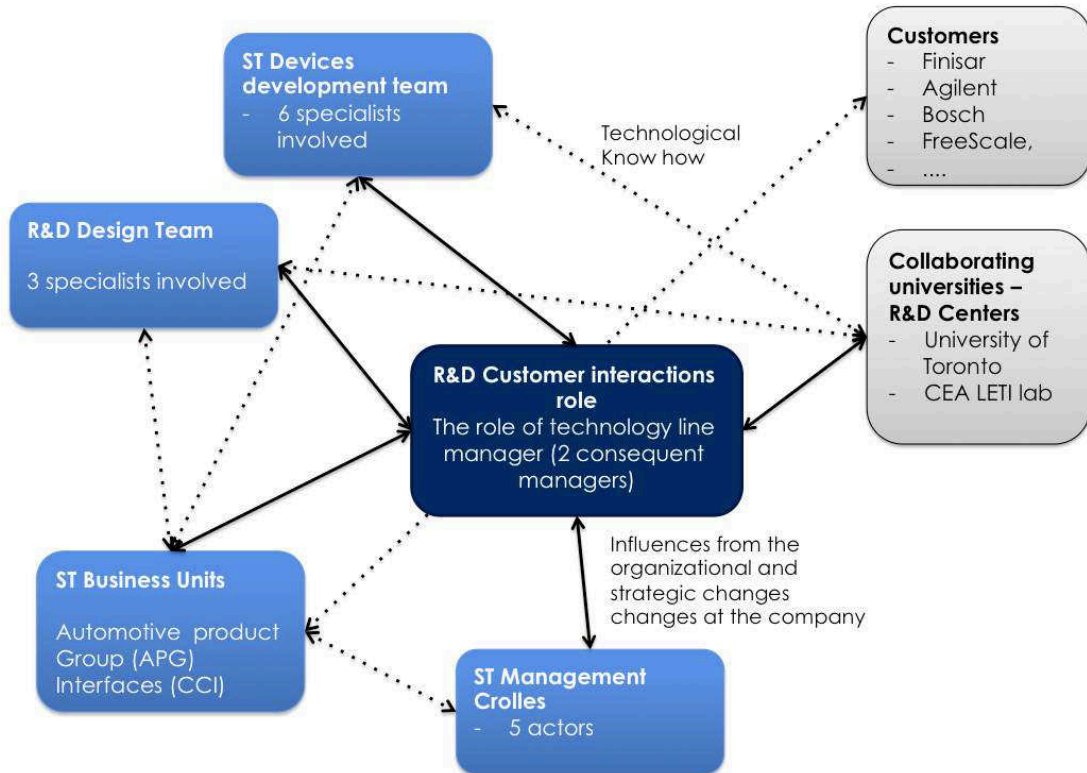

Figure 47 - Actors involved in BICM09MW exploration

The second group of participants (Figure 47) including the “R&D Customer Interactions” function defined the exploration as a platform design aiming to resolve the particular system issue – **“Wi-Fi connections in the big public systems like airports, train stations, and more generally high-density places with a lot of connected devices”**, which by its requirements comprised the necessary functions for the emerging market applications. **This announced the key role of a team leader who aimed to organize the platform exploration in addressing what was unknown for all the targeted markets**; he was seeking for common challenge for several markets. This strategy required multi-market exploration and appeared to be a more intentional strategy of genericity building than trial and learning.

The example of BICMOS9MW cannot be described only by market pull or techno push strategies; there is a co-exploration of technology and market. Therefore we need to find a suitable way to analyze this double unknown situation. Moreover, the revealed differences in the case treatment had to be examined. The framework that enabled the analysis of the market – technology relations through function description was applied. This framework (see Part I) helps to understand how this how this platform was really developed and how the interdependencies between technologies and markets were acquired.

4.2. Towards common unknown strategy

Until 2002 the group was working on the optimization of bipolar transistor for analog signal processing to address the emerging standards of 60 GHz. There was no particular client demand at the beginning. In the following 2002 the group was analyzing which potential high-volume markets and technological effort needed to develop to address it while reusing the previous research results on bipolar transistor. Several potential future applications were identified: optical communications, automotive radar, fast download application using emerging 60 GHz standards, hard disk drive applications, standard linear products. After identifying different functions relatively to each application, they found out compatibility in between several functional requirements (see Figure 48). They worked on a common unknown concept of generic technology for potential markets. It did not target any particular market from the predefined list but tried to maximize number of functions future technology can address.

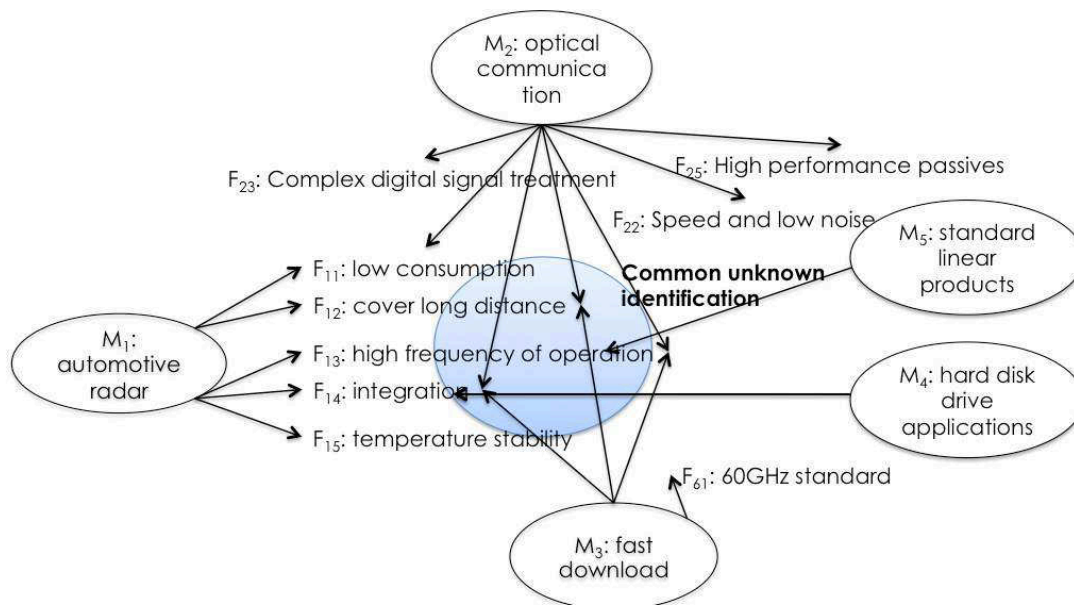

Figure 48 - Market functional compatibilities identification

The project team that worked on the technology exploration at STMicroelectronics reconstructed a sort of artificial market space « Wi-Fi to enable high device connectivity » with wider in genericity scope than the alternatives that facilitated technology adoption by derivative markets later. This system was supposed to enable high connectivity of a huge amount of devices as laptops, smart phones, tablets, etc. The exploration space integrated all the functions needed for high-density devices' connectivity in big public systems. Functional requirements of the system contained both high-frequency emissions that were addressed by bipolar technology developed in 2000-2002 and

helped to combine different functional requirements as low power consumption, digital signal treatment, covered distance, etc. This approach enabled the team to maximize the list of functions by superposing several applications. Instead of fixing the set of markets applications and organizing exploration by minimizing resources spent, they inverted the reasoning by fixing the resources and maximizing the scope of considered applications for genericity building.

Therefore, **Common unknown** was identified as a knowledge gap that connects different application areas. The work was not done to accomplish the most promising market. The generic concept of unknown allowed exploring maximum common functions with a fixed budget of R&D and addressing several markets (Figure 49). The proposed strategy permits to work on double unknown situations without fixing a concrete market or technology at the beginning.

The reasoning was based on unknown core to manage and it was mostly conducted by a Technology line manager (TLM) capable of reasoning both in terms of potential markets and related technological solutions. The TLM played the role of the interface between markets and technologies and was capable to work on needs of emerging applications. Moreover, due to volatility of probability and value distribution, the reasoning based on probability of market existence and expected value for projects is risky and does not provide relevant information to select a dominant application.

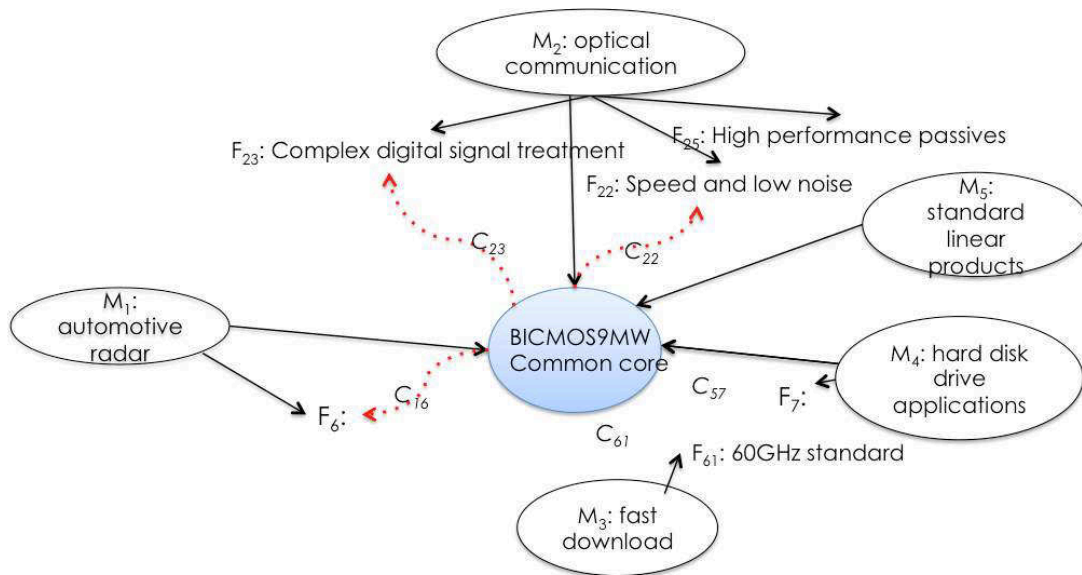

Figure 49 - Technology platform development followed common unknown strategy

Once the technological platform BICMOS9MW was developed it did not address directly any of the applications but provoked significant minimization of the cost for other projects. Several market applications were attracted and projects were launched to reuse the developed platform to build modules with specific to each market applications properties. The technological phenomenon

Appendix 2: Case study: Research anomaly identification:

developed addresses maximum functions with the particular budget associated to access all the defined markets. The developed technology allowed to explore maximum functions with fixed budget of R&D and addresses several markets at the same time.

The developed technology platform BiCMOS9MW did not address the initial system need but served to address different applications such as automotive radar, optical communications and wireless fast download systems, high speed instrumentation, and non invasive imaging.

5. CONCLUSION

5.1. Common unknown vs. Trial and learning strategy

As our analysis reveals, the initial phase of BiCMOS9MW consisted in predefining system issues and orientating technological development for multi-market applications. “Wi-Fi for high connectivity devices” appeared as a concept to legitimize an advanced technology development that comprises requirements of several emerging markets.

The technology was not initially launched to develop a radar application. If it would, the development would be orientated to maximize the value of automotive radar anti-collision 77 – 79 GHz to detect objects as far as 200 m. This would completely exclude the need of other emerging applications (*e.g.*, Speed and low noise/ high voltage capability for optical communication) and make technological reuse costly and the exploration area narrow. The learning would be orientated by the automotive area. In this the definition was much broader to define a technological core that could be potentially attractive to emerging applications (following common unknown strategy). Yet, the radar application was the first technology addressed after all.

The discrepancies in the interpretation of this case were due to the level of organizational involvement. The technology line managers defined the initial positioning of the platform and were aware of the multi-market approach. On the contrary, engineers and researchers involved in project development were responsible for certain parts of the design, executed successfully technological development, and led projects but were not necessarily part of the projects strategy definition. The same can be seen at the level of Ph.D. projects (for the analysis see Part IV).

5.2. BiCMOS9MW as an example of generic technology design

The analysis indicates important element of the cases that are compliant with the results of this thesis. First, the exploration was positioned in double unknown: technologies and markets were not yet defined. Markets were still emerging and there existed other technological alternative. The exploration consisted in mobilizing the existing knowledge and competencies (in bipolar and CMOS technologies) to design generic technologies for multiple markets.

Second, regarding the techno-economic conditions, the technologies are aggregative which means that they could easily incorporate new functions. Moreover, market signals were low but dynamically changing in time. It is well demonstrated in 2.2 where external markets signals were changing and new ones were emerging in time.

Third, we see that the process required an ability to identify relevant knowledge gaps to formulate generic core and lead this exploration. The role of the technology line manager appeared crucial for BICMOS9MW's success as a generic technology. The manager was not only coordinating the ecosystem of various actors but exploring both known and yet unknown issues to determine generic concept and account for GT.

Moreover, this case reveals that within the classical organizational structures, the transversal exploration within several business areas could be challenging. The technology strives to find the first sponsor because he is supposed to pay for technology development and the divisions were not ready to share costs of the exploration in this case. The new types of R&D financing are indispensable for the organizations in order to prioritize more flexible joint exploration of generic technologies.

Appendix 3

R&D Project Portfolio analysis: the example of etching process step

This part attempts to provide more details on the case of Ph.D. portfolio organization at ST. Through the *ex post* analysis of ST Ph.D. thesis projects portfolio, Section 1 builds on the particularity of this portfolio and attempts to provide further insights on the generic technology design in practice. Portfolio organization of Advanced R&D projects enables effective exploration of the unknown market and technology spaces. Therefore, the work on innovative research portfolio management can bring new tools and frameworks for companies that face challenges of increasing complexity of technologies in addition to shorter product life cycles. It forces firms to rely on R&D as a source of strategy and the companies are inclined to evaluate their technologies from a portfolio's perspective in which a set or a sub-set of R&D projects are evaluated together, in relation to each other. Section 2 presents the example of the etching portfolio which is an R&D type of portfolio that comprises mostly Research and Development types of projects and is subscribed in "Moore's Law" exploration.

1. RESEARCH PORTFOLIO ORGANIZATION AT STMICROELECTRONICS

To better investigate the projects interaction, we analyzed a research projects portfolio at ST. The chosen portfolio contains 400 Ph.D. thesis projects launched from 2002 to 2010. Initially the work consisted of screening of Ph.D. projects portfolio in STMicroelectronics. This allowed distinguishing of different types of projects in the portfolio (related to innovative exploration, conceptive research or classical research optimization and development projects (RID model)).

The projects within the portfolio were classified according to their area (compliant with the working groups defined by the ITRS community). In addition to working groups defined by the ITRS we add "More than Moore" groups as Imagers, NEMS/MEMS, 3D integration and Innovation management group. For the results of classification see Figure 50.

Research project ST Crolles 2002 - 2010. Classified by ITRS domains

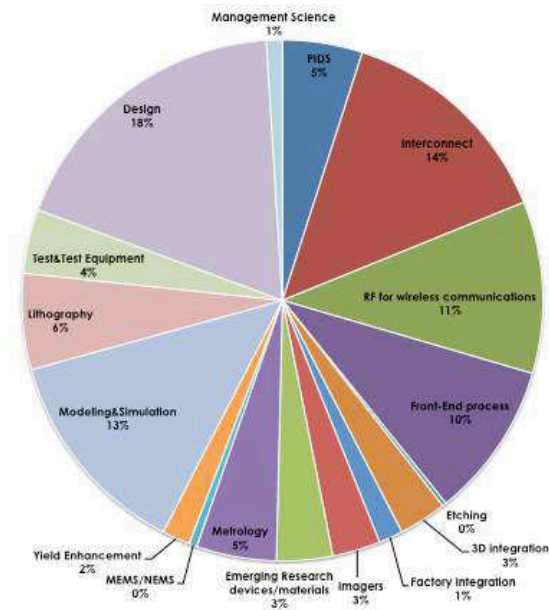

Figure 50 - Research project classification

To analyze and reveal types of projects and their interdependencies, they have to be codified in a unified way. Initially, we codified each project by associated keywords. In this case a thesis can be defined as a set of attributes in the space of scientific and engineering language. Moreover, for each thesis project we underlined the initial questions and results for the academic community (in terms of publications), business (collaboration with BUs, patents), and development projects. We underlined whether the results were re-used within the same domain or provided some inputs to the other exploration areas, and whether it provokes further investigations. The projects were classified according to the definitions established by RID model (Le Masson, 2006). To illustrate, the examples of research, development and innovation projects are provided in Table 16.

The first classification comprised a lot of heterogeneous thesis projects where the distinction in three types appeared vague (*i.e.*, there were projects comprising research and development activity) to classify based on three types. Therefore, the introduction of second order filter could allow distinguishing high and low level brief projects. High-level brief is an innovative project that leads to a completely new ideas and solutions. Low-level brief is a development project that lead to a new process step based on an existing phenomenon and that was not proved before. Moreover, compliant with the results of Felk (2011), conceptive research type of innovative projects within brief and seek for alternative original project forms for innovation functions (such as projects leading to genericity) were revealed.

Table 16 Ph.D projects examples according to RID model

Project types	RID Model	
	Definition	Examples within ST Ph.D projects portfolio
Research	<p>A project with well-established goals to model a certain phenomenon: resolve clearly define problem by applying rigorous methodology</p> <p>Objective: create and validate knowledge</p>	<p>2004 – 2007 Ph.D project “Matching Study of Si/SiGe:C Heterojunction Bipolar Transistors (HBT) in BiCMOS Technologies”</p> <p>Keywords: (Matching measurements at high currents, physical mismatch models, characterization of HBT matching...)</p> <p>Modeling type of projects</p>
Development	<p>A project with well-established goals to improve existing technology/design. The procedure or procedures of optimization used to make a system or design as effective or functional as possible.</p> <p>Objective: propose products and rules that allow fabricating products that fulfill predefined specifications and mobilize advanced resources.</p>	<p>2005 – 2009 Ph.D project “Optimization of heterojunction bipolar transistor Si / SiGe: C BiCMOS technology for 0.25μm applications power amplifier for wireless communications”</p> <p>Keywords: (reaching requirements for power amplification, optimization of high voltage NPN for B7RF architecture, contribution to the development of technology for power amplification)</p>
Innovation (Brief)	<p>Exploratory projects that lead to innovative solutions, alternative ways of modeling/realization of certain phenomenon</p> <p>Objective: structure innovative fields, prepare potential specifications and identify necessary competences for the concepts considered as strategic for a company</p>	<p>2003 – 2006 Ph.D projects “Development and study of vertical Si/SiGe heterojunction bipolar transistors on thin-film SOI”</p> <p>Brief: what is the benefit of using thin SOI for HBT?</p> <p>Keywords: (thin-SOI SiGe HBT structure on 0.13μm technology on 160nm-thick SOI, isolation extrinsic base and collector, performance range exploration to reach H9SOI-SiGe technology, exploration</p>

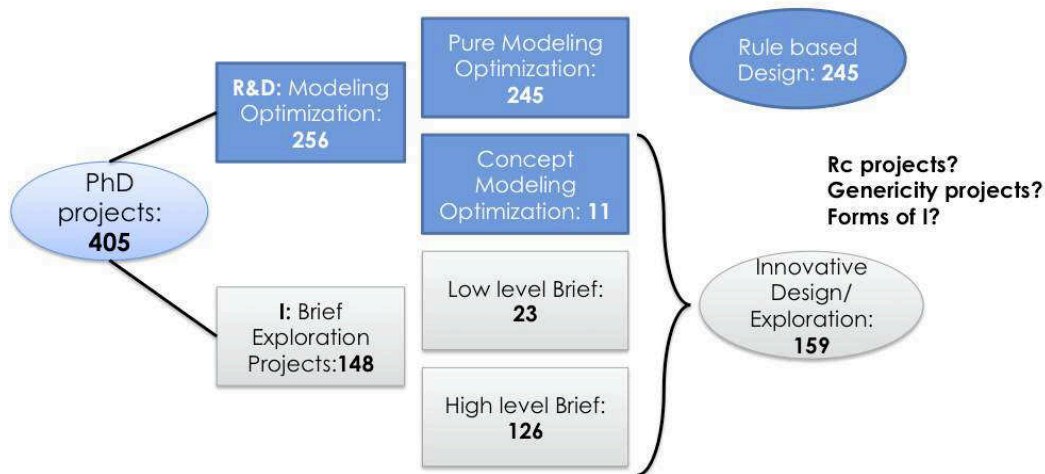

Figure 51 - Ph.D Thesis portfolio analysis

We use the C-K methodology to create projects cartography and to analyze the evolution of knowledge space through thesis exploration. To better investigate the dynamic of research projects portfolio, the interdependencies between projects and influence of previous experience to projects selection, we have chosen different research areas: 1) subscribed to Moore’s Law challenge - Etching projects portfolio construction. The etching portfolio presents a rather classical approach driven by Moore’s Law portfolio. It comprises mostly R and D type of projects. 2) Portfolios subscribed in “More than Moore” activity comprise 3D Integration, Imaging, Bipolar technologies. The example of Bipolar project was presented previously.

2. PROJECT PORTFOLIO ORGANIZATION: THE ETCHING PROCESS STEP

Etching is one of the key process steps for making micro-electronic devices. Etching is a collection of steps in the process of integrated circuits (IC) fabrication to produce high-resolution patterns in many of the thin layers of the circuits and selectively remove masking layers.

Generally, more than 400 steps are necessary today for the IC fabrication. These steps are divided into two parts: 1) « front-end-of-line » (FEOL) - the fabrication of the active part of IC and the local interconnections which determine the active zone of ICs 2) « back-end-of-line » (BEOL) interconnects fabrication to enable connections within active zones. This process comprises three major steps: transport of etchants to surface in order to obtain the desired pattern, surface reaction, and removal of product species. The etching process step is rather complex itself. The IC fabrication comprises 10 etching steps, 10 different gases are used within etching, at least 8 different knobs are required to control the plasma properties. The etching Ph.D. portfolio at ST consists of 23 projects launched during the period from 2002 till 2010. Each project lasted 3-4 years and was conducted in

collaboration with an associated research lab (mostly with LTM CNRS lab). The research portfolio is quite stable; around 2-3 projects are initiated every year.

Generally, the evolution of microelectronics is still mainly driven by the size reduction of its components. Classic transistor scaling has defined modern scaling and related performance enhancement based on new materials in strain engineering and high- κ metal gate schemes. With each new generation transistor gate pitch is scaling as 0.7x per node and area scales as 0.5x. Yet, physical gate length of transistor scales is only 0.9x. Innovations in silicon technology such as strained-Si channels, high- κ /metal gate stacks and non-planar multi-gate transistor structures have all enabled the scaling and performance trends. According to Moroz (2011) most of the transistor innovation is in stress engineering and high- κ metal gates. High- κ metal gate (HKMG) incorporates a high- κ dielectric, which reduces leakage and improves the dielectric constant.

The etching portfolio is structured along the main axis: *“Obtain desired thin film pattern with CMOS N+1 (for new CMOS generation)”* (Figure 52). To prepare each new generation new materials have to be etched, new gases to be added to remove the etched materials and obtain desired film patterns, the process of etching is a one of the key enablers for each new generation. As pointed by Bensahel (2012) the issue is not even to obtain smaller and more performing circuits, but to control their dimension at the Nano metric space. Various parameters should be controlled within etching. Among them, the most important ones are: line width roughness defined as a deviation from the critical dimensions (CD) and profile control.

The Ph.D. projects analysis showed that research projects launched by etching group could be structured along four main axes: 1) FEOL – gate etching 2) BEOL - interconnects propagation 3) photoresist degradation in lithography 4) the process of metrology. It is important to underline that 3rd and 4th exploration areas required external expertise and collaboration with lithography and metrology groups and the developed solution directly concerns these teams. The knowledge space in Figure 52 represents the expertise required to adapt and develop the etching procedure for each new generation.

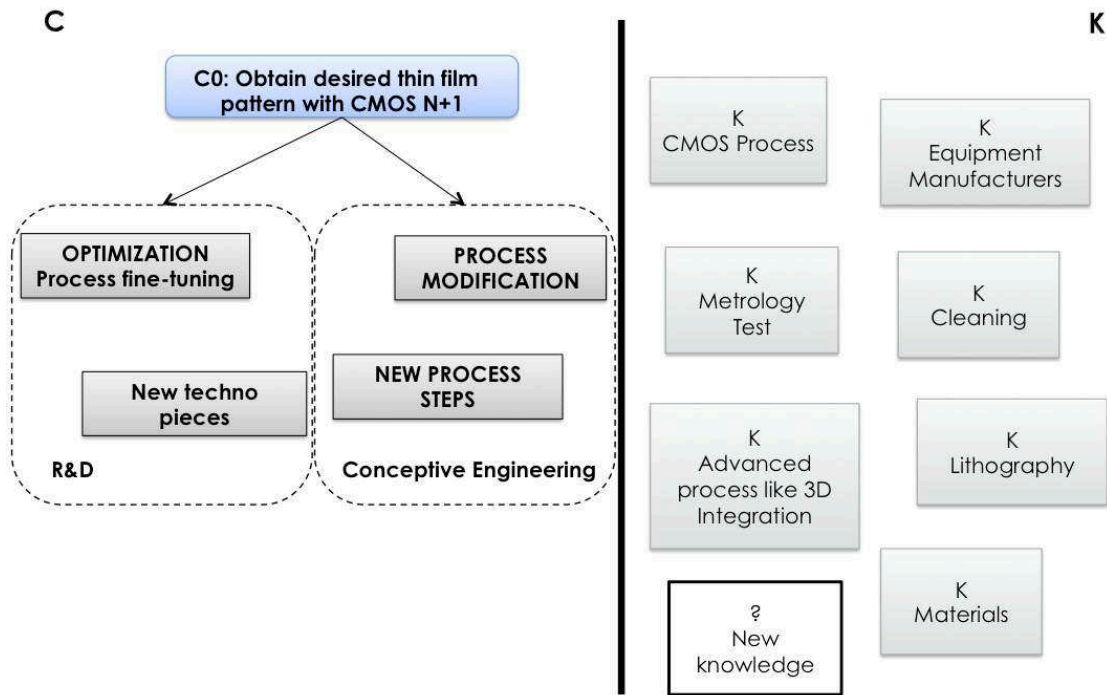

Figure 52 - CK-modeling Etching

Regarding gate etching and interconnects etching, the exploration process is rather stable, the research is concentrated on developing new procedures to etch new materials, new plasmas and gases and improving etch parameters (e.g., selectivity, optimum power calibration, roughness), achieving compatibility within materials (see Figure 53 for gate etching).

For instance, poly- silicon gate etching was possible thanks to the silicon dioxide that has been used as a gate oxide material for decades (see the first partition in C-K). Though, as transistors decrease in size, the thickness of the silicon dioxide gate dielectric decreases and below 2 nm (at the figure of the gate stack it is still 3 nm), leakage currents increase, which provokes high power consumption and reduces device reliability. This brought in the use of high-k materials, which enable increased gate capacitance and further miniaturization without the associated leakage effects (Project 1) (Figure 53). Initially, nitrided hafnium silicates (HfSiON) material was used for the 65 nm generations. Yet, this material is risky for trap-related leakage currents, which tend to increase with stress over device lifetime and thus, new high-k HfO₂ thin film materials were implemented to 45 nm generation by using Cl₂/CO plasmas (Project 2). The second project is classified as optimization since it deployed the knowledge that was developed by other sources. By deploying BCl₃ based plasmas to enable infinite selectivity of HfO₂ thin film over SiO₂ and Si substrates by adjusting bias power (Project 5). Project 7 illustrated the potential of reactive plasma etching on the selective High K/metal gate etching. By adjusting bias power, selectivity could be controlled which permits the etching of ultra-thin layers of high-k.

We can see that the research projects are heavily R&D driven to enable successful fabrication of new CMOS generations (in this case for gate etching). They enable the development of new methods for plasma gate etching by using new thin films and corresponding plasma to obtain high quality profile.

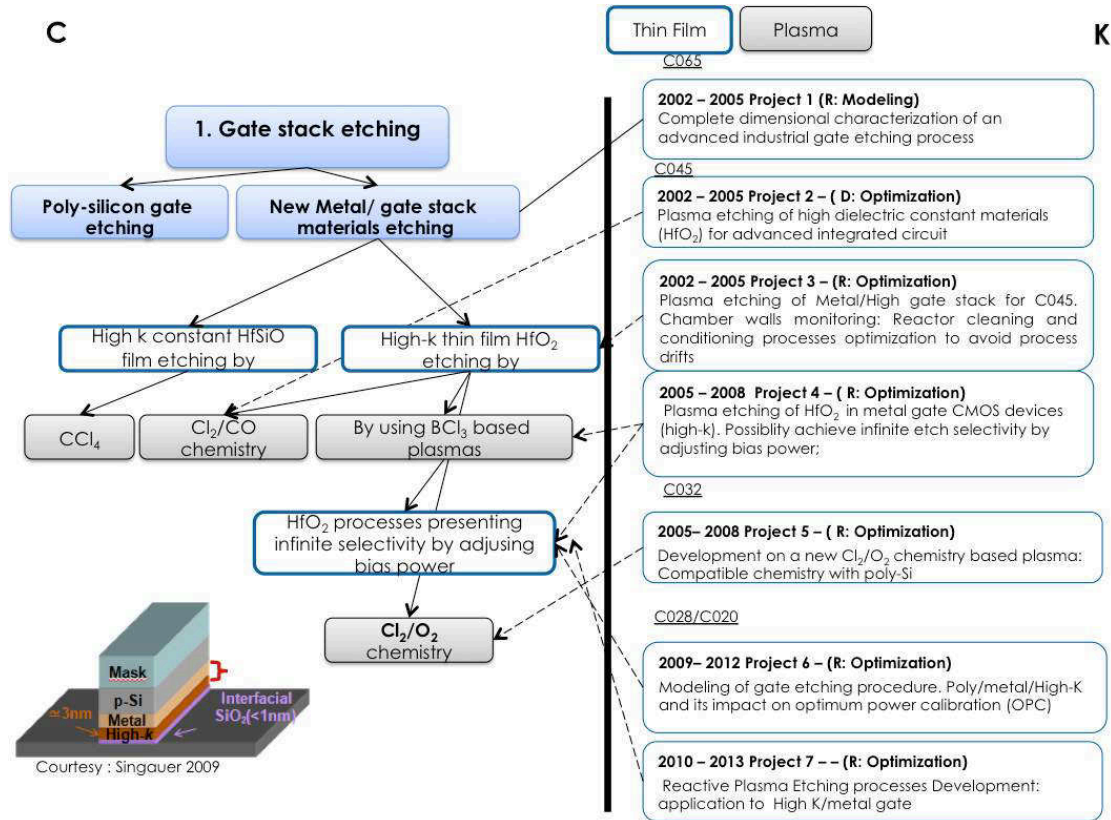

Figure 53 - C-K modeling: gate etching

Regarding interconnects etching, research was mainly driven by the evolution of low-k²⁸ interlevel dielectric materials to reduce the RC delay by either lowering the interconnects' wire resistance or reducing the capacitance. Each new generation requires materials with lower k (4.2 for 130 nm and 2.3 for 20 nm), which has led to the use of porous materials. Overall, 7 Ph.D. from 23 projects were launched from 2002 to 2010 to deal directly with the issue of interconnect etching. For instance, one

²⁸ Low-k dielectric is a material with a small dielectric constant relative to silicon dioxide. Insulating dielectrics separate the conducting parts: transistors and interconnects form each other to reduce parasitic capacitance, enable lower heat dissipation and faster switching speed.

Appendix 3: R&D Project Portfolio analysis

of the optimization projects (2006 – 2009) developed a concept of scatterometric porosimetry²⁹ for the study of etching process of porous materials and their characterization for CMOS 45 nm node. The project, launched in 2009, used the developed expertise and attempted to optimize the introduced concept of plasma etching. This thesis resulted in a protocol that enables the widening of this method to complex stacks of materials for 28 nm.

Each new project launched from 2002 to 2010 is based on the results of the previous explorations and attempts to reuse them for new CMOS generation (the change between generations is indicated within the C-K diagram, the projects are positioned in K basis). They effectively optimize and build on the existing and acquired knowledge. The projects observed within gate etching and interconnects are mostly research and development types that support the logic of “rule-based design”. These explorations are highly compliant with the ITRS roadmaps. They do not look to revise the already established rules and do not challenge the validity of CMOS logic.

The differences were observed within the exploration oriented to process control. In situ and real time control of the different process steps in semiconductor device manufacturing becomes a critical challenge, especially for the lithography and plasma etching processes (El Kodadi, 2009). The normally used etching control was based on offline scatterometry. The joint research work of ST with the LTM laboratory, permitted to introduce dynamic scatterometry, which can be used as a real time monitoring technique during the resist trimming process (see Figure 54). These two projects revised the previously established rules of scatterometric procedures and proposed a “rule-breaking” Advanced R&D Solution for both gate etching (Project 17) and interconnects (Project 18); they led to the development of new concepts.

Overall, it is shown that etching project portfolio comprises projects that are mostly based on validation of certain techniques, on process fine-tuning and new technological pieces development to ensure further growth, devices performance and reliability. These projects are mostly R and D types with the accent on optimization and implementation of research phenomenon. This exploration in unknown is highly structured thanks to the ITRS roadmaps that guide the needs of new CMOS generations and define etching roadmaps to support it. There are explicit interdependencies based on continuity of these projects, direct reuse of obtained results within the portfolios in different aspects of thesis and implicitly based on the resources and inputs sharing. Within portfolio projects were mostly defined according to the different “clients” (metrology, lithograph, CMOS fabrication process) for project exploration. Etching appears as one of the key enablers for generic technologies.

²⁹ Scatterometry is a critical dimension measurement technology used to precisely determine the dimensions on the semiconductor wafer that directly control the resulting performance of the integrated circuit devices

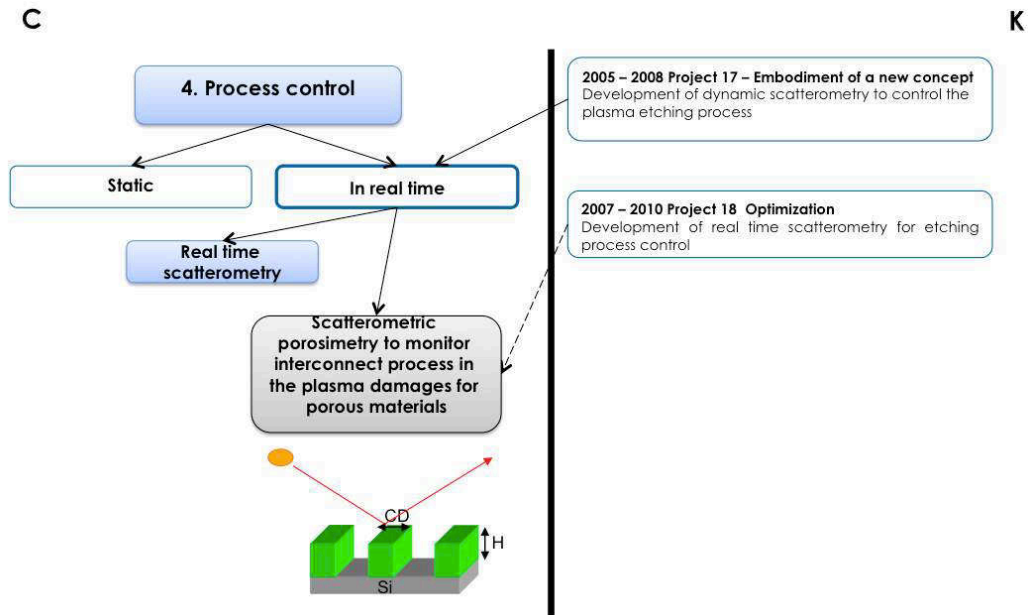

Figure 54 - C-K Modeling: Process Control

Still, this portfolio comprises exploration of new concepts, new steps and new procedures that modify the process (like changing process control by implementing real time scatterometry). The rule-breaking projects were not issued from the stream of new CMOS generation driven-projects. The advances in metrology and equipment manufacturers drove them. Their conceptive nature structured unknown and influenced the classical process of fabrication while enabling easier and more precise dynamic control of etching.

Still, this portfolio comprises exploration of new concepts, new steps and new procedures that modify the process (like changing process control by implementing real time scatterometry). The rule-breaking projects were not issued from the stream of new CMOS generation driven-projects. The advances in metrology and equipment manufacturers drove them. Their conceptive nature structured unknown and influenced the classical process of fabrication while enabling easier and more precise dynamic control of etching.

Limits and disruption in traditional Moore's Law approach

The analyzed etching portfolio presents a rather classical driven approach by the Moore's Law portfolio. Still a lot of issues remained to support upcoming generations. Such as, nowadays no solutions are available to control variations that are smaller than 2 nm, which is necessary to ensure good performance of electrical devices of advanced technological nodes. Metrology techniques needed to control various parameters are becoming more and more complex and require measuring multiple parameters simultaneously. Moreover, traditional scaling is approaching its limits. As Figure

Appendix 3: R&D Project Portfolio analysis

55 shows, this trend cannot continue since there is no space left for contact. The proposed solutions are to keep channels close to the gate and remove current paths that are away from the gate. The two architectures are proposed to deal with this issue: FinFet and FDSOI. FD-SOI is a planar process technology that delivers the benefits of reduced silicon geometries while enabling a simplification of the manufacturing process. FD-SOI transistors operate at frequencies up to 30% faster than the maximum frequency of an equivalent transistor manufactured using bulk CMOS, enabling faster processors to be built (source: ST).

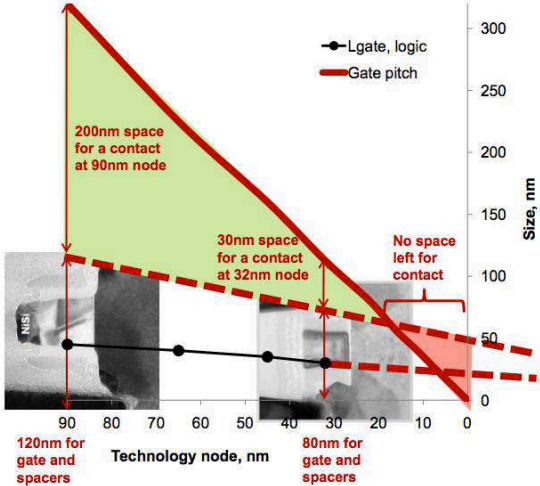

Figure 55 - Transistor size evolution³⁰

In addition, for the 22 nm node and beyond, 3D Integration transistor architectures that allow vertical stacking of devices are planned to be used. This architecture requires changes in the etching process and could even revolutionize the way etching is presumed nowadays (i.e., in the case of 3D Integration for vertical chip stacking). These changes could bring the etching portfolio to consider launching conceptive research projects and even integrate market specific knowledge on product requirements.

³⁰ Source: Microlab Berkley 2011: Transition from Planar MOSFETs to FinFETs and its Impact on Design and Variability

Appendix 4

Generic Technology in patent portfolio design: designing technological patents in high uncertainty

Patents play an ever-increasing role in modern economies and are often used as a measure of technology innovativeness. While dealing with the design of generic technologies, its features could influence the patent filling strategy. Does one have to protect a technological core or aim to obtain patents on associated modules? This appendix aims to provide some insights on the patent strategy for GTs. It attempts to clarify the notion of genericity in patent strategies and the potential ways of protecting generic technologies and provides an example of patent design strategy in the case of GT. It mobilizes the C-K theory and more precisely the CK Invent methodology for patent portfolio design that has been derived from it.

1. ON THE NOTIONS OF GENERIC PATENT PORTFOLIO DESIGN

Patent is a result of research on inventive activity. The relations between patents, innovation and R&D over time has been shown by various researchers (Granstrand, 1999, Mansfield, 1986). Patents are largely used as economic indicators (Schmookler, 1966) and various researchers use patents as a measure of innovations.

Each technology comprises public and proprietary goods aspects. Proprietary aspects ensure profits for firms in the future and public aspects enables community to profit from technological advances. Nelson (1989) stresses the importance of balance between the proprietary and public aspects. When it comes to generic technology design, both technologies and future applications are unknown. Taken into account the pervasive nature of generic technology, what could be a strategy that protects a new generic design, does not infringe the existing intellectual properties and permit to profit from genericity by developing other markets (not necessary by IPs holder)?

General purpose character of technologies is often examined using patent data (see (Hall and Trajtenberg, 2004, Moser and Nicholas, 2004, Novelli, 2010). Novelli (2010) used patent databases to analyze “generality” of photonics technology. Generality is defined based on technology diversification, relevance to scientific knowledge, uncertainty, set of control variables, time effects, subfields and firm effect. Using patent data that are associated with the Cohen-Boyer rDNA patents Feldman and Yoon (2012), define a set of empirical predictions about GPTs. They revealed that the

Appendix 4: Generic Technology in patent portfolio design

Cohen-Boyer patents cite different technology components in the application sector, suggesting **greater technological complementarity**. Moreover, the forward citations of Cohen-Boyer patents represent a larger range of technology classes, which suggests higher **potential of wider applicability** and **technological discontinuity**. When by attempting to develop generic technology, do the designers have to fill patents by taking into account technological complementarity, discontinuity and wider application area?

The logic of patenting is often regarded as an objective of the research (Sincholle, 2009). Patents play an important role in technology diffusion; they represent an accelerated version of technology development. The well-known theory of inventive problem solving (TRIZ) and its derived methods are used to generate design solutions based on existing IP documents. Yet, TRIZ is often criticized for its limited inventive novelty due to the departure from the already existing solutions (existing knowledge). Reich and Shai (2012) demonstrated that this method is suitable for 'in- and near- box' designs. To increase reliability and originality of the solution Koh (2013) indicated the importance of patent infringement checks before and during the design of solutions. Though, the author admits that this could influence the design creativity.

Dealing with highly innovative fields, patent design could occur even before the design activities or research work in general. In Felk (2011) a model of patent design primarily to technology emergence was introduced. This work on patent design mobilized the method C-K Invent derived from the C-K theory and initially tested in case of the design of new domain associated with 3D Integration. This model is based on definition of 'Action', 'Effect' and 'Knowledge' grant criteria based on C-K theory, where each concept is a combination of actions and effects. Invention is considered novel only when Action (interventions made on objects) and Effects (consequences brought by actions) do not make part of a common knowledge and as a result new knowledge is created. The defined "generative concepts" lead to enlarged design space and identify a wide range of opportunities for specific problems. The authors show how to create a strong patent portfolio in the field of interest to strategically position future patents within the predefined design space.

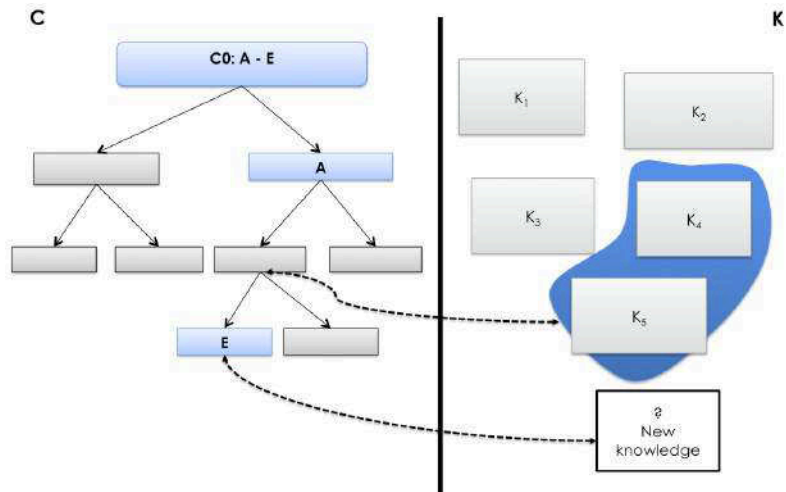

Figure 56 - C-K Models based on A, K, E (adapted from (Felk 2011))

This experiment was conducted for disruptive 3D Integration technology at STMicroelectronics. In 2008, when the technology was still immature and the unknowns were high, the authors demonstrated that by working on the generative concepts like “*definition of a Trough-X-Via (TXV) as interconnect between devices rather than Through-Silicon-Via (TSV)*” allowed considering any type of substrate and ways of interconnecting devices through this substrate. The high rate of issued ideas from this and relevant concepts led to a high number of inventions which in turn enabled ST to obtain patents and launch new exploration projects.

As Part III indicates the design of Generic Technologies is driven by generic concepts where the domain of existence D is crucial to design to account for larger application area. The validity domain D needs to be covered while designing patents. What might be a suitable patenting logic for generic technology? How to protect them? Driven on the successful use of CK Invent method for creating patent portfolio, can CK Invent methodology be used to explore, define validity domain and design patent portfolio around generic technology.

2. DESIGNING GENERIC SUB-DOMAINS

Following the specific activities included in intervention research approach, we accounted for phases of collaborative research process design, inquiry process and research implementation. While pursuing the goal of exploring different patent strategies, we implemented the model of patent design for disruptive contexts introduced in Felk et al. (2011) and adapted it to the various contexts: (1) emerging technological field with lack of expertise (2) patent portfolio creation for the actual problem (3) markets related innovative technology exploration. Overall, we conducted 4 empirical tests in various areas and distinct level of unknowns involved: 1) in 3D Integration area for a

Appendix 4: Generic Technology in patent portfolio design

problematic of thermal management 2) energy management and recuperation 3) multi-touch haptic solutions 4) silicon photonics.

These four explorations were launched with the aim to design technologies which can be applied within various contexts and market areas. Each experiment was conducted through a 3 – 6 months period with teams in charge of developing relevant technological blocks. Our goal was to analyze how teams tackled generic character of corresponding technologies and how patent propositions change in order to protect genericity. All four experiments have resulted in a number of inventions and patent proposals were filed. For simplicity reasons, below we present the first empirical case. For detailed CK Invent method presentation see Felk et al. (2011).

Our experimentation initially involved 3D Integration technology when its level of maturity increased, contrary with the experimentation presented in Felk et al. (2011), and the first products using 3D Integration appeared on the market. The idea behind 3D Integration is that instead of trying to squeeze everything into a single die, multiple dies could be used³¹. Each die may use a different fabrication technology optimized for that particular type of circuitry, such as memory, logic, analog, sensors etc. The dies could be connected “Through Silicon Vias (TSVs)”, much the same as vias on a printed circuit board (PCB) or interposers could be integrated. Still, taking into account its generic character and potential in other emerging market application, we decided to repeat the experiment.

Initially, following the approach of *conceptive research*, we attempted to propose cartography of the existing solutions and associated problems to reveal potential blocking points, knowledge gaps and issues raised by 3D Integration. The concept explored initially was rather broad: “*Vertical stacking of dies with max functionality and optimal design point to facilitate heterogeneous integration*”. To the general definition of 3D we added functionality dimension to account for larger application domain.

The exploration of the initial concept helps to prioritize various issues and to identify a rather critical area where patents were missing and solutions were required to ensure further technology dissemination. The chosen critical area consisted in “**Thermal management issue of 3D Integration circuits**”. This problem was initially revealed thanks to the particular solution known as Wide I/O, which represents direct stack of memory and processor. Wide I/O was considered as a driver of 3D commercialization. Though, its thermal performance was weak. For instance, thermal analysis indicated that temperature rise induced by the logic part would be so high that the temperature constraints outside the package ($T=65^{\circ}\text{C}$) would not be respected anymore (simulation $T > 175^{\circ}\text{C}$) (Figure 57). The innovative solutions to deal with overheating were crucial to commercialize 3D Technology.

³¹For more details see: Brian Bailey, “[Is Wide I/O a game changer?](#)”, May 29, 2012. Accessed October 10, 2013

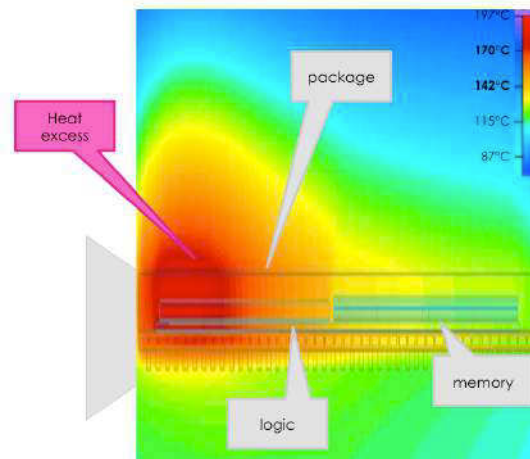

Figure 57 - Wide I/O Thermal Analysis. Source: Corporate Packaging and Automation Stress Analysis lab -ST Agrate

The revealed issue based on temperature requirements and limits of multiple states of wide I/O product appeared to be much broader. For instance, smartphone platforms are tightly coupled with thermal performance at silicon, package, PCB and mechanical systems. Thermal management appears to be one of a key design challenge. There is a need in new methods and materials to reduce heat resistance from transistor and active cooling methods have to be researched to deal with reduced footprints, increased power density and multiple heat sources of heterogeneous 3D solutions.

At the same time, thermal management solutions that exist for PCs, servers and any other high performance applications cannot be directly reused in smartphones and tablets. According to the ITRS report “by 2018 at 18 nm power dissipation will reach 151 W for cost performance and 198 W for high performance applications”. Will heat removal techniques meet power density, heat flux and thermal resistance needs of future products?

The previously launched experiment in 3D Integration area allowed a number of important patents to be obtained. Yet, the issue of thermal management was uncovered by this exploration. Taking into account the actual problem, the projection of the ITRS on thermal management problems, the diversity of potential application of 3D Integration, the exploration teams have decided to initially focalize the exploration in thermal management of 3D stacks in order to explore and potentially create **the domain of existence for new ideas and design generic sub-domain portfolio that proposes intelligent thermal management solutions for a large variety of applications using 3D**. Then how to allow for further technology dissemination by solving a rather generic problem of overheating?

The problem of overheating in 3D stacks arises on several levels: system, interface and die. Following the CK Invent methodology, we initiated innovative space exploration by solving issues of thermal management at each of these levels (Figure 58). At each level we were aiming to build the design space by defining what are the couples of Action and Effects that still remain as concepts.

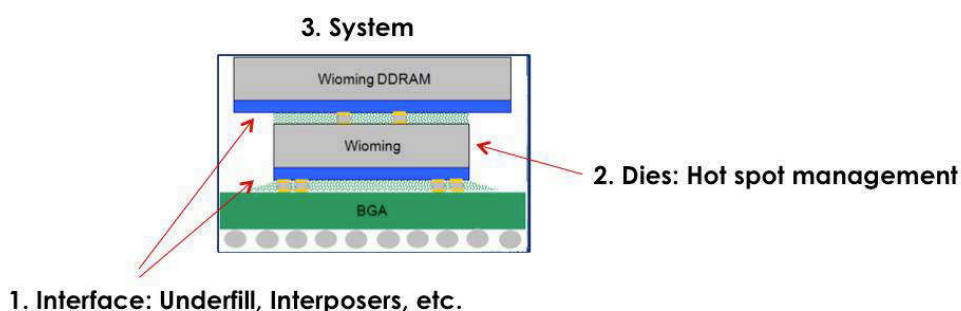

Figure 58 - Defining exploration area

The experimentation comprised working session and preparation work between them. The generic concept explored at each area was: “3D Integration with smart thermal dissipation at interface system or/and die level for all the applications that will potentially use 3D Integration”, which allow accounting for various applications using 3D and design its validity domain.

The working sessions comprised group discussion to identify new concepts, new vocabulary for innovation field exploration and mapping the potential ideas using CK diagrams. The preparation work between sessions consisted in searching for missing knowledge, enriching the emerging propositions and identifying blocking points. The process continued till the list of promising concepts were defined and refined according to the main patentability criteria (*e.g.*, novelty, invention step, embodiment). For instance, one of the emerged propositions was to fabricate an interposer in WIDE I/O application to improve conductivity and thermal management. Interposer makes use of phase-changing material (PCM) that stocks the energy recuperated from heat during the phase of fusion of PCMs and dissipating it during solidification. The application of this proposal was not limited just to WIDE I/O. **As a result, a number of inventions were defined to propose wide-scope patents deeply linked to generic concept exploration.** Each identified idea was evaluated through the patent committee screening process leading to fill a number of patent proposal and obtaining important solutions to deal with thermal management in 3D (and also planar) integrated circuits.

3. REFLECTIONS ON GENERICITY OF PATENT PORTFOLIO EX ANTE

The findings of this study have a number of implications for future practice and theory. The presented experimentation demonstrates that **genericity of technology could be taken into account by designing a patent portfolio.** C-K theory allows modeling the novel and inventive character of generic technologies design by integrating the complex knowledge structures and provides useful insights on the design of generic sub-portfolios of patents.

By managing ideas exploration through the process coupled with generic concept, one can ensure technological complementarity. For instance, the exploration of ideas at interface, dies or system

level was coordinated to ensure their compatibility internally and also the heterogeneous character of 3D Technologies to stack various electronic and even optical dies (in case of silicon photonics) enables to combine expertise and provoke further ideas exploration in other areas. This supports the notions of larger validity domain design for generic technologies and its pervasive character. By designing domain of existence for thermal solutions in 3D, the generic sub-domain for various solutions could be established and genericity could be valorized. It permits to control for applicability of generic technology to various areas since, as pointed out by (Novelli, 2010) technology could be general without being pervasive. By working on domain of existence for patent design, one could potentially overcome the criticism that “any technology could be called a GPT with the benefit of hindsight” (Field, 2008).

Yet, the example presented here just shows potential ways of dealing with valorization of generic character of technology *ex ante* and provides the empirical evidence of patent portfolio design in case of GTs. It is shown that designing generic sub-domains could protect genericity. Though, the theoretical construct remains to be built.

This research has thrown up many questions in need of further investigation: How to “intelligently” design generic patent portfolio with controlled costs and optimized exploration strategy? How to deal with patent infringements? What could be a technology licensing policy for rivals and partners? Moreover, what could be a process of exploration regarding patent pools?

List of figures

Figure 1 - Double unknown phenomenon: technologies and markets are ill-defined and yet-unknown	37
Figure 2 - Fastest Growing Consumer Technologies. For instance, It shows how much more rapid cellphone adoption has been than home computer adoption. The raised question is how long will it take for smartphones to reach saturation in the US.	44
Figure 3 - Technology adoption. Breakthrough Communication Technologies	46
Figure 4 - Principal Research questions.....	59
Figure 5 - Research methodology.....	62
Figure 7 - Research synopsis.....	73
Figure 8 - Comparative Framework - Risk management strategies.....	87
Figure 9 - Technology-Market matching: Technology Push and Market Pull	89
Figure 10 - Double unknown characterization.....	89
Figure 11 - Trial and learning strategy - BAW FEM case.....	92
Figure 12 - Initial technology-market evaluation. BICMOS case	94
Figure 13 - Costs and probabilities SU_1 and SU_2	97
Figure 14 - Common technology.....	100
Figure 15 - Universal technology.....	100
Figure 16 - Generic technology.....	101
Figure 17 - Generic hardware and software layer	104
Figure 18 - Generic function identification	105
Figure 19 - Technology-Market modeling	121
Figure 20 - Unknown technologies graph.....	122
Figure 21 - Conditions of strategies applicability	127
Figure 22 - Generativity and genericity.....	144

Figure 23 - Generic concept definition	153
Figure 24 - Early steam engines design in C-K-theory	155
Figure 25 - Generic concept of steam engines	157
Figure 26 - Generic MEMS technology and D design in C-K-theory.....	159
Figure 27 - Principle of superposition.....	164
Figure 28 - Superposition strategy “3DTouch” project exploration.....	166
Figure 29 - Principle of Environment Projection.....	167
Figure 30 - Environment projection strategy “HEATec” project exploration	170
Figure 31 - Principle of Environment Attraction	171
Figure 32 – The strategy of Environment attraction - “GreeNet” project exploration	172
Figure 33 - Generic Technology Design action logic	184
Figure 34 - R&D and Business Units collaboration.....	185
Figure 35 - Cross-application manager expertise	192
Figure 36 - 3DTouch Generic Technology Design action logic	194
Figure 37 - RID model (adapted from (Hatchuel et al, 2001)).....	198
Figure 38 - Bipolar Ph.D projects portfolio (2002 - 2006)	203
Figure 39 - RID and conceptive engineering.....	205
Figure 40 - Results summary.....	217
Figure 41 - Microprocessor Transistor counts - Moore's Law.....	238
Figure 42 - Semiconductor value chain.....	239
Figure 43 - Towards More than Moore (Source: STMicroelectronics).....	241
Figure 44 - MEMS market	246
Figure 45 - BICMOS Platform underlying technologies	251
Figure 46 - BICMOS9MW technology.....	253
	281

Figure 47 - Actors involved in BICM09MW exploration	257
Figure 48 - Market functional compatibilities identification	258
Figure 49 - Technology platform development followed common unknown strategy	259
Figure 50 - Research project classification	264
Figure 51 - Ph.D Thesis portfolio analysis	266
Figure 52 - CK-modeling Etching.....	268
Figure 53 - C-K modeling: gate etching.....	269
Figure 54 - C-K Modeling: Process Control	271
Figure 55 - Transistor size evolution.....	272
Figure 56 - C-K Models based on A, K, E (adapted from (Felk 2011)).....	275
Figure 57 - Wide I/O Thermal Analysis. Source: Corporate Packaging and Automation Stress Analysis lab -ST Agrate.....	277
Figure 58 - Defining exploration area.....	278

List of tables

Table 1 Corresponding papers.....	75
Table 2 - Risk management strategies.....	85
Table 3 - Strategies characterization	95
Table 4 - Strategies comparison.....	96
Table 5 Type of technologies	102
Table 6 - STHORM project characterization	105
Table 7 - Criteria of strategies dominance.....	119
Table 8 – Scenarios definition.....	124
Table 9 - Simulation Results	125
Table 10 Conditions of strategies higher performance.....	126
Table 11 - Genericity and Technology in Design Theories	148
Table 12 - Genericity in design theories.....	150
Table 13 - Strategies of existence domain design	173
Table 14 Multiple Organizational contexts for GTs exploration	187
Table 15 Cross-application manager	191
Table 16 Ph.D projects examples according to RID model.....	265

List of corresponding papers

Paper I	Kokshagina, O., Le Masson, P., Weil, B., CogeZ, P. (2013). Risk management strategies in double unknown: Gambling on markets or designing interdependencies, under review, the R&D Management Journal
Paper II	Kokshagina, O., Hassen A., Le Masson, P., Weil, B., CogeZ, P. (2013) Supporting or killing the design of generic technologies? Towards a new model of business plan – working paper (presented at INFORMS 2012, R&D Management Conference 2014)
Paper III	Kokshagina, O., Le Masson, P., Weil, B., CogeZ, P. 2013. How design theories enable the design of generic technologies: notion of generic concepts and genericity improvement. ICED 2013, August 19-22, Seoul, Korea
Paper IV	Kokshagina, O., Le Masson, P., Weil, B., CogeZ, P. 2013. Portfolio management in high uncertainty: the role of cross-application manager– under review, Creativity and Innovation Management
Paper V	Kokshagina, O., T. Gillier, Le Masson, P., Weil, B., CogeZ, P. 2013. Rethinking the management of ideas contests in high-tech environment: the case of generic technology, Under Review
Paper VI	CogeZ, P., Kokshagina, O., Le Masson, P. & Weil, B. 2013 Industry-Wide Technology Road Mapping in Double Unknown – The Case of the Semiconductor Industry. ICE & IEEE – ITMC Conference Hague

Paper I

**Risk management strategies
in double unknown:
Gambling on markets or
designing interdependencies.**

RISK MANAGEMENT STRATEGIES IN DOUBLE UNKNOWN SITUATIONS (TECHNOLOGY AND MARKET): GAMBLING ON MARKETS OR DESIGNING INTERDEPENDENCIES?

ABSTRACT

What is the best way to manage risks in exploration projects under both technological and market uncertainty? Existing strategies include minimizing technological uncertainties through market pull and market uncertainties through technology push or building an evolutionary path through either a trial-and-learning process or parallel trials. An alternative strategy for addressing unknowns is revealed in this paper based on theoretical analysis and is introduced through an analytical framework that integrates the logic of uncertainty and interdependencies management. This framework is applied to examine a set of exploratory projects at the European semiconductor provider STMicroelectronics. The results demonstrate that a widely deployed trial-and-learning strategy can be risky and that its success depends on the cost of an initial trial. Furthermore, the proposed framework emphasizes a new “common unknown” strategy that allows for the design of a generic technology that is capable of addressing several emerging markets through management and learning interdependencies. The introduced strategy provides a new method of technological platform development in the context of radical innovation. The findings from this study provide important insights into the management of unknown situations and clarify the capability of actors to coordinate exploration when both technologies and markets are unknown.

1 INTRODUCTION

Existing methods for risk management (RM) address specific forms of uncertainty. A project’s chance of success is inversely proportional to the initial technological and market uncertainties. Under low uncertainty, project alternatives can be identified, and uncertainty management consists of making the optimal choice between possible decisions and probable states of nature. RM consists of choosing the most promising technology to address the needs of the more advantageous market by using various criteria such as subjective net present value (NPV), discounted cash flow, and the probability of market emergence. When uncertainty is high, probabilistic approaches are limited because probabilities evolve during the process of exploration and initially cannot be correctly estimated. Under these circumstances, uncertainty reduction approaches are mobilized to reduce uncertainty. A decision maker cannot list all of the possible outcomes, and probabilities cannot be assigned; thus, the project must cope with high uncertainty. Management strategies entail reducing risks by fixing either market or technological objectives. In the case of market pull, risk reduction is based on the identification of particular market needs followed by a suitable technology design (Coombs, 2007). In the case of technology push, RM is based on seeking potential applications for new technological inventions through R&D, production, and sales centers (Linton & Walsh, 2008; Voss, 1984).

Regarding breakthrough innovation projects, firms often confront unknowns in conducting exploration. In this case, the level of uncertainty is so high that neither the level nor the list of risks is known. Defined as unforeseeable uncertainty in research by Loch and colleagues (Loch et al., 2008; Loch, 2006), this situation is characterized by a team's unawareness of an event's existence or its probability of occurring. The difference between unforeseeable uncertainty and chaos is that in a situation of unforeseeable uncertainty, the team begins with reasonable assumptions and goals. In R&D contexts, this scenario often corresponds to a "double unknown" situation in which neither technologies nor markets are known. In a double unknown situation, the nature of risks is unknown: alternatives have not yet been formulated, and thus, their values cannot be determined. Markets are considered unknown because the product features that could make them successful are initially unknown (O'Connor & Rice, 2012). Nevertheless, markets whose *ex ante* probability of existence is rather low can become important *ex post*. Technologies are unknown because a variety of solutions might be designed for certain functions, but none of them exist. In this situation, which emerging markets will succeed and which technologies will be more advantageous remain unclear. Therefore, a "double unknown" situation is considered risky, difficult to control, and expensive, and the appropriate strategy is often to wait until the uncertainties related to certain aspects of the project are reduced.

In such situations, both market pull and technology push are limited because there is no market to pull or technology to push. Although the level of uncertainty is controlled by market pull or technology push to enable project selection (Barclay, 1992; Rothwell, 1992), these strategies do not integrate uncertainty reduction. If uncertainty is higher, then the selection criteria normally take uncertainty into consideration, the resulting technologies or markets remain at the lower level, and no learning occurs. In addition to technology push and market pull, other methods have been proposed to address double unknowns. One of the most advanced strategies involves first predetermining the market trial and then reducing unknowns through learning and product adaptation, a strategy called trial-and-learning (Loch, 2008; Lynn, 1998). By addressing unforeseen uncertainty, this strategy recognizes "unforeseen chance nodes" that can redefine contingent plans during exploration to maximize the

probability of trial success. When the acquired knowledge from learning is used to develop other market alternatives with this strategy, an entirely new platform for novel business opportunities can be created. Thus, technology can become a platform for different contexts, creating interdependencies between several previously independent markets through the process of learning and reuse (Loch et al., 2008). By interdependencies, we refer to the valid use of the same technological elements for different markets. By independent, we mean that the elements contribute to a particular function in their own way (Baldwin & Clark, 2000). In trial-and-learning, the choice of the first trial determines the interdependencies among all the subsequent tests and defines the learning direction. Therefore, the first trial conditions the structure of the interdependencies. Trial success highly depends on the results of this trial; however, no indications are given for how to choose a trial. Because of the high level of uncertainty, trial selection might be misleading, and a risk of path dependency may arise. It is important to stress that the trial-and-learning strategy does not necessarily attempt to address multiple markets; instead, it is often necessary to reduce the scope of trials in order to decrease development costs.

Nevertheless, there exist alternative strategies whose success in double unknown situations is strongly dependent on the design of interdependencies. The literature on the history of economics of technology proposes different forms of interdependencies management (Rosenberg, 1994) through general-purpose technology development. General-purpose or generic technologies (GTs) are defined as technologies or platforms that can address several known markets and that can create new uses that are unanticipated at the time the technology was invented or discovered. Once developed, GTs resolve challenges associated with double unknown exploration. GTs increase exploration benefits, encourage growth, and reduce risk of failure by ensuring technology reuse by various markets. The value of GTs has been demonstrated from historical (Moser & Nicholas, 2004), economic (Bresnahan & Trajtenberg, 1995), and sociological perspectives (Powell, 1987). While GTs are generated from exploration, little research has focused on their design, and they are not generally treated as an RM strategy. In the trial-and-learning strategy, if a trial leads to the design of a platform, multiple

applications could be developed as well. This strategy thus provides a type of evolutionary path for GT development. However, is it the only way?

The historical case of steam engines development helps to illuminate an alternative strategy. Steam engines are recognized as GTs (Rosenberg & Trajtenberg, 2004). A “continuous rotary motion” has been shown to underlie the pervasiveness of steam engines (Frenken & Nuvolari, 2004). The exploration of this technology did not follow an evolutionary path for technology development through trial-and-learning. Historical studies demonstrate that Boulton and Watt intentionally integrated the logic of rotary motion from the water wheel on a steam engine to enable the application of regular and cheap power to all industrial undertakings (Dickinson, 2010). This GT made the design relevant for applications with rotary motion such as spinning mules, power looms, driving machinery in factories, propelling transports, mills and mines, turbines, and steamboats. The GT arose from the specific innovation project that used rotary motion for energy transfer and, in turn, provoked new market explorations. The adopted strategy appears to have fostered market opportunities to a greater extent than it reduced uncertainties for known markets.

More recently, in the semiconductor industry, micro-electro-mechanical systems (MEMS) technology led to the following revolutionary developments across several industries: 1) arrays of micro-mirrors, which enabled digital film projectors; 2) accelerometers such as those in Wii controllers, which changed gaming; and 3) the iPhone 4, which became the first portable consumer device to incorporate a three-axis accelerometer, a three-axis gyroscope, and a three-axis electronic compass. A wide variety of industrial applications deployed in mobile, consumer, medical, automobile, military, and other industries were affected by MEMS and the derivatives of this technology. The development of this technology led to the creation of completely new uses that were unanticipated at its inception (Groen & Walsh, 2013). The pervasiveness and multimarket success of MEMS under double unknowns was achieved because the market and technology design followed neither market pull nor technology push strategies. Did the development follow a trial-and-learning strategy? Here again, the analysis tends to show that the designer in this case intentionally targeted multiple marketing applications to develop GTs and thus maximized the number of relevant markets (Bryzek, 1996).

On the one hand, pursuing the development of a technology that maximizes the number of markets in a double unknown situation seems risky and costly; on the other hand, the historical examples show that winners often succeed by designing GTs and ensuring the existence of multiple markets (Maine & Garnsey, 2006; Youtie et al., 2008). Studies on how to design GTs for as-yet unknown markets are still lacking. This paper addresses this research gap by investigating the possibility of new strategies, which are more effective than trial-and-learning for designing GTs for unknown markets.

To comprehend the situation of double unknown management, this study follows the logic of the phenomena of identification and characterization (Siggelkow, 2007). The study aims to address a research gap arising from the absence of strategies when technologies and markets are still unknown. By extending the RM framework to the trial-and-learning strategy and platform management, new ways of addressing unknowns and interdependencies related to double technological and market unknowns might be considered. This paper is organized as follows. First, the paper presents a characterization and identification of existing models in the risk and interdependency management literature (Section 2). As a result, a comparative framework is formulated to determine the research gap that is not covered by the well-known strategies. Second, the paper defines the descriptors that help to investigate abnormal strategies of technology and market matching and to characterize their performance (Section 3). Third, these descriptors are applied to empirical cases of advanced technology development in the semiconductor industry in order to identify anomalies that do not follow classical RM strategies. By analyzing two project portfolios, this study highlights situations in which a trial-and-learning strategy leads to risky exploration and inefficient learning interdependencies management. Market intuition can be misleading and can result in failure. Conversely, the proposed “common unknown” strategy performs better when the creation of interdependencies in multimarket, multitechnological environments is targeted. The common unknown strategy provides a new way to increase the generic character of GTs when designing GTs in double unknown situations.

2 LITERATURE REVIEW AND PROBLEM FORMULATION

In this section, we compare existing RM strategies and show that they can be classified according to three primary issues: 1) the assumption of either independency or interdependency; 2) the interdependencies that are known or unknown; and 3) the creation of interdependencies through either emergence or design.

2.1 Independencies and interdependencies in RM strategies

When uncertainty is low, when the possible alternatives are known, and when their values can be determined, risk minimization at the level of a singular project occurs (the S_1 strategy). S_1 provides methods to help decision makers cope with uncertainty (Chapman, 1990; Lipshitz & Strauss, 1997). RM includes methods to either increase the probability that an event will occur or increase that event's impact on the project (Petit & Hobbs, 2010). These strategies minimize unknowns by selecting less uncertain projects that are predicted *a priori* to have a higher probability of occurrence. The level of uncertainty allows the prioritization of corresponding markets and the selection of a more promising technological alternative, which results in maximal economic performance (*i.e.*, using expected NPV, discount cash flow). RM focuses on addressing uncertainties associated with project feasibility, the market, technology, and financial and organizational aspects (Ward & Chapman, 2003). In S_1 , risks should be managed by project leaders who are capable of defining and calculating information based on the probability of success. Thus, this strategy seeks to identify favorable technology T_i -market M_i couples from the list of predefined candidates. The probability of the success of S_1 is equivalent to the probability of the chosen technology-market couple:

$$p(S_1) = \max_{i=1}^n (p(T_i, M_i)), \text{ where } n \text{ is the number of considered alternatives.}$$

When the uncertainties are too high to select the most promising technology-market couple and when complexity is high, selectionism can be used. Selectionism (S_2) consists of launching multiple trials in parallel and then selecting the most favorable approach (Lenfle & Loch, 2010; Loch et al., 2008). S_2 is often considered to be more expensive and is affordable to use for large problems. S_2 is less time consuming and more suitable for market-driven approaches that need faster response. The managerial

framework for S_2 shares the same characteristics as the S_1 strategy but is applied to several projects, allowing for a choice when uncertainties are reduced. In this case, the aim is to select a T_i - M_i couple with a higher probability from the launched set of trials N : $p(S_2) = 1 - \prod_{i=1}^n p(M_i T_i, M_2 T_2, \dots, M_N T_N)$.

Unlike S_1 , S_2 consider projects independently without considering the influence of project dependencies on the overall portfolio performance and aims to select a more valuable alternative. Nevertheless, the importance of evaluating projects in relation to each other and the importance of interdependencies management are stressed (Elmqvist & Le Masson, 2009). The third family of strategies attempts to account for interdependencies between projects. How are interdependencies considered?

2.2 Management in cases of known and unknown interdependencies

When the structure of interdependencies is known, a platform strategy (S_3) can be used. For instance, in the case of modularization, Baldwin and Clark (1997) propose that firms build market options while reusing the platform core and minimizing the risks of platform acceptance. Platforms represent the core of a technological system and must be interdependent with other parts of the system (Gawer & Cusumano, 2008). Baldwin and Clark (2006) demonstrate how a known platform can generate several options. They show that a system's total economic value can be expressed as the sum of a minimal system value V (platform core) plus the incremental value V_i added to the performance of each of the modules $V_0 + \sum V_i^N$. The system's expected value is the aggregated portfolio profitability. Each module attempts to address different market derivatives in order to maximize the total economic value of the portfolio. The cost of portfolio exploration is predefined by the R&D budget. The portfolio manager must know the platform well to identify derivatives. The information needed for a platform-driven strategy is based on the existence of the platform core and the cost of developing each option. In this case, the technological platform can be used in several markets, and value distributions can be estimated. The probability of the success of S_3 is defined by the probability of the success of all of the market modules M_i made accessible by platform T_0 :

$p(S_3) = 1 - (1 - p_{M_1 T_1 | T_0})(1 - p_{M_2 T_2 | T_0}) \dots (1 - p_{M_N T_N | T_0})$, where N is the number of market options. In S_3 , the platform is given. An option can be selected among different available platforms k , and the goal is to identify a T_0 that maximizes system value through the creation of interdependencies between platform and market options. The platform with higher probability is chosen: $p(T_0) = \max_{k=1}^n T_k$. The platform is considered to be independent from specific market needs but still provides access to them by creating interdependencies through complementary market exploration. To have potential as a platform, a technology or a product must perform a function that is essential to a technological system and that solves a business problem for many firms in the industry (Gawer & Cusumano, 2008).

S_3 is not usually related to RM, but it gives an efficient mechanism to reduce uncertainty. In S_3 , the reasoning is based not on technology-market success but on a technological platform's ability to address multiple markets. Nevertheless, contrary to the decision-making approaches, the effect of learning when dealing with platforms is difficult to evaluate. With double unknowns, which dependencies must be created to increase genericity and to develop a successful platform remain unclear. Criteria for platform success must be established.

S_1 , S_2 , and S_3 address various uncertainties (primarily variation and foreseeable uncertainties, according to De Meyer et al. and Pich et al. (De Meyer et al., 2002; Pich et al., 2002)). Notably, these strategies substantially differ from each other because they do not address the same objects (projects versus platforms), because they are not managed by the same actors (project managers versus platform leaders), and because they are not evaluated with the same criteria (success of a single project versus the aggregated successes of multiple projects). S_1 and S_2 treat projects independently; S_3 is based on the management of known interdependencies. With respect to highly uncertain situations, such as unforeseeable uncertainties or chaos (Pich, 2002), the use of S_1 might be impossible because all projects are too risky. One might still formulate hypotheses based on estimated probabilities of success, but this hypothesizing would change significantly by the end of the project. The use of S_3 strategy might be impossible because no platform may be available to use several times with limited costs. In addition, the existing literature on product platforms assumes that the platform leader

understands the final use of products and that the platform leader is able to develop these new products (Gawer, 2010). This assumption is certainly invalid in the context of radical innovation when the platform core, market options, and thus interdependencies are unknown.

When confronting dynamic environments (Eisenhardt & Brown, 1998), periods of market booms and busts (Zilber, 2007), and the emergence of disruptive technologies (Christensen, 1997), managers' ability to make real-time decisions based on known categories of problems and considered alternatives is limited. Firms are less able to rely on existing knowledge in such high-uncertainty situations than in established markets (O'Connor, 2008; Paulson et al., 2007). The structure of interdependencies is unknown *a priori*, and uncertainties are associated with radical innovation; thus, knowledge creation is required in novel contexts. Below, we analyze strategies for interdependencies management in situation with high uncertainty.

2.3 Emergent or intentionally driven strategies for interdependencies management in double unknown situations

Interdependencies can be created through either discovery or more intentional approaches. In certain strategies, interdependencies management consists of accumulated learning. A trial-and-learning approach (Loch et al., 2008; Lynn, 1998) is based on iterative, selected trials that are coupled with flexible changes in a course of action. This strategy aims to transform the initial situation of high uncertainty by formulating the problem and integrating knowledge. The trials serve mostly to decrease uncertainties and to increase the probability of success. They can decrease both market and technological uncertainties and may open new market possibilities; this strategy is adapted to the double unknown context. This sequential development of trial projects and associated learning enables the acquisition of expertise through an exploration project. The strategy corresponds to the selection and consequent generalization of a particular project to develop additional applications (i.e., the trial-and-learning strategy— SU_1).

Under certain restrictions, this type of strategy corresponds to a real options approach and aims to exploit flexibility in sequential development (Kogut & Kulatilaka, 2004). Following an initial investment in a trial project, managers gather new information and can reorient and change the scope

of that project (Huchzermeier & Loch, 2001). The knowledge that is produced in the first option enables managers to create new projects, as in SU_1 . SU_1 enables managers to organize exploration in situations involving unknowns by determining and subsequently developing trials. The primary goal of learning is to increase the probability of market existence and technology feasibility. When reuse is considered, the developed technology can serve as a platform for other market applications. Empirically, Loch et al. (2008) apply the probe-and-learn method to the case of Escend Technology, a start-up. In this case, management teams systematically explored unknowns by making trial proposals for the market and investigated the nature of both markets and technologies. This process is generally shaped as an iterative process of successive approximation in which the design experiment phase is critical because it sets the boundaries and direction of exploration (Loch et al., 2011).

A hybrid strategy combining trial-and-learning with selectionism is considered when a project is subject to high complexity and unknowns (Lenfle, 2011). As indicated previously, with selectionism, several trials are launched to select the best solution. In this default strategy, the learning is not incorporated into the process. By combining selectionism with trial-and-learning, a more efficient way to acquire learning and to design interdependencies can be achieved. However, this strategy does not indicate how to define the set of trials in selectionism or how to incorporate learning from the different trials to determine a potential common core. With respect to GT design, this strategy remains heavily dependent on the initial trial selection, and path dependency remains a risk. Therefore, the analysis in this paper is limited to the independent examination of trial-and-learning and selectionism. In SU_1 , the probability of success is heavily dependent on the choice of the initial market trial M_0 with probability p_0 , which can be increased through the learning process and the development of technology T_0 . When this strategy considers the reuse of the accumulated knowledge to develop other market alternatives, the success of the other markets heavily depends on the results of the trial. The joint probability of success can be defined as

$$p(SU_1) = 1 - p_{M_0 T_0} (1 - p_{M_1 T_1 | M_0 T_0}) (1 - p_{M_2 T_2 | M_0 T_0}) \dots (1 - p_{M_N T_N | M_{0..N} T_{0..N}}).$$

In the case of reuse, interdependencies are managed through consequent learning. This strategy aims not to increase the number of markets N directly but to increase the probability of the success of at

least one market. This strategy is based not on the T_0 that addresses several markets M_i as with S_3 but on a complex relation between multiple $M_i - T_i$ couples.

A more intentional design-driven approach can be considered when the goal is not to choose the most powerful alternative but to generate options and to transform local possibilities into new opportunities through collective reflection. More generally, one can deduce a strategy of designing a GT, T_0^* , that is capable of addressing multiple emerging markets M_i . Is it possible to identify a strategy of technological development that maximizes the number of markets that technology will address or create (*max N*)? If one can design a technological platform T_0^* , which can address several market applications $M_1...M_N$, the probability of success is as follows:

$p(SU_2) = 1 - p_{T_0^*}(1 - p_{M_1|T_0^*})(1 - p_{M_2|T_0^*})... (1 - p_{M_N|T_0^*})$. Once a T_0^* is developed, the probability of success is high. For instance, consider 10 emerging markets with a 15% probability of existence. The probability of success for each of these markets is low, and following the classical logic of decision making, these markets will not be considered. However, if a platform attempts to address 10 markets, the probability of the emergence of at least one market is $1 - (1 - 0.15)^{10} = 0.803$, which is high for unknown exploration. The aim of this paper is to identify a new strategy for double unknown management that facilitates GT design for several emerging markets.

2.4 Comparative framework—unknown and interdependencies management

To summarize, various RM strategies address different levels of uncertainty involving known and unknown structures of interdependencies. The deduced comparative framework suggests the following strategies (*fig. 1*):

1. For independent project alternatives
 - a. when the level of uncertainty is **low**, *risk minimization at the level of projects* (S_1) can be used to prioritize different alternatives and select one;
 - b. when the level of uncertainty is **high**, *selectionism type* (S_2) can be used to select the most promising solution at the beginning of exploration.
2. For interdependent projects
 - a. with an existing platform core

- i. Platform driven (S_3) strategies can be used for risk and interdependencies management by reusing an existing platform core to develop various market options.
- b. with an unknown platform
 - i. Trial-and-learning (SU_1) or a combination of trial-and-learning and selectionism can be used to build a trial project to develop a platform core and consequent options;
 - ii. A **research gap** exists regarding the appropriate strategy to build a GT for multiple emerging markets.

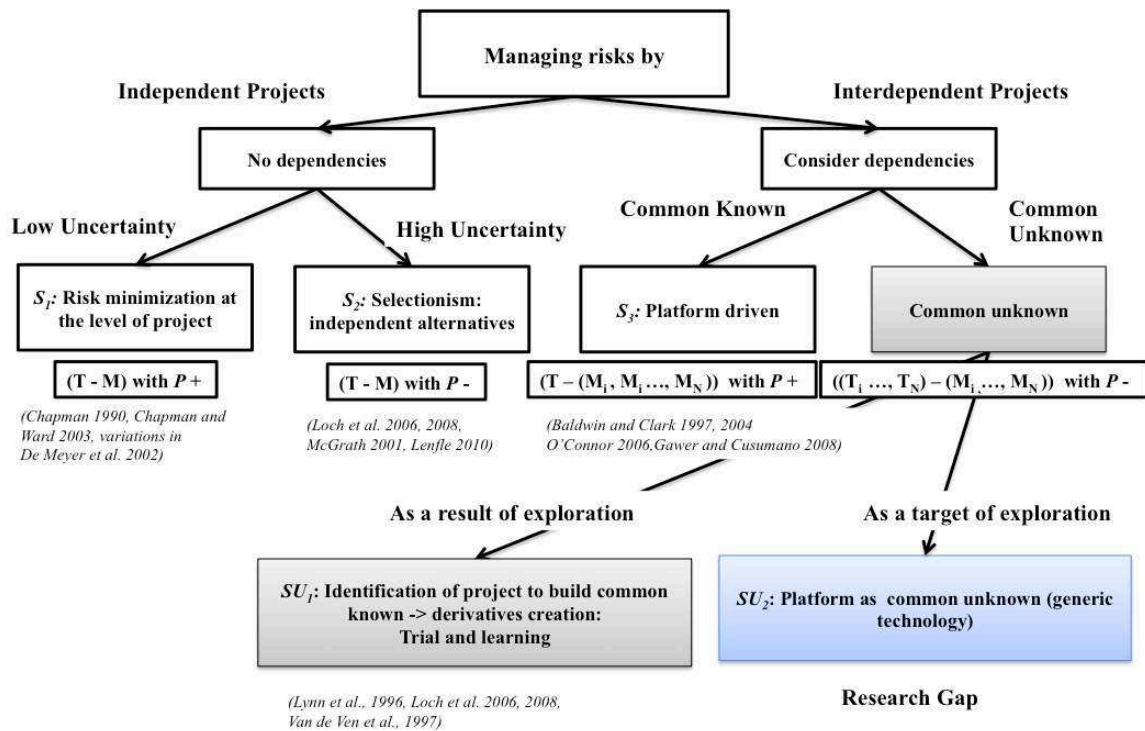

Fig. 1 Comparative framework—RM strategies

The review shows that SU_1 is a pertinent strategy for double unknown management but that other strategies may be identified. Although SU_1 is considered highly advantageous, its first step of trial selection appears to be critical to the success of the strategy. If the trial does not lead to a successful market and if the developed technology is too specific to be reused in other markets, the strategy leads to failure. In a turbulent and complex environment with multiple market signals in particular, SU_1 can

provide misleading information and fail to facilitate the integration of relevant learning. The performance of SU_1 in double unknown situations must be determined. Moreover, what could be an intentional strategy to generate options and develop GTs (SU_2)? Can such a strategy be more effective than SU_1 in double unknown situations?

These strategies are not clearly identifiable because their reasoning is often constrained by classical market- or technology-driven strategies. Therefore, to address the research gap, the mechanism for observing and revealing the abnormal strategies in double unknown must be developed.

The goal of this study is to (1) identify an intentional strategy to generate options and develop GTs (SU_2) and (2) to compare the performance of RM strategies in double unknown situations through the nature of their risks and development costs.

3 RESEARCH APPROACH

This study aims to characterize a new phenomenon that the literature has not yet discussed. Thus, a case study approach is chosen (Siggelkow, 2007; Yin, 2003). The comparative framework allows existing strategies for double unknown situations to be considered and reveals possible alternative strategies for GT design. To fill the research gap, an analytical framework for data analysis is first proposed. Second, a set of exploratory projects at the European semiconductor firm STMicroelectronics is analyzed to reveal the abnormal strategies of technology and market matching by using the elaborated framework and to characterize the performance of those strategies.

3.1 Unit of analysis—analytical framework of double unknown characterization

How can one organize and conduct exploration when both technologies and markets are unknown? Double unknown markets are considered unknown because their volumes and values are unknown and because their probability distributions are volatile (Oriani & Sobrero, 2008; Perlitz et al., 1999). By examining developed technologies and obtained markets through longitudinal studies *ex post*, only successful markets that emerged through exploration are revealed. Thus, *ex post*-only strategies such as trial-and-learning are easy to reveal. Identifying more intentional strategies that address markets

before transactions is difficult; therefore, to discover an anomaly in the design of interdependencies, a new data analysis instrument is needed.

As shown by the literature review, to analyze strategies that address the creation of interdependencies, we must detect and examine how interdependencies between technologies (T) and markets (M) are designed. An instrument that avoids direct consideration of T - M couples and that enables us to identify the emergence of new T and M is required.

In this respect, markets must be described independently from products and technologies. This issue has long been addressed in consumer behavior theory (Lancaster, 1966). Since the 1960s, goods have been characterized by functions. New market applications can be assimilated as a set of functions F_1, F_2, \dots, F_n addressed by goods. Each market M_i can be described as the set of functional elements F_1, F_2, \dots, F_n that it targets. Similarly, technologies must be described independently of products and markets. In the engineering design and technology management literature (Akao, 1990), the value of technology is assimilated to functions F_1, F_2, \dots, F_n addressed by each technology T_i . To identify a technology for a chosen market means precisely to address its functions. Technology is considered advantageous if it addresses powerful functions that result in market success.

To understand the logic of interdependencies in unknown situations, the notion of functions is used to verify and characterize technologies by the functions that they address and to verify and characterize the markets by the functions that they seek. The notion of functions is used to attract stakeholders and markets to technological concepts without the necessary technology description. According to the functional analysis of systematic design, Suh (1990) notes that when the goal is to create a design solution that does not yet exist, functions must be defined in a “solution-neutral” environment without interaction with the physical domain. Functions address an intermediate area between applications when designers are able to work on still unknown technologies and markets without necessarily determining them.

For instance, technology T_k can address multiple functions F_i and thus all markets M_l requiring the subset of these functions. Conversely, a single market M_k can be addressed by several technologies T_l . This exploration can be viewed as a matching of potential functions that markets seek and that

technologies accomplish. Following the definition of technology push, predetermined technology T_k can address multiple functions and thus all markets M_i that require the subset of these functions. Successfully developed technology T_k pushes solutions to search for promising markets M_l . Conversely, needs that are predefined by markets M_k are pulled to discover better technology (in terms of performance) T_l .

In a double unknown situation, there might exist T_i that address the series of F_j and some known M_j and undefined M_i that seek the series of F_i (fig. 2). Each new subset of functions generated from the combination of F_j and F_i can be viewed either as unknown markets with very low probability or as unknown technologies. A new T - M couple exists when a new technology addresses unrelated subsets of functions F_l and when this subset corresponds to a new realized market. T - M mapping through functions helps managers to verify the correspondence between technologies and markets.

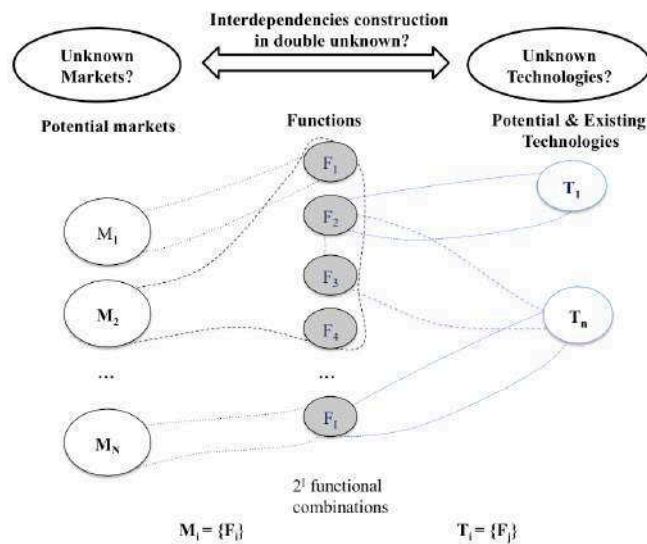

Fig. 2 Analytical framework for double unknown characterization

In the case of SU_l , the goal is to identify a market trial M_i that has a higher probability of success. Despite the high level of uncertainty, the aim is to prescribe subjective probabilities to define a trial project. For example, there is a volatile market M_0 (which is still uncertain but has higher potential than the other markets) that seeks the three key functions $F_1, F_2,$ and F_3 (see fig. 3). Exploration consists of designing a T_0 to address $F_1, F_2,$ and F_3 and to increase the probability of trial existence P_0 . Once T_0 is developed, M_l might be realized by integrating a new function F_4 and thus by extending T_0 .

to T_{01} . Technology T_0 is progressively extended to create a platform that addresses M_0, M_1 . The platform establishes a common core T_0 that addresses essential functions, which is a common need for several players (Gawer & Cusumano, 2008).

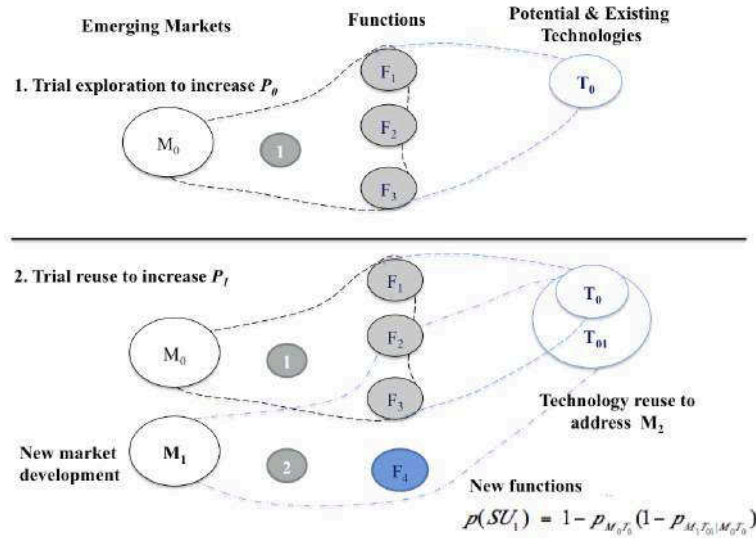

Fig. 3 Trial-and-learning strategy representation

The proposed analytical framework for data analysis allows us to define the SU_1 pattern for double unknown management. Each new market exploration is based on technology advancement that is developed through a trial phase. New markets are created through trials by extending the list of functions pulled by markets.

The analytical framework remains sufficiently generic to imagine a variety of strategies to link the set of functions that markets seek and that technologies address. How can these strategies be evaluated based on the cost, nature of risks, and organizational implications? The existence and relevance of these strategies to double unknown management must be tested on empirical cases of advanced technology exploration, and their performance must be based on 1) the nature of the risks to be managed and 2) the development costs required to deploy the strategy.

3.2 Field relevance

Where can the anomaly be identified? In the semiconductor industry, *a priori* double unknown situations are not rare. The relevance of the semiconductor industry for exploring breakthrough innovations has been shown by various researchers (Cohen & Levinthal, 1989; Eisenhardt, 1989b).

The strong competition and quickly changing environments that characterize the semiconductor industry allow firms to explore both new technologies and new functionalities and to create new products and markets while coping with unknowns. The pace of innovation in the semiconductor industry is extremely high, and to innovate successfully, companies must incorporate both market and technological dimensions, which requires double unknown exploration. Market volatility makes it impossible to estimate costs and volumes by using traditional techniques. The unknown character of technologies is predefined by the variety of technological possibilities driven by scientific discoveries, by their disruptive nature, and by the lack of feasibility and standards to clearly evaluate advancements. For example, because of these changes, the International Technology Roadmap for Semiconductors (ITRS) community created a new technology working group to include significant parts of the “More-than-Moore” (MtM) domain in its work and to pursue roadmap exploration in double unknown situations. The MtM trend is characterized by the functional diversification of semiconductor-based devices and technologies that cover a wide range of fields and that aim for extensive knowledge-creation methods in science-based environments (Le Masson et al., 2012; Robinson et al., 2012).

Moreover, the heavily research-driven and disruptive semiconductor industry offers an emblematic example of the existence of GTs (Bresnahan & Trajtenberg, 1995); thus, this industry is particularly relevant for exploring GT design strategies in double unknown situations. Highly innovative and research driven, the European semiconductor firm STMicroelectronics (hereinafter ST) is a relevant case company to address our research questions. ST’s work is conducted in advanced R&D groups that do not follow the MtM trend. The company faces a high level of uncertainty regarding both technology and future markets. For instance, at ST, there are successful examples of GTs, including MEMS and silicon-germanium BiCMOS technologies.

3.3 Data collection and analysis

The empirical study was designed as a collaborative case study (Eisenhardt, 1989a; Yin, 2003). We aimed to test existing hypotheses and to formulate new ones. To identify anomalies, the portfolio of advanced research projects (more than 400 projects clustered into 14 research groups) within ST was

analyzed. An anomaly can be identified when technology is developed independently from the identified markets, which signifies that none of the primarily identified markets is considered promising. The portfolio of research projects was chosen because of varied technological exploration and potentially varied application areas, which provide an important basis for testing new strategies for creating interdependencies between technology and markets. Clusters were primarily established according to the axis of technological development. Each cluster comprises a portfolio of collaborative R&D projects, PhD theses, and even business unit development projects.

The data were collected over an 8-month period from November 2010 through June 2011. For this study, the primary sources of data were regular, frequent semistructured interviews. We interviewed specialists participating in or leading technology development within advanced R&D technology and design groups, business units, and some of the associated external research centers, as well as former PhD students. Approximately 50 interviews were conducted over 8 months. In addition to data collection through interviews, secondary sources were reviewed. These supporting documents included European project reports, presentations, thesis manuscripts, project descriptions, and mail documents. The internal validity and reliability of the chosen methodology were achieved through triangulation of the project documentation and case study examinations. The triangulation was continued during derived analysis and feedback seminar sessions with company managers to discuss and test the validity of our hypothesis. This procedure enabled the continuous involvement of ST employees according to the guidelines of engaged scholarship (Van de Ven, 2007) and collaborative research (Shani et al., 2008).

The analytical model introduced in Section 3.1 was used to identify abnormal strategies within these projects. The first project portfolio screening allowed us to identify four cases (approximately 40 projects in 4 portfolios) and two of them were examined in further detail. The model allowed us to filter out projects that create interdependencies and that evolve over time. In the first case, trial-and-learning paradoxically resulted in the failure of technological development; the second case involved a portfolio that was difficult to interpret but that led to successful development. This case allowed us

to introduce a new strategy for GT design, and the comparison of strategies helped us to understand under which conditions the proposed strategy is superior to trial-and-learning.

The first case study involved the development of the advanced bulk acoustic wave (BAW) technology targeting the mobile consumer market. The development of this technology was initially managed as an exploration project to increase the probability of success in the selected market. The developed technology attracted the interest of another market, and the team attempted to reuse its accumulated knowledge for this market. However, by progressively extending the list of functions for technology development after the trial-and-learning process, the team was not able to successfully introduce the solution to the targeted markets. This case helps to elucidate the risks of the trial-and-learning strategy under situations of uncertainty.

The second case study was selected from the semiconductor industry, where a high-frequency bipolar transistor with an ameliorated back-end (Chevalier, 2007) was designed to address all environment constraints and to provide several market applications with a low adaptation cost. In this case, while reusing existing technological blocks such as complementary metal oxide semiconductors (CMOS) and bipolar transistors, the team succeeded in introducing the new technology for use in several emerging applications. Our analysis first showed that the case was managed using neither a project- nor a platform-based strategy. Moreover, the team did not account for an exploration project to create a platform core. The team leader designed a platform exploration by identifying unknowns for several emerging markets and determining a potential common challenge for those markets. Instead of fixing the set of applications and organizing its exploration by minimizing the resources spent, the team inverted its reasoning by fixing the resources and maximizing the scope of considered applications. Surprisingly, although the developed technology initially did not address any of the markets, it succeeded in 5 of them. This case was used to formulate the common unknown strategy.

4 DOUBLE UNKNOWN: TECHNOLOGY-MARKET DEVELOPMENT

4.1 Description of the case studies within the proposed analytical framework

4.1.1 Trial-and-learning (SU_1): Integrated radio frequency front-end module for mobile phones

SU_1 was investigated through a case study of advanced technology development at ST involving BAW for front-end module (FEM). The initially targeted market was mobile consumer M_1 , and a solution was sought for the emerging radio frequency FEM filter application. The common discrete filter solution was a surface acoustic wave (SAW) T_1 filter that ensured F_1 and F_2 but that did not ensure integration into FEM F_3 or miniaturization F_4 (fig. 4). The team aimed to develop a solution for predetermined market M_1 by integrating filters and duplexers F_3 directly on the board to substantially reduce space F_4 and therefore the cost of solution F_1 . First, the team pursued a market-driven approach to develop a new solution for promising consumer M_1 . Based on key functional requirements F_i for future applications, the research team identified BAW technology T_2 that enabled the acquisition of the integrated F_3 , a multisynchronized FEM, which significantly reduced the size (to at least 4 times smaller than the commonly deployed SAW solution) F_4 and allowed for low-frequency F_2 . The research group developed a solution according to a problem that was initially formulated in response to a particular client demand with an estimated subjective probability of success $p(M_1, T_2)$. However, the required investment was much higher than the initially expected investment because special equipment (*i.e.*, trimmer machines) needed to be developed and installed at a factory and because the initially identified market was not ready to pay for the solution.

The lack of interdependency with the market motivated the R&D group to continue exploring the technological potential and researching how to reuse the accumulated knowledge. The newly developed T_2 attracted the interest of a time-reference application M_2 , and the team attempted to reuse the accumulated knowledge to develop an integrated synchronized time-reference application. The BAW oscillator technology was smaller than the existing Quartz-type T_3 oscillator and enabled devices on FEM F_6 to be multisynchronized. Consequently, a technological platform T_2 was successfully created through the trial-and-learning process. However, in progressively extending the

list of functions addressed by technology development following SU_1 , they did not successfully introduce the solution to the targeted markets.

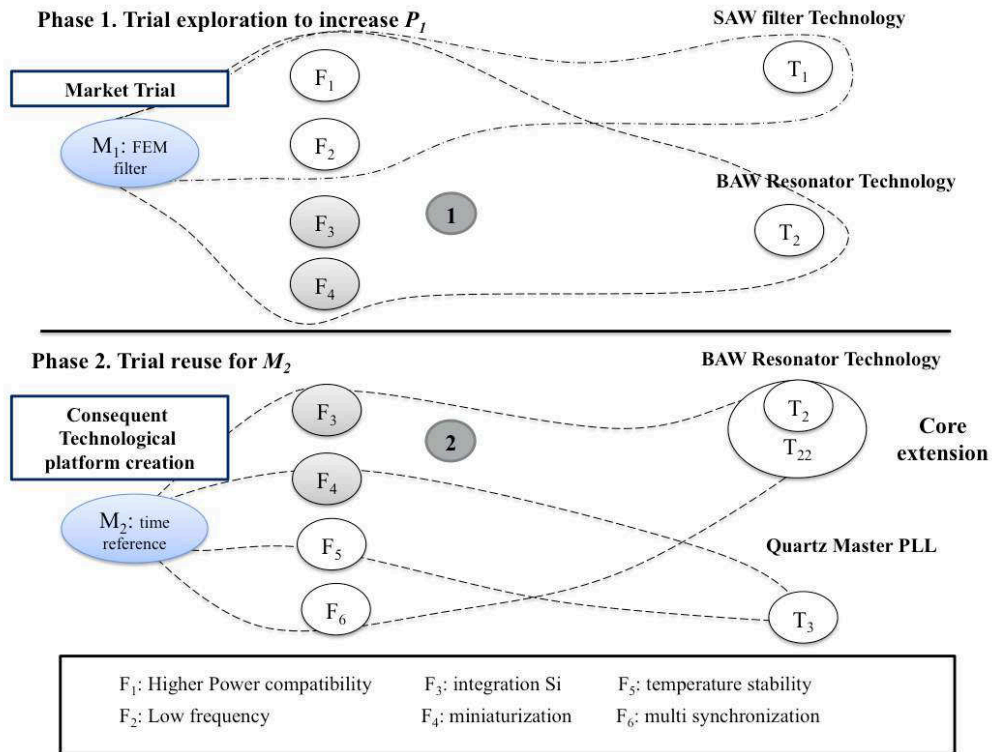

Fig. 4 BAW technology development

Despite its attractive functionality, the BAW solution was unable to achieve temperature stability comparable to that of the existing Quartz solution F_5 and failed to fulfill its promising application. Unknowns addressed in the first phase of technology development were poorly reused in the second phase; they were suitable only for the initially identified filter solution (*fig. 4*). The analytical framework reveals that the BAW development followed SU_1 in which the interdependencies were created on T_2 . This case demonstrates that uncontrolled residual risks arise based on trial selection. T_2 was not easily reusable for identified M_2 because the probability of its success depends on the results of the first step $1 - p_{M_1 T_2} (1 - p_{M_2 T_{22} | M_1 T_2})$. The success of SU_1 heavily depends on the flexibility of the designed technology and the choice of the initial market. However, because of high market uncertainty, the initial trial selection could provide misleading results. This strategy could result in a rigid common core when knowledge from exploration is not applied to relevant market areas during

the evolutionary path. With SU_1 , the risk arises that the exploration area that is selected at the outset is too narrow.

4.1.2 Common unknown strategy (SU_2): Bipolar CMOS platform development for mmWave applications (BiCMOSMW)

The purpose of Si-based BiCMOSMW technology T_2 is to combine the advantages of two types of transistors: the bipolar transistor T_1 for lower consumption F_1 , higher switching speed F_2 , higher gain, better noise performance and the CMOS transistor T_3 for integration F_4 , complex digital signal treatment F_5 , higher density, better performance for logic operations F_6 , power speed blocks, and control functions (*fig. 5*). Until 2002, the group was working on optimizing bipolar transistor T_1 for analog signal processing to meet the emerging 60 GHz standards. No particular client demand was apparent at the project outset. Initially, the elaborated technology did not directly address any markets. Moreover, the technology was neither developed randomly nor required for existing markets.

The exploration team attempted to establish a complete list of emerging markets that might be attracted by future technological exploration. Several potential applications were identified: automotive radar M_1 , optical communications M_2 , fast download application using emerging 60 GHz standards M_3 , hard-disk drive applications M_4 , and standard linear products M_5 . After identifying different functions related to each market, the team attempted to determine the functions that each market sought to address and aimed to define the functions that were common to all of them (F_2 , F_4 , F_5 , and F_6 in *fig. 5*).

Moreover, they listed the already available technologies based on T_1 and T_2 and the functions that each technology could address. It is important to stress that none of these technologies directly addressed any of the identified markets. By adopting the trial-and-learning strategy, the research team could have worked on extension T_1 or T_2 by following the process of consequent learning to address the identified markets. Instead, they compared different markets to determine the similar functions that each market sought and the common needs that remained to be developed—the “common unknown”. The defined common unknown concept could facilitate the design of GTs for potential markets. The team did not target any particular market from the list but aimed to maximize the

number of functions that the future technology could address by reusing existing technological blocks based on T_1 and T_2 .

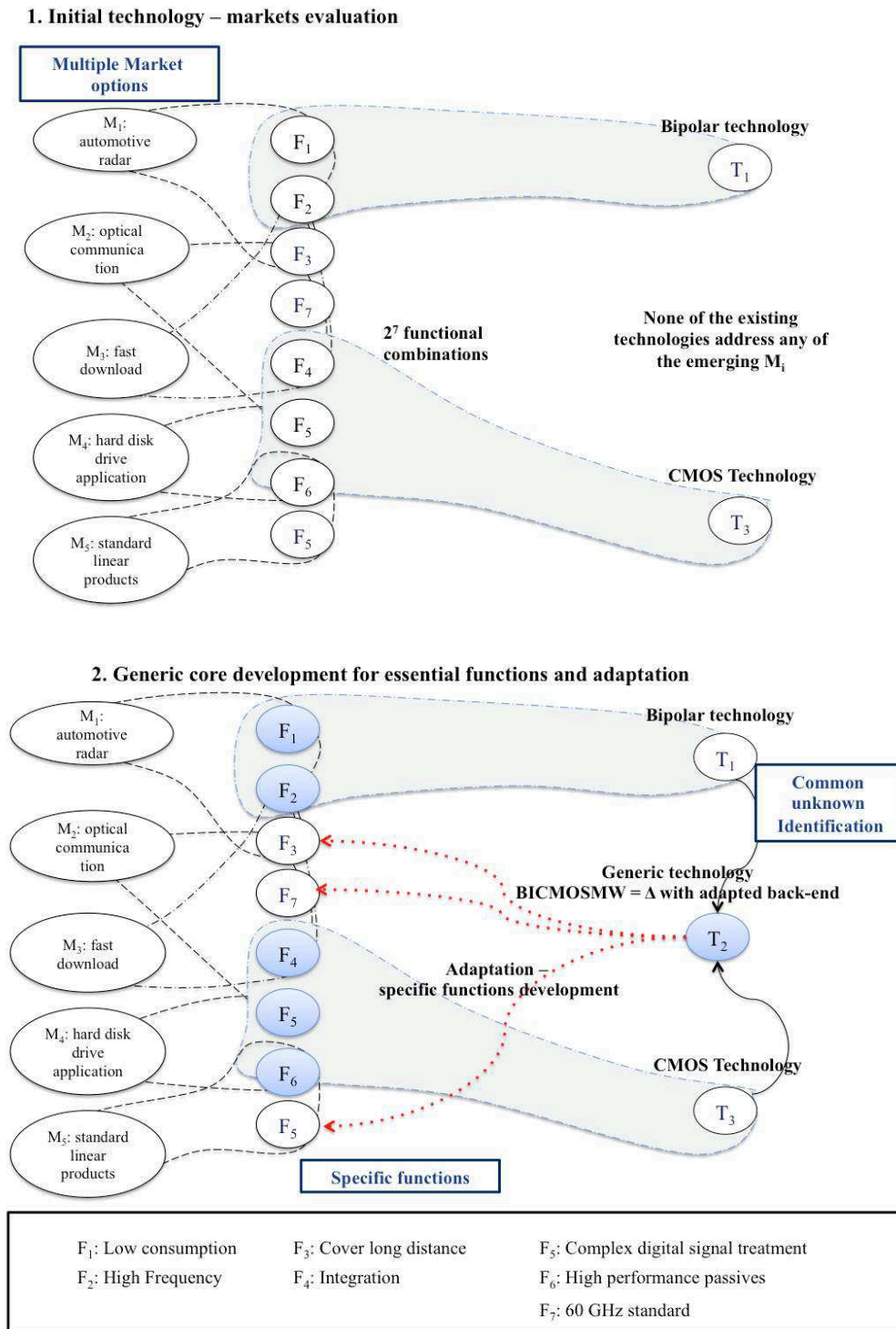

Fig. 5 BiCMOSMW technology development

The exploration area was called “Wi-Fi for airport connectivity” because it integrated all the functions that are needed for high connectivity and high density. The common unknown was determined to be learning dependencies that could connect different functions and technologies. In this common unknown strategy SU_2 , the resulting technological core was ultimately used to develop complementary modules that addressed specific functions of each market. All the emerging markets were addressed. Thus, the issue was not to address one trial or one more promising market but to address several of them—*i.e.*, markets that made use of the common unknown. Finally, a technological platform was designed by using existing technological capabilities, and complementary modules were developed to address all the predefined markets. This example shows that in a double unknown situation, firms must not only understand the commonality of functions to address but also have a notion of their technological capabilities.

Because of the volatility of probability and value distributions, reasoning based on the probability of market existence and expected project value is risky and does not provide relevant information to select a dominant application. While considering the 5 applications identified for T_2 , assume that the probability of the existence of each market is less than 20%. In this case, the purpose was not to determine the probability of the emergence of a particular market but to determine the probability of the emergence of at least one market, leading to the following equation: $1-(1-0.2)^5 \sim 0.7$. Thus, if a number of potentially interdependent markets exist and if a technology can address these interdependencies, common unknown management can be successful in double unknown situations. Through technology reuse to develop remaining F_3 , F_5 , and F_7 , the developed platform addressed applications such as automotive radar, optical communication, wireless fast download systems, high-speed instrumentation, and noninvasive imaging. The common unknown concept allowed the team to explore common functions that address several markets with their fixed R&D budget.

In this case, the development was primarily guided by a technology line manager who was responsible for coordinating business units and R&D groups for researching and commercializing the assigned technology. The manager’s technological and market competences made him particularly

suitable for determining potential markets and related technological solutions and for guiding the exploration team.

4.2. Case analysis and comparison

4.2.1 Common unknown strategy

SU_1 enables the evolution of consequent functions through trial exploration: interdependencies management is based on the consequent advancement of the trial project. In the case of SU_2 , there is an evolution of functions that emerging technologies can address and that markets seek. Interdependencies are created directly among various market alternatives. This strategy does not start with a trial project to create a platform core (as in SU_1); instead, various options for design platforms are determined in double unknown situations. The future platform is designed to ensure exploration. Exploration is highly challenging in a double unknown situation because neither the options nor the platform core are known *a priori*. In the early stages of innovation exploration, a concept can be defined based on the interdependencies among future market derivatives.

SU_2 is based on the design of a technological platform that accounts for compatible functions and consists in the design of dependencies based on technological anticipation and simultaneous multimarket analysis.

Drawing on the case of BiCMOSMW technology development, this strategy consists of the following steps:

1. List the emerging market applications M_1, M_2, \dots, M_N , and identify key functional F_1, F_2, \dots, F_k elements that each application targets. Identify the essential functions F_2, F_3 , and F_4 for different markets, and design a GT T_0^* to address these functions by mobilizing the existing technological capabilities T_1, T_2 (fig. 6). Paradoxically, T_0^* is of higher probability but does not correspond to any of the identified markets. The strategy thus differs from SU_1 , in which T_0 can have a lower probability but is related to M_0 with a higher probability.
2. Reuse a common technology T_0^* to address the remaining functions F_1, \dots, F_k to fulfill considered or apparent market needs.

In SU_2 , highly competent actors are required for reasoning through alternatives in a double unknown situation: these actors must be capable of identifying accessible knowledge based on future clients and common functions to determine a common unknown. The condition for the set of emerging markets to succeed is the common interest among them—*i.e.*, the common core that is an object of RM. Thus, the criterion that can be used for common unknown management is the probability of the emergence of at least one market. To succeed, one must identify an accessible common unknown that creates interdependencies between emerging markets by using few resources.

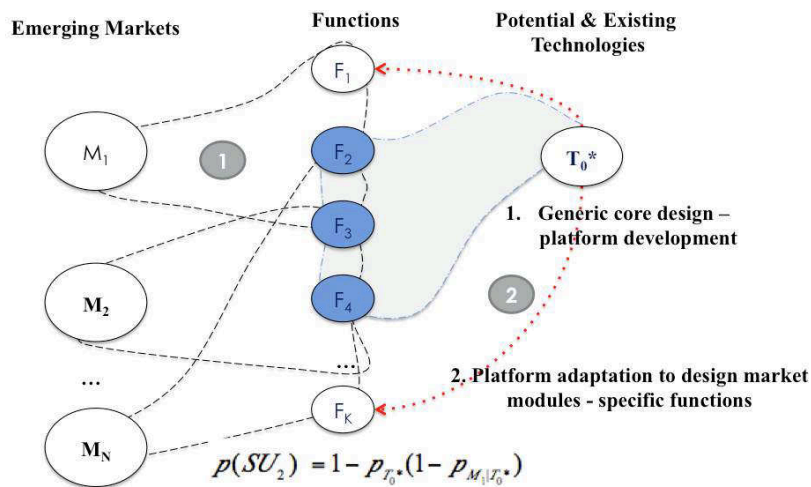

Fig. 6 Common unknown strategy representation

4.2.2 Case study performance

The above analyses show that SU_2 , which typically appears to be costly and risky, leads to successful development and that SU_1 , which appears to be a natural path between project-driven exploration and market derivative creation, fails to address identified options.

In terms of performance, the examples reveal that SU_1 entails residual risks that are not controlled by strategy. These risks arise from trial project selection that might result in inadequate technology exploration. Such inadequate technology exploration is precisely what occurred in the first case study. The chosen trial did not decrease the uncertainties that were relevant to future market derivatives because the exploration was limited to a particular identified market. Instead, expensive adaptation was required to address future options. When initiating development with SU_1 , a risk manager

normally does not account for future market options that may be addressed because his primary goal is the success of the chosen exploration project. This approach could result in a rigid common core that can rarely be reused by other market derivatives (*table 1*). In SU_1 , first, a trial with higher probability is predetermined $p(M_0, T_0)$, and the cost of trial project exploration is paid $C(M_0, T_0)$. This step is critical. Depending on the trial results, the cost of market modules $\sum_{i=1}^n C(M_i, T_i)$ may be smaller or may require significant adaptation and additional resources (see *fig. 7*). The probability of success is heavily dependent on the first trial exploration: $1 - P_{M_0 T_0} (1 - P_{M_1 T_1 | M_0 T_0}) (1 - P_{M_2 T_2 | M_0 T_0}) \dots (1 - P_{M_N T_N | M_0 T_0})$. As in the case of the BAW technology, the development of the time reference option required additional resources to customize the developed technology, and the company was not ready to allocate additional resources.

Table 1. RM strategy comparison in double unknown situations

	Nature of risks	Development cost
SU_1	Uncontrolled residual risks based on problem formulation could result in a rigid common core that is not adaptable to market derivatives. The inflexibility of the common core is due to the primary goal of the strategy, which is to increase the probability of a trial market, not to develop various market options.	Aggregated cost of alternative development; cost of selected market exploration to construct a platform core.
SU_2	Risk of formulating an adequate common core—not only to minimize uncertainties but also to maximize the variability of future compatible options—may arise. The primary goal is to address various market options.	Preliminary exploration cost to design a common core and to ensure a low adaptation derivatives cost.

In SU_2 , a risk of common unknown identification exists. This strategy attempts to avoid hypotheses related to associated contexts. Nevertheless, SU_2 entails preliminary exploration costs to determine the common unknown $C(T_0^*)$ with a probability of existence $p(T_0^*)$. $p(T_0^*)$ is lower than the probability

of trial existence $p(M_0, T_0)$ in SU_1 . The probability of the existence of T_0^* is low, but once it is designed, the probability of market success increases: $1 - p_{T_0^*}(1 - p_{M_1|T_0^*})(1 - p_{M_2|T_0^*}) \dots (1 - p_{M_n|T_0^*})$ (fig. 7).

The cost of adaptation must be lower to ensure the success of portfolio $C_i \sim \varepsilon$ and to easily valorize the technology across various market applications. In the case of BiCMOSMW, we found that costs can be controlled and that SU_2 can lead to successful development.

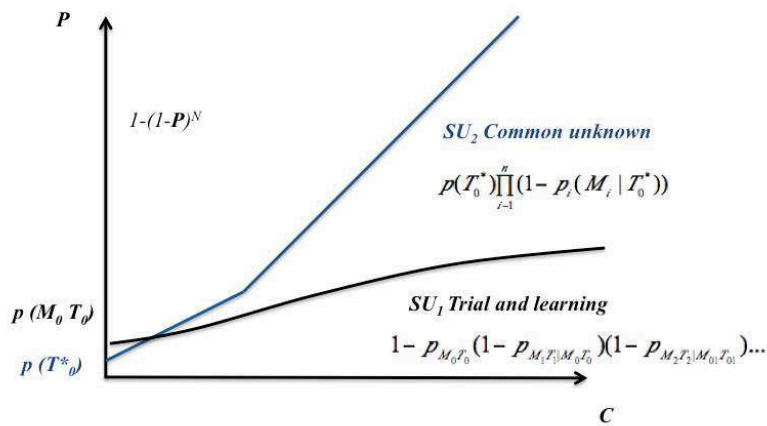

Figure 7 Costs and probabilities of SU_1 and SU_2

The RM aim to reduce uncertainty is not explicit with SU_2 . Instead, the variety of potential options must be increased. The common unknown is created based on interdependencies among emerging markets. For SU_2 , uncertainties for the selected exploration area must be minimized, and the variability of future options and design interdependencies must be maximized. Thus, this strategy appears to be attractive for addressing variable emerging markets but seems to be more expensive than more traditional strategies, such as trial-and-learning, market pull, or technology push. As shown in fig. 7, the applicability of SU_2 strongly depends on adaptation costs $C_i \sim \varepsilon$. These costs must be sufficiently low to ensure that the platform core can be adapted for specific market modules, which limits the applicability of this strategy to industries involving modularity, such as semiconductor and nanotechnology industries. SU_1 and SU_2 in (fig. 7) are valid strategies when these conditions are fulfilled. When a single market has a higher probability of existence, the trial-and-learning strategy will have a higher likelihood of success.

5 RESULTS AND DISCUSSION

In this paper, an *ex post* analysis of the project portfolios at ST allowed us to select two cases that exemplified the design of GTs for further investigation. The first case shows the limitations of the trial-and-learning strategy by demonstrating that the first trial can limit the exploration area and restrict the usefulness of the resulting technology in complementary markets. Consequently, the often attractive trial-and-learning strategy may be risky when the first trial leads to the development of a platform that cannot fulfill future markets. This strategy is preferable when there is a dominant application that can be addressed through consequent trial development. Trial-and-learning is an attractive strategy when market signals are high in value, stable, and derived from one market but when technologies are flexible. Thus, by adding new technological features, a wider set of functions can be generated by developing GTs for this market, and platform reuse can be ensured. Moreover, when technological alternatives are independent, the common unknown strategy does not lead to higher performance.

The second case presents a new possibility of platform design logic. This new strategy—common unknown—was demonstrated through the comparative framework of RM that accounts for *double unknowns* and interdependencies management. With this strategy, the objective is to address several different markets that could use a common set of core elements or a common unknown. By focusing on a broad domain of emerging applications, this strategy allows developers to maximize the number of markets that are addressed by the platform under development. The strategy is attractive because of its flexibility, but it appears to be more expensive to implement than classical strategies such as trial-and-learning, market pull, and technology push. Thus, the conditions that make the intentional design of GTs advantageous are defined. This study demonstrates that the common unknown is particularly relevant when markets are equally unknown or when equally weak and multiple market signals exist. In the upstream phases of technology and market development, the creation of potential interdependencies can commonly be accounted for. Moreover, because the cost of the common unknown strategy is higher, this strategy is more relevant when technologies are easier to combine and recombine, which is normally the case in the semiconductor or nanotechnology industries. The

proposed common unknown strategy provides new perspectives on the value management of exploratory projects. This strategy aims at knowledge creation but controls costs and maximizes the likelihood that a platform is relevant for future markets. The common unknown strategy offers important insights for the literature on risk, interdependencies management, and platform emergence. Both the trial-and-reuse strategy and the common unknown strategy require different visions and lead to different organizational consequences. The strategy of platform emergence by project exploration requires that firms organize exploration between particular R&D and business units. The common unknown strategy requires a coordinator who interacts with all business units and R&D centers and who is capable of identifying emerging industrial trends. Moreover, this strategy furthers our understanding of the managerial criteria that are suitable for double unknown situations and aims to define a new manager who is capable of piloting unknown markets and technologies. Using a model of double unknown exploration, managers employing a common unknown strategy should be able to manage existing learning dependencies among different alternatives while accounting for the possibility of a new interdependencies design. Managers' business plan should be based on a model of creating a technological core for multiple markets, not on a classical revenue model of generating more benefits from a highly promising market application. Cross-application managers coordinate a round table of potential partners, whereas in trial-and-learning, an entrepreneur is looking for a single blockbuster platform.

This paper demonstrates the limitations of market-driven strategies for the creation of interdependencies in double unknown situations. In general, the portfolio analysis of the other projects at ST demonstrates that the common unknown strategy is less frequently used than trial-and-learning. Similarly to trial-and-learning, the common unknown intentional strategy supports the design of GTs, although the former does so intrinsically. As this study shows, the proposed common unknown strategy is applicable in particular organizational contexts. The empirical work conducted at ST shows that the strategy's applicability is limited to certain contexts and that it requires specific tools and methods to reason in double unknown situations. Moreover, managers employing a common

unknown strategy require specific competencies for reasoning in double unknown situations. These issues shape the directions for further research.

6 CONCLUSION

6.1 Theoretical and managerial contributions

The great need for successful innovative solutions requires exploration of both markets and technologies at the earliest stages of development (Backman et al., 2007). Inspired by successful examples of steam engines and MEMS, this research investigates the performance of strategies of double unknown management. An introduced in this paper, a new strategy based on the common unknown concept facilitates the management of double unknown situations.

The study demonstrates that in double unknown situations, both uncertainty and learning interdependencies management are crucial for successful development. In double unknown situations, existing or emerging technologies may not be able to be reused for the most promising market, or the most suitable technology for the most attractive market may not be able to be identified. Instead, in double unknown situations, existing knowledge must be used to design interdependencies amidst emerging technologies and markets. A manager employing the common unknown strategy must be able to imagine future technological platforms that, once developed, will change the knowledge structure to address existing and emerging markets. For instance, the design of rotary motion for steam engines provided many new applications for other engines (mines, mills, textiles, boats, etc.) (Youtie et al., 2008).

In situations of high uncertainty, firms tend to prefer more emergent and evolutionist strategies, such as trial-and-learning. These strategies are based on injecting learning into so-called emergent strategies (Mintzberg, 1990) (*e.g.*, logical incrementalism (Quinn, 1978), incorporating the logic of action (Starbuck, 1992)). Surprisingly, the common unknown strategy belongs to a more deterministic class of strategies and manages double unknowns in a more predictable way. This strategy is relatively comparable to the old classical strategy of “design school” in which the challenge does not entail choosing among alternatives but instead entails “generating options via collective reflection-in-action” (Garud & Karunakaran, 2013).

This research provides new perspectives on uncertainty management in exploration processes in emerging industrial sectors (Rothwell & Gardiner, 1989) that differ from risk reduction and that allow market possibilities to be designed through the identification and subsequent development of GTs. Moreover, this study contributes to the field of innovation management in efficient delivery from the perspectives of multiple projects. By employing an original method of RM based on the identification of a knowledge gap to construct a common unknown core, a company can build its innovative capabilities (Lawson & Samson, 2001) through knowledge management and thus place itself in a better position to innovate in emerging fields. Working simultaneously on marketing, firms can use technological and strategic inputs to enable stronger collaboration between R&D and business units. Consequently, firms can enhance the value of proposed solutions and can decrease the risk of failure resulting from developing rigid technologies for non-profitable markets in a double unknown situation. Finally, this work demonstrates that GTs can be designed during the process of double unknown management. Confronted with the issues of contemporary innovations when a breakthrough is important, firms can use the introduced platform design strategies as an enabling mechanism to decrease risks when they pursue major innovation exploration. Importantly, most of the literature on platforms and platform strategy does not consider the logic of platform design (Gawer, 2014). This is thus an important, original contribution. The opportunity to design platforms and to develop new platform-based business models helps companies to ensure product variety and to reduce complexity within product lines (Pruett & Thomas, 2008). In addition, platform development through “common unknowns” might ensure that firms can access external resources by opening up the platform and attracting complementary innovators within a supportive ecosystem. This paper is the first attempt to describe a way to identify the scope and contents of a technological platform. The common unknown strategy is an original method to define a platform core and to determine its scope.

6.2 Perspectives and limitations

This work identifies an original strategy for designing GTs through functional combinations and analyzes practical cases of platform design at ST. The common unknown strategy offers a functional approach to defining a platform. The notion of functions was used to examine double unknown

situations—to describe projects *ex ante* by being unknown. The notion of functions allows markets that are still evolving and functions that future technologies might offer to be described. From this perspective, an *ex post* description of functions facilitates an analysis of GTs. While seeking to design GTs in a double unknown situation, one must address function dynamics—i.e., how functions are added, how functions are changing, and which function must be considered for a platform core. Study of function dynamics certainly requires further research on the notion of functions and functional approaches for defining a platform core. Further research must provide more theoretical and empirical depth on the type of functions and their characterization in double unknown situations. For instance, specific knowledge domains that have well-defined functions might serve as building blocks for future technological platforms. Such a contribution must be more deeply rooted in the economic and organizational aspects of platform-based organizations (Baldwin & Woodard, 2009; Gawer, 2014).

Moreover, in addition to the trial-and-learning and common unknown strategies, other strategies can be developed. Further work should aim to identify effective strategies for determining the platform core in double unknown situations. Certainly, the implementation of the proposed strategy might be limited to certain industry dynamics (Farr & Fischer, 2007). This study demonstrates that the common unknown and trial-and-learning strategies perform differently in the semiconductor industry. The conditions and limitations of the strategies in double unknown situations should thus be tested. Moreover, further research could lead to further investigations of the identified common unknown strategy to guide innovative portfolio management. For such investigations, we need a better understanding of the strategies' limitations, advantages, and applicability to other types of projects and industrial contexts.

This article opens further research avenues on problems associated with uncertainty management (Enkel et al., 2009; Gassmann, 2006). Who are the entities and actors that are capable of piloting double unknowns? Should a single actor, an innovation board composed of marketing and technological experts, or separate cross-functional teams (Griffin & Hauser, 1996) dedicated to GT management lead efforts in double unknown management?

Moreover, what type of business model might be adapted to double unknown management? Generally, business models enable us to manage risks implied by technological development (Mason & Stark, 2004). Traditional business plans consider that a technology-market couple will be developed, and RM entails reducing the risk of technological or market failure. These business plans focused on risk reduction are constructed based on the assumption that markets and technologies are known, and we attempt to recognize promising markets and reasons why goals are technologically achievable. In double unknown situations, the classical logic of business plan construction is not adaptable. Further research is thus needed in this area.

REFERENCES

- Akao, Y. (1990) *Quality function deployment: integrating customer requirements into product design*: Productivity Press.
- Backman, M., Börjesson, S. and Setterberg, S. (2007) Working with concepts in the fuzzy front end: exploring the context for innovation for different types of concepts at Volvo Cars. *R&D Management*, **37**, 17-28.
- Baldwin, C. Y. and Clark, K. B. (2000) *Design rules: The power of modularity*: Mit Press.
- Baldwin, C. Y. and Woodard, C. J. (2009) The architecture of platforms: A unified view. *Platforms, markets and innovation*, 19-44.
- Baldwin, Y. C. and Clark, B. K. (1997) Managing in an Age of Modularity. *Harvard Business Review*.
- Baldwin, Y. C. and Clark, B. K. (2006) Modularity in the design of complex engineering systems. Book chapter in *Complex Engineering systems: Science meets technology*. In: Ali Minai, D. B. a. Y. B. Y., ed. *New England Complex System Institute Series on Com-plexity*. New York: Springer-Verlag.
- Barclay, I. (1992) The new product development process: past evidence and future practical application, Part 1. *R&D Management*, **22**, 255-264.
- Bresnahan, T. F. and Trajtenberg, M. (1995) General purpose technologies 'Engines of growth'? *Journal of econometrics*, **65**, 83-108.
- Bryzek, J. (1996) Impact of MEMS technology on society. *Sensors and Actuators A: Physical*, **56**, 1-9.
- Chapman, C. (1990) A risk engineering approach to project risk management. *International Journal of Project Management*, **8**, 5-16.
- Chevalier, P. H. (2007) High-Speed SiGe BiCMOS Technologies: 120-nm Status and End-of-Roadmap Challenges *SiRF*, 18-23.
- Christensen, C. M. (1997) *The innovator's dilemma: when new technologies cause great firms to fail*: Harvard Business Press.
- Cohen, W. M. and Levinthal, D. A. (1989) Innovation and learning: the two faces of R & D. *The economic journal*, **99**, 569-596.
- Coombs, R. (2007) Core competencies and the strategic management of R&D. *R&D Management*, **26**, 345-355.
- De Meyer, A., Loch, C. H. and Pich, M. T. (2002) From variation to chaos. *MIT Sloan Management Review*.
- Dickinson, H. W. (2010) *Matthew Boulton*: Cambridge University Press.
- Eisenhardt, K. (1989a) Building Theories from Case Study Research. *The Academy of Management Review*, **14**, 532-550.
- Eisenhardt, K. M. (1989b) Making fast strategic decisions in high-velocity environments. *Academy of Management Journal*, 543-576.
- Eisenhardt, K. M. and Brown, S. L. (1998) Time pacing: Competing in markets that won't stand still. *Harvard Business Review*, **76**, 59-71.
- Elmquist, M. and Le Masson, P. (2009) The value of a 'failed' R&D project: an emerging evaluation framework for building innovative capabilities1. *R&d Management*, **39**, 136-152.
- Enkel, E., Gassmann, O. and Chesbrough, H. (2009) Open R&D and open innovation: exploring the phenomenon. *R&D Management*, **39**, 311-316.
- Farr, C. M. and Fischer, W. A. (2007) Managing international high technology cooperative projects. *R&D Management*, **22**, 055-068.
- Frenken, K. and Nuvolari, A. (2004) The early development of the steam engine: an evolutionary interpretation using complexity theory. *Industrial and Corporate Change*, **13**, 419-450.
- Garud, R. and Karunakaran, A. (2013) A Design approach to navigating cognitive traps: the case of google inc. *EURAM 2013 (European Academy of Management) Conference*. Istanbul.
- Gassmann, O. (2006) Opening up the innovation process: towards an agenda. *R&D Management*, **36**, 223-228.

- Gawer, A. (2010) The organization of technological platforms. In: Nelson Phillips, G. S., Dorothy Griffiths, ed. *Technology and Organization: Essays in Honour of Joan Woodward in Research in the Sociology of Organizations*: Emerald Group Publishing Limited.
- Gawer, A. (2014) Bridging differing perspectives on technological platforms: Toward an integrative framework. *Research Policy*.
- Gawer, A. and Cusumano, M. A. (2008) How companies become platform leaders. *MIT Sloan Management Review*, **49**, 28-35.
- Griffin, A. and Hauser, J. R. (1996) Integrating R&D and marketing: a review and analysis of the literature. *Journal of product innovation management*, **13**, 191-215.
- Groen, A. and Walsh, S. (2013) Introduction to the Field of Emerging Technology Management. *Creativity and Innovation Management*, **22**, 1-5.
- Huchzermeyer, A. and Loch, C. H. (2001) Project Management Under Risk: Using the Real Options Approach to Evaluate Flexibility in R&D. *Management Science*, **47**, 85-101.
- Kogut, B. and Kulatilaka, N. (2004) Real options pricing and organizations: the contingent risks of extended theoretical domains. *Academy of Management Review*, **29**, 102-110.
- Lawson, B. and Samson, D. (2001) Developing innovation capability in organisations: a dynamic capabilities approach. *International Journal of Innovation Management*, **5**, 377-400.
- Le Masson, P., Cogez, P., Felk, Y. and Weil, B. (2012) Revisiting absorptive capacity from a design perspective. *International Journal of Knowledge Management Studies*, **5**, 10-44.
- Lenfle, S. (2011) The strategy of parallel approaches in projects with unforeseeable uncertainty: The Manhattan case in retrospect. *International Journal of Project Management*, **29**, 359 – 373.
- Lenfle, S. and Loch, C. (2010) Lost roots: how project management came to emphasize control over flexibility and novelty. *California Management Review*, **53**.
- Linton, J. D. and Walsh, S. T. (2008) A theory of innovation for process-based innovations such as nanotechnology. *Technological Forecasting and Social Change*, **75**, 583-594.
- Lipshitz, R. and Strauss, O. (1997) Coping with uncertainty: A naturalistic decision-making analysis. *Organizational Behavior and Human Decision Processes*, **69**, 149-163.
- Loch, C. H., DeMeyer, A. and Pich, M. T. (2011) *Managing the unknown: A new approach to managing high uncertainty and risk in projects*: Wiley.
- Loch, C. H., Solt, M. E. and Bailey, E. M. (2008) Diagnosing Unforeseeable Uncertainty in a New Venture*. *Journal of product innovation management*, **25**, 28-46.
- Loch, C. L., De Meyer, A. and Pitch, M. T. (2006) *Managing the unknown: A new approach to managing high uncertainty in projects*: New York: Wiley.
- Loch, C. L., Solt, M. E., Bailey E. M. . (2008) Diagnosing unforeseeable uncertainty in a new venture. *The Journal of Product Innovation Management*, **25**.
- Lynn, S. G., Akgun, E. A. . (1998) Innovation strategies under uncertainty: a contingency approach for new products development. *Engineering Management Journal*, **10**, 11-17.
- Maine, E. and Garnsey, E. (2006) Commercializing generic technology: The case of advanced materials ventures. *Research Policy*, **35**, 375-393.
- Mason, C. and Stark, M. (2004) What do investors look for in a business plan? A comparison of the investment criteria of bankers, venture capitalists and business angels. *International Small Business Journal*, **22**, 227-248.
- Mintzberg, H. (1990) The design school: reconsidering the basic premises of strategic management. *Strategic management journal*, **11**, 171-195.
- Moser, P. and Nicholas, T. (2004) Was electricity a general purpose technology? Evidence from historical patent citations. *American Economic Review*, 388-394.
- O'Connor, C. G., Ravichandran T., Robenson, D. (2008) Risk management through learning: Management practices for radical innovation success. *Journal of High Technology Management Research*, **19**, 70-82.
- O'Connor, G. C. and Rice, M. P. (2012) New Market Creation for Breakthrough Innovations: Enabling and Constraining Mechanisms. *Journal of product innovation management*.
- Oriani, R. and Sobrero, M. (2008) Uncertainty and the market valuation of R&D within a real options logic. *Strategic management journal*, **29**, 343-361.
- Paulson, A. S., O'Connor, G. C. and Robeson, D. (2007) Evaluating radical innovation portfolios. *Research-Technology Management*, **50**, 17-29.
- Perlitz, M., Peske, T. and Schrank, R. (1999) Real options valuation: the new frontier in R&D project evaluation? *R&D Management*, **29**, 255-270.
- Petit, Y. and Hobbs, B. (2010) Project portfolios in dynamic environments: Sources of uncertainty and sensing mechanisms. *Project Management Journal*, **41**, 46-58.
- Pich, T. M., Loch, H. C. and DeMeyer, A. (2002) On uncertainty, Ambiguity and Complexity in Project Management. *Management Science*, **48**, 1008-1023.
- Powell, W. W. (1987) Explaining technological change: JSTOR, 185-197.
- Pruett, M. and Thomas, H. (2008) Experience - based learning in innovation and production. *R&D Management*, **38**, 141-153.
- Quinn, J. B. (1978) Strategic Change: " Logical Incrementalism.". *Sloan management review*, **20**, 7-19.
- Robinson, D. K., Le Masson, P. and Weil, B. (2012) Waiting games: innovation impasses in situations of high uncertainty. *Technology Analysis & Strategic Management*, **24**, 543-547.
- Rosenberg, N. (1994) *Exploring the black box: Technology, economics, and history*: Cambridge University Press.

- Rosenberg, N. and Trajtenberg, M. (2004) A general-purpose technology at work: The Corliss steam engine in the late 19th century United States. *The Journal of Economic History*, **64**, 61-99.
- Rothwell, R. (1992) Successful industrial innovation: critical factors for the 1990s. *R&D Management*, **22**, 221-240.
- Rothwell, R. and Gardiner, P. (1989) The strategic management of re - innovation. *R&D Management*, **19**, 147-160.
- Shani, A. B., Coghlan, D. and Coughlan, P. (2008) *Handbook of collaborative management research*: Sage Publications Thousand Oaks, CA.
- Siggelkow, N. (2007) Persuasion with case studies *Academy of Management Journal*, **50**, 20-24.
- Starbuck, W. H. (1992) Learning by knowledge-intensive firms *Journal of management Studies*, **29**, 713-740.
- Suh, N. P. (1990) *The principles of design*: Oxford University Press New York.
- Van de Ven, A. H. (2007) *Engaged scholarship: A guide for organizational and social research*: OUP Oxford.
- Voss, C. A. (1984) Technology push and need pull: a new perspective. *R&D Management*, **14**, 147-151.
- Ward, S. and Chapman, C. (2003) Transforming project risk management into project uncertainty management. *International Journal of Project Management*, **21**, 97-105.
- Yin, R. (2003) *Case Study Research: Design and Methods*: Thousand Oaks, California: Sage Publications, Inc.
- Youtie, J., Iacopetta, M. and Graham, S. (2008) Assessing the nature of nanotechnology: can we uncover an emerging general purpose technology? *The Journal of Technology Transfer*, **33**, 315-329.
- Zilber, T. B. (2007) Stories and the discursive dynamics of institutional entrepreneurship: The case of Israeli high-tech after the bubble. *Organization Studies*, **28**, 1035-1054.

Paper II

**Supporting or killing the
design of generic
technologies: Towards a new
model of business plan**

Supporting or killing the technological platform design? Towards new contingent criteria for strategies selection

Olga Kokshagina¹, Pascal Le Masson² and Benoit Weil³,
Hassen Ahmed⁴

¹ olga.kokshagina@mines-paristech.fr

² pascal.le_masson@mines-paristech.fr

³ benoit.weil@mines-paristech.fr

⁴ mr.hassen.ahmed@gmail.com

¹⁻⁴At the Center for Management Science, Mines ParisTech, Boulevard Saint-Michel 60, 75006, Paris, France

The circumstances in which firms operate have moved towards novel and unknown environments, thereby fundamentally modifying the logic of decision making, rendering planning approaches inadequate. The literature highlights that in these situations companies have to adapt more flexible approaches, to incorporate learning and privilege interactions among projects and corresponding environments. Moreover, sector dynamic influences the choice of strategies under high uncertainty. There are sectors “pushed” by technologies or “pulled” by markets. In the situations of double technology and markets unknowns an interesting solution is highlighted: the design of technological platform that is able to address many emerging markets. Yet it is not self-evident when these strategies are advantageous for the firms that are subject to the environmental dynamics and pursuing double unknown. A simulation study has been carried out to clarify the contingent criteria in which the exploration of multiple technologies and markets could lead to platform design. The conducted simulation experiment reveals two main contingent variables: the existence of market signals and the “segregative” or “aggregative” nature of technological systems. The study endeavors to provide an improved theoretical understanding of double unknown management and the corresponding strategies.

1. Introduction

Faced with uncertainty and turbulent environments, companies are confronted with the case when both technologies and markets are unknown – called here “double unknown”. In double unknown, projects interact in ways so unpredictable that no plausible range of management scenarios can be identified. This situation is often considered hazardous. There is a presence of multiplied uncontrolled risks and the exploration costs are hard to estimate. When multiple unknowns are present, plenty of technological

alternatives and market applications might be imagined. They are all highly uncertain and therefore, it is impossible to evaluate their probability of occurrence, estimate risks and determine a winning candidate. Moreover, the chances of winning are inversely proportional to the initial uncertainty. This leads to reject the projects that cope with high level of unknowns. Still, in some industries such as semiconductors, nanotechnologies firms aiming to maintain their competitiveness over time have to organize exploration while controlling costs and risks in double unknown. In these cases do the project

leaders suppose to deal with negative net present values or on what basis they have to make their decisions?

The question occurs whether “double unknown” could be somehow managed and when the companies have to pursue the axis of double unknown exploration.

Innovation management literature proposes either market pull or technology push strategies to deal with “unknowns”. However, these strategies deal with singular form of unknowns (consequently technology- or market-based). Market pull strategy drives innovation when market needs can be determined and revenue flows can be forecasted. In this case the unknown is technology-based and the goal is to reduce technological uncertainties and develop a relevant solution for a promising market (Brem & Voigt, 2009). Conversely, technology push strategy tends to reduce the market unknowns associated to the commercialization of a known technology (Caetano & Amaral, 2011; Linton & Walsh, 2008). Both market pull and technology push assume existence of the market needs or prevailing technology candidates consequently and are limited in the situation of dual exploration of markets and technologies.

Exploratory learning theory and risk management suggest a more advanced trial and learning strategy to deal with unknown (Loch et al., 2008; Lynn, 1998; Sommer et al., 2009). A firm following this strategy should first identify a trial with the higher probability to succeed and increase this probability during the process of consequent learning. The series of probes often result in technological prototypes and solutions aiming to address a variety of market segments. When this strategy considers “reuse” of the acquainted learning, it might lead to a new platform creation for novel business opportunities. In this case, this strategy can be viewed as a consequent process of platform generalization. Yet, it highly depends on the success of a particular trial (Lynn et al., 1996) and therefore might be too unpredictable and costly while facing the unknowns in high-tech.

Following the logic of technological platform that addresses various markets through complementary modules development, Kokshagina et al. (2013) propose a more intentional way of platform development. Platform-based product development is known to increase variety, reduce costs and significantly shorten the development times (Gawer, 2008). To enable successful exploration of unknown environments, a strategy of developing a platform that by scaling its dimensions or substituting its modules is able to target various markets becomes attractive. Though, Le Masson et al. (2009) note that in the literature on platform strategy the nature of the platform is known in advance and prior research mostly focuses on platforms dissemination and commercialization. The proposed in (Kokshagina et al., 2013) strategy, called “common unknown”, aims to identify a “common unknown” for several emerging markets by designing a platform and complementary innovations. The strategy is attractive in its flexibility, yet it appears to be more expensive than trial and learning, market pull, and

technology push.

Both trial and learning and common unknown provide far more experimental and conventional methods to deal with double unknown. Common unknown offers an effective way of double unknown management through intentional platform design but it appears to be costly and the conditions that make this strategy advantageous remain unclear. In case of trial and learning, the performance of the strategy is not evident and the conditions when the “reuse” is beneficial need to be examined.

It appears that the criteria for projects selection and evaluation implied by different strategies differ significantly. In order to determine the validity of each strategy and reveal contingent criteria of their applicability, their performance need to be compared. This paper aims to clarify these criteria for the firms confronted with high velocity unknown environments. Hence this paper tackles the following research questions: what is the validity domain of strategies faced with various industrial dynamics? What are the relevant contingent criteria to detect reliable strategies and choose the one that will lead to higher performance and secure the investment in double unknown?

There is clearly a lack of theoretical insights on the nature of different strategies that are able to deal with unknown and their comparison. The lack of unified framework may be due to the complexity of the underlying phenomena as suggested in (Lant & Mezias, 1990). As shown in (Davis et al., 2007), the simulation study’s primary value occurs in creative experimentation to produce novel theoretical insights. By using simulation research to compare different strategies (trial and learning, market pull, technology push, common unknown) in various techno-economic conditions and gain new insights, this paper demonstrates that there is a different set of rules and structure to ease the way strategies are managed in double unknown.

The built simulation model provides variation along two dimensions: market signals and the cost of technological reconfiguration. Market signals may be high or low in value, stable or changing, and coming from one or many markets. Technologies in turn may be “segregative,” that is, difficult to combine with others, or “aggregative,” that is, easy to combine and recombine. Automobiles manufacturing is an example of segregative technology; semiconductors and nanotechnology are aggregative technologies.

The proposed study puts into evidence the economic conditions and validity domain of identified strategies in unknown environments. The simulation results show that when market signals are high in value, stable, and derived from one market, and the technology is segregative, then a market pull strategy is advantageous, and there is no need to pursue platform development. In contrast, when market signals are high in value, stable, and derived from one market, but technologies are aggregative, then by adding new technological features, it is possible to penetrate a wider set of uses by developing a technology for this

market. Trial and Learning is then the most advantageous strategy. Finally, when market signals are low in value, changing over time, and coming from multiple markets, and technologies are aggregative, then a common unknown or “platform” strategy is advantageous.

The paper is organized as follows. The second paragraph presents the theoretical background. This paragraph draws upon the literature on the innovation management strategies; from the classical techno push and market pull to the more sophisticated trial and learning or common unknown ones. It establishes the preliminary list of contingent criteria for strategies selection. The third paragraph discusses the theoretical background and the rationale of the model. Model attempts to compare management strategies in a large variety of industrial environments. The contribution of the proposed model is the configuration of the environmental landscapes that influence the strategies performance and their applicability in time. The fourth section is devoted to the simulation results and their interpretation. Finally, the paper concludes with general discussion and limits of the model.

2. Management strategies in turbulent environment and the relevant contingent criteria

The number of different factors normally justifies strategies' choice. For instance, driven by the idea of choosing the strategy that requires less investment for satisfactory results, (Beach & Mitchell, 1978) demonstrate that strategies selection is based on the type of problem, the surrounding environment and the characteristics of a decision makers involved.

Management strategies under risks deal with a fixed at the beginning set of alternatives and their associated probabilities. Their goal is to choose a best alternative using the estimated probability distribution and reduce uncertainty. These strategies deal with market knowledge that usually considers market success and probability of market existence along with technical knowledge in terms of development cost and probability of technology existence. The most common criteria used to evaluate the explorations are: subjective probabilities estimation (Chapman & Ward, 2003), project losses definition (Jaafari, 2001), variations in (De Meyer, 2002), project outcomes estimations (as net present value).

When uncertainty is high, one cannot just frame problem scope to a list of pre-selected alternatives, innovation managers have to be flexible and take into account emerging through time solutions. When technology is at the embryonic stage, entrepreneurs are often faced with both market and technology uncertainty. They do not know how technology will be deployed and what are the market segments that technology will address. In this case the choice of one

technology to a more promising market is risky and several markets and technologies might be explored simultaneously.

When the level of unknown is high, strategies selection depends on the level of unknown, market and technological dynamics and their speed of renewal. The various type of uncertainty has to be taken into account: market uncertainty, technological uncertainty, environmental uncertainty, organizational uncertainty (Mu et al., 2009). These uncertainty levels can differ significantly. For instance, markets and technologies might be unknown (McGrath, 2001; McGrath & MacMillan, 1995; O'Connor, 2006). In these cases the goal is to minimize risks for particular market demand or market opportunity (market pull strategy (Mowery & Rosenberg, 1979)) or reduce risks by formulating a concrete technology proposition (technology push strategy).

Market pull is a customer need-driven model, which is based on close interactions of the marketing department with customers. When technology is unknown, market pull strategy is used to reduce technological uncertainty and obtain forecasted revenue flows (Brem & Voigt, 2009). Market pull is driven by the predetermined market areas or identified customer needs (Chidamber & Kon, 1994). Markets are pulled by the estimated market value (through potential benefits, costs, probability of success) and by the nature of market itself. This strategy appears relevant when market signals are high and stable (see Table 1).

In contrast, technology push tends to reduce the market risks associated to the commercialization of a promising technology (Caetano & Amaral, 2011; Linton & Walsh, 2008). Technology push is a technology-driven model, which is based on the idea that scientists come up with a good idea or discovery. This is a situation where an emerging technology or a new combination of the existing technologies drive the innovative product and problem solution in the market place. Potential market applications are essentially unknown. Technology push implies the use of anticipatory and exploratory market research methods and is pushed by a more promising technology. Market potential cannot be derived at the early exploration stages. The strategy choice often depends on the technological character and the estimated costs of technology development (Table 1). (Das & Van de Ven, 2000) indicate that the nature of technology that can be novel or evolved and the nature of markets whether concentrated or dispersed, influence the firms' selection of consequent strategies. Technological and marketing contingencies affect the opportunity and constraints on innovation. Their nature and dynamics clearly influence selections of technology push or market pull strategy.

In double unknown the list of candidates is infinite and their probability distributions are equally volatile. The rate of new applications' creation and even new markets is high and market signals are dynamic (Hill & Jones, 2007). Moreover, the speed of markets renewal and the success rates of radical innovation are

positively influenced by the innovation speed (Goktan & Miles, 2011) and should be taken into consideration while dealing with double unknown.

For instance, Loch et al. (2008) suggest to use trial and learning strategy in the case of unforeseeable uncertainty and complexity. When Trial and learning considers reuse of acquainted learning to develop markets, it can result in the successful platform development. Still the criterion of success is mostly based on the value obtained through the trial exploration. Though, this strategy does not aim to maximize the number of markets to develop. Trial and learning promises the highest potential when unforeseeable uncertainty is high. Yet it is not clear whether this strategy seek for a trial with higher probability of existence or it attempts to incorporate further learning to develop a technological platform that creates value across several market sectors.

“Common unknown” strategy attempts to intentionally design the technological platform, which addresses several markets and provokes emergence of new applications. The benefits of this strategy were shown on the practical examples of platform development for several emerging markets in the semiconductor industry. The strategy is attractive in its flexibility, yet it appears more expensive than classical strategies since it comprises both the platform development and the complementary modules to address several markets. The platform development advocates modular architecture built upon a common core (Gawer, 2009). Common unknown strategy aims then to pursue modular design but in double unknown it is unclear what will be a platform core and how to ensure small costs of development. Moreover, it needs to be compared with trial and learning that can result in platform development as well.

Both common unknown and trial and learning incorporate learning, interactions among the market and technologies and enable to organize exploration in double unknown. They empower to develop platforms capable of addressing several potential future markets. These strategies incorporate learning and path dependencies. When the level of unknown is high, it is important to take into account the logic of learning and incorporate new alternatives. Firms should integrate strategic flexibilities that allow for spontaneous reaction for changing environments (Zhou & Wu, 2010). Path dependence occurs when the initial conditions are followed by a series of contingent (or chance) events whose influence on the path taken is larger than that of the initial conditions (Vergne & Durand, 2010). Trial and learning and Common unknown deal with complex technological exploration. Christensen (1997) indicates that technologies are becoming more complex and the integration of new features could be costly and challenging. The complexity poses some issues of technology adaptation to other markets and limits the possibility to easily develop modular architecture of platforms. The criterion to define the level of technological adaptation seems to be critical while dealing with platforms

emergence.

The industrial environment itself influences strategies selection. According to (Christensen et al., 1998), it can be unknown or dominant design. In the case of dominant design, there exist leading technologies and actors that guide further explorations and predefine industrial dynamics. The unknown environments are more competitive, there are various technological candidates and the product portfolios are much more diversified (Kaplan & Tripsas, 2008).

Each of the presented strategies provides powerful mechanism for the exploration in unknown. Though, the criteria and the methods they use differ significantly. For instance, Market Pull and Trial and Learning appear to be driven by the market conditions. Technology push and Common Unknown consider the costs of technological exploration. Moreover, Trial and learning and Common Unknown consider interdependencies and measure the effect of learning to the strategies performance. While attempting to launch a new exploration, a strategy has to be chosen according to the initial industrial conditions. The goal is to reveal the contingent criteria that influence strategies performance and enable to achieve higher performance. This brings to the principal research questions: What are the criteria that enable to detect which strategy ought to be used for projects exploration? Which criteria facilitate the choice between strategies?

Strategies	Preliminary Conditions
Market Pull	Relevant when market signals are high and stable (Das & Van de Ven, 2000). Primarily used to commercialize technologies and replace the existing applications, markets (Walsh et al., 2002)
Technology Push	Relevant in case market signals are absent , the suppliers are involved in the strategies determination, cost of technology development (Walsh & Linton, 2011)
Trial and Learning	Promises the highest potential when unforeseeable uncertainty is high (Sommer & Loch, 2004)
Common unknown	Performs better while targeting interdependencies creation in multi-market, multi-technological environments (Kokshagina et al., 2013)

Table 1. Preliminary Criteria for strategies dominance.

3. Model

The complexity of the underlying problem is well suited to simulation modeling. The reason is twofold. First of all, simulation enables a powerful methodology for advancing theory and research on complex behaviors and system (Harrison et al., 2007). It leads to produce novel theoretical insights (Davis et al., 2007). Simulation tools enable to analyze multiple dependent processes simultaneously. They are considered as a good exploration strategy to examine the relations between the multiple variables and reveal the dominant criteria. Second, the simulation study was chosen thanks to the existence of important research results on

the strategies that deal with novel and unknown environments provided both by the theory and qualitative research and due to the absence of the insights on how these processes interact with each other.

3.1. Modeling principles for unknown, interdependent and high velocity environments

A model is built to further compare these management strategies in a large variety of environments. There are two principal classes of models to account for unknown: 1) models that are based on uncertainty management techniques including real options (Camerer & Weber, 1992; Huchzermeyer & Loch, 2001); 2) models that incorporate complexity and represent innovative projects as local search on rugged landscapes. The second class of models is mostly based on Kauffman NK model for interactions dimensions and is broadly applied to strategic decision-making (Caldart & Ricart, 2004; Gavetti et al., 2005; Rivkin, 2000; Sommer & Loch, 2004).

Decision-making models that include real options deal with uncertain dynamic environments (McGrath, 1997). Normally these models use Bayesian logic that considers sets of random alternatives evolving in time. These types of models neglect the interdependencies and consider rather simple landscapes. They consider strategies as decision-making policies to choose the more promising alternative (Gunther McGrath & Nerkar, 2004; Mitchell & Hamilton, 2007).

Complexity type of models deals with systems that comprise multiple interacting entities. Complexity is defined as large number of parts that interact in a non-trivial way within each other and external systems (Caldart & Ricart, 2004; Sommer & Loch, 2004). It is considered that organizations evolve by modifying their existing forms in an attempt to enhance their fitness value in a payoff surface (Levinthal, 1997). For instance, NK model enables to deal with rather rugged landscapes where interdependencies shape complex environments (Kauffman, 1993). Though, in NK the system size (number of variables) N is fixed at the beginning and doesn't evolve in time (Sting et al., 2011). Only K , which is the number of elements of N , with which a given attributes interact is changing. NK considers rather complex but stable environments. Strategies are modeled as search strategies to maximize fitness value of the landscape. The simplest ones are strategies of local search, which is highly efficient when companies' business attributes vary incrementally (Caldart & Ricart, 2004; Rivkin, 2000). In addition to local search, Caldart and Ricart (2004) enlighten strategies of search that 1) involve the adaptation of new corporate business models or simultaneous alteration of many elements N in the case of explorative activities with low exploitation level; 2) deal with explorative nature of activities without losing the benefits of exploitation by manipulating the

interdependencies (K) between different elements of N . In this case the goal is to find new unforeseen combinations of known but previously distant parameters. Global search models take into account the interdependencies and model complex strategies to achieve higher performance: trial and learning and selectionism (Sommer & Loch, 2004; Sommer et al., 2009). These strategies deal with complex landscapes. Though, the NK model behind does not consider the landscape evolution in time and the strategies' visibility is limited by initially defined configurations.

Since platforms are more probable to emerge in dynamic and unknown environments, the primary interest of this study is to apprehend the relevant strategies behavior in the environments where the time of technological development has the same order of magnitude as industrial dynamics. In the case of high turbulence, complex search models become irrelevant since their landscape is initially fixed and don't consider environment evolution. In double unknown the evolution of the landscape should be considered to incorporate alternatives that were not considered initially or emerged during the exploration process. Hence, the current model is based on the landscape reconfiguration. The goal is to test how strategies performance and their applicability change with the reference to the industrial dynamism in time. The model pursues to take into account dynamic environments as in the decision-making models and interdependencies as in the complexity models and enlarge it to the cases of double unknown management.

3.2. Technologies and Markets interactions

A developed model helps to introduce dynamic technologies and markets and test management strategies performance in high-velocity environments that are characterized by their dynamics, uncertainty and complexity (Eisenhardt, 1989; Wirtz et al., 2007).

The model is based on the interactions between technologies and markets. In engineering designing the end goal is represented as a creation of a product or a system that performs a function or functions to fulfill the customer needs (Hirtz et al., 2002). Dealing with technology and market interactions, we propose to make a parallel with technologies that perform certain functions that markets seek to address.

3.2.1. Markets definition

Markets are considered being unknown since their volume, value are unclear and probability distributions are volatile (Oriani & Sobrero, 2008; Perlitz et al., 1999). Even if their values are unknown it is possible to assume what might be the desired functions that future markets inquire. The issue has long been addressed in consumer behavior theory (Lancaster, 1966) which proposes to characterize goods by functions. Following this logic each market can be assimilated as a set of functions F_1, F_2, \dots, F_n it targets. The market is characterized by its functional and value dimensions.

The unknown nature of the market is taken into account by the volatility of market signals and corresponding functions, their turbulence rate. Market is determined as set of functions F_i with associated potential profit, probability of existence and the estimated development costs to attain each function. New functions creation might lead to new markets. The set of markets in the model comprise the ones that the company is able to address, targets and those that are still unknown for the company. This set is represented as a set of F_i linked by the market constraints.

3.2.2. Technology definition

In the engineering design and technology management literature (Akao, 1990), the value of technology is assimilated to the functions that each technology addresses. To find a technology to a chosen market means precisely to address its functions. Technology is considered advantageous if it addresses promising functions that lead to winning markets. Technology is a set of physical elements that ensures certain functions F_i with associated development cost and probability of existence.

Technologies can be characterized by their complexity and technological systems dynamics. As this paper deals with technological platforms, the technological elements and their substitution modularizations have to be taken into account. Two types of technological architectures exist: modular and integral (Baldwin, 1997; Baldwin, 2006; Sanchez, 2004). Lenfle (2011) indicates that the more modular a technology or a product is, the easier it is to combine its elements. Thus, in case of modular architecture the capacity to link two technological elements is high and therefore the cost of reconfiguration is low. In case of integral architecture, the goal is to choose a more performing solution without seeking for a capacity to link them since the costs are high. This capacity to combine technological elements appears to be critical while dealing with platform design. It defines the way of interaction between technological elements and its path dependencies.

Apart from integral (high costs of reconfiguration) and modular (low costs), other more or less modular or integral solutions should be considered. The capacity to link the technological elements is characterized in the model with an associated cost and a probability of creating a dependency. This capacity evolves in time and depends on the internal firm capacity and the associated sector dynamic.

Moreover, each time the new dependencies are ensured, the technological landscape is changing. To model various capabilities of technological configuration, several configuration criteria were proposed (see Appendix A for detailed description of criteria).

3.2.3. Technology and Market Interactions

A winning solution is described as a technology and market couple with higher probability of success. Even if the classical notion of technology-market couples is used, it is stated that the relations between them are not

evident in case of unknown environments. There are strategies that deal with multiple technologies and multiple markets coupling by interdependencies creation.

When dealing with innovative exploration, the interdependencies management is becoming crucial for projects success (Elmqvist & Le Masson, 2009). Since the strategies are dealing with interdependencies creation, the model needs to see how these technology (T) and market (M) interdependencies were designed. The interdependencies help to clarify the interactions between functions that drive each market and can be addressed by the existing or emerging technologies. The goal is to rethink the structure of interdependencies of different alternatives in order to develop platforms or specific technologies depending on the emerging market needs in highly volatile environments. The notion of functions exists both in functional and technological domain. The relation between technologies and markets is defined via functions. In the model, the combination of functions can characterize a technology or lead to win a market. So the market is a combination of functions with certain probability of success and technology is a capacity to combine these functions with an associated development cost. Each new subset of functions generated from the combination of F_j functions that each market seeks to address and F_i that technology can develop can be seen as unknown markets (markets with very low probability) or can be seen as unknown technologies. In addition, functions evolve in time; they can be created or addressed by competitors. A new couple of $T - M$ exists when a new technology addresses unrelated subset of functions F_i and this subset corresponds to a new realized market.

Defining the environment in the model consists of setting up the rules that guide the interaction and the evolution of the model's objects: markets and technologies. The notion of the environment includes all elements, factors, and conditions that have an impact on the choices made, when applying a management strategy. For more details on conditions see Appendix A. The criteria taken into account in the model are compliant with the section 2.

3.3. Strategies choice in unknown exploration

3.3.1. Ideal strategy

There are endogenous and exogenous criteria that influence markets and technologies evolution (see Appendix A) and various forms of management are possible. The initial landscape of existing technologies and markets defined through functions that correspond to technologies or markets and their interaction is rugged and plenty of local optima can be defined at time t .

In the proposed model the goal is to develop technologies that fulfill promising functions and result in gaining at least one market. These technologies are based on the technological reconfiguration and aim to

reuse the already existing technological elements. The higher number of technological elements and their reconfiguration the company is capable of developing, the higher its theoretical chance of attaining several markets. If the budget is infinite, then the goal is to find an optimal path to construct all the links between the future and the existing technological elements. The algorithm is similar to finding a minimum-spanning tree for a connected weighted graph. It finds a subset of the edges that forms a tree that includes every vertex (i.e. every technology), where the total weight of all the edges (i.e. the total risk of the unknown technologies) in the tree is minimized. Though, the budget is limited and there is new knowledge emergence in time and the existence of residual unknown.

3.3.2. Strategies under constraints

Under the budget constraints search algorithm to develop all the connection is too costly. In addition, technologies and markets evolve in time. The goal then becomes: *given a budget of an R&D exploration and commercialization, which technological elements should be developed to have an access to a larger amount of markets?* In this representation strategies are the algorithms that define how this goal will be achieved by taking into account the endogenous and exogenous criteria. The following strategies were modeled: market pull, technology push, trial and learning, common unknown. The principles of strategies modeling are described in Appendix A.

Taken together, there exist various industrial environments defined using associated criteria C_i (Appendix A). Each environment contains N technologies T_i and there is a capability to develop new technologies T_j through the combination of existing and emerging ones. This technological portfolio targets both the established markets M_i and leads to a creation of new markets M_L . There is a list of strategies that companies can adopt to account for higher performance in these environments. The performance represents a function of the expected outcomes and the state of actions.

Given the budget constraints, existing and emerging T_j and M_i , given the set of strategies, which strategy the company should choose to obtain higher performance in terms of benefits?

4. Simulation

4.1 Data and experimental design

Simulation is conducted by defining environments through combinations of identified objects and criteria. These environments determine the initial conditions for the simulation. The strategies including a random strategy determine the actions of the model.

A simulation plan comprises different experiments to be run to identify the environments when each of the

strategies is dominant. Each strategy is tested using various criteria in order to reveal the contingent criteria. The simulation begins with the object definition.

Each scenario was tested during several time periods. The time period is a period that follows the decision making for a particular budget allocated for this period. The time period varies with industrial sectors. For instance in the semiconductors industry a time period is generally two years but in the nuclear industry a time period could mean ten years. When running a dynamic simulation the initial data for the time period n is the result of time period $n-1$. Moreover, the possibility of reallocating the remaining budget of time lap $n-1$ to the budget of time lap n is introduced.

After each time period, the new budgets can be reallocated; technology and market lotteries were performed, new technologies, markets and functions added randomly or considering path dependency effects to ensure the landscape evolution in time. The market lottery determines whether the development was successful or not. The lottery is played in all the M_i . The lottery determines randomly the markets that are addressed by competitors at this time period. If the markets that the company attempted to address at the current time period pass the lottery (meaning that the competitors did not succeed at addressing these markets first), the firm generated the benefits and the development is successful. In the current version of the model, each market can be addressed only one time. The technological lottery has a purpose of testing technological feasibility and performance. It determines whether the technology that the company develops offers a greater performance than the solutions that already exist in the markets. To play the lottery a number $0 < x < 1$ is randomly generated. If $x \leq p_i$ probability of technology development then the exploration can be considered successful. Otherwise, it leads to a failure and the loss of the invested money.

The simulation run is repeated for a variety of environment conditions and criteria combinations (see Appendix B for more details on simulation algorithm). The aim is to reveal the conditions where each strategy has the best performance meaning higher average profit. For each strategy the number of parameters were considered: technology development costs, costs of reconfiguration for the remaining technologies (to determine the capacity to create platform that addresses several market applications), risks, market expectations, percentage of the markets that strategy was capable to win (both for the existing dominant markets and the emerging), profits average value and its deviation. The performance includes both the outcome and the costs of the actions.

The initial experiment enabled to define the criteria configurations when each strategy has higher performance (in terms of profit). This experiment consisted in varying the initial criteria. For each combination the model was run during 5 time periods and repeated at least 20 times to reveal the preliminary scenarios where each strategy has higher performance

These configurations resulted in determining 4

scenarios where each strategy has higher performance (see Table 2).

Criteria	Scenario 1: Market Pull	Scenario 2: Technology Push	Scenario 3: Trial and Learning	Scenario 4: Common unknown
Probability of market existence (C_1)	High	Low	Low	Low
Market signals dynamic (C_2)	Stable	Dynamic	Dynamic	Dynamic
Speed of Market Renewal (C_3)	Fast	Slow	Stable	Stable
Type of environment (C_4)	Dominant	Unknown	Unknown	Unknown
Ratio of dominant markets vs. unknown (C_5)	Dominant Environment (at least 10% of dominant markets)	Unknown (less than 1% of dominant markets)	Unknown (less than 10% of dominant markets)	Unknown (less than 10% of dominant markets)
Path dependency (C_6)	Not applicable	Not applicable	High	Low
Capacity to recombine technological elements – defined through cost of technological reconfiguration (C_7)	Low (High costs of technological reconfiguration)	Medium Low	Medium High	High (Min cost)

Table 2 Scenarios definition (for criteria description see Appendix A)

To confirm the validity of the established scenarios and their statistical significance they were tested on the bigger set of data. For each scenario 40 trials (Scenario 1) or 100 trials (Scenario 2,3 and 4) were carried out. Each strategy behavior was observed through 5 time periods. The simulation results enabled to define conditions where each strategy accounts for higher performance (see Appendix C).

4.2. Insights gained based on simulation study

Two-sample *t*-test, was used to analyze two population means based on independent samples from the two populations or groups. We test the null hypothesis that the samples come from populations with equal means, against the alternative that the means are unequal. The results obtained from the analyses are given in Appendix C.

Regarding **Scenario 1**, the *t*-tests for independent group indicate a significant preference for Market pull strategy ($M = 23785.2$, $SD = 10842.5$) over Common unknown ($M = 2188.5$, $SD = 3176.5$), conditions $t(40) = 12.$, $P^{****} = 7.8917e-16$, where later fails to privilege the stronger market signal. The use of the low reconfiguration criterion means that adaptability between the new technological islands and the existing technologies is low which reduces significantly performance of Common Unknown and Trial and Learning ($M = 4161.5$, $SD = 4422$), $t(40) = 10.5$, $P^{****} = 1.4681e-14$. Technology Push ($M = 1786.2$, $SD = 3131.2$), $t(40) = 12.3$, $P^{****} = 4.1161e-16$, and Random Strategy ($M = 489.7$, $SD = 1001.9$), $t(40) = 13.5$, $P^{****} = 1.8945e-16$ have low performance in case of known environment with stable market signals and low technological compatibility.

Scenario 2 represents a configuration when Technology push ($M = 106.5$, $SD = 379.9$) approach has the best performance. The use of average capacity to combine technological elements slowed down the performance of Common Unknown strategy because

the costs of technological configuration were high ($M = 106.55$, $SD = 379.9$), $t(100) = 2.9$, $P^{****} = 0.0045$. The low speed of market renewals, low probabilities of market existence and unknown type of the environment decreased the performance of Market Pull strategy ($M = 94.5$, $SD = 335.6$), $t(100) = 3.1$, $p^{***} = 0.0022$. Moreover, high adaptation costs for further market explorations prevented Trial and Learning from winning ($M = 89.9$, $SD = 356.3$), $t(100) = 3.1$, $p^{***} = 0.020$.

As the results of **Scenario 3** shows (see Appendix C), there is a significant difference for Trial and Learning strategy ($M = 52575.9$, $SD = 28449.1$) in unknown environment with average speed of market renewals and high path dependency. Rather high technological compatibility privileges patent design high path dependency impede Common Unknown $M = 5874.1$, $SD = 3225.7$) from winning $t(100) = 16.3$, $P^{****} = 3.9655e-30$. Market Pull ($M = 18627.3$, $SD = 19653.9$), $t(100) = 9.8$, $p^{****} = 2.0333e-18$ fails since it doesn't take into account path dependency. Technology push ($M = 15598.2$, $SD = 143443.2$), $t(100) = 11.6$, $p^{****} = 1.7395e-22$ and Random strategy ($M = 846.1$, $SD = 1414.2$), $t(100) = 18.2$, $p^{****} = 2.3476e-33$ performances are significantly lower.

In the case of multiple low and dynamic market signals with high technological compatibility and path dependency (**Scenario 4**), Common unknown strategy has higher profit ($M = 9331.7$, $SD = 5103.2$) than market pull ($M = 5874.1$, $SD = 3225.7$), $t(100) = 5.7$, $P^{****} = 4.6355e-08$, technology push ($M = 2699.9$, $SD = 3555.9$), $t(100) = 10.7$, $p^{****} = 8.2318e-21$, trial and learning ($M = 5972.6$, $SD = 4009.9$), $t(100) = 5.2$, $p^{****} = 5.8140e-07$ and random ($M = 493.2$, $SD = 1503.1$), $t(100) = 16.6$, $p^{****} = 1.8384e-32$ strategies. These results are significant at the $p = 0.001$ level.

5. Findings

5.1. Conditions of strategies applicability

The simulation results confirm that in scarcely innovative environments the market pull strategy (Scenario 1) is superior when there are dominant markets signals. This model is compliant with the literature findings and confirms that market pull is relevant for the environment with reliable, high market signals. The technological compatibility is less important or difficult to establish in this case and one can account for integral architectures. We define the technologies that are not easily compatible as “segregative”, meaning that they cannot easily incorporate new functions and be combined with other technologies (interdependencies are expensive to design), learning does not occur (Table 3).

The similar trend is observed in Trial and Learning strategy (Scenario 3), which is based on market signals as well. Though, Trial and Learning is relevant in the dynamic unknown environments market signals are weaker, speed of market renewal is higher and therefore learning process becomes crucial and path dependency actually determines how the learning path following the trial exploration. In this case technological compatibility is more important; this strategy is limited when the technological character is segregative. Technologies have to be more flexible to easily integrate new functions – “aggregative” technological character. In case of aggregative technological character the costs of reconfiguring

technological parameters are low – modular architecture might be thought. Once technology is aggregative, Trial and Learning dominates Market Pull, which is compliant with the existing literature. The criterion of technological aggregativity was revealed as an important one for strategies selection in dynamic unknown environments.

For instance, technology push (Scenario 2) confronted with dynamic environments seeks for high technological compatibility and its value but does not include market signals at the beginning of exploration. Common unknown strategy (Scenario 4) appears to be beneficial ones the markets signals are weak but multiple and dynamic, technologies are aggregative meaning that they are flexible and can easily incorporate new functions. The adaptability costs are low.

The model endeavor that two contingent criteria are important for strategies selection: the existence of market signals and its strength and the technological systems that are more or less segregative. The two contingent criteria of “market signals stability” and the degree of “technological aggregativity” are formulated as the combinations of the most important criteria from strategies scenarios. The model shows that they influence at most strategies performance (see fig. 3 and table 4).

		Type of Environment C_5	
		Unknown	Known
Market Signals Stability	Stron	Markets C_1 & C_2 & C_3 High, stable market Signals with high speed of market renewal	Market Pull Technological compatibility is low C_7 , Path dependence – no relevant C_6
		Average, multiple market signals with average speed of market renewal	Trial and learning Technological compatibility is average C_7 and strong path dependency C_6
		Low, multiple market signals in average speed of market renewal	Common Unknown Technological compatibility is high C_7 and average path dependency C_6
	Weak	Weak market signals and low market speed renewal	Technology Push Technological compatibility is average, Path dependence – no relevant C_6
		Aggregative Technologies	Segregative Technologies

Table 3 Conditions of strategies higher performance

5.2. Towards technological platform design: on the notion of aggregativity

The findings reveal that the technological platform design is relevant for the novel and unknown environments where reliable market signals are absent and technological systems are aggregative. Moreover markets signals should be multiple and dynamic. Trial and Learning is relevant for platform design when a trial market can be identified and the developed path dependent technology can be flexible to “aggregate” emerging markets complementarities. Common

unknown is advantageous for platform building when multiple market signals drive the aggregative technologies exploration through interdependencies creation (Fig. 1).

Both common unknown and trial and learning strategies lead to develop a technological platform that addresses variability of market complementarities and need to incorporate the logic of market evaluation when uncertainty is high. This development cannot adapt the criterion of more profitable market or highly performing technology since it seeks for a technological core suitable for newly emerging markets and the level of unknown is high. This, in order to account for platform, the development should be

pursued when the uncertain environments are characterized by the absence of reliable market signals but the high probability of their emergence in the future (multiple signals).

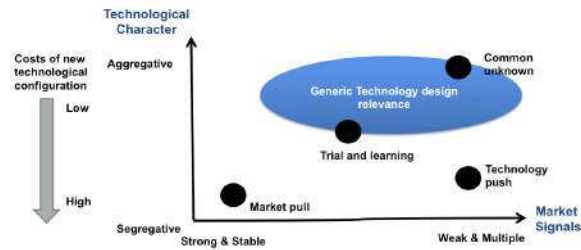

Figure 1 Conditions of strategies applicability

The critical parameter for technological platform success is an aggregativity of the emerging technological systems. Our definition of **aggregativity** corresponds somehow to the definition of (Wimsatt, 2000), who determines aggregativity as non-emergence of a system property relative to properties of its parts. Aggregativity attempts to “bring different things together into total, whole mass or sub-total, forming a total”. In technological context, aggregativity corresponds to the technological ability to integrate new features by combining technological building blocks with lower resources.

For instance, the industrial environment of electronic industry appears to be fast-paced, highly dynamic, attempting to propose new radical innovation and create new technologies, new products to ensure their long-term growth. This industry is driven by high competition, explicit needs for technological innovations and cost reduction. To pursue easier integration and design flexibility within complicated supply chain and product generation change, industry is become more modular and standardized. The industry aims to preserve its capacity to mix and match new knowledge areas and technologies to diversify their portfolios and thus, companies aim to presume their aggregativity level.

6. Contribution and discussion

6.1. Theoretical and managerial contribution

Great need of successful innovative solutions to justify high investments in R&D and manufacturing requires exploration of both markets and technologies at the earliest stages of development (Backman et al., 2007). This work aimed to investigate the conditions which lead to a successful management of double unknown and technological platform design that is capable to build value across different market areas.

The model that takes into account novel environments has been developed and a simulation analysis has been conducted to determine the contingent criteria. The proposed in this paper model incorporates the evolving in time environments, deals with interdependencies creation. It aims to investigate

performance and conditions of different strategies in the situation where the industrial dynamic has the same order of magnitude as the time of development. Given the high turbulence of the scenarios, the search strategies in this paper are less powerful than in complexity type of models. One of the implications of the model for managerial decision-making is concerned with the nature of uncertainty and associated environments that influence the strategies selection.

Our findings propose the contingent criteria that determine strategies’ applicability in highly uncertain environments. They provide important insights to practitioners in the process of managerial strategies selection. The identified here conditions lead to clarify the dominance of certain strategies in respect of the various industrial dynamics (Farr & Fischer, 2007). For instance, common unknown could account for higher performance in unknown environment of the semiconductor industry and market pull strategy could lead to higher results in integrated automotive industry when market needs are clearly defined. While the importance of market character was obvious for the strategies selection, the revealed by this work technological character appears to be crucial while pursuing multiple technological and market exploration in novel environments.

The aggregative character appears to be crucial to account for higher genericity. For instance, the industrial structure of semiconductors permits them to account for highly modular technologies, which could appropriate the increasing number of function with controlled costs. On the contrary, the segregative industries, like traditional automotive sector, are limited in their way of incorporating new functions and easily positioning on new markets. When the industry appears to be segregative, the design of technological platform appears to be more challenging and often not pertinent. The defined contingent criteria are not just the evaluation criteria on whether the platform design can be pursued. They can be considered as an opportunity for action: *i.e.*, certain technological characteristics are more segregative than others, so may be one can consider how to change them. In this perspective, there exist more explorations of the aggregative nature within the semiconductor industry. The technological components became cheaper, more compatible and the interdependencies are easier to design. The companies are even proposing to the customers to build their own electric vehicles in couple of hours, which completely change the nature of the technological development within the industry.

The results indicate that the technological platform design models are more beneficial when companies are searching for competitive advantages in long term. It was shown that market pull often dominates initially but their performance decreases drastically after third time period when the environment is unknown.

This work provides important managerial recommendations for practitioners attempting to explore both new uses and technological phenomena, which is especially relevant for turbulent environment and high rate of competition in high tech industries (Duysters & Man, 2003; Tierney et al., 2012).

Moreover, it contributes to the field of innovation management on the efficient benefits delivery from a multiple project perspectives.

6.2. Further research and limits

The simulation model constructed in this work compares strategies performance. The advantages of the proposed model are dynamics of market signals, ability to model technological and market interdependencies, novel type of environments and their evolution in time.

The results obtained through simulation invite to model closely the relations between the environments and the undertaken strategies that will allow gaining new insights and achieving more context-specific results. In this matter the model might incorporate more sophisticated environments by using the data from practical cases. Moreover, following every time period, market re-identification can be added. The current version of the model only comprises new market generation and their extinction when the market lottery is unfavorable. The existing markets updates including their type, the level of uncertainty, the associated costs could be considered after each time period to account for more realistic environment. In addition, the competing technologies could be added. In the current version each function can be addressed only by one technology. Further research will attempt to overcome the main limitations of the model by using the larger samples. Using a data corresponding to the real populations could provide important insights.

The defined criteria for technological platform design invite to reconsider the decision-making criteria in case of double unknown and further work will be undertaken to properly define revenue models suitable for platforms and generic technologies development.

In general, the transversal nature of technological platform exploration poses challenges on their governance. Role of different stakeholders including associated business units, clients need to be considered in order to clarify the form of business model innovation suitable for generic technologies exploration. Further work is required to establish the role of managers able to successively estimate the external contingent criteria and implement relevant strategies to pursue exploration in double unknown. These research avenues should bring to larger application area of business models that deal with novel and unknown environments and adjust the model.

7. References

- Akao, Y. (1990) *Quality function deployment: integrating customer requirements into product design*: Productivity Press.
- Backman, M., Börjesson, S. and Setterberg, S. (2007) Working with concepts in the fuzzy front end: exploring the context for innovation for different types of concepts at Volvo Cars. *R&D Management*, **37**, 17-28.
- Baldwin, Y. C., Clark B. K. . (1997) Managing in an Age of Modularity. *Harvard Business Review*.
- Baldwin, Y. C., Clark B. K. . (2006) Modularity in the design of complex engineering systems. Book chapter in Complex Engineering systems: Science meets technology. In: Ali Minaei, D. B. a. Y. B. Y., ed. *New England Complex System Institute Series on Com-plexity*. New York: Springer-Verlag.
- Beach, L. R. and Mitchell, T. R. (1978) A contingency model for the selection of decision strategies. *Academy of Management Review*, **3**, 439-449.
- Brem, A. and Voigt, K. I. (2009) Integration of market pull and technology push in the corporate front end and innovation management—Insights from the German software industry. *Technovation*, **29**, 351-367.
- Caetano, M. and Amaral, D. C. (2011) Roadmapping for technology push and partnership: a contribution for open innovation environments. *Technovation*, **31**, 320-335.
- Caldart, A. A. and Ricart, J. E. (2004) Corporate strategy revisited: a view from complexity theory. *European Management Review*, **1**, 96-104.
- Camerer, C. and Weber, M. (1992) Recent developments in modeling preferences: Uncertainty and ambiguity. *Journal of risk and uncertainty*, **5**, 325-370.
- Chapman, C. and Ward, S. (2003) *Project risk management: processes, techniques and insights*: Wiley.
- Chidamber, S. R. and Kon, H. B. (1994) A research retrospective of innovation inception and success: the technology-push, demand-pull question. *International Journal of Technology Management*, **9**, 94-112.
- Christensen, C. M. (1997) *The innovator's dilemma: when new technologies cause great firms to fail*: Harvard Business Press.
- Christensen, C. M., Suárez, F. F. and Utterback, J. M. (1998) Strategies for survival in fast-changing industries. *Management Science*, **44**, S207-S220.
- Das, S. S. and Van de Ven, A. H. (2000) Competing with new product technologies: a process model of strategy. *Management Science*, **46**, 1300-1316.
- Davis, J. P., Eisenhardt, K. M. and Bingham, C. B. (2007) Developing theory through simulation methods. *Academy of Management Review*, **32**, 480-499.
- De Meyer, A., Loch, H. C., Pitch, T. M. . (2002) Managing project uncertainty: From Variation to Chaos. *MIT Sloan Management Review*, **43**, 60-67.
- Duysters, G. and Man, A. P. (2003) Transitory alliances: an instrument for surviving turbulent industries? *R&D Management*, **33**, 49-58.
- Eisenhardt, K. M. (1989) Making fast strategic decisions in high-velocity environments. *Academy of Management Journal*, **32**, 543-576.
- Elmqvist, M. and Le Masson, P. (2009) The value of a 'failed' R&D project: an emerging evaluation framework for building innovative capabilities. *R&D Management*, **39**, 136-152.
- Farr, C. M. and Fischer, W. A. (2007) Managing international high technology cooperative projects. *R&D Management*, **22**, 055-068.
- Gavetti, G., Levinthal, D. A. and Rivkin, J. W. (2005) Strategy making in novel and complex worlds: the power of analogy. *Strategic Management Journal*, **26**, 691-712.
- Gawer, A. (2009) *Platforms, Markets and Innovation*: Edward Elgar Publishing.
- Gawer, A. a. C., M. A. . (2008) How companies become platform leaders. *MIT Sloan Management Review*, **49**, 28-35.
- Goktan, A. B. and Miles, G. (2011) Innovation speed and radicalness: are they inversely related? *Management Decision*, **49**, 533-547.
- Gunther McGrath, R. and Nerkar, A. (2004) Real options reasoning and a new look at the R&D investment strategies of

- pharmaceutical firms. *Strategic Management Journal*, **25**, 1-21.
- Harrison, J. R., Lin, Z., Carroll, G. R. and Carley, K. M. (2007) Simulation modeling in organizational and management research. *Academy of Management Review*, **32**, 1229-1245.
- Hill, C. W. and Jones, G. R. (2007) *Strategic Management: An Integrated Approach*: CengageBrain. com.
- Hirtz, J., Stone, R. B., McAdams, D. A., Szykman, S. and Wood, K. L. (2002) A functional basis for engineering design: reconciling and evolving previous efforts. *Research in engineering Design*, **13**, 65-82.
- Huchzermeier, A. and Loch, C. H. (2001) Project Management Under Risk: Using the Real Options Approach to Evaluate Flexibility in R... *D. Management Science*, **47**, 85-101.
- Jaafari, A. (2001) Management of risks, uncertainties and opportunities on projects: time for a fundamental shift. *International Journal of Project Management*, **19**, 89-101.
- Kaplan, S. and Tripsas, M. (2008) Thinking about technology: Applying a cognitive lens to technical change. *Research Policy*, **37**, 790-805.
- Kauffman, S. (1993) *The origins of order: Self organization and selection in evolution*: Oxford University Press.
- Kokshagina, O., Le Masson, P., Weil, B. and Coge, P. (2013) Platform emergence in double unknown (technology, markets): common unknown strategy. In: Çetindamar, D., Daim, T., Başoğlu, N. and Beyhan, B., eds. *Strategic planning decisions in the high tech industry*. London: Springer.
- Lancaster, K. J. (1966) A new approach to consumer theory. *The journal of political economy*, **74**, 132-157.
- Lant, T. K. and Mezias, S. J. (1990) Managing discontinuous change: A simulation study of organizational learning and entrepreneurship. *Strategic Management Journal*, **11**, 147-179.
- Le Masson, P., A., H. and Weil, B. (2009) Platforms for the design of platforms: collaborating in the unknown. In: Gawer, A., ed. *Platforms, Markets and Innovation*: Edwar Elgar Publishing Limited, 396.
- Lenfle, S. (2011) The strategy of pallel approaches in projects with unforseeable uncertainty: The Manhattan case in retrospect. *International Journal of Project Management*, **29**, 359 – 373.
- Levinthal, D. A. (1997) Adaptation on rugged landscapes. *Management Science*, **43**, 934-950.
- Linton, J. D. and Walsh, S. T. (2008) Acceleration and extension of opportunity recognition for nanotechnologies and other emerging technologies. *International Small Business Journal*, **26**, 83-99.
- Loch, C. H., Solt, M. E. and Bailey, E. M. (2008) Diagnosing Unforeseeable Uncertainty in a New Venture*. *Journal of Product Innovation Management*, **25**, 28-46.
- Lynn, G., Morone, J. and Paulson, A. (1996) Marketing and discontinuous innovation: the probe and learn process. *California Management Review*, **38**.
- McGrath, R. G. (1997) A real options logic for initiating technology positioning investments *Academy of Management Review*, **22**, 974-996.
- McGrath, R. G. (2001) Exploratory learning, innovative capacity, and managerial oversight *Academy of Management Journal*, **44**, 118-131.
- McGrath, R. G. and MacMillan, I. C. (1995) *Discovery driven planning*: Wharton School, Snider Entrepreneurial Center.
- Mitchell, G. R. and Hamilton, W. F. (2007) Managing RD as a strategic option. *Research-Technology Management*, **50**, 41-50.
- Mowery, D. and Rosenberg, N. (1979) The influence of market demand upon innovation: a critical review of some recent empirical studies. *Research Policy*, **8**, 102-153.
- Mu, J., Peng, G. and MacLachlan, D. L. (2009) Effect of risk management strategy on NPD performance. *Technovation*, **29**, 170-180.
- O'Connor, C. G. (2006) Organizing for Radical Innovation: An Exploratory Study of the Struc-tural Aspect of RI Management Systems in Large Established Firms. *The Journal of Product Innovation Management*, **23**, 475-497.
- Oriani, R. and Sobrero, M. (2008) Uncertainty and the market valuation of R&D within a real options logic. *Strategic Management Journal*, **29**, 343-361.
- Perlitz, M., Peske, T. and Schrank, R. (1999) Real options valuation: the new frontier in R&D project evaluation? *R&D Management*, **29**, 255-270.
- Rivkin, J. W. (2000) Imitation of complex strategies. *Management Science*, **46**, 824-844.
- Sanchez, R. (2004) Creating modular platforms for strategic flexibility. *Design Management Review*, **15**, 58-67.
- Sommer, S. C. and Loch, C. H. (2004) Selectionism and learning in projects with complexity and unforeseeable uncertainty. *Management Science*, **50**, 1334-1347.
- Sommer, S. C., Loch, C. H. and Dong, J. (2009) Managing complexity and unforeseeable uncertainty in startup companies: An empirical study. *Organization Science*, **20**, 118-133.
- Sting, F., Mihm, J. and Loch, C. (2011) Collaborative search.
- Tierney, R., Hermina, W. and Walsh, S. (2012) The pharmaceutical technology landscape: A new form of technology roadmapping. *Technological Forecasting and Social Change*.
- Vergne, J. P. and Durand, R. (2010) The missing link between the theory and empirics of path dependence: conceptual clarification, testability issue, and methodological implications. *Journal of management Studies*, **47**, 736-759.
- Walsh, S. T., Kirchoff, B. A. and Newbert, S. (2002) Differentiating market strategies for disruptive technologies. *Engineering Management, IEEE Transactions on*, **49**, 341-351.
- Walsh, S. T. and Linton, J. D. (2011) The strategy-technology firm fit audit: a guide to opportunity assessment and selection. *Technological Forecasting and Social Change*, **78**, 199-216.
- Wimsatt, W. C. (2000) Emergence as non-aggregativity and the biases of reductionisms. *Foundations of Science*, **5**, 269-297.
- Wirtz, B. W., Mathieu, A. and Schilke, O. (2007) Strategy in high-velocity environments. *Long Range Planning*, **40**, 295-313.
- Zhou, K. Z. and Wu, F. (2010) Technological capability, strategic flexibility, and product innovation. *Strategic Management Journal*, **31**, 547-561.

Appendix A. Environments and strategies description

Criteria	Variables	Comments
Probability of markets existence (C ₁)	High Low	Defines type of markets: unknown (with probability p<10%) or dominant (p> 90%)
Market signals dynamic (C ₂)	Stable Dynamic	Determined by the market probability evolution at each time period (t_i)
Speed of Market Renewal (C ₃)	Fast Slow Stable	Three possible scenarios: (1) Fast renewal – after each t_i , M_i (created) > M_j (addressed). This scenario represents a thriving economical environment (2) Stable – after each t_i , M_i (created) = M_j (addressed). This scenario is a reflection of a stable economy where the demand is stable. (3) Slow renewal – after each t_i , M_i (generated) < M_j (addressed). This is the case of a suffering economy where clear client demand is disappearing in a way that risk and uncertainty are increasing.
Type of environment (C ₄)	Dominant Unknown	(1) Dominant environment (DE) : The dominant design is characterized by the main T^* existence that addresses the maximum number of F_i . After each t_i , new F_i will be most likely addressed by T^* (meaning that the technological effort needed to address F_i by using T^* is lower than with the others T_j). (2) Unknown environment (UE) is characterized by the multiplicity of technological candidates T_i , where each one addresses very few functions F_i . The fact that there are many technologies implies the existence of even more unknown technologies since all technologies are linked to each other with unknown yet edges. In an unknown environment there is very little information about markets.
Ration of dominant markets vs. unknown (C ₅)	Dominant vs. Unknown	The ratio of dominant design or unknown environment defines the environment type. If the ratio of dominant design markets is more than 5% and unknown markets less than 1% - the environment is considered to be dominant .
Path Dependency (C ₆)	Not applicable High Low	Technologies are path dependent. In this model path dependency influences the distance in between the edges (High path dependency means high adaptability in between the edges).
Capacity to recombine technological elements – defined through cost of technological reconfiguration (C ₇)	Low Medium Low Medium High High	These rules define the capacity to recombine the technological elements. This capacity in the model is defined through costs of technological reconfiguration. The following reconfiguration criteria to determine the value: 1) Low: as an aggregated cost of technological elements 2) Medium Low: less than as an aggregated cost of technological elements 3) Medium High: as a maximal cost of technological elements 4) High: as a minimal cost of technological elements
Budget reallocation	YES NO	Refers to the remaining budget reallocation in between t_i

Strategies of technology-market exploration

<p>Market Pull</p> <p>This strategy is modeled as:</p> <ol style="list-style-type: none"> 1. Identify the markets M_i with higher potential benefit. 2. Define what are the T_i to develop to address these markets under budget constraints – technology creation. <p>plays one market with higher potential benefit and develops a solution for it.</p>
<p>Technology Push</p> <p>The choices are based solely on the technological portfolio. This strategy is modeled in the following way:</p> <ol style="list-style-type: none"> 1. Identify less risky edges to develop and abandon the development of the most expansive edges. 2. Develop all the selected edges (T_i) regarding budget constraints 3. Verify if any of the markets can be addressed.
<p>Trial and learning</p> <p>The first phase consists in selecting a trial project that would help to reduce risks and uncertainty and to build a platform to address various market options:</p> <ol style="list-style-type: none"> 1. Define a trial market M^* with higher expectancy 2. Develop required T_i to address trial market M^*. <p>The second phase consists in reusing the trial as a platform in order to address other market derivatives.</p> <ol style="list-style-type: none"> 3. Identify the less risky edges with maximum connectedness 4. Develop the edges using the remaining budget.

Common unknown

This strategy aims at building a platform core as an object to conceive:

1. Determine the unknown T_i (edge) with the *highest potential*.
2. Develop the edge with highest potential – platform core
3. Reuse the obtain platform core to address market derivatives, respecting the budget constraints.

Appendix B. Simulation

Figure 2 Simulation algorithm

Appendix C. Simulation results

This section represents the results of the simulation and t -test findings. T-tests were performed for the last time period $t=5$. For each scenario 5 time periods were modeled and each time period represents the mean and standard deviations of 40 trials for Scenario 1 and 100 trials for the other scenarios.

Scenario 1. Market Pull (MP) M = 23785.2, SD = 10842.514

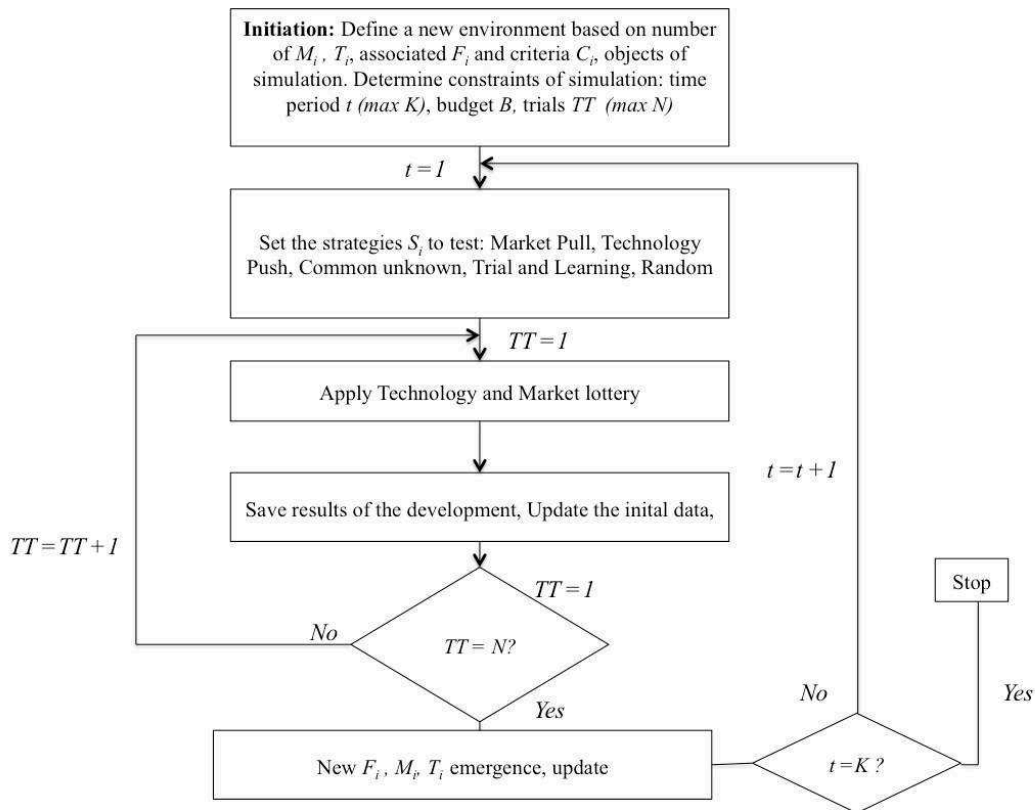
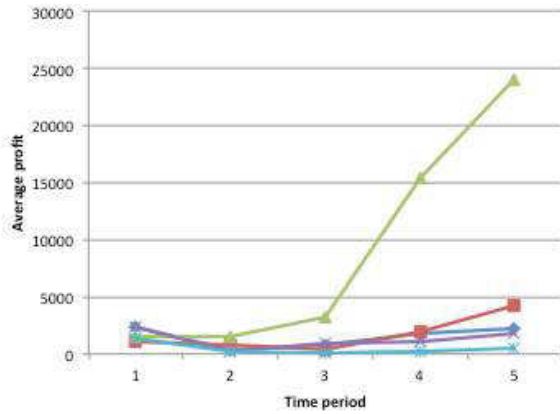

Figure 3 Scenario 1: Market Pull

MP - CU (M = 2188.5, SD = 3176.483)	MP - TP (M = 1786.25, SD = 3131.206)	MP - TL (M = 4161.525, SD = 4422.0513)	MP - RS (M = 489.675, SD = 1001.875)
P**** = 7.8917e-16 t(40) = 12.0895 DF = 45.6457	P**** = 4.1161e-16 t(40) = 12.3385 DF = 45.4602	P**** = 1.4681e-14 t(40) = 10.5991 DF = 51.6249	P**** = 1.8945e-16 t(40) = 13.5309 DF = 39.6659

Scenario 2. Technology push (TP) M = 329.77, SD = 674.803

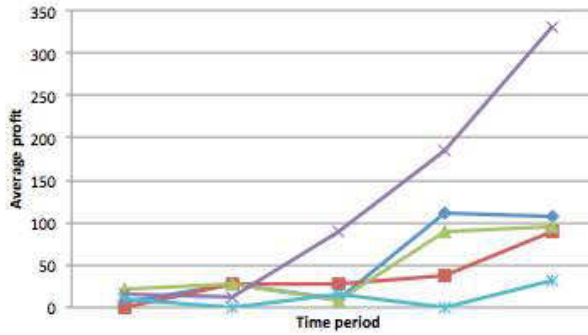

Figure 4 Scenario 2: Tehnology Push

TP - CU (M = 106.55, SD = 379.926)	TP - MP (M = 94.55, SD = 335.591)	TP - TL (M = 89.86, SD = 356.327)	TP - RS (M = 30.97, SD = 229.113)
P*** = 0.0045 T(100) = 2.8825 DF = 165.0329	P*** = 0.0022 T(100) = 3.1211 DF = 145.1474	P*** = 0.0020 T(100) = 3.1439 DF = 150.2263	P**** = 5.2583e-05 T(100) = 4.1929 DF = 121.5257

Scenario 3. Trial and Learning (TL) M = 52575.93, SD = 28449.159

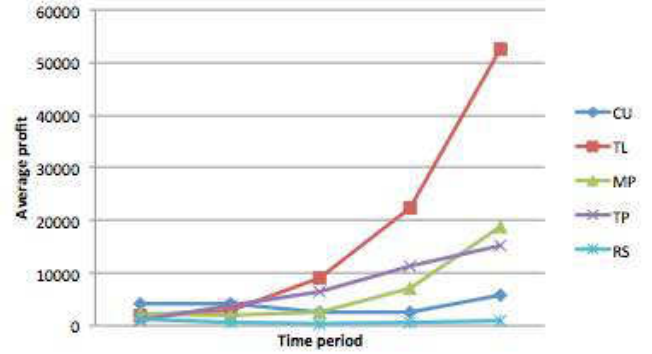

Figure 5 Scenario 3: Trial and learning

TL - CU (M = 5874.06, SD = 3225.716)	TL - TP (M = 15598.18, SD = 143443.235)	TL - MP (M = 18627.28, SD = 19653.878)	TL - RS (M = 846.15, SD = 1414.27)
P**** = 3.9655e-30 T(100) = 16.3114 DF = 101.5451	P**** = 1.7395e-22 T(100) = 11.6062 DF = 146.275	P**** = 2.0333e-18 T(100) = 9.8180 DF = 175.967	P**** = 2.3476e-33 T(100) = 18.1608 DF = 99.489

Scenario 4. Common unknown (CU) M = 9331.74, SD = 5103.216523

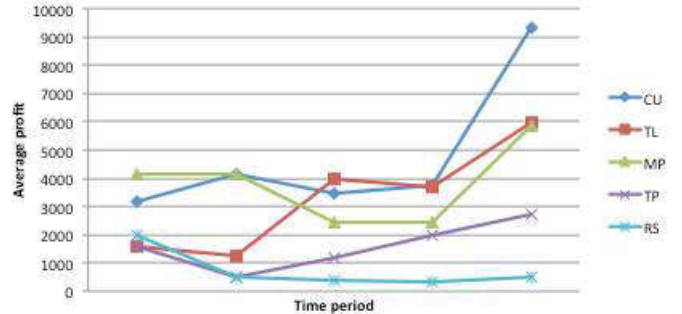

Figure 6 Scenario 4: Common unknown

CU - MP (M = 5874.06, SD = 3225.716)	CU - TP (M = 2699.99, SD = 3555.887)	CU - TL (M = 5972.64, SD = 4009.917)	CU - RS (M = 493.18, SD = 1503.134)
P**** = 4.6355e-08 T(100) = 5.7273 DF = 167.2194	P**** = 8.2318e-21 T(100) = 10.6621 DF = 176.7946	P**** = 5.8140e-07 T(100) = 5.1757 DF = 187.5091	P**** = 1.8384e-32 T(100) = 16.6139 DF = 116.0497

Paper III

**How design theories enable
the design of generic
technologies: notion of
generic concepts and
genericity improvement**

HOW DESIGN THEORIES ENABLE THE DESIGN OF GENERIC TECHNOLOGIES: NOTION OF GENERIC CONCEPT AND GENERICITY IMPROVEMENT

Olga KOKSHAGINA (1,2), Pascal LE MASSON (1), Benoît WEIL (1), Patrick COGEZ (2)
1: Mines ParisTech, France; 2: STMicroelectronics, France

ABSTRACT

Generic technologies enable to create benefits across wide range of industrial applications. Though providing important insights on generic technologies commercialization, less attention was paid to generic technologies creation. Then, is it possible to design directly generic technologies? Can the intention to build genericity be expressed ex ante? The proposed study indicates that formal design theories provide powerful mechanism of genericity construction when the environments are initially fixed and partially unknown. It is demonstrated that starting point to design generic technology is a generic concept. In addition to a concept definition proposed by C-K theory, the descriptors associated to the domain of existence were added. The generic concept targets the existence domains that are not reduced to one solution but several of them both known or partially unknown. Moreover, it is highlighted that different descriptors of existence domain can lead to various genericity levels. The economic reasoning behind the genericity building provides insights on the dynamics of engineering systems.

Keywords: design theories, generic technology, genericity, generic concept, genericity building, existence domain, descriptors of existence domain

Contact:
Olga Kokshagina
Mines ParisTech
Center for Management Science CGS
Paris
75272
France
olga.kokshagina@mines-paristech.fr

1 INTRODUCTION

Technology management stresses the importance of generic technology (GT) development. Numerous studies have attempted to understand the value of general-purpose technologies from historical (Landes, 1990, Moser and Nicholas, 2004), economical (Lipsey et al., 2005), sociological perspectives (Powell, 1987). The investment in GT development is recognized as one of the instruments to deal with high marketing and technological uncertainty. Successful examples of GTs exploration are demonstrated through the analysis of electricity, semiconductors, steam engines, nanotechnologies (Edquist and Henrekson, 2006, Rosenberg and Trajtenberg, 2004). GT signifies breadth of application areas (Bresnahan and Trajtenberg, 1995) and is characterized by its technological dynamism. To account for GT, one has to design a platform that by definition incorporates the underlying core technology and facilitates development of a stream of market derivatives (Gawer, 2009). These platforms support generic technologies development, which create leveraged growth, market variety and high benefits. Various scholars investigated the impact of GT development *ex post* (Edquist and Henrekson, 2006). Providing important insights on GT commercialization (Maine and Garnsey, 2006), market complementarities development, less attention was paid to generic technology creation.

The goal of this paper is generic technology creation and more precisely genericity building. Following evolutionary approaches of technological change (Nelson and Winter 1982, Dosi 1982) that deal with path dependencies and consequent trial exploration, GT emergence can be achieved using trial and error mechanisms (Miyazaki, 1994). Generic platform development can be build upon a trial, where trials are often selected from the known list of alternatives. Then, is it possible to directly design generic platforms? Can the intention to build genericity be expressed *ex ante*? The aim of the current work is to understand whether there exists a design process aiming to build genericity.

Dealing with the issue of GT design, formal design theories are used in the paper. The study shows that formal design theories provide powerful mechanism of genericity building when the environments are initially fixed or still unknown. Literature review enables to highlight the importance of descriptors of existence domain to construct genericity in unknown. The introduced generic concept targets the existence domains that are not reduced to one solution but several of them that can be known or partially unknown. To demonstrate the possible extensions of applications range, different forms of domain of existence are used: the formal mathematical models and engineering models. The most recent C-K Design Theory is used to illustrate genericity building.

2 LITERATURE REVIEW: DESIGN FOR GENERIC TECHNOLOGIES: GENERICITY AND GENERICITY BUILDING

2.1 Generativity and genericity of design theories

Then, what is genericity and how formal design theories account for genericity building? Formal design theories aim to reach mathematical and logical rigor both to formulate hypothesis and to prove their findings (Hatchuel et al., 2011). The following theories were selected for the study: General Design Theory, Axiomatic Design, Coupled Design Process, Infused Design, Concept-Knowledge design theory. It was shown that design theories are theories of generativity (Hatchuel et al., 2011). Generativity is defined as a capacity to describe the set of various alternatives; it is an “ability to produce novel design proposals”. Design theories had to think beyond pure combinatorial processes and explore different forms of generativeness: dynamic transformations, adaptations, hybridizations, discovery and renewal of objects (Hatchuel et al., 2011). Generativity enables new objects creation with desired properties and ensures new knowledge exploration for their existence.

Genericity seeks to integrate economic reasoning, enables the economy of knowledge expansions for new objects creation. It aims to obtain several solutions at once. Genericity is defined as a capacity to propose generic technological core that address set of environments in generative space. Genericity can be defined over generativity. Then, how was genericity tackled by design theories so far?

2.2 Design Theories and genericity

The design theories don't explicitly discuss technologies and genericity, but design solutions (Pahl and Beitz, 1995). In certain design theories, one design solution has to be robust to several known environments. The several environments, for which a solution has to be validated, is called here an existence domain. There are certain forms of genericity and technologies. In order to distinguish these

notions of genericity and technology treated by each theory, the analysis of formal models is needed. In the case of **General design theory (GDT)** (Yoshikawa, 1985) a design solution is an entity included in specifications and contains necessary manufacturing information (Reich, 1995). Entities are characterized through subsets that are either functions or attributes. The design process consists in designating a domain on the attribute concept space, which is included by that on a concept function space. The design process is limited to the combination of prescribed functions and structures following axioms of GDT. According to the theory, if the entity space has Hausdorff structure, we can address all the functional combinations. The problem appears when the space of attributes doesn't cover completely the set of functional combinations. Then Hausdorff correspondence is impossible to construct and all the functional combinations cannot be addressed.

It can be interpreted as a form of genericity associated to the set of functional combinations. The technology can be considered as the structure of attribute space available to address the function space in Table 1. The structure of entity space defines genericity. When structure of entity space has Hausdorff structure (ideal knowledge), maximum genericity can be obtained. If not, genericity can be conceived only according to certain subset of functions.

In **Axiomatic Design (AD)** (Suh, 1999) the design process occurred in physical domain and functional domain. The goal of the designer is to built mapping between functional requirements (FRs) in the functional domain and design parameters (DPs) of the physical domain by selecting proper DPs to ensure FRs. In the axiomatic approach design is controlled by two axioms of Suh: the independence and information axiom. By obtaining the decoupled diagonal matrix of FRs and DPs, one can address each function separately or developed DPs can be changed according to each function independently. If a matrix is decoupled then the designers will be able to reach all the functional combinations. So in AD genericity is constructed on the set of achievable functional requirements. The technology can be defined as the set of FRs and DPs relations in Table 1. The higher genericity is obtained when the relations in between DP and FRs are ensured by independency axiom and the matrix is diagonal.

Both GDT and AD provide tools that are quite powerful to design GT. The form of genericity does not pose any problems since the environments are considered to be known and predefined in advance by the entity space or functional combinations. Genericity is described by the extension of the existence domain, which is defined by the set of all possibly described environments.

The **Coupled design theory (CDP)** (Braha and Reich, 2003) offers the way to organize design process of functions and descriptions co-evolution by transition in 'closure' spaces. Creating functional or structural closures at each design step enables to integrate new knowledge and consider functions emergence from 'closure' spaces. It means that in between functions there are order relations. This theory formalizes exploration in partially unknown spaces and closure operators lead to conceive not just existing functions but also their proximal refinement. CDP enables to treat genericity beyond initial functional combinations. Genericity can be explained as functions and new words - future functions candidates. The higher genericity is achieved thanks to closure operators. CDP incorporates unknown environments by consideration of new words and provides the attributes to facilitate the generic concept definition. This theory enables to deal with **genericity induced by unknown** in Table 1. Yet, designed process is limited by pre-established closure spaces. The operators of transitions in closure spaces ensure genericity, but the exploration of new functional sets is limited by proximal closure operations. Technology is described as functional and structural descriptions.

Infused design (ID) (Shai and Reich, 2004) permits not only to create functions and organize explorations in closed space proximity like CDP, but to integrate new knowledge from other disciplines. In ID instead of looking for closure functions, the goal is the common representation composed of model type and terminology (M, T) that accommodates all the original ones. The ID privileges transformations of original into reference problems. These transformations are based on mathematical operations of duality, generality, and equivalence.

ID shows the possibility to construct genericity and not just to account for it. In ID the genericity can be defined as combination of classical genericity inside each problem and the form of genericity in between them. The first type of genericity is similar to the ones in CDP, AD and GDT. The second is ensured by transformation operators and brings the power of knowledge generation. For instance, duality operators enable the propagation of the previously unknown solution in between different domains. The nature of results is not known a priori. There is a form of **genericity induced by unknown that relies several knowledge domains**. Genericity construction is based on the operators and not defined over space. The existence domain is defined by the operators of propagation.

The knowledge circulation can provoke both new solutions and also new surprises and concepts (like face force discovery). The technology is the set of model type and terminology in each and across domains. Then, the genericity gain is ensured by obtaining generic solutions in each domain and their transfer across the disciplines using operators.

Table 1. Technology and genericity definitions in Design theories

	GDT	AD	CDP	ID	C-K
Technology	Structure of entity space	Set of FRs and DPs relations	Functional and structural descriptions	Set of models and terminology in each and across domains	Initial knowledge (K-space)
Genericity defined over extension domain	Functional combinations	Range of functional requirements	Functional combinations and new words	Within problems (discrete models) and duality across problems	K-reordering, Concepts
Genericity Improvement	Hausdorff measure	Diagonal matrix (independency)	Closure operations	Transformation operations	<i>Descriptors of existence domain</i>
Genericity by reference to a fixed referential			Genericity induced by unknown		
Defined over Space			Genericity operators		

Concept – Knowledge (C-K) design theory (Hatchuel and Weil, 2009) doesn't use mapping in between functions and attributes. It defines the design process as a continuous refinement of a concept described by various properties P_i that need to be met based on existing knowledge and producing new one. The design reasoning is based on the distinction and interaction in between two independent spaces: Concept (desired unknown) and Knowledge space (existing and available knowledge). In C-K the concept is defined as « There exists some object x for which a group of properties P_1, P_2, \dots, P_n are true in K » (Hatchuel and Weil, 2009) such that a concept is undecidable with respect to current K . According to C-K theory, creative design requires an expansive partition. This partition will enable creation of new attribute(s) P' that was not initially an attribute of x in K . This theory models the integration of new knowledge and connections in between knowledge disciplines through operators of knowledge disjunction ($K \rightarrow C$), conjunction ($C \rightarrow K$), and expansion ($C \rightarrow C, K \rightarrow K$) in Figure 1.

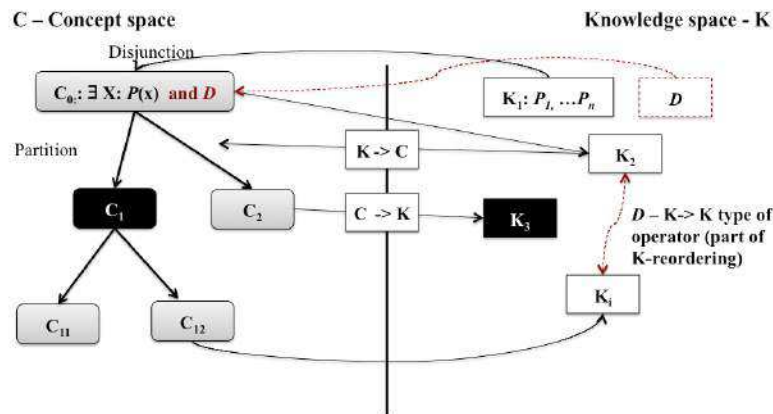

Figure 1: Generic extension in C-K theory

In C-K technology can be defined as the initial K-space. Genericity goes beyond the validation of *ex ante* targeted sets of specifications. It includes all the new objects generated by K-reordering (as well as new concepts), i.e. by combination of the newly designed object with the previously known objects, the combination of the new and the old knowledge. As in ID, genericity is based on genericity building operators. More precisely in C-K theory it depends on K-reordering, which is defined as the operation of propagation that follows the conjunction emergence ($C \rightarrow K$): this is the effect of the newly generated knowledge, coming from the unknown, on the K space. Genericity improvement in C-K appears to be linked to the expansion strategy: certain design can enable limited K-reordering – object identity preservation or the complete object reconstitution – object identity discussion.

To summarize, the existing theories give a tendency to predefine generic space that can be constructed

through combination of known and unknown. The different types of genericity were identified: genericity by reference to a fixed referential in known and genericity induced by unknown. In case of known environments, GDT and AD provide powerful solutions. For genericity in unknown, it has been demonstrated that the design theories evolution brings the possibility to reason on unknown yet environments (CDP, ID and C-K). Genericity is defined over existence domain and there are various forms of descriptors of existence domain for genericity building. Genericity can be analyzed as a Hausdorff measure in an entity space (GDT), as an hypercube in vector space of FRs (AD), as a set of closure operators (CDP) in Table 1. The most generative formal models lead to distinguish genericity defined over a fixed referential (entity space, functional space, closure space) or obtained by operators that help to propagate and hybridize the new into the old, beyond the new validated conjunction. These descriptors can be 1) deduced from existing knowledge (as in case of duality operator in ID) meaning that the rules of propagation exist and are used for knowledge propagation or 2) can be conceived during the exploration. Literature review reveals different genericity building descriptors but their contribution to acquired genericity can be demonstrated only when the results are obtained. Then, how these descriptors of existence domain influence genericity construction *ex ante*?

To tackle this question, it is important to properly introduce the notion of generic concept itself. A concept is called generic once it is valid for several environments. Obviously it should have an existence domain beyond a singleton and lead to explore multiple application areas. GT creation is often considered as progressive trial and error mechanism of genericity building. But can a generic concept be identified *ex ante* and how to ensure that it leads to GT creation?

In C-K if an initial concept $xP(x)$ is valid for multiple applications, the descriptors of existence domain (called here D) are already established. Following AD and GDT this concept is generic for multiple known applications. In ID and C-K there could be descriptors of multiple environments D , which, combined with the existing knowledge, could lead to new applications creation. Then, what is the form of D that leads to genericity creation? Can one account for genericity creation by adding D to the formulation of the initial concept: $xP(x)D$, Figure 1. It leads to formulate following research questions:

Q1: What is generic concept *ex ante*? How does genericity depend on the descriptors of existence domain D ? Furthermore, there should be a possibility to increase genericity.

Q2: How to account for higher genericity building?

To tackle identified research questions on genericity induced by the unknown, the Concept-Knowledge Design theory (Hatchuel and Weil, 2009) is used since it is independent from a particular engineering domain. The question of genericity improvement is tackled and different possibilities are indicated.

3 GENERIC CONCEPT AND GENERICITY BUILDING

The aim is to understand the mechanisms of expansive genericity. The work is conducted on modeling the necessary descriptors of existence domain. Following the previously defined hypothesis, a generic concept can be presented as $xP(x)D$. In C-K theory when one particular conjunction in space C is achieved, a new entity can be created P' . In K space propagation operators need to establish the relations in between P' and all the other knowledge entities K_1, K_2, \dots, K_n using the descriptors of existence domain d_1, d_2, \dots, d_n included in D . From one conjunction plenty of them can be obtained.

Example: For instance, while designing a new car breaking system for the new Volkswagen XYZ, the existence domain is reduced to one type of car and obtained genericity is zero. The rules of compatibility of a breaking system have to be compliant with Volkswagen XYZ and thus, considered to be known (D exists in K). Conversely, if one seeks to design a new breaking system that can be substituted to all the existing or not yet created car architectures, the compatibility rules are unknown. They have to be conceived during the exploration process (D is unknown).

Thus, generic power of concept is based on the association it creates in between new object and the elements of K basis. The two cases are examined: 1) $D \in K$ exists in initial knowledge basis, the descriptors of existence domain are fixed 2) $D \notin K$ has to be designed and is unknown in K .

3.1 Genericity building in case of existing descriptors of existence domain

To study the logic of genericity construction in case of existing descriptors of existence domain, the cases with mathematical and engineering knowledge structures are investigated.

Illustration 1: Mathematical knowledge structure – algebraic extensions

In mathematics various extension operators could be interpreted as design (Hatchuel et al., 2012). The main idea of field extensions is to start with a base field and construct a larger field that contains the base field and satisfies additional properties. In case of algebraic extensions knowledge basis K is defined and propagation rules are ensured by mathematical operations of addition and multiplication in Figure 2. To extend the field Q of rational numbers, the initial concept type $\exists X: f(x) = 0$ has to be solved. Variety of partitions can be obtained ensuring generativity of design space. For instance, taking $x^2-2=0$, a polynomial of Q with rational coefficients. The roots of $x^2-2=0 \notin Q$ – hence, there is an “unknown” object to conceive. It is possible to solve this equation by functional approximation. This algorithmic method allows to consequently build a $\sqrt{2}$ as a limit of a series of rationales. At the end a new $xP(x)$ solution is obtained – $\sqrt{2}$. Its creation doesn’t enable its compatibility with the field Q , since in Q there is a possibility to multiply and addition rational numbers only.

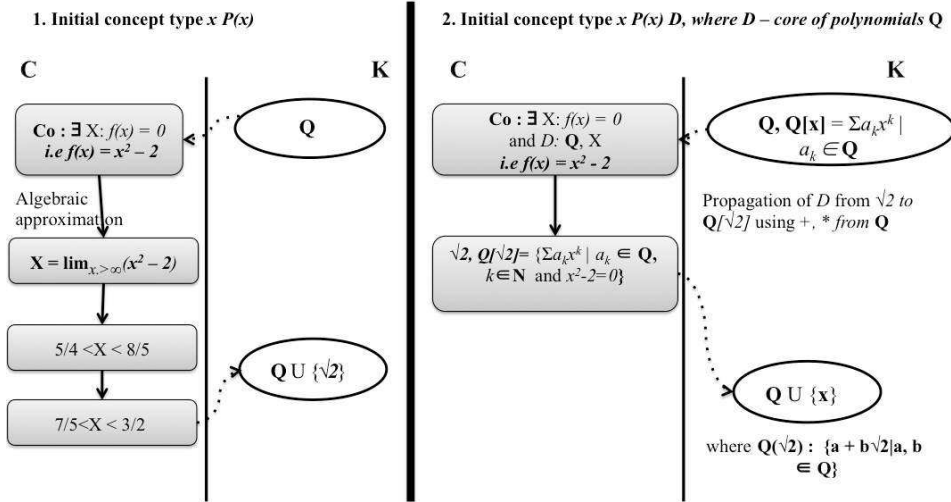

Figure 2. Algebraic fields expansion in C-K-theory

Following the theory of algebraic extensions (Bastida, 1984), another solution would be to find a non-zero polynomial type $\sum a_k x^k$ with $a_k \in Q$. The concept $\exists X: f(x) = 0$ contains directly D – a core of polynomials $Q[x] = \sum a_k x^k$ with $a_k \in Q$. The algebraic extensions lead to work on a concept $xP(x)D$. For instance, direct consideration of $\sqrt{2}$ from the field of real numbers R , enables to obtain solution. The obtained $\sqrt{2}$ can be propagated to new entities by combining the old Q with the new $\sqrt{2}$ through operations preserved from $Q[x]$. The descriptors D in this case are operators of addition and multiplication. It is important to underline that operators of multiplication and addition used to ensure knowledge propagation from Q to R exist in initial knowledge basis and preserved. Generic concept is obtained through propagation from $\sqrt{2}$ to $Q[\sqrt{2}]$ using these combinative operations. In the case of algebraic extension, descriptors of extension domain D are given at the beginning. For instance, this propagation also generates similar entities. For instance x^2-1 is equivalent to 1 because $x^2-1 = x^2-2 + 1$ and $x^2-2=0$ or equivalent to x^4-4x^2+5 as $x^4-4x^2+5 = (x^2-2)^2+1$. Adding directly an extension field $Q[x]$ to the field of rational number forms both a new solution $\sqrt{2}$ but also all the finite extensions of the field Q type $Q\{a+b\sqrt{2} | a,b \in Q\}$. The conjunction is made once all the rules of propagation are obtained. When D is added to the formulation of initial concept, it enables to obtain the set of solutions and not just a new number $\sqrt{2}$.

Illustration 2: Engineering knowledge structure – Steam engines development

To investigate the generic concept identification with engineering knowledge structure, steam engines example is chosen. Steam engine is recognized as a general purpose technology (Rosenberg and Trajtenberg, 2004) used in various domains as reciprocating pumps, spinning mules, driving machinery in factories, mines, propelling transports.

In 1712 Thomas Newcomen dealing with the increasing need in energy, developed atmospheric engines that brought benefits to mills, but they were inefficient in terms of the energy use to power them. Handling this problem of energy loss, James Watt developed a steam engine with separate

condensation chamber (1763). The main use was to pump water out of mills. In 1780s Watt's business partner, Matthew Boulton, an entrepreneur aware of the issues of the newly emerging industry (in particular iron work, through his collaboration with Wilkinson), had an idea to develop an energy source compatible with industrial systems like textile factories, driving machinery in Figure 3.

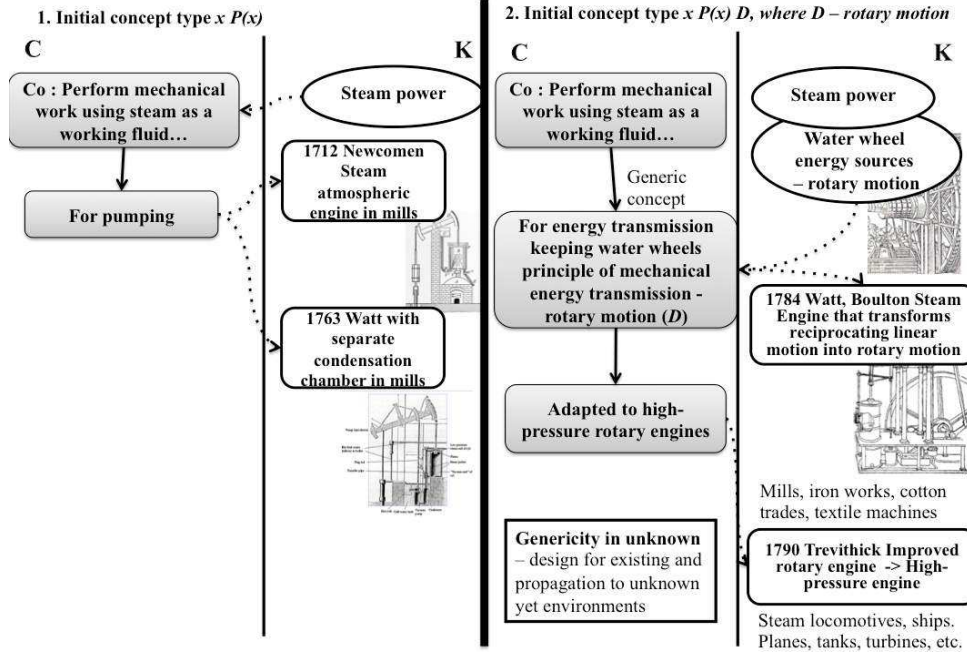

Figure 3. Generic steam engine design in C-K-theory

According to (Dickinson, 2010) “Boulton created the environment which enabled Watt to work on the further instrument that brought steam engines from an apparatus for lifting water into one with an immensely larger field of application to general power purposes”. He conceived existing knowledge on commonly deployed water wheel energy sources to ensure rotary motion between energetic source and the mechanism that uses this motion. In 1781 Boulton wrote to Watt: “we should determine to take out a patent for certain methods of producing rotative motion” (Dickinson, 2010). The conversion of reciprocating into rotary motion was facilitated by Watt's development of double acting engine which resulted in a more uniform movement of the piston and made this design state of the art for applications with rotary motions (Frenken and Nuvolari, 2004).

The generic concept incorporated D based on the preserved system of water wheels energy transmission in Figure 3. The design of a set of entities was achieved through the identification of one descriptor of existence domain – rotary motion (D). This concept is generic since it is compatible both with known environments, where the energetic source can be transferred by rotary motion, and with the extensive number of unknown initially environments. Furthermore, Boulton and Watt established standard units of measure for both the fuel efficiency (duty) and the power (horsepower), which lead to further diffusion and economic significance of engines. It is important to underline the effort on genericity adaptation. Once steam engine with rotary motion was designed, it took years to improve and disseminate them to the markets. E.g., first locomotive with steam power was introduced in 1804, 20 years after the invention of the first rotary engine. These examples demonstrate that what counts is the capacity to enable propagation, fabricate sets of the relations in between objects. Both algebraic extension and rotary steam engines use existing descriptors of existence domain to design new objects.

3.2 Genericity construction in case of designed descriptors of existence domain

In the second case $D \notin K$ has to be conceived and is unknown in K . Then, how to obtain a generic concept in case of unknown descriptors of extension domain?

Illustration 1. Mathematical knowledge structure - complex numbers

The process of genericity building described in 3.1 stops when there are no more solutions for $\exists X: f(x) = 0$ beyond the initial knowledge set. Consider $f(x) = x^2 + 1 \in Q(x)$. It is impossible to use fields of polynomials $Q[x]$ as D . $x^2 + 1 = 0$ has no root in R , it is a maximal ideal (Bastida, 1984). To extend it,

one has to use the field of $\mathbf{R}[x]$. Working on a closed field \mathbf{R} , Cauchy (1831) extended Sturm's theorem to count and locate the real roots of any real polynomial to count and locate the complex roots of any real polynomial. Created by Cauchy extension can be interpreted as a descriptor D that leads to complex extension $C = \mathbf{R}[i]$, where $i^2 = -1$. The roots of $f(x)$ are $\pm i$, and so $f(x)$ splits in C ; that is, $f(x) = (x+i)(x-i)$ is a product of linear polynomials in $C[x]$.

In this case the logic of D renewal enables to build higher genericity that incorporates the field of complex numbers. It is impossible to obtain solution to $f(x) = 0$ which has no root in C . Following logic of polynomial operators, the maximal genericity is obtained.

Illustration 2. Engineering knowledge structure – MEMS case

MEMS (Micro Electro Mechanical System), micron-size devices that can sense or manipulate the physical world, are exceptionally diversified. MEMS encompass the process-based technologies used to fabricate tiny integrated devices and systems that incorporate functionalities from different physical domains into one device. MEMS revolutionized various product domains and created new ones by bringing together silicon-based microelectronics and micromachining technology (Bryzek, 1996).

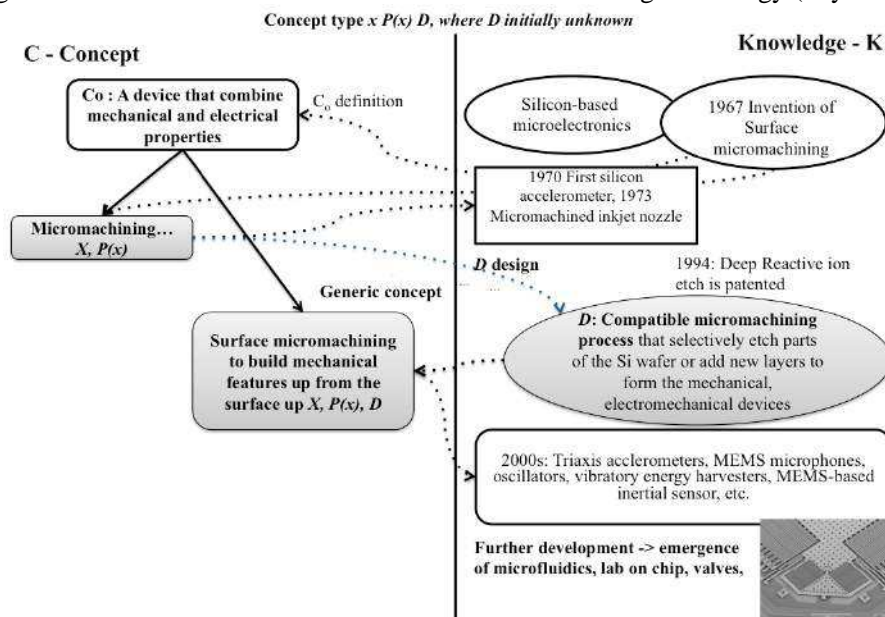

Figure 4. Generic MEMS technology and D design in C-K-theory

In the last decade, MEMS have provoked revolutions in several industries: arrays of micromirrors enabled digital film projectors, accelerometers like those in Wii controller have changed gaming, the iPhone 4 became the first portable consumer device to incorporate a three-axis accelerometer, three-axis gyroscope, and three-axis electronic compass. MEMS became a generic technological platform that enables the development of products, augmenting the computational ability of microelectronics with the perception and control capabilities of microsensors and microactuators, expanding the space of possible designs and applications. MEMS technology is the integration of mechanical elements, sensors, actuators, and electronics on a common substrate through microfabrication technology (D).

MEMS development started in 1950s when silicon strain gauges became commercially available. Not far after this, Dr. Richard Feynman, in his famous talk “There’s plenty of room at the bottom”, described the tremendous potentials in the micro technology field. After the invention in 1967 of surface machining the first silicon accelerometer, micromachined inkjet nozzle were developed (Heeren and Salomon, 2007). In the mid 1990s two enabling technologies appeared. The deep reactive ion etching of silicon made possible to etch deep high aspect ration trenches into silicon. The development of silicon on insulator wafers enabled high quality silicon layers for micromechanical structure. Thanks to these technologies, the micromechanical components were fabricated using compatible micromachining processes to selectively etch away parts of the silicon wafer or add new structural layers to form the mechanical and electromechanical devices (D design). Through these innovative processes MEMS became a true GT and manufacturing platform. Thus, MEMS appeared to be generic when new descriptor D that ensures its propagation emerged. The genericity continued to

be built. For instance, the emergence of microfluidics in the medical applications opens a lot of possibilities for MEMS in the drug delivery in Figure 4.

4 GENERICITY IMPROVEMENT

While pursuing genericity, the goal is to maximize the number of environments GT will address. Then, how to account for higher genericity?

Illustration 1. Mathematical knowledge structure – Field extensions

Going back to the example of algebraic field extension, once new field $Q(x_1)$ is designed, it can be spread in $Q(x_1)$ (x_2), ... these fields are consequently added - the new one is "bigger" than the previous with the condition that $f(x_n) = 0$ has no root in $Q(x_{n-1})$. So having $Q(\sqrt{2})$, it is possible to proceed with $X^2 - \sqrt{2} = 0$ which doesn't have roots in $Q(\sqrt{2})$ and generates $Q(\sqrt{2})(2^{1/4})$ which is higher in genericity. The "size" of the extended field depends on the initial concept. For instance, consider the polynomial $x^4 - 2 = 0$ over Q . Its roots are $\sqrt[4]{2}$, $-\sqrt[4]{2}$, $\sqrt[4]{2}i$, $-\sqrt[4]{2}i$. $x^4 - 2$ has splitting field $Q(\sqrt[4]{2}, i)$ of the size 8 over Q . To write every element of this field, one needs $1, \sqrt[4]{2}, \sqrt[4]{8}, \sqrt[4]{2}i, \sqrt[4]{4}i, \sqrt[4]{8}i, i$ and so the field size is 8. Based on the root $\sqrt[4]{2}$, the generated field is $Q(\sqrt[4]{2}) = \{a + b\sqrt[4]{2} + c\sqrt[4]{2}^3 + d\sqrt[4]{2}, a, b, c \in Q\}$, where $Q(\sqrt[4]{2})/Q$ has size 4. There is $Q \subset Q(\sqrt{2}) \subset Q(\sqrt[4]{2})$. The extension will also depend on the K base. In Q , it is possible to provoke infinity of more or less generic extension. But in R , it is proven that all algebraic extensions of R are isomorphic to the field of complex numbers C .

Illustration 2. Engineering knowledge structure – steam engines

Drawing on the principles of engineering design, the design process can be accomplished through: planning and clarifying the task, conceptual design, embodiment design, detail design (Pahl and Beitz, 1995). Theoretically, it is possible to account for genericity improvement at each phase till the detail stage of design is achieved. Embodiment keeps technical specification and the goal is to ensure predefined volumes, which means to ensure compatibility with the identified environments. These are descriptors (D) defined at the level of embodiment (based on design parameters).

In case of steam engines the compatibility with factory machinery was achieved through rotary motion preservation. Using the principles of engineering design language, the descriptors are defined at the embodiment level. Though, the existence domain can be defined at the conceptual or functional level as well. For instance, one could think of designing steam engines compatible with various forms of energy transmission. In this case, descriptors should be defined at the functional level.

Example: New automotive engine can be generic by being substitutable to the previous engine (keep the transmission logic, the peripheral components). In this case all interfaces, are kept equivalent (D preserved) and genericity improvement is based on embodiment. Otherwise, new automotive engine will require to create new interface rules to be compatible with a range of vehicle (the electric motor might lead to redesign the interface of air-conditioning, safety systems), incorporate other functions. Thus, genericity improvement is at the core of engineering language and can be achieved by functions or by embodiment.

5 RESULTS AND DISCUSSION

The evaluation of GT is often based on the number of markets it achieves, the benefits it generates. From the engineering point of view the genericity is characterized by the number of potential applications that technology will address, which requires reasoning in unknown.

According to the first research question, the proposed study demonstrated that to be generic *ex ante* a concept has to incorporate descriptors of existence domain D . A generic concept has a form $XP(x)D$, where D ensures the composition of x with the existing knowledge domains and bring forward knowledge propagation towards unknown environments. It is demonstrated that generic concept aims at designing not only one entity but aims at generating a set of entities. The descriptors of existence domain D can be identified from the initial knowledge or conceived during the design process. Based on the knowledge structure they can take various forms: it can be mathematical operators in case of field extension or they can be associated with the compatibility of the object and associated environments in case of engineering knowledge. In case of genericity construction in unknown, the goal is not to obtain a new object through expansive partition but a new object that influence the existing knowledge domains and create maximal knowledge propagation. Having defined a form of D

imposes a certain structure of future knowledge and control the operation of K-reordering, which brings interesting theoretical perspective to C-K theory. Regarding the second question, the level of attained genericity can be improved. In the mathematical knowledge structure the measure of the field size characterizes genericity level. In the real objects the measure is the number of partially unknown environments compatible with the emerging object through descriptors of existence domain.

This work is limited to the study of two forms of genericity based on algebraic field extensions and selected engineering objects. Other knowledge topologies could enable to identify new powerful form of genericity. For instance in models of K-space (Hendriks and Kazakci, 2010) emphasized that different structures to model knowledge yield different conceptive power and degrees of flexibility. Moreover, not examined in this work social and psychological design approaches could provide new perspectives on the process of GT design. The economic reasoning behind the genericity building provides insights on the dynamics of engineering systems.

REFERENCES

- Bastida, J. R. 1984. *Field extensions and Galois theory*, Cambridge University Press.
- Braha, D. & Reich, Y. 2003. Topological structures for modeling engineering design processes. *Research in Engineering Design*, 14, 185-199.
- Bresnahan, T. F. & Trajtenberg, M. 1995. General purpose technologies ‘Engines of growth’? *Journal of econometrics*, 65, 83-108.
- Bryzek, J. 1996. Impact of MEMS technology on society. *Sensors and Actuators A: Physical*, 56, 1-9.
- Dickinson, H. W. 2010. *Matthew Boulton*, Cambridge University Press.
- Edquist, H. & Henrekson, M. 2006. Technological breakthroughs and productivity growth.
- Frenken, K. & Nuvolari, A. 2004. The early development of the steam engine: an evolutionary interpretation using complexity theory. *Industrial and Corporate Change*, 13, 419-450.
- Gawer, A. 2009. *Platforms, Markets and Innovation*, Edward Elgar Publishing.
- Hatchuel, A., Le Masson, P., Reich, Y. & Weil, B. A systematic approach of design theories using generativeness and robustness. Proceedings of the 18th International Conference on Engineering Design (ICED11), Vol. 2, 2011. 87-97.
- Hatchuel, A. & Weil, B. 2009. CK design theory: an advanced formulation. *Research in Engineering Design*, 19, 181-192.
- Hatchuel, A., Weil, B. & Le Masson, P. 2012. Towards an ontology of design: lessons from C–K design theory and Forcing. *Research in Engineering Design*, 1-17.
- Heeren, V. H. & Salomon, P. 2007. MEMS Recent Developments, Future Directions. Loughborough University.
- Hendriks, L. & Kazakci, A. 2010. Design as imagining the future: a formal account. Logic and Interactive Rationality. In: Grossi, D., Minica, S., Rodenhauer, B. & Smets, S. (eds.) *Logic and Interactive Rationality*. Yearbook2010.
- Landes, D. S. 1990. Why are we so rich and they so poor? *The American Economic Review*, 80, 1-13.
- Lipsey, R. G., Carlaw, K. I. & Bekar, C. T. 2005. *Economic Transformations: General Purpose Technologies and Long-Term Economic Growth*, OUP Oxford.
- Maine, E. & Garnsey, E. 2006. Commercializing generic technology: The case of advanced materials ventures. *Research Policy*, 35, 375-393.
- Miyazaki, K. 1994. Search, learning and accumulation of technological competences; the case of optoelectronics. *Industrial and Corporate Change*, 3, 631-654.
- Moser, P. & Nicholas, T. 2004. Was electricity a general purpose technology? Evidence from historical patent citations. *American Economic Review*, 388-394.
- Pahl, G. & Beitz, W. 1995. *Engineering design: a systematic approach*, Springer.
- Powell, W. W. 1987. Explaining technological change. JSTOR.
- Reich, Y. 1995. A critical review of general design theory. *Research in Engineering Design*, 7, 1-18.
- Rosenberg, N. & Trajtenberg, M. 2004. A general-purpose technology at work: The Corliss steam engine in the late 19th century United States. *The Journal of Economic History*, 64, 61-99.
- Shai, O. & Reich, Y. 2004. Infused design. I. Theory. *Research in Engineering Design*, 15, 93-107.
- Suh, N. P. 1999. A theory of complexity, periodicity and the design axioms. *Research in Engineering Design*, 11, 116-132.
- Yoshikawa, H. 1985. Design theory for CAD/CAM integration. *CIRP Annals-Manufacturing Technology*, 34, 173-178.

Paper IV

**Portfolio management with
high uncertainty: the role of
cross-application manager in
double unknown situation**

Portfolio management with high uncertainty: the role of cross-application managers in double unknown situations*

Olga KOKSHAGINA^{1,2}, Pascal LE MASSON¹, Benoit WEIL¹, Patrick COGEZ²

⁽¹⁾MINES PARISTECH, CGS - Center for scientific management
60 Boulevard Saint-Michel, 75272 Paris Cedex 06, France

⁽²⁾Technology R&D, STMicroelectronics, Crolles, France
850, rue Jean Monnet, F-38926 Crolles Cedex

corresponding author: olga.kokshagina@mines-paristech.fr

Abstract. This article investigates portfolio management in highly uncertain environments. We define highly uncertain situations as occurring when project alternatives can be identified, and uncertainty management consists of making the optimal choice between possible decisions and probable states of nature as well as situations in which the level of uncertainty is so high that neither the level of risks nor the list of risks are known. In the latter situation, in which both technology and markets are yet unknown, the literature highlights a winning solution: the design of generic technology that is able to address many emerging markets and create value across a broad range of applications. This paper seeks to determine how to organize project portfolios for successful generic technology exploration. Through four empirical contexts of portfolio structuring in the semiconductor industry, we examine these cases to determine how genericity was acquired, which organizational capabilities were mobilized, and how they were managed. The analysis reveals that the design of generic technology requires "cross-application" managers who are able to supervise the interactions among innovative concepts developed in different business and research groups and who are responsible for creating and managing technological and marketing exploration portfolios within organizational structures of a company.

Keywords: Project portfolio management, Portfolio risk management, unknown, generic technology, Interdependencies, cross-application manager

*Under submission Creativity and Management Journal

Introduction

Portfolio risk management focuses on the ability of a project portfolio to achieve its strategic objectives (Olsson, 2007, Lycett et al., 2004). The project portfolio management (PPM) perspective addresses the potential logic of risk mitigation (Sanchez et al., 2009, Olsson, 2008). However, the mitigations that are considered largely affect portfolio reviews and reorganizations to increase overall portfolio performance (Petit, 2012). Teller and Kock (2012) illustrated the positive correlation between risk management quality, measured as risk transparency and risk coping capacity, and the success of a project portfolio. Decisions can be made under risk scenarios when managers are capable of listing all possible outcomes associated with a decision and can assign a probability of occurrence to each outcome.

Significant changes in business environments and ever-growing competition are causing portfolio managers to cope with uncertainty by changing the strategic directions of portfolios and balancing and prioritizing projects. In these situations, risk management is not sufficient for managing high uncertainty and complexity in portfolios in dynamic environments (Petit, 2012). The notion of uncertainty is broader than we often believe it to be. As shown by Langlois and Cosgel (1993), Knight's distinction between risk and uncertainty goes beyond a distinction between insurable and uninsurable risk. Uncertainty covers two types of situations: The first type of situation occurs when project alternatives can be identified and when managing uncertainty consists of making the optimal choice between given possible decisions and probable states of nature. However, when uncertainties are high, probabilistic approaches are limited because the probabilities evolve during the process of exploration and cannot be correctly estimated initially. In this case, uncertainty reduction approaches are mobilized to reduce these uncertainties. The second type includes cases that are often called “unk-unk” or so-called “chaos”, in which the level of unknownness is so high that neither the level of risks nor the list of risks is known. In R&D contexts, this scenario often corresponds to “double unknown” situations in which neither technologies nor markets are known. In this case, the alternatives are not yet determined and can emerge during the exploration process. These situations are often considered simply unmanageable, and the idea is often to wait until the unknown aspects of a project are reduced.

In the first type of logic, project portfolio logic enables one to cope with uncertainty by applying models of decision making under uncertainty to select among a set of given alternatives and probable states of nature that maximize the expected utility and share the risks among portfolio alternatives. The standard for portfolio management (PMI, 2008) comprises the changes in portfolio performance and business strategy that are needed to adapt to changing environments. Petit and Hobbs (2010) indicated that the drivers of change go beyond that considered by PMI classes and are not yet considered by the PMI standard. As an example, the authors suggested sensing mechanisms to primarily address uncertainties in project scope. The nature of management within an organization varies when we consider highly uncertain innovative projects. Significant changes in the environmental construct and the high probability of unknown risks could cause companies to question the entire portfolio and even result in its failure. Thus, portfolios are largely built when such unknown risks are reduced. However, organizations constantly cope with increasing levels of uncertainty, and to retain a leadership position in the market, they seek to innovate in environments that are unconventional for them.

With regard to breakthrough innovation projects, the exploration phase is confronted with both undetermined markets and technologies (Danneels, 2004, Lynn et al., 1996). Mullins and Sutherland (1998) indicated that firms operating in such environments require new practices to mitigate risks, manage uncertainties, and increase the likelihood of future success.

Numerous methods, such as innovation journeys (Van de Ven and Poole, 2005), discovery-driven planning (McGrath and MacMillan, 2009), information gap decision theory (Ben-Haim, 2006), the diagnosis of unforeseeable uncertainties through trial and learning (Loch et al., 2008), and the real options approach (O'Connor, 2008a, Kogut and Kulatilaka, 2001), attempt to manage these high uncertainties and relevant interdependencies. In this case, high uncertainty incorporates unknown meaning that both technologies and market have not yet determined, and the exploration phase could lead to incorporating new facets that could reduce the unknowns. Uncertainty reduction approaches for portfolio management are limited. The second logic could add a new action possibility: to design a new alternative to cope with the probable states of nature, which would lower the unknown risks. In this paper, we aim to investigate project portfolio construction under the second type of uncertainty – double unknown. The idea is to profit from the double technological and market unknowns to design alternatives that reduce these unknowns and to enable the structuring and effective management of project portfolios. These alternatives could result in the formation of new interdependencies between emerging alternatives. What could the alternative be, and how can it be designed?

The literature on the history of the economics of technology suggests different forms of interdependency management (Rosenberg, 1994) through the development of general-purpose technologies. Generic (or general-purpose) technologies (GTs) are technological platforms that are capable of addressing multiple emerging and existing markets. GTs, once developed, enable the reduction of unknowns. They increase benefits, encourage growth and reduce the risk of failure by ensuring technology reuse in various markets. The value of GTs is demonstrated from historical (Moser and Nicholas, 2004), economic (Bresnahan and Trajtenberg, 1995), and sociological perspectives (Powell, 1987). The development and design of GTs appear to be highly advantageous for high-technological firms in coping with unknown environments and strategic foresight (Olleros, 1986). The literature provides successful examples of the development of generic, general-purpose technologies within the nanotechnology, pharmaceutical, IT, biotechnology, and semiconductor industries (Bresnahan and Trajtenberg, 1995, Christensen, 2003, Mangematin and Walsh, 2012, Scherer, 1993, Youtie et al., 2008). Drawing on these studies, the design of GT appears to be particularly relevant for industries in which the speed of product development has the same order of magnitude as the rate of industrial renewal and, therefore, in which the design of GTs that are capable of addressing multiple and existing emerging markets becomes advantageous. GTs attempt to structure the double unknown situation by creating interdependencies between the emerging technology and multiple markets. GTs empower firms to achieve and sustain their competitive advantages by seeking a risk-free alternative. Hence, by designing a generic technology that is independent from any specific market requirements, we obtain the risk-free alternative that facilitates technology diffusions within various application domains and that constructs project portfolios around this GT to develop these markets. From this perspective, the risks are minimized by designing an alternative – generic technology – whose success is independent of all known risks.

To manage the activity of GT design, various mechanisms can be found within the current literature. The trial and learning (Loch et al., 2008) strategy involves selecting a trial and reducing unknowns through the process of consequent learning and platform design. The trial and learning approach corresponds to the strategy of local search that is based on accumulated knowledge generating further improvements and breakthroughs. A common unknown strategy attempts to avoid traps of local search and seeks to directly create the interdependencies between future technologies and markets to ensure technology adaptation by several market units (Kokshagina et al., 2013). A GT portfolio consists of projects for

platform design (generic core) in which a platform is a common core that ensures essential functions and common needs for several players (Gawer and Cusumano, 2008) and projects of complementary module development to account for GT dissemination.

These emergent methods seek to provide relevant strategies and design processes for the successful implementation of GT. The methods aim to cope with interdependencies of design in highly uncertain environments. However, the existing research shows that with the possibility of modeling the design of GT, the logic of GT design is not sufficient in itself. When addressing GT design, the portfolio exists only potentially; it is constructed consequently. The manner in which projects are designed and managed within a portfolio enables coping with unknown risks. Thus, a project portfolio can be constructed to account for GT design and its complementarities. How can project portfolio exploration be organized while coping with double unknowns to account for GTs? Moreover, the organizational forms involved in GT portfolio organization and the managerial role must be clarified. Vaccaro et al. (2012) demonstrated that leadership behaviors contribute to management innovation, and they emphasize the importance of transformational leadership to future success. Thus, who is capable of addressing this reasoning? How is it embedded within the organizational structure of a company? What are the necessary competences of actors who are capable of successfully developing and executing a GT portfolio?

The aim of the present paper is to cope with both PPM and portfolio constitution in highly uncertain environments to account for GT development. This study is organized based on two research questions: 1) Which organizational structures can facilitate the management of multiple projects to meet the goal of successful technology development for several markets under high uncertainty? 2) Which actors are important, and what are their roles? The setting is the high-velocity semiconductor industry, which is constantly confronted with competition, fastly changing markets and rapid technological obsolescence, which together force the industry to explore both market and technological unknowns. For this investigation, a multiple qualitative case study approach (Yin, 2008) was used to provide new insights into the emerging phenomenon of PPM to address unknown risks. The findings indicate that to account for GT exploration in high uncertainty, the process must be highly transversal. The new manager figure that we call the *cross-application manager* appears to be critical for successful portfolio structuring and management to account for successful GT design.

Theoretical background

The literature review is organized in the following manner. First, current PPM practices in risks, uncertainty and unknowns are discussed. Second, the possible organizational structures and associated methods for coping with innovation exploration are revealed. Finally, the role of management and the competence of necessary actors in handling unknown risks are identified.

Portfolio management in risk, uncertainty and unknown – current and evolving practices

To guarantee a company's long-term survival, its renewal and organizational growth must be ensured. PPM often accompanies the practices that are developed within the new product development literature (Killen et al., 2008, Cooper et al., 2001). PMI (2008) defines a project portfolio as "a collection of projects or programs and other work that are grouped together to facilitate effective management of that work to meet strategic business objectives". According to the literature, project portfolio success can be defined through the following elements: average project success, strategic fit, portfolio balance, synergies, and economic success (Meskendahl, 2010, Jonas et al., 2012).

The literature on PPM considers risk management to be one of the crucial elements to ensure portfolio success (Petit and Hobbs, 2010, Olsson, 2008, Lee, 2011). Classical models of risk management suppose that the likelihood of success is highly proportional to the initial technological and market uncertainties. When uncertainties are low, the nature of technologies and markets and the associated project alternatives can be listed. When a manager can make a list of all possible outcomes associated with a decision and can assign a probability of occurrence to each of the outcomes, a *decision can be made in consideration of this risk*. Classical risk management techniques provide methods to help decision makers cope with such uncertainties (Chapman, 1990, Lipshitz and Strauss, 1997). Portfolio risk management incorporates risk management at the level of each product and portfolio itself. Greater visibility for stakeholders and decision makers can be achieved by improving common portfolio risk management (Teller and Kock, 2012, Olsson, 2008).

More advanced approaches for portfolio risk management are required when uncertainties are high because the states of the environment are often impossible to predict and because probability-based risk management becomes irrelevant as a result of high market and technology volatility (Petit, 2012, Pender, 2001, Loch et al., 2008). Choices made under uncertainty are often driven by the maximization of expected utility. Utility is a function of profit that comprises the value of benefits associated with each state of nature weighted by its probability and the utility of the decision itself. It aims to select the most promising alternatives (maximal utility) for the predefined list. This theory relies on various derived techniques to cope with uncertainty management (Savage, 1972, Raiffa, 1968). The economic return of a portfolio greatly depends on technological and commercial uncertainties (Verworn, 2009). Real-options theory is suggested to guide investment decisions under uncertainty (McGrath, 1997, Dixit and Pindyck, 1994, O'Connor, 2008b) by estimating whether the option of investing in a new technology is worth taking or by determining how the learning process influences the option value. Real options provide powerful tools that account for dynamic environments. For instance, the real-options approach to project evaluation seeks to correct the deficiencies of traditional methods of valuation through the recognition that managerial flexibility can bring significant value to projects (Carlsson et al., 2007).

Nevertheless, real-options approaches are limited when addressing high uncertainty because the learning that is considered in these techniques is based on the distribution of subjective probabilities associated with the states of nature. The learning process does not affect these states and the corresponding decisions, which is critical in unknown contexts, as new technological alternatives could emerge and new markets could be created during the exploration phase. Real options consider that the decisions and states of nature are independent. To apply real options, a decision maker must know the project's potential, underlying assets, and needs based on the potential states of nature. Moreover, the estimated option value should indicate the reliable actions to follow. In the case of highly uncertain or unknown exploration, these conditions can scarcely be met. In addition, new alternatives and unexpected results could emerge throughout the period of exploration.

Wouters et al. (2011) proposed a project portfolio option-value method that attempts to provide an overview of major challenges and key criteria of success for companies in the presence of many technological and marketing uncertainties and attempts to account for the interdependencies among projects in a portfolio. Visual tools attempt to facilitate interdependencies management within a portfolio (Killen and Kjaer, 2012). A transparent risk management culture within organizations helps to better reveal and manage interdependencies within various portfolio projects (Teller and Kock, 2012). Various types of interdependencies are important to consider (Blau et al., 2004, Collyer and Warren, 2009). For instance, Eilat et al. (2006) suggested resource interactions, benefit interactions and technical dependencies

between projects. Archer and Ghasemzadeh (1999) addressed financial interdependencies. In addition, Killen et al. (2009) underlined the importance of outcome dependences, which involve the re-use of the results within projects, including both technical and commercial aspects, and learning dependencies that lead to incorporating the capabilities and knowledge gained through various projects. The interdependencies between projects are more complex when handling unknowns (Chien, 2002, Mikkola, 2001), but complex interdependent systems can be a source of breakthrough (Fleming, 2012). Petit and Hobbs (2010) discussed PPM adapted for dynamic uncertain environments once the portfolio is selected. The authors demonstrated that the dynamic capabilities approach can be used to analyze the operational levels within an organization (Petit, 2012, Killen et al., 2012, Killen et al., 2008). Nevertheless, the PPM that copes with uncertainty often considers that projects are already identified within the portfolio. However, when the exploration phase is confronted with unknown environments, markets are considered unknown because the product features that could make them successful are initially unrevealed (O'Connor and Rice, 2012). Technologies are unknown, which means that for some figures of merit, a variety of solutions might be designed, although none of them exist at the moment. This exploration of yet undefined technologies and markets is precisely what is called double unknown or unk-unks (Mullins, 2007, McGrath and MacMillan, 2009). In this situation, it is ambiguous as to which emerging markets will succeed and which technological forms will be more advantageous. The identity of technology is not presumed, and future uses are not fixed (Gillier and Piat, 2011). In this situation, the projects are still undetermined. Thus, how can we cope with double unknown situations in designing GTs and building project portfolios?

The literature demonstrates that firms often fail to incorporate innovations. For instance, Henderson and Clark (1990) showed that innovations that change the product architecture challenge existing companies' expertise and often ultimately fail to recognize these types of obstacles and respond to them. For instance, each generation of photolithography equipment conceived for a new generation of transistors in semiconductor manufacturing provoked a change in the leadership position within the industry. Only when the road mapping activity within the International Technology Roadmap for Semiconductors (ITRS) emerged were the processes standardized and scientific efforts coordinated within various industrial players (Walsh, 2004).

Kock et al. (2011) underlined that technological innovativeness can increase the customer value of future products but also implies challenges in the innovating firm and its environment. The resulting complexities must be carefully estimated and managed through the process of high uncertainty exploration; the innovating organization and its employees must be prepared to identify and address these complexities and to develop necessary competences. Thus, the organizational entities leading the exploration of innovation projects in unknown situations appear to be crucial for industrial success and for proper portfolio creation and management. Moreover, Meskendahl (2010) indicated that when applied to PPM, a firm's strategic orientation significantly influences its portfolio decisions and therefore the structure of the portfolio. The construction of a portfolio and its alignment with more mature project portfolios within an organization must be investigated. *Thus, do innovation organizations capable of managing the portfolio exploration process in a double unknown context exist? Which actors are capable of effectively managing commercial and technological unknowns?*

Organizational structures for portfolio exploration in unknown situations

Organizational structures comprise the ways in which companies arrange communication and align and harness efforts from their members (Hamel, 2006, Birkinshaw et al., 2008). There

exist various governance models for organizations that confront high levels of uncertainty. One approach consists of leveraging new capabilities by other more advanced companies' acquisitions that offer competitive solutions. This approach is widely adapted by the market leaders in the ICT industry, which constantly enlarge their portfolios and competences through start-up acquisitions. The second approach involves ensuring growth and developing competencies through internal or collaborative innovation exploration. Descriptive approaches of "innovation journeys" within ecosystems or within companies are conducted gradually to identify organizational structures that enable disruptive innovation (Veryzer, 1998, Van de Ven et al., 1999, Garud and Karnøe, 2003). Major innovations (MIs), including both radical and disruptive innovations, are considered an important mechanism for enabling growth and renewal (O'Connor, 2008b). Various organizational processes require various organizational capabilities that are difficult to implement and adapt (Nelson and Winter 1982). Moreover, the ability to link advanced technologies to opportunities in a market in which most of these opportunities do not yet exist is difficult to maintain, given the constant organizational pressures to attain immediate profit (O'Connor and Veryzer, 2001).

Regarding the influence of collaboration for innovation exploration, Fleming et al. (2007) identified brokered and cohesive collaboration. Brokerage assumes the existence of a hub through which all collaborators can interact. Cohesive structure does not presume the existence of a central entity; rather, the groups independently establish and develop their relations. The authors showed that the various trade-offs between these two models can be adapted in various organizational situations (Fleming, 2012). Innovation intermediaries (*e.g.*, including actors involved in brokering, networking and cohesive structures) appear to be critical to technology-matching processes of innovation exploration (Howells, 2006). By demonstrating that intermediaries primarily perform in situations in which risks are reduced and projects are defined, Agogue et al. (2013) suggested that these intermediaries, when confronting uncertainties, could find roles to play to profit from the potential collaboration associated with unknowns. The authors showed that in these cases, the intermediary could "design prerequisites and offer leadership in the process of joint exploration and creation of knowledge".

The variety of existing organizational structures for innovation management could potentially be appropriated for GT exploration. Thus far, however, there has been little discussion of organizational entities for portfolio structuring and management in yet unknown environments. Moreover, the role of leadership in situations of uncertain exploration appears to be critical. The importance of the creation of learning and interdependencies is well stated, and the need for expertise to handle the process of unknown exploration is clarified. However, it is unclear *how a portfolio can be constructed under yet unknown technologies and markets to account for successful GT exploration. What are the necessary capabilities to manage and build GTs?*

Necessary actors and their competences for portfolio management in unknown situations

The literature provides various reasons to enable the successful exploration of innovative projects. Among these reasons, the "human side of radical innovation" appears to be particularly important for obtaining desired outcomes (O'Connor and McDermott, 2004). The authors revealed that radical innovation requires a multiplicity of roles, although there is a lack of connectivity and continuity between them. The authors underlined that the teams that are involved in breakthrough innovation exploration differ from those involved in incremental innovation. The breakthrough innovation teams are driven by their volunteerism, informal recruitment and expertise levels rather than by clarified sets of goals (Howell and Higgins, 1990). Both external and internal networks appear to thrive in radical innovation projects.

Confronting exploration in multiple innovative projects, firms rely on organizational learning capability and dynamic capability development (O'Connor, 2006, King and Tucci, 2002). Eisenhardt and Martin (2000) defined dynamic capabilities as a “set of specific human and organizational assets that can be used to implement value-creating strategies”. To cope with unforeseeable uncertainties and the turbulence in the surrounding environments, these teams must be flexible in their behavior, knowledge base and corresponding actions (Mietzner and Kamprath, 2013). For instance, the use of self-managed teams represents an example of an effective structure of innovation management. Such a structure involves the introduction of teams responsible for their own internal functioning, setting of priorities, and decision making within an organization (Bunderson and Boumgarden, 2010). Eisenhardt (1989b) demonstrated that the greater use of information accelerates the strategic decision process. Various scholars have underlined that managers can effectively coordinate innovative processes, stimulate creativity and influence the organizational choices of companies (Finkelstein and Hambrick, 1990, Birkinshaw et al., 2008). The higher the number of coordinating individuals, the higher the probability of generating useful and novel ideas (Sandstrom and Bjork, 2010). The importance of intensive coordination during the phases of portfolio creation or the early phases of portfolio cooperation is emphasized. Beringer et al. (2013) revealed that within immature PPM systems, line managers play the key role of knowledge mediators between senior management, who represent business strategy, and projects managers, who focus on daily business. Firms' innovation capacity can be maximized when corporate foresight comprises the strategic roles of exploring business fields, the initiation roles of increasing the number of innovative concepts and ideas, and the opening role of challenging the innovative projects (Rohrbeck and Gemünden, 2011).

However, the question remains as to how many individuals are needed to fulfill these roles and how they should collaborate in the process of unknown exploration. Previous studies demonstrated that leadership behavior is correlated with the size of organizations (Vaccaro et al., 2012, Koene et al., 2002). Moreover, the exploration of unknowns in the design of a GT for multiple uses requires a combination of technical, business and organizational skills. Most projects involve cross-disciplinary interactions among specialists, which poses communication challenges across groups (Mietzner and Kamprath, 2013). Team-based innovation requires a balance of creative and pragmatic processes both within teams and between teams and their organizational stakeholders (Büchel et al., 2013). Leonard - Barton (1992) emphasized the importance of organizational learning to mobilize teams' core capabilities without “being hampered by their dysfunctional flip side”. Moreover, to ensure innovation success, the alignment of priorities between all responsible parties appears to be critical (Martinez, 2013).

It is demonstrated within the literature that unknowns are challenging to address. Nevertheless, organizations attempt to initiate radical, major innovation by disrupting the existing technologies and creating new markets. The various organizational entities (e.g., intermediaries, innovation hubs, corporate foresight) and the corresponding actors' competences have been investigated from various research perspectives. Additionally, a GT alternative may provide a promising solution for portfolio organization in unknown situations. Thus, is it possible to identify actor(s) who have all of the necessary competences within an organization? More broadly, how can the exploration of project portfolios in unknown situations be organized to design GT?

Methods

The purpose of this work is to gain an understanding of PPM for GT design in highly uncertain environments. Given the newness of this research field and the lack of available

knowledge, a qualitative research methodology is recommended (Yin, 2008). The study is conducted within the semiconductor industry, an environment in which the probability of GT existence is *a priori* high (Miyazaki, 1994, Olleros, 1986). The semiconductor industry is confronted with both high rates of innovative technology development and new market creation (Teece, 1986). The empirical research has employed a multiple case study methodology (Yin, 2008). The multiple case study approach is particularly relevant to experimentally validate the findings and to lead to more robust results (Eisenhardt, 1989a). Multiple cases enable accounting for a more accurate level of abstraction and helps to achieve better generalizability. The chosen cases represent separate experiments in which patterns were identified and tested. The different organizational contexts were selected to better reveal the phenomenon. According to Garg and Eisenhardt (2012), 4 cases are considered sufficient to provide variation and to demonstrate the construct in multiple situations.

We conducted multiple case studies of innovative technology development in various contexts at STMicroelectronics, the largest European semiconductor provider. The 4 identified cases offer rather different frameworks and units of analysis, which permits different perspectives on the research questions: 1) the innovation contests – **Case 1**; 2) the ITRS “More than Moore” working group – **Case 2**; 3) the technological invention design with various groups – **Case 3**; and 4) ex-post analysis of a research project portfolio – **Case 4**. These four contexts represent different organizational settings and comprise various units of analysis (*Table 1*). Each of these portfolios encloses the examples of generic and specific projects (see the *Appendix*). We examine these cases to uncover how genericity was acquired, which organizational capabilities were mobilized, and how and by whom they were managed.

Insert Table 1 about here

Data collection and analysis

The information-gathering techniques used in this study included in-depth interviews with a variety of company representatives and external collaborators associated with each portfolio from a variety of functional perspectives. Experts with commercial, marketing, financial, technological, research, development, and operational backgrounds were involved and were directly implicated in executing, organizing, participating, managing, supporting or decision-making roles within portfolios.

The internal validity and reliability of the chosen methodology were achieved through triangulation among the conducted case analysis, the derived analysis and the judgments of company representatives. This procedure enabled continuous involvement of the firm according to the guidelines of engaged scholarship (Van de Ven, 2007) and collaborative research (Shani et al., 2008). Overall, during a 2-year period, the authors had frequent access to case information and organized feedback sessions with company representatives. The 1st and 4th authors conducted partial exploration in Cases 1 and 3. Moreover, the 4th author attended 17 face-to-face meetings and 40 conference calls of the International Roadmap Community and is directly involved in the “More than Moore” initiation of the ITRS. This involvement allowed for understanding of multiple sources of influence on the organized challenges and revealed conflicting views on the issues analyzed in the paper. The participation of the 2nd and 3rd authors was useful in analyzing the data independently from the external position. In addition to the data collection, a review of secondary sources was conducted. These supporting documents included various sources of information (*Table 1*).

Results: Organizational structures for GT portfolio constitution in unknown situations

The organizational structures for each of the contexts depicted in the *Figures 1 – 4* were developed based on the information acquired through the case studies. The case analysis enabled an examination of 4 organizational contexts structured around the exploration of portfolios. The deduced findings were discussed with the company representatives to gain their feedback and modification.

Case finding 1. Innovation challenge “Business Innovation Process”

An innovation contest called the “Business Innovation Process” (BIP) was initially organized in 2009 by two geographical sites of STMicroelectronics in France (Crolles and Grenoble, which involve more than 6,400 employees) located in the Rhone Alpes region, known as the “French Silicon Valley” in microelectronics and nanotechnology. The contest targeted transversality, ecosystem development and value for users and for ST of future innovative solutions to address several business areas. The process was launched with the following goal:

“to boost the Grenoble and Crolles sites’ contribution to ST value creation through better innovation and better use of local clusters” (BIP, 2009b).

The technologies mastered by the two sites involved in this contest are diverse. These technologies were developed by the central R&D groups that are responsible for specific technological development, advanced R&D units that seek to explore immature, still unknown technologies, external R&D centers that are involved in technological development with ST and R&D groups that are associated with each business unit independently of the general R&D. On the technology side, the contest allowed the open participation of any employee of these groups. Likewise, the wording regarding the targeted uses and markets allowed for a wide variety of solutions involving the open participation of all business units and strategy and marketing units. Hence, this process was clearly positioned in a situation of double unknown (double technology and market exploration) and privileged open collaboration and learning. The process involved the phases of challenge initialization, idea generation, selection and ideas development. The high number of ideas collected through each challenge (33, 60 and 110) resulted in 20 selected projects that were built through idea grouping and generalization (over a 3-year period). As a result of the exploration, 4 technologies appeared to be generic, and they formed their own GTs portfolios by creating new complementary projects (see *Table 2*). The *Appendix* provides examples of GT and specific exploration cases within the portfolios. The specific ideas issued from BIP and the associated portfolios primarily involved the collaboration of a particular business unit and research group (*Figure 1*).

The exploration relevant to GT aimed to propose a solution that imposes the collaboration of several R&D groups to address the needs of several business units and to provoke the exploration of new markets. Thus, some idea propositions attempted to create complementary projects and to organize portfolios to explore both the generic construct and its market modules. For instance, initiated in 2009, the “Real Challenge” innovation contest 3DTouch project was selected as a result of both its disruptive nature and its vast market potential:

“Based on the material properties (tissue, wood, leather...), a micro-electro-mechanical-system (MEMS) actuator can simulate the surface of the object to the customer at home and help him to select and buy products online. This solution can be dedicated to medical applications, to establish diagnostics at distance, [to] e-commerce applications...” (BIP, 2009a).

The generic project in the case of 3DTouch indicated the method of developing a platform that addresses generic functions independent of the environment and dissociates them from the adaptable modules that include specific functions. Furthermore, platform enrichment was organized through portfolio creation, which included both the development of interdependencies to address the development of market modules by reusing generic technology and management to ensure the deployment of market complementarities and generic core enrichment. The generic haptic technology yielded by 3DTouch gave rise to a portfolio that currently comprises the following: several research projects, collaborative projects with external research centers and industrial partners, and ongoing projects in BUs to develop commercial products. The generic portfolio was consequently created to explore new unknown environments by acquiring the necessary knowledge and expertise. BIP played the role of innovation hub or incubator to prioritize the collaboration of various business and R&D units (*Figure 1*). This entity privileged the exploration of multiple emerging markets and new technologies by creating interdependencies and by reducing unknowns.

Insert Figure 1 about here

The example of 3DTouch demonstrates that the manager role appears to be critical to privilege generic aspects of the solution rather than to prioritize specialization in more promising markets. For instance, one of the potential customers were interested in using haptic technology for eye-less keyboard application and eye-less haptic mouse. If a manager chooses to address only these promising markets, then the transparency of a multi-touch capacitive solution required for smartphones and tablets would be difficult even to consider. In this case, the manager was able to design a portfolio in which functions specific to the market were managed in separate projects and in which the generic core was a common project that facilitates its reuse by the emerging market areas. This manager, which we propose to call the **cross-application manager (CAM)**, was able to manage the links between technological requirements and market needs. On the contrary, the lack of collaboration within these roles and insufficient management of learning interdependencies might consequently lead to the failure in GT exploration. Moreover, it is important to note the key role of the organizing committee, which did not seek to select the winner of the challenge but privileges the accumulation of joint expertise within participants from different backgrounds. This committee – the Core Innovation Team – privileged multi-market exploration and helped project leaders build their network both internally and externally, and the team played the role of the interface between various technological and business groups. This team involved people from the R&D, BU and strategic departments (an approximate total of 15 specialists) and played the role of CAM during the business innovation process (*Table 2*). Overall, from 20 projects issued from the ideas contest, the only 4 successful ones that are still ongoing appear to be generic. These projects seek to develop new technologies and orientate them towards several emerging markets (e.g., 3DTouch). Their success is highly correlated with the presence of the managers who privilege multi-market exploration and conduct the reasoning in unknown yet environments. The rejected projects led to propose the incremental innovations for the chosen by the projects leaders market applications. In this case, the exploration conducted to reduce uncertainty and not to account for larger application area.

Case finding 2. ITRS “More than Moore” working group

The ITRS aims to provide industry with roadmaps that “align” the priorities between the various company actors responsible for transforming an idea into growth through innovation. In their study of the ITRS, Le Masson et al. (2012) demonstrated the possibility of collectively managing the innovation capabilities of the ecosystem by creating roadmaps that

are largely driven by the predictable range of technological change, which is known as Moore's Law. Technology working groups (TWGs) of the ITRS International Roadmap Community (IRC) are responsible for creating their roadmaps according to future transistor generation and the challenges associated with scaling. They deal with uncertainty reduction for predefined technological domains (i.e., system drivers, design,...see *Figure 2*). The ITRS first mentioned the "More than Moore" (MtM) trend in 2005. The MtM handles situations in which the figure of merit is no longer miniaturization; the exploration is exposed to various emerging markets and technologies that involve the management of various parameters. This trend demonstrates that the decoupling between the market and technology that is common in the semiconductor industry could no longer be supported; companies are now truly in double unknown situations with many potential markets exhibiting high levels of uncertainty with regard to sizes, timing, and needs and with many potential technologies. In 2011, the European members of the committee wrote a "More than Moore" white paper that guides the ITRS community to identify those MtM technologies for which a roadmapping effort would be feasible and desirable (Arden et al., 2010). This committee seeks to "build the link between societal needs, markets and technologies well beyond the ITRS current practice, and is likely to require the involvement of many actors beyond the ITRS historical membership" (Arden et al., 2010). The white paper proposed to complement the usual technology push approach of the ITRS by the sketch of broad "application scenario". Technology building blocks that should be road mapped "have to enable functionalities to account for several applications and markets (Cogez et al., 2013). The MtM technology working group attempts to build a transversal roadmap based on generic functions. These generic functions are precisely the common technology needs of various future markets, which can in turn be used as a template for companies addressing portfolio organization in double unknown situations (*Figure 2*). The transversal collaboration within MtM and various TWGs and the exposure to disruptive markets would lead the ITRS to structure a portfolio of potential MtM solutions. This portfolio presents the potential challenges and directions that companies could take to coordinate their scientific and development efforts. The idea of using generic functions and the incorporation of market ideas permit the committee to structure the effort toward the portfolio of GTs.

Insert Figure 2 about here

This case demonstrates that highly coordinated activities of individuals leading the MtM trend have increased its importance within the community. From its first mention in 2005, the citation of MtM in 2011 reached 79, and among 18 TWGs within the ITRS, 11 groups cite MtM. Additionally, a purely MtM-oriented group was created in 2011 for MEMS portfolio exploration. The coordinators of the MtM group play the role of CAM within the ITRS community (*Table 2*). They search for existing knowledge gaps within the landscape of technologies and markets to define the direction of technological development and identify interdependencies that can be built to acquire generic technology. They do not seek to reduce uncertainty by choosing a particular technological trajectory but they aim to structure unknowns to privilege genericity exploration. Their position within the ecosystem of the major industrial players of the semiconductor industry facilitates their access to necessary information and enables them to test the relevance of their propositions.

Case finding 3. Exploration sessions for patent portfolio creation

At ST, each inventor (who could be anyone in the company) can submit its proposal to the patent committee members for their evaluation. Potential inventors must present and defend their inventions to be granted a patent. A patent is represented in this case as a "by-product" design activity, which can be obtained once products are almost fully defined. With regard to

generic technology design, both technologies and future applications are unknown. Given the pervasive nature of generic technology, what a strategy to protect a new generic design would not infringe on the existing intellectual properties and permit profiting from genericity by developing other markets (not necessary by the IPs holder)?

The logic of patenting is often regarded as an objective of research. In highly innovative fields, patent design can occur even before the design activities or research work in general. In the work of Felk et al. (2011), a model of patent design primarily for technology emergence was introduced. The authors showed how to create a strong patent portfolio in the field of interest to strategically position future patents within the predefined design space. This experiment was conducted for disruptive 3D integration technology at STMicroelectronics. The 3D integration technology is recognized as a generic technology with a broad range of anticipated applications, such as memory, portable devices, and high-performance computers. The resulting 3D circuits are the individual chips in which several layers of active electronic components are stacked vertically and horizontally. In 2008, when the technology was still immature with high levels of unknowns, the authors demonstrated that by working on generic concepts such as the “*definition of a Trough-X-Via (TXV) as an interconexion between devices rather than Through-Silicon-Via (TSV)*”, one can consider any type of substrate and ways of interconnecting devices through this substrate. The high rate of ideas generated and relevant concepts led to a high number of propositions, which in turn enabled the company to obtain patents and to launch new exploration projects at ST. The group that initially participated in this work succeeded in proposing more than 10% of the invention disclosures at ST in 2009 (Felk et al., 2011). The joint exploration session enabled the company to better position patent propositions, to define interdependencies and therefore to design stronger patent portfolio to protect a GT. This and 4 other experiences of patent portfolio design within ST that were conducted later demonstrate the opportunity to obtain larger patent propositions that are generic and to propose powerful solutions for identified market challenges as well (Figure 3).

Insert Figure 3 about here

Each group of idea exploration largely included participants with technological backgrounds but also included participants from business units who were interested in a particular type of technological exploration. The working sessions were organized and conducted by a coordinator/ animator who managed the group and directed them toward the exploration of new concepts to achieve greater genericity. All of the participants contributed to the elaboration of ideas and the formulation of invention proposals. At the end, the list of inventions were established and presented to the committee. Each proposition had a number of authors assigned to it who were responsible for exploring the technological proposition on a deeper level and developing it once the idea is issued through the process. It is important to underline the role of the coordinators/animators of these sessions, who played the role of cross-application manager temporarily during each transversal exploration (Table 2). These coordinators push the exploration towards the unknown yet domains and aimed to avoid the incremental optimization of the existing technological solutions which often brings to “weak” invention proposals. As a result, a portfolio of inventions was established to help better valorize and protect the emerging GTs.

Case finding 4. Research project portfolio

The portfolio of PhD projects conducted within ST through 2002–2010 was considered for analysis. These projects are managed within the technology R&D group. Overall, the data represent 405 thesis projects. The projects are classified according to the technological group ownership (similar to the TWGs of the ITRS) (Figure 4). The analysis showed that the

research groups primarily managed their project portfolios independently. Each research project lasts approximately 3-4 years, and the results are communicated within the groups and used to define goals for subsequent exploration. The advanced R&D group is largely responsible for the “More than Moore” projects exploration. The resources available are shared within the groups.

For instance, the project portfolio managed by etching group involves 21 projects launched within an 8-year period. These projects are structured within a common goal to “*obtain the desired thin film pattern with the next CMOS generation*”. In 2002, the etching group launched a project that aimed to develop a plasma-etching process of high dielectric constant materials for advanced integrated circuits (CMOS generation 45 nm). The results of this work led to the launch of a new project in 2005 that showed how to achieve infinite etch selectivity by adjusting the power of bias. The results led to the implementation of new plasmas for etching. Within etching and other research portfolios, project interdependencies (especially learning interdependencies) and technological uncertainties are effectively managed. In addition to the classical research project portfolio exploration that delivers solutions to particular business units, the analysis enabled the identification of different types of project clusters (primarily within advanced R&D groups) that attempt to incorporate the recent advancements of each research portfolio and that seek to integrate the notion of market value directly into the research projects. This type of portfolio (4 clusters out of 10) directly incorporated market knowledge and thus resulted in faster market disruption. For instance, the bipolar project portfolio (10 Ph.D. projects involved) and the corresponding roadmap were driven both by the increase in the optical communications data rate and by the emergence of applications at higher frequencies (Chevalier et al., 2007). The portfolio was structured along the bipolar technology adapted for millimeter-Wave applications. It is a technological platform based on a Heterojunction Bipolar Transistor (HBT), which features include many advantages comparing to CMOS devices like their low noise factor, higher voltage and higher resistance for the same speed (for further details see (Chevalier et al., 2007)). The co-exploration of technology and markets enabled the introduction of this technology to various markets, such as the rapid download, optical communication, medical, and high-frequency markets. Another previous study (Kokshagina et al., 2013) demonstrated that the technology behind a project was generic and that the portfolio was designed with this reasoning in mind to support and introduce this technology to several market areas. This cluster oriented toward GT exploration aimed to mobilize the resources from all other research teams and to build interdependences with various Bus and external partners to better position the portfolio in multiple markets.

Insert Figure 4 about here

Figure 4 shows that there are groups that have demonstrated the efficient establishment of a technology–market relationship. In this case, there is no need for transversal exploration toward the GTs, the idea behind is to reduce uncertainties and deliver the best solutions in terms of technological performance to attain higher benefits. Once the levels of uncertainty are higher, the technology under question has the premises of being generic, and the role of clusters for GT exploration becomes advantageous. Furthermore, the lack of communication and visibility could lead to poorly reused results among the groups. For instance, within the etching group, one of the research projects aimed to explore the etching of “through-silicon-via” for 3D integration (another research group). However, this exploration was not organized in collaboration with the 3D integration group, and the knowledge acquired did not incorporate the advancements in 3D fields, which most certainly influenced the quality of the results obtained. The presence of managers (the team coordinator and technology line managers) playing the role of CAMs enabled the company to build the interface within

various BUs and R&D centers and to position technologies as generic earlier, which in turn allowed for more rapid technology appropriation by the market through the construction of previous interdependencies. The portfolio organization of the R&D projects enabled effective exploration of the emerging market and technology spaces; it incorporates the clusters dealing with unknowns, uncertainties and risks. The clusters dealing with both unknown technologies and markets require the presence of CAM to coordinate exploration towards the successful GTs design.

The work on innovative research portfolio management can bring new tools and frameworks for companies confronting technologies challenges of increasing complexity in addition to shorter product life cycles. This environment forces firms to rely on R&D as a source of strategy, and companies are inclined to evaluate their technologies from a portfolio perspective in which a set or a sub-set of R&D projects are evaluated together in relation to one another.

Toward cross-application management

The effect of cross-disciplinary exploration, exposure to unknown structure and the constant technology-market coordination process resulted in greater genericity in all of the analyzed cases.

The successful implementation of GTs requires multiple roles to guide the technology and market exploration phases as well as their propagation, appropriation, communication, and management. Exposure to yet unknown markets and technological structures provides an opportunity for project leaders to proceed toward GT development and to address multiple markets. Although these transversal projects offer solutions for several BUs, they often pose challenges in terms of BU investments for technology development, managerial responsibility, technology ownership, and time to market. For instance, BUs need to decide how they will share the costs of platform development and which remaining costs they must pay for market complementarities. To ensure platform adaption by various markets, GT managers must manage these organizational risks. Additionally, GT managers must be able to ensure platform insertion into both existing markets that can generate profit in the short term and emerging markets to ensure long-term growth for GT.

In summary, portfolio structuring for GT motivates managers to seek transversal ideas to address several market areas (existing and new areas) and new original technological solutions that are flexible and robust to address several environments. Managers should privilege a variety of market applications while reusing the existing technological competences and developing new competences with minimal costs of re-adaptation between future modules. These results indicate the existence of an actor(s) who has the expertise to identify missing technologies and markets and to construct interdependencies. We refer to this actor as cross-application manager. The role of the CAM appears to be pivotal in the pursuit of GT design.

The CAM must coordinate the exploration between various technological and market groups. His role is primarily responsible for the identification of opportunities within a portfolio and the creation of future interdependencies within technological alternatives and marketing opportunities. The CAM should be able to mobilize technical experts to assess the technological character to estimate whether the emerging technology has the potential to address emerging market needs. Thus, the CAM should mobilize GTs and organize their exploration such that they are able to attract market functionality and to provoke further market exploration (*Table 2*). In summary, the CAM should be able to 1) manage multiple technology and market exploration simultaneously in a double unknown context; 2) know the

functional structure of emerging and existing markets within various business units and their existing technological portfolio; 3) evaluate external and internal R&D technological portfolio and reveal the character of technologies while identifying knowledge voids; and 4) be responsible for identifying opportunities for generic technology development.

Insert Table 2 about here

Discussion and conclusion

Theoretical and managerial contribution

Cross-application manager and corresponding organizational structures

The current paper investigates the role of management in generic PPM in situations with unknowns. The presented work shows that the design of GT requires a new actor in organizations – a cross-application manager who is able to ensure the interaction of innovative concepts developed in different business and research lines. This figure may be challenging to identify, and the necessary level of expertise is difficult to achieve without relevant experience, but this role appears to be necessary for the processes of genericity building and portfolio constitution. Through the process of unknown exploration, this actor permits the coordination of creativity within an organization.

The multiple case analyses reveal that the GT appears to be successful when managerial support is present and pilots the transversal technological and market exploration. For example, within the business innovation process in **Case 1**, the project leaders who privileged genericity succeeded in developing a generic platform for several markets. More importantly, the generic projects were the only ones that were considered successful within the context of these challenges. The existence of the technology working group “More than Moore” in **Case 2** and its accomplishments, which were oriented toward the exploration of the double unknown, relies heavily on the involvement of its coordinator(s). He privileges the construction of roadmaps in double unknowns based on the identification of generic functions (Cogez et al., 2013). The success of GT exploration is correlated with the existence of an actor playing this role at least temporarily. For instance, **Case 3** shows that the coordinator(s) and/or animator of the patent exploration session temporarily plays the role of cross-application manager to orient the group toward generic portfolio exploration to ensure both the generic character of technologies and the multiplicity of future uses. **Case 4** corresponds to the R&D management model for radical innovation exploration (O'Connor and DeMartino, 2006), which focuses on discovery and goes beyond the role of R&D as BU's exploration centers solve their engineering development needs. As O'Connor and DeMartino (2006) indicated, these R&D groups require greater business development skills and seek to explore transitioned projects. Likewise, the advanced R&D groups at ST attempt to design GTs, which requires the long-term strategic vision of the groups' leaders and their capacity to position and orient scientific discoveries toward more profitable business needs. Another similar model (O'Connor and DeMartino, 2006) is comparable to the organizational structure observed in **Case 1**. As the authors stated, this model simultaneously privileges the discovery and acceleration of the technology and market platforms identified by companies executives. In this model, the cross-application layer is managed by the project leaders of each generic portfolio and by challenge organizers as well.

The figure of CAM supports the changes in both markets and technological exploration and the operating conditions that are directly linked with the innovation capabilities of organizations (Green et al., 2007). The platform leader and his role comprise the interaction with a large number of complementarities that occupy peripheral positions (Gawer, 2010).

Similar to the platform leader, the role of CAM comprises the interdependencies that accumulate to further promote the portfolio that is designed as a result of the platform. However, in addition to the duties of platform leader, the CAM role also comprises generic core identification and building.

Toward portfolio structuring in unknown situations

This research creates new perspectives for high levels of uncertainty management in the processes of exploring emerging industrial sectors (Rothwell and Gardiner, 1989). This study contributes to the field of innovation management with respect to the efficient combination of contributions from multiple project perspectives. Resource limitations require an organization to strategically allocate resources to a subset of possible projects (Dickinson et al., 2001). Portfolio risk management seeks to reduce uncertainty by better estimating the risks in a portfolio; it is not a design process. However, an exploration project can be financed to reduce technical uncertainty or, according to the markets, to gain knowledge to reduce uncertainty in consumer behaviors. The projects that attempt to design GTs enable, as shown by this paper, the organization and structuring of portfolios under contexts of high uncertainty. The generic project is the core of a portfolio and must ensure its independence from the set of possible specific contests (such as specific market applications) and must create interdependencies with the emerging markets. The generic platform must be attractive for multiple markets and must provoke their creation.

To develop successful GT exploration, the organization of portfolios in unknown contexts becomes critical. To account for successful exploration, it was demonstrated that in unknown situations, both uncertainty and interdependency management are crucial. The portfolio design based on GTs is helpful for building more balanced portfolios. Long-term strategic and less risky application-specific projects are balanced within such portfolios. Moreover, such a portfolio is balanced by the constant resource interdependencies created during the building of the portfolio (Meskendahl, 2010, Killen et al., 2008).

Companies that engage in the exploration of generic (general-purpose) technologies naturally link their portfolios with their strategic orientation. Generic project portfolios reduce unknowns by enhancing the cooperation among technological, market, and strategic research units and thus create synergies within portfolios (Loch, 2008, Cooper et al., 2001). The economic success of a portfolio depends on its commercial and market success (Shenhar et al., 2001). When coordinating portfolio structuring in the context of unknowns, the CAM encounters double difficulty, as potential value is difficult to estimate because of the rapidly changing industrial environment and high volatility.

Despite the challenges associated with environments with high uncertainty and high velocity common to high-tech industries such as semiconductors (Cohen and Levinthal, 1989), this work shows that it is possible to account for portfolio management in unknown environments through the design of generic technology that creates interdependencies within technologies and markets and that constitutes a portfolio to explore this technology and its market derivatives. This study has demonstrated that earlier efforts in portfolio organization enable reducing unknowns and accounting for higher genericity. Moreover, the possibility of incorporating new projects over time signals the flexibility and easier adaptation of a portfolio in the face of new challenges.

Further research and implications

This research demonstrates the importance of the cross-application manager in structuring and guiding portfolios of GTs. This study contributes to examining the link between the organizational structures and necessary competences for portfolio organization to account for

PPM in unknown environments. The empirical understanding of the issues of GT exploration in highly uncertain, dynamic environments and the associated role of management were added to the interdisciplinary PPM context. This research provides a new perspective on the strategic management of innovation through portfolio structuring.

Generally, the literature confirms the interest in developing GTs (Youtie et al., 2008, Maine and Garnsey, 2006). However, methods of organizing the development of generic radical technologies and associated management techniques remain understudied. In terms of the contribution to the literature, the proposed paper attempts to address the issue of designing GTs, to provide insights into portfolio organization to account for genericity and to define the importance of the managerial role (defined here as the cross-application manager) in accounting for GT design. However, this research is limited to the empirical context of the semiconductor industry. The findings must be verified in the larger context and within various industries. The sample size should be increased, and the effect of GT presence on the success of the overall portfolio must be quantified. The conditions in which a company must privilege GT exploration within a portfolio and organize its exploration in the context of unknowns remain to be identified.

This paper could lead to new research avenues in the field of creativity and cognition in relation to new competences that can be used to cope with unknowns. For instance, techniques that have recently emerged in using enhanced interactions through communication, boundary spanning (Rapp et al., 2013) or enhanced cognitions (Agogu e et al., 2012) to overcome fixation effects could potentially be used to enhance genericity and to cover larger application areas.

Finally, our findings bring new perspectives to GT development from the PPM perspective. The results of this research provide important insights into the governance of unknown situations and clarify the capability of actors in coordinating exploration when both technology and markets are unknown.

References

- Agogu e, M., Le Masson, P. & Robinson, D. K. (2012) Orphan innovation, or when path-creation goes stale: a design framework to characterise path-dependence in real time. *Technology Analysis & Strategic Management*, 24, 603-616.
- Agogue, M., Ystr om, A. & Le Masson, P. (2013) Rethinking the role of intermediaries as an architect of collective exploration and creation of knowledge in open innovation. *International Journal of Innovation Management*, 17.
- Archer, N. P. & Ghasemzadeh, F. (1999) An integrated framework for project portfolio selection. *International Journal of Project Management*, 17, 207-216.
- Arden, W., Brillou et, M., Cogez, P., Graef, M., Huizing, B. & Mahnkopf, R. (2010) More-than-Moore white paper. Version, 2, 14.
- Ben-Haim, Y. (2006) *Info-gap decision theory: decisions under severe uncertainty*, Academic Press.
- Beringer, C., Jonas, D. & Kock, A. (2013) Behavior of internal stakeholders in project portfolio management and its impact on success. *International Journal of Project Management*.
- Bip. (2009a) *Business Innovation Process: Challenge   id es Crolles - Grenoble* [Online]. Available: bip-challenge-idees.gnb.st.com.
- Bip. (2009b) *Business Innovation Process. Lancement BIP Grenoble*.

- Birkinshaw, J., Hamel, G. & Mol, M. J. (2008) Management innovation. *Academy of management Review*, 33, 825-845.
- Blau, G. E., Pekny, J. F., Varma, V. A. & Bunch, P. R. (2004) Managing a portfolio of interdependent new product candidates in the pharmaceutical industry. *Journal of Product Innovation Management*, 21, 227-245.
- Bresnahan, T. F. & Trajtenberg, M. (1995) General purpose technologies 'Engines of growth'? *Journal of econometrics*, 65, 83-108.
- Büchel, B., Nieminen, L., Armbruster-Domeyer, H. & Denison, D. (2013) Managing stakeholders in team-based innovation: The dynamics of knowledge and trust networks. *European Journal of Innovation Management*, 16, 22-49.
- Bunderson, J. S. & Boumgarden, P. (2010) Structure and learning in self-managed teams: Why "bureaucratic" teams can be better learners. *Organization Science*, 21, 609-624.
- Carlsson, C., Fullér, R., Heikkilä, M. & Majlender, P. (2007) A fuzzy approach to R&D project portfolio selection. *International Journal of Approximate Reasoning*, 44, 93-105.
- Chapman, C. (1990) A risk engineering approach to project risk management. *International Journal of Project Management*, 8, 5-16.
- Chevalier, P., Szlag, B., Boissonnet, L., Cremer, S., Chantre, A. & Granger, E. (Year) Published. Advanced silicon technologies for wireless communications. *Research in Microelectronics and Electronics Conference, 2007. PRIME 2007. Ph. D., 2007. IEEE*, 291-297.
- Chien, C. F. (2002) A portfolio-evaluation framework for selecting R&D projects. *R&D Management*, 32, 359-368.
- Christensen, J. F. (2003) Introduction: The industrial dynamics of biotechnology: new insights and new agendas. *Industry and Innovation*, 10, 223-230.
- Cogez, P., Kokshagina, O., Le Masson, P. & Weil, B. (2013) Industry-Wide Technology Road Mapping in Double Unknown – The Case of the Semiconductor Industry. 2013 IEEE International Technology Management Conference & 19th ICE Conference. The Hague.
- Collyer, S. & Warren, C. M. (2009) Project management approaches for dynamic environments. *International Journal of Project Management*, 27, 355-364.
- Cooper, R. G., Edgett, S. J., Kleinschmidt, E. J. & Business, M. G. D. S. O. (2001) Portfolio management for new products.
- Danneels, E. (2004) Disruptive technology reconsidered: A critique and research agenda. *Journal of product innovation management*, 21, 246-258.
- Dickinson, M. W., Thornton, A. C. & Graves, S. (2001) Technology portfolio management: optimizing interdependent projects over multiple time periods. *Engineering Management, IEEE Transactions on*, 48, 518-527.
- Dixit, A. K. & Pindyck, R. S. (1994) *Investment under uncertainty*, 1994. Princeton UP, Princeton.
- Eilat, H., Golany, B. & Shtub, A. (2006) Constructing and evaluating balanced portfolios of R&D projects with interactions: A DEA based methodology. *European Journal of Operational Research*, 172, 1018-1039.

- Eisenhardt, K. (1989a) Building Theories from Case Study Research. *The Academy of Management Review*, 14, 532-550.
- Eisenhardt, K. M. (1989b) Making fast strategic decisions in high-velocity environments. *Academy of Management journal*, 543-576.
- Eisenhardt, K. M. & Martin, J. A. (2000) Dynamic capabilities: what are they? *Strategic management journal*, 21, 1105-1121.
- Felk, Y., Le Masson, P., Weil, B., Coge, P. & Hatchuel, A. (Year) Published. Designing patent portfolio for disruptive innovation - a new methodology based on CK theory Proceedings of the 18th International Conference on Engineering Design (ICED11), Vol. 2, 2011. 214-225.
- Finkelstein, S. & Hambrick, D. C. (1990) Top-management-team tenure and organizational outcomes: The moderating role of managerial discretion. *Administrative Science Quarterly*, 484-503.
- Fleming, L. (2012) Breakthroughs and the “long tail” of innovation. *MIT Sloan Management Review*. v10.
- Fleming, L., Mingo, S. & Chen, D. (2007) Collaborative brokerage, generative creativity, and creative success. *Administrative Science Quarterly*, 52, 443-475.
- Garg, S. & Eisenhardt, K. M. (2012) Building Theory From Multiple Case Studies.
- Garud, R. & Karnøe, P. (2003) Bricolage versus breakthrough: distributed and embedded agency in technology entrepreneurship. *Research policy*, 32, 277-300.
- Gawer, A. (2010). The organization of technological platforms. In: Nelson Phillips, G. S., Dorothy Griffiths (ed.) *Technology and Organization: Essays in Honour of Joan Woodward in Research in the Sociology of Organizations*. Emerald Group Publishing Limited.
- Gawer, A. & Cusumano, M. A. (2008) How companies become platform leaders. *MIT Sloan Management Review*, 49, 28-35.
- Gillier, T. & Piat, G. (2011) Exploring Over: The Presumed Identity of Emerging Technology. *Creativity and Innovation Management*, 20, 238-252.
- Green, L., Miles, I. & Rutter, J. (2007) Hidden innovation in the creative sectors. Manchester Institute for.
- Hamel, G. (2006) The why, what, and how of management innovation. *Harvard business review*, 84, 72.
- Henderson, R. M. & Clark, K. B. (1990) Architectural innovation: the reconfiguration of existing product technologies and the failure of established firms. *Administrative science quarterly*, 9-30.
- Howell, J. M. & Higgins, C. A. (1990) Champions of technological innovation. *Administrative science quarterly*, 317-341.
- Howells, J. (2006) Intermediation and the role of intermediaries in innovation. *Research policy*, 35, 715-728.
- Itrs. (2011) International Technology roadmap for Semiconductors. Executive summary.
- Jonas, D., Kock, A. & Gemunden, H. (2012) Predicting Project Portfolio Success by Measuring Management Quality---A Longitudinal Study.

- Killen, C., Krumbeck, B., Kjaer, C. & G, D.-L. (2009) Managing project interdependencies: exploring new approaches.
- Killen, C. P., Hunt, R. A. & Kleinschmidt, E. J. (2008) Project portfolio management for product innovation. *International Journal of Quality & Reliability Management*, 25, 24-38.
- Killen, C. P., Jugdev, K., Drouin, N. & Petit, Y. (2012) Advancing project and portfolio management research: Applying strategic management theories. *International Journal of Project Management*, 30, 525-538.
- Killen, C. P. & Kjaer, C. (2012) Understanding project interdependencies: The role of visual representation, culture and process. *International Journal of Project Management*, 30, 554-566.
- King, A. A. & Tucci, C. L. (2002) Incumbent entry into new market niches: The role of experience and managerial choice in the creation of dynamic capabilities. *Management Science*, 48, 171-186.
- Kock, A., Gemünden, H. G., Salomo, S. & Schultz, C. (2011) The mixed blessings of technological innovativeness for the commercial success of new products. *Journal of Product Innovation Management*, 28, 28-43.
- Koene, B. A., Vogelaar, A. L. & Soeters, J. L. (2002) Leadership effects on organizational climate and financial performance: Local leadership effect in chain organizations. *The Leadership Quarterly*, 13, 193-215.
- Kogut, B. & Kulatilaka, N. (2001) Capabilities as real options. *Organization Science*, 12, 744-758.
- Kokshagina, O., Le Masson, P., Weil, B. & Cogež, P. (2013). Platform emergence in double unknown (technology, markets): common unknown strategy. In: Çetindamar, D., Daim, T., Başoğlu, N. & Beyhan, B. (eds.) *Strategic planning decisions in the high tech industry*. London: Springer.
- Langlois, R. N. & Cosgel, M. M. (1993) Frank Knight on risk, uncertainty, and the firm: a new interpretation. *Economic Inquiry*, 31, 456-465.
- Le Masson, P., Weil, B., Hatchuel, A. & Cogež, P. (2012) Why are they not locked in waiting games? Unlocking rules and the ecology of concepts in the semiconductor industry. *Technology Analysis & Strategic Management*, 24, 617-630.
- Lee, W. (2011) Risk Based Asset Allocation: A New Answer To An Old Question? *The Journal of Portfolio Management*, 37, 11-2.
- Leonard - Barton, D. (1992) Core capabilities and core rigidities: A paradox in managing new product development. *Strategic management journal*, 13, 111-125.
- Lipshitz, R. & Strauss, O. (1997) Coping with uncertainty: A naturalistic decision-making analysis. *Organizational Behavior and Human Decision Processes*, 69, 149-163.
- Loch, C. H., Solt, M. E. & Bailey, E. M. (2008) Diagnosing Unforeseeable Uncertainty in a New Venture*. *Journal of Product Innovation Management*, 25, 28-46.
- Loch, C. L., Kavadias, S. (2008) *Handbook of New Product Development Management*, Elsevier Ltd.
- Lycett, M., Rassau, A. & Danson, J. (2004) Programme management: a critical review. *International Journal of Project Management*, 22, 289-299.

- Lynn, G., Morone, J. & Paulson, A. (1996) Marketing and discontinuous innovation: the probe and learn process. *California management review*, 38.
- Maine, E. & Garnsey, E. (2006) Commercializing generic technology: The case of advanced materials ventures. *Research Policy*, 35, 375-393.
- Mangematin, V. & Walsh, S. (2012) The future of nanotechnologies. *Technovation*, 32, 157-160.
- Martinez, J. L. (2013) Practitioner's Insight: Learning to Manage Emerging Technologies. *Creativity and Innovation Management*, 22, 6-9.
- Mcgrath, R. G. (1997) A real options logic for initiating technology positioning investments *Academy of management review*, 22, 974-996.
- Mcgrath, R. G. & Macmillan, I. C. (2009) *Discovery-driven growth: A breakthrough process to reduce risk and seize opportunity*, Harvard Business Press.
- Meskendahl, S. (2010) The influence of business strategy on project portfolio management and its success—A conceptual framework. *International Journal of Project Management*, 28, 807-817.
- Mietzner, D. & Kamprath, M. (2013) A Competence Portfolio for Professionals in the Creative Industries. *Creativity and Innovation Management*.
- Mikkola, J. H. (2001) Portfolio management of R&D projects: implications for innovation management. *Technovation*, 21, 423-435.
- Miyazaki, K. (1994) Interlinkages between systems, key components and component generic technologies in building competencies. *Technology Analysis & Strategic Management*, 6, 107-120.
- Moser, P. & Nicholas, T. (2004) Was electricity a general purpose technology? Evidence from historical patent citations. *American Economic Review*, 388-394.
- Mullins, J. W. (2007) Discovering “unk-unks”. *MIT Sloan Management Review*, 48, 17-21.
- Mullins, J. W. & Sutherland, D. J. (1998) New product development in rapidly changing markets: an exploratory study. *Journal of product innovation management*, 15, 224-236.
- O'connor, C. G. (2006) Organizing for Radical Innovation: An Exploratory Study of the Structural Aspect of RI Management Systems in Large Established Firms. *The Journal of product innovation management*, 23, 475-497.
- O'connor, C. G., Ravichandran T., Robenson, D. (2008a) Risk management through learning: Management practices for radical innovation success. *Journal of High Technology Management Research*, 19, 70-82.
- O'connor, G. C. (2008b) Major Innovation as a Dynamic Capability: A Systems Approach*. *Journal of product innovation management*, 25, 313-330.
- O'connor, G. C. & Demartino, R. (2006) Organizing for radical innovation: an exploratory study of the structural aspects of RI management systems in large established firms. *Journal of product innovation management*, 23, 475-497.
- O'connor, G. C. & Rice, M. P. (2012) New Market Creation for Breakthrough Innovations: Enabling and Constraining Mechanisms. *Journal of Product Innovation Management*.

- O'Connor, G. C. & Veryzer, R. W. (2001) The nature of market visioning for technology - based radical innovation. *Journal of Product Innovation Management*, 18, 231-246.
- O'Connor, G. C. & McDermott, C. M. (2004) The human side of radical innovation. *Journal of Engineering and Technology Management*, 21, 11-30.
- Olleros, F.-J. (1986) Emerging industries and the burnout of pioneers. *Journal of Product Innovation Management*, 3, 5-18.
- Olsson, R. (2007) In search of opportunity management: is the risk management process enough? *International Journal of Project Management*, 25, 745-752.
- Olsson, R. (2008) Risk management in a multi-project environment: An approach to manage portfolio risks. *International journal of quality & reliability management*, 25, 60-71.
- Pender, S. (2001) Managing incomplete knowledge: Why risk management is not sufficient. *International Journal of Project Management*, 19, 79-87.
- Petit, Y. (2012) Project portfolios in dynamic environments: organizing for uncertainty. *International Journal of Project Management*, 30, 539-553.
- Petit, Y. & Hobbs, B. (2010) Project portfolios in dynamic environments: sources of uncertainty and sensing mechanisms. *Project Management Journal*, 41, 46-58.
- Pmi. (Year) Published. A Guide to the Project Management Body of Knowledge: PMBOK® Guide. 2008. Project Management Institute.
- Powell, W. W. (1987) Explaining technological change. JSTOR.
- Raiffa, H. (1968) Decision analysis: introductory lectures on choices under uncertainty.
- Rapp, A., Beitelspacher, L. S., Grewal, D. & Hughes, D. E. (2013) Understanding social media effects across seller, retailer, and consumer interactions. *Journal of the Academy of Marketing Science*, 1-20.
- Rohrbeck, R. & Gemünden, H. G. (2011) Corporate foresight: its three roles in enhancing the innovation capacity of a firm. *Technological Forecasting and Social Change*, 78, 231-243.
- Rosenberg, N. (1994) Exploring the black box: Technology, economics, and history, Cambridge University Press.
- Rothwell, R. & Gardiner, P. (1989) The strategic management of re - innovation. *R&D Management*, 19, 147-160.
- Sanchez, H., Robert, B., Bourgault, M. & Pellerin, R. (2009) Risk management applied to projects, programs, and portfolios. *International journal of managing projects in Business*, 2, 14-35.
- Sandstrom, C. & Bjork, J. (2010) Idea management systems for a changing innovation landscape. *International Journal of Product Development*, 11, 310-324.
- Savage, L. (1972) The foundations of statistics, DoverPublications. com.
- Scherer, F. M. (1993) Pricing, profits, and technological progress in the pharmaceutical industry. *The Journal of Economic Perspectives*, 7, 97-115.
- Shani, A. B., Coughlan, D. & Coughlan, P. (2008) Handbook of collaborative management research, Sage Publications Thousand Oaks, CA.

- Shenhar, A. J., Dvir, D., Levy, O. & Maltz, A. C. (2001) Project success: a multidimensional strategic concept. *Long range planning*, 34, 699-725.
- Teece, D. J. (1986) Profiting from technological innovation: Implications for integration, collaboration, licensing and public policy. *Research policy*, 15, 285-305.
- Teller, J. & Kock, A. (2012) An empirical investigation on how portfolio risk management influences project portfolio success. *International Journal of Project Management*.
- Vaccaro, I. G., Jansen, J. J., Van Den Bosch, F. A. & Volberda, H. W. (2012) Management innovation and leadership: The moderating role of organizational size. *Journal of Management Studies*, 49, 28-51.
- Van De Ven, A. H. (2007) *Engaged scholarship: A guide for organizational and social research*, OUP Oxford.
- Van De Ven, A. H., Polley, D. E., Garud, R. & Venkataraman, S. (1999) *The innovation journey*, Oxford University Press New York.
- Van De Ven, A. H. & Poole, M. S. (2005) Alternative approaches for studying organizational change. *Organization Studies*, 26, 1377-1404.
- Verworn, B. (2009) A structural equation model of the impact of the “fuzzy front end” on the success of new product development. *Research Policy*, 38, 1571-1581.
- Veryzer, R. W. (1998) Discontinuous innovation and the new product development process. *Journal of product innovation management*, 15, 304-321.
- Walsh, S. T. (2004) Roadmapping a disruptive technology: A case study: The emerging microsystems and top-down nanosystems industry. *Technological Forecasting and Social Change*, 71, 161-185.
- Wouters, M., Roorda, B. & Gal, R. (2011) Managing Uncertainty During Rd Projects: A Case Study. *Research-Technology Management*, 54, 37-46.
- Yin, R. K. (2008) *Case study research: Design and methods*, Sage Publications, Incorporated.
- Youtie, J., Iacopetta, M. & Graham, S. (2008) Assessing the nature of nanotechnology: can we uncover an emerging general purpose technology? *The Journal of Technology Transfer*, 33, 315-329.

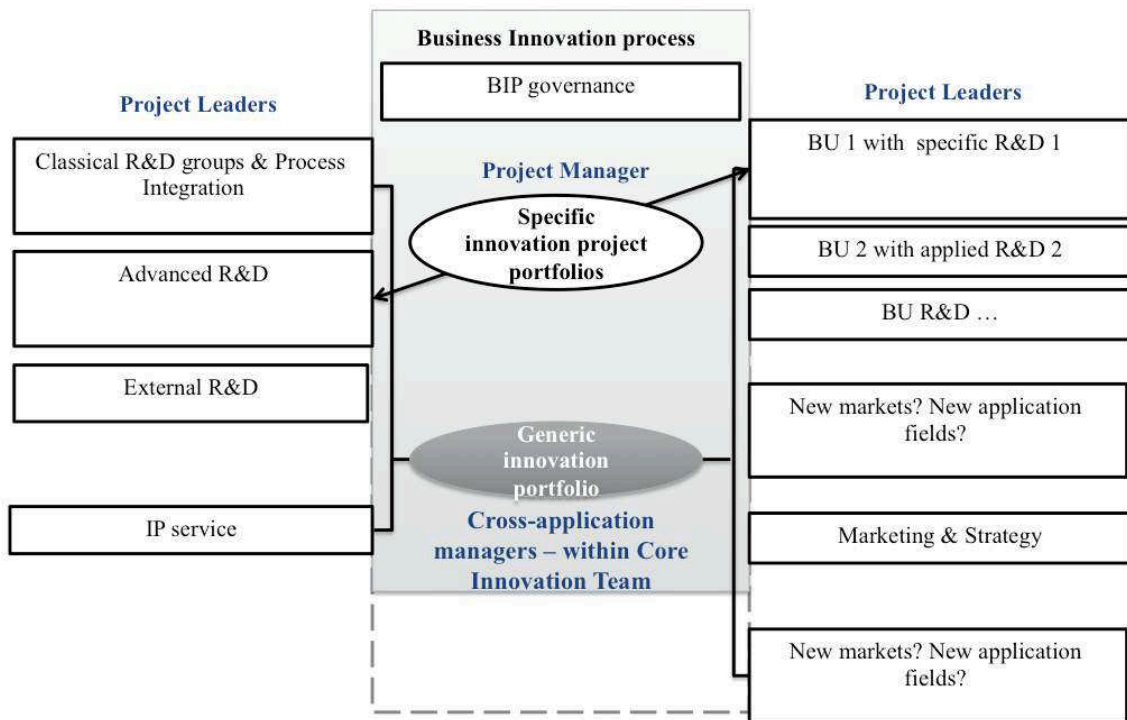

Figure 1 Business innovation process for generic portfolio structuring

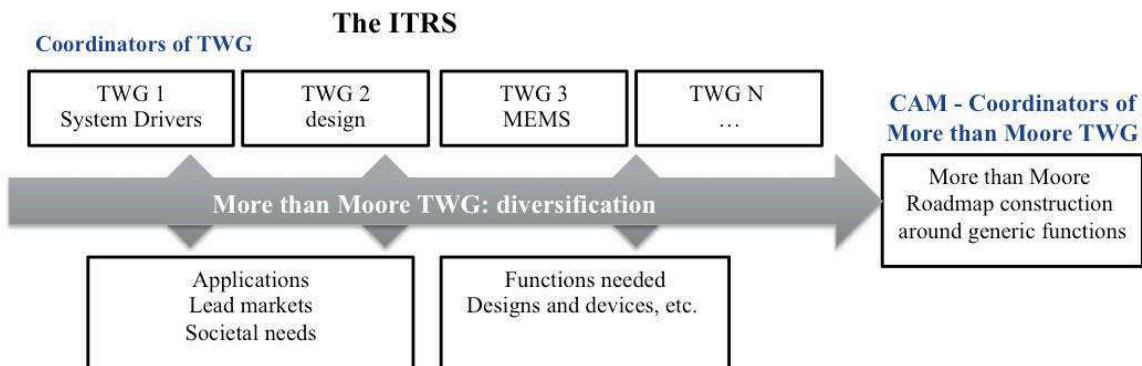

Figure 2 More than Moore ITRS TWG in the process of unknown exploration

The Patent portfolio exploration

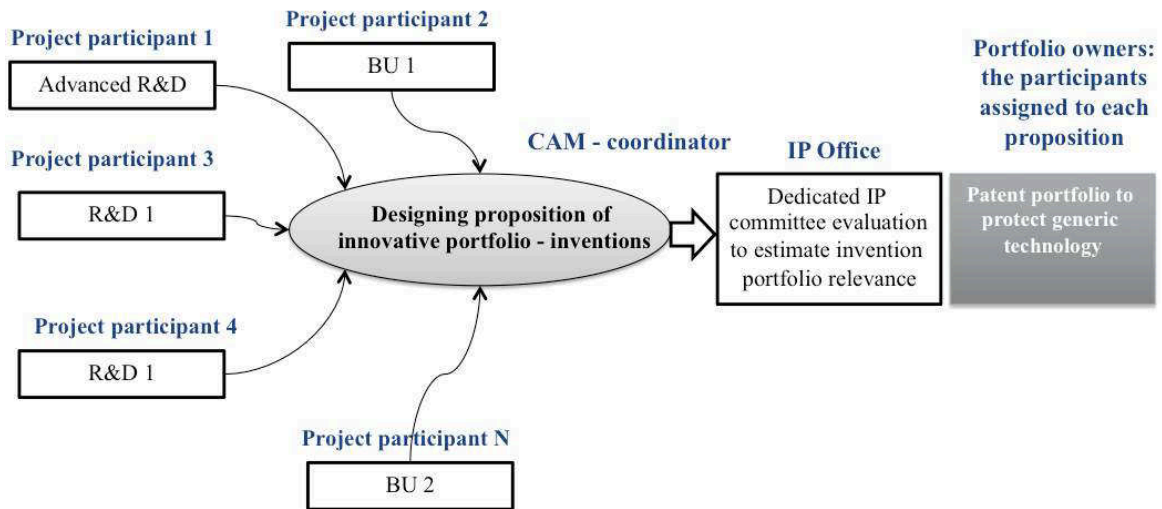

Figure 3 Designing a patent portfolio around generic technology

Research project portfolio

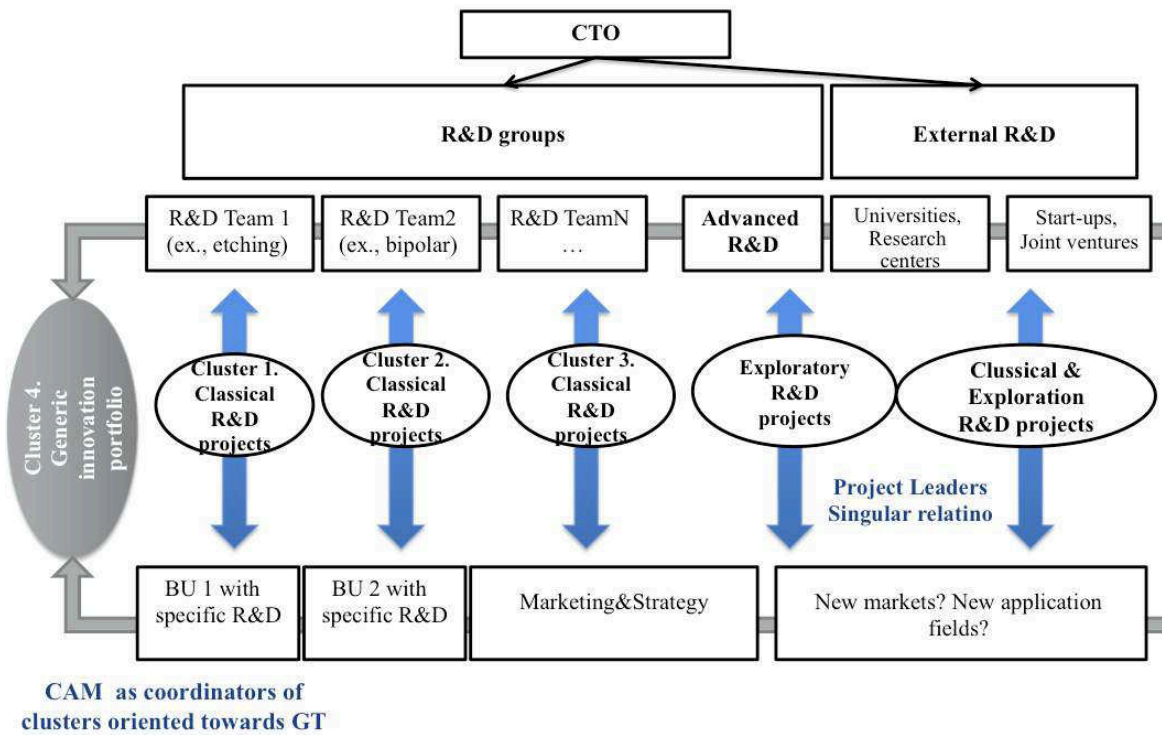

Figure 4 Generic project portfolio

Table 1 Data description and units of analysis

	Case 1	Case 2	Case 3	Case 4
Description	Open Innovation contests – Business Innovation Process (3 consequent innovation challenges)	The International Technology Roadmap for Semiconductors (ITRS) technology working group “More than Moore (MtM)”	Generic patent design with various advanced technological groups	<i>Ex-post</i> analysis of a research project portfolio
Time period	2009-2012	2005-2013	2008-2013	2003-2010
Unit of analysis	Innovation exploration projects accepted after the idea collection phase – 20 projects in 3 years	The working group composed of actors from various semiconductor companies (Intel, NXP, and STMicroelectronics)	5 exploration groups (in 3D Integration, energy harvesting, haptic multi-touch, and photonics technologies)	10 research project clusters (~400 research projects)
Involved organizational entities	Business units, strategy, marketing, and R&D groups	Companies representatives and MtM TWG leaders	Business units and R&D groups	R&D groups
Supporting documents	Internal press releases, innovation week programs, flyers, the three databases associated with idea collection for each contest, evaluation committee assessment reports, presentations of selected ideas at the various milestones, mail, and survey results	The ITRS conference calls of the International Roadmap Committee (IRC - the steering committee of the ITRS) since 2005 (the fourth author attended), working documents of several specialized working groups of the ITRS, and publicly available documents	Internal database of innovation disclosures, patent reviews, meeting minutes and presentations from brainstorming sessions	Internal database of document workflow for each thesis project (including the annual reports, project description, final document and resume presentation) and description of associated collaborative projects if a Ph.D. students were a part of a more global European and international program

Table 2 Cross-application manager

	Case 1	Case 2	Case 3	Case 4
Results of GT portfolios	4/20 (+/-)	(+)	(+)	4/10 (+/-)
The role of CAM	4 GT projects (from 20) led to successful generic portfolio creation. The managers performed the role of CAM.	The coordinator of TWG “More than Moore” held the group together and pursued the exploration of generic functions for both technologies and key application domains.	The animator role of patent exploration sessions appeared to be critical to refine and organize the patent portfolio around generic technology.	For each portfolio resulting in generic technology, a technology leader performed the function of technology line manager (CAM).

Appendix. Summary of significant data: generic and specific technologies

	Specific exploration	Toward generic technology portfolio
Market Environment	Well-defined application domain (single market)	Multi-environment (distinct search, diversified markets and technology portfolios)
Technology behind	Unique expertise	Broad scientific knowledge involved to form generic core
Case 1. Innovation Contest	<p>Project “Power-Eating Report”. Replace equipment power plugs by a new model that measures and reports power consumption using the CPL network:</p> <p><i>elaborated technology application context coupling</i></p>	<p>3DTouch project. A generic platform for an active surface to simulate haptic touch sensations was designed to maximize the number of targeted environments including e-commerce applications, eye-less consumer back type keyboards, automotive applications gaming, and medical diagnosis through surface simulation using MEMS or piezoelectricity actuator:</p> <p><i>a generic platform that seeks to address multiple markets and create new uses (multiple projects involved)</i></p>
Case 2. ITRS MtM working group	<p>TWG Interconnect. One of the challenges: the rapid introductions of new materials/processes that are necessary to meet conductivity requirements and reduce dielectric permittivity create integration and material characterization challenges (ITRS, 2011): <i>the problem is fixed, and the goal is to provide a technological solution</i></p>	<p>TWG More than Moore – MEMS</p> <p>Scope: The ITRS MEMS technology roadmap focuses on the key technologies associated with mobile internet devices, such as smart phone and tablet computers. The key MEMS device technologies considered are the following: accelerometers and gyroscopes, microphones, and RF MEMS, including resonators, varactors, and switches. The roadmap also reviews emerging MEMS applications, including optical filters, picoprojectors, the electronic nose, microspeakers, and ultrasound devices (ITRS, 2011): <i>multiple technological and marketing challenges: exploration in double unknown</i></p>
Case 4. Generic patent design		<p>Design a patent portfolio on “3D processes”: Vertical stacking of dies with maximum functionality and optimal design point enabling heterogeneous integration for various applications – <i>obtaining a rich patent portfolio to protect enabling</i></p>

		<i>technology</i>
Case 3. Generic project portfolio	<p>Research project portfolio for etching:</p> <p>Obtain desired thin-film pattern with CMOS N+1 by coping with the challenges: the thinning of GATE oxide by passing to CMOS N+1, the convergence of the required process space, process complexity, etc.: <i>21 Ph.D. projects – fixed problem and, technological challenges</i></p>	<p>Research project portfolio for bipolar technology: BiCMOS9MW (B9MW) is ST second-generation, high-performance 0.13 μm SiGe BiCMOS technology, targeting high-frequency applications: optical communications up to 100 Gb/s, automotive radar sensors at 77 GHz, wireless communications at 60 GHz (W-HDMI), high-speed instrumentation, non-invasive imaging (medical and security).</p> <p>The heart of SiGe technology is a SiGe heterojunction bipolar transistor (HBT), which offers advantages over both conventional silicon bipolar and silicon CMOS for the implementation of communication circuits.</p> <p><i>10 Ph.D. projects – twofold exploration of technologies and associated marketing challenges</i></p>

Paper V

**Towards a new form of ideas
contests in high-tech
environment: design
community building in double
unknown**

TOWARDS A NEW FORM OF IDEAS CONTESTS IN HIGH-TECH ENVIRONMENT: DESIGN COMMUNITY BUILDING IN DOUBLE UNKNOWN*

**Olga KOKSHAGINA^{1,3*}, Thomas GILLIER², Patrick COGEZ³,
Pascal Le MASSON¹, Benoit WEIL¹**

⁽¹⁾MINES PARISTECH, CGS - Center for scientific management,
60 Boulevard Saint-Michel, 75272, Paris, France

⁽²⁾Grenoble Ecole de Management, 12, rue Pierre Sémard, 38003, Grenoble France

⁽³⁾Technology R&D, STMicroelectronics, 850, rue Jean Monnet, 38926, Crolles, France

*corresponding author: olga.kokshagina@mines-paristech.fr

Abstract:

Following the open innovation paradigm, many technological firms organize idea contests to surface bright ideas for new products, services or business models. This article focuses on a new form of innovation contest: the generic technology idea contest, which aims to design technological platforms that can enable emerging applications in various business domains to be economically addressed. Based on the analysis of a series of innovation contests conducted by STMicroelectronics, this research points out main elements of the generic technology ideas contest: challenge initiation, idea generation and collection, genericity identification, enrichment and its reward system. The findings indicate that such innovation contests do not fundamentally establish commercial relations between seekers and solvers as usually described in the literature. Rather, this type of contests aims to build design communities who are able to collectively explore the potential of technological platforms. Managerial recommendations, key mechanisms for enhancing the genericity of ideas and probing questions are formulated to facilitate the organization of generic technology innovation contests by high-tech firms.

Keywords: innovation contests, creativity, generic technology, co-design, double unknown, institutional logic

* Under submission Technology Analysis & Strategic Management journal

1. Introduction

Organizing ideas contests (ICs) to attract contributions from wide-ranging participants has become more and more popular. To discover new ideas for future business and R&D effort, technological firms often organize internal brainstorming sessions (Schulze and Hoegl, 2008), crowdsourcing with universities (Perkmann and Walsh, 2007), industrial partners (Eickelpasch and Fritsch, 2005) and potential customers such as BMW (Füller and Matzler, 2007), IBM (Bjelland and Wood, 2008) and Siemens (Schepers et al., 1999). ICs are widely deployed in industrial contexts, and so have gained increasing interest from economic and management scholars (Adamczyk et al., 2012).

Technological firms and ideas contests in which organizers attempt to overcome particular technological lock-ins or open up new application areas have a long common history: we mention just few examples. In 1913, the International Association of Recognized Automobile Clubs announced in Paris that they were offering a prize of \$100,000 (nearly \$2.5 millions nowadays) for the best fuel (other than gasoline) to use in internal combustion engines in an effort to address the rapidly increasing price of gasoline by interesting chemists developing “a fuel which cannot be rigged or cornered by any nation or combination of national interests”. In 1959, the physicist Richard Feynman offered prizes of \$1,000 for the development of the first motor measuring less than 1/64th of an inch on each dimension, and for the first text written at 1/25,000th scale (see (KEI, 2008)).

This paper focuses on idea contests in the case of ‘double unknowns’. Double unknowns (or ‘unk-unks’ (McGrath, 2001) or unforeseeable uncertainties (Pich et al., 2002)) are high uncertainty situations in which neither technologies nor markets are yet known. This does not mean, however, that technological development starts from a green field: rather, in many cases, a profusion of potential technologies are evolving from existing, known seeds. But how they should be developed, which factors really matter, are quite unclear, so that, even if a panel of likely technological candidates can be predefined, the technology is still considered unknown. Markets are likewise unknown, due to the extremely low probability of success. In such cases, of highly uncertain exploration, both usage and technical domains are unstable (Gillier and Piat, 2011).

While such double unknown situations are difficult to manage (Eisenhardt, 1989; Hillson, 2010), they open the possibility of designing technological platforms for emerging market needs. This paper employs the definition of a platform as “a set of subsystems and interfaces developed to form a common structure from which a derivative products can be efficiently developed and produced”, echoing those proposed by (Gawer, 2010; McGrath, 1995; Muffatto and Roveda, 2002). Such platforms allow generic technologies (GT) to be built where the latest can create value across a broad range of applications (Bresnahan and Trajtenberg, 1995).

This article aims to examine the use of ICs in the specific case of double unknown situations via which firms aim to pursue the development of GTs. Surprisingly, the literature on ICs provides few recommendations regarding the double unknown situations. Innovation contests are often organized either in situations where the technological aspects are considered as being known, or users or markets as having been identified. For example, the case where both market and technological uncertainties are high is not represented in the IC typology proposed by (Terwiesch and Xu, 2008) (Figure 1). The literature usually defines the IC as an exchange between a seeker who faces an innovation-related problem and offers an incentive award and a solver who provides the best solution. From this economic perspective contests in double unknown give any value promises neither for seekers nor for solvers.

Our findings indicate that the idea contests in double unknown situations can exist if it follows an institutional logic (Coriat and Weinstein, 2002; Kanter, 2011). Institutional perspective determines the social context in which the various agents operate. These actors can be individuals and groups (Hartley et al., 2002). Institutional theory emphasizes that the organizations are more than just a means to produce goods and services, they represent also social and cultural systems. Suchman (1995) pointed out that the actors in this case do not just compete for resources but also seek legitimacy. They appear as “vehicles for accomplishing societal purposes and providing meaningful livelihoods for those who work with them” (Kanter, 2011). This logic could help us to gain the insight on the premises of the ICs in double unknown and define the appropriate form for the ICs targeting the design of platforms that enable the development of GTs.

The paper is organized as follows. The first part clarifies the specificities of GT development, and more precisely the particularities associated with platform design. It then continues with an overview of the organization of idea contests in technological contexts, and goes on to outline more fully the problem of organizing and defining ICs that result in the development of GTs and their incubation in high-tech firms. An analysis framework is built based on the main criteria of IC in high-tech firms, and the difficulties and specifics of idea contests appropriate for developing GTs are then considered. Given the exploratory nature of this research, a case study approach was chosen, and research questions derived from the literature are investigated empirically by analyzing the case of a series of ICs organized by the semiconductor manufacturer STMicroelectronics. The semiconductor industry is particularly relevant for this investigation, as it often has to engage in double unknown explorations, and the pervasiveness of their use makes semiconductors a prime example of general-purpose technologies (Miyazaki, 1994; Olleros, 1986; Wessner, 2003). This study establishes a new IC process that focuses on building generic technologies and enables the transformation of individual ideas into new technological platforms. Overall, this paper proposes a way to encourage joint exploration of the technological and the market domain by introducing the concept of ICs for generic technologies. The originality of these contests appears in creation of coalitions that collectively explore and prepare future generic technologies exploration by mutually improving the quality of submissions.

2. Theoretical background and hypothesis. Ideas contests in high-tech firms

This section begins by laying out the theoretical dimensions of the research. The first part deals with the features of GT development in double unknown situations, and demonstrates the importance of ICs pursuing GTs. The second part presents a review of the existing literature regarding ICs in high-tech firms. Two forms are described: user- and technology-driven ideas contests (UIC and TIC respectively). Finally, this part considers the limits of the classical ICs for GT development and deduces research questions.

2.1. Creation of generic technologies by platform design

Generic technologies have been defined as technological platforms whose exploitation can “yield benefits for a wide range of sectors” (Keenan, 2003). GTs are more likely to emerge in fast-paced dynamic environments (Cantwell and Qui, 2009; Maine and Garnsey, 2006; Miyazaki, 1994): semiconductors, biotechnology, electricity, nanotechnology are domains which are *a priori* well positioned to take advantage of GTs, given their wide industrial application areas, technological diversity and rate of scientific breakthroughs (Bresnahan and Trajtenberg, 1995; Moser and Nicholas, 2004; Shea et al., 2011; Youtie et al., 2008).

Various benefits of GTs to new companies who develop and exploit such technologies have been noted, among them: the flexibility to extend the scope of initially considered market applications, including to markets of various maturity levels and across various domains; to share risks and decrease R&D costs between several applications; and to help attract venture capital and large corporate investment (Maine and Garnsey, 2006; Shane, 2004). For instance, suppose there are 20 independent niche markets, each of which has a 20% probability of emerging. The probability of at least one market emerging at the end is equal to $1 - (1 - 0.2)^{20} \sim 0.98$. Thus, if there is a platform that addresses parts of all these markets, its applicability is virtually guaranteed (with a probability of 98%) to emerge in at least one market. By exploring GTs, companies could design solutions suitable for several uses, and so increase company benefits, making the development and diffusion of GTs a key area of their strategy interests.

The literature on generic technologies mostly deals with those GTs that already exist, and prior research has mostly focused on their dissemination and commercialization, providing extensive analyses of GTs from an *ex post* perspective, i.e., once the technology has been shown to be generic, commercialized and its value been acknowledged. For instance, David (1990) indicates that the dissemination of electricity was driven by the invention of the dynamo, which promoted the development of light bulbs and electric motors, and innovations in plant and urban design. This research proposes dealing with GTs at an earlier stage – by studying the design of novel GTs themselves.

For GTs to gain wider diffusion, and thus greater market penetration, their adaptation must be cost-effective, i.e. reach certain levels of efficiency so that they trigger further innovations (Youtie et al., 2008). In this case, their exploration is no longer grounded on a single root technology, but rather involves creating and managing technological interdependencies, so that the initial generic technology gives birth to a richer technological platform (Tierney et al., 2013). In this process, the role of platform owners becomes crucial in encouraging platform adaptation (Rochet and Tirole, 2003) and flexibility, so that its application to another domain does not involve a complete and costly redesign.

Novelli (2010) named two pre-conditions for building a successful generic technological core: that it is based on scientific principles that pave the way for the development of additional knowledge that will enrich the technology; and that it encompasses multiple distinct technologies that can be combined in various ways to catalyze subsequent development. Generic technologies are more likely to emerge in the case of high-tech companies with advanced internal R&D centers, joint explorations with R&D partners and diversified technological portfolios.

Still, the exploration process for developing generic technologies is often unclear. As Gambardella and McGahan (2010) suggest, businesses problems can arise from the lack of techniques for effectively designing and putting GTs to use, which can require both overcoming existing technological lock-ins and simultaneously investigating new uses. Subsequent challenges include how to transform an emerging technology into a future GT, and how to organize a development process that can broaden the technology's genericity.

2.2. Innovation contests: the special case of GT in double unknown situations

2.2.1. Innovation ideas contests – analysis framework

Idea contests are organized to explore both new uses and new technologies. Terwiesch and

Xu (2008) argue that ICs can be modeled as mechanisms by which a seeker (a company, a research center, an ecosystem of actors) facing an innovation-related problem broadcasts the problems to potential solvers, and offers a reward to whoever comes up with the best solution. Various types of systems for managing such ICs exist, including anonymous online contributions, employee-driven idea systems, web-based idea collaborative contests, innovation tournaments organized within or beyond companies, crowdsourcing with external collaborators (Gorski and Heinekamp, 2002).

The literature identifies the following elements of IC organization: challenge initiation, idea generation and selection, idea development (Bjelland and Wood, 2008), while Malone et al. (2009) determine the ideation phase as including organization, collection and collaboration; the phase of ideas selection; and their incubation processes. Regarding challenge initiation and idea collection, Jeppesen and Lakhani (2010) emphasize need for openness in innovation challenges, and demonstrated that broad participants' involvement can offer considerable benefits. Terwiesch and Xu (2008) give insights into the problem solving efficiency of idea contests focusing on costs and the number of problem solvers, demonstrating that the applicability of the type of challenge vary according to technological and market uncertainty. Moreover, the authors demonstrate that the award system should take into account the type of the innovation problem that seekers face. Levels of managerial support, resources and awards, competitive or collaborative environments can influence participants' motivation and the final results of the challenge (Bullinger et al., 2010; Neyer et al., 2009). The advantage of ideas contests to support new business development at the early stages is widely underlined in the literature.

Evaluation criteria need to be established for the idea selection phase, and various criteria have been suggested: Poetz and Schreier (2012), for instance, report an example where the quality of ideas was measured according to their novelty, customer benefit and feasibility. The idea development or incubation phases then seek ways to create better value from the ideas, by exploiting them either externally and internally (Alexy et al., 2012).

2.2.2. Innovation ideas contests in technological contexts: user- and technology-driven ICs

Our literature review enabled us to distinguish two types of ideas contests organization in technological contexts: user-driven (UICs) and technology-driven contests (TICs) (see Figure 1).

UICs are generally open to large audiences, and so have also been labeled "crowdsourcing" (Penin and Burger-Helmchen, 2011). The themes are often broad, simple and easily comprehensible, and the technological principles involved, their limits and advantages are often well-known in advance. Kristensson and Magnusson (2010) argue that it is better to avoid prescribing technical details *ex ante* if users' imaginations are to be stimulated. In this case the exploration process aims to re-use the principles underpinning an existing technological portfolio to create new uses and functionalities (Stopford and Baden-Fuller, 2006). In this manner, Bluetooth hold an annual contest to generate new product ideas that use Bluetooth v4 in conjunction with low energy technologies. The 2012 winner created the CoreMD device, which can sense temperature, heart rate, or interstitial glucose, alert the user that a certain threshold has been reached, and even administer drugs such as insulin, glucagon, or amylin (Bluetooth, 2012). User ideation contests (UICs) target a list of new product offers, new applications that the seeker can develop using existing technological solutions. UICs are often launched during the fuzzy front end phase of new product development (Reid and De Brentani, 2004) where a technology is pre-defined, and the uncertainty is in the possible markets, so the aim is to identify previously unexploited market

applications: thus deploying a 'technology push' logic (Linton and Walsh, 2008). The challenge in such ICs is to find new market functionalities, new uses, to offer new products to existing markets, or even to develop new products which will create new markets: managerial support mostly concerns challenge evaluation and creating a competitive atmosphere.

The openness of such contests is high in order to find wider functionalities, so the requirements for entering the competition are low (Dahlander and Gann, 2010). For instance, Magnusson (2009) showed that pioneering users' ideas can bring higher user value and originality, and can even break the dominant logic of a company. Once the idea collection process is over, the competition support team evaluates the ideas based on classical value management criteria (e.g., Net Present Value, probability of success), and those selected are developed during an incubation period. Still, solvers experience uncertainty in seekers taste, in their preference. Rewards can take various forms: financial rewards in the case of crowdsourcing, increased reputation in the relevant user community, or even the possibility of employment as part of a new product development effort to commercialize the idea (Piller and Walcher, 2006). User ideation often solves problems in the short-term, offering high number of incremental and achievable innovations: the results will depend greatly on the users abilities and proficiency (Heiskanen et al., 2010). There is risk of choosing a technology that will not generate enough applications and results, and in developing functions, which are too specific and cannot be reused to address a wide range of other needs. 'Ideas from the crowd' are often criticized for their immaturity and low degree of elaboration, or even because the solutions proposed are too far from the companies' existing strategies (Bayus, 2012; Magnusson, 2009). Penin and Burger-Helmchen (2011) have shown that crowdsourcing can be best applied when a problem can be clearly defined and the solution legally protected. UICs resemble the "ideation project" suggested in (Terwiesch and Xu, 2008) framework which deals with uncertainty in the performance function - on whether or not the user/seeker will like the solution (see Table 1 for UIC description).

The second type of idea contest (TICs) entails more technical investigations. When it comes to high-tech exploration areas the problem complexity increases, since innovations in such areas often require specific technical expertise to recognize and exploit ideas, so such contests are usually restricted to narrower audiences. These are expert-based challenges, which aim to upgrade – perhaps significantly - the technologies currently applied to given applications or contexts, or even to solve technological lock-ins. This resembles (Terwiesch and Xu, 2008) model of trial-and-error project which seeks solutions to well-defined problems, where there is high technological uncertainty about whether the solutions will work. In TICs solvers cannot anticipate performance of future solutions, the landscape appear to be extremely rugged and experimentation is required.

For instance, a contest was organized in the well-known global innovation marketplace InnoCentive, to identify a method or technology that could accurately detect and locate small losses of pressurized fluid from supply networks (Innocentive, 2012). In this case, the context parameters were fixed, and the aim of the challenge was to discover new technology features which could open new market opportunities or improve existing applications. Likewise, NASA launched a new open innovation challenge to find a solution to maximize the amount of solar energy that the International Space Station could harvest: the challenge was open to anyone, with a \$30,000 award to the winner (Bratvold, 2012). In these examples, the seeker pursued new technological solutions to resolve identified problems: both the field of exploration and the future uses of the discovered technology were already known.

The aim of TICs is to develop technological prototypes, obtain proof of concepts for

market applications or contexts of technological uses that are specified in the challenge. The goal is to find more robust and better performing solutions, and the logic can be seen as ‘market pull’ (Brem and Voigt, 2009) – as exploration to find the most suitable technology to address market needs. The uncertainty is in the technology, and the process can be formulated as: given defined market areas and scopes of use, the seeker aims to discover new technological principles that can lead to new technical solutions or can significantly improve the performance of existing ones. For instance, the seeker in one InnoCentive Challenge - United Healthcare - desired prototypes of novel combinations or modifications (‘mods’) of existing, off-the-shelf technologies (including computer software and smartphone applications) that could be used to motivate people to make healthier lifestyle choices and/or help manage chronic health conditions more effectively (InnoCentive, 2013). Since new or updated technological solutions need to be developed, these challenges require more specific expertise, so the openness of the contest low. Due to the need for proof (via demonstrations or prototypes), the duration of the challenge is also usually longer. The goal is to discover more innovative and higher performing technologies at reduced development cost to the seeker (Baldwin and von Hippel, 2011; Moseson et al., 2012), and the support team evaluates the ideas based on performance and robustness criteria. The incubation phase consists of technology development (See *Table 1* for TIC description).

Insert Figure 1 about here

2.2.3. Towards a new logic for ICs in case of double unknown: from economic to institutional perspective

The classification of innovation challenges adopted in this study corresponds to that proposed by (Terwiesch and Xu, 2008), who defines three types of projects according to the market and technological uncertainty facing the seeker: trial-and-error (similar to TIC), ideation (UIC) and expertise-based projects (Figure 1). The expertise-based challenges are relevant when seekers and solvers have similar beliefs. According to (Terwiesch and Xu, 2008), in this case seekers face uncertainty regarding the future performance of proposed solutions.

We are interested in identifying a type of IC that is adapted to the case when both markets and technologies are highly uncertain (unknown), which have not yet been analyzed in the literature. In this double unknown situation, ICs need to cope with situations of simultaneously unstable markets and technologies, and where both dimensions are likely to be evolving at the same time (Gillier et al., 2010). Thus it is hard to predefine desired technological principles so as to involve users in the ideation process from the beginning (as in UIC – see *Table 1*), and user involvement is also tricky in high-tech contests due to the lack of understanding of future uses for identified technologies. For instance, it would have been difficult to foresee how the piezoelectric vibration principle could be used to deliver a haptic feedback featured in various tablets and smartphones, or the light emitting polymers now widely deployed in flat panel organic light emitting diode (OLED) displays. To predict such outcomes would have required very high levels of expertise in both marketing and technological areas. The classical ICs are based on the established seekers – solvers relationships where the latest are attracted by the appropriate rewarding systems. Then, from the economic point of view the ICs in double unknown does not bring any commercial value: 1) there is no potential market value or clear market needs; 2) technological performance and even the technological alternatives are unknown. Thus, It appears extremely risky for seekers to launch the contest in this situation. Moreover, the incentive award schemes to motivate the solvers are not evident to establish. We claim that institutional logic can provide new insights on the definition of ICs in these cases. In fact, the scholars have pointed out that innovation is

not only driven by an economic logic (Kanter, 2011; Suchman, 1995). Aside from the economic issues, innovation can also be beneficial for institutions through the actors' interactions which are involved in the production, the diffusion and the management of scientific and technical knowledge (Bjerregaard, 2010; Hargrave and Van de Ven, 2006)

Sociologists view markets as social institutions that are constructed in culturally specific ways (Slater and Tonkiss, 2001). Innovative explorations tend to be characterized by a division of labor to attain mutually beneficial divisions. By studying the institutional and organizational dimensions of the innovation, Coriat and Weinstein (2002) show the importance of the institutional approach to explain the variety of firm patterns, their evolution and determine the social context in which the various agents and primarily firms operate. While taking the institutional lenses, we could gain a new perspective to the ICs definition, its motivation in case of generic technologies exploration and propose a mechanism of institutional support.

Insert Table 1 about here

In situations of the dual exploration of both markets and technologies (Sanchez, 1996), one way to deal with unknowns and ensure long-term growth is to design generic (also known as general purpose) technologies that can address many emerging markets. The organization of idea contests that favor such technologies would decrease the risks of developing single market failures and increase technologies application areas. The participants involved in such ideation could enrich future ideas by better defining GTs, and by associating them with new applications, thus opening up emerging markets or developing new needs, bringing new technological aspects within the scope of traditional projects and attracting additional investment. But - do such ICs that are specifically organized to conceive generic technologies *ex ante* exist? If yes, what is the logic behind and the motivation of both seekers and solvers to launch this type of contest?

To summarize, the existing typology of idea contests has not taken double unknown situations into account (Terwiesch and Xu, 2008). The forms of ICs identified in the literature so far (i.e. UICs and TICs), and their evaluation criteria and incubation processes, seem inappropriate to the process of simultaneous technology and market exploration for developing generic technologies. There is no evidence of serious attempts to organize idea contests designed *ex ante* to produce generic technologies when both market uses and relevant technological principles are unknown (see Figure 1). The goal of such generic technology idea contests (GTICs) would be to design genericity itself: the object of this research is to determine an appropriate form of ICs for creating GTs. The general framework we suggest involves the examination of each ICs element: thus our research question can be decomposed in four sub-questions: (1) In which contexts could GTICs be organized? (2) What criteria are relevant for selecting ideas that could form the basis of generic platforms? (3) How should generic platforms be explored and implemented in high-tech firms? (4) What are the collectives of seekers and solvers and what is the seekers motivation system associated to this kind of context?

3. Research settings

3.1. Context and Data Site

Given the exploratory nature of this study to describe the specifics of GTIC, we adopted a case study methodology as an appropriate research approach (Yin, 1994). This method

enables us to examine GTICs in their natural setting, and is relevant since our goal is to gain insights into the organization of such contests, rather than to validate hypotheses. The study setting is the semiconductor industry, an environment which faces high rates of both innovative technology development and of new market creation (Teece, 1986), and where the probability of GTs existence *a priori* is high (Miyazaki, 1994; Olleros, 1986).

STMicroelectronics (ST), Europe's largest semiconductor company, has organized ICs of various types: for instance, the Innovation Cup - a UIC organized in 2011- involved students from different European countries in imagining new applications for ST products. The R&D centers of STMicroelectronics' existing business units are leading many innovative activities to explore various new product development and technologies for the markets which they address. It was felt, however, that these innovation processes were leaving out innovations which could deliver potential solutions for several market areas, but which would not promise to involve volumes big enough to be financed by individual business units. To allow for the development of such "transversal" innovations, two French STMicroelectronics sites - at Crolles and Grenoble in the Rhone-Alpes region (known as the 'French Silicon Valley', specializing in microelectronics and nanotechnologies) employing between them over 6400 people - decided in 2009 to develop a unique idea contest named Business Innovation Process (BIP). BIP aimed to run a series of challenges which would target transversality, ecosystem development and value for users (and for ST) by developing future innovative solutions designed to address several business areas, and was launched:

"to boost Grenoble and Crolles' sites contribution to ST value creation through better innovation and better use of local clusters" (BIP, 2009b)

An internal ST magazine article announced the first innovation week and further challenges thus:

"Up to now we haven't fully taken advantage of either (1) the complementarities of the two sites: Crolles (expertise in development of technological platform, device design flows, and manufacturing) and Grenoble (expertise in advanced packaging completing the technological offer with marketing, design and sales of our products); or (2) the presence in the Global competitive cluster of Minalogic and other industrial leaders such as Schneider Electric, Becton Dickinson." (Cogez, 2010a)

The two sites involved in this IC specialized in very diverse technologies, so the contest was very open on the technology side, and (as noted in *Appendix A*) the wording regarding the target markets and uses allowed for a wide variety of solutions. Initially restricted to company employees, the idea submission process was later on open to regional university students, who were also given the opportunity to accompany some of the selected proposals through the idea development phase, which allowed for the integration of knowledge from other domains and enlarged the exploration area. So the overall process was clearly positioned to address the double unknown situation.

3.2. Data collection

To analyze STMicroelectronics' series of innovation challenges thoroughly, we collected data over 3 years of challenges from 2009 onwards, which were entitled "Real Sense", "Green Energy" and "Make life easier and better for everybody". 36, 18 and 67 participants submitted ideas to these challenges respectively (see *Appendix A* for further details), and participants could submit multiple ideas. We conducted semi-structured interviews with both seekers and solvers of the three ICs from Grenoble and Crolles ST sites, mostly ST

employees and participants from the external research centers and regional universities involved in ideation process. Overall, we conducted over 30 interviews with specialists both from marketing and technical backgrounds, from strategic and operational units, from both Crolles and Grenoble sites and from external participants (intern students and universities involved in ideation), who were involved in submitting ideas, in organizing the contests, in selecting ideas, and in their subsequent incubation phases. The interviewees included idea submitters, commentators, project participants in projects developed from contest ideas, and members of the Core Innovation Team (CIT), who organized the contests and the Innovation Venture board (IVB) members, who played the role of internal customers for the proposed ideas. This allowed us to understand the multiple sources of influence on the challenges and revealed conflicting views on the issues analyzed in the paper. We reviewed secondary sources - supporting documents including internal press releases, innovation week programs, flyers, the three databases used to collect ideas for each contest, the evaluation committees' assessment reports, presentations of selected ideas at the various milestones, communication e-mails from CIT to company employees. We also ran an anonymous survey to obtain general feedback on the organizing process, including from contestants whose ideas were not chosen to be followed up. The overall rate of survey response was 50% (around 40 responses in total). See *Appendix A* for transcripts of the anonymous survey questions.

3.3. Data analysis

We triangulated our case study analyses against the internal IC organization data we collected to check the internal validity and reliability of our chosen methodology, and also triangulated our derived analysis against the BIP organizing committee's judgments. This enabled the continuous involvement of that committee, conforming with the guidelines of engaged scholarship (Van de Ven, 2007) and collaborative research (Shani et al., 2008). The third author was directly involved in the organization of all three innovative ideas contests, and was a part of CIT, which allowed us to gain insights into the entire process, from the ideas contest organization, the idea collection phase through until the end of the incubation period. The first and second authors analyzed the data independently from their external position. We shared our analysis of the projects that went through the BIP contest process with company representatives, which enabled us to identify the GT innovation patterns involved.

4. Case description. Business Innovation Process (BIP)

The following section describes the challenge according to the elements previously introduced in the Table 1, which we present and analyze separately.

4.1. Challenge initiation

BIP is an internal initiative organized by STMicroelectronics to support its innovation efforts by "*filling the gaps left by the division of internal innovation processes and managing transversality*" (Cogez, 2010b). BIP involved 3 annual innovation challenges starting in 2009 which each concentrated on different themes. The contests were announced via the company intranet, mail announcements, special posters and flyers and launched by innovation weeks designed to detail the particular challenges and suggest ways to tackle them. Various academic and industrial actors were invited to raise the awareness of ST employees at Crolles and Grenoble about innovation issues and processes. Plenary sessions were organized during lunchtimes to allow for wider attendance, and technological showroom visits and coached brainstorming sessions were also organized during the innovation weeks. The purpose was to

increase the visibility of BIP and participation levels, and to identify people interested in tackling innovative issues. The innovation weeks also served as a basis to launch the collection of ideas.

The CIT, which involved around 15 specialists from ST business, R&D and strategic units departments, was in charge of both organizing the contests and evaluating the idea that were submitted. CIT members were responsible for putting the process and tools together, for sharing information and ideas, establishing relationships and networks, and collecting ideas from potential innovators and transforming them into innovation proposals, for tutoring project managers, for choosing which ideas were selected and transformed into exploration projects, and assisting in building project teams.

The first challenge - named “Real Sense” - organized in 2009 - was intended to:

“envision new uses, new user experiences, taking advantage of different mixes of 3D Technologies. Contestants should try to imagine what could be done by combining 3D video and graphic rendering, and 3D capture combined with innovative user interfaces (virtual touch-pad, virtual tablet, head tracking, ...) all together” (BIP, 2009a)

These solutions were to provide new user experiences by reusing combinations of emerging technologies that were mostly new to ST.

The “Green Energy” challenge (organized in 2010) aimed to explore two distinct areas of energy management leading to two sub-themes: 1) “Instant power, wherever I need it” - announced as:

“It is necessary to invent products, services, applications that transport us to the world where we will be able to access as much energy as we need for whatever we need it for. The ideas should address energy production or increase energy recuperation, or decrease energy losses during its transportation for various needs” (Cogez, 2010a)

and 2) a “Master your power, yes we can” theme, asking contestants:

“to imagine the products, services, applications that enable us to control our energy balance sheet as a consumer or producer, and to explore new energy sources” (Cogez, 2010a)

The 2011 “Make life easier and better for everybody” contest targeted ideas to:

“help people who are fragile in the face of their environments...by developing solutions that allow them to live easier and better. These solutions should have a potential to apply to everybody”. (LeServiceCommunication, 2011)

4.1.1. Analysis: IC for dual marketing and technological explorations

This step shows that all the three challenges sought to explore ideas in double unknown fields, where neither markets nor technologies were fixed at the beginning. So the general character of each exploration was quite open: each call was designed to attract new ideas in both technologies and usages. This was made possible by the challenges being organized at the ecosystem level, with experts from different BUs, R&D centers, regional universities and partner research centers from Rhone-Alpes region contributing to broaden contests areas and integrating knowledge and expertise from various domains to enable the pursuit of transversal exploration. Challenged by the market needs from the various BUs and technological constraints, participants were pushed to think ‘outside the box’ of their day-to-day work

concerns, to consider emerging technological opportunities that could fit several BUs and even create new ones. By bringing people with different knowledge backgrounds to work together, keeping the challenge boundaries quite open and favoring long-term transversal innovations, CIT members anticipated both usage and technology explorations at the same time. ICs in this case do not correspond neither to the UIC where solvers aim to create the best possible presentation in order to attain higher potential benefit for a seeker; nor to the TIC where solvers experiment to find the technological alternative which provides the highest performance. *Here the effort is clearly made to motivate solvers to reuse the existing and emerging technological principles, to develop new ones and explore yet-unknown markets.*

4.2. Ideas generation and selection

The contest calls normally lasted 1-2 months, and ideas were collected electronically via the company's intranet website: some that had been collected during the initial innovation week brainstorming sessions were submitted on the website in advance. The number of ideas collected from ST employees during each challenge was 33, 60 and 110 respectively. Participants could submit multiple ideas, or could submit single propositions collectively.

The idea contests were open to all the employees on both Crolles and Grenoble sites: they could participate and contribute by sending their own ideas, or simply by commenting on and thus enriching those already proposed. Submissions had to give precise details of the concept, proposed application areas, their source of inspiration (e.g., if similar concepts already existed) and the idea's potential advantage for ST by listing potential business units that might use it. The third challenge was also opened up to the innovation classes of several regional universities, which raised the total number of ideas collected to 128. During the collection phase, contestants, committee members and company employees had an opportunity to enrich, comment on or even challenge the ideas that had been submitted online. This phase was followed by evaluation and selection, after which the most interesting ideas were clustered into exploration projects. (The numbers of participants and number of ideas submitted, selected and clustered in each challenge are given in *Appendix B*.)

Submitted ideas were initially evaluated according to their originality, their potential applications, the opportunities they offered ST, the implementation effort they were like to incur in the long and short term and their transversality (meaning their breadth of application and involvement of different ST actors).

For instance, the 3DTouch idea came from the 2009 "Real sense" challenge, and the initially submitted idea gained high marks thanks both to its disruptive nature and its wide market potential:

"Based on the material's properties (tissue, wood, leather...), a MEMS actuator can simulate the surface of the object to the customer at home and help him to select/buy. This solution can be dedicated to medical applications to establish diagnostics at a distance, [to] e-commerce applications..." (BIP, 2009a).

The idea involved using an active surface to simulate the haptic sensation of touch. Haptic technology is a tactile feedback technology that takes advantage of the human sense of touch by applying forces, vibrations, or motions to give such sensations to touch screens and video games. The proposition's breakthrough character set both technological and business model challenges and led to the pursuit of both market and technology explorations. Likewise, the Fourmis idea (submitted to the 2010 "Green Energy" challenge) proposed a breakthrough thermal-mechanical energy conversion technology to transform continuous heat flows into electricity. This was recognized as a generic solution (although the term was not used at the

time) that could be used in many systems, and had the potential to address a wide range of market applications, such as mobile devices, intelligent buildings, structural monitoring, body sensors, smart grids, photovoltaic complementary systems, etc. In both these cases, the potential for these ideas to be developed towards generic technologies was evident in the originality of the initial ideas.

In other cases, ST adopted an alternative strategy to surface generic technologies. Some individual ideas that were close to each other were clustered together, and CIT members suggested to further develop them within a single project, also taking advantage of the feedback given by other users during the submission process, which enhanced the initial propositions. Participants who proposed similar ideas would thus often end up forming exploration groups together.

4.2.1. Analysis: Opening the scope of ideas submission through collaboration

Following the UIC definition, the selection committee would have to describe its preference towards a certain proposition using its potential market value or any other chosen criteria (e.g., proposition attractiveness, its clarity). By using TIC mechanisms decision makers would verify if the proposal corresponds to the desired performance, development and implementation costs. In BIP, the challenges were organized in collaborative manner: ideas could be commented on and enriched, and the openness of the contests to other participants' judgments helped to enlarge the market and technology areas that were explored (see Appendix B). Some ideas initially submitted as single market ideas were enriched by the comments of other participants who recognized their potential value in other application domains. Technological ideas - which were mostly came from members of the R&D groups - were challenged by specialists from BUs as to their suggested application areas, particular in terms of their ability to meet client needs, and this feedback increased the probability of ST gaining transversal ideas, and thus of developing GTs. Participants had to state the value they thought their proposed innovations could bring to the ecosystem as a whole - not just to particular markets - which encouraged them refine their ideas submitted towards a wider, more generic scope. CIT members instead of selecting the best proposals privileged partnerships creation between solvers, motivate them to work together and aim to orientate exploration, while privileging learning to competition.

4.2.2. Analysis: From singular ideas to the emergence of platform ideas

While this was not explicitly stated during the discussions, CIT members favored those ideas that displayed generic potential, and tried to identify individual ideas that were more likely to be able to be transformed into generic platforms during the exploration process. We observed two ways in which future platforms were identified. In the first, the individual ideas already displayed generic potential (the '*4.2.2.1. Identification of singular ideas with generic potential*' section below exemplifies the identification of genericity), while in the second, similar ideas were transformed into generic clusters (the '*4.2.2.2. Generic Ideas from Clusters*' section demonstrates this clustering process).

A mechanism to match technologies and markets was needed to construct generic ideas. Kokshagina et al. (2012) showed that in double unknown contexts, even though both dimensions are highly uncertain, it is possible to predefine the set of functional combinations for emerging technologies and markets. The exploration phase can then be seen as a process of matching the potential functions that markets seek and that technologies can accomplish, which allows us to verify and characterize technologies and markets accordingly. According to (Gawer and Cusumano, 2008), a platform is a structure that has a common core which

ensures essential functions and addresses needs that are common for several players. These functions are generic, so they ensure the diffusion of the platform and its adoption by market derivatives. In this case markets can be defined by the functions they seek to offer, and technologies by the functions they address. The notion of functions gives us the possibility of working on technologies and markets without directly considering technology-market couples. In this study, we consider generic ideas as proposals that attempt to build platforms and GTs. Generic ideas can be characterized by the markets they attempt to address M_i , the underlying technological principles T_i that need to be developed and the functions that T_i allows to fulfill, or that M_i is requesting. For example : the technological principles underlying “inertial MEMS” allow to fulfill the function “acceleration measurement”, and the market “car safety” request that function (to detect the need for airbag deployment). In the following section, we describe how the 3DTouch project developed from the 3DTouch idea by specifically distinguishing T_i , F_i , M_i .

4.2.2.1. Identification of singular ideas with generic potential: The case of the 3DTouch platform

The key proposal of the 3DTouch project lay in the ability to physically sense the texture of an interactive device. The 3DTouch idea aims to transmit more complex information to the user than the simple acknowledgement of a command by using the high tactile sensitivity of the fingers, and attempts to develop a technology that provides rich haptic feedback via one or more vibratory actuators, which are excited by electrical signals. As initially submitted, the idea attempted to maximize the number of targeted environments including e-commerce applications (e-shopping for clothes, furniture,...) M_1 , tactile keyboard elements integrated on the reverse sides of devices to enable faster navigation for consumers, automotive applications where vision is limited and ‘typing blind’ becomes necessary M_2 , gaming M_3 to enhance immersion, gesture learning, medical diagnosis M_4 through surface simulation using MEMS or piezoelectricity actuators (see Figure 2). Each market environment requires different functions to be addressed, and adds particular constraints. The main idea is to use the active surface to simulate touch by integrating vibratory actuators into various objects of which some part is handheld. For instance, addressing M_1 by developing a tactile touch panel, which is associated with a tablet or smartphone display, or using an external device with tactile properties, requires the development of various functions. To enable different sensation effects on tactile screens vibration effects must be integrated by using piezoelectricity technologies. Moreover, a database of various vibration simulations according to the tissue properties F_1 should be built; actuators should be integrated and controlled F_3 . For multitouch displays the touch layer needs to be transparent F_2 , the surface should be capacitive F_4 and the solution must be low power and low voltage F_5 . For M_2 , M_3 actuators need to be smaller and their compatibility with capacitive sensors should be achieved at both screen and control levels. To develop a generic technology a solution should address all the functions identified as being required by the market domains M_1 , M_2 , M_3 , M_4 .

Even if all these market domains require haptic multitouch technology and seek for common functions F_3 , F_4 , F_5 , some functions are specific to each application and can even appear to be mutually exclusive (i.e., screen transparency management and actuators management). Moreover, a technology that would explicitly address functions required by all identified applications requires a complicated and most probably expensive technological exploration. The goal is then to reuse the existing technological principles T_1 , T_2 , T_3 to form a platform that addresses generic functions F_3 , F_4 , F_5 , and to address the mutually exclusive functions via separate modules once the platform is built.

The CIT members recognized the idea as generic since it demonstrated the ability to address applications in various environments with limited resources. In practical terms, the generic idea should indicate a method to develop a platform that is independent from the generic environmental functions and dissociates them from the modules that are adapted to address specific functions. Technological platform building realizes the generic potential of an idea, enabling existing uses to be enhanced and new ones developed. In this case, the prototype stage resulted in a generic platform which incorporated both transparency and multi-vibration principles with enhanced user perception and embeddable low power solutions (F_3, F_4, F_5). While this prototype could not address any market directly, it did create a GT platform with a high probability of being used in several applications.

Insert Figure 2 about here

4.2.2.2. Building generic ideas: cluster building strategy. The case of sensing detector network

We observed two modes of clustering single ideas: 1) cluster creation based on technological principles 2) cluster creation based on functional combinations. We discuss an example of the first below (for reasons of clarity), but cluster creation based on functional combinations follows similar processes.

In the ‘Green Energy’ contest, the individual ideas 1 - 3 (see Figure 3) were intended to address various applications: M_1 intelligent power management (Idea 1), M_2 smart building heat management (Idea 2), M_3 auto-management based on user preference and user detection in a room (Idea 3) using T_1 detector network based on different sensing techniques (motion, temperature, power consumption, etc.). Idea 1 attempts to integrate different types of detectors sensitive to motion, temperature, ...(F_1) into a network (F_4) that gathers information for intelligent power management using software platform to track events, manage data (F_3) and so optimize power consumption (F_2). Idea 2 is based on the detection of various activities through sensors (F_3, F_4) to adapt the energy environment and manage power consumption (F_2). Idea 3 for M_3 endeavors to recognize a user’s position (F_5) and activity, and to autonomously analyze and manage their environments through establishing a system of network (F_4).

The CIT suggested regrouping these ideas based on the similarity of their technological principles, so the cluster was driven by common technological parameters to address various applications. In this case, cluster building was based on developing a sensing detector network for M_1, M_2, M_3 and all the emerging markets that might seek similar functions. Once a technology-driven cluster was identified, a generic platform to track events and manage data from sensor networks was refined. Ideas were clustered together by selecting the appropriate combination of two or more ideas, and so enabling more transversal ideas to be developed. In this phase, the platform was identified, the generic core was refined, future market products were identified and collaboration needed to gain expertise in new domain was highlighted.

Insert Figure 3 about here

Each selected project was assigned to a champion selected within the CIT community who supported project communication but was not necessary involved directly in the exploration efforts. As the examples demonstrate, the purpose of identifying genericity in both strategies was not to address the entire list of functions for all identified emerging applications, but to identify and solve the common problem(s): future innovation capability

was a target of the exploration itself. This phase enabled the compatibility and the interdependencies between various properties to be maximized and common functions to be grouped as a generic technological core. The phase of ideas generation and selection appears to be quite different from the classical process of ideas selection. It is a process of co-development, which is orientated towards an elaboration of generic solutions.

4.3. Ideas development

The platforms that emerged from this process opened up new product development possibilities. Project teams then launched quick exploratory processes along 8 axes: prototype, customer value, degree of disruption, strategic alignment (with ST technical and marketing capabilities and strategies), value chain, selling strategy, financial implications and risks. The goal was to prepare the projects to be evaluated by a group of high level managers who were in a position to decide whether or not to finance them, and - if their assessments were positive - to provide the resources for further exploration during a so-called 'consolidation' phase that normally lasted 6 months and could be renewed after a further evaluation and if the platform had been enriched. This group was called the Innovation Venture Board (IVB) and represented a group of internal customers. Those projects to which resources were allocated had to design both technology and market options. At the end of the consolidation phase, a final committee evaluation could lead to projects being transferred to existing business units, to the creation of new units to handle them, to external transfers (e.g., via creating a start-up) or to the project being stopped. Given the relatively high number of ideas submitted in all three challenges (see Appendix B), surprisingly only 4 projects are still on-going. All appear to be highly generic and the enrichment of their genericity was mostly achieved during phase 3, which opened up new market possibilities that were unrecognized when the ideas were launched, so that the platform genericity identified at that stage was further improved by considering new application areas. Various projects issued from these 4 platforms are on-going within the company in collaboration with research partners, with the aim of both building new markets modules and further enriching the platforms. Brainstorming sessions were organized to find new ideas for potential uses and for how the technologies could be enriched after the first platform core prototype had been developed. Platform enrichment of ideas initially sourced from the ICs also led to the creation of several collaborative projects with both academia and private companies, and portfolios of patents were issued around each project.

4.3.1. Analysis: From upstream platform core identification to robust platform deployment

Following step 3, the genericity that had been identified needs to be developed and markets addressed through modular exploration. For instance, the 3DTouch project was approved by the IVB and resources were allocated to continue exploration (see Figure 4). Platform enrichment comprised both the creation and management of interdependencies to ensure the deployment of market complementarities, and the further enrichment of the generic core itself. Project enrichment was continued by developing specific functions to address a predefined list of market applications. For instance, to develop tissue sensing for e-commerce, the generic core had to be reused to create design catalogues or to ensure high-precision management and low power for consumer back-typing applications. In addition to the exploration of the identified market complementarities, new markets emerged that were potentially interested in the generic platform. For example, in 3DTouch the security, gaming, education markets appeared once a platform based on an 'active surface for haptic touch' had been built.

Further work was also undertaken to increase the genericity of the platform core. In

the 3DTouch case, the screen flexibility (obtained through graphene sheets or OLED display) led on to the development of deformable transparent tactile objects. The proposed idea involved innovation at the system level that required the involvement of ST's clients and partners, and even led to the creation of a new micro-ecosystem around the emerging solutions. A generic haptic technology was developed via a cooperative framework between participants, in which collaborations with glass substrate suppliers, LCD screen makers, module makers, touch sensor makers, display assemblers and OEMs was crucial (see Figure 4).

Insert Figure 4 about here

The collaboration development within the company and externally was highly supported by both the CIT who facilitate beneficial division of labor and IVB members who were primarily responsible to support the costs of transaction to build the partnerships.

4.4 Combining organizational and institutional perspectives: seekers - solvers relations and their motivation

In BIP the role of seekers is played by the IVB team, which represents the pools of highly qualified specialists that internally could recognize the value of proposals and build an innovative ecosystem for further ideas exploration towards new markets. It is important to underline that seekers comprise experts with various profiles and none of them is a real buyer of a technology. Their goal is to constitute the *ad hoc* value of proposal for the future buyers. The IVB members did not provide any warranties to buy the winner solutions. Instead, they aim to deliver the appropriate financing for further ideas exploration. The corresponding cost transactions comprise the resources to establish the exchange interfaces within the external partners, to support mutual development. The CIT team appears as an organizational structure within seekers and solvers that drives the BIP institution. Despite the contest organization and deployment, they were managing the process of ideas co-development, privileged genericity, ideas clustering and joint team building. In the description of their mission, CIT members mention their aim in unlocking business potential, converting teams experience in valuable knowledge, overcoming obstacles. They privileged co-exploration to “picking a winner” cases. They attempted to integrate highly motivated individuals to launch projects exploration even if their ideas were not selected and thus, increase the quality of future proposals and enlarge the scope of ideas.

From the solvers side, in classical ICs they appear to be motivated by incentive rewards, which were absent in BIP. The participation was neither driven by the hierarchical order, nor by the career evolution expectation. The process appeared completely voluntary. Participants were actually motivated to constitute new teams, push their ideas towards new markets creation, new business models that go beyond the traditional ST business. Their motivation was in their expertise development; in potential benefits they would obtain ones their generic solution will appear on the markets or even in changing their role towards future project managers of their proposals.

5. Findings. Generic technology ideas contest (GT_{IC})

The findings presented below are organized around the research sub-questions previously posed and their analysis.

Context of GT_{IC} organization

We found that the ICs organized by STMicroelectronics did not aim at the development of specific technology-market couples, as in stage-gate processes, but attempted to explore both new markets and new technologies by privileging cooperation to competition. For instance, one of the ideas aimed at recovering energy losses was developed to address several emerging application areas like wireless sensors network, smart grid management, autonomous healthcare, thermal wall management, bionics, mobile devices. Project teams aimed to increase the total efficiency of energy generation, using an idea that proposed to use several multi-harvesting systems. By working on new forms of electronics that need far less power, the team developed a new approach to energy harvesting that generated electricity from small temperature gradients and at low temperatures, using a technology based on direct thermal-mechanical energy and mechanical-electrical energy conversions using piezoelectricity principles.

In double unknown situations, the exploration of new functions that the market seeks and the emerging technologies that could address them need to be prioritized: just developing new functions (as in UICs) or new technologies (TICs) by themselves is insufficient. The goal is to build flexible technologies that can easily integrate new functionalities in multi-market environments. To harvest the appropriate range of ideas, the challenge contest has to be open and to focus on both technological and market exploration. Collaboration between participants and organizers also appeared to be critical while pursuing genericity, and the outcome of the process should be the development of new technological platforms (see Table 2).

Insert Table 2 about here

Criteria for ideas selection: from isolated ideas to platforms

CIT did not simply select the best ideas according to commonly used criteria as in UIC and TIC challenges. Its members chose neither the most promising applications for already developed technologies (by maximizing net present value), nor did they seek to minimize the development costs for more promising selected market applications. They sought transversality of ideas to address several market areas (existing and new ones) and new original technological solutions, which were both flexible and robust to address several environments. They favored addressing a variety of market applications by reusing existing technological competences, and developing new ones with minimal adaptation costs between future modules. The criteria used in GTIC should incorporate the logic of value maximization through several market considerations and the construction of interdependencies between them (see Table 2).

The CIT regrouped submitted ideas to enable more generic ideas to develop, and targeted ideas with higher generic potential. This led us to identify two strategies for developing generic ideas: 1) Identification of **ideas with generic potential** that recognized ideas with higher intrinsic generic potential (in terms of both technological and functional parameters) and that could be transformed into platform ideas. Ideas of this kind contained generic technological concepts that did not just attempt to address several existing application, but also triggered the creation of new uses and new technological principles. 2) **Generic Ideas from Cluster building strategy** that lead to the creation of new uses rather than just the development of common solutions for the initially proposed contexts. As in the technology-market matching models, idea-clustering strategies can be achieved through grouping individual ideas into platforms either on the basis of functions or of technological principles. Moreover, as the idea collection process showed, the visibility of already submitted ideas to other participants, and their commenting and feedback on them, had a

positive effect on the likelihood of deepening and widening of range of ideas' application areas.

The importance of adaptation process in case of GT development - Genericity building

Most of the generic ideas simply targeted several application areas which attempted to generate higher benefits. But the multiplicity of markets that each idea attempted to address made it difficult for the company to associate concrete units responsible for project development. These high-potential projects proposed both new technological concepts and new markets. It is important to underline that the generic ideas that stemmed from contests, were initially still too immature to pursue new product development directly. In the case of GTIC, the adaptation of ideas often takes a long time, but is crucial for successful genericity building. Because of the high levels of uncertainty involved, the development phase includes both the development and testing of applications and further genericity building, which comprises the enrichment of both the core and of the interdependencies designed to address predefined markets and to broaden exploration towards new applications that were not considered (or even existed) before the platform had been developed.

Risks associated with GT development in case of GTIC

The principal risk while pursuing genericity is to prevent specialization towards more promising market applications or dominant technologies at the early stages of exploration. There is a tendency to favor dominant market signals rather than to keep exploring genericity for still unknown markets, which could result in a rigid platform core: so the key role of CIT and project leaders appears to be to avoid hyper-adaptation.

The double unknown situation makes it possible for some projects to proceed towards GT development, to address multiple markets. Though these transversal projects offer solutions for several BUs, they can often also pose challenges in terms of the BUs' technology development investments, managerial responsibility and technology ownership. For instance, BUs need to decide how to share costs of platform development, and which other market modules they can develop based on the platform. GT managers need to manage these organizational risks to ensure platform adaption to various markets, and also to ensure the platforms can be relevant to both existing markets (to generate profit in the short-term) and to emerging markets to ensure the long-term growth of generic technologies.

Managerial guidance of GTIC innovation contest

The managerial guidance for GTIC organization includes probing questions at each step of ICs development (see Table 3) so as to estimate whether a GTIC is suitable to a particular organizational context and learn more about how to build successful GTs.

Insert Table 3 about here

From market based towards design community building

The presented in this paper innovation contests is designed to create partnerships. GTIC enable to improve the quality of submitted ideas and selected proposals through the process of collective exploration. The introduced GTIC contests aims to profit from competition to establish larger collaborative participants networks that work together to prepare future technologies and markets that would interest high number of buyers. Compliant with the findings of (Eickelpasch and Fritsch, 2005), our research provides incentives for self-organization and allow teams to build the organizations forms of innovative labor that suits their interest. Despite the absence of the incentive reward mechanisms, solvers of this contest

pursue more strategic goal of their expertise building and their evolution towards the new collectives creation, extending their network.

6. Conclusion

6.1. Theoretical and managerial contribution

By dealing with the question of ICs from the institutional point of view, this paper demonstrates the interest in pursuing ideas challenges in double unknown. The relevance of innovation contests for GT development in high-tech environments is clearly supported by our findings. The evidence from this study suggests a form of GT innovation contest that is different from those driven by identified users or technologies in seeker – solver predefined relations. *The ICs defined in this paper appears as a new policy that aims to create the new design communities for joint generic technologies exploration.* The collective orientation of contests participants by the CIT members demonstrates how cooperation in the competitive environment of the contests leads to greater innovativeness and higher quality of propositions which according to the results of (Bullinger et al., 2010) could extend the boundary spanning perspective. The CIT team proposes a rather efficient mechanism of institutional support for GTICs by playing the important role of the construction of techno-economic role of an innovation.

The analysis of STMicroelectronics' business innovation process presented here gives important insights into the conditions that govern the emergence of generic technologies. Generally, the chances of developing a GT increase when the individual ideas can be transformed in a platform of multi-application ideas that use the same technological building block(s) (**'Ideas with Generic Potential'** strategy), but combining a group of ideas into a richer, broader concept can also result in GT development (**'Generic Ideas from Clusters'** strategy). To promote genericity, one needs to avoid the intuitive approach of adapting to already known market environments, which is easier and faster, but leads to developments that tend to be specific to single markets (that can also be successful, but more often in short term).

This idea transformation strategies proposed in this paper increase the probability of those ideas being accepted within a firm and facilitates the management of the absorption of unsolicited ideas, which as Alexy et al. (2012) note, is often problematic. Clustering facilitates the incorporation of highly disruptive ideas that are often rejected due to their 'double unknowns' and the consequent ambiguity of their chances of success (Sommer et al., 2009).

As demonstrated here, GTIC fosters the possibility of further genericity building through the continuous enrichment of platform and market modules. Platform enrichment is a crucial step to ensure the further exploration and on-going existence within the company of generic ideas that may still be too uncertain to be transferred to product groups. In contrast to classical ideas contests - which often stop with the selection of the winning ideas - organizers of GTIC contests have to facilitate the further enrichment of submitted ideas to develop higher genericity and successful market modules through collaborative open innovation processes (Huang, 2011). Fundamental knowledge acquired during platform building can both prepare for the company's long-term growth, and better equip it to respond rapidly to market changes (Kim and Kogut, 1996). Such contests as those reported here can be seen as opportunities for innovative ideas exploration for on-going platform enrichment (Boudreau et al., 2011).

This study yields important managerial recommendations and tools for practitioners attempting to explore both new uses and technological phenomena, which are especially relevant to the turbulent environments and high rates of competition in high tech industries (Duysters and Man, 2003; Tierney et al., 2012), and is consistent with a robust design approach that suggests the need for high variability of uses and application (Bstieler, 2005). From the human resources point of view, such idea contests enable a company to identify corporate entrepreneurs and experts within its workforce (Santos and Spann, 2011), to gather people with a range of various technical and commercial backgrounds together in the process of pursuing innovative technologies development, and to organize coaching sessions for such highly motivated people. The BIP contest series organized by STM enabled project leaders to develop their skills, to gain completely new expertise and to enlarge their networks within the company (Hennebelle, 2013).

The process that ST organized for collecting and developing generic ideas enabled the design of valuable technological platforms and the creation of important ecosystems for further technology development. The idea of GTICs identified here appears to be beneficial for new technologies whose maturity is low and market value is still uncertain (Mortara et al., 2013). Overall, this research shows the inappropriateness of the conventional user and technological driven contests to the challenge of developing generic technologies. It introduces a new platform building innovation contest process that can be combined with those classical contest forms to build richer technological platforms and address wider application areas, and offers useful insights to practitioners faced with the challenge of exploring technology and market 'double unknowns' in high-tech industries.

6.2. Limitations of the Study and suggestions for further Research

Obviously, the limitations of our methodological approach mean that we cannot provide decisive evidence on the effectiveness of the organization of generic technology ideas contests: the empirical applicability of our findings need to be tested on a larger sample of firms dealing with market–technology exploration in double unknown situations. Further work is also needed to pursue the development of a model of generic technology exploration, and to investigate whether the model we have observed is limited to the semiconductor sector or can be applied in various environmental contexts.

In addition, the transitions between phases of innovation contests that target genericity development remain to be investigated. Intuitively, the closure of each phase is based on the remaining uncertainties, resources and the appreciation of the results by CIT members and project leaders: but when exactly platform exploration should finish and the construction of market modules should start is not easily specified. More generally, when is it better to finalize genericity building? Is it just a matter of time - or which criteria should be used to measure the resolution of this effort? How can one best organize the adoption of generic technologies by business units or facilitate the creation of start-ups? Despite the advantages of GTs development, it is important to underline the problems of governance during the process of adopting transversal innovations in a company, the lack of appropriate business plans to manage uncertainty and the problems of managing generic ideas in general (Griffin and Hauser, 1996; Mason and Stark, 2004).

This work also poses questions about creativity of the process. How can innovative thinking on double unknown best be stimulated when the target is platform creation? Why do certain idea submitters favor generic over specific ideas? Are there methods which aim to overcome fixation effects, with suggestions including enhancing social interaction through communication (Purcell and Gero, 1996), boundary spanning (Rapp et al., 2013) or enhancing cognition (Agogu e et al., 2012). But can these techniques enhance the degree of

genericity of ideas? How can participants be stimulated to build genericity? And with which sorts of stimuli?

These research avenues should help adjust the model and enlarge the application areas of generic technology innovation contests.

Acknowledgements

The authors thank STMicroelectronics Crolles and Grenoble sites, the members of the Core Innovation team and the Innovation Venture Board for the insightful comments that they provided on this work. The authors thank the intern students Maxime Barthelemy, Adrien Guémy and Vincent Louvier for the quality of their empirical work on the case of Business Innovation Process at STMicroelectronics.

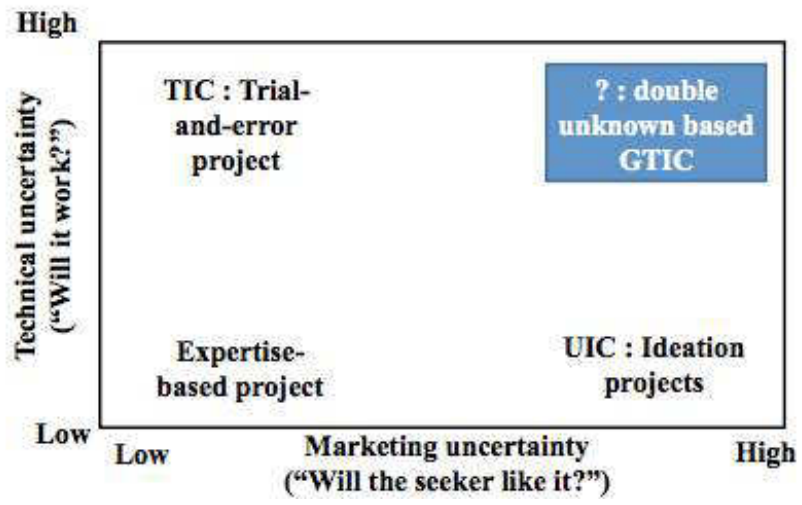

Figure 1 Typology of Ideas contests: the specific case of double unknown (adapted from (Terwiesch and Xu, 2008))

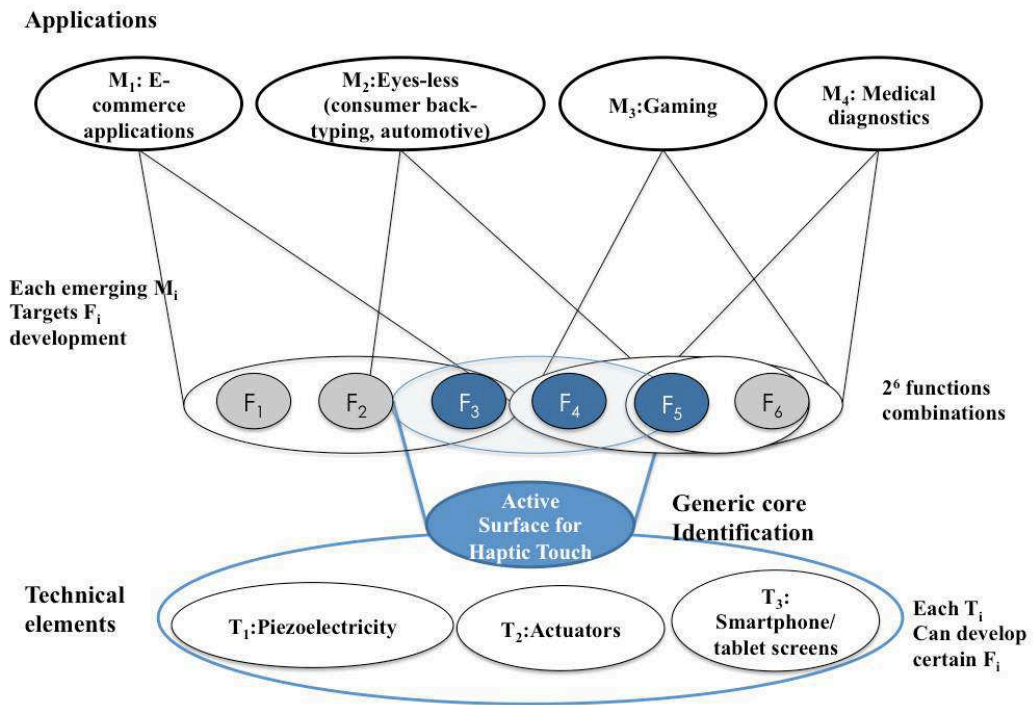

Figure 2 3D Touch generic ideas recognition - “Real Sense challenge”

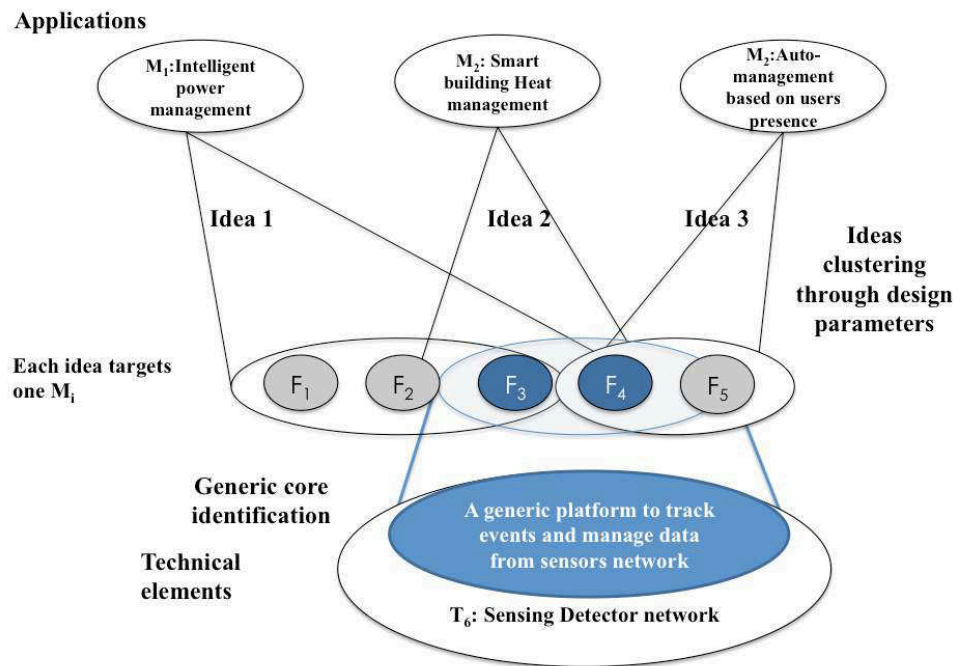

Figure 3 Ideas clustering through design parameters “Green Energy” challenge

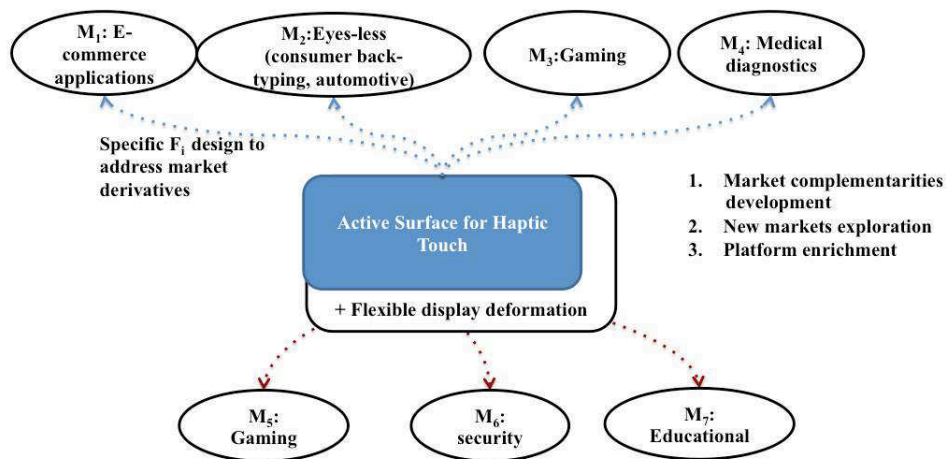

Figure 4 3DTouch platform development – genericity building

Table 1. Innovation ideas contests in technological contexts

Elements	Parameters	User (U _{IC})	IC (T _{IC})	Limits of U _{IC} and T _{IC} for GT _{IC}
Challenge initiation	Context	NPD, FFE, New product offers, applications	Technological prototypes, proof of concepts, Robustness	U _{IC} : Too Specific applications T _{IC} : Too specific technology development.
	Uncertainty level	Market based uncertainty	Technology based uncertainty	U _{IC} and T _{IC} are not suitable when T and M are unknown
	Openness	High	Low	
Idea generation and selection	Evaluation Criteria	Max Net Present Value	Min Cost of development	For double unknown the combination of market driven and technological criteria need to be used
Idea development	Valorization	Chosen Product development	Technology development	U _{IC} and T _{IC} don't take manage product and technology diffusion together
Motivation	Reward System	Fixed-price awards	Performance contingent award	Fixed price awards are hard to determine before the challenge launch; Performance based awards could be suitable in unknown

Table 2. Generic technology IC contest

Step	Parameters	GT _{IC}
Outcome	Creation of design communities to explore technological platform, develop new business directions	
Challenge initiation	Context	Innovation capability, Genericity is a target
	Uncertainty level	Double unknown (Both Technology and markets are unknown)
	Openness	High to account for larger market area, low to design new generic technology
Ideas Generation and Selection	Evaluation Criteria	Variety of market applications, min cost of readaptation
Ideas development	Valorization	Platform opens up new possibilities for product development; Design modularity as well opportunities for new challenges type UIC, TIC while reusing core
Motivation	Joint Expertise Building	The primarily motivation is not to win the contest but to build the community that facilitates the development of new business directions where they will play the key role.

Table 3. Managerial guidance for GTIC organization

GT _{IC} elements	Probing Questions
Challenge initiation	<ul style="list-style-type: none"> - Are all the stakeholders in line with GT_{IC} objectives? (i.e. developing long-term technological platform for several markets, focusing on breakthroughs innovation...) - Does the contest brief enable participants to cover different technological and markets domains? - Does the contest encourage multidisciplinary teamwork and the development of ecosystem?
Ideas generation and selection - genericity identification	<ul style="list-style-type: none"> - Are there transversal ideas or mostly functionally or technologically interdependent ideas? - Are ideas submitters stimulated to work together? Are there comments that add useful information on other application domains or technological alternatives? - Do single ideas have generic potential: seek to address several market needs? - Do several ideas seek to address or explore similar market modules? - Do several ideas seek to develop similar technological platform for various market needs?
Ideas development - genericity building	<ul style="list-style-type: none"> - Does platform ready to be commercialized (NPD)? - Are there specific functions to develop market modules? - Are there other markets modules that platform can address/create? - Is it possible to increase platform genericity by incorporating other functions leading to enlarge market area?

References

- Adamczyk, S., Bullinger, A.C., Möslein, K.M., 2012. Innovation Contests: A Review, Classification and Outlook. *Creativity and Innovation Management* 21, 335-360.
- Agogué, M., Le Masson, P., Robinson, D.K., 2012. Orphan innovation, or when path-creation goes stale: a design framework to characterise path-dependence in real time. *Technology Analysis & Strategic Management* 24, 603-616.
- Alexy, O., Criscuolo, P., Salter, A., 2012. Managing innovation-Managing Unsolicited Ideas for R&D. *California Management Review* 54, 116.
- Baldwin, C., von Hippel, E., 2011. Modeling a paradigm shift: From producer innovation to user and open collaborative innovation. *Organization Science* 22, 1399-1417.
- Bayus, B., 2012. Crowdsourcing New Product Ideas Over Time: An Analysis of Dell's Ideastorm Community. Available at SSRN 1979557.
- BIP, 2009a. Business Innovation Process: Challenge à idées Crolles - Grenoble.
- BIP, 2009b. Business Innovation Process. Lancement BIP Grenoble.
- Bjelland, O.M., Wood, R.C., 2008. An Inside View of IBM's' Innovation Jam'. *MIT Sloan Management Review* 50, 32-40.
- Bjerregaard, T., 2010. Industry and academia in convergence: micro-institutional dimensions of R&D collaboration. *Technovation* 30, 100-108.
- Bluetooth, 2012. Bluetooth Innovator of the Year 2011 Honored at ISPO Munich.
- Boudreau, K.J., Lacetera, N., Lakhani, K.R., 2011. Incentives and problem uncertainty in innovation contests: An empirical analysis. *Management Science* 57, 843-863.
- Bratvold, D., 2012. NASA Launches Open Innovation Challenge to Improve the International Space Station.
- Brem, A., Voigt, K.I., 2009. Integration of market pull and technology push in the corporate front end and innovation management—Insights from the German software industry. *Technovation* 29, 351-367.
- Bresnahan, T.F., Trajtenberg, M., 1995. General purpose technologies 'Engines of growth'? *Journal of econometrics* 65, 83-108.
- Bstieler, L., 2005. The Moderating Effect of Environmental Uncertainty on New Product Development and Time Efficiency*. *Journal of product innovation management* 22, 267-284.
- Bullinger, A.C., Neyer, A.K., Rass, M., Moeslein, K.M., 2010. Community-Based Innovation Contests: Where Competition Meets Cooperation. *Creativity and Innovation Management* 19, 290-303.
- Cantwell, J., Qui, R., 2009. General Purpose Technology (GPT), firm technological diversification and the re-structure of MNC international innovation networks, Druid conference summer conference.
- Cogez, P., 2010a. 1ère semaine de l'innovation pour les sites de Crolles et de Grenoble, World Class - Technocrolles. STMicroelectronics, Crolles.

- Cogez, P., 2010b. Domaine d'expertise. Le BIP (Business Innovation process). Le BIP s'approche de son premier anniversaire, Edition locale - Site de Crolles. STMicroelectronics, Crolles.
- Coriat, B., Weinstein, O., 2002. Organizations, firms and institutions in the generation of innovation. *Research Policy* 31, 273-290.
- Dahlander, L., Gann, D.M., 2010. How open is innovation? *Research Policy* 39, 699-709.
- David, P.A., 1990. The dynamo and the computer: an historical perspective on the modern productivity paradox. *The American Economic Review* 80, 355-361.
- Duysters, G., Man, A.P., 2003. Transitory alliances: an instrument for surviving turbulent industries? *R&D Management* 33, 49-58.
- Eickelpasch, A., Fritsch, M., 2005. Contests for cooperation—A new approach in German innovation policy. *Research Policy* 34, 1269-1282.
- Eisenhardt, K.M., 1989. Making fast strategic decisions in high-velocity environments. *Academy of Management Journal*, 543-576.
- Füller, J., Matzler, K., 2007. Virtual product experience and customer participation—A chance for customer-centred, really new products. *Technovation* 27, 378-387.
- Gambardella, A., McGahan, A.M., 2010. Business-model innovation: General purpose technologies and their implications for industry structure. *Long Range Planning* 43, 262-271.
- Gawer, A., 2010. The organization of technological platforms, in: Nelson Phillips, G.S., Dorothy Griffiths (Ed.), *Technology and Organization: Essays in Honour of Joan Woodward in Research in the Sociology of Organizations*. Emerald Group Publishing Limited.
- Gawer, A., Cusumano, M.A., 2008. How companies become platform leaders. *MIT Sloan Management Review* 49, 28-35.
- Gillier, T., Piat, G., 2011. Exploring Over: The Presumed Identity of Emerging Technology. *Creativity and Innovation Management* 20, 238-252.
- Gillier, T., Piat, G., Roussel, B., Truchot, P., 2010. Managing Innovation Fields in a Cross-Industry Exploratory Partnership with C-K Design Theory. *Journal of product innovation management* 27, 883-896.
- Gorski, C., Heinekamp, E.J., 2002. Capturing employee ideas for new products. *The PDMA toolbox for new product development*, 219-242.
- Griffin, A., Hauser, J.R., 1996. Integrating R&D and marketing: a review and analysis of the literature. *Journal of product innovation management* 13, 191-215.
- Hargrave, T.J., Van de Ven, A.H., 2006. A collective action model of institutional innovation. *Academy of Management Review* 31, 864-888.
- Hartley, J., Butler, M.J., Benington, J., 2002. Local government modernization: UK and comparative analysis from an organizational perspective. *Public Management Review* 4, 387-404.
- Heiskanen, E., Hyysalo, S., Kotro, T., Repo, P., 2010. Constructing innovative users and user-inclusive innovation communities. *Technology Analysis & Strategic Management* 22, 495-511.
- Hennebelle, I., 2013. Management Rebondir dans sa boîte en devenant intrapreneur, *L'Expansion*, France, pp. 108-109.

- Hillson, D., 2010. *Exploiting Future Uncertainty: Creating Value from Risk*. Gower Publishing Company.
- Huang, H.-C., 2011. Technological innovation capability creation potential of open innovation: a cross-level analysis in the biotechnology industry. *Technology Analysis & Strategic Management* 23, 49-63.
- Innocentive, 2012. *Accurately Locating Fluid Loss in Complex Networks*.
- Innocentive, 2013. *Breakthrough Health Tech Modifications – Consumer Technology that Improves Health*.
- Jeppesen, L.B., Lakhani, K.R., 2010. Marginality and problem-solving effectiveness in broadcast search. *Organization Science* 21, 1016-1033.
- Kanter, R.M., 2011. *How great companies think differently*. Harvard Business Review.
- Keenan, M., 2003. Identifying emerging generic technologies at the national level: the UK experience. *Journal of Forecasting* 22, 129-160.
- KEI, 2008. *Selected Innovation Prizes and Reward Programs*. KEI Research Note 1, in: Washington, D.K.E.I. (Ed.), p. 51.
- Kim, D.-J., Kogut, B., 1996. Technological platforms and diversification. *Organization Science* 7, 283-301.
- Kristensson, P., Magnusson, P.R., 2010. Tuning Users' Innovativeness During Ideation. *Creativity and Innovation Management* 19, 147-159.
- LeServiceCommunication, 2011. *Plus qu'un mois pour participez au challenge à idées: "Make life easier and better for Everybody! "*, Crolles.
- Linton, J.D., Walsh, S.T., 2008. Acceleration and extension of opportunity recognition for nanotechnologies and other emerging technologies. *International Small Business Journal* 26, 83-99.
- Magnusson, P.R., 2009. Exploring the Contributions of Involving Ordinary Users in Ideation of Technology-Based Services. *Journal of product innovation management* 26, 578-593.
- Maine, E., Garnsey, E., 2006. Commercializing generic technology: The case of advanced materials ventures. *Research Policy* 35, 375-393.
- Malone, T., Laubacher, R., Dellarocas, C., 2009. *Harnessing crowds: Mapping the genome of collective intelligence*.
- Mason, C., Stark, M., 2004. What do investors look for in a business plan? A comparison of the investment criteria of bankers, venture capitalists and business angels. *International Small Business Journal* 22, 227-248.
- McGrath, M.E., 1995. *Product Strategy for high-technologies companies*. Irwin professional publishing, New York.
- McGrath, R.G., 2001. Exploratory learning, innovative capacity, and managerial oversight. *Academy of Management Journal* 44, 118-131.
- Miyazaki, K., 1994. Interlinkages between systems, key components and component generic technologies in building competencies. *Technology Analysis & Strategic Management* 6, 107-120.
- Mortara, L., Ford, S.J., Jaeger, M., 2013. *Idea Competitions under scrutiny: Acquisition, intelligence or public relations mechanism? Technological Forecasting and Social Change*.

- Moser, P., Nicholas, T., 2004. Was electricity a general purpose technology? Evidence from historical patent citations. *American Economic Review*, 388-394.
- Moseson, A.J., Lama, L., Tangorra, J., 2012. Development By Technology Seeding. *Journal of International Development*.
- Muffatto, M., Roveda, M., 2002. Product architecture and platforms: a conceptual framework. *International Journal of Technology Management* 24, 1-16.
- Neyer, A.K., Bullinger, A.C., Moeslein, K.M., 2009. Integrating inside and outside innovators: a sociotechnical systems perspective. *R&D Management* 39, 410-419.
- Olleros, F.-J., 1986. Emerging industries and the burnout of pioneers. *Journal of product innovation management* 3, 5-18.
- Penin, J., Burger-Helmchen, T., 2011. Crowdsourcing of inventive activities: definition and limits. *International Journal of Innovation and Sustainable Development* 5, 246-263.
- Perkmann, M., Walsh, K., 2007. University–industry relationships and open innovation: Towards a research agenda. *International Journal of Management Reviews* 9, 259-280.
- Pich, T.M., Loch, H.C., DeMeyer, A., 2002. On uncertainty, Ambiguity and Complexity in Project Management. *Management Science* 48, 1008-1023.
- Piller, F.T., Walcher, D., 2006. Toolkits for idea competitions: a novel method to integrate users in new product development. *R&D Management* 36, 307-318.
- Poetz, M.K., Schreier, M., 2012. The value of crowdsourcing: can users really compete with professionals in generating new product ideas? *Journal of product innovation management* 29, 245-256.
- Purcell, A.T., Gero, J.S., 1996. Design and other types of fixation. *Design Studies* 17, 363-383.
- Rapp, A., Beitelspacher, L.S., Grewal, D., Hughes, D.E., 2013. Understanding social media effects across seller, retailer, and consumer interactions. *Journal of the Academy of Marketing Science*, 1-20.
- Reid, S.E., De Brentani, U., 2004. The fuzzy front end of new product development for discontinuous innovations: a theoretical model. *Journal of product innovation management* 21, 170-184.
- Rochet, J.C., Tirole, J., 2003. Platform competition in two–sided markets. *Journal of the European Economic Association* 1, 990-1029.
- Sanchez, R., 1996. Strategic product creation: Managing new interactions of technology, markets, and organizations. *European Management Journal* 14, 121-138.
- Santos, R., Spann, M., 2011. Collective entrepreneurship at Qualcomm: combining collective and entrepreneurial practices to turn employee ideas into action. *R&D Management* 41, 443-456.
- Schepers, J., Schnell, R., Vroom, P., 1999. From Idea to BusinessHow Siemens Bridges the Innovation Gap. *Research-Technology Management* 42, 26-31.
- Schulze, A., Hoegl, M., 2008. Organizational knowledge creation and the generation of new product ideas: A behavioral approach. *Research Policy* 37, 1742-1750.
- Shane, S.A., 2004. *Academic entrepreneurship: University spinoffs and wealth creation*. Edward Elgar Publishing.

- Shani, A.B., Coghlan, D., Coughlan, P., 2008. Handbook of collaborative management research. Sage Publications Thousand Oaks, CA.
- Shea, C.M., Grinde, R., Elmslie, B., 2011. Nanotechnology as general-purpose technology: empirical evidence and implications. *Technology Analysis & Strategic Management* 23, 175-192.
- Slater, D., Tonkiss, F., 2001. Market society: Markets and modern social theory. Polity Press Cambridge.
- Sommer, S.C., Loch, C.H., Dong, J., 2009. Managing complexity and unforeseeable uncertainty in startup companies: An empirical study. *Organization Science* 20, 118-133.
- Stopford, J.M., Baden-Fuller, C.W.F., 2006. Creating corporate entrepreneurship. *Strategic Management Journal* 15, 521-536.
- Suchman, M.C., 1995. Managing legitimacy: Strategic and institutional approaches. *Academy of Management Review* 20, 571-610.
- Teece, D.J., 1986. Profiting from technological innovation: Implications for integration, collaboration, licensing and public policy. *Research Policy* 15, 285-305.
- Terwiesch, C., Xu, Y., 2008. Innovation contests, open innovation, and multiagent problem solving. *Management Science* 54, 1529-1543.
- Tierney, R., Hermina, W., Walsh, P.d.S.T., 2013. The pharmaceutical technology landscape: a new form of technology roadmapping. *Technological Forecasting and Social Change* 80, 194 - 211.
- Tierney, R., Hermina, W., Walsh, S., 2012. The pharmaceutical technology landscape: A new form of technology roadmapping. *Technological Forecasting and Social Change*.
- Van de Ven, A.H., 2007. Engaged scholarship: A guide for organizational and social research. OUP Oxford.
- Wessner, C.W., 2003. Securing the Future: Regional and National Programs to Support the Semiconductor Industry. National Academies Press.
- Yin, R.K., 1994. Discovering the future of the case study method in evaluation research. *Evaluation Practice* 15, 283-290.
- Youtie, J., Iacopetta, M., Graham, S., 2008. Assessing the nature of nanotechnology: can we uncover an emerging general purpose technology? *The Journal of Technology Transfer* 33, 315-329.

Appendix A

Questionnaire submitted to IC participants (on scales of 0 to 5 for the evaluation questions with the possibility of leaving additional comments) – Internal Document

<p>Profile:</p> <ol style="list-style-type: none">1) What is your function within the company?2) Seniority level?3) In which challenges didn't you take part (Challenge 1: Real Sense; 2: Real Energy; 3: Make life easier and better?)
<p>Feedback on the different phases:</p> <ol style="list-style-type: none">1) Ideas collection<ul style="list-style-type: none">• Was the challenge description and theme selection clear?• For the different ways of ideas collection did you prefer?• How do you estimate the efficiency of ideas collection?• Were the results on ideas collection and selection clear for you?• Other remarks and suggestions2) Creation of possible platforms<ul style="list-style-type: none">• Were the processes steps clear for you?• Was it useful to have external participants during the common meetings?• Was the fact of having external members in your project group positive for you: for personal development; for idea maturity?• Were these coaching sessions helpful for you in your everyday work?• Other remarks and suggestions3) Support of Core Innovation Team (CIT) and Innovation Venture board (IVB) evaluation<ul style="list-style-type: none">• How do you estimate support of CIT members (for networking, sponsorship of your project)?• Was the CIT feedback beneficial for your innovative project development?• Were there matching in between the given initially selection criteria and the final decision of IVB members?• Was the presentation of the final IVB results clear for you?• Other remarks and suggestions for the CIT support and the IVB selection
<p>Vision and interest:</p> <ol style="list-style-type: none">1) What do you think is an objective of this initiative? (open question)2) Was a participation in this process positive or negative experience for you?3) What will you change for this experience to be positive? (open question)4) What motivated you to participate in innovation contest?5) Will you encourage your colleagues to participate in a future challenge and its incubation phase?6) Will you be motivated to participate again?

Appendix B Business innovation process Empirical comparison

Table B.1. Innovation challenges description

Innovation Challenge	“Real Sense”	“Green Energy”	“Make life easier and better for everybody”
Number of submitters	36	18	67
Period of ideas collection	December 2009 – February - 2010	April – June 2010	May – June 2011
Period of ideas enrichment (before incubation)	May - June 210	November 2010 – January 2011	September 2011 – December 2011
Step 2. Number of ideas submitted	33	60	128
Examples of issued Technological domains variety	Optical sensors, Image processing techniques, Communication technology, Haptic Technology, 3D, RFID, sensors, MEMS, radars, ...	Heat to electricity converters, detector networks, eco-light bulbs, sensors, and batteries. Electric fuses, CPL networks, PV panels, filters,...	Sensors, Radars, LCD, optical sensors, Communication technology, organic solar cells, detectors, audio-video transmission,...
Examples of issued application domains variety	Consumer, Medical, Entertainment, Automotive domains, Gaming, Security, Retail, navigation,...	Energy efficiency through consumption control, automation, power and thermal management; Smart cities, Home automation, nomad devices, bio-energy, lightening,...	Health, Robotics, Security, Entertainment, Sport, Smart building,
Step 3. Ideas evaluation/number of projects selected	5 projects launched: 2 with generic potential and 3 clusters combined form 8 ideas	3 projects launched 3 of generic potential identified and 6 clusters from 25 ideas	6 projects launched: 5 clusters for 29 ideas, 1 generic potential

Paper VI

**Industry-Wide Technology
Road Mapping in Double
Unknown – The Case of the
Semiconductor Industry**

Industry-Wide Technology Roadmapping in Double Unknown – The Case of the Semiconductor Industry

Patrick Coge¹, Olga Kokshagina^{1,2}, Pascal Le Masson², and Benoît Weil²

¹ *STMicroelectronics, 850 rue Jean Monnet, 38926 Crolles, France,
{patrick.cogez,olga.kokshagina}@st.com*

² *MINES Paristech, CGS - Center for Management Science, 60 Boulevard Saint-Michel, 75006 Paris,
{lemasson,bweil}@ensmp.fr*

Abstract

Many companies face today a dilemma of “double unknown” when deciding where to put their research dollars: ignorance of which one among many possible technologies is most likely to emerge and similar ignorance of which one among many possible applications will most likely be a driver for the technology. Generic technologies are widely recognized to be beneficial for various market applications ([Bresnahan, Trajtenberg, 1995]; [Maine, Garsney, 2006]) and recent research results show that double unknown can lead companies to organize design activity to develop generic technologies suitable for several emerging markets application [Kokshagina, et al. 2012a].

However, the investigations so far focused on the level of the individual firm, while a “double unknown” situation is typically characterizing an industrial sector as a whole. This is in particular the case of the semiconductor industry: While the International Technology Roadmap for Semiconductors (ITRS) primary focus has been and still is the continuation of Moore’s law, it introduced recently the “More than Moore” concept, to account for technologies which do not necessarily follow the CMOS miniaturization trends, and represent a growing part of the total silicon-based semiconductor market. The sheer diversity of both those technologies and their potential applications renders a roadmapping exercise very challenging. Nevertheless, given the benefits that roadmapping has brought to the semiconductor industry, the International Roadmap Committee (IRC) of the ITRS has decided to extend its activities to this new field. Which strategies do the ITRS experts implement to select which technologies to roadmap and which applications to target in double unknown? In this paper, we show that to design roadmaps for More than Moore technologies, the ITRS experts apply a strategy of “common unknown” [Kokshagina, et al. 2012a], along with additional community building activities specific to the situation of inter-firm collaboration.

Keywords

Roadmap, double unknown, innovation, technology, semiconductor

1 Introduction

The current period is characterized by an unprecedented pace of innovation, whereby both the objects being designed and their use have to be revisited. If they don’t respond to that new context, companies can very rapidly go from leadership to bankruptcy. Examples abound: The demise of Nokia for failing to recognize the transition of the mobile phone from an object that corresponded to its name (indeed, a device that allowed to place and receive calls in situation of mobility) to a multi-usage connected device (at the same time phone, internet terminal, camera, entertainment center, productivity device, GPS, and so on) was brutal.

Companies are facing a situation of “double unknown” (cf. Figure 1): ignorance of which one among many possible technologies is most likely to emerge – and therefore worth being invested into – and similar ignorance of which one among many possible applications will most likely be a driver for the technology. Neither market pull nor technology push strategies seem to be adequate answers in this situation.

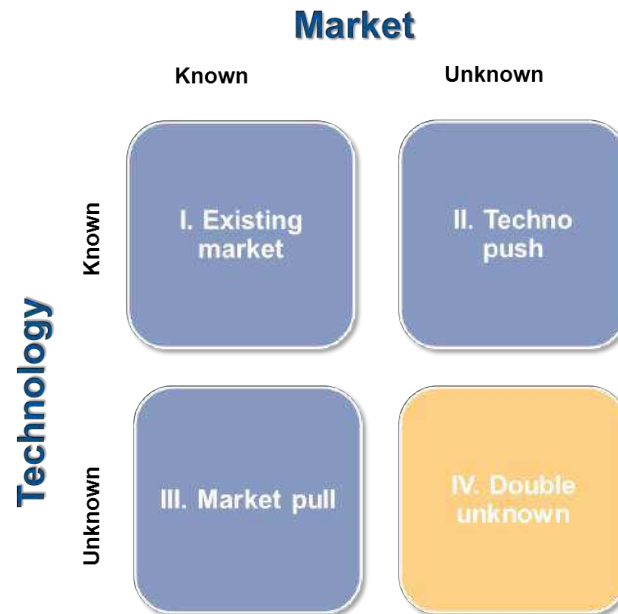

Figure 1: Double unknown situation

Management research has identified innovative strategies displayed by individual firms to manage their R&D efforts in this new paradigm ([Loch, et al. 2008]; [Kokshagina, et al. 2012a]). The situation of technological lock-in [Arthur 1989], however, is often characteristic of an industry as a whole, not just of a single company, and it is often outside of the reach of a single player to break out of this lock-in [Cowan, Hulten, 1996]. Overcoming this lock-in could be viewed by the industry players as a common good, to be collectively pursued, in spite of the competition between them. In this paper, we will look at a collective attempt by industrial competitors to lead a technology and market exploration in double unknown and investigate what is the strategy being pursued.

2 Relation to Existing Theories and Work

To refine our research question, we turn to two bodies of literature. First, we study which strategies have been identified for individual firms to manage research projects or portfolios of research projects when facing a situation of double unknown. Then, we turn our attention to the literature on industry-wide collaborative efforts.

2.1 Research strategies in double unknown

Nowadays firms are faced with turbulent environments due to the constant change of markets, consumers, competitors and technologies themselves. In these cases, probability distributions are unknown and this situation is often called ambiguity [Knight 1921]. Various researchers tackle this problematic. Among the most common methods are: subjective probabilities estimation [Chapman, Ward, 2003], project losses definition [Jaafari 2001], variations [De Meyer, et al. 2002], project outcomes estimations (ex., net present value), etc. There are situations where not just the outcomes but even the project structures themselves are unknown (chaos situations in [Pich, et al. 2002]) and the uncertainties cannot be anticipated by creating project plans (“unforeseeable uncertainties”). These chaos, unforeseeable, unk unks or double unknown situations deal with a level of risks that is so high that common classical risk management criteria like Discounted Cash Flow, Net Present Value, Internal Rate of Return have to be discounted at such a high rate that project or portfolio managers will never accept their too small values [O’Connor 2006].

Nevertheless, various researchers are interested in the way of discovering, managing “unknown” ([Loch, et al. 2006]; [Mullins 2007]; [Krishnan, Bhattacharya, 2002]). Innovation journeys [Van de Ven, Polley, 1992], Discovery-driven planning [McGrath, Macmillan, 2009], information gap decision theory [Ben-Haim 2001], diagnosis of unforeseeable uncertainties [Loch, et al. 2006], a real options approach [O’Connor, et al. 2008] represent various ways to address unknowns.

Selectionism consists in launching several alternatives in parallel and selecting the best approach later ([Lenfle 2011]; [Pich, et al. 2002]; [McGrath 2001]). Less time consuming than probe and learning, it is more suitable for market driven approaches that need fast response. As it often results in expensive development, it is affordable for big engineering problems (e.g., Manhattan project in [Lenfle 2011]).

Trial-and-learning ([Pich, et al. 2002]; [Van de Ven, et al. 1999]) consists of iteratively attempting selected trials. Through the process of trial development, changes in the course of action can be made, which enable flexibility and project redefinition. [Loch, et al. 2008] show that these approaches lead to fabricate a trial project to create knowledge that allows reducing uncertainty and identify alternatives. This enables the passage from the risk management at the level of independent trial project to the level of portfolio management. The trial project becomes a platform core and subsequent development will lead to the management of interdependencies between this platform and platform derivatives (see logic of platform development in ([Gawer 2009]; [Gawer 2010]; [Baldwin, Clark, 2006]; [Sanchez 2004])). Existing platform literature assumes that platforms are known ([Gawer 2010]) and the exploration is based on the development of modules reusing this platform core. In trial and learning strategy, the common core is acquired as a result of exploration of uncertain projects, and serves as a basis of subsequent explorations. Thus this strategy enables the design of both platform and modules in double unknown.

[Loch, et al. 2008] proposed a complementary model for diagnosis of unforeseeable uncertainty by learning problem structure and decomposing the problem. They developed a model for diagnosis of unforeseeable uncertainty by learning problem structure. By studying each sub problem and isolating pieces by uncertainty, they select trial-and-learning, selectionism or plan-and-achieve target methods. In the situation of high uncertainty and low complexity, they suggested to use trial and learning approach and in both high uncertainty and complexity, a combination of trial and learning and selectionism.

Despite clear benefits of these strategies to organize exploration in double unknown, it was shown that the selection of a trial project could result in the development of a rigid platform core, barring the platform leader to reuse this platform to address other market opportunities [Kokshagina, et al. 2012a].

[Kokshagina, et al. 2012a] introduced a “common unknown” strategy that deals with double unknown situations. This strategy does not attempt to obtain common core as a result of exploration, but works directly with “common unknown” as an object to conceive and manage. The common unknown is a platform for several emerging market options. Technological exploration phases allow to design a common technological core which will enable the exploration of several emerging markets. The benefits of this strategy were shown on the practical example of generic technology design for several emerging markets in the semiconductor industry.

Selectionism, trial and learning and common unknown strategies allow to incorporate the notions of risk management in highly uncertain exploration, enabling to organize exploration in double unknown situation at the firm level. There is, however, a lack of knowledge regarding industry wide exploration efforts in similar situations. Is it possible to reuse the identified strategies at that ecosystem level?

2.2 Industry-wide collaborative efforts

We first look at technology sharing cartels : According to economists ([Baumol 1992]; [Petit, Tolwinski, 1997]) or historians ([Pasquier 2008]; [Cortat 2009]), those cartels may lead the members to stronger forms of horizontal collusion, such as fixing prices, outputs levels to reduce innovation outlays and to integrate research efforts in shared research programs. The resulting effect is one of reduced variety of technologies or markets being investigated. In situation of double unknown, the formation of an industry-wide cartel would mean that not just an individual firm, but a whole industry would gamble on a technology or a market, while both are highly uncertain. An unlikely collective gamble...

More relevant is the study of technology roadmaps, which can be defined as “a time-based structured framework to develop, represent and communicate strategic plans, in terms of the co-evolution and development of technologies, products and market.” ([Phaal, et al. 2004]). They mainly consist in mapping the relationship between markets and product plans and technology forecasts. Besides firm roadmaps, which have been very well documented and studied ([Groenveld 1997]; [Willyard, McClees, 1987]), [Albright, Kappel, 2003] suggest that roadmaps can be extended beyond corporate boundaries, as a means of improving the current best practices. These roadmaps are expected to “align” the priorities between the various company actors responsible for transforming an idea into growth through innovation [Whalen 2007]. Perhaps the best studied example of such a roadmap is the International Technology Roadmap for Semiconductors (ITRS). Its track record demonstrates that it is possible and mutually beneficial for competitors to collectively manage as a common good the innovation capabilities of their ecosystem [Cogez, et al. 2010]. But the authors showed that the development of such an industry-wide roadmapping practice was enabled by some unique characteristics of the industry: a predictable rate of technological change, i.e. the exponential growth of the number of components on a fixed silicon area, which became known as Moore’s law [Moore 1965], and the genericity of the benefits of scaling: if the transistors were made smaller, not only could they be fabricated at a lesser cost, but they would also be faster, and consume less power. Whatever the driving needs of the end markets that would eventually come true (cost, power consumption, speed, or any combination thereof), scaling the transistor would meet these needs. Moore’s law allowed decoupling the tasks of exploring market and technology (cf. Figure 2):

- The R&D department focused on bricks reaching the performances defined by Moore’s law. They were not constrained by potential specificities of the markets that the company would eventually address, since the improved performances provided by the next generation technology could benefit any kind of market;
- The marketing department developed the markets which could be addressed with the promised future performances. They knew the performance level that could be reached with the next generation technology, and were not constrained in their quest for new markets given the genericity of that technology.

This decoupling mechanism is clearly demonstrated by the strong emergence of the fabless/foundry business model, whereby fabless companies specialize on designing new products, while leaving to foundries the fabrication activities.

So Moore’s law allowed many companies, independently of the markets which they were pursuing, to develop a collective roadmapping effort within a pure technology-push framework, without sharing any market knowledge. This is no longer the case for More than Moore technologies : MEMS (Micro-Electro-Mechanical Systems – a technology where miniaturization is not the only figure of merit, hence belonging to the More than Moore trend), for example, were characterized in the mid 2000’s by the phrase “one product, one fabrication process, one testing procedure, one package” [Tierney, et al. 2013]. In the absence of such “natural” decoupling mechanism, is it still possible for competing firms to collaborate when facing a situation of double unknown?

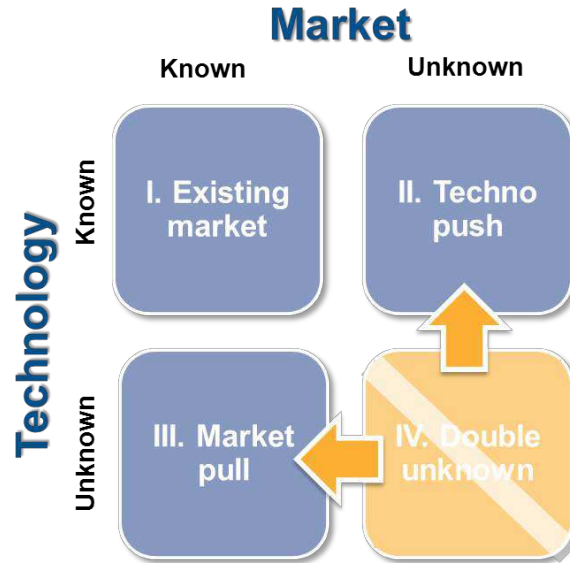

Figure 2: More's law splitting the double unknown

This short review of literature shows that several strategies have been identified for individual firms to deal with double unknown situations, while we are left with a void as to whether such strategies can be identified at an industry-wide level. In this paper, we will exhibit such an example, which lead us to our research questions : What are the characteristics of this industry-wide strategy of exploration in double unknown? Is it similar to one of those identified so far for individual firms, or is it a different path?

3 Research Approach : Longitudinal Case Study To Uncover ITRS Strategy For Dealing With More Than Moore Roadmapping

Since we want to uncover a phenomenon not discussed yet in the literature, we resort to a case study approach [Siggelkow 2007]. The previous review leads us to revisit the case of the ITRS. Contrary to prior studies, we will not focus on its “core business”, which remains staying on Moore's law. Instead, we note that the ITRS has indicated its willingness to roadmap also the new More than Moore trend [ITRS 2005]. We conducted a longitudinal study ([Eisenhardt 1989]; [Yin 2003],) on the period 2005 to 2012, 2005 being the year of the first mention of the “More than Moore” industry trend by the ITRS.

3.1 Case relevance

We first argue that the ITRS is now facing a double unknown situation: While the transistor miniaturization is still the main driving force between the microelectronics industry dynamics, in the recent years, devices have emerged that incorporate functionalities which do not necessarily require scaling according to “Moore's Law,” but provide additional value to the end customer in different ways. This “More-than-Moore” approach typically allows for the non-digital functionalities (e.g., RF communication, power control, passive components, sensors, actuators) to migrate from the system board-level into a package sold by the semiconductor company.

In the absence of Moore's law to guide the researchers when dealing with More than Moore technologies, we no longer have the decoupling phenomenon exposed previously, which allowed to break out of the double unknown dilemma. Nevertheless, given the recognized benefits of roadmapping, the ITRS has indicated its willingness to roadmap also the new More than Moore trend [ITRS 2005], which makes it a relevant case to study to look for an answer to our research questions.

3.2 Data collection and analysis

The first author of this paper has attended 17 face-to-face meetings and over 40 conference calls of the International Roadmap Committee (IRC - the steering committee of the ITRS) since 2005, and, in addition to the publicly available outputs of the ITRS process, had access to working documents of several specialized working groups of the ITRS.

[Kokshagina, et al. 2012a] developed a management framework (objects to manage, criteria, actors and required competences, necessary information to characterize potential risk management strategies in double unknown) to study the different strategies identified in the case of individual firms. We used this “lens” to analyze the strategy deployed by the ITRS.

4 Case exposure and Findings

4.1 Emergence and implementation of the ITRS methodology to roadmap More than Moore technologies over the 2005-2012 period

The proposal to extend the ITRS activities to More than Moore technologies was first introduced for discussion within the International Roadmap Committee during the 2005 general ITRS Summer meeting in San Francisco, at the initiative of the European members, who were representing companies which, for the most part, were thriving on those technologies. This initiative translated into a first mention of this new trend in the executive summary of the 2005 edition of the ITRS.

The next step took place during the 2006 ITRS Spring meeting in Maastricht, The Netherlands, where the IRC, during a plenary session, explained the importance of More than Moore technologies for the industry. It stressed ITRS role as defining the questions to be solved by the research community. Various Technology Working Groups (ITWG) were asked to extend their investigations to those technologies. The IRC also chartered one of its members to reach out of the ITRS community, among others by establishing contact with iNEMI, an association of electronics suppliers (in short, the customers of the semiconductor companies) issuing a roadmap for electronic systems.

During the 2006 summer meeting in San Francisco, the IRC organized a discussion with five working groups most likely to be impacted by More than Moore technologies. The Wireless Group indicated that it had been investigating those technologies for many years already, other groups listed possible technologies to be investigated further. It was suggested to select product emulators with aggressive requirements which would help to identify various technologies, and to develop a tool that would allow estimating a value trade-off between various performance metrics.

The discussion continued during the 2007 Spring meeting in Annecy, France, within a dedicated workshop attempting to define which new forms of coordination and new tools for roadmapping could be needed to handle these More than Moore technologies. The suggestion to start from the end-product requirements was reiterated by the working groups, complemented by the idea to introduce an “abstract level to simulate solutions” before translating them into technologies. The meeting concluded with a public conference, during which this new activity of the ITRS was for the first time presented to the general public. This public advertising of this new activity was reinforced at the Summer public conference of that same year, in San Francisco, when a panel discussion was organized on that topic.

In 2008, the IRC proposed that the TWG most involved in MtM technologies form a cross-TWG study group. More than Moore topic had then become a staple of the IRC agenda, and Moore than Moore cross-TWG meetings were part of all Spring and Summer general ITRS meeting agendas. More than Moore technologies started to appear frequently in the chapters of the roadmap (cf. Table 1, where 2011 data are an underestimation, since data regarding “Assembly

and Packaging” chapter, a very active contributor to the More than Moore roadmapping effort, are missing).

Year of ITRS edition	2005	2007	2009	2011 (*)
Total number of mentions of More than Moore	1	31	49	79
Total number of ITRS working groups (incl. IRC)	16	17	17	18
Number of TWG mentioning More than Moore	1	6	9	11
Average number of mentions per involved TWG	1.0	5.2	5.4	7.2

Table 1: Number of “More than Moore” mentions in ITRS editions ((*)2011 “Assembly and Packaging” data missing)

However, a clear methodology was still missing for the construction of that roadmap. To fill that gap, the European members of the IRC wrote a “More than Moore white paper”, posted on the ITRS web site at the end of 2010, which proposed “a methodology that helps the ITRS community to identify those MtM-technologies for which a roadmapping effort is feasible and desirable” [Arden, et al. 2010]. That paper listed the necessary conditions for that effort (cf. Table 2):

1. restricted set of figures of merits (FOM)
2. convergence of opinion among a majority of the key players on the progress trends that these figures of merit are expected to follow (LEP)
3. potential market of significant size inducing a wide applicability of the roadmap (WAT)
4. willingness to share information (SHR)
5. existence of a community of players (ECO)

Table 2: conditions for an industry-wide technical roadmap effort [Arden, et al. 2010]

The white paper proposed to complement the usual technology push approach of the ITRS by the sketch of broad “application scenarii”. Technology building blocks that would be roadmapped “should enable functionalities which are enabling several applications and markets. They should be “robust” or versatile enough against potential scenario changes”. The link between markets and devices (elementary technology building blocks) was ensured by “functions” (cf. Figure 3).

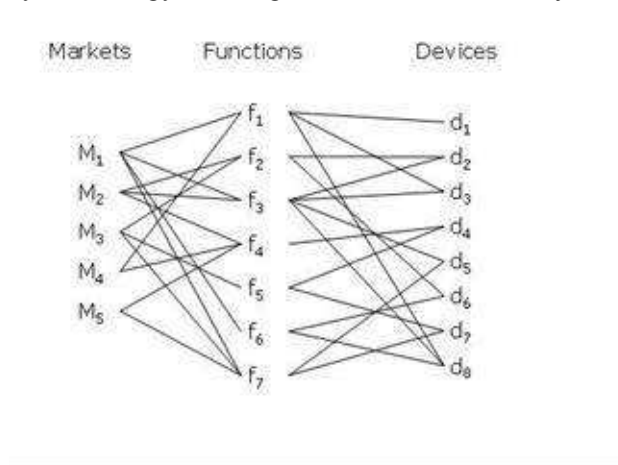

Figure 3: Relationship between markets and relevant devices [Arden, et al. 2010]

The methodology went as follow : “If market M₁ and M₄ rely on similar evolution trends for the performances of function f₁, then this function performance trend will lead to a convergence on

the d_1 device law of expected progress (LOP), and define the figures of merit by which this device should be measured (FOM). Knowledge of markets M_1 and M_4 also allow to estimate the readiness to share (SHR) of the market actors, and the existence of a community between these actors (ECO). Finally, the device or technology applicability (WAT) will depend on the predictable evolution of markets [...] exact numbers are not required [...] For example, we can estimate that high speed bipolar devices will be required to build millimeter wave imaging systems, which in turn can appear in many markets [...]. It is likely that in many combinations of the possible evolution scenario for these various markets, the applicability of this technology will be wide.”

As one of its final remarks, the paper noted that “building this link between societal needs, markets and technologies goes well beyond the ITRS current practice, and is likely to require the involvement of many actors beyond the ITRS historical membership.”

In 2011 and 2012, the ITRS has been applying and refining that methodology:

- Representatives of iNEMI were systematically invited to present their activities and views during the ITRS face-to-face meetings, and participated in More than Moore workshops.
- Four application domains were identified as of interest for potentially driving roadmaps of More than Moore technologies : Automotive, lighting, Energy, and Health care.
- The matrix presented in figure 3 was further split in several levels, from the application domain to the device, and presented during the 2012 Winter meeting in Seoul (cf. Figure 5).

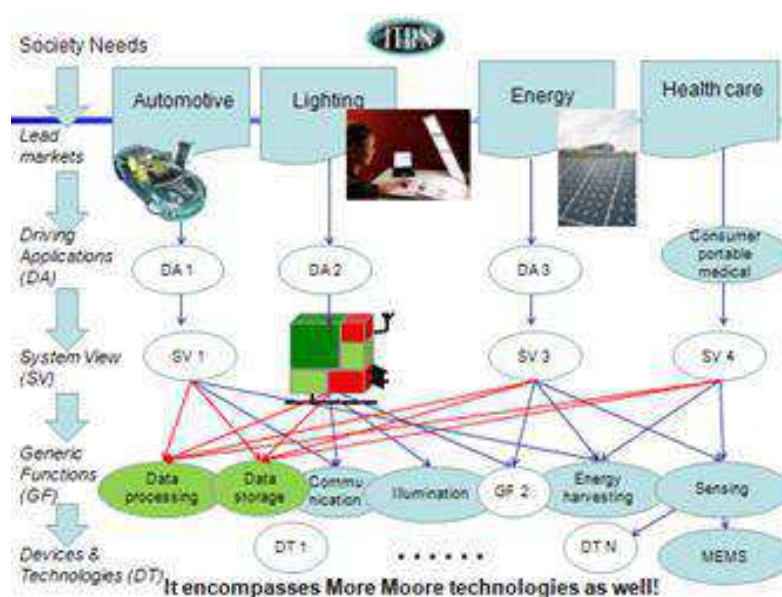

Figure 5: Extract from Dec 2012 ITRS MtM presentation

In particular, a “driving application” level was introduced. In the words of a participant to the 2012 Summer Workshop, these driving applications should be concrete integration examples, large and ambitious enough to encompass many of the functions that will eventually come to exist.

At the time of writing of this paper, a list of generic functions was being discussed, to be then shared with the iNEMI for feedback. Besides this orderly process, the 2012 winter meeting in Seoul showed that many TWGs had already included More than Moore technologies in their tables, for devices that were still being identified through the proposed methodology. For example, the Emerging Research Devices group had mapped energy harvesting devices.

2011 was also the year when a new TWG, MEMS, was spun off the Wireless TWG (where only MEMS used for RF filtering applications were discussed). The story of its creation is interesting:

MEMS technology became a hot topic in the industry around 2006 with its introduction first in gaming consoles, and rapid expansion in mobile phones and other devices afterwards, but MEMS makers (a subgroup of the semiconductors makers) were at first very reluctant to work together towards a roadmap, for lack of decoupling between technology and product: some experts argue that in MEMS, the technology is the product. They finally agreed, nevertheless, to meet around one common issue: the testing of their devices, for which they felt not enough research was being conducted, while this represented both a sizable amount of their costs and a demand from their customers. Once this community was created around this common purpose, it was possible to introduce discussions about more general future needs, with smart phones and tablets as the driving applications.

While the above describes the general process observed by the ITRS community for roadmapping More than Moore technologies, some TWGs have followed different paths. The Wireless TWG declared from the start that they were handling More than Moore technologies since their creation in 2003, and thus did not really embrace the methodology. In parallel, the interconnect TWG started to include tables roadmapping in detail the characteristics of the Through-Silicon-Vias technology as early as 2007, without spending too much time on the generic functions that it could fulfill.

4.2 Analysis

As we argued in section 3.1, the ITRS exemplifies the existence of competitors collectively exploring possible futures in a situation of double unknown: since 2005, it very deliberately embarked on this journey. Is it following any of the strategies (selectionism, trial and error, and common unknown) that we identified through our literature study for individual firms?

Our case study doesn't fit selectionism: for a collective effort, this strategy would consist in letting several technologies develop in parallel, observe which is the "winner" and start building a roadmap for that winning technology. Clearly, the ITRS didn't choose that "wait and see" attitude. This is not surprising:

- it would result in a collective waste of resources, and go against the ITRS claim that it has "improved the quality of R&D investment decisions made at all levels and has helped channel research efforts to areas that most need research breakthroughs" [ITRS 2011];
- within a company, the failure of one project can be counterbalanced by the success of another one. At the collective level, there is no such risk sharing : the failure of a technology can mean the demise of the company championing it, and its competitors will not share that risk. So the selectionism strategy could result simply in a lock-in situation, with no individual company willing to risk spending too much money on any given technology, given the high risk of failure involved. Again, this goes against ITRS role of accelerating innovation [Le Masson, et al. 2012].

The ITRS isn't using trial and learning either. Actually, this strategy wouldn't fit a collective approach: if each actor is tasked with leading a separate exploration, what would be the incentive for it to share with others what it has learned by exploring a given market or a given technology?

In fact, we can argue that the only possible strategy at the industry level is to decouple technology and market. The founding document of the ITRS, the Memorandum of Understanding with respect to the International Technology Roadmap for Semiconductors, signed in 2000, explicitly stated that "the Sponsoring Participants shall cooperate to identify generic technology needs for the global semiconductor industry without regard to particular products of individual companies and encourage on an industry-wide basis potential solutions to future technology challenges". As noted in section 2.2, in the early days of the semiconductor roadmap, this decoupling was made possible through the existence of an object, the transistor, for which all actors could agree on an evolution which would be beneficial for all, independently of the markets being addressed. In the absence of such object for More than Moore technologies,

the ITRS actors are introducing an intermediate level of “generic functions”. Even if companies are interested in different markets, each market corresponding to a different set of functions, those companies can nevertheless build a common interest around functions that belong to several “functional bundles”. The exploration is falling neither on the techno-push nor on the market-pull side, but remains in the double unknown space, attempting to define the characteristics of future technologies able to address several potential future markets. In a sense, the ITRS actors are re-creating the generic technology needs mentioned in the Memorandum of Understanding cited above.

As such, this strategy closely mirrors the “common unknown” strategy evidenced by [Kokshagina, et al. 2012a]. Following the framework proposed there, we examine now more closely what are the objects being managed in this exploration process, the criteria being used (optimized) for this management, who are the actors, and which resources (information and competencies) are mobilized:

- Rather than technologies, the prime object of exploration is at a higher level of abstraction, what the ITRS experts have named “generic functions”, defined as common needs of various markets. No single industry player knows for sure what they will be, they are truly “common unknowns”.
- Given the uncertainty of any single potential market, the main criteria for definition of the relevant generic functions is the robustness vs. scenario changes. Likewise, the application drivers are chosen to be broad enough to catch any functional requirements that will actually come to fruition. This is very similar to the case of the BiCMOSmW platform development cited in [Kokshagina, et al. 2012a] as an example of strategy of common unknown.
- To perform this exploration, the ITRS enrolls, in addition to the traditional expertise of its members, knowledge and competencies related to electronic systems, and end markets.
- It therefore needs to reach out to new actors beyond its usual constituency. It started by creating strong links with iNEMI, as a proxy for representatives of future markets.

We find clear similarities between the “common unknown” strategy identified within companies in [Kokshagina, et al. 2012a], and the path followed by the ITRS to develop the roadmap of More than Moore technologies. As noted in [Kokshagina, et al. 2012b], this strategy is well adapted under the conjunction of two conditions : the market is highly uncertain, which is clearly the case here, and technologies are aggregative, i.e., selecting to develop one function does not preclude the addition of other functions later on, a condition which is also mostly verified for semiconductor technologies.

Since we are dealing with an industry wide process, and not intra-firm processes which were the focus of previous works, we are also capable of identifying additional activities which those previous works did not discuss:

- The build-up of a community of players willing to share information, which is a prerequisite to any collective work. This was exemplified in the creation of the MEMS working group, which achieved it by first defining an issue shared by all actors.
- It more generally, the definition of abstract levels (“generic functions”, “driving applications”) allowed to alleviate the issues of competition, and to define new common visions for future development.

The exceptions noted at the end of the case exposure are understandable. The TWG “Advanced/Mixed Signal and RF Technologies for Wireless Communications” is dedicated to a clearly defined market, and is therefore not in a situation of double unknown. It did not see the added value of an exploration of generic functions. The MEMS technologies, first present in that TWG for their use in RF applications, had to get out of that group to explore other functions. Likewise, the rapid instantiation of the TSV roadmap in the usual format of ITRS technology

tables can be understood since this is an enabling technology, not linked to any particular function, and useful for almost any market: this is a “universal” technology, and a technology push approach makes perfectly sense here.

5 Conclusion

In this paper, we have evidenced the collective design by industrial competitors of a brief for technologies-to-come which should be able to address several potential future markets. Such activities were already observed inside individual firms, but not at the industry-wide level : Previous studies ([Schaller 2004]; [Cogez, et al. 2010]) showed how semiconductor actors organized themselves in a “college of the unknown” [Le Masson, et al. 2012] in order to help sustain Moore’s law, a design brief which bore value for the whole industry. Moore’s law, however, predated the collective organization [Tierney, et al. 2013], and actually was the basis for such collective organization, since it allowed companies to share and support a common technology development vision without disclosing their product strategy, given the unique characteristics of the transistor, as argued in paragraph 2.2. So, one could expect that the decrease of the number of companies able to sustain Moore’s law would lead to a disaggregation of this collective effort. In this paper we show, on the contrary, that his “college of the unknown” attempts to capitalize on the competences that it developed on roadmapping activities to go one step further : we witness a collective effort to generate a new, additional shared body of expectations which would enable further collaboration.

Past history offers us examples of such colleges acting as architects of industrial sectors in the past, such as the Lunar Society [Schofield 1957], or the Franklin Institute [Sinclair 1974]. One could have thought that the contemporary firms were large enough to organize their ecosystems by themselves, and research has focused on the innovation leader (“focal firm”) who makes use of external resources for his own goals ([Elmqvist, et al. 2009]). We found that there is still room for collective agencies to animate the ecosystems and uncover unknown common purposes. This is of particular relevance for many of today’s societal challenges, for which highly expected innovations are not coming to fruition by the mere play of market forces, thus prompting public authorities to set up instruments to speed up the innovation process ([Agogu , et al. 2012]). What forms can these collective agencies take, which methods and tools can they use, what is their governance, how do they gain legitimacy? This deserves extensive further research.

Acknowledgements

The authors would like to thank the IRC team, and in particular Mart Graef, Bert Huizing, and Reinhard Mahnkopf for the rich discussions and actions regarding the roadmap evolution, and the reviewers for their very relevant and constructive inputs.

References

- Agogu , M., Le Masson, P., & Robinson, D. K. R. (2012) Orphan Innovation, or when path-creation goes stale: missing entrepreneurs or missing innovation? *Technology Analysis & Strategic Management*, April 2012 (to be published).
- Albright, R. E., and Kappel, T. A. (2003) Roadmapping the corporation. *Research Technology Management*, 46, (2), pp. 31
- Arden, W., Brillou t, M., Cogez, P., Huizing, B. and Mahnkopf, R. (2010). “More than Moore white paper”, ITRS public web site, <http://www.itrs.net>
- Arthur, W. Brian (1989) Competing technologies, increasing return and lock-in by historical events. *the Economic Journal*, 99, 116 – 131.
- Baumol, W. J. (1992) Horizontal Collusion and Innovation. *the Economic Journal*, 102, (410), pp. 129-137
- Baldwin, Y. C., Clark B. K. (2006) Modularity in the design of complex engineering systems. Book chapter in *Complex Engineering systems: Science meets technology*. In: Ali Minai, D. B. a. Y. B. Y. (ed.) *New England Complex System Institute Series on Com-plexity*. New York: Springer-Verlag.

- Ben-Haim, Y. (2001) Information-gap decision theory: decisions under severe uncertainty, Academic Pr.
- Bresnahan T. and M. Trajtenberg (1995) General purpose technologies : Engines of growth, *Journal of Econometrics*, 60 : 83-108
- Chapman, C. & Ward, S. (2003) *Project risk management: processes, techniques and insights*, Wiley.
- Cogez, P., Le Masson, P. and Weil, B. (2010) The management of a new common goods for collective growth in ecosystems: roadmapping for disruptive innovation in semiconductor industry. Conference proceedings, IPDM 2010, Murcia, Spain.
- Cortat, A. (2009) How cartels stimulate innovation and R&D: Swiss cable firms, innovation and the cartel question. *Business History*, 51, (5), pp. 754-769
- Cowan R. and Hulten S. (1996) Escaping Lock-In: The Case of the Electric Vehicle. *Technological Forecasting and Social Change*, Volume 53, Number 1, September 1996 , pp. 61-79(19)
- De Meyer, A., Loch, H. C., Pitch, T. M. (2002) Managing project uncertainty: From Variation to Chaos. *MIT Sloan Management Review*, 43, 60-67.
- Eisenhardt, K. M. (1989) Building Theories from Case Study Research. *Academy of Management Review*, 14, (4), pp. 532-550.
- Elmquist, M., Fredberg, T. & Ollila, S., (2009) Exploring the field of open innovation: a review of research publications and expert opinions. *European Journal of Innovation Management*, 12(3), pp. 326-345.
- Gawer, A. (2009) *Platforms, Markets and Innovation*, Edward Elgar Publishing.
- Gawer, A. (2010) The organization of technological platforms. In: Nelson Phillips, G. S., Dorothy Griffiths (ed.) *Technology and Organization: Essays in Honour of Joan Woodward in Research in the Sociology of Organizations*. Emerald Group Publishing Limited.
- Groenveld, P. (1997) Roadmapping integrates business and technology, *Research and Technology Management*, vol. 40, no. 5, pp. 48–55, Sept.–Oct. 1997.
- ITRS. (2005) *International Technology Roadmap for Semiconductors 2005 Edition*.
- ITRS. (2011) *International Technology Roadmap for Semiconductors 2011 Edition*.
- Jaafari, A. (2001) Management of risks, uncertainties and opportunities on projects: time for a fundamental shift. *International journal of project management*, 19, 89-101.
- Knight, F. H. (1921) *Risk, uncertainty and profit*. New York: Hart, Schaffner and Marx.
- Kokshagina O., Le masson P., Weil B., Cogez P. (2012a) Risk Management Strategies in Double Unknown: Understanding the Role of Common Unknown. The conference proceedings, IPDM 2012, Manchester, UK
- Kokshagina O., Le masson P., Weil B., Cogez P. (2012b), Platform emergence in double unknown (technology, market): Common challenge strategy. R&D Management Conference, Grenoble, 2012
- Krishnan, V. & Bhattacharya, S. (2002) Technology selection and commitment in new product development: The role of uncertainty and design flexibility. *Management Science*, 48, 313-327.
- Le Masson, P., Weil, B., Hatchuel, A., Cogez, P. (2012) Why are they not locked in waiting games? Unlocking rules and the ecology of concepts in the semiconductor industry. *Technology Analysis and Strategic Management*, 24 (6) : 617-630(14)
- Lenfle, S. (2011) The strategy of pallel approaches in projects with unforeseeable uncertainty: The Manhattan case in retrospect. *International Journal of Project Management*, 29, 359 – 373.
- Loch, C. H., Solt, M. E. & Bailey, E. M. (2008) Diagnosing Unforeseeable Uncertainty in a New Venture. *Journal of Product Innovation Management*, 25, 28-46.
- Loch, C. L., De Meyer, A. And Pitch, M. T. (2006) *Managing the unknown: A new approach to managing high uncertainty in projects*, New York: Wiley.
- Maine, E. Garsney E. (2006) Commercializing generic technology : The case of advanced material ventures. *Research Policy* 35(3): 375-393
- Mcgrath, R. G. (2001) Exploratory learning, innovative capacity, and managerial oversight *Academy of Management Journal*, 44, 118-131.
- Mcgrath, R. G. & Macmillan, I. C. (2009) *Discovery-driven growth: A breakthrough process to reduce risk and seize opportunity*, Harvard Business Press.
- Memorandum of Understanding with Respect to the International Technology Roadmap for Semiconductors, signed July 10, 2000.
- Moore, G.E. (1965) Cramming more Components onto Integrated Circuits, *Electronics*, 38 (8). reproduced in *Proc. IEEE*, 86, 82 (1998).

- Mullins, J. W. (2007) Discovering “unk-unks”. MIT Sloan Management Review, 48, 17-21.
- O'Connor, C. G. (2006) Organizing for Radical Innovation: An Exploratory Study of the Structural Aspect of RI Management Systems in Large Established Firms. *The Journal of Product Innovation Management*, 23, 475-497.
- O'Connor, C. G., Ravichandran T., Robenson, D. (2008) Risk management through learning: Management practices for radical innovation success. *Journal of High Technology Management Research*, 19, 70-82.
- Pasquier, H. (2008) Acteurs, stratégies et lieux de 'recherche et développement' dans l'industrie horlogère suisse, 1900-1970. *Entreprises et histoire*, 52, pp. 76-84.
- Petit, M. L., and Tolwinski, B. (1997) Technology sharing cartels and industrial structure. *International Journal of Industrial Organization*, 15, (1), pp. 77-101.
- Phaal, R., Farrukh, C. J. P., and Probert, D. (2004) Technology roadmapping - A planning framework for evolution and revolution. *Technological Forecasting and Social Change*, 71, pp. 5-26
- Pich, M. T., Loch, C. H. & De Meyer, A. (2002) On uncertainty, ambiguity, and complexity in project management. *Management Science*, 48, 1008-1023.
- Sanchez, R. (2004) Creating modular platforms for strategic flexibility. *Design Management Review*, 15, 58-67.
- Schaller, R. R. (2004) Technological Innovation in the Semiconductor Industry: A Case Study of the International Roadmap for Semiconductors (ITRS). Thesis, George Mason University, Fairfax, VA. 861 p
- Schofield, R.E. (1957) *The lunar society of birmingham, a social history of provincial science and industry in eighteenth-century England*. Oxford: Clarendon Press.
- Siggelkow. (2007) Persuasion with case studies. *Academy of Management Journal*, 50, (1), pp. 20-24.
- Sinclair, B. (1974) *Philadelphia's philosopher mechanics - a history of the Franklin Institute 1824-1865*. Baltimore: The Johns Hopkins University Press
- Tierney, R., Hermina, W. and Walsh, S. (2013). The pharmaceutical technology landscape: a new form of technology roadmapping. *Technological forecasting and Social Change*, 80, pp. 194-211.
- Van De Ven, A. H. & Polley, D. (1992) Learning while innovating. *Organization Science*, 3, 92-116.
- Van De Ven, A. H., Polley, D. E., Garud, R. & Venkataraman, S. (1999) *The innovation journey*, Oxford University Press, USA.
- Whalen, P. J. (2007) Strategic and technology planning on a roadmapping foundation. *Research and Technology Management*, 50, (3), pp. 40-51
- Willyard C. H. and McClees C. W. (1987) Motorola's technology roadmap process. *Research Management*., pp. 13-19, Sept.-Oct. 1987.
- Yin, R. K. (2003), *Case Study Research: Design and Methods*., 3rd, Applied Social Research Methods Series, Volume 5, L. Bickman et D. J. Rog, Sage, Thousand Oaks.

Gestion de risque en situation de double inconnu: théorie, modèle et organisation pour la conception de technologies génériques

RESUME : Comment assurer un développement à risques limités alors que marchés et technologies sont inconnus? Ces situations ne peuvent pas être gérées par les stratégies existantes comme *market pull* ou *techno push*; et le processus type « *trial and learning* » apparaît trop coûteux et imprévisible. Or certaines industries comme les semi-conducteurs doivent organiser des développements technologiques à coûts et risques contrôlés, alors que les inconnues techniques et commerciales sont très importantes. Dans ces situations le succès coïncide avec l'existence des technologies génériques. Mais comment concevoir ces technologies génériques ? La thèse modélise la conception des technologies génériques et étudie des modèles d'action collective associés.

Ce travail débouche sur quatre résultats principaux : 1) Une stratégie de gestion du risque original, consistant à identifier un « *common unknown* » ; 2) Un travail de modélisation et de simulation précisant les critères de contingence de cette nouvelle stratégie; 3) La caractérisation de concepts génériques et de processus de conception de genericité à l'aide des théories de la conception les plus récentes; 4) Une nouvelle figure managériale, le « *cross-application manager* », indispensable pour le succès de la conception de technologies génériques.

Mots clés : technologie générique, gestion de risque, double inconnu, théories de la conception, semi-conducteurs, management de l'innovation

Risk Management in double unknown : Theory, Model and Organization for the design of Generic Technologies

ABSTRACT : Can a company organize development with controlled risk while promising markets and eligible technologies are yet unknown? These situations cannot be handled with classical techno push or market pull strategies; and "trial and learning" processes are too unpredictable and too costly while facing with unknowns in high-tech. However, in some industries such as semiconductors, one has to organize exploration while controlling costs and risks in double unknown. In this situation the success of technological development in double unknown is correlated with the existence of generic technologies. Though, it remains unclear how to account for the design of generic technologies. This thesis models the design of generic technologies and investigates the associated models of collective action.

This work is based on four main results: 1) an original model of risk management that consists of identifying "common unknown" for several potential applications; 2) the modeling and simulation defining the techno-economic conditions in which the introduced "common unknown" strategy is relevant; 3) The characterization of the notion of generic technological concepts and the process of genericity design built upon the most recent design theory formalisms ; 4) a new managerial figure, the « *cross-application manager* », essential for the success of generic technologies design.

Keywords : generic technology, risk management, double unknown, design theories, semiconductors, innovation management