



HAL
open science

**Sustaining the supply of multiple ecosystem services :
An analysis based on the simulation of the joint
production of wood and non-wood goods in forests**

Nicolas Robert

► **To cite this version:**

Nicolas Robert. Sustaining the supply of multiple ecosystem services: An analysis based on the simulation of the joint production of wood and non-wood goods in forests. *Silviculture, forestry*. AgroParisTech, 2013. English. NNT: 2013AGPT0005 . pastel-01058410

HAL Id: pastel-01058410

<https://pastel.hal.science/pastel-01058410v1>

Submitted on 26 Aug 2014

HAL is a multi-disciplinary open access archive for the deposit and dissemination of scientific research documents, whether they are published or not. The documents may come from teaching and research institutions in France or abroad, or from public or private research centers.

L'archive ouverte pluridisciplinaire **HAL**, est destinée au dépôt et à la diffusion de documents scientifiques de niveau recherche, publiés ou non, émanant des établissements d'enseignement et de recherche français ou étrangers, des laboratoires publics ou privés.



Doctorat ParisTech

THÈSE

pour obtenir le grade de docteur délivré par

**L'Institut des Sciences et Industries
du Vivant et de l'Environnement**

(AgroParisTech)

Spécialité : Sciences Économiques

présentée et soutenue publiquement par

Nicolas ROBERT

le 22 janvier 2013

Vers une production durable de multiples services écosystémiques

—

**Analyse par la simulation de la production jointe
de bois et de non-bois en forêt**

Directrice de thèse : **Anne STENGER**

Jury

M. Bo JELLESMARK THORSEN , Professeur, Département forêt et paysage, Université de Copenhague (DK)	Rapporteur
M. Daowei ZHANG , Professeur, École des sciences forestières et de la nature, Université d'Auburn (US)	Rapporteur
M. Jean-Philippe BOUSSEMARY , Professeur, Université Charles de Gaulle – Lille 3 et IESEG (FR)	Président
Mme Annemarie BASTRUP-BIRK , Dr., Agence européenne de l'Environnement (DK)	Examinateur
M. Thomas KNOKE , Professeur, Centre des sciences de la vie et de l'alimentation de Weihenstephan, Université technique de Munich (DE)	Examinateur
M. Claude VIDAL , Directeur général adjoint chargé des affaires forestières, IGN (FR)	Examinateur
Mme Anne STENGER , Directrice de recherche, LEF, INRA – AgroParisTech (FR)	Directrice de thèse



Sustaining the supply of multiple ecosystem services

An analysis based on the simulation of the joint
production of wood and non-wood goods in forests

v1.1

—
Nicolas ROBERT*

January 22, 2013

*French National Institute of Geographic and Forest Information (IGN) and Laboratory of Forest Economics (AgroParisTech and INRA)

Foreword

This work results from cooperation between the French National Forest Inventory (now the French National Institute of Geography and Forest Information) and the INRA-AgroParisTech Laboratory of Forest Economics from 2008 to 2011.

The technical development was part of the contribution of the National Forest Inventory to the *Forgeco* project founded by the Systerra research program of the French National Research Agency. The objective of this project is to design tools for integrated and sustainable forest management at the landscape scale.

Analyzing the impact of payments for environmental services in the forestry sector requires bio-technical and economic tools to characterize the joint production of goods and environmental services. This thesis provides elements to address some of the scientific questions raised in the European Collaborative Project *Newforex* (New Ways to Value and Market Forest Externalities).

Acknowledgements

I would like to express my gratitude to my supervisor, Anne Stenger, Head of the Laboratory of Forest Economics, INRA-AgroParisTech until December 2012. She proposed that I discover and investigate this very rich topic. Her understanding, encouragement and personal guidance provided a solid basis for the present thesis.

I warmly thank Franck Lecocq, Head of the International Research Center on the Environment and Development (CIRED), for his strong support in the theoretical development of the economic model.

My sincere thanks to the members of the thesis committee, and in particular to Jean-Philippe Boussemart for his invitation to present my work to his team in Lille. They gave me important feedback that helped me go on with my work.

I would like to thank Claude Vidal, Director of the National Forest Inventory (IFN) until 2011, who gave me the opportunity to work on this thesis and who accepted to sit on the jury. I am grateful to Jean-Marc Frémont, Head of the Department of Studies at IFN until 2011 and to my colleagues from the former IFN, especially Antoine Colin, for their wholehearted support.

This work would not have been possible without the forest growth simulator Fagacées developed by the Forest and Wood Resources Laboratory, INRA-AgroParisTech and the exchanges I had with Jean-François Dhôte, Jean-Michel Leban, Frédéric Mothe and Gilles Le Moguédec during my stay in this lab in 2007 and 2008.

I am thankful to my colleagues from the Lab of Forest Economics and in particular to Éric Nazindigouba Kéré and Sylvain Caurla for the – sometimes endless – discussions we had. These discussions helped me out of the dark side of thesis writing.

Finally, I thank my parents and friends who supported me throughout these four years.

Offre de multiples services écosystémiques – Analyse à l’aide de simulations de la production jointe de bois et de non-bois en forêt.

Résumé

Les écosystèmes produisent de nombreux biens et services contribuant au bien-être des sociétés. Cependant, l’utilisation intensive des ressources naturelles a compromis le fonctionnement de certains de ces écosystèmes ainsi que les services qu’ils rendent. La dégradation de certains services tels que le climat et la biodiversité a entraîné une prise de conscience de leur rôle dans le fonctionnement des sociétés ainsi qu’une croissance de la valeur qui leur est accordée. Pour contrecarrer la dégradation des services rendus par les écosystèmes, des mécanismes de rémunération de leur production ont été mis en place tels que le marché européen du carbone ou les obligations de compensation lorsque des ouvrages ou infrastructures dégradent la biodiversité. Toutefois, lorsque les mécanismes mis en œuvre ne concernent qu’un seul service, ils peuvent avoir des effets, positifs ou négatifs, sur la fourniture d’autres services produits conjointement. Afin d’éviter les effets indésirables, tels que la destruction d’un service pour en produire un autre, ou des inefficacités comme le double-paiement d’une même activité, il est nécessaire de mieux connaître les relations entre les productions des écosystèmes. Par cette thèse, nous contribuons à l’identification de ces relations entre produits et services en développant une approche par la simulation de la production jointe de bois et de non-bois en forêt.

Dans une première partie, nous identifions les enjeux concernant la production de services environnementaux et nous définissons une méthode d’analyse. Les forêts sont des exemples d’écosystèmes multifonctionnels : elles produisent des biens, comme le bois, et fournissent de nombreux services. Par exemple, elles participent à la régulation du climat, à la préservation de la biodiversité et sont des lieux de récréation si bien qu’elles occupent une place importante dans les engagements environnementaux internationaux tels que le protocole de Kyoto et la convention des Nations Unies sur la biodiversité. La signature de ces accords ainsi que les engagements pour une gestion forestière durable (Forest Europe, Processus de Montréal) au cours des dernières décennies illustrent la préoccupation croissante des sociétés pour assurer une production durable de services environnementaux en forêt. Par ailleurs, la littérature montre que les propriétaires privés prêtent attention non seulement à la production de bois, mais aussi à l’esthétique et à la valeur patrimoniale de leur forêt (Joshi and Arano, 2009; SCEES, 2002; Kurttila et al., 2001), tendance qui s’observe partout dans le monde (les paiements pour services environnementaux étant à plus de 80 % observés dans les écosystèmes forestiers, voir Wunder et al., 2008). L’analyse des relations entre les différents produits et services rendus par les forêts permet d’identifier a) si les besoins des sociétés sont compatibles avec les objectifs des propriétaires privés et, en cas de divergence, b) de savoir si des incitations permettraient de concilier objectifs publics et privés. Nous développons un cadre d’analyse dont le socle est constitué par une enveloppe des possibilités de profits déterminée à l’échelle de l’unité de production. Nous démontrons d’un point de vue théorique que l’analyse par les frontières de profit prenant les produits deux à deux n’est pas suffisante pour évaluer la pertinence des mécanismes d’incitation. Les différents produits et services doivent être caractérisés simultanément afin d’évaluer les synergies et antagonismes qui peuvent générer des

surcoûts lors de la production simultanée. Par une analyse multidimensionnelle (à plus de deux biens), les coûts d'opportunité monétaires et non-monétaires (liés à la réduction d'un service sans valeur monétaire) de l'accroissement de la fourniture d'un service peuvent être estimés. Ainsi, en fonction des marchés existant pour certains services et de la forme de l'enveloppe des possibilités de profit, nous montrons qu'il peut être préférable d'offrir les services soit avec un paiement séparé pour chacun d'eux, soit avec un paiement joint et unique pour les deux biens. Pour appliquer notre cadre d'analyse à la forêt dont la production s'échelonne sur de longues périodes, nous définissons une méthode qui permet d'estimer l'ensemble des possibilités de production de services environnementaux et le profit maximum correspondant puis nous définissons l'enveloppe de cet ensemble.

Dans une seconde partie, nous appliquons les méthodes proposées pour analyser la production de multiples services dans des futaies de chêne sessile du centre de la France. Nous identifions des moyens d'évaluer le profit tiré de la production de bois, le stockage de carbone, l'attractivité des forêts pour les activités récréatives et la protection de la diversité des oiseaux. La période de rotation des chênaies est longue et varie suivant les itinéraires de gestion. Pour comparer ces itinéraires, nous calculons soit la valeur moyenne des services rendus au cours de la rotation, soit la valeur présente nette des produits et services au moment de la régénération, phase initiale de la sylviculture, à partir de laquelle tous les choix sont possibles. Nous déterminons l'enveloppe de l'ensemble des possibilités de production à l'aide du modèle de croissance et production *Fagacées* (Le Moguédec and Dhôte, 2012). Les résultats montrent que la production moyenne des trois services (carbone, récréation et biodiversité) ainsi que la valeur moyenne annuelle issue de la production de bois sont compatibles sur la majeure partie de l'ensemble des possibilités de production. Cependant, si l'objectif est de maximiser l'un des services, les progrès possibles sont faibles. De plus, des arbitrages sont nécessaires et le coût monétaire et non-monétaire de l'accroissement d'une unité de ce service est élevé. En considérant la valeur actualisée nette des produits et services, les arbitrages sont importants sur l'ensemble des productions possibles et des interactions entre les produits apparaissent. Obtenir à moindre coût une plus grande diversité des oiseaux que celle observée pour le scénario maximisant la production, nécessite de réduire simultanément la valeur actuelle nette du stockage de carbone et celle de l'attractivité pour la récréation. D'un autre côté, augmenter le stock de carbone par rapport au scénario maximisant le profit aura un plus faible coût d'opportunité monétaire si l'attractivité pour la récréation est augmentée simultanément et que la biodiversité est réduite. Les propriétaires, s'ils sont intéressés par la récréation, peuvent accepter des incitations inférieures au coût d'opportunité monétaire de cet accroissement du carbone. Dans les forêts peu fertiles, les ensembles des possibilités de productions ont des formes similaires, mais sont réduits. Cependant, la réduction n'est pas identique dans toutes les dimensions, si bien que les coûts d'opportunité de la fonction récréative et, dans une moindre mesure, du stockage de carbone sont plus faibles dans ces forêts. À l'échelle d'un massif forestier, une gestion optimale voudrait par conséquent que les parcelles gérées pour la récréation soient les moins productives. En ouverture, nous proposons des pistes pour passer de l'échelle du peuplement à celle du massif pour déterminer comment produire au mieux les différents services publics fournis par les forêts, propriétés de nombreux propriétaires privés. Enfin, bien que l'exemple d'application choisi concerne la forêt, nous observons que le cadre d'analyse que nous proposons pourrait être appliqué à d'autres secteurs, non seulement celui de l'agriculture mais aussi ceux de l'énergie et de l'industrie.

Sustaining the supply of multiple ecosystem services – An analysis based on the simulation of the joint production of wood and non-wood goods in forests.

Abstract

Ecosystems provide numerous goods and services to human beings. However, the intensive use of natural resources has impacted the functioning of ecosystems and reduced their production capacities. In this context, societies and individuals are giving increasing importance to environmental services (ES). To capture the values of ESs and to ensure their sustainable provision, payment mechanisms to offset the reduction in ES provision have been elaborated. These include projects such as REDD+, the European carbon market or national rules concerning compensation for biodiversity losses. Due to the jointness in ES production, single purpose offset mechanisms can either threaten or create opportunities to increase other services which do not have an explicit monetary value. To be effective, managers and decision makers need detailed information on the links between ESs. To increase the knowledge of the simultaneous production of multiple ESs, this thesis proposes a methodology based on simulations of the joint production of wood and non-wood goods in forests. Estimations of opportunity costs derived from the analysis provide information on ES gains and losses when forest owners are asked to increase one service.

Forests offer examples of multi-output production processes which provide many different ESs. Forests supply not only goods such as wood and game, but also services. For example, they contribute to climate regulation, biodiversity preservation and protection from natural hazards. Current international commitments (e.g. the Kyoto Protocol and the Convention on Biodiversity) highlight the increasing social demand for ESs such as global change mitigation and biodiversity protection. On the other hand, the literature shows that most forest landowners are household producers: they express interest in promoting wood production and aesthetic or patrimonial values (Joshi and Arano, 2009; SCEES, 2002; Kurttila et al., 2001). Analyzing the relations between the different outputs should help us determine if pursuing social goals in private forests is possible and which incentive mechanisms or regulations could close the gap between social and private objectives. We have therefore developed an analytical framework based on profit possibility frontiers at the level of the production unit. We demonstrate that hypotheses based on the paired complementarity between ESs are not sufficient to draw conclusions concerning the suitability of a payment mechanism. An integrated analysis – simultaneously exploring all ESs – is required. We can then derive an estimate of the monetary and non-monetary opportunity costs of increasing the provision of one service. With existing ES markets in mind, we highlight which of two alternatives would be most appropriate: bundling or stacking payment for ESs. To apply this framework to complex long-lasting production processes such as those found in forestry, we have elaborated a method to determine the profit possibility set through multiple management simulations.

In the second part of this thesis, we apply the framework to the analysis of a multipurpose oak forest management strategy. We identify ways to estimate wood production and carbon sequestration using volume functions. For complex services such as recreation and the preservation of bird species biodiversity, we calibrate specific indicators. Because the duration of a forest cycle is long, we use time aggregation techniques, averaging or discounting the

production level over the whole cycle. Then, we determine the production possibility set and derive the profit possibility frontier with a sessile oak (*Quercus petraea*) growth and yield simulator called *Fagacées* (Le Moguédec and Dhôte, 2012). On the one hand, when productions are averaged, they are complement over almost the whole range of the production possibility set. There are high opportunity costs in the limited part of the set where there are tradeoffs. On the other hand, when productions are discounted, there are high tradeoffs between productions. We note in particular that, compared to a scenario which maximizes profit, increasing the biodiversity indicator is least costly if both carbon storage and recreation are reduced. Moreover, increasing the recreation function is least costly if carbon storage is simultaneously increased but biodiversity is reduced. We show that on stands with a lower site index – stands where trees grow slower due to site characteristics – the relation between outputs are similar, but the opportunity costs of providing recreation and, to a lesser extent, carbon storage are reduced; however, the opportunity cost of providing biodiversity increases. Owners of low site index stands may therefore be more sensitive to measures in favor of recreation than biodiversity. At the landscape level, the optimum provision of multiple ESs might be obtained through a spatial differentiation of management goals based on the site indices of the stands. Finally, we propose ways to take into account the current development status of the forest and to upscale the study from the stand scale – i.e. the production unit – to the landscape scale. We note that the analytical framework could be applied to other processes in agriculture and even in the energy or industrial sectors.

Bibliography

- Joshi, S. and Arano, K. G. (2009). Determinants of private forest management decisions: A study on West Virginia NIPF landowners. *Forest Policy and Economics*, 11(2):118–125.
- Kurttila, M., Hamalainen, K., Kajanus, M., and Pesonen, M. (2001). Non-industrial private forest owners' attitudes towards the operational environment of forestry - a multinomial logit model analysis. *Forest Policy and Economics*, 2(1):13–28.
- Le Moguédec, G. and Dhôte, J.-F. (2012). Fagacées: a tree-centered growth and yield model for sessile oak (*Quercus petraea* l.) and common beech (*Fagus sylvatica* l.). *Annals of Forest Science*, 69(2):257–269.
- SCEES (2002). Structure de la propriété forestière privée en 1999. *Agreste – Chiffres et Données – Agriculture*, 144. Direction des affaires financières, Service Central des Enquêtes et Études Statistiques, Ministère de l'Agriculture et de la Pêche. 94 p.
- Wunder, S., Engel, S., and Pagiola, S. (2008). Taking stock: A comparative analysis of payments for environmental services programs in developed and developing countries. *Ecological Economics*, 65(4):834–852.

Contents

I	Questions and methodology	17
1	Increasing stakes of the supply of environmental services	19
1.1	ES: private and social interests	20
1.1.1	Private and public goods	20
1.1.2	Production and externalities	21
1.1.3	Joint production: the core of the problem of ES undersupply	22
1.1.4	Environmental and ecosystem services	23
1.2	Private forestry: a typical multi-output process with externalities	24
1.2.1	Forest ecosystems produce wood and amenities	25
1.2.2	Varied production objectives of forest owners	26
1.3	Identification of the demand for environmental services	28
1.3.1	International environmental commitments and social needs	29
1.3.2	Forestry's special place in environmental commitments	30
1.3.3	Public demand for forest environmental services in France	31
1.4	Supply of environmental services in private forests	33
1.4.1	Household producers	33
1.4.2	Survey of French forest owners' expectations	34
1.4.3	Intentions to produce wood and non-wood services	36
1.5	Defining appropriate policies	38
1.5.1	Public environmental policies	38
1.5.2	Converting externalities into privately valuable products	39
2	Payment for environmental services in multi-output production processes	45
2.1	Possible costs of environmental services (ES)	45
2.1.1	Valuing ESs	46
2.1.2	The marginal costs: A technical estimate of ES value	46

2.2	Opportunity costs of ES provision: an analytical approach	48
2.2.1	Single ES transformation function	48
2.2.2	Double ES transformation function	51
2.2.3	Envelope of the maximum profit possibilities	52
2.2.4	Impact of the joint ES production on the opportunity cost of a single ES provision	52
2.3	Joint ES production and the maximum profit equation	53
2.3.1	Relationship between outputs is a key factor	53
2.3.2	When ESs have independent opportunity costs	56
2.3.3	When there is a synergy in ES provision	56
2.3.4	When ESs conflict	57
2.3.5	Characteristics of the profit function in the boundary of the ES set	61
2.4	Impact of PES designs on multiple ES provision	64
2.4.1	Underlying hypotheses	64
2.4.2	Payment for a single service	65
2.4.3	Bundling or stacking PES?	67
2.4.4	PES portfolio strategies	69
3	ES production possibilities and costs	75
3.1	Variation in the profit function with ES supply	76
3.1.1	From production possibility sets to profit functions	76
3.1.2	Particularities of ES provision by ecosystems	77
3.1.3	Determining the production possibility set using surveys	78
3.1.4	Modeling as a surrogate for surveys	79
3.2	PPS envelopment	82
3.2.1	Parametric modeling	82
3.2.2	Non-parametrical methods	83
3.3	Enveloping a non-convex production set with weakly disposable outputs	93
II	Application to high oak forests	101
4	Estimating ecosystem production	105
4.1	Estimation of directly measurable outputs	106
4.1.1	Wood volume and stumpage value	106

4.1.2	Global change mitigation	109
4.2	Estimation of ES provision using indicators	114
4.2.1	A scenic beauty indicator to estimate the recreation function	114
4.2.2	Evaluating the contribution of a stand to biodiversity	119
4.3	Comparing production when rotation periods differ	126
4.3.1	Average profits and service provision	126
4.3.2	Discounted quantities	128
5	Modeling stand level profit possibilities	137
5.1	Modeling multipurpose high oak forest management	137
5.1.1	Forest management: an interaction between man and nature	137
5.1.2	Growth and yield simulation with <i>Fagacées</i>	139
5.1.3	Simulation of multipurpose forest management	141
5.2	Calculating the profit possibility frontier	143
5.2.1	Relations between management practices and outputs: exploring the PPS	144
5.2.2	Stability of the estimations using the model	146
5.3	Synergies and tradeoffs in the production of ecosystem services	148
5.3.1	Impossibility to define an optimum scenario for all outputs	148
5.3.2	Envelope of the multiple production set and tradeoff analysis	150
5.4	Sensitivity analysis	156
5.4.1	Increasing the discount rate shrinks the PPS	156
5.4.2	Suppressing the ES relative value variation factor increases the opportunity costs	157
5.4.3	Increasing fuel wood price would not alter the optimum decisions	159
5.4.4	Low site index forests more suitable for recreation	162
5.4.5	Limits of the simulation approach	162
5.5	Conclusion	165
6	Conclusions	169
6.1	Contribution to understanding multipurpose forest management	169
6.1.1	An original stand level multipurpose analysis	170
6.1.2	Integrated analysis of multipurpose forest management	170
6.1.3	Difficulties and solutions to estimate ES provision in the long run	172
6.2	Implications for decision makers	174

6.2.1	Preservation and restoration of environmental services: between markets and regulation	175
6.2.2	Recommendations	175
6.2.3	Payment as an incentive to forest owners for ES provision?	177
6.3	Extension of the modeling approach	178
6.3.1	Modeling the Production Possibility Set envelope at various stages . . .	178
6.3.2	Production possibility sets and uncertainties	180
6.3.3	From the stand to the landscape scale	181
6.4	Conclusion	182
Appendix		191
A Forest Europe criteria and indicators		191
B Forest owner survey questionnaire		193
C R scripts		205
C.1	Script calculating the discounted value of services and gathering simulation results	205
C.2	Script to determine and display the envelope of the PPS	209
Glossary		213

Introduction

Ecosystems provide numerous goods to human beings. Since the development of agriculture and forestry, many ecosystems have been managed and transformed to provide more goods corresponding to identified needs: food, fuel wood, building material... Huge forests were converted to agriculture or artificialized to increase the utility of the land for the development of humanity. Most management practices have aimed at maximizing the production of identified products and services originating from ecosystems. Because of limited knowledge of the interactions between outputs and of the benefits resulting from some unvalued services, these practices are not necessarily optimal in the long run. For example, intensive harvesting to produce timber and fuel wood destroys forests. The positive roles of the environmental services provided by these forests do not appear until these services have almost vanished. If it is too late to react and restore the ecosystems, the wealth and even society itself can suffer from the loss (see for example the case of Easter Island in Diamond, 2012). The land produces many goods and services. Its management, and in particular forest management, is a multi-purpose process which requires a multi-dimensional understanding (in the sense of taking many goods and services together at the same time) to ensure sustainable benefits.

Many environmental services are public goods, such as biodiversity and carbon storage. Other services, such as recreation and hunting, can be considered to be public, club or private depending on accessibility to the service. Goods such as wood or crops are private goods. Most private owners manage their land to produce private goods, and sometimes public goods that they value for their own personal use. For example, a forest owner can have two objectives: profit related to wood harvesting and personal recreation. However, these objectives may not be compatible with social expectations. Dead wood lying on the ground is not convenient for recreation (Lindhagen and Hornsten, 2000), but it helps protect biodiversity (Hagan and Grove, 1999; Bouget et al., 2009). Private and public interests consequently diverge. To induce private producers to supply public services, policy makers can use market-based instruments and regulations. Rules which allow producers that harm environmental services to pay service providers to offset the harm is one such possibility. For example, the carbon cap and trade system promotes production of cleaner energy (Limpitoot et al., 2011) and land owners can be paid to sequester carbon in forests (Murray, 2003).

The payment should offset the loss of revenue resulting from a decrease in production in order to offer the additional service. This seems suitable in a first approach, but such a change in management can affect other services. The effect can be positive. For example, Venter et al. (2009) show that carbon payments could help protect biodiversity. However, in the previously mentioned case, recreation and biodiversity are substitutes. If the forest owner is asked to better preserve biodiversity, she might consider that the offered monetary

compensation – calculated as the reduction in profit plus transaction cost – is not high enough to compensate for all her losses (including recreation). Therefore, she may not react to such incentives. Suppose that an increase in one public environmental service can be achieved at a lower opportunity cost when a second environmental service is reduced than when the second service is maintained at its original level of provision. In this case, a payment mechanism established to enhance the first service will most likely be detrimental to the second service. To avoid such side effects, the regulation of the market must take into account the multiple dimensions of the production processes.

Would payment be an appropriate means to ensure a sustainable provision of environmental services in forests? The goal of this thesis is to tackle this issue to help decision makers design appropriate policies. Therefore, we explore many sub-questions. Are there tradeoffs between products and services that benefit both the forest owner and the environmental services provided by forests to society? Would private forest owners offer more environmental services if they were paid? Is the monetary opportunity cost a suitable estimate of the amount of compensation to pay forest owners if they value non-marketed environmental services?

When several public environmental services are simultaneously provided and could be subject to payment or regulations, complementary questions are raised. Would the payment for one environmental service affect the provision of other environmental services? If a forest owner can be paid for the provision of several services simultaneously, should she be allowed to ask for two separate payments (stacking payments)? Would it be preferable to ask her to sell the services as a bundle? Finally, would it be less costly to specialize forest management at the landscape scale, or to provide services uniformly in every forest of the landscape? To address these questions, we propose analyzing profit possibilities as did Montgomery (2002) and Boscolo and Vincent (2003). However, we have increased the number of dimensions to estimate the opportunity costs of the simultaneous provision of several joint environmental services. We describe the entire envelope of the profit possibility set to be able to evaluate the different constraints on service production. This multidimensional analysis offers new opportunities to characterize the interactions in the provision of forest goods and services. We illustrate our approach with a case study concerning the management of oak high forests to produce wood, to store carbon, to offer a good recreation experience and to protect biodiversity.

The thesis is divided into two parts of three chapters each. The first part introduces the context and presents the tools that we have developed to analyze the provision of environmental services. In the first chapter, we identify the stakes in the supply of ecosystem services by private forest owners. We highlight the need for tools to evaluate the multi-dimensional provision of environmental services. In the second chapter, we develop a theoretical approach to multi-output production systems and we establish an analysis framework. This framework is based on envelopes of profit possibilities. The theory shows that we need to estimate the entire envelope, and not only the frontier. The shape of the envelope, in particular convexities or non-convexities, provides information which helps us evaluate the impact of various policies. In the third chapter, we propose a non-parametric method to estimate such envelopes. Due to the long rotations in forestry, little information on effective production is available, but we show that growth and yield models can make up for this lack.

In the second part, we apply the methodology to the management of sessile oak high forests and draw conclusions concerning possible payments for environmental services. The approach requires estimating the ecosystem services and the profit. Chapter four presents the estimation of profits and carbon storage using information on the stand and on harvests. We also establish indicators for the attractiveness for recreation and for the preservation of bird species diversity. These indicators take on various non-monetary values during the forest rotation. We therefore propose comparing either the average value of the goods and services or their discounted value at the beginning of the rotation. Chapter five presents the envelopes of the profit possibilities simulated with the bio-technical model *Fagacées* (Le Moguédec and Dhôte, 2012). The results show that discounting in particular plays an important role in the estimation of the tradeoffs among productions. Finally, in chapter six, we elaborate on the possible uses of profit possibility envelopes by decision makers and propose answers to the aforementioned questions concerning payment for environmental services. We suggest expanding the study at the landscape scale to better understand the production of environmental services shared by numerous land owners.

Bibliography

- Boscolo, M. and Vincent, J. (2003). Nonconvexities in the production of timber, biodiversity, and carbon sequestration. *Journal of Environmental Economics and Management*, 46(2):251–268.
- Bouget, C., Brin, A., and Moreau, P. A. (2009). Dead wood and saproxylic biodiversity at different spatial scales. *RenDez-Vous Techniques*, 25/26.
- Diamond, J. (2012). Ecological lessons from past societies. In *EcoSummit 2012 - Ecological Sustainability – Restoring the Planet’s Ecosystem Services*. 30 Sept. - 5 Oct. 2012, Columbus, Ohio, USA. (see also Diamond, J. (2005). *Collapse: How Societies Choose to Fail or Succeed*. The Penguin Group. ISBN: 0-670-03337-5).
- Hagan, J. and Grove, S. (1999). Coarse woody debris. *Journal of Forestry*, 97(1):6–11.
- Le Moguédec, G. and Dhôte, J.-F. (2012). Fagacées: a tree-centered growth and yield model for sessile oak (*Quercus petraea* L.) and common beech (*Fagus sylvatica* L.). *Annals of Forest Science*, 69(2):257–269.
- Limpaitoon, T., Chen, Y., and Oren, S. (2011). The impact of carbon cap and trade regulation on congested electricity market equilibrium. *Journal of Regulatory Economics*, 40(3):237–260.
- Lindhagen, A. and Hornsten, L. (2000). Forest recreation in 1977 and 1997 in Sweden: changes in public preferences and behaviour. *Forestry*, 73(2):143–153.
- Montgomery, C. A. (2002). Compatibility of timber and conservation: Tracing the tradeoff frontier. In Johnson, A., Haynes, R., and Monserud, R., editors, *USDA Forest Service General Technical Report Pacific Northwest*, volume 563, pages 225–232, Portland. US Department of Agriculture, Forest Service Pacific Northwest Research Station.
- Murray, B. C. (2003). *Economics of Forest Carbon Sequestration*, volume 72 of *Forestry Sciences*, chapter 13, pages 221–241. Kluwer Academic Publisher. Sills, E. O. and Abt, K. L. (Ed.).
- Venter, O., Laurance, W. F., Iwamura, T., Wilson, K. A., Fuller, R. A., and Possingham, H. P. (2009). Harnessing carbon payments to protect biodiversity. *Science*, 326(5958):1368–1368.

Part I

Questions and methodology

Chapter 1

Increasing stakes of the supply of environmental services

Clean air, beautiful landscapes, regulated climatic conditions, protection of the soil, biodiversity and the presence of natural resources are some of the characteristics of the environment that directly or indirectly benefit human beings. Since the industrial revolution in the 18th and 19th centuries, the consumption of natural resources has dramatically increased. This economic growth has been based on an increase in monetary welfare mainly resulting from the exploitation of massive quantities of non-renewable resources. The creation of national income and product accounts (NIPA's) in the late 1930s and gross domestic product (GDP) in 1942 as tools to measure a country's economic status highlights the predominant function of finance at that time. Although the study of ecology started in the seventeenth century with scientists like Linnaeus or Buffon (Egerton, 2007), its contribution to the economy was not recognized before the second half of the twentieth century.

Environmental economics appeared in the 1970s and 1980s with a rise in concern for the environment. Environmentalists pointed out the impact of mass production on the environment and the fact that the degradation of the environment (e.g. water and air pollution) had detrimental effects on human health and well-being as well as on some production processes. Since then, several concepts have been developed to take environmental damage into account in the evaluation of production processes. However, firms continue to degrade the environment. This results from market failure (Randall, 1983). Political decisions can be taken to limit the destruction of the environment but this requires appropriate information concerning the relations between the economy and the provision of environmental services (ES).

The aim of this thesis is to contribute to a better understanding of the joint production of goods and ESs at the scale of the management unit. We therefore develop a theoretical model and a methodology which we apply to the management of high oak forests. In this chapter, we first introduce definitions of the main concepts, then we show that forestry is a relevant example of a multipurpose production process that can be used as a case study. Then we identify both public and private needs for goods and services that are provided by forests and highlight possible conflicts. We finally introduce that usual market based instruments used

by policy makers to reconcile both private and public objectives would gain efficiency if these tools integrate multiple services.

1.1 Provision of environmental services: mixing private and social interests

In the framework of environmental economics, the description of some major concepts can help us understand the stakes related to the provision of ESs by private producers. We therefore introduce the concepts of public and private goods, of jointness in production and of externality. Finally, we define environmental and ecosystem services.

1.1.1 Private and public goods

Goods do not benefit everyone in the same way. Some goods are rivalrous, which means that if one person enjoys them, then no one else can (Samuelson, 1954). For example if someone eats a piece of bread, then no one else can eat it, too. On the contrary, goods are not rivalrous if one can benefit from them without diminishing the ability of another person to benefit from them. Take, for example, air quality. Everyone breathes the same air in a given place. If a factory reduces its air pollution, then this will benefit everyone.

Goods can also be excludable, which means that it is possible to limit the access to payers. A good example of this is a park with an entrance fee. On the other hand, goods can also be non-excludable which means that anybody can benefit from them without paying, sometimes because the cost of keeping non-payers from enjoying the benefits of the goods is prohibitive.

Based on these two characteristics, goods are often classified into four categories (see Samuelson, 1954; Head, 1962): private, club, common and public (see Table 1.1). Note that excludability and rivalry are binary criteria in the table, though some authors prefer to characterize them on a continuous scale (Romstad et al., 2000). Let us take an example to show how rivalry can be placed on a continuous scale. Bird watching is a non-rivalrous service: if a person is watching birds, another one can do it at the same time without reducing the benefit for the first person. However, if too many people come to watch, they might disturb the birds and consequently reduce the opportunity to see birds. The service becomes rivalrous in case of over use.

Table 1.1: Classification of goods with the Samuelson/Musgrave matrix

	Excludable	Non-excludable
Rivalrous	Private goods	Common goods / common-pool resources
Non-rivalrous	Club goods	Public goods

Most environmental services, for example clean air, pure water or biodiversity, are public goods. In certain conditions, recreation can be a club service, when the access to the recreation area is limited to members of a specific group or is subject to payment. This contrasts

with consumption goods such as food, housing, and energy... which are usually produced and marketed privately. Production processes generally interact with the environment: they use natural resources (e.g. fossil fuels, metal, fibers, soil, water and air) and reject waste residues back into the environment. Producing private goods can therefore affect environmental services which would have been more abundant in the absence of private production. Understanding the links between the provision of private and public goods is therefore critical to perceive how the quest for private well-being can affect social well-being.

1.1.2 Production and externalities

The theory of (negative) externalities is in the core of environmental economics (van den Bergh, 2001). Externalities exist when the private costs (or benefits) to the producers (or purchasers) of goods or services differ from the total social costs (or benefits) entailed in the production (or consumption) of the goods or services (Pigou, 1920). Let us take an example: a firm produces a product A that is sold on the market, and during the production process, it alters the provision of service B which produces neither a cost nor a profit for the firm but does benefit society. B is an externality in the production of A . The theory of externalities started with Pigou (1920) who highlighted a possible divergence between private and social products. The goal of most companies is to maximize their own profit, not to benefit society. In a market economy, the highest social welfare can consequently only be attained if social and private benefits coincide. Pigou concluded that rules must be established to transfer the social liability of the service B to the producers. This would result in an internalization of B in the objectives of the private producer (B and A would be two outputs of the production process).

Knight (1924) proposed another view of the problem: the failure of the market to maximize public wealth comes from the absence of payment for public services. Coase (1960) introduced the role of positive transaction costs into Pigou's examples. He showed that – in case of perfect competition – maximum social wealth can be achieved without any liability to the producer if society takes measures to reduce the potential loss in the output B resulting from the firm's production process to supply A . Although the debate concerning liability is still open (Demsetz, 2010), the conflicts between private and public interests and the concept of externality are more than ever in the forefront of the debate on production, essentially because of the rise in environmental concerns.

Environmental services are often good examples of externalities either because they are naturally produced without human intervention but are affected by human activities (e.g. biodiversity, water quality, carbon storage in forests...), or because they result from an interaction between a human activity and the environment (e.g. recreation, landscape amenities). These services often benefit society, but are not marketed and have no monetary value either for the producer or for the purchaser of the product. Hardin (1968) introduced the notion of externality in the framework of pollution and showed, through his "tragedy of the commons" theory, that since pollution is shared by the entire society while the profit is individual, the impact of the production process on the environment is often underestimated, or even ignored as long as it remains imperceptible. Attempting to increase everyone's individual benefits leads to choices that reduce the global wealth.

Following Pigou (1920)'s approach, if the externality is negative (e.g. water or air pollution), then the producer does not support the total cost of production; the part of the cost related to the externality is supported by society. For example, a plane flight is a valuable service to the traveler, but it generates air pollution which badly affects society and is ignored in the ticket pricing. Such a situation may create conflicts between the private interests of the producer or consumer and the public interests. In effect, market failure results because the externality is incorrectly valued.

When the production process creates a positive externality that is a public service (private and public goods are complementary), society has a stake in the production of private goods. If society does not pay for it (free ride), then the producer has no interest in maintaining the level of service. If the producer finds a production process which increases his profits but reduces the availability of a public service, then the producer will prefer the new process, unless the loss in profits due to the higher production of public service is monetarily compensated for. For example, the owner of a broadleaved forest might switch to coniferous forest, which is usually more profitable. This change in management will reduce the recreation service because coniferous forests are less attractive (Colson et al., 2010). In order to keep the level of service, the society can compensate the forest owner for the loss in profit resulting from keeping the broadleaved forest. The provision of public service becomes then privately valuable. In other words, externalities are internalized.

If the economy runs at the Pareto optimum without taking care of the externalities, then the provision of externalities, including environmental services, is uncontrolled. This may lead to a reduction in public services and possibly in the total wealth (the sum of all individual and social wealth). An interaction between society and firms is therefore required to limit the production of negative externalities and to ensure the provision of positive externalities.

1.1.3 Joint production: the core of the problem of ES undersupply

Externalities are usually unintended outputs in a production process. They result from the production technology used to produce desired goods or services when the costs of production of the desired output and the externality are not separable. Two outputs from the same process are said to be joint when it is impossible to identify the production costs for each output individually (Mill, 1848). Joint production is common in many economic fields. For example, Chizmar and Zak (1983) showed that education can be seen as a two-output function: a cognitive achievement and an attitude towards the field taught (economics, in their example). Many other authors have considered multiple outputs in farm production (Mundlak, 1963; Just et al., 1983; OECD, 2001) and more recently in the forestry sector (Hof et al., 1985; Arthaud and Rose, 1996; Pattanayak et al., 2002). Let us take an example in the field of forestry: when trees are cut in a forest to supply both timber and fuel wood, the same initial operations of cutting and extraction are required and production costs cannot be split between the two products.

Three cases of jointness exist:

- products are complementary: an increase in the production of one of the outputs implies an increase in the production of the second;

- products are substitutes: an increase in the production of one output requires a decrease in the production of the other;
- products are neutral: the production of one output may be increased or decreased without affecting the other.

In environmental economics, joint production has often been studied in attempt to analyze the causes of pollution generated by production processes, as in Hardin (1968). For example, traditional pig breeding leads to water pollution by nitrates (Piot-Lepetit and Le Moing, 2007); salmon aquaculture simultaneously generates a beneficial output –salmon– and a harmful output –pollution– (Liu and Sumaila, 2010). If the technology is already efficiently operated, then reducing pollution requires a decrease in production or a change in technology, which in turn, might increase production costs.

When beneficial and harmful outputs are produced simultaneously, two hypotheses are commonly made: (1) the outputs are weakly disposable: this means that if given quantities of outputs can be produced using limited quantities of inputs, then any proportional reduction in the quantities of outputs can also be produced (Shephard, 1970); (2) the beneficial outputs are nulljoint with the harmful ones: this implies that zero harmful production can only be achieved when zero goods are produced (Färe and Jansson, 1976). These two hypotheses are particularly relevant when harmful outputs correspond to a reduction in environmental services or a pollution¹. Therefore, the study of environmental externalities must partly focus on increasing our knowledge of the joint production of goods and externalities.

1.1.4 Environmental and ecosystem services

The environment has value to human beings because it provides *environmental services* – also called *environmental benefits* – such as clean air, potable water and so on. These services result from the natural presence of a combination of physical, chemical or biological characteristics. These characteristics are affected by both natural and artificial production systems. For example, if an industrial manufacturing process simultaneously produces goods and pollutes the air, then it reduces the environmental benefits from clean air (Baumgärtner et al., 2001). These environmental services are not necessarily related to the functioning of ecosystems, but they can be. As an example of a natural ecosystem production system, forests are often presented as positive providers of environmental services (Forest Europe, 2011). The environmental services are in this case mostly non-marketed outputs of the ecosystem (biodiversity, soil protection, amenities, etc.).

Ecosystems contribute to environmental services, but also to the production of goods such as food, raw materials (fiber, wood and fuel wood), medicinal resources, etc. (see Figure 1.1). The benefits people obtain from ecosystems are called *ecosystem services* (Millennium Ecosystem Assessment, 2005). These include all goods and services provided by ecosystems, only one part of which is captured on the commercial market (Costanza et al., 1997). The other part of the goods and services provided by ecosystems contributes mostly to environmental

¹Baumgärtner et al. (2001) used an analogy with entropy to highlight the relevance of these hypotheses. He took the example of the extraction of iron from iron ore. Iron has lower entropy than iron ore. The process requires the use of low entropy fuel and produces iron. Because the entropy only increases, running this process necessarily generates high entropy waste which includes CO₂, residues, etc.

services. So, an environmental service – provided by the environment – can be an ecosystem service – provided by an ecosystem – and conversely, but it is not mandatory.

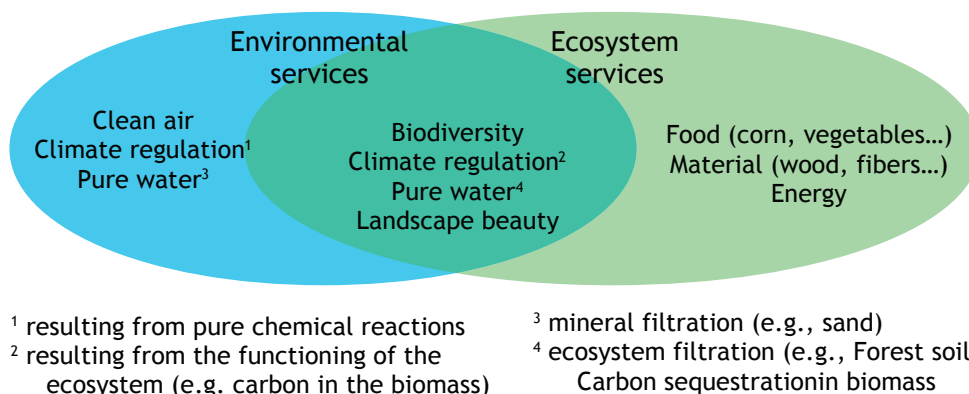

Figure 1.1: Intersection of the sets of environmental and ecosystem services

Ecosystem services are not necessarily environmental services (and conversely). Payment for environmental services often concerns functions in the set where environmental and ecosystem services overlap (intersection of the sets).

Many environmental services such as the preservation of biodiversity are substitutes for the production of marketed goods (see e.g. Hauer et al., 2007). The free market does not properly value environmental services, especially when these services are public goods (Aldy et al., 1998). Similarly to the case of externalities², market failure results in an under-provision of environmental services (Bator, 1958). To preserve or increase the provision of environmental services, some authors have suggested a mechanism called *Payment for Environmental Services* (PES, see Pagiola and Platais, 2002; Wunder, 2005). Some schemes, such as payment to ensure the preservation of landscapes resulting from agricultural activities, had already been developed in the 1990s in many countries (e.g. Norway, Switzerland, Japan, the European Union; see OECD, 2009). Although the PES mechanism mostly concerns services provided by ecosystems, it is called Payment for Environmental Services because it aims at increasing the provision of the services in the intersection of the set of environmental and ecosystem services. Other ecosystem products are supposed to be properly supplied by the conventional market.

1.2 Private forestry: a typical multi-output process with externalities

The definitions given in the previous section are applicable to the provision of environmental services in the forest sector. Forestry is an activity which is closely related to the environment. First, the wood production process results from the interaction between a biological process (tree growth) and human intervention (plantation, pruning, thinning, harvesting). Second,

²Harming environmental services such as greenhouse gases emissions can be externalities in some production processes such as heating.

wood harvesting impacts crown cover, number and age of standing stems and many other forest characteristics which are relevant to the provision of environmental services, e.g. the preservation of biodiversity, carbon storage, landscape quality, protection from erosion, avalanches and rockfall. Third, the forest is a semi-natural space in which numerous stakeholders are involved: scientific experts, investors, ecologists, and public – all of whom may have conflicting interests. The management of privately owned forests is a particularly clear example of a multiple production system subject to competing interests and stakes.

1.2.1 Forest ecosystems produce wood and amenities

Forests produce multiple goods and services which de Groot et al. (2002) classified into three categories: 1. economic goods (e.g. wood products, hunting leases), 2. environmental services (e.g. biodiversity protection, carbon storage, protection against natural hazards, improvement of the water quality), and 3. socio-cultural values (e.g. recreation, scenery, history).

Among the economic goods, wood products generally are the main source of revenue. In the European Union, harvested wood products generate an average of 146 euros per year and per hectare of forest available for wood supply (Forest Europe, 2011). However, harvested wood products only account for a small part of the total value of forest productions (e.g. Montagné et al., 2009, state that harvested wood products correspond to 20% of the total value of French forests). Other products like fruits, nuts, mushrooms, game meat, wild honey, bees-wax, cork, etc., account for less than 10% of the total value of all forest products combined.

Other than products or materials, forests produce many services; however, only a few of them are economically rewarded. Hunting is the only service which is a source of significant income today. In France, the total value of hunting leases in 2003 was 72.5 million euros, equivalent to nearly 4% of the total income from harvested wood (MAP, 2006). However, this share of hunting leases over the total forest income is subject to huge disparities between properties. Due to restrictive regulations, hunting is leased on less than 15% of the private forested properties. Therefore, in these properties, hunting can generate higher revenues than wood production, especially when the potential for wood production is low.

Near large cities, forest recreation is an important service which is often supplied by public forests. Indeed, providing recreational opportunities to the public is one of the objectives stated in the contract between the state or local community – the forest owner – and the managing agency (in France, the National Forest Service – ONF). In these contracts, the community often accepts a reduction in income from forest harvesting to finance recreation facilities in the forest.

Many other environmental services provided by forests such as landscape quality, biodiversity preservation, water purification, carbon storage... are rarely subject to payment³. These public services are externalities of forest management and are provided free of charge. Consequently, if forest owners' main objective is to maximize profit (industrial forest owner), they will manage their forest to produce the highest possible net income (from wood or hunting). The negative or positive impact of their decisions on the provision of environmental services will have no influence on their choices. Moreover, their management plan will not

³There are examples of compensation for the protection of biodiversity such as payments related to Natura 2000 protection network in Europe.

take into account the potential increase in the provision of services even if it would not cost. This may result in a low provision of social amenities and lead to globally lower social wealth.

Figure 1.2 shows the envelope of a production possibility set – the envelope of the set of all possible combinations of outputs subject to a limited quantity of inputs – for private products and public services. If private products and public services are substitutes and the manager maximizes his private utility function – composed of profits and other amenities benefiting to the manager –, then production will not be optimum for society because the provision of public services will be too low. Maximizing the provision of public services may not provide optimum results either, because society values both public and private wealth.

The part of the production possibility set between A_E and A_2 on the envelope corresponds to the best combination of outputs: it is not possible to produce more of any of the outputs without reducing another output or increasing inputs. This subset of the envelope is the production possibility frontier (PPF). Note that the optimal provision of private and public services is obtained when operating the technology at the point where the production possibility frontier intersects the highest iso-utility curve.

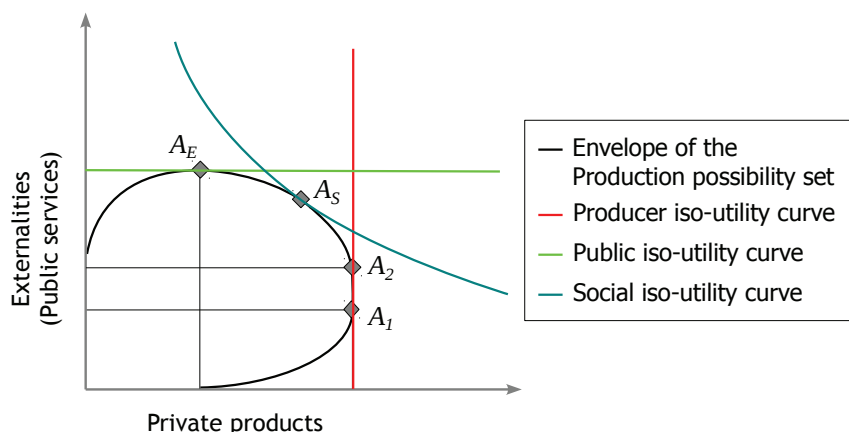

Figure 1.2: Conflicts between private and public utility

If the private producers' objective is to maximize their profits from private products (the only term in the utility function), then the production level will be between A_1 and A_2 , although A_2 would be preferable from the social point of view. The public iso-utility corresponds to an exclusive preference for public services. The goal would be to obtain the highest level of services which are considered as externalities by the producer (here A_E). The social utility is composed of both the public wealth and the sum of private wealth. The social iso-utility curve corresponds to the acceptable tradeoffs between the provision of private products and the supply of public services. In this figure, the social optimum in the production possibility is located at A_S .

1.2.2 Varied production objectives of forest owners

Many private forest owners belong to the so-called category of Non-Industrial Private Forest Owners (NIPFs). They do not maximize their profits, but rather their utility. In this case, the utility function includes profits and some of the services called amenities, for example

recreation, hunting, etc. (Binkley, 1981). These NIPFs are considered as household producers because they produce goods and services in their forests for their own consumption (Becker, 1965). In fact, they benefit in part from the public services supplied by the forest⁴ (Max and Lehman, 1988). They might therefore be willing to participate in the provision of environmental services (Raunihar and Buongiorno, 2006) and to adopt management methods for multipurpose forestry. The divergence between the optimum social level of production and the actual level of services supplied by the forest may be reduced if the same environmental services, or complementary ones, are of interest to private forest owners and the public. For example, if owners value wood products but also the aesthetics of their forests, and if landscape has value to the public, then these owners will provide more public services than if their goal was to maximize their profits. In Figure 1.3, an environmentalist would produce more environmental services than the social optimum and a multifunctional producer willing to make limited compromises to favor environmental services (“profit multifunctional manager”) would produce slightly fewer environmental services than the social optimum.

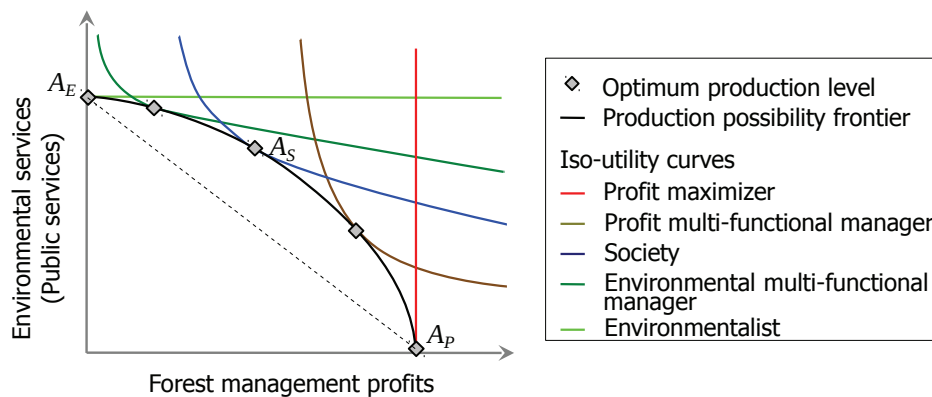

Figure 1.3: Variety of household producer utility-functions and optimal management

Household producers can operate at any level in the production set depending on their objectives and their capacity to efficiently manage their forest (efficient management produces outputs within the PPF). Most private forest owners have iso-utility curves similar to either the “profit multi-functional manager” (preference for profits, while giving little value to environmental services) or the “environmental multi-functional manager” (preference for environmental services if production can still provide some profits). The average provision of profits and environmental services resulting from the various management profiles is in the set delimited by the frontier and the line between the most environmentally oriented management (A_E) and the most profitable management (A_P) applied by the foresters.

Interestingly, certain combinations of different forestry practices can lead to a global supply of externalities which is close to the social optimum. However, if a forest is not optimally managed (not on the PPF), the social optimum cannot be reached. The PPF presented in Figure 1.3 is convex. In this case, the combination of outputs from the different producers – if they operate efficiently – is inside the set delimited by the PPF and the segment A_EA_P , but the social optimum cannot be reached unless every forest owner produces the same combination of outputs as the social optimum A_S . If the PPF for individual producers is not convex,

⁴Note that these public services are therefore not externalities to these producers

then the variety of management types creates opportunities to increase the overall utility compared to standardized or uniform management (Boscolo and Vincent, 2003). Various management types may increase social utility and displace the profit/environmental services mix corresponding to the optimum social provision of profits and services (Figure 1.4).

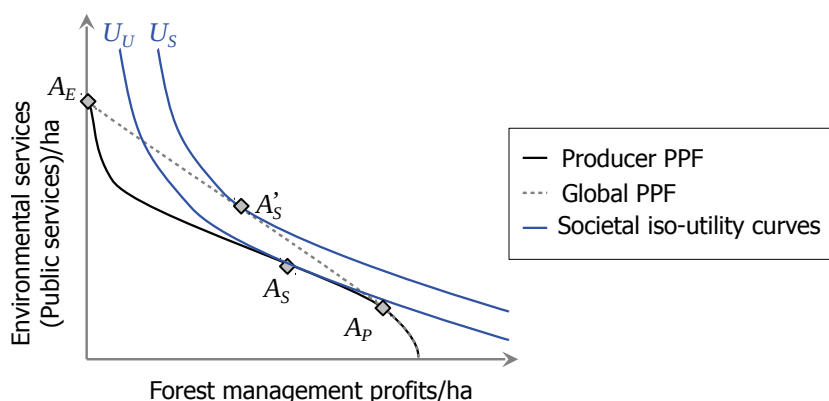

Figure 1.4: Individual producer PPF and global PPF

In this figure, we suppose that the production possibility frontier (PPF) at the single production unit level is not convex, and that the environmental services are additive. In this case, if all producers provide A_S , corresponding to the highest social utility per hectare under a standard management hypothesis, the total utility U_U resulting from the uniform management will be lower than if some producers specialize in the supply of environmental services (A_E) and other producers specialize in profits (A_P) to provide on average A'_S (utility $U_S > U_U$).

The conciliation of private and public interests to achieve the highest social welfare is the duty of public policy makers. It is a complicated task because of the multiplicity of stakes and cases. Proposing appropriate policy solutions for a better supply of environmental services requires:

- identifying the public and private needs and determining their utility functions;
- knowing the production processes and evaluating the current practices;
- designing adapted tools to attain higher social wealth.

This approach can be extended to other production processes where producers can obtain non-marketed environmental or public benefits. A good example is the beneficial effect on farmers' health of a reduction in pesticides in organic farming.

1.3 Identification of the demand for environmental services

Now, let us investigate the social and private needs for environmental products and services that have been identified to date, with the forest as an example. As mentioned previously, two types of demand for environmental goods coexist: a social demand and a private demand. Social demand is identified by policy makers in both governmental and nongovernmental organizations and is recorded in international and national agreements. Private producers'

demand can be determined by analyzing the current status of production and consumption on the market. In the next section, we explore these two sources of information (institutional agreements on the one side and market based statistics on the other) and point out the consistencies and discrepancies between social and private demand which mainly stems from the society's interest in externalities and benefits. Furthermore, we emphasize the importance of a better understanding of production possibilities to satisfy both types of demand.

1.3.1 International environmental commitments and social needs

In the second half of the twentieth century, many countries enjoyed exceptional economic growth: the post-World War II economic expansion. Economic prosperity together with full employment and increased leisure time created opportunities for the development of a new perception of human well-being. It was during this period that the impact of human activities on the environment became a major concern. This concern led to the recognition of the benefits of the environment to human beings in the Declaration of the Conference of the United Nations on the Human Environment in Stockholm in 1972.

Since then, environmental issues have been discussed during numerous international conferences and new approaches to environmental protection have been developed. One of the most important conferences was the Earth Summit in Rio in 1992 where the concept of *sustainable development* was first introduced. This concept arose from the awareness that unbridled economic development might ruin the capability of future generations to develop and to continue to benefit from the ecosystem services we currently enjoy. The question was how to reduce the impact of human activities. The two main international agreements which resulted from the Rio Summit were the Convention on Biological Diversity (CBD) and the United Nations Framework Convention on Climate Change (UNFCCC). The CBD came into force in December, 1993, and aims to preserve biological diversity and promote sustainable use of biological resources (United Nations, 1992a). The goal of the UNFCCC is to stabilize "greenhouse gas concentrations in the atmosphere at a level that would prevent dangerous anthropogenic interference with the climate system" (United Nations, 1992b). Within this framework, in 1998, 84 parties adopted the Kyoto Protocol which came into force in 2005. Currently, 192 parties (191 nations) are involved in this Kyoto protocol. The signatory nations thus clearly expressed their intention to reduce the impact of human activities on the environment in order to preserve ecosystem viability and the services they provide over the long term.

One difficulty that policy makers encounter when dealing with environmental services is the estimation of the benefits from these services. To be able to take political decisions with an environmental dimension, policy makers agree on the need for means to estimate the production of environmental services and their economic value. Two major reports illustrate such valuation approaches: the Millennium Ecosystem Assessment (MEA, 2005) and the Economics of Ecosystems and Biodiversity (TEEB, 2010). The MEA showed that ecosystems do indeed provide services which benefit society. The assessment further showed that the provision of ecosystem services has globally decreased over the last 50 years, and is likely to continue decreasing in the near future. Action is therefore required. Following this assessment, TEEB identified one of the most critical parameters identified in the MEA: the interaction between ecosystem services can multiply the value of some services which appear

to have little value at first. The report also showed that poor people are more dependent on ecosystem goods. Finally, TEEB provides several concrete examples where the value of ecosystem services is estimated. The report does not propose an overall estimate of ecosystem benefits because of the complexity and variability of the situations, but it does give practical guidelines. Ecosystem services do have a value and before decision-makers act, they must be provided with an estimate of the possible impact of their decisions on the future provision of these services.

1.3.2 Forestry's special place in environmental commitments

Forest management has a special place in international environmental conventions because forestry practices can be either a threat to or an opportunity for the provision of environmental services. For example, the massive deforestation prior to planting oil palm trees and the illegal logging of highly valuable trees (high-grading) have resulted in losses of biodiversity, a reduction in forest carbon stocks and soil degradation. On the other hand, afforestation and appropriate forest management practices can increase carbon storage capacity, reduce landslide risks, create recreational opportunities and contribute to local economic development.

Biodiversity During the 2010 CBD conference, a specific decision concerning forest biodiversity was adopted by the participants (COP 10 Decision X/36.Forest biodiversity). Ninety-two parties agreed on the need to preserve forest biodiversity and resources. As a first step, the countries and certain international organizations such as the Food and Agriculture Organization of the United Nations (FAO) agreed to assess the current state of forest diversity and list recommendations to preserve or improve biodiversity. Official means of cooperation between countries will then be established to protect the forest biodiversity.

Greenhouse gases Forests were also at the forefront of the UNFCCC negotiations because trees store large quantities of carbon (638 Gt C) and play an important role in carbon fluxes. On the one hand, deforestation and forest degradation release considerable quantities of carbon into the atmosphere every year (1.2 Pg C.yr^{-1}). This corresponds to nearly 12% of total annual anthropic emissions (van der Werf et al., 2009). On the other hand, afforestation and forest restoration are among the few options available to sequester CO_2 and to reduce net emissions. To increase carbon sequestration service in forests and to avoid large carbon releases due to deforestation, the policy makers at UNFCCC agreed on incentive mechanisms, for example the CDM (Clean Development Mechanism) in the framework of REDD (Reducing Emissions from Deforestation in Developing Countries).

The wood and forest sector also plays a role in the global anthropic greenhouse gas (GHG) balance. Wood is a renewable material which, in many cases, emits less GHG than alternative materials during its life cycle. This is obvious in the building sector when steel or concrete is replaced by wood (Börjesson and Gustavsson, 2000; Adalberth, 1999). Furthermore, as a source of energy, wood is renewable and virtually nearly carbon-neutral and can therefore help reduce net carbon emissions (Schlamadinger et al., 1997). Although the effect of wood use on GHG is not explicitly mentioned in the UNFCCC agreement, it was taken into account in the total estimated balance which includes, among others, emissions from the energy and

manufacturing sectors. To sum up, the wood and forest sector is subject to two contradictory pressures: to store more carbon and to supply more wood. Fortunately, an appropriate balance between these two objectives can create conditions favorable to meeting the goal of reducing GHG emissions (Taverna et al., 2007).

Sustainable forestry Forests have been specifically mentioned in international agreements which aim to preserve their multiple production functions. Many countries are now involved in sustainable forest management (SFM) through programs such as the Ministerial Conference on the Protection of Forests in Europe (Forest Europe), the Montreal Process and the ITTO (International Tropical Timber Organization). The goal of these programs is to report on the forest status and trends in the different member countries while taking into account the ecological, economic and sociocultural functions of the forest. This encourages countries to preserve and improve the provision of forest environmental services. In addition, each group defined criteria for SFM. Table 1.2 lists the criteria adopted by Forest Europe (source: Forest Europe, 2011). To prove the sustainability of their forest management, member countries regularly report on the status of indicators which correspond to respond to each criterion (The list of Forest Europe indicators can be found in Appendix A). For Forests in Europe five reports have been compiled since the 1990s (1993, 1998, 2003, 2007 and 2011).

Table 1.2: Criteria used in Forest Europe to define a sustainable forest management

Criterion 1	Maintenance and Appropriate Enhancement of Forest Resources and their Contribution to Global Carbon Cycles
Criterion 2	Maintenance of Forest Ecosystem Health and Vitality
Criterion 3	Maintenance and Encouragement of Productive Functions of Forests (Wood and Non-Wood)
Criterion 4	Maintenance, Conservation and Appropriate Enhancement of Biological Diversity in Forest Ecosystems
Criterion 5	Maintenance and Appropriate Enhancement of Protective Functions in Forest Management (notably soil and water)
Criterion 6	Maintenance of other socio-economic functions and conditions

(Source: Forest Europe, 2011)

The criteria and indicators used in SFM include private and public goods provided by forests and emphasize the need for both immediate and long-term approaches to the provision of these goods.

1.3.3 Public demand for forest environmental services in France

In 2007, the French government organized a national debate on the environment called the *Grenelle de l'Environnement*. Policy makers, scientists, nongovernmental organizations, public and private bodies all agreed on the need for urgent measures to preserve, and in some cases, restore the environment. In line with international orientations, they set priorities for reducing the impact of human activities on the environment (MEDDTL, 2007). Their main

concern was to mitigate global warming. The measures mentioned include promoting more efficient energy use in the construction and transportation sectors and reducing the proportion of carbon in the energy mix. The second set of measures deals with the preservation of biodiversity and ecosystem health to ensure the sustainable provision of ecosystem services in the future. Reducing biodiversity loss, improving the quality of aquatic ecosystems and promoting sustainable agriculture are examples of the orientations given. During the discussions, the need for better protection of human health and the environment in a growing economy was emphasized. Reducing noise and the use of harmful substances, improving air quality and preventing pollution and technological hazards are some of the objectives listed. Finally, including ecological concerns in public decisions was suggested to better achieve both ecological and economic goals.

The *Grenelle* agreement clearly shows that awareness of the value of environmental services is increasing. However, there are many uncertainties related to the levels of provision expected both at the present time and in the future. For example, releasing large quantities of carbon into the atmosphere has little immediate influence on the current climate; but in the future, the accumulated carbon will dramatically and permanently alter the climate. Yet GHG effects on global warming are still barely known as is the impact of climate change on the economy in the long run.

Following the *Grenelle* debates, several decisions pertaining directly to forests were taken during the Forest and Wood Sector meeting (*Assises de la forêt et du bois*). The objective was set to reorient forest management so as to produce more wood (12 million cubic meters in 2012) thereby helping reduce net GHG emissions. Part of the additional wood harvested will be used as building material and will therefore improve carbon storage, and part will be used to produce energy thus avoiding GHG emissions which would have resulted from the use of fossil fuels. Improved management techniques should not only make it possible to produce more wood without negatively affecting biodiversity; they should also coincide with an improvement in the quality of the environment.

To ensure the sustainable provision of wood in a changing environment, adaptation strategies must be adopted. With global change, the frequency and/or intensity of extreme climatic events such as storms and droughts are likely to increase (IPCC, 2007; Wang et al., 2011). Management techniques can be employed to limit these risks. For example, reducing stand density, which reduces tree water demand and favors fast diameter growth, or reducing the diameter for the final harvest are strategies that not only lead to shorter rotations; they can reduce the risk of monetary loss in case of a major climatic event (Seidl et al., 2011). Another alternative, which anticipates species migration due to a warming climate, is to progressively plant species which are more likely to thrive under the climatic conditions expected when the stand reaches maturity (see e.g. Gray et al., 2011). However, even if these management approaches are efficient from the point of view of wood production, there is no certainty that they will enhance the total wealth generated by forests including the preservation of biodiversity, recreation and landscape amenities. Society as a whole, and many private forest owners, may not be willing to accept intensified management in forests where scenic beauty and biodiversity are highly valued. Consequently, there is a need for a clearer assessment of both the demand for non-wood forest products or services and the willingness of forest owners to provide these services before appropriate policy measures such as information campaigns, training or monetary incentives can be applied.

1.4 Supply of environmental services in private forests

Management in public forests is based on an agreement between the forest owner (either a local community or the state) and the National Forest Service (in France, the ONF). These agreements set out multiple objectives which include making profits and providing public services. They should reflect the social demand for public services and the willingness to pay for these services. However, in France as in most European countries, most of the forested land is private. In fact, nearly three quarters of the total forested area is owned by more than 3.3 million private forest owners. These forests contribute, along with the public forests, to the provision of public environmental services. However, the level of contribution depends on the forest management chosen by the private owner. To ensure that private forests sustainably provide multiple services, it is important to understand the owners' objectives and how they take management decisions.

1.4.1 Household producers

As mentioned in paragraph 1.2.2, monetary gain is not necessarily a primary objective of NIPFs. To take into account the fact that forest owners value amenities, Hartman (1976) extended Faustmann's model (1849) of optimum rotation period with maximized return by integrating the role of amenities. The harvesting behavior model he designed follows:

$$U(T) = \frac{G(T) \cdot e^{-rT} + \int_0^T e^{-rt} F(t) dt}{1 - e^{-rT}} \quad (1.1)$$

subject to: $U(T)$: forest utility to the owner if the rotation period is T ;
 $G(T)$: net discounted value at T of the wood produced during the rotation period T ;
 $F(t)$: utility of the amenities at time t , $t \in (0; T)$.

Suppose that a forest owner chooses rotation period T to maximize his utility (equation 1.1). If the amenity function $F(t)$ increases with time, then the optimum rotation period will be longer than if profit is the only objective (i.e. $F(t) = 0$, which corresponds to the Faustmann model). Opposite conclusions would be obtained if the amenity function decreased with time which is rarely assumed.

The term "amenity" encompasses various private services but also public services such as recreation, hunting or biodiversity protection. Numerous studies have established that NIPFs are willing to supply public services (Joshi and Arano, 2009; Raunikar and Buongiorno, 2006; Kurttila et al., 2001). One of the reasons is that most private forest owners are household producers: they too benefit from the supplied environmental services, e.g. landscape beauty. A second reason for their willingness to supply public services is that they may benefit from a product which is complementary to environmental services. For example, if forest owners value the presence of old trees for the beauty of their forest, then they will simultaneously contribute to the preservation of bird species nesting in these old trees. Kahneman and Knetsch (1992) noticed that the willingness to pay for public goods reveals the moral satisfaction that comes from an implication in the provision of public goods. In the forest case, the provision of environmental services would then give the forest owner moral satisfaction which in turn increases the utility of their forests. When services are valued by the forest owner, they are

not, strictly speaking, externalities. However, some forest ecosystem services, such as the preservation of bark beetles, are true externalities, not amenities. We therefore need to better understand amenities and how they benefit different forest owners.

1.4.2 Survey of French forest owners' expectations

Numerous studies have demonstrated that non-industrial private forest owners are willing to supply wood and services (see Beach et al., 2005, for a review of the literature on NIPF behaviors). However, the particularities of French forest owners are barely known. Few surveys have been conducted in France. The Ministry of Agriculture investigated who French forest owners are and what kind of forests they own (SCEES, 2002). More recently, two regional investigations were carried out in Limousin and Rhone-Alpes to understand the objectives of the local forest owners and how they would respond to incentives to harvest more fuel wood (Association Forêts Massif-Central, 2008; CRPF Rhône-Alpes et al., 2009). These last two studies confirmed that supplying wood is not the sole objective of French forest owners. They also value recreational and hunting activities and their forest is often seen as a part of the family heritage they want to preserve for their children to benefit from. However, these studies did not value the services nor did they determine how these values influence the owners' management decisions related to production in their forests. We therefore designed a specific forest owner survey to clearly determine their willingness to provide environmental services⁵.

Objectives and sampling design

French forests are very diverse in terms of tree species, composition and spatial organization. We therefore expected to find a wide range of forest owner attitudes depending on the income potential of their forests and on ownership structure. The latest forest resource analyses (Colin et al., 2009) show that the quantity of wood technically available for bioenergy differs from one region to another and depends on the current wood harvest and the maturity of the forests. We chose to conduct our survey at the regional scale (NUTS 2) to better grasp the local phenomena which influence the behavior of the forest owner, for example, forest activities existing in the region or the behavior of other owners with whom he or she may interact. We selected five regions: Auvergne (a mountainous area), Burgundy (a hilly region in eastern France), Lorraine-Alsace (low-lands and uplands in northeastern France), Provence-Alpes-Côte d'Azur (Mediterranean forests) and Pays de la Loire (lowlands in the oceanic region).

Information on the structure of private forests in France (SCEES, 2002) shows that very small forest owners (with less than 1 ha) represent nearly two thirds of the total number of forest owners, even though all together they only own 7% of the total private forested area in the country. In our survey, we wanted to collect information on all types of private ownerships so we decided to stratify our sample by region and by property size class obtained from the cadastral survey (see Table 1.3). Unlike previous studies, we also included very small forest

⁵This survey was conducted within the framework of the NewForEx European project (financed by the European Commission) and was also partly funded by the Lorraine Region (Emerging projects)

ownerships to obtain at least some information on this segment of the population. The forest owners were randomly sampled from the SCEES list of forest owners and questionnaires were sent by postal mail. Three response options were proposed: to return the questionnaire by postal mail in a prepaid envelope, to fax the completed questionnaire or to complete the survey on the internet.

Because we knew the total number of forest owners in each stratum and the total forested area owned by each group, once we had received the completed questionnaires, we used three different approaches depending on the target of the calculation: (1) we estimated the raw number of answers directly; (2) we extrapolated a representative behavior from our results using the total number of forest owners in each stratum and (3) we estimated the total forested area concerned by each type of behavior and extrapolate the impact the owners' decisions would have on the availability of private forests for wood production and environmental services. We will discuss the approaches we selected below. Discrepancies will arise if the selected criterion is not equally represented in each stratum of the sample. For example, if half of the responding forest owners are willing to supply a service, and a majority of these owners are in the small forest owner stratum, then in reality, the total number of forest owners willing to provide this service might be high, but the total area concerned is small.

Structure of the questionnaire

Our survey was designed with multiple objectives in mind⁶ and a wide range of questions were asked. One of our goals was to collect information on forest owners' willingness to supply environmental services and which ones they would give priority to. The questionnaire was split into three main sections: (1) forest property, (2) harvesting practices and (3) sociological information on the owner (for a translation of the questionnaire see Appendix B).

In the first section, we first asked for the total surface area of forest owned and the location of the different forest stands. Then we focus our questions on the forests located in the region surveyed. The description of the plots included local characteristics (number of patches, number of neighboring forest properties, environmental and social stakes in the area) as well as the uses of the forest and the goals that the owner had set.

The second section contained questions on the characteristics and quantities of the standing wood, on past harvests and income from these operations, on the intention to harvest in the future and on global costs and investments.

Finally, the third section gathered information about the forest owner, their knowledge of the forest, their relations with their neighbors (past or intended), their family, their professional situation, their bequest intentions and their non-forest revenues.

Responses and response rate

The response rate was lower than expected: less than 4% (see Table 1.3) compared to an expected response rate of 10%. This poor response rate could be explained by the length

⁶It was designed to provide information to other studies on the valuation of amenities by forest owners and on the cooperation between forest owners.

of the questionnaire (10 pages) and the poor quality of the address database, supposedly updated in 2009. Indeed, we learned that 33 forest owners had died (often before 2000) and 68 people who were sent the questionnaire declared that they had never owned a forest. Other questionnaires may have been sent to non-forest owners or to the deceased. The small size of our final sample limits the interpretation of our results.

Table 1.3: Number of questionnaires sent and number of replies in the forest owner survey

Forest area	Initial sample per region	Number of answers				
		Auvergne	Bourgogne	LorAls	PACA	PDL
$A < 1$ ha	600	11 (1.8)	12 (2.0)	4 (0.7)	11 (1.8)	11 (1.8)
$1 \text{ ha} \leq A < 4$ ha	600	13 (2.2)	15 (2.5)	13 (2.2)	20 (3.3)	21 (3.5)
$4 \text{ ha} \leq A < 10$ ha	600	15 (2.5)	22 (3.7)	24 (4.0)	17 (2.8)	20 (3.3)
$10 \text{ ha} \leq A < 25$ ha	500	15 (3.0)	21 (4.2)	24 (4.8)	15 (3.0)	35 (7.0)
$25 \text{ ha} \leq A < 50$ ha	300	14 (4.7)	18 (6.0)	23 (7.7)	14 (4.6)	19 (6.3)
$50 \text{ ha} \leq A < 100$ ha	200	13 (6.5)	13 (6.5)	13 (6.5)	9 (4.5)	24 (12.1)
$100 \text{ ha} \leq A$	200	15 (7.5)	21 (10.5)	11 (5.5)	7 (3.5)	32 (16.0)
<i>Total</i>	3000	96 (3.2)	122 (4.1)	112 (3.7)	93 (3.1)	162 (5.4)

LorAls: Lorraine – Alsace ; PACA: Provence-Alpes-Côte d’Azur; PDL: Pays de la Loire

The response rate was lowest among the very small forest owners possibly because of a higher number of incorrect addresses but also because this category of owner might be less interested in such a survey (owners with less than 0.5 ha rarely view their forest property as a valuable asset, as it was confirmed in our survey). Many of the forest owners who responded to the survey could not fill in the details concerning the resources in their forest (Section 2 of the questionnaire). This can be interpreted either as a lack of forest management knowledge on their part or as an absence of interest in the monetary aspects of forest production. As a result, we were not able to interpret the results in terms the impact owner choices would have on the production possibility set corresponding to their forests. We therefore restricted our analyses to owner willingness to supply goods and services and to the actual uses provided by their forests.

1.4.3 Intentions to produce wood and non-wood services

Supplying wood is one of the main objectives for more than half of the forest owners surveyed (see Figure 1.5), more precisely for 92% of the owners with more than 25 ha and for 47% of the owners with less than 1 ha. Consequently, three quarters of the private forest area in the study regions are concerned with wood production. There is, however, a large disparity between regions: in Auvergne, Burgundy and Lorraine more than 80% of the private forests surveyed are managed for wood supply, whereas just slightly over 50% of the forested area in PACA supplies wood (see Figure 1.6).

Wood supply is the exclusive objective of only 6% of all the owners (8.6% of the forested area). Multiple objectives are usually pursued, e.g. wood and recreation (30% of all owners, all size categories combined) or wood and hunting (15%, mainly large forest owners). Some forest owners did not mention any objectives for their forest. This concerns nearly 6% of the forested area, mainly in the less than 1 ha category.

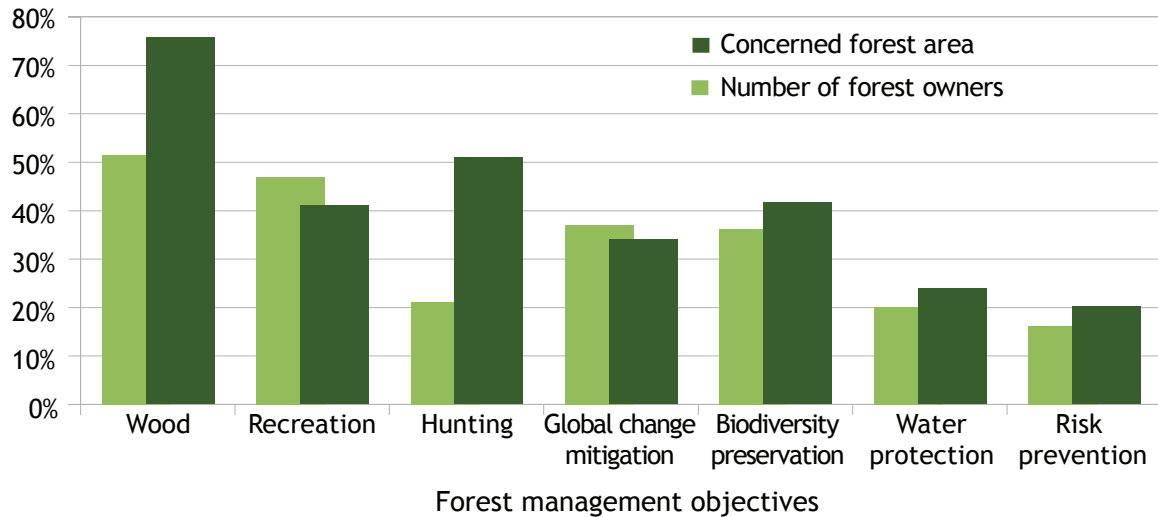

Figure 1.5: Wood is the priority for about 50% of the owners, but half of the private forest area is mainly concerned by this objective.

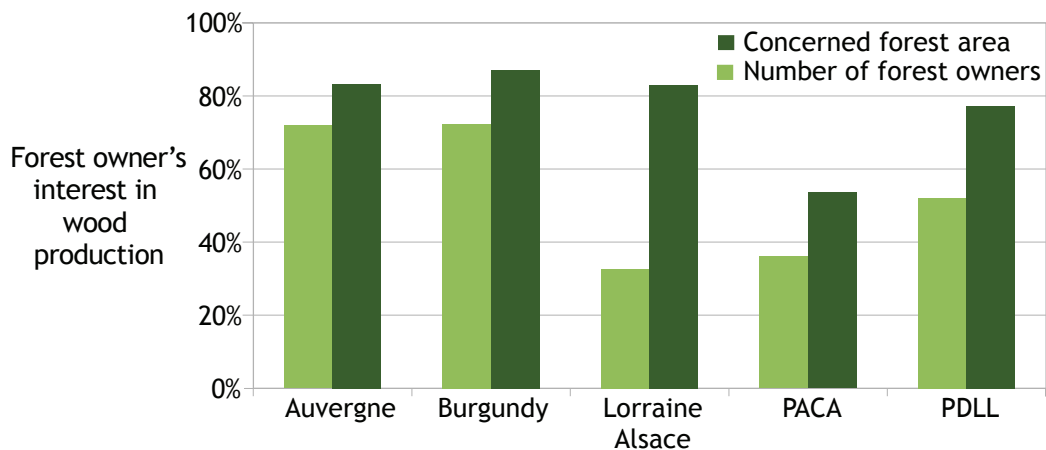

Figure 1.6: Supplying wood is the most common objective in all the different regions.

In Lorraine-Alsace, the share of forest owners interested in producing wood appears small (less than 33%) as a result of the small forest owners' limited interest in supplying wood. However, this result is not significant because only 4 owners in the less than 1 ha category responded in this region. In Lorraine-Alsace, 65% of the owners of forest larger than 1 ha are interested in wood production.

Many owners also claim that their forests contribute to the provision of public services such as carbon storage or the preservation of biodiversity even though they are not paid for these services.

Our survey confirms that forest owners are willing to participate in the provision of environmental services, even without incentives. However, their behavior varies depending on the size of their property and the type of product they can produce on their land. This leads to heterogeneous forest management practices and outputs. If the production of public services in a given region appears insufficient, and policy makers wish to increase the supply of public services in an economically efficient way, they must know (1) how the current level of provision is obtained; (2) what production potential is available starting from the present situation, and (3) what type of incentives can best help achieve the public goals.

Moreover, forest owners' precise objectives vary from region to region. This would be in favor of regional level policies. For example, in the Mediterranean regions, policy makers could take decisions to encourage wood harvesting and complementary environmental services such as the reduction of net CO₂ emissions, and in the northern part of the country, they could propose incentives for the preservation of biodiversity to owners of more productive forests.

1.5 Defining appropriate policies

To ensure the provision of multiple ESs by private forest owners which have various behaviors, decision makers must define appropriate policies. If the goal is to interest private forest owners in the provision of public goods, then policy makers can use various tools such as regulations, incentives or market based instruments. We review these instruments and show that an increase in their efficiency requires better knowledge of the joint production of commodities and ESs.

1.5.1 Public environmental policies

The nations that have signed international environmental agreements must find solutions at the national level to favor changes in production practices which will allow them to conform to the objectives they have agreed to. Therefore, they must address clear messages to both producers and consumers enjoining them to reduce the environmental effect of their activities so as not to exceed the defined limits.

If we assume that companies maximize their profitability subject to demand and to regulation and tax constraints, then there are numerous ways to encourage environmentally friendly production processes. In a market economy, managing demand is one of the possible levers. The demand for manufactured products can be modified, for example, by educating consumers in environmental issues, by imposing taxes on less environmentally friendly products or by subsidizing more environmentally friendly products (Baumol, 1972; Kohn, 1996). This type of Pigovian tax/subsidy combination was established on the car market in France in 2008⁷.

⁷If there are no substitutes for a particular product (and the demand is limited to the nation concerned by the regulation), the taxation will result in lower demand and lower consumption. The environmental target can be met but with a decrease in production. The tax would slow down the economy.

A second approach is to determine consumers' demand and their willingness to pay for environmental services and, ultimately, to create a market for these services. Acting on the demand will indirectly impact the producers in different ways and can help achieve environmental objectives. On the one hand, a consumer preference for more environmentally friendly products will increase the profitability of clean production. On the other hand, establishing a market for environmental services will offer companies a second source of income (or trigger additional costs for dirty companies) and will consequently displace the maximum profit equilibrium (Al-Najjar and Anfimiadou, 2012). Companies will react by improving the environmental performance of their production processes⁸. The best results will be obtained for products like gasoline whose consumption directly harms the environment. However, when products manufactured in the country are sold on the international market, national policies that alter only domestic demand will have a much lower impact.

1.5.2 Converting externalities into privately valuable products

To reduce the country's human footprint on the environment, policy makers can take measures that directly affect producers. Such measures include incentives to promote environmental quality or pollution regulations which favor the development of new cleaner production processes (Baumol, 1972). However, such regulations are sometimes hard to enforce and firms may end up bearing differently the environmental burden. More flexible tools are needed to reduce the costs of adapting to stricter constraints and to increase the efficiency of the adaptive process. These tools include market-based instruments such as cap and trade systems for environmental services.

Market-based environmental policies are some of the most cost effective instruments available (Stavins, 2001). Payment for environmental services (PES) has become a common way to internalize externalities (Pattanayak et al., 2010). The assumption is that by integrating environmental services, into the market, supply and demand will regulate the production of environmental services efficiently and sustainably.

Marketable environmental services become valuable products for private firms because they contribute to profitability (Pigou, 1920). In the absence of constraints on environmental degradation, the demand for ESs is null and business continues as usual. However, as soon as stricter limits for degradation are set, the ES prices increase (as, for example, with the carbon market). Companies that become more environmentally friendly can sell part of their credits. Firms that continue to degrade more than the allowed threshold will have to reduce their impact on the environment or buy credits to compensate for their excessive impact (or pay a tax). It should be noted that a company will most likely pay the tax if it is lower than the price of compensatory credits on the market. Therefore, if the tax is too low, the market will fail to control environmental degradation because companies will not invest in improving their processes; rather, they will simply pay the tax. We note that if compensations by third parties are allowed, forests are expected to bear a large part of the mitigation effort, especially for global change and biodiversity issues.

⁸Note that if two substitute products are made of different materials, one of which impact the environment far less than the other, the company producing the most degrading product might disappear because it could be impossible for them to attain a pollution level as low as the other.

To take effective political measures, policy makers must have a clear understanding of the interrelations between the environment and production processes. They must be able to assess how different regulations will affect production processes and which environmental goals will put the most appropriate pressure on firms without harming the economy.

In this chapter, we have established that environmental services (ES) are being threatened by current production practices. With the degradation of environmental quality, the need for ESs has become more obvious. Since these services are often externalities of the production process, manufacturers have virtually no interest in preserving the environment. The private forest owner is a specific type of entrepreneur who may include some, but not all, ESs in their utility function. To ensure ES provision in the long run, policy makers can use for example market-based tools to internalize environmental externalities. This will give producers incentives to provide ESs. The list of public services provided by forests is long. Management decisions taken by forest owners alter wood production and ES provision in various ways because of the jointness in the production of all the outputs. Therefore, designing efficient policies requires detailed information concerning the joint production of goods and services. In the next chapter, we propose a general approach to production processes with multiple joint outputs that will help clarify the potential effects of developing markets for some ESs on ES provision in general.

Bibliography

- Adalberth, K. (1999). Energy use in four multi-family houses during their life cycle. *International Journal of Low Energy and Sustainable Buildings*, 1.
- Al-Najjar, B. and Anfimiadou, A. (2012). Environmental policies and firm value. *Business Strategy and the Environment*, 21(1):49–59.
- Aldy, J. E., Hrubovcak, J., and Vasavada, U. (1998). The role of technology in sustaining agriculture and the environment. *Ecological Economics*, 26(1):81–96.
- Arthaud, G. J. and Rose, D. W. (1996). A methodology for estimating production possibility frontiers for wildlife habitat and timber value at the landscape level. *Canadian Journal of Forest Research*, 26(12):2191–2200.
- Association Forêts Massif-Central (2008). Étude des motivations des propriétaires forestiers du Massif central. Technical report, CRPF Limousin and GEOLAB.
- Bator, F. M. (1958). The anatomy of market failure. *The Quarterly Journal of Economics*, 72(3):351–379.
- Baumgärtner, S., Dyckhoff, H., Faber, M., Proops, J., and Schiller, J. (2001). The concept of joint production and ecological economics. *Ecological Economics*, 36(3):365–372.
- Baumol, W. J. (1972). On taxation and the control of externalities. *The American Economic Review*, 62(3):307–322.
- Beach, R., Pattanayak, S., Yang, J., Murray, B., and Abt, R. (2005). Econometric studies of non-industrial private forest management: a review and synthesis. *Forest Policy and Economics*, 7(3):261–281.
- Becker, G. S. (1965). A theory of the allocation of time. *Economic Journal*, 75(299):493–517.
- Binkley, C. S. (1981). *Timber supply from private nonindustrial forests: a microeconomic analysis of landowner behavior*, volume 92 of *Bulletin*. Yale University / School of Forestry and Environmental Studies.
- Boscolo, M. and Vincent, J. (2003). Nonconvexities in the production of timber, biodiversity, and carbon sequestration. *Journal of Environmental Economics and Management*, 46(2):251–268.
- Börjesson, P. and Gustavsson, L. (2000). Greenhouse gas balances in building construction: wood versus concrete from life-cycle and forest land-use perspectives. *Energy Policy*, 28(9):575–588.
- Chizmar, J. and Zak, T. (1983). Modeling multiple outputs in educational production-functions. *American Economic Review*, 73(2):18–22.
- Coase, R. H. (1960). The problem of social cost. *Journal of Law and Economics*, 3:1–44.
- Colin, A., Barnérias, C., Salis, M., Thivolle-Cazat, A., Coulon, F., and Couturier, C. (2009). Biomasse forestière, populicole et bocagère disponible pour l'énergie à l'horizon 2020. Technical report, ADEME. Available from: http://www.dispo-boisenergie.fr/doc/ADEME_boisenergie_rapport_final_dec2009.pdf [cited 2012-10-28].
- Colson, V., Garcia, S., Rondeux, J., and Lejeune, P. (2010). Map and determinants of woodlands visiting in Wallonia. *Urban Forestry and Urban Greening*, 9(2):83–91.
- Costanza, R., d'Arge, R., de Groot, R., Farber, S., Grasso, M., Hannon, B., Limburg, K., Naeem, S., O'Neill, R. V., Paruelo, J., Raskin, R. G., Sutton, P., and van den Belt, M. (1997). The value of the world's ecosystem services and natural capital. *Nature*, 387(6630):253–260.
- CRPF Rhône-Alpes, TPR Rhône-Alpes, AD Valor, and SYNTHÈSE-mk (2009). Mobilisation de la ressource - bois dans la région Rhône-Alpes. focus sur le bois énergie. Technical report, CRPF Rhône-Alpes.

- de Groot, R. S., Wilson, M. A., and Boumans, R. M. J. (2002). A typology for the classification, description and valuation of ecosystem functions, goods and services. *Ecological Economics*, 41(3):393–408.
- Demsetz, H. (2010). Fallacies in the economic doctrine of externalities. Lecture at the Property and Environment Research Center (Bozeman, Montana). Report: <http://mylaw2.usc.edu/assets/docs/contribute/Demsetz.pdf>.
- Egerton, F. N. (2007). A history of the ecological sciences, part 23: Linnaeus and the economy of nature. *Bulletin of the Ecological Society of America*, 88(1):72–88.
- Faustmann, M. (1849). Calculation of the value which forest land and immature stands possess for forestry. *Allgemeine Forst und Jagd Zeitung*, pages 441–455.
- Forest Europe (2011). State of Europe’s Forests 2011. Status and trends in sustainable forest management in Europe. Technical report, Forest Europe Liaison Unit Oslo, Forest Europe, UNECE and FAO.
- Färe, R. and Jansson, L. (1976). Joint inputs and the law of diminishing returns. *Journal of Economics*, 36(3):407–416.
- Gray, L. K., Gylander, T., Mbogga, M. S., Chen, P.-y., and Hamann, A. (2011). Assisted migration to address climate change: recommendations for aspen reforestation in western Canada. *Ecological Applications*, 21(5):1591–1603.
- Hardin, G. (1968). The tragedy of the commons. *Science*, 162(3859):1243–1248.
- Hartman, R. (1976). Harvesting decision when a standing forest has value. *Economic Inquiry*, 14(1):52–58.
- Hauer, G., Cumming, S., Schmiegelow, F., Adamowicz, W. L., Weber, M., and Jagodzinski, R. (2007). Tradeoffs between forestry resource and conservation values under alternate forest policy regimes: A spatial analysis of the Western Canadian boreal plains. Staff paper series, University of Alberta, Department of Rural Economy. Available from: <http://purl1.umn.edu/52086>.
- Head, J. (1962). Public goods and public policy. *Public Finance*, 27:197–219.
- Hof, J. G., Lee, R. D., Dyer, A. A., and Kent, B. M. (1985). An analysis of joint costs in a managed forest ecosystem. *Journal of Environmental Economics and Management*, 12(4):338 – 352.
- IPCC (2007). *Climate change 2007: the physical science basis.*, chapter Global Climate Projections, pages 747–845. IPCC (Intergovernmental Panel on Climate Change), Working group 1. Solomon, S., D. Qin, M. Manning, Z. Chen, M. Marquisand, K.B. Averyt, M. Tignor and H.L. Miller (Eds.), Cambridge University Press, Cambridge, United Kingdom and New York, NY, USA edition.
- Joshi, S. and Arano, K. G. (2009). Determinants of private forest management decisions: A study on West Virginia NIPF landowners. *Forest Policy and Economics*, 11(2):118–125.
- Just, R., Zilberman, D., and Hochman, E. (1983). Estimation of multicrop production-functions. *American Journal of Agricultural Economics*, 65(4):770–780.
- Kahneman, D. and Knetsch, J. L. (1992). Valuing public goods: The purchase of moral satisfaction. *Journal of Environmental Economics and Management*, 22(1):57–70.
- Knight, F. H. (1924). Some fallacies in the interpretation of social cost. *The Quarterly Journal of Economics*, 38(4):582–606.
- Kohn, R. (1996). An additive tax and subsidy for controlling automobile pollution. *Applied Economics Letters*, 3(7):459–462.
- Kurttila, M., Hamalainen, K., Kajanus, M., and Pesonen, M. (2001). Non-industrial private forest owners’ attitudes towards the operational environment of forestry - a multinomial logit model analysis. *Forest Policy and Economics*, 2(1):13–28.

- Liu, Y. and Sumaila, U. R. (2010). Estimating pollution abatement costs of salmon aquaculture: A joint production approach. *Land Economics*, 86(3):569–584.
- MAP (2006). Les indicateurs de gestion durable des forêts françaises 2005. Technical report, Ministère de l’Agriculture et de la Pêche.
- Max, W. and Lehman, D. E. (1988). A behavioral model of timber supply. *Journal of Environmental Economics and Management*, 15(1):71–86.
- MEDDTL (2007). Table ronde – récapitulatif (Ministère de l’Environnement et du Développement durable, des transports et du logement). Available from: http://www.legrenelle-environnement.gouv.fr/IMG/pdf/engagements_grenelle.pdf [cited 2012-10-28].
- Mill, J. S. (1848). *Principles of Political Economy with some of their Applications to Social Philosophy*, volume III, chapter XVI. Of Some Peculiar Cases of Value, page 624. Library of Economics and Liberty. William J. Ashley (Ed.). Available from: <http://www.econlib.org/library/Mill/m1P45.html> [cited 2012-10-28].
- Millennium Ecosystem Assessment (2005). Ecosystems and human well-being: Synthesis. Technical report, Island Press, Washington DC.
- Montagné, C., Niedzwiedz, A., and Stenger, A. (2009). Les comptes de la forêt française : un outil d’évaluation intégré des biens et services (marchands et non marchands) fournis par la forêt. *Recherches en Économie et Sociologie Rurales*, 5:4. Available from: <http://www.inra.fr/esr/publications/iss/pdf/iss09-05.pdf?PHPSESSID=50905e9fc3d4015d1bbb25ecc8f7f314>.
- Mundlak, Y. (1963). Specification and estimation of multiproduct production functions. *Journal of Farm Economics*, 45(2):433–443.
- OECD (2001). Multifunctionality – towards an analytical framework – agriculture and food. Technical report, Organisation for Economic Co-operation and Development. Available from: <http://www.oecd.org/dataoecd/62/38/40782727.pdf> [cited 2012-10-28].
- OECD (2009). Agricultural policies in OECD countries 2009: Monitoring and evaluation. Technical report, Organisation for Economic Co-Operation and Development.
- Pagiola, S. and Platais, G. (2002). Payments for environmental services. *Environment Strategy Notes*, 3:4. World Bank.
- Pattanayak, S. K., Murray, B. C., and Abt, R. C. (2002). How joint is joint forest production? An econometric analysis of timber supply conditional on endogenous amenity values. *Forest Science*, 48(3):479–491.
- Pattanayak, S. K., Wunder, S., and Ferraro, P. J. (2010). Show me the money: Do payments supply environmental services in developing countries? *Review of Environmental Economics and Policy*, 4(2):254–274.
- Pigou, A. C. (1920). *The Economics of Welfare*. Library of Economics and Liberty. Available from: <http://www.econlib.org/library/NPDBooks/Pigou/pgEW1.html> [cited 2012-10-28].
- Piot-Lepetit, I. and Le Moing, M. (2007). Productivity and environmental regulation: the effect of the nitrates directive in the French pig sector. *Environmental and Resource Economics*, 38(4):433–446.
- Randall, A. (1983). The problem of market failure. *Natural Resources Journal*, 23(1):131–148.
- Raunikar, R. and Buongiorno, J. (2006). Willingness to pay for forest amenities: The case of non-industrial owners in the south central United States. *Ecological Economics*, 56(1):132–143.
- Romstad, E., Vatn, A., Rørstad, P. K., and Søyland, V. (2000). Multifunctional agriculture – implications for policy design. Technical Report 21, Agricultural University of Norway – Department of Economics and Social Sciences.
- Samuelson, P. A. (1954). The pure theory of public expenditure. *The Review of Economics and Statistics*, 36(4):387–389.

- SCEES (2002). Structure de la propriété forestière privée en 1999. *Agreste – Chiffres et Données – Agriculture*, 144. Direction des affaires financières, Service Central des Enquêtes et Études Statistiques, Ministère de l’Agriculture et de la Pêche. 94 p.
- Schlamadinger, B., Apps, M., Bohlin, F., Gustavsson, L., Jungmeier, G., Marland, G., Pingoud, K., and Savolainen, I. (1997). Towards a standard methodology for greenhouse gas balances of bioenergy systems in comparison with fossil energy systems. *Biomass and Bioenergy*, 13(6):359–375.
- Seidl, R., Fernandes, P. M., Fonseca, T. F., Gillet, F., Jönsson, A. M., Merganicová, K., Netherer, S., Arpaci, A., Bontemps, J.-D., Bugmann, H., González-Olabarria, J. R., Lasch, P., Meredieu, C., Moreira, F., Schelhaas, M.-J., and Mohren, F. (2011). Modelling natural disturbances in forest ecosystems: a review. *Ecological Modelling*, 222(4):903–924.
- Shephard, R. (1970). *Theory of cost and production functions*. Princeton University Press, Princeton, NJ.
- Stavins, R. N. (2001). Experience with market-based environmental policy instruments. Discussion paper, Resources for the Future, 1616 P Street, NW Washington, D.C. 20036. Available from: <http://www.rff.org/documents/RFF-DP-01-58.pdf>.
- Taverna, R., Hofer, P., Werner, F., Kaufmann, E., and Thürig, E. (2007). *The CO₂ Effects of the Swiss Forestry and Timber Industry. Scenarios of future potential for climate-change mitigation*. Number 0739 in Environmental studies. Federal Office for the Environment, Bern. Available from: <http://www.bafu.admin.ch/publikationen/publikation/00076/index.html?lang=en>.
- TEEB (2010). The economics of ecosystems and biodiversity: Mainstreaming the economics of nature: A synthesis of the approach, conclusions and recommendations of TEEB. Technical report, The Economics of Ecosystems and Biodiversity. Available from: http://www.teebweb.org/LinkClick.aspx?fileticket=bYhDohL_TuM%3d&tabid=1278&mid=2357.
- United Nations (1992a). Convention on Biological Diversity. Available from: <http://www.cbd.int/doc/legal/cbd-en.pdf>.
- United Nations (1992b). United Nations Framework Convention on Climate Change. Available from: <http://unfccc.int/resource/docs/convkp/conveng.pdf>.
- van den Bergh, J. (2001). Ecological economics: themes, approaches, and differences with environmental economics. *Regional Environmental Change*, 2(1):13–23.
- van der Werf, G. R., Morton, D. C., DeFries, R. S., Olivier, J. G. J., Kasibhatla, P. S., Jackson, R. B., Collatz, G. J., and Randerson, J. T. (2009). CO₂ emissions from forest loss. *Nature Geoscience*, 2(11):737–738.
- Wang, X., Wan, H., Zwiers, F., Swail, V., Compo, G., Allan, R., Vose, R., Jourdain, S., and Yin, X. (2011). Trends and low-frequency variability of storminess over Western Europe, 1878–2007. *Climate Dynamics*, pages 1–17.
- Wunder, S. (2005). Payments for environmental services: Some nuts and bolts. *Occasional Paper. CIFOR, Bogor.*, 42. Available from: http://www.cifor.org/publications/pdf_files/OccPapers/OP-42.pdf.

Chapter 2

Payment for environmental services in multi-output production processes Bundling or stacking PES?

In the previous chapter, we saw that many production processes, in particular agriculture and forestry, both consume and supply public and private goods. We pointed out that policy makers could use market-based instruments to encourage producers to reduce their impact on the environment or to increase the provision of environmental services (ES). In this chapter, we examine the implications of different payment schemes (payment for a single ES, stacked or bundled payment for multiple ESs) on ES provision when multiple outputs are at stake. Therefore, we develop an original multidimensional approach taking into account at least one profitable output and two ESs. We demonstrate that, when there is synergy in the provision of two ESs, economies of scope are made if both services increase at the same time. On the contrary, if the interaction between ESs makes it more costly to provide them simultaneously, then the optimum solution is to specialize the management in order to provide one service at a time. Finally, we show that increasing the supply of one ES at the lowest monetary cost can lead to a degradation of another ES.

In the first part, we show that the opportunity cost of ES provision can be used as an estimate of the value of an ES. Then we define a multi-output production framework and derive the profit function that gives opportunity cost estimates. We characterize the maximum profit as a function of the provision of two ESs and analyze the impact of an increase in the provision of one of the ESs according to assumptions concerning the interactions in the provision of both ESs. Finally, we investigate the possible implications of proposing payment for ESs if constraints on the provision or compensation for the degradation of other ESs are in force or not.

2.1 Possible costs of environmental services (ES)

The difficulty in the definition of a compensation for the degradation of an ES lies in the problem of estimating its value. We present different methods that are currently used to

determine this value and show that the estimate of the marginal cost of provision is a good estimate of the value from the supply side.

2.1.1 Valuing ESs

Natural and semi-natural ecosystems provide a wide variety of services (de Groot et al., 2002). The value of these services is very difficult to estimate, especially when public goods or non-used goods¹ are concerned. ESs benefit people differently; consequently, acceptable prices for these goods will vary. For example, the quality of the landscape is of higher value to people living in it than to the people who are only passing through. Moreover, some ESs (e.g., carbon storage or biodiversity) provide indirect benefits, which remain unperceived and unvalued until a decrease in the level of the service finally ends up affecting human well-being.

The concept of ES is anthropogenic, and so is their valuation (Liu et al., 2010). Three types of values are usually identified (de Groot et al., 2002): (1) an ecological value, related to ecosystem functioning and to the rarity of the service; (2) a socio-cultural value, which includes non-material roles of ecosystems in our well-being (e.g. educational or spiritual roles); and (3) an economic value.

Numerous studies have attempted to estimate the economic value of environmental services. Many of them estimate the willingness to pay (WTP) for ESs from the demand side (e.g., Hotelling, 1947; Knetsch, 1963; Peters et al., 1989) or the willingness to accept compensation (WTA) for damaged ESs from the supply side (e.g., Kline et al., 2000; Wossink and Swinton, 2007; Martinez Cruz et al., 2010). These values can be estimated either with revealed preferences – which corresponds to an actual valuation of the services subject to direct or in payment – or with stated preferences – hypothetical payment that appear to be acceptable. Revealed preferences are derived from avoided cost or replacement cost estimates, from travel cost evaluation or through hedonic pricing – in other words, through the estimation of the additional price of goods resulting from the environmental characteristics, e.g. the increase in the price of a house resulting to its proximity to the sea or to the forest. Stated preferences involve contingent valuation techniques that aim at determining the willingness to pay for non-marketed goods and services using surveys. However, these types of results represent the individual satisfaction level derived from the goods more than the economic value of the goods themselves. As a result, ES pricing levels can be quite contrasted and are often disconnected from the real costs of providing the ES or saving the environment.

2.1.2 The marginal costs: A technical estimate of ES value

If payment mechanisms were set to promote ES production or to ensure the sustainability of their provision, what values would be appropriate? Wunder (2007) defines a payment for an environmental service (PES) as:

1. a voluntary transaction where
2. a well-defined environmental service (or a land use likely to secure that service)
3. is being ‘bought’ by a (minimum one) service buyer

¹Goods that are not used by individuals may be given an option, bequest or altruistic value.

4. from a (minimum one) service provider
5. if and only if the service provider secures the provision of the service (conditionality).

If we assume that the need for ESs is identified and that the methodologies to measure and secure the provision exist, then the existence of a PES requires an agreement between buyers and providers. Theoretically, a payment for ES provision can take place if the proposed amount is lower than (or equal to) the beneficiary's WTP and at least as high as the supplier's WTA. In reality, because of the existence of transaction costs, WTP must be at least equal to WTA plus transaction costs (Coase, 1960). However, due to asymmetry in the treatment of gains and losses, also called the endowment effect², estimates for WTP are often lower than WTA (Knetsch and Sinden, 1984; Mitchell and Carson, 1988; Burton et al., 2000). This does not necessarily mean that payment is impossible. When real cases are at stake, consumers might accept to pay more than what they had planned to and providers might accept lower compensation.

PES can have two different objectives:

1. to maintain the level of environmental services or to avoid their degradation. Such payments are already taking place to protect the tropical forest in order to preserve its biodiversity and carbon storage capacity. The aim of the payment is to discourage potential users from degrading their environment;
2. to restore or to increase the provision of environmental services. The goal of this payment is to encourage potential producers to increase their provision of environmental services. This often involves modifying past practices that induced a reduction in the ES, for example to favor afforestation or forest restoration.

These two objectives differ in that their status within the current context is not the same. In the first case, the provision of the ES is under threat; whereas in the second case, there is a potential gain in this ES. However, the payment plays the same role in both cases: it compensates the producer for the reduction in profits resulting from sustaining ES provision. From the demand side (WTP), the maximum payment acceptable corresponds to the difference in value between the maximum profit scenario and the ES protection scenario. From the supplier's point of view (WTA), the minimum payment acceptable corresponds to the difference in profit between the ES protection scenario and the maximum profit scenario (see Pagiola and Platias, 2002). If most producers also benefit from non-monetary values, like private forest owners, the scope of the theoretical framework should be enlarged: the opportunity cost should be measured in terms of the reduction in the producer's total benefit (monetary and non-monetary), not only in terms of loss of net profits. The end result would be similar – i.e. the PES objective would be attained (see Figure 2.1), but the amount paid would be higher or lower depending on how the producer values the non-monetary services provided (e.g., scenic beauty, environment, etc.).

Estimating the total ES benefit is particularly complex because of the diversity of the producers' utility functions (see section 1.4). As a first step toward such an estimate, we will consider industrial forest owners whose objective is to maximize their profit. In this case, the payment should at least compensate for the loss of profit resulting from management which takes ESs into account. Estimates for industrial forest owners parallel the more general

²The endowment effect is observed because potential gains are less valued than losses: people give more value to what they own than to what they can acquire.

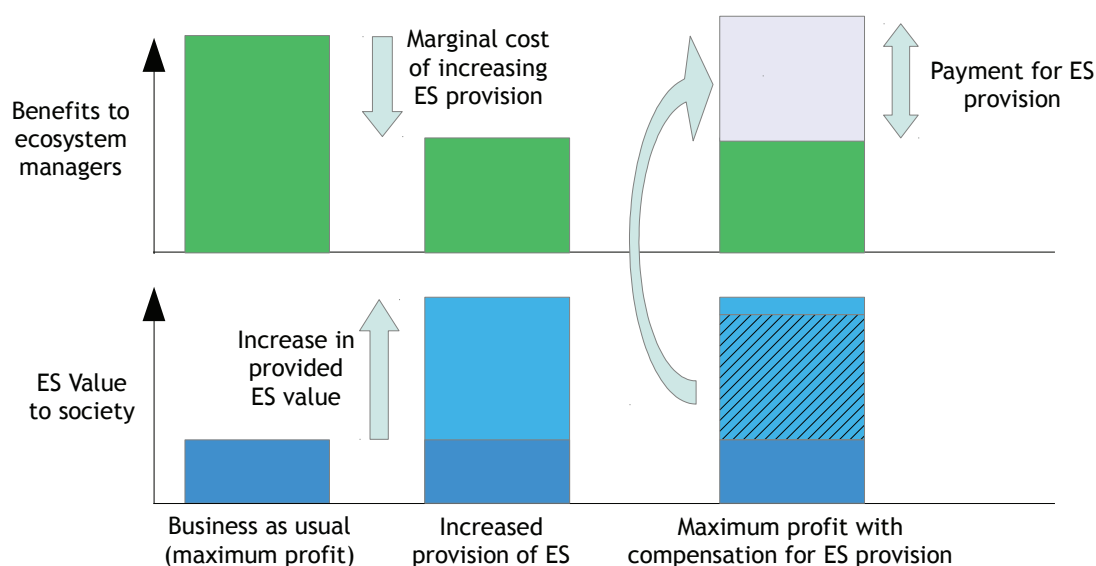

Figure 2.1: PES framework (payment for environmental services)

The payment should at least compensate for the loss of monetary and non-monetary benefits.
(adapted from Pagiola and Platais, 2002)

case of private companies, especially those in the industrial sector. Below, we propose an analytical framework which is valid for any production process. We discuss applications to forestry in chapter 5.

2.2 Opportunity costs of ES provision: an analytical approach

2.2.1 Single ES transformation function

Several attempts to estimate the environmental performance and efficiency of production processes have been made. In one approach, environmental goods or services are considered to be inputs in the production process: costs for energy consumption (Giampietro, 1997) for example, or waste assimilation (Jaffe et al., 2002) or pollution costs (Hailu, 2003). Optimizing the production process therefore requires minimizing these inputs when producing a defined quantity of outputs, or products. Environmental inputs and other inputs, such as labor costs, are exchangeable in such models.

Other authors integrate ESs in terms of pollution or environmental degradation. This approach considers ESs to be outputs, specifically undesirable outputs (e.g., production of a pollutant; see Fare et al., 1989; Piot-Lepetit and Le Moing, 2007; Yang and Pollitt, 2007). These outputs are weakly disposable³ and null-joint⁴ with desirable outputs. In this second

³Weak disposability of environmental outputs implies that it is impossible to reduce the harm done to the environment without reducing the production of the desired output, when the production process is efficiently operated.

⁴If outputs are null-joint, then it is impossible to produce one output without producing the other. Here, this corresponds to the impossibility of producing the desired product without harming the environment.

approach, the production possibility set P subject to a vector of input quantities x is written as follows:

$$P(x) = \{(y, e) : x \text{ can produce } (y, e)\} \quad (2.1)$$

with y the desirable output vector, e the undesirable output vector (externality measured in terms of pollution or environmental degradation). In many cases, undesirable outputs are not freely disposable (i.e. it would not be possible to reduce the production of undesirable outputs e without reducing the production of desirable outputs y). This gives the following characteristic:

$$\forall (y, e) \in P(x), \forall y' < y, (y', e) \in P(x) \quad (2.2)$$

This process formula is commonly used in the literature on industry and agriculture when environmental harm (CO₂ emissions, water pollution) is taken into account (Hailu, 2003; Vardanyan and Noh, 2006; Van Ha et al., 2008; Liu and Sumaila, 2010). However, environmental externalities in the production process can also be positive. Equation 2.1 and the weak-disposability hypothesis are valid in either case (negative or positive externalities). The only difference is that in the second case, e is a desirable output that is produced together with the other outputs. This is common in forestry and occasionally occurs in agriculture, especially when valuing carbon storage or landscape. In standard multi-output analyses, the producer is assumed to desire all outputs. Environmentally-based multi-output analyses are less obvious because the ES outputs (whether negative or positive) may not be valued by the producer; this could create situations in which companies aiming to maximize their profit sometimes actually increase the provision of environmental services at no cost (the environmental dimensions are not even included in the efficiency estimate).

To evaluate the cost-efficiency of the provision of environmental services, some authors have used a profit function π instead of a production function (see for example Lichtenstein and Montgomery, 2003; Nalle et al., 2004; Polasky et al., 2008), as follows:

$$\pi(y, e) = py - c(y, e), \quad (y, e) \in P(x) \quad (2.3)$$

where p is the vector of output prices and $c(y, e)$ is the cost function of producing the output vector y subject to a vector of externalities e . $c(y, e)$ increases with the increase in the production of one or several outputs; it also increases with the provision of environmental services⁵. The profit function $\pi(y, e)$ is the maximum possible profit when producing output quantities y and environmental services e . Analyzing the maximum of this function subject to different levels of e ($\pi_y(e) = \max_e \pi(y, e)$) allows us to make a direct estimate of the monetary opportunity cost of the ES as presented in Montgomery et al. (1994), Stone and Reid (1997) and Kant (2002).

Figure 2.2 shows an example of a profit function and the opportunity cost (Δ_π) of improving the environmental service e (here biodiversity) from e_a to e_b . This curve represents a case where a minimum level of biodiversity is required to produce the highest profits (portion of

⁵ $\frac{\partial c(y, e)}{\partial y} > 0$ and $\frac{\partial c(y, e)}{\partial e} > 0$

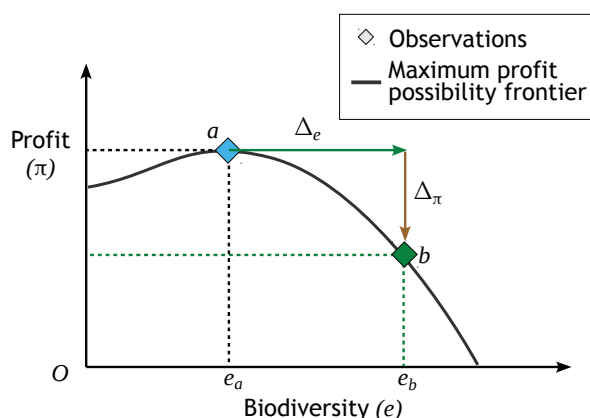

Figure 2.2: Estimation of the opportunity cost of environmental services using a maximum profit function.

Increasing the provision of the environmental service e from e_a to e_b has an opportunity cost of Δ_π .

the curve before a), but any further increase in biodiversity reduces the maximum achievable profit. From a to b (and beyond), there is a tradeoff between profits and the preservation of biodiversity. Most studies on the opportunity cost of providing environmental services have focused on the identification of tradeoffs (see e.g., Vincent and Binkley, 1993; Montgomery et al., 1994; Montgomery, 2002; Polasky et al., 2008; Juutinen et al., 2008).

Boscolo and Vincent (2003) highlighted that the shape – and especially the convexity of the maximum profit curve – can help us identify local and global strategies to produce environmental services at the lowest cost. If the maximum profit curve decreases and is convex, then the marginal cost of providing more ESs increases with the expected level of ESs, as does their total opportunity cost (Figure 2.2). In a set of production units, if the total provision of an ES is the sum of the ES provision of each production unit and if the process has non-increasing returns to scale⁶ then, because of the convexity of the curve, uniform multifunctional management of the units is optimal. Every producer will provide the same level of environmental services, corresponding to the same accepted payment⁷.

Non-convexities can appear in some production processes. Swallow et al. (1990) showed, for example, that during the lifetime of a forest, several local profit maxima could appear because of variations in the value of wood products and amenities as the stand matures. Boscolo and Vincent (2003) also showed that non-convexity could result from fixed harvesting costs and administrative constraints. They analyzed timber production value as a function of biodiversity preservation or of carbon sequestration. The non-convexities they observed at the management unit level (Figure 2.3) support implementing specialized management for each production unit. Some of the units should be totally dedicated to the provision of ESs (point b) while others should produce more limited ESs and the greater part of the financial

⁶In other words, if the production possibilities do not expand with the size of the production unit.

⁷In fact, if the price paid for each ES unit is independent of the level of service provided to the customer (reflected by market price), then the producer might produce less than expected because the optimum level of provision for the maximum profit corresponds to the level at which the marginal cost $-\frac{d\pi}{de}$ is equal to the payment value.

returns (point c). Note that if management units could be split into sub-units and the total quantity of inputs could be independently allocated to these sub-units, then the global frontier would be convex.

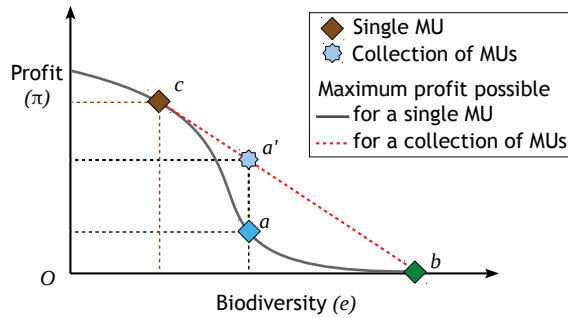

Figure 2.3: Maximum profit function:
Impact of non-convexity at the management unit (MU) level

Because of the non-convexity of the profit function at the MU scale, at a larger scale (a collection of MUs) it is possible to make more average profit per unit for the same quantity of ES if management is specialized in each MU (to produce e_a biodiversity value, the optimum uniform management is a ; the optimum specialized management is $a' = \alpha b + (1 - \alpha)c$, adapted from Boscolo and Vincent, 2003).

Several studies (e.g., Montgomery et al., 1994; Calkin et al., 2002; Nalle et al., 2004; Juutinen et al., 2008) present the conflicts between profit and one ES. Though Boscolo and Vincent (2003) investigate both biodiversity protection and carbon storage, they analyze the two services independently. Studies that actually combine two ESs are rare. Nelson et al. (2008) analyzed the simultaneous effect of different policies with limited budget on both carbon and biodiversity and highlighted a tradeoff between the two ESs at the landscape level when budget is limited. At such a scale, they determine a convex frontier corresponding to the management of a collection of units, but such management involves numerous owners who may consider their own production possibilities rather than the global possibilities. This raises specific questions, such as whether the production possibility frontier subject to a limited budget is convex at the management unit level. To examine this question, we propose a theoretical approach to the simultaneous production of multiple ESs at the scale of the management unit.

2.2.2 Double ES transformation function

Let us model a three-output production process with limited input quantities x (x includes land and capital). The three outputs⁸ are a marketable product y (for example wood, measured in equivalent m^3 of sawnwood-quality wood⁹) and the value of two ESs $e_1 \in E_1$

⁸In this chapter, the term “output” refers to any of the products of the production process, whereas ES or service only refers to the non-monetary benefits of the production process (e_1 and e_2).

⁹The price of wood depends on the volume, diameter and quality of the log. However, if we consider that the relative prices of the different products vary little, we standardize the value using the price of a cubic meter

(e.g. the preservation of biodiversity) and $e_2 \in E_2$ (e.g. carbon storage). We assume that these outputs originate from a single process, for example agriculture or forest management. Let $F(y, e_1, e_2, x)$ be the transformation function corresponding to a management unit and existing technology. S_{x_0} is the production possibility set subject to a quantity of input limited to x_0 :

$$S_{x_0} = \{(y, e_1, e_2) \in Y \times E_1 \times E_2 : F(y, e_1, e_2, x) \leq 0, x \leq x_0\} \quad (2.4)$$

2.2.3 Envelope of the maximum profit possibilities

If we suppose that there is no payment for either ES, the profit equation corresponding to the process presented in 2.2.2 can be written as follows:

$$\pi(y, e_1, e_2)_{x_0} = p \cdot y - C(y, e_1, e_2)_{x_0} \quad (2.5)$$

where $C(y, e_1, e_2)_{x_0}$ is the cost of providing the output quantities (y, e_1, e_2) subject to a limited quantity of inputs x_0 , and p is the price of one cubic meter of sawnwood.

Let $(E_1 E_2)_{x_0}$ be the subset¹⁰ of all possible values of e_1 and e_2 in the set S_{x_0} and h the maximum of the profit function π (with $\pi(y, e_1, e_2)$ convex in y) for each couple (e_1, e_2) .

$$\forall (e_1, e_2) \in (E_1 E_2)_{x_0}, h(e_1, e_2) = \max_{e_1, e_2} \pi(y, e_1, e_2) \quad (2.6)$$

h is an injection from $(E_1 E_2)_{x_0}$ to \mathbb{R} and it corresponds to the upper envelope of the profit possibilities in the ES production possibility set $(E_1 E_2)_{x_0}$.

2.2.4 Impact of the joint ES production on the opportunity cost of a single ES provision

Iso-profit curves drawn on a two-output production possibility set provide relevant information on how the combination of non-financially valuable outputs can be associated when accepting a given reduction in profit. Let us assume that a producer maximizes her profit and provides the maximum amount of ESs possible corresponding to this maximum profit (point a on Figure 2.4). In this case, any increase in the provision of ESs will reduce the maximum profit. If this producer is asked to increase the provision of one of the ESs, she may very well choose the least costly way. This will correspond to the highest profit possible, subject to a defined amount of e_1 . If $h(e_1, e_2)$ is convex, then the most profitable scenario will be at the point where the ES line is tangent to the highest iso-profit curve (see Figure 2.4).

The iso-profit equation would be such that:

$$dh(e_1, e_2) = \frac{\partial h(e_1, e_2)}{\partial e_1} de_1 + \frac{\partial h(e_1, e_2)}{\partial e_2} de_2 = 0 \quad (2.7)$$

of sawnwood (p_r) as a reference. If wood products i have volumes y_i and prices p_i , then the total volume y_r in equivalent cubic meters of the reference r , whose price is p_r , is such that $\sum_i p_i y_i = p_r y_r$.

¹⁰ $(E_1 E_2)_{x_0} \in E_1 \times E_2$

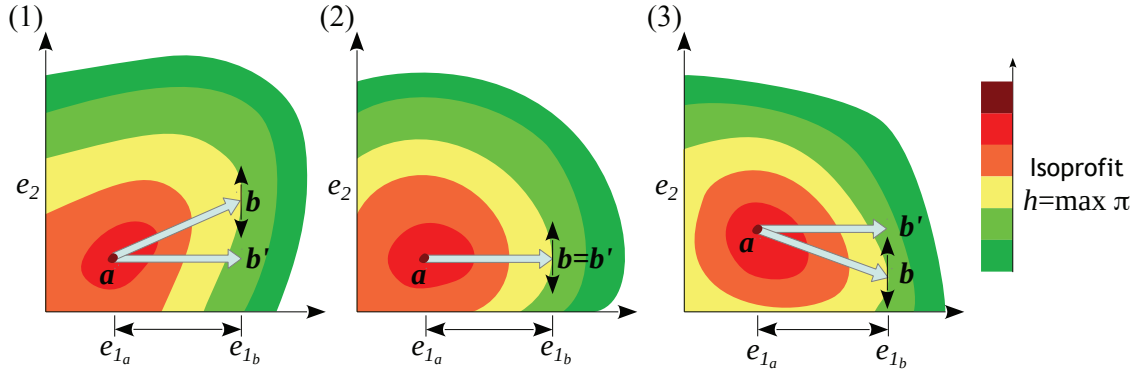

Figure 2.4: ES provision iso-profit function.

The production unit a is managed to maximize profit and efficiently provide ESs. Depending on the shape of the iso-profit curves, increasing the provision of service e_1 with the lowest loss of profit (b) leads to (1) an increase in the provision of service e_2 ; (2) an equal provision of e_2 ; (3) a reduction in e_2 provision.

We deduce from this formula that the cost of an increase in one ES can (at least partly) be balanced by:

1. an increase in the second ES if the partial derivatives¹¹ have opposite signs (Figure 2.4, part 1);
2. a decrease in the second ES if the partial derivatives have the same sign (Figure 2.4, part 3).

Note that there is no way to reduce the loss of profit if an increase in e_1 is desired and $\frac{\partial h(e_1, e_2)}{\partial e_2} = 0$ in the portion of the curve concerned (Figure 2.4, part 2).

This first level approach shows that, because of the relationships between profits and the provision of services, increasing the provision of one service at the lowest opportunity cost can lead to either an increase or a decrease in the provision of the other service. When both ESs are potentially subject to increased provision, then a deeper characterization of the interactions between ES provision and the profit is required.

2.3 Joint ES production and the maximum profit equation

Here, we consider that the two services e_1 and e_2 are freely disposable, i.e. the production levels of each ES can be chosen independently in a subset $E_{1_0} \times E_{2_0}$ of $E_1 \times E_2$. Such a subset exists if there is no direct relation between the two ESs being considered.

2.3.1 Relationship between outputs is a key factor

If h (maximum profit as a function of ES provision) is continuous and differentiable in $E_{1_0} \times E_{2_0}$, $(e_{1_a}, e_{1_b}) \in E_{1_0}^2$ and $(e_{2_a}, e_{2_b}) \in E_{2_0}^2$, we can approximate the maximum profit achievable

¹¹In the concerned part of the iso-profit curve.

given an ES provision of (e_{1_b}, e_{2_b}) with a first order Taylor series expansion of h as follows:

$$h(e_{1_b}, e_{2_b}) = h(e_{1_a}, e_{2_a}) + \frac{\partial h}{\partial e_{1_a}}(e_{1_b} - e_{1_a}) + \frac{\partial h}{\partial e_{2_a}}(e_{2_b} - e_{2_a}) + o(e_{1_b} - e_{1_a}, e_{2_b} - e_{2_a}) \quad (2.8)$$

$h(e_{1_b}, e_{2_b}) - h(e_{1_a}, e_{2_a})$ corresponds to the opportunity cost (minimum loss of profit if the initial profit was maximum) of increasing the ES provision from point a (e_{1_a}, e_{2_a}) to point b (e_{1_b}, e_{2_b}) . This first order development shows that the opportunity cost of a simultaneous increase in both e_1 and e_2 is approximately equal to the sum of the opportunity costs of separately increasing e_1 and e_2 . This is only valid for very small differences in e_1 and e_2 values. This approximation can hide the effect of possible synergies in the production of e_1 and e_2 which could call the previous statement into question: the total opportunity cost of increasing e_1 and e_2 is not necessarily equal to the sum of increasing the two services independently.

To explore the possible variations in opportunity costs resulting from interactions between simultaneous increases in two different ESs, we used a second order Taylor series expansion. If h is continuous and twice differentiable in $E_{1_0} \times E_{2_0}$, then we can write the variation in the maximum profit resulting from an increase/a decrease in e_1 or in e_2 as follows:

$$\begin{aligned} \Delta\pi_{e_{1_a,b}} &= h(e_{1_b}, e_{2_a}) - h(e_{1_a}, e_{2_a}) \\ &= \frac{\partial h}{\partial e_{1_a}}(e_{1_b} - e_{1_a}) + \frac{1}{2} \frac{\partial^2 h}{\partial e_{1_a}^2}(e_{1_b} - e_{1_a})^2 + o((e_{1_b} - e_{1_a})^2) \end{aligned} \quad (2.9)$$

$$\begin{aligned} \Delta\pi_{e_{2_a,b}} &= h(e_{1_a}, e_{2_b}) - h(e_{1_a}, e_{2_a}) \\ &= \frac{\partial h}{\partial e_{2_a}}(e_{2_b} - e_{2_a}) + \frac{1}{2} \frac{\partial^2 h}{\partial e_{2_a}^2}(e_{2_b} - e_{2_a})^2 + o((e_{2_b} - e_{2_a})^2) \end{aligned} \quad (2.10)$$

Where $\Delta\pi_{e_{1_a,b}}$ is the opportunity cost of increasing the provision of e_1 from e_{1_a} to e_{1_b} while keeping e_2 at a constant value e_{2_a} , and $\Delta\pi_{e_{2_a,b}}$ is the opportunity cost of increasing the provision of e_2 from e_{2_a} to e_{2_b} while keeping e_1 at a constant value e_{1_a} .

The impact of a simultaneous variation in e_1 and e_2 from a (e_{1_a}, e_{2_a}) to b (e_{1_b}, e_{2_b}) has an approximate opportunity cost of $\Delta\pi_{a,b}$.

$$\begin{aligned} \Delta\pi_{a,b} &= h(e_{1_b}, e_{2_b}) - h(e_{1_a}, e_{2_a}) \\ &\approx \frac{\partial h}{\partial e_{1_a}}(e_{1_b} - e_{1_a}) + \frac{\partial h}{\partial e_{2_a}}(e_{2_b} - e_{2_a}) + \frac{1}{2} \frac{\partial^2 h}{\partial e_{1_a}^2}(e_{1_b} - e_{1_a})^2 + \frac{1}{2} \frac{\partial^2 h}{\partial e_{2_a}^2}(e_{2_b} - e_{2_a})^2 \\ &\quad + \frac{\partial^2 h}{\partial e_{1_a} \partial e_{2_a}}(e_{1_b} - e_{1_a})(e_{2_b} - e_{2_a}) \end{aligned} \quad (2.11)$$

$$\Delta\pi_{a,b} \approx \Delta\pi_{e_{1_a,b}} + \Delta\pi_{e_{2_a,b}} + \frac{\partial^2 h}{\partial e_{1_a} \partial e_{2_a}}(e_{1_b} - e_{1_a})(e_{2_b} - e_{2_a}) \quad (2.12)$$

Equation 2.12 clearly shows that, depending on the relations between the profit and the combination of the outputs e_1 and e_2 , the variation in profit resulting from a change in production from a to b (simultaneous variation in e_1 and e_2) can be either higher or lower

than the sum of the variations in profit that would result from independently changing e_{1a} to e_{1b} on the one hand, and e_{2a} to e_{2b} on the other. Figure 2.5 represents a situation in which the partial profit functions π_{e_1} and π_{e_2} are convex and strictly decreasing. In this example, ESs interact negatively. This leads to an increase in the opportunity cost of increasing e_1 when e_2 increases. Inversely, if there was a positive interaction between ESs, it would lead to a decrease in the opportunity cost of increasing e_1 when e_2 increases.

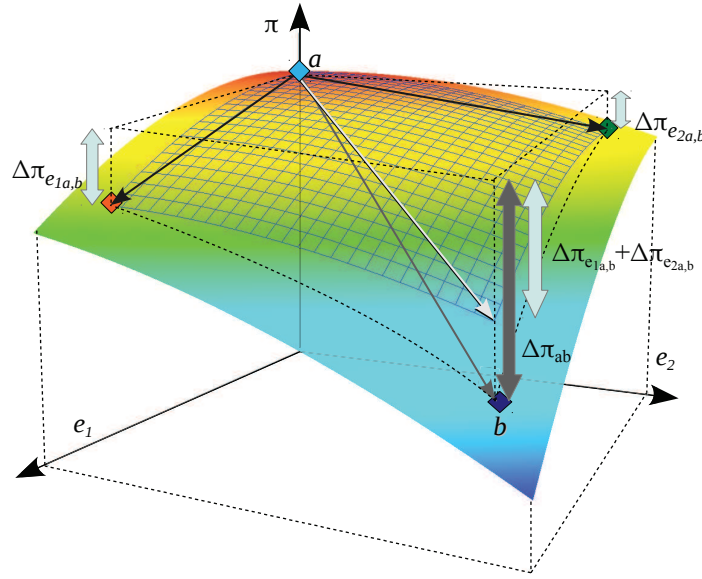

Figure 2.5: Variation in the maximum profit function ($\Delta\pi_{a,b}$) when the production of environmental services (e_1, e_2) changes from $a (\pi_a, e_{1a}, e_{2a})$ to $b (\pi_b, e_{1b}, e_{2b})$.

Starting from point a , any increase in ES provision is costly. Increasing e_1 from e_{1a} to e_{1b} while keeping e_2 at its original level e_{2a} costs $\Delta\pi_{e_{1a,b}}$ (and similarly for e_2). In the case represented here, the interaction between the ESs makes it more costly to increase the production of e_2 from e_{2a} to e_{2b} if the level of production of e_1 is e_{1b} instead of e_{1a} . The total opportunity cost of increasing the production of both e_1 and e_2 from a to b ($\Delta\pi_{ab}$) is higher than the sum of the partial costs of increasing each ES separately ($\Delta\pi_{e_{1a,b}} + \Delta\pi_{e_{2a,b}}$).

Figures 2.6 to 2.8 illustrate how different interactions between ESs affect the loss of total profit when ES provision is increased from $a(e_{1a}, e_{2a})$ to (e_{1a}, e_{2b}) , (e_{1b}, e_{2a}) or $b(e_{1b}, e_{2b})$. We present a simplified case in which the profit decreases linearly with the provision of one ES when the level of the other ES is kept constant at its original value a . The comments following each figure may be generally applied to any profit function that is convex with the provision of ESs.

We present three possible relationships between ESs and profit:

- Profit diminishes when the provision of either one or the other ES increases ($\frac{\partial h}{\partial e_1} < 0$ and $\frac{\partial h}{\partial e_2} < 0$). For example, carbon sequestration increases when the forest is dense and when harvesting is delayed well beyond Faustmann's optimum harvest age (Faustmann, 1849). At the same time, these lightly managed forests with old trees are likely to provide numerous recreational opportunities. However, letting the forest age in such

way requires an investment which will provide virtually no financial return. Increasing either ES induces a reduction in profits. This is a first order term that cannot determine the impact of increasing one ES on the costs of increasing the other.

- Profit increases when the provision of one ES increases but decreases with the other ($\frac{\partial h}{\partial e_1} > 0$ and $\frac{\partial h}{\partial e_2} < 0$ or inversely). For example, in forestry, growing large diameter trees not only increases profits (higher prices for higher quality wood), but also reduces net greenhouse gas emissions¹². Conversely, leaving large trees unharvested (and even large snags) is crucial to maintaining forest biodiversity, but the cost is high.
- Profit increases when the provision of either one or the other ES increases ($\frac{\partial h}{\partial e_1} > 0$ and $\frac{\partial h}{\partial e_2} > 0$). For example, biodiversity favors the resilience of forest stands to a certain extent, thus decreasing the risk of pest or disease infestations and their ensuing costs, and therefore increasing potential profits. Forests managed in a suboptimal way (it could be possible to provide more services and get more profit), can result from the forest manager's lack of knowledge or interest in the production process, but it also can be the consequence of the risk aversion of the forest manager, if risk increases with potential profits.

2.3.2 When ESs have independent opportunity costs

If the two ESs have independent effects on the maximum profit ($\Delta\pi_{a,b} = \Delta\pi_{e_{1a,b}} + \Delta\pi_{e_{2a,b}}$ ¹³) as illustrated in Figure 2.6, then the investments, or loss of profit, accepted to increase one of the services will not interact with the process of providing the other service and will neither reduce nor increase the opportunity cost of a higher provision of the second service. For example, increasing recreational access to a forest by blacktopping an existing forest road would not affect carbon sequestration in the trees. Suppose that the two services are independent and profits increase with service e_1 and decreases with e_2 then the loss of profit resulting from an increase in e_2 can be compensated for by an increase in e_1 . However, this compensation is impossible if the producers initially maximize their profits because they will already provide the highest level of e_1 (profits and e_1 are simultaneously maximized). If we suppose that both environmental services are compatible with making a profit, then a rational producer will maximize the provision of both ESs to make the maximum profit.

However, most examples in agriculture or forestry do not comply with the independence assumption because there are many interactions between the ESs and the stand or biological resource. Let us go on then to examine possible interactions between ESs.

2.3.3 When there is a synergy in ES provision

If profit decreases with both e_1 and e_2 in $E_{1_0} \times E_{1_0}$, and the two ESs interact positively ($\Delta\pi_{a,b} > \Delta\pi_{e_{1a,b}} + \Delta\pi_{e_{2a,b}}$ ¹⁴), then when increasing the provision of one service, the opportunity cost of increasing the second diminishes. Figure 2.7 shows an example in which

¹²Large diameter trees are expected to be used in the building sector, where the substitution effect is higher than in the energy sector.

¹³ $\frac{\partial^2 h}{\partial e_{1a} \partial e_{2a}} = 0$ in equation 2.12

¹⁴ $\frac{\partial^2 h}{\partial e_{1a} \partial e_{2a}} > 0$ in equation 2.12

the cost of providing the ESs (e_{1b}, e_{2b}) will be slightly higher than the cost of providing either (e_{1a}, e_{2b}) or (e_{1b}, e_{2a}) and much lower than the sum of the opportunity costs of separately providing the ES improvements.

If there is constant returns to scale and if the management unit (MU) can be decomposed into two sub-MUs which can be managed independently, then the lowest loss of profit resulting from an increase in both ESs simultaneously will be obtained if the two MUs are managed in the same way to produce the same mix of outputs. Uniform multifunctional production processes will be more financially efficient than specialized processes.

Note that if profit increases with one ES (e_1) and decreases with the other (e_2), and if there is synergy in the provision of the two ESs, then the opportunity cost of providing the second service will be lower if the provision of the first is maximized. Consequently, if the producers maximize their profits, then they will bear a lower opportunity cost for providing ESs e_2 than if they had not maximized their profits.

Finally, if profit increases with the production levels of both ESs, and if there is synergy in the provision of the two ESs, then the highest profit corresponds to the highest level of ES production. No incentive is required to produce ESs¹⁵ in this case.

2.3.4 When ESs conflict

The last case occurs when a conflict arises in the provision of the two ESs: providing more of one ES increases the cost of (or diminishes the maximum profit from) providing the second one ($\Delta\pi_{a,b} < \Delta\pi_{e_{1a,b}} + \Delta\pi_{e_{2a,b}}$ ¹⁶). Equation 2.13 shows that increasing the provision of e_2 from e_{2a} to e_{2b} would cost more (or bring in less profit) if e_1 is also increased from e_{1a} to e_{1b} (with $e_{2a} < e_{2b}$ and $e_{1a} < e_{1b}$).

$$\begin{aligned}\Delta\pi_{a,b} &= h(e_{1b}, e_{2b}) - h(e_{1a}, e_{2a}) \\ &= (h(e_{1b}, e_{2a}) - h(e_{1a}, e_{2a})) + (h(e_{1b}, e_{2b}) - h(e_{1b}, e_{2a})) \\ \Delta\pi_{a,b} &> (h(e_{1b}, e_{2a}) - h(e_{1a}, e_{2a})) + (h(e_{1a}, e_{2b}) - h(e_{1a}, e_{2a})) \\ &\Rightarrow h(e_{1b}, e_{2b}) - h(e_{1b}, e_{2a}) > h(e_{1a}, e_{2b}) - h(e_{1a}, e_{2a})\end{aligned}\quad (2.13)$$

With constant returns to scale, if the MU can be split into two independently managed sub-MUs (the total inputs being equal to the initial inputs), then the least costly management practice will be to increase the provision of e_1 in one of the sub-MUs and to increase the provision of e_2 in the other sub-MU (see point b' in Figure 2.8).

Here, specialization is more cost-efficient than standard management. Note that, as for a single ES with a non-convex profit function, the specializing production can offer less costly opportunities to improve ES provision, and in this case, the global profit function becomes convex (see equation 2.14).

¹⁵There are two potential reasons why an operator does not use this optimum production process: the operator may simply lack information or there are unmeasured drags (e.g. effect of this process on other by-products not evaluated in the study, increased risks, legal constraints).

¹⁶ $\frac{\partial^2 h}{\partial e_{1a} \partial e_{2a}} < 0$ in equation 2.12

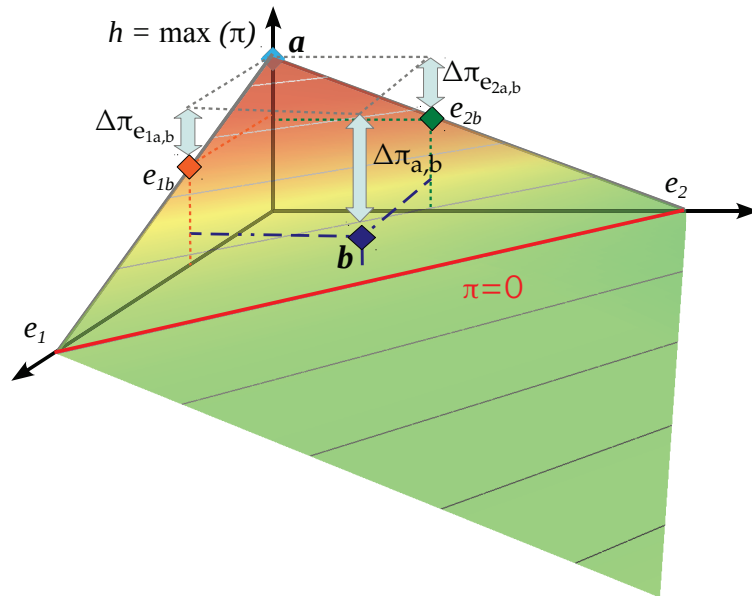

Figure 2.6: Maximum profit as a function of the provision of two independent ESs. Variation in the maximum profit function when ES production changes from $a (e_{1a}, e_{2a})$ to $b (e_{1b}, e_{2b})$. The independence of the opportunity costs means that the cost of increasing the provision of e_1 remains the same whether e_2 is e_{2a} or e_{2b} (and inversely).

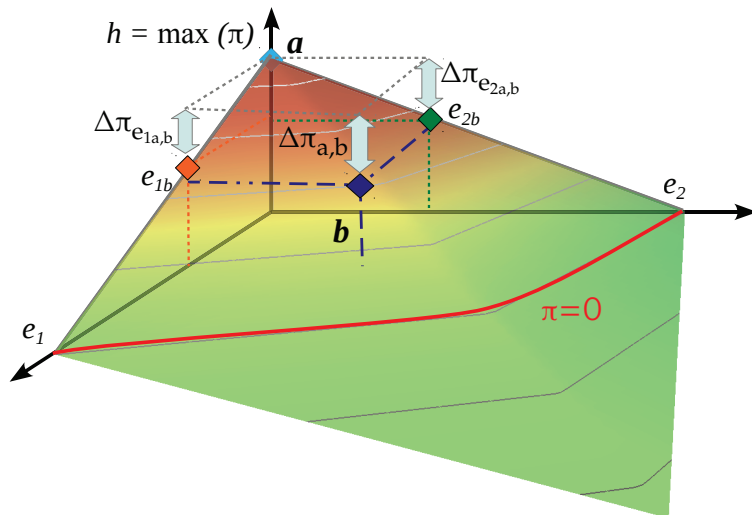

Figure 2.7: Maximum profit function when there is synergy in the provision of two ESs. Variation in the maximum profit function when ES production changes from $a (e_{1a}, e_{2a})$ to $b (e_{1b}, e_{2b})$. Because of the synergy in the production of the two ESs, the total opportunity cost of providing e_{1b} and e_{2b} simultaneously is lower than the sum of the opportunity costs of providing (e_{1b}, e_{2a}) and (e_{1a}, e_{2b}) independently.

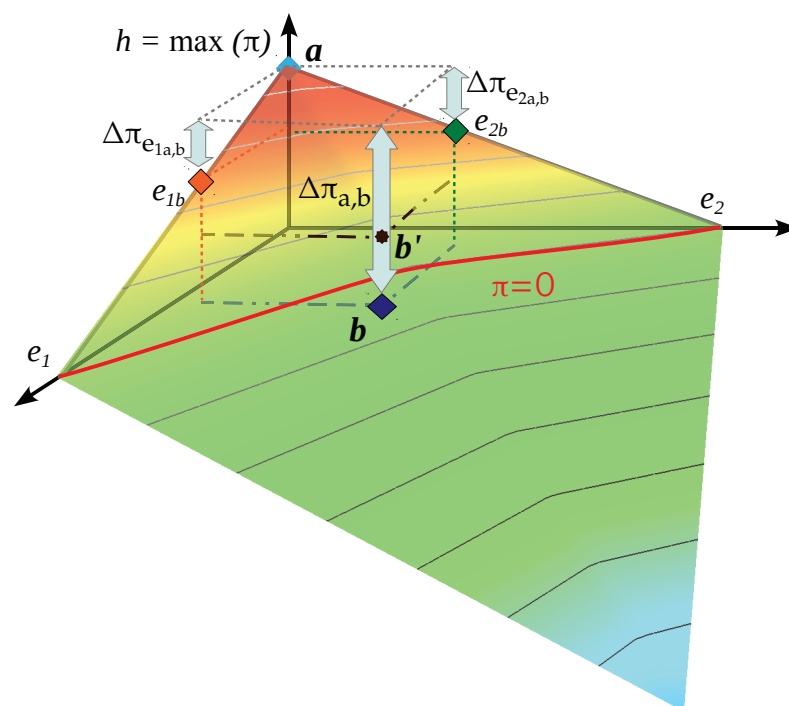

Figure 2.8: Maximum profit function when there are conflicts in the provision of two ESs.

Variation in the maximum profit function when ES production changes from a (e_{1a}, e_{2a}) to b (e_{1b}, e_{2b}). Because of the conflicts between producing the two ESs, the total opportunity cost of providing e_{1b} and e_{2b} simultaneously is higher than the sum of the opportunity costs of providing (e_{1b}, e_{2a}) and (e_{1a}, e_{2b}) independently. b is the optimum for single unit management; b' is the global optimum for two specialized management units.

$$\Delta\pi_{a,b'} = \alpha\Delta\pi\left(\frac{e_{1b} - e_{1a}}{\alpha}, e_{2a}\right) + (1 - \alpha)\Delta\pi\left(e_{1a}, \frac{e_{2b} - e_{2a}}{1 - \alpha}\right) > \Delta\pi_{a,b} \quad (2.14)$$

subject to

$$\begin{aligned} \alpha &\in (0; 1) \\ e_{1a} + \frac{e_{1b} - e_{1a}}{\alpha} &\in E_{1_0} \\ e_{2a} + \frac{e_{2b} - e_{2a}}{1 - \alpha} &\in E_{2_0} \end{aligned}$$

In this case, if profit decreases with the provision of each ES, then the simultaneous provision of both services costs even more than the separate provision of ESs. If profit increases with service e_1 then a producer who wants to maximize her profits will have higher opportunity costs for providing e_2 than a producer who does not. This can create situations in which lower profit makers are more likely to provide e_2 than profit maximizers. If the profit increases with each service, but the ESs interact negatively with each other, then an increase in e_2 becomes less profitable when the provision of e_1 increases. As long as the provision of e_1 does not reduce the profitability of e_2 to 0, then a producer maximizing her profit will offer both services. If the interaction between services is such that the provision of the second service becomes costly (see condition in equation 2.15), then one service will be given priority (most likely the one that makes it possible to reach the highest profit), the second one will be produced at a level which does not reduce the total profit. Mathematically¹⁷, if $\max_{e_1} h_{e_{2a}}(e_1) > \max_{e_2} h_{e_{1a}}(e_2)$, the producer will give priority to e_1 at the highest level possible e_{1_m} . The optimum level of e_2 production will be such that $\frac{dh_{e_{1_m}}}{de_2}(e_{2_m}) = 0$ or, using the approximation defined in equation 2.11:

$$\begin{aligned} h(e_{1_m}, e_{2_m}) &\approx h(e_{1_a}, e_{2_a}) + \frac{\partial h}{\partial e_{1_a}}(e_{1_m} - e_{1_a}) + \frac{\partial h}{\partial e_{2_a}}(e_{2_m} - e_{2_a}) + \frac{1}{2} \frac{\partial^2 h}{\partial e_{1_a}^2}(e_{1_m} - e_{1_a})^2 \\ &\quad + \frac{1}{2} \frac{\partial^2 h}{\partial e_{2_a}^2}(e_{2_m} - e_{2_a})^2 + \frac{\partial^2 h}{\partial e_{1_a} \partial e_{2_a}}(e_{1_b} - e_{1_a})(e_{2_b} - e_{2_a}) \quad (2.15) \end{aligned}$$

The approximation of the first order differential subject to a given value of e_{1_m} becomes:

$$\frac{\partial h}{\partial e_{2_m}}(e_{1_m}, e_{2_m}) \approx \frac{\partial h}{\partial e_{2_a}} + \frac{\partial^2 h}{\partial e_{2_a}^2}(e_{2_m} - e_{2_a}) + \frac{\partial h^2}{\partial e_{2_a} \partial e_{1_a}} \quad (2.16)$$

Which results in an approximate value of e_{2_m} subject to e_{1_m} of:

$$e_{2_m} \approx e_{2_a} - \frac{\partial e_{2_a}^2}{\partial^2 h} \left(\frac{\partial h}{\partial e_{2_a}} + \frac{\partial h^2}{\partial e_{2_a} \partial e_{1_a}} \right) \quad (2.17)$$

¹⁷With $h_{e_{2a}}(e_1) = h(e_1, e_{2a})$ the maximum profit as a function of e_1 with e_{2a} constant.

If this e_{2_m} value exists ($e_{2_m} - e_{2_a} \geq 0$ and $e_{2_m} \in E_{2_0}$) then the line containing all points m (e_{1_m}, e_{2_m}) separates the domain of increasing profit with both services from the domain of increasing profit with one service (e_1) and not with the other (e_2)¹⁸.

In Table 2.1, we summarize the possible interactions between ES provision and profit in the part of the production possibility set where ESs are freely disposable. Note that ESs may be freely disposable in some parts of the set, but in most cases, ES production possibility is likely to be limited and this creates additional constraints.

2.3.5 Characteristics of the profit function in the boundary of the ES set

In most production processes, environmental services are linked together. It is therefore possible to determine a two-ES production possibility set (PPS) in which, whatever the quantity of marketable product y , all possible combinations of e_1 and e_2 are included. Let ES_{x_0} be the ES production possibility set.

$$\begin{aligned} ES_{x_0} &= \left\{ (e_1, e_2) \in E_1 \times E_2 : \{ \exists y \in Y : F(y, e_1, e_2, x) \leq 0, x \leq x_0 \} \right\} \\ &= \{ (e_1, e_2) : \exists (y, e_1, e_2) \in S_{x_0} \} \end{aligned} \quad (2.18)$$

The envelope of the environmental PPS characterizes the relationships between the two environmental products. If ES_{x_0} is compact and convex, the external envelope can be described as the set containing both the maximum and the minimum of e_2 for each value of e_1 , and the maximum and the minimum of e_1 for each value of e_2 . This envelope gives information on the jointness in the ES production.

Let $f_M(e_1)$ be the maximum of e_2 corresponding to e_1 and $f_m(e_1)$ be the minimum of e_2 corresponding to e_1 .

- If $f_m(e_1)$ decreases in $E_{1_d} \subset E_1$, then increasing the provision of e_1 makes it possible to reduce e_2 . If the profit decreases with e_1 and e_2 , then because of the limits of the ES PPS, it would not be possible to decrease e_2 to maintain the same profit, unless the iso-profit curve has the same slope as $f_m(e_1)$ in this part of the set (see arrow *a* in Figure 2.9).
- Further, if $f_m(e_1)$ increases in $E_{1_i} \subset E_1$, then any increase in the provision of e_1 requires a simultaneous increase in e_2 (see arrow *b* in Figure 2.9). If the provision of environmental services is costly, then the obligation to increase in e_2 simultaneously with e_1 will lead to higher costs. In this case, the opportunity costs of increasing e_1 cannot be separated from the opportunity costs of increasing e_2 .
- If $f_M(e_1)$ increases in $E_{1_i} \subset E_1$, then the considered ESs are complements in this part of the production set. Any increase in the provision of e_1 creates opportunities to increase e_2 simultaneously (see arrow *c* in Figure 2.9). The effect of a simultaneous increase in environmental services depends on the relations between them and the profit, as

¹⁸Note that a similar situation can be theoretically found if profit decreases with two positively interacting ESs. The opportunity cost of providing a second ES while simultaneously providing a first one can become null or even negative (providing both ESs simultaneously would then be less detrimental to profits than providing just one).

Table 2.1: Impact of the interactions between profit and ES provision when ESs are freely disposable.

$\frac{\partial \pi(e_1, e_2)}{\partial e_1}$	$\frac{\partial \pi(e_1, e_2)}{\partial e_2}$	$\Delta \pi_{a,b} ? \Delta \pi_{e_1, a,b} + \Delta \pi_{e_2, a,b}$	Implications
–	–	>	Simultaneous increase in the provision of both ESs is less costly than independent provision
+	–	>	The opportunity cost of e_2 decreases with the increase in e_1 provision
+	+	>	Simultaneous increase in both ESs is the most profitable
–	–	=	The total opportunity cost is the same whether ES provision is increased simultaneously or separately
+	–	=	Providing more or less of e_1 has no influence on the opportunity cost of increasing e_2
+	+	=	Simultaneous increase in both ESs is as profitable as separated provision
–	–	<	Providing both ESs simultaneously is more costly than an independent provision; specialization is less costly
+	–	<	The opportunity cost of providing e_2 increases when e_1 provision increases
+	+	<	The profit from an increase in e_2 decreases with the increase in e_1 provision. In some cases, the provision of one of the services can become costly.

This table summarizes the conclusions depending on the individual interactions between ESs and the profit (two-first columns) and on the joint interaction between ESs (third column). The three first lines correspond to a synergy between ESs (see paragraph 2.3.3), the three lines in the middle correspond to independent ESs (see paragraph 2.3.2) and the three last lines correspond to conflicting ESs (see paragraph 2.3.4).

described previously. However, if the lowest opportunity cost is achieved while increasing both ESs at the same time (in the example, if profit decreases with e_1 and increases with e_2), this increase is limited to the level $(e_1, f_M(e_1))$. Because of this constraint, the minimum cost of providing e_1 might increase faster if the ES provision (e_1, e_2) is on the edge of the ES production possibility set (PPS) rather than in the middle of the PPS, where ESs are freely disposable.

- Further, if $f_M(e_1)$ decreases in $E_{1_d} \subset E_1$, then the ESs are substitutes in this part of the production set. Because of the tradeoff between the ESs, any increase in e_1 requires a reduction in e_2 , even if it would be less costly to maintain e_2 at the same level (see arrow d in Figure 2.9). The opportunity cost of increasing e_1 has two aspects: a loss of profit and a reduction in e_2 provision.

If the production systems are complex, the profit functions are likely to change in the different parts of the ES PPS. Therefore, the conclusions explained above will apply only to the subsets of the PPS where those characteristics are met.

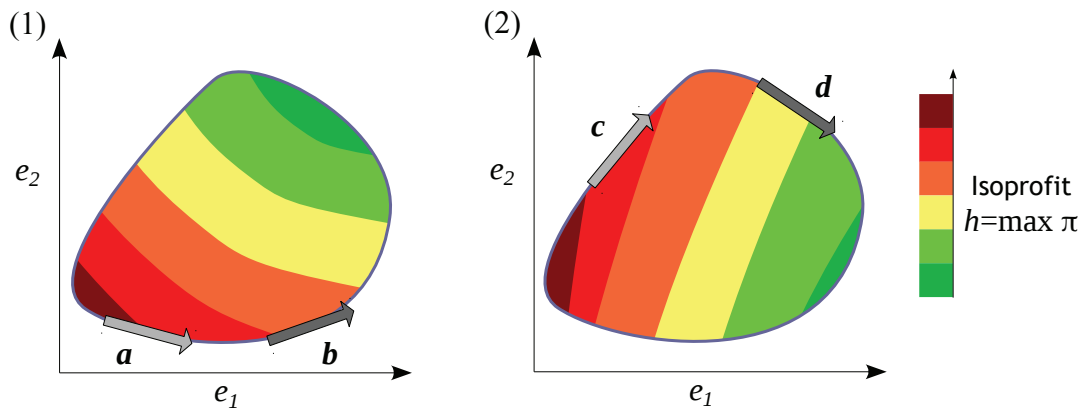

Figure 2.9: Environmental services production possibility frontier and profit function.

- (1) If the profit decreases with the production of both environmental services, then the lowest opportunity cost of an increase in the provision of e_1 is obtained along the lower part of the ES PPS envelope (lowest provision of e_2). The cost of the increase in the provision of e_1 can only be partly compensated for by a reduction in e_2 when $f_m(e_1)$ decreases (arrow a). If $f_m(e_1)$ increases (arrow b), then any increase in e_1 requires an increase in e_2 .
- (2) If the profit decreases with e_1 and increases with e_2 , then the most cost effective way of increasing the provision of e_1 is to follow the upper part of the ES PPS envelope (highest provision of e_2). If $f_M(e_1)$ increases, then the loss of profit resulting from an increase in e_1 can be reduced slightly as a consequence of an increase in e_2 (arrow c). If $f_M(e_1)$ decreases, then any increase in e_1 requires a reduction in both profits and e_2 (arrow d).

We have shown here that understanding the envelope of the ES PPS allows us to predict the possible impacts of an increase in one ES on the other one when the outputs are joint. To summarize, the PPS envelope gives information regarding:

- the limits of a possible reduction in one of the services when another one is increased;
- the likelihood of having to increase both services simultaneously;
- the tradeoff between services.

Combined with a function linking the maximum profit to the provision of ESs, it described how opportunity costs vary depending on the relationships between ESs. This information will help designing payments for environmental services (PES).

2.4 Impact of PES designs on multiple ES provision

As presented in section 2.2, interactions between ESs are likely to change the profitability or the opportunity costs related to increasing the production of the ESs. If there is under-provision of ESs even though the maximum possible profit would increase with higher ES provision, insufficient knowledge of the production possibilities – or unevaluated factors such as competing outputs, risks, scale or scope effects – may be responsible. Proposing compensation payment (e.g., PES) would not be financially efficient here because the payment would be compensating for an increase in production that could have happened in any case. More appropriate policy measures would include providing producers with better information or with training courses or giving them access to forest insurance.

However, in most situations, the under-supply of ESs results from the decrease in the maximum profit with the increase in ES production. PES is designed to encourage ES provision and the payments will have different effects depending on the applied payment scheme and on the concerned ESs. In the next section, we focus on payment related to a given increase in the level of ESs¹⁹ (output-oriented payment).

We evaluate the possible impact of a payment for one service alone on the provision of a second service. When two services are at stake, we analyze the interest of paying for a bundle of services or stacking payments.

2.4.1 Underlying hypotheses

We assume that the amount paid at least²⁰ compensates for the opportunity cost of the increase in ES provision (or for the absence of reduction in ES provision). Examples include contracts between forest owners and the State to maintain a specific ecosystem (the provider and the buyer agree on price and objectives). Note that, for a socially efficient contract, the amount of the compensation should not exceed the social value of the service which is however often difficult to estimate (Engel et al., 2008).

We also suppose that both profits and ES provision are certain and that there is no asymmetry of information between the landowners and the state during the negotiation phase. In case of uncertainty, the willingness to supply ESs will depend on the risk aversion of the supplier and on the difference in uncertainty between the marketable products and the environmental services. The absence of uncertainty makes payment related to output levels or to input levels equivalent. However, in reality, payment is not identical because the knowledge of the processes may be imperfect, measuring the outputs may sometimes be impossible, etc.

¹⁹Theoretically, payments to prevent ES provision from being reduced and payments to increase ES provision should be similar; but in practice, the amount paid for an increase in ESs is much higher than the amount paid for preserving the current level of ES provision (Engel et al., 2008)

²⁰The minimum amount of the compensation is equal to the opportunity cost plus the transaction costs, the costs of measuring the production, etc.

(Gibbons et al., 2011). For example, if a forester leaves some old trees in the forest to preserve cavity nester habitat, she bears the costs of unharvested trees, but she is not certain that cavity nesters will live in her forest. If the condition for the payment is the presence of old trees, then she is almost certain that she can achieve this goal. If the payment is subject to the presence of specific species or to the number of individual, then there is high uncertainty in the outcome of old tree retention and in the estimation of the bird diversity. These aspects could be subject to further developments and new research perspectives.

Gregersen et al. (2010) also highlighted that in some circumstances, the opportunity cost is an inappropriate estimate, in particular in case of illegal activities (illegal logging) or conflict with national policies. We will not discuss these situations, although in the case of illegal activities, paying to preserve environmental services is a tool that can be used along with regulations to discourage such practices (Kemkes et al., 2010).

An alternative to provider-buyer negotiations can be to define compensation based on the price per unit established on the market. The producer will be interested in providing ESs if the opportunity costs can be compensated for by a payment at market price. If this market price can be considered exogenous, the producer will provide ESs at the level at which the marginal cost of ES provision equals the market price per unit. Such a case occurs on the carbon market. If the producer provides the ESs in a cost-efficient manner and if the production function is convex, the total opportunity cost will be lower than the received payment. This mechanism may seem less efficient from the demand side (it would be possible to obtain more service for the same price), but often sits well with policy makers (auto-regulation of ES provision by the market).

Most authors set additionality as a primary condition for payments. The rationale of additionality is that payment is used to produce a service that would not have existed otherwise (Wunder, 2005; WRI, 2009). This concept can be extended to increases in the quantity or the quality of a service that would not be possible without payment and to avoided reduction in the supply of a service that would have occurred without payment. The objective of the payment mechanism is to avoid any environmental harm that would otherwise happen or to provide a service to offset the harm someone else has caused.

2.4.2 Payment for a single service

Global warming mitigation and reducing the loss of biodiversity are two ESs that have been recognized worldwide. Numerous PES examples have been set up, mainly in developing countries, to maintain the carbon stock in forests, to store additional carbon or to preserve sites for their biodiversity (see e.g. Zelek and Shively, 2003; Wunder, 2007; Barton et al., 2009). However, these incentives, which are directed at only one ES, have effects on other ESs and these effects are rarely monitored.

As we saw in paragraphs 2.2 and 2.3, in case of a tradeoff between the provision of a service e_1 and profit, there may be many different ways to increase the provision of e_1 . If a production process impacts the provision of two ESs e_1 and e_2 , but only one of them (e_1) is valued, then a producer maximizing her revenue will attempt to receive a payment which compensates for the minimum opportunity cost $\Delta h(e_1)$ of providing e_1 without taking e_2 into account: $\Delta h(e_1) = \max_{e_1} \pi(y, e_1, e_2)$. Let us denote $\Delta h(e_1, e_{2_0})$ the opportunity cost of a change in the

provision of e_1 subject to a constant provision of e_2 : $\Delta h(e_1, e_2) = \max_{e_1, e_2=e_2} \pi(y, e_1, e_2)$. As shown in paragraph 2.2.4, if $\Delta h(e_1) = \Delta h(e_1, e_2)$, then a payment to increase e_1 will not affect the provision of e_2 (see Figure 2.4, part 2). On the other hand²¹, if $\Delta h(e_1) < \Delta h(e_1, e_2)$, then increasing e_1 provision is less costly when e_2 provision is changed. Two cases are possible: the lowest opportunity cost is achieved either:

1. when e_1 and e_2 are simultaneously increased (see Figure 2.4, part 1);
2. when e_2 is decreased to compensate for the opportunity cost of providing more e_1 (see Figure 2.4, part 3).

In the first case, if a payment is proposed to increase e_1 provision, then the provision of the unvalued ES (here e_2) can also increase without additional financing. Payment for e_1 creates a new opportunity to promote the provision of e_2 . This is particularly interesting when e_2 has not been valued because of either a lack of knowledge of the service itself or because of the impossibility to properly estimate the service with existing tools. Moreover, if e_1 is more visible and the willingness to pay for it is higher (e.g. iconized endangered species; see Jacobsen et al., 2008), then promoting payment for the visible service can be a proxy for increasing the provision of other services (e.g., protecting global biodiversity). Another example is the European Union PES scheme to maintain agriculture in mountainous areas to preserve landscape quality; these traditional agricultural practices also play a role in protecting biodiversity²².

In the second case, a payment for e_1 will lead to a reduction in the provision of e_2 because it would cost more to maintain the second unvalued service as well. For example, if forest owners are paid to produce fuel wood and thereby participate in the reduction of net CO₂ emissions (e_1), then they may decide to convert their forests to short rotation coppice to provide the service more efficiently²³. This change in management would reduce the high level of biodiversity related to mature forests (e_2). In this case, paying for the production of one ES (e_1) will threaten another (e_2). To lessen this threat, policy makers can set constraints on the minimum provision of e_2 which is not subject to payment in the contract. Though this would raise the cost of the target increase in e_1 , such a cost might be acceptable to the owner if the opportunity cost of not harming e_2 ²⁴ does not exceed the economic value of e_1 .

Note that e_2 may be an unknown service, which consequently has never been given a defined economic value. However, later in the future, we may discover that the service is highly beneficial and that society has taken free advantage of it for years. This in fact, was the case for carbon storage in the forest. We should therefore try to anticipate the value of these currently unknown or unevaluated services. If they are destroyed because of our ignorance, the costs of restoring them can be extremely high. Moreover, the loss can be irreversible. Payment mechanisms and conditions must therefore be set as precisely as possible to avoid unpredictable or uncontrollable consequences.

²¹ $\Delta h(e_1) > \Delta h(e_1, e_2)$ is impossible because adding a constraint on e_2 can only reduce the profit possibilities. $\Delta h(e_1) = \max_{e_1} \pi(y, e_1, e_2) = \max_{e_1} \Delta h(e_1, e_2) \leq \Delta h(e_1, e_2)$.

²²Note that these services are also complements in the production process

²³If fuel wood is the only expected use of the wood products, continuing with longer rotations also produces fuel wood, but less profitably because the harvest will intervene much later

²⁴The opportunity cost of keeping e_2 while increasing e_1 equals $\Delta h(e_1, e_2) - \Delta h(e_1)$.

2.4.3 Bundling or stacking PES?

In the previous paragraph, we showed that payment for a single service when at least two are produced could lead to opportunities for or threats to other ESs. If both services are valuable, then we can propose payment for both services to limit the threat to one of the services. Two options are available (see Pagiola and Platays, 2002):

1. to pay for (or sell) a collection of services (bundling);
2. to pay for (or sell) each ES independently (stacking or layering).

Selling an increased provision of multiple environmental services as a bundle can be justified because the same change in production can sometimes simultaneously increase the provision of several ESs, as we have seen above. This is most likely to happen if the total opportunity cost can be supported by one single buyer and if the sum of the increases in value of the services provided is higher than the total opportunity cost. This type of payment is particularly relevant for inputs or management practices such as setting aside land (e.g., Nelson et al., 2008), or to preserve a specific land-use (e.g., Asquith et al., 2008) which has an impact on several outputs (carbon sequestration and species conservation in the first example; bird habitats and watershed protection in the second). However, if payment is subject to output levels, then the PES can be very difficult to manage because the mix of different services provided is likely to change over time. This argues in favor of assigning an independent payment to each service. Stacking payments may therefore be preferable.

Paying for each service independently can result in a global increase in all services. Furthermore, when payments are stacked, different buyers can contribute (e.g. one pays for the preservation of biodiversity and another one for carbon storage). Like single-buyer PES, the objective of the payment is to compensate for the opportunity cost of the ES provision. In some cases, the opportunity cost of increasing one ES cannot be compensated for by a payment for that service only because the opportunity cost to the provider is higher than the value estimated by the buyer. However, if a second ES can be provided simultaneously without any additional opportunity cost, and if there is a buyer willing to pay for the second ES, compensation becomes possible if the sum of the payments is greater than the total opportunity cost (see scenario m_1 in Figure 2.10). On the other hand, if payment for one service is sufficient to compensate for the total opportunity cost of the change, then the cogency of a second payment is questionable (see scenario m_2 in Figure 2.10); one of the payments is unnecessary because it does not directly lead to an increase in ESs that would not have happened otherwise (absence of additionality).

Stacking also creates the opportunity to offset the losses of some ESs resulting from the provision of another service. Let us suppose that the producer receives a first payment for an increase in e_1 that compensates for the lowest loss of profit resulting from this increase. If the second service e_2 is increased or stays at the same level, then no harm is done to e_2 . On the contrary, if e_2 diminishes (see Figure 2.4, part 3), then a second payment would allow the producer to keep e_2 at its original level (or even to increase e_2 provision). This would justify the stacked payment. However, in all fairness, the producer should be the one who pays for the second service, because the harm results directly from the options she chose when contracting for the first ES. The producer can then transfer the cost of preserving e_2 to the

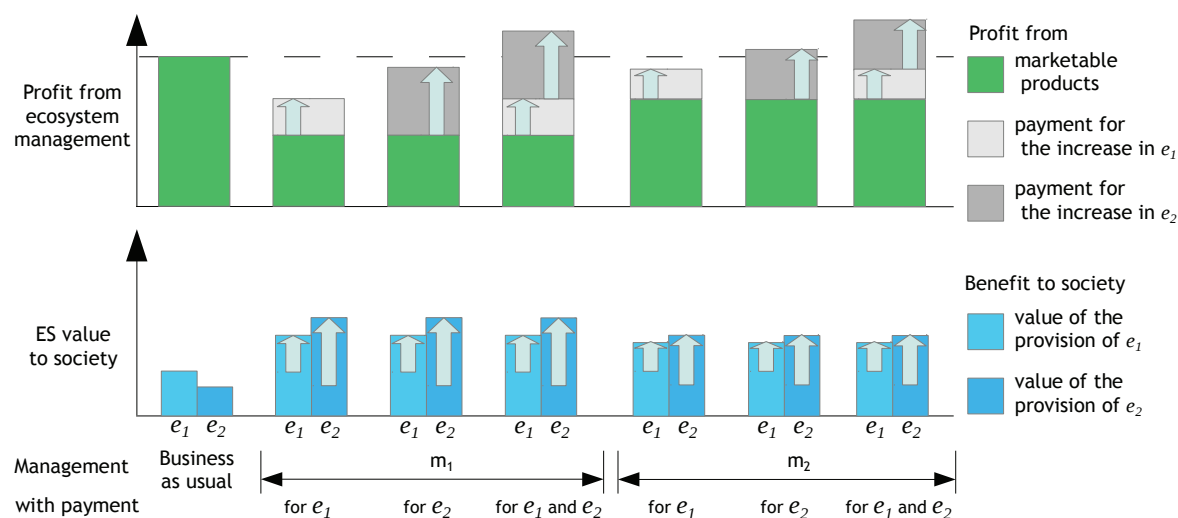

Figure 2.10: Opportunities offered by stacked (or layered) payment.

Business as usual is the reference scenario. Both alternative scenarios m_1 and m_2 shown above provide more ESs but less profit. m_1 is more costly, but provides the highest level of ESs. In m_1 , if payment is provided for either e_1 or e_2 alone, then the scenario cannot be financed. However, stacking payments for both e_1 and e_2 will compensate for the opportunity costs of m_1 and makes the scenario possible. In m_2 , payment for e_2 alone would be sufficient to finance the scenario. Stacking payments for increases in both e_1 and e_2 is questionable (not financially efficient). (adapted from WRI, 2009)

buyer of the first service for whom the total cost of the requested increase in e_1 becomes the opportunity cost subject to a constant level of other ES provision (see paragraph 2.4.2).

The interaction between ESs plays a role in the opportunity costs of providing the different services (see paragraph 2.3). When there is synergy in ES provision, if the producer finds a first buyer to finance an increase in e_1 at its original opportunity cost (see $\Delta\pi_{e_1,a,b}$ in Figure 2.7), and later finds a second buyer for an increase in e_2 , the opportunity cost supported by the second buyer could be lower than if the producer did not already have compensation for an increase in e_1 . Progressively stacking payment to the best advantage for a given environmental project can help raise the required funding²⁵.

Whatever the payment scheme, raising funds to maintain or increase the provision of ESs requires clearly understanding the production process and knowing where to find potential buyers for the different services offered. Such knowledge costs a lot (fixed costs to enter the PES market) but the investment will be rewarded if the contracts are large enough. Therefore, payments may rather concern several forest stands and properties rather than just one.

²⁵Timing can be crucial: if a project is started with a payment for one service, and funds are raised later for a second service, the options chosen at the beginning of the project may not leave enough possibilities to increase the provision of the second service.

2.4.4 PES portfolio strategies

Emerging regulations in favor of the environment, including the mandatory compensation of harm resulting from certain activities, are creating new business opportunities in the provision of ESs. Unfortunately, most firms that are potential ES buyers have limited knowledge of the potential ES providers. In many countries like France, these potential providers include a few large organizations (e.g. the National Forest Service, national parks, banks and insurance companies) and numerous small landowners. Though the national organizations are clearly visible in the sector, they potentially provide only a small fraction of the ESs. A huge part of the potential is in the hands of millions of small landowners. Consequently, there are expansion opportunities for brokerage companies that bring ES buyers and providers together. These firms have a crucial role to play in building provider databases and PES portfolios that correspond to the needs identified by the buyers. These portfolios must be designed to keep the costs of ES provision as low as possible and to limit the risks²⁶. To meet these goals, they can take advantage of the number of MUs in their portfolio and can allocate resources and objectives to the different MUs in the most efficient way.

Boscolo and Vincent (2003) demonstrated that the maximum profit as a function of the provision of one ES could be non-convex and that, in such a case, specialization is more efficient than standard management when several MUs are managed. In such a case of non-convexity at the MU level, a broker with a portfolio composed of several similar units (with the same accumulated production possibility) will have the opportunity to specialize the production in each unit, and thus have more production possibilities than a single MU manager such as a small forest owner (see paragraph 2.2.1). By choosing an appropriate portfolio strategy, a broker can provide ESs more cost-efficiently than a single producer could²⁷.

If two ESs are provided, then the same phenomenon of expanding production possibilities through the management of a collection of MUs can be demonstrated. Let $\Pi_{P_0}(e_1, e_2)_{nx_0}$ be the maximum profit equation corresponding to a portfolio P_0 of n similar production units $i \in [1, n]$ with a maximum profit function $h_i(e_1, e_2)_{x_0}$ as defined in equation 2.6 (x_0 is the vector of inputs, e_1 and e_2 are additive).

$$\Pi_{P_0}(e_1, e_2)_{nx_0} = \sum_{i=1}^n h_i(e_{1_i}, e_{2_i})_{x_0} \quad \text{subject to } e_1 = \sum_{i=1}^n e_{1_i} \text{ and } e_2 = \sum_{i=1}^n e_{2_i} \quad (2.19)$$

The average profit per unit is $\Pi_{P_0}(e_1, e_2)_{nx_0}/n$. This corresponds to one theoretical unit producing e_1/n and e_2/n . However, in a portfolio, if m ($m \leq n$) production units are managed to produce $h(e_{1_a}, e_{2_a})_{x_0}$ and the others $(n - m)$ produce $h(e_{1_b}, e_{2_b})_{x_0}$, then the average production per unit in the portfolio $P_{ma, (n-m)b}$ is:

²⁶We will not deal with the question of risks where since this question has been considerably investigated in the finance and insurance literature (e.g., Aigner et al., 2012)

²⁷Transaction costs may be higher with a broker, but the gain in efficiency resulting from their expertise (the lower cost of developing knowledge in processes and of measuring the achieved objectives) compensates for these costs.

$$\frac{1}{n} \Pi_{P_{m_a, (n-m)_b}}(m \cdot e_{1_a} + (n-m)e_{1_b}, m \cdot e_{2_a} + (n-m)e_{2_b})_{nx_0} = \frac{m}{n} h(e_{1_a}, e_{2_a})_{x_0} + \left(1 - \frac{m}{n}\right) h(e_{1_b}, e_{2_b})_{x_0} \quad (2.20)$$

The function in equation 2.20 is convex if n tends to infinity. The profit possibility at the broker level becomes nearly convex if the number of units is high²⁸, and this, even if the envelope of the maximum possible profit at the production unit level is not convex.

If a broker proposes several ESs and stacks the payments, defining the portfolio becomes more complex. He/she must take into account non-convexities related to single ES and must analyze the output mix (see section 2.3). We showed that simultaneously providing two ESs could sometimes cost more than providing each one independently. If this is the case, a broker will be able to adapt the portfolio to such characteristics by allocating some production units to the provision of one service and others to a different service. If ES values are additive, the global envelope of production possibilities corresponds to the convex envelope of each single-unit production set multiplied by the number of units (equation 2.20 multiplied by n).

Actually, a broker is unlikely to find several similar production units to set up her portfolio. If the units are similar, the allocation of the output mix to the units will have no influence on the global result (i.e. any of the units could provide any of the required services). If the units are dissimilar, analyzing the diversity of possible production levels in each unit should reveal the best ES to allocate to each unit in the portfolio. For example, if some of the units can produce biodiversity for a lower opportunity cost than others, priority for the production of biodiversity should be given to these units. The design and management of a portfolio require expert knowledge of the possibilities offered by each production unit. The professional broker has the expertise to allocate the various objectives to the forest stands depending on their capacity to provide the services at the lowest opportunity cost.

Conclusions

In this chapter, we have analyzed the maximum profit as a function of one and two environmental services. We showed that paying for one ES could threaten the other one if maintaining its provision level becomes more costly as a result of the increase in the first ES. We also showed that when both services can be valued and if there is synergy between them, it is advantageous to provide the two services simultaneously. On the contrary, if producing both services simultaneously is more costly than producing each one separately, specialization of the production units is desirable. Because of the complexity of the interactions and the possible economies of scope when several units are involved, management for ES provision and ES valuation opens a new market for brokerages or associations specialized in ES trading.

In the model we presented in this chapter, we assumed that the value of ESs was measurable and that a reference, such as the current or the desirable level of ES provision, could be defined.

²⁸If the production process displays constant returns to scale, then the allocation of the area (a major input) for each output mix creates a convex set. However, in most production processes such as forestry and agriculture, there is a minimum size required for the production (often referred to as indivisibility). This creates non-convexities (Tone and Sahoo, 2003).

However, this is not always true and ES value often complicated to measure. These difficulties to evaluate the contribution of a project to the increase in ES provision are an obstacle to setting PES, when additionality is the rule. Moreover, for some services like biodiversity, there is no certainty that the objectives will be met, even if all the means available are provided (Gibbons et al., 2011). Payment is often offered to encourage measures intended to increase the provision of services. However, precautions must be taken when payments are made for two complementary ESs to avoid double payment. Payment for both ESs is acceptable when the payment offered for one service is not sufficient to cover opportunity costs.

We elaborated our conclusions using the maximum profit function subject to ES supply. Designing such a function requires measuring the concerned ESs and their changes, determining the envelope of the ES production possibilities and estimating the maximum profit possible for each level of ESs. In the following chapters, we propose a method to estimate ES production and we show how this method is applicable in the forestry sector using a simulation approach.

Bibliography

- Aigner, P., Beyschlag, G., Friederich, T., Kalepky, M., and Zagst, R. (2012). Modeling and managing portfolios including listed private equity. *Computers & Operations Research*, 39(4):753–764.
- Asquith, N. M., Vargas, M. T., and Wunder, S. (2008). Selling two environmental services: In-kind payments for bird habitat and watershed protection in Los Negros, Bolivia. *Ecological Economics*, 65(4):675–684.
- Barton, D. N., Faith, D. P., Rusch, G. M., Acevedo, H., Paniagua, L., and Castro, M. (2009). Environmental service payments: Evaluating biodiversity conservation trade-offs and cost-efficiency in the Osa conservation area, Costa Rica. *Journal of Environmental Management*, 90(2):901–911.
- Boscolo, M. and Vincent, J. (2003). Nonconvexities in the production of timber, biodiversity, and carbon sequestration. *Journal of Environmental Economics and Management*, 46(2):251–268.
- Burton, A., Chilton, S., and Jones, M. (2000). The WTP/WTA discrepancy: A preliminary qualitative examination. *Environmental Values*, 9(4):481–491.
- Calkin, D. E., Montgomery, C. A., Schumaker, N. H., Polasky, S., Arthur, J. L., and Nalle, D. J. (2002). Developing a production possibility set of wildlife species persistence and timber harvest value. *Canadian Journal of Forest Research*, 32(8):1329–1342.
- Coase, R. H. (1960). The problem of social cost. *Journal of Law and Economics*, 3:1–44.
- de Groot, R. S., Wilson, M. A., and Boumans, R. M. J. (2002). A typology for the classification, description and valuation of ecosystem functions, goods and services. *Ecological Economics*, 41(3):393–408.
- Engel, S., Pagiola, S., and Wunder, S. (2008). Designing payments for environmental services in theory and practice: An overview of the issues. *Ecological Economics*, 65(4):663–674.
- Fare, R., Grosskopf, S., Lovell, C. A. K., and Pasurka, C. (1989). Multilateral productivity comparisons when some outputs are undesirable - a nonparametric approach. *Review of Economics and Statistics*, 71(1):90–98.
- Faustmann, M. (1849). Calculation of the value which forest land and immature stands possess for forestry. *Allgemeine Forst und Jagd Zeitung*, pages 441–455.
- Giampietro, M. (1997). Socioeconomic constraints to farming with biodiversity. *Agriculture Ecosystems and Environment*, 62(2-3):145–167.
- Gibbons, J. M., Nicholson, E., Milner-Gulland, E. J., and Jones, J. P. G. (2011). Should payments for biodiversity conservation be based on action or results? *Journal of Applied Ecology*, 48(5):1218–1226.
- Gregersen, H., El Lakany, H., Karsenty, A., and White, A. (2010). Does the opportunity cost approach indicate the real cost of REDD+? Rights and realities of paying for REDD+. Technical report, Rights and Resources, CIRAD. Available from: <http://www.rightsandresources.org/documents/index.php?pubID=1555>.
- Hailu, A. (2003). Pollution abatement and productivity performance of regional Canadian pulp and paper industries. *Journal of Forest Economics*, 9(1):5–25.
- Hotelling, H. (1947). Letter of June 18, 1947, to Newton B. Drury. Technical report, National Park Service. Included in the report *The Economics of Public Recreation: An Economic Study of the Monetary Evaluation of Recreation in the National Parks*, 1949. Mimeographed. Washington, D.C.: Land and Recreational Planning Division, National Park Service.
- Jacobsen, J. B., Boiesen, J. H., Thorsen, B. J., and Strange, N. (2008). What’s in a name? the use of quantitative measures versus ‘iconised’ species when valuing biodiversity. *Environmental and Resource Economics*, 39(3):247–263.
- Jaffe, A., Newell, R., and Stavins, R. (2002). Environmental policy and technological change. *Environmental and Resource Economics*, 22:41–70. 10.1023/A:1015519401088.

- Juutinen, A., Luque, S., Monkkonen, M., Vainikainen, N., and Tomppo, E. (2008). Cost-effective forest conservation and criteria for potential conservation targets: a Finnish case study. *Environmental Science and Policy*, 11(7):613–626.
- Kant, S. (2002). The marginal cost of structural diversity of mixed uneven-aged hard maple forests. *Canadian Journal of Forest Research*, 32(4):616–628.
- Kemkes, R. J., Farley, J., and Koliba, C. J. (2010). Determining when payments are an effective policy approach to ecosystem service provision. *Ecological Economics*, 69(11):2069–2074.
- Kline, J. D., Alig, R. J., and Johnson, R. L. (2000). Forest owner incentives to protect riparian habitat. *Ecological Economics*, 33(1):29–43.
- Knetsch, J. (1963). Outdoor recreation demands and benefits. *Land Economics*, 39(4):387–396.
- Knetsch, J. and Sinden, J. (1984). Willingness to pay and compensation demanded - experimental-evidence of an unexpected disparity in measures of value. *Quarterly Journal of Economics*, 99(3):507–521.
- Lichtenstein, M. E. and Montgomery, C. A. (2003). Biodiversity and timber in the coast range of Oregon: Inside the production possibility frontier. *Land Economics*, 79(1):56–73.
- Liu, S., Costanza, R., Farber, S., and Troy, A. (2010). Valuing ecosystem services. *Annals of the New York Academy of Sciences*, 1185(1):54–78.
- Liu, Y. and Sumaila, U. R. (2010). Estimating pollution abatement costs of salmon aquaculture: A joint production approach. *Land Economics*, 86(3):569–584.
- Martinez Cruz, D., Bustamante González, A., Jaramillo Villanueva, J., Silva Gómez, S., Tornero Campante, M., and Vargas López, S. (2010). Willingness to accept payments by forest owners for maintaining hydrologic environmental services. *Tropical and Subtropical Agroecosystems*, 12(3). Available from: <http://www.ccba.uady.mx/ojs/index.php/TSA/article/view/489>.
- Mitchell, R. and Carson, R. (1988). *Evaluating the validity of Contingent Valuation Studies*, pages 187–200. Venture Publishing Co., State College, PA. in Peterson, G., Driver, B., Gregory, R. (Eds.), *Amenity Resource Valuation: Integrating Economics with Other Disciplines*.
- Montgomery, C. A. (2002). Compatibility of timber and conservation: Tracing the tradeoff frontier. In Johnson, A., Haynes, R., and Monserud, R., editors, *USDA Forest Service General Technical Report Pacific Northwest*, volume 563, pages 225–232, Portland. US Department of Agriculture, Forest Service Pacific Northwest Research Station.
- Montgomery, C. A., Brown, G. M., and Adams, D. M. (1994). The marginal cost of species preservation - the northern spotted owl. *Journal of Environmental Economics and Management*, 26(2):111–128.
- Nalle, D. J., Montgomery, C. A., Arthur, J. L., Polasky, S., and Schumaker, N. H. (2004). Modeling joint production of wildlife and timber. *Journal of Environmental Economics and Management*, 48(3):997–1017.
- Nelson, E., Polasky, S., Lewis, D. J., Plantinga, A. J., Lonsdorf, E., White, D., Bael, D., and Lawler, J. J. (2008). Efficiency of incentives to jointly increase carbon sequestration and species conservation on a landscape. *Proceedings of the National Academy of Sciences*, 105(28):9471–9476.
- Pagiola, S. and Platais, G. (2002). Payments for environmental services. *Environment Strategy Notes*, 3:4. World Bank.
- Peters, C. M., Gentry, A. H., and Mendelsohn, R. O. (1989). Valuation of an Amazonian rainforest. *Nature*, 339(6227):655–656.
- Piot-Lepetit, I. and Le Moing, M. (2007). Productivity and environmental regulation: the effect of the nitrates directive in the French pig sector. *Environmental and Resource Economics*, 38(4):433–446.
- Polasky, S., Nelson, E., Camm, J., Csuti, B., Fackler, P., Lonsdorf, E., Montgomery, C., White, D., Arthur, J., Garber-Yonts, B., Haight, R., Kagan, J., Starfield, A., and Tobalske, C. (2008). Where to put things? spatial land management to sustain biodiversity and economic returns. *Biological*

- Conservation*, 141(6):1505–1524.
- Stone, M. and Reid, R. (1997). Opportunity costs of spotted owl management options for British Columbia. *Canadian Public Policy-Analyse de Politiques*, 23(1):69–82.
- Swallow, S. K., Parks, P. J., and Wear, D. N. (1990). Policy-relevant nonconvexities in the production of multiple forest benefits. *Journal of Environmental Economics and Management*, 19(3):264–280.
- Tone, K. and Sahoo, B. K. (2003). Scale, indivisibilities and production function in data envelopment analysis. *International Journal of Production Economics*, 84(2):165–192.
- Van Ha, N., Kant, S., and Maclaren, V. (2008). Shadow prices of environmental outputs and production efficiency of household-level paper recycling units in Vietnam. *Ecological Economics*, 65(1):98–110.
- Vardanyan, M. and Noh, D.-W. (2006). Approximating pollution abatement costs via alternative specifications of a multi-output production technology: A case of the US electric utility industry. *Journal of Environmental Management*, 80(2):177–190.
- Vincent, J. R. and Binkley, C. S. (1993). Efficient multiple-use forestry may require land-use specialization. *Land Economics*, 69(4):370–376.
- Wossink, A. and Swinton, S. M. (2007). Jointness in production and farmers’ willingness to supply non-marketed ecosystem services. *Ecological Economics*, 64(2):297 – 304.
- WRI (2009). Stacking payments for ecosystem services. *WRI Fact Sheet*.
- Wunder, S. (2005). Payments for environmental services: Some nuts and bolts. *Occasional Paper*. CIFOR, Bogor., 42. Available from: http://www.cifor.org/publications/pdf_files/OccPapers/OP-42.pdf.
- Wunder, S. (2007). The efficiency of payments for environmental services in tropical conservation. *Conservation Biology*, 21(1):48–58.
- Yang, H. and Pollitt, M. (2007). Distinguishing weak and strong disposability among undesirable outputs in DEA: The example of the environmental efficiency of Chinese coal-fired power plants. Cambridge Working Papers in Economics 0741, Faculty of Economics, University of Cambridge. Available from: <http://ideas.repec.org/p/cam/camdae/0741.html>.
- Zelev, C. A. and Shively, G. E. (2003). Measuring the opportunity cost of carbon sequestration in tropical agriculture. *Land Economics*, 79(3):342–354.

Chapter 3

Possibilities and costs of ES provision

A simulation approach

Ecosystems such as forests provide numerous goods and services. The goal of industrial producers is to maximize profits from their activities. If this activity is land management (e.g. forestry or agriculture), this maximum profit depends on the land production capacity, the available production technology and the cost of using this technology. Production processes can also use or produce goods and services such as biodiversity and amenities which are not directly costly or profitable to the producer but may have a social or a non-monetary value. Household producers, who use themselves part of their products, give value to part of these non-marketed goods and services such as recreation. However, some other products are not valued by any producer. To secure the provision of the social services, policy makers have to take measures. They need therefore information on interactions between the provision of public services and production of private goods as well as estimates of the opportunity costs of providing social services.

In chapter 2, we showed that the profit function subject to a definite provision of environmental services is an appropriate tool for decision-making. In this chapter, we propose a method to estimate such functions for ecosystem management processes such as forestry and agriculture at the stand level. The stand is considered as the smallest area on which a management practice can be applied. In other words, it corresponds to a decision making unit (DMU) which cannot be split. Because ecosystem management jointly provides numerous goods and services, we have to find a tool to envelop multi-dimensional non-convex sets in which outputs are partly complementary and partly substitutes. We firstly establish relationships between the production possibility set and the profit function, and then we review existing methods for determining the production possibility frontier from which we derive a methodology based on simulations to estimate possibilities and opportunity costs of providing environmental services (ES).

3.1 Variation in the profit function with ES supply

3.1.1 From production possibility sets to profit functions

Production processes with ES issues correspond to multi-output transformation processes with externalities as presented in section 2.2. The set of all possible combinations of marketable outputs y and other ecosystem services e subject to a limited quantity of inputs x is noted $P(x)$:

$$P(x) = \{(y, e) : x \text{ can produce } (y, e)\} \quad \text{with } (y, e) \in Y \times E \quad (3.1)$$

If the input quantities x can vary in X where X is a subset of \mathbb{R}^{+in} (*in* input numbers) limited by x_0 , then the PPS subject to $x \leq x_0$ becomes $P_{x_0} = \bigcup_{x \in X} P(x)$.

For industrial producers, y are the only desirable outputs and e are externalities. Household producers consider in their goals some non-marketed products e_1 (Tahvonen, 1999), but will not value the others (e_2 , with $e = (e_1, e_2)$ and $E = E_1 \times E_2$). The goal of land managers can be considered as minimizing the costs ($C(x) = p_x \cdot x$, with p_x the price of inputs¹ x) of producing the highest quantity of desirable goods and services (y, e_1). If there is a tradeoff between outputs, land managers will produce the combination of desirable outputs e_1 and profits that maximizes their utility functions \mathcal{U} subject to a maximum quantity of inputs x_0 which includes available land area, financial investment and labor (equation 3.2).

$$\max \mathcal{U}_{x_0}(\pi, e_1) = \max \mathcal{U}(p_y \cdot y - p_x \cdot x, e_1), \quad \text{with } (y, e_1, e_2) \in P_{x_0} \quad (3.2)$$

where \mathcal{U}_{x_0} is the utility function of the land manager² subject to a maximum input quantity x_0 . However, services not valued by the land managers (e_2) may also be impacted by management practices, for example if there are tradeoffs between productions, it would not be possible to produce the desirable outputs without reducing undesirable outputs, (see chapter 2). Therefore, profit possibilities as a function of both desirable and undesirable ES provision must be established to analyze both monetary and non-monetary³ opportunity costs of providing public ESs. Three steps are needed:

1. to analyze the PPS P_{x_0} ;
2. to determine the envelope of the PPS in the ES dimensions (including e_1 and e_2) together with possible productions of marketable products;
3. to calculate maximum profits for possible combinations of ES provision (i.e. in the ES PPS).

The profit function h subject to a limited quantity of inputs x_0 and the provision of environmental services (e_1, e_2) is as follows:

$$h(e_1, e_2) = \max_{y, x} (p_y \cdot y - p_x \cdot x) \quad \text{subject to } (e_1, e_2), \quad (y, e_1, e_2) \in P_{x_0} \quad (3.3)$$

¹ p_x is a line vector and x is a column vector.

²For an industrial manager, $\mathcal{U}_{x_0}(\pi, e_1) = \mathcal{U}_{x_0}(\pi, 0)$.

³ESs can benefit to private managers even if they are not marketed.

To envelop profit possibilities, an appropriate envelopment method must be applied because profits can be considered neither as an output nor as an input of the production process. To produce a quantity of desirable goods y_i , a minimum quantity of inputs x_i is required. Profits are therefore related to the production possibility frontier (PPF). If none of the outputs is marketed but inputs are used, profits are negative. It is impossible to produce outputs without using inputs and consequently, a process using zero inputs produces no profit: $P(0) = \{0\}$. Profits could be considered as a particular weakly disposable output which can be negatively or positively produced.

3.1.2 Particularities of ES provision by ecosystems

The environment provides services to human-beings even without human intervention. However, production processes such as agriculture and industry affect ESs. Depending on the type of service and the nature of the externality produced by production processes, ESs can be considered as inputs such as potable water in the beverage industry, or outputs such as CO₂ in the energy sector (Fare et al., 2004).

However, some services have complex relationships with production processes: they exist prior to the beginning of the production process and still exist after, but its characteristics are altered. Let us take the example of biodiversity and land-use changes. Natural and semi-natural forests provide habitats for a wide biodiversity. Converting these forests to agriculture modified habitats which became more suitable for other species. Converting these agricultural lands back to forest by means of plantations can recreate conditions favorable to some species endangered by farming activities (Brockerhoff et al., 2008). The conversion from agriculture to plantation forests can be considered as a process supplying habitat characteristics (output), but therefore, the agricultural ecosystem has to be replaced. If the value of the service is estimated in terms of the total value of the species in the area, afforestation can be interpreted as process using a certain level of biodiversity – provided by the agricultural ecosystems – to produce another level of biodiversity (converting forest to agriculture is the reverse process, but full reversibility is not certain). To take into account these ES characteristics, some authors proposed to define ESs as natural capital (Costanza and Daly, 1992; Harte, 1995) or environmental asset endowments (Aldy et al., 1998). Like with any capital, the process can use more ESs (supply of additional services) or less ESs (reduction in the services) than it produces.

The management of an ecosystem on a piece of land to provide goods and ESs is a particular process: the production process will unlikely consume the ESs entirely or produce no ES. Using the same example of biodiversity, if the change in land-use modified the habitats, new habitats are created and supply services: they host another kind of biodiversity. In these production processes, it is thus impossible to nothing out of something. This does not comply with the production theory which implies the possibility to produce nothing (zero outputs) out of something (non-zero inputs). Envelopment procedures must be adapted to these specific products.

3.1.3 Determining the production possibility set using surveys

Our goal is to describe the envelope of the ES PPS and the corresponding profit possibilities. The first step is to collect information on this set. In the farming sector, the PPS are observed using statistics elaborated from farmer surveys. Public institutes have collected information concerning the characteristics of the farms, their input uses such as land area, seeds, fertilizers, pesticides, labor and output produced such as quantities of meat, grain, vegetable or fruits and environmental impacts (see e.g. Boussemart et al., 2011; Piot-Lepetit and Vermersch, 1998). These data are available to compare the way farming technologies are used and to create a benchmark or level of reference.

In forestry, datasets describing the management over the entire rotation of a stand are rare, particularly when the rotation period is long (more than 100 years). Forests often change several times owners between the initial stage (regeneration or plantation) and the final harvest. Information concerning previous investments and harvests is rarely kept and transmitted from one owner to the other.

One of the most extensive databases on French private forest owners results from the survey conducted by the statistical service of the Ministry of Agriculture⁴ in 1999. This survey concerned 6995 forest owners which were asked to provide information on their forests (total area, location, forest type) and the quantity of harvested wood products in the last five years. However, these data cannot be used to determine production possibility frontiers because stand types and locations are too different. There is no possibility to estimate the site index and the maturity of the forests. Moreover, the 5-year window is too short to have enough information on wood harvest, especially on forest properties smaller than 10 ha.

The survey conducted in 2010 by the Laboratory of Forest Economics (INRA-AgroParisTech) and the French administration in charge of guiding private forest management⁵ (see section 1.4) showed that obtaining information on private forests over long periods with details concerning tree species and maturity is difficult, because many owners are not familiar with forestry. This last point is crucial if the goal of the study is to analyze multipurpose forestry including some environmental services such as biodiversity, which evaluation requires much time and specific knowledge such as the recognition of bird or beetle species.

During long rotation periods, the economic environment and the management objectives change. A well-known French example is the oak forest in Tronçais which was planted in the seventeenth century by Colbert, minister of Louis XIV, to supply the French navy. However, by the time trees were mature, navy's boats were made of iron and not wood. The forest remained a sanctuary for old oak, with high biodiversity and patrimonial value. Because of the modification in the objectives and in the value of the productions, management practices are progressively modified. Changes are different from one forest to another depending on the stand development stage at the time the management plan is modified. This creates many cases which are not comparable. To circumvent these lacks of information, modeling approaches can be used.

⁴In 1999, this survey was conducted by the *Service central des enquêtes et études statistiques* now replaced by the *Service de la statistique et de la prospective*.

⁵Centre national de la Propriété forestière

3.1.4 Modeling as a surrogate for surveys

Modeling the production possibility set

Biologists described the functioning of ecosystems such as fields and forests, and established models to predict the production of crops, wood, etc. as a function of inputs such as seeds, water or fertilizer, and management practices, e.g. ploughing, plantation period, harvesting techniques, etc. Some of these models are implemented in simulators. Economists can adapt these simulators for bio-economic modeling of land management practices such as forestry (see e.g. Montgomery, 2002; Polasky et al., 2008) and agriculture (Herrero et al., 1999). Simulation has several advantages over real datasets:

- inputs are clearly determined and output quantities are predicted with the same mechanisms for all scenarios;
- several management scenarios can be simulated, all other things being equal;
- the production system is controlled from the beginning to the end of the rotation, even if this lasts more than 100 years, and outputs can be predicted at each time.

This methodology has however several weak points. In general, the models have a validity domain which is limited (forest type, species, maximum age, etc.) compared to the whole set of possibilities. Moreover, it is possible to simulate unrealistic scenarios. Operating the simulator requires a good understanding of its structure and its prediction capacity together with knowledge of the real management practices to be able to criticize the results. Most simulators are deterministic and are consequently unable to represent random effects. Finally, models that integrate climate and meteorological interactions are complex to operate and prediction necessitate a long computation time which limits the simulation possibilities. A good practice with this simulation approach is to compare the *virtual* results with actual practices that can be observed at different periods.

Several steps are required to model a PPS (see Figure 3.1). First, even if we use simulated scenarios, we have to identify actual forest stakes, i.e. which products and services should be considered in the analysis, over which period. If outputs desirable to the producer are potentially taken into account, choosing the externalities (e.g. social services or non-used services) depends on the objective of the analysis. Second, for each selected output, means to measure the production have to be found, for example a number of items produced or the value of these items. For outputs which are not directly related to timber growth and harvest, such as biodiversity or landscape, values are not easy to estimate. Numerous indicators, based on elements that are favorable to these functions, exist. The appropriate indicator must be chosen, depending on the stakes and the management hypotheses that will be compared. Finally, a bio-technical model representing the considered ecosystem must be adapted to provide information on output quantities and others properties that are necessary to estimate the indicators. Finally the PPS can be determined by systematic exploration (methodology presented below) or by tracing the frontier using optimization algorithms (see e.g. Calkin et al., 2002; Boscolo and Vincent, 2003; Nalle et al., 2004).

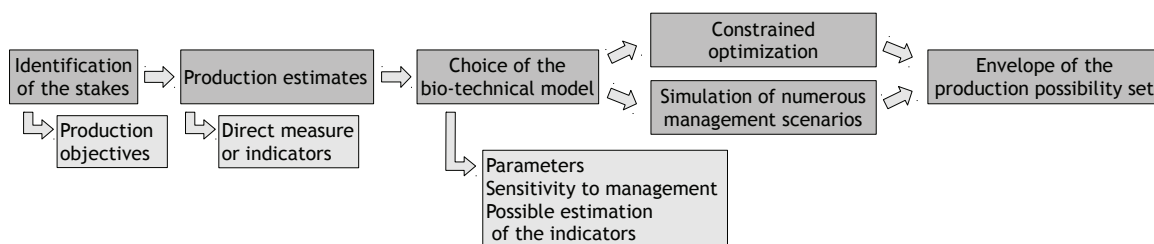

Figure 3.1: Two modeling approaches to find the envelope of a PPS

Constrained optimization has been used in several studies. The exploration of the set using the simulation of management scenarios requires a combination with statistical frontier estimates.

Establishing the profit possibility frontier

Many forest bio-economic studies aim at determining the highest possible profits as a function of the provision of environmental services (see e.g. Montgomery, 2002; Calkin et al., 2002; Boscolo and Vincent, 2003; Polasky et al., 2008; Juutinen et al., 2008). This function makes it possible to estimate the opportunity cost of preserving or increasing these services. The above-mentioned authors developed constrained optimization algorithms to find the envelope of the profit possibilities using one ES dimension (see Figure 3.2). For example, Calkin et al. (2002) used simulated annealing to establish the tradeoff between the net present value of wood production and the likelihood of species persistence. Using optimization methodologies, profit possibilities are determined directly, and the characterization of the PPS is not required. These methodologies give their best results when the bio-technical models are simple enough and can produce continuous predictions of output values.

However, when a production process is not continuous, the output set is likely to be not compact. For example, in forestry, it would not make sense to cut trees when the diameter threshold is exactly reached. The forester will wait for the best period for the operations (e.g. when trees have no leaves or when the soil is dry or frozen). So, simulating cutting possibilities only once a year seems appropriate, but it creates discontinuities in the possibilities (continuous modeling is theoretically possible, but it would increase the complexity of the simulator). Moreover, it is rare to wait less than 3 to 5 years between thinnings. Finally, when a stand is thinned, its characteristics change quickly (e.g. stand density, dead wood quantity, etc.) and so the provision of services. The output set might be discontinuous and non-compact.

Complex models often have to be simplified to be able to use optimization algorithm, and to verify that there is a solution subject to the set of constraints. These simplifications are even more important when the simulator uses several parameters that interact with each other. The simplified model makes it possible to examine the theoretical existence of a solution (Loisel and Dhôte, 2011).

On the other hand, we may want to benefit from the possibilities offered by the full simulator to analyze results corresponding to current practices (see for example Boscolo and Vincent, 2003, who compared existing practices to optimization results). Moreover, the complete simulator

may give information on the stand status that is appropriate to the estimation of the outputs considered in the study. Therefore, we propose a method using the *full simulator* to model the PPS. This approach can be decomposed in five steps:

1. specification of the possible range of the parameters which are constrained by the validity of the simulator and by realistic values;
2. first simulations to explore the PPS with a limited number of combinations of parameter values which covers the entire validity range of the simulator;
3. determination of the points on the envelope of a first profit possibility frontier;
4. identification of the factors determining the presence on the envelope and densification of the simulations in the relevant area (close to the profit possibility frontier);
5. envelope of the final set.

This methodology requires the combination of a growth model and an algorithm to determine the envelope of the ES PPS and the variation in the maximum profit subject to ES provision. To limit the number of simulations, we suggest to establish a first estimation of the profit possibility set before producing more simulated results in the part of the set that are relevant for the study. The production set corresponding to the simulator will be entirely described if all the possibilities are covered. However, with continuous parameters, this number is infinite. The limited set of parameter values must be established depending on the precision objective.

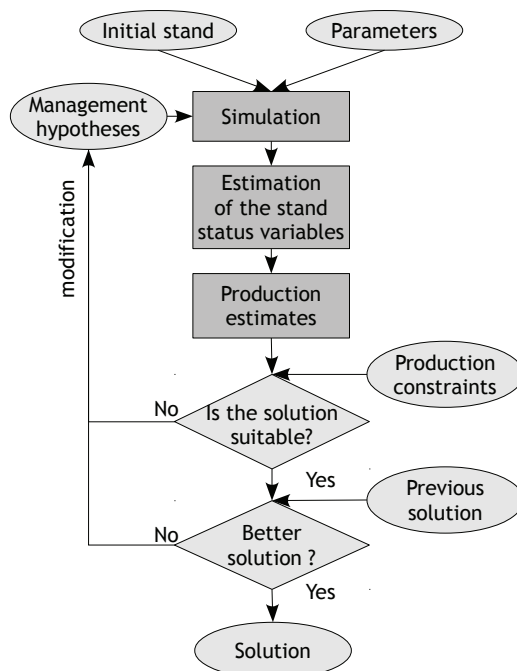

Figure 3.2: Determination of the profit possibility frontier using optimization

3.2 PPS envelopment

In the previous section, we saw that the PPS has several particularities that necessitate special adaptations of existing PPS envelopment methods. We present some methodologies that are commonly used to determine production possibility frontiers (PPF) and make use of their properties to develop a specific envelopment methodology.

The literature concerning PPF analysis started with the objective to compare the efficiency of production units when input and output quantities differ. Farrell (1957) proposed a conceptual framework for efficiency measurement. He set the first steps of the different envelopment methodologies. In his work, the production possibility envelope contains the production units that are fully efficient, in other words a production unit cannot produce more of one of the products (or reduce the consumption of an input) than a units on the frontier without increasing inputs or decreasing other outputs. The search for the PPF concerns the part of the production set where there are tradeoffs between productions (or substitutability between inputs). However, ES production may be complementary with the provision of goods in one part of the production set and substitutable in another part. In a two-dimension analysis, this PPF is the most interesting part. With more dimensions, there is interest in any portion of the envelope of the PPS where there is at least pairwise substitution. Because of this particularity, existing procedures may not be suitable, but their review provides information to establish our own approach.

3.2.1 Parametric modeling

Parametric modeling is used when it is possible to model or approximate the production with an analytical formula. Parametric frontiers include deterministic frontiers and stochastic frontier.

When the relation between inputs and outputs can be modeled using deterministic functions, a deterministic frontier can be estimated. This frontier corresponds to the following equation:

$$y_i = f(x_i; \beta) \cdot \exp(-U_i) \quad (i = 1, 2, \dots, N) \quad (3.4)$$

with: i : index of the decision making unit (DMU);

N : number of DMUs

y_i : output vector of DMU i ;

x_i : input vector of DMU i ;

U_i : positive random variable;

β : vector of parameters;

$f(x_i; \beta)$: standard production function (such as Cobb-Douglas, Translog, etc.).

This equation implies that the quantity of outputs is in a range between 0 and the maximum output quantity predicted by the production function $y_i = f(x_i; \beta)$ ($i = 1, 2, \dots, N$).

Aigner and Chu (1968) established this deterministic PPF using a Cobb-Douglas production function as an example, with industrial processes in mind. Russell and Young (1983) used Aigner and Chu's method to estimate the productivity of 56 farms in England. Following this first example, many other studies in the agricultural sector carried out deterministic frontier analysis (Battese, 1992). These studies mostly aimed at estimating the efficiency

of farm practices to produce goods (crop, meat, milk, etc.) at the lowest cost. Multi-output production processes were not modeled. This modeling approach imposes that every observation is below the frontier. This frontier is therefore sensitive to extreme values. These values may result from exceptional production conditions which are not representative of the usual conditions, from the variability in the production if the process is not deterministic, or from errors in estimating inputs or outputs. The frontier is likely to be overestimated.

To take into account variability in the production that cannot be explained by deterministic models, two groups of authors independently developed similar methods known as stochastic frontier analysis (SFA): Aigner et al. (1977) and Meeusen and Broeck (1977). SFA uses the same model structure as deterministic frontiers, but adds a random error variable V_i . This variable is centered and independent from U_i (see equation 3.5)

$$y_i = f(x_i; \beta) \cdot \exp(V_i - U_i) \quad (i = 1, 2, \dots, N) \quad (3.5)$$

Battese and Corra (1977) tested both deterministic and stochastic frontier analysis to evaluate the performance of sheep production in the Pastoral Zone of Eastern Australia using data from the Australian Grazing Industry Survey. They found significant differences between the frontiers obtained with the two methods. These differences were in favor of adding the stochastic effect in their analysis. These models have been extended for use with panel data which make it possible to evaluate the variation in efficiency with time (Pitt and Lee, 1981). This is especially interesting when the production process is influenced by external factors such as the weather.

In this literature survey, we have not found any application of parametric frontiers to analyze forestry. This may result from the impossibility to represent forest production with standard production functions or any similar function that can be estimated with linear or quadratic regressions. Moreover, the lack of detailed information on the entire production process (over the entire rotation) for several comparable production units makes it impossible to estimate the parameters. However, SFA methodology was used in forestry to determine self-thinning boundary lines (Weiskittel et al., 2009).

Even-though we cannot parameterize a forest production function using these approaches, we note that this production function could be derived from a bio-economical simulator. If the simulator includes stochastic effects, economical techniques can help estimate the resulting random variation in the outputs.

3.2.2 Non-parametrical methods

When transformation functions are complex, or even unknown, parametrical methods are not applicable. A second group of approaches based on the non-parametrical envelopment of inputs and outputs from observed decision making units (DMUs) was developed. Most commonly used methods are Data Envelopment Analysis (DEA), Free Disposal Hull (FDH) and derivative from these methods.

Data envelopment analysis (DEA).

In 1957, Farrell proposed to determine the convex envelope of the observed inputs and outputs using a piecewise linear function (see Figure 3.3). This idea had not been developed until Charnes, Cooper et Rhodes published an article in 1978 that firstly mentioned the method as *Data Envelopment Analysis* (DEA).

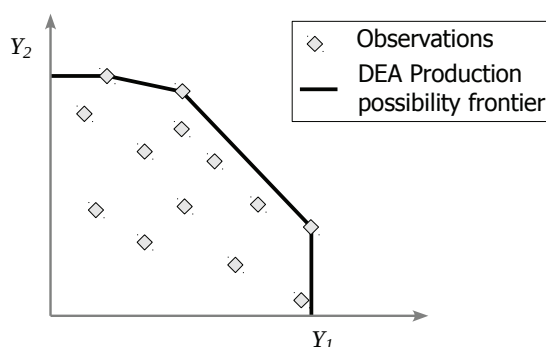

Figure 3.3: Output oriented PPF determined using DEA.

Observations on the PPF are considered as efficient. It is impossible to produce more of one output (e.g. y_1) without reducing the other (y_2).

If constant returns to scale (CRS) is assumed, the convex DEA PPF is defined as follows:

$$P_{DEA,CRS} = \left\{ (x, y) \mid x \geq \lambda_i x_i, y \leq \lambda_i y_i, x, y \geq 0, \lambda_i \geq 0, \quad i = 1, 2, \dots, N \right\} \quad (3.6)$$

with $x_i \geq 0$: input vector of DMU i

$y_i \geq 0$: output vector of DMU i

N : number of observed DMUs

To determine an output oriented PPF using DEA requires solving the mathematical problem in equation 3.7.

$$\begin{aligned} \min_{\nu, \mu} \quad & \nu^T x_o / \mu^T y_o \\ \text{subject to} \quad & \nu^T x_i / \mu^T y_i \geq 1 \quad (i = 1, \dots, o, \dots, N) \\ & \nu, \mu \geq 0 \end{aligned} \quad (3.7)$$

with:

o : index of the evaluated DMU;

$i = 1, \dots, N$: indices of all DMUs in the sample;

x_i : input vector of DMU i ;

y_i : output vector of DMU i ;

ν, μ : scalar corresponding to implicit costs and revenues;

T : transposition operator.

Charnes et al. (1978) reduced this non-linear and non-convex formulation of the problem to a linear programming problem known as CCR (initials of their three last names). With X the input matrix of the N DMUs and Y the output matrix of these same N DMUs, and subject to the same constraints of equation 3.7 the linear program is as follow:

$$\begin{aligned} \max_{\phi, \lambda} \phi & & (3.8) \\ \text{subject to } X\lambda &\leq x_o \\ \phi y_o &\leq Y\lambda \\ \lambda &\geq 0 \end{aligned}$$

where ϕ is a scalar λ is a vector.

To use this method the following assumption must be verified: the frontier is convex, returns to scale are constant, inputs and outputs are freely disposable and can be summed. This last characteristic is true in the general case (e.g. goods): outputs (and inputs) are measured in value which is directly linked to the quantity and quality of outputs (or inputs). The total value of outputs produced (or inputs used) by several DMUs is the sum of the values produced by each of them. However, this may not be the case of all ESs. As we will see in chapter 4, wood production and carbon storage are additive, but the preservation of bird species diversity is not additive.

The assumption of constant returns to scale in CCR is unlikely to be valid in production processes which are based on land management for two reasons. First, producers support fixed costs which are related to the activity but independent from the area (e.g. the cost of moving the harvesting tools to the forest). Second, the total value of provided ESs may depend on the managed area: e.g. ESs which have higher value per unit when supplied on small to medium areas than on very large areas or ESs which have almost no value when produced on too small areas. For example, recreation activities in forests require a sufficient area. Therefore, the value of this service increases with the extent of the forest from small to medium size forests (Abildtrup et al., 2011). Scale effects can thus be observed when dealing with ES provision. Banker, Charnes et Cooper (1984) adapted the CCR model to take into account variable returns to scale and to be able to make the distinction between DMUs that are technically inefficient or scale inefficient. Units are technically inefficient if they could produce more outputs with the same quantity of inputs (or reduce inputs needed to produce the same quantity of outputs) without changing the operating scale. They are scale inefficient if at the scale at which they operate, they appear efficient, but changing scale (increasing or decreasing inputs and outputs by a single factor), gives opportunities for progresses. To represent the scale effect, Banker et al. (1984) added to the linear program a constraint on the vector λ . Their program, called BCC is represented by equations 3.9.

$$\begin{aligned}
& \max_{\phi, \lambda} \phi && (3.9) \\
& \text{subject to } X\lambda \leq x_o \\
& \quad \phi y_o \leq Y\lambda \\
& \quad \lambda \geq 0 \\
& \quad \sum_i \lambda_i = 1
\end{aligned}$$

where ϕ is a scalar λ is a vector.

After these two initial steps, numerous adaptations of DEA were developed such as:

- Super-efficiency analysis, which consists in the evaluation of the efficiency of each unit using a frontier determined with a BBC DEA applied to a set that contains all observations except the evaluated unit. This relaxes the hypothesis that the maximum efficiency is 1 and it allows ranking the units according to their contribution to the determination of the frontier (Andersen and Petersen, 1993);
- Generalized DEA (GDEA) which includes both CCR and BCC program and additional developments. It integrates in particular DEA model with predilection cones which can be used to describe the preferences of the evaluator for a selected set of DMUs (Yu et al., 1996);
- Methods to evaluate processes with weakly disposable inputs or outputs (Korhonen and Luptacik, 2004). It has applications in environmental economics to consider in particular undesirable outputs (we develop this point p. 90).

The convexity of the set remains implicit in most DEA models. However, there are some reasons to anticipate non-convexities for the input or the output sets, for example because of decreasing marginal rate of production. Post (2001b) separated the PPS into two subsets and proposed a method in which the convexity is separately required for the output and the input sets. Post (2001a) also proposed a methodology to determine the frontier when one of those sets is non-convex, but there exist a function that transforms the non-convex production set in a convex set. He developed the trans-concave DEA model. This model requires that the output or the input sets are trans-concave. There is however still a need for additionality of the outputs and not all sets can be convexified. We therefore look at the FDH model which does not impose any condition concerning the convexity of the PPF.

Free Disposal Hull (FDH)

To analyze potentially non-convex PPF, Deprins et al. (1984) defined a piecewise linear envelop (see Figure 3.4) called free disposal hull. The equations corresponding to the FDH model are

the following:

$$P_{FDH} = \{(x, y) | x \geq x_i, y \leq y_i, x, y \geq 0, \quad i = 1, 2, \dots, N\} \quad (3.10)$$

with $x_i \geq 0$: input vector of DMU i

$y_i \geq 0$: output vector of DMU i

N : number of DMUs

Mathematically, the output oriented FDH model is as follows:

$$\begin{aligned} \max \beta_p & \quad (3.11) \\ \text{subject to } X\lambda & \leq x_p \\ \beta_p y_p & \leq Y\lambda \\ \sum_{i=1}^N \lambda_i & = 1 \\ \lambda_i & \in \{0; 1\} \quad (i = 1, 2, \dots, N) \end{aligned}$$

This model is based on several assumptions: outputs (respectively inputs) must be freely disposable⁶ and output values can be summed. This second condition is mathematically mandatory to use the linear programming definition. However, only comparability is required in the definition of the PPF (see equation 3.10). Such analysis would therefore make sense even if outputs produced by several DMUs cannot be added.

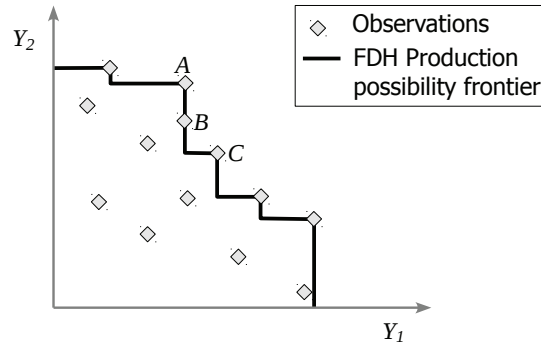

Figure 3.4: Output oriented PPF determined using FDH.

Observations on the PPF are considered as efficient. DMUs A and C are fully efficient: it is impossible to produce more of y_1 without reducing y_2 and inversely. DMU B is weakly efficient: it is impossible to produce more y_1 without reducing y_2 but it is possible to produce more y_2 without reducing y_1 (produce as much outputs as A).

A PPF determined using FDH is closer to the datasets than a PPF obtained with DEA: it corresponds to the smallest envelope of the data under free disposal hull assumption.

⁶Inputs (or outputs) are freely disposable if it is possible to use more of one input (or produce less of one output) without changing the level of consumption of other inputs and the production of outputs.

Therefore, the quality of the PPF estimated with such a method depends on the number of observations and this frontier is sensitive to extreme points. Moreover, the frontier might be underestimated, and efficiency over estimated: many DMUs are considered as efficient with this method whereas they would not be with DEA. Finally, some DMUs are on the frontier although there are possibilities to increase one of the outputs without reducing at least one of the others (see point *B* in Figure 3.4) – or to reduce one of the inputs without increasing at least one of the others. These DMUs are sometimes referred to as “weakly efficient” DMUs. DMUs for which there are no possibilities to increase any of the outputs without decreasing at least one of the others (see points *A* and *C* in Figure 3.4) – decrease any of the inputs without increasing least one of the others). These points are “fully efficient” DMUs.

To highlight the existence of these “fully efficient” DMUs and the outsiders position of some DMUs which draw the frontier, Van Puyenbroeck (1998), proposed to evaluate each DMU using the whole set of DMUs except the evaluated one (this work is based on Andersen and Petersen, 1993). This produces the program in equations 3.12, with m the number of inputs and r the number of outputs.

$$\begin{aligned}
 \max \beta_p & & (3.12) \\
 \text{subject to } \sum_{\substack{i=1 \\ i \neq p}}^N \lambda_i x_{i,j} & \leq x_{p,j} & (j = 1, 2, \dots, m) \\
 \sum_{\substack{i=1 \\ i \neq p}}^N \lambda_i y_{i,k} & \geq \beta_p y_{p,k} & (k = 1, 2, \dots, r) \\
 \sum_{i=1}^N \lambda_i & = 1, \lambda_i \in \{0; 1\} & (i = 1, 2, \dots, N)
 \end{aligned}$$

This modified FDH approach (called “A&P FDH”) evaluates the role that each observation plays in the determination of the frontier. It discriminates weakly efficient DMUs from fully efficient DMUs. In our example in Figure 3.4, DMU *B* is weakly efficient. The frontiers determined with the observation *B* or without this observation *B* would be the same ($\beta_B = 1$) and this does not come from the fact that there is another DMU that produces exactly the same amount of output with the same amount of inputs as *B*. On the contrary, DMUs *A* and *C* are fully efficient (β_A and β_C are greater than 1). Without the observations *A* or *C*, a different frontier would have been estimated. The efficiencies of DMUs below the frontier are the same as with standard FDH. The weak point of A&P FDH is that it is impossible to determine the parameter β_p for some DMUs.

To avoid such problems and to classify all DMUs, Jahanshahloo et al. (2004) developed a classification algorithm based on 0–1 linear programming (0–1 LP FDH). Unlike other approaches, the goal of this algorithm is not to estimate the efficiency of DMUs, but to describe the dataset precisely and to discriminate efficient DMUs from dominated DMUs. The classification algorithm considers a DMU p as efficient if there is no other DMU i in the set of DMUs $i \in [1, N]$ such that:

$$\begin{pmatrix} Y_p \\ -X_p \end{pmatrix} \leq \begin{pmatrix} Y_i \\ -X_i \end{pmatrix} \text{ and } \begin{pmatrix} Y_p \\ -X_p \end{pmatrix} \neq \begin{pmatrix} Y_i \\ -X_i \end{pmatrix} \quad (3.13)$$

In other words, DMU p receives a score of 1 if no other DMU can produce at least as much outputs with as little inputs as p if it does not produce the same quantities of outputs with the same quantities of inputs as p . If DMU p is dominated by any other DMU, then it receives a score of 0.

Sun and Hu (2009) proposed another DMU ranking methodology based on the model from Mehrabian, Alirezaee and Jahanshahloo (MAJ, 1999). MAJ is an adaptation of Andersen and Petersen's model (Andersen and Petersen, 1993) that uses an additive term (ω_1) in the estimate of the efficiency allowing changes in the output mix. Sun and Hu (2009) relaxed the convexity assumption of the MAJ model. Their model (MAJ FDH) corresponds to equations 3.14 where η_p is called the super efficiency of DMU $_p$.

$$\begin{aligned} \eta_p &= \max(\omega_p + 1) & (3.14) \\ \text{subject to } & \sum_{\substack{i=1 \\ i \neq p}}^N \lambda_i x_{i,j} \leq x_{p,j} & (j = 1, 2, \dots, m) \\ & \sum_{\substack{i=1 \\ i \neq p}}^N \lambda_i y_{i,k} \geq y_{p,k} + \omega_p & (k = 1, 2, \dots, r) \\ & \sum_{i=1}^N \lambda_i = 1, \lambda_i \in \{0; 1\} & (i = 1, 2, \dots, N) \end{aligned}$$

MAJ FDH makes it possible to rank the efficiency of more DMUs than A&P FDH, but the evaluation of the efficiency for some DMUs remain unfeasible (e.g. when one of the outputs is not produced by one the DMUs).

Different methods can consequently be used to analyze the performance of DMUs. With MAJ FDH, a DMU with a super-efficiency of 1 does not necessarily imply that this DMU is on the frontier. FDH, A&P FDH, 0–1 LP FDH and MAJ FDH methods give different ranking results. With all these methods except FDH, fully efficient DMUs can be discriminated from weakly efficient DMUs. If the purpose is to determine the smallest set of DMUs that can describe the frontier, 0–1 LP FDH seems appropriate. It is also usable even when outputs are not additive. In the case of forestry – the example that we develop in this thesis – some hypotheses in this framework are however missing and in particular free disposability.

Free Coordination Hull (FCH Green and Cook, 2004) is one of the last developments concerning non-convex non-parametric frontiers approach. These authors take into account the fact that proportionally reducing the production of DMUs (e.g. if there is a minimum size for the production technology) as in DEA might be impossible, but they assume that comparing a DMU C not only to two DMUs $A(y_A, x_A)$ and $B(y_B, x_B)$ as in FDH, but also to a DMU $(A+B)(y_A+y_B, x_A+x_B)$ makes sense. This gives the possibility to analyze potential gains in efficiency when specializing the production. Blancard et al. (2011) used this method to analyze the potential increase in efficiency resulting from the farm specialization. The same approach can be used to evaluate the most efficient production in two forest stands which can be managed to produce on each of them either y_A , y_B or y_C . If only uniform management is accepted, then these two stand will produce $2y_A$, $2y_B$ or $2y_C$. Comparison of the efficiency

will be possible using FDH. On the other hand, if specialized management is accepted, then the production possibilities are $2y_A$, $2y_B$, $2y_C$ but also $y_A + y_B$, $y_A + y_C$ and $y_B + y_C$. One of these sums (e.g. $y_A + y_B$) might make it possible to produce more than the uniform optimum management y_C (see Figure 3.5). This principle is particularly relevant when upscaling the PPF from the minimum DMU scale (scale at which only one type of management can be applied) to the landscape scale or at the scale of large forest properties.

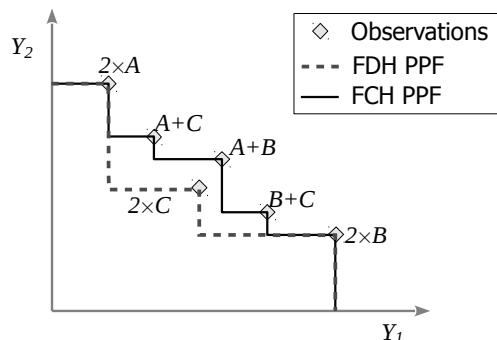

Figure 3.5: Comparison between output-oriented PPF determined using FDH and using FCH.

Here $2 \times C$ appears efficient using FDH, but if there is no constraint on uniform management, $A + B$ on the FCH PPF would be more efficient.

Relaxing the free disposal hypothesis

Free disposability of both inputs and outputs is assumed in all previously presented models. However, in many production processes, outputs cannot be considered as freely disposable, especially if there are externalities. Methods to take into account undesirable outputs such as air, water and soil pollution, in evaluations of the efficiency of production systems (see paragraph 1.1.3) were mainly developed in environmental economics. These undesirable outputs are sometimes considered as inputs in the production function to represent the fact that their production may induce complementary production costs. However, if it is impossible to produce the desirable goods without polluting, these inputs can also not be considered as freely disposable. Another critique of considering undesirable outputs as inputs is that the relations between desirable and undesirable outputs are broken. If we take such a modeling approach, a process producing nothing (zero outputs) could then ruin the environment (the consumption of environmental quality being considered as an input). This is however impossible, since the consumption of the environment in this case comes from the production of the output. Färe and Grosskopf (2003) made a similar observation on Hailu and Veeman's approach of undesirable outputs using a nonorthodox monotonicity condition (Hailu and Veeman, 2001). These methods are thus not adapted. The free disposal hypothesis must be relaxed.

Chung et al. (1997) described the joint production of undesirable outputs and (b) and desirable outputs (y) with three hypotheses: (1) undesirable outputs are weakly disposable, (2) desirable outputs are freely disposable and (3) null-joint production of the two undesirable outputs. Let $P(x)$ be the PPS using input quantities x : $P(x) = \{(y, b) : x \text{ can produce } (y, b)\}$. The first

proposal implies that, given an input quantity x , reducing undesirable outputs cannot be done without reducing the production of desirable outputs: $\{(y, b) \in P(x), 0 \leq \theta \leq 1\} \Rightarrow (\theta y, \theta b) \in P(x)$. The second proposal says that it is possible to reduce the production of desirable outputs without reducing undesirable outputs produced: $\{(y, b) \in P(x), y' \leq y\} \Rightarrow (y', b) \in P(x)$. Finally, the third proposal implies that producing no undesirable outputs necessitates to produce no desirable outputs either: if $(y, b) \in P(x)$ and $b = 0$ then $y = 0$. Using these proposals, Chung et al. (1997) developed a model based on DEA to determine the convex frontier when undesirable outputs are not freely disposable (but inputs and desirable outputs being freely disposable) and if the technology exhibits current returns to scale. Färe and Grosskopf (2009) extended this algorithm to define a PPF with undesirable outputs, if the set is convex and if the technology exhibits variable returns to scale (see equations 3.15).

$$\begin{aligned}
 P = \left\{ (y, b, x) \mid \right. & \theta \sum_{i=1}^N \lambda_i y_{i,k} \geq y_k, & k = 1, \dots, r \\
 & \theta \sum_{i=1}^N \lambda_i b_{i,l} = b_l, & l = 1, \dots, s \\
 & \sum_{i=1}^N \lambda_i x_{i,j} \leq x_j, & j = 1, \dots, m \\
 & \sum_{i=1}^N \lambda_i = 1, & i = 1, \dots, N \\
 & \lambda_i \geq 0, & i = 1, \dots, N \\
 & \left. 0 \leq \theta \leq 1 \right\}
 \end{aligned} \tag{3.15}$$

N : number of observed DMUs $y_{i,k}$: desirable output k of DMU i
 with: $b_{i,l}$: undesirable output l of DMU i $x_{i,j}$: inputs j of DMU i
 λ : vector of N intensity variables θ : disposability parameter (or abatement factor)

Kuosmanen and Podinovski (2009) criticize this formulation of the weak disposability of undesirable outputs that uses a single abatement factor θ (scalar) because frontiers established with this method give too restrictive envelopes of the PPS. It excludes some production possibilities and in some cases, the convexity assumption can be violated. They propose to use a vector of abatement factors θ_i ($i \in 1, \dots, N$) instead of a single scalar (see equation 3.16).

$$\begin{aligned}
P = \left\{ (y, b, x) \mid \right. & \sum_{i=1}^N \theta_i \lambda_i y_{i,k} \geq y_k, & k = 1, \dots, r \\
& \sum_{i=1}^N \theta_i \lambda_i b_{i,l} = b_l, & l = 1, \dots, s \\
& \sum_{i=1}^N \lambda_i x_{i,j} \leq x_j, & j = 1, \dots, m \\
& \sum_{i=1}^N \lambda_i = 1 & i = 1, \dots, N \\
& \lambda_i \geq 0, & i = 1, \dots, N \\
& 0 \leq \theta_i \leq 1 & i = 1, \dots, N \left. \right\}
\end{aligned} \tag{3.16}$$

These developments show that the DEA linear programming method can be adapted to take into account weak disposability. The combination of the disposability parameter and the intensity variables create a two-way envelope: if a process produces desirable goods and externalities, the PPF of desirable goods is the frontier between the PPF of all outputs (where it is impossible to produce more externalities without reducing the production of desirable goods) and the part of the envelope where externalities have characteristics similar to inputs (producing more desirable goods requires an increase in externalities). Such two-way envelopes of the production possibilities are particularly relevant for the analysis presented in chapter 2. However, as mentioned above (see page 86), the convexity of the PPS envelope that we analyze is not ensured. Moreover, we are interested in possible non-convexities. An FDH approach seem more appropriate, but adaptations made to DEA to take into account weekly disposable outputs cannot be transposed to FDH-like⁷ methods because they imply that the frontier is convex in the part in which desirable and undesirable outputs are complementary⁸. In multipurpose forestry, the core of the production is the natural growth of the trees. Forest management operations aim at modifying the natural production to meet some objectives. The same operation can affect several outputs positively or negatively depending on the nature and the intensity of the operation and the relation between outputs. Because of these interactions, forest outputs are not freely disposable. Moreover, many biological processes react non-linearly to management practices. This is likely to create non-convexities in the PPF. A particular development is thus required.

⁷The tree disposability of inputs and outputs is a basic assumption in FDH.

⁸Frontiers established using conventional DEA are convex envelopes of the tradeoff between outputs corresponding to the part of the PPS where producing more desirable outputs necessitate reducing the production of undesirable goods.

3.3 Enveloping a non-convex production set with weakly disposable outputs

We want to establish the smallest non-convex envelope the PPS of a forestry process with weakly disposable externalities at the DMU level⁹. Estimating the efficiency of all DMUs is not the major issue, but determining fully efficient DMUs as in Jahanshahloo et al. (2004, see equation 3.13) is. We propose here a methodology to envelope the PPS of DMUs subject to fixed input quantities x . Let $P(x)$ be this PPS of desirable outputs y and externalities e . $P(x) = \{(y, e) : x \text{ can produce } (y, e)\}$.

Two particularities of production systems based on forest ecosystems are important to define the PPS envelope:

- Environmental services may exist even without human interaction: the vegetation grows naturally on unmanaged lands; this participates to climate regulation and provides habitat for various species. Producing zero output is then impossible.
- The weak disposability assumption may not only be valid for externalities, but also to desirable outputs. For example, keeping more biodiversity can increase net primary production (Loreau et al., 2001).

We consequently propose to allow weak disposability of all outputs, and to analyze the envelope in every direction. We consider that an observation belongs to the envelope if there is no other observation in the set that produces (1) strictly more of one output and at least as much or as little of the other outputs, or (2) strictly less of one output and at least as much or as little of the other outputs. In a process producing one desirable output y and one externality e , the envelope E_{S_x} of the PPS $P(x)$ is defined as follows:

$$E_{S_x} = \left\{ \begin{array}{l} \left(\begin{array}{c} y_i \\ e_i \end{array} \right) \in P(x) \mid \left\{ \begin{array}{l} \nexists \left(\begin{array}{c} y_j \\ e_j \end{array} \right) \in P(x), i \neq j \mid \{y_j > y_i, e_j > e_i\} \\ \text{or } \{y_j > y_i, e_j < e_i\} \\ \text{or } \{y_j < y_i, e_j > e_i\} \\ \text{or } \{y_j < y_i, e_j < e_i\} \end{array} \right\} \end{array} \right\} \quad (3.17)$$

This can be seen as an extension of the 0–1 LP FDH (see equation 3.13). The conditions are represented in Figure 3.6. If we divide the production space into sectors corresponding to each condition mentioned above, an observation is included in the envelope if at least one of the sectors is empty. Figure 3.7 shows the envelope of the set represented in Figure 3.6 determined using the method described in Equation 3.17.

When three outputs are observed, the output space is split into height parts (2³). As previously mentioned, an observation is in the envelope if one of these subspaces is empty. In the part of the set where there is a tradeoff between outputs, this envelope corresponds to the FDH PPF. It can be determined using FDH programs repeatedly: one time with all outputs as outputs, then changing every weakly disposable output to input one at a time, then for all combinations. DMUs that are at least one time on the PPF are part of the envelope.

⁹A DMU here is the smallest forest area on which management can be applied. On this area, uniform management only is applicable.

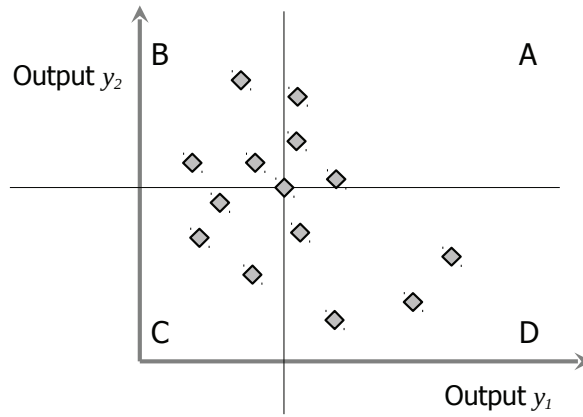

Figure 3.6: Subsets of the production space to determine if a DMU is in the PPS envelope.

A DMU belongs to the PPF envelope if at least one of the sectors A, B, C or D is empty.

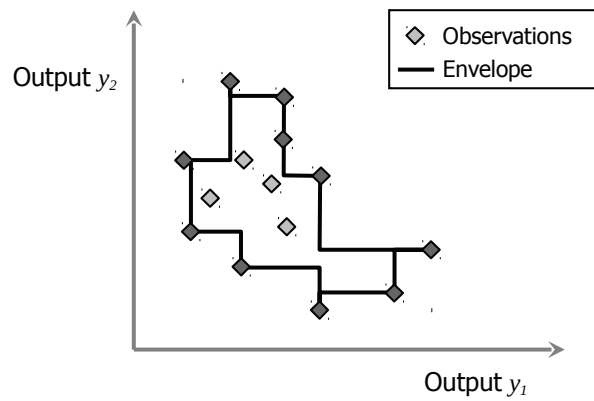

Figure 3.7: Envelope of a two-output production set.

Observations in dark gray belong to the PPS envelope.

The determined envelope suffers from the same critiques as FDH: it is sensitive to extreme observations, and as it is close to the data, some possibilities might be excluded from the set. However, if the number of DMUs is high, we are likely to describe the envelope of the PPS properly. Last, there are possible holes in the set if the upper part of the envelope crosses the lower part. The set would then not be compact (see example on Figure 3.8). In such a case, the validity of the envelope of the production set is questionable, and especially in the part of the two subsets of the set that contain no observations and are located between the subsets. The effective envelope would be obtained when the two subsets are independently determined. If compactness is mandatory for the analysis, then this assumption must be checked. This requires the verification that for every free disposable output e_i , the PPF corresponding to the maximum of this output (corresponding to the FDH PPF with e_i as an output) is always at least equal to the minimum of this output (corresponding to the FDH PPF with e_i as an input). If the PPF is determined using a modeling approach, this can also be characterized theoretically in the evaluation of the impact of parameters on the output production.

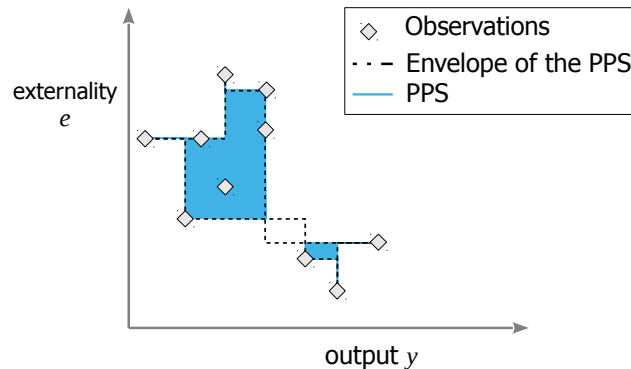

Figure 3.8: Example of a non-compact production set.

The set is divided into two parts (in blue). There is a lag between the two parts of the PPS (white-color dotted rectangle between the two blue shapes).

Finally, our objective is to determine the profit possibilities as a function of ES provision. Knowing the production possibility set makes it possible to estimate the maximum production of marketable goods as a function of inputs such as labor and material, subject to ES provision. From this set, we can calculate the maximum profit as a function of ES provision. This function is defined on the entire ES PPS. It corresponds to the superior envelope of the profit possibilities (see equation 3.3)¹⁰. This function can be approximated using the method that we developed, assuming that the profit is freely disposable (products can be only partly sold) and ESs are weakly disposable. Because of the structure of the envelopment methodology, the profit possibility frontier obtained might be underestimating the maximum profit. To limit the underestimation, the PPS must be explored. When the PPS is described with a bio-technical simulator, numerous simulations and an analysis of the relations between the outputs and the parameters of the model will increase the quality of the predicted PPS envelope. Therefore,

¹⁰ $h(e_1, e_2) = \max_{y,x} (p_y \cdot y - p_x \cdot x)$ subject to $(e_1, e_2), (y, e_1, e_2) \in P_{x_0}$

we propose to simulate practices that cover the full validity range of the simulator for each combination of parameters. To evaluate the local continuity of the set, the impacts of small modifications in the parameter should be analyzed for scenarios that are on the frontier.

Simultaneously using the envelopment methodology and a bio-technical production model, we can establish the expected profit possibility frontier. Similarly to optimization approaches, the resulting frontier is a characteristic of the structure of the simulator. However, the methodology gives the opportunity to determine the frontier with complex simulators which have non-convex and non-continuous production sets. The errors in the estimation of the frontier with our method are of the same kind as with the FDH program. The determination of a precise frontier requires a large number of outsider DMUs. The number of these outsiders is likely to increase with the number of simulations, even if the simulation parameters are randomly chosen for each simulation. However, a multistep directed procedure would be more effective: A limited number of simulations are run and a first envelope of the profit possibilities is estimated. Then, parameters leading to the scenarios on the envelope are analyzed. A new set of simulations is run with parameters close to the previous outliers. A second envelope of the profit possibilities is determined, confirming previous outliers or replacing them. This process can be iterated with an increased number of simulations until the envelope reaches stability (outliers at the step $n - 1$ are also outliers at the step n) and the expected precision.

Conclusions

We developed a methodology to envelop non-convex compact production sets based on FDH. This method requires many observations, which are unlikely to exist in the forestry sector. Referring to examples developed by Boscolo and Vincent (2000); Nalle et al. (2004) and others, we propose to create this dataset using a simulation approach. However, since optimization is not always possible due to the complexity of some simulators and non-continuity of the predicted value, we suggest characterizing how the simulator reacts to parameters and then to simulate multiple scenarios to describe the production set. This simulated set can then be enveloped using the method developed in this chapter. Last, the methodology is elaborated for a stand level analysis. Changing scale would require information on how the value of the different goods and services produced by different stands can be aggregated.

In this chapter, we considered that outputs were measurable. If goods produced by ecosystem such as crops, meat or wood production are measurable and their value can be estimated using market prices, environmental services and in particular, social services are much more complex to estimate. In the next chapter, we elaborate methodologies to take into account marketable and non-marketable ecosystem services in forest production possibility analysis.

Bibliography

- Abildtrup, J., Garcia, S., Olsen, S. B., and Stenger, A. (2011). Recreation value of forests in lorraine: A spatial analysis. In *18th Annual Conference of the European Association of Environmental and Resource Economists*, June 29th to July 2nd 2011, Rome.
- Aigner, D. and Chu, S. (1968). On estimating the industry production function. *American Economic Review*, 58:826–839.
- Aigner, D., Lovell, C. A. K., and Schmidt, P. (1977). Formulation and estimation of stochastic frontier production function models. *Journal of Econometrics*, 6(1):21–37.
- Aldy, J. E., Hrubovcak, J., and Vasavada, U. (1998). The role of technology in sustaining agriculture and the environment. *Ecological Economics*, 26(1):81–96.
- Andersen, P. and Petersen, N. C. (1993). A procedure for ranking efficient units in data envelopment analysis. *Management Science*, 39(10):1261–1265.
- Banker, R. D., Charnes, A., and Cooper, W. W. (1984). Some models for estimating technical and scale inefficiencies in data envelopment analysis. *Management Science*, 30(9):1078–1092. Available from: <http://mansci.journal.informs.org/cgi/content/abstract/30/9/1078>.
- Battese, G. E. (1992). Frontier production-functions and technical efficiency - A survey of empirical applications in agricultural-economics. *Agricultural economics*, 7(3-4):185–208.
- Battese, G. E. and Corra, G. S. (1977). Estimation of a production frontier model: With application to the pastoral zone of Eastern Australia. *Australian Journal of Agricultural Economics*, 21(3):169–179. Available from: <http://purl.umn.edu/22266>.
- Blancard, S., Boussemart, J.-P., and Leleu, H. (2011). Measuring potential gains from specialization under non-convex technologies. *Journal of the Operational Research Society*, 62(10):1871–1880.
- Boscolo, M. and Vincent, J. (2003). Nonconvexities in the production of timber, biodiversity, and carbon sequestration. *Journal of Environmental Economics and Management*, 46(2):251–268.
- Boscolo, M. and Vincent, J. R. (2000). Promoting better logging practices in tropical forests: A simulation analysis of alternative regulations. *Land Economics*, 76(1):1–14.
- Boussemart, J.-P., Leleu, H., and Ojo, O. (2011). Could society’s willingness to reduce pesticide use be aligned with farmers’ economic self-interest? *Ecological Economics*, 70(10):1797–1804.
- Brockerhoff, E., Jactel, H., Parrotta, J., Quine, C., and Sayer, J. (2008). Plantation forests and biodiversity: oxymoron or opportunity? *Biodiversity and Conservation*, 17(5):925–951.
- Calkin, D. E., Montgomery, C. A., Schumaker, N. H., Polasky, S., Arthur, J. L., and Nalle, D. J. (2002). Developing a production possibility set of wildlife species persistence and timber harvest value. *Canadian Journal of Forest Research*, 32(8):1329–1342.
- Charnes, A., Cooper, W. W., and Rhodes, E. (1978). Measuring the efficiency of decision making units. *European Journal of Operational Research*, 2(6):429–444.
- Chung, Y. H., Fare, R., and Grosskopf, S. (1997). Productivity and undesirable outputs: A directional distance function approach. *Journal of Environmental Management*, 51(3):229–240.
- Costanza, R. and Daly, H. E. (1992). Natural capital and sustainable development. *Conservation Biology*, 6(1):37–46.
- Deprins, D., Simar, L., and Tulkens, H. (1984). *Measuring Labor-Efficiency in Post Offices*, chapter 10, pages 243–266. Amsterdam: North Holland. Marchand, M., Pestieau, P. and Tulkens, H. (Ed.).
- Fare, R., Grosskopf, S., and Hernandez-Sancho, F. (2004). Environmental performance: an index number approach. *Resource and Energy Economics*, 26(4):343–352.
- Farrell, M. J. (1957). The measurement of productive efficiency. *Journal of the Royal Statistical Society*, 120(3):253–290.

- Färe, R. and Grosskopf, S. (2003). Nonparametric productivity analysis with undesirable outputs: Comment. *American Journal of Agricultural Economics*, 85(4):1070–1074.
- Färe, R. and Grosskopf, S. (2009). A comment on weak disposability in nonparametric production analysis. *American Journal of Agricultural Economics*, 91(2):535–538.
- Green, R. H. and Cook, W. D. (2004). A free coordination hull approach to efficiency measurement. *The Journal of the Operational Research Society*, 55(10):1059–1063.
- Hailu, A. and Veeman, T. S. (2001). Non-parametric productivity analysis with undesirable outputs: An application to the canadian pulp and paper industry. *American Journal of Agricultural Economics*, 83(3):605–616.
- Harte, M. J. (1995). Ecology, sustainability, and environment as capital. *Ecological Economics*, 15(2):157–164.
- Herrero, M., Fawcett, R., and Dent, J. (1999). Bio-economic evaluation of dairy farm management scenarios using integrated simulation and multiple-criteria models. *Agricultural Systems*, 62(3):169–188.
- Jahanshahloo, G. R., Lotfi, F. H., Shoja, N., and Tohidi, G. (2004). A method for finding efficient DMUs in DEA using 0-1 linear programming. *Applied Mathematics and Computation*, 159(1):37–45.
- Juutinen, A., Luque, S., Monkkonen, M., Vainikainen, N., and Tomppo, E. (2008). Cost-effective forest conservation and criteria for potential conservation targets: a Finnish case study. *Environmental Science and Policy*, 11(7):613–626.
- Korhonen, P. J. and Luptacik, M. (2004). Eco-efficiency analysis of power plants: An extension of data envelopment analysis. *European Journal of Operational Research*, 154(2):437–446.
- Kuosmanen, T. and Podinovski, V. (2009). Weak disposability in nonparametric production analysis: Reply to fare and grosskopf. *American Journal of Agricultural Economics*, 91(2):539–545.
- Loisel, P. and Dhôte, J.-F. (2011). A tree-growth model to optimize silviculture. *Nonlinear Analysis: Real World Applications*, 12(5):2784–2793.
- Loreau, M., Naeem, S., Inchausti, P., Bengtsson, J., Grime, J. P., Hector, A., Hooper, D. U., Huston, M. A., Raffaelli, D., Schmid, B., Tilman, D., and Wardle, D. A. (2001). Ecology - biodiversity and ecosystem functioning: Current knowledge and future challenges. *Science*, 294(5543):804–808.
- Meeusen, W. and Broeck, J. v. D. (1977). Efficiency estimation from cobb-douglas production functions with composed error. *International Economic Review*, 18(2):435–444.
- Mehrabian, S., Alirezaee, M. R., and Jahanshahloo, G. R. (1999). A complete efficiency ranking of decision making units in data envelopment analysis. *Computational Optimization and Applications*, 14(2):261–266.
- Montgomery, C. A. (2002). Compatibility of timber and conservation: Tracing the tradeoff frontier. In Johnson, A., Haynes, R., and Monserud, R., editors, *USDA Forest Service General Technical Report Pacific Northwest*, volume 563, pages 225–232, Portland. US Department of Agriculture, Forest Service Pacific Northwest Research Station.
- Nalle, D. J., Montgomery, C. A., Arthur, J. L., Polasky, S., and Schumaker, N. H. (2004). Modeling joint production of wildlife and timber. *Journal of Environmental Economics and Management*, 48(3):997–1017.
- Piot-Lepetit, I. and Vermersch, D. (1998). Pricing organic nitrogen under the weak disposability assumption: An application to the french pig sector. *Journal of Agricultural Economics*, 49(1):85–99.
- Pitt, M. M. and Lee, L.-F. (1981). The measurement and sources of technical inefficiency in the indonesian weaving industry. *Journal of Development Economics*, 9(1):43–64.
- Polasky, S., Nelson, E., Camm, J., Csuti, B., Fackler, P., Lonsdorf, E., Montgomery, C., White, D., Arthur, J., Garber-Yonts, B., Haight, R., Kagan, J., Starfield, A., and Tobalske, C. (2008). Where

- to put things? spatial land management to sustain biodiversity and economic returns. *Biological Conservation*, 141(6):1505–1524.
- Post, T. (2001a). Estimating non-convex production sets - imposing convex input sets and output sets in data envelopment analysis. *European Journal of Operational Research*, 131(1):132–142.
- Post, T. (2001b). Transconcave data envelopment analysis. *European Journal of Operational Research*, 132(2):374–389.
- Russell, N. P. and Young, T. (1983). Frontier production-functions and the measurement of technical efficiency. *Journal of Agricultural Economics*, 34(2):139–150.
- Sun, S. and Hu, S. C. (2009). Discriminating efficient units using maj fdh. *Applied Mathematics and Computation*, 215(8):3116–3123.
- Tahvonen, O. (1999). Forest harvesting decisions: the economics of household forest owners in the presence of *in situ* benefits. *Biodiversity and Conservation*, 8(1):101–117.
- Van Puyenbroeck, T. (1998). Some remarks on modified fdh. *Journal of Productivity Analysis*, 9(1):81–94.
- Weiskittel, A., Gould, P., and Temesgen, H. (2009). Sources of variation in the self-thinning boundary line for three species with varying levels of shade tolerance. *Forest Science*, 55(1):84–93.
- Yu, G., Wei, Q., Brockett, P., and Zhou, L. (1996). Construction of all dea efficient surfaces of the production possibility set under the generalized data envelopment analysis model. *European Journal of Operational Research*, 95(3):491–510.

Part II

Application to high oak forests

In this second part, we put the PPS simulation method presented in Figure 3.1 into practice. We take the example of an high oak forest that could be located in the Perche Regional Natural Park¹¹, between Normandy and Centre region, France. In this park, the sustainable development of human activities is promoted together with the protection of the environment, especially in its Natura 2000 zone. The forests are subject to multi-purpose management: they provide renewable energy and material, but also preserve the environment and support recreational activities¹². In chapter 4, we illustrate the first steps of our methodology: identification of the stakes and production estimators. In chapter 5, we simulate and analyze the results at the stand level.

Oak forests account for one third of the forest area in France (source: French National Institute of Geographic and Forest Information, 2006–2010¹³). The three main oak species are pedunculate oak (*Quercus robur*), the principal oak species in France – especially in private forests –, sessile oak (*Quercus petraea*), – the principal oak species in public forests – and Downy Oak (*Quercus pubescens*). Sessile oak is of particular interest because its wood is extremely valuable: the highest quality trees are used for barrels, beams, furniture, etc.

Due to long rotations, high sessile oak forests also have an important patrimonial value. They grow over long periods, and thus create a link between generations. Old sessile oak forests also have considerable aesthetic value. This makes them suitable for recreation. Old trees also host numerous plant and animal species and therefore play a role in biodiversity protection. For all these reasons, management plans for these forests must take multiple outputs into account.

In our example at the stand level, we analyze the simultaneous production of wood and three other services: carbon storage, recreation and the preservation of biodiversity. Wood is the only merchantable commodity that we consider herein since it is usually the main source of revenue in most productive forests. The valuation of the three ESs selected does not necessarily lead to transactions. Even though new markets are emerging for carbon storage in forests – mainly in developing countries for the moment –, recreation, often for their own use, is a typical owner objective in private forests. Moreover, the preservation of biodiversity can be subject to regulations in some regions. Simultaneously analyzing these four dimensions will help understand how paying for one (or several) of the ESs will impact the other ESs and forest owners' willingness to accept incentives to change their forest management practices. In chapter 4, we elaborate estimators for the values of the forest products and services. In chapter 5, we simulate the profit possibility frontier (PPF) and analyze it. Finally, in chapter 6, we show how policy makers can benefit from our results when they take decisions concerning payment for environmental services. In addition, we suggest further research to improve the knowledge of joint ES production in forestry.

¹¹Regional natural parks in France are inhabited rural areas of remarkable beauty whose environment and cultural heritage is at risk. The goals of regional natural parks are to protect nature, share local traditions and support the economic and wealth development of local community into the future.

¹²<http://www.parc-naturel-perche.fr/en/index.asp> (last accessed November 18, 2012)

¹³<http://inventaire-forestier.ign.fr/spip/spip.php?article709> (last accessed November 18, 2012)

Chapter 4

Estimating ecosystem production

Estimating the costs and benefits of environmental services (ES) implies estimating the provision of these services. In the previous chapters, we proposed a theoretical characterization of the profit possibilities depending on ES provision and assumed that goods and services provided by the forest were measurable. This is obviously true when concerned outputs are related to easily quantifiable goods such as wood or carbon sequestration in trees. On the other hand, some services are more difficult to estimate because their definition is complex, e.g. biodiversity and scenic beauty, or because they depend on several interconnected processes or stakes, such as in the production of clean water or the protection against landslides.

To illustrate how multi-purpose forest management involves the simultaneous production of interconnected ESs, let us take the example of a high oak stand in the Perche regional natural park. In the private and public forests within this park, the production of high quality oak is one of the main objectives. Hunting leases and mushroom picking are also sometimes valued in these forests, as for example in the Saussay forest, but are rarely the main source of revenue. Consequently, we will consider income from wood production only. The park is near Paris (travel time: 1.5 hours) and is covered by old forests which attract visitors and host several rare bird species. Forest management in the area must therefore respond to multiple environmental pressures such as recreation and biodiversity protection. Globally, forests contribute to global change mitigation which has become one of the main issues in forest management over the last decades. The three ESs we will analyze for the management of these oak forests are carbon, biodiversity and recreation.

In this chapter, we will first estimate directly measurable outputs (wood and carbon) and then, based on a literature review, we will establish indicators to estimate the provision of services related to recreation and biodiversity. These estimators and indicators are instantaneous values (at time t). Finally, because forest production processes take a long time and rotation periods differ from one management scenario to another, we propose techniques that integrate the variations in the provision of services over time (t) to compare output supply over long periods.

4.1 Estimation of directly measurable outputs

The monetary or non-monetary values of some outputs, such as wood supply and carbon storage are functions of the measurable characteristics of the harvested trees or of the trees living in the forest. Production can therefore be estimated technically by using field measurements or forest growth and yield models. The major concern then becomes how to precisely define the good or service and chose the appropriate unit of measurement.

4.1.1 Wood volume and stumpage value

As we mentioned before, wood production is the main management goal in the high oak forests in the Perche regional park. The current management system produces highly valuable, quality wood which is the main source of revenue. Although hunting can also provide revenue and plays an important role in regulating wild game populations, we have not taken this activity into account since the revenue generated is marginal (hunting leases in France concern less than 15% of the private forest area and less than 2% of the private forest owners¹). We therefore consider wood production as the only source of revenue in our analyses.

Wood quantities can be calculated in the field with volume tables when trees are standing, and directly measured when trees are felled and cut into pieces. Wood quality is typically evaluated by visual inspection of the tree or the logs. Forest management practices such as thinning and pruning have a direct influence on the quantity and quality of the wood produced as well as on the size of the logs. These tree characteristics are the main factors that determine the possible uses of the wood and its price on the market (Cavaignac and le Moguedec, 2006). The value of the wood products varies with forest management practices. In an analysis based on growth and yield models, the simulator predicts the volume of the trees. Some simulators can also differentiate between marketable timber and non-marketable wood (small branches and shoots).

The price that a forest owner can obtain from one cubic meter of wood is very difficult to predict at the beginning of a rotation: even if the future forest eventually produces the expected quantity and quality of wood, many factors affect the market price. The classic wood market follows supply and demand curves and price fluctuations. For example, the Lothar and Martin wind storms in December 1999 threw more than 140 million cubic meters of wood in France and caused a crash in wood prices. It took three to five years for the market to recover. Market fluctuations are not the only source of variations in price. Wood is often commercialized through bids or negotiated prices. Moreover, when the forest owner sells standing trees, the buyer proposes a price that depends on assumptions concerning the wood quality. However, it is harder to estimate the value of standing trees than that of felled trees. Stumpage price, which is the average fee per cubic meter that a firm pays the owner before harvesting the trees, is consequently subject to greater individual variations than the price of felled trees. Moreover, defects do not play the same role to all potential buyers

¹Moreover, it is not valued by owners in the same way: 2% of the owners lease hunting, 8% hunt themselves, 80% have to let hunting in their property without payment and 10% forbid hunting in their properties (Forêt privée française, 2009).

depending on their target uses (sliced lumber, staves, laminated veneer lumber or firewood, see e.g. Cavaignac et al., 2006).

In our analyses, we have chosen to use stumpage rate, which is the average fee per cubic meter that a firm pays the owner to have the right to harvest trees, because many forest owners sell standing timber and receive a payment which corresponds to the net value of the trees that are felled by the buyer.

In our example, we only simulated oak production. We therefore developed a model to estimate the stumpage price of oaks. In real terms, this price decreased in current value from 1981 to 1995, then remained stable until 2005. In 2007, the price recovered to the 1981 price in constant money. It is clear here that future variations cannot be evaluated with any accuracy. We therefore do not consider either seasonal or yearly price variations following Faustmann (1849).

Stumpage price is traditionally represented in a table as a function of the diameter class and the quality of the log (DeBald and Mendel, 1976). However, for simulation purposes, the use of the discrete table would not be appropriate since the price of a tree would change dramatically with a slight increase in diameter. We therefore calibrated a price function using a table of observed prices for standing oak trees in France between May 2009 and April 2011 (statistics published every two months in Chavet and Chavet, 2011, ²). We modeled price with a piecewise continuous function of the diameter. The parameters of the function were estimated using a weighted least square. We chose a piecewise function of the diameter stems because, below a certain threshold diameter, trees have no value or at best, their price merely compensates harvesting costs. Above a certain diameter, the price increases until the stem becomes so large that it becomes impossible for conventional industries to saw it. Although a niche market does exist for these very large stems (diameter above 60 cm or 80 cm depending on the species) and offers very high prices, many of these trees are sold as fuel wood because the seller cannot find the appropriate buyer. The price per cubic meter of these large trees therefore varies greatly and the average stumpage rate increases very slowly, or even decreases, with the diameter.

The oak stumpage rate dataset that we used contains the upper and lower boundaries of the observed prices in different size and quality classes. For our regression, we assume that the price is randomly selected in the range and we weight the maximum and minimum values equally. On the other hand, because reliable relations between tree diameter and wood quality can be established (see Myers et al., 1986), we weight the quality classes in proportion to the qualities usually observed in the field (Bruciamacchie, personal discussion). Depending on production conditions, up to 2% of the trees can be in the highest quality grade (A); around 10% of the wood is in the middle quality grade (B). Eq. 4.1 shows the established relationships between the net price in euros for the sale of one cubic meter of timber and the diameter at breast height ($DBH_{i,t}$ in cm) of tree i at time t .

$$p(DBH_{i,t}) = \max(0; 1.09 \times DBH_{i,t} - 12.14; 90.63 \times \ln(DBH_{i,t}) - 284.52) \quad (4.1)$$

²These statistics represent the price range per cubic meter of standing wood as a function of the diameter of the trees and of the wood quality broken down into three categories.

Global warming has led to increasing interest in green energy production. Policy makers have decided to propose incentives in favor of the development of fuel wood use for industry and household heating. These policies have increased the demand for wood whatever the quality. If this demand increases faster than the wood supply, the price of fuel wood (typically small wood and branches) will increase (Caurila et al., 2010). To evaluate how such policies influence the opportunity cost of the provision of other services and alter the compatibility of services, we established a second wood price function with a doubled price for fuel wood. This not only increases the value of small trees and gives value to very small wood; it also increases the value of large trees. With results from the *wood quality workshop* module of the *Fagacées* model³, we estimated the quantity of fuel wood contained in each stem according to tree diameter class and the relative contribution of this share of fuel wood to the total price of the standing tree. For example, the volume of trees larger than 70 cm DBH is composed of up to 30% of low quality wood usable for energy. However, because other wood products have a much higher value, fuel wood contributes very little to the total value of the tree. Doubling the fuel wood price will increase the average price of these large trees by only 1% to 5% compared to an increase of up to 50% in the value of 20 cm DBH trees. The modified calibrated price function is therefore:

$$p_{\text{fuel}}(DBH_{i,t}) = \max(0; 1.09 \times DBH_{i,t} - 5.13; 96.42 \times \ln(DBH_{i,t}) - 306.49) \quad (4.2)$$

The net benefit of selling timber at t ($B_{\text{wood}}(t)$) is the total stumpage for the trees, with $P(DBH_{i,t})$ the net price per cubic meter and $Vm_{i,t}$ the merchantable volume of tree i harvested at t .

$$B_{\text{wood}}(t) = \sum_i p(DBH_{i,t}) \times Vm_{i,t} \quad (4.3)$$

The merchantable volume $Vm_{i,t}$ is predicted according to the volume function calibrated by Bouchon (1974), with $DBH_{i,t}$ the diameter at breast height and $h_{i,t}$ the total height of tree i harvested at t .

$$Vm_{i,t} = \frac{1}{1000} \left(222.49 - 32.242 \cdot DBH_{i,t} + 1.4296 \cdot DBH_{i,t}^2 - 0.0043207 \cdot DBH_{i,t}^3 + 0.014263 \cdot DBH_{i,t} h_{i,t}^2 + 0.0092357 \cdot DBH_{i,t}^2 h_{i,t} \right) \quad (4.4)$$

The annual monetary balance – or net annual profit – is not always positive, because it costs money to establish the stand and there are annual maintenance expenses. Most regular oak forests in France start from natural regeneration and foresters have to manage this regeneration during the young stages. In the beginning of the rotation, many costly operations are conducted to favor the development of the stand. Operations that are conducted in the first 15 years, including seedbed preparation, control of competing vegetation, weeding, pruning and pre-commercial thinnings cost between 3000 and 4500 euros/ha (current value at the beginning of the rotation, Forest operation standards from the French National Forest Service). The costs depend on the effort required to favor the growth of the target species. In our simulations, we use an initial cost (C_0) of 3000 euros/ha, with a discount rate of 2%.

³See <http://capsis.cirad.fr/capsis/presentation> and de Coligny et al. (2005)

In addition, the forest owners support fixed maintenance costs of about 40 euros/ha/year. These costs include property taxes, insurance and management costs.

Finally, the profit generated by forest management activities at time t is equal to the profits from wood harvests minus the total costs at time t . Computing the total profit corresponding to a given management scenario requires a method which integrates instantaneous profit with time; we present this method in section 4.3.

4.1.2 Global change mitigation

Forests play many roles in climate regulation. They modify albedo, surface roughness and evapotranspiration which change energy transfers in the atmosphere (Anderson et al., 2011). However, the effect at the forefront of global change mitigation strategies today is that forests and wood products store carbon. Carbon dioxide is a powerful greenhouse gas (GHG) and its concentration in the atmosphere has increased quickly due to agricultural practices involving deforestation and the increasing use of fossil fuel since the beginning of the industrial era (Burschel, 1995; IPCC, 2001). To limit net GHG emissions, Clean Development Mechanisms (CDM) have been developed, most of which consist in carbon storage through afforestation and forest management practices (see a review in Olsen, 2007). Forest can be managed to produce wood for use in the building and furniture-making sectors as well as for energy to reduce the use of fossil fuels (Baral and Guha, 2004; Werner et al., 2005).

We have tried to analyze the impact of different oak forest management scenarios on the climate regulation service provided by forests. Albedo, roughness and evapotranspiration do not change very much in our scenarios, since we exclude afforestation, deforestation and species change from our analysis. We focus on two dimensions of the carbon issue: stocks and fluxes. Carbon stocks are the carbon quantities stored in the ecosystem. The largest quantities of carbon per hectare are stored in old forests (Luyssaert et al., 2008). Maintaining these stocks over time is one issue. Secondly, carbon in ecosystems is continuously being sequestered and released in a variety of natural processes. Managing forests to maximize carbon sequestration or to offset anthropogenic emissions is a second way to mitigate global change through forestry (Taverna et al., 2007).

Carbon storage

Carbon is one of the main components of wood. Photosynthesis is a process that transforms carbon dioxide and water into sugars which are a chemical source of energy for the living plant but also the basis for organic compounds such as lignin. During the photosynthesis process, a plant captures carbon which is later released during the respiration process. However, a large part of the captured carbon remains sequestered in the plant until its final degradation. If annual plants play a small role in carbon sequestration because of their short lifespan, carbon storage in the ligneous species, especially in trees, is important. The Earth's forest biomass stores about 488 Gt of carbon (IPCC, 2001). Forest soils also store large quantities of carbon, much more than with other land uses. Forests store more than half of the terrestrial carbon, which is equivalent to two thirds of the carbon in the atmosphere.

In forests, carbon is stored in the soils, in trees, shrubs and herbaceous species. Though the soil carbon content in a temperate forest is comparable to the carbon content of the biomass, it varies much more slowly. When land use changes, major differences in soil carbon storage occur, in particular when forests are converted to agricultural land or agricultural lands are afforested (Deckmyn et al., 2004). However, if the forest remains intact and the dominant species stays the same and if changes occur only in the thinning and harvesting schedules with similar quantities of slash left in the forest after operations, soil carbon storage remains relatively constant (Jandl et al., 2007). For above-ground biomass, except in very young forests, the largest carbon stocks are located in the ligneous parts of trees. In French forests, trunks, branches and roots store 90% of the carbon in the biomass (Dupouey et al., 1999). Carbon storage in this forest stratum varies greatly during the rotation of the stand due to harvesting; consequently, ligneous mass can be used to estimate changes in carbon storage with management scenarios.

The carbon contained in the wood is not immediately released into the atmosphere when the tree is harvested. It remains in the wood products until they are burnt or degrade over time (Seidl et al., 2007; Profft et al., 2009). Wood product lifespans vary between a few months for fuel wood to hundreds of years for building materials such as beams (Paquet and Deroubaix, 2003). Pingoud and Wagner (2006) showed that this carbon sequestration period could be prolonged by burying degraded wood products in landfills rather than burning them. Moreover, even though decomposition emits methane, which is a stronger greenhouse gas than CO₂, because the decomposition process is very slow, landfilling discarded wood products remains positive for GHG concentrations in the atmosphere for up to half a century.

Burning wood for energy instantaneously releases the stored carbon, however, this carbon would be released into the atmosphere after five to ten years of decay in the forest if these products were not landfilled. So, in most cases, burning merely accelerates the carbon release; the quantities released are the same if the wood is left to decay in the forest or if discarded wood products decompose in the atmosphere. If the wood is burned to replace fossil fuels in energy production, then GHG emissions are avoided (Baral and Guha, 2004). Moreover, using wood as a building material instead of energy demanding material such as iron also makes it possible to reduce GHG emissions (Werner et al., 2005; Petersen and Solberg, 2005). The reduction in net GHG emissions is often referred to as the *substitution effect*. Forest management influences the shape and the size of the logs which are determining for the type of wood products that can be supplied.

Estimating the carbon storage function

As we have seen, the carbon stored in the forest biomass is mainly contained in trees. According to (Patenaude et al., 2003), trees and roots store more than 80% of the carbon in broadleaved woodlands in Great Britain. This percentage varies during the rotation. Herbaceous plants and shrubs constitute a large part of the biomass carbon stock at the beginning of the rotation, but they contribute to only a small part of the stock in older forests (Peichl and Arain, 2006). Restricting carbon storage estimates to trees and roots consequently leads to an underestimation of the total carbon stock in the forest biomass, especially in young stages, but this underestimation remains limited except in very open forests.

To estimate carbon storage in trees and roots, we used coefficients from the Carbofor project (Loustau et al., 2004, see Table 4.1) related to stem volume and species type. We calculated:

- total volume (stem, branches and roots), using volume ratios;
- dry wood biomass, using basic density⁴;
- stored carbon mass, using the carbon ratio in dry wood.

Table 4.1: Coefficients to calculate carbon stocks and fluxes in France.
(source Carbofor project)

Coefficient	broadleaf	coniferous
Branches/stem ratio	1.611	1.335
Roots/stem ratio	1.28	1.30
Basic density (in kg/m ³)	546	438
Carbon quantity (kg) in 1 kg dry wood	0.475	

These global parameters can be used to estimate carbon storage in any forest. However, the precision obtained with these parameters is limited and, when available, we prefer to use volume functions. Such functions exist for oak to predict the above-ground volume of the tree which includes the stem and the branches (Vallet et al., 2006). The total volume $Vt_{i,t}$ (in m³) of oak tree i with a diameter at breast height of $DBH_{i,t}$ (in cm) and a total height of h_i (in m) at time t is:

$$Vt_{i,t} = \left(0.471 - 0.00108 \cdot DBH_{i,t} + 0.668 \frac{\sqrt{DBH_{i,t}}}{h_i} \right) \frac{DBH_{i,t}^2 \times h_i}{4 \cdot 10^4} \quad (4.5)$$

In this equation, the term in brackets correspond to a shape parameter. The density of the wood is calculated with a formula calibrated by Le Moguedec (unpublished) based on Guilley et al.'s (1999) work on oak density. This formula gives the density of the rings in tree i produced at time τ ($Dr_{i,\tau}$ in kg.m⁻³) as a function of ring width ($Rw_{i,\tau}$ in mm) and tree age ($age_{i,\tau}$ in years) as well as type of wood (heart wood / sap wood). Density values higher than 859 kg.m⁻³ or lower than 355 kg.m⁻³ were not observed; these values are therefore considered to be thresholds.

$$Dr_{i,\tau} = \max(355; \min(859; 554.8 + cWt - 0.6762 \cdot age_{i,\tau} + 22.61 \cdot Rw_{i,\tau})) \quad (4.6)$$

with the coefficient corresponding to wood type $cWt = -21.54$ kg.m⁻³ for sap wood and $cWt = 19.80$ kg.m⁻³ for heart wood.

The above ground biomass of tree i at t is then:

$$Bag_{i,t} = \sum_{\tau=1}^t Dr_{i,\tau} \times (Vt_{i,\tau} - Vt_{i,\tau-1}) \quad (4.7)$$

Root biomass (or below-ground biomass in kg) is calculated with the function developed by Drexhage and Colin (2001): $Bbg_{i,t} = 10^{-1.56+2.44 \times \log(DBH_{i,t})}$. As shown in Table 4.1, we used

⁴The basic density is the mass of dry wood per unit of volume.

a carbon content of 47.5% of the dry mass. The total quantity of carbon ($CS(t)$ in metric tons of carbon) stored in the n_t trees growing in the stand at t is:

$$CS(t) = 0.475 \sum_{i=0}^{n_t} (Bag_{i,t} + Bbg_{i,t}) \quad (4.8)$$

The total carbon storage in the tree biomass varies considerably during the rotation, as shown in Figure 4.1. Compared to these fluctuations, the variation in carbon stored in the soil is negligible as long as the land use remains oak forest (Vallet, 2005). Considering forest soil carbon storage in the comparison of different scenarios of oak forest management would not make any difference in the results.

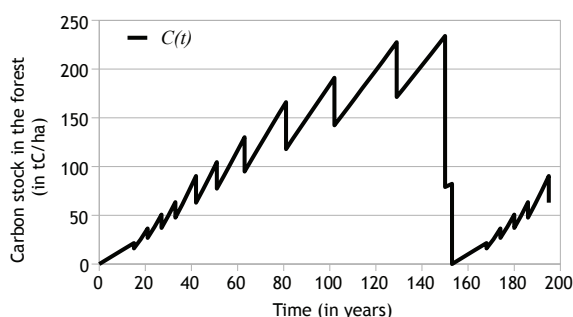

Figure 4.1: Variation in carbon stocks ($CS(t)$) during a rotation

This diagram represents carbon storage in the above- and below-ground biomass of trees, with a management scenario targeting a dominant diameter of 70 cm, initial RDI: 0.8; final RDI: 0.6; medium thinning intensity.

Potential effect of the use of harvested wood products

Our study only takes into account actual carbon storage in the forest. It is worth noting that the forest-products sector as a whole has a broader impact on the greenhouse gas (GHG) balance for two reasons: carbon storage continues in marketed wood products and GHG emissions are reduced when wood is used as a substitute for certain other materials. These mitigation functions are related to the type and quality of the wood supplied by the forests.

Forest management affects the type of wood products that can be produced. Pieces of almost any size and quality can be used for energy, while only higher quality and larger logs can be used for beams, barrels or furniture. If forests are managed to supply only small trees or to produce larger trees as quickly as possible, they will produce little or no high-quality wood for noble uses such as sawn wood, sliced veneer and staves. The technical characteristics of the wood products change their potential carbon storage and substitution effects.

As presented in Table 4.2, the type of wood products obtained from the forest influences the length of time the carbon is stored in the wood (see also Vallet, 2005; Fortin et al., 2012). For example, fuel wood is generally burnt one or two years after harvest, whereas beams can last several centuries and create a long-term carbon sink.

Some activities related to the wood-products sector have global impacts on the GHG balance. In many cases, using wood in construction (e.g. wood frame versus iron frame buildings) reduces GHG emissions during the construction, maintenance and demolition phases (Petersen and Solberg, 2005). Wood is also considered as a low carbon-emitting source of energy (Schlamadinger et al., 1997). Wooden crossties are counter examples. Although they last for decades, because of their chemical treatment, their production and disposal emit more GHG than for concrete crossties. To maximize global change mitigation through the use of wood products, we need to clearly understand carbon storage levels and the substitution effect related to each wood product.

Table 4.2: Average lifespan and substitution effect of oak wood products.

Wood products Second transformation	Average lifetime (years)	Substitution effect (kg eq C/kg dry wood)	Substituted material
Firewood	1.67	0.100	Fossil fuel
Residues used for energy	1.83	0.307	Fossil fuel
Paper and packaging	3.03	0.381	Plastic then fossil fuel
Furniture	10.18	0.285	Metal
Barrels	4.50	0 ^a	–
Building sector	14.58	0.269	Concrete and steel frame

Paper and packaging products are rarely made of oak. The substitution effect presented for paper and packaging products includes burning of the products after disposal to produce energy. Furniture, barrels and building materials are assumed to be burnt after disposal without any valuation for energy at the end of their lifespan. Source: Robert (2008)

^aOak barrels are used for wine and alcoholic beverages because of their specific characteristics (tannin, gas exchanges), and therefore cannot be real substitutes to cement or aluminum wine-tanks.

Table 4.2 (adapted from Paquet and Deroubaix, 2003; Vallet, 2005, and applied to the second transformation sector) shows the expected average lifespan and substitution effect of wood when it enters the different production sectors. The average lifespan is calculated as the cumulative average lifespan of each part of a log entering the transformation sector, and includes by-products with very short lifespans (these by-products are sometimes burnt to dry other pieces of wood) compared to boards and beams. Since longer carbon storage is obtained with large, high-quality trees, carbon storage in wood products is complementary to benefits from harvested wood products.

The substitution effect is the impact on net GHG emission resulting from replacing any equivalent material by wood. Calculating this substitution effect requires comparative life cycle analyses to account for emissions during production, maintenance and disposal (from cradle to grave) of two substitutable products. If the lifespan of the products differs, then the difference is corrected by the lifespan ratio between the two products, e.g. if one product lasts twice as long as the other, then the emissions from the first product will be compared to twice the emissions from the second one. Schlamadinger et al. (1997); Petersen and Solberg (2003); Gustavsson and Sathre (2006) used these comparative analysis to estimate the substitution effect for common wood products. The figures shown in Table 4.2 were derived from these results. For wood products, the highest carbon storage and the highest substitution effect are

obtained when the producer maximizes high quality products; thus maximizing wood value. The GHG mitigation service is therefore strongly correlated with maximization of profit. However, substitution coefficients are very uncertain: Petersen and Solberg (2005) report variations of one to five times depending on the substituted material. Moreover, carbon storage in wood products occurs outside the forest itself and depends on the actual uses of the products. This cannot be controlled by the forest owners. The owners cannot be compensated for a service (carbon storage in wood products) they do not control. Finally, a payment mechanism which would promote carbon storage in wood products is likely to increase the price offered for other building materials and would consequently increase the opportunity cost of services which are substitute for wood supply. The payment effect would be even greater if wood product users received subsidies for the substitution effect. Therefore, in our stand-level study, we estimate the contribution of forest management to global change mitigation in terms of carbon sequestration in the forest only.

4.2 Estimation of ES provision using indicators

When services are complex and difficult to estimate, indicators are often used to provide an indirect or partial evaluation. An indicator is generally a simple measure or estimator that makes it possible to evaluate the status of and changes in complex systems such as the economy or the environment. These indicators are important tools for policy decision making and for communication (Smeets and Weterings, 1999). These indicators must therefore be easy to grasp and must provide critical information on the status of the represented system to be widely accepted. They should also be sufficiently sensitive to provide an early warning of changes in the system (Noss, 1990).

Numerous indicators have been developed over the last few decades to help monitor sustainable development in countries and communities; they include economic, social and environmental dimensions in a mid- to long-term perspective (Mitchell et al., 1995). Many of them are subject to debate among scientists and users, especially in the field of biodiversity and when social values are concerned. In this section, we analyze information on recreation and biodiversity preservation in forests and derive simple indicators that vary with forest management scenarios.

4.2.1 A scenic beauty indicator to estimate the recreation function

Forests provide opportunities for many types of leisure activity: hiking, biking, tree climbing, etc. (Rapey and Michalland, 2002). Areas with beautiful or large forests attract tourists and add value to nearby homes. Facilities such as parking places and picnic areas increase the attractiveness of the forests. Forestry activities, on the other hand, reduce the aesthetic value of the forest and consequently, its attractiveness decreases (Panagopoulos, 2009). In this subsection, we review the literature concerning factors related to the forest recreation function. These factors mainly appear to be attributes of the forest and its surrounding landscape (recreational facilities, lakes, rivers and distance to the city) and, to a lesser extent, the aspect of the forest itself which is influenced through the way it is managed (tree species, density and age). Management practices change the visual aspect of the forest and thus its

attractiveness . We have therefore created an indicator for the recreational attractiveness of a forest. This indicator reacts to forest management scenarios.

Recreation facilities: determining factors of recreation

Since visiting a forest generally does not require payment (with the exception of parks), there is no market for forest recreation which could give a direct estimation of the value of this service. The non-market value of forest recreation is therefore often estimated through methods such as revealed and stated preferences.

Revealed preferences include the travel cost method (Clawson and Knetsch, 1966) which assumes that the forest recreation value is at least as high as the amount of money people pay to travel to the forest. In With this method, Peyron et al. (2002) estimated an average recreation value of the forests in France at 126 euros/ha/year. This value varies with the location of the forest: forests near large cities have a higher recreational value than forests far away from cities. It also varies with non-forest attributes such as the presence of rivers, lakes and facilities (Abildtrup et al., 2011). The presence of recreation facilities can also increase the price of real estate in the area. The travel distance hides the fact that people who highly value forest recreation may want to buy a house close to the forest, even if they have to pay more. Using a hedonic pricing approach, Tapsuwan et al. (2012) found such a relation between house prices and the distance to recreation sites. They were able to estimate the value of a river with high recreational attractiveness. Rapey and Michalland (2002) observed the behavior of visitors to the forest and showed that the public prefers forests which are accessible by car and have parking places, open trails and picnic areas. They also found that most visitors stay close to the facilities and parking places and that stand type and structure play only a minor role in recreational attractiveness.

Colson et al. (2010) combined spatial data concerning forest stands and information on visitors given by forest owners and reached similar conclusions: factors determining the intensity of recreational activities in Walloon forests not only include distance to the city or to tourist centers, but also the presence of lakes and rivers. They also found that medium slopes in terrain (10% – 30%), public ownership, and broadleaf-dominated forests favor recreational attractiveness. There are various reasons why public forests are more attractive: they are almost all open to the public whereas many private forests are not, though few are fenced; and public forests are managed specifically to avoid disturbance to the public. We note that if public forests with recreational stakes were all managed in a similar way to host the public, revealed preferences would vary only a little with the forest status, because the variety of the choices would be limited.

Contrary to revealed preferences, stated preferences make it possible to capture people's preferences that remain unexpressed because the service is not proposed or it is too costly. With a contingent valuation method, Hörnsten and Fredman (2000) showed that 40% of Swedish people would like to reduce the distance between their home and the forest and that a shorter distance to the forest would increase the frequency of their visits. Using a choice experiment, Christie et al. (2007) analyzed how visitors' preferences and willingness to pay change according to their activities. Visitors all want facilities corresponding to their leisure activities (horse trails, bike trails, wildlife viewing areas). However, Christie et al. also

noted that simple facilities such as parking places, toilets and picnic areas were important to walkers, horse riders and general visitors, but not to cyclists or nature watchers. Moreover, some dedicated facilities are disliked by non-practitioners, for example, walkers dislike the presence of horse riding trails. Managing forest for recreational purposes implies knowing which activity is in the highest demand. At the landscape scale, it would appear to be most efficient to allocate specific areas in the forest to the visitors' objectives. The studies mentioned above did not analyze any preference for management techniques or forest types.

Mattsson and Li (1994) conducted a contingent valuation study on the impact of forest management on the provision of non-wood services. They highlight that Swedish visitors value natural regeneration using advance growth or seed trees more than they do single tree selection forests (selective logging). Forests in which broadleaved trees are dominant are preferred to forests dominated by coniferous species, especially spruce. The recreational value is higher if different forest developmental stages are present at the landscape scale, excluding regeneration or plantation stages. Abildtrup et al. (2011) found a similar preference for broadleaved or mixed forests in the Lorraine region (France). However, the impact of forest management practices on recreation value is hard to estimate using contingent valuation because most people cannot visualize the impact of specific practices (more or less intensive thinnings, for example). Moreover, forest beauty is less a factor of recreation value than facilities and accessibility: people will go to the nearest forest with appropriate trails, parking places, etc., even if the aesthetic quality of the forest is unexceptional.

However, the scenic beauty of the forest can affect the visitor's satisfaction. Scenic beauty has often been analyzed using psycho-physical techniques as proposed by Daniel and Boster (1976): pictures of differently managed forests are presented to a sample of people who are asked to note them or to rank them by preference. Pictures increase contingent valuation possibilities because they clearly show the results of different forestry operations without resorting to subjective descriptions. Moreover, with the development of imaging software, it is now possible to create pictures showing different stand states resulting from different management practices, everything else being equal (Tyrvaainen et al., 2003). Ribe (1989) reviewed studies on scenic beauty conducted from 1960 to 1989. He noticed that old-growth forests are preferred over recently harvested forests but also that lightly managed forests tend to be preferred over unmanaged ones. Globally, psycho-physical studies show that forests with old trees and irregular stands increase visitors' satisfaction. On the other hand, very young stands, very dense forests and forests with woody debris, dead trees and lying dead wood provide limited access and visual penetration. Therefore, they are not liked by the public (Carlén et al., 1999). Clearcuts also negatively influence the public's perception of the forest. Keeping some trees (less than 3 m³ is enough) spread over the entire area – process known as the shelterwood system – or leaving an unharvested buffer zone to hide the clearcut reduces the social effect of clearcuts (Holgen et al., 2000). Except in very dense forests, thinnings decrease the scenic beauty, but in the case of low intensity thinnings, landscape quality can be restored rapidly (Silvennoinen et al., 2002) and may even become higher because of increased visual penetration.

Finally, Delphi surveys merit interest because they are less time-consuming than visitor surveys and still provide managers with sound information. Delphi surveys are based on the following principle: experts are asked several rounds of questions until they reach an agreement. Edwards et al. (2011) used such a method to derive recreation scores across

Europe, although the expectations vary from one place to the other and from one person to another (Jensen and Skovsgaard, 2009). Unsurprisingly, their results are in line with the literature. Although this methodology can efficiently rate simulated scenarios, we did not use such an approach because it is usable for a limited quantity of scenarios only. We propose a traditional estimation of scenic beauty based on results of the above mentioned studies.

Elaboration of a scenic beauty indicator for regular oak forests

Our objective is to simulate the impact of different silvicultural scenarios on the recreation potential of a stand. Forest practices such as thinning interact with the visual aspect of the forest and thus influence visitor satisfaction. Therefore, we focus on the recreational attractiveness of the forest resulting from the forest stand characteristics. According to the above literature review, there appears to be three determining forest attributes for the beauty and the attractiveness of a forest: 1) the maturity of the stand, 2) visitor accessibility to or visual penetration into the stand, and 3) the type and diversity of the species. A few studies have attempted to predict the recreational value of the forests as a function of forest characteristics (see e.g. Eriksson and Lindhagen, 2001), but none of these characteristics are directly applicable in our case because, while infrastructure and species composition were important factors in these previous studies, they do not vary in our study.

Since we simulate a forest stand and the continuous variation of its characteristics through time, a continuous model for stand attractiveness is more appropriate. Consequently, we developed a new indicator for recreational attractiveness at the stand scale based on observations and on literature results. Our indicator is applicable to high oak forests and varies with the management of the stand.

The *maturity* of the stand can be characterized by the presence and dominance of large trees or by the average age of the trees in the stand, especially in regular forests. The Delphi survey conducted by Edwards et al. (2011) showed that if young forests (5 to 15 years old) are graded 1 or 2, then medium aged stands (15 to 50 years old) would be graded 3 to 7 and old stands (more than 50 years old) would be graded 6 to 10 depending on the type of management. Attractiveness increases exponentially with stand age. The model developed by Eriksson and Lindhagen (2001) shows a similar exponential relation between recreation and stand age. Sessile oaks grow slowly and reach their maturity between 100 and 160 years in France. In our indicator, we therefore considered that most of the increase in attractiveness resulting from the aging of the stand occurs when the stand is less than 100 years old. The increase then slows down and finally becomes very slow when the stand reaches 200 years of age.

The estimation of *visitor accessibility* (or visual penetration) is related to stand density which is often estimated with two criteria: the number of stems and the DBH of the trees. Many authors have noted that there seems to be an optimum density for attractiveness, neither too low nor too high. For example Buhyoff et al. (1986) found a social optimum of 2800 stems per hectares when the DBH of the trees ranged from 2.5 to 12.5 cm. Jensen and Skovsgaard (2009) found that in a 15-year-old oak forest, the optimum density was comprised between 300 and 5300 stems per hectare. In older stands, slightly managed forests were preferred over both unmanaged and intensively managed forests. This corresponds to a stand density of 100

to 150 stems per hectare when the quadratic mean of the DBH of the trees reaches 65 cm in oak high forests. Using these observations, we calibrated a relationship between forest attractiveness ($A(t)$) and forest age, the average DBH of the trees and stem density.

$$A(t) = \left(1 - e^{-10^{-2} \cdot t}\right) \times e^{-0.045(\log(nb_{\text{stems}t}) + 0.02 \cdot d_{gt} - 3.76)^2} \quad (4.9)$$

where

t is age of the stand (in years)

nb_{stems} is the number of stems at t

d_{gt} is the mean diameter at breast height of the stems at t (in cm)

Since our concern is the impact of various management practices in pure oak forests on recreation, our indicator does not take into account the preference for broadleaved over coniferous woodland highlighted in Colson et al. (2010). The use of the indicator is consequently restricted to the comparison of oak forest management practices.

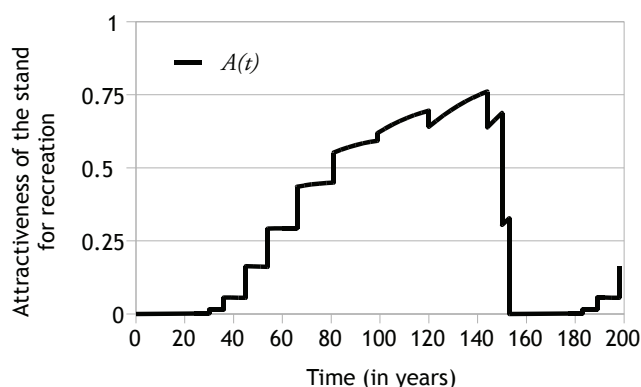

Figure 4.2: Simulation of changes in attractiveness during a rotation
(Example of the management of a highly productive oak forest with a target diameter of 70 cm subject to medium intensity thinnings)

Figure 4.2 shows how the attractiveness indicator changes with stand development. The indicator is able to represent the impact of thinnings and cuttings on the attractiveness of the stand as highlighted by Silvennoinen et al. (2002) for pine, spruce or birch forests. Young forests (up to 40 years old in the example) offer little access and visual penetration due to the very high density of small trees. First thinnings open visual paths and the subsequent growth in diameter and height lead to a rapid increase in attractiveness until the indicator reaches 0.6 at 90 years old. Afterwards (up to 145 years), attractiveness increases more slowly and can even drop after thinnings because they create openings in the forest which can be perceived by visitors as unnecessary. A few years after the operations, however, forest attractiveness is restored or even enhanced due to easier access into the forest and increased visibility. The final felling (in two steps to favor natural regeneration) returns attractiveness to its initial level.

Our model reflects a certain point in time, with information on preferences collected over the last few decades. However, preferences change from one generation to the next. Younger

generations are more urban and visit forests to rediscover a near-natural setting, whereas former generations preferred domesticated forests that supplied wood as well (Hörnsten, 2000). Changes in preferences over the coming decades are impossible to predict precisely. However, with population growth, the pressure on the environment is likely to increase and the demand for forest recreation may increase as well. The uncertainty about changes in recreation preferences will play a role in the choice of the temporal aggregation technique presented in section 4.3.

4.2.2 Evaluating the contribution of a stand to biodiversity

Our goal in the following section is to define a way to estimate the contribution of a stand to biodiversity. The two main questions we address are: Which purpose does this indicator fulfill? How does this indicator react to the management hypothesis we are testing? We first propose a definition of biodiversity, then we review various ways to estimate biodiversity using direct and indirect indicators. Finally, we create an indicator applicable to oak forests that react to management practices.

What is biodiversity?

The diversity of life forms has been studied for a long time. During the classical period of Ancient Greece, Aristotle and his contemporaries were already describing the diversity of living things and had undertaken a first classification. In the eighteenth century, Carl von Linné proposed a systematic classification and set the basis for modern taxonomy. Buffon also analyzed the evolution of life in its environment. After observing that species living in different places with similar physical conditions can differ, he introduced the concept of biogeography. At that time, the study of biological diversity included both living forms and their environment. However, the modern concept of biodiversity only appeared in the second half of the twentieth century, along with the increasing awareness that human activities have threatened numerous species on earth (Wilson, 1988; Chapin et al., 2000).

The modern concept of biodiversity is anthropo-centered: diversity is analyzed in relation to human beings, either because people benefit from biological diversity or because human activities affect it either positively or negatively. The term 'biodiversity' entered common vocabulary in 1992 during the Earth Summit in Rio which highlighted the need for a better use of natural resources and for the protection of biological diversity. One year later, the Convention on Biological Diversity of the United Nations entered into force. In Article 2 of the Convention, biological diversity is defined as:

the variability among living organisms from all sources including, inter alia, terrestrial, marine and other aquatic ecosystems and the ecological complexes of which they are part: this includes diversity within species, between species and of ecosystems (United Nations, 1992).

However, the concept is complex and resists definition; in 1996, DeLong could still write that biodiversity does not have a single definition. Even today, some experts claim that the notion only refers to the diversity of biotic elements, whereas others say that it includes the

diversity of ecosystems in all their biotic and abiotic dimensions (Gosselin and Laroussinie, 2004, Chap. 1, § 3).

Two types of biodiversity can be considered (Chevassus-au-Louis et al., 2009):

- patrimonial – or remarkable – biodiversity: this refers to the existence and the preservation of entities such as genes, species, habitats or landscapes that have an intrinsic – and not necessarily monetary – value. These entities are often rare, emblematic or endangered species, such as the giant panda.
- functional – or ordinary – biodiversity: this type of biodiversity does not have an identified intrinsic value, but contributes to the functioning of ecosystems and to the ES provision resulting from the abundance of and the interactions between entities.

Patrimonial diversity is generally associated to specific places and cannot be moved, thus engendering high local stakes. The specific value of these patrimonial entities is such that they can be subject to particular ecosystem management practices, such as the creation of biological preserves or measures to maintain the characteristics of a landscape. Functional biodiversity, on the other hand, is likely to be found in many places and preserving this type of biodiversity is an issue nearly everywhere. Therefore, in the following sections, we will focus on the preservation of functional biodiversity, which has greater value to providers of ecosystems services because it enhances the stability of the ecosystem and provides better resilience in case of hazardous events.

Biodiversity is a broad concept which remains partly open to discussion but which underlines the interactions between human beings and their environment and highlights human responsibility in the loss of biodiversity. To give decision-makers tools to set goals and evaluate policies, methodologies have to be established to evaluate biodiversity. This raises the question of measurability. The concept is so wide and takes into account so many independent and non-comparable dimensions that measuring biodiversity is impossible (Mayer, 2006). However, some of its attributes such as species richness can be estimated and can be used as indicators of biodiversity.

Biodiversity characterization involves various aspects depending on the scale and the nature of the diversity that is being analyzed. *Genetic* diversity corresponds to the variability of genes in a population; *individual* diversity represents the variability between living things, for example in species diversity; *ecosystem* diversity refers to the variability among living systems. Scale is crucial when attempting to assess the level of biodiversity: for example, doubling the area of study increases the probability of finding more species (MacArthur, 1965). Moreover, the method used to evaluate biodiversity must comply with the scale (Whittaker, 1972; Halffter, 1998). Four levels of biodiversity are commonly used. *Alpha* biodiversity corresponds to a small-scale approach, e.g. the number of species at the stand level; *beta* diversity corresponds to the diversity over a collection of stands; and finally, *gamma* and *delta* diversity concern larger scales such as landscapes, entire territories or the world. At larger scales, the evaluation of biodiversity can correspond to an aggregated estimation of the local diversities such as the number of ecosystem categories or the variability of alpha or beta diversity.

To analyze the effect of various management practices on biodiversity at the stand level in high oak forests, we used an alpha scale characterization of functional biodiversity.

How to estimate biodiversity?

Many biodiversity indicators have been defined at the international level to facilitate reporting to the United Nations' Convention on Biological Diversity and to monitor sustainable forest management processes in programs such as Forest Europe and the Montreal Process. However, these nation-wide indicators are not suitable at the local level. At the stand level, other indicators, such as the Potential Diversity Indicator, have been developed (Larrieu and Gonin, 2008). Although global and local indicators are not comparable, they all obey similar constraints: they must correspond to preservation objectives, they must be sensitive enough to provide an early warning of change, and they must highlight species richness, genetic variability, the sustainable quality of ES or ecosystem resilience.

Since an indicator can only represent one given part of global biodiversity, it must:

1. correspond to an identified stake: a species, a species group, a family or an ecosystem;
2. be observed at a defined scale (stand, landscape, country);
3. be measured with an appropriate unit: number of individuals, species or species groups; characteristics of the environment which are favorable to biodiversity such as dead wood quantity...

A single indicator seldom suffices to accurately represent biodiversity because its multiple dimensions are not measurable on a single scale. Therefore a suite of indicators is usually required (Noss, 1990). International processes therefore use several indicators, each of which represents a different aspect of biodiversity (see e.g. the Forest Europe indicators for the fourth criterion in appendix A).

Naturalness and diversity indicators. Among the numerous existing biodiversity indicators, two major approaches can be distinguished: naturalness and species diversity. These approaches correspond to different perceptions of the role of biodiversity. The principle of naturalness stems from the consideration that human activities have changed the environment and disturbed its ecosystems. Corresponding indicators evaluate the distance between the characteristics of the current ecosystem and those of the ecosystem that would exist instead if there had been no human influence. Knowledge of the original "natural" state is thus required to develop such indicators. The key standards are pristine forests (Müller et al., 2007; Rademacher and Winter, 2003). Naturalness indicators (for example, the proximity to climax index) are used to evaluate the impact of harvesting practices in virgin tropical forests (Boscolo and Vincent, 2003) and in temperate forests, although standards⁵ are rare (Buongiorno et al., 1995; Eriksson and Lindhagen, 2001). These indicators could help managers make progress towards less disturbing and more close-to-nature forestry (Gossum et al., 2005).

On the other hand, indicators may estimate aspects of biodiversity that may originate from anthropic activities. In fact, human intervention can create new habitats and leave room for exotic species to establish themselves (DeLong, 1996). After centuries, these anthropic habitats may have created new ecosystem that become worth preserving for cultural value. For example, the capercaillie (*Tetrao urogallus*) in the Vosges mountains was able to develop and thrive because of alternating open and closed areas created by agricultural activities. In the context of climate change, introducing species further north to anticipate global warming is a way to increase diversity, and possibly to prevent species from disappearing and preserve

⁵Note that standards may have to be updated with global warming, because the natural conditions change.

the resilience of the forest at the regional level (Gray et al., 2011), although it may reduce the naturalness.

Direct and indirect indicators Indicators can be direct – one of the characteristics of biodiversity such as species richness is directly estimated –, or indirect – factors that favor or limit biodiversity are assessed, but the effective biodiversity level is not measured. Direct and indirect indicators are often complementary and can be used simultaneously to characterize biodiversity (Redon et al., 2009).

The most frequent direct indicator is the number of species in a taxon, also called species richness. With this indicator, numerous authors have been able to link the number of bird species or coleoptera to forest characteristics (see e.g. Martikainen et al., 2000; du Bus de Warnaffe and Deconchat, 2008; Berndt et al., 2008). The selection of the species to include is of major importance. For example, Müller et al. (2007) could find no differences in the total number of bird species between intensive and close-to-nature management practices in German beech forests; however, they highlighted huge differences in the number of species characteristic of pristine forests. The number of tree and shrub species is included in the indicator list for the sustainable forest management of French forests (MAP, 2006). However, the sustainability of this number of species is not taken into account and the viability of the populations could be limited over time due to too few remaining individuals. This indicator also equally weights all species, whereas some of them could be of greater social or biological importance in the ecosystem.

A second indicator is the number of individuals of a particular species or taxon, also called species abundance. This approach is preferred when dealing with the preservation of an endangered species and makes it possible to determine whether the species can reproduce. For example, Garmendia et al. (2006) analyzed links between Black and White-backed woodpeckers and forest management practices in the Pyrenees. These two species are dependent on mature beech forests and are therefore impacted by intense harvests. Such studies are even more warranted when umbrella species such as the above-mentioned White-backed woodpecker are concerned. The presence of umbrella species reveals a globally high level of biodiversity because they require very complex habitats which host many other species (Simberloff, 1999) or because they are essential elements in an ecosystem (Maleque et al., 2009). In some cases, the total biomass of a given species is preferred over the number of individuals, for example when dealing with mosses, lichens and mushrooms. However, for both methods (counting individuals and measuring biomass), there is not always consensus on the most appropriate indicator species. Furthermore, controlling the population of one species can lead to a biased practice, such as feeding or protecting the indicator species, which then does not play its indication role anymore.

We note that direct indicators presented above can be used at various scales, from the stand to the country level. Except for abundance, these indicators are not Lebesgue measures: when changing scale, the value of the indicator corresponding to a collection of stands is not equal to the sum of the indicator values at the stand level. For example, if the number of coleoptera species is 15 in one stand and 20 in a second one, the global number of species is comprised between 20 (if 15 species are common to both stands) and 35 (if all the species are different). A second property of these indicators is that larger areas give higher probabilities of finding diverse species, but the relation is not systematic. Scale thus is critical. Such indicators can

be relevant when analyzing diversity changes over time in the same delimited place (stand or landscape).

Observing species and populations is rather complex: it requires specific skills (e.g. extensive knowledge of the species, bird song recognition, etc.) and the use of specialized equipment such as catching nets, and may be quite time-consuming. Consequently, indicators based on the characterization of populations cannot be used everywhere. Fortunately, specialists have established relationships between biodiversity and habitat characteristics (Fielding and Haworth, 1995; Psyllakis and Gillingham, 2009; Caprio et al., 2009) and have shown that measuring these characteristics can help estimate biodiversity.

Indirect indicators are estimates of biotic or abiotic characteristics of the environment that are favorable to certain types of biodiversity; they include land cover, forest structure and dead wood quantities. The quality of an indirect indicator depends on its capability to predict biodiversity and its ease of assessment. In forestry, the number of old trees is a good predictor of saprophyte diversity (Hagan and Grove, 1999). This indicator has led to applications in forestry with the principle of Green Tree Retention (Koskela et al., 2007): five to ten trees per hectare are kept to prevent biodiversity loss. Other frequently used indirect indicators are stand structure (Lindenmayer et al., 2000) and dead wood quantity and quality, important in preserving saprophytes (Franc, 2007; Jonsell et al., 1998), beetles (Brin et al., 2009) and associated species such as woodpeckers (Martikainen et al. (2000); Angelstam et al. (2002); Drapeau et al. (2009)). Comparing the level of these indicators in managed forests and old forests can be used as a surrogate for close-to-nature management indicators.

However, once again a single measurement may not be sufficient: though dead wood plays a significant role, tree species also contribute to the ecosystem (Bouget et al., 2009). Moreover, maximizing indirect indicators such as deadwood may not make sense. An over-mature forest composed of only old trees is more sensitive to storms and less resilient. Very high quantities of dead wood may not protect biodiversity better than an appropriate quantity, but biodiversity may be threatened below a minimum quantity. Exactly what the appropriate quantity is remains subject to debate (Bütler Sauvain, 2003). Indicators such as dead wood quantity and the number of old trees can be summed when changing scale, but if all the preservation efforts are concentrated in the same area, the positive impact on biodiversity may be less effective than if the preservation efforts had been more uniformly distributed. Therefore, some authors have elaborated indirect indicators which are functions of observed reactions of a defined type of biodiversity to a habitat parameter. Eriksson and Lindhagen (2001) or Grove (2002) parameterized indicators using a logarithm of deadwood quantity to show that adding one more unit of dead wood has a higher impact on biodiversity if the initial amount was low than if the initial amount was already high.

As we have seen above, evaluating biodiversity is a multidimensional problem that does not have one single solution. Various types of indicators exist, but none of them is directly applicable to our case study because they rely on data which were not available in our simulation. We therefore propose to elaborate an indicator adapted to our case study.

Predicting biodiversity with a model To analyze the opportunity cost of preserving biodiversity at the management unit level in high oak forests with a simulator, the biodiversity indicator must be applicable at the stand level and must also be sensitive to forest attributes

that can be predicted by the simulator. Let us take the example of sensitive bird species. As mentioned above, the preservation of bird species diversity is at stake in many places. In our example of the Perche Regional Natural Park, two types of species are important candidates for preservation efforts: cavity nesters, which can typically be observed in closed mature forests, and migrant bird species to which the forest offers a temporary habitat. Since we had access to information concerning these bird species and stand status, we were able to elaborate an indicator for bird species richness.

Data concerning high oak forests and bird species were collected in 2004 and 2005 and were provided by Frederic Archaux (Irstea at Nogent-sur-Vernisson, France). The survey plots were located in three forested areas in the Perche Regional Natural Park: the Perche – Trappe state forest, the Moulin state forest and the Bellême state forest. The dataset is composed of 175 records that contain stand variables such as average tree age, basal area, dominant height and dominant diameter, and the number of species heard in each forest during the survey (see Archaux, 2005, for a detailed description of the bird survey). Species were classified into cavity nesters, woodpeckers, trans-Sahara migratory species and the total number of species was included. It should be noted that trans-Sahara migrant species are mainly present in open forests, but some of them, e.g. *Jynx torquilla*, also are cavity nesters.

Using the *lm* procedure in R version 2.11.1, we fitted linear models to predict the number of bird species in each species group, but we could only find a model with significant parameters to predict the total number of bird species (see equation 4.10).

$$Nb_{\text{bird species}} = a_{\text{forest location}} + b \cdot h_{\text{dom}} + c \cdot h_{\text{dom}}^2 \quad (4.10)$$

with h_{dom} the dominant height of the stand in m. Results are presented below.

R outputs

```
Call:
lm(formula = Nb_BirdSpecies ~ Hd + Hd2 + Place, data = Datenmatrix)

Residuals:
    Min       1Q   Median       3Q      Max
-6.412 -1.861  0.277  2.192  5.772

Coefficients:
              Estimate Std. Error t value Pr(>|t|)
(Intercept) 14.804539   0.967175  15.307 < 2e-16 ***
Hd           -0.413785   0.098000  -4.222 3.92e-05 ***
Hd2           0.012211   0.002158   5.658 6.32e-08 ***
PlaceMoulin -3.278578   0.471314  -6.956 7.11e-11 ***
PlacePerche -0.001777   0.563979  -0.003  0.997
---
Signif. codes:  0 '***' 0.001 '**' 0.01 '*' 0.05 '.' 0.1 ' ' 1

Residual standard error: 2.692 on 171 degrees of freedom
Multiple R-squared:  0.4651, Adjusted R-squared:  0.4526
F-statistic: 37.18 on 4 and 171 DF,  p-value: < 2.2e-16
```

The model explains nearly half of the variability of the number of observed species. The major characteristic influencing the number of species is the dominant height. The highest number

of species was found for high dominant height (more than 25 m). In this case, the habitat was suitable for cavity nesters (including woodpeckers) which are much more diverse than open forest bird species. Interestingly, the lowest number of observed bird species was obtained in forests with a dominant height of 15 to 20 m. These stands may not be adapted to either open, or non-forest, birds or to cavity nesters. The highest dominant height in the dataset was 42 m (observed twice in the Bellême forest only). So, the habitat indicator should not be used when the stand dominant height is much higher. Since no more than 20 species were observed at any one plot, we set 20 as the maximum index value.

Forest location also played a role in the potential number of species. Species richness was higher in the Bellême forest and in the Perche-Trappe forest than in the Moulin forest. This might mean that fewer species were present in the Moulin area than in the other two forests. When using the model as an indicator in a simulation process, the location of the forest, and thus the diversity potential, must be defined. The number of observed species results from the combination of an adapted habitat, represented in the model by the dominant height, and a more general diversity potential. Note that when management possibilities are compared within the same forest, the differences come from habitat only.

If we assume that the simulated stand is located in the Bellême forest, then the indicator $Bio(t)$ representing the potential number of species hosted by the forest with a dominant stand height h_{dom_t} (in m) at time t is as follows:

$$Bio(t) = \min(14.804539 - 0.413785 \cdot h_{dom_t} + 0.012211 \cdot h_{dom_t}^2; 20) \quad (4.11)$$

The highest level of the biodiversity indicator is obtained when the dominant height is above 43.5 m, as observed by Archaux (2005). In forest stands composed of small trees our model indicates an expected species richness of 14.8, which mainly corresponds to species adapted to open areas or characteristic of very young forests (see Figure 4.3). Such high species richness is overrun when the dominant height of the stand is above 33.9 m, but the list of species is then different. The lowest species richness value is obtained when the stand reaches a status that is less appropriate for migrant birds, and is still not favorable to cavity nesters (between 15 m and 20 m).

The model developed above takes tree height as the relevant characteristic for bird species habitat and it makes it possible to predict the potential number of bird species with a growth and yield simulator. This number will be used as a biodiversity indicator. It takes a particular U-shape over the stand growth which is not commonly presented in the literature, because young and mature forest habitats are usually analyzed separately. However, it is well known that bird species that live in young forests differ from species that live in old forests. According to Archaux (personal discussion) the U-shape is not surprising because young and mature forest habitats differ considerably. Separating migrant bird species from cavity nesters (two species groups with different protection stakes) would be more informative, though the relationships we found between these two species groups and stand height were not significant. Our model cannot be used in every high oak forest in France, because of the specificity of the Perche region, in particular its role as a temporary habitat for migrant birds. We have nonetheless fulfilled our objective to model bird diversity in the study area.

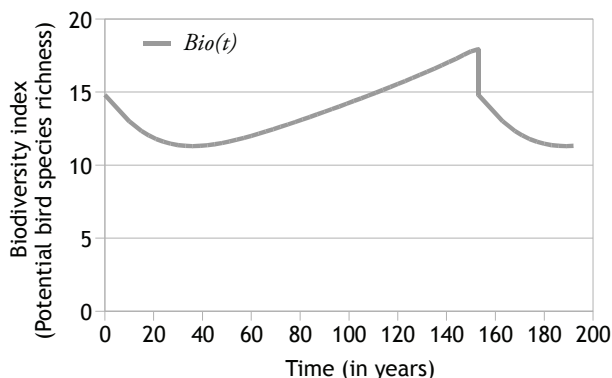

Figure 4.3: Simulation of changes in bird species richness in a high oak forest
 (Example of a simulation with a target diameter of 70 cm; initial RDI: 0.8;
 final RDI: 0.6; medium thinning intensity)

4.3 Comparing production when rotation periods differ

In the next section, we explore multiple management scenarios designed to produce forest products and services. Varying stand density, thinning intensity and diameter at breast height for final felling bring about considerable differences in rotation lengths and production dynamics. To be able to compare simulation results, we need to aggregate production over a defined period of time or over the entire rotation. Like Faustmann (1849) and followers, we assume that a given management scenario can be repeated forever and always lead to the same production levels. We propose two time aggregation methods: average production and discounted production. Both methods imply the assumption that the quantities of ES measured correspond to values that can be summed at the stand level. This assumption is true for money and carbon quantities, but may be questionable for the recreation attractiveness and bird species richness. However, for the purpose of the exercise, we consider that all estimated ES values are comparable to economic values and correspond to a willingness to pay for these services.

4.3.1 Average profits and service provision

When we calculate average production of wood and ESs, we do not make any difference between short-term and long-term production. However, we determine the time that is required to produce wood of the desired quality and the average level of services produced during this period. Total average production value corresponds to the production from a virtual property split into as many stands of the same area as possible stand ages (e.g. 102 stands if the final cut is done at 102 years), each of which has a different age. Since each virtual stand represents a different one-year increment in age, if there are no changes in management from one stand to the next, the total yearly production on the property (the sum of the virtual stands) is constant. This corresponds to a steady state.

The average net profit produced every year with a given type of forest management corresponds to the sum of the benefits resulting from the selling harvested wood minus the costs of stand establishment and maintenance.

$$\bar{P} = \frac{\sum_{t=0}^T (B_{\text{wood}}(t) - C_m) - C_0}{T} \quad (4.12)$$

where

T is the duration of one rotation

$B_{\text{wood}}(t)$ is the net benefit of standing timber sold and harvested at time t

C_0 is the costs of establishing the forest at $t = 0$

C_m corresponds to management and insurance costs each year.

The average profit is estimated in euros per hectare and per year. In the calculation of $B_{\text{wood}}(t)$ (equation 4.3), the price function is the one in equation 4.1⁶, but it can be replaced by the price function that includes an increase in the demand for fuel wood (equation 4.2⁷). The average value is similar to what foresters often call ‘sustained yield’, but it includes management costs and the variations in wood value with tree growth.

To calculate continuously produced services, we sum up the quantity of services provided over time and divide this figure by the rotation length⁸. Global indicators representing the average production of the services during the rotation result as follows:

$$\overline{CS} = \frac{\int_{t=0}^T CS(t)dt}{T} \quad (4.13)$$

$$\overline{A} = \frac{\int_{t=0}^T A(t)dt}{T} \quad (4.14)$$

$$\overline{Bio} = \frac{\int_{t=0}^T Bio(t)dt}{T} \quad (4.15)$$

where \overline{C} is the average quantity of carbon stored in the forest, \overline{A} is the average recreation attractiveness and \overline{Bio} is the average bird species richness indicator. When choosing these average indicators, we assumed that there are no temporal production priorities: management choices are made to provide these services in the highest average quantity, whatever the kinetics of provision.

Biologists often consider the maximum sustained yield (MSY) as the optimum management goal. This approach is being discussed by economists who compare the production value to land rent (Faustmann, 1849). The calculated average production of the sustained yield of multiple outputs can be taken as a proxy for the discounted value of the outputs when the discount rate tends to 0 (Samuelson, 1976).

An alternative approach to using average values is possible to estimate recreation and bird diversity indicators. If we can determine a minimum value for $A(t)$ that makes the forest appropriate for recreation, then we can estimate the percentage of time during the rotation

⁶ $p(DBH_{i,t}) = \max(0; 1.09 \times DBH_{i,t} - 12.14; 90.63 \times \ln(DBH_{i,t}) - 284.52)$

⁷ $p_{\text{fuel}}(DBH_{i,t}) = \max(0; 1.09 \times DBH_{i,t} - 5.13; 96.42 \times \ln(DBH_{i,t}) - 306.49)$

⁸Note that the value of \bar{P} can also be written $\bar{P} = \frac{1}{T} \left(\int_{t=0}^T (B_{\text{wood}}(t)) dt - C_0 \right) - C_m$ with T in years

that the forest is suitable for recreation. This corresponds to the percentage of the total area that is suitable for recreation in the virtual forest composed of the same number of stands as years in the rotation period. For biodiversity, the image of the virtual forest suggests that the total number of species that is preserved due to the co-existence of various stages would be a good aggregated value. However, we could not estimate this total number with our available data.

4.3.2 Discounted quantities

In order to take into account the difference between fast production scenarios and slower production scenarios (i.e. with shorter or longer rotations), we calculated discounted quantities of products and services. For our calculations, we assumed that the management scenarios were infinitely repeatable over time. We characterized the wood production value by the net present value carried over to an infinite series of rotations (NPVIS) with a discount rate r .

$$NPVIS = \frac{\sum_{t=0}^T (B_t \cdot (1+r)^{T-t} - C_m) - C_0}{(1+r)^T - 1} \quad (4.16)$$

Discounting monetary values such as the benefit from wood harvest is a more usual approach than estimating the average annual benefit. Discounting was introduced by Faustmann (1849) to set forest rotations that optimize revenue. Discounting also makes it possible to estimate the value of a forest investment over long periods of time in a growing economy. Discounting gives value to the time in terms of preference for the present. It also assumes that the income increases. These hypotheses imply that one euro in the future will have less value than one euro at the present time.

Setting a proper discount rate is rather complex (Derycke, 1966; Brukas et al., 2001). For forest projects, rates are usually comprised between 2% and 4% but can reach up to 10% for stands where trees reach maturity in 40 years or less (Calvet et al., 1997; Boscolo and Vincent, 2003; Nalle et al., 2005). In our work, we applied a 2% discount rate because of the long-term return on investment for sessile oak, a slow-growing species. To verify the sensitivity of our results to this discount rate, we also ran the calculation with a 2.5% discount rate.

For continuously produced services, we similarly calculated the present value of the service provided at t and integrated it over time. Discounting the production level of non-marketable services, especially environmental services such as global change mitigation, involves ethical questions which have led to intense debate (see for example comments on the Stern review in Dasgupta, 2006; Nordhaus, 2007). The rationale of the discussion is that the preservation of the environment is a concern for future generations which could value the environment differently. There are many uncertainties concerning the impact of current changes in biodiversity or climate and the technical capability of future generations to adapt to the new situations.

The preference for the present which contributes to the value of the discount rate is also difficult to estimate because 1) an increase in income could contribute to a higher demand for environmental services, and 2) the provision of these services might be limited as a result of previous choices. The relative utility of non-market ESs might grow faster than the utility

of profits from wood harvesting. To take into account this fact, we adjusted the net present value formula with a price correction factor (or relative price factor) that represents the relative change in value between the ES and timber sales revenues (Guesnerie, 2004). With a discount rate r and price correction factors pc_{CS} , pc_A and pc_{Bio} for carbon stock, recreation attractiveness and bird species richness respectively, the indicators are as follows:

$$CS_{PV} = \frac{(1+r+pc_{CS})^T}{(1+r+pc_{CS})^{T-1}} \int_{t=0}^T CS(t) \cdot (1+r+pc_{CS})^{-t} dt \quad (4.17)$$

$$A_{PV} = \frac{(1+r+pc_A)^T}{(1+r+pc_A)^{T-1}} \int_{t=0}^T A(t) \cdot (1+r+pc_A)^{-t} dt \quad (4.18)$$

$$Bio_{PV} = \frac{(1+r+pc_{Bio})^T}{(1+r+pc_{Bio})^{T-1}} \int_{t=0}^T Bio(t) \cdot (1+r+pc_{Bio})^{-t} dt \quad (4.19)$$

We propose a correction factor of -1% on carbon sequestration, recreation and biodiversity, assuming that their value would increase faster than wood value. We will evaluate how this factor affects the results.

The first difficulty in the analysis of environmental services is to define and to delimit their scope. Measurement techniques are a second issue. Using ES provision estimators is one way to overcome measurement limitations. These estimators are essential if a service provision is to be paid for. All the stakeholders must reach agreement on the indicators, then set references and objectives. Estimators also play an important role when payment mechanisms are based on the means utilized to enhance or preserve ESs. In fact, how these means affect ES provision must be evaluated prior to establishing contracts; payment opportunities must be analyzed to determine the lowest opportunity cost for sustained ES provision.

In this chapter, we have presented different methods to estimate environmental services. Some ESs are directly measurable (wood quantities, carbon storage), while others require indicators which describe certain aspects of the service (recreation, biodiversity). We have also proposed two time aggregation techniques (average value and discounted value) to take into account the long production periods in forest contexts. A growth and yield simulator which integrates these estimators can provide multi-output production possibility sets as we will see in the next chapter.

Bibliography

- Abildtrup, J., Garcia, S., Olsen, S. B., and Stenger, A. (2011). Recreation value of forests in lorraine: A spatial analysis. In *18th Annual Conference of the European Association of Environmental and Resource Economists*, June 29th to July 2nd 2011, Rome.
- Anderson, R. G., Canadell, J. G., Randerson, J. T., Jackson, R. B., Hungate, B. A., Baldocchi, D. D., Ban-Weiss, G. A., Bonan, G. B., Caldeira, K., Cao, L., Diffenbaugh, N. S., Gurney, K. R., Kueppers, L. M., Law, B. E., Luyssaert, S., and O'Halloran, T. L. (2011). Biophysical considerations in forestry for climate protection. *Frontiers in Ecology and the Environment*, 9(3):174–182.
- Angelstam, P., Breuss, M., Mikusinski, G., Stenstrom, M., Stighall, K., and Thorell, D. (2002). Effects of forest structure on the presence of woodpeckers with different specialisation in a landscape history gradient in NE Poland. *Avian Landscape Ecology: Pure and Applied Issues in the Large-Scale*, pages 25–38.
- Archaux, F. (2005). Impact de la diversité en essences et de la stratification verticale pour l'avifaune de plaine – Cas des grands massifs forestiers du parc naturel régional du Perche. Technical report, Cemagref.
- Baral, A. and Guha, G. S. (2004). Trees for carbon sequestration or fossil fuel substitution: the issue of cost vs. carbon benefit. *Biomass and Bioenergy*, 27(1):41–55.
- Berndt, L., Brockerhoff, E., and Jactel, H. (2008). Relevance of exotic pine plantations as a surrogate habitat for ground beetles (Carabidae) where native forest is rare. *Biodiversity and Conservation*, 17(5):1171–1185.
- Boscolo, M. and Vincent, J. (2003). Nonconvexities in the production of timber, biodiversity, and carbon sequestration. *Journal of Environmental Economics and Management*, 46(2):251–268.
- Bouchon, J. (1974). Les tarifs de cubage. Technical report, INRA et ENGREF, Nancy (France).
- Bouget, C., Brin, A., and Moreau, P. A. (2009). Dead wood and saproxylic biodiversity at different spatial scales. *RenDez-Vous Techniques*, 25/26.
- Brin, A., Brustel, H., and Jactel, H. (2009). Species variables or environmental variables as indicators of forest biodiversity: A case study using saproxylic beetles in Maritime pine plantations. *Annals of Forest Science*, 66(3):306.
- Brukas, V., Thorsen, B. J., Helles, F., and Tarp, P. (2001). Discount rate and harvest policy: implications for Baltic forestry. *Forest Policy and Economics*, 2(2):143–156.
- Buhyoff, G. J., Hull, R. B., Lien, V. J. N., and Cordell, H. K. (1986). Prediction of scenic quality for southern pine stands. *Forest Science*, 32:769–778.
- Buongiorno, J., Peyron, J.-L., Houllier, F., and Bruciamacchie, M. (1995). Growth and management of mixed-species, uneven-aged forests in the french jura: Implications for economic returns and tree diversity. *Forest Science*, 41(3):397–429.
- Burschel, P. (1995). Wald – forstwirtschaft und globale Ökologie. *Forstwissenschaftliches Centralblatt*, 114(1):80–96.
- Bütler Sauvain, R. (2003). *Dead wood in managed forests: how much and how much is enough?* PhD thesis, École polytechnique fédérale de Lausanne, Lausanne. Available from: <http://library.epfl.ch/theses/?nr=2761>.
- Calvet, P., Lemoine, B., and Peyron, J. L. (1997). The discount rate and silvicultural management of stands: Case of the maritime pine in France. *Canadian Journal of Forest Research*, 27(8):1268–1275.
- Caprio, E., Ellena, I., and Rolando, A. (2009). Assessing habitat/landscape predictors of bird diversity in managed deciduous forests: a seasonal and guild-based approach. *Biodiversity and Conservation*, 18(5):1287–1303.

- Carlén, O., Mattsson, L., Atlegrim, O., and Sjöberg, K. (1999). Cost efficiency in pursuing environmental objectives in forestry. *Journal of Environmental Management*, 55(2):111–125.
- Caurla, S., Lecocq, F., Delacote, P., and Barkaoui, A. (2010). The French forest sector model: Version 1.0 – presentation and theoretical foundations. Technical Report 3, LEF (INRA–AgroParisTech). Available from: http://www.nancy.inra.fr/lef/content/download/3310/33596/version/1/file/doc_LEF_n2010-03.pdf.
- Cavaignac, S. and le Moguedec, G. (2006). Un modèle pour estimer le prix des bois façonnés. application aux lots de chene. *RenDez-Vous Techniques*, 12:10–14.
- Cavaignac, S., le Moguedec, G., and Nepveu, G. (2006). Two complementary indicators to rank various oak wood defects according to different users' advice. *New Zealand Journal of Forestry Science*, 36(2/3).
- Chapin, F. S., Zavaleta, E. S., Eviner, V. T., Naylor, R. L., Vitousek, P. M., Reynolds, H. L., Hooper, D. U., Lavorel, S., Sala, O. E., Hobbie, S. E., Mack, M. C., and Diaz, S. (2000). Consequences of changing biodiversity. *Nature*, 405(6783):234–242.
- Chavet, M. and Chavet, P. (2011). Cours indicatif au m³ réel sur écorce des bois sur pied, découpe commerciale. *La forêt privée – Revue forestière européenne*, 318:48–49.
- Chevassus-au-Louis, B., Salles, J.-M., Bielsa, S., Richard, D., Martin, G., and Pujol, J.-L. (2009). Approche économique de la biodiversité et des services liés aux écosystèmes. Technical report, Centre d'analyse stratégique – Premier Ministre (France).
- Christie, M., Hanley, N., and Hynes, S. (2007). Valuing enhancements to forest recreation using choice experiment and contingent behaviour methods. *Journal of Forest Economics*, 13(2-3):75–102.
- Clawson, M. and Knetsch, J. L. (1966). *Economics of outdoor recreation*. Resources for the Future by Johns Hopkins Press in Baltimore.
- Colson, V., Garcia, S., Rondeux, J., and Lejeune, P. (2010). Map and determinants of woodlands visiting in Wallonia. *Urban Forestry and Urban Greening*, 9(2):83–91.
- Daniel, T. C. and Boster, R. S. (1976). Measuring landscape esthetics: the scenic beauty estimation method. *USDA Forest Service Research Paper, Rocky Mountain Forest and Range Experiment Station*, RM-167. Available from: http://www.fs.fed.us/rm/pubs_rm/rm_rp167.pdf.
- Dasgupta, P. (2006). Comments on the Stern Review's Economics of Climate Change. Available from: <http://www.econ.cam.ac.uk/faculty/dasgupta/STERN.pdf>.
- de Coligny, F., Meredieu, C., Labbé, T., Vallet, P., and Dreyfus, P. (2005). Using capsis for connection with wood quality. In *Proceedings of the fifth Workshop "Connection between Forest Resources and Wood Quality : Modelling Approaches and Simulation Software"*, Waiheke Island, New Zealand.
- DeBald, P. and Mendel, J. (1976). *SETs: stand evaluation tools. An individual-tree approach to making stand evaluations*. USDA Forest Service research paper NE. Forest Service, U.S. Dept. of Agriculture, Northeastern Forest Experiment Station. Available from: http://www.fs.fed.us/ne/newtown_square/publications/research_papers/pdfs/scanned/OCR/ne_rp336.pdf.
- Deckmyn, G., Muys, B., Quijano, J. G., and Ceulemans, R. (2004). Carbon sequestration following afforestation of agricultural soils: comparing oak/beech forest to short-rotation poplar coppice combining a process and a carbon accounting model. *Global Change Biol*, 10(9):1482–1491.
- DeLong, D. C. (1996). Defining biodiversity. *Wildlife Society Bulletin*, 24(4):738–749.
- Derycke, P.-H. (1966). Taux d'intérêt, taux d'actualisation et croissance économique. *Revue économique*, 17(4):525–536. Available from: http://www.persee.fr/web/revues/home/prescript/article/reco_0035-2764_1966_num_17_4_407717.
- Drapeau, P., Nappi, A., Imbeau, L., and Saint-Germain, M. (2009). Standing deadwood for keystone bird species in the eastern boreal forest: Managing for snag dynamics. *Forestry Chronicle*, 85(2):227–234.

- Drexhage, M. and Colin, F. (2001). Estimating root system biomass from breast-height diameters. *Forestry*, 74(5):491–497.
- du Bus de Warnaffe, G. and Deconchat, M. (2008). Impact of four silvicultural systems on birds in the Belgian Ardenne: implications for biodiversity in plantation forests. *Biodiversity and Conservation*, 17(5):1041–1055.
- Dupouey, J., Pignard, G., Badeau, V., Thimonier, A., Dhôte, J., Nepveu, G., Bergès, L., Augusto, L., Belkacem, S., and Nys, C. (1999). Stocks et flux de carbone dans les forêts françaises. *Comptes Rendus de l'Académie d'Agriculture française*, 85(6):301–318.
- Edwards, D., Jensen, F. S., Marzano, M., Mason, B., Pizzirani, S., and Schelhaas, M. J. (2011). A theoretical framework to assess the impacts of forest management on the recreational value of European forests. *Ecological Indicators*, 11(1):81–89.
- Eriksson, L. and Lindhagen, A. (2001). A model indicating effects of multipurpose use of forestry on stand level. *Criteria and Indicators for Sustainable Forest Management at the Forest Management Unit Level*, 38:83–98.
- Faustmann, M. (1849). Calculation of the value which forest land and immature stands possess for forestry. *Allgemeine Forst und Jagd Zeitung*, pages 441–455.
- Fielding, A. H. and Haworth, P. F. (1995). Testing the generality of bird-habitat models. *Conservation Biology*, 9(6):1466–1481.
- Fortin, M., Ningre, F., Robert, N., and Mothe, F. (2012). Quantifying the impact of forest management on the carbon balance of the forest-wood product chain: A case study applied to even-aged oak stands in france. *Forest Ecology and Management*, 279:176–188.
- Forêt privée française (2009). Private forest property in france: Key figures. Available from: http://www.foretpriveefrancaise.com/data/info/141462-ChiffresCles_english_2008.pdf.
- Franc, N. (2007). Standing or downed dead trees - does it matter for saproxylic beetles in temperate oak-rich forest? *Canadian Journal of Forest Research*, 37(12):2494–2507.
- Garmendia, A., Carcamo, S., and Schwendtner, O. (2006). Forest management considerations for conservation of Black Woodpecker *Dryocopus martius* and White-backed Woodpecker *Dendrocopos leucotos* populations in Quinto Real (Spanish Western Pyrenees). *Biodiversity and Conservation*, 15(4):1399–1415.
- Gosselin, M. and Laroussinie, O. (2004). *Biodiversité et gestion forestière – Connaître pour préserver*, volume 20 of *Études – Gestion des Territoires*. Cemagref – GIP Ecofor, Cemagref edition.
- Gossum, P. V., Luyssaert, S., Serbruyns, I., and Mortier, F. (2005). Forest groups as support to private forest owners in developing close-to-nature management. *Forest Policy and Economics*, 7(4):589–601.
- Gray, L. K., Gylander, T., Mbogga, M. S., Chen, P.-y., and Hamann, A. (2011). Assisted migration to address climate change: recommendations for aspen reforestation in western Canada. *Ecological Applications*, 21(5):1591–1603.
- Grove, S. J. (2002). Tree basal area and dead wood as surrogate indicators of saproxylic insect faunal integrity: a case study from the australian lowland tropics. *Ecological Indicators*, 1(3):171–188.
- Guesnerie, R. (2004). Calcul économique et développement durable. Delta working papers, DELTA (Ecole normale supérieure). Available from: <http://econpapers.repec.org/RePEc:del:abcdef:2004-02>.
- Guilley, E., Hervé, J.-C., Huber, F., and Nepveu, G. (1999). Modelling variability of within-ring density components in quercus petraea liebl. with mixed-effect models and simulating the influence of contrasting silvicultures on wood density. *Annals of Forest Science*, 56(6):449–458.
- Gustavsson, L. and Sathre, R. (2006). Variability in energy and carbon dioxide balances of wood and concrete building materials. *Building and Environment*, 41(7):940–951.

- Hagan, J. and Grove, S. (1999). Coarse woody debris. *Journal of Forestry*, 97(1):6–11.
- Halffter, G. (1998). A strategy for measuring landscape biodiversity. *Biology International*, 36.
- Holgen, P., Mattsson, L., and Li, C. Z. (2000). Recreation values of boreal forest stand types and landscapes resulting from different silvicultural systems: An economic analysis. *Journal of Environmental Management*, 60(2):173–180.
- Hörnsten, L. (2000). *Outdoor recreation in Swedish forests*. PhD thesis, Dept. of Forest Management and Products, SLU.
- Hörnsten, L. and Fredman, P. (2000). On the distance to recreational forests in Sweden. *Landscape and Urban Planning*, 51(1):1–10.
- IPCC (2001). *Chapter 3: The Carbon Cycle and Atmospheric Carbon Dioxide*. I.C. Prentice and G.D. Farquhar and M.J.R. Fasham and M.L. Goulden and M. Heimann and V.J. Jaramillo and H.S. Kheshgi and C. Le Quéré and R.J. Scholes and D.W.R. Wallace. In: *Climate Change 2001: The Scientific Basis*. Contribution of Working Group I to the Third Assessment Report of the Intergovernmental Panel on Climate Change [Houghton, J.T., Y. Ding, D.J. Griggs, M. Noguer, P.J. van der Linden, X. Dai, K. Maskell, and C.A. Johnson (eds.)]. Cambridge University Press, Cambridge, United Kingdom and New York, NY, USA, 881pp. IPCC.
- Jandl, R., Lindner, M., Vesterdal, L., Bauwens, B., Baritz, R., Hagedorn, F., Johnson, D., Minkinen, K., and Byrne, K. A. (2007). How strongly can forest management influence soil carbon sequestration? *Geoderma*, 137(3-4):253–268.
- Jensen, F. S. and Skovsgaard, J. P. (2009). Precommercial thinning of pedunculate oak: Recreational preferences of the population of Denmark for different thinning practices in young stands. *Scandinavian Journal of Forest Research*, 24(1):28–36.
- Jonsell, M., Weslien, J., and Ehnstrom, B. (1998). Substrate requirements of red-listed saproxylic invertebrates in Sweden. *Biodiversity and Conservation*, 7(6):749–764.
- Koskela, E., Ollikainen, M., and Pukkala, T. (2007). Biodiversity conservation in commercial boreal forestry: The optimal rotation age and retention tree volume. *Forest Science*, 53(3):443–452.
- Larrieu, L. and Gonin, P. (2008). L'indice de biodiversité potentielle (ibp): une méthode simple et rapide pour évaluer la biodiversité potentielle des peuplements forestiers. *Revue Forestière Française*, 60(6).
- Lindenmayer, D. B., Margules, C. R., and Botkin, D. B. (2000). Indicators of biodiversity for ecologically sustainable forest management. *Conservation Biology*, 14(4):941–950.
- Loustau, D., Granier, A., Balesdent, J., Disnar, J.-R., Déqué, M., St-André, L., Pignard, G., Dupouey, J.-L., Ciais, P., Ogée, J., Desprez-Loustau, M.-L., Dufrêne, E., François, C., and Davi, H. (2004). Rapport final du projet Carbofor. Technical report, Ministère de l'Écologie et du Développement durable, programme Gestion et Impacts du Changement Climatique.
- Luysaert, S., Schulze, E. D., Börner, A., Knohl, A., Hessenmoller, D., Law, B. E., Ciais, P., and Grace, J. (2008). Old-growth forests as global carbon sinks. *Nature*, 455(7210):213–215.
- MacArthur, R. H. (1965). Patterns of species diversity. *Biological Reviews*, 40(4):510–533.
- Maleque, M. A., Maeto, K., and Ishii, H. T. (2009). Arthropods as bioindicators of sustainable forest management, with a focus on plantation forests. *Applied entomology and zoology*, 44(1):1–11.
- MAP (2006). Les indicateurs de gestion durable des forêts françaises 2005. Technical report, Ministère de l'Agriculture et de la Pêche.
- Martikainen, P., Siitonen, J., Punttila, P., Kaila, L., and Rauh, J. (2000). Species richness of coleoptera in mature managed and old-growth boreal forests in southern Finland. *Biological Conservation*, 94(2):199–209.
- Mattsson, L. and Li, C.-Z. (1994). How do different forest management practices affect the non-timber value of forests? an economic analysis. *Journal of Environmental Management*, 41(1):79–88.

- Mayer, P. (2006). Biodiversity - the appreciation of different thought styles and values helps to clarify the term. *Restoration Ecology*, 14(1):105–111.
- Mitchell, G., May, A., and McDonald, A. (1995). PICABUE - a methodological framework for the development of indicators of sustainable development. *International Journal of Sustainable Development and World Ecology*, 2(2):104–123.
- Myers, J. R., Miller, G. W., Harry V. Wiant, J., and Barnard, J. E. (1986). Butt-log grade distributions for five appalachian hardwood species. *Broomal, PA: Northeastern Forest Experiment Station, NE-RP-590:4*. Available from: http://www.fs.fed.us/ne/newtown_square/publications/research_papers/pdfs/scanned/ne_rp590p.pdf.
- Müller, J., Hothorn, T., and Pretzsch, H. (2007). Long-term effects of logging intensity on structures, birds, saproxylic beetles and wood-inhabiting fungi in stands of european beech *fagus sylvatica* l. *Forest Ecology and Management*, 242(2-3):297–305.
- Nalle, D. J., Arthur, J. L., and Montgomery, C. A. (2005). Economic impacts of adjacency and green-up constraints on timber production at a landscape scale. *Journal of Forest Economics*, 10(4):189–205.
- Nordhaus, W. D. (2007). A review of the stern review on the economics of climate change. *Journal of economic literature*, 45(3):17.
- Noss, R. F. (1990). Indicators for monitoring biodiversity – a hierarchical approach. *Conservation Biology*, 4(4):355–364.
- Olsen, K. H. (2007). The clean development mechanism’s contribution to sustainable development: a review of the literature. *Climatic Change*, 84:59–73.
- Panagopoulos, T. (2009). Linking forestry, sustainability and aesthetics. *Ecological Economics*, 68(10):2485–2489.
- Paquet, P. and Deroubaix, G. (2003). Extension de l’éligibilité de la séquestration forestière du carbone à l’ensemble des stocks de la filière bois. Technical report, Coordination CTBA, pour l’Ademe, programme GICC.
- Patenaude, G. L., Briggs, B. D. J., Milne, R., Rowland, C. S., Dawson, T. P., and Pryor, S. N. (2003). The carbon pool in a British semi-natural woodland. *Forestry*, 76(1):109–119.
- Peichl, M. and Arain, A. A. (2006). Above- and belowground ecosystem biomass and carbon pools in an age-sequence of temperate pine plantation forests. *Agricultural And Forest Meteorology*, 140(1-4):51–63.
- Petersen, A. K. and Solberg, B. (2003). Substitution between floor constructions in wood and natural stone: comparison of energy consumption, greenhouse gas emissions, and costs over the life cycle. *Canadian Journal of Forest Research*, 33(6):1061–1075.
- Petersen, A. K. and Solberg, B. (2005). Environmental and economic impacts of substitution between wood products and alternative materials: a review of micro-level analyses from Norway and Sweden. *Forest Policy and Economics*, 7(3):249–259.
- Peyron, J. L., Harou, P., Niedzwiedz, A., and Stenger, A. (2002). National survey on demand for recreation in French forests. Technical report, INRA – report for Eurostat. Available from: http://www.prodinra.inra.fr/prodinra/pinra/data/2009/03/PROD2009c26057da_20090330101618470.pdf.
- Pingoud, K. and Wagner, F. (2006). Methane emissions from landfills and carbon dynamics of harvested wood products: The first-order decay revisited. *Mitigation and Adaptation Strategies for Global Change*, 11(5-6):961–978.
- Profft, I., Mund, M., Weber, G. E., Weller, E., and Schulze, E. D. (2009). Forest management and carbon sequestration in wood products. *European Journal of Forest Research*, 128(4):399–413.
- Psyllakis, J. M. and Gillingham, M. P. (2009). Using forest structure and composition to predict the occurrence of vertebrate species in douglas-fir forests of british columbia. *Biological Conservation*,

- 142(7):1427–1441.
- Rademacher, C. and Winter, S. (2003). Totholz im buchen-urwald: Generische vorhersagen des simulationsmodells beforecwd zur menge, räumlichen verteilung und verfügbarkeit. *Forstwissenschaftliches Centralblatt*, 122(5):337–357.
- Rapey, H. and Michalland, B. (2002). Observations et analyse sur la variabilité de la récréation en forêt dans des secteurs de moyenne montagne. *Revue Forestière Française*, 54(5):455–468.
- Redon, M., Sarthou, J. P., and Larrieu, L. (2009). Expert assessment of a forest stand - a study of the complementary between two biodiversity indicators. *Revue Forestiere Française*, 61(6).
- Ribe, R. G. (1989). The aesthetics of forestry - what has empirical preference research taught us. *Environmental Management*, 13(1):55–74.
- Robert, N. (2008). Stocks de carbone dans les produits bois et effet substitution. Technical report, Lerfob (INRA–AgroparisTech).
- Samuelson, P. A. (1976). Economics of forestry in an evolving society. *Economic Inquiry*, 14(4):466–92.
- Schlamadinger, B., Apps, M., Bohlin, F., Gustavsson, L., Jungmeier, G., Marland, G., Pingoud, K., and Savolainen, I. (1997). Towards a standard methodology for greenhouse gas balances of bioenergy systems in comparison with fossil energy systems. *Biomass and Bioenergy*, 13(6):359–375.
- Seidl, R., Rammer, W., Jager, D., Currie, W. S., and Lexer, M. J. (2007). Assessing trade-offs between carbon sequestration and timber production within a framework of multi-purpose forestry in Austria. *Forest Ecology and Management*, 248(1-2):64–79.
- Silvennoinen, H., Pukkala, T., and Tahvanainen, L. (2002). Effect of cuttings on the scenic beauty of a tree stand. *Scandinavian Journal of Forest Research*, 17(3):263–273.
- Simberloff, D. (1999). The role of science in the preservation of forest biodiversity. *Forest Ecology and Management*, 115(2-3):101–111.
- Smeets, E. and Weterings, R. (1999). Environmental indicators: Typology and overview. Technical Report 25, European Environment Agency. Available from: <http://www.eea.europa.eu/publications/TEC25>.
- Tapsuwan, S., MacDonald, D. H., King, D., and Poudyal, N. (2012). A combined site proximity and recreation index approach to value natural amenities: An example from a natural resource management region of murray-darling basin. *Journal of Environmental Management*, 94(1):69–77.
- Taverna, R., Hofer, P., Werner, F., Kaufmann, E., and Thürig, E. (2007). *The CO₂ Effects of the Swiss Forestry and Timber Industry. Scenarios of future potential for climate-change mitigation*. Number 0739 in Environmental studies. Federal Office for the Environment, Bern. Available from: <http://www.bafu.admin.ch/publikationen/publikation/00076/index.html?lang=en>.
- Tyrvaïnen, L. I., Silvennoinen, H., and Kolehmainen, O. (2003). Ecological and aesthetic values in urban forest management. *Urban Forestry and Urban Greening*, 1(3):135–149.
- United Nations (1992). Convention on Biological Diversity. Available from: <http://www.cbd.int/doc/legal/cbd-en.pdf>.
- Vallet, P. (2005). *Impact de différentes stratégies sylvicoles sur la fonction “puits de carbone” des peuplements forestiers. Modélisation et simulation à l’échelle de la parcelle*. PhD thesis, ENGREF.
- Vallet, P., Dhote, J. F., Le Moguedec, G., Ravart, M., and Pignard, G. (2006). Development of total aboveground volume equations for seven important forest tree species in France. *Forest Ecology and Management*, 229(1-3):98–110.
- Werner, F., Taverna, R., Hofer, P., and Richter, K. (2005). Carbon pool and substitution effects of an increased use of wood in buildings in Switzerland: first estimates. *Annals of Forest Science*, 62(8):889–902.
- Whittaker, R. H. (1972). Evolution and measurement of species diversity. *Taxon*, 21(2):213–251.

Wilson, E. O., editor (1988). *Biodiversity*. National Academy Press, 2101 Constitution Avenue, NW; Washington, DC 20418.

Chapter 5

Modeling stand level profit possibilities

With the increasing concern about the provision of environmental services (ES), forest management is becoming more and more complex. When wood supply is the only objective, decisions are more straight-forward than when numerous joint productions are of interest. Knowing the multi-output production possibilities a forest stand can supply would help managers take the most appropriate and most efficient management decisions.

In this chapter, we put into practice the methodology developed in sections 3.1.4 and 3.3 to envelop profit possibilities for high oak forests. We consider the profit from wood production and three ESs: carbon storage, recreation and bird diversity estimated using the procedures presented in chapter 4. In our case study, we use the forest growth and yield simulator *Fagacées* (Le Moguédec and Dhôte, 2012) to simulate the production of goods and services in sessile oak forests. We will first present the simulator and its parameters, then determine profit possibility envelopes and represent them on diagrams. We evaluate the sensitivity of these envelopes to simulation parameters. Finally, we examine how the results obtained can serve multipurpose oak forest management and how they can contribute to the design of possible payment for environmental services and public policies.

5.1 Modeling multipurpose high oak forest management

5.1.1 Forest management: an interaction between man and nature

Forest management is an activity that aims at producing desired goods and services in a forest. Forest sites vary and their characteristics can be more or less favorable to tree growth: land area, slope steepness, soil richness, climatic conditions, etc. We briefly examine the potential impact of some of these characteristics on forest production below.

- Land area plays a role for two major reasons: (1) In most management operations, economies of scale are possible. For example, the fixed costs of taking a skidder to the forest are the same whatever the area; (2) Some services require a minimum area for their production. To protect some species, the ecosystem must be large enough to host and feed enough individuals of a given species. If the area is too small, less than

1 or 2 ha for cavity nesters, for example, the forest will not be able to play a role in biodiversity preservation.

- Steep slopes increase harvesting costs, but can also create opportunities to produce complementary services such as protection from landslides or rock falls.
- Soil and climate are the most important contextual parameters: they contribute to the productivity of the stand to which is often attributed a site index corresponding to the dominant height of the trees at a given age. As in agriculture, it is possible to interact with soil richness and climatic conditions through fertilization or irrigation. However, this is rather rare in forestry since the gain in productivity is generally insufficient to make such operations profitable. Instead, foresters rely on choosing appropriate species and adapting their management practices to the existing conditions.

Managing an even-aged forest implies carrying out a series of operations from the establishment of the young forest to the final cut. The forester has to take decisions regarding the type of operation, its intensity and scheduling. These decisions depend on his knowledge of the terrain, his management objectives for the forest and his assumptions regarding uncertainties (likelihood of drought, storms...). Therefore, many different management plans can be elaborated for the same forest. They will influence the forest production potential in various ways.

At the beginning of a cycle, the manager can choose between:

- favoring natural regeneration while helping the desired species become established. This is a common practice in broadleaved forests in France;
- planting seedlings, quite common for pine and other coniferous species, especially when selected seedlings are available. Plantations are also useful when natural regeneration is insufficient or when the objective is to change the species;
- seeding when the regeneration is insufficient or to mix genetic provenances.

After this first, relatively costly establishment phase, several other expensive field operations must be done to prepare the forest for exploitation, opening racks and managing competing species, for example. Thinnings are planned to reduce competition, enhance timber quality and encourage faster tree growth. The first thinnings – also called “pre-commercial thinnings” – are costly and do not generate income because the trees are too small. Later on, however, thinnings become profitable. Thinning intensity can be modulated: intensive thinnings disturb the ecosystem and can increase the sensitivity of the forest to storm hazards (Gardiner et al., 1997), but not only can they be more profitable than less severe thinnings, fewer interventions are needed over the rotation period. Finally, once the management objective – typically defined in terms of a target tree diameter – is reached, the stand is cut. During the final harvest, the stand is either cut all at once (clearcut), leaving exposed ground that will be artificially regenerated (by plantation or seeding), or cutting takes place in several stages and seed trees are left to progressively open areas for natural regeneration. These seed trees are generally selected for their high quality (straight stem, limited branchiness, superior volume growth...), to ensure high genetic quality for regeneration. When a forest is naturally regenerated, the end of one cycle overlaps with the beginning of the next.

The forest management process is continuously repeated, but planning may be adapted when needed, for example, if the expected growth is not achieved because of climatic events or if objectives are changed. If new objectives are set at the beginning of the rotation, then

all options are open. On the other hand, if objectives are revised during the course of the rotation, previous decisions can influence the opportunities positively (final products may be obtained faster) or negatively (production possibilities might be restricted). For example, if a forest has been very heavily thinned during the first phases of its growth to produce fewer but faster-growing trees, it is nearly impossible to create a dense forest with straight stems for high quality timber without clearcutting the forest and starting the process over.

It is rather complex to use field data to evaluate production possibilities at the beginning of the rotation and to predict how management choices will change those production possibilities. In fact, it is almost impossible to find a large enough area with homogeneous growth conditions to test various management hypothesis. Furthermore, experiments would necessarily last a long time before differences could be monitored. The lengthy time scale involved in forestry is the most essential justification for a simulation approach. Simulations are more flexible and comparisons are easier to make since each parameter can be controlled, all other things being equal.

5.1.2 Growth and yield simulation with *Fagacées*

Definitions. At the core of the simulation approach is a model based on field data and observations developed by biologists to help foresters take management decisions. For example, such simulators have been used to establish references management plans (Twery, 2004) and to write management guidelines (Sardin, 2008)¹. Simulators are also used to evaluate the sustainability of forestry practices (Peng, 2000). Here, we use the biotechnical growth and yield model *Fagacées*, which was developed to simulate even-aged high forests of pure beech or pure sessile oak (Le Moguédec and Dhôte, 2012). According to Porté and Bartelink (2002)'s classification, it is a distance-independent tree-centered model. This means that every tree in the model is identified, but not located in space and that the competition between trees is modeled at the stand level.

Site index is one of the most important factors in the growth model. Growth in dominant height is one of the most conservative parameters when management practices are changed. The model uses dominant height equations designed by Duplat and Tran-Ha (1997) for sessile oak in France. Since oaks grow over very long periods, the site index corresponds here to the dominant height of a regular stand at 100 years of age.

The relative density index (RDI) is also a significant characteristic used in the simulator (Reineke, 1933). This index represents the level of spatial saturation by trees growing in the stand. It is the ratio between the number of trees in a forest and the maximum number of trees that could live in that forest, given the dominant diameter. RDI equals 1 (maximum value) if the stand is on the self-thinning curve. In this case, some trees will die and leave room for others to grow. The self thinning curve is a linear relation between the logarithm of the dominant diameter and the logarithm of the maximum number of trees given the dominant diameter. In most management scenarios, natural tree mortality resulting from over-density is avoided by means of regular thinning. RDI is a saturation indicator that can be used to evaluate the need for harvesting. An RDI value below 0.5 corresponds to an open forest. In

¹Sardin used the *Fagacées* simulator to prepare oak management scenarios.

traditional management scenarios, the RDI value ranges from 0.6 to 0.8. In very dense forests, this value is between 0.9 and 1.

The model. Technically, the model is composed of a chain of equations that:

- generate the initial stand status: status of the plantation or the natural regeneration after 15 years;
- calculate tree growth as a function of stand parameters at each step;
- estimate if trees are dying due to over density and propose virtual harvesting tools.

The simulation starts when the stand is 15 years old. The simulation process is based on an interactive loop as presented in figure 5.1. Initial parameters are: stand area, site index and initial stand type (plantation density or random regeneration). A file containing inventory information from a real stand can also be input to initiate the simulation. In this case, the simulation starts from the age of the inventoried stand.

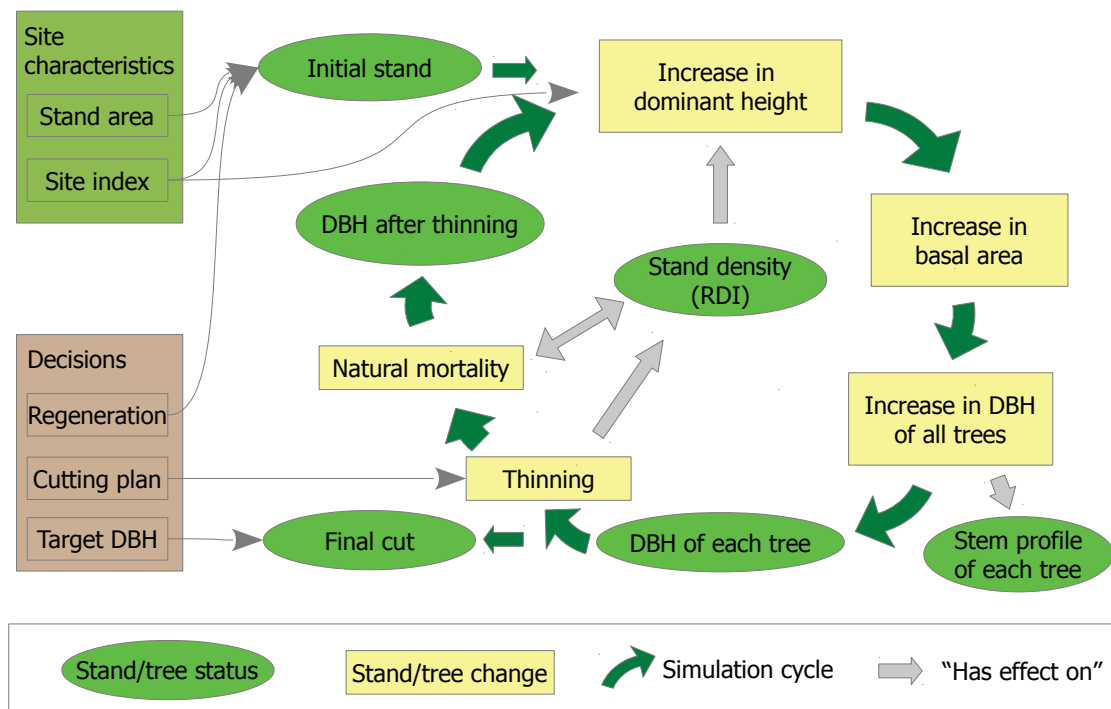

Figure 5.1: Simulation with *Fagacées*: a recursive interactive model

(adapted from Le Moguédec and Dhôte, 2012)

When forest growth is simulated from a natural regeneration, then the status of the initial stand (number of trees, height and DBH) is randomly generated as a function of the stand site index.

Then at each step, tree growth and stand status are calculated as follows:

- first the increase is calculated at the stand level:
 - stand dominant height increases depending on site index, age of the stand and RDI,

- increase in basal area is calculated as a function of dominant height, dominant height increment and RDI;
- then the growth is allocated to the trees:
 - each tree is allocated a DBH increment as a function of its diameter (small trees have very slow growth or no growth due to competition with larger trees) so that the total increase in tree basal area equals the stand level increase in basal area,
 - the height increment of each tree is calculated using an allometric relation of tree DBH and stand dominant height;
- harvests are simulated at the tree level; this can be done in various ways: designating the trees to be cut, choosing the number of stems to be harvested in each DBH class, or reducing stand density to a target value estimated with RDI;
- if RDI is higher than 1, some trees are randomly selected to die (with a preference for small slow growing trees) so that the RDI value drops below 1.

After this final step, the calculation starts again from the dominant height calculation for the next time step. In the model, the minimum time step is one year. The simulated growth and harvest cycle is repeated until the final harvest when all the trees are felled. The decision for the final harvest can be taken as a function of time, but it is more frequently related to the diameter and the value of the wood produced. The simulator can use either criterion to launch the final harvest. The model was calibrated with information from 27- to 277-year-old forest stands, with only very few data for stands more than 200 years old. Therefore, simulations for stands more than 250 years old are not usually considered to be reliable.

Software modules are available to estimate the volume and size of harvested logs, as well as the biomass and carbon content of the trees in the forest (stem, branches, buds and roots). Using stand and tree level information provided by the simulator, we programmed additional functions to estimate the monetary value of the harvested timber, the recreation attractiveness and the bird species diversity, as defined in chapter 4.

5.1.3 Simulation of multipurpose forest management

Our reference scenario corresponds to a newly harvested 4 ha stand. Since the simulator does not take edge effect into account, the area is a proportional multiplying factor. We assume that there are enough seedlings to allow natural regeneration, a common practice for oak forests in France. We will describe the multiple outputs that are produced as a function of the applied management.

Let us suppose that the stand site index is 32.5 m at 100 years. This corresponds to very fertile stands. We chose this hypothesis because for high site indices the maximum average increase in volume (total timber volume produced divided by the rotation length) is obtained with rotations shorter than 250 years for oak. Note that for medium to low site indices, the average increase in volume always increases with the length of the rotation: the maximum is not defined².

²The dominant height function increases slowly in the young forest, then accelerates for some years of fast growth before decelerating towards an almost linear growth (linear asymptote). In the case of medium and low site indexes, the growth speed during the fast growth period is too low to compensate for the slow growth during the stand establishment.

The manager takes decisions concerning the *dominant diameter* (d_{dom}) expected at the end of the rotation and the intensity and timing of the thinnings. The management plan for an oak forest can include more than 15 interventions during the rotation; this leads to a very large number of management possibilities, which sometimes vary only slightly. We cannot simulate all the possible scenarios, and even modeling only a few dozen management plans with each step included would be prohibitively time-consuming. We therefore identify the major differences that can be expected among scenarios and then use a tool to generate the subsequent management plans.

Harvesting trees reduces the number of trees and thus regulate the RDI. The RDI value can consequently be used as an indicator of the type of management and of thinning intensity. The main management differences can be summarized by the variation in stand RDI during the rotation; thinning intensity can be summarized by the maximum reduction in RDI allowed when thinning is performed. The *Fagacées* model includes a procedure that automatically plans thinnings as a function of the initial RDI value (RDI_i), the final RDI value (RDI_f), the range in which the RDI is supposed to vary (RDI_r)³, the time taken to reach the final RDI, and the target dominant diameter d_{dom} . In our case, we determined the time to reach the final RDI as a function of RDI_i , RDI_f and target d_{dom} . The principle of the system is that a thinning is done whenever the RDI value is above the line between ($\text{RDI}_i + \text{RDI}_r$) and ($\text{RDI}_f + \text{RDI}_r$). Thinning intensity is at least twice the RDI_r , so that the RDI after thinning is close to the line between ($\text{RDI}_i - \text{RDI}_r$) and ($\text{RDI}_f - \text{RDI}_r$) (see Figure 5.2).

In the simulation, RDI values are taken between 1, which corresponds to an absence of management, and 0.4, which corresponds to management for very low tree density. RDI values below 0.4 would not be accurately predicted because other species grow in the stand and have an influence on the provision of ecosystem services such as carbon storage. During the rotation, the RDI can be maintained within the same range ($\text{RDI}_i = \text{RDI}_f$), or the range can be increased ($\text{RDI}_i < \text{RDI}_f$) or decreased ($\text{RDI}_i > \text{RDI}_f$). The RDI_r representing thinning intensity is comprised between 0.05 for very light thinnings and 0.2 for intensive thinnings. In the last case, up to half of the trees can be harvested during one thinning.

Because sessile oak grows slowly compared to poplar or Black Locust (*Robinia pseudoacacia* L.), we do not propose rotations that would produce trees smaller than 30 cm; smaller diameters would be comparable to short rotation coppice for which species other than oak would be planted. Nor do we simulate management scenarios to produce trees larger than 90 cm since the rotation would be more than 250 years, a time span which is outside the validity range of the model. Moreover, very large oaks are rather complicated to market and their value is highly variable. Including very large diameter trees would require including price uncertainty in the simulation.

The model is mostly deterministic. However, random variables are used to generate the initial stand if the simulation starts from a virtual stand. In the automatic thinning procedure as for natural mortality, felled or dying trees are also randomly selected. These stochastic processes may affect the results. To limit the effect of the random initial stand status, we generate the stand only one time and record its initial status. All subsequent simulations start from this one recorded status. Variations resulting from the stochastic choice in the thinning and

³The lower the RDI thinning range, the lower the intensity of the thinnings.

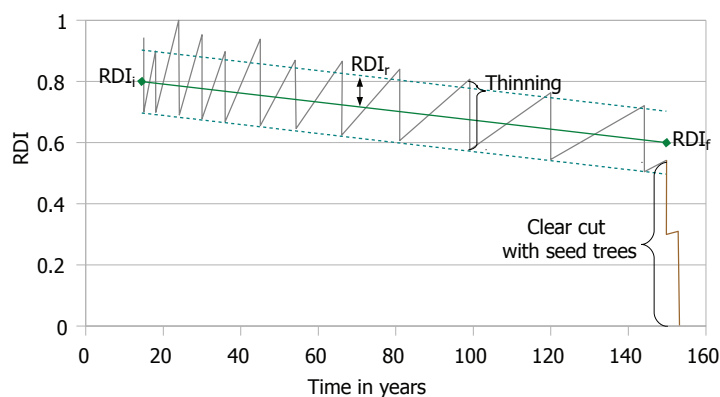

Figure 5.2: Simulation of forest management: RDI variation during the rotation

Example of a simulation with target d_{dom} : 70 cm; RDI_i : 0.8; RDI_f : 0.6; RDI_r : 0.1. The simulation starts when the stand is 15 years old. Each thinning instantly reduces the RDI. Due to the 3-year time step, stand RDI can sometimes exceed the line between $(RDI_i + RDI_r)$ and $(RDI_f + RDI_r)$.

natural mortality processes can then be analyzed by repeating the simulations with the same parameters.

The simulator based on the *Fagacées* model is programmed in Java and integrated into the open-source simulation platform Capsis (Dufour-Kowalski et al., 2012). The open source simulator (programmed by Vallet, 2005) uses a time step of 3 years to avoid overly frequent thinnings which would not be plausible⁴. The model already included a carbon storage indicator. We added additional modules to the existing *Fagacées* model to be able to use a target diameter as a simulation goal and to estimate timber value as well as the recreational value and biodiversity indicators. We ran numerous simulations in batch mode using a script that we programmed in Java. Information on the production and the stand status at each step of the simulation is stored in a text file (csv format). This file also includes the average value of the four services over the rotation period. To compute the discounted value of the services and to group the results from all the simulations (stored in the afore-mentioned csv files), we developed a script in R⁵ (see in appendix C.1). This made it possible to test various discount rates without repeating the entire simulation process.

5.2 Calculating the profit possibility frontier

As described in paragraph 3.1.4, we elaborate the profit possibility frontier – i.e. the maximum profit possible subject to the provision of given values of environmental services. We do this in several steps which include the global exploration of the production possibility set (PPS) and a more detailed description of the PPS envelope. As mentioned above, in the basic scenario, the site index is 32.5 m at 100 years, we calculate profit based on the current price of standing

⁴Note that choosing 3 instead of one year step also accelerates the simulation and limits the computer memory footprint.

⁵See (R Development Core Team, 2006) and <http://www.r-project.org/>

wood (p , see equation 4.1) and discount the values of the different outputs with a discount factor of 2% and corrective factors of -1% for environmental services (see paragraph 4.3.2). We will analyze the impact of these assumptions on the PPF at the end of this chapter.

5.2.1 Relations between management practices and outputs: exploring the PPS

To explore the production set, we first carried out a limited number of simulations to determine how each management parameter influences the results. We tested all the combinations of the following parameter values, excluding impossible scenarios:

- target d_{dom} : 30, 50, 70, 90 cm
- RDI_i : 0.4, 0.6, 0.8, 1.0
- RDI_f : 0.4, 0.6, 0.8, 1.0
- RDI_r : 0.5, 1.0, 1.5, 2.0

Note that scenarios with RDI_i and RDI_f equal to one and scenarios with RDI_i and RDI_f greater than 0.8 and RDI_r equal to 0.2 are all non-management scenarios, because the self-thinning curve ($\text{RDI}=1$) is always included in the acceptable RDI range and thinnings are therefore never done. The total number of different management schemes is therefore 209. Next, we determined a temporary PPS envelope based on these first simulations to see which parameters determine the value of the different outputs.

The average values of the four ecosystem services considered (profits from wood harvest \bar{P} , carbon storage \bar{CS} , recreational attractiveness \bar{A} and bird species biodiversity $\bar{B}i\bar{o}$) all react to management parameters. The most important parameter is the target dominant diameter (d_{dom}): both minimum and maximum ES production possibilities increase with this diameter, except for the minimum value of $\bar{B}i\bar{o}$. If the goal were to describe the PPF only, then simulations with large diameters would be sufficient. However, since we want to envelope the entire production set, the number of values taken by the target d_{dom} must be densified over the whole range.

There is not a single scenario that produces the highest level of all average ecosystem services: all scenarios on the production possibility frontier – i.e. for which it is impossible to produce more of one output reducing the production of another – have a target d_{dom} of 90 cm. Tradeoffs result from other factors. The second and third most determining factors after target dominant diameter are initial and final RDI (RDI_i and RDI_f). The average provision of ecosystem services mostly increases with these parameters, except for \bar{A} and RDI_i because of the lower attractiveness of young dense forests, and for \bar{P} and RDI_i because maximizing RDI_i leads to natural mortality which is less profitable than harvesting. We finally note that maximizing both initial and final RDI does not lead to the highest provision of services except in the case of carbon storage. Thinning intensity has little impact on production possibilities. High thinning intensity (RDI_r) reduces maximum profit possibilities slightly, but the minimum remains unchanged.

If we consider the present value of the different outputs, we reach similar conclusions concerning the significance of the parameters (see Figure 5.4): target d_{dom} , RDI_i and RDI_f are the most influential parameters. However, RDI_f is less significant, since changes are observed later than RDI_i and discounting reduces the influence of late differences. A second issue is

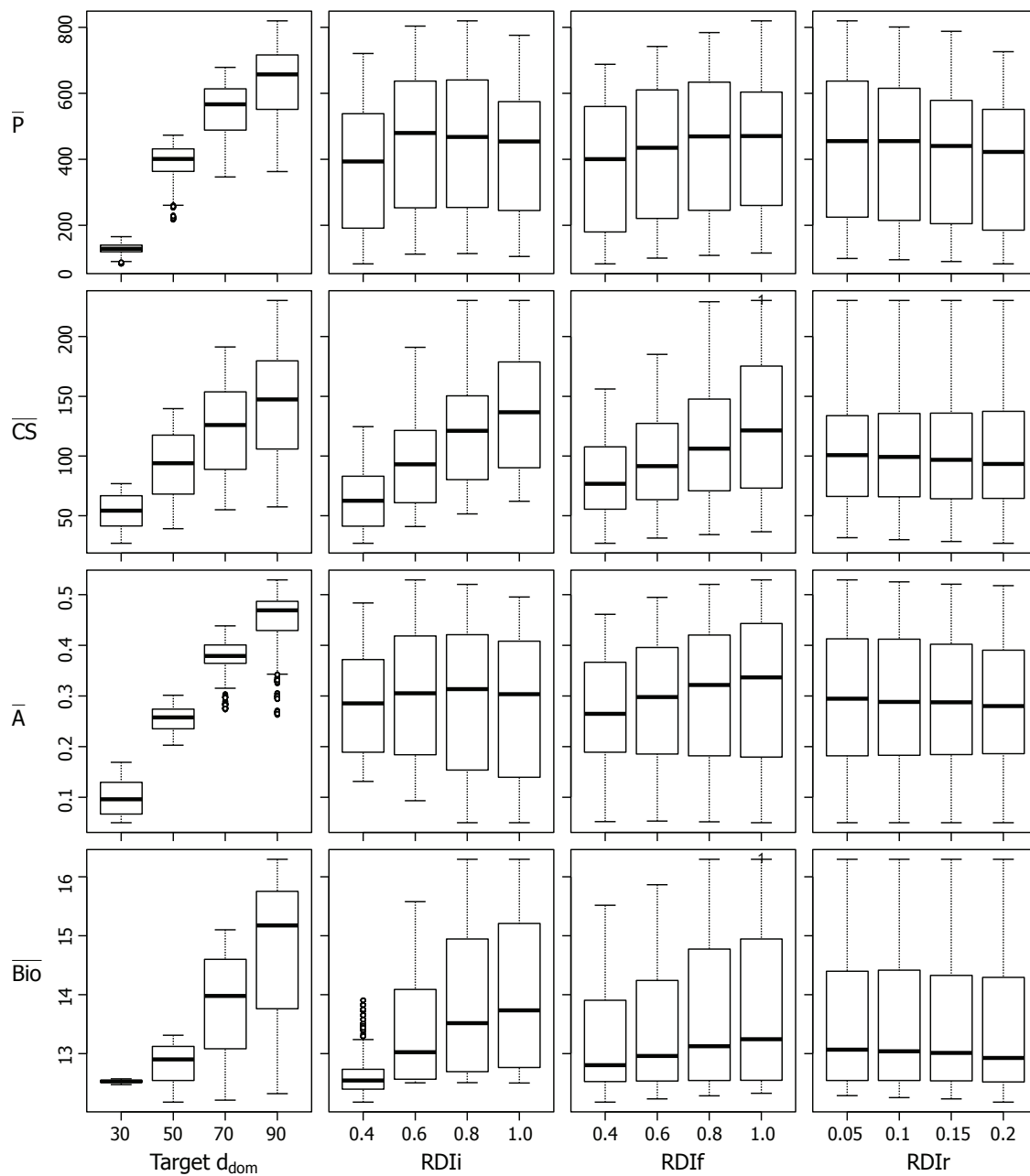

Figure 5.3: Exploration of the variation in the *average* provision of ecosystem services depending on the management parameters.

Profits from wood harvest \bar{P} in euros/ha/year, carbon storage \bar{CS} in tC/ha, recreational attractiveness \bar{A} and bird species biodiversity \bar{Bio} as a function of the target dominant diameter (Target d_{dom}), the initial and final RDI (RDI_i and RDI_f) and thinning intensity RDI_r .

raised by our preliminary results: the four discounted outputs respond in very different ways to the management parameters: from almost no influence of the parameter on production levels (e.g. Bio_{PV} and RDI_f) to positive (CS_{PV} and RDI_i) or negative (Bio_{PV} and target d_{dom}) effects or even effects fluctuating around a probable optimum value ($NPVIS$ and target d_{dom} or RDI_i). To pinpoint these possible optimum values, numerous scenarios must be simulated with parameters close to the best scenarios identified to approach the optimum values. However, because of the considerable variation in output values for the three main parameters (target d_{dom} , RDI_i and RDI_f), we recommend densifying the simulation set for these three parameters.

Consequently, to explore the full PPS, we simulated all the combinations of the parameter values as specified in Table 5.1. This generated more than 20,000 simulations.

Table 5.1: Range and steps for the parameters in the different simulated scenarios

Variables	Notation	Min from	Max to	Step by
Target DBH in cm	d_{dom}	30	90	2
Initial RDI	RDI_i	0.4	1.0	0.05
Final RDI	RDI_f	0.4	1.0	0.05
Thinning intensity	RDI_r	0.05	0.2	0.05

The results were processed with the two R scripts given in appendix C. Our PPS envelopment program uses the *fields* library to draw the iso-profit curves.

5.2.2 Stability of the estimations using the model

In our PPS modeling approach, we propose simulating each management scenario only once. Since the model includes some stochastic processes, we checked to be sure that they had very little influence on the results and that the uncertainty in the production possibility estimates would be limited. Therefore, during the exploration phase, we repeated the calculation 30 times for each of the 209 management scenarios, always starting with the same virtual stand. The results show that the relative standard deviation of all output estimates is always less than $4.10^{-13}\%$ for all management scenarios. This confirms that the model is highly deterministic and that a single simulation of each management scenario is sufficient.

A second round of simulations was done to evaluate the impact of the randomly created virtual stand. We generated 30 different virtual stands and simulated production levels resulting from the above-described 209 scenarios on each stand. The random simulation of the virtual stand induced limited variations in all outputs. The variation in the profit from wood harvest went up to 9 euros/ha/year (less than 1% of the maximum value). The difference for NPVIS went up to 115 euros, which is less than 2.5% of the total value. For the ESs, the differences are very low (below 1% of the maximum value of these services). These small differences have little influence on the classification of the scenarios on the frontier; they would not affect recommendations since they are limited to slight modifications in thinning intensity or forest density (RDI_i or RDI_f). The production possibility set is consequently expected to differ only

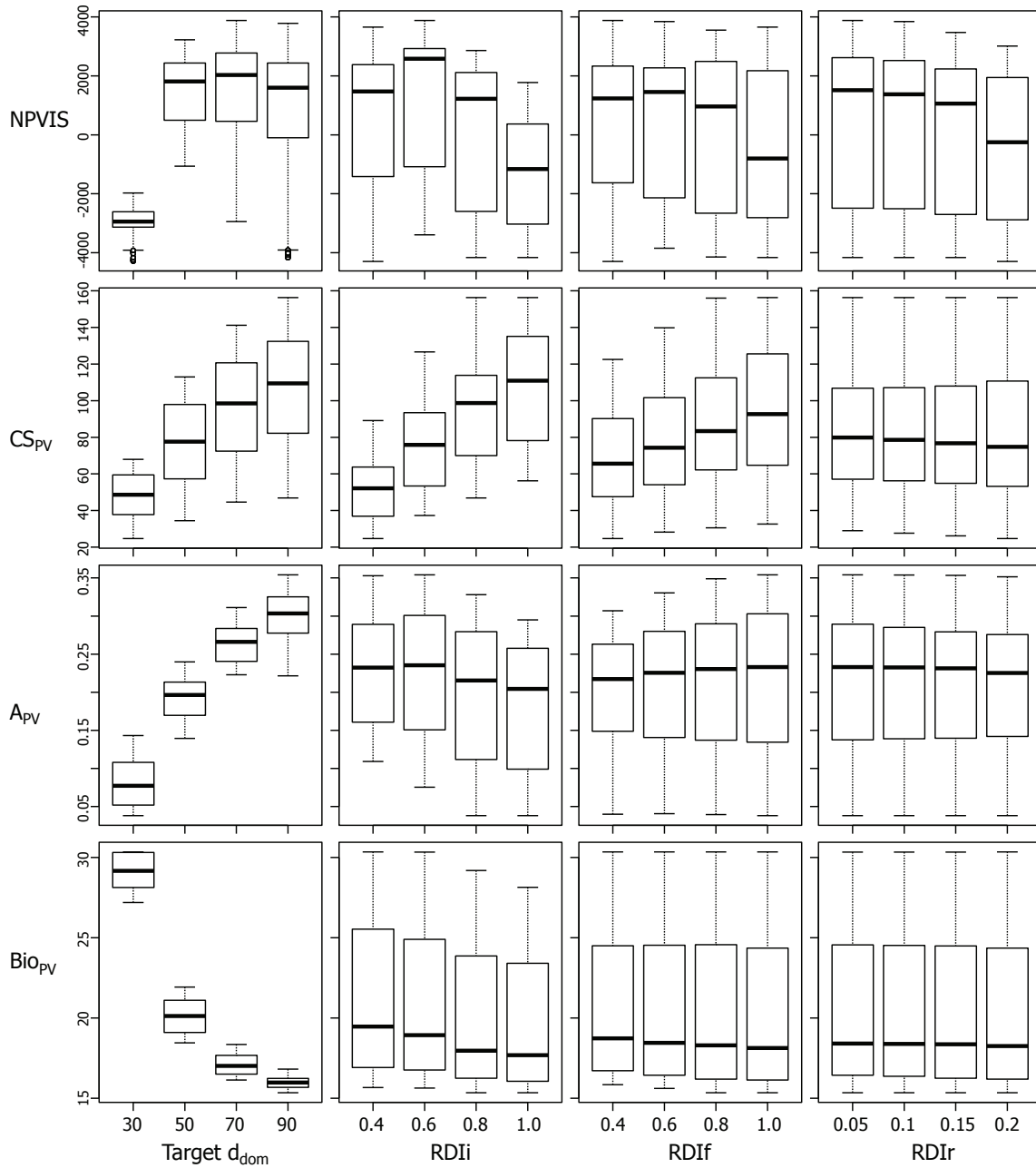

Figure 5.4: Exploration of the variation in the *discounted* provision of ecosystem services depending on management parameters.

Profits from wood harvest $NPVIS$ in euros/ha, carbon storage CS_{PV} in tC/ha, recreational attractiveness A_{PV} and bird species biodiversity Bio_{PV} as a function of target dominant diameter (Target d_{dom}), initial and final RDI (RDI_i and RDI_f) and thinning intensity RDI_r .

slightly with the exact composition of the initial stand, which cannot be entirely controlled in real conditions.

We include site index in our simulations to indicate tree growth potential, but there are other causes of variations in growth such as local weather conditions during the regeneration phase. Therefore, the PPS simulated by the model gives an overview of the production possibilities which is subject to slight variations from one location (or one period) to another.

5.3 Synergies and tradeoffs in the production of ecosystem services

To present the simulation results, we begin with the scenarios that optimize the production of one service or profits, then we represent the profit possibility frontier and show how it can be analyzed.

5.3.1 Impossibility to define an optimum scenario for all outputs

The single-output optimum scenarios for each production are presented in Table 5.2. The first four lines correspond to scenarios optimizing the production of one single average output, the four last lines, the scenarios that maximize one discounted output. The value of the maximized output is in grey. Both average and discounted outputs are presented in this table to highlight the differences that are induced by these two time-aggregation techniques. The table clearly shows that no one scenario maximizes the provision of all outputs at the same time: there are tradeoffs.

Let us consider the average value of the outputs. All the best single-purpose management scenarios have a target diameter of 90 cm. Two services, \overline{CS} and \overline{Bio} , are maximized with the same management scenario: thinning is not scheduled between natural regeneration and the final cut (1 is always included in the RDI range), but some trees are nonetheless harvested just before their death. In the scenario that maximizes \overline{CS} , fewer trees are felled just before death. This creates a few slight differences between the two scenarios. The scenario maximizing average profit is also not very different from the two before: tree density is very high, and the rotation is consequently long. In this case, however, trees never die from over crowding; the density is always controlled. This scenario maximizes the value of the wood produced while keeping stand establishment costs to a minimum. Note that maximizing the yield⁶ requires shorter rotations (the target d_{dom} is 46 cm), but this leads to less profit (lower timber value) and to more investment (higher regeneration frequency). Managing the forest for its recreational attractiveness involves more open forest ($RDI_i=0.6$) at the beginning of the rotation and very light thinnings ($RDI_r=0.05$). This management priority only slightly reduces average profit, but the consequences on carbon storage and biodiversity are more important because the trees grow faster in diameter and the final felling age is lower.

Using the discounting time aggregation technique gives contrasted results. The scenarios optimized for one single output differ considerably. The optimum scenario for carbon storage

⁶Maximum sustained yield, or MSY

Table 5.2: Output estimates and parameters corresponding to the best single-output scenarios

Optimized output	Management parameters				Average values				Discounted values			
	d_{dom}	RDI_i	RDI_f	RDI_r	\bar{P}	\bar{CS}	\bar{A}	\bar{Bio}	$NPVIS$	CS_{PV}	A_{PV}	Bio_{PV}
\bar{P}	90	0.9	0.95	0.05	814	210	0.503	16.1	-80	145	0.299	15.5
\bar{CS}	90	0.8	1.0	0.2	524	228	0.484	16.2	-4068	155	0.277	15.4
\bar{A}	90	0.6	1.0	0.05	799	173	0.525	15.5	1693	120	0.353	15.8
\bar{Bio}^a	90	0.8	0.8	0.2	530	227	0.484	16.2	-4039	155	0.276	15.4
$NPVIS$	72	0.55	0.55	0.05	589	96	0.367	13.5	3993	77	0.279	17.9
CS_{PV}	90	0.8	1.0	0.2	524	228	0.484	16.2	-4068	155	0.277	15.4
A_{PV}	90	0.5	1.0	0.05	775	150	0.507	14.9	2728	106	0.358	16.1
Bio_{PV}	30	0.4	0.85	0.2	111	35	0.148	12.6	-3565	31	0.125	30.4

\bar{P} , \bar{CS} , \bar{A} and \bar{Bio} are the average values of profit, carbon storage, recreational attractiveness and bird species diversity respectively. $NPVIS$, CS_{PV} , A_{PV} and Bio_{PV} are the discounted values of these outputs with a 2% discount rate.

^anote that this scenario corresponds to a zero harvesting scenario; The scenarios with initial and final RDI equal to 1 give almost the same results. The differences come from the stochastic prediction of the tree growth in the simulator.

is the only one which remains identical when either the average value or the discounted value is applied. This comes from the fact that the carbon stock in the trees is high at the end of the rotation? and delaying the final harvest increases the storage effect. If we only consider carbon sequestration dynamics and not the carbon released at harvest, the optimum scenario would have been similar to MSY maximization⁷.

A_{PV} maximization is slightly more intensive at the beginning of the rotation than without discounting. This increases the time needed to establish a forest suitable for recreation. Delaying the final cut, which suddenly and dramatically reduces recreational attractiveness, is positive and therefore, the optimum target d_{dom} is 90 cm (the maximum).

$NPVIS$ optimization results from a compromise between the increase in timber quantity and value over time and the discount rate. In our simulation, this optimum was obtained for a target diameter of 72 cm. Because timber value is mainly related to the tree DBH, the best practice is to favor fast growth in diameter without compromising volume productivity. The optimum is obtained with the lowest possible RDI_i and RDI_f values such that RDI after thinning is never lower than 0.5, here RDI_i and RDI_f are 0.55 and RDI_r is 0.05⁸.

The scenario that maximizes Bio_{PV} is the one with the shortest rotation period and low RDI_i . This scenario results from a combination of the U-shaped variation in the bird diversity indicator over time and the discount rate: though the number of species in old forests is higher than in young regenerating forests, it takes more than 100 years to reach a higher number of

⁷Taking into account carbon storage in wood products would not change the conclusions, because it would add less than 15% of the total quantity of carbon stored and mostly for long scenarios. Adding the substitution effect will lead to scenario in line with the maximum $NPVIS$ because the value of the products is generally well linked to their substitution capacity (Robert, 2008).

⁸Stands with an RDI value below 0.5 grow slower in dominant height and also in total volume. The growth potential is insufficiently valued and part of the resources is used by shrubs and herbaceous species.

species. If we had given a much higher value to species specific to old forest habitats, then the best scenario for bird protection would have been obtained with longer rotations⁹.

Single-product optimum scenarios show that it is impossible to find one scenario which simultaneously maximizes production of all three modeled goods and services. Moreover, choosing of the time aggregation rule is critical to the results: functions that seem to be only slight substitutes when described with their average values turn out to be very high substitutes when values are discounted. Below, we simultaneously analyze the four outputs to characterize the degree of complementarity and substitutability.

5.3.2 Envelope of the multiple production set and tradeoff analysis

Using the envelopment procedure, we draw graphs that represent the envelope of the simulated production possibility set (PPS). In our study, we characterize four dimensions. In line with chapter 2, we represent them on three graphs with the environmental services along the axes and the maximum profit shown as iso-profit curves.

Figure 5.5 represents the envelope of the average production possibility set. This envelope is stretched from low to high levels of provision for the four outputs, especially in the \overline{Bio} , \overline{CS} and \overline{P} dimensions. This shows that reducing one of these outputs would not help achieve the higher output of the others. There is high complementarity over a wide range of possibilities: any increase in the provision of one of the services gives opportunities, and even forces, the others to increase. However, above 210 tC/ha and 16.1 bird species on average, there is a huge tradeoff between profits and the ESs. The opportunity cost of carbon storage is about 16 euros/year/tC, which is much higher than the current value of carbon emissions (15 euros/t CO₂¹⁰, equivalent to 2.12 euros/tC/year at a 4% discount rate). The opportunity cost of increasing the bird diversity index by 0.1 is 284 euros/ha per year. This 0.1 increase in the average index value corresponds to a longer preservation of the old forest habitat which is necessary to preserve some rare species. The major difference between a management scheme maximizing average profit and those maximizing \overline{CS} and \overline{Bio} is the absence of thinnings in the two last scenarios (which are very similar).

On the other hand, the graphs with a recreation axis (top right and bottom left) show a much wider envelope. This suggests that there are many possible ways to vary the provision of \overline{Bio} or \overline{CS} without impacting attractiveness. Similar to the previous case, increasing attractiveness opens new options to increase \overline{P} , \overline{CS} and \overline{Bio} , unless the expected \overline{A} is higher than 0.484. The difference in profit between the profit-maximizing scenario and the attractiveness-maximizing scenario is only 15 euros/ha/year, however \overline{CS} and \overline{Bio} are also reduced by 37 tC/ha by 0.4 respectively.

Suppose that a forest owner's objective is to create an attractive forest for future generations and generate profits. She will reduce the tree density of the young forest to facilitate penetration and to encourage faster tree growth in diameter. However, before she puts her

⁹With a site index of 32.5 m at 100 years and a discount rate of 2%, the value of old forest species (species that require more than 100 year old stands) must be more than 100 times as high as the value of young forest species.

¹⁰The price for Carbon Dioxide CO₂ emission in the European Union Allowance scheme was about 15 euros/t CO₂ on August 15, 2012 (EUAZ12= 14.94 euros and EUAZ13=15.94).

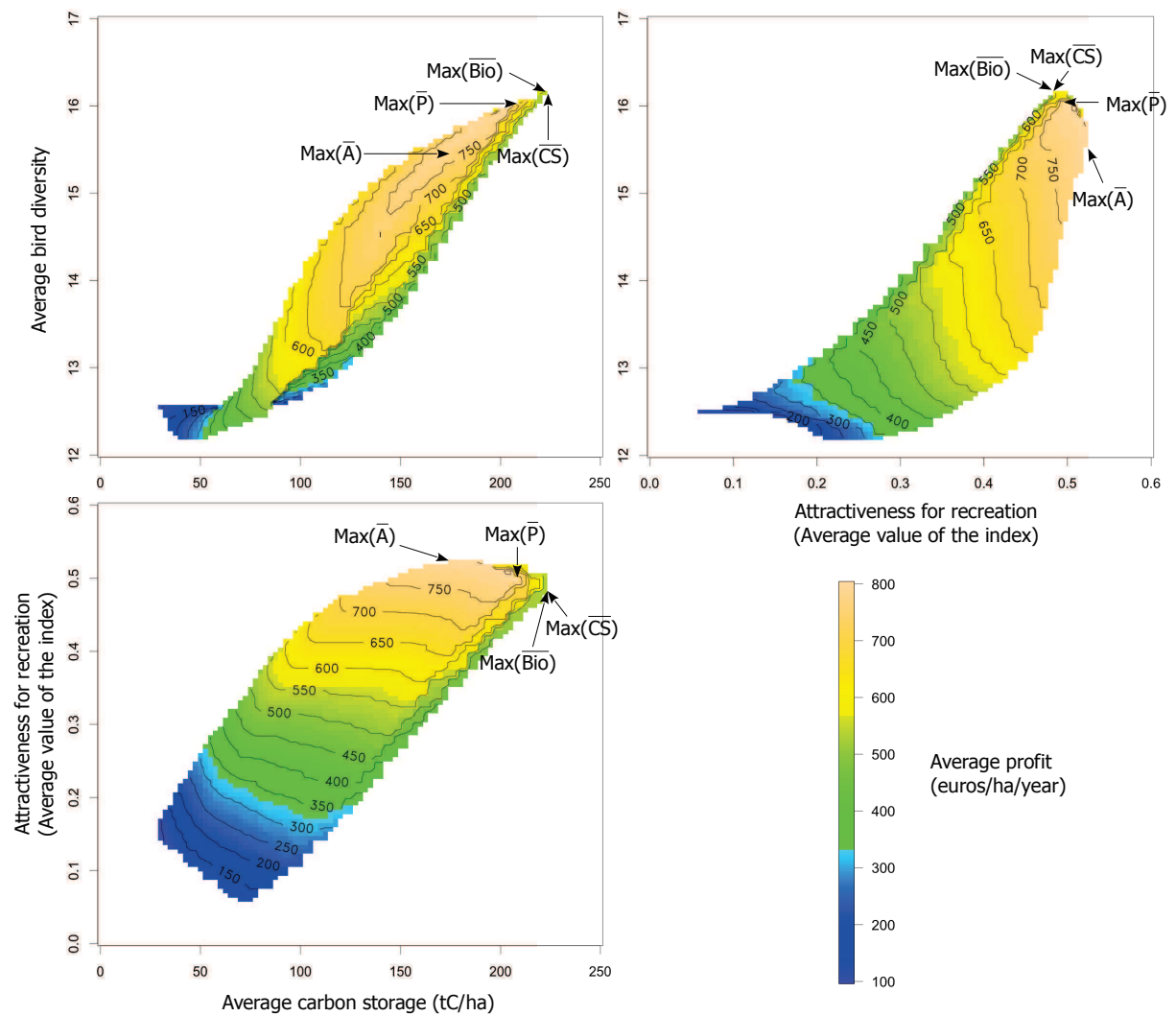

Figure 5.5: The envelope of *average* outputs shows high complementarity between \bar{P} , \bar{CS} and \bar{Bio} .

Envelope of the average profit possibilities \bar{P} depending on the average ES provision \bar{CS} , \bar{A} and \bar{Bio} .

management into practice, if a buyer is interested in paying to increase the level of \overline{CS} expected with the initial management plan by 30 tC/ha¹¹, then:

- the manager may choose to densify the forest in the early stages (increase the RDI_i value to 0.65 or 0.7) thereby reducing the attractiveness of the forest only slightly (see scenario 1 on Figure 5.6). This would induce a change along the $\overline{A} \times \overline{CS}$ production possibility frontier.
- or the manager may accept to reduce the attractiveness of the forest more substantially and increase her profits (see scenario 2 on Figure 5.6).

The owner will only accept scenario 1 if the received payment compensates for the decrease in profit and the loss of \overline{A} . In scenario 2, the income increases, but \overline{A} is more reduced. The choice will depend on the value given by the forest owner to \overline{A} . From her original choice (maximizing \overline{A}), we can imagine a scenario where she accepts to reduce her profit by 15 euros/ha/year in order to increase \overline{A} by 0.02 unit. If the owner does accept such a scenario, it gives us indications about the threshold value of \overline{A} to the forest owner. Furthermore, because of the complementarity between \overline{CS} and \overline{Bio} , the forest will provide a higher \overline{Bio} value and this could be a second source of financing to compensate for the loss of \overline{A} .

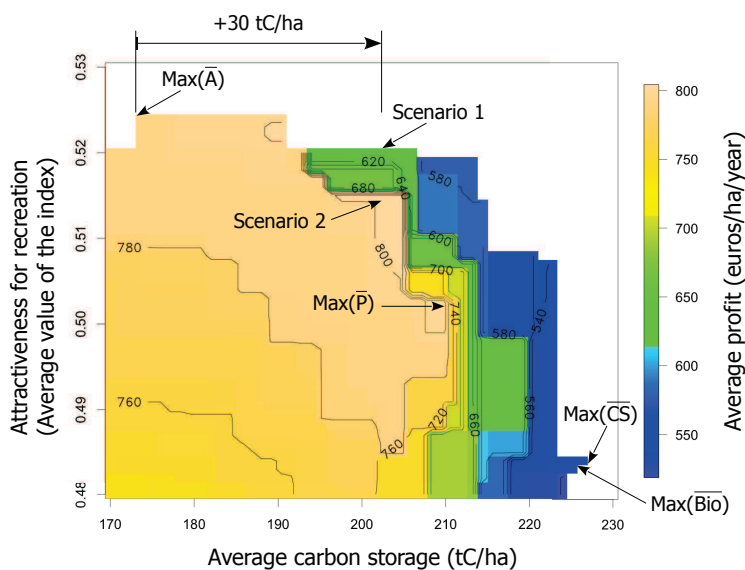

Figure 5.6: The tradeoff between \overline{CS} , \overline{P} and \overline{A} .

If a forest owner's intention is to manage the forest to produce $\text{Max}(\overline{A})$ and a buyer pays her to increase \overline{CS} by 30 tC/ha, then she might prefer management scenario 1 over management scenario 2 and ask the buyer to compensate for the difference in profit between $\text{Max}(\overline{A})$ and scenario 1 at least.

When discounting, the shape of the production possibility set changes. As mentioned in paragraph 5.3.1, optimum scenarios also differ from ones identified with average values, but this time, the scenarios are in very different parts of the PPS. Tradeoffs between outputs are huge as shown on Figure 5.7.

¹¹We assume here that the reference for the carbon credit is the carbon storage expected by the forest subject to the management plan that would be applied without complementary financing.

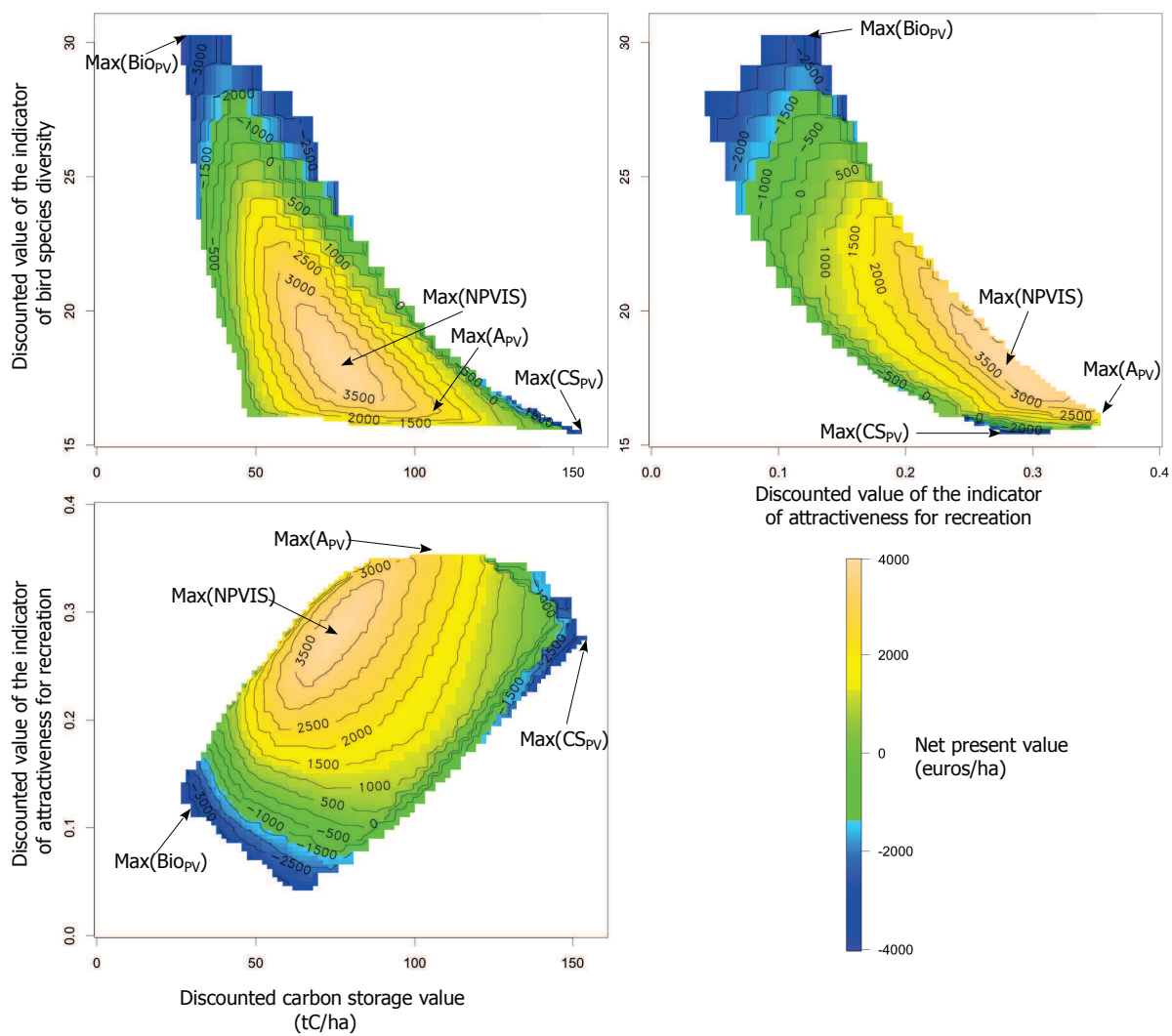

Figure 5.7: The envelope of *discounted* productions shows high substitutability among the four outputs.

Envelope of the discounted profit possibilities (maximum *NPVIS*) depending on the discounted ES provision *CS_{PV}*, *A_{PV}* and *Bio_{PV}*.

These diagrams also show that the frontier is a bigger part of the envelope than for average values. Once discounted, the outputs appear to be mainly substitutes. For example, maximizing CS_{PV} requires minimizing Bio_{PV} (see upper left diagram in Figure 5.7). This comes from the different variations in output levels over time. Carbon storage increases quite regularly during the rotation, with a slight inflection when the forest gets old. Discounting reduces the difference between medium term and long-term rotations, but longer rotations still have a slight advantage due to postponed carbon release. The case of attractiveness is similar, but this time, in the early stages, the indicator is very close to 0, then it increases rapidly. Discounting is favorable to management schemes that make it possible to obtain an aesthetic forest as fast as possible. The complementarity between carbon storage and recreational attractiveness is not impacted much by discounting. The production possibility set is consequently very similar in the $CS_{PV} \times A_{PV}$ plane (bottom left diagram in Figure 5.7).

The profit from wood harvesting increases in three phases during the rotation. The price of small wood is very low and the harvested wood barely compensates for the cost of the first thinnings. Then, wood quantity and value increase quickly and harvests become more and more profitable. Later on, wood growth and the increase in price with diameter stabilize and progress slightly more slowly. Discounting reduces the interest of the last period in the rotation. Unlike carbon storage and recreational attractiveness, which are reduced by the final felling, most of the income from harvesting is produced at the end of the rotation. Postponing this end is only interesting if the discounted value is still increasing. The target d_{dom} and the time needed to reach this diameter become important parameters. Discounting encourages more intensive management than averaging. $NPVIS$ becomes a clear substitute for CS_{PV} and is a slightly better substitute for A_{PV} than when calculating with average values, as illustrated by the shift to the bottom left of the iso-profit lines on the diagrams in Figure 5.7.

The bird diversity indicator is severely impacted by the time aggregation technique. If the average value of the indicator is maximized over a long rotation, the maximum discounted value is obtained with short rotations. This comes from the U-shape of the variation in the indicator over time. Bio_{PV} becomes a substitute for the other three outputs. Over time, the frontier is stretched between a high Bio_{PV} (and simultaneously low levels of other outputs) and a low Bio_{PV} (and simultaneously medium to high levels of other services; see Figures 5.7 and 5.8). If a forest owner who maximizes the $NPVIS$ is asked to increase the provision of Bio_{PV} , then this will not only cost money, it will also require a reduction in the provision of other services. On Figures 5.7 and 5.8, we see that it would be possible to increase Bio_{PV} up to a value of 24 without changing the carbon stock, if $NPVIS$ is reduced by 4500 euros/ha and A_{PV} is reduced by 0.2. No higher increase in Bio_{PV} is possible without reducing carbon storage. The same increase in Bio_{PV} would be possible with a reduction in $NPVIS$ of less than 2000 euros/ha if CS_{PV} is also reduced by 20 tC/ha. In the case, the loss in A_{PV} will be only 0.1 unit. The opportunity cost of preserving CS_{PV} when increasing Bio_{PV} is rather high. It would be less costly to reduce carbon storage in that stand, and compensate for this reduction by an increase of 20 tC/ha in another forest, which is possible at constant Bio_{PV} at an opportunity cost of 2000 euros/ha and with a reduction in A_{PV} by 0.01 unit¹².

¹²Note that the indicator of biodiversity and attractiveness for recreation are not additive, the total performance of such a scenario cannot be calculated here.

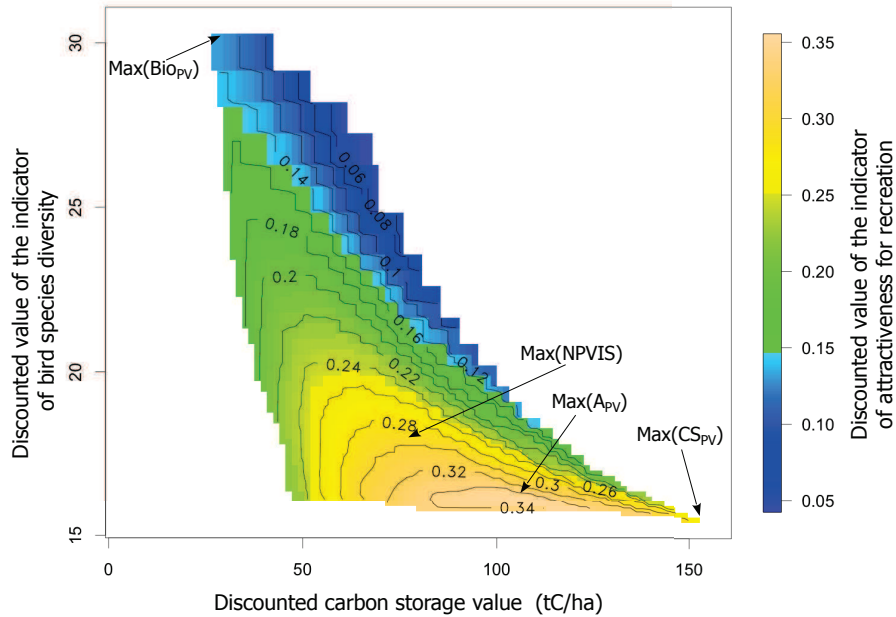

Figure 5.8: Envelope of *discounted* output levels for environmental services.

Envelope of the discounted provision of recreational attractiveness (A_{PV}) depending on discounted carbon storage possibilities (CS_{PV}) and the present value of bird species diversity (Bio_{PV}).

If a forest owner who wants to maximize the $NPVIS$ of her forest is asked to increase carbon storage by 20 tC/ha, she might accept a price of less than 45 euros/tC/ha (the opportunity cost if there is no constraint on preserving Bio_{PV}) because the management plan could increase A_{PV} which the owner may value. A_{PV} value is in the same range as the current value of carbon on the European market¹³. However, if there is a regulation prohibiting reductions in Bio_{PV} , then the opportunity cost would raise to 75 Euros/tC/ha and would necessitate a decrease in A_{PV} by 0.05. In the absence of such regulations, the decrease in Bio_{PV} partly pays for the supply of the other ESs.

If a continuous envelope could have been drawn, then a large part of the PPF in the $Bio_{PV} \times CS_{PV}$ plane would have been considered as non-convex (the PPF would be convex for CS_{PV} below 70 tC/ha). It would also be non-convex over the entire PPF in the $Bio_{PV} \times A_{PV}$ plane. As shown by Boscolo and Vincent (2003) in case of non-convexities, trying to provide Bio_{PV} and CS_{PV} or A_{PV} in the same stand at the same time would be less efficient than providing the two separately in two independent stands.

¹³Thomson Reuters Point Carbon believes that the market can “expect an average price of 15 euros/t CO₂ for the remainder of 2011, rising to 16 euros/t CO₂ and 17 euros/t CO₂ for 2012 and 2013 respectively” (<http://www.pointcarbon.com/aboutus/pressroom/pressreleases/1.1556678>) for permanent storage/release. 15 euros/t CO₂ = 55 Euros/tC.

5.4 Sensitivity analysis

These results rely on a modeling approach which uses numerous hypotheses such as discount rate, the relative price variation factor, the price of wood and site index. We evaluate how these parameters influence management recommendations, the shape of the PPS envelope and estimated opportunity costs.

5.4.1 Increasing the discount rate shrinks the PPS

In our reference scenario, we used a 2% discount rate. As we have seen in the previous paragraph, the four outputs (profit, recreation, carbon storage and biodiversity) react differently to discounting. To check if changes occur with a different discount rate, we increased it to 2.5%. We did not increase it further, because the *NPVIS* of all scenarios become negative with a 3% discount rate.

Increasing the discount rate to 2.5% emphasizes the differences at the beginning of the management scenarios.

To estimate the effect of these hypotheses, we tested two alternative scenarios: (1) we suppressed the corrective factor, and (2) we increased the discount factor to 2.5% while keeping the correction factors to -1% . We ran these tests with the same R scripts and adjusted parameters.

Increasing the discount rate reduced the difference between the value of outputs from longer rotations and the value of outputs from shorter rotations. Optimum management scenarios were not affected by the increase in discount rate, except for *NPVIS* maximization, which requires shorter rotations with a target d_{dom} of 62 cm, and for A_{PV} maximization, which involves beginning with a slightly lower density ($RDI_t=0.45$).

Starting from the scenario maximizing *NPVIS*, the opportunity cost of increasing C_{PV} by 20 tC/ha increases to 42.8 euros/tC versus 39.5 euros/tC with a discount rate of 2%. On the other hand, the opportunity cost of increasing attractiveness by 0.01 unit is reduced to 80.5 euros compared to 85.5 euros with a 2% discount rate. One reason for the lower tradeoff between *NPVIS* and A_{PV} is that the management scenarios optimizing one output or the other are very similar at the beginning and only diverge after more than 100 years. The opportunity cost of increasing Bio_{PV} becomes much higher (124 euros for the first unit, compared to 91 euros with a 2% discount rate) because Bio_{PV} values are highly reduced. To increase this indicator by one unit, a much stronger management effort is required.

The 0-euro iso-profit curve delineates a much smaller part of the set. A_{PV} maximization requires accepting a negative net profit. If a forest owner decides to maximize her recreation, she must either consider a discount rate below 2.5% or accept to pay for the service¹⁴.

The shape of the PPS envelope in the $C_{PV} \times A_{PV}$ dimensions is more compact. It highlights the tradeoff between the two services which is mostly related to the density of the forest at the beginning of the rotation (see Figure 5.9).

¹⁴In urban areas, the market value of the forest may increase if it is attractive for recreation. It may compensate for the opportunity cost.

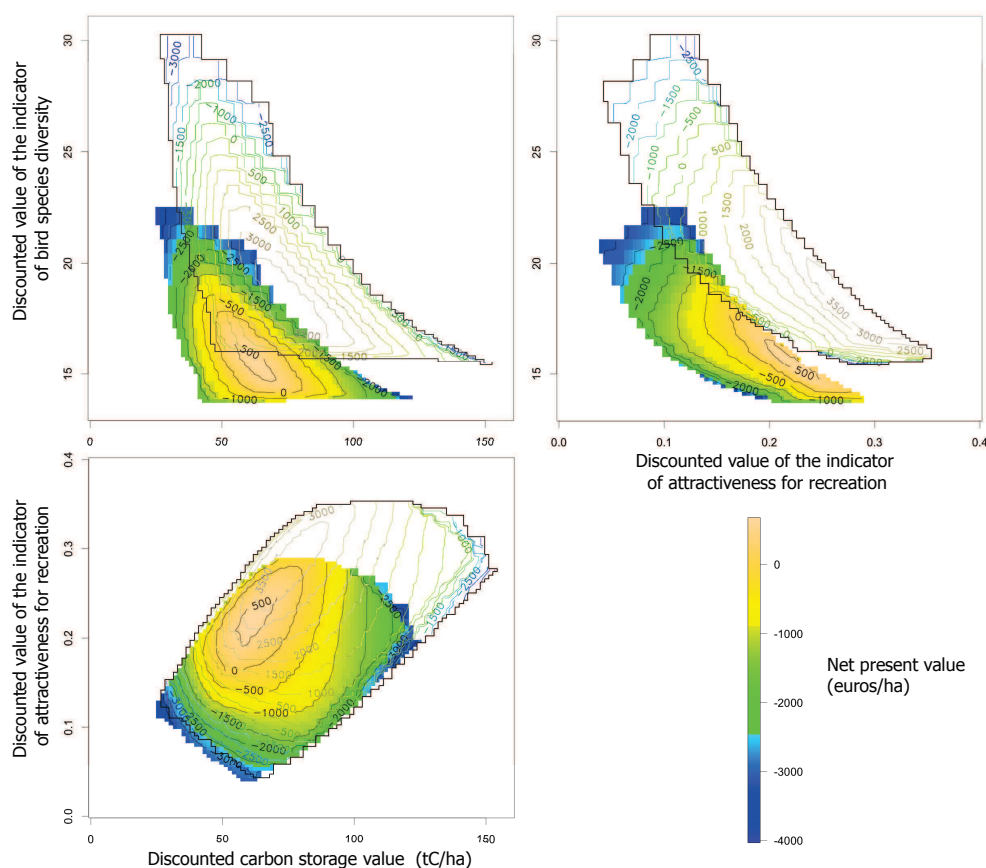

Figure 5.9: Increasing the discount rate shrinks the production set, mainly in the $NPVIS$ and the $BiopV$ dimensions.

The PPS envelope with a discount rate of 2.5% is represented in bright color. The PPS envelope with a 2% discount rate is represented in pale color.

Increasing the discount rate induces changes in substitutability among services: if substitutability originates from short-term differences in management, then it will increase, but if substitutability originates from long-term differences, then complementarity will increase.

5.4.2 Suppressing the ES relative value variation factor increases the opportunity costs

In our simulations, we assumed that the ES value would increase faster than the timber value by 1% per year (see paragraph 4.3.2). Figure 5.10 shows that suppressing this relative value variation factor shrinks the PPS in the ES dimensions. As with the increase in discount factor, the tradeoffs between ESs become more important when substitutability comes from short-term management differences (RDI_i); the tradeoffs are less important when substitutability comes from long-term management differences (RDI_f). In the simulations below, the optimum management scenarios are the same as in the reference case except for the scenario maximizing

APV for which more intensive management at the beginning of the rotation is more efficient ($RDI_i = 0.4$).

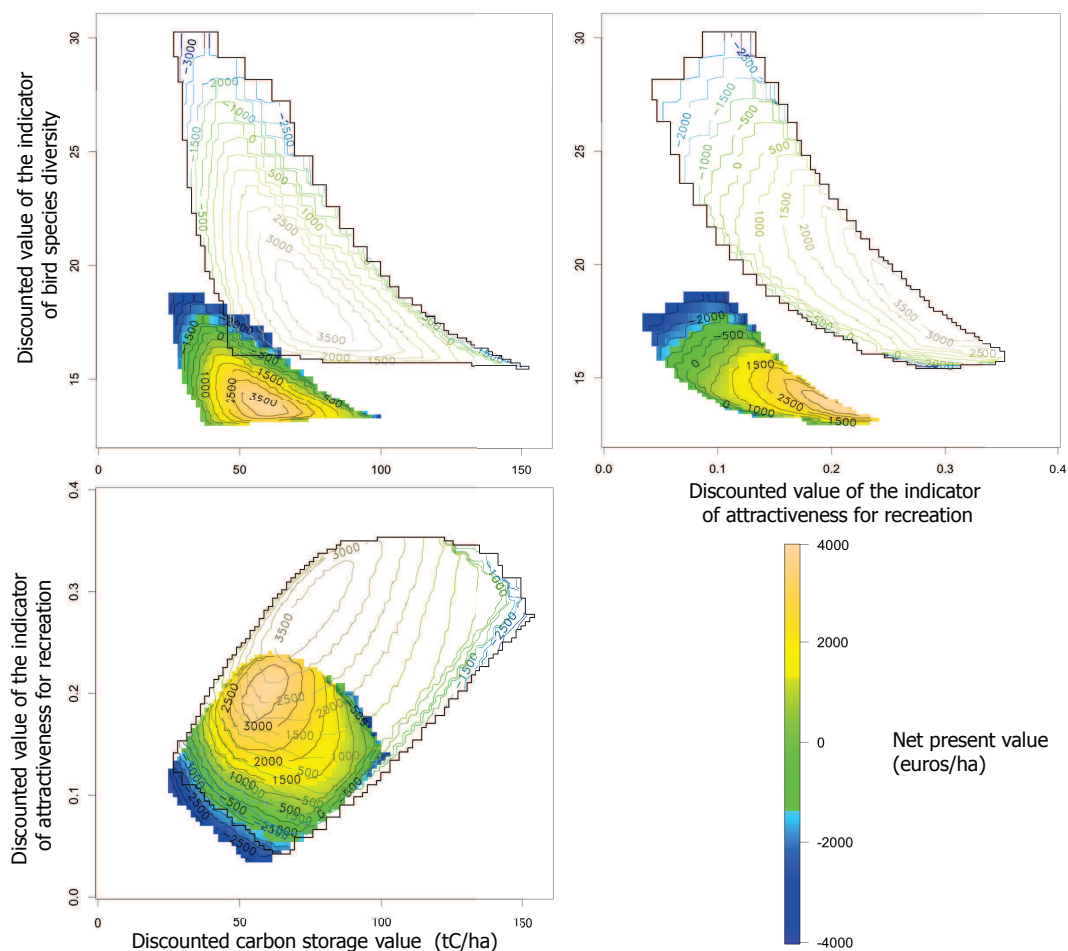

Figure 5.10: Suppressing the relative value variation factor condenses the PPS and increases the opportunity costs.

The PPS envelope without the relative value variation factor for ESs is represented in bright color. The PPS envelope with a 2% discount rate is represented in pale colors.

The strongest impact of suppressing the relative value variation factor is a high increase in the opportunity costs of ES provision (see Table 5.3). This results from the decrease in the ES present value without changing $NPVIS$. Generating profits and providing ESs in the forest are long-term processes. If an ES value increases faster than wood value over time (as assumed for a positive relative value variation factor), then the potential future value of the ES has a greater importance today than if the value stayed the same. In other words, providing one more unit of an ES, as seen from today, requires reaching higher instantaneous values in the future if the ES value relative to the wood value stays proportionately the same than if the ES value increases more than wood value with time. Providing an additional unit of the present value of the service will therefore be more demanding if the relative value does not increase.

Table 5.3: Effect of some hypotheses on the opportunity cost of an increase in one ES provision independent of other ESs.

Hypothesis	Opportunity costs	C_{PV} euros/tC/ha	A_{PV} euros/0.01 unit	Bio_{PV} euros/unit
Reference		39.5	85.5	91.0
Discount rate : 2.5%		42.8	80.5	124.1
ES relative value variation factor:0		87.9	261.5	594.2
Higher fuel wood price		39.1	89.7	121.3
Site index : 27.5 m at 100 years		35.1	58.0	92.2

Reference parameters: Discount rate: 2%, ES relative value variation factor: 1%, normal fuel wood price, site index: 32.5 m at 100 years. The opportunity costs are calculated using management scenarios alternative to the maximization of the $NPVIS$ which provide at least 20 tC/ha more for C_{PV} , 0.04 unit more for A_{PV} , one unit more for Bio_{PV} .

5.4.3 Increasing fuel wood price would not alter the optimum decisions

The national policies designed to increase the use of fuel wood as a substitute for fossil fuels will put pressure on the market. In case of a lack of available fuel wood, this will increase the price of small wood and may change the timber market, especially if the provision of fuel wood competes with other sectors such as paper mills and sawmills (Caurla et al., 2010). Low quality oak wood is rarely used for purposes such as paper, but it is very valuable for energy. The price of small trees and branches, which are commonly used for energy, will increase with the market price, and so will the relative price of fuel wood compared to high-end wood products. As the price hierarchy changes, so will the possible profits. This may influence the opportunity costs of the provision of ecosystem services. To evaluate this potential impact, we modified a function describing the net value of standing timber to take into account a twofold increase in fuel wood price (p_{fuel} in equation 4.2 on page 108).

Increasing the fuel wood price did not change the scenarios that maximize profit (see paragraph 5.3.2). Figures 5.11 and 5.12 show that the iso-profit curves are a little higher than on the diagrams obtained with a current wood price, but their shapes and positions are very similar. Doubling the price of fuel wood only slightly changes production possibilities. It generally increases the profit from the forest and some shorter rotation scenarios become profitable. However, in certain scenarios profits shift upward more than in others. In particular, the scenarios to produce the highest quantities of wood become proportionately more profitable. The opportunity costs of providing ecosystem services are consequently changed (see Table 5.3). Stands with higher densities at the beginning sequester more carbon and produce more small wood which becomes profitable with a higher fuel wood value. The opportunity cost of carbon sequestration is reduced. On the other hand, increasing A_{PV} or Bio_{PV} costs more since these ESs depend on decreasing the RDI_i which reduces the quantity of small wood available for fuel.

Doubling the fuel wood price will consequently not modify the optimum forest management scenario for wood production and it may even reduce the opportunity cost of increasing carbon storage. However, it may induce a decrease in A_{PV} or Bio_{PV} (only \bar{A} with average values) which will remain substitutes for profit and carbon storage.

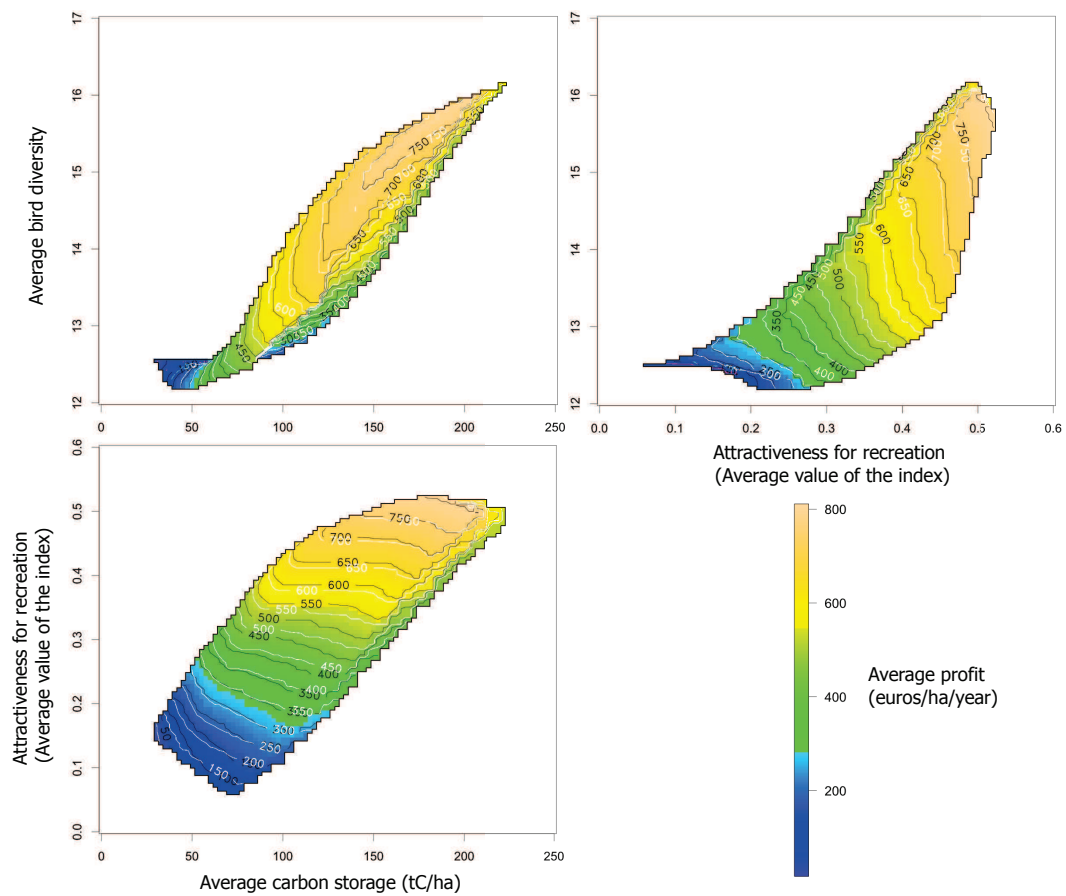

Figure 5.11: Envelope of *average* production possibilities subject to a doubled fuel wood price.

The black iso-profit lines correspond to the profit function with a doubled fuel wood price.

The white iso-profit lines correspond to the profit function with the current fuel wood price.

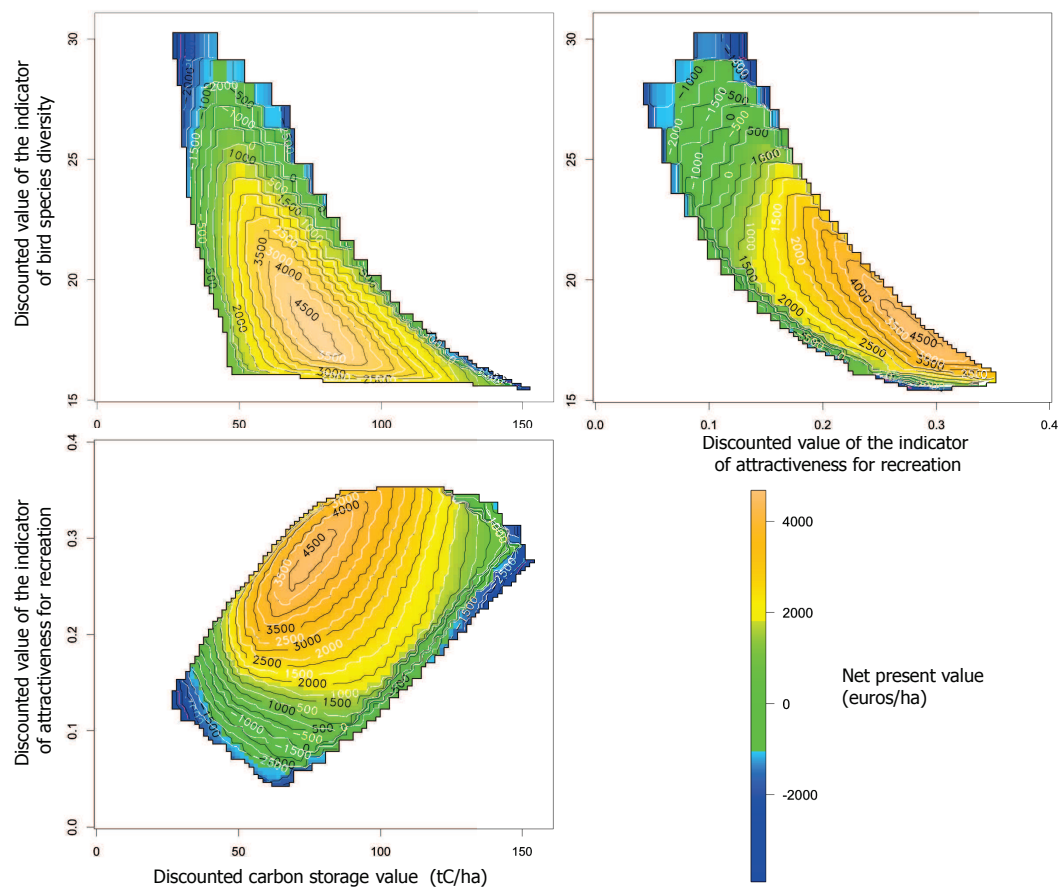

Figure 5.12: Envelope of *discounted* production possibilities subject to a doubled fuel wood price.

The black iso-profit lines correspond to the profit function with a doubled fuel wood price. The white iso-profit lines correspond to the profit function with the current fuel wood price.

If the fuel wood price is multiplied by ten or even more, then it will compete with other wood products and conclusions will yet again change. The optimum $NPVIS$ would then be obtained with a scenario that is closer to the maximization of sustained yield. This scenario would have a lower target d_{dom} and consequently would reduce carbon storage.

5.4.4 Low site index forests more suitable for recreation

In the previous simulations, the forest stand had a high site index indicating suitable conditions for fast oak growth. Site index varies from one location to the other. When the site index is lower, wood production is slower and the maximum profit is lower. To determine how the site index affects ES production possibilities, we ran the model with a site index of 27.5 m at 100 years (instead of 32.5 m at 100 years). The scenario that optimizes \bar{P} required a slightly more open forest at the beginning (RDI_i of 0.85 instead of 0.9) for a faster growth in diameter. The same result is obtained to maximize \bar{A} (RDI_i of 0.55 instead of 0.60). However, these differences are so small that they are included in the range of variations resulting from the random generation of the stand (see paragraph 5.2.2).

Figures 5.13 and 5.14 represent the PPS envelopes of the average and discounted outputs. The shape is similar to the PPS obtained with a higher site index, but the values of all outputs are reduced except for recreational attractiveness¹⁵. The size of the domain with a positive profit is reduced. The scenario that maximizes \bar{A} is still close the one that maximizes \bar{P} , but when discounting, maximizing A_{PV} leads to a negative $NPVIS$.

Starting from a scenario optimized for $NPVIS$, the opportunity cost of an increase in Bio_{PV} is slightly higher than on a more productive stand. On the other hand, it decreases slightly for C_{PV} and substantially for A_{PV} (see Table 5.3). This suggests that it would be more efficient to specialize forests depending on their site index, to favor carbon storage and recreational attractiveness in stands with lower site indices and bird diversity in stands with high site indices.

5.4.5 Limits of the simulation approach

Many points on the frontier correspond to scenarios simulated with the highest target dominant diameter ($d_{dom} = 90$ cm). Using larger target d_{dom} could produce results above our simulated frontier. However, a diameter of 90 cm is already high compared to actual practice in the field. The production possibilities resulting from scenarios with larger diameters are difficult to estimate since very large trees have a higher risk of losing value due to decay and since the price of those trees varies considerably with demand, which is very limited. Moreover, the low number of stems at the end of the rotation leaves room for some regeneration which results in an irregular stand whose dominant height is virtually impossible to predict. The value of the biodiversity indicator, which is calibrated for a dominant height below 45 m, thus becomes uncertain. Finally, the simulator cannot simulate the very long rotations which are needed to produce very large trees.

¹⁵The increase comes from longer rotation to obtain a d_{dom} of 90 cm with a lower site index. Limiting the rotation duration would have led to the same maximum, but to final d_{dom} of less than 85 cm.

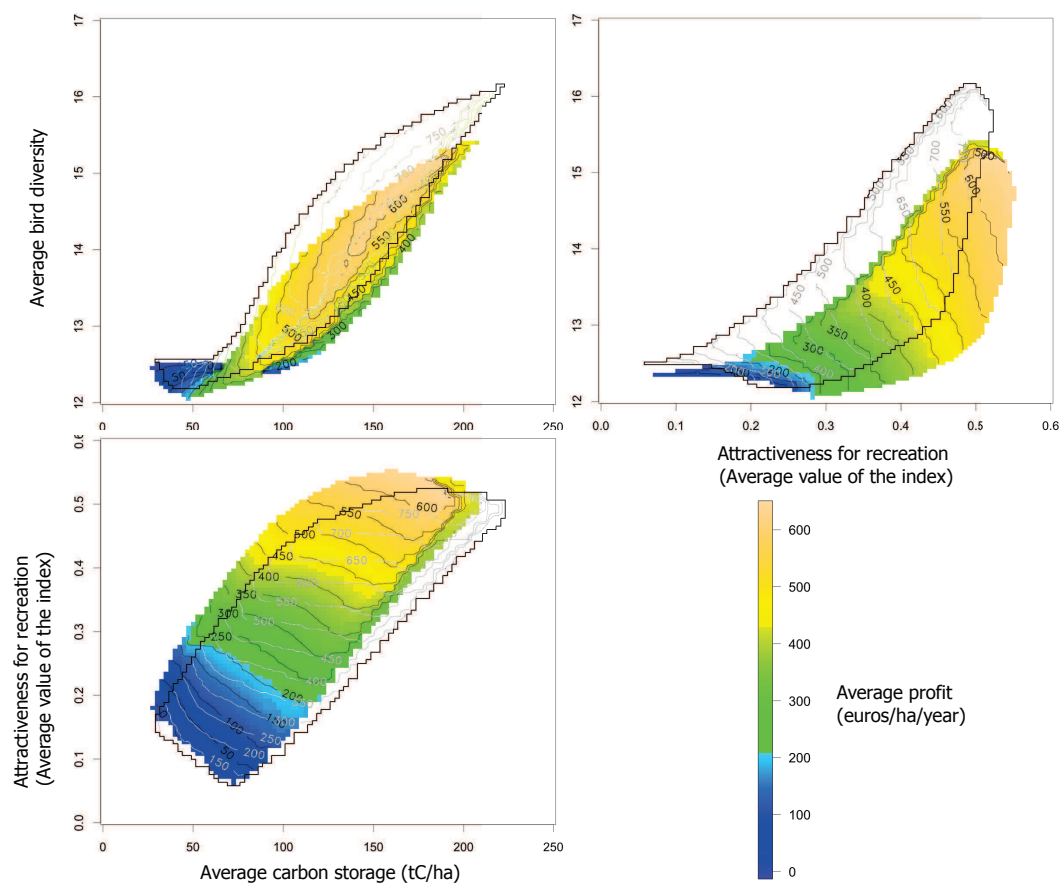

Figure 5.13: Envelope of *average* outputs in a stand with a site index of 27.5 m at 100 years.

A lower site index reduces the maximum average profit, bird diversity and carbon storage, but it slightly increases the maximum recreational attractiveness. The PPS envelope of a stand with a site index of 32.5 m at 100 years is in pale color.

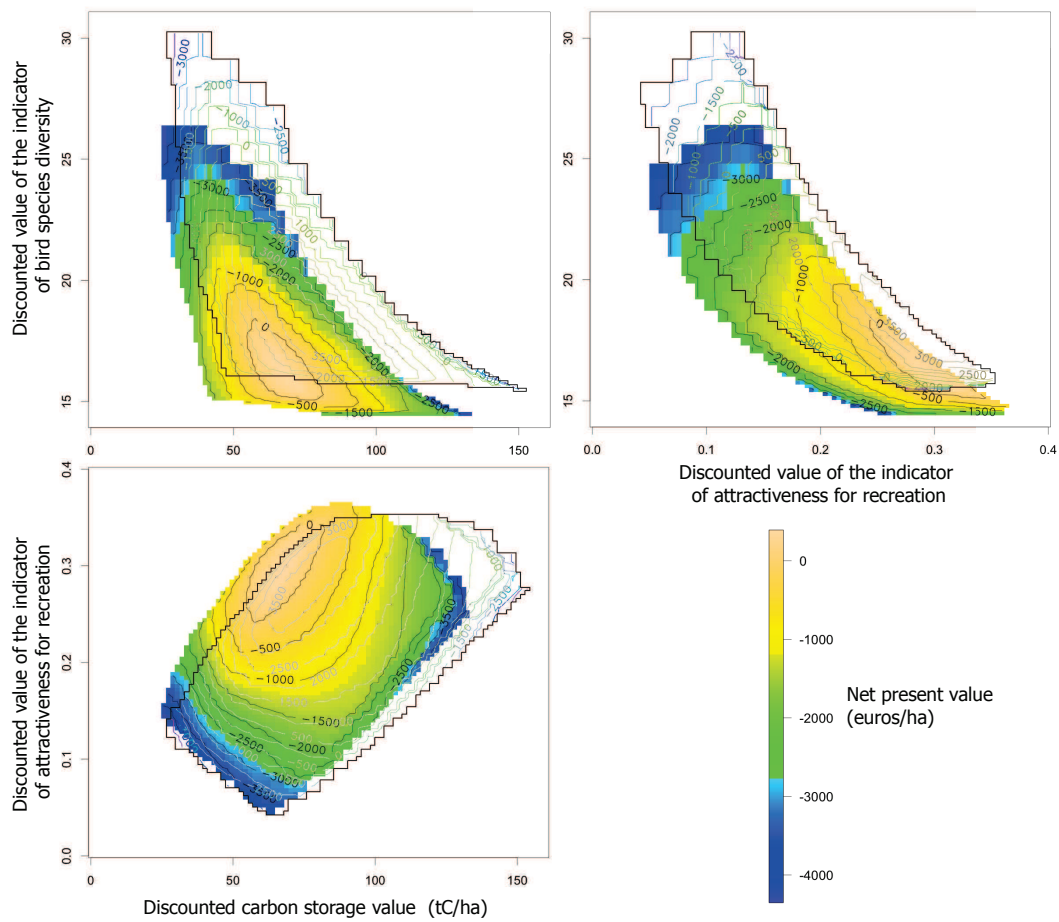

Figure 5.14: Envelope of *discounted* outputs in a stand with a site index of 27.5 m at 100 years.

In stands with lower site indices, the net present value of wood, the discounted values of carbon storage and of the bird diversity indicator are reduced. The discounted value of recreational attractiveness is not significantly different. The PPS envelope of a stand with a site index of 32.5 m at 100 years is in pale color.

The simulator was not capable of simulating dead wood resulting from processes other than over-density. We therefore did not include this parameter in the biodiversity, carbon and recreation indicators. However, dead wood plays an important positive role in the preservation of biodiversity (Grove, 2002). It also sequesters carbon. On the other hand, it reduces the attractiveness of the forest for recreation (Lindhagen and Hornsten, 2000). If natural mortality could be included in the simulator, additional information on production possibilities could be calculated.

Finally, production was assumed to be certain in our simulations. Wind throw, forest fires, drought and diseases were not taken into account (Seidl et al., 2011). These events create uncertainty in the outcome of the production processes and including them in the simulations would be very difficult. Finally, the impact of global change has not been taken into account, although it is likely to change production conditions (Fontes et al., 2010), in particular site index (Bontemps et al., 2009). There are also uncertainties concerning wood prices and changes in the perception of scenic beauty. Because of all these variations, there is a need to better integrate uncertainty in the modeling approach. If outputs are affected differently, the PPS envelope may change shape depending on forest owners' degree of risk aversion.

5.5 Conclusion

In this chapter, we have presented the PPS envelopes modeled for four outputs of oak forest management. We have shown that the interrelations between profit and environmental services are complex. Managing a forest to maximize profit does not necessarily reduce the ES provision to the minimum. However, there are tradeoffs, not only between the different ESs and profit, but also among ESs. Paying a forest owner to increase one of the services may lead to a reduction in other ESs because the least costly increase in the target service can cause a reduction in the provision of other ESs, or because the target service is a substitute for other ESs.

We have also highlighted that the choice of the time aggregation technique, either averaging and discounting, is an important issue that can change the apparent relations among forest ecosystem services. The differences are even stronger when the values vary differently over time (e.g. the difference between a gradually increasing service such as carbon storage and a U-shape provision curve such as bird diversity).

The modeling approach can help forest owners take the appropriate management decision when they are proposed payment for an increase in a given environmental service. In particular, the model provides information about the impact on other services that the owner favors. For example, recreational attractiveness might be reduced with no compensation included in the package (e.g. increasing Bio_{PV} is less costly when A_{PV} is simultaneously decreased) or it might be increased at no cost (e.g. increasing C_{PV} is less costly when A_{PV} is simultaneously increased). Analyzing the impact of site index may also reveal more cost-efficient ways to provide ESs by exploiting the potential of each stand independently. There may be an interest in marketing ES bundles at the forest scale rather than at the stand level.

Policy makers would also benefit from this information when setting up a market for a given environmental service (A), such as carbon sequestration, to determine whether addition rules

concerning the provision of other ESs (B) are necessary. Rules may be required to prohibit any reduction in B or to accept a reduction only if it is compensated for by an increase in another location. A secondary market for B may then be created if (1) there are opportunities to increase B in other locations, (2) if the cost of increasing A is reduced when B is reduced, and (3) if the total cost of increasing A and compensating for the loss in B is lower than the cost of increasing A subject to a constant level of B . This is the case for C_{PV} and $BiOPV$ as we have shown in this chapter.

Bibliography

- Bontemps, J.-D., Hervé, J.-C., and Dhôte, J.-F. (2009). Long-term changes in forest productivity: A consistent assessment in even-aged stands. *Forest Science*, 55(6):549–564.
- Boscolo, M. and Vincent, J. (2003). Nonconvexities in the production of timber, biodiversity, and carbon sequestration. *Journal of Environmental Economics and Management*, 46(2):251–268.
- Caurla, S., Lecocq, F., Delacote, P., and Barkaoui, A. (2010). The French forest sector model: Version 1.0 – presentation and theoretical foundations. Technical Report 3, LEF (INRA–AgroParisTech). Available from: http://www.nancy.inra.fr/lef/content/download/3310/33596/version/1/file/doc_LEF_n2010-03.pdf.
- Dufour-Kowalski, S., Courbaud, B., Dreyfus, P., Meredieu, C., and de Coligny, F. (2012). Capsis: an open software framework and community for forest growth modelling. *Annals of Forest Science*, 69(2):221–233.
- Duplat, P. and Tran-Ha, M. (1997). Modelling the dominant height growth of sessile oak (*Quercus petraea* Liebl.) in France. inter-regional variability and effect of the recent period (1959-1993). *Annals of Forest Science*, 54(7):611–634.
- Fontes, L., Bontemps, J. D., Bugmann, H., Van Oijen, M., Gracia, C., Kramer, K., Lindner, M., Roetzer, T., and Skovsgaard, J. P. (2010). Models for supporting forest management in a changing environment. *Forest Systems*, 19:8–29.
- Gardiner, B., Stacey, G., Belcher, R., and Wood, C. (1997). Field and wind tunnel assessments of the implications of respacing and thinning for tree stability. *Forestry*, 70(3):233–252.
- Grove, S. J. (2002). Tree basal area and dead wood as surrogate indicators of saproxylic insect faunal integrity: a case study from the Australian lowland tropics. *Ecological Indicators*, 1(3):171–188.
- Le Moguédec, G. and Dhôte, J.-F. (2012). Fagacées: a tree-centered growth and yield model for sessile oak (*Quercus petraea* l.) and common beech (*Fagus sylvatica* l.). *Annals of Forest Science*, 69(2):257–269.
- Lindhagen, A. and Hornsten, L. (2000). Forest recreation in 1977 and 1997 in Sweden: changes in public preferences and behaviour. *Forestry*, 73(2):143–153.
- Peng, C. (2000). Understanding the role of forest simulation models in sustainable forest management. *Environmental Impact Assessment Review*, 20(4):481 – 501.
- Porté, A. and Bartelink, H. (2002). Modelling mixed forest growth: a review of models for forest management. *Ecological Modelling*, 150:141–188.
- R Development Core Team (2006). *R: A Language and Environment for Statistical Computing*. R Foundation for Statistical Computing, Vienna, Austria. ISBN 3-900051-07-0. Available from: <http://www.R-project.org>.
- Reineke, L. (1933). Perfecting a stand-density index for even aged forests. *Journal of Agricultural Research*, 46:627–638.
- Robert, N. (2008). Quelles gestion, récolte et utilisation du bois sont susceptibles de réduire les émissions de gaz à effet de serre ? In GIP-Ecofor, editor, *La filière forêt-bois européenne : Des bio-réponses aux nouveaux enjeux climatiques et énergétiques ?*
- Sardin, T. (2008). *Guide des sylvicultures - Chênaies continentales (Silviculture guides - Continental oak forests, in French)*. Office national des forêts (French National Forest Service).
- Seidl, R., Fernandes, P. M., Fonseca, T. F., Gillet, F., Jönsson, A. M., Merganicová, K., Netherer, S., Arpaci, A., Bontemps, J.-D., Bugmann, H., González-Olabarria, J. R., Lasch, P., Meredieu, C., Moreira, F., Schelhaas, M.-J., and Mohren, F. (2011). Modelling natural disturbances in forest ecosystems: a review. *Ecological Modelling*, 222(4):903–924.

Twery, M. J. (2004). Modelling in forest management. Available from: http://www.fs.fed.us/ne/burlington/research/ne4454/pdf_pubs/forest_mgmt_modelling.pdf.

Vallet, P. (2005). *Impact de différentes stratégies sylvicoles sur la fonction “puits de carbone” des peuplements forestiers. Modélisation et simulation à l’échelle de la parcelle*. PhD thesis, ENGREF.

Chapter 6

Conclusions

Multi-output profit possibility frontiers: a tool to design environmental policies

Loss of biodiversity, global change, increasingly frequent landslides. . . these events raise many questions about environmental services (ES). Which services does the environment provide? Which ones do we value? Is it possible to reduce the impact of human activities on the environment? Can ESs be preserved or restored? How much would it cost? To address some of these questions, we propose a framework to analyze the provision of multiple ESs in complex ecological production systems. This framework uses the “envelope of profit possibilities”. We have developed a methodology based on simulations to define such envelopes and have applied it to the management of high oak forests. Although our example concerns forestry, the methodology and the conclusions could apply to broader perspectives.

In this chapter, we show the coherence of our results with the literature and highlight the added value of our stand-level multidimensional analysis. We draw general conclusions and explain how these results can be used by decision makers to better manage for ES provision. Finally, we suggest additional developments to address multipurpose forestry at the landscape level when forests are in different maturity stages.

6.1 Contribution to understanding multipurpose forest management

In this thesis, we analyze profit possibilities in two original ways: we characterize multipurpose forest management at the stand scale and we estimate the maximum profit as a simultaneous function of at least two joint ESs. We also apply different time aggregation techniques to ES provision. We discuss these points and highlight how they contribute to a better understanding of ES provision in forests.

6.1.1 An original stand level multipurpose analysis

Stand level characterization of forest growth and yield is common in the bio-technical modeling literature (see Porté and Bartelink, 2002, for a review of the modeling approaches). The goal of these models is to represent the impact of management techniques on wood production in order to identify best practices. Their use has been extended to estimate ES provision, in particular carbon storage (Liski et al., 2001; Vallet et al., 2009; Fortin et al., 2012) and occasionally other services such as biodiversity preservation (Wikstrom and Eriksson, 2000; Yousefpour and Hanewinkel, 2009) and recreation (Eriksson and Lindhagen, 2001).

Approaching the production process at the scale of the management unit (a piece of land which is subject to uniform management planning, the stand) is appropriate when analyzing the behavior of small forest owners (Koskela et al., 2007; Kurttila et al., 2008) and makes it possible to estimate their production possibilities. However, although many small forest owners have only one stand or management unit, analyzing production possibilities at the stand scale is rare in forestry (in the agricultural sector, the common unit for profit possibility analysis would be the farm and not the field, see e.g. Boussemart and Dervaux, 1994). One of the reasons might be that it is almost impossible to find several forests growing in similar conditions. Following Boscolo and Vincent (2003), we used a simulation approach that allows the management parameters to change. This technique ensures the comparability of the results because initial stand and growth conditions are identical and variations can be controlled. It also gives full control over the production system (any management scheme can be tested) and provides suitable information to managers concerning practices (Seidl et al., 2007). For example, our results show that multifunctional production of carbon storage and recreation can be achieved at a reduced opportunity cost in forests managed with a medium to high density (RDI of about 0.8) and with a diameter for the final cut of more than 60 cm.

Compared to landscape scale estimation of the production possibilities (see e.g. Polasky et al., 2008; Juutinen et al., 2008), our simulation approach does not allow us to directly derive an optimal allocation of the resources at the landscape level. However, we can suggest favoring multifunctionality at the stand scale if the production set is convex, or at the landscape scale with a specialized production at the stand scale if the production set is not convex (see Vincent and Binkley, 1993, and chapter 2). In oak forests, we accordingly suggest specializing some stands to protect open-forest bird species while other stands will provide both carbon storage and recreation. Stand-level analysis is complementary with landscape scale approaches and is relevant when the objective is to ask small non-industrial private forest owners (NIPF) to participate in the provision of ESs: Landscape-level evaluation provides information concerning global optima but ignores the individual's perception of the production possibilities. Combining it with a stand level approach which would likely give a different profit possibility frontier makes it possible to propose methods to pursue global ES objectives taking into account that these ESs are provided by several individual owners.

6.1.2 Integrated analysis of multipurpose forest management

Over the last few decades, several studies have tried to determine the production possibilities offered by different land management practices. These studies focused mainly on two outputs and identified tradeoffs between the profit from the production of a commodity such as food

or wood, and the provision of one ES. The major emphasis was on the opportunity cost of biodiversity preservation (Roise et al., 1990; Arthaud and Rose, 1996; Montgomery, 2002; Calkin et al., 2002) or carbon storage (Boscolo et al., 1997; Seidl et al., 2007). Some studies examined several ESs, but results are expressed in two dimensions only: profit and one ES. For example, Boscolo and Vincent (2003) produced two independent profit possibility frontiers to estimate the tradeoff between carbon storage and profit on one hand and preservation of biodiversity and the profit on the other hand. In Polasky et al. (2008), food and timber production, carbon storage and rural residential land uses are all converted into monetary values and are represented on a single axis. The second dimension is the preservation of biodiversity. Tradeoffs are estimated along these two dimensions. Two-dimensional analyses are convenient because the frontiers can be estimated with a single-objective optimization algorithm subject to a constraint on the minimum provision of one ES (e.g. maximization of profit subject to a certain level of biodiversity). These methods have been quite well developed. However, adding a second environmental dimension to maximize several objectives simultaneously requires different methods.

Upcoming methodologies for multidimensional optimization do exist. Toth and McDill (2009) evaluated the performance of different specific optimization algorithms to estimate multipurpose profit possibility frontiers. They applied their approach to the tradeoff between the net present value (NPV) of the commodities produced in the area and two biodiversity indicators at the landscape level: surface area of mature forest patches and total perimeter of the patches (or edge length). The best scenario for biodiversity is to have the largest area of mature forest habitat and the smallest edge length. Their frontier displays an interesting shape: in a first step: edge length appears to be almost a complement of NPV (the shorter the edge length, the higher the NPV). On the other hand, patch area is a substitute for NPV and for edge length (the larger the area, the longer the edge). The three-dimensional diagram highlights that edge length is in fact a substitute for NPV when the habitat area is fixed. Moreover, the opportunity cost of reducing edge length increases with habitat area. The interaction between the biodiversity indicators corresponds to case (3) in Figure 2.4. Note that in this example, it would not make sense to optimize the two indicators independently because they assess the same objective: increasing biodiversity by ensuring a large, only slightly fragmented area of mature forest habitat.

Other examples of multipurpose analysis have shown that two environmental objectives can be pursued at the same time if the objective is not to maximize only one of them at the lowest opportunity cost. In their study concerning payment to prevent deforestation, Venter et al. (2009) show that, at the global level, initiatives to reduce carbon emissions from deforestation and degradation are likely to increase biodiversity, but that this increase is slight if carbon-cost efficiency is maximized. According to the authors, a minor change in the allocation of the production factors would make it possible to increase the preservation of biodiversity much more, with only a slight reduction in carbon storage. This relationship most likely stems from a non-linear tradeoff between carbon storage and biodiversity. In our framework, this type of case appears when the iso-cost curve is strictly convex and reasoning out the production of both services at the same time is more efficient (see Figure 2.7). We also found similar interactions between the present values of biodiversity and carbon storage in our stand-level profit possibility frontier. Compared to a management program that maximizes revenue, an

increase in both biodiversity and carbon storage is possible (to a limited extent), but if the goal is to minimize the cost of carbon storage, then biodiversity will decrease.

These examples show that our analysis framework for multiple ES production provides a deeper understanding of the interactions in ES provision. However, the production of a multidimensional profit possibility frontier is complex and requires considerable bio-technical expertise.

6.1.3 Difficulties and solutions to estimate ES provision in the long run

Reliable estimation of ES provision is one of the key requirements needed to put our framework into practice. Obtaining such estimations is particularly complex when non-commodity ecosystem services are at stake because:

- they may be provided in the absence of human activity and contribute to human well-being without being identified making it hard to give them a value (TEEB, 2010);
- ES provision varies with time and must be analyzed over long periods since present decisions can affect both short-term and long-term provision;
- each management unit contributes to a global service, but the management of any one unit is not solely responsible for the variations in ES provision.

We discuss the first two points below and propose ways to integrate the last point, which requires extending the multi-output analysis to a global level to take into account the interactions between production units (see paragraph 6.3.3).

Measurement units. Estimating ES provision is subject to discussions concerning measurement units. As mentioned in chapter 4, when direct measurement is possible, the unit seems self-evident. However, even in these cases, commonly accepted measurements can be disputed. For example, the conversion factor of one metric ton of CH₄ into metric tons equivalent of CO₂ is usually 58, but this figure is based on a 100-year time horizon and the assumption of a linear effect of the CH₄ and CO₂ concentrations. Changing the calculation method to take into account longer periods, the effective impact on global warming and the time of residence in the atmosphere as well as the discount factor would modify the equivalence and thus the estimate of the carbon emission offset service (Boucher, 2012).

The question of measurement unit is even more complicated for services such as the protection of biodiversity, which do not directly create value or provide measurable wealth. Moreover, biodiversity cannot be represented by one single number. The indicators measured usually reveal only one part of the global biodiversity and therefore, the indicator chosen is of utmost importance (Butler, 2009). Establishing an indicator necessarily reveals a specific type of diversity, and is even sometimes based on *a priori*, for example when biodiversity is assessed in terms of naturalness (Moravčík et al., 2010).

In our simulations, we used an estimate of the number of bird species potentially found in the forest. This number is highest in old-growth forests, but is also quite high in early stage forests. It is lowest in mid-stage forests. Diaz et al. (2005) found similar results on Chiloé Island (Chile). However, using an indicator based on the number of bird species without any weighting of the different species could be misleading, because it implicitly gives the same

value to endangered (mostly old forest species) and non-endangered species. The structure of the indicator is responsible for the production possibility frontier obtained with discounted values. We could have modified the indicator and weighted the species by threatened status as defined in the Red List of the International Union for Conservation of Nature (Butchart et al., 2004). Had we used such an indicator, we would have found that longer rotations lead to an increase in biodiversity as did Hauer et al. (2007). Discounted carbon storage and bird diversity values would then have displayed the same complementarity as average carbon storage and bird diversity.

Finally, the difficulty of estimating services such as recreation lies in the separation between the preferences of the public for specific types of forests and their actual use for recreation. In our approach, we estimated the aesthetic value of the forest, a feature which varies considerably during the rotation. On the other hand, Abildtrup et al. (2011) showed that recreational use of the forest mainly depends on its distance from users' homes, except when numerous forests are available in the area. Consequently, our indicator may not represent overall recreational value but rather the value for people living nearby. It is also likely to correspond to the value that the forest owners give to their forest. Therefore, our indicator seems relevant to evaluate how aesthetics can interfere with the management decisions NIPFs make.

Temporal aggregation. Sustainable management integrates the principle of trans-generational equity, i.e. that the needs of current generations should be met without reducing the options for future generations to meet theirs (United Nations, 1992). Most outputs that rely on ecosystem functioning require long-term planning; indeed, an ecosystem can be destroyed quickly, and its restoration may be long or even be impossible. Moreover, the impact of the degradation of ecosystems on wealth can be revealed after years. Forest management is a good example of a process that requires long-term anticipation since it takes from 20 to more than 200 years for a forest to reach maturity. Typically, there are several ways to take time into account, including setting a finite time horizon (usually from 30 to 100 years) or keeping an infinite horizon.

Finite time horizons are used at the stand level when the time period of the analysis covers a certain number of rotations (see e.g. Liski et al., 2001). Finite horizons are used at the landscape level to address limited-time decision planning, such as in the elaboration of a management plan that will be revised in the future (Lichtenstein and Montgomery, 2003; Hauer et al., 2010). They are also relevant for processes that are not subject to temporal variations higher than the tendency, such as soil carbon uptake after a change in land use (Marland, 2004) and for large-scale analyses that soften local variations in timber production or carbon storage (Colin et al., 2009). Another example where finite horizons are pertinent is when the ES objective is to prevent species from disappearing over a certain period. The service is then estimated at the end of the period by the number of remaining species (Calkin et al., 2002; Nalle et al., 2004).

On the other hand, infinite time horizon makes it possible to compare decisions which will have impacts at various timescales. When using infinite time horizon, we assume that the rotation can be identically repeated infinitely. In some papers, mainly in forest management literature, average production value is calculated (see e.g. Lasch et al., 2005; Vallet et al., 2009; Fortin et al., 2012). This can be interpreted as the production possible when several

forests at different maturity stages are managed according to the same plan. Production is then smoothed among stands and the average supply over a 5- or 10-year period would be equal to the estimated average production in one stand over the entire duration of infinitely repeated rotations. However, if the aim is to evaluate the long term effects of management scenarios, then the uncertainty of the future (uncertainty concerning both demand and supply) reduces the relevance of the average production value. In economics, the present production value is usually preferred (one of the first authors in forest economics was Faustmann, 1849). Discounting gives less weight to the future and helps take decisions today in accordance with our current preferences.

In this study, we used both the averaging and the discounting approach to assess how these two approaches affect production possibility frontiers. With a discount rate close to 0, management recommendations for the provision of different services tend to maximize the average sustained yield (Binkley, 1987). We therefore chose not to investigate very low discount rates (less than 1%). We found that a discount rate of only 2% changes the perception of the complementarity between services. To establish production possibility frontiers in forestry, authors generally discount both monetary and non-monetary (i.e. ESs) values (see e.g. Boscolo and Vincent, 2000; Andersson et al., 2006; Hauer et al., 2010) except when the target is to ensure a certain level of diversity in a defined time horizon, as in Calkin et al. (2002) and Nalle et al. (2004).

Diaz et al. (2009) highlighted that Reduced Emissions from Deforestation and Forest Degradation (REDD) initiatives to offset carbon emissions through the preservation of old growth forests are likely to have a positive impact in biodiversity. We found similar results in oak forests, when we considered the average values of the products, which give the same weight to the ES provision in the short and in the long run. Diaz et al. also explain that targeting short-term carbon storage would lead to a reduction in biodiversity, because the management projects would likely emphasize planting fast-growing species rather than preserving older forests. We also found that focusing on short-term carbon uptake – which we represented by a discounted value of carbon – can lead to decisions that will reduce biodiversity¹.

6.2 Implications for decision makers

By using multipurpose analyses at the management unit level, scientists can better understand the joint production of goods and services by ecosystems. The results can also be interpreted to inform decision makers and help them identify appropriate tools to foster private forest owners to provide of ecosystem services. Multipurpose analysis is also a means for decision makers to meet ES provision goals at the lowest cost by allocating the objectives to the different forests properly. Policy makers can use market-based tools and regulations to ensure ES provision; we make recommendations based on the results of this thesis and draw conclusions concerning NIPFs' possible responses to monetary incentives.

¹We must mention that we also discounted the biodiversity indicator and that it resulted in giving a higher value to bird species that are hosted in open forests.

6.2.1 Preservation and restoration of environmental services: between markets and regulation

The environment has always provided goods and services such as clean water, oxygen, material, food and many others free of cost. Humans have modified some of the natural processes to increase production, in particular of commodities, that are of direct interest to them. However, some production-oriented processes have side effects: they produce negative externalities (or reduce positive externalities). When the production of a commodity (e.g. agricultural crops) reduces environmental services which are valued by a second producer (e.g. pure water), the second producer can pay the first one to avoid environmental degradation. This is how the payment for environmental services (PES) first appeared in the private sector. For example, in the 1990s, the Vittel water company proposed incentives to farmers in their water catchment area if they applied management practices to limit nitrate runoff (Perrot-Maître, 2006). This was more cost-efficient than taking risks concerning water quality. The riparian forest buffer in New York State is another example of such a PES program to preserve water quality (Chichilnisky and Heal, 1998). This program eliminated the need for a multi-billion dollar treatment plant to provide potable water to New-York citizens. These examples illustrate that some ESs can be marketed when the benefit of the services can be identified and measured, and when the opportunity cost of the service is clearly measurable.

However, services which indirectly participate in human welfare (e.g. climate regulation) or whose benefits are not clearly identified and measured (e.g. biodiversity preservation) are rarely subject to trade. Some donors give money to environmental associations to restore and preserve ecosystems or to offset carbon emissions. However, these initiatives are only based on a few people's feeling of social responsibility. Voluntary payments remain rare and cannot prevent ES losses. Therefore, economists have proposed establishing markets which run on cap and trade or compensation mechanisms. These markets can only be created if there are regulations that compel those who consume or threaten ESs to compensate for their negative impact, possibly by paying ES providers to increase their production. Due to the growing awareness of threats on ESs in the last few decades, policy makers have established new rules to increase marketing environmental services. These include obligations to evaluate the impacts of projects and to offset these impacts². New environmental markets increase and mitigation banks and compensation funds were established, mainly for biodiversity and carbon (Biggsby, 2009; Madsen et al., 2010).

6.2.2 Recommendations

Most mitigation banks and compensation funds have been created for a single objective: to preserve and restore biodiversity, to offset carbon emissions, to protect watersheds... The measures they rely on usually involve land conservation, afforestation and forest restoration. However, these measures have an impact on numerous other ESs such as biodiversity and carbon storage that are handled by different banks and funds (see Carlén et al., 1999; Eriksson

²In French law: Regulation n° 76-629 of July 10, 1976 regarding nature protection, and more recently, the regulation n° 2008-757 of August 1, 2008 regarding environmental responsibility and dispositions to adapt to the European Community regulations in the environmental sector.

and Lindhagen, 2001; Nelson et al., 2008, and chapter 5). We therefore recommend that these different dimensions be integrated into the regulations.

The market must include multiple services. In our demonstration in chapter 2, we showed that separating the supply of different ES or splitting PES might lead to non-optimal decisions. This is especially true when it is more efficient to propose bundles of services, or when the opportunity cost can be decreased through the degradation of another ES. We therefore suggest promoting integrated planning and sale of ESs by way of cooperation among funding institutions. Some institutions have already designed projects to supply multiple services in a bundle. For example, some projects combine biodiversity preservation and social development (Wunder et al., 2008) or watershed and biodiversity protection (Asquith et al., 2008; Pattanayak et al., 2010).

Appropriate rules must be established. Our second recommendation is to impose the monitoring of the impact of compensation projects on the provision of other ESs, with an obligation to compensate for possible losses or to value gains. However, such monitoring and exchange rules may not be sufficient for some services such as biodiversity. For example, it seems possible to compensate for the disturbance of a rare habitat hosting endangered species once biodiversity is given a monetary value; however, functional compensation would be virtually impossible (Bateman et al., 2011). National laws adapted to these markets must therefore have the power to forbid projects that threaten the provision of ESs. Without proper regulations, ES markets might spell the doom of the ESs themselves³.

Prefer reduced degradation to offsetting. Our observations suggest that offsetting environmental degradation – for example, paying a forest owner to store emitted carbon – can lead to side effects which may not be estimated in the transaction – e.g. modification of habitats. Offsetting can lead to cascade effects on various environmental services which would not have been impacted if the first degradation had not occurred. The price of offsetting should therefore be greater or equal not only to the price of compensating for the environmental degradation – in our example, a carbon emission – but should also include compensation for all the side effects. Since the indirect impact may be difficult to estimate, policy makers should urge producers to reduce their environmental impacts rather than give them tools to offset environmental degradation.

Ecosystem degradation and restoration can also be characterized with an analogy to entropy. A production system transforming inputs in outputs transfers the entropy of the inputs to the outputs (target product and waste). If the process is reversible, the entropy of the outputs is equal to the entropy of the inputs. However, most transformation processes are irreversible and typically the entropy of the outputs is greater than the entropy of the inputs. Suppose producer wishes to compensate for the increase in entropy resulting a the transformation process by processing the waste from the initial production, the waste transformation process will again increase the total entropy which will be embedded in other outputs. Reducing the increase in entropy resulting from the initial production system would therefore be more efficient than relying on seeming compensation.

³The expression here is taken from Wunder (2006), but the argument is different.

Use the precautionary principle. We are not aware of all the benefits ESs bring to human societies. Our awareness of their positive effects may occur only when they begin disappearing. Take the example of hedges. In north-western France, the length of hedges was dramatically reduced to favor the mechanization of agriculture and increase cultivated surface area. However, it has now become obvious that these hedges had many functions other than simply delimiting the land and shielding crops from wind; they also stabilized the soil and reduced fertilizer and pesticide leakage (Ghazavi et al., 2008). In other words, hedges provided services contributing to crop production that were noticed only after their removal. In this example, hedges can be replanted to restore the service, but this requires time. For other services, reversibility may not be possible. For example, if a species disappears, no compensation is possible. The case of greenhouse gases emitted for the past century is an eloquent example; decision makers must remember that damaging an ES with a currently unknown value may have high costs in the future. The multiplicity and complexity of the interactions between human-beings and their environment plead in favor of the precautionary principle in public decisions.

6.2.3 Payment as an incentive to forest owners for ES provision?

The production possibility frontier that we estimated for high oak forests shows that carbon storage can be increased in forests that are currently being managed to maximize profit, recreation or biodiversity. Paying landowners for additional carbon sequestration would likely reduce profits from goods, and could sometimes also reduce another service (or several services), such as recreation. Monetary compensation, which only considers the loss of profit, would not be sufficient to make forest owners change their management objectives.

Each forest owner manages her forest differently depending on her objectives (see section 1.4). If we assume that payment is based on the additional service provided, then the initial level of provision must be estimated. Obviously, this level of provision not only depends on the current provision, but also on the expected provision if the current forest management plan is applied. Calculating the reference level is therefore complex. Moreover, a scenario that maximizes the net present value of the land seems to be a reasonable reference for industrial forest owners. But small private forests may already be providing more (or fewer) ESs under their current management than if these forests had been managed to maximize the NPVIS. For example, a NIPF maximizing forest attractiveness will also store more carbon; yet, the marginal quantity of carbon that can be stored in her forest is lower than in a forest that is managed to maximize the profit. Moreover, the NIPF will have to reduce the attractiveness of her forest. She might be unlikely to do so. The owner might therefore be disinclined to do so. Conversely, proposing the maximization of the NPVIS as a reference is likely to create a demand for payment from forest owners who would not have to change their practices to provide the service. This raises the question of equity between ES providers.

Paying for the provision of ESs creates a market for ESs, which in the past were provided by many landowners for free thanks to their willingness to contribute to global wealth. Various reactions can occur when an ES market is created: (1) some owners may hide or reduce their ES provision unless they are paid to maintain it; (2) some owners will give up wood production to maximize their revenues from ESs; (3) many owners will refuse to join the PES to keep full control in their forests. Forest owners are often constraint-averse for several reasons: reaching

the defined results is often uncertain; contracts are usually binding in the long run (although NATURA 2000 contracts can be limited to 5 years); forest owners want to keep their freedom to manage their forest as they see fit; and lastly, the value of a piece of land can drop if this land is subject to limiting regulations (see e.g. Zhang, 2004, who shows that certain forest owners choose management strategies to prevent the red-cockaded woodpecker from settling in their forests, which would thus come under environmental protection rules).

Pricing the services might result in a reduced willingness to supply ESs because this provision would become part of the profit function instead of an independent part of the benefit function in which social benefits can have higher value than monetary ones. Consequently, creating a market for forest environmental services may not be the most appropriate way to ensure ES provision in private forests in Europe. It might be more appropriate to give incentives for re-forestation with endemic species or using better harvesting practices.

6.3 Extension of the modeling approach

Using our model, we calculated the four-dimensional Production Possibility Set (PPS) envelope corresponding to an oak stand which has just been regenerated. This is, of course, one very specific case. To increase our understanding of broader forest management production possibilities, we suggest further evaluating how production possibilities change with stand age and upscaling our results from the stand level to the landscape scale.

6.3.1 Modeling the Production Possibility Set envelope at various stages

In this thesis, we analyzed the management possibilities starting from a recently cleared stand that offered opportunities to regenerate naturally. However, this stage only occurs once in a century in sessile oak forests. More typical management questions concern already developed stands. These forests have been managed before and previous choices may have limited (or increased) the opportunities. Moreover, at a given stand age, some management practices may leave more options open than others.

The average time aggregation technique would not be appropriate for such an analysis, because it assumes that rotations are repeated forever with the same parameters and that stand growth rates remain the same. This restricts the management options to the ones that recreate the current stand at the same stage. For instance, if the current stage is regeneration after clear-cutting, this corresponds to a phase every regular forest goes through, whatever the management parameters. However, if the current status is an already grown forest, this creates a second reference point in time at which stand status is defined. Reproducing these two points (regeneration and grown forest) forever can only be achieved through a very limited number of management schemes, and one of the only parameter that would make differences is the target d_{dom} . The resulting profit possibility frontier would be smaller than the one presented in chapter 5 because of the two constraints. The second constraint (reproducing the current status for every rotation) would not make sense, because once the trees are felled and the forest is regenerated, all possibilities are once again open.

The discounting time aggregation technique seems more appropriate, because the question now becomes: “How can we optimize the management of the existing stand knowing the current decision possibilities and the production possibility set once the stand is regenerated?” To analyze these aspects of forest management, we need a generalized version of the current ES value. Past expenses are sunk costs and previous ES provision plays no role in the present valuation. Consequently, only present and future productions are taken into account. If we consider only those management scenarios that lead to final clear-cutting, then present values of ESs that will be produced during the started rotation are equal to the cumulated discounted instantaneous values provided until the end of the current rotation. At the end of the rotation, the final felling reopens the whole set of production possibilities determined in the regeneration case. However, the production possibility set is then shrunk by the discount rate (r) corrected by relative price correction factors r_C , r_A and r_{Bio} for ESs.

Consequently, to envelope the production possibilities in an existing stand, we must not only determine the production possibilities if that stand is regenerated (see in the previous chapter), but also the production possibilities until the final felling of the current forest. Although this calculation is beyond the scope of our thesis, we give some indications below.

- The envelope of the production possibilities will be at least as large as the production set determined for regeneration plus the profit (positive or negative) from harvesting all the trees in the stand at the beginning of the rotation.
- For carbon storage and recreational attractiveness, which increase with time and plunge at final harvest, the more the stand develops, the higher the production possibilities. Optimizing the production of these two ESs requires keeping the forest growing as long as possible, while possibly harvesting certain trees to increase recreative value or maintaining maximum tree density for carbon storage (Luyssaert et al., 2008; Vallet, 2005, see e.g.).
- Concerning the present value of harvested wood, the optimum choice will depend on the development stage. If the sum of the discounted timber value plus the discounted maximum profit possibility determined previously increases with time, then the forest will be managed until the opportunity cost of postponing the harvest is null. If the stand has already passed that stage, then the optimum choice will be to harvest the stand and start again from a natural regeneration.
- The scenario that maximizes biodiversity preservation is more complex to determine because of the U-shape of the indicator. If the stand is very young (low dominant height), the optimum scenario will be to harvest the trees as soon as possible and regenerate to favor the numerous young forest bird species. However, if the forest has already passed the point where regenerating would increase diversity (dominant height above 33 m), then the optimum scenario will be to delay the final harvest as much as possible, to favor high tree density and large target d_{dom} .

If the three-first points just enlarge the PPS, the fourth point can lead to strong changes in the PPS shape. In a young forest, the preservation of bird diversity appears to be supplementary to the three other outputs. In a more mature forest, the ES could become a complement of carbon storage, as in PPSs determined with average indicators. Maximizing our biodiversity indicator implies preserving old forest habitats in more than 100-year-old high forests, whereas it implies preserving open forest habitats in younger stands.

The opportunity cost of changing management to improve the provision of one ES will change with time and with the stand status which results from past decisions. For example a 75-year old very intensively managed forest cannot be transformed into a dense forest in less than 25 years and even if transformation is eventually successful, the forest will have fewer but larger trees than if it had been managed with a high density of trees from the beginning of the rotation. Our model can evaluate these types of situations.

Modeling the PPS as presented in chapter 5 is possible for many species other than oak. The prerequisites include a growth and yield simulator and procedures to derive estimates of the productions from the simulator. Many models integrated in the Capsis platform can therefore be used, such as *Fagacées* for beech⁴, *PP3* for maritime pine and *Sylvestris* for Scots Pine.

6.3.2 Production possibility sets and uncertainties

As mentioned before, we modeled the PPS with a deterministic simulator. We have seen in paragraph 5.2.2 that the simulator gives the same results if we repeat a simulation with the same parameters (initial stand characteristics and management scheme). The only source of variability is the random creation of the initial stand. In reality, the same management practices are very unlikely to produce exactly the same results due to genetic characteristics of the trees, meteorological conditions, random events (storms, drought and diseases) and unpredictable variations in wood price.

Adding genetic variability and annual fluctuations in meteorological conditions would introduce some randomness in the results. However, on average, the estimated outputs would be comparable to results obtained with the simulator, which was calibrated with measurements made in numerous existing forests subject to these two factors. On the other hand, natural events were not taken into account in the simulations. If they had been included, the expected profit possibilities are likely to have decreased, especially production in long rotations. The PPS is likely to change with risk intensity. However, since outputs react to risks differently, we cannot clearly determine if we over- or underestimated the production possibilities. Our test with an increased discount rate⁵ shows that the opportunity cost might be underestimated for carbon storage and preservation of bird diversity, but over-estimated for recreational attractiveness (see paragraph 5.4.1). Taking storm effects into account might also increase the role of the thinning intensity, because of the high sensitivity of intensively thinned stands to storm damage.

Wood prices are often considered to follow a stochastic trend (Ahrens and Sharma, 1997). Many studies have included this source of uncertainty in the decision planning process and have evaluated how this trend affects harvesting behavior (see e.g. Insley and Rollins, 2005). Moreover, Zhou and Buongiorno (2011) showed that considering stochastic interest rates increases the present value. Price variations modify the profit possibilities and the estimated value of an increase in an ES. For example, if an increase in carbon storage requires lengthening the rotation and thereby constrains the harvesting schedule, then selling timber when the price is at its highest may not be possible.

⁴This model is parameterized to simulate even-aged forests of both oak and beech as single species.

⁵A higher discount rate is a proxy to the reduction in production resulting from hazards that can destroy the forest.

Companies selling ESs such as carbon storage have developed mechanisms to ensure the buyer that the carbon storage is effectively being done; they sell credits corresponding to a share of the sequestration value from several forests in different locations. With such systems, a forest owner can sell carbon credits through these companies at a lower price than the carbon market, and still earn a certain income. Such mechanisms are likely to transform the PPS envelope, providing certainties in some dimensions and leaving uncertainties in others.

Finally, uncertainties are likely to change the forest manager's perception of the PPS. If she is risk-neutral, then the PPS envelope will correspond to the expected production value which – in absence of storm, fire and pest hazards – equals the one we estimated. However, if the manager is risk-averse, she might consider a much smaller envelope; and conversely, if she is a risk-taker, she might consider an inflated envelope. Monitoring how the PPS envelope changes with respect to uncertainties could help predict differences in the behavior of forest owners with similar ES preferences.

6.3.3 From the stand to the landscape scale

We analyzed forest management at the stand scale. This is relevant in European countries where services are provided by forest owners, small or large, who can enjoy or sell ESs only on their properties. This scale is also appropriate to investigate how these owners perceive incentives to change their management to increase carbon storage, if they initially have a preference for wood production or for recreation. However, ES provision should also be evaluated at larger scales since forest owners (in particular large forest owners) often manage several stands at different development stages. Moreover, services such as preserving biodiversity require a spatial and temporal allocation of habitats at large scales (Franc et al., 2007; Gass et al., 2009). The landscape level is the more suitable in this case. At landscape scale, the forest stands offer different production possibilities (site index) and are at various development stages.

For additive outputs such as the profit⁶ or carbon storage, the opportunities offered at the landscape scale are simply the sum of the production possibilities in the stands (see e.g. Vincent and Binkley, 1993). Other functions such as recreational attractiveness or biodiversity must be characterized differently. Biodiversity is often evaluated at landscape scale with fragmentation indicators or species preservation probabilities that depend on land cover (Poulin et al., 2008; Johnston, 2008). A broader scale makes it possible to evaluate biodiversity in a more functional way. In the case of our biodiversity indicator (bird species richness), we estimated the probability of a stand hosting a certain number of bird species – in other words, the suitability of the forest habitat to host bird species if they are already present in the neighborhood. At the landscape scale, we could calculate the total surface area of the habitats available for each species and estimate the probability that a species will still be present in the future (see e.g. Schumaker et al., 2004). This probability will drop if the habitat temporarily disappears from the landscape. The indicators will be different at the landscape scale and at the stand level. Similarly, for recreation, if the forest was open to the public (or to all the owners involved), recreational attractiveness could be considered over the entire area. This indicator could represent for example, the variation in the total

⁶Except if the intervention area were so small that it would create important diseconomies of scale.

area suitable for recreation (i.e. with an attractiveness that exceeds a minimum threshold) through time. We recommend using a sigmoid function of the surface area to clearly show that if the recreation area became too small, it would not provide the service, and inversely, if the recreation area was large, extending the area would increase the service very little (Gundersen et al., 2006; Rapey and Michalland, 2002).

Forest management at the landscape scale often involves numerous stakeholders with different interests. Designing a local policy to preserve or increase ESs requires collaborative work between land managers and ES beneficiaries (Carmona-Torres et al., 2011). The owners themselves benefit not only from wood harvesting, but also from some ESs (see section 1.4). Consequently, giving them monetary compensation only for a loss of profits may not be appropriate to make them change forest management to pursue a landscape level objective (Kurttila et al., 2008). Knowing both landscape level and stand level production possibilities can help evaluate how the contribution of each forest owner to the general objective affects her own production possibilities and her monetary and non-monetary opportunity costs. With these elements, management plans can be proposed and discussed with managers and beneficiaries (Cordonnier et al., 2010). Proposals could include grouping forest owners and cooperation between the actors of a given territory (Goldman et al., 2007).

6.4 Conclusion

The originality of our modeling method for the profit possibility frontier lies in the simultaneous integration of at least three dimensions (profit and several ESs) at the management unit level. Reduced to two dimensions, our results are globally in line with the literature, but the aforementioned originality opens new perspectives to help analyze the global provision of ESs by various NIPFs who have wood-production and non-wood-production objectives. Thanks to this approach, we can offer some suggestions to policy makers who would like to rely on the market to ensure the provision of ESs:

- Any ES market must include several ecosystem services.
- Before allowing forest owners to sell compensation credits, rules must be defined to evaluate the impact of the project on other services, and to prevent other services from being hindered.
- Stacking PESs should be permitted to increase offsetting opportunities.
- The impact of human activities on the environment must be more closely monitored to avoid threatening currently unrecognized services.

Upscaling our work to the landscape or the national scale would provide a multi-level approach that would enhance the performance of the tool. Each ES could thus be analyzed at the most relevant scale (e.g. carbon storage at the global scale, biodiversity at the habitat scale and profits at the forest owner scale). We would gain from including these back effects in the analysis.

We have discussed the interactions involved in the provision of the services, but there are also interactions in the use of the services. For example, recreation activities such as bird watching can reduce biodiversity because of disturbance (Rusterholz et al., 2011). Such feedback effects

could be taken into account for a more efficient allocation of areas for biodiversity preservation and areas for wildlife observation.

Finally, our framework for multipurpose analyses presented in chapter 2 could be used for a wider range of issues in which human activities interact with the environment. For example, in the electricity production sector, there is a revealed tradeoff between the cost of energy and CO₂ emissions, with coal being one of the cheapest primary sources of energy. There are alternative sources that reduce CO₂ emissions, for example nuclear energy, but producing nuclear power requires large quantities of water to cool the reactor and water resources may become more limited with global change⁷. Bio-energy may be another option to help reduce CO₂ emissions. However, if crops or coppices are grown for energy purposes alone, then there is another tradeoff between land use for food or energy production.

⁷Note that during the drought in 2003 in France, some nuclear plant had to be slowed down because of the reduced the volume of water in the rivers. <http://www.southwestclimatechange.org/blog/11151>

Bibliography

- Abildtrup, J., Garcia, S., Olsen, S. B., and Stenger, A. (2011). Recreation value of forests in lorraine: A spatial analysis. In *18th Annual Conference of the European Association of Environmental and Resource Economists*, June 29th to July 2nd 2011, Rome.
- Ahrens, W. and Sharma, V. (1997). Trends in natural resource commodity prices: Deterministic or stochastic? *Journal of Environmental Economics and Management*, 33(1):59–74.
- Andersson, M., Sallnas, O., and Carlsson, M. (2006). A landscape perspective on differentiated management for production of timber and nature conservation values. *Forest Policy and Economics*, 9(2):153–161.
- Arthaud, G. J. and Rose, D. W. (1996). A methodology for estimating production possibility frontiers for wildlife habitat and timber value at the landscape level. *Canadian Journal of Forest Research*, 26(12):2191–2200.
- Asquith, N. M., Vargas, M. T., and Wunder, S. (2008). Selling two environmental services: In-kind payments for bird habitat and watershed protection in Los Negros, Bolivia. *Ecological Economics*, 65(4):675–684.
- Bateman, I. J., Mace, G. M., Fezzi, C., Atkinson, G., and Turner, K. (2011). Economic analysis for ecosystem service assessments. *Environmental & Resource Economics*, 48(2):177–218.
- Biggsby, H. (2009). Carbon banking: Creating flexibility for forest owners. *Forest Ecology and Management*, 257(1):378–383.
- Binkley, C. S. (1987). When is the optimal economic rotation longer than the rotation of maximum sustained yield? *Journal of Environmental Economics and Management*, 14(2):152–158.
- Boscolo, M., Buongiorno, J., and Panayotou, T. (1997). Simulating options for carbon sequestration through improved management of a lowland tropical rainforest. *Environment and Development Economics*, 2(03):241–263.
- Boscolo, M. and Vincent, J. (2003). Nonconvexities in the production of timber, biodiversity, and carbon sequestration. *Journal of Environmental Economics and Management*, 46(2):251–268.
- Boscolo, M. and Vincent, J. R. (2000). Promoting better logging practices in tropical forests: A simulation analysis of alternative regulations. *Land Economics*, 76(1):1–14.
- Boucher, O. (2012). Comparison of physically- and economically-based CO₂-equivalences for methane. *Earth System Dynamics*, 3(1):49–61. Available from: <http://www.earth-syst-dynam.net/3/49/2012/>.
- Boussemart, J.-P. and Dervaux, B. (1994). Diagnostic de l'efficacité productive par dea : application à des élevages porcins. *Cahiers d'Économie et Sociologie Rurales*, 31:44–58.
- Butchart, S. H. M., Stattersfield, A. J., Bennun, L. A., Shutes, S. M., Akçakaya, H. R., Baillie, J. E. M., Stuart, S. N., Hilton-Taylor, C., and Mace, G. M. (2004). Measuring global trends in the status of biodiversity: Red list indices for birds. *PLoS Biology*, 2(12):2294–2304.
- Butler, D. W. (2009). Planning iterative investment for landscape restoration: Choice of biodiversity indicator makes a difference. *Biological Conservation*, 142(10):2202–2216.
- Calkin, D. E., Montgomery, C. A., Schumaker, N. H., Polasky, S., Arthur, J. L., and Nalle, D. J. (2002). Developing a production possibility set of wildlife species persistence and timber harvest value. *Canadian Journal of Forest Research*, 32(8):1329–1342.
- Carlén, O., Mattsson, L., Atlegrim, O., and Sjöberg, K. (1999). Cost efficiency in pursuing environmental objectives in forestry. *Journal of Environmental Management*, 55(2):111–125.
- Carmona-Torres, C., Parra-Lopez, C., Groot, J. C. J., and Rossing, W. A. H. (2011). Collective action for multi-scale environmental management: Achieving landscape policy objectives through cooperation of local resource managers. *Landscape and Urban Planning*, 103(1):24–33.

- Chichilnisky, G. and Heal, G. (1998). Economic returns from the biosphere. *Nature*, 391(6668):629–630.
- Colin, A., Barnérias, C., Salis, M., Thivolle-Cazat, A., Coulon, F., and Couturier, C. (2009). Biomasse forestière, populeicole et bocagère disponible pour l'énergie à l'horizon 2020. Technical report, ADEME. Available from: http://www.dispo-boisenergie.fr/doc/ADEME_boisenergie_rapport_final_dec2009.pdf [cited 2012-10-28].
- Cordonnier, T., de Morogues, F. B., Caron, A., Chauvin, C., Dreyfus, P., Ginisty, C., Dupouey, J.-L., Luque, S., Mathias, J.-D., Robert, N., and Rochel, X. (2010). From metaphor to action: implementing viable forest ecosystem management in landscapes. the forgeco project. IUFRO Landscape Ecology Working Group International Conference. September 21 to 27. Bragança, Portugal.
- Diaz, I. A., Armesto, J. J., Reid, S., Sieving, K. E., and Willson, M. F. (2005). Linking forest structure and composition: avian diversity in successional forests of Chiloe' Island, Chile. *Biological Conservation*, 123(1):91–101.
- Diaz, S., Hector, A., and Wardle, D. A. (2009). Biodiversity in forest carbon sequestration initiatives: not just a side benefit. *Current Opinion in Environmental Sustainability*, 1(1):55–60.
- Eriksson, L. and Lindhagen, A. (2001). A model indicating effects of multipurpose use of forestry on stand level. *Criteria and Indicators for Sustainable Forest Management at the Forest Management Unit Level*, 38:83–98.
- Faustmann, M. (1849). Calculation of the value which forest land and immature stands possess for forestry. *Allgemeine Forst und Jagd Zeitung*, pages 441–455.
- Fortin, M., Ningre, F., Robert, N., and Mothe, F. (2012). Quantifying the impact of forest management on the carbon balance of the forest-wood product chain: A case study applied to even-aged oak stands in france. *Forest Ecology and Management*, 279:176–188.
- Franc, N., Gotmark, F., Okland, B., Norden, B., and Paltto, H. (2007). Factors and scales potentially important for saproxylic beetles in temperate mixed oak forest. *Biological Conservation*, 135(1):86–98.
- Gass, R., Rickenbach, M., Schulte, L., and Zeuli, K. (2009). Cross-boundary coordination on forested landscapes: Investigating alternatives for implementation. *Environmental Management*, 43(1):107–117.
- Ghazavi, G., Thomas, Z., Hamon, Y., Marie, J. C., Corson, M., and Merot, P. (2008). Hedgerow impacts on soil-water transfer due to rainfall interception and root-water uptake. *Hydrological Processes*, 22(24):4723–4735.
- Goldman, R. L., Thompson, B. H., and Daily, G. C. (2007). Institutional incentives for managing the landscape: Inducing cooperation for the production of ecosystem services. *Ecological Economics*, 64(2):333–343.
- Gundersen, V., Frivold, L. H., Myking, T., and Øyen, B. H. (2006). Management of urban recreational woodlands: the case of Norway. *Urban Forestry and Urban Greening*, 5(2).
- Hauer, G., Cumming, S., Schmiegelow, F., Adamowicz, W., Weber, M., and Jagodzinski, R. (2010). Tradeoffs between forestry resource and conservation values under alternate policy regimes: A spatial analysis of the western Canadian boreal plains. *Ecological Modelling*, 221(21):2590–2603.
- Hauer, G., Cumming, S., Schmiegelow, F., Adamowicz, W. L., Weber, M., and Jagodzinski, R. (2007). Tradeoffs between forestry resource and conservation values under alternate forest policy regimes: A spatial analysis of the Western Canadian boreal plains. Staff paper series, University of Alberta, Department of Rural Economy. Available from: <http://purl.umn.edu/52086>.
- Insley, M. and Rollins, K. (2005). On solving the multirotational timber harvesting problem with stochastic prices: A linear complementarity formulation. *American Journal of Agricultural Economics*, 87(3):735–755.

- Johnston, K. M. (2008). *Using an Ecological Framework to Explicitly Model Time, Space, and the Decision Making of Objects*. PhD thesis, Yale University. Available from: <http://gradworks.umi.com/3317265.pdf>.
- Juutinen, A., Luque, S., Monkkonen, M., Vainikainen, N., and Tomppo, E. (2008). Cost-effective forest conservation and criteria for potential conservation targets: a Finnish case study. *Environmental Science and Policy*, 11(7):613–626.
- Koskela, E., Ollikainen, M., and Pukkala, T. (2007). Biodiversity conservation in commercial boreal forestry: The optimal rotation age and retention tree volume. *Forest Science*, 53(3):443–452.
- Kurttila, M., Leskinen, P., Pykalainen, J., and Ruuskanen, T. (2008). Forest owners' decision support in voluntary biodiversity-protection projects. *Silva Fennica*, 42(4):643–658.
- Lasch, P., Badeck, F., Suckow, F., Lindner, M., and Mohr, P. (2005). Model-based analysis of management alternatives at stand and regional level in brandenburg (germany). *Forest Ecology and Management*, 207(1-2):59–74.
- Lichtenstein, M. E. and Montgomery, C. A. (2003). Biodiversity and timber in the coast range of Oregon: Inside the production possibility frontier. *Land Economics*, 79(1):56–73.
- Liski, J., Pussinen, A., Pingoud, K., Mäkkipää, R., and Karjalainen, T. (2001). Which rotation length is favourable to carbon sequestration? *Canadian Journal of Forest Research*, 31(11):2004–2013.
- Luyssaert, S., Schulze, E. D., Börner, A., Knohl, A., Hessenmoller, D., Law, B. E., Ciais, P., and Grace, J. (2008). Old-growth forests as global carbon sinks. *Nature*, 455(7210):213–215.
- Madsen, B., Carroll, N., and Moore Brands, K. (2010). State of biodiversity markets report: Offset and compensation programs worldwide. Technical report, Forest Trends. Available from: <http://www.ecosystemmarketplace.com/documents/acrobat/sbdlmr.pdf>.
- Marland, G. (2004). Studies on enhancing carbon sequestration in soils. *Energy*, 29(9-10):1643–1650.
- Montgomery, C. A. (2002). Compatibility of timber and conservation: Tracing the tradeoff frontier. In Johnson, A., Haynes, R., and Monserud, R., editors, *USDA Forest Service General Technical Report Pacific Northwest*, volume 563, pages 225–232, Portland. US Department of Agriculture, Forest Service Pacific Northwest Research Station.
- Moravčík, M., Sarvašová, Z., Merganič, J., and Schwarz, M. (2010). Forest naturalness: criterion for decision support in designation and management of protected forest areas. *Environmental Management*, 46(6).
- Nalle, D. J., Montgomery, C. A., Arthur, J. L., Polasky, S., and Schumaker, N. H. (2004). Modeling joint production of wildlife and timber. *Journal of Environmental Economics and Management*, 48(3):997–1017.
- Nelson, E., Polasky, S., Lewis, D. J., Plantinga, A. J., Lonsdorf, E., White, D., Bael, D., and Lawler, J. J. (2008). Efficiency of incentives to jointly increase carbon sequestration and species conservation on a landscape. *Proceedings of the National Academy of Sciences*, 105(28):9471–9476.
- Pattanayak, S. K., Wunder, S., and Ferraro, P. J. (2010). Show me the money: Do payments supply environmental services in developing countries? *Review of Environmental Economics and Policy*, 4(2):254–274.
- Perrot-Maitre, D. (2006). The vittel payments for ecosystem services: a 'perfect' pes case? Technical Report Project Paper No.3, International Institute for Environment and Development. London, IIED. Available from: <http://pubs.iied.org/pdfs/G00388.pdf>.
- Polasky, S., Nelson, E., Camm, J., Csuti, B., Fackler, P., Lonsdorf, E., Montgomery, C., White, D., Arthur, J., Garber-Yonts, B., Haight, R., Kagan, J., Starfield, A., and Tobalske, C. (2008). Where to put things? spatial land management to sustain biodiversity and economic returns. *Biological Conservation*, 141(6):1505–1524.

- Porté, A. and Bartelink, H. (2002). Modelling mixed forest growth: a review of models for forest management. *Ecological Modelling*, 150:141–188.
- Poulin, J. F., Villard, M. A., Edman, M., Goulet, P. J., and Eriksson, A. M. (2008). Thresholds in nesting habitat requirements of an old forest specialist, the brown creeper (*Certhia americana*), as conservation targets. *Biological Conservation*, 141(4):1129–1137.
- Rapey, H. and Michalland, B. (2002). Observations et analyse sur la variabilité de la récréation en forêt dans des secteurs de moyenne montagne. *Revue Forestière Française*, 54(5):455–468.
- Roise, J., Chung, J., Lancia, R., and Lennartz, M. (1990). Red-cockaded woodpecker habitat and timber management: production possibilities. *Southern Journal of Applied Forestry*, 14(1).
- Rusterholz, H.-P., Verhoustraeten, C., and Baur, B. (2011). Effects of long-term trampling on the above-ground forest vegetation and soil seed bank at the base of limestone cliffs. *Environmental Management*, 48(5):1024–1032.
- Schumaker, N. H., Ernst, T., White, D., Baker, J., and Haggerty, P. (2004). Projecting wildlife responses to alternative future landscapes in Oregon’s willamette basin. *Ecological Applications*, 14(2):381–400.
- Seidl, R., Rammer, W., Jager, D., Currie, W. S., and Lexer, M. J. (2007). Assessing trade-offs between carbon sequestration and timber production within a framework of multi-purpose forestry in Austria. *Forest Ecology and Management*, 248(1-2):64–79.
- TEEB (2010). The economics of ecosystems and biodiversity: Mainstreaming the economics of nature: A synthesis of the approach, conclusions and recommendations of TEEB. Technical report, The Economics of Ecosystems and Biodiversity. Available from: http://www.teebweb.org/LinkClick.aspx?fileticket=bYhDohL_TuM%3d&tabid=1278&mid=2357.
- Toth, S. F. and McDill, M. E. (2009). Finding efficient harvest schedules under three conflicting objectives. *Forest Science*, 55(2):117–131.
- United Nations (1992). Rio declaration on environment and development – report of the United Nations conference on environment and development – annex 1. Technical report, United Nations. Available from: <http://www.un.org/documents/ga/conf151/aconf15126-1annex1.htm>.
- Vallet, P. (2005). *Impact de différentes stratégies sylvicoles sur la fonction “puits de carbone” des peuplements forestiers. Modélisation et simulation à l’échelle de la parcelle*. PhD thesis, ENGREF.
- Vallet, P., Meredieu, C., Seynave, I., Belouard, T., and Dhote, J. F. (2009). Species substitution for carbon storage: Sessile oak versus Corsican pine in France as a case study. *Forest Ecology and Management*, 257(4):1314–1323.
- Venter, O., Laurance, W. F., Iwamura, T., Wilson, K. A., Fuller, R. A., and Possingham, H. P. (2009). Harnessing carbon payments to protect biodiversity. *Science*, 326(5958):1368–1368.
- Vincent, J. R. and Binkley, C. S. (1993). Efficient multiple-use forestry may require land-use specialization. *Land Economics*, 69(4):370–376.
- Wikstrom, P. and Eriksson, L. O. (2000). Solving the stand management problem under biodiversity-related considerations. *Forest Ecology and Management*, 126(3):361–376.
- Wunder, S. (2006). Are direct payments for environmental services spelling doom for sustainable forest management in the tropics? *Ecology and Society*, 11(2):23.
- Wunder, S., Engel, S., and Pagiola, S. (2008). Taking stock: A comparative analysis of payments for environmental services programs in developed and developing countries. *Ecological Economics*, 65(4):834–852.
- Yousefpour, R. and Hanewinkel, M. (2009). Modelling of forest conversion planning with an adaptive simulation-optimization approach and simultaneous consideration of the values of timber, carbon and biodiversity. *Ecological Economics*, 68(6):1711–1722.

- Zhang, D. (2004). Endangered species and timber harvesting: The case of red-cockaded woodpeckers. *Economic Inquiry*, 42(1):150–165.
- Zhou, M. and Buongiorno, J. (2011). Effects of stochastic interest rates in decision making under risk: A markov decision process model for forest management. *Forest Policy and Economics*, 13(5):402–410.

Appendix

Appendix A

Criteria and indicators of the Forest Europe process

Criteria and indicators of the Forest Europe process presented in Forest Europe

No	Indicator name	Full text
Criterion 1: Maintenance and Appropriate Enhancement of Forest Resources and their Contribution to Global Carbon Cycles		
1.1	Forest area	Area of forest and other wooded land, classified by forest type and by availability for wood supply, and share of forest and other wooded land in total land area
1.2	Growing stock	Growing stock on forest and other wooded land, classified by forest type and by availability for wood supply
1.3	Age structure and/or diameter distribution	Age structure and/or diameter distribution of forest and other wooded land, classified by forest type and by availability for wood supply
1.4	Carbon stock	Carbon stock of woody biomass and of soils on forest and other wooded land
Criterion 2: Maintenance of Forest Ecosystem Health and Vitality		
2.1	Deposition of air pollutants	Deposition of air pollutants on forest and other wooded land, classified by N, S and base cations
2.2	Soil condition	Chemical soil properties (pH, CEC, C/N, organic C, base saturation) on forest and other wooded land related to soil acidity and eutrophication, classified by main soil types
2.3	Defoliation	Defoliation of one or more main tree species on forest and other wooded land in each of the defoliation classes "moderate", "severe" and "dead"
2.4	Forest damage	Forest and other wooded land with damage, classified by primary damaging agent (abiotic, biotic and human induced) and by forest type
Criterion 3: Maintenance and Encouragement of Productive Functions of Forests (Wood and Non-Wood)		
3.1	Increment and fellings	Balance between net annual increment and annual fellings of wood on forest available for wood supply
3.2	Roundwood	Value and quantity of marketed roundwood
3.3	Non-wood goods	Value and quantity of marketed non-wood goods from forest and other wooded land
3.4	Services	Value of marketed services on forest and other wooded land
3.5	Forests under management plans	Proportion of forest and other wooded land under a management plan or equivalent
Criterion 4: Maintenance, Conservation and Appropriate Enhancement of Biological Diversity in Forest Ecosystems		
4.1	Tree species composition	Area of forest and other wooded land, classified by number of tree species occurring and by forest type
4.2	Regeneration	Area of regeneration within even-aged stands and uneven-aged stands, classified by regeneration type
4.3	Naturalness	Area of forest and other wooded land, classified by "undisturbed by man", by "semi-natural" or by "plantations", each by forest type
4.4	Introduced tree species	Area of forest and other wooded land dominated by introduced tree species
4.5	Deadwood	Volume of standing deadwood and of lying deadwood on forest and other wooded land classified by forest type
4.6	Genetic resources	Area managed for conservation and utilisation of forest tree genetic resources (in situ and ex situ gene conservation) and area managed for seed production
4.7	Landscape pattern	Landscape-level spatial pattern of forest cover
4.8	Threatened forest species	Number of threatened forest species, classified according to IUCN red list categories in relation to total number of forest species
4.9	Protected forests	Area of forest and other wooded land protected to conserve biodiversity, landscapes and specific natural elements, according to MCPFE assessment guidelines
Criterion 5: Maintenance and Appropriate Enhancement of Protective Functions in Forest Management (notably soil and water)		
5.1	Protective forests – soil, water and other ecosystem functions	Area of forest and other wooded land designated to prevent soil erosion, to preserve water resources, or to maintain other forest ecosystem functions, part of MCPFE class "Protective Functions"
5.2	Protective forests – infrastructure and managed natural resources	Area of forest and other wooded land designated to protect infrastructure and managed natural resources against natural hazards, part of MCPFE class "Protective Functions"
Criterion 6: Maintenance of other socio-economic functions and conditions		
6.1	Forest holdings	Number of forest holdings, classified by ownership categories and size classes
6.2	Contribution of forest sector to GDP	Contribution of forestry and manufacturing of wood and paper products to gross domestic product
6.3	Net revenue	Net revenue of forest enterprises
6.4	Expenditures for services	Total expenditures for long-term sustainable services from forests
6.5	Forest sector workforce	Number of persons employed and labour input in the forest sector, classified by gender and age group, education and job characteristics
6.6	Occupational safety and health	Frequency of occupational accidents and occupational diseases in forestry
6.7	Wood consumption	Consumption per head of wood and products derived from wood
6.8	Trade in wood	Imports and exports of wood and products derived from wood
6.9	Energy from wood resources	Share of wood energy in total energy consumption, classified by origin of wood
6.10	Accessibility for recreation	area of forest and other wooded land where public has a right of access for recreational purposes and indication of intensity of use
6.11	Cultural and spiritual values	Number of sites within forest and other wooded land designated as having cultural or spiritual values

Appendix B

Questionnaire of the forest owner survey

Survey to analyse the key factors involved in marketing wood

The following questionnaire was developed within the framework of a research project. The data collected will remain anonymous and confidential. The information received will be used for statistical processing and modelling for research purposes.¹ The recipient of these data is the Laboratoire d'Économie Forestière (Forest Economics Laboratory), UMR 356, INRA–AgroParisTech (Engref), 14 rue Girardet, CS 14216, 54042 Nancy, France.

The questionnaire consists of three parts. The first part (A) is related to your property: your forest property, its management, your objectives, your habits, management constraints, management costs, etc. The second part (B) deals with the production and sale of wood on your property. Finally, the third part (C) concerns your involvement in forest development networks and your personal characteristics. Some of the questions in parts A and B can be answered by your forest manager if you do not directly manage your forest. However, we would prefer that you answer the questions yourself whenever possible. In contrast, part C directly concerns you in your capacity of current forest owner.

The following questionnaire concerns (except for part A.1) your forest property located within the limits of the community whose name is given on the upper left side of the attached letter, as well as the neighbouring communities. This forest will hereafter be referred to as the “forest studied”.

If you own land in the area under different titles (e.g., individual owner or owner of shares of a group), the forest studied is your property that is the geographically closest to your place of dwelling.

Part A - Your property

In this document, we define **forest** as a wooded area (not including the garden) of more than 0.5 ha in one continuous block, regardless of whether this area is composed of a single or several stands. Your property is considered to be a forest regardless of its area if it is part of a set of wooded stands with an area greater than 0.5 ha. Temporarily felled plots (plots that have been clearcut, leaving the way for new stand growth) must be considered as forests.

1. Description of your total forest property

(including the forest studied and, if the case may be, your other forests)

1.1. Total area of your forest(s) in France: ha

1.2. Number(s) of the department(s) in which your forest(s) are located:

1.3. Do you plan to expand your forest property?

- Yes, you are looking for plots to expand your property
- Yes, if an opportunity arises, you will take it into consideration
- No

1.4. Do you plan to reduce your forest property?

- Yes
- No

¹The information received will be processed for research purposes, as defined in the introductory letter. The recipients of the data are: **the Laboratoire d'Économie Forestière (Forest Economics Laboratory) and the Centre National de la Propriété Forestière (CNPF) (French Centre for Forest Property)**. In accordance with the French Data Protection Act of 6 January 1978, you have the right of access and of rectification of information that concerns you. If you wish to exercise this right and obtain the information that concerns you, please contact INRA, Laboratoire d'Économie Forestière, 14, rue Girardet, CS 14216, 54042 Nancy, France.

1.5. What is the origin of your forest property? (several answers are possible).

- You purchased the forest plots
- You inherited them or received them by donation
- You exchanged non-forest plots for forest plots
- You planted non-forest plots
- Some of your farm fields were naturally taken over by forests

1.6. In what year did you become a forest owner for the first time?

2. Description of your forest

The following questions only concern the "forest studied" (see definition, page 1).

2.1. Total forest areaha
2.2. Is your property in one continuous block? <input type="radio"/> Yes <input type="radio"/> No, you have several forests or your forest is divided → the number of groups ² of adjacent plots that your forest is divided into. groups
2.3. Number of management units³ on your property (enter 0 if you have not defined a management unit) units
2.4. Area of the forest massif where your forest is located	<input type="radio"/> Less than 25 ha <input type="radio"/> From 25 to 100 ha <input type="radio"/> From 100 to 500 ha <input type="radio"/> More than 500 ha
2.5. How many forest properties border on yours? (properties at less than 50 m from the edge of yours) neighbouring properties <input type="checkbox"/> You don't know
2.6. Travel time between your main place of residence and your forest (if you have several forests, you can tick several boxes)	<input type="radio"/> Less than 1 hour <input type="radio"/> From 1 to 2 hours <input type="radio"/> More than 2 hours
2.7. Number of days per year that you are present on your forest property	<input type="radio"/> Never <input type="radio"/> From 1 to 9 days per year <input type="radio"/> From 10 to 24 days per year <input type="radio"/> From 25 to 49 days per year <input type="radio"/> More than 50 days per year
2.8. Reason for your presence in the forest	<input type="checkbox"/> Forestry work (maintenance, cutting) <input type="checkbox"/> Management, overseeing operations <input type="checkbox"/> Leisure, hiking <input type="checkbox"/> Hunting <input type="checkbox"/> Other:

3. Please specify your management priorities for your forest

(1: main objectives; 2: secondary objectives; leave box empty if the objective has not been considered)

² The groups are geographically separated by:
 - forest plots that do not belong to you;
 - non-forest plots (whether you are the owner or not);
 - a road or a river more than 7 m wide.

³ A management unit is a homogeneous forest area in terms of species and of structure for which you have defined a silvicultural operations plan.

Forestry	Your classification by order of priority	Do you derive an income from these objectives?
Wood production	...	<input type="radio"/> Yes <input type="radio"/> No
Leisure activities, hiking	...	<input type="radio"/> Yes <input type="radio"/> No
Hunting	...	<input type="radio"/> Yes <input type="radio"/> No
Participation in climate change mitigation (carbon storage, production of a renewable material and energy)	...	<input type="radio"/> Yes <input type="radio"/> No
Preservation of biodiversity	...	<input type="radio"/> Yes <input type="radio"/> No
Preservation of water quality	...	<input type="radio"/> Yes <input type="radio"/> No
Risk prevention (erosion, landslides, avalanches)	...	<input type="radio"/> Yes <input type="radio"/> No
Other (specify):	<input type="radio"/> Yes <input type="radio"/> No

4. Services provided by your forest

4.1. Is your forest within a protected area/zoning?

Yes

- Natura 2000 site area concerned: ha
- a natural national park area concerned: ha
- a natural regional park area concerned: ha
- a natural reserve area concerned: ha
- the perimeter of a water collection site area concerned: ha
- other: area concerned: ha

Management constraints linked to these zonings:

- choice of species
- types of treatments
- other:

No

4.2. Is your property enclosed?

Yes, totally

Yes, partially

If yes, why?

- To be able to hunt all year
- To protect your property from wildlife
- To forbid access to your property from intruders
- Other:

No

4.3. Do you have a management document for the forest studied?

- Yes,
 - a simple management plan for ha; since when (year)?
 - model management rules for ha; since when (year)?
 - code of practice for forest management for ha; since when (year)?
- No

4.4. Is the forest studied part of a forest certification?

- Yes,
 - PEFC (Pan-European Forest Certification)
 - FSC (Forest Stewardship Council)
 - Other:
- No

4.5. Do you have a hunting plan for the forest studied? For which species?

- Yes, for the following species:
- No

4.6. Does hunting take place on your property?

- Yes,
 - you hunt on your property or a member of your family does
 - you grant the right to hunt to one of your acquaintances
 - your property is part of the hunting grounds of an ACCA (approved French municipal hunting association)
 - you rent your hunting ground
 - you sell game meat and by-products
- No

4.7. Are leisure activities (hiking, mountain biking, etc.) possible on your property?

- Yes,
 - you or members of your family indulge in leisure activities on the property
 - your forest is frequented by the public
- No

5. Physical constraints related to logging in the forest studied

5.1. Which access roads serve the forest studied?

- Paved road
- Forest road
- Gravel road
- Other forest road
- No road

5.2. What is the average distance that wood must be hauled for the forest studied? (average distance to be covered between the site where the wood is harvested and the site where it can be loaded onto a truck; if you have several forests with different distances, specify the most frequent case)

- Less than 200 m
- From 200 m to 500 m
- From 500 m to 1000 m
- From 1000 m to 2000 m
- More than 2000 m

5.3. Is the landform an obstacle for harvesting wood on your property?

- Yes, on a large part of the property
- Yes, on a small part of the property (less than a third of the area)
- No

6. Wood supply in the forest studied

In the following table, you are asked to describe your forest.

	Broadleaved forest	Coniferous forest	Mixed forest	Poplar stands
Forest area (<i>in ha</i>) ha ha ha ha
Main species
Other species present
Tree size	<input type="checkbox"/> Large trees <input type="checkbox"/> Small trees <input type="checkbox"/> Mixed	<input type="checkbox"/> Large trees <input type="checkbox"/> Small trees <input type="checkbox"/> Mixed	<input type="checkbox"/> Large trees <input type="checkbox"/> Small trees <input type="checkbox"/> Mixed	<input type="checkbox"/> Large trees <input type="checkbox"/> Small trees <input type="checkbox"/> Mixed
Current stumpage volume	V: m ³	V: m ³	V: m ³	V: m ³

Commentaries and additional information (structure: high forest, coppice, coppice with standards, planting, natural regeneration, etc.):

.....

.....

.....

.....

.....

.....

.....

7. How much does the management of your forest property cost?

Current management expenses (management fees, follow-up operations):

..... euros/year

Harvesting costs: euros/m³ of timber

Regeneration costs: euros/ha

Planting costs: euros/ha

Property tax on undeveloped land: euros/ha

Other costs (please specified) euros

Part B - Production and sales

The following questions refer exclusively to the "forest studied".

1. Have you logged wood during the past five years?

- Yes → Go directly to questions B2 and B4 (do not answer questions B3)
- No → Go directly to questions B3 and B4 (do not answer questions B2)

2. History of your logging operations

2.1. Who was responsible for your last logging operation of *timber*?

2.1.1. Felling

- you or a member of your family
- a professional that you hired for the purpose
- the buyer

2.1.2. Skidding and hauling

- you or a member of your family
- a professional that you hired for the purpose
- the buyer

2.2. How did you market most of the wood from your last harvest of timber?

2.2.1. You sold it

- standing
- on the side of the road
- delivered

2.2.2. You sold it

- to professionals
- directly to individuals

2.2.3. You went through an intermediary

- Yes, I went through
 - a forestry expert
 - a forestry cooperative
 - another intermediary (the French Forestry Commission (ONF), etc.)
- No

2.3. Who was responsible for your last logging operation of *firewood*?

- you or a member of your family
- a professional that you hired for the purpose
- the buyer

2.4. History of the last wood harvests for the forest studied

Harvest year	Area concerned by the harvest (ha)	Volume removed at the time of harvest (in m ³ or in cords)				Revenue from the harvest (euros)
		Timber		Firewood		
		Put on the market	Personal use	Put on the market	Personal use	
2009 ha	V: m ³	V: m ³	V: cords	V: cords	€.....
2008 ha	V: m ³	V: m ³	V: cords	V: cords	€.....
2007 ha	V: m ³	V: m ³	V: cords	V: cords	€.....
2006 ha	V: m ³	V: m ³	V: cords	V: cords	€.....
2005 ha	V: m ³	V: m ³	V: cords	V: cords	€.....

Additional information (reasons for the harvest):

3. Marketing intentions

Please answer the following three questions if you have not harvested wood for commercial purposes over the past 5 years

3.1. Why didn't you sell wood over the past five years?

- Your wood was not yet mature.
- You used the wood that you harvested for your own personal use.
- The price of wood was too low.
- You preferred to develop the amenities (hunting, landscape, biodiversity, leisure activities, etc.).
- You didn't have the time.
- You didn't know how to do it; you would have needed technical advice.
- Other (specify):

3.2. What is the lowest price that you would accept to sell your wood for?

(Thank you for answering, even if you are not sure of the price.)

Size of stumpage at 1,30 m	Minimum price for stumpage	Species you would consider (please specify the price)
Firewood	<input type="checkbox"/> €1/m ³
	<input type="checkbox"/> €2/m ³
	<input type="checkbox"/> €5/m ³
	<input type="checkbox"/> €10/m ³
	<input type="checkbox"/> €20/m ³
Timber	<input type="checkbox"/> €50/m ³
	<input type="checkbox"/> €100/m ³
	<input type="checkbox"/> €200/m ³
	<input type="checkbox"/> €300/m ³
	<input type="checkbox"/> €400/m ³

4. Do you intend to sell wood over the next five years?

- Yes
- No, because:
 - Your wood is not yet mature.
 - You will use the wood that you harvest for your own personal use.
 - You are waiting for the price of wood to go up.
 - You prefer to develop the amenities (hunting, landscape, biodiversity, leisure activities, etc.).
 - You don't have the time.
 - You don't know how to do it; you need technical advice.
 - Other (specify):

Part C – The owner

1. Insertion in a forest development network

1.1. Do you belong to a professional forestry organisation or to a joint management group?

- Yes
 - to an association of property owners
 - to a CETEF (French Centre for Technical and Experimental Studies in Forestry)
 - to a forest development group
 - to a forestry cooperative
 - other:
- No

1.2. Do you plan to take actions in conjunction with your neighbouring property owners?

- Yes
 - to carry out forestry operations
 - to protect the environment
 - to preserve an area for leisure activities and hiking
 - to establish a hunting ground
 - other:
- No

1.3. Who manages your forest?

- You directly manage your own forest
- One of the members of your family manages your forest
- You use the services of an independent forestry expert
- You use the services of another person qualified in forest management (a salaried expert, a technician of the ONF (French Forestry Commission) or CRPF (Regional Centres for Forest Owners), etc.)

2. Your family situation

2.1. You are:

- A man
- A woman

2.2. What is your marriage status?

- Married
- Registered civil union (PACS)
- Single
- Divorced
- Widowed
- Other (specify):

2.3. How old are you? years

2.4. How many people live in your house?

2.5. How many children do you have?

3. Your professional situation

3.1. What is your level of education?

- No degree or diploma
- First-cycle educational diploma (BEP-C), middle school diploma (Brevet des colleges), occupational certification (CAP), Certificate of Professional Proficiency (BEP)
- High school diploma
- High school diploma + 2 years higher education (higher technicians licence (BTS), DEUG, etc.)
- High school diploma + 3 or 4 years higher education (licence, Master's degree, Master's 1, etc.)
- High school diploma + 5 or more years higher education (engineer, Master's 2, etc.)

3.2. What is your main activity?

- Forester
- Farmer
- Merchant, tradesman, business manager
- Executive, highly-educated professional (e.g., university professor, doctor, lawyer, engineer, etc.)
- Intermediate occupation (e.g., nurse, senior technician, elementary school teacher, etc.)
- Salaried employee
- Labourer
- Retired (tick the category of your last activity)
- Other (not in the labour force)

3.3. Please indicate the category of the annual income standard of your tax household? (This sum corresponds to revenues that you declare to the tax services; as with the rest of the survey, it will remain anonymous and confidential.)

- Less than €6,000
- From €6,000 to €12,000
- From €12,000 to €18,000
- From €18,000 to €25,000
- From €25,000 to €35,000
- From €35,000 to €50,000
- From €50,000 to €100,000
- More than €100,000

3.4. What is the share of your forestry revenue compared to your total revenue? ... %

4. Your forest and your heirs

4.1. What is your owner status?

- Individual
- Life tenant
- Bare owner
- Undivided co-ownership
- Member of an investment group or family real estate investment company (SCI)
- Landholding corporation
- Other:

4.2. Do you intend to bequeath your forest?

- Yes
- No
- You have not thought about the question.

4.3. How many heirs are already involved in the management of your forest?

4.4. If you were asked to participate in one of the nine games of chance presented in the table below, which one would you choose?

Circle the game of your choice

Example:

If you play Game 3, you have a 50% chance of winning €64 (winnings 1), if not, you win €24 (winnings 2).

	Winnings 1	Winnings 2
<i>Chances of winning</i>	50%	50%
Game 1	€40	€40
Game 2	€51	€32
Game 3	€64	€24
Game 4	€78	€16
Game 5	€86	€12
Game 6	€91.5	€8
Game 7	€92.9	€6
Game 8	€93.4	€4
Game 9	€93.5	€1

Would you accept being contacted for further questioning within the framework of this questionnaire?

- Yes
 No

If yes, please provide your name, address and the other information requested below (they will be kept in the strictest confidence):

First name(s):

Last name(s):

Street address:

Zip code:..... City:

Telephone:

E-mail:@.....

Thank you for having taken the time to fill in this questionnaire. It will allow us to more effectively understand the needs of forest owners and to model the production capacities of goods and services of French forests. The results of this anonymous survey will be available on the Internet site of the Forest Economy Laboratory (Laboratoire d'Économie Forestière) at the end of 2010.

<http://www.nancy.inra.fr/lef>

Contact: E-mail: enquete@nancy-engref.inra.fr

Telephone: +33 (0)3 83 39 68 68

Appendix C

R scripts

C.1 Script calculating the discounted value of services and gathering simulation results

```
1 #--- R-script to load datasets --- N. Robert 2012.08.11
2 DiscountRate <- 0.02
3 DiscountAtt <- DiscountRate-0.01
4 DiscountBio <- DiscountRate-0.01
5 DiscountCarb <- DiscountRate-0.01
6
7
8 testObject <- function(object)
9 {
10   exists(as.character(substitute(object)))
11 }
12
13
14 if(testObject(synthesis)) rm(synthesis)
15
16 # ----- Working directory -----
17 setwd("~/Documents/workspace/capsis4.2.2/tmp/Several-stands")
18
19 # --- Initiating loops to process all simulation results ---
20 fertility=as.data.frame(c("32.5"))
21 dg=as.data.frame(c("90.0", "70.0", "50.0", "30.0")) # "50.0", "30.0",
22 rdiI=as.data.frame(c("0.4", "0.6", "0.8", "1.0"))
23 rdiF=as.data.frame(c("0.4", "0.6", "0.8", "1.0"))
24 nbPlantedTrees = as.data.frame(c("1600")) #, "900", "1100", "1500", "2000"
25 rdiTB = as.data.frame(c("0.05", "0.1", "0.15", "0.2"))
26 Iteration= as.data.frame(c(0:29))
27
28 for (iter in 1:nrow(Iteration)){ # --- this version loads 30 repetitions of
   similar management scenarios
29 for (nbPlantedTreesIndex in 1:nrow(nbPlantedTrees)){
30   for (fertilityIndex in 1:nrow(fertility)){
31     for (dgIndex in 1:nrow(dg)){
32       for (rdiIIndex in 1:nrow(rdiI)){
33         for (rdiFIndex in 1:nrow(rdiF)){
34           for (rdiTBIndex in 1:nrow(rdiTB)){
```

```

35     fileName <- paste("Oak_", as.character(fertility[fertilityIndex,1]),
36       "-", as.character(Iteration[iter,1]), "-",
37       as.character(rdiI[rdiIIndex,1]), "-",
38       as.character(rdiF[rdiFIndex,1]), "-",
39       as.character(rdiTB[rdiTBIndex,1]), "-",
40       as.character(dg[dgIndex,1]), "-",
41       as.character(nbPlantedTrees[nbPlantedTreesIndex,1]), ".csv",
42       sep=" ")
43
44 # ----- Load stand tables -----
45
46 stand <- read.table(as.character(fileName), header=TRUE, sep=" ",
47   na.strings="NA", dec=".", strip.white=TRUE, skip=2)
48 stand$CarbonStorage <- stand[, "StemCarbonStorage"]+stand[, "RootCarbonStorage"]
49
50 DiscountedValue <- 0
51 HarvestedWood <-0
52
53 # --- Natural regeneration or plantation costs ---
54
55 ifelse(as.numeric(as.matrix(nbPlantedTrees[nbPlantedTreesIndex,1])) == 1600,
56   regenerationCosts <- 3000,
57   regenerationCosts <-
58     as.numeric(as.matrix(nbPlantedTrees[nbPlantedTreesIndex,1])) *1.5-3000)
59 DiscountedValue <- -regenerationCosts
60
61 # -----
62
63 # --- Sum of discounted profit ---
64 for (i in 1:(nrow(stand)-1)){
65   ifelse(is.na(stand[i, "HarvestedTimberValueEuros"]), 0, DiscountedValue <-
66     stand[i, "HarvestedTimberValueEuros"]/((1+DiscountRate)^stand[i, "Date"]) +
67     DiscountedValue)
68   ifelse(is.na(as.numeric(as.matrix(stand[i, "ThiV_ha"]))), 0,
69     HarvestedWood <- as.numeric(as.matrix(stand[i, "ThiV_ha"])) + HarvestedWood)
70 }
71
72 # --- NPVIS and management costs ----
73 managementCosts <- 40 # in euros per year
74 DiscountedValue <-
75   DiscountedValue*((1+DiscountRate)^stand[nrow(stand), "Date"]) /
76   ((1+DiscountRate)^stand[nrow(stand), "Date"]-1) -
77   managementCosts*(1+DiscountRate)/DiscountRate
78 HarvestedWood <- HarvestedWood/(stand[nrow(stand), "Date"]-1)
79
80 # -----
81 # --- Integral of the discounted scenic beauty indicator over time ---
82
83 rA <- log(1+DiscountAtt)
84
85 DiscountedAtt <- 0 # a stand without trees is not attractive
86
87 DiscountedAtt <- (stand[1, "RecreationAttractiveness"]-0)/(stand[1, "Date"]) *
88   (1-exp(-rA*stand[1, "Date"])) / rA
89
90

```

C.1. Script calculating the discounted value of services and gathering simulation results 207

```

77 for (i in 1:(nrow(stand)-2)){
78   if(stand[i,"Date"]!=stand[i+1,"Date"]){
79     aA <-
      (stand[i+1,"RecreationAttractiveness"]-stand[i,"RecreationAttractiveness"])
      / (stand[i+1,"Date"]-stand[i,"Date"])
80     DiscountedAtt <-
      aA/rA*(exp(-rA*stand[i,"Date"])-exp(-rA*stand[i+1,"Date"])) +
      DiscountedAtt
81   } else { DiscountedAtt <-(stand[i+1,"RecreationAttractiveness"]
82     -stand[i,"RecreationAttractiveness"])*exp(-rA*stand[i,"Date"]) +
      DiscountedAtt
83   }
84 }
85
86 # --- Discounted value of scenic beauty if the rotation is infinitely repeated
87 # ----
88 DiscountedAtt <- DiscountedAtt * ((1+DiscountAtt)^stand[nrow(stand),"Date"]) /
89 ((1+DiscountAtt)^stand[nrow(stand),"Date"]-1)
90
91 # -----
92 # --- Integral of the discounted bird diversity indicator over time ---
93
94 rB <- log(1+DiscountBio)
95
96 DiscountedBio <- stand[nrow(stand)-1,"BiodivBirds"] # the last status
97 # corresponds to the beginning of a new rotation.
98
99 DiscountedBio <-
100 (stand[1,"BiodivBirds"]-stand[nrow(stand)-1,"BiodivBirds"])/(stand[1,"Date"])
101 * (1-exp(-rB*stand[1,"Date"])) / rB + DiscountedBio
102
103 for (i in 1:(nrow(stand)-2)){
104   if(stand[i,"Date"]!=stand[i+1,"Date"]){
105     aB <- (stand[i+1,"BiodivBirds"]-stand[i,"BiodivBirds"]) /
106     (stand[i+1,"Date"]-stand[i,"Date"])
107     DiscountedBio <-
108     (aB/rB*(exp(-rB*stand[i,"Date"])-exp(-rB*stand[i+1,"Date"]))) +
109     DiscountedBio
110   } else { DiscountedBio <- (stand[i+1,"BiodivBirds"]
111     -stand[i,"BiodivBirds"])*exp(-rB*stand[i,"Date"]) + DiscountedBio
112   }
113 }
114
115 # --- Discounted value of bird diversity if the rotation is infinitely
116 # repeated ----
117 DiscountedBio <- DiscountedBio * ((1+DiscountBio)^stand[nrow(stand),"Date"]) /
118 ((1+DiscountBio)^stand[nrow(stand),"Date"]-1)
119
120 # -----
121 # --- Integral of the discounted carbon storage in trees over time ---
122
123 Carbon <- 0
124
125 rC <- log(1+DiscountCarb)

```

```

117
118 DiscountedCarb <- 0 # The initial carbon storage in trees is null
119 DiscountedCarb <- stand[1, "CarbonStorage"]/stand[1, "Date"]*
      (1-exp(-rC*stand[1, "Date"])) / rC
120
121
122 for (i in 1:(nrow(stand)-2)){
123   if(stand[i, "Date"] != stand[i+1, "Date"]){
124     aC <- (stand[i+1, "CarbonStorage"]-stand[i, "CarbonStorage"]) /
      (stand[i+1, "Date"]-stand[i, "Date"])
125     DiscountedCarb <- (aC/rC*(exp(-rC*stand[i, "Date"])
      -exp(-rC*stand[i+1, "Date"]))) + DiscountedCarb
126   } else { DiscountedCarb <-(stand[i+1, "CarbonStorage"]
      -stand[i, "CarbonStorage"])*exp(-rB*stand[i, "Date"]) + DiscountedCarb
127     }
128   }
129
130
131 # --- Discounted value of carbon storage if the rotation is infinitely
      repeated ----
132 DiscountedCarb <- DiscountedCarb*((1+ DiscountCarb)^stand[nrow(stand), "Date"])
      / ((1+ DiscountCarb)^stand[nrow(stand), "Date"]-1)
133
134 # -----
135
136 temp <- cbind(fertility[fertilityIndex,1], rdiI[rdiIIndex,1],
      rdiF[rdiFIndex,1], dg[dgIndex,1], rdiTB[rdiTBIndex,1],
      nbPlantedTrees[nbPlantedTreesIndex,1], stand[nrow(stand),
      c(1, 28, 29, 30, 31, 32, 35)], DiscountedValue, HarvestedWood,
      DiscountedAtt, DiscountedBio, DiscountedCarb)
137
138 ifelse(testObject(synthesis), synthesis <- rbind(synthesis, temp), synthesis
      <- temp)
139
140   }
141 }
142 }
143 }
144 }
145 }
146
147 }
148 colnames(synthesis) <- c("Fertility", "rdiI", "rdiF", "dg", "rdiTB",
      "nbPlantedTrees", "RotationDuration", "WoodValueEuros",
      "BiodivCavityNesters", "BiodivMigrantBirds",
      "RecreationAttractiveness", "BirdBiodiv", "CarbonStorage", "NPVIS",
      "WoodVolume", "DiscountedAtt", "DiscountedBio", "DiscountedCarbonStorage")
149
150 synthesis$NetWoodValueEuros <- synthesis$WoodValueEuros
      -regenerationCosts/synthesis$RotationDuration -managementCosts
151
152 write.csv(synthesis, file = "Results_DiscountR_NPV_2_1_1_1-test.csv")

```

C.2 Script to determine and display the envelope of the PPS

```

1  #--- R-script to trace the envelope of a PPS --- N. Robert 2012.08.11
2
3  #--- Function to compute the upper envelope and to represent it ---
4  graphique3D <- function (Donnees, labels, minX, maxX, minY, maxY, nSteps)
5  {
6  Graph <- Donnees[, labels]
7  XY <- as.data.frame(expand.grid(list(X=seq(minX, maxX, length.out=nSteps+1),
8    Y=seq(minY, maxY, length.out=nSteps+1))))
9  colnames(XY) <- labels[2:3]
10 XY$Z <- NA
11 Grid <- tapply(XY[,3], XY[,c(1,2)], c)
12
13 for (i in 1:nrow(Grid)){
14   for (j in 1:ncol(Grid)){
15     if(((length(Graph[((Graph[2]>=as.numeric(rownames(Grid))[i]) &
16       (Graph[3]>=as.numeric(colnames(Grid))[j])],[,1])>0) &
17       (length(Graph[((Graph[2]<=as.numeric(rownames(Grid))[i]) &
18         (Graph[3]<=as.numeric(colnames(Grid))[j])],[,1])>0) &
19       (length(Graph[((Graph[2]<=as.numeric(rownames(Grid))[i]) &
20         (Graph[3]>=as.numeric(colnames(Grid))[j])],[,1])>0) &
21       (length(Graph[((Graph[2]>=as.numeric(rownames(Grid))[i]) &
22         (Graph[3]<=as.numeric(colnames(Grid))[j])],[,1])>0))
23     {
24       Grid[i,j] <- min(
25         max(Graph[((Graph[2]<=as.numeric(rownames(Grid))[i]) &
26           (Graph[3]>=as.numeric(colnames(Grid))[j])],[,1]),
27         max(Graph[((Graph[2]>=as.numeric(rownames(Grid))[i]) &
28           (Graph[3]<=as.numeric(colnames(Grid))[j])],[,1]),
29
30         max(Graph[((Graph[2]<=as.numeric(rownames(Grid))[i]) &
31           (Graph[3]<=as.numeric(colnames(Grid))[j])],[,1]),
32         max(Graph[((Graph[2]>=as.numeric(rownames(Grid))[i]) &
33           (Graph[3]>=as.numeric(colnames(Grid))[j])],[,1]), na.rm=F)
34     }
35   }
36 }
37 image(x=unique(XY[,1]), y=unique(XY[,2]), z=as.matrix(Grid), xlab=labels[2],
38   ylab=labels[3], col=gray((300:100)/320))
39 contour(x=unique(XY[,1]), y=unique(XY[,2]), z=as.matrix(Grid), add=TRUE,
40   nlevels=15)
41 return(list(XY[,1],XY[,2],Grid))
42 }
43
44 #--- Function to draw a previously calculated envelope with various parameters
45 ---
46
47 replot <- function(Daten){
48   par(cex=2)
49   image.plot(x=unique(Daten[[1]]), y=unique(Daten[[2]]),
50     z=as.matrix(Daten[[3]]), xlab=names(dimnames(Daten[[3]])[1]),
51     ylab=names(dimnames(Daten[[3]])[2]), col=topo.colors(300))

```

```

37   contour(x=unique(Daten[[1]]), y=unique(Daten[[2]]), z=as.matrix(Daten[[3]]),
38           add=TRUE, nlevels=15, labcex=2, method="flattest", vfont=c("sans serif",
39                               "bold"), col="white")
40   }
41   setwd("~/Documents/workspace/capsis4.2.2/tmp/Sim3") # --- working directory
42   synthesis <- read.csv("Results_DiscountR_NPV_2_1_1_1.csv") # --- dataset
43   prepared with data-gathering procedure
44   synthesis <- (synthesis[,-c(1)])
45   # --- show the range of the different outputs
46   maxSynthesis <- rbind(synthesis[which.max(synthesis$NetWoodValueEuros),]
47                        [,c(4,2,3,5,36,12,11,13,14,17,16,18)],
48                        synthesis[which.max(synthesis$CarbonStorage),]
49                        [,c(4,2,3,5,36,12,11,13,14,17,16,18)],
50                        synthesis[which.max(synthesis$RecreationAttractiveness),]
51                        [,c(4,2,3,5,36,12,11,13,14,17,16,18)],
52                        synthesis[which.max(synthesis$BirdBiodiv),]
53                        [,c(4,2,3,5,36,12,11,13,14,17,16,18)],
54                        synthesis[which.max(synthesis$NPVIS),] [,c(4,2,3,5,36,12,11,13,14,17,16,18)],
55                        synthesis[which.max(synthesis$DiscountedCarbonStorage),]
56                        [,c(4,2,3,5,36,12,11,13,14,17,16,18)],
57                        synthesis[which.max(synthesis$DiscountedAtt),]
58                        [,c(4,2,3,5,36,12,11,13,14,17,16,18)],
59                        synthesis[which.max(synthesis$DiscountedBio),]
60                        [,c(4,2,3,5,36,12,11,13,14,17,16,18)])
61   maxSynthesis
62   # Load the library required to draw the iso-profit curves
63   library(fields)
64   # Parameters for the representation, to be adjusted depending on the needs.
65   # The "maxSynthesis" table gives guidelines for the values.
66   # Manual setting is needed for meaningful representations.
67   nbSteps <- 100
68   #
69   MinP <- 0 # -- min Net wood value=average Profit
70   MaxP <- 2000 # -- max Net wood value=average Profit
71   MinC <- 0 # -- min average carbon storage in trees
72   MaxC <- 250 # -- max average carbon storage in trees
73   MinA <- 0 # -- min average attractiveness
74   MaxA <- 0.6 # -- max average attractiveness
75   MinBio <- 12 # -- min average bird diversity
76   MaxBio <- 17 # -- max average bird diversity
77   MinNPV <- -2500 # -- min net present value
78   MaxNPV <- 12500 # -- max net present value
79   MinCPV <- 0 # -- min carbon storage in trees present value
80   MaxCPV <- 160 # -- max carbon storage in trees present value
81   MinAPV <- 0 # -- min attractiveness present value
82   MaxAPV <- .4 # -- max attractiveness present value
83   MinBioPV <- 15 # -- min bird diversity present value

```



```

83 MaxBioPV <- 28 # -- max bird diversity present value
84
85
86 # --- representation of the maximum profit possibilities depending on the
      provision of other services.
87 GraphP_CxA <- graphique3D(synthesis, c("NetWoodValueEuros", "CarbonStorage",
      "RecreationAttractiveness"), MinC, MaxC, MinA, MaxA, nbSteps)
88 GraphP_CxBio <- graphique3D(synthesis, c("NetWoodValueEuros", "CarbonStorage",
      "BirdBiodiv"), MinC, MaxC, MinBio, MaxBio, nbSteps)
89 GraphP_AxBio <- graphique3D(synthesis, c("NetWoodValueEuros",
      "RecreationAttractiveness", "BirdBiodiv"), MinA, MaxA, MinBio, MaxBio,
      nbSteps)
90 GraphC_AxBio <- graphique3D(synthesis, c("CarbonStorage",
      "RecreationAttractiveness", "BirdBiodiv"), MinB, MaxB, MinBio, MaxBio,
      nbSteps)
91
92 GraphNPV_CPVxAPV <- graphique3D(synthesis, c("NPVIS",
      "DiscountedCarbonStorage", "DiscountedAtt"), MinCPV, MaxCPV, MinAPV,
      MaxAPV, nbSteps)
93 GraphNPV_CPVxBioPV <- graphique3D(synthesis, c("NPVIS",
      "DiscountedCarbonStorage", "DiscountedBio"), MinCPV, MaxCPV, MinBioPV,
      MaxBioPV, nbSteps)
94 GraphNPV_APVxBioPV <- graphique3D(synthesis, c("NPVIS", "DiscountedAtt",
      "DiscountedBio"), MinAPV, MaxAPV, MinBioPV, MaxBioPV, nbSteps)
95 GraphCPV_APVxBioPV <- graphique3D(synthesis, c("DiscountedCarbonStorage",
      "DiscountedAtt", "DiscountedBio"), MinAPV, MaxAPV, MinBioPV, MaxBioPV,
      nbSteps)
96
97
98 # --- Redraw a previously calculated envelope (example) ---
99 replot(GraphNPV_CPVxAPV)

```

Glossary

A

amenity an amenity is any attribute of a geographic location for which a resident or potential migrant would be willing to pay, either through higher housing costs, lower wages, or other location-specific costs, but for which there is no market through which the individual can directly purchase a given amount of that good. Specifically, as used in the economics literature, amenities are those public goods that can only be enjoyed by being present in a particular location. Thus, various aspects of environmental quality, including scenic, air, and water quality; access to public recreational and cultural resources; and absence of disamenities, such as crime, congestion, and noise, all fall under the heading of amenity resources., p. 33.

D

decision making unit Smallest scale at which management decision are taken, e.g. a production unit, a forest stand., p. 82.

dominant diameter Average diameter of the 100 largest diameter trees per hectare., p. 124.

dominant height Average height of the 100 largest diameter trees per hectare., p. 124.

E

ecosystem A unit of living organisms (plants, animals and microorganisms), all interacting among themselves and with the environment (soil, climate, water and light) in which they live., p. 23.

H

household producer Producers that have the ability to process inputs to produce outputs to satisfy their own needs., p. 27.

O

opportunity cost 1. The cost of an alternative that must be forgone in order to pursue a certain action. Put another way, the benefits you could have received by taking an alternative action. 2. The difference in return between a chosen investment and one that is necessarily passed up., p. 45.

output The amount of energy, work, goods, or services produced by a machine, factory, company, or an individual in a period., p. 21.

P

production possibility frontier The collection of all combinations of the *maximum* amounts of goods and services that can be produced with available resources and technology., p. 26.

production possibility set The collection of all combinations of the amounts of goods and services that can be produced with available resources and technology., p. 26.

U

utility Pleasure or satisfaction (value for money) derived by a person from the consumption of a good or service or from being in a particular place, and for the maximization of which all economic actions are motivated., p. 26.

W

weak disposability Characteristic of an input (output) which consumption (production) cannot be reduced without reducing the quantity of outputs., p. 48.

Sustaining the supply of multiple ecosystem services – An analysis based on the simulation of the joint production of wood and non-wood goods in forests.

Ecosystems provide numerous goods and services to human beings. However, the intensive use of natural resources has impacted the functioning of ecosystems and reduced their production capacities. In this context, societies and individuals are giving increasing importance to environmental services (ES). To capture the values of ESs and to ensure their sustainable provision, payment mechanisms to offset the reduction in ES provision have been elaborated. These include projects such as REDD+, the European carbon market or national rules concerning compensation for biodiversity losses. Due to the jointness in ES production, single purpose offset mechanisms can either threaten or create opportunities to increase other services which do not have an explicit monetary value. To be effective, managers and decision makers need detailed information on the links between ESs. To increase the knowledge of the simultaneous production of multiple ESs, this thesis proposes a methodology based on simulations of the joint production of wood and non-wood goods in forests. Estimations of opportunity costs derived from the analysis provide information on ES gains and losses when forest owners are asked to increase one service.

Offre de multiples services écosystémiques – Analyse à l'aide de simulations de la production jointe de bois et de non-bois en forêt.

Les écosystèmes produisent de nombreux biens et services contribuant au bien-être des sociétés. Cependant, l'utilisation intensive des ressources naturelles a compromis le fonctionnement de certains de ces écosystèmes ainsi que les services qu'ils rendent. La dégradation de certains services tels que le climat et la biodiversité a entraîné une prise de conscience de leur rôle dans le fonctionnement des sociétés ainsi qu'une croissance de la valeur qui leur est accordée. Pour contrecarrer la dégradation des services rendus par les écosystèmes, des mécanismes de rémunération de leur production ont été mis en place tels que le marché européen du carbone ou les obligations de compensation lorsque des ouvrages ou infrastructures dégradent la biodiversité. Toutefois, lorsque les mécanismes mis en œuvre ne concernent qu'un seul service, ils peuvent avoir des effets, positifs ou négatifs, sur la fourniture d'autres services produits conjointement. Afin d'éviter les effets indésirables, tels que la destruction d'un service pour en produire un autre, ou des inefficacités comme le double-paiement d'une même activité, il est nécessaire de mieux connaître les relations entre les productions des écosystèmes. Par cette thèse, nous contribuons à l'identification de ces relations entre produits et services en développant une approche par la simulation de la production jointe de bois et de non-bois en forêt.