



HAL
open science

Étude de la dispersion atmosphérique du pollen de maïs : contribution à la maîtrise des risques de pollinisation croisée

Nathalie Jarosz

► **To cite this version:**

Nathalie Jarosz. Étude de la dispersion atmosphérique du pollen de maïs : contribution à la maîtrise des risques de pollinisation croisée. Biologie végétale. INAPG (AgroParisTech), 2003. Français. NNT : 2003INAP0031 . tel-00007521

HAL Id: tel-00007521

<https://pastel.hal.science/tel-00007521v1>

Submitted on 1 Dec 2004

HAL is a multi-disciplinary open access archive for the deposit and dissemination of scientific research documents, whether they are published or not. The documents may come from teaching and research institutions in France or abroad, or from public or private research centers.

L'archive ouverte pluridisciplinaire **HAL**, est destinée au dépôt et à la diffusion de documents scientifiques de niveau recherche, publiés ou non, émanant des établissements d'enseignement et de recherche français ou étrangers, des laboratoires publics ou privés.



Institut National de la Recherche Agronomique
Institut National Agronomique Paris-Grignon
UNITE MIXTE DE RECHERCHE INRA- INA-PG
ENVIRONNEMENT ET GRANDES CULTURES



Fédération Nationale des Professionnels de
Semences de Maïs et de Sorgho
Groupement National des Interprofessionnels des
Semences

THESE

présentée en vue de l'obtention du

DOCTORAT de l'Institut National Agronomique Paris-Grignon

Ecole Doctorale ABIES

par

Nathalie JAROSZ

Etude de la dispersion atmosphérique du pollen de maïs
Contribution à la maîtrise des risques de pollinisation croisée

Soutenue le 19 décembre 2003 devant le jury composé de :

Thierry Doré	Professeur, INA-PG	Président
Gilles Bergametti	Directeur de recherche CNRS, Créteil	Rapporteur
Yves Brunet	Directeur de recherche INRA, Bordeaux	Rapporteur
Joël Cuguen	Professeur, Lille 1	Rapporteur
Alastair McCartney	Principal Scientist, Rothamsted Research, UK	Examineur
Xavier Foueillassar	Ingénieur, Arvalis – Institut du Végétal, Pau	Examineur
Laurent Huber	Directeur de recherche INRA, Grignon	Directeur de thèse
Benjamin Loubet	Chargé de recherche INRA, Grignon	Encadrant

Remerciements

Le travail de ce mémoire a été réalisé au sein de l'unité mixte de recherche Environnement et Grandes Cultures de l'INRA de Grignon dans l'équipe Biosphère-Atmosphère en partenariat avec Arvalis, institut du végétal ainsi que cofinancée par le GNIS et la FNPSMS.

Je suis très reconnaissante envers Laurent Huber et Benjamin Loubet qui m'ont fait confiance il y a de cela déjà trois ans en me choisissant pour effectuer ce travail. Je les remercie vivement d'avoir encadré cette thèse et d'avoir mis à ma disposition les moyens nécessaires à son aboutissement. J'exprime toute ma gratitude à Benjamin Loubet pour son suivi tout au long de cette étude. Merci à Pierre Cellier d'avoir accepté d'être mon directeur de thèse intérimaire.

J'adresse mes remerciements à Thierry Doré pour m'avoir fait l'honneur et le plaisir de présider mon jury. J'ai apprécié les commentaires des rapporteurs Yves Brunet, Joël Cuguen et Gilles Bergametti sur le mémoire de thèse. Je remercie également Alastair McCartney d'avoir accepté de participer au jury de thèse.

J'associe à mes remerciements Brigitte Durand qui a apporté tout son savoir-faire et sa bonne humeur dans la préparation et la réalisation des expérimentations de terrain et surtout pour les comptages de grains de pollen!

Ma reconnaissance va encore à Xavier Foueillassar qui a été mon interlocuteur privilégié avec Arvalis ainsi que Régis Boisseau pour leurs remarques « professionnelles ».

Je remercie Etienne Klein pour ses participations actives aux comités de pilotage.

Merci également à Claudine Lauransot et Marina Pavlidès qui m'ont aidée dans mes recherches bibliographiques.

Merci à tous mes collègues de Grignon pour leur sympathie, en particulier, merci à tous ceux qui m'ont apporté leur soutien à la fois scientifique et psychologique. Merci à mes amis qui m'ont encouragée.

Enfin et avant tout, un très grand merci à ma famille qui m'a toujours soutenue malgré mes choix non conventionnels. Un merci chaleureux à la dernière-née, Chloé, qui ne se doute pas encore à quel point elle m'a supportée...

Liste des figures	5
Liste des tableaux	9
Introduction	11
Chapitre I Le pollen de maïs et sa dissémination dans l'atmosphère	15
I.1 Les acteurs de la pollinisation anémophile	15
I.1.1 La plante de maïs	15
I.1.2 Caractéristiques biophysiques du grain de pollen	16
I.1.2.1 Teneur en eau	17
I.1.2.2 Vitesse de sédimentation	19
I.1.2.3 Viabilité	21
I.1.3 Les soies	23
I.2 Le transfert de pollen dans l'atmosphère	24
I.2.1 Mécanismes	24
I.2.1.1 Libération	24
I.2.1.2 Transport	26
I.2.1.3 Dépôt	27
I.2.2 Méthodes de mesure	30
I.2.2.1 Estimation de la production de pollen	30
I.2.2.2 Mesure de la concentration de pollen dans l'air	31
I.2.2.3 Mesure du dépôt de pollen	34
I.3 Modèles de dispersion atmosphérique de particules biotiques	34
I.3.1 Modèles empiriques	35
I.3.2 Modèles physiques	35
I.3.2.1 Modèle de type gaussien	36
I.3.2.2 Modèle de type gradient-diffusion	37
I.3.2.3 Modèle lagrangien	38
Chapitre II Mesures de la concentration atmosphérique et des flux de pollen de maïs	40
II.1 Field measurements of airborne concentration and deposition of maize pollen	40
II.1.1 Introduction	40
II.1.2 Material and Methods	41
II.1.2.1 Experimental site	41
II.1.2.2 Micrometeorological measurements	42
II.1.2.3 Pollen Measurements	43
II.1.2.3.1 Pollen concentration in the source plot.	43
II.1.2.3.2 Pollen production.	44
II.1.2.3.3 Pollen concentration downwind of the source plot.	44
II.1.2.3.4 Pollen deposition to the ground	45
II.1.3 Results	47
II.1.3.1 Micrometeorological measurements	47
II.1.3.2 Pollen production	47
II.1.3.3 Pollen concentration in the source plot	48
II.1.3.4 Vertical profiles of pollen concentration	50
II.1.3.5 Wind speed and horizontal flux of pollen	50
II.1.3.6 Pollen deposition	52
II.1.4 Discussion	52
II.1.4.1 Dynamics of pollen emission	52
II.1.4.2 Airborne pollen concentrations	54
II.1.4.3 Validity of the integrated deposition and mass balance approaches	55
II.1.4.4 Deposition and horizontal fluxes of pollen	58
II.1.4.5 Deposition velocities	58
II.1.5 Concluding remarks	59

II.2 Variabilité de la vitesse de sédimentation des grains de pollen de maïs	60
II.2.1 Introduction	60
II.2.2 Matériel et méthodes	61
II.2.2.1 Teneur en eau du pollen	61
II.2.2.2 Mesure de la vitesse de sédimentation	61
II.2.2.3 Diamètre et densité des grains de pollen	63
II.2.3 Résultats	64
II.2.3.1 Caractéristiques du grain de pollen	64
II.2.3.2 Distribution de V_s	64
II.2.3.3 Vitesse de sédimentation et teneur en eau	65
II.2.4 Discussion-Conclusion	67
 Chapitre III Modelling airborne concentration and deposition rate of maize pollen	 69
III.1 Introduction	69
III.2 Material and Methods	70
III.2.1 Model	70
III.2.1.1 Turbulence field	71
III.2.1.2 Model parameters and input variables	72
III.2.1.3 Concentration and deposition	74
III.2.2 Experimental data	74
III.2.2.1 Micrometeorological measurements	75
III.2.2.2 Concentration measurements	76
III.2.2.3 Deposition measurements	77
III.2.2.4 Canopy structure measurements	77
III.2.3 Model validation	77
III.2.3.1 General setting	77
III.2.3.2 Turbulence	77
III.2.3.3 Canopy structure	78
III.2.3.4 Numerical settings and validation strategy	79
III.3 Results	80
III.3.1 Montargis experiment	80
III.3.1.1 Airborne concentration	81
III.3.1.2 Deposition rates	81
III.3.2 Grignon experiment	82
III.3.2.1 Airborne concentration	83
III.3.2.2 Deposition rates	85
III.4 Discussion	85
III.4.1 Discrepancy between measured and modelled deposition rates near the source	85
III.4.1.1 Deposition measurements	86
III.4.1.2 Concentration measurements	86
III.4.1.3 Settling velocity	86
III.4.1.4 Pollen resuspension	88
III.4.1.5 Turbulence	89
III.4.1.6 Effect of the β parameter	90
III.4.2 Cumulated pollen deposition with distance	90
III.4.3 Effect of microclimate on pollen short-range deposition	91
III.5 Conclusion	92
 Chapitre IV Estimating variations in maize pollen emission and deposition	 94
IV.1 Introduction	94
IV.2 Material and Methods	95
IV.2.1 Experimental site	95
IV.2.2 Micrometeorological measurements	96

IV.2.3 Measurements of pollen concentration and deposition rate _____	97
IV.3 Results _____	98
IV.3.1 Micrometeorological conditions _____	98
IV.3.2 Pollen production _____	101
IV.3.3 Pollen concentration and deposition rates within the source plot _____	102
IV.3.4 Pollen concentration and deposition rates downwind of the source plot _____	106
IV.4 Discussion _____	109
IV.4.1 Comparison of pollen release rate and production _____	109
IV.4.2 Variability in pollen production among situations _____	110
IV.4.3 Influence of environmental factors on the daily dynamics of pollen release _____	111
IV.4.4 Intermediate-distance dispersal _____	111
IV.4.5 Long-distance dispersal _____	112
IV.4.6 Influence of roughness change on deposition rates _____	114
IV.5 Conclusions _____	114
<i>Conclusion et perspectives _____</i>	<i>116</i>
<i>Références bibliographiques _____</i>	<i>120</i>

LISTE DES FIGURES

- Figure 0-1.** Architecture de la téosinte mexicaine et du maïs. La téosinte et le maïs sont dotés d'une inflorescence principale. La téosinte est également composée de plusieurs branches latérales, avec inflorescences primaire (mâle) et secondaire (femelle). Le maïs typique a des branches latérales courtes à inflorescence primaire (et parfois secondaire) femelle. Adapté de Freeling & Walbot (1994). _____ 11
- Figure I-1.** Structure du grain de pollen entouré de deux parois, la paroi interne, ou intine, et la paroi externe, ou exine. Le pollen a un unique pore par lequel le tube pollinique va émerger et se développer (Gay, 1979). _____ 16
- Figure I-2.** Pollen de maïs hydraté (figure de gauche) et partiellement déshydraté (figure de droite). Un changement de couleur (de crème à ambré) et de forme (de sphéroïdale à prismatique) se produit alors que le pollen se déshydrate. L'échelle est à 100µm (Aylor, 2003). _____ 17
- Figure I-3.** Evolution de la teneur en eau relative θ (masse d'eau / masse sèche du grain) des grains de pollen exposés à l'air à une température de 23,5°C en fonction du temps et pour 4 humidités relatives de l'air (RH en%). Tiré de Aylor (2003). _____ 18
- Figure I-4.** Potentiel hydrique des feuilles (leaf), des soies (silks), et du pollen en fonction de l'heure de la journée, mesuré au champ pendant la floraison (Westgate & Boyer, 1986b). _____ 18
- Figure I-5.** Vitesse de sédimentation (V_s) pour 3 variétés de maïs en fonction de son diamètre du volume équivalent (D_e). Le courbe en trait continu fin est calculée avec la loi de Stokes (équation I-4) et la courbe en trait discontinu est calculée avec l'équation I-5 ($\rho_p = 1.2 \text{ g cm}^{-3}$). Tiré de Aylor (2002). _____ 21
- Figure I-6.** Mesures de la germination in vitro (A) ainsi que de la formation de grains (seed set) dans l'épi (B) en fonction de la teneur en eau des grains de pollen (Roeckel-Drevet et al., 1995). ($\square, \blacksquare, \circ$) représentent trois populations de pollen récolté sur des parcelles différentes et trois jours différents. Pour chacune de ces populations, chaque point représente la moyenne et, les barres verticales, l'écart-type de trois répétitions. _____ 22
- Figure I-7.** Emergence des soies d'un épi de maïs. Encart: zoom sur une soie où on peut voir que de nombreux grains de pollen sont collés alors qu'uniquement l'un d'entre eux participera à la fécondation (Aylor et al., 2003) _____ 23
- Figure I-8.** Mécanismes de transfert de pollen dans l'atmosphère: libération des panicules, transport dans l'atmosphère et dépôt sur la végétation ou le sol. Des phénomènes de resuspension postérieurs au dépôt de pollen peuvent également se produire. _____ 24
- Figure I-9.** Photo de gauche: axe principal de 2 panicules, celle de gauche est à l'anthèse (notez la sortie des anthères au bout de leur filet). Photo de droite (tirée de (Aylor et al., 2003)): libération du pollen des anthères. Encart: zoom sur l'extrémité d'une anthère montrant les grains de pollen _____ 25
- Figure I-10.** Evolution de la concentration moyenne en pollen de maïs en fonction de la distance à la source, exprimée en pourcentage de la concentration mesurée à 1 m de la source, mesurée par Raynor et al. (1972a) en 1963 et 1964, par Jones & Brooks (1950), Jones & Newell (1946) et Haskell & Dow (1951). Tiré de Raynor et al. (1972a). _____ 27
- Figure I-11.** Evolution du dépôt normalisé par le dépôt à 1 m en fonction de la distance à la source pour le pollen de maïs (CORN) de 90 µm de diamètre, le pollen de la fléole des prés (TIM) de 34 µm et le pollen de l'ambrosie (RAG) de 20 µm. Tiré de Raynor et al. (1972a). _____ 29
- Figure I-12.** Sac en film plastique OSMOLUX transparent et poreux entourant une panicule et fixée à la base à l'aide d'un lien afin de récolter le pollen produit. _____ 30
- Figure I-13.** Le principe Coulter. Les grains de pollen en suspension dans le bûcher rempli d'un électrolyte vont passer par un orifice et modifier le courant entre les deux électrodes. _____ 31
- Figure I-14.** (a) Vue d'ensemble du Burkard. (b) Tambour permettant une mesure sur 7 jours. Tiré de British Aerobiology Federation (1995) _____ 32
- Figure I-15.** Préparation de la bande du Burkard pour un comptage au microscope. (a) Décollage de la bande du tambour. (b) Transfert de la bande sur la règle de découpage en plaçant le début de la bande (marquée par les lycopodes) à gauche sur l'heure de début, G, à l'aide de la graduation (c). Les 7 bandes sont découpées suivant les rainures de la règle (correspond à minuit) et placées à l'aide d'une pince (d) sur une lame de microscope (e). La bande est recouverte de Gelvatol et d'une lamelle pour fixer les grains de pollen. Tiré de British Aerobiology Federation (1995) _____ 32

- Figure I-16.** Rotorod en rotation sur son axe et alimenté par un moteur 12V. _____ 34
- Figure I-17.** Dispersion de spores en aval d'une source ponctuelle située à une hauteur H . L'axe x représente la direction du vent moyen et l'axe z , la direction verticale. Les distributions gaussiennes de la concentration en spores C dans les directions verticale (a – a) et latérale (b – b). Les écarts types σ_z et σ_y sont également illustrés. D'après McCartney & Fitt (1985). _____ 36
- Figure I-18.** Schéma d'un panache de spores libérées d'une source située à l'intérieur d'un champ. Les spores sortant du couvert végétal résultent du flux vertical de spores à travers un plan en haut du couvert entre les distances avales x_h et x_l . F_x et F_z sont les flux horizontal et vertical de spores et F_g le flux vers le sol. D'après (Aylor, 1990). _____ 38
- Figure II-1.** Experimental design. (■) Sonic anemometers, (◆) the meteorological mast and Burkard trap, (▲) the mass balance masts, and (●) the deposition plates. The mass balance masts, and deposition plates were moved so that they were downwind of the source plot. Prevailing direction of wind was generally from 225°. 41
- Figure II-2.** Two-hourly moving average airborne pollen concentration above the source plot, as measured with the Burkard trap (continuous line), compared with the estimated daily pollen production (dotted line). _____ 48
- Figure II-3.** (a) Pollen concentration and SWI measured in the source plot between 29 July and 3 August 2000. (b) Average daily pattern of pollen concentration measured above the source plot. The concentrations were normalised with the maximum concentration of the day before taking the average. The bold line represents the mean for 5 days (29, 30, 31 July; 1 and 2 August), and error bars represent the standard deviation over these days. The dotted line shows the emission pattern measured on the 3 August. _____ 49
- Figure II-4.** Vertical profiles of pollen concentration measured downwind of the source plot using rotating-arm spore traps at $x = 3$ m (dotted line) and $x = 10$ m (solid line) for runs R6 (a), R7 (b) and R8 (c). Error bars were estimated as the mean standard error over the two rods of each rotating-arm. _____ 50
- Figure II-5.** Vertical profiles of wind speed normalised by the wind speed at the greatest height (4 m) and averaged over all runs at $x = 3$ m (black line) and $x = 10$ m (grey line). The log profile (dotted line) with $z_0 = 0.07$ m in neutral condition ($u_* = 0.2$ m s⁻¹ and $L = -\infty$) is also drawn. Open circles represent values of the 12 runs 3 m downwind of the source plot and cross symbols represent values of the 12 runs 10 m downwind. Error bars show the standard deviation over the different runs. _____ 51
- Figure II-6.** Vertical profiles of horizontal flux of pollen F_x at $x = 3$ m (dotted line) and $x = 10$ m (solid line) for runs R6 (a), R7 (b) and R8 (c). Error bars were estimated as the sum of the relative errors on wind-speed and concentration. _____ 51
- Figure II-7.** Measured deposition rate divided by the measured deposition rate at $x = 1$ m, as a function of downwind distance from the source for runs R1-R2 and R4-R12. The mean deposition rate is shown as a bold line with filled circles. _____ 52
- Figure II-8.** Median normalised concentration profile, estimated over runs R1-R2, R4-R12 at $x = 3$ and $x = 10$ m. The error bars show the standard deviation over the different runs. The profiles were normalised by dividing by the maximum concentration measured at the 3 m mast for each run, and subsequently averaged by taking the median over all runs. _____ 55
- Figure II-9.** Pollen deposition between $x = 3$ and $x = 10$ m, estimated with the mass balance technique compared to the measured deposition rates. Open symbols show runs R3, R9, R10 and R12, where the wind direction relative to the masts was larger than 30%. A linear regression gives $y = 0.98x - 16$ ($R^2 = 0.8$). _____ 56
- Figure II-10.** Schéma du principe de mesure de la vitesse de sédimentation. _____ 62
- Figure II-11.** Illustration de la méthode d'analyse d'image. L'image de gauche représente la photographie brute de pollen de maïs en chute. L'image de droite représente le résultat obtenu après application d'un filtre gaussien, d'un filtre mettant en exergue les structures verticales de l'image et enfin d'un seuil binaire. _____ 63
- Figure II-12.** Distributions de V_s pour (a) un hybride (Adonis bleu) et une lignée (N69) et différentes teneurs en eau du grain. Les vitesses les plus faibles correspondent à des teneurs en eau de 14-22% et les plus élevées à des teneurs en eau de 58-62%. _____ 65
- Figure II-13.** (a) Vitesse de sédimentation moyenne, V_s et écart-type en fonction de la teneur en eau pour l'ensemble des séries. (b) Vitesse de sédimentation en fonction de la teneur en eau pour chaque variété. _____ 66
- Figure II-14.** Densité des grains de pollen à teneur en eau supérieure à 40% (cercles pleins; la courbe est la fonction $y = 10120 x^{-2}$) et inférieures à 40% (triangles vides; la courbe est la fonction $y = 2245 x^{-2}$) en fonction du diamètre d_p pour l'ensemble des séries. _____ 67

- Figure II-15.** Masse des grains de pollen à teneur en eau supérieure à 40% (cercles pleins) et inférieure à 40% (triangles vides) en fonction du diamètre d_p pour l'ensemble des séries. _____ 67
- Figure III-1.** Exemples of trajectories for 100 maize pollen grains released from a 20 m field (along wind) surrounded by a bare soil. The tassels extend from 2.2 to 2.5 m height and the LAI of the canopy is 4. _____ 71
- Figure III-2.** Wind speed profiles illustrating the parameterisation of the turbulent exchanges in the transition zone between two adjacent canopies. Interpolation is made between equilibrium profiles in contiguous fields. Here x_{ci} is the downwind fetch of the field i and x_{upwind} and $x_{downwind}$ are the upwind and downwind distance influenced by the roughness change. _____ 72
- Figure III-3.** Profile of leaf area densities (LAD) used in the model for Grignon and Montargis. The corresponding LAI was roughly 4. The projection of LAD (bold line) along the horizontal LAD^x (grey continuous line) and the vertical planes LAD^z (black dotted line) are also represented. They were estimated by projection of a reconstructed canopy following Drouet et al. (2003). _____ 79
- Figure III-4.** Results of Montargis simulations (R6, R7, R8, R11). (a) Measured concentration profile (C) at $x = 3$ m (■) and $x = 10$ m (□) and simulated profiles at $x = 3$ m (thin line) and at $x = 10$ m (dotted line) downwind from the source. (b) Measured (■) and simulated (thin line) deposition downwind from the source (D). (c) Measured profiles of mean wind speed U at $x = 3$ m (■) and $x = 10$ m (□) and simulated at $x = 3$ m (thin line) and at $x = 10$ m (dotted line) downwind from the source. _____ 80
- Figure III-5.** Mean relative error in concentration in Montargis at $x = 3$ m (▲, thin line) and 10 m (△, dotted line) downwind from the source as a function of height z . It was estimated as the average over 8 simulations of the difference between measured and simulated concentrations divided by measured concentration at a given height. _____ 81
- Figure III-6.** Mean relative error in deposition rates in Montargis at different distances downwind from the source. It was estimated as the averaged over all simulations of the difference between measured and simulated deposition divided by measured deposition at a given distance. _____ 82
- Figure III-7.** Results of 4 Grignon simulations (S_{113} , S_{219} , S_{221} , S_{223}). (a) Measured concentration (C) profiles at $x = 3$ m (■) and $x = 10$ m (□) and simulated profiles at $x = 3$ m (thin line) and at $x = 10$ m (dotted line) downwind from the source. (b) Measured (■) and simulated (thin line) deposition (D) downwind from the source. (c) Measured profiles of mean wind speed U at $x = 3$ m (■) and $x = 10$ m (□) and simulated at $x = 3$ m (thin line) and at $x = 10$ m (dotted line) downwind from the source. _____ 83
- Figure III-8.** Mean relative error in concentration in Grignon for S1 (a) and S2 (b) at $x = 3$ m (▲, thin line) and 10 m (△, dotted line) downwind from the source as a function of z . It was estimated as the average over all simulations of the difference between measured and simulated concentration divided by measured concentration at a given height. _____ 84
- Figure III-9.** Mean relative error on deposition rates in Grignon at different distances downwind from the source for S1 (◆, thin line) and S2 (◇, dotted line) series, averaged over 5 and 14 runs, respectively. _____ 85
- Figure III-10.** Sensitivity analysis to the settling velocity V_s . Concentration profile at (a) $x = 3$ m and (b) $x = 10$ m downwind from the source and (c) the deposition as a function of x are represented for simulations S_{113} with $V_s = 0.26$ m s⁻¹ for single grains (black thin line), 0.37 m s⁻¹ for doublets (grey thin line), 0.45 m s⁻¹ for triplets (black dotted line), 0.52 m s⁻¹ for quadruplets (grey dotted line) and 0.58 m s⁻¹ for quintuplets (black dotted dash line). _____ 88
- Figure III-11.** Measured cumulated pollen deposition as a function of downwind distance x , expressed as a percentage of the release rate for all runs in Grignon, except runs S_{218} - S_{220} for which the deposition rates were too uncertain. The release rate was estimated by "inversion" of the SMOP model. _____ 91
- Figure III-12.** Cumulated pollen deposition at $x = 120$ m as a function of u^* and $1/L$. Shown are measured (circle) and modelled (triangle) cumulated pollen depositions from $x = 1$ m to $x = 120$ m, and modelled (diamond) cumulated pollen depositions including deposition within the source. All three are expressed as percentage of the source strength estimated by model inversion (see text for details). _____ 92
- Figure IV-1.** Schematic plan of Grignon (a) and Sore (b) experiments. In Grignon, two 24 × 48 experimental plots delayed in flowering time were surrounded by wheat (S_0) and stubble after harvesting (S_1 and S_2). During experiments with plot 1, mean wind direction was from NE and during experiments with plot 2 from SW. In Sore, the crop was 500 × 1000 (not to scale) and surrounded by a pine forest, except for an area of about 50 ha of natural grassland on the east extending to 500 m downwind in the prevailing wind direction. _____ 96

- Figure IV-2.** Two-hourly moving average airborne pollen concentration measured above the source plot with a Burkard trap (continuous line) together with the estimated daily pollen production (dotted line) for (a) plot 1 and (b) plot 2 of the Grignon experiment and (c) the Sore experiment. The double bar in (a) denotes that the 27 July, the Burkard was disconnected during wheat harvest around the maize plot. The arrows in (c) denotes days when the center pivot-irrigation system was just above the Burkard trap. _____ 103
- Figure IV-3.** Averaged daily dynamics of normalised pollen concentration above the source plot in Montargis between the 29 July and 2 August 2000 (black bold line), in Grignon between the 24 and 28 July 2001 (black thin line), in Grignon between the 11 and 17 August 2001 (light grey line), and in Sore between the 21 and 24 July 2002 (black dotted line). Each line corresponds to the average over each period of the concentration normalised by its daily maximum. _____ 104
- Figure IV-4.** (a) The daily dynamics of the 23 July 2001 (grey line) is represented with the averaged daily dynamics of pollen concentration over 4 days (24, 25, 26 and 28 July). Error bars represent the standard deviation over these 4 days. (b) The concentration dynamics (black dotted line) is shown between the 23 and 28 July together with the surface wetness index SWI (grey dotted line), and the vapour pressure deficit VPD (black line). _____ 105
- Figure IV-5.** Vertical profiles of pollen airborne concentration (a) and deposition rates (b) within the maize canopy at Sore and Grignon for the 5 trials P1 to P5. _____ 106
- Figure IV-6.** Average vertical profiles of concentration (a) and horizontal flux (b) for S₁ (triangles), S₂ (circles) trials in Grignon as well as Montargis (squares). Filled symbols represent the measurements at x = 3 m and open symbols at x = 10 m. Averages were made over 9 measurements for S₁, 15 for S₂ and 12 for Montargis. ____ 107
- Figure IV-7.** (a) Pollen deposition rates normalised by deposition at x = 10 m, as a function of the downwind distance x normalised by the roughness length for each trials in Montargis (black lines), Grignon (dark grey lines) and Sore (bright grey lines). The median normalised deposition rates are also shown for Montargis (squares), Grignon (triangles) and Sore (diamonds). The roughness length z₀ was 0.01 m in Montargis, 0.07 for S₀, 0.02 for S₀ and 0.01 for S₂ in Grignon and 0.05 in Sore. (b) Frequency distribution of pollen deposition rates at x = 10 m for Montargis (black bars), for Grignon (grey bars) and Sore (light grey bars). _____ 108
- Figure IV-8.** Inferred release rate (Q_{model}) using the SMOP-2D model versus the measured production (Q_{meas}), for Montargis (squares), Grignon S₁ (grey triangles), Grignon S₂ (light grey triangles) and Sore (diamonds). 110
- Figure IV-9.** Integrated horizontal flux at x = 10 m downwind of the source as a function of the integrated horizontal flux at x = 3 m. Three experiments are shown: S₁ Grignon (circles), S₂ Grignon (squares) and Montargis (triangles). The lines are the linear regression forced through 0, they were y = 0.5 x for S₁ Grignon, y = 0.5 x for S₂ Grignon and y = 0.4 x for Montargis. _____ 112
- Figure IV-10.** Sore experiment. (a) Relative deposition rate normalised by deposition at x = 10 m (triangles) and relative concentration normalised by the concentration at x = 10 m (circles). (b) Relative deposition fitted to an exponential function (y = 56 exp (-0.01 x)). In (a) and (b), the deposition rates were fitted to a power law ~1/x, and the concentrations were fitted to a power law ~1/√x. _____ 113
- Figure IV-11.** Deposition velocity as a function of the downwind distance for three experimental trials at Sore (A2, A3 and A5). _____ 113
- Figure IV-12.** Relative deposition (normalised by deposition at x = 1 m) as a function of relative downwind distance (normalised by the roughness length, z₀) for S₀, S₁ and S₂ experiments at Grignon. The values of z₀ were 0.07, 0.02 and 0.01 for S₀, S₁ and S₂ experiments, respectively. _____ 114

LISTE DES TABLEAUX

Tableau I-1. Valeurs de la vitesse de sédimentation, V_s , de la densité, ρ_p , et des diamètres d_p correspondants, trouvées dans la littérature. _____ 20

Tableau I-2. Production de pollen par panicule, et durée de pollinisation typiquement observées pour des lignées, du maïs doux (alimentation humaine) et du maïs consommation (alimentation animale). _____ 25

Tableau I-3. Classe de stabilité (Pasquill, 1962) et représentation analytiques de σ_z . Tiré de McCartney & Fitt (1985). _____ 37

Table II-1. Location and description of the meteorological instruments used during the experiment. Height is height above ground. Negative height denotes measurements in the soil. _____ 43

Table II-2. Date, solar time, sampling line orientation and average micrometeorological conditions measured above and within the source plot during each experimental run. Where R_g is the global solar radiation; RH the relative humidity; SWI the surface wetness index; Rain the rainfall; T_a the air temperature; VPD the vapour pressure deficit of the air; U the wind speed, WD the wind direction and WDr the wind direction relative to sampling line direction. All measurements were made at a height of 2.1 m except U which was measured at 2.4 m and R_g and WD which were measured at 5 m. u_* , the friction velocity, and L, the Monin-Obukhov length, were measured with the sonic anemometers. Means and standard deviation are given. _____ 46

Table II-3. Number of plants starting and ending flowering, and daily pollen production per plant. The flowering status was estimated by observing 25 plants, pollen production was assessed from the same five individual plants. The total production over the pollination period was 1.4×10^7 grains per plant. _____ 48

Table II-4. Pollen production, integrated deposition rates and horizontal fluxes at different distances downwind of the source. The measured deposition rate at $x = 1$ m is also given as a reference for Figure II-7. D_{1-3} is the integrated deposition rate between $x = 1$ and 3 m, D_{1-32} is the integrated deposition rate between $x = 1$ and 32, D_{3-10} is the integrated deposition rate between $x = 3$ and 10 m, downwind of the source. Also shown are estimates of the horizontal flux, integrated between $z = 0$ and $z = 4$ m height, at $x = 3$ m ($F_3^{(0-4)}$) and $x = 10$ m ($F_{10}^{(0-4)}$) downwind of the source. ΔF_{3-10} is the horizontal flux difference between $x = 3$ and $x = 10$ m. The integrated deposition rates D_{1-3} and D_{1-32} are also expressed in percentage of the pollen production per meter of lateral width of the source. Runs lasted between 90 and 180 min. (-) denotes lack of data. _____ 53

Tableau II-5. Gamme des teneur en eau (h_r), vitesse de sédimentation (V_s), masse (m_p), diamètre (d_p), densité (ρ_p) et nombre de Reynolds (Re) moyens des grains de pollen pour cinq hybrides (Adonis bleu, Adonis, Banguy et DK300) et trois lignées (M521, N62 et N69). _____ 64

Table III-1. Main input parameters of the SMOP-2D model, with units and typical values used in this study. 73

Table III-2. Location and description of the two experiments. h_c is the mean height of the maize plot, h_s is the (lower – upper) mean height of maize tassels (emitting pollen), and LAI is the leaf area density estimated for each canopy. The heights of concentration measurements and the downwind distances of deposition rate measurements are also given. Concentrations were measured using rotating-arm pollen traps and deposition rates using cups. The indicated concentration measurements were performed at downwind distances $x = 3$ and 10 m. The deposition rate measurements were performed at a height $z = 0.25$ m in Montargis and $z = 0.30$ m in Grignon. _____ 75

Table III-3. Parameters used in the model for each simulation, as well as wind direction WD_f relative to the sampling line. $h_{c,d}$ is the height of the canopy downwind from the source (the canopy height of the source plot is given in Table III-2); z_0 is the roughness length of the same canopy; x_{upwind} and $x_{downwind}$ are the upwind and downwind distance of the transition zone at the downwind edge of the source (expressed as a factor of the source canopy height h_c); u_* is the friction velocity, and L the Monin-Obukhov length over the downwind surface; $U(z = 50 \text{ m})$ is the calculated wind speed at $z = 50$ m over the downwind surface, using the values given in this table for z_0 , u_* and L, and $d = 0.7 \times h_{c,d}$. $U(z = 50 \text{ m})$ is considered constant over the whole domain, and is used to calculate the homogeneous wind speed profiles over each canopy (upwind, source and downwind), using the surface parameters of each canopy (z_0 and d). _____ 76

Table IV-1. Measurements made and methods used during Grignon and Sore experiments. Small containers are 50 mm in diameter and 70 mm high and large containers are 170 mm in diameter and 60 mm high in Grignon experiment and 117 mm diameter and 76 mm height in Sore experiment. _____ 98

Table IV-2. Date, solar time, sampling line orientation and average micrometeorological conditions measured above and within the source plot during each experimental trial. R_g - global solar radiation; RH - relative humidity; T_a - air temperature; VPD - vapour pressure deficit of the air; U - wind speed, Std WD – standard deviation of wind direction and WDr – wind direction relative to sampling line direction. All measurements were made at a height of 2 m at Grignon and 2.5 m at Sore except U and WD which were measured at 5 m and 4.3 m and R_g , which was measured at 2.5 m and 5 m at Grignon and Sore, respectively. u_* , the friction velocity, and L, the Monin-Obukhov length, were measured with the sonic anemometers at 4.5 m at Grignon and 6 m at Sore. Means and standard deviation are given. _____ 99

Table IV-3. Date, solar time, average micrometeorological conditions measured during concentration and deposition vertical profile measurements in Sore. $U_{2.7}$ and $U_{4.3}$ are the mean wind speed measured at 2.7 m and 4.3 m height. Mean and standard deviation are given. _____ 101

Table IV-4. Percentage of plant starting and ending flowering and daily pollen production per tassel for Grignon and Sore experiments. Percentage of the pollen production per tassel over all the period is also given. _____ 102

Introduction

Le maïs (*Zea mays* L.) est l'une des plantes les plus cultivées dans le monde. Originaire d'Amérique centrale, il posséderait une espèce sauvage apparentée, la téosinte (*Zea mexicana* (Schard.) Kuntze) qui, au travers de différentes étapes de domestication aurait conduit il y a 7000 à 10000 ans au maïs (Figure 0-1). La téosinte possède des petits épis qui ne donnent que très peu de graines tandis que le maïs actuel ne possède qu'un ou deux épis portant de nombreux grains. Le maïs est la base de l'alimentation pour de nombreuses populations et aussi une matière première de choix, recherchée par les transformateurs industriels.

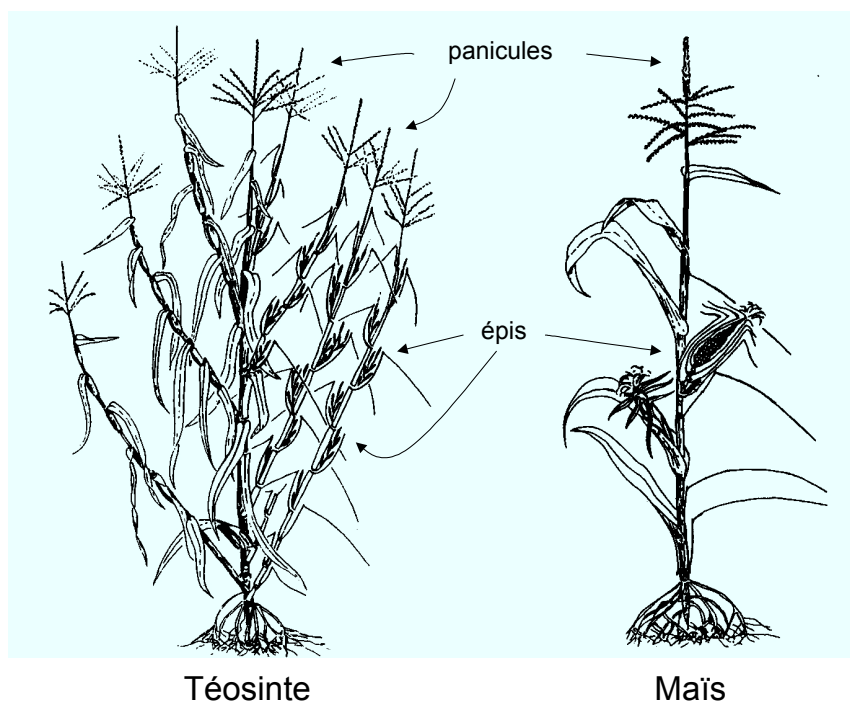

Figure 0-1. Architecture de la téosinte mexicaine et du maïs. La téosinte et le maïs sont dotés d'une inflorescence principale. La téosinte est également composée de plusieurs branches latérales, avec inflorescences primaire (mâle) et secondaire (femelle). Le maïs typique a des branches latérales courtes à inflorescence primaire (et parfois secondaire) femelle. Adapté de Freeling & Walbot (1994).

Le maïs cultivé aujourd'hui résulte de cinq siècles d'amélioration par l'homme. Ce processus de sélection a permis d'adapter cette plante aux différents climats et usages, d'accroître sa résistance et d'optimiser sa productivité. Les techniques modernes d'hybridation ont permis d'apporter des améliorations considérables durant le 20^{ème} siècle. Elles consistent à croiser deux lignées pures, populations pour lesquelles certains caractères se retrouvent inchangés d'une génération à l'autre. Les semences hybrides obtenues combinent les intérêts de leurs géniteurs, et donnent des plantes plus vigoureuses et productives que ces derniers (vigueur hybride). Devant la grande diversité des variétés de maïs résultant de la sélection, les producteurs de semences cherchent depuis longtemps à contrôler les risques de pollinisation croisée entre variétés pour maximiser la pureté variétale et adapter en conséquence les pratiques culturales.

La récente et rapide introduction des organismes génétiquement modifiés (OGM) a accru l'intérêt des producteurs de maïs mais aussi des scientifiques à mieux comprendre les avantages et les inconvénients liés à la culture des OGM. Depuis la commercialisation en 1996 des cultures transgéniques, leur surface a très rapidement augmenté dans le monde pour atteindre 58,7 millions d'hectares en 2002 (James, 2002). En 2002, quatre pays principaux détiennent 99% des cultures transgéniques. Les Etats Unis se placent en 1^{ère} position avec 66% du total des surfaces cultivées en OGM, suivis par l'Argentine (23%), le Canada (6%) et la Chine (4%). Depuis leur introduction, les cultures transgéniques ont augmenté en moyenne de plus de 10% par an. Globalement, le nombre d'espèces cultivées est très restreint: les principales cultures d'OGM sont le soja, qui occupait en 2002, 62% de la surface totale en OGM, suivis par le maïs (21%) et le coton (12%). Durant les 6 dernières années (1996-2002), la tolérance aux herbicides a été le principal caractère recherché, la résistance aux insectes arrivant en seconde place. En 2002, le caractère de tolérance aux herbicides a été développé chez le soja, le maïs et le coton, et était présent sur 75% de la superficie totale cultivée en OGM alors que le caractère de résistance aux insectes en représentait 8%. Par exemple, dans le cas de la pyrale du maïs, le *Bacillus thuringiensis* ou Bt est une bactérie du sol qui produit une toxine insecticide à laquelle les papillons sont sensibles. Un gène de Bt est introduit dans le maïs qui va fabriquer lui-même la toxine insecticide et devenir résistant à la pyrale.

Les principales questions relatives à l'introduction des OGM sont les risques sur la santé humaine, les risques pour les écosystèmes et ceux inhérents à la coexistence entre cultures. Concernant les écosystèmes cultivés, le pollen provenant d'une culture transgénique peut transmettre par fécondation le transgène considéré aux plantes de son environnement, cultivées ou sauvages. Par exemple, la présence de transgènes dans des lignées indigènes de

maïs au sud du Mexique a été signalée (Quist & Chapela, 2001). Bien que ce constat ait été critiqué quant à la technique utilisée (Christou, 2002), la question reste posée concernant l'intégrité génétique des lignées indigènes. En outre, la possibilité de pollinisation croisée entre le maïs et la téosinte a été démontrée (Doebley, 1990; Baltazar & Schoper, 2002). Le maïs n'ayant pas d'espèces apparentées en Europe, la présence dans l'agroécosystème de plantes résultant d'une transgénèse ne peut pas conduire à un croisement avec une espèce sauvage. Les deux grandes préoccupations sont donc (1) la maîtrise des flux de gènes entre maïs transgénique et non transgénique, biologique ou conventionnel, et de façon plus classique, mais non sans une très réelle acuité, la maîtrise des croisements intervariétaux, et (2) la maîtrise de la dissémination de gènes dans l'environnement dans un souci de maintien de la biodiversité.

La culture du maïs OGM en Europe occupe des surfaces peu importantes (40 000 hectares en Espagne). Une des raisons pour lesquelles la commercialisation des OGM a été retardée est essentiellement liée à la directive 2001-18-EC qui exigeait l'évaluation des effets indirects des OGM sur l'environnement et la nécessité d'en contrôler l'impact après commercialisation (Dale, 2002). A la suite de la publication très récente de deux règlements relatifs à la traçabilité et l'étiquetage des denrées alimentaires issues d'OGM (Journal officiel des Communautés européennes, 18/10/03), la levée du moratoire européen sur les OGM est très vraisemblable. Cet important dispositif réglementaire s'accompagne de la publication d'études scientifiques britanniques récentes qui mettent en lumière le danger que représenterait pour l'environnement la modification génétique du colza, de la betterave voire du maïs (Squire *et al.*, 2003). Au moment où se pose la question de l'éventualité d'une législation sur la coexistence de cultures traditionnelles et OGM, rappelons que la France s'est montrée favorable à l'établissement de règles nationales sur la coexistence mais d'une façon harmonisée entre les Quinze; ces règles s'appliqueraient bien évidemment au maïs entre autres cultures. Parmi les questions en suspens relatives à cette culture figure depuis 1999 le dossier très avancé de l'autorisation d'exportation dans l'Union du maïs Bt-11 (maïs doux non replantable destiné à la consommation humaine). A l'heure actuelle, il apparaît que les décisions au niveau européen pourraient échapper aux experts des Etats membres pour être confiées aux politiques particulièrement sensibles aux retards dommageables que pourrait prendre l'Union dans le secteur de la recherche et de l'innovation concernant les biotechnologies végétales, en particulier face au continent nord-américain. Alors que les opinions de certains Etats membres contrastent fortement avec l'optimisme de la Commission Européenne aujourd'hui favorable aux OGM, l'approfondissement des travaux scientifiques

apparaît comme une priorité au milieu de ce dossier passionnel et caractérisé par la coexistence d'un fort potentiel économique et par la persistance d'incertitudes quant aux effets de la dissémination d'OGM dans l'environnement.

C'est dans cet esprit que l'INRA, les Instituts techniques et divers organismes européens de recherche s'intéressent à l'impact des pratiques agricoles sur les risques de persistance, de propagation et de contournement des transgènes. Concernant l'analyse de la dissémination des gènes par croisement entre espèces ou variétés, il est clair que le mécanisme de la pollinisation constitue une voie essentielle. La pollinisation entomophile a fait l'objet de recherches par les zoologistes ou les généticiens dans le cas du colza (Chèvre *et al.*, 1997). Par contre, les processus physiques et biophysiques responsables de la pollinisation anémophile du maïs demeurent largement peu connus depuis les travaux des années 70 (Ogden *et al.*, 1969; Raynor *et al.*, 1972a). En plus des préoccupations agronomiques (pureté variétale, distances d'isolement, ...) à l'origine de ce travail de thèse cofinancé par l'INRA et l'interprofession, il a semblé logique sur un plan strictement scientifique de commencer l'étude de ces processus dans le cas du pollen de maïs qui présente l'avantage d'être un bioaérosol constitué d'une population monodisperse de particules de grande taille, ce qui est favorable sur le plan de la métrologie et de la modélisation de manière à valider un modèle mécaniste de transport de pollen, en préalable à une investigation approfondie des processus.

L'étude qui va suivre a été réalisée à l'INRA dans l'Unité Mixte de Recherche "Environnement et Grandes Cultures" à Grignon, en partenariat avec Arvalis - Institut du Végétal. Elle s'est attachée à mieux comprendre les processus de dispersion atmosphérique du pollen de maïs dans l'environnement. Par dispersion, il faut comprendre dispersion *sensu stricto*, c'est-à-dire, le transport dans l'atmosphère du grain de pollen depuis sa libération jusqu'à son dépôt, et non dispersion "efficace" qui comprendrait également la fécondation, voire la formation des grains.

Ce travail de thèse s'articule autour de quatre chapitres. Le premier fait le point sur les connaissances actuelles sur le pollen et sa dissémination dans l'atmosphère. Le deuxième traite des mesures de concentration et dépôt en conditions "réelles", de la vitesse de sédimentation en conditions contrôlées, ainsi que des méthodologies développées à ces occasions. Le troisième s'attache à tester la validité d'un modèle mécaniste de dispersion initialement développé pour des gaz (Loubet, 2000) et généralisé à la dispersion de particules biotiques dans l'atmosphère. Enfin, la dernière partie analyse l'ensemble des données obtenues au cours des expérimentations menées sur trois années consécutives.

Chapitre I Le pollen de maïs et sa dissémination dans l'atmosphère

Les connaissances relatives à la formation de pollen, à ses caractéristiques biophysiques, aux conditions physiques et physiologiques de fécondation ont fait l'objet de progrès certains depuis les années 70. Pendant cette même période, l'étude de la dissémination du pollen dans l'atmosphère et de son dépôt a très peu progressé. Dans le contexte actuel (optimisation de la pureté variétale, dissémination d'OGM), cette étude prend un relief évident d'autant plus que de réels acquis scientifiques sont attendus.

I.1 Les acteurs de la pollinisation anémophile

I.1.1 La plante de maïs

Le maïs est une graminée herbacée, annuelle, qui atteint 2 à 3 m de hauteur à maturité. Cette plante possède de longues et larges feuilles alternes et retombantes. C'est une plante monoïque, autrement dit, une plante dont les organes reproducteurs mâle et femelle sont séparés verticalement sur le même pied. Les fleurs mâles sont regroupées en une inflorescence terminale, la panicule, tandis que les fleurs femelles sont regroupées sur une ou plusieurs ramifications latérales, les épis (Figure 0-1). Bien que la plante soit autofertile, la fécondation est essentiellement allogame et la pollinisation anémophile. Le taux de fécondation croisée est d'au moins 95% en raison de la séparation des sexes dans l'espace (monoécie) et de la maturité différée des organes mâle et femelle (protandrie).

En France, le maïs est semé en avril-mai, fleurit en juillet-août et ses grains sont récoltés en octobre-novembre. Pendant la phase végétative, la semence germe, la plantule lève et développe toutes les feuilles. La phase reproductrice démarre alors par la formation de la panicule, suivie par celle de l'épi. L'appareil végétatif continue de croître un peu au-delà de la

floraison. Après la fécondation, les grains vont se former et se remplir avant d'atteindre leur maturité. Encore humides, ils peuvent continuer à sécher sur pied si le climat est assez sec, avant d'être récoltés en épis ou en grains. La plante entière peut aussi être récoltée et ensilée avant la maturité complète du grain pour l'alimentation des ruminants.

I.1.2 Caractéristiques biophysiques du grain de pollen

Les études menées sur le pollen de maïs sont peu nombreuses et anciennes (Durham, 1943; Ogden *et al.*, 1969) et les résultats obtenus sont souvent peu précis concernant les conditions dans lesquelles se sont déroulées les expériences. Des études récentes et en grande partie prospective tentent de combler ce vide (Aylor, 2002; Aylor, 2003).

Le pollen de maïs, produit dans les anthères des panicules, a une forme sphéroïdale. Il est monodispersé avec un diamètre moyen de l'ordre de 90 μm (Di-Giovanni *et al.*, 1995), ce qui en fait un des plus gros grains parmi les pollens anémophiles (Laaidi *et al.*, 1997). Rappelons que la taille des grains de pollen peut varier de quelques micromètres (pollen de figuier par exemple) jusqu'à 200 μm (pollen de courge). Sa densité est comprise entre 1 et 1,45 (Durham, 1943; Aylor, 2002) selon les conditions de déshydratation du grain. La structure du grain de pollen se caractérise par une paroi interne, l'intine, qui constitue la membrane squelettique du pollen et par une paroi externe, l'exine, lisse et fine, typique des pollens anémophiles (Figure I-1).

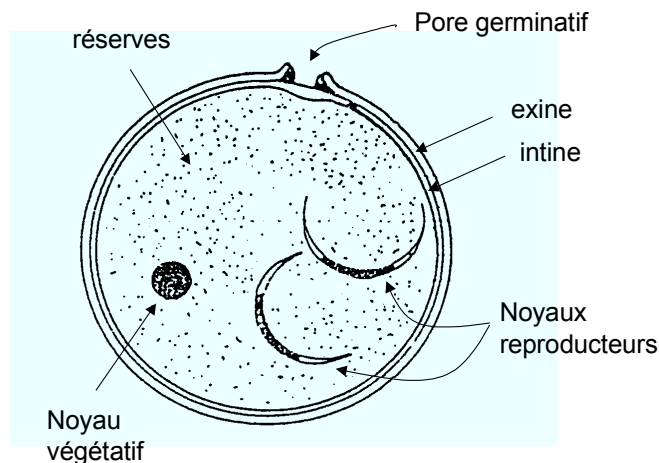

Figure I-1. Structure du grain de pollen entouré de deux parois, la paroi interne, ou intine, et la paroi externe, ou exine. Le pollen a un unique pore par lequel le tube pollinique va émerger et se développer (Gay, 1979).

La dynamique de production journalière de pollen est diurne avec un maximum se produisant en milieu de matinée (Ogden *et al.*, 1969) et l'anthèse (floraison mâle) dure environ 7 jours pour une même panicule (Girardin, 1998). Le nombre de grains produits

dépendra de la synchronisation entre l'anthèse et l'émergence des soies (floraison femelle) (Uribelarrea *et al.*, 2002).

1.1.2.1 Teneur en eau

Une des plus importantes propriétés du pollen est sa teneur en eau, car elle affecte à la fois la vitesse de sédimentation (Aylor, 2002) et sa survie (Buitink *et al.*, 1996; Luna *et al.*, 2001). Elle est généralement exprimée en pourcentage de la masse totale du grain.

A l'anthèse, le pollen a une teneur en eau élevée, environ 60% de la masse du grain de pollen (Kerhoas, 1986). Le pollen de maïs figure parmi les plus hydratés et est connu pour être particulièrement sensible à la déshydratation (Buitink *et al.*, 1996; Luna *et al.*, 2001). L'état de déshydratation dépend principalement du déficit de pression de vapeur de l'air et peut évoluer d'un état bien hydraté à pratiquement déshydraté en 1 à 4 h (Kerhoas, 1986; Luna *et al.*, 2001; Aylor, 2003). Lors de la déshydratation, de nombreux changements physiques se produisent comme par exemple le changement de la forme sphéroïdale du grain de pollen qui devient prismatique (Figure I-2).

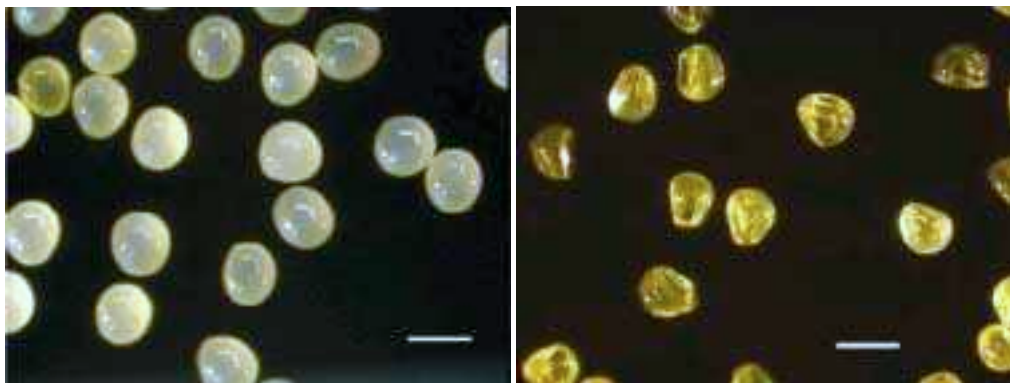

Figure I-2. Pollen de maïs hydraté (figure de gauche) et partiellement déshydraté (figure de droite). Un changement de couleur (de crème à ambré) et de forme (de sphéroïdale à prismatique) se produit alors que le pollen se déshydrate. L'échelle est à 100 μ m (Aylor, 2003).

Après la libération, la teneur en eau du pollen diminue avec le temps (Aylor, 2003). Pour des grains de pollen exposés à l'air à une température de 23,5°C, la teneur en eau n'est plus que de 15,7% au bout de 4 h à 75% d'humidité relative de l'air (RH) et 4,4% au bout de 3h à 20% de RH (Figure I-3). En dessous de 10 à 15% de teneur en eau, le pollen n'est probablement plus viable (Kerhoas, 1986; voir également I.1.2.3).

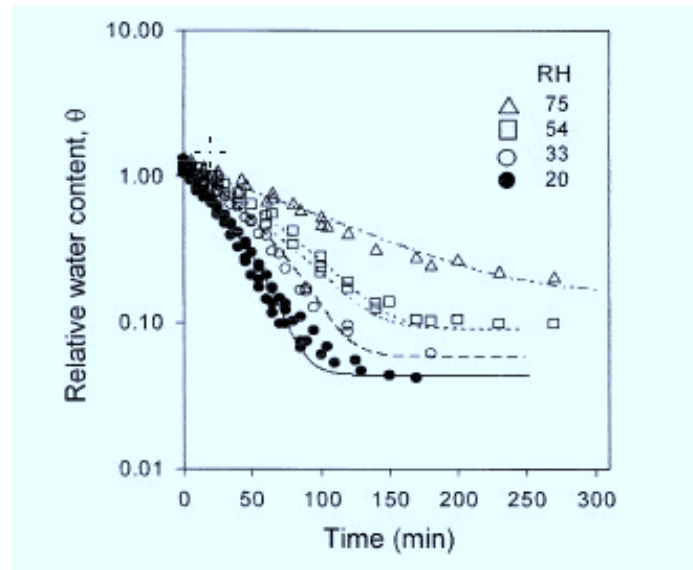

Figure I-3. Evolution de la teneur en eau relative θ (masse d'eau / masse sèche du grain) des grains de pollen exposés à l'air à une température de 23,5°C en fonction du temps et pour 4 humidités relatives de l'air (RH en%). Tiré de Aylor (2003).

Le potentiel hydrique (ψ) traduit l'effet des différentes forces de liaison (osmotique, capillaire,...) existant entre les molécules d'eau et les constituants du système étudié (sol, plante, pollen) (Guyot, 1997). Il peut être défini de façon schématique comme le travail qu'il faudrait fournir à une unité de masse d'eau située pour la faire passer de l'état d'eau liée à un état de référence correspondant à celui de l'eau libre à la même température. En prenant l'état de référence à zéro, tous les potentiels caractérisant l'eau liée seront négatifs car il faut fournir de l'énergie pour extraire de l'eau. Westgate & Boyer (1986b) ont montré que le potentiel hydrique du pollen diminue au cours de la journée de -1,2 MPa à -12,5 MPa (Figure I-4).

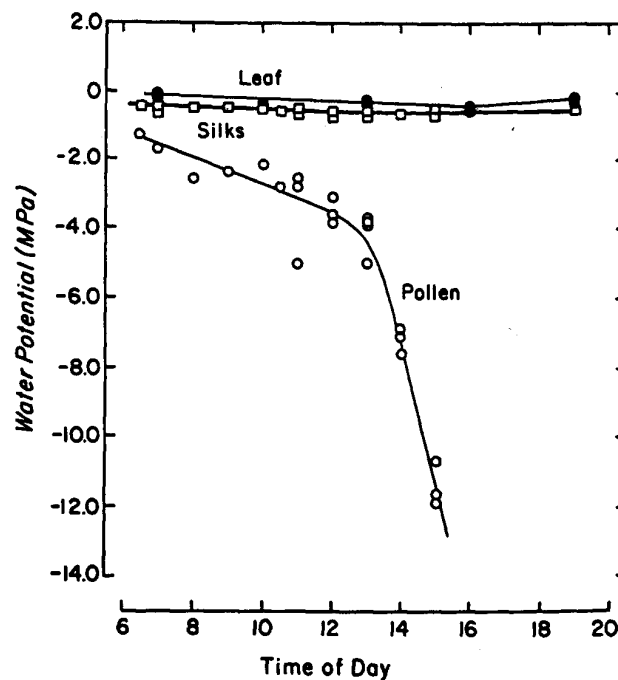

Figure I-4. Potentiel hydrique des feuilles (leaf), des soies (silks), et du pollen en fonction de l'heure de la journée, mesuré au champ pendant la floraison (Westgate & Boyer, 1986b).

Aylor (2003) a également trouvé que le potentiel hydrique du pollen est relié à la teneur en eau relative (θ) du grain par la relation suivante:

$$\psi = -3,218 \theta^{-1,35} \quad (\text{I-1})$$

ce qui signifie qu'un potentiel hydrique de $-1,2$ MPa correspond à une teneur en eau d'environ 60% et de $-12,5$ MPa correspond à une teneur en eau de 25%.

1.1.2.2 Vitesse de sédimentation

La vitesse de sédimentation, V_s , est la vitesse limite de chute du pollen en air calme. Cette vitesse limite résulte d'un équilibre entre le poids \mathbf{P} de la particule, la force de traînée \mathbf{F} et la poussée d'archimède \mathbf{A} . Pour une particule sphérique, la force de traînée, \mathbf{F} , a pour expression:

$$\mathbf{F} = 3\pi\rho\mu d_p \mathbf{V} \quad (\text{I-2})$$

où ρ est la densité de l'air ($1,27 \cdot 10^{-3} \text{ g cm}^{-3}$ à 15°C), μ est la viscosité cinématique de l'air ($1,42 \times 10^{-1} \text{ cm}^2 \text{ s}^{-1}$ à 20°C), d_p le diamètre de la particule et \mathbf{V} la vitesse de la particule. Cette relation est valable pour des nombres de Reynolds faibles ($\text{Re}_p \ll 1$), le nombre de Reynolds de la particule étant défini comme suit:

$$\text{Re}_p = \frac{V_s d_p}{\mu} \quad (\text{I-3})$$

Sachant que $\rho_p \gg \rho$, ρ_p étant la densité du grain de pollen, la vitesse de sédimentation s'exprime alors par la loi de Stokes:

$$V_s = \frac{1}{18} \frac{d_p^2 g \rho_p}{\mu} \quad (\text{I-4})$$

et ne dépend plus que du diamètre et de la densité du grain de pollen.

La vitesse de sédimentation du maïs, calculée avec la loi de Stokes en prenant $d_p = 90 \mu\text{m}$ et $\rho_p = 10^{-3} \text{ g cm}^{-3}$ (Di-Giovanni *et al.*, 1995), donne une valeur élevée du nombre de Reynolds (Re_p) égale à 1,47. Dans ce cas, la force de traînée \mathbf{F} du milieu n'est plus proportionnelle à \mathbf{V} mais à \mathbf{V}^n , n variant avec Re_p . La vitesse de sédimentation est alors égale à:

$$V_s^2 = \frac{4 g d_p \rho_p}{3 C_D \rho} \quad (\text{I-5})$$

où C_D , nombre sans dimension, est appelé coefficient de traînée de la particule. Pour des valeurs de $\text{Re}_p > 0,1$, la loi de Stokes ne s'applique plus et le coefficient de traînée est alors bien représenté par Seinfeld & Pandis (1998):

$$C_D = \frac{24}{\text{Re}_p} \left[1 + \frac{3}{16} \text{Re}_p + \frac{9}{160} \text{Re}_p^2 \ln(2 \text{Re}_p) \right] \quad 0,1 < \text{Re}_p < 2$$

$$C_D = \frac{24}{\text{Re}_p} \left(1 + \frac{1}{6} \text{Re}_p^{2/3} \right) \quad 2 < \text{Re}_p < 50 \quad (\text{I-6})$$

relation valable pour des particules sphériques et un intervalle de valeur de Re_p correspondant au cas du maïs. Les valeurs de V_s pour le maïs ont été mesurées à l'aide de différentes méthodes et sont comprises entre 18 cm s^{-1} et 31 cm s^{-1} (Tableau I-1).

Tableau I-1. Valeurs de la vitesse de sédimentation, V_s , de la densité, ρ_p , et des diamètres d_p correspondants, trouvées dans la littérature.

V_s cm s^{-1}	ρ_p g cm^{-3}	d_p μm	Auteurs
18	1	90	(Durham, 1943; Durham, 1946a)
20	-	90 - 100	(Raynor <i>et al.</i> , 1972a)
$30,95 \pm 7,63$	-	$90 \pm 9,28$	(Di-Giovanni <i>et al.</i> , 1995)
26 ± 5	1,25 - 1,45	76 - 106	(Aylor, 2002)

Ferrandino & Aylor (1984) ont utilisé une tour de sédimentation en verre de 1,2 m de hauteur et ont mesuré le temps de parcours des spores sur différentes portions de la tour. Ils se sont attachés à déterminer les différences de vitesse de sédimentation pour des grains isolés ou en agrégats. Ils ont trouvé une relation du type $(V_s)_N = \sqrt{N} V_s$ où N est le nombre de spores dans l'agrégat. Sawyer *et al.* (1994) a mesuré la vitesse de sédimentation des conidies d'entomophthorales dans une chambre en verre à l'aide d'un vidéo-microscope et d'une analyse d'images. Di-Giovanni *et al.* (1995) ont mesuré la variabilité des vitesses de sédimentation en faisant tomber le pollen ou les spores du haut d'une tour d'environ 1,50 m dans un cylindre en acier. Simultanément, le moteur dirigeant un disque en rotation au bas de la tour, et sur lequel sont disposées des lames microscopiques est démarré. Aylor (2002) a repris le système utilisé par Ferrandino & Aylor (1984) et a mesuré la vitesse de sédimentation dans les minutes suivant la récolte sur la panicule. Ainsi, il a pu relier V_s au changement de taille, de masse et de forme des grains de pollen pendant son dessèchement. En particulier, la Figure I-5 montre que plus le diamètre du volume équivalent du grain, D_e , en cours de déshydratation diminue, plus sa vitesse décroît. Le diamètre D_e est le diamètre de la sphère possédant la même masse m_p , et la même masse volumique ρ_p que le grain de pollen.

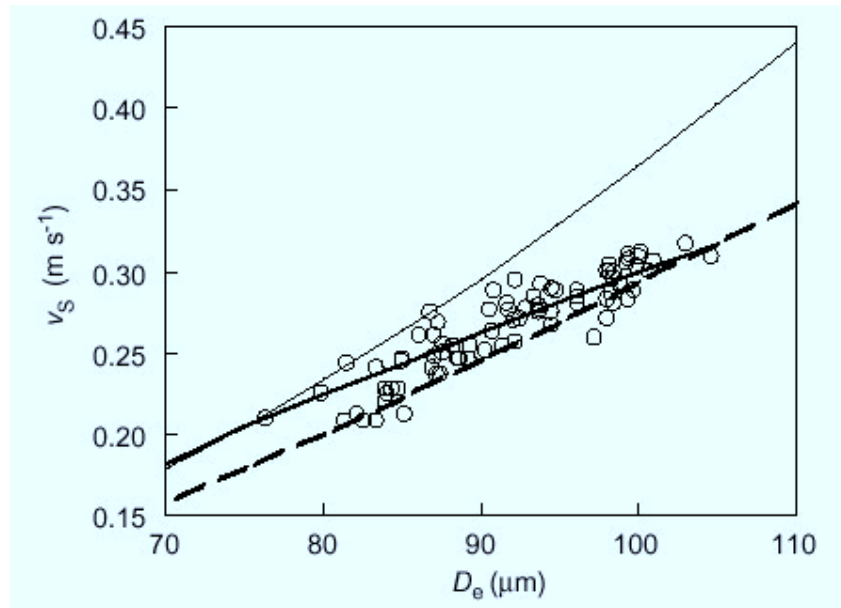

Figure I-5. Vitesse de sédimentation (V_s) pour 3 variétés de maïs en fonction de son diamètre du volume équivalent (D_e). Le courbe en trait continu fin est calculée avec la loi de Stokes (équation I-4) et la courbe en trait discontinu est calculée avec l'équation I-5 ($\rho_p = 1.2 \text{ g cm}^{-3}$). Tiré de Aylor (2002).

I.1.2.3 Viabilité

La viabilité du pollen, c'est à dire sa capacité à germer une fois arrivé sur le stigmate, varie selon les conditions climatiques extérieures lors de la libération des grains. Kerhoas (1986) a montré que 13 à 15% de teneur en eau est un seuil critique au-dessous duquel apparaissent des changements physiques, biophysiques et cytologiques dans le grain. Roeckel-Drevet *et al.* (1995) ont montré que le taux de germination *in vitro* augmente jusqu'à 80% pour une teneur en eau passant de 60% à 50% puis diminue de 80% à 0% pour une teneur en eau passant de 50% à 10%, alors que la formation des grains elle, diminue de 80% à 20% pour une teneur en eau passant de 60% à 20% puis augmente à 80% pour une teneur en eau passant de 20% à 10% (Figure I-6). L'augmentation de la germination *in vitro* est liée à une augmentation de l'activité métabolique dans le grain de pollen due à la légère déshydratation. Ensuite, la diminution à la fois de la germination *in vitro* et de la formation de grains peut être due soit à la difficulté du pollen à se réhydrater sur le milieu de germination ou sur le stigmate, soit à la difficulté du pollen sec à rétablir son métabolisme après la déshydratation. Enfin, lorsque les grains de pollen se déshydratent de 20 à 10% de teneur en eau, Kerhoas *et al.* (1987) ont montré que du sucrose s'accumule dans le cytoplasme et au niveau de la membrane et le pollen de maïs acquiert une tolérance à la dessiccation. Un tel état biophysique peut permettre à l'activité métabolique du pollen de reprendre après réhydratation sur le stigmate. Le fait que l'on n'observe pas la même reprise d'activité avec la

germination *in vitro* suggère que le milieu utilisé ne contient pas tous les éléments nécessaires à la réhydratation du pollen.

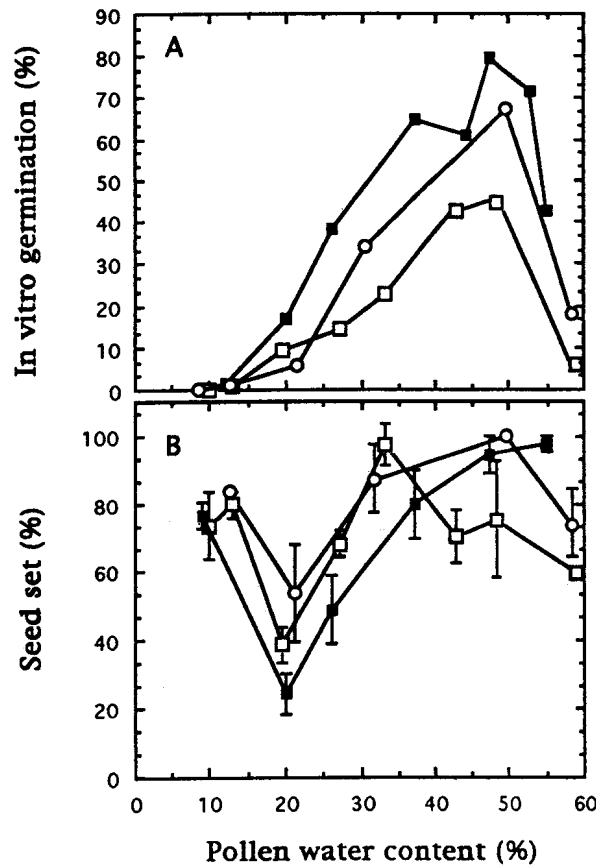

Figure I-6. Mesures de la germination *in vitro* (A) ainsi que de la formation de grains (seed set) dans l'épi (B) en fonction de la teneur en eau des grains de pollen (Roeckel-Drevet *et al.*, 1995). (□,■,○) représentent trois populations de pollen récolté sur des parcelles différentes et trois jours différents. Pour chacune de ces populations, chaque point représente la moyenne et, les barres verticales, l'écart-type de trois répétitions.

Herrero & Johnson (1980) ont trouvé que la viabilité du pollen était fortement réduite à des températures au-dessus de 38°C mais aussi qu'elle dépendait beaucoup du génotype étudié. De plus, cette diminution de viabilité n'affecte pas systématiquement la formation des grains étant donné que la panicule produit considérablement plus de pollen qu'il en est nécessaire pour la fécondation. Cela dépendra de la synchronisation entre l'anthèse et l'émergence des soies ainsi que de la réceptivité femelle. Uribe Larrea *et al.* (2002) ont montré qu'une émergence des soies précoce (c'est-à-dire avant le maximum de production de pollen) n'affecte pas la formation des grains alors qu'une émergence des soies tardive (c'est-à-dire après le maximum de production de pollen) réduit le nombre de grains formés de plus de moitié. Westgate & Boyer (1986a) ajoute que du pollen ayant un potentiel hydrique aussi bas que celui rencontré en fin de journée (Figure I-4), est capable de féconder.

I.1.3 Les soies

Les soies correspondent à la partie femelle de la fleur (Figure I-7). Les soies émergent par le haut de l'épi et continuent de se développer jusqu'à la fécondation (Basseti & Westgate, 1993a). Le potentiel hydrique du pollen est toujours plus bas que celui des soies, quelle que soit l'heure du jour (Figure I-4), ou la disponibilité en eau (Westgate & Boyer, 1986b). Ainsi, le potentiel hydrique du pollen favorise toujours le mouvement de l'eau des soies vers le grain de pollen qui développera alors son tube pollinique vers un ovule.



Figure I-7. Emergence des soies d'un épi de maïs. Encart: zoom sur une soie où on peut voir que de nombreux grains de pollen sont collés alors qu'uniquement l'un d'entre eux participera à la fécondation (Aylor *et al.*, 2003)

En plus de la séparation dans l'espace, le développement de la panicle et celui de l'épi peuvent être également séparés dans le temps si les conditions météorologiques ne sont pas favorables, en particulier si la plante portant les soies subit un stress hydrique au moment de l'émergence (Hall *et al.*, 1982; Bruce *et al.*, 2002). Cependant, Basseti & Westgate (1993c) ont montré que les soies deviennent progressivement moins sensibles aux déficits en eau quand la longueur des soies augmente jusqu'à environ 200 mm. La réceptivité des soies, plus que la viabilité du pollen, peut être un facteur déterminant dans le remplissage des grains dans des environnements secs (Schoper *et al.*, 1986).

I.2 Le transfert de pollen dans l'atmosphère

I.2.1 Mécanismes

Le transfert de pollen dans l'atmosphère s'effectue en 3 étapes: la libération du pollen par les panicules, le transport dans l'atmosphère et enfin le dépôt qui peut avoir lieu sur les organes végétatifs (feuilles), les organes reproducteurs (soies) et sur le sol (Figure I-8).

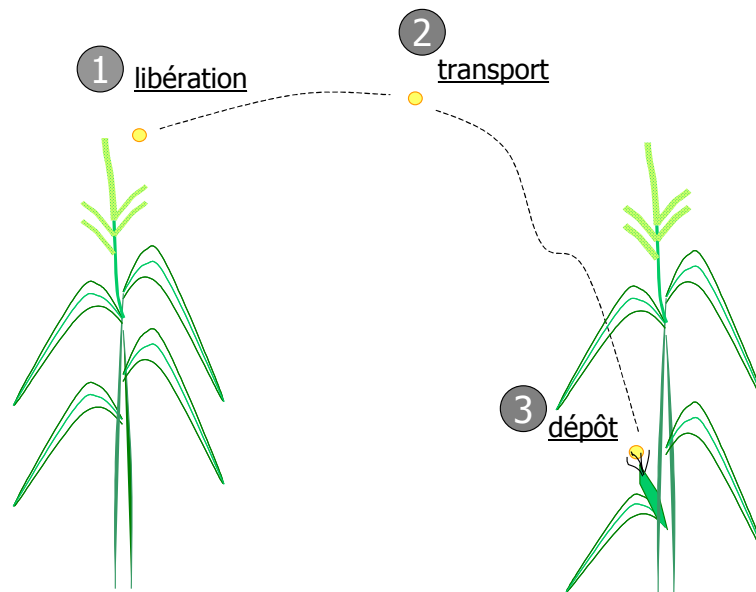

Figure I-8. Mécanismes de transfert de pollen dans l'atmosphère: libération des panicules, transport dans l'atmosphère et dépôt sur la végétation ou le sol. Des phénomènes de resuspension postérieurs au dépôt de pollen peuvent également se produire.

I.2.1.1 Libération

La panicule est située à l'extrémité supérieure de la plante. Elle est composée d'un axe principal et de plusieurs ramifications latérales. A l'anthèse, les filets poussent et expulsent les anthères. Lorsque l'air est sec le cytoplasme se dessèche; la contraction provoque alors une dépression de la membrane des anthères qui s'ouvre (Figure I-9) et libère le pollen. On ne connaît pas à ce jour le rôle précis du vent dans la libération du pollen. On peut cependant penser que, les panicules étant situées au sommet de la plante, autrement dit dans la zone du couvert où la vitesse du vent est élevée, le vent n'est pas un facteur limitant sur la libération en tant que telle. De même, la quantité de pollen libérée par rapport à celle produite dans les anthères, n'est pas connue tout comme son évolution au cours de la journée.



Figure I-9. Photo de gauche: axe principal de 2 panicules, celle de gauche est à l'anthèse (notez la sortie des anthères au bout de leur filet). Photo de droite (tirée de (Aylor *et al.*, 2003)): libération du pollen des anthères. Encart: zoom sur l'extrémité d'une anthère montrant les grains de pollen

Lors de pollinisation anémophile, la quantité de pollen libérée est considérable au regard du nombre de grains de pollen qui participent effectivement à la fécondation. Différentes études menées entre 1998 et 2000, ont permis de quantifier les productions de pollen en fonction du type de maïs (Foueillassar X., comm. pers.; Tableau I-2). Comme un épi est composé généralement de 750 à 1000 graines, cela veut dire que la panicule produit 1000 à 24000 grains de pollen pour une soie. Cette production peut compenser les distances entre les panicules et les soies, à condition que l'anthèse et l'émergence des soies soient synchronisées et que les soies soient réceptives (Basseti & Westgate, 1993b; Uribelarrea *et al.*, 2002).

Tableau I-2. Production de pollen par panicule, et durée de pollinisation typiquement observées pour des lignées, du maïs doux (alimentation humaine) et du maïs consommation (alimentation animale).

	Production $\times 10^6$ grains panicule ⁻¹	Durée de pollinisation Jours
Lignée	1 - 5	6 - 13
Maïs doux	11 - 18	12 - 15
Maïs consommation	7 - 14	12 - 18

D'une manière générale, le pollen est libéré pour une période de 5 à 8 jours pour une panicule, ce qui représente des durées de pollinisation à l'échelle d'un champ de 6 à 18 jours, différences qui sont fonctions de la variété maïs également de l'hétérogénéité du champ. La libération de pollen a lieu essentiellement du milieu de matinée à midi et est quasiment nulle la nuit (Ogden *et al.*, 1969).

Des phénomènes de remise en suspension peuvent également se produire, même si dans le cas du maïs, aucune étude n'a mis en œuvre pour quantifier ce genre d'événements. Le vent peut enlever le pollen directement en le soulevant des surfaces ou en secouant les panicules. Les forces aérodynamiques et mécaniques générées par le vent doivent dépasser les forces gardant les particules sur les surfaces (Aylor, 1975b; Braaten *et al.*, 1990; Geagea *et al.*, 1997; Ibrahim *et al.*, 2003)

1.2.1.2 Transport

Le transport du pollen de maïs dans l'atmosphère se fait essentiellement par le vent. Percival (1947, 1955) et Nowakowski & Morse (1982), ont observé que des abeilles peuvent butiner les panicules de maïs. Cependant, les inflorescences n'ont sélectionné au cours de leur évolution aucune couleur, ni architecture adaptée aux abeilles. De plus, les abeilles n'interviennent certainement que très peu dans la pollinisation croisée puisqu'elles ne butinent que les inflorescences mâles. Les insectes ont un rôle certainement mineur dans la pollinisation croisée du maïs au regard de la dispersion anémophile, et en particulier dans la pollinisation à longue distance.

Le mouvement des grains de pollen dans l'atmosphère va dépendre essentiellement de la hauteur à laquelle est libéré le pollen, de sa vitesse de sédimentation (V_s) ainsi que de la vitesse horizontale du vent moyen (U), de l'écart-type de la composante verticale de la vitesse du vent (σ_w), de la stabilité thermique de l'atmosphère ainsi que des caractéristiques des surfaces au sol. Etant donné le caractère stochastique de la turbulence atmosphérique, les grains de pollen individuels suivent des trajectoires différentes, même s'ils sont libérés par la même panicule (McCartney, 1994).

Très peu d'études ont été publiées sur la dispersion du pollen de maïs, les expérimentations de Raynor *et al.* (1972a) sont certainement les plus importantes sur le sujet. Ces travaux ont permis de mesurer la dispersion du pollen en aval d'une parcelle de maïs circulaire de 18 m de diamètre en 1963 et 1964. Les concentrations ont été mesurées à 4 hauteurs au-dessus du sol (de 0,5 à 4,6 m) à 5 distances de la source sur des rayons espacés de 20° jusqu'à environ 60 m. Ils ont trouvé que 1% du pollen mesuré à 1 m était mesuré à 60 m de la source, ce qui ne veut pas dire que 1% du pollen mesuré à 1 m est toujours présent dans l'air à 60 m comme les auteurs l'ont affirmé car ils n'ont pas fait de bilan de masse pour pouvoir franchir ce cap.

Cependant, les résultats sont très variables selon les études (Figure I-10). Haskell & Dow (1951) ont trouvé des résultats similaires à ceux de Raynor *et al.* (1972a) alors que Jones

& Newell (1946) ont trouvé que 1% du pollen mesuré à 1 m était toujours mesuré à 430 m et Jones & Brooks (1950) que 0,75% de grains de maïs formés à 1 m, l'est à 500 m. Ces observations résultent très probablement du fait que les sources de pollen étaient plus grandes et les vitesses de vent plus élevées que celles rencontrées pendant les expérimentations de Raynor *et al.* (1972a). Cependant, le manque de données météorologiques précises ne permet pas de conclure. De plus, les méthodes de mesure étaient différentes selon les études donc difficilement comparables. Celles de Raynor *et al.* (1972a) et Jones & Newell (1946) mesuraient les concentrations par impaction sur des lames microscopiques verticales tandis que celles de Jones & Brooks (1950) et Haskell & Dow (1951) mesuraient directement la fécondation croisée par comptage de grains formés dans l'épi.

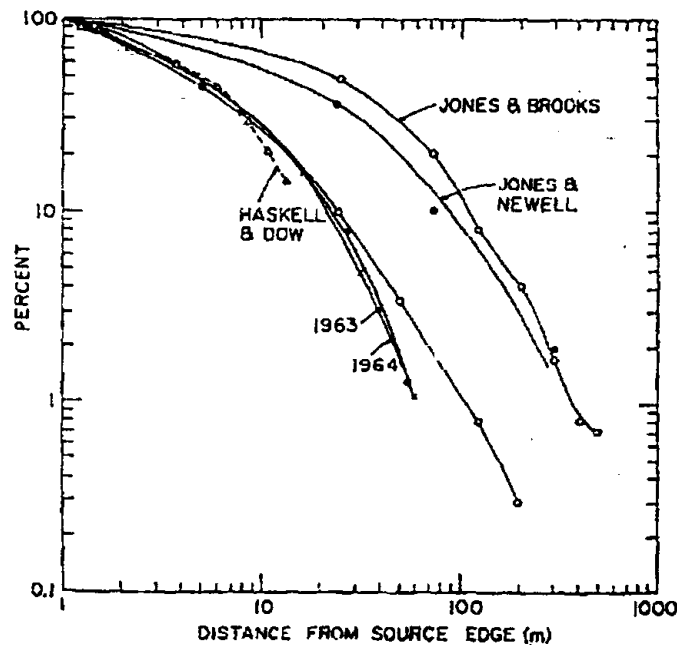

Figure I-10. Evolution de la concentration moyenne en pollen de maïs en fonction de la distance à la source, exprimée en pourcentage de la concentration mesurée à 1 m de la source, mesurée par Raynor *et al.* (1972a) en 1963 et 1964, par Jones & Brooks (1950), Jones & Newell (1946) et Haskell & Dow (1951). Tiré de Raynor *et al.* (1972a).

1.2.1.3 Dépôt

Le pollen se dépose sur les surfaces (végétation, sol) par les actions combinées de la sédimentation gravitationnelle et de l'impaction inertielle (Legg & Powell, 1979). Le dépôt du pollen par sédimentation sur la végétation, S , est proportionnel à la vitesse de dépôt du pollen V_d et à la concentration locale en pollen, C (McCartney & Aylor, 1987):

$$S = C V_d \quad (\text{I-7})$$

La vitesse de dépôt V_d peut être égale à la vitesse de sédimentation de pollen V_s (définie au paragraphe I.1.2.2) quand l'écoulement est laminaire. Quand on considère le dépôt dans un couvert végétal, V_d est généralement supposée égale à la vitesse de sédimentation de pollen, V_s (Aylor, 1975a; Legg & Powell, 1979). Cependant, en haut du couvert, V_d est égale à environ deux fois V_s , du fait de la turbulence qui favorise le dépôt (McCartney & Aylor, 1987).

Le pollen peut également s'impacter directement sur les surfaces. En effet, l'inertie de la particule ne lui permet pas de suivre exactement la ligne de courant autour d'un objet. Le dépôt par impaction, I , est proportionnel à C et la vitesse de vent U (McCartney & Aylor, 1987):

$$I = C U E \quad (\text{I-8})$$

où l'efficacité d'impaction E augmente avec la taille du grain de pollen (V_s) et la vitesse du vent (U) mais décroît avec la largeur (l) de la surface. Dans les écoulements laminaires, E est une fonction non linéaire d'un nombre sans dimension, le nombre de Stokes, $St = V_s U / g l$. Aylor (1982) a appliqué une relation pour des cylindres:

$$E = \frac{0,86}{1 + 0,442 St^{1,967}} \quad (\text{I-9})$$

Raynor *et al.* (1972a) ont également mesuré le dépôt dans et en aval de la source lors de l'expérimentation menée en 1964. Ils ont trouvé que le dépôt à 60 m représentait 0,2% du dépôt mesuré à 1 m de la source (Figure I-11), en comparaison de 1,4% pour le pollen de la fléole des près et 2,6% pour celui d'ambrosie qui ont des diamètres respectifs de grains de 34 μm et 20 μm . Ainsi, plus le pollen est gros et plus il se dépose rapidement en aval de la source. Raynor *et al.* (1972a) a estimé que le dépôt de pollen dans la source représentait 63% du dépôt total sur le sol. En revanche, le dépôt sur la végétation n'a pas été pris en compte dans cette estimation et représente très certainement encore une part non négligeable de dépôt dans la source. Cependant, aucune étude ne s'est intéressée à quantifier le dépôt de pollen de maïs dans le couvert lui-même.

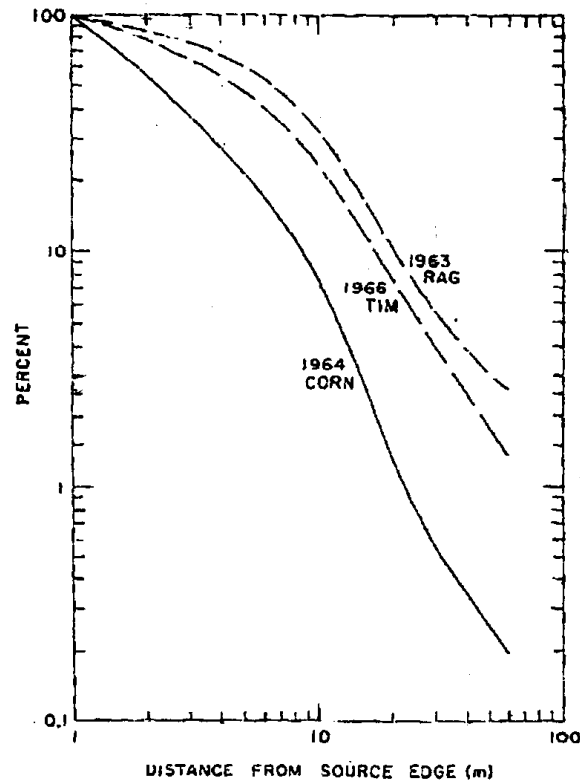

Figure I-11. Evolution du dépôt normalisé par le dépôt à 1 m en fonction de la distance à la source pour le pollen de maïs (CORN) de 90 μm de diamètre, le pollen de la fléole des prés (TIM) de 34 μm et le pollen de l'ambrosie (RAG) de 20 μm . Tiré de Raynor *et al.* (1972a).

Après que le pollen se soit déposé, il peut, soit rebondir, soit rouler sur les feuilles, soit être enlevé des feuilles lorsqu'elles sont secouées ou être emporté par un léger souffle de vent, (Aylor *et al.*, 2003). Des études théoriques (Dahneke, 1971), en conditions contrôlées (sous tunnel de ventilation) (Paw U, 1983; Aylor & Ferrandino, 1985; Braaten *et al.*, 1990) ainsi qu'en conditions naturelles (Aylor & Ferrandino, 1985) ont été effectuées sur le rebond de différents types de particules (microbilles, spores et pollen) sur différents types de surfaces (verre, feuilles de différents végétaux) et ont permis de mettre en évidence que pour rebondir la vitesse incidente de la particule doit dépasser une vitesse critique qui est inversement proportionnelle à son diamètre (Dahneke, 1971). Cette vitesse critique varie d'une particule à l'autre et est fonction de la surface sur laquelle elle rebondit. De plus, Aylor *et al.* (2003) ont montré dans une étude préliminaire que la plupart des grains de pollen situés sur la partie supérieure d'une feuille de maïs, serait remis en suspension pour une vitesse seuil du vent de 0,2-0,5 m s^{-1} . Cependant, Ibrahim *et al.* (2003) ont signalé que le détachement d'une particule n'est pas forcément suivi d'un réentraînement dans l'écoulement.

I.2.2 Méthodes de mesure

De nombreuses méthodes ont été développées pour mesurer la concentration et dépôt de particules biotiques. Dans ce chapitre, seules sont retenues les méthodes les plus fréquemment utilisées et, plus particulièrement celles utilisées dans cette thèse et qui ne sont pas détaillées dans les chapitres suivants.

I.2.2.1 Estimation de la production de pollen

La quantité de pollen produite par une panicule est déterminée à l'aide d'un sac transparent en film plastique Osmolux (Pantek, Montesson, France) (Figure I-12). Ces sacs sont imperméables à l'eau de pluie mais permettent la circulation de l'air et de la vapeur d'eau, ce qui limite la condensation et permet d'éviter que les grains de pollen n'éclatent (Foueillassar X., comm. pers.). En revanche, ils n'évitent certainement pas l'effet de serre entraînant un réchauffement des panicules. Ils sont placés pendant 24 h, généralement le matin, sur une panicule entière et fermées à la base de la panicule à l'aide d'un lien.



Figure I-12. Sac en film plastique OSMOLUX transparent et poreux entourant une panicule et fixé à la base à l'aide d'un lien afin de récolter le pollen produit.

Le pollen ainsi récolté est ensuite rincé à l'aide d'un électrolyte (Coulter Isoton, Beckman, USA) pour un comptage ultérieur au compteur automatique de particules (Coulter Multisizer III, Beckman, USA). Le principe Coulter est une méthode de détection volumétrique (Figure I-13). Les grains de pollen sont mis en suspension dans un bêcher rempli d'Isoton, dans lequel vient plonger un tube en verre, percé à la base d'un orifice parfaitement calibré. Deux électrodes situées de part et d'autre de l'orifice mesurent la résistance. Un courant aspire le pollen et quand celui-ci passe à travers l'orifice, les électrodes enregistrent une variation de résistance dont l'amplitude est directement proportionnelle au

volume. Ainsi, non seulement le Coulter permet de compter le nombre de grains mais également d'accéder à la taille du grain compté. Cependant, le diamètre des grains mesuré avec le Coulter est celui du grain humecté. En outre, l'agitateur qui assure le mélange des grains de pollen pendant la mesure, a certainement tendance à sélectionner l'aspiration des plus petits grains par ségrégation des plus gros sur les bords du bûcher.

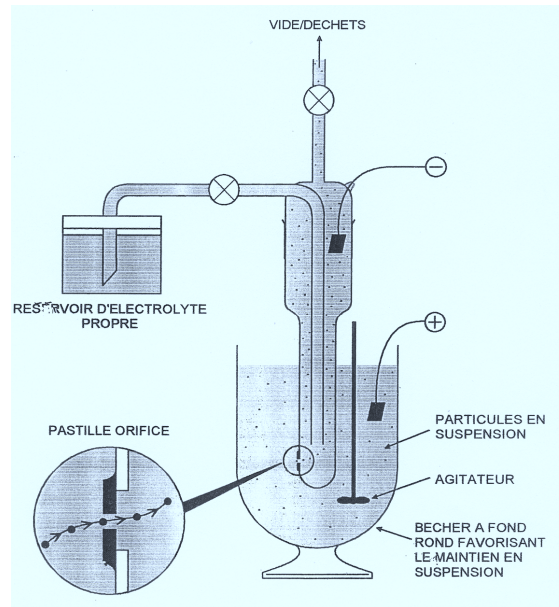

Figure I-13. Le principe Coulter. Les grains de pollen en suspension dans le bûcher rempli d'un électrolyte vont passer par un orifice et modifier le courant entre les deux électrodes.

1.2.2.2 Mesure de la concentration de pollen dans l'air

Le Burkard (Burkard Manufacturing Co., Rickmansworth, UK) est un capteur volumétrique et automatique, basé sur le principe du piège à spores de Hirst (1952), qui permet de mesurer la concentration en spores ou pollen dans l'air en continu. Placé au milieu d'une parcelle émettrice, il permet alors d'accéder à la dynamique de la libération de pollen. Le Burkard aspire l'air à un débit de 10 litres par minute à travers un orifice de 2×14 mm qui est maintenu face au vent grâce à une girouette et protégé de la pluie par un plateau (Figure I-14). Derrière l'orifice, une bande, graissée avec une solution à base de vaseline et d'hexane (British Aerobiology Federation, 1995), est placée sur un tambour qui tourne à un rythme de 2 mm par heure, permettant de collecter le pollen sur une période de 7 jours en continu. Le début et la fin de la mesure sont marqués à l'aide de spores de lycopode (de 20-30 μm de diamètre) placées devant l'orifice.

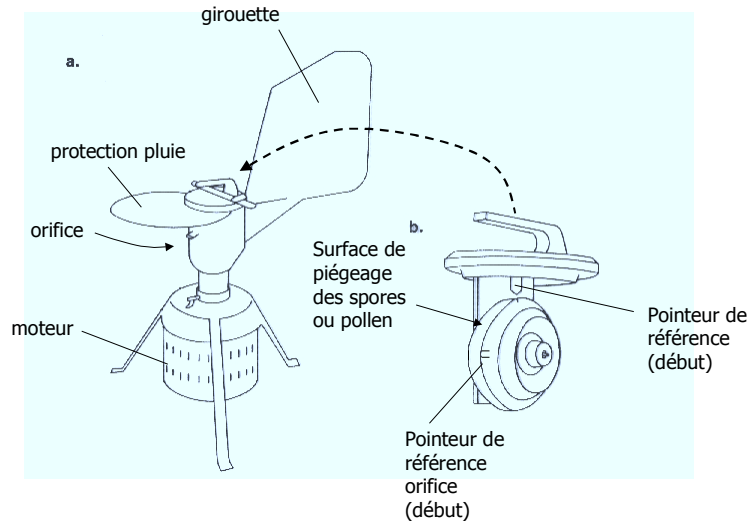

Figure I-14. (a) Vue d'ensemble du Burkard. (b) Tambour permettant une mesure sur 7 jours. Tiré de British Aerobiology Federation (1995)

Après exposition, la bande est découpée en sections de 48 mm, correspondant à une journée d'exposition, à l'aide d'une règle graduée (Figure I-15). Chacune des sections est ensuite placée sur une lame de microscope, les grains de pollen sont fixés au Gelvatol (Burkard Manufacturing Co., Rickmansworth, UK) et recouverts d'une lamelle pour un comptage ultérieur au microscope.

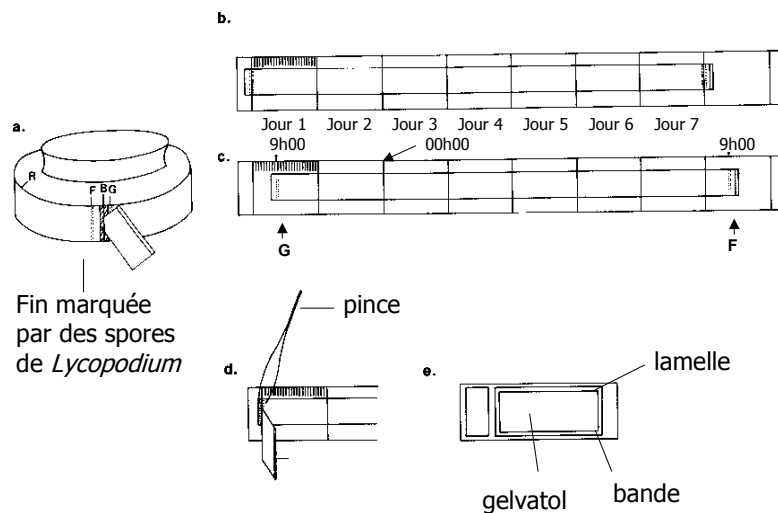

Figure I-15. Préparation de la bande du Burkard pour un comptage au microscope. (a) Décollage de la bande du tambour. (b) Transfert de la bande sur la règle de découpage en plaçant le début de la bande (marquée par les lycopodes) à gauche sur l'heure de début, G, à l'aide de la graduation (c). Les 7 bandes sont découpées suivant les rainures de la règle (correspond à minuit) et placées à l'aide d'une pince (d) sur une lame de microscope (e). La bande est recouverte de Gelvatol et d'une lamelle pour fixer les grains de pollen. Tiré de British Aerobiology Federation (1995)

Ce type de capteur est particulièrement utilisé dans la surveillance de spores et pollen allergisants. L'efficacité d'impaction dépend des variations de vitesse et direction du vent et de la taille de la particule. Hirst (1952) a montré qu'avec un débit d'échantillonnage de 10 l min^{-1}

et en utilisant le mélange de vaseline et d'hexane pour enduire la bande, l'efficacité d'impaction de spores de *Lycopodium* dans un tunnel de ventilation était de 62,4 à 93,8% avec des vitesses de vent allant de 1,5 à 9,3 m s⁻¹ (Hirst, 1952). Pour des vitesses de vent supérieures à 2 m s⁻¹, des spores de 50 µm de diamètre sont piégées plus efficacement que des spores de 20 µm. Cependant, cette observation semble s'inverser lorsque l'efficacité est mesurée au champ. Ceci est très principalement dû au lent temps de réponse du capteur au changement de direction de vent, à la petite taille de l'orifice et au faible débit d'échantillonnage (Lacey & Venette, 1995). Ces résultats suggèrent donc que dans le cas du maïs, le capteur sous-estime très certainement la concentration.

Un second type de capteur utilisé est le rotorod. Celui-ci est aisé à fabriquer et se compose d'une tige en laiton en forme de U mise en rotation à l'aide d'un petit moteur (12 V) (Figure I-16). Les particules sont capturées sur les bras verticaux de la tige, sur lesquels a été préalablement disposée une bande enduite de graisse de silicone. Le débit d'échantillonnage D_t (l min⁻¹) dépend de la vitesse de rotation du rotorod (ω en tours min⁻¹) et des dimensions de la surface de capture. Si on considère que l'efficacité d'impaction est de 100% (elle est probablement proche de 86% (Aylor, 1982)), le débit pour les deux bras verticaux est alors de:

$$D_t = 2 \times \pi d_r h_t l_t \omega \quad (\text{I-10})$$

où d_r est le diamètre du rotorod, h_t la hauteur et l_t la largeur de la tige. Si on prend l'exemple du rotorod utilisé par McCartney *et al.* (1997), le débit d'échantillonnage varie de 150 et 200 l min⁻¹ pour une vitesse de rotation allant de 3000 à 4000 tours min⁻¹ ($d_a = 7,2$ cm; $h_a = 6$ et $l_a = 0,16$ cm).

Dans le cas de la mesure de concentration du pollen de maïs, le rotorod est une méthode plus avantageuse que celle du Burkard: son débit d'échantillonnage est beaucoup plus élevé et il n'est pas sensible aux variations de direction de vent. Cependant, il doit être utilisé sur des périodes de temps courtes afin d'éviter la saturation des tiges.

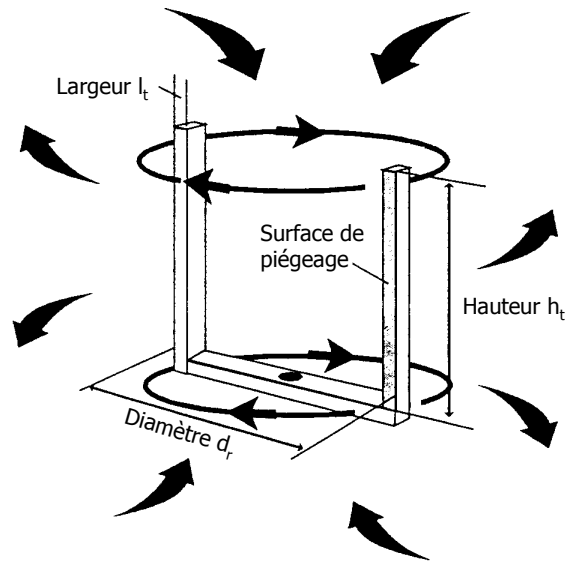

Figure I-16. Rotorod en rotation sur son axe et alimenté par un moteur 12V.

I.2.2.3 Mesure du dépôt de pollen

Le dépôt est souvent mesuré à l'aide de lames microscopiques ($2,5 \times 7,5$ cm) déposées sur le sol et recouvertes d'une substance collante (graisse de silicone par exemple) (Durham, 1946b). Malgré leur simplicité, l'interprétation des résultats est difficile en terme de quantité de pollen dans l'air car la capture ne peut être reliée au volume échantillonné et les différents auteurs confondent souvent concentration, dépôt et quantité mesurée. Le dépôt mesuré dépend de la taille et de la forme de la surface d'échantillonnage (May & Clifford, 1967). Les effets de la turbulence peuvent être diminués en exposant les lames de microscopes sur des surfaces horizontales plus grandes que la lame (Durham, 1946b) ou dans le fond d'un grand pot (McCartney *et al.*, 1985).

I.3 Modèles de dispersion atmosphérique de particules biotiques

Les expérimentations présentent l'avantage de mesurer directement les concentrations et dépôt de pollen au champ mais les résultats obtenus restent fortement dépendant des conditions météorologiques rencontrées. En revanche, elles sont indispensables pour valider des modèles de dispersion qui permettent d'analyser une diversité de situations. On distingue les modèles empiriques et physiques.

I.3.1 Modèles empiriques

Ces types de modèles peuvent être utiles pour décrire des gradients de concentration ou de dépôt en aval de la source. Les modèles empiriques les plus utilisés sont la loi puissance et le modèle exponentiel (McCartney & Fitt, 1985). La loi puissance fait l'hypothèse que le nombre de grains de pollen déposés (D) ou la concentration dans l'air (C) est inversement proportionnel à la distance en aval de la source (x):

$$D = ax^b \quad (\text{I-11})$$

où a et b sont des constantes. Une relation exponentielle négative peut souvent être utilisée pour exprimer l'évolution de D avec x :

$$D = D_0 \exp(-\alpha x) \quad (\text{I-12})$$

où D_0 et α sont des constantes. Le coefficient α détermine le taux de diminution du dépôt (ou de la concentration) avec la distance. Bien qu'elle ne soit pas valable dans certaines situations (Aylor, 1987), la relation exponentielle fournit une méthode pratique pour visualiser les gradients en exprimant la demi-distance ($d_{1/2} = \ln 2 / \alpha$) qui est la distance à laquelle le dépôt (ou la concentration) a diminué de moitié. La demi-distance, pour les spores et pollen dispersés par le vent, est située entre quelques centimètres et quelques centaines de mètres (McCartney, 1994) suivant la taille des grains. Fitt *et al.* (1987) ont comparé les deux modèles pour différents pollen et spores. Ils rapportent que, dans le cas de la loi puissance, b varie entre 1,61 et 2,09 pour les spores de lycopodes et 1,27 et 1,91 pour du pollen de maïs. De même, pour la loi exponentielle, ils trouvent des valeurs de α comprises entre 0,077 et 0,149 pour les lycopodes, et entre 0,084 et 0,184 pour le maïs et une demi-distance entre 4,67 et 9 m pour les lycopodes et entre 3,77 et 8,27 m pour le pollen de maïs. Cependant, Aylor *et al.* (2003) soulignent le fait que les fonctions de dispersion ont une queue de distribution très étendue et que par conséquent, le concept de demi-distance est inapproprié voire trompeur. Les modèles empiriques sont essentiellement descriptifs. Ils ne permettent pas d'extrapoler en dehors des conditions de l'expérimentation.

I.3.2 Modèles physiques

Les processus de dispersion des particules ne diffèrent pas de ceux concernant la dispersion des gaz si deux conditions sont respectées (Csanady, 1973): (1) les particules doivent être assez légères pour suivre les tourbillons les plus rapides qui contribuent à la dispersion, (2) les particules tombent assez lentement pour qu'elles ne sortent pas du tourbillon dans lequel elles sont transportées avant que celui-ci ne disparaisse. En fonction du

repère utilisé, deux approches sont couramment utilisées, l'une fait appel au repère eulérien, fixe et lié à l'observateur et l'autre au repère lagrangien qui suit le mouvement du fluide ou de la particule.

I.3.2.1 *Modèle de type gaussien*

La première approche est d'adapter le panache gaussien de la dispersion des gaz. Ces modèles ont été plus particulièrement utilisés pour prédire les concentrations en polluants dans l'atmosphère et plus récemment de spores (McCartney & Fitt, 1985). Ils supposent que la distribution moyenne des particules peut être décrite verticalement et latéralement par des courbes gaussiennes et que l'écart-type dans chacune des directions (σ_z selon la direction verticale et σ_y selon la direction latérale) change avec la distance en aval de la source x (Figure I-17). Il est également supposé que le dépôt ne modifie pas la concentration. Pour une source émettant Q particules par unité de temps et de longueur et pour un modèle à deux dimensions (2D), la concentration à la distance x et à la hauteur z est décrite par:

$$C(x,z) = \frac{Q}{U} \frac{1}{\sqrt{2\pi}\sigma_z} \left[\exp\left(-\frac{(h_s-z)^2}{2\sigma_z^2}\right) + \exp\left(-\frac{(h_s+z)^2}{2\sigma_z^2}\right) \right] \quad (\text{I-13})$$

où h_s est la hauteur de la source et U la vitesse moyenne du vent dans la couche de surface. Le dépôt peut être partiellement pris en compte en réduisant le terme source, Q , en fonction de la distance (McCartney & Fitt, 1985).

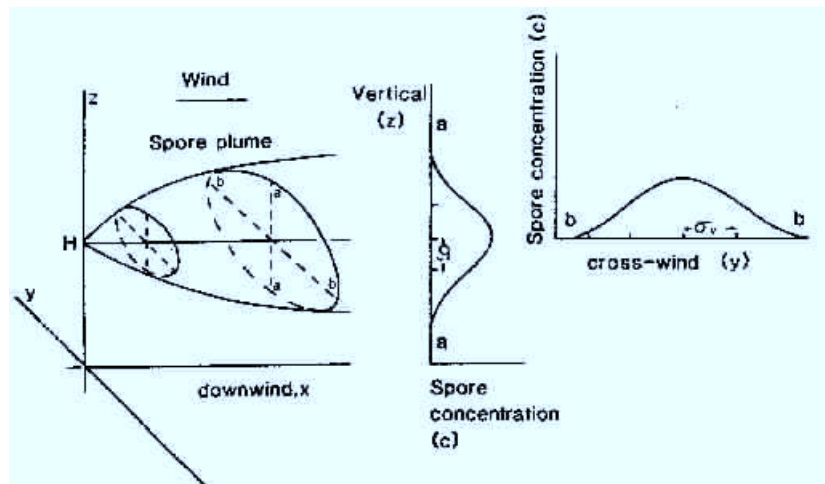

Figure I-17. Dispersion de spores en aval d'une source ponctuelle située à une hauteur H . L'axe x représente la direction du vent moyen et l'axe z , la direction verticale. Les distributions gaussiennes de la concentration en spores C dans les directions verticale (a – a) et latérale (b – b). Les écarts types σ_z et σ_y sont également illustrés. D'après McCartney & Fitt (1985).

De manière générale, plus l'écoulement est turbulent et plus le panache s'étale rapidement avec la distance. Des valeurs de σ_z sont décrites analytiquement en fonction de la stabilité de l'atmosphère (Tableau I-3).

Tableau I-3. Classe de stabilité (Pasquill, 1962) et représentation analytiques de σ_z . Tiré de McCartney & Fitt (1985).

Classe de stabilité	Description	Ecart-type de $C(x,z)$ de la direction z σ_z
A	fortement instable	$0,20 x$
B	instable	$0,12 x$
C	légèrement instable	$0,08 x (1 + 0,002 x)^{-0,5}$
D	neutre	$0,06 x (1 + 0,0015 x)^{-0,5}$
E	légèrement stable	$0,03 x (1 + 0,0003 x)^{-1}$
F	stable	$0,016 x (1 + 0,0003 x)^{-1}$

I.3.2.2 *Modèle de type gradient-diffusion*

Les modèles de type gradient-diffusion sont basés sur l'analogie à la diffusion moléculaire et ont été utilisés pour étudier la dispersion de spores et de pollen (Itier & Pauvert, 1979; Legg & Powell, 1979; Aylor, 1982; McCartney & Lacey, 1991). La dispersion de particules est décrite par les équations de diffusion classiques avec des termes supplémentaires pour tenir compte du dépôt (Figure I-18). Pour une source linéaire et infinie, la variation de la concentration C est exprimée en 2D à l'aide d'une équation différentielle:

$$U \frac{\partial C}{\partial x} = \frac{\partial}{\partial z} \left(K_z \frac{\partial C}{\partial z} \right) + V_s \frac{\partial C}{\partial z} - DC \quad (\text{I-14})$$

où K_z est la diffusivité turbulente verticale, V_s la vitesse de sédimentation des particules et D le taux de dépôt volumique (par sédimentation et impaction). L'équation (I-14) exprime la conservation du nombre de particules. Pour résoudre cette équation, K_z , U et D doivent être définis en chaque point de l'espace.

Le principal inconvénient de ces modèles est lié à l'hypothèse que les échelles de longueur des mouvements verticaux des masses d'air sont petites en comparaison de la longueur caractéristique représentative des variations des concentrations en particules. Ce qui est particulièrement inexact à proximité de la source (Aylor, 1990) et dans un couvert végétal. Une autre difficulté provient du fait que ces modèles ne prennent pas véritablement en compte les rafales de vent qui, dans le cas des spores, semblent jouer un rôle primordial dans la libération (Shaw *et al.*, 1979; Aylor, 1990).

simples permettent de créer un modèle LS pour les petites particules inférieures à 300 μm de diamètre (Wilson, 2000).

Aylor & Flesch (2001) ont utilisé un modèle à deux dimensions pour incrémenter la composante horizontale (u) et verticale (w) du fluide dans lequel une spore se déplace dans la direction du vent moyen horizontal (x) et la direction verticale (z) pendant un pas de temps dt :

$$\begin{aligned} du &= a_u dt + b_u d\xi_u & dx &= u dt \\ dw &= a_w dt + b_w d\xi_w & dz &= (w - V_s) dt \end{aligned} \quad (\text{I-16})$$

où les coefficients de Langevin a_u , b_u , a_w et b_w sont fonctions de la vitesse et de la position; $d\xi_u$ et $d\xi_w$ sont des nombres aléatoires tirés parmi des distributions gaussiennes indépendantes, chacune de moyenne 0 et de variance dt ; et V_s est la vitesse de sédimentation du pollen en air calme.

Même s'ils nécessitent de définir un champ de vent eulérien, les modèles lagrangiens permettent de prendre en compte l'effet des rafales. Ils ont été utilisés avec succès pour prédire la dispersion de spores (Aylor & Flesch, 2001) et de particules de différentes tailles (Wilson, 2000).

Chapitre II Mesures de la concentration

atmosphérique et des flux de pollen de maïs

II.1 Field measurements of airborne concentration and deposition of maize pollen

Article publié dans Agricultural and Forest Meteorology, 119 (2003)37-51

II.1.1 Introduction

Over the last few years there has been an increasing interest in pollen dispersal, particularly in relation to gene flow from transgenic crops (Lavigne *et al.*, 1998; Klein, 2000) and the maintenance of seed quality. Maize (*Zea mays*) is primarily wind pollinated and is one of the most cultivated cereal crop in many parts of the world. Transgenic maize cultivars are widely grown in North America. However, at present there are concerns about possible gene transfer from transgenic maize crops to non-transgenic crops.

There have been surprisingly few studies reporting pollen dispersal from maize crops. The studies of Raynor *et al.* (1970, 1972a,b) are probably the most comprehensive. They measured atmospheric concentrations and deposition rates of maize pollen at different distances downwind of two circular experimental plots of 18.3 m diameter. They noted that concentration and deposition of maize pollen were several times smaller than those for timothy (*Phleum pratense*), a grass, and ragweed (*Ambrosia artemisiifolia*), an anemophilous weed. Maize pollen grains are roughly spherical with diameters around 90 μm (Di-Giovanni *et al.*, 1995) and are much larger than either timothy (about 40 μm) or ragweed (18 – 20 μm) pollen. Raynor *et al.* (1970, 1972a,b) clearly showed a quantitative effect of the grain size on dispersion and deposition of pollen. The other outcome of their studies was to determine the isolation distance required for production of purebred seed. They found that concentration and deposition of maize pollen declined rapidly with distance from the plot. However, the

meteorological conditions during their experiments were not reported in sufficient detail to enable validating a dispersion model for maize pollen. Without the use of such model, it would be hard to draw generalised conclusions about distance of maize pollen dispersal in a range of climatic conditions.

In this study, we present the results of an experiment where vertical and horizontal profiles of airborne maize pollen concentrations and deposition rates were measured downwind of a 20 m × 20 m maize plot. We also present estimates of horizontal fluxes of maize pollen at two distances downwind from the source and discuss their validity.

II.1.2 Material and Methods

II.1.2.1 Experimental site

The experiment were done between the 24 July and the 6 August 2000, on a commercial farm at Montargis (latitude = 48°00'N; longitude = 2°44'E; altitude = 90 m), France. The experimental design consisted of a 20 m × 20 m plot of maize, thereafter called source plot, cultivar Adonis (blue grains Pau Semences, France), located in the centre of a 120 m × 122 m area of bare soil (Figure II-1).

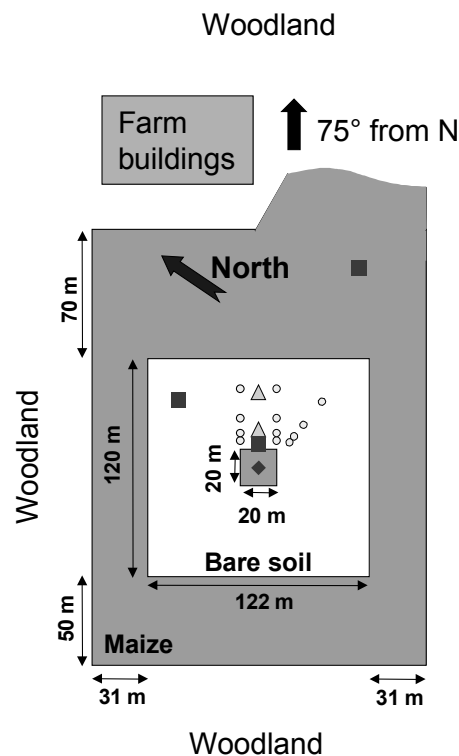

Figure II-1. Experimental design. (■) Sonic anemometers, (◆) the meteorological mast and Burkard trap, (▲) the mass balance masts, and (●) the deposition plates. The mass balance masts, and deposition plates were moved so that they were downwind of the source plot. Prevailing direction of wind was generally from 225°.

The plot and surrounding bare soil was located in the middle of a 184×240 m maize field (target field), cultivar Adonis. The maize in the plot and surround was sown on 17 May at a sowing density of $98,000$ plants ha^{-1} . The experimental site had woodland (approximately 15 m tall) to the north, east and west. Two farm buildings were also to the north (Figure II-1). Measurements were made of the dispersal of maize pollen downwind of the central source plot on 12 occasions during flowering. The experiments are referred to as R1 to R12 in the rest of the paper. The downwind distance from the source will be called hereafter x , and the height above the ground z . All times are given in universal time, UT (\equiv GMT), which is the local time minus 2h during the experiment, and was very close to the solar time. This experiment was conducted in parallel with an other experiment to measure cross-pollination of the target field by the source plot.

The heights of the highest leaf (canopy height), the tassel and the ear were measured on 30 plants in the source plot on 31 July. The median height of the base and the top of the tassels were 2.2 and 2.5 m ($\pm 10\%$, standard deviation/median) respectively, the median canopy height was 2.28 m ($\pm 9\%$), and the median height of the ears was 1.1 m ($\pm 8\%$).

II.1.2.2 Micrometeorological measurements

Wind speed, wind direction, air temperature, relative humidity, surface wetness index and global radiation were measured in the centre of the source plot. The instruments were mounted on several masts. The name, type and height of each instrument are given in Table II-1). Net radiation, soil heat flux and rain were measured in the bare soil area. Measurements were recorded every 5 s using a Campbell CR10 datalogger (Campbell Scientific, UK), and averaged over 15 min. During each experiment a 3D ultrasonic anemometer was operated in the centre of the source plot, another above the bare soil area, and a third above the target field (Figure II-1, Table II-1). Unfortunately, the sonic anemometer placed above the target field did not work during some of the experiments. The friction velocity (u_*) and the Monin-Obukhov length (L) were therefore estimated as the average of the two other sonic anemometers. The values of u_* and L were very similar for these two sonic anemometers, and were representative of the bare soil surface. Wind speed profiles, up to $z = 4$ m, were measured at $x = 3$ and 10 m downwind from the source plot using cup anemometer (see Table II-1 for measurements heights). All meteorological data were averaged over each run to ease the comparison between runs, and to provide input data for future dispersion modelling.

Table II-1. Location and description of the meteorological instruments used during the experiment. Height is height above ground. Negative height denotes measurements in the soil.

Parameter	Symbol	Height m	Location	Type/Source
Global radiation	R_g	5	Source plot	Pyranometer, model CM6, Kipp & Zonen, Delft, The Netherlands
Net radiation	R_n	2	Bare soil	Net radiometer, model S-1, Swissteco, Oberriet, Switzerland
Relative humidity	RH	2.1 and 4.1	Source plot	Capacitive hygrometer, Vaisala, Helsinki, Finland
Surface wetness index	SWI	2.1	Source plot	Wetness grid sensor model 237 Campbell scientific, Shepshed, UK
Air temperature	T_a	2.1 and 4.1	Source plot	0.2 mm ² copper-constantan thermocouples, Thermoelectric Limeil Brévannes, France
Horizontal wind speed	U	2.4	Source plot	Cup anemometer, MCB opto electronic, Courbevoie, France
Friction velocity &	u_*	1.1 2	Bare soil Source plot	Ultrasonic anemometer, Model R2, Gill instruments, Lymington, UK
Monin-Obukhov length	L	3.95	Target field	
Wind direction	WD	5	Source plot	Wind-vane, INRA own design, France
Ground heat flux	G	- 0.1	Bare soil	Flux plates, Campbell scientific, Shepshed, UK
Horizontal wind speed	U	0.25, 0.5, 1.0, 2.0 and 4.0	Flux profile masts	Cup anemometer, MCB opto electronic, Courbevoie, France; CIMEL, Paris, France
Rainfall	Rain	1.0	Bare soil	Rain gauge, Campbell scientific, Shepshed, UK

II.1.2.3 Pollen Measurements

II.1.2.3.1 Pollen concentration in the source plot.

A 7-day recording spore trap (Burkard Manufacturing Co., Rickmansworth, UK) was placed in the centre of the source plot with its inlet orifice at about the height of the tassels, and was operated continuously throughout the experiment. The operation of this type of trap is described in detail elsewhere (British Aerobiology Federation, 1995; Lacey & Venette, 1995). Briefly, the trap collected spores on a clear film (Melinex tape, Burkard Manufacturing Co., Rickmansworth, UK) attached to a slowly rotating drum, allowing pollen concentration to be recorded over a 7 day period. The tape surface was coated with a mixture of petroleum jelly and paraffin wax (British Aerobiology Federation, 1995). After exposure, each tape was cut into 48 mm sections, representing 24 hours exposure periods, and was permanently mounted on a microscope slide using Gelvatol (Burkard Manufacturing Co., Rickmansworth, UK) and a glass coverslip (British Aerobiology Federation, 1995). The hourly concentrations of maize pollen grains were estimated by counting them on 2mm wide transects using a light microscope.

II.1.2.3.2 Pollen production.

The pollen production per plant per day was determined using the same five individual plants each day. Polythene bags Osmolux (Pantek, France) were placed over the whole tassel at 09:00 UT every day and left for a period of 24 h. The pollen grains that accumulated in the bags were collected in bottles containing electrolyte solution (Coulter Isoton, Beckman, USA). The number of pollen grains collected was estimated by counting sub-samples with a cell counter (Coulter Multisizer III, Beckman, USA). The proportion of flowering plants in the field was also estimated by observing the number of plant that has started flowering and the number of plants that had finished flowering for 25 plants in the plot each day. These observations and the measurements of pollen production from the marked plants were used to estimate the daily pollen production in the whole plot. The production during each run was estimated by multiplying the daily production by the ratio of pollen concentration in the crop integrated over the run to pollen concentration integrated over the whole day.

II.1.2.3.3 Pollen concentration downwind of the source plot.

Vertical profiles of pollen concentration were measured at $x = 3$ and 10 m downwind of the source plot using 4 m tall “mass balance” masts (the same masts used for wind speed profiles). Pollen concentrations were measured at 5 heights (0.25, 0.5, 1.0, 2.0 and 4.0 m above the ground) using rotating-arm spore traps (McCartney & Lacey, 1991; McCartney *et al.*, 1997). The traps were built at INRA based on the design of McCartney & Lacey (1991), with slight changes. Each trap was made from a 2 mm square section brass rod bent into a U-shape to give two vertical arms, 50 mm long and 78 mm apart (diameter of the trap, d_a). The arms were attached to 12V electric motors that rotated between 3000 and 4000 rpm, depending on the applied voltage (equivalent air sampling rate of 158 and 210 l min⁻¹). The rotational velocity (ω) of each trap was calibrated against applied voltage, which was measured before and after each experiment to estimate the rotation speed of each individual trap. Pollen grains were collected on two acetate strips (approximately 2.15 mm wide (l) and 50 mm high (h)) glued to the leading edge of the vertical arms. The strips were covered with a thin layer of silicon grease to retain the catch. After each run, these slides were detached and permanently mounted on a microscope slide as for the Burkard samples, prior to visual counting using a light microscope. The airborne pollen concentration, C , was determined assuming an impaction efficiency of 0.86 (Aylor, 1982), according to the following equation:

$$C = \frac{N}{0.86 \pi d_a \omega l h \Delta t} \quad (\text{II-1})$$

where N is the average number of pollen grains per arm for each trap, d_a is the rotating-arm diameter, ω is the rotational velocity, l is the width of the rotating-arm, h is its height, and Δt is the duration of each run. The masts were moved before each experiment so that they were aligned within the downwind fetch of the source. The rotating-arm traps were operated for periods of between 90 and 180 min.

The horizontal flux of pollen at height z , $F_x(z)$, was estimated from the mean averaged pollen concentration, $C(z)$ and wind speed, $U(z)$ as $F_x(z) = C(z).U(z)$, neglecting the turbulent component of the horizontal flux $\overline{u'c'}$, where u' and c' are the fluctuating component of the wind speed and concentration, respectively (see Section II.1.4 for an estimation of this term). The integrated horizontal flux passing through each mast, $F_x^{\{0-4\}}$, was estimated by integrating $F_x(z)$ from $z = 0$ to 4 m using the trapezoidal method. Since the $F_x(z)$ should be zero at the lower boundary, due to a zero wind speed, the measured $F_x(z)$ was extrapolated to $F_x(0) = 0$. The roughness length z_0 and the displacement height d were neglected, as they are small over a bare soil.

II.1.2.3.4 Pollen deposition to the ground

The deposition rate of pollen was estimated using small containers (diameter = 50 mm, height = 70 mm), containing approximately 30 ml of Coulter Isoton. The containers were placed 1, 2, 3, 4, 8, 10, 16 and 32 m downwind of the source plot along three lines. The tops of the containers were at 0.35 m above the ground for one line and at 0.15 m for the two others. They were opened at the beginning of each run and closed at the end. The number of pollen grains collected in each container was estimated by first filtrating the sample, rinsing the filters with Coulter Isoton, taking four 100 μ l sub-samples, and counting the number of pollen grains in each sample using a binocular microscope. Deposition rates were calculated from estimates of the number of pollen grains collected and time of exposure. The deposit traps were operated for the same time as the rotating-arm traps (see Table II-2). The integrated deposition rates between $x = 1$ and 3 m (D_{1-3}), $x = 3$ and 10 m (D_{3-10}), and $x = 1$ and 32 m (D_{1-32}), were estimated by integrating the measured deposition along x , using a trapezoidal rule. As this integration is one dimensional, the integrated deposition rate is not the total deposition as a function of distance. The deposit between $x = 3$ and 10 m was also estimated, using the mass balance method, as the difference between the integrated horizontal fluxes measured with the masts at these distances (ΔF_{3-10}):

$$\Delta F_{3-10} = F_3^{\{0-4\}} - F_{10}^{\{0-4\}} \quad (\text{II-2})$$

Table II-2. Date, solar time, sampling line orientation and average micrometeorological conditions measured above and within the source plot during each experimental run. Where R_g is the global solar radiation; RH the relative humidity; SWI the surface wetness index; Rain the rainfall; T_a the air temperature; VPD the vapour pressure deficit of the air; U the wind speed, WD the wind direction and WDr the wind direction relative to sampling line direction. All measurements were made at a height of 2.1 m except U which was measured at 2.4 m and R_g and WD which were measured at 5 m. u_* , the friction velocity, and L , the Monin-Obukhov length, were measured with the sonic anemometers. Means and standard deviation are given.

Experiment				R_g	RH	SWI	Rain	T_a	VPD	U	u_*	L	WD	WDr
Run	Date (July)	Time (UT*)	Sampling line direction (°)	(W m ⁻²)	(%)	(%)	(mm)	(°C)	(kPa)	(m s ⁻¹)	(m s ⁻¹)	(m)	(°)	(°)
R1	25	08:30-10:30	248	595 ± 145	81 ± 5	0	0	19.4 ± 0.8	0.44 ± 0.14	0.8 ± 0.1	0.21 ± 0.05	-10	256 ± 18	8
R2	25	11:00-14:00	250	680 ± 168	61 ± 3	0	0	23.3 ± 0.6	1.13 ± 0.13	0.6 ± 0.1	0.17 ± 0.05	-6	241 ± 27	-9
R3	25	14:30-15:30	250	98 ± 77	70 ± 11	50	0	21.2 ± 1.5	0.78 ± 0.34	0.4 ± 0.2	0.08 ± 0.01	-4	209 ± 52	-41
R4	26	08:00-10:00	250	468 ± 106	80 ± 4	0	0	19.8 ± 0.8	0.45 ± 0.11	0.9 ± 0.2	0.25 ± 0.08	-22	247 ± 20	-3
R5	26	13:15-15:15	250	679 ± 135	57 ± 2	0	0	24.8 ± 0.4	1.35 ± 0.09	0.7 ± 0.1	0.31 ± 0.05	-48	244 ± 10	-6
R6	27	08:00-10:00	250	242 ± 96	81 ± 2	1	0	19.1 ± 0.4	0.43 ± 0.05	0.7 ± 0.1	0.21 ± 0.05	-36	233 ± 17	-17
R7	27	12:45-14:15	250	298 ± 94	69 ± 2	2	0	21.1 ± 0.4	0.76 ± 0.08	0.6 ± 0.1	0.17 ± 0.07	-14	266 ± 8	16
R8	28	07:45-08:15	270	352 ± 183	83 ± 1	4	1.6	18.7 ± 0.8	0.36 ± 0.10	0.9 ± 0.1	0.26 ± 0.1	-43	263 ± 5	-7
R9	30	08:15-10:15	270	700 ± 151	63 ± 4	0	0	22.6 ± 1.1	1.02 ± 0.18	0.1 ± 0.1	0.12 ± 0.09	**	153 ± 42	-117
R10	30	13:00-15:00	270	690 ± 201	52 ± 3	0	0	24.7 ± 0.8	1.51 ± 0.13	0.6 ± 0.1	0.19 ± 0.09	-16	302 ± 19	32
R11	31	07:30-09:30	117	583 ± 79	64 ± 9	12	0	23.2 ± 1.9	1.06 ± 0.36	0.4 ± 0.1	0.13 ± 0.11	-9	98 ± 15	-19
R12	31	10:00-12:30	117	751 ± 98	50 ± 2	0	0	26.3 ± 0.7	1.73 ± 0.11	0.4 ± 0.1	0.17 ± 0.004	-8	154 ± 22	37

* Universal Time (roughly close to solar time. In France, it is local time – 2h in summer)

** Monin-Obukhov length was out of its range of validity, and as u_* was small this suggests that the conditions during this run were close to free convection.

Equation (II-2) assumes that three components of the mass balance can be neglected: (i) the turbulent component of the horizontal flux ($\overline{u'c'}$) at each distance, (ii) the vertical flux through the lid of the volume delimited by the two masts ($F_z(z = 4 \text{ m})$), and (iii) the divergence of the lateral flux ($\partial F_y / \partial y$). The validity of these assumptions is evaluated in Section II.1.4.

II.1.3 Results

II.1.3.1 Micrometeorological measurements

The spring and early summer of 2000 at Montargis were particularly wet, which delayed the growth and flowering of the maize crop. During the experimental period, rain occurred on the first 4 days, however it only rained during run R8, and run R3 was interrupted due to rain. Average values of micrometeorological variables for each run are given in Table II-2. During most runs, wind speed was low, mean solar radiation ranged between about 100 and 750 W m^{-2} , and relative humidity varied from 50 to 83%. During all runs the thermal stratification of the surface boundary layer was unstable, as shown by the negative Monin and Obukhov length and the large standard deviations for wind direction ($5\text{-}52^\circ$). During run R9, the air flow was probably close to free convection. For 8 of the runs the mean wind direction relative to the direction of the masts and containers was less than 20° ; for three of them it was between 30 and 40° (R3, R10 and R12), and for run R9, it was greater than 100° .

II.1.3.2 Pollen production

Pollen production began on 26 July and lasted 14 days, with the maximum production occurring on the 1 and 2 August (Table II-3). The number of pollen grains emitted per day per plant ranged from 10^4 to 2×10^6 , which corresponds to roughly 5×10^7 to 7×10^9 grains per day for the whole source plot. Over the pollination period, pollen production was on average 1.4×10^7 grains per plant.

Table II-3. Number of plants starting and ending flowering, and daily pollen production per plant. The flowering status was estimated by observing 25 plants, pollen production was assessed from the same five individual plants. The total production over the pollination period was 1.4×10^7 grains per plant.

Day of year 2000	Plants starting flowering (%)	Plants ending flowering (%)	Daily pollen production for the whole field	
			grains day ⁻¹ plant ⁻¹	% of the total pollen production
25 July	0	0	1.3×10^4	0.1
26 July	4	0	1.9×10^5	1.3
27 July	16	0	3.3×10^5	2.4
28 July	12	0	5.5×10^5	4.0
29 July	16	0	1.0×10^6	7.4
30 July	20	0	1.3×10^6	9.2
31 July	20	0	1.7×10^6	12.2
1 August	8	0	1.9×10^6	13.5
2 August	0	20	1.8×10^6	13.0
3 August	4	8	1.7×10^6	12.3
4 August	0	4	1.3×10^6	9.6
5 August	0	28	9.7×10^5	7.0
6 August	0	12	5.8×10^5	4.2
7 August	0	16	2.9×10^5	2.1
8 August	0	8	1.3×10^5	1.0
9 August	0	4	5.0×10^4	0.4
10 August	0	0	1.8×10^4	0.1

II.1.3.3 Pollen concentration in the source plot

Figure II-2 shows the 2-hourly moving average pollen concentration measured above the source plot between the 24 July and 3 August. The concentration had a clear diurnal periodicity and the daily maximum had a similar dynamics as the estimated pollen production over the period (Figure II-2).

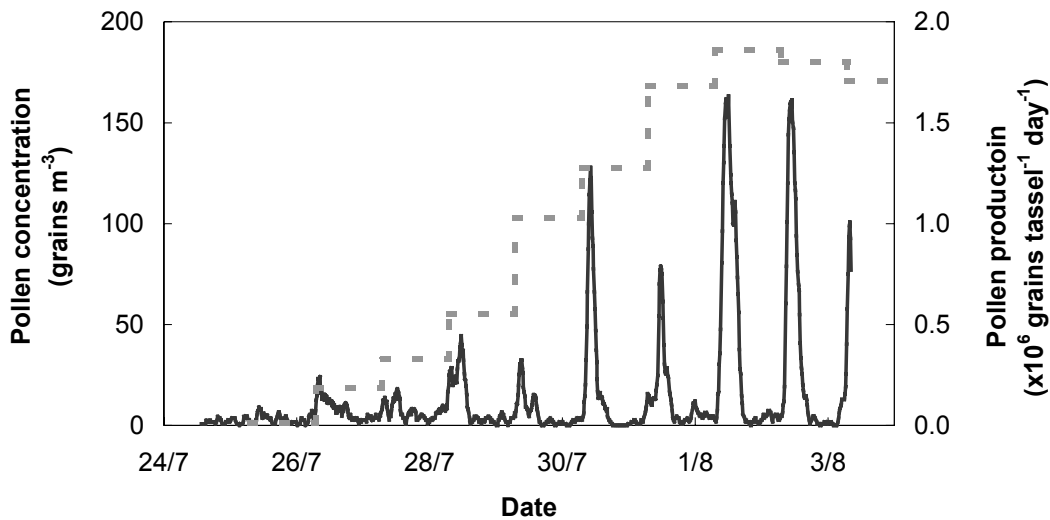

Figure II-2. Two-hourly moving average airborne pollen concentration above the source plot, as measured with the Burkard trap (continuous line), compared with the estimated daily pollen production (dotted line).

The daily pattern of pollen concentration between 29 July and 3 August, is shown in Figure II-3a, together with the surface wetness index (SWI), as measured by the wetness sensors. SWI tended to fall from nearly 100% (wet) to nearly 0% (dry) as pollen started to be released, except for the 3 August (Figure II-3a). The daily pattern, normalised by the daily maximum concentration, and averaged over the 5 first days of Figure II-3a is plotted in Figure II-3b. It shows that pollen emission began at about 08:00 UT and ended at about 16:00 UT, and the maximum concentration occurred at around 10:00 UT. Almost no pollen was trapped at night (between 18:00 and 06:00 UT), although small peaks were occasionally observed. The pattern on 3 August was unusual as the concentration started to increase at around 06:00 UT.

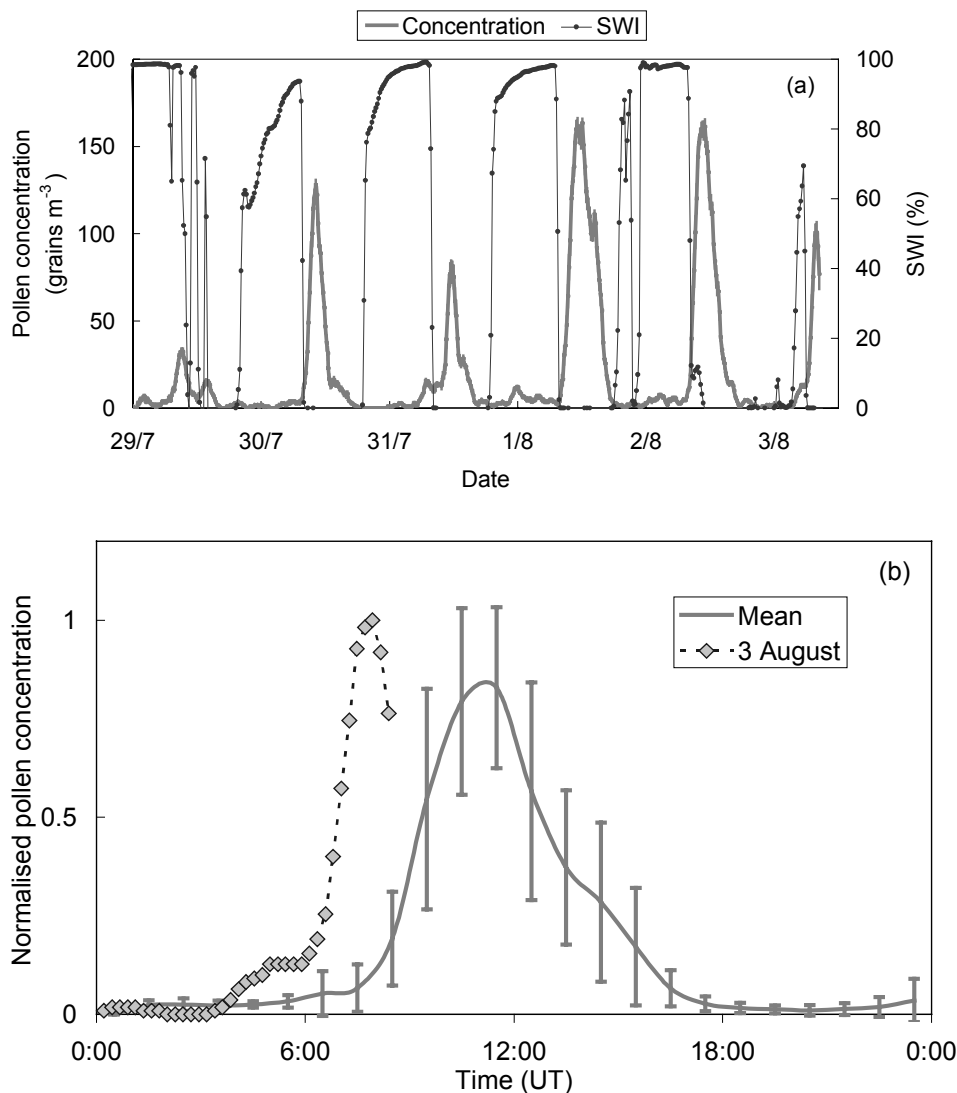

Figure II-3. (a) Pollen concentration and SWI measured in the source plot between 29 July and 3 August 2000. (b) Average daily pattern of pollen concentration measured above the source plot. The concentrations were normalised with the maximum concentration of the day before taking the average. The bold line represents the mean for 5 days (29, 30, 31 July; 1 and 2 August), and error bars represent the standard deviation over these days. The dotted line shows the emission pattern measured on the 3 August.

II.1.3.4 Vertical profiles of pollen concentration

All vertical profiles of pollen concentration had a similar shape, with the maximum concentration always located below 2 m, for profiles at $x = 3$ m from the source and below 1 m, for profiles at $x = 10$ m from the source. Profiles for runs R6, R7 and R8 are shown in Figure II-4. As expected, the concentration decreased with distance downwind of the source and generally decreased with height above 2 m. Concentrations ranged from 0 to 210 grains m^{-3} , 3 m downwind and from 0 to 45 grains m^{-3} , 10 m downwind.

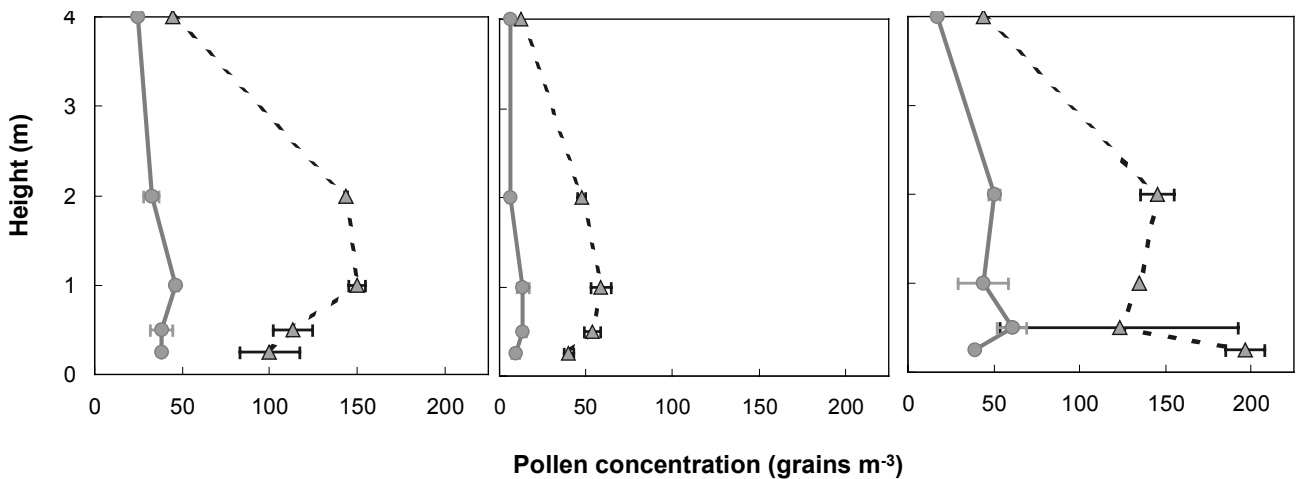

Figure II-4. Vertical profiles of pollen concentration measured downwind of the source plot using rotating-arm spore traps at $x = 3$ m (dotted line) and $x = 10$ m (solid line) for runs R6 (a), R7 (b) and R8 (c). Error bars were estimated as the mean standard error over the two rods of each rotating-arm.

II.1.3.5 Wind speed and horizontal flux of pollen

Figure II-5 shows the vertical profiles of wind speed at $x = 3$ and 10 m averaged over all runs. In the figure the values of wind speed have been normalised by the speed of the highest anemometer at each mast, which corresponded to the highest wind speed (between 1.1 and 2.4 m s^{-1}). At $x = 3$ m downwind of the source, the wind speed profile was greatly influenced by the source plot, as showed by the depletion of the profile. At $x = 10$ m, the wind speed profile is closer to the unperturbed profile (log profile in Figure II-5), indicating that the influence of the source plot is getting weaker. A log profile with a roughness length, $z_0 = 0.07$ m, mimics the measured profile at $x = 10$ m, which corresponds to a farmland with many hedges according to Panofsky & Dutton (1984).

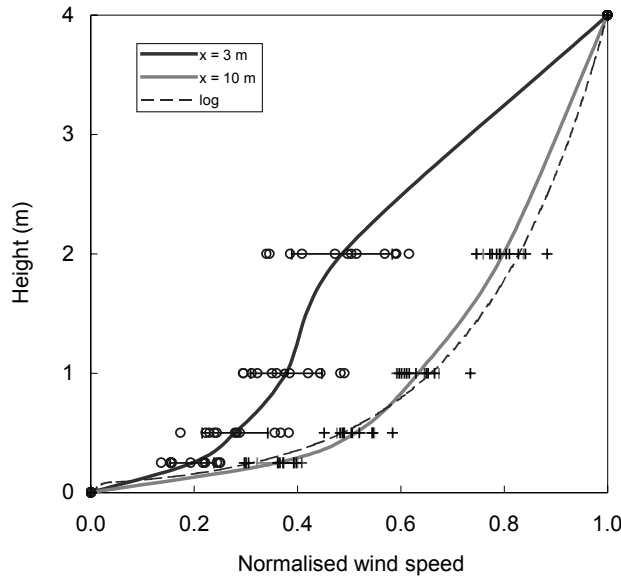

Figure II-5. Vertical profiles of wind speed normalised by the wind speed at the greatest height (4 m) and averaged over all runs at $x = 3$ m (black line) and $x = 10$ m (grey line). The log profile (dotted line) with $z_0 = 0.07$ m in neutral condition ($u_* = 0.2 \text{ m s}^{-1}$ and $L = -\infty$) is also drawn. Open circles represent values of the 12 runs 3 m downwind of the source plot and cross symbols represent values of the 12 runs 10 m downwind. Error bars show the standard deviation over the different runs.

The vertical profiles of horizontal flux of pollen grains ($F_x(z)$) are shown in Figure II-6 for three typical runs (R6-R8). Fluxes were greater at $x = 3$ m than at $x = 10$ m. The fluxes $F_x(z)$ ranged from 0 to 200 grains $\text{m}^{-2} \text{s}^{-1}$ and, for the 3m mast, the maximum value usually occurred at about $z = 2$ m. It is difficult to extrapolate the profile of $F_x(z)$ above $z = 4$ m, as the slope were not always negative between $z = 2$ and 4 m, especially at $x = 10$ m. However, using a linear extrapolation from the two highest points of the profile at $x = 3$ m, the flux above $z = 4$ m was found to represent about 40% of $F_3^{(0-4)}$. However, this is probably overestimated since the flux profile at $x = 3$ m would probably decrease exponentially with height.

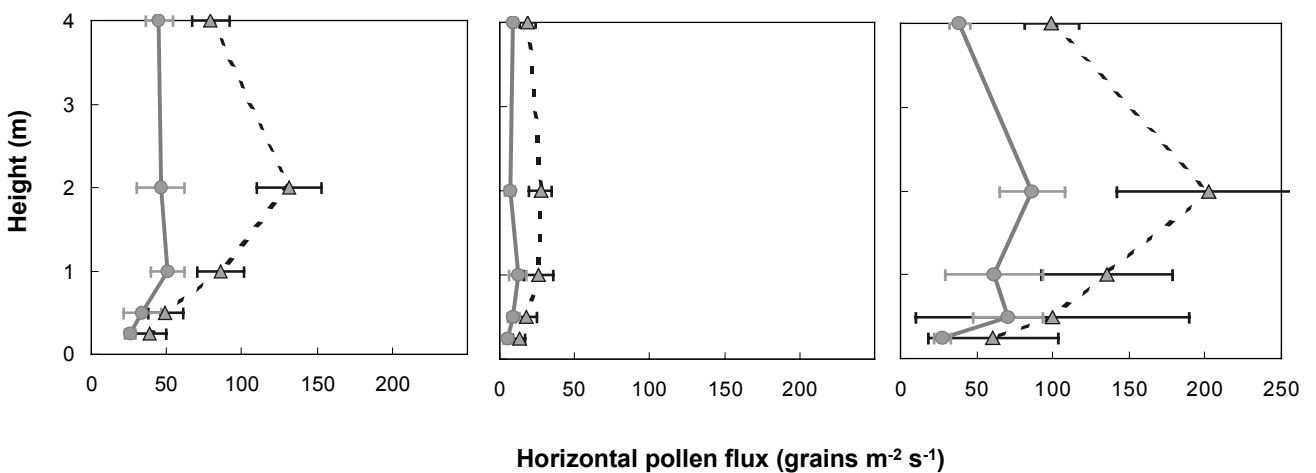

Figure II-6. Vertical profiles of horizontal flux of pollen F_x at $x = 3$ m (dotted line) and $x = 10$ m (solid line) for runs R6 (a), R7 (b) and R8 (c). Error bars were estimated as the sum of the relative errors on wind-speed and concentration.

The integrated horizontal fluxes passing through the masts $F_3^{\{0-4\}}$ and $F_{10}^{\{0-4\}}$ are shown in Table II-4. The flux at 10 m was usually between $\frac{1}{4}$ and $\frac{1}{2}$ of that at 3 m. The flux $F_3^{\{0-4\}}$ ranged from 1 to 560 grains $\text{m}^{-1} \text{s}^{-1}$, which is an order of magnitude smaller than the estimated pollen production per meter width of the source plot.

II.1.3.6 Pollen deposition

Figure II-7 shows the measured pollen deposition rates divided by the deposition rate at $x = 1$ m as a function of the downwind distance from the source. The actual deposition rates can be estimated by multiplying the values in Figure II-7 by the deposition rate measured at $x = 1$ m (Table II-4). Deposition rates decreased with distance downwind of the source and ranged from 10 to 150 grains $\text{m}^{-2} \text{s}^{-1}$ between $x = 1$ and 10 m, and from 3 to 10 grains $\text{m}^{-2} \text{s}^{-1}$ between $x = 16$ and 32 m. The integrated deposition rates between 1 and 3 m, 1 and 32 m and 3 and 10 m downwind from the source (D_{1-3} , D_{1-32} and D_{3-10} respectively) are given in Table II-4. The difference between the integrated horizontal fluxes at $x = 3$ and 10 m, ΔF_{3-10} (Equation II-2) generally compared well with D_{3-10} (Table II-4).

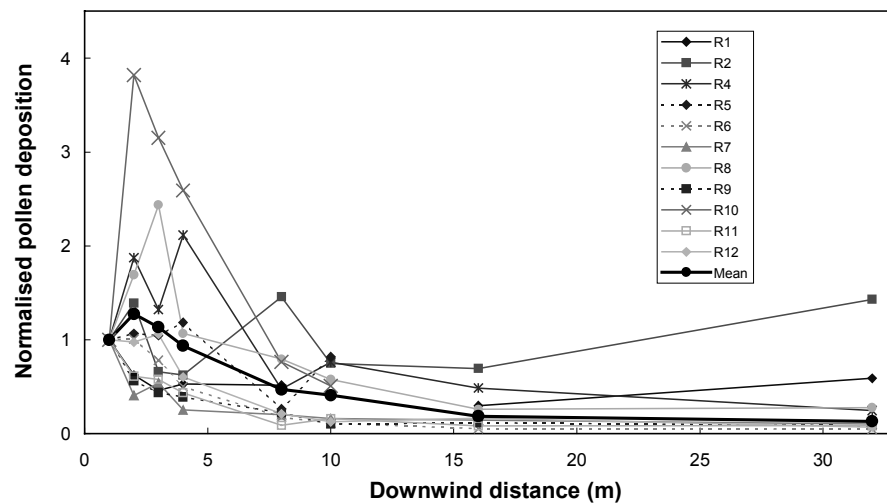

Figure II-7. Measured deposition rate divided by the measured deposition rate at $x = 1$ m, as a function of downwind distance from the source for runs R1-R2 and R4-R12. The mean deposition rate is shown as a bold line with filled circles.

II.1.4 Discussion

II.1.4.1 Dynamics of pollen emission

The pollen concentration in the crop had a marked diurnal periodicity with the maximum concentration usually occurring in the morning at around 10:00 UT, a pattern common to wind pollinated plants (Scott, 1970; Gregory, 1973). However, we never found a

Table II-4. Pollen production, integrated deposition rates and horizontal fluxes at different distances downwind of the source. The measured deposition rate at $x = 1$ m is also given as a reference for Figure II-7. D_{1-3} is the integrated deposition rate between $x = 1$ and 3 m, D_{1-32} is the integrated deposition rate between $x = 1$ and 32, D_{3-10} is the integrated deposition rate between $x = 3$ and 10 m, downwind of the source. Also shown are estimates of the horizontal flux, integrated between $z = 0$ and $z = 4$ m height, at $x = 3$ m ($F_3^{(0-4)}$) and $x = 10$ m ($F_{10}^{(0-4)}$) downwind of the source. ΔF_{3-10} is the horizontal flux difference between $x = 3$ and $x = 10$ m. The integrated deposition rates D_{1-3} and D_{1-32} are also expressed in percentage of the pollen production per meter of lateral width of the source. Runs lasted between 90 and 180 min. (-) denotes lack of data.

Run	Pollen production (grains m ⁻¹ s ⁻¹)	Deposition rate at $x = 1$ m (grains m ⁻² s ⁻¹)	Deposition rate integrated over x					Horizontal flux		
			D_{1-3}		D_{1-32}		D_{3-10} (grains m ⁻¹ s ⁻¹)	$F_3^{(0-4)}$ grains m ⁻¹ s ⁻¹	$F_{10}^{(0-4)}$ grains m ⁻¹ s ⁻¹	ΔF_{3-10} grains m ⁻¹ s ⁻¹
			grains m ⁻¹ s ⁻¹	%	grains m ⁻¹ s ⁻¹	%				
R1	40	14	33	81	186	462	43	34	4	30
R2	42	3	11	26	107	256	24	15	7	8
R3	12	-	-	-	-	-	-	1	0	1
R4	862	23	94	11	505	59	189	276	22	254
R5	478	14	42	9	-	30	69	80	66	15
R6	763	69	201	26	449	59	158	370	172	197
R7	935	50	110	12	339	36	84	89	34	55
R8	3068	45	198	6	812	26	308	556	248	308
R9	14679	141	322	2	918	6	277	208	62	146
R10	2043	8	53	3	258	13	84	101	51	50
R11	3551	138	331	9	865	24	249	293	66	227
R12	16833	138	415	2	1183	7	387	434	115	319

bimodal pattern of pollen concentration as observed by Flottum *et al.* (1984) for sweet corn pollen. The start of pollen emission in the morning appeared to coincide with the drying of the crop (Figure II-3a). This may explain why pollen emission started earlier on 3 August than on previous days (Figure II-3b), as the crop remained almost dry during the previous night (as indicated by the small surface wetness index).

II.1.4.2 Airborne pollen concentrations

The shapes of the vertical concentration profiles were fairly consistent between runs as indicated by the small error bars in Figure II-8, which show the standard deviation of the profiles over all runs. The maximum concentration occurred at about 1 m height at $x = 3$ m and at about 0.5 m height at $x = 10$ m, indicating a settling of the pollen plume with distance. An exponential curve ($C(z) = A \exp(-\alpha z)$) was fitted to the average profiles above 1 m height. The coefficient α , which relates to the rate of decrease in concentration with height, was 0.46 and 0.26 m^{-1} at $x = 3$ and $x = 10$ m, respectively, and the regression was quite good ($R^2 = 95\%$ and 99% respectively). These values are similar to those found by McCartney and Lacey (1991) for oilseed rape pollen near the edge of the crop.

The pollen concentrations tended to be larger than those reported by Raynor *et al.* (1972a), but this probably only reflects a difference in pollen production by the source. Indeed, although no quantitative estimate of the production is given by Raynor *et al.* (1972a), it was probably smaller as the plant density was 3 to 6 times smaller than in the present study ($15,210 \text{ plants ha}^{-1}$ to $37,640 \text{ plants ha}^{-1}$) and they used two or three cultivars with different flowering dates in order to prolong pollination period. However, they also found that sweet corn pollen concentrations decreased rapidly with distance downwind of the source plot. They found that the concentration at 1.5 m above the ground, which corresponded to 1.07 times the height of the tassels, decreased by a factor of roughly two between $x = 3$ and 10 m. In this study the concentration decreases by a factor of 3 at the same height relative to the tassels (2.7 m). The larger deposition gradient observed in the present study may be due to a larger turbulence intensity generated by the canopy being taller in this study than in that of Raynor *et al.* (1972a). McCartney and Lacey (1991) found that the pollen concentration at 0.8 m height (just below flower height) downwind of a $20 \text{ m} \times 20 \text{ m}$ spring oilseed rape plot decreased by a factor of 3.7 on average between $x = 3$ and $x = 10$ m, which is even larger than in this study. Oilseed rape pollen has a much smaller settling velocity (0.017 m s^{-1}) than maize pollen, thus we would expect that the horizontal concentration gradient would be shallower as deposition rates would be less. However, the lighter oilseed rape pollen grains may have been

more rapidly dispersed vertically and in the crosswind direction, which would have made the concentration gradients steeper.

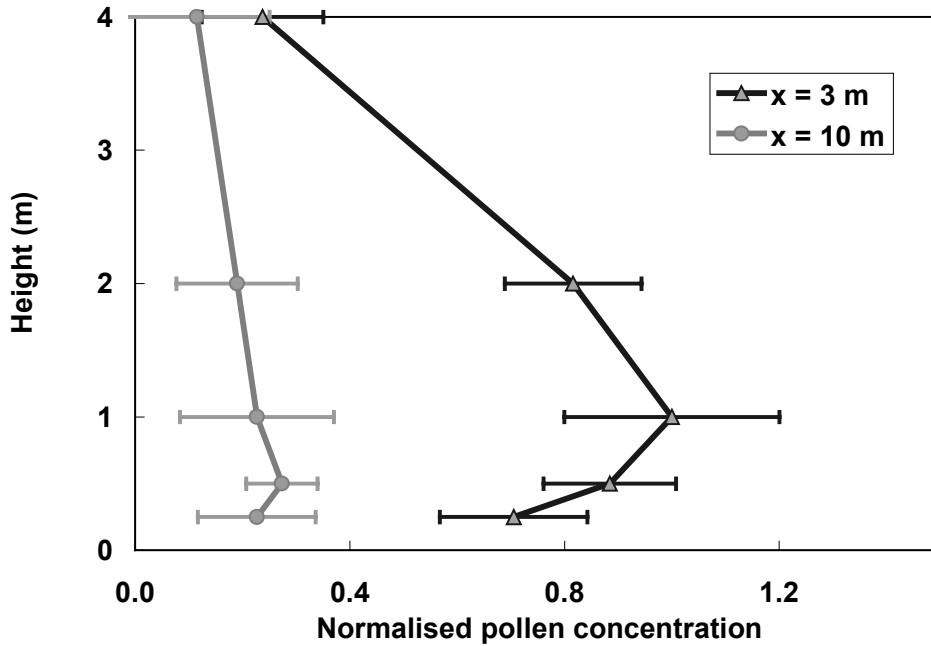

Figure II-8. Median normalised concentration profile, estimated over runs R1-R2, R4-R12 at $x = 3$ and $x = 10$ m. The error bars show the standard deviation over the different runs. The profiles were normalised by dividing by the maximum concentration measured at the 3 m mast for each run, and subsequently averaged by taking the median over all runs.

II.1.4.3 Validity of the integrated deposition and mass balance approaches

The integrated deposition rates were estimated by one-dimensional integration over x . However, as shown by Raynor *et al.* (1972a) the pollen dispersion is clearly three-dimensional. The total deposition rate could be estimated by multiplying the integrated deposition rate by a Gaussian function expressing the diffusion of pollen as a function of distance in the cross-wind direction provided that the mean wind direction relative to the direction of the masts is correct.

The horizontal flux difference ΔF_{3-10} , was well correlated with the integrated deposition rate D_{3-10} (Figure II-9).

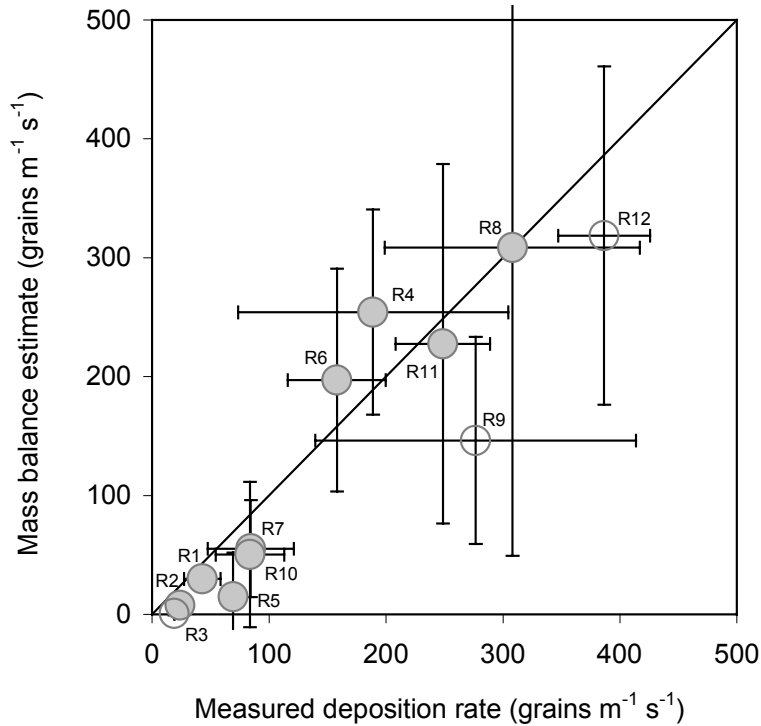

Figure II-9. Pollen deposition between $x = 3$ and $x = 10$ m, estimated with the mass balance technique compared to the measured deposition rates. Open symbols show runs R3, R9, R10 and R12, where the wind direction relative to the masts was larger than 30%. A linear regression gives $y = 0.98x - 16$ ($R^2 = 0.8$).

This means that the other components of the mass balance (turbulent component of the flux $\overline{u'c'}$, vertical flux at $z = 4$ m $F_z(z = 4$ m), and divergence of the lateral flux $\partial F_y / \partial y$) between the two masts either are small or cancel each other. Their magnitude and direction are discussed here:

- For gaseous compounds under homogeneous conditions, the turbulent component of the horizontal flux ($\overline{u'c'}$) is generally negative downwind of a source, and of the order of 10-20% (Wilson & Shum, 1992; Denmead *et al.*, 1998). However, due to inertia and "crossing-trajectories" effects (Snyder & Lumley, 1971; Reynolds, 2000), $\overline{u'c'}$ for heavy particles, such as maize pollen, should be smaller. Nevertheless, turbulence intensity increases immediately downwind of a roughness change (Gash, 1986), or a windbreak (Heisler & DeWalle, 1988), up to three times its magnitude in normal conditions at distances several times the height of the canopy. Coherent structures are also present downwind of such obstacles (e.g., Zhuang & Wilson, 1993). These two effects are likely to increase the magnitude of $\overline{u'c'}$ at $x = 3$ and 10 m, downwind of such a small source plot (20 m \times 20 m), behaving roughly like a windbreak. Moreover, the large gradients in horizontal turbulent kinetic energy near the downwind edge of the field are likely to induce turbophoretic fluxes, which is a convective drift down gradient of velocity variance

(Reynolds, 2000; Wilson, 2000). In addition to these effects, the fact that the maize pollen might be liberated in gusts of wind may bring a positive contribution to $\overline{u'c'}$, since in such a case, u' is positive (by definition of a gust), when c' is positive (pollen is present). This later contribution might diminish or balance the negative contribution due to the increase in turbulence kinetic energy.

- The vertical flux through the lid of the control volume at $z = 4$ m can be seen as the sum of a “convective flux”, due to the average vertical component of the wind speed (\overline{w}), which is non zero downwind of a roughness change, a “settling flux” due to the settling speed of the pollen, a “diffusive flux”, which includes “diffusion” due to gradient in pollen concentration, and a “turbophoretic flux” due to gradient in turbulence intensity and turbulence length scale. The concentration gradient “diffusive flux” should be positive as it stands above the height of the source. In contrast, the “convective flux” should be negative as the average vertical wind speed is directed towards the ground. Similarly, the “settling flux” is negative. The “turbophoretic flux” may be positive as the vertical gradient of turbulent kinetic energy is negative above the height of the canopy at small distances downwind of the obstacle (The turbophoretic flux is opposed to the gradient of particle velocity variance, Reynolds, 2000). Although we can draw some qualitative analysis, we do not have sufficient measurements to determine the sign and the magnitude of $F_z(z = 4 \text{ m})$.
- Divergence of the lateral flux ($\partial F_y / \partial y$) is certainly non-zero, however, to our knowledge, there are no reported measurements to estimate its contribution. All we can ascertain is that, as shown by Raynor *et al.* (1972a) inertia effects would diminish lateral diffusion of maize pollen compared to smaller pollens (ragweed and timothy) and gases.

In addition, to these potential errors, when the wind angle to the mass balance masts increased in magnitude, several errors might appear: (i) the two mast might not see the same part of the source, (ii) the effective distance of the two mast to the source increases, and (iii) when the wind angle is greater than 45° , the mast at $x = 10$ m might stand outside the fetch of the source. For these reasons the comparison between D_{1-3} and ΔF_{3-10} in Figure II-9 has different symbols when the wind angle was larger than 30° .

The different terms of the mass balance discussed here above need more work to be quantified. They could probably be estimated with the use of a Lagrangian stochastic model such as described by Aylor & Flesch (2001), or Reynolds (2000), which could be extended to 3D turbulence, despite the uniqueness problem (Thomson, 1987; Leuzzi & Monti, 1998).

II.1.4.4 Deposition and horizontal fluxes of pollen

The shape of the deposition gradient downwind of the source was fairly consistent for most of the experimental runs (Figure II-7), with deposition rate decreasing rapidly with distance from the source. On average the deposition rates at distances greater than 20 m were less than 20% of the rate at 1 m, and less than 10% at 32 m. However, the deposition gradients found here were shallower than those found by Raynor *et al.* (1972a), where deposition rates 10 m and 20 m downwind were 6% and 1% of those 1 m from the source, respectively. On several occasions the maximum deposition rate was observed at larger distances than $x = 1$ m (Figure II-7). On those occasions, u_* was larger than during the other runs, suggesting more effective horizontal transport of pollen grains. Deposition rates tended to slightly increase between $x = 16$ and 32 m probably because of the presence of the target field at $x = 50$ m.

It is difficult to accurately estimate the flux of pollen leaving the plot as the closest measurements were made 3 m from the edge. However, a rough estimate can be made by adding the integrated deposition rate from $x = 1$ to 3 m, in a metre wide strip, to the flux estimated at the two masts (Table II-4), neglecting the horizontal flux passing above $z = 4$ m and the turbulent component of the flux. It appears that about 60% of the pollen released at the edge of the plot was still airborne 3 m downwind and about 30% at 10 m. Differences between $F_3^{\{0-4\}}$ and $F_{10}^{\{0-4\}}$ were generally accounted for by deposition, suggesting that pollen above 4 m effectively remained airborne at $x = 10$ m. The estimates of $F_3^{\{0-4\}}$ are nearly always less than D_{3-32} and D_{3-16} . This discrepancy suggests that a large fraction of the horizontal flux is passing over $z = 4$ m at $x = 3$ m. As discussed in Section II.1.4.3, it is difficult to know whether $\overline{u'c'}$ is positive or negative at $x = 3$ m. These results emphasised the need to measure concentration higher than 4 m.

II.1.4.5 Deposition velocities

Maize pollen deposition velocities ($V_d = \text{deposition rate} / \text{concentration}$) were estimated at $x = 3$ and 10 m using concentrations measured 0.25 m above the ground. Values ranged between 0.2 m s^{-1} and 1.8 m s^{-1} and averaged $0.6 \pm 0.1 \text{ m s}^{-1}$ and $0.7 \pm 0.5 \text{ m s}^{-1}$ at $x = 3$ and 10 m, respectively. Raynor *et al.* (1972a) found similar values: $0.3\text{-}0.8 \text{ m s}^{-1}$ for concentrations measured at 0.5 m height and distances of 7.7, 15.3 and 32 m downwind; and $0.6\text{-}1.9 \text{ m s}^{-1}$ for concentrations measured at 1.5 m height and 9.2, 15.3 and 32 m downwind. Values of V_d were roughly between two and three times the settling velocity, V_s , reported for maize pollen ($0.2 - 0.3 \text{ m s}^{-1}$, Di-Giovanni *et al.*, 1995). A similar discrepancy between V_s and

V_d has been observed by Raynor *et al.* (1972a) downwind of a maize field and by McCartney & Aylor (1987) for *Lycopodium* spores in a wheat canopy. As mentioned in Section II.1.4.3, "convective" and "turbophoresis" fluxes should enhance deposition just downwind of the source plot, which explains the observed ratio V_d/V_s . However, V_d was not significantly different between $x = 3$ and 10 m, although it was more scattered at 10 m.

II.1.5 Concluding remarks

The results of this study concur broadly with the few published studies for maize pollen dispersal. It is clear that both pollen concentration and deposition rates decrease rapidly with distance from the edge of the source. Although large number of maize pollen grains are produced by a maize crop these experiments suggest that only a relatively small proportion may escape from the maize crop. Our estimates of the flux of pollen escaping from the plot, combined with deposition measurements, suggest most of the pollen released was deposited within about 30 m of the plot. Indeed, roughly 95% of pollen emitted is deposited at 10 m from the source and 99% at 30 m.

The work presented here was done under relatively low wind speeds, thus further experiments may be needed to determine whether pollen dispersal would be enhanced under windier conditions. The pollen deposition within the source (both ground and foliage), although not being the focus of interest here, should be studied in more detailed, as it represents the largest deposition fraction, and therefore the largest uncertainty on the quantity emitted. It would also give valuable information on the deposition processes to silks. These results, however, will provide useful data for testing and validating pollen dispersal models, which would be useful for studying the role of long distance dispersal in the analysis of gene flow in maize.

II.2 Variabilité de la vitesse de sédimentation des grains de pollen de maïs

II.2.1 Introduction

La vitesse de sédimentation (V_s), définie dans le paragraphe I.1.2.2, est un paramètre essentiel de la dispersion et du dépôt de pollen de maïs; ce paramètre intervient explicitement dans les modèles de dispersion tels que celui utilisé dans le chapitre III. Dans un milieu donné (densité et viscosité du milieu fixés), V_s dépend uniquement de la forme, de la taille et de la densité (ou de la masse) de la particule. Or il ressort de plusieurs études que le pollen de maïs est plus ou moins hydraté lors de sa libération et que de plus, il se déshydrate rapidement dans l'air (Kerhoas, 1986; Aylor, 2002). Aylor (2002) a également montré que le pollen de maïs se déforme et change de taille à mesure qu'il se déshydrate, et que cela affecte la vitesse de sédimentation. Il n'existe toutefois pas d'étude qui rapporte la variabilité de V_s en fonction de la variété de maïs. On peut pourtant penser que la variété peut jouer à la fois sur la distribution de taille du pollen et son hygroscopie.

En l'absence de forces électrostatiques, la vitesse terminale d'une particule sphérique en chute libre dans un air calme et à température et pression constantes suit la loi de Stokes (Equation I-4). Toutefois, même si le pollen de maïs est sphérique, il n'existe pas d'étude donnant avec précision la distribution de V_s . Di-Giovanni *et al.* (1995) ont mesuré la variabilité des vitesses de sédimentation en faisant tomber le pollen ou les spores du haut d'une tour d'environ 1,50 m dans un cylindre en acier. Simultanément, le moteur dirigeant un disque en rotation au bas de la tour, et sur lequel sont disposées des lames microscopiques démarrait. Le défaut de cette méthode est qu'il est difficile de connaître avec précision le moment où le pollen est libéré. Rambert *et al.* (1998) ont utilisé une méthode bien plus performante basée sur la vélocimétrie Doppler à laser pour déterminer à la fois les vitesses de sédimentation et le diamètre des grains ou agrégats de spores de rouille du blé et de lycopode. Plus récemment, Aylor (2002) a mesuré des vitesses de sédimentation du pollen de maïs à mesure qu'il se déshydratait, en chronométrant le temps de chute entre deux points d'un tube en verre convenablement éclairé.

Le but de ce travail était de réaliser une première caractérisation de la distribution des vitesses de sédimentation du pollen de maïs pour plusieurs variétés et différents teneurs en eau du grain, sans toutefois chercher à contrôler l'humidité de l'air ambiant ou la température.

La méthode décrite ici, basée sur la photographie de trajectoires de particules en chute, a été mise au point et testée au préalable sur des spores de lycopode (Moutton, 2002).

II.2.2 Matériel et méthodes

Une série de mesures a été effectuée dans les serres de l'institut Arvalis (Montardon) sur 27 plantes de maïs de 8 variétés différentes. Cinq hybrides simples (Adonis et Adonis bleu, Pau Semences S.A., Lescar; Kalis, Rustica, Mondonville; Banguy, Nickerson S.A., Croissy Beaubourg et DK300, R.A.G.T. Semences, Rodez) et trois lignées (N69, N62, M521) ont été utilisées. Le maïs a été cultivé en serre en automne 2003 dans des pots de 15 litres contenant du terreau Motex NS, irrigués par un système goutte à goutte représentant un volume de 500 ml d'eau par jour. Un éclairage à l'aide de lampes au sodium (400 watts) pendant 10 h par jour a été mis en place afin de compenser le manque de luminosité et permettre au maïs de croître dans de bonnes conditions. Pour chacune des séries de mesure, le pollen était collecté dans une feuille de papier enroulée en forme de cône directement sur la panicule en agitant doucement la plante. Dans les 2 à 5 minutes suivant le prélèvement, l'échantillon était réparti en 3 sous-échantillons, un pour mesurer la teneur en eau, un autre pour déterminer les diamètres et le dernier pour mesurer les vitesses de sédimentation.

II.2.2.1 *Teneur en eau du pollen*

Le sous-échantillon destiné à la mesure de l'humidité des grains de pollen était placé dans un récipient d'aluminium taré puis pesé. Ensuite, le récipient était mis à sécher dans un four pendant 5 minutes à 85°C. Le poids sec était mesuré et les grains de pollen transvasés dans un pot rempli d'électrolyte (Coulter Isoton, Beckman, USA) pour un comptage ultérieur au compteur automatique de particules (Coulter Multisize III, Beckman, USA). La teneur en eau est alors déterminée comme étant la masse d'eau contenue dans le grain de pollen divisée par la masse du grain "frais".

II.2.2.2 *Mesure de la vitesse de sédimentation*

Les mesures de la vitesse de sédimentation en air calme, V_s , ont été obtenues à l'aide d'une méthode basée sur l'analyse d'image. Le dispositif est composé d'une tour de sédimentation en inox de 0,95 m de hauteur et 0,15 m de diamètre, située au-dessus d'une chambre noire éclairée par les côtés à l'aide de fibres optiques et d'une caméra CCD reliée à un ordinateur qui enregistre directement les films (Figure II-10).

Le sous-échantillon de pollen destiné à mesurer V_s était placé en haut de la tour et légèrement secoué afin de faire tomber le pollen à travers un filtre permettant de retenir les

anthères. Pendant sa chute dans la tour, le pollen a le temps d'atteindre sa vitesse terminale avant d'entrer dans la chambre noire par une fente d'environ 5 mm permettant au pollen de se trouver dans le champ focal de la caméra. La chute des grains de pollen est alors photographiée 15 fois par seconde avec un temps d'intégration (d'exposition), τ , égal à 41,67 ms pour toutes les mesures. L'ensemble était fermé hermétiquement et isolé thermiquement à l'aide de plaques d'isolation des toits afin d'éviter tout courant d'air extérieur ou convection thermique dans la chambre pouvant perturber la chute des grains.

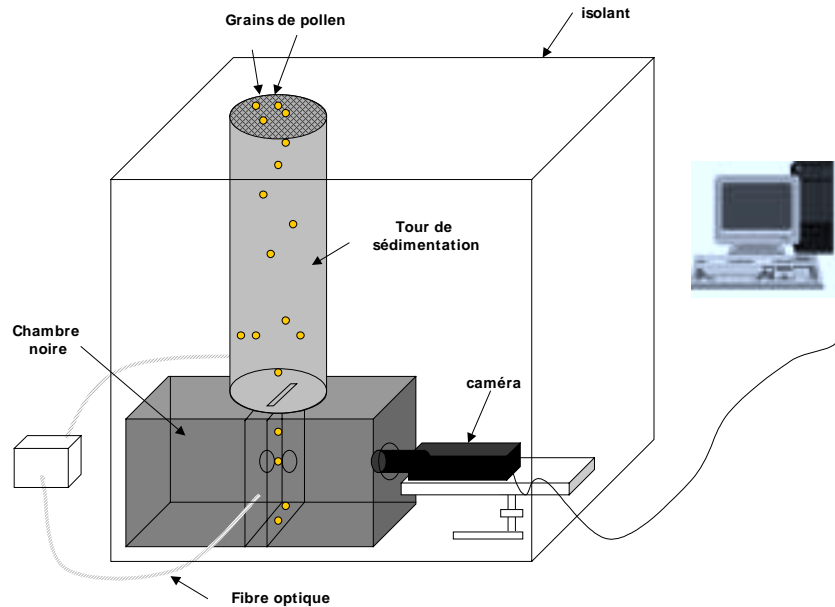

Figure II-10. Schéma du principe de mesure de la vitesse de sédimentation.

Les séquences vidéo sont traitées numériquement afin de déterminer la distribution de taille des traces obtenue à l'aide d'un logiciel librement accessible (Image J, <http://rsb.info.nih.gov/ij/>) en appliquant deux filtres (un filtre gaussien et un filtre mettant en exergue les structures verticales de l'image) et un seuil en nuances de gris (entre 21 et 255). Les traces obtenues sont ensuite dénombrées et caractérisées géométriquement de façon automatique (Figure II-11). Pour finir, l'histogramme des tailles de trace est déterminé, puis divisé par le temps d'intégration pour obtenir la distribution de V_s .

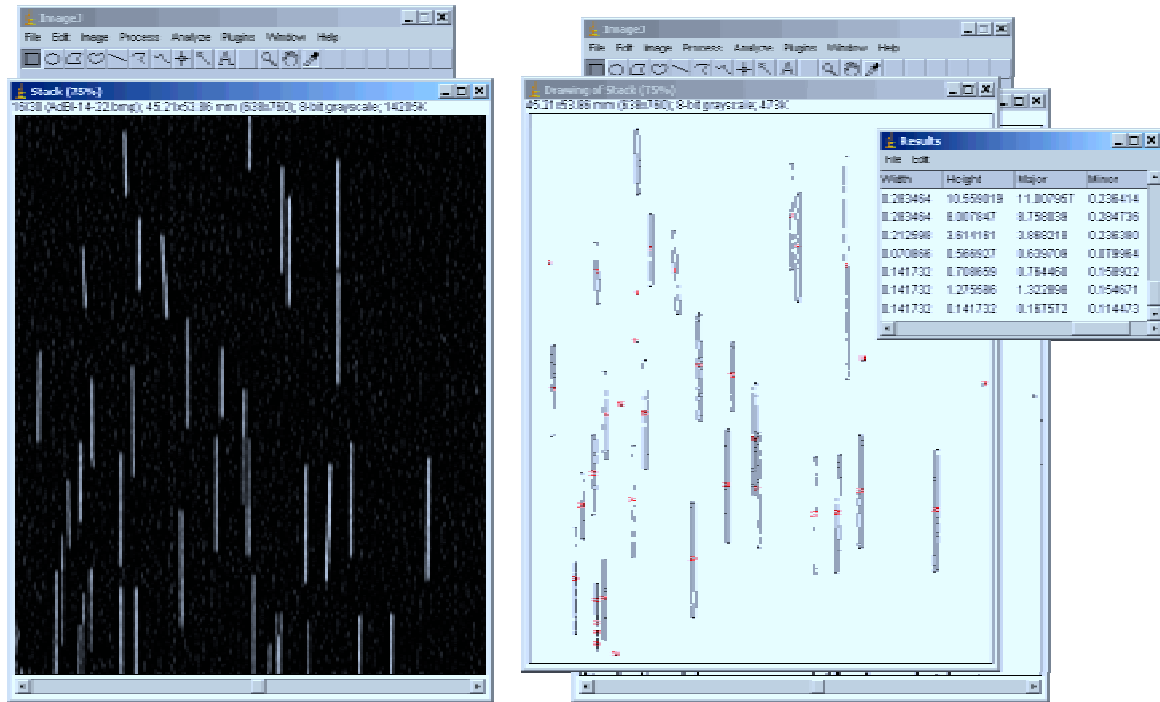

Figure II-11. Illustration de la méthode d'analyse d'image. L'image de gauche représente la photographie brute de pollen de maïs en chute. L'image de droite représente le résultat obtenu après application d'un filtre gaussien, d'un filtre mettant en exergue les structures verticales de l'image et enfin d'un seuil binaire.

II.2.2.3 Diamètre et densité des grains de pollen

Le sous-échantillon de pollen destiné à estimer le diamètre et la densité des grains était pesé et transvasé dans un récipient rempli d'Isoton pour dénombrement et mesure de la distribution des diamètres au Coulter. La masse moyenne d'un grain de pollen était ensuite calculée pour chacune des séries comme la masse totale de l'échantillon divisé par le nombre de grain de l'échantillon.

Malheureusement, la mesure de la distribution des diamètres de pollen au Coulter ne permet pas d'obtenir les diamètres réels, mais plutôt un diamètre "humecté" du grain. Une autre méthode a donc été utilisée pour estimer le diamètre moyen des grains à partir des vitesses de sédimentation. Sachant que pour une particule sphérique de masse m_p et de diamètre d_p , la densité de la particule est donnée par:

$$\rho_p = \frac{6 m_p}{\pi d_p^3} \quad (\text{II-3})$$

Le diamètre des grains peut être ensuite calculé à partir des V_s moyennes de la distribution obtenue par analyses d'images et en combinant les équations I-5 et II-3:

$$d_p^2 = \frac{8 g m_p}{\pi C_D \rho V_s^2} \quad (\text{II-4})$$

où ρ est la densité de l'air et C_D est le coefficient de traînée calculé par l'équation I-6.

II.2.3 Résultats

II.2.3.1 Caractéristiques du grain de pollen

La teneur en eau des grains de pollen mesurée est de 39% en moyenne sur les 98 séries analysées et se situe dans une gamme de 6 à 62%. La gamme pour chacune des variétés est détaillée dans le Tableau II-5. La masse moyenne d'un grain de pollen est de 423 ng. Le diamètre estimé par l'équation II-4 varie entre 65 et 138 μm avec une moyenne de 90 μm et la densité se situe dans une gamme de 0,44 à 2,25 g cm^{-3} et de moyenne 1,17 g cm^{-3} . Le nombre de Reynolds varie de 0,73 à 2,36. Il ne semble pas y avoir de différences claires entre les variétés. On peut néanmoins noter que les hybrides ont des diamètres et des masses maximums plus grands que les lignées.

Tableau II-5. Gamme des teneur en eau (h_r), vitesse de sédimentation (V_s), masse (m_p), diamètre (d_p), densité (ρ_p) et nombre de Reynolds (Re) moyens des grains de pollen pour cinq hybrides (Adonis bleu, Adonis, Banguy et DK300) et trois lignées (M521, N62 et N69).

Variétés	h_r %	V_s m s^{-1}	m_p ng	d_p μm	ρ_p g cm^{-3}	Re
Adonis bleu	12 – 62	17,5 – 27,7	276 – 632	79,0 – 129,5	0,55 – 1,55	0,98 – 2,17
Adonis	7 – 56	17,7 – 28,6	256 – 660	70,2 – 138,2	0,44 – 2,02	0,92 – 2,25
Banguy	6 – 57	17,0 – 18,2	236 – 697	71,7 – 131,0	0,59 – 2,25	0,86 – 2,36
DK300	16 – 56	17,8 – 22,8	276 – 481	77,7 – 92,4	1,13 – 1,40	0,98 – 1,47
Kalis	12 – 43	17,9 – 20,4	267 – 531	75,2 – 113,0	0,70 – 1,20	0,95 – 1,57
M521	9 – 52	13,2 – 21,9	225 – 485	76,8 – 96,0	0,62 – 1,05	0,83 – 1,48
N62	15 – 53	15,0 – 25,5	247 – 539	70,4 – 98,6	0,61 – 1,56	0,89 – 1,59
N69	7 – 58	15,8 – 24,6	195 – 520	65,7 – 92,6	0,93 – 2,16	0,73 – 1,55

II.2.3.2 Distribution de V_s

Les distributions de V_s ont été obtenues, après filtrage, sur 400 à 20000 traces de pollen. Deux exemples sont donnés sur la Figure II-12 pour deux variétés et teneurs en eau différentes. On voit bien la séparation entre grains secs (V_s faibles) et grains humides (V_s élevées). On peut remarquer également, qu'un second pic apparaît toujours, même s'il est faible par rapport au premier. Le faible pic pour des grains humides, est probablement le reflet d'une sous-population de grains plus secs que la population entière mais peut-être aussi d'un traitement des images qui nécessiterait un affinage plus précis. Le faible pic (V_s élevées) observé pour une population de grains secs (correspondant aux V_s les plus faibles) est plus certainement lié au traitement d'images qui compterait deux traces qui se suivent comme une grande trace. Une autre possibilité est également l'agrégat de plusieurs grains de pollen. Ferrandino and Aylor (1984) ont montré qu'un agrégat de N grains a une vitesse de $\sqrt{N} V_s$, ce qui veut dire que le deuxième pic correspondrait à un agrégat de 3 grains de pollen, hypothèse peu vraisemblable pour des grains secs.

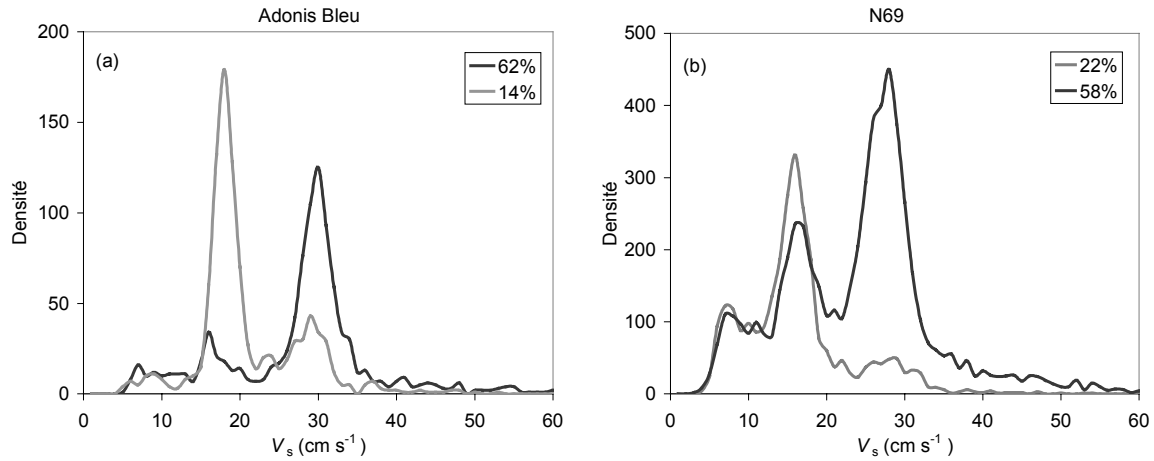

Figure II-12. Distributions de V_s pour (a) un hybride (Adonis bleu) et une lignée (N69) et différents teneurs en eau du grain. Les vitesses les plus faibles correspondent à des teneurs en eau de 14-22% et les plus élevées à des teneurs en eau de 58-62%.

II.2.3.3 Vitesse de sédimentation et teneur en eau

La Figure II-13 montre l'évolution des V_s moyennes en fonction de la teneur en eau du grain sur l'ensemble des séries. En dessous de 40% de teneur en eau, la vitesse de sédimentation du pollen est égale à $17,4 \pm 5,7 \text{ cm s}^{-1}$ et pour des teneurs en eau supérieures à 40%, $V_s = 23,4 \pm 9,2 \text{ cm s}^{-1}$. Ainsi, la vitesse de sédimentation augmente en moyenne avec la teneur en eau du grain ainsi que l'écart-type de la distribution. Aucune différence claire entre variété ne semble toutefois se dessiner (II-13b).

On peut voir sur la Figure II-14 que plus le diamètre du grain est petit, plus le grain est dense, et, inversement, plus il est gros, moins il est dense. De plus, deux sous-populations de grains se distinguent: celle ayant une teneur en eau inférieure à 40% et celle ayant une teneur en eau supérieure à 40%. La masse du grain augmente avec son diamètre, mais dans une proportion moindre que son volume puisque la densité n'est pas constante (Figure II-15).

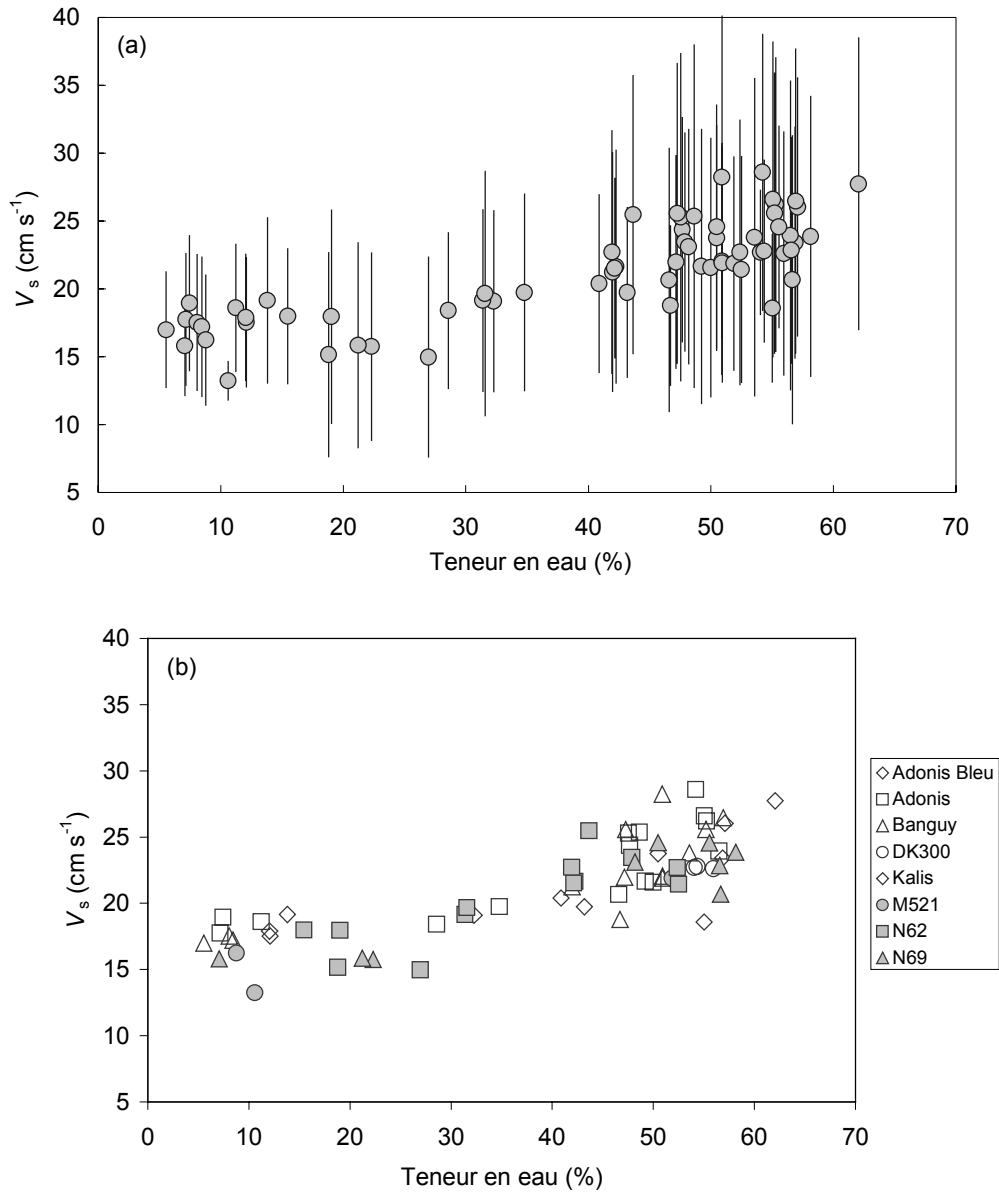

Figure II-13. (a) Vitesse de sédimentation moyenne, V_s et écart-type en fonction de la teneur en eau pour l'ensemble des séries. (b) Vitesse de sédimentation en fonction de la teneur en eau pour chaque variété.

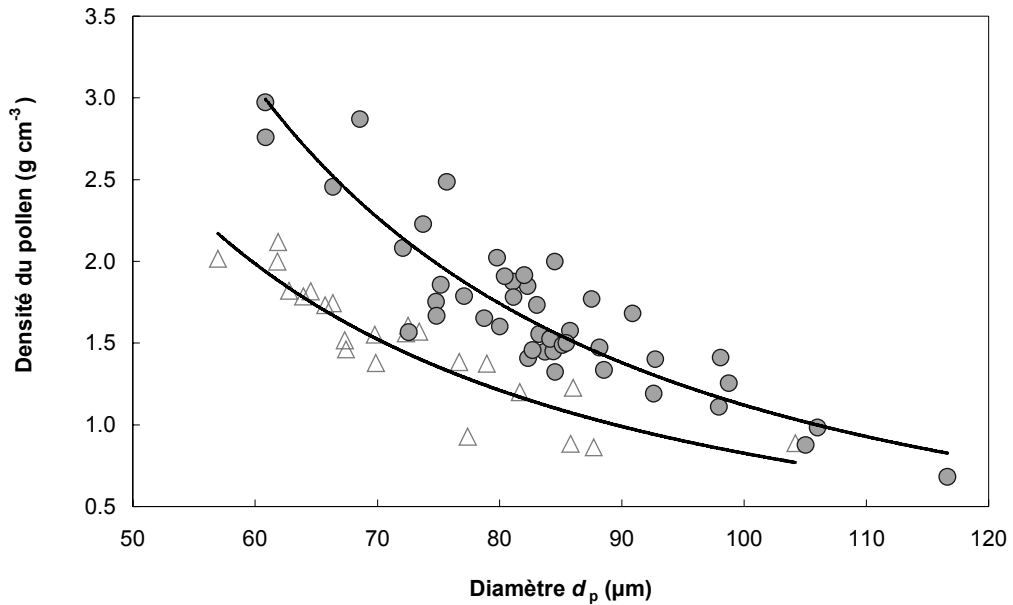

Figure II-14. Densité des grains de pollen à teneur en eau supérieure à 40% (cercles pleins; la courbe est la fonction $y = 10120 x^{-2}$) et inférieures à 40% (triangles vides; la courbe est la fonction $y = 2245 x^{-2}$) en fonction du diamètre d_p pour l'ensemble des séries.

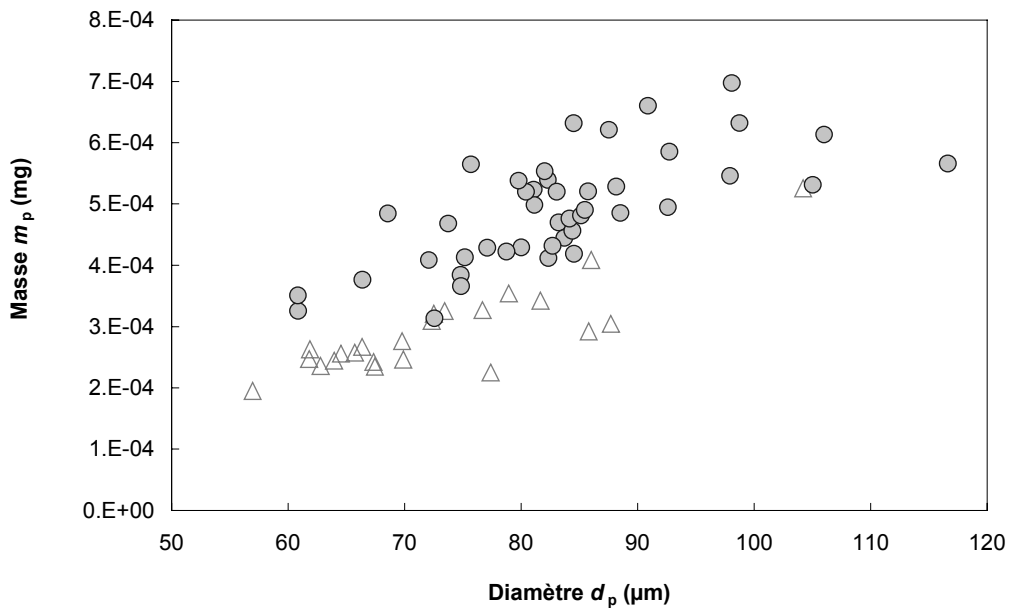

Figure II-15. Masse des grains de pollen à teneur en eau supérieure à 40% (cercles pleins) et inférieure à 40% (triangles vides) en fonction du diamètre d_p pour l'ensemble des séries.

II.2.4 Discussion-Conclusion

Cette étude présente une méthode originale de mesure de la distribution de vitesse de sédimentation. Cette méthode présente l'avantage d'être directe (mesure directe du déplacement) et d'éviter les problèmes liés au chronométrage de la chute du pollen rencontrés avec des méthodes comme celles utilisées par Di-Giovanni *et al.* (1995). De plus, elle est plus

facile à mettre en œuvre et moins onéreuse que la méthode de vélocimétrie Doppler à laser (Rambert *et al.*, 1998).

Les principales difficultés rencontrées sont liées à la calibration de l'image (les grains passent tous dans un même plan focal) et au dispositif de libération du pollen. A terme, ce dernier devrait libérer une quantité faible et homogène de pollen afin d'éviter les recouvrements de trajectoires. Une amélioration possible consisterait à calibrer la chambre avec des particules de taille et de densité précisément définies.

Toutefois, malgré ces défauts, cette méthode a permis de déterminer des distributions réalistes des vitesses de sédimentation pour des pollens plus ou moins humides. Les vitesses moyennes obtenues sont plus faibles que celles trouvées jusqu'à maintenant. Di-Giovanni *et al.* (1995) a mesuré $V_s = 31 \pm 8 \text{ cm s}^{-1}$ et Aylor (2002) a trouvé $V_s = 26 \pm 5 \text{ cm s}^{-1}$ pour les grains secs et humides. Notre étude montre que $V_s = 23 \pm 9 \text{ cm s}^{-1}$ pour des grains humides (teneur en eau supérieure à 40%) et $V_s = 17 \pm 6 \text{ cm s}^{-1}$ pour des grains secs (teneur en eau inférieure à 40%).

Un point intéressant est que la densité du grain ne varie pas avec la teneur en eau du grain (nom montré ici). Il semble donc que le diamètre du grain ait plus d'influence sur la densité que la teneur en eau, bien que la variabilité observée aux faibles diamètres correspond certainement à l'effet de la teneur en eau. Par ailleurs, la mesure des distributions de V_s révèle l'existence de distributions multimodales avec 2 ou 3 modes et non unimodales comme exprimées jusqu'à maintenant. Ces modes semblent correspondre à l'expression de la teneur en eau des grains de pollen.

Chapitre III Modelling airborne concentration and deposition rate of maize pollen

Article en préparation pour Atmospheric Environment

III.1 Introduction

Pollen dispersion has shown increasing interest in relation to recent introduction of genetically modified (GM) crops and the maintenance of seed quality. In Europe, the main issue for maize (*Zea mays*) crops is to quantify gene flow dispersion from transgenic to non-transgenic crops knowing that there is no risk of hybridisation with wild relative, teosinte, and maize landraces, which grows in Central America (White & Doebley, 1998; Matsuoka *et al.*, 2002) and which is subject to scientific debate (Quist & Chapela, 2001; Christou, 2002).

Until now, most studies on pollen dispersion from crops were based on observed contamination of target plants in the vicinity of a “contaminating” plot (Lavigne *et al.*, 1998; Klein, 2000). These studies are of great interest since they can give direct estimates of the percentage of contamination. However, the models based on these studies have a limited predictive capacity, since they rely on the specific meteorological conditions that were encountered during the experiments. In this paper, we evaluate an alternative, and complementary approach, which consists in using a Lagrangian Stochastic (LS) model to simulate wind dispersion of maize pollen. The model called SMOP-2D (Stochastic Mechanistic mOdel for Pollen dispersion and deposition in 2 Dimensions) predicts pollen concentration and deposition rate downwind from an emitting field. SMOP-2D explicitly takes into account atmospheric turbulence and pollen aerodynamic characteristics through a mechanistic approach and includes an empirical parameterisation of the turbulence field for heterogeneous landscapes. These features allow the model to be extrapolated to contrasting situations. The class of LS models has proved to be accurate for calculating the dispersion of

atmospheric gases (Wilson & Sawford, 1996), and has been successfully extended to simulate heavy particle dispersion (Walklate, 1986; Reynolds, 1999; Wilson, 2000) including spore release rate estimates (Aylor & Flesch, 2001). Since SMOP-2D does not take into account biological processes, it can only predict a “potential contamination” by pollen, although the Lagrangian framework is well adapted to take into account the evolution of the pollen with time and environmental conditions.

In this study, the LS model SMOP-2D is validated against two experiments that were conducted in 2000 (Jarosz *et al.*, 2003a; Ch. II.1) and 2001 (Ch. IV). During these experiments, airborne concentration and deposition rates of maize pollen were measured at several locations within and downwind from various sizes maize fields (20 × 20 m and 24 × 48 m). In conjunction, micrometeorological conditions and canopy structure were reported during the whole pollination period to provide the input variables and the parameters for SMOP-2D.

III.2 Material and Methods

III.2.1 Model

SMOP-2D (Stochastic Mechanistic mOdel for Pollen Dispersion and Deposition in 2 Dimensions) is a Lagrangian stochastic (LS) model in 2 dimensions (downwind direction x and vertical ascendant z), which simulates the wind dispersion of pollen grains by calculating a large number of individual trajectories (Figure III-1). SMOP-2D is a generalised version of the LS model initially developed for atmospheric ammonia dispersion (Loubet, 2000; Loubet *et al.*, 2003), very similar to the model reported by Aylor & Flesch (2001) for spore dispersion. Provided the pollen is in the correct size range ($20 \mu\text{m} \leq \text{diameter} \leq 300 \mu\text{m}$), the dispersion of pollen can be regarded as the dispersion of a passive scalar, with a settling velocity V_s added to the vertical velocity component (Wilson, 2000). Pollen displacement is calculated using the following two-dimensional joint stochastic differential equations:

$$\begin{aligned} du &= a_u dt + b_u d\xi_u & dx &= u dt \\ dw &= a_w dt + b_w d\xi_w & dz &= (w - V_s) dt \end{aligned} \quad (\text{III-1})$$

where u and w are the horizontal and vertical air velocity components, respectively; a_u , b_u , a_w and b_w are the Langevin coefficients; and $d\xi_u$ and $d\xi_w$ are random numbers drawn from Gaussian distributions with mean zero and variance dt . The Langevin coefficients are functions of the averaged components of air velocity (U and W , for horizontal and vertical,

respectively), the horizontal (σ_u^2) and vertical (σ_w^2) Eulerian velocity variances, the shear stress ($\overline{u'w'}$), and the dissipation rate of turbulent kinetic energy (ϵ). Under equilibrium conditions, W is assumed to be zero. The coefficients a_u , b_u , a_w and b_w are determined from the well mixed condition and the Kolmogorov's similarity hypothesis (Thomson, 1987). They can be found for stationary and horizontally homogeneous flow in Aylor & Flesch (2001). Due to gravitational forces and inertia heavy particles do not follow the fluid trajectories (Sawford & Guest, 1991). This effect is taken into account by reducing the fluid velocity time scale τ_p along a particle trajectory compared to that along a fluid trajectory T_L (Sawford & Guest, 1991):

$$\tau_p = \frac{T_L}{\sqrt{1 + \left(\frac{\beta V_s}{\sigma_w}\right)^2}} \quad (\text{III-2})$$

where β is an empirical dimensionless constant. We chose $\beta = 3$ (Snyder & Lumley, 1971). This value for particle dispersion is still a subject of debate (see e.g. Wilson, 2000).

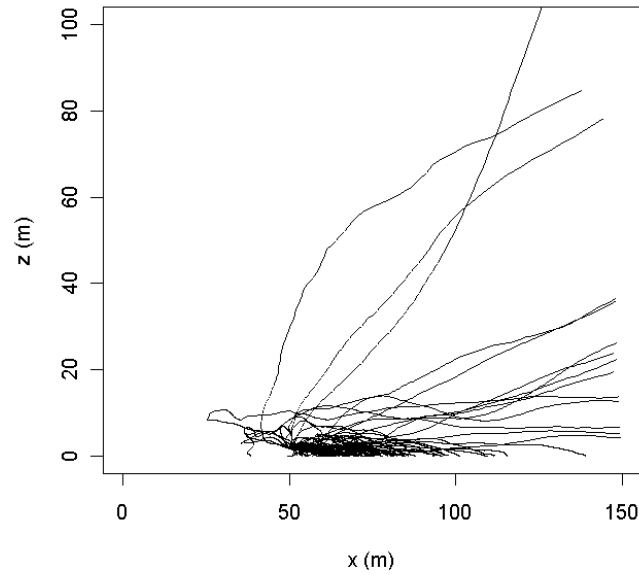

Figure III-1. Examples of trajectories for 100 maize pollen grains released from a 20 m field (along wind) surrounded by a bare soil. The tassels extend from 2.2 to 2.5 m height and the LAI of the canopy is 4.

III.2.1.1 Turbulence field

The details of the turbulence parameterisation under horizontally homogeneous conditions can be found in Loubet (2000) and Loubet *et al.* (2003), particularly the vertical profiles of U , W , σ_u^2 , σ_w^2 , $\overline{u'w'}$ and ϵ .

In this paper, a simple empirical parameterisation of the turbulent field in the transition zone between two different canopies was chosen to simulate the influence of changes in canopy height and structure along the downwind direction x (Figure III-2). The transition

zone is delimited by the upwind and downwind distances x_{upwind} and x_{downwind} , respectively. Within this area, each vertical profile of a given turbulent characteristic is interpolated between the upwind and downwind equilibrium profiles with a 3rd degree polynomial P . To simplify the polynomial expression, the normalised distance X is introduced:

$$X = \frac{x - x_{\text{upwind}}}{x_{\text{downwind}} - x_{\text{upwind}}} \quad (\text{III-3})$$

The polynomial is defined as $P(X) = -2X^3 + 3X^2$, which satisfies four constraints: $P(0) = 0$, $P(1) = 1$ and $P'(0) = P'(1) = 0$, in order to ensure the continuity of the profiles and their derivatives over the transition zone. Moreover, mass conservation is ensured by setting W as the integral over z of the derivative of U over x ($-dU/dx$). Although this parameterisation is crude, it allows the most influencing parameters to vary realistically over the transition zone. Probably the less adequate parameterisation is that of $\overline{u'w'}$, which should increase at the transition and decrease afterwards, whereas in the present model it is assumed to smoothly change from upwind to downwind value.

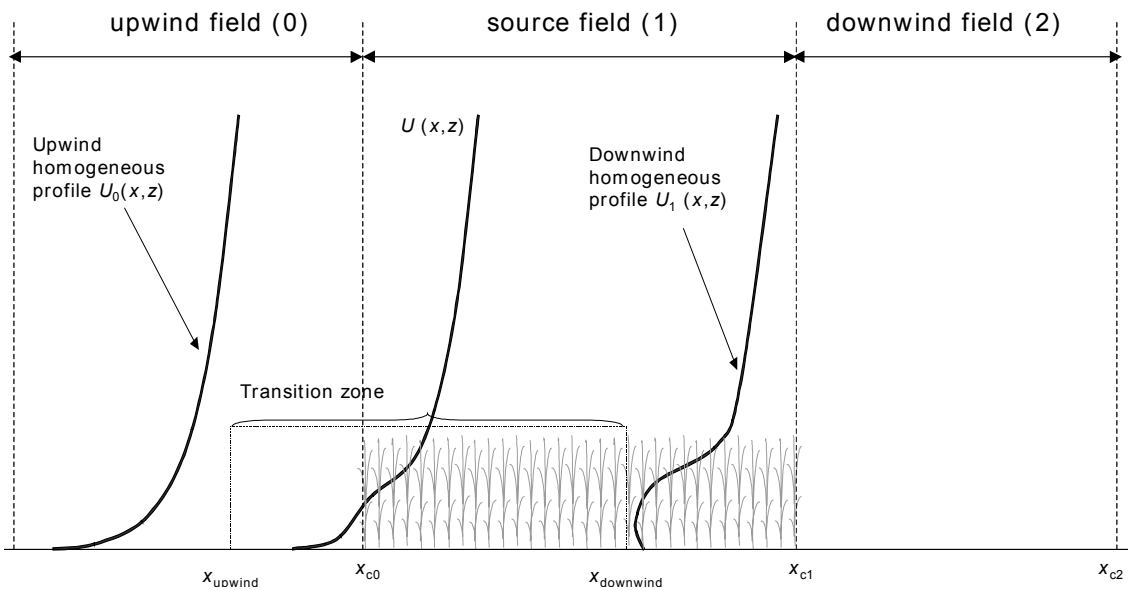

Figure III-2. Wind speed profiles illustrating the parameterisation of the turbulent exchanges in the transition zone between two adjacent canopies. Interpolation is made between equilibrium profiles in contiguous fields. Here x_{c_i} is the downwind fetch of the field i and x_{upwind} and x_{downwind} are the upwind and downwind distance influenced by the roughness change.

III.2.1.2 Model parameters and input variables

SMOP-2D requires canopy and pollen characteristics as well as micrometeorological variables (Table III-1). The canopy parameters needed for each field are the downwind fetch (x_c), the height (h_c), the roughness length (z_0), the displacement height (d) and the leaf area density (LAD), as well as its horizontal and vertical projections (LAD^x and LAD^z). The total

size of the domain has to be defined in horizontal (x_D) and vertical (z_D) directions, as well as the number of horizontal (N_x) and vertical (N_z) nodes in the mesh for concentration estimates. The grid within the source is refined in N_h vertical layers. Finally, a Gaussian distribution is used for the settling velocity V_s . Unless otherwise stated, a mean of 0.31 m s^{-1} and a standard deviation of 0.08 m s^{-1} was taken for the distribution of V_s , which is consistent with Di-Giovanni *et al.* (1995), although smaller means have been measured by others (Aylor, 2002).

Table III-1. Main input parameters of the SMOP-2D model, with units and typical values used in this study.

Symbol	Parameter	Units	Typical values used in this study
CANOPY			
x_c	Downwind fetch of the field	m	20 - 200
h_c	Canopy height	m	0.1 - 0.2 and 2.2 - 2.3
z_0	Roughness length	m	$0.1 \times h_c$
d	Displacement height	m	$0.7 \times h_c$
L_f	Leaf size	m	0.01 - 0.05
x_{upwind}	Upwind distance influenced by the roughness change	m	$3 - 10 \times h_c$
x_{downwind}	Downwind distance influenced by the roughness change	m	$10 - 20 \times h_c$
LAD (z)	Leaf Area Density as a function of z	$\text{m}^2 \text{ m}^{-3}$	
LAD ^x (z)	Fraction of the plant projected onto horizontal plan	$\text{m}^2 \text{ m}^{-3}$	
LAD ^z (z)	Fraction of the plant projected onto vertical plan	$\text{m}^2 \text{ m}^{-3}$	
DOMAIN			
$0 - x_D$	Horizontal size of the domain	m	130 or 254
$0 - z_D$	Vertical size of the domain	m	10
GRID			
N_x	Number of horizontal nodes in the grid	-	100
N_z	Number of vertical nodes in the grid	-	20
N_h	Number of vertical layers within the source	-	10
SOURCE			
N_p	Number of pollen grains released	-	100000
$x_{\text{Smin}} - x_{\text{Smax}}$	Horizontal limits of the source	m	0 - 20 or 0 - 24
$z_{\text{Smin}} - z_{\text{Smax}}$	Vertical limits of the source	m	2.0 - 2.3 or 2.2 - 2.5
S_{dens}	Release rate of the source	grains $\text{m}^{-2} \text{ s}^{-1}$	1
PARTICLE			
V_s	Mean settling velocity of the pollen	m s^{-1}	0.31
std V_s	Standard deviation of settling velocity	m s^{-1}	0.08
β	Empirical constant in the Lagrangian timescale	-	3
TURBULENCE			
L	Monin-Obukhov length	m	-2 to -100
U_{ref}	Mean wind speed at a reference height z_{ref}	m s^{-1}	1.72 - 10.81
z_{ref}	The reference height at which wind speed is given	m	50
C_0	Universal Lagrangian velocity structure constant	-	3
σ_u / u_*	Ratio of along-wind squared root velocity variance to u_*		3.1
σ_w / u_*	Ratio of vertical squared root velocity variance to u_*		1.4
γ	Attenuation coefficient for mean wind speed in the canopy		2.5
$T_L u_* / h_c$	Ratio of the fluid Lagrangian time scale (T_L) times u_* to h_c within the canopy		0.3
$\Delta t / T_L$	Time step for the particle trajectory as a ratio of T_L		0.01

III.2.1.3 Concentration and deposition

The model outputs are the pollen concentration (C) in the defined grid within and at any distance downwind from the source, as well as the deposition rate on the ground (D^g) and on the vegetation structure (D^v). The concentration C is calculated at any point (i,j) of the grid ($i = 1$ to N_x and $j = 1$ to N_z) as follows:

$$C(i,j) = V_{\text{source}} \times \frac{1}{N_p} \sum_{n=1}^{N_p} T_n(i,j) / V(i,j) \quad (\text{III-4})$$

where V_{source} is the volume of the source, T_n is the residence time of the particle n in the grid element of volume $V(i,j)$, described by Flesch (1995).

The deposition within the canopy can be simply expressed as the sum of the contribution due to gravitational settling and the contribution due to inertial impaction (Legg & Powell, 1979). The probability that the pollen deposits on the vegetation (D^v) or on the ground (D^g) over a time step dt is calculated according to Aylor & Flesch (2001). The deposition rate either at the ground or on the vegetation at any distance i ($i = 1$ to N_x) is specified as:

$$D^{g,v}(i) = V_{\text{source}} \times \frac{1}{N_p} \sum_{n=1}^{N_p} D_n^{g,v}(i) / A(i) \quad (\text{III-5})$$

where $D_n^{g,v}$ is the probability that the pollen grain n deposits on the ground or vegetation area A .

III.2.2 Experimental data

The model outputs were compared with concentrations and deposition rates measurements obtained during two field experiments carried out in France at Montargis and Grignon, in 2000 and 2001 (Jarosz *et al.*, 2003a; Ch. II.1 et IV). Pollen concentration and deposition rates measurements were done within and downwind from 20×20 m and 24×42 m maize plots, respectively (Table III-2). Micrometeorological measurements were also performed during the whole pollination period. The plots were isolated from other possible sources of maize pollen and surrounded by bare soil at Montargis and stubble at Grignon. At Grignon, pollen measurements were made on two different plots delayed in time in order to have two different flowering dates. Trials were made at 12 occasions at Montargis (R1 to R12), and 17 (S₁1 to S₁17) and 15 (S₂18 to S₂32) occasions at Grignon for the first and second date, respectively. The trials were selected for comparison with the model when the mean wind direction was less than 20° and 25° away from the direction of sampling lines for

Montargis (8 runs) and Grignon (19 runs), respectively. Some runs showed very small deposition rates (S_{218} to S_{220}). They were kept for comparison with the model estimates but were not retained for studying cumulated deposition rates.

Table III-2. Location and description of the two experiments. h_c is the mean height of the maize plot, h_s is the (lower – upper) mean height of maize tassels (emitting pollen), and LAI is the leaf area density estimated for each canopy. The heights of concentration measurements and the downwind distances of deposition rate measurements are also given. Concentrations were measured using rotating-arm pollen traps and deposition rates using cups. The indicated concentration measurements were performed at downwind distances $x = 3$ and 10 m. The deposition rate measurements were performed at a height $z = 0.25$ m in Montargis and $z = 0.30$ m in Grignon.

Location	Source plot size (x × y) m	Surrounding area	h_c (m)	h_s (m)	LAI ($m^2 m^{-2}$)	Concentration measurements (m above the ground)	Deposition measurements (downwind distance m)
Montargis	20 × 20	bare soil	2.3	2.2 - 2.5	4	0.25, 0.5, 1, 2 and 4	1, 2, 3, 4, 8, 10, 16 and 32
Grignon	24 × 42	stubble	2.2	2.0 - 2.3	4	0.2, 0.5, 1, 2, 4, 6.4	1, 2, 3, 4, 8, 10, 16, 32, 60, 120 and 200

III.2.2.1 Micrometeorological measurements

Wind speed, wind direction, air temperature, relative humidity, surface wetness index, global radiation, net radiation, soil heat flux and rain were recorded during all the experiments. Friction velocity (u_*), Monin-Obukhov length (L), as well as σ_u^2 and σ_w^2 were measured with a 3D ultrasonic anemometer. Details of the experimental set-up is reported in Jarosz *et al.* (2003a; Ch. II.1). All meteorological data were averaged over each run to provide input data to the dispersion model. The friction velocity u_* ranged from 0.13 to 0.31 $m s^{-1}$ and from 0.31 to 0.71 $m s^{-1}$ at Montargis and Grignon, respectively (Table III-3). All trials were under unstable stratification, which corresponds to sunny clear days, typical conditions for maize emission and dispersion (McCartney & Lacey, 1991; Jarosz *et al.*, 2003a; Ch. II.1).

Table III-3. Parameters used in the model for each simulation, as well as wind direction WD_r relative to the sampling line. $h_{c,d}$ is the height of the canopy downwind from the source (the canopy height of the source plot is given in Table III-2); z_0 is the roughness length of the same canopy; x_{upwind} and $x_{downwind}$ are the upwind and downwind distance of the transition zone at the downwind edge of the source (expressed as a factor of the source canopy height h_c); u^* is the friction velocity, and L the Monin-Obukhov length over the downwind surface; $U(z = 50 \text{ m})$ is the calculated wind speed at $z = 50 \text{ m}$ over the downwind surface, using the values given in this table for z_0 , u^* and L , and $d = 0.7 \times h_{c,d}$. $U(z = 50 \text{ m})$ is considered constant over the whole domain, and is used to calculate the homogeneous wind speed profiles over each canopy (upwind, source and downwind), using the surface parameters of each canopy (z_0 and d).

	Date	Time	WD_r deg / sampling line direction	$h_{c,d}$ m	z_0 m	x_{upwind} $\times h_c$ (m)	$x_{downwind}$ $\times h_c$ (m)	u^* m s ⁻¹	$1 / L$ m	$U(z = 50 \text{ m})$ m s ⁻¹
2000										
R1	25 July	8:30 – 10:30	8	0.1	0.03	3	15	0.21	-0.11	2.78
R2	25 July	11:00 – 14:00	-9	0.1	0.02	3	10	0.17	-0.20	2.25
R4	26 July	8:00 – 10:00	-3	0.1	0.07	3	15	0.26	-0.05	3.22
R5	26 July	13:15 – 15:15	-6	0.1	0.07	3	10	0.31	-0.03	4.12
R6	27 July	8:00 – 10:00	-17	0.1	0.06	3	10	0.21	-0.04	2.57
R7	27 July	12:45 – 14:15	16	0.1	0.02	3	15	0.17	-0.11	2.42
R8	28 July	7:45 – 8:15	-7	0.1	0.03	7	15	0.26	-0.09	3.53
R11	31 July	7:30 – 9:30	-19	0.1	0.01	3	10	0.13	-0.50	1.72
2001										
S₁₉	28 July	9:00 – 11:00	23	0.1	0.007	7	20	0.27	-0.10	4.60
S₁₁₀	28 July	11:10 – 13:20	-3	0.1	0.03	5	15	0.29	-0.07	4.08
S₁₁₂	29 July	8:30 – 10:30	17	0.1	0.003	8	17	0.20	-0.25	3.51
S₁₁₃	29 July	10:50 – 12:50	23	0.1	0.03	10	15	0.29	-0.11	3.84
S₁₁₄	29 July	13:15 – 15:20	11	0.1	0.03	9	15	0.31	-0.08	4.29
S₂₁₈	8 August	9:05 – 12:05	13	0.05	0.075	8	15	0.71	0.00	10.81
S₂₁₉	9 August	8:45 – 11:55	8	0.05	0.075	9	15	0.56	-0.01	8.16
S₂₂₀	9 August	12:10 – 14:20	6	0.05	0.06	9	17	0.68	-0.01	10.35
S₂₂₁	11 August	9:25 – 12:25	5	0.05	0.1	7	12	0.31	-0.06	3.50
S₂₂₃	12 August	9:45 – 11:45	-10	0.05	0.1	3	20	0.41	-0.03	5.12
S₂₂₄	12 August	12:05 – 14:10	-22	0.05	0.05	5	20	0.38	-0.03	5.25
S₂₂₅	12 August	14:30 – 16:30	-4	0.05	0.03	3	20	0.38	-0.02	6.11
S₂₂₆	13 August	8:45 – 10:45	16	0.05	0.06	3	10	0.32	-0.05	4.09
S₂₂₇	13 August	11:00 – 13:00	-13	0.05	0.13	3	10	0.38	-0.03	4.43
S₂₂₈	13 August	13:10 – 15:10	0	0.05	0.12	3	15	0.38	-0.03	4.56
S₂₂₉	14 August	9:20 – 11:35	-8	0.05	0.13	10	20	0.31	-0.05	3.37
S₂₃₀	14 August	11:50 – 14:05	-15	0.05	0.08	10	20	0.39	-0.02	5.12
S₂₃₁	15 August	8:50 – 12:05	-10	0.05	0.07	3	20	0.48	-0.01	6.75
S₂₃₂	15 August	12:15 – 15:25	-3	0.05	0.05	3	20	0.57	-0.01	8.87

III.2.2.2 Concentration measurements

Vertical profiles of pollen concentration were measured at different heights (Table III-2) at $x = 3$ and 10 m downwind from the source plot. Vertical profiles of wind speed were also recorded at the same location as the concentration measurements. The concentrations were estimated using rotating-arm spore traps (McCartney & Lacey, 1991; Jarosz *et al.*, 2003a; Ch. II.1) operated for periods ranging from 1:30 h to 3:00 h at Montargis and 2:00 h to 3:15 h at Grignon.

III.2.2.3 Deposition measurements

Pollen deposition rates were measured using small containers (diameter = 50, height = 70 mm) filled with electrolyte solution (Coulter Isoton, Beckman, USA) (Jarosz *et al.*, 2003a; Ch. II.1) between $x = 1$ m and 32 m at Montargis and Grignon, and wider ones (diameter = 170 mm, height = 60 mm) between $x = 60$ m and 200 m in Grignon (Table III-2).

III.2.2.4 Canopy structure measurements

The mean canopy height as well as the tassel heights and extents were measured over 25 plants in Montargis and 50 plants in Grignon. The leaf area density (LAD) was not measured in Montargis, whereas it was determined over 25 plants using a FASTRAK 3D-digitiser (Polhemus, Colchester, USA) in Grignon. A model for reconstructing three-dimensional structure of graminaceous plants, based on digitising (MODICA) (Drouet, 2003), allowed to estimate the LAD^x and LAD^z by simple projection of the reconstructed maize canopy. The estimated LAI was 4.

III.2.3 Model validation

III.2.3.1 General setting

SMOP-2D was validated against the measurements performed in the two experiments detailed above. Although the data available in the two situations are not exactly the same, the methodology and the simulations were similar. The simulated domain was divided in three canopies: the first one located upwind of the maize crop with index $i = 0$, the second one being the maize crop itself, constituting the unique source of pollen $i = 1$, and the last one located downwind from the maize crop $i = 2$ either being bare soil or stubble, depending on the experiment (Table III-1). In all simulations, $i = 0$ and 2 were given the same canopy characteristics. No deposition was assumed on the vegetation in canopy 2, but only ground deposition, which anyway does not introduce big differences in deposition rates since those canopies were small and not dense.

III.2.3.2 Turbulence

Each field was characterised by its height h_c^i , its displacement height d_i , its roughness length z_0^i and its leaf area density vertical profile LAD^i . We used typical formulations for z_0 and d , namely $z_0^i = 0.1 \times h_c^i$ and $d_i = 0.7 \times h_c^i$ except for $i = 0$ and $i = 2$, for which z_0^i was estimated by fitting measured and calculated wind profiles as explained below (Table III-2). The mean wind speed U_{ref} at the reference height (z_{ref}) was estimated from measured friction

velocity u^* and Monin-Obukhov length L over the downwind field ($i = 2$), using the standard Monin-Obukhov similarity theory:

$$U(z) = \frac{u^*}{k} \left\{ \ln\left(\frac{z-d}{z_0}\right) - \Psi_m\left(\frac{z-d}{L}\right) + \Psi_m(z_0/L) \right\} \quad (\text{III-6})$$

where k is the von Kármán constant and Ψ_m is the stability correction function given in appendix A. Within each canopy, the wind speed profile was defined by $U(z) / U(h_c) = \exp[\gamma(z/h_c - 1)]$ (Cionco, 1972), where γ is an attenuation factor set to 2.5, which corresponds to canopies not too dense (Raupach *et al.*, 1996). For all simulations, the ratios σ_u / u^* and σ_w / u^* were set to 3.1 and 1.4, respectively, above the canopy under neutral conditions. In all experiments σ_w / u^* was measured and was very close to the value of 1.3 – 1.4. On the contrary, σ_u / u^* changes with the stability of the atmosphere and the topography of the area. However, it was decided to fix it to a constant value of 3.1 to test the model in a situation where these parameters would not be available. Values of u^* and L^{-1} are given for each simulation in Table III-3.

Over the transition zone, the x_{upwind} and x_{downwind} distances have been adjusted to fit measured wind speed profiles at $x = 3$ m and 10 m, respectively. They ranged from 3 to $10 \times h_c$, and from 10 to $20 \times h_c$, at the upwind and downwind edge of the source field respectively (see Table III-3).

III.2.3.3 Canopy structure

The maize leaf area density $LAD(z)$ and its projections along the horizontal and vertical plane (LAD^x and LAD^z respectively) was assumed identical in shape in Grignon and Montargis, and based on the measured three dimensional canopy structure using the digitiser in Grignon (Figure III-3, Table III-2). The characteristic leaf size, used to estimate the deposition of pollen to vegetation was set to 0.05 m for maize and 0.01 for bare soil or stubble in all experiments, as this parameter is crude, and it was considered better to minimise the number of parameters varying throughout the simulations. The heights and sizes of the tassels (the “source” of pollen) were also measured in each case and are given in Table III-2.

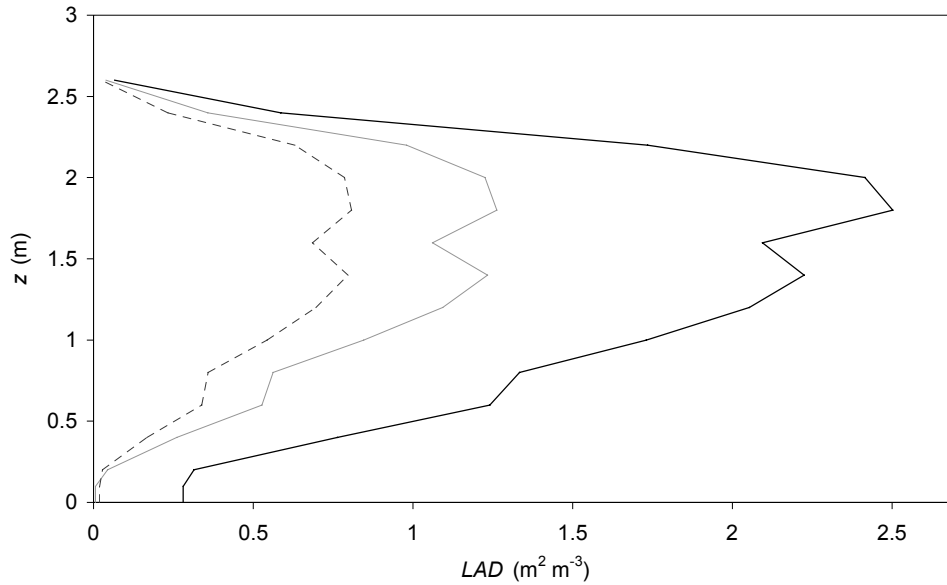

Figure III-3. Profile of leaf area densities (LAD) used in the model for Grignon and Montargis. The corresponding LAI was roughly 4. The projection of LAD (bold line) along the horizontal LAD^x (grey continuous line) and the vertical planes LAD^z (black dotted line) are also represented. They were estimated by projection of a reconstructed canopy following Drouet *et al.* (2003).

III.2.3.4 Numerical settings and validation strategy

The chosen number of particles released was $N_p = 100\,000$ for each simulation. The size of the domain was $z_D = 10$ m for each case, and $x_D = 130$ m and 254 m for Montargis and Grignon, respectively. The number of grid meshes was set to $N_x = 100$ in the horizontal, $N_z = 20$ in the vertical, and $N_h = 10$ in the canopy.

During the experiments, the pollen release rate to the atmosphere was not quantified as this flux remains difficult to estimate (see Jarosz *et al.*, 2003a (Ch. II.1) for a discussion). However, this variable constitutes a major input to the model SMOP-2D, which needs to be determined. Therefore, in this study the source strength was estimated by “inversion” of the model. Inversion was done by first running the model with a release rate of $1 \text{ grain m}^{-2} \text{ s}^{-1}$ and then estimating the source strength using the slope of the linear regression (line forced to zero) between simulated and measured concentrations at $x = 3$ m.

Since the source strength of the model has been set to make measured and modelled concentrations fit at $x = 3$ m, the quality of the model could not be estimated using these data. Therefore, the simulations were compared to independent data, namely the vertical concentration profiles at $x = 10$ m, and the deposition rates.

III.3 Results

III.3.1 Montargis experiment

The Figure III-4 displays four typical vertical profiles (R6, R7, R8 and R11) of measured and simulated concentration at $x = 3$ m and 10 m and the measured and the simulated deposition rates downwind from the source plot. As the parameters z_0 , d , x_{downwind} and x_{upwind} were set for each run by fitting the measured and simulated vertical profiles of horizontal wind speed at $x = 3$ m and at $x = 10$ m, these profiles are also given in order to show the quality of the model parameterisation.

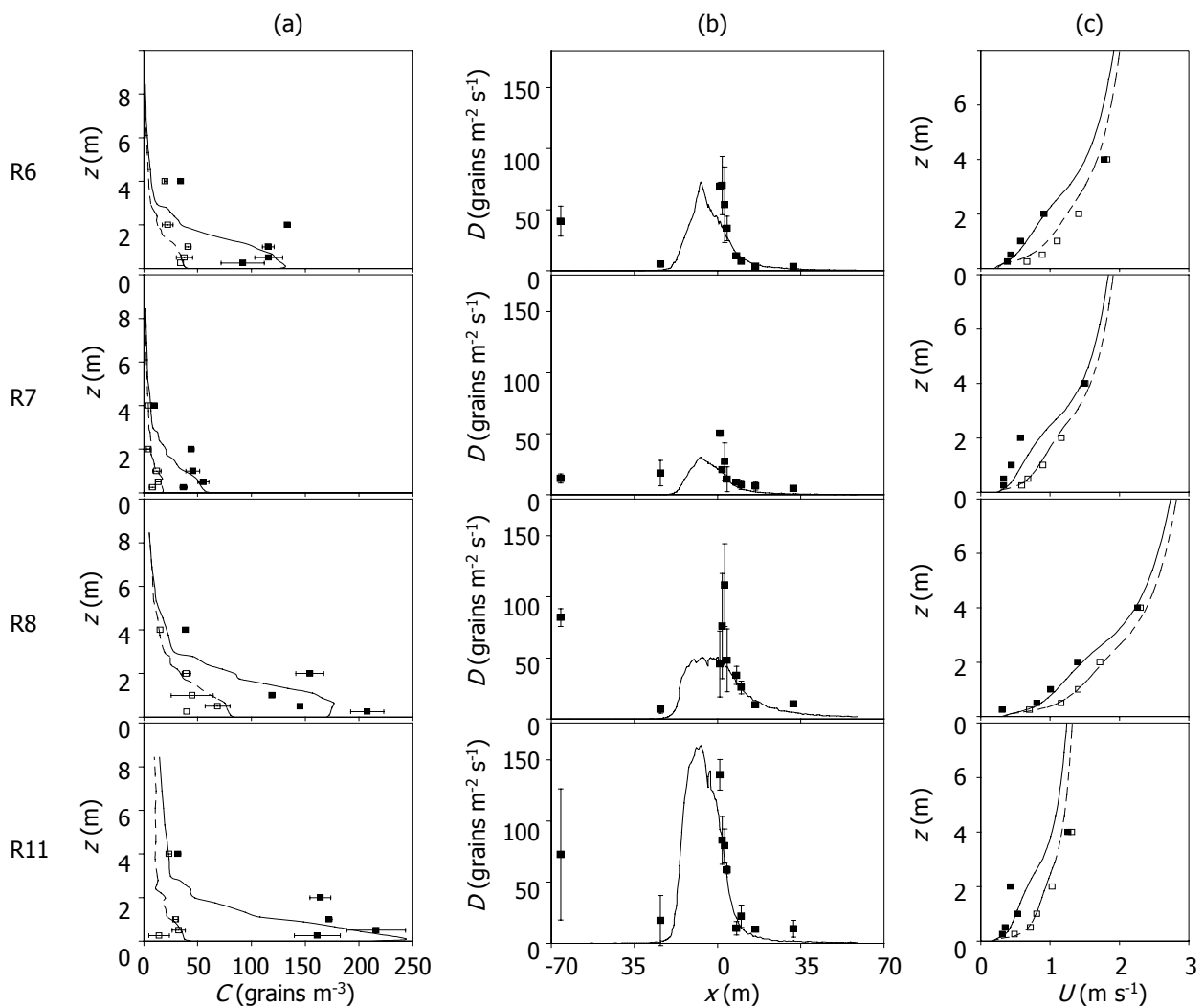

Figure III-4. Results of Montargis simulations (R6, R7, R8, R11). (a) Measured concentration profile (C) at $x = 3$ m (■) and $x = 10$ m (□) and simulated profiles at $x = 3$ m (thin line) and at $x = 10$ m (dotted line) downwind from the source. (b) Measured (■) and simulated (thin line) deposition downwind from the source (D). (c) Measured profiles of mean wind speed U at $x = 3$ m (■) and $x = 10$ m (□) and simulated at $x = 3$ m (thin line) and at $x = 10$ m (dotted line) downwind from the source.

III.3.1.1 Airborne concentration

The Figure III-4a shows good agreement in general between measured and simulated concentration profiles at $x = 3$ m and $x = 10$ m. Two encouraging features can be noticed in particular: (1) the order of magnitude of the concentration at $x = 10$ m is correct, and (2) the shape of the concentration profiles at $x = 3$ and $x = 10$ m are reasonably reproduced by the model in their major traits. However, at $x = 3$ m, the model underestimates systematically the concentrations at heights $z = 2$ m and 4 m, as if the modelled pollen plume fell down too quickly compared to measurements. Figure III-5 displays the vertical profiles of the mean relative error between measured and modelled concentration, which is, for each height, the difference between the two concentrations divided by the measured concentration. At $x = 3$ m, the concentrations are underestimated at $z = 4$ m and in less extent at $z = 2$ m. Beyond the qualitative analysis, Figure III-5 shows that the underestimation of the modelled concentration at $x = 3$ m, and $z = 2$ m or 4 m reaches 50%, whereas at $x = 10$ m and $z = 2$ m the overestimation is less than 25% but more than 200% at $z = 1$ m and 4 m.

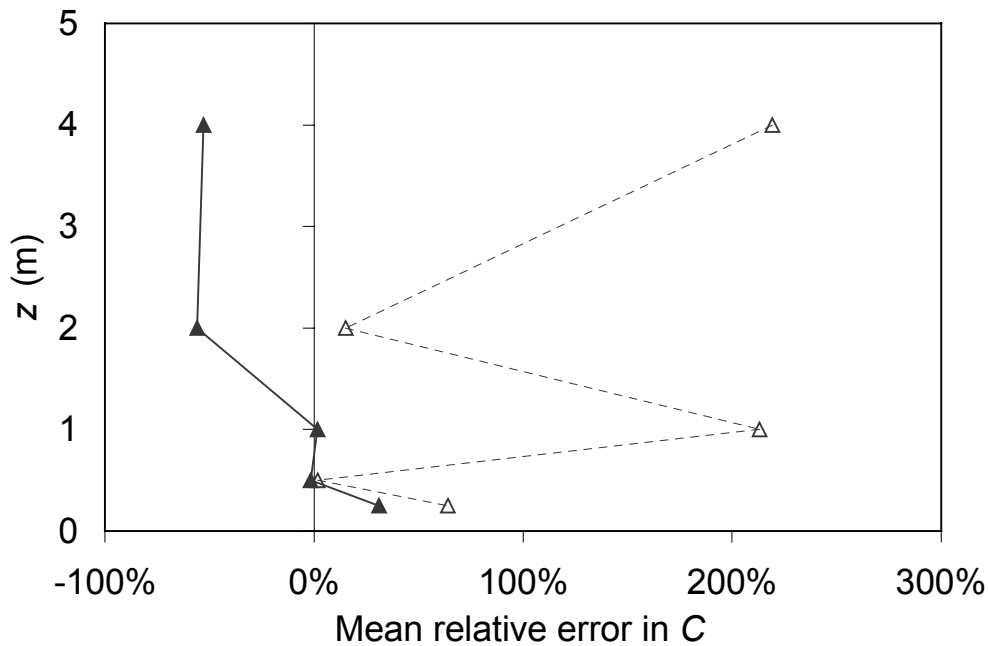

Figure III-5. Mean relative error in concentration in Montargis at $x = 3$ m (▲, thin line) and 10 m (△, dotted line) downwind from the source as a function of height z . It was estimated as the average over 8 simulations of the difference between measured and simulated concentrations divided by measured concentration at a given height.

III.3.1.2 Deposition rates

Baring in mind that the modelled source strength was fitted using the concentration profile at $x = 3$ m, it is encouraging to see that the order of magnitude of the deposition rates

were, in most of the Montargis cases, well simulated by the model (Figure III-4b). However, the model systematically underestimates the measured deposition rates. Figure III-6 shows the mean relative error between the simulated and measured deposition rate as a function of the downwind distance to the source. The deposition rate is always underestimated by the model by around 40% at $x = 16$ m and up to 80% at $x = 32$ m.

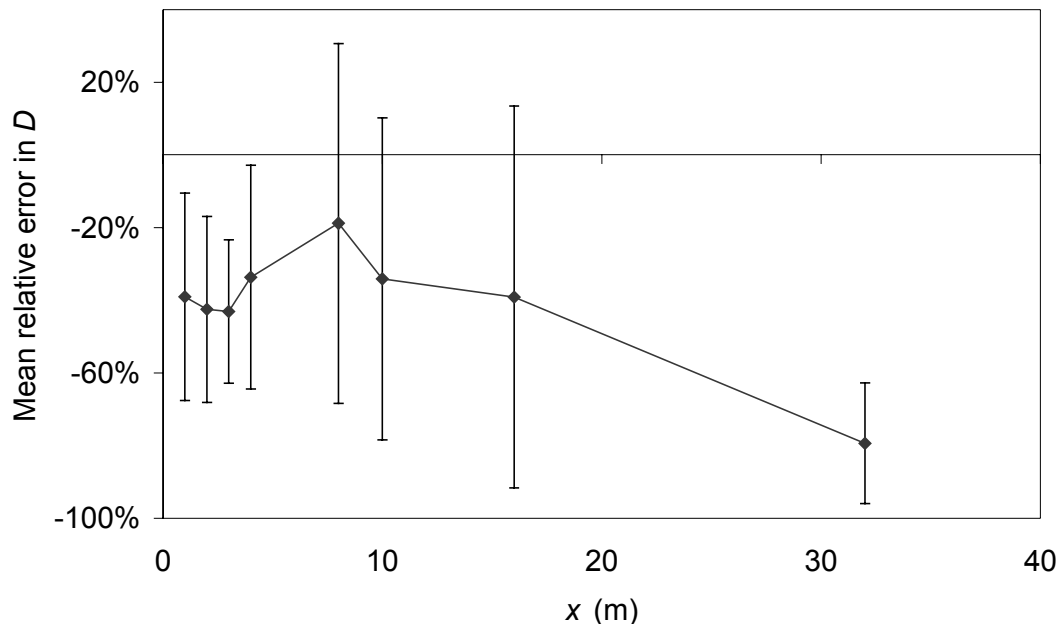

Figure III-6. Mean relative error in deposition rates in Montargis at different distances downwind from the source. It was estimated as the averaged over all simulations of the difference between measured and simulated deposition divided by measured deposition at a given distance.

III.3.2 Grignon experiment

During the Grignon experiment, the concentration was measured at a higher level (at $z = 6.4$ m) and the deposition further down ($x = 200$ m) than during the Montargis experiment. Moreover, in Grignon the maize plot was surrounded by stubble and was isolated as opposed to Montargis where transition zone surrounding the maize source plot was itself surrounded by another maize field. The Figure III-7 shows four typical measured and simulated concentration profiles at $x = 3$ m and 10 m, as well as the measured and simulated deposition rates and the horizontal mean wind speed profiles at $x = 3$ m and 10 m, downwind from the source, for the first (S_1) and second (S_2) flowering dates during the Grignon experiment (S_1 13, S_2 19, S_2 21, S_2 23).

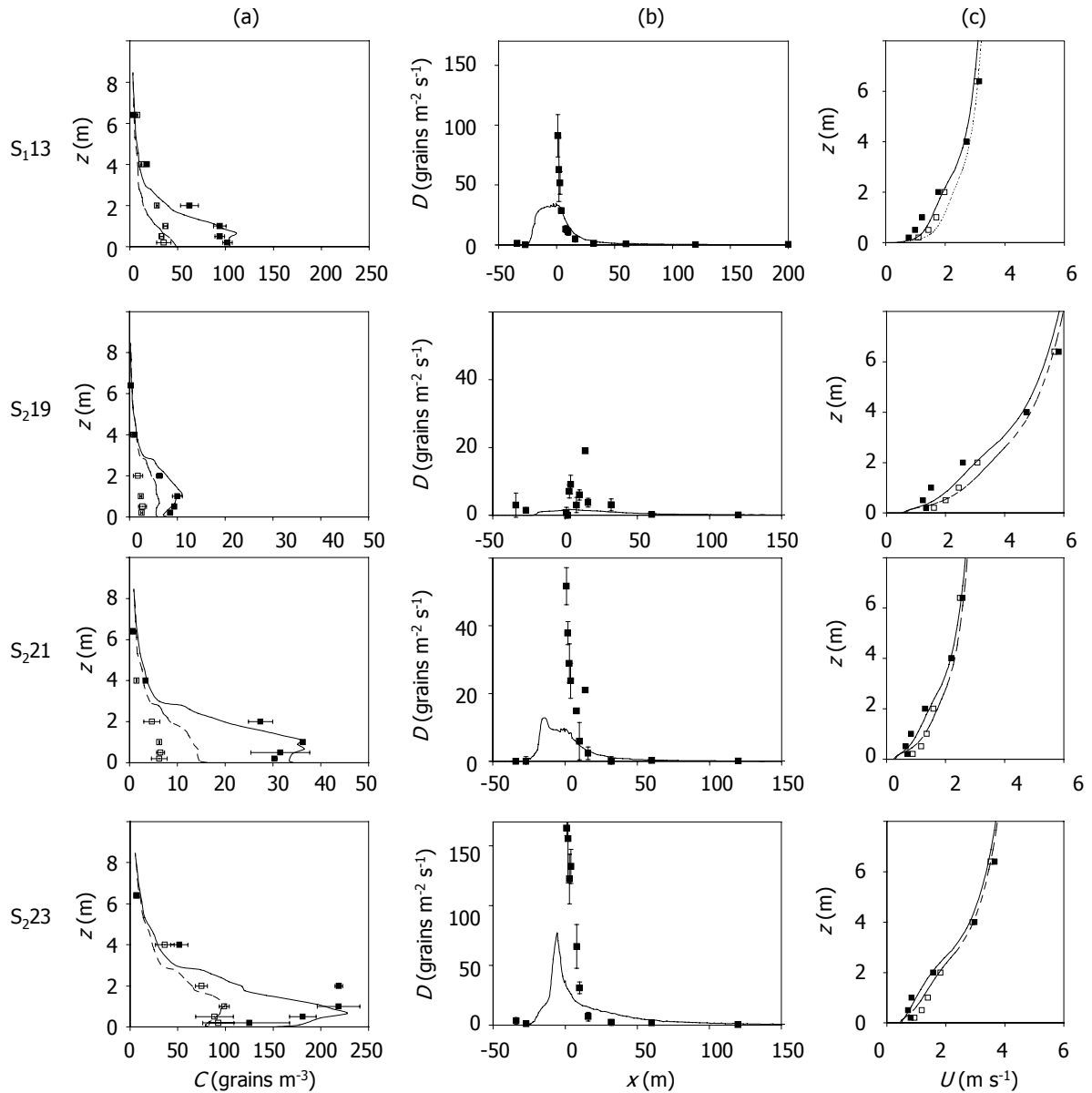

Figure III-7. Results of 4 Grignon simulations (S_{113} , S_{219} , S_{221} , S_{223}). (a) Measured concentration (C) profiles at $x = 3$ m (■) and $x = 10$ m (□) and simulated profiles at $x = 3$ m (thin line) and at $x = 10$ m (dotted line) downwind from the source. (b) Measured (■) and simulated (thin line) deposition (D) downwind from the source. (c) Measured profiles of mean wind speed U at $x = 3$ m (■) and $x = 10$ m (□) and simulated at $x = 3$ m (thin line) and at $x = 10$ m (dotted line) downwind from the source.

III.3.2.1 Airborne concentration

In Figure III-7, the model performance regarding the vertical profiles of concentration simulated at $x = 3$ and $x = 10$ m is similar to what is observed in Montargis (Figure III-4), although the overall agreement with measurements is better (data not shown). The magnitude of the concentration is well simulated at $x = 10$ m, and the shape of the concentration profiles are quite well represented by the model, apart from a systematic model underestimation at $z = 2$ and 4 m at $x = 3$ m. However, in general, the apparent settling down of the modelled

plume is less pronounced than in Montargis, especially for runs S₂18 to S₂20, corresponding to large wind speeds (u_* ranging from 0.56 to 0.71 m s⁻¹). Figure III-8 displays the relative errors on concentration for the S₁ and the S₂ series of experiment. The concentrations were overestimated by the model at $z = 6.4$ m by 180% at $x = 3$ m and 100% at $x = 10$ m for S₁ experiment and by only 50% at $x = 3$ m and 80% at $x = 10$ m for S₂. As noticed above, the general agreement between the model and the measurements is better than in Montargis as the model underestimates the concentration at $z = 2$ m, by 40% at $x = 3$ m and at $x = 10$ m for the S₁. It can also be noted that in the series S₂ the concentration is always overestimated by the model at $x = 10$ m, but only by 15 to 70%.

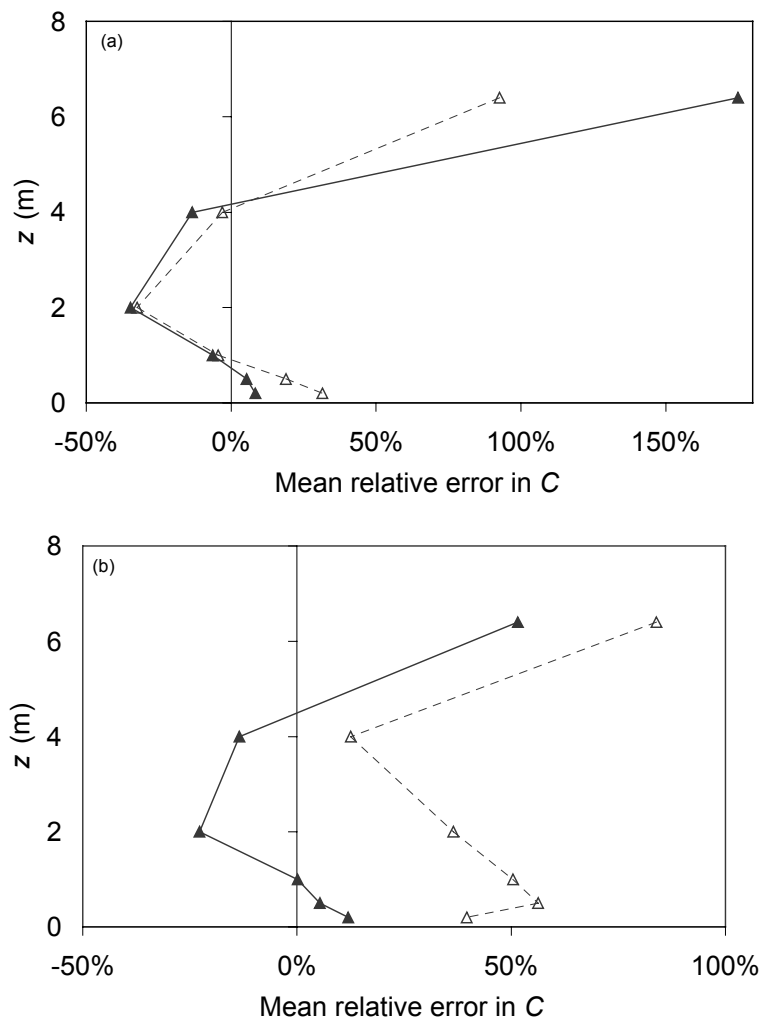

Figure III-8. Mean relative error in concentration in Grignon for S1 (a) and S2 (b) at $x = 3$ m (▲, thin line) and 10 m (△, dotted line) downwind from the source as a function of z . It was estimated as the average over all simulations of the difference between measured and simulated concentration divided by measured concentration at a given height.

III.3.2.2 Deposition rates

Similarly to what was observed in Montargis, the deposition rates close to the source in Grignon are underestimated by the model (Figure III-7). The underestimation is similar in magnitude to what is observed for Montargis (Figure III-6) as shown by the relative error in Figure III-9. However, as opposed to Montargis, for Grignon, the deposition rates are very well simulated at $x = 8$ m, with a relative error close to zero on average, but they are overestimated between $x = 16$ and 60 m, and underestimated at $x = 120$ m (note that only S_1 series are available for 120 m).

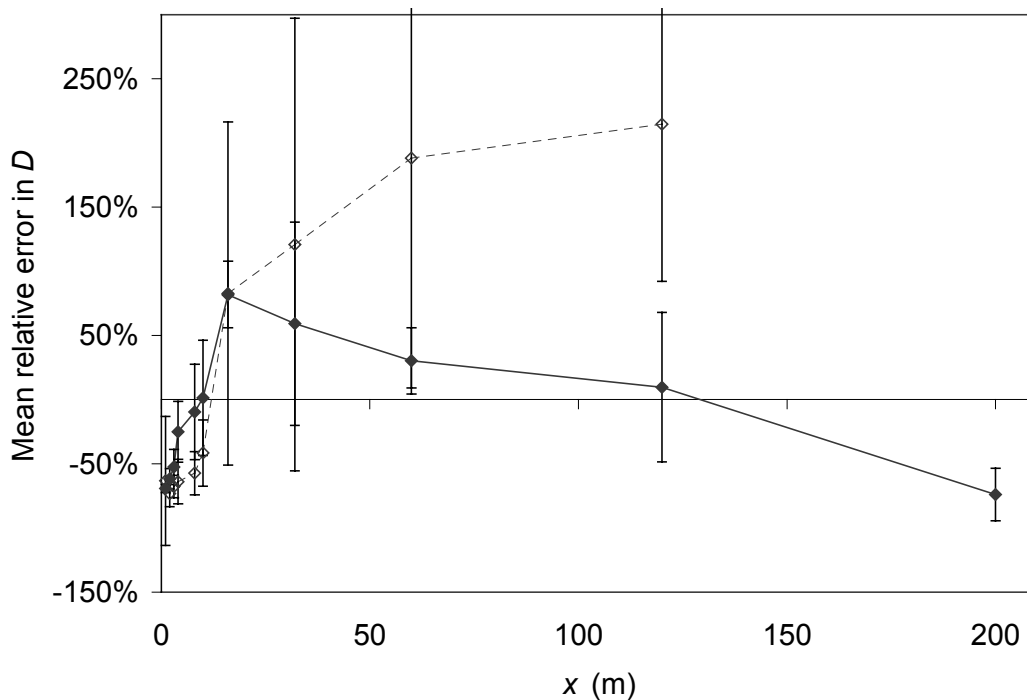

Figure III-9. Mean relative error on deposition rates in Grignon at different distances downwind from the source for S_1 (\blacklozenge , thin line) and S_2 (\diamond , dotted line) series, averaged over 5 and 14 runs, respectively.

III.4 Discussion

III.4.1 Discrepancy between measured and modelled deposition rates near the source

In all the simulations presented in this study, one major feature is that the model underestimates the deposition rate in the vicinity of the maize plot, whereas it correctly simulates the concentration levels. It could be argued that a correct modelling of the deposition rate near the source is not essential to determine potential out-crossing, which takes place at further distances. However, local deposition influences the quantity of pollen

available for long-range transport, and is therefore of great importance. Various assumptions are proposed below to explain the underestimation of the deposition rate by the model.

III.4.1.1 Deposition measurements

First of all, the height of the deposition rate measurement (25 and 30 cm in Montargis and Grignon, respectively) was suspected to influence the deposition rates. A simulation assuming that all particles were deposited at a height of 30 cm showed no significant difference with deposition at the ground, thus suggesting that deposition rates are identical at 0 and 30 cm height. This result was expected since the probability for the pollen to escape from the layer 0-30 cm is in a first approximation proportional to its travelling time (roughly $0.3 / V_s \sim 1$ s), times the probability that w is positive and larger than V_s , which can be estimated between 12% and 28% over all situations, based on a Gaussian distribution for w with mean 0 and standard deviation $\sigma_w = 1.3 u_*$.

Second, the shape of the deposition cups could influence the deposition of pollen through a disturbance of the local turbulence. McCartney *et al.* (1985) have experimentally shown that the spores collected on horizontal microscope slides openly exposed was almost twice as much as slides placed on a table or at the bottom of large cups. Hence the cups could lead to the underestimation of the deposition rate, although in these experiments, they were small in height (less than 7 cm height) compared to the results of McCartney *et al.* (1985). Nevertheless, the opposite result is observed: measured deposition rates are larger than the modelled ones.

III.4.1.2 Concentration measurements

Another potential explanation for the discrepancy between measurements and model would be an underestimation of the concentration by the rotating-arm pollen traps, which would lead to the underestimation of the source strength and in turn to the underestimation of the deposition rate by the model. If this was the case, the correct concentrations would be higher, and hence the source strength and the deposition rate. However, the model underestimates the deposition rates only near the source (Figures III-6 and III-9), and an increased deposition rate at all distances would therefore not better fit the measurements.

III.4.1.3 Settling velocity

The underestimation of deposition close to the source could be linked to a erroneous parameterisation of the distribution of settling velocities for maize pollen. In all runs, the distribution of V_s was taken from Di-Giovanni *et al.*(1995), who found a Gaussian distribution

with mean 0.31 and standard deviation 0.08 m s⁻¹. Personal observations (Ch. II.2) as well as experiments by Aylor (2002), gives a wider range of values for V_s , with generally smaller means from 0.20 m s⁻¹ to 0.32 m s⁻¹, with an average of 0.26 m s⁻¹. However, lower V_s would generate less deposition, and will therefore increase the model underestimation of deposition rate. On the opposite, one is tempted to claim that the underestimation of the deposition rate near the maize plot would be due to V_s being underestimated in the model. The existence of clusters of maize pollens with 2 or 3 pollen grains has been reported by Ferrandino & Aylor (1984), Di-Giovanni *et al.* (1995), and Aylor (2002). These clusters of pollen seem to exist in very little quantity for maize, although it is hard to determine their existence during their travel, as they could quickly breakdown when they are sampled. Moreover, resuspended pollen may be clustered. Ferrandino & Aylor (1984) reports that doublets and triplets would settle 40% and 73% faster than single pollen, respectively. In practice, the presence of clusters would create a secondary maximum in the distribution of V_s at $\sqrt{N}V_s$ where N is the number of pollen clustered. Therefore doublets and triplets would have $V_s = 0.37$ cm s⁻¹ and 0.45 cm s⁻¹, if V_s for single pollen is taken as $V_s = 0.26$ cm s⁻¹. Figure III-10 displays the concentration profiles and the deposition rates simulated for the S₁₃ run, with V_s ranging from single pollen to a cluster of 5 particles (which are unlikely to exist). Figure III-10 shows that for larger V_s the model better simulates the deposition rates near the source but does not simulate correctly the concentration profiles, especially at $x = 10$ m, where measured concentration are greatly underestimated for large V_s . These results suggest that the underestimation of deposition by the model near the source is unlikely to be only due to pollen settling velocity and/or clusters.

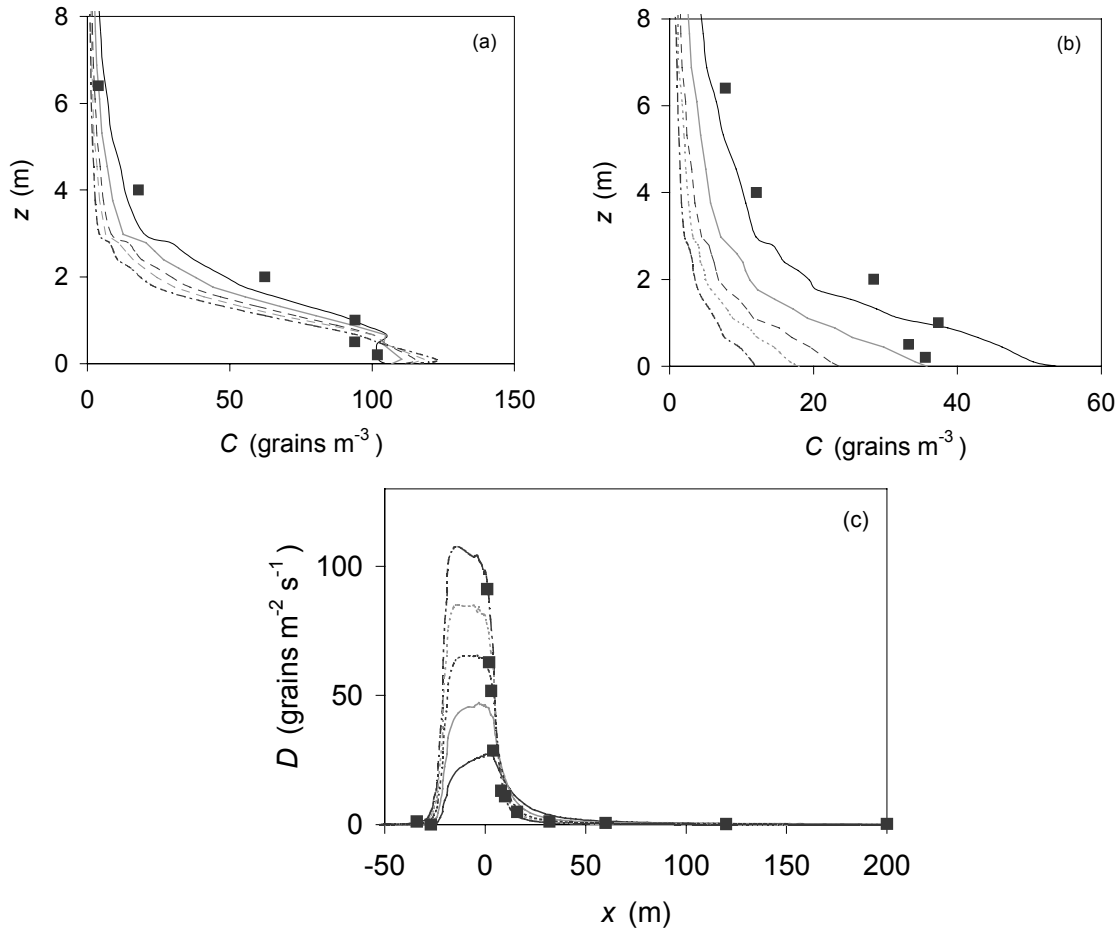

Figure III-10. Sensitivity analysis to the settling velocity V_s . Concentration profile at (a) $x = 3$ m and (b) $x = 10$ m downwind from the source and (c) the deposition as a function of x are represented for simulations S_{13} with $V_s = 0.26$ m s^{-1} for single grains (black thin line), 0.37 m s^{-1} for doublets (grey thin line), 0.45 m s^{-1} for triplets (black dotted line), 0.52 m s^{-1} for quadruplets (grey dotted line) and 0.58 m s^{-1} for quintuplets (black dotted dash line).

III.4.1.4 Pollen resuspension

To our knowledge, little information is known about pollen resuspension from either leaves or the ground. Aylor *et al.* (2003) have shown experimentally that pollen could be quite easily dislodged from maize leaves by either leaf shaking, roll-off or small air flow (0.2 to 0.5 m s^{-1}). He also showed that leaf hairs are not sticky for maize pollen. Hence pollen resuspension from leaves is likely to happen and it has been observed for other particles (Aylor & Ferrandino, 1985; Braaten *et al.*, 1990; Ibrahim *et al.*, 2003). The fraction of deposited maize pollen that is resuspended from the ground in the atmosphere is of little interest for gene transfer, since this short-living pollen (Dumas, 1990) is likely to dye off quickly by contact with heating ground. However, pollen from leaves could be maintained in living conditions due to larger humidity and smaller temperature in the canopy. To study the potential effect of pollen resuspension on measured concentration, simulations with a source

height taken between $z = 1.7$ and 2.0 m, corresponding to the height of maximum observed LAD (Figure III-3) were performed (not shown). Two values of V_s were used: $V_s = 0.26 \text{ m s}^{-1}$, which corresponds to a fresh pollen and $V_s = 0.15 \text{ m s}^{-1}$, which corresponds to dry pollen (Ch. II.2). It shows that resuspension (modelled by the lower height source) does not modify much the simulated concentrations and deposition rates. Note also that the simulation with $V_s = 0.15 \text{ m s}^{-1}$, which would correspond to dry pollen, does not agree with measured deposition rates and concentrations, thus dismissing the assumption of dry pollen resuspension to explain the observed enhanced deposition rate near the source.

III.4.1.5 Turbulence

Another likely explanation of the underestimation of the deposition close to the source is the difficulty to describe correctly the turbulent flow in the transition zone at the downwind edge of the source with the crude parameterisation used here, especially for U , W , σ_w and $\overline{u'w'}$.

Indeed, the underestimation of the deposition rate and the concentration above the canopy height, downwind from the source, could be induced in particular by an underestimation of the turbulence intensity (σ_w / U) in this area: indeed, larger turbulence intensity would induce larger vertical diffusion, which favours larger deposition rates near the source and increased concentration above the source level.

The topography in both Montargis and Grignon sites was especially complex, and the downwind source area could not be considered as a simple rough to smooth transition zone. Indeed, the maize canopies were only about 20 m long in the downwind distance ($\sim 10 h_c$), hence the downwind source area was also located in the smooth to rough transition zone of the upwind edge (Irvine *et al.*, 1997). Measurements of the turbulence intensities in this area using ultrasonic anemometers (Gill, R2 and R3, data not shown) have shown an increase of σ_w / u_* above its standard boundary layer value ($\sim 1.7 u_*$ instead of $1.3 u_*$), in the first 10 m downwind from the maize plot. Moreover, measured W downwind from the canopy showed a quite large downward flow with W down to $-0.7 u_*$, whereas the parameterisation gave $W \sim 0.4 u_*$. The observation reported here are in good agreement with Irvine *et al.* (1997) at $x / h_c = 14.5$ downwind from the smooth to rough edge, which corresponds to 10-15 m downwind from the source. Hence, enhanced σ_w and negative W near the source could partly explain larger measured deposition rates. Parameterised values of $\overline{u'w'}$ are much smaller (by a factor of 2 to 3) than those measured over the canopy and downwind, which were about $-4 u_{*upwind}^2$. Irvine *et al.* (1997) found an increase of $\overline{u'w'}$ up to $-2.5 u_*^2$ downwind from a

single transition, which is consistent with the double transition in this study. This is a crucial point because, a larger $\overline{u'w'}$ such as a larger σ_w , tend to both increase upward dispersion and downward diffusion, and hence deposition. However, unlike σ_w , the model underestimation of $\overline{u'w'}$ is much larger. It is therefore likely that a better parameterisation of $\overline{u'w'}$, but also W and σ_w , in the transition zone would increase the deposition rate near the source.

III.4.1.6 Effect of the β parameter

Wilson (2000) reported simulations of the deposition of glass beads (mean diameter $\varnothing = 107 \mu\text{m}$), released from a point source at 15 m height over prairie land. He found that β had a great influence on the deposition rates. Simulations (not shown) have been performed with different values of β ($\beta = 1.5, 2, 3, 4$ and 5), and shows little influence of β on short-range deposition of pollen. Increasing β seems to decrease vertical diffusion near the source but also to decrease deposition further downwind.

III.4.2 Cumulated pollen deposition with distance

A major difficulty when analysing deposition rates of maize pollen from different measurement data sets is the need for normalisation in order to allow comparison between different conditions. This is usually done by dividing the deposition rate by its value at a fixed distance ($x = 1 \text{ m}$) (e.g., Raynor *et al.*, 1972a), and the same is applied to concentration profiles. However, such normalisation is biased since the deposition rate (as well as the concentration) at $x = 1 \text{ m}$ depends on micrometeorological conditions. As presented in section III.2.3.4, the source strength is estimated by “inversion” of the SMOP model. This gives the opportunity to normalise the measured deposition rates by the “estimated” source strength. Moreover, it is interesting to compare measured and modelled cumulated deposition rates at $x = 120 \text{ m}$, to see whether the model overestimation at larger distances compensates the underestimation near the source. Figure III-11 displays the measured cumulated deposition rates at $x = 120$ and 200 m expressed as the percentage of the simulated source strength estimated by "inversion" of the model Grignon. It is noticeable that “measured” cumulated deposition always increased sharply close to the source, and from $x = 32 \text{ m}$ asymptotically reaches an equilibrium. The cumulated deposition rates at $x = 120 \text{ m}$ were in the range 39% to 67% for S_1 and 52% to 83% for S_2 . A comparison of measurements with the model shows that the model underestimates by 30% in average the cumulated deposition.

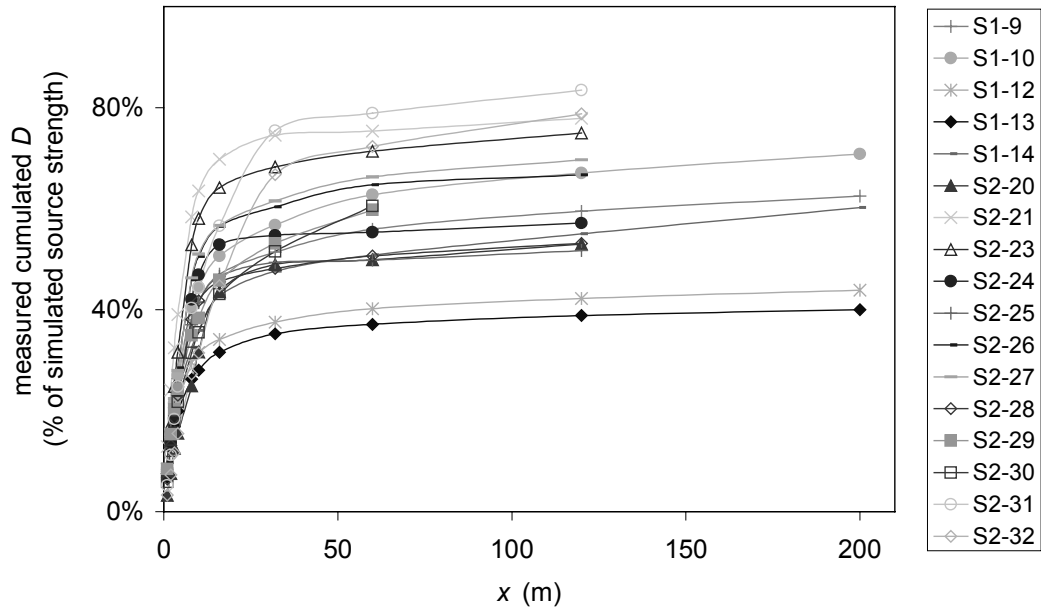

Figure III-11. Measured cumulated pollen deposition as a function of downwind distance x , expressed as a percentage of the release rate for all runs in Grignon, except runs S₂18-S₂20 for which the deposition rates were too uncertain. The release rate was estimated by "inversion" of the SMOP model.

Notice however that the cumulated deposition does not include deposition in the source itself, which explains why these numbers are far from 100%. Deposition was not measured inside the source. However, an estimate can be given using the model: from 17% to 50% of the emitted pollen is redeposited in the source, with a mean of 40%. The modelled cumulated deposition at $x = 120$ m including deposition in the source ranges from 71% to 91%, with an average of 86%.

III.4.3 Effect of microclimate on pollen short-range deposition

In general, a larger horizontal wind speed U led to less pollen deposition near the source, but more cumulated deposition at $x = 120$ m. A plot of the "measured" and modelled cumulated deposition (not including the source) at $x = 120$ m against u_* and L^{-1} is given in Figure III-12. It clearly shows that deposition of pollen downwind from the source increases with u_* . However, in the mean time deposition inside the source diminishes as well, leading to an overall deposition being rather constant with u_* . A maximum appears around $u_* = 0.3 - 0.4 \text{ m s}^{-1}$. This suggests that wind speed only displaces the location of pollen deposited but changes its magnitude by less than 15%. Figure III-12 also shows that under unstable stratification of the surface boundary layer, pollen deposition downwind from the source is diminished, but deposition in the source is increased. The maximum overall deposition (including in the source) is observed for moderately unstable stratification. These conclusions

should however be tempered, as the model does not properly simulate the deposition rates at $x = 120$ m and no inside source deposition was measured. Baring these concerns in mind, Figure III-12 suggests that near neutral and very unstable stratification of the atmosphere are the best conditions for the pollen to travel far away from the source.

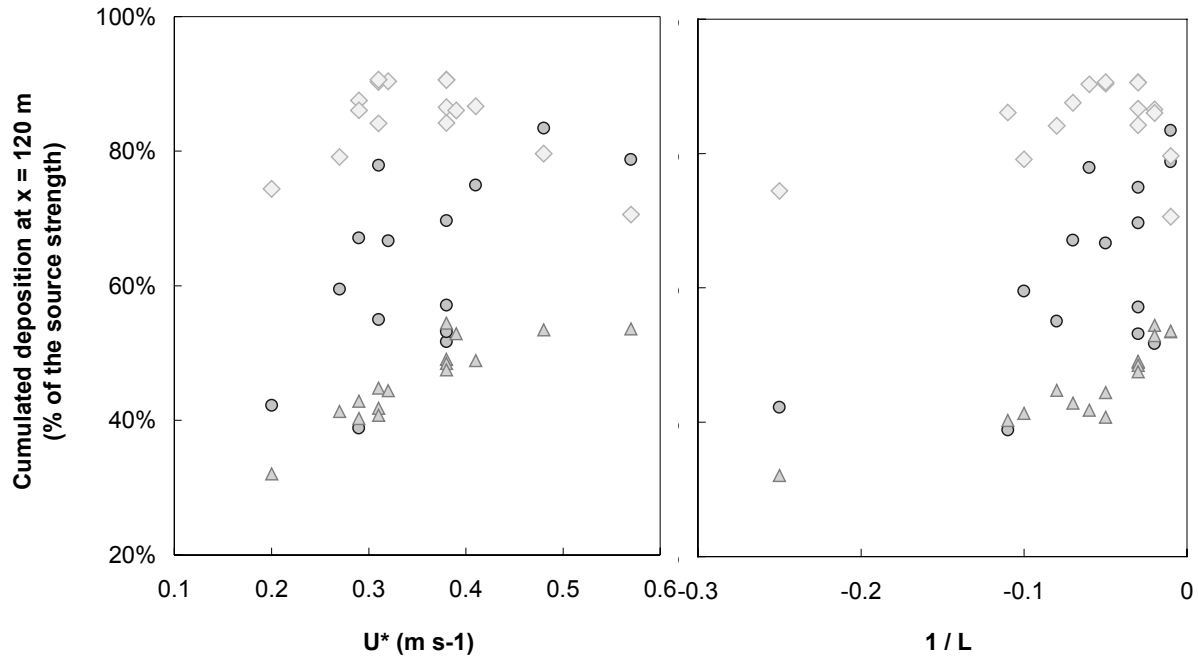

Figure III-12. Cumulated pollen deposition at $x = 120$ m as a function of u_* and $1/L$. Shown are measured (circle) and modelled (triangle) cumulated pollen depositions from $x = 1$ m to $x = 120$ m, and modelled (diamond) cumulated pollen depositions including deposition within the source. All three are expressed as percentage of the source strength estimated by model inversion (see text for details).

The pollen that is still airborne will however not always remain viable. Luna *et al.* (2001) have shown that 100% of pollen during typical conditions of maize flowering is non-viable after 2h, and even 1h in drier weather conditions. Moreover, the pollen, reaching a target silk will have to compete with the pollen locally released in greater quantities (Hauptli & William, 1988). Therefore, the contamination of target fields is bound to be much smaller than the quantity of pollen still airborne at a given distance. It should however be stressed out that results suggest that a significant quantity of pollen (about 15%) can escape from the field and represent a risk of contamination at further distances than 120 m.

III.5 Conclusion

This study have shown that SMOP-2D simulates correctly the airborne pollen concentration pattern downwind from small size maize crop but generally underestimates the deposition rates in the first 10 to 16 m downwind from the crop. A range of assumptions were raised and evaluated by sensitivity analysis to question this discrepancy. This critical analysis

led to the conclusions that: the underestimated deposition rate could not plausibly be due to (1) biased concentration or deposition rate measurements, (2) presence of heavier pollen, or clusters of pollens, with larger V_s , (3) pollen resuspension from the leaves or the ground, or (4) value of the β parameter, reducing the particle lagrangian time scale. The model underestimation of the deposition rate is probably rather due to a parameterisation of the turbulent field over and close to the emitting source. This rises the general question that Lagrangian Stochastic models need to be coupled with at least 2nd order Eulerian flow models, if they have to be used in complex terrain.

The cumulated pollen deposition between $x = 1$ and 120 m was estimated based on measured deposition rates and expressed as a percentage of the inferred emission rates. It is found that 39% to 83% of the pollen emitted is deposited in this area, while modelled estimates are 30% smaller on average. Using the model, the quantity of pollen redeposited in the source itself was estimated to range from 17% to 50%, which leads to an overall modelled deposition of 86% on average at $x = 120$ m. Based on 16 runs, it appears that the most favourable conditions for pollen dispersal were either near neutral or very unstable stratification of the atmosphere.

It should be stressed however, that many processes are involved in the effective out-crossing, apart from pollen dispersal. All pollen transported will not systematically fertilise a silk. Other factors are involved in the effective out-crossing: biological including pollen viability, silk receptivity, time synchronisation between crops, competition between foreign and local pollen, as well as meteorological, including rain wash out, ultra violet solar radiation. Any model trying to estimate effective out-crossing would require to either mechanistically or empirically integrate all these features.

Chapitre IV Estimating variations in maize pollen emission and deposition

Article en préparation pour Agricultural en Forest Meteorology

IV.1 Introduction

Recent introduction of genetically modified (GM) crops has increased the interest in studying pollen dispersal, particularly in relation to gene flow from GM to non-GM crops. But such interest existed for years, especially in relation to the question of seed quality maintenance. Maize (*Zea mays* L.) is primarily wind pollinated, and as such is a good reference for studying the effect of micrometeorological parameters on pollen dispersal. It is also a GM crop of major interest, especially in the US (James, 2002).

Few studies report maize dispersal experiments (Raynor *et al.*, 1972a) over either short downwind distances or limited range of weather conditions. Recent reviews (Emberlin, 1999; Feil & Schmid, 2002; Aylor *et al.*, 2003) emphasised the lack of quantitative studies where maize pollen concentration has been measured above a 5 m height and concentration and deposition further than 100 m downwind. Measurements of contrasted meteorological conditions are also often missing, which does not allow to understand in detail the dispersal process of maize pollen. The pollen release rate by the maize crop is also of critical importance in order to understand dispersal. However, direct measurement of the release rate is difficult to undertake and consequently the emission dynamics, particularly during the day is poorly known. Some studies (Ogden *et al.*, 1969; Jarosz *et al.*, 2003a; Ch. II.1) reported daily emission dynamics with concentration measurement above the source and Jarosz *et al.* (2003b; Ch. III) inferred the release rate by coupling daily pollen production measured directly on the tassel and concentration measured above the source.

In this study, we present concentration and deposition measurements of maize pollen downwind of a small size plot and a large commercial field, the latest corresponding to a more realistic size of maize crop than previous studies. Measurements were done up to 200 m downwind from the source in 2001 and 400 m in 2002. We compare pollen release rate inferred using a dispersal model and pollen production in the field and we examine the influence of environmental factors on pollen emission dynamics. We also discuss the influence of roughness change on deposition rates.

IV.2 Material and Methods

IV.2.1 Experimental site

Three experimental seasons were conducted in France at Montargis in 2000, Grignon (latitude = 48°51'N; longitude = 1°55'E; altitude = 101 m) in 2001 and Sore (latitude = 44°19'N; longitude = 0°34'W; altitude = 71 m) in 2002. The Montargis experiment has already been reported in Jarosz *et al.* (2003a; Ch. II.1), and will therefore not be detailed here. However, the results from all three experiments will be analysed together. Pollen concentration and deposition rate measurements were done within and downwind of 20 × 20 m, 24 × 48 m and 500 × 1000 m maize plots, for Montargis, Grignon and Sore, respectively (Jarosz *et al.*, 2003a; Ch. II.1 and Figure IV-1). The plots were isolated from other possible sources of maize pollen, except in Montargis. At Grignon, measurements were made on 2 different plots (plot 1 and plot 2) whose flowering dates were delayed. Plot 1 was sown on 29 April 2001 and plot 2 on 30 May 2001 both with Adonis cultivar (Pau Semences S.A, Lescar, France) with a density of 90000 grains ha⁻¹. The plot 1 was surrounded by wheat and stubble after harvesting and the plot 2 by stubble. In Sore, a 50 ha commercial field was sown with Kalis cultivar (Rustica, Mondonville, France) on 18 April 2002 with a density of 85000 grains ha⁻¹. The maize plot was surrounded by a pine forest (approximately 20 m height), except for an area of roughly 50 ha of natural grassland extending to 500 m downwind of the maize field in the prevailing wind direction.

The height (h_c) of the maize canopy was measured over 25 plants in Grignon where it was 2.2 m tall and over 20 plants in Sore where it was 2.6 m tall. The height of the tassels (h_s) was between 2.0 and 2.3 m above the ground at Grignon and between 2.4 and 2.9 m at Sore.

Daily trials were made on 32 occasions in Grignon and lasted about 2 hours each: 8 over wheat (S₀1 to S₀8), 9 over stubble (S₁9 to S₁17) for plot 1 and 15 over stubble (S₂18 to S₂32) for plot 2. Daily trials were made on 7 occasions at Sore (A₁ to A₇) over natural

grassland, which lasted about 10 hours each, and on 5 occasions within the maize crop itself (P1 to P9), lasting 30 min each. Sore is located in the South West of France with warm conditions in the summer in a region with sandy soil, where maize crops required irrigation. The maize field was equipped with a center pivot-irrigation of 500 m long.

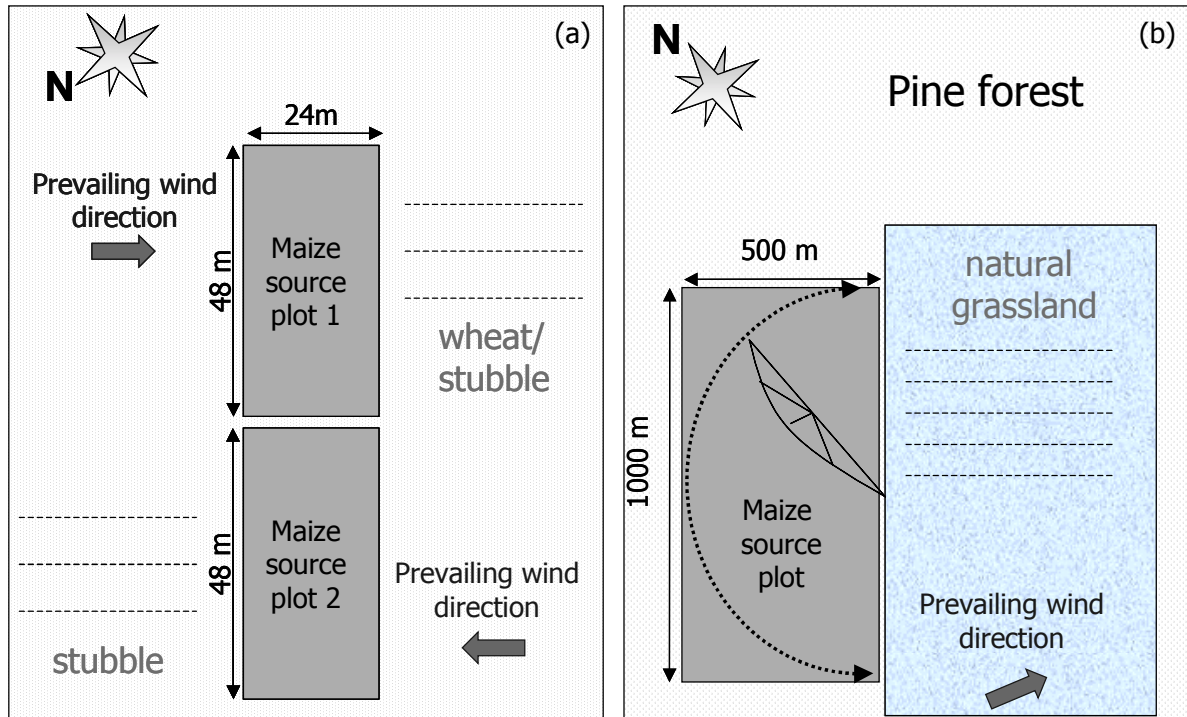

Figure IV-1. Schematic plan of Grignon (a) and Sore (b) experiments. In Grignon, two 24×48 experimental plots delayed in flowering time were surrounded by wheat (S_0) and stubble after harvesting (S_1 and S_2). During experiments with plot 1, mean wind direction was from NE and during experiments with plot 2 from SW. In Sore, the crop was 500×1000 (not to scale) and surrounded by a pine forest, except for an area of about 50 ha of natural grassland on the east extending to 500 m downwind in the prevailing wind direction.

IV.2.2 Micrometeorological measurements

Micrometeorological measurements were also performed during the whole pollination period. Wind speed and direction, air temperature, relative humidity, surface wetness index, global radiation, net radiation, soil heat flux and rain were recorded during all the experiments. The meteorological masts were located in the maize plot, except at Grignon where global radiation, net radiation, soil heat flux and rain were measured above the wheat / wheat stubble, in order to get the radiation balance of the surrounded area. The friction velocity (u^*) and the Monin-Obukhov length (L) were measured with a 3D ultrasonic anemometers located at 4.5 m height and 16 m upwind of the plot 1 and downwind of the plot 2 at Grignon, and at 6 m height and 20 m downwind the commercial field at Sore. Details of the micrometeorological instruments and measurement methods are reported in Jarosz *et al.*

(2003a; Ch. II.1). All meteorological data were averaged over each trial to provide input data to the dispersion model used to estimate the release rate in section IV.4.1.

IV.2.3 Measurements of pollen concentration and deposition rate

Table IV-1 displays all pollen measurements made in 2001 and 2002. Time variation of pollen production was estimated by covering 6 randomly chosen tassels at Grignon and the same 10 tassels at Sore with plastic bags (Osmolux Pantek, Montesson, France). Flowering dynamics was determined from 50 given plants, following the method of Jarosz *et al.* (2003a; Ch. II.1). The pollen release rate of the source plot was also inferred from the concentration profiles measured at $x = 3$ m in Montargis and Grignon, using the SMOP-2D model, following the method described by Jarosz *et al.* (2003b; Ch. III). In Sore the same method was applied, but the concentration measured at $x = 10$ m and $z = 1$ m was used instead.

Concentration was measured continuously during all the pollination period using a 7-day recording spore trap (Burkard Manufacturing Co., Rickmansworth, U. K.) placed in the middle of the plot at Grignon and Sore in order to get the source emission dynamics. Pollen concentration was also measured using rotating-arm pollen traps (McCartney *et al.*, 1997; Jarosz *et al.*, 2003a; Ch. II.1). Vertical profiles of concentration were measured at Grignon at $x = 3$ m and $x = 10$ m downwind of the source plot at 6 heights and at Sore within the source at 7 heights, as indicated in Table IV-1. In Grignon, wind speed was measured with cup anemometers at the same height as pollen concentration, in order to estimate the horizontal flux passing the masts at $x = 3$ m and $x = 10$ m, as detailed in Jarosz *et al.* (2003a; Ch. II.1). Concentration was also measured at different distances downwind of the source at Sore: two rotating-arm pollen traps were placed at 1 m height, at distances as given in Table IV-1.

Deposition rates were estimated using measurements of pollen grains received in small containers for short distances and larger ones for remote distances, both filled with an electrolyte solution (Coulter Isoton, Beckman, USA). Three deposition measurement replicates were made from $x = 1$ m to 32 m and 2 replicates at $x = 60$, 120 and 200m at Grignon and 5 replicates were made at all distances at Sore (Table IV-1). The number of pollen grains were counted by using an automatic counter (Coulter Multisize III, Beckman, USA) for short distances, where the pollen concentration in the electrolyte solution was high. For farther distances, a binocular was used for counting. Vertical profiles of deposition rates within the source were also performed at Sore at heights indicated in Table IV-1. Four additional long distance deposition measurements were made over periods of 4 to 5 days.

Two containers were placed at 800 m west and south and two others at 1000 m east and north, east being the prevailing wind-direction.

The description of all instruments used for pollen measurements is given in detail in Jarosz *et al.* (2003a; Ch. II.1). Downwind of the source, trials were made several times each day at Grignon and lasted between 2:00 h and 3:15 h while they were made once a day at Sore and lasted between 9:25 h and 11:15 h. Within the source, pollen measurements were operated over a shorter period of time (about 30 min) in order to avoid saturation of the rods.

Table IV-1. Measurements made and methods used during Grignon and Sore experiments. Small containers are 50 mm in diameter and 70 mm high and large containers are 170 mm in diameter and 60 mm high in Grignon experiment and 117 mm diameter and 76 mm height in Sore experiment.

	Method	Grignon Year 2001	Sore Year 2002
Source			
Production	plastic bags	6 plants randomly chosen	10 fixed plants
Flowering dynamics	visual observation	50 plants	50 plants
Emission dynamics	Burkard	$z = 2.5$ m	$z = 2.9$ m
Vertical profile of deposition	small containers	-	$z = 0.2, 1.2, 1.65, 2.1$ and 2.65 m
Vertical profile of concentration	rotating-arm traps	-	$z = 0.5, 0.95, 1.5, 1.95, 3, 5.1, 7.4$ m
Downwind			
Vertical profile of concentration	rotating-arm traps	$x = 3$ m et 10 m $S_0: z = 1.05, 1.35, 1.85, 2.85, 4, 6.4$ m S_1 & $S_2 : z = 0.2, 0.5, 1, 2, 4, 6.4$ m	-
Concentration	rotating-arm traps	-	$x = 10, 20, 50, 125, 250$ and 400 m $z = 1$ m $z = 0.3$ m
Deposition	small containers	$z = 0.3$ m $x = 1, 2, 3, 4, 8, 10, 16, 32$ m	$x = 10, 20, 50,$ $x = 125, 250$ and 400 m
	large containers	$x = 60, 120$ and 200 m	$+ x = 800$ et 1000 m ($z = 1.5$ m)

IV.3 Results

IV.3.1 Micrometeorological conditions

Table IV-2 shows the averaged standard meteorological data for all trials of Sore and Grignon. The weather conditions were sunny (high global radiation) and the mean wind speed was low ($U = 1.9 - 4.7$ m s⁻¹) for S_0 and S_1 trials and high for S_2 ($U = 2.6 - 7.2$ m s⁻¹) at Grignon, whereas it was very low at Sore ($U = 0.5 - 1.4$ m s⁻¹). The friction velocity u_* ranged from 0.21 to 0.71 m s⁻¹ and from 0.12 and 0.41 m s⁻¹ at Grignon, and Sore respectively. All trials were made under unstable stratification ($L < 0$) on sunny clear days, corresponding to typical conditions for maize pollination (McCartney and Lacey, 1991; Jarosz *et al.*, 2003a;

Table IV-2. Date, solar time, sampling line orientation and average micrometeorological conditions measured above and within the source plot during each experimental trial. R_g - global solar radiation; RH - relative humidity; T_a - air temperature; VPD - vapour pressure deficit of the air; U - wind speed, $Std\ WD$ – standard deviation of wind direction and WDr – wind direction relative to sampling line direction. All measurements were made at a height of 2 m at Grignon and 2.5 m at Sore except U and WD which were measured at 5 m and 4.3 m and R_g , which was measured at 2.5 m and 5 m at Grignon and Sore, respectively. u_* , the friction velocity, and L , the Monin-Obukhov length, were measured with the sonic anemometers at 4.5 m at Grignon and 6 m at Sore. Means and standard deviation are given.

Experiment			Sampling	R_g	RH	T_a	VPD	U	u_*	L	$Std\ WD$	WDr
Trial	Date	Time (UT*)	line direction (deg)	$W\ m^{-2}$	%	$^{\circ}C$	kPa	$m\ s^{-1}$	$m\ s^{-1}$	m	deg	deg / sampling line direction
2001												
1st flowering date												
S ₀ 1	22 July	9:45 - 12:30	290	625 ± 148	48 ± 2	26.1 ± 0.6	1.77 ± 0.10	2.5 ± 0.6	0.27 ± 0.10	-11	31	-88
S ₀ 2	22 July	12:50 - 15:15	290	557 ± 176	45 ± 1	27.5 ± 0.6	2.03 ± 0.10	2.4 ± 0.4	0.29 ± 0.13	-15	21	-119
S ₀ 3	24 July	8:25 - 10:25	20	734 ± 63	55 ± 5	22.1 ± 1.1	1.12 ± 0.21	2.4 ± 0.2	0.23 ± 0.10	-4	122	286
S ₀ 4	24 July	10:45 - 12:45	20	861 ± 9	47 ± 3	24.3 ± 0.5	1.63 ± 0.12	2.8 ± 0.3	0.31 ± 0.09	-9	20	314
S ₀ 5	24 July	13:00 - 15:00	20	763 ± 60	42 ± 3	25.8 ± 0.1	1.91 ± 0.10	2.7 ± 0.3	0.31 ± 0.10	-8	15	319
S ₀ 6	25 July	8:15 - 10:20	20	667 ± 75	61 ± 3	24.5 ± 1.3	1.21 ± 0.19	2.1 ± 0.4	0.21 ± 0.08	-4	9	10
S ₀ 7	25 July	10:40 - 12:40	20	646 ± 164	53 ± 2	27.0 ± 0.5	1.66 ± 0.12	2.3 ± 0.3	0.28 ± 0.08	-8	9	3
S ₀ 8	25 July	12:55 - 14:55	20	544 ± 256	52 ± 1	28.0 ± 0.5	1.83 ± 0.11	2.2 ± 0.3	0.28 ± 0.09	-11	12	2
S ₁ 9	28 July	9:00 - 11:00	20	673 ± 54	59 ± 4	27.2 ± 0.4	1.49 ± 0.17	3.9 ± 0.6	0.27 ± 0.08	-10	9	23
S ₁ 10	28 July	11:10 - 13:20	20	685 ± 80	54 ± 1	28.6 ± 0.5	1.80 ± 0.06	3.1 ± 0.3	0.29 ± 0.09	-15	8	-3
S ₁ 11	28 July	13:35 - 15:35	20	627 ± 104	46 ± 4	29.6 ± 0.4	2.24 ± 0.21	3.4 ± 0.4	0.26 ± 0.08	-12	118	43
S ₁ 12	29 July	8:30 - 10:30	20	591 ± 50	56 ± 3	26.3 ± 0.4	1.51 ± 0.14	2.9 ± 0.4	0.20 ± 0.07	-4	16	17
S ₁ 13	29 July	10:50 - 12:50	20	835 ± 16	45 ± 3	28.2 ± 0.5	2.08 ± 0.17	3.1 ± 0.6	0.29 ± 0.10	-9	9	23
S ₁ 14	29 July	13:15 - 15:20	20	728 ± 69	40 ± 1	29.4 ± 0.2	2.47 ± 0.06	3.6 ± 0.5	0.31 ± 0.08	-13	8	11
S ₁ 15	30 July	11:35 - 13:35	20	821 ± 13	41 ± 2	31.1 ± 0.4	2.66 ± 0.14	1.9 ± 0.6	0.26 ± 0.11	-13	112	165
S ₁ 16	1 August	8:40 - 11:50	20	749 ± 72	53 ± 3	25.4 ± 0.9	1.52 ± 0.18	4.7 ± 0.3	0.36 ± 0.08	-18	6	41
S ₁ 17	1 August	12:00 - 15:00	20	745 ± 95	46 ± 1	27.7 ± 0.4	2.01 ± 0.09	4.1 ± 0.4	0.34 ± 0.12	-18	11	40
2nd flowering date												
S ₂ 18	8 August	9:05 - 12:05	220	526 ± 169	69 ± 8	18.2 ± 0.6	0.57 ± 0.08	7.1 ± 0.7	0.71 ± 0.09	-367	7	13
S ₂ 19	9 August	8:45 - 11:55	220	522 ± 189	59 ± 3	19.3 ± 0.8	0.93 ± 0.12	5.7 ± 0.5	0.56 ± 0.06	-133	12	8
S ₂ 20	9 August	12:10 - 14:20	220	659 ± 299	48 ± 3	21.3 ± 1.1	1.32 ± 0.16	7.2 ± 0.7	0.68 ± 0.09	-148	11	6
S ₂ 21	11 August	9:25 - 12:25	220	751 ± 103	49 ± 5	20.5 ± 0.9	1.24 ± 0.19	2.6 ± 0.5	0.31 ± 0.10	-17	24	5

Table IV-2 continued.

Experiment		Sampling line direction (deg)	R_e W m ⁻²	RH %	T_a °C	VPD kPa	U m s ⁻¹	u_* m s ⁻¹	L m	$Std\ WD$ deg	WDr deg / sampling line direction	
Trial	Date											Time (UT*)
S ₂ 22	11 August	12:45 - 14:45	220	753 ± 57	41 ± 1	22.6 ± 0.5	1.63 ± 0.07	2.6 ± 0.4	0.31 ± 0.14	-13	20	6
S ₂ 23	12 August	9:45 - 11:45	220	773 ± 38	43 ± 2	23.7 ± 0.7	1.67 ± 0.12	4.2 ± 0.4	0.41 ± 0.08	-40	9	-10
S ₂ 24	12 August	12:05 - 14:10	220	767 ± 82	40 ± 1	26.0 ± 0.7	2.03 ± 0.12	3.9 ± 0.5	0.38 ± 0.09	-30	12	-22
S ₂ 25	12 August	14:30 - 16:30	220	498 ± 86	38 ± 1	26.3 ± 0.3	2.12 ± 0.03	4.2 ± 0.3	0.38 ± 0.05	-65	21	-4
S ₂ 26	13 August	8:45 - 10:45	220	678 ± 58	61 ± 4	22.9 ± 1.3	1.09 ± 0.20	3.0 ± 0.7	0.32 ± 0.09	-20	24	16
S ₂ 27	13 August	11:00 - 13:00	220	798 ± 6	50 ± 4	26.8 ± 0.9	1.77 ± 0.23	3.3 ± 0.7	0.38 ± 0.12	-35	12	-13
S ₂ 28	13 August	13:10 - 15:10	220	688 ± 58	42 ± 3	28.5 ± 0.4	2.26 ± 0.13	3.2 ± 0.4	0.38 ± 0.07	-39	20	0
S ₂ 29	14 August	9:20 - 11:35	160	735 ± 52	47 ± 3	28.9 ± 0.7	2.12 ± 0.19	2.8 ± 0.4	0.31 ± 0.09	-20	9	-8
S ₂ 30	14 August	11:50 - 14:05	160	778 ± 26	41 ± 2	30.5 ± 0.5	2.58 ± 0.16	3.5 ± 0.5	0.39 ± 0.08	-43	8	-15
S ₂ 31	15 August	8:50 - 12:05	200	683 ± 130	52 ± 8	29.2 ± 2.0	2.00 ± 0.52	4.9 ± 0.5	0.48 ± 0.08	-70	10	-10
S ₂ 32	15 August	12:15 - 15:25	200	691 ± 94	40 ± 2	32.3 ± 0.3	2.90 ± 0.15	6.1 ± 0.9	0.57 ± 0.08	-131	8	-3
2002												
A1	16 July	7:15 - 17:00	310	429 ± 148	65 ± 9	23.0 ± 1.6	1.00 ± 0.30	2.3 ± 0.8	0.38 ± 0.12	-75	52	-9
A2	17 July	7:00 - 17:00	310	549 ± 197	71 ± 11	23.2 ± 1.8	0.86 ± 0.39	2.2 ± 0.6	0.32 ± 0.11	-26	14	-16
A3	18 July	7:20 - 16:45	310	722 ± 159	52 ± 15	27.0 ± 3.1	1.81 ± 0.72	1.6 ± 0.5	0.12 ± 0.17	-1	113	-180
A4	20 July	7:10 - 17:20	310	562 ± 220	65 ± 14	28.0 ± 4.6	1.50 ± 0.79	0.3 ± 0.1	0.15 ± 0.11	-2	68	-31
A5	21 July	7:15 - 18:30	310	611 ± 226	57 ± 11	27.0 ± 2.2	1.59 ± 0.51	0.9 ± 0.9	0.20 ± 0.19	-1	68	-36
A6	22 July	7:30 - 17:45	310	571 ± 271	57 ± 9	23.1 ± 1.6	1.24 ± 0.32	1.8 ± 0.6	0.27 ± 0.14	-5	114	-217
A7	23 July	7:25 - 17:20	310	683 ± 175	48 ± 13	25.6 ± 1.6	1.76 ± 0.53	2.3 ± 1.3	0.41 ± 0.22	-30	21	-7

Ch. II.1). Trials S₀₃, S₀₆, S₁₁₂, A3, A4 and A5 occurred under conditions close to free convection (low u^* and $L \approx 0$). The mean wind direction was less than 25° and 35° apart from the direction of sampling lines on 20 occasions at Grignon and 5 occasions at Sore. The wind-direction was generally highly variable, as reflected by the large standard deviation observed in both Grignon and Sore (up to 122°), which is expected under very unstable conditions. No rain occurred during the trials.

Table IV-3 displays the measured meteorological variables during periods of vertical deposition and concentration measurements within the source. Global solar radiation was high and ranged from 490 and 870 W m⁻². Air temperature ranged between 23 and 29°C and the relative humidity of the air was high. Three trials were under conditions close to free convection (P1, P2 and P4) and two under unstable stratification (P3 and P5). The mean wind speed was generally low both at 2.7 m and 4.3 m height.

Table IV-3. Date, solar time, average micrometeorological conditions measured during concentration and deposition vertical profile measurements in Sore. $U_{2.7}$ and $U_{4.3}$ are the mean wind speed measured at 2.7 m and 4.3 m height. Mean and standard deviation are given.

Trial	Date	Time	R_g W m ⁻²	RH %	T_a °C	VPD kPa	$U_{2.7}$ m s ⁻¹	$U_{4.3}$ m s ⁻¹	u^* m s ⁻¹	L m
2002										
P1	18 July	10:45 - 11:15	873 ± 46	49 ± 2	26.5 ± 0.3	1.77 ± 0.09	1.2 ± 0.2	2.1 ± 0.4	0.07 ± 0.1	-0.3
P2	18 July	13:30 - 14:00	859 ± 12	42 ± 0	29.2 ± 0.4	2.35 ± 0.06	0.9 ± 0.1	1.9 ± 0.1	0.08 ± 0.11	-0.4
P3	19 July	14:15 - 14:45	750 ± 19	59 ± 0	27.7 ± 0.5	1.53 ± 0.05	0.9 ± 0.2	1.8 ± 0.6	0.23 ± 0.09	-4
P4	20 July	8:40 - 9:15	496 ± 114	74 ± 0	23.3 ± 0.1	0.73 ± 0	0.4 ± 0.1	0.2 ± 0	0.03 ± 0.04	-0.1
P5	20 July	9:30 - 10:00	616 ± 97	71 ± 2	24.7 ± 0.9	0.91 ± 0.12	0.5 ± 0	0.2 ± 0	0.11 ± 0.16	-2

IV.3.2 Pollen production

In Grignon, pollination began on 22 July 2001 and lasted 9 days for plot 1 with a maximum on 25 July, and it began on 9 August 2001 and lasted 9 days for plot 2 with a maximum on 14 August (Table IV-4). In Sore, pollination started on 15 July 2002 and lasted 13 days with a maximum on 21 July. The total production was 6.6×10^6 grains per tassel for plot 1 and 34×10^6 for plot 2 at Grignon, and 6.7×10^6 grains per tassel at Sore.

Table IV-4. Percentage of plant starting and ending flowering and daily pollen production per tassel for Grignon and Sore experiments. Percentage of the pollen production per tassel over all the period is also given.

	Plant starting flowering %	Plant ending flowering %	Daily production	
			grains day ⁻¹ tassel ⁻¹	%
2001				
Plot 1				
22 July	40	0	4.2×10^5	6.3
23 July	13	0	5.5×10^5	8.3
24 July	30	0	8.6×10^5	13.0
25 July	17	0	1.0×10^6	15.6
26 July	0	2	1.0×10^6	15.3
27 July	0	4	9.7×10^5	14.6
28 July	0	17	8.0×10^5	12.0
29 July	0	19	6.0×10^5	9.0
30 July	0	19	4.0×10^5	6.0
			6.7×10^6	
Plot 2				
9 August	4	0	3.1×10^5	0.9
10 August	10	0	1.1×10^6	3.2
11 August	0	0	1.1×10^6	3.2
12 August	26	0	3.1×10^6	9.3
13 August	50	0	7.0×10^6	20.8
14 August	10	0	7.8×10^6	23.1
15 August	0	12	6.9×10^6	20.4
16 August	0	34	4.2×10^6	12.5
17 August	0	26	2.2×10^6	6.5
			34×10^6	
2002				
15 July	30	0	1.3×10^5	2.0
16 July	10	0	3.0×10^5	4.5
17 July	10	0	4.7×10^5	7.2
18 July	20	0	7.3×10^5	11.0
19 July	10	0	8.7×10^5	13.1
20 July	10	0	8.0×10^5	12.2
21 July	10	0	1.1×10^6	16.3
22 July	0	0	9.6×10^5	14.6
23 July	0	30	5.4×10^5	8.1
24 July	0	10	3.9×10^5	5.9
25 July	0	10	2.2×10^5	3.3
26 July	0	10	8.1×10^4	1.2
27 July	0	20	3.0×10^4	0.5
			6.6×10^6	

IV.3.3 Pollen concentration and deposition rates within the source plot

Figure 2 shows the average pollen concentration measured continuously in the crop during the pollinating period in 2001 (Fig. IV-2a and IV-2b for S₁ and S₂, respectively) and 2002 (Fig. IV-2c). The maximum concentration was around 200 grains m⁻³ for plot 1 of 2001, 400 grains m⁻³ for plot 2 of 2001 and 300 grains m⁻³ for 2002. In Grignon S₁ and S₂, the dynamics of pollen concentration measured with the Burkard trap is similar, with the largest concentration observed in the first 4 to 5 days of pollination, and a subsequent decrease. On the opposite, in Sore, the concentration remains small during the first 6 to 7 days of pollination and then increase towards the end of the pollination period. This is probably due to

irrigation, which was sometimes just above the Burkard trap, as marked with arrows in the Figure IV-2c.

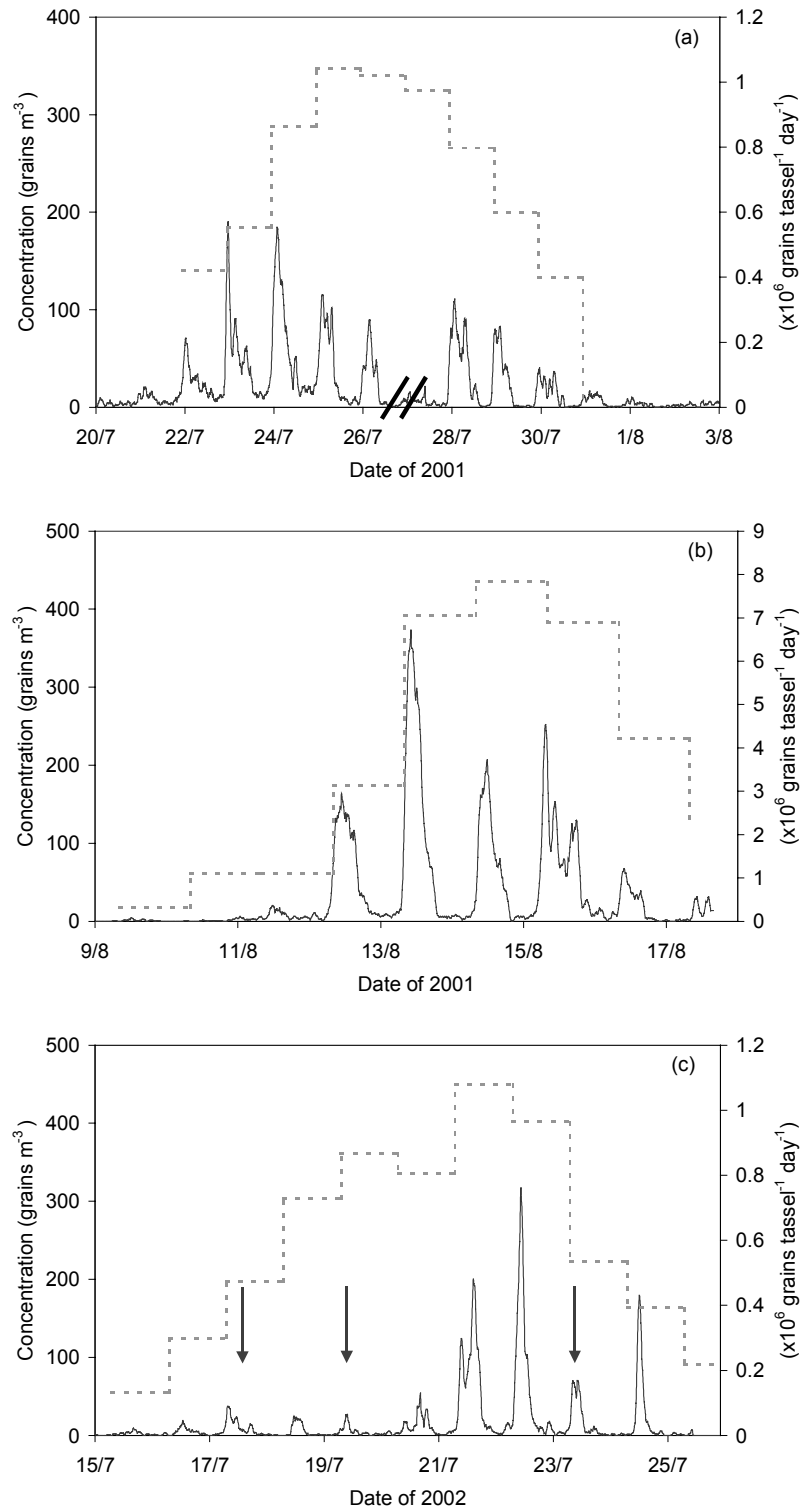

Figure IV-2. Two-hourly moving average airborne pollen concentration measured above the source plot with a Burkard trap (continuous line) together with the estimated daily pollen production (dotted line) for (a) plot 1 and (b) plot 2 of the Grignon experiment and (c) the Sore experiment. The double bar in (a) denotes that the 27 July, the Burkard was disconnected during wheat harvest around the maize plot. The arrows in (c) denotes days when the center pivot-irrigation system was just above the Burkard trap.

The daily dynamics of pollen concentration is shown for the three experiments in Figure IV-3. It was similar between years with slight differences: the pollen release started at around 8:00 UT and lasted until 18:00 UT with a maximum occurring between 11:00 and 12:00 UT. In Grignon and Montargis, the maximum was reached earlier and the magnitude higher than in Sore. Moreover, in S₁, a second peak was observed at around 16:00 UT. The fact that the maximum value in Figure IV-3 is smaller in Sore probably expresses the fact that the time when the daily maximum occurred is more variable than in Grignon and Montargis, due to irrigation.

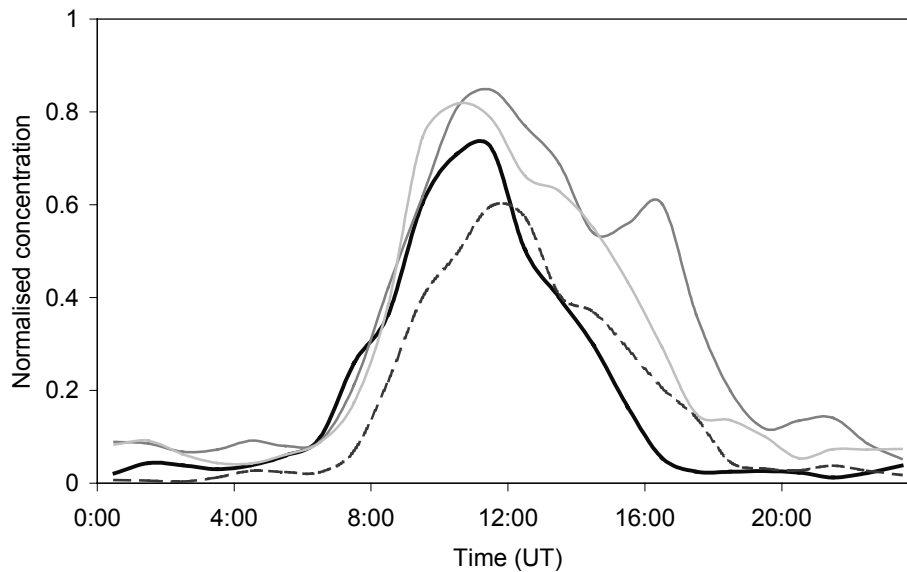

Figure IV-3. Averaged daily dynamics of normalised pollen concentration above the source plot in Montargis between the 29 July and 2 August 2000 (black bold line), in Grignon between the 24 and 28 July 2001 (black thin line), in Grignon between the 11 and 17 August 2001 (light grey line), and in Sore between the 21 and 24 July 2002 (black dotted line). Each line corresponds to the average over each period of the concentration normalised by its daily maximum.

Figure IV-4a shows the daily dynamics of concentration for a particular day, the 23 July 2001, when the pollen release started earlier than other days, together with the concentration dynamics averaged over 4 following days (24, 25, 26 and 28 July. Moreover, the concentration dynamics is shown between the 22 and 25 July together with the surface wetness index SWI in Figure IV-4b, and the vapour pressure deficit VPD in Figure IV-4b. Figure IV-4 shows that the pollen release started simultaneously with dew disappearance (SWI close to zero, Fig. IV-4b) and increasing vapour pressure deficit (VPD, Fig. IV-4b), except for the 23 July 2003, when there was no dew during the previous night. Note also that in all experiments, concentration at night remains high, attributed to pollen resuspension.

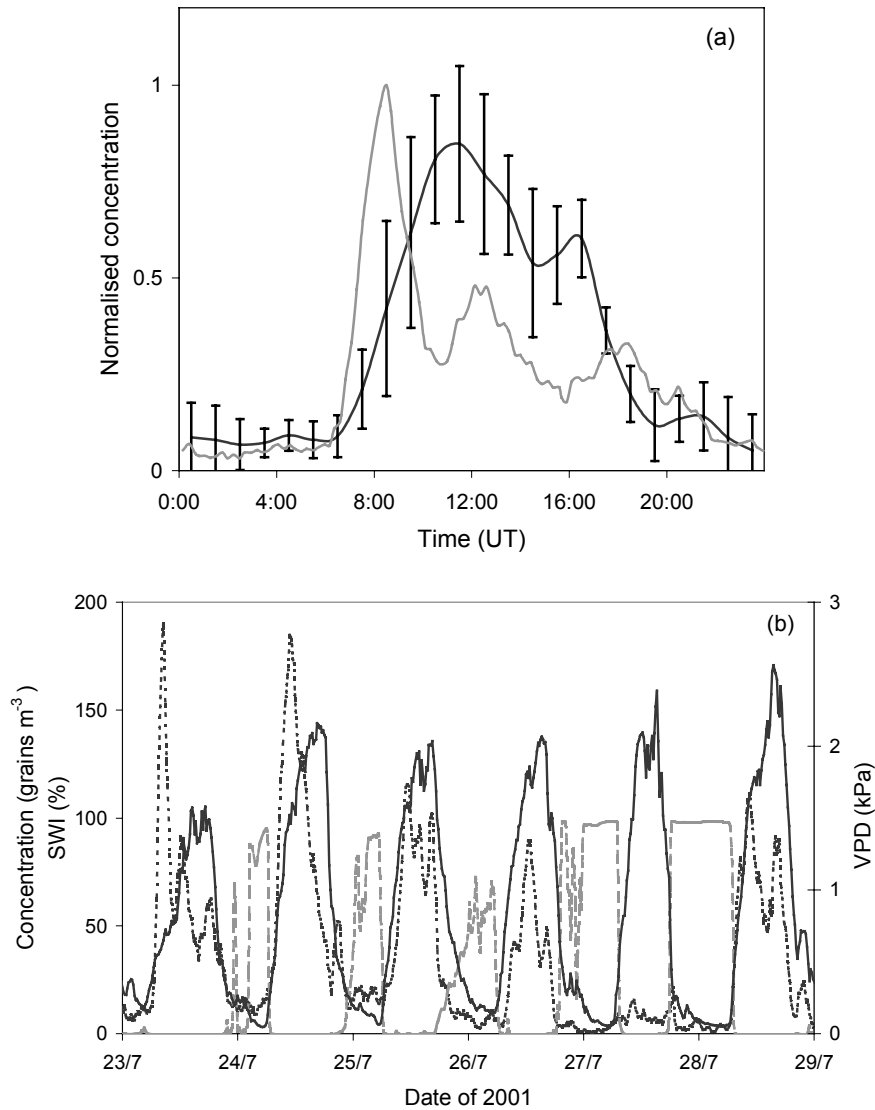

Figure IV-4. (a) The daily dynamics of the 23 July 2001 (grey line) is represented with the averaged daily dynamics of pollen concentration over 4 days (24, 25, 26 and 28 July). Error bars represent the standard deviation over these 4 days. (b) The concentration dynamics (black dotted line) is shown between the 23 and 28 July together with the surface wetness index SWI (grey dotted line), and the vapour pressure deficit VPD (black line).

Figure IV-5a shows vertical profiles of deposition measured within the source plot in Sore. There was a great variability between measurements, but the maximum deposition was generally observed at around $0.8 \times h_c$, which is below the height of the tassels. Maximum deposition ranged from 10 to $670 \text{ grains m}^{-2} \text{ s}^{-1}$ in Sore. Vertical profiles of concentration showed also a maximum at about $0.8 \times h_c$ ranging from 80 to $190 \text{ grains m}^{-3}$ (Figure IV-5b). Concentration decreased rapidly within the canopy towards the ground and decreased slowly above the canopy with increasing height. Pollen was still observed at $x = 7.4 \text{ m}$ in significant quantities with concentration ranging from 4 to 40 grains m^{-3} .

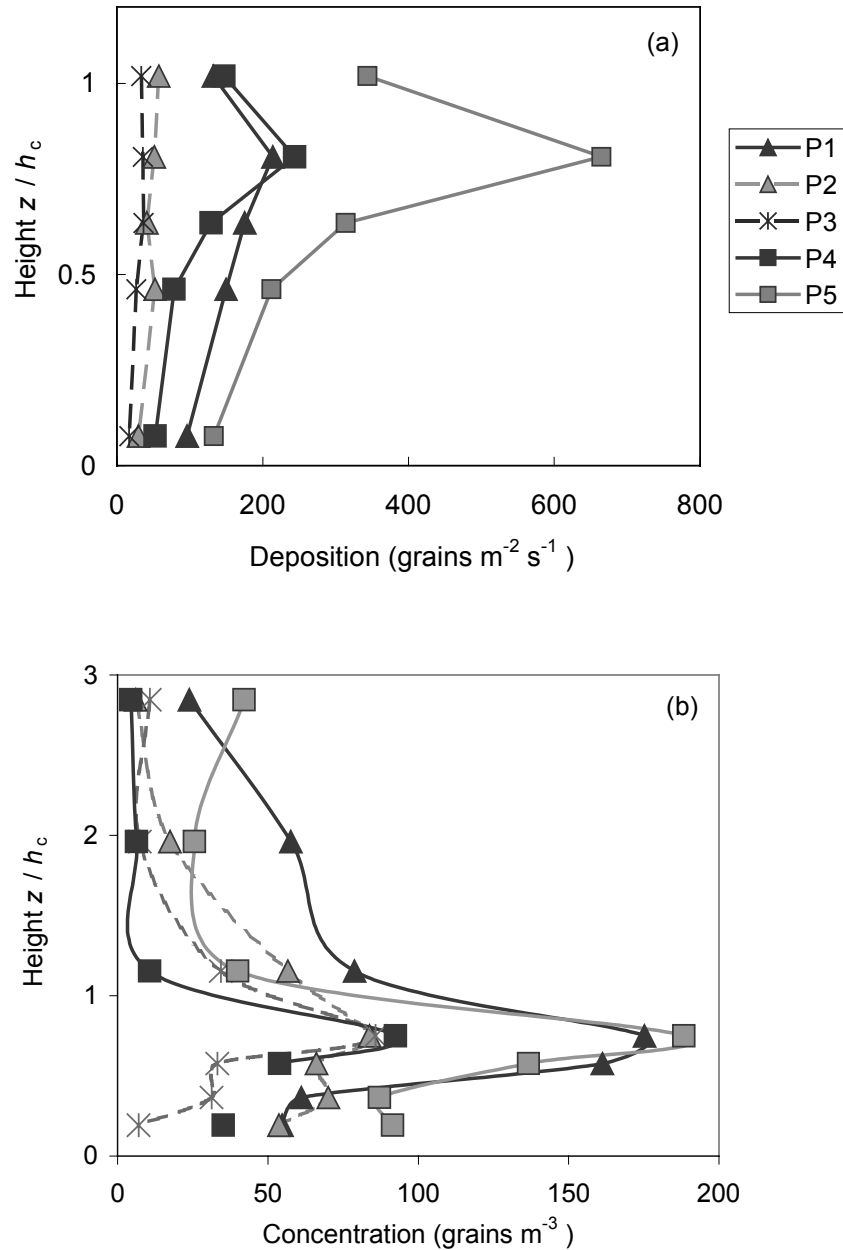

Figure IV-5. Vertical profiles of pollen airborne concentration (a) and deposition rates (b) within the maize canopy at Sore and Grignon for the 5 trials P1 to P5.

IV.3.4 Pollen concentration and deposition rates downwind of the source plot

Figure IV-6a shows the average vertical profiles of pollen concentration downwind of the source for trials S_1 and S_2 in Grignon and for Montargis. Concentration values ranged from 0 to 164 grains m^{-3} and 0 to 389 grains m^{-3} for plot 1 and plot 2, respectively at $x = 3$ m and from 0 to 50 grains m^{-3} and 0 to 140 grains m^{-3} at $x = 10$ m. In trials S_1 the concentration was of the same order of magnitude as in Montargis trials. Maximum concentrations were observed below the canopy height. The horizontal flux of pollen at height z passing through a

1 meter square area per second can be estimated using the mass balance method as $F(z) = C(z)U(z)$, where C is the concentration shown above, U is the horizontal mean wind speed (m s^{-1}) and z is the height. Horizontal fluxes are shown in Figure IV-6b. They ranged from 0 to 185 grains $\text{m}^{-2} \text{s}^{-1}$ for S_1 and from 2 to 490 grains $\text{m}^{-2} \text{s}^{-1}$ for S_2 at $x = 3 \text{ m}$ and from 0 to 71 grains $\text{m}^{-2} \text{s}^{-1}$ for S_1 and from 0 to 214 grains $\text{m}^{-2} \text{s}^{-1}$ for S_2 at the $x = 10 \text{ m}$. The maximum flux was observed at about the height of the tassels at $x = 3 \text{ m}$ and was generally below it at $x = 10 \text{ m}$, showing the settling of the pollen plume. However, this feature was not observed in S_2 in Grignon, due to larger wind speed transporting the pollen further away.

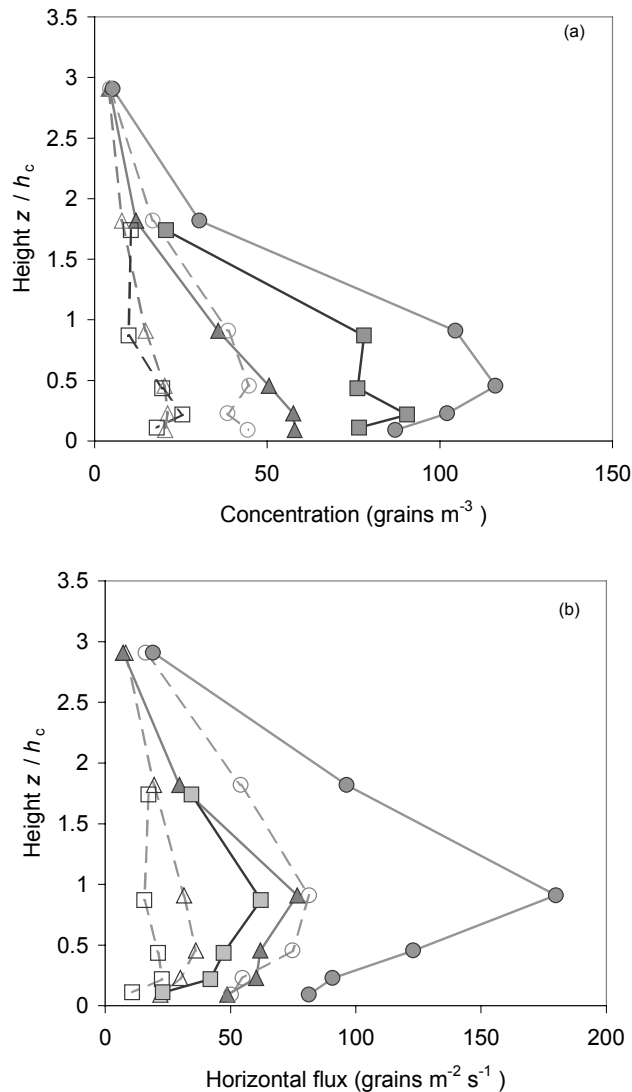

Figure IV-6. Average vertical profiles of concentration (a) and horizontal flux (b) for S_1 (triangles), S_2 (circles) trials in Grignon as well as Montargis (squares). Filled symbols represent the measurements at $x = 3 \text{ m}$ and open symbols at $x = 10 \text{ m}$. Averages were made over 9 measurements for S_1 , 15 for S_2 and 12 for Montargis.

Deposition normalised by the deposition at $x = 10 \text{ m}$ is shown on Figure IV-7a as a function of the downwind distance x normalised by the roughness length of the downwind field z_0 . In Montargis and Grignon z_0 was estimated from the wind profile at $x = 10 \text{ m}$ and

from the sonic anemometer in Sore. It was 0.03 m at Montargis, 0.07 over wheat in Grignon (S_0), 0.02 and 0.01 over stubble for S_1 and S_2 , respectively, and 0.05 over natural grassland in Sore. Figure IV-7b shows the frequency distribution of deposition rates at $x = 10$ m downwind for each experiment. Figure IV-7a shows that the pollen deposition rates decreased rapidly with distance and varied between and within experiments. Interestingly, the deposition rates measured during the three experiments show a similar shape, although the source size was different. Moreover, Figure IV-7b shows that the magnitude of the deposition rates at $x = 10$ m were similar in all experiments, and ranged between 10 and 40 grains $m^{-2} s^{-1}$ in general.

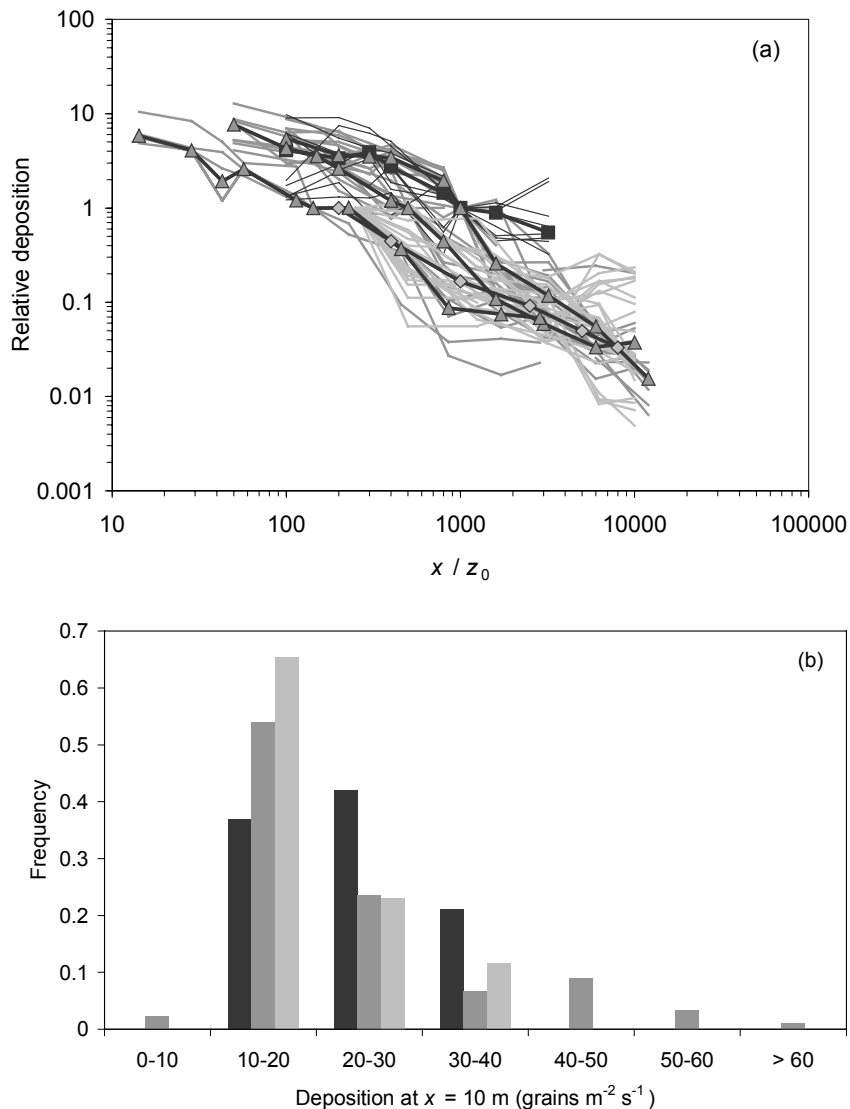

Figure IV-7. (a) Pollen deposition rates normalised by deposition at $x = 10$ m, as a function of the downwind distance x normalised by the roughness length for each trials in Montargis (black lines), Grignon (dark grey lines) and Sore (bright grey lines). The median normalised deposition rates are also shown for Montargis (squares), Grignon (triangles) and Sore (diamonds). The roughness length z_0 was 0.01 m in Montargis, 0.07 for S_0 , 0.02 for S_1 and 0.01 for S_2 in Grignon and 0.05 in Sore. (b) Frequency distribution of pollen deposition rates at $x = 10$ m for Montargis (black bars), for Grignon (grey bars) and Sore (light grey bars).

IV.4 Discussion

IV.4.1 Comparison of pollen release rate and production

Figure IV-8 shows the inferred release rate using the dispersal model and the inference method described in Jarosz *et al.* (2003b; Ch. III), as a function of the measured pollen production using plastic bags. Measured release rates are 3 to 10 times larger than inferred ones in Grignon S₂ and 4 to 30 times larger in Sore, whereas they agree in Grignon S₁ and they are smaller in Montargis. In Sore, the discrepancy may come from smaller concentrations at $x = 10$ m, caused by irrigation or wind direction changes, which are additional dispersion and deposition processes not taken into account in the model. Jarosz *et al.* (2003b; Ch. III) have shown that in Grignon S₂, the deposition rate was greatly underestimated by the model, especially in and near the maize canopy, which means that the model “does not simulate enough pollen release”, which is confirmed by Figure IV-8. It may also well be that the production estimated by covering tassels with plastic bags is not a reliable method. First, the number of plants used to estimate the production is undoubtedly not large enough (6 plants in 2001 and 10 plants in 2002) to represent correctly the whole plot, particularly in 2002 where the plot was 50 ha in size and visually very inhomogeneous. Secondly, the presence of the plastic bag probably favours pollen release, due to warmer conditions induced by a greenhouse effect in the bag, and consequently leads to overestimating the overall production. The great scatter between inferred and modelled release rate in Figure IV-8 shows how estimating release rates of spores or pollen still remains an issue, especially when the surface is dynamically heterogeneous (roughness change). However, under homogeneous surfaces, the use of a dispersion model have proven to be useful and accurate to infer source strength of both gases (Raupach, 1989; Flesch *et al.*, 1995) or spores (Aylor & Flesch, 2001) from measured concentrations.

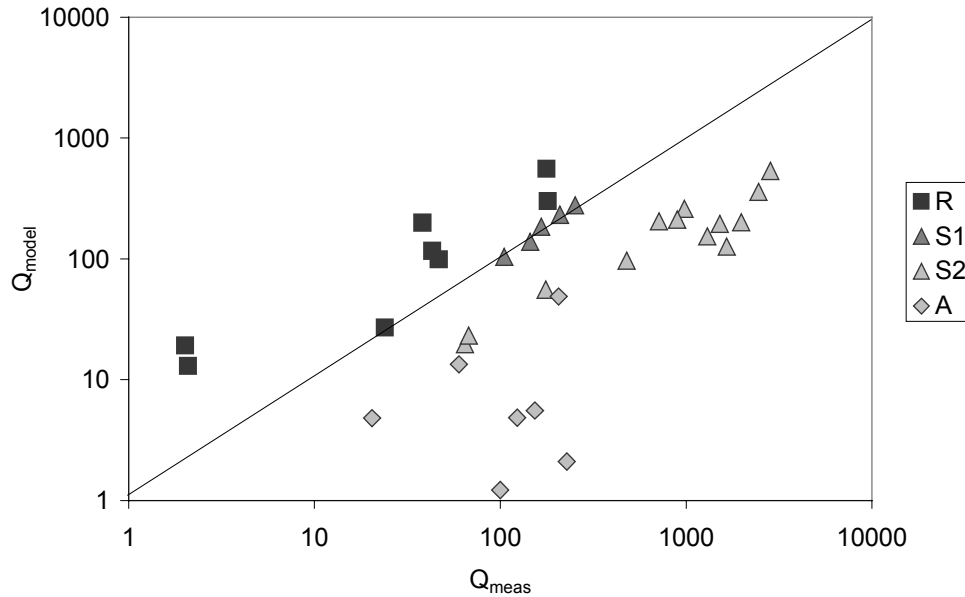

Figure IV-8. Inferred release rate (Q_{model}) using the SMOP-2D model versus the measured production (Q_{meas}), for Montargis (squares), Grignon S₁ (grey triangles), Grignon S₂ (light grey triangles) and Sore (diamonds).

IV.4.2 Variability in pollen production among situations

The observed maximum concentration in the source for the trials S₁ in Grignon was of the same order as in Montargis (Jarosz *et al.*, 2003b; Ch. III), whereas it was twice less than for the trials S₂ (Figure IV-2). This difference is also observed, but with a larger magnitude in the pollen production (Figure IV-4). Even if measured production is not accurate, it gives a good feeling of the qualitative differences between the situations. As the same cultivar were sown for the two plots in Grignon, the difference in production can only be explained by stresses either due to meteorological factors (temperature), or soil conditions (drought), or other biological factors (pathogens). Unfortunately, there is little information on the effects of such stresses on pollen production. However, we should note that in S₁ the maize field have probably been under water stress during its early growth, and pollination started after a period of relatively cool conditions and high relative humidity. In contrast, S₂ started pollinating during a warm and dry period. Nevertheless, it is difficult to go further in the analysis, as the meteorological and soil conditions encountered from sowing to pollinating should be known to study any effect of stress on pollen production. The contrast between S₁ and S₂ production shows anyway that these stresses are probably of critical importance when modelling dispersal of maize pollen such as proposed by Aylor *et al.* (2003), as they influence greatly the amount of pollen available for dispersal.

IV.4.3 Influence of environmental factors on the daily dynamics of pollen release

Jarosz *et al.* (2003a; Ch. II.1) observed that pollen started to be released in the morning simultaneously to crop drying. The results of Figure IV-4b confirms in an independent experiment that the pollen release rate is correlated with the increase of *VPD* during the morning. This means that pollen release in the morning is directly linked with the drying of the air surrounding the tassels: the pollen starts to be released once a threshold *VPD* (around 0.2 to 0.5 kPa) has been passed. Figure IV-4b, showing the surface wetness index *SWI*, confirms that the release of pollen starts with the drying of the surface, which is much more rapid on the 23 July 2001 since no dew was formed at night.

Deposition within the maize crop is directly dependent on the intensity of the source. The maximum depositions are observed when the release rate of the maize tassels is high, that is to say during the morning and when close to 100 of the plants are emitting (Figure IV-5a). After midday, deposition is greatly diminished even during days with maximum emission. The concentration profiles within the source shows a similar behaviour (Figure IV-5b).

IV.4.4 Intermediate-distance dispersal

Horizontal fluxes at $x = 3$ m and 10 m were integrated between the ground to the upper height of measurements. The integrated flux at $x = 10$ m is plotted against the one at $x = 3$ m in Figure IV-9. The flux at 10 m was 0.5 times the flux at 3 m at Grignon and 0.4 times at Montargis. This difference could be explained by the mean wind speed, which is lower in Montargis but this influence does not appear between S_1 and S_2 measurements although more windy conditions occurred during S_2 trials. Moreover, the flux was only integrated up to $z = 4.0$ m in Montargis but up to $z = 6.5$ m in Grignon, which might explain the better recapture rate at $x = 10$ m in Grignon. It is interesting to note in Figure IV-6 that the horizontal flux at $z = 6.5$ m is still important at $x = 10$ m, which indicates that a significant fraction of the pollen has travelled above that height.

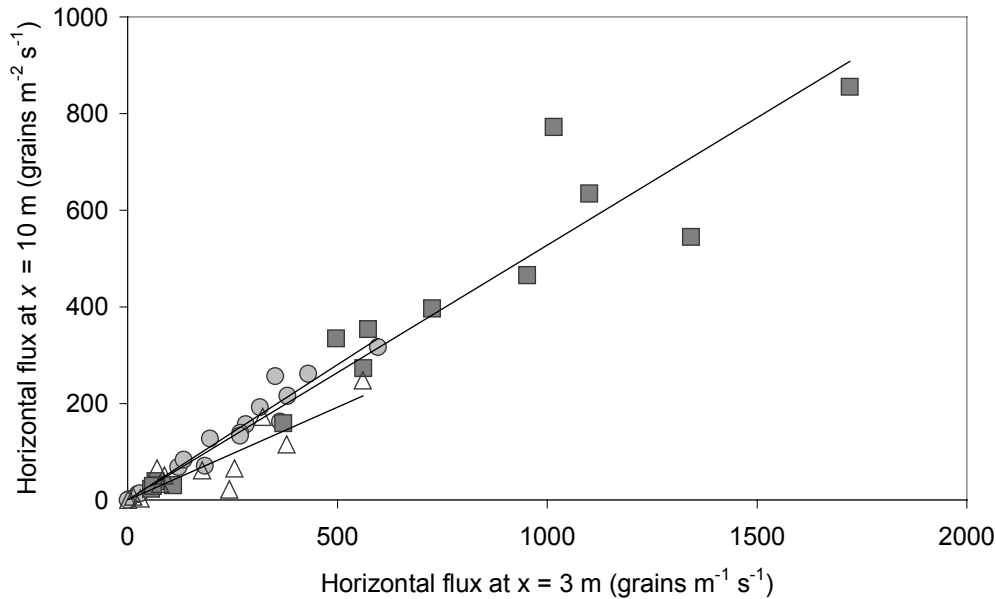

Figure IV-9. Integrated horizontal flux at $x = 10$ m downwind of the source as a function of the integrated horizontal flux at $x = 3$ m. Three experiments are shown: S_1 Grignon (circles), S_2 Grignon (squares) and Montargis (triangles). The lines are the linear regression forced through 0, they were $y = 0.5x$ for S_1 Grignon, $y = 0.5x$ for S_2 Grignon and $y = 0.4x$ for Montargis.

IV.4.5 Long-distance dispersal

Horizontal deposition gradients are generally better described by a power law than an exponential law (Aylor, 1987). Figure IV-10a displays the median deposition normalised by deposition and at $x = 10$ m up to $x = 400$ m for the Sore experiment. For all our experiments, deposition rates decreased with distance according to a power law of the form $\sim 1/x$ as for the data from Raynor *et al.* (1972a). The relative concentration is also shown in Figure IV-10a and fits well with a power law of the form $\sim 1/\sqrt{x}$.

Deposition was also measured at 4 cardinal points at 800 and 1000 m far from the maize plot at Sore. If these data are taken into account, deposition seems to better fit an exponential form $\sim \exp^{-0.01x}$ (Fig. IV-10b). In one hand, deposition rates estimated at these distances were not always in the downwind fetch of the source and were measured over several days and nights, which means that they were probably underestimated, compared to the other concentration measurements averaged over shorter and more favourable periods (wind direction perpendicular to the source). In the other hand, long distance measurements are probably more realistic of the deposition rates encountered in real situations. Therefore, deposition may well follow such an exponential form at farther distances. It is interesting to stress that relative deposition is 400 times less with an exponential than with a power law function at 1 km, showing how crucial is the choice of the empirical functions used for longer range dispersion.

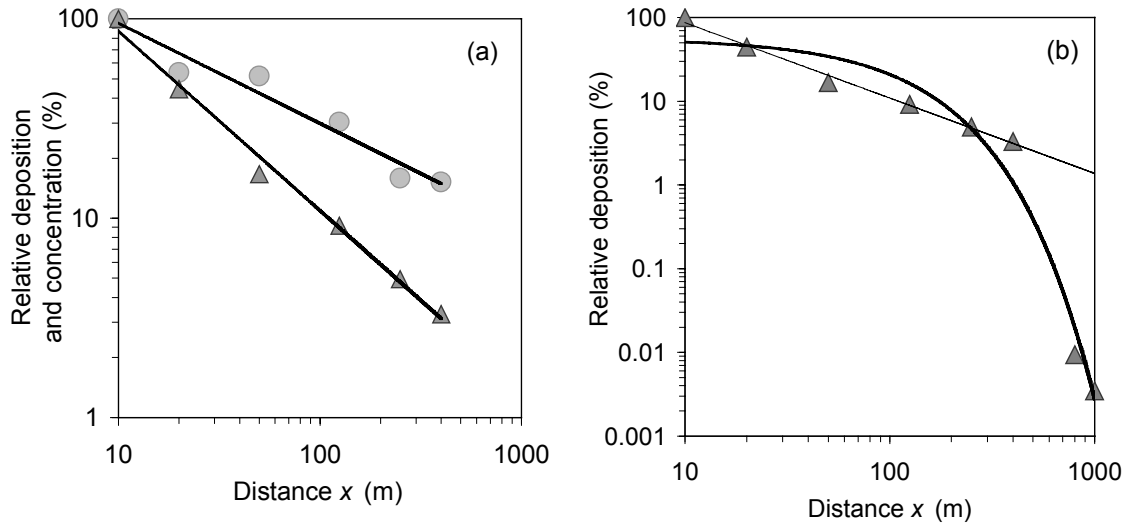

Figure IV-10. Sore experiment. (a) Relative deposition rate normalised by deposition at $x = 10$ m (triangles) and relative concentration normalised by the concentration at $x = 10$ m (circles). (b) Relative deposition fitted to an exponential function ($y = 56 \exp(-0.01 x)$). In (a) and (b), the deposition rates were fitted to a power law $\sim 1/x$, and the concentrations were fitted to a power law $\sim 1/\sqrt{x}$.

Deposition velocities, V_d , are represented as a function of downwind distance in Figure IV-11. V_d ranged from 0.2 to 0.7 m s^{-1} , which is 1 to 3 times more than the settling velocity V_s . V_s is the terminal velocity of pollen grains in still air, that is to say without turbulence. The values of V_s range from 0.2 m s^{-1} to 0.3 m s^{-1} (Di-Giovanni *et al.*, 1995; Aylor, 2002; Ch II.2). Values of V_d are higher than V_s close to the source ($x < 50$ m), which correspond to distances where pollen dispersal is still under the influence of the roughness change. The observed deposition enhancement could be explained by the negative vertical air velocity found downwind of a rough-to-smooth change, and by the enhanced turbulent kinetic energy magnitude and gradients in this transition zone. A sensitive analysis in Jarosz *et al.* (2003b; Ch. III) have shown that large V_d near the source ca not be explained by clusters of pollen.

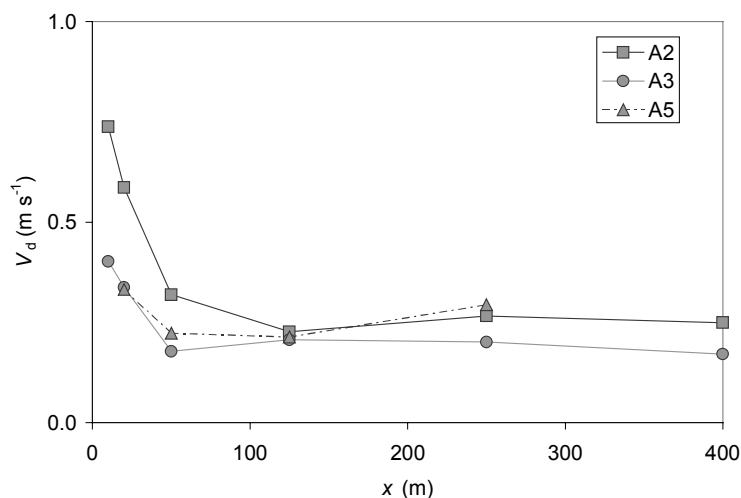

Figure IV-11. Deposition velocity as a function of the downwind distance for three experimental trials at Sore (A2, A3 and A5).

IV.4.6 Influence of roughness change on deposition rates

The deposition normalised by deposition at $x = 1$ m for the Grignon experiment is presented as a function of the downwind distance normalised by the roughness length in Figure IV-12. Measurements are well fitted by a power law function $\sim 1/x$. The larger the roughness is the less rapidly the deposition decreases with distances. The larger the roughness is, the longer deposition remains high near the source but also decreases faster further away. At 200 m, deposition is 0.6 of what was deposited at $x = 1$ m for $z_0 = 0.07$ (S_0) and 0.3 for $z_0 = 0.02$ (S_1) and 0.2 for $z_0 = 0.01$ (S_2). However, it is difficult to draw definite conclusions as observed differences could be due to other factors than only z_0 . In order to investigate the true role of z_0 on dispersal, dispersion models including a good description of the turbulent field are needed.

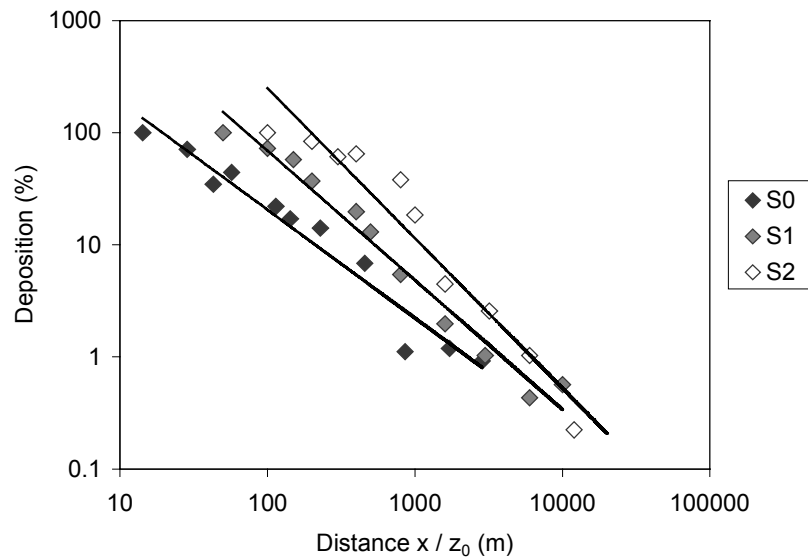

Figure IV-12. Relative deposition (normalised by deposition at $x = 1$ m) as a function of relative downwind distance (normalised by the roughness length, z_0) for S_0 , S_1 and S_2 experiments at Grignon. The values of z_0 were 0.07, 0.02 and 0.01 for S_0 , S_1 and S_2 experiments, respectively.

IV.5 Conclusions

This study has shown that maize pollen grains are still present high above (7m) and far from (1000 m) maize crops. The estimation of the amount of pollen release is consequently of paramount importance to appreciate the amount of pollen available for long distance dispersal. The pollen release starts once a threshold of VPD is passed (between 0.2 to 0.5 kPa) and its dynamics is correlated with the dynamics of VPD surrounding the tassels. It also appears that estimating release rates still remains an issue particularly when the maize plot is heterogeneous. Moreover, a comparison of pollen production in different conditions showed

that meteorological and soil conditions encountered during maize growth may have a great influence on the pollen production and therefore may be of critical importance when modelling dispersal of maize pollen.

This study has also showed that the pollen deposition velocities V_d is 2 to 3 times larger than the settling velocity V_s at farther distances. The reason for this increased V_d is still unclear although previous studies (Jarosz *et al.* 2003b; Ch. III) have shown that it can not be explained by clusters of pollen.

Horizontal deposition seems to follow a power law over short distance downwind from the source and an exponential law at farther distances. This emphasised that the choice of an empirical function to describe dispersal is crucial for long range dispersion. The roughness of the field located downwind of the maize crop has an influence on deposited quantities. The larger the roughness is the less rapidly the pollen deposition decreases with distance.

Finally, this work provides an important data set with contrasting weather conditions to validate dispersal models and further investigate maize pollen dispersal processes.

Conclusion et perspectives

Ce travail constitue un apport notable à la compréhension des mécanismes d'émission, de dispersion atmosphérique et de dépôt de pollen de maïs, d'autant plus que peu de progrès ont été accomplis sur ces questions depuis une trentaine d'années. Dans un premier temps, plusieurs ensembles de mesures effectuées en aval de différents couverts de maïs ont permis de quantifier la concentration et le dépôt de pollen jusqu'à des distances de 400 m et dans le même temps de développer des méthodes de mesure de flux et de vitesse de sédimentation, méthodes dont la validité a été démontrée dans le cas du pollen de maïs. Les mesures de concentration associées à des mesures de vent ont permis d'appliquer la méthode des bilans de masse et ainsi d'accéder à la quantité de pollen toujours présent dans l'air à une distance donnée. De plus, une méthode développée au cours de la thèse a permis de mesurer les distributions de vitesse de sédimentation du pollen de maïs et d'établir leur évolution en fonction de l'état d'hydratation du grain. Dans un deuxième temps, ces mêmes mesures ont constitué un jeu de données important, tant au niveau de la variété des conditions météorologiques rencontrées que des situations expérimentales, permettant de valider un modèle Lagrangien Stochastique (LS) de dispersion de particules biotiques.

Les quantités de pollen libérées par les panicules sont une composante essentielle à connaître dans l'étude de la dispersion car elles conditionnent les quantités disponibles à longue distance. L'analyse de la dynamique de libération du pollen a permis de confirmer l'existence d'un cycle diurne de l'émission mais aussi de montrer la corrélation des émissions matinales avec le dessèchement de l'air ambiant: quand la pression de vapeur de l'air dépasse un seuil donné, le pollen commence à se libérer. Cependant, une analyse critique des résultats a montré que les taux de libération de pollen restent difficiles à estimer par mesure directe sur la panicule et que les estimations par "inversion" du modèle de dispersion restent incertaines. Des différences substantielles de quantité de pollen libéré ont été constatées sur deux couverts différant seulement par leur date de semis (même site, même variété, même densité) et donc ayant rencontré des conditions météorologiques différentes avant et lors de la pollinisation.

Cependant, le manque d'informations avant la pollinisation ne permet pas de conclure sur l'éventualité d'un stress hydrique, et par ailleurs, met en évidence l'importance d'un suivi commençant dès le semis des graines de maïs.

La quantité réelle de pollen toujours présente dans l'air à une distance donnée a été estimée à l'aide de la méthode de bilan de masse. Les résultats obtenus sont extrêmement variables en fonction des conditions météorologiques rencontrées. Les conditions favorables sont une très forte instabilité thermique de l'atmosphère, conditions rencontrées l'été lors de belles journées ensoleillées et ventées. En revanche, une pluie ou une irrigation du champ peut quasiment interrompre la libération de pollen et *a fortiori* diminuer fortement la dispersion.

Le maximum de dépôt en aval de la source a lieu, en général, juste à la lisière du couvert de maïs. Cependant, une vitesse de frottement élevée a pour effet de déplacer le maximum de quelques mètres en aval et d'augmenter le dépôt cumulé de pollen loin de la source. La rugosité de la surface, au-dessus de laquelle le pollen se disperse, joue également un rôle déterminant dans le dépôt du pollen. Plus le couvert est rugueux et moins le dépôt de pollen décroît rapidement.

Ces mesures de concentration et de dépôt ont permis de valider un modèle LS de dispersion. Ce modèle simule correctement les profils de concentration mais sous-estime le dépôt proche de la source. L'analyse des différentes causes pouvant être à l'origine de cette sous-estimation a montré que les agrégats de pollen et la remise en suspension ne peuvent expliquer les écarts observés. En revanche, la paramétrisation de la turbulence dans la zone de transition entre le couvert de maïs et le couvert en aval pourrait expliquer ces divergences et reste le point faible du modèle.

Un paramètre important du modèle est la distribution de la vitesse de sédimentation du pollen. Elle a été caractérisée pour différentes variétés de maïs et teneurs en eau du grain. Plus le grain se déshydrate et plus sa vitesse est faible. En revanche, aucune différence n'a été mise en évidence entre les variétés.

Même si la question de la présence de pollen à grande distance n'a pas fait l'objet d'une étude approfondie dans ce travail, nous avons pu mesurer une faible quantité de pollen à 1000 m de la source. En outre, Brunet *et al.* (2003) ont mesuré du pollen viable dans la haute atmosphère, en particulier dans des conditions atmosphériques de convection libre, dans des quantités du même ordre de grandeur que celles nous avons mesurées en aval de la source. Le pollen qui se retrouve à haute altitude peut séjourner dans des conditions lui permettant de se conserver et parcourir alors plusieurs kilomètres avant de se déposer.

Quels risques potentiels pour la pollinisation croisée? Que le pollen soit toujours présent à de grandes distances ne veut pas dire qu'il y aura contamination systématique. Il faut avant cela (1) que le grain de pollen se dépose effectivement sur une soie (2) que celle-ci soit réceptive (3) qu'il soit toujours viable afin de pouvoir développer son tube pollinique et enfin (4) qu'il ait la chance d'être le grain de pollen qui fécondera la soie sur laquelle il se sera déposé. A terme, pour faire du modèle de dispersion un outil d'aide à la maîtrise des risques de pollinisation croisée, il sera important de:

- (1) soit affiner la paramétrisation de la turbulence, soit coupler le modèle existant avec un modèle d'écoulement afin de prendre en compte correctement les effets de la turbulence, en particulier dans une transition entre le couvert de maïs et un autre couvert végétal
- (2) inclure dans le modèle des fonctions empiriques permettant de prendre en compte, par exemple, la viabilité du pollen voire la croissance du tube pollinique afin d'étendre la dispersion *sensu stricto* jusqu'à la fécondation.
- (3) étudier plus en détail l'évolution temporelle du taux d'émission d'une source de pollen, qu'il s'agisse d'une panicule individuelle ou de l'ensemble du couvert, au cours d'une journée et de la période de pollinisation en relation avec les conditions météorologiques. En particulier, il faudra déterminer si les rafales de vent ont un rôle à jouer dans la libération ou la dissémination du pollen. La connaissance du déterminisme du comportement de la source de grains de pollen est essentielle dans la mesure où la capacité du modèle à prévoir les concentrations et les flux en dépend étroitement
- (4) Apporter un éclairage sur certaines questions non abordées jusqu'à ce jour, comme par exemple les effets de la charge électrique du grain de pollen. Aucune étude n'a tenté de mesurer la charge de pollen de maïs. Il est pourtant assez probable que, comme tout aérosol, la mise en suspension du pollen dans l'air provoque son chargement. De plus, des études très récentes (Gan-mor *et al.*, 1995; Bechar *et al.*, 1996) basées sur la pollinisation électrostatique naturelle, ont montré qu'un grand nombre de fleurs sont morphologiquement adaptées pour prendre avantage des forces électrostatiques lors de la pollinisation par des insectes. Ces fleurs ont généralement un pistil plus long et lorsqu'un nuage de pollen chargé en forces électrostatiques passe, elles collectent plus de grains que les autres.

Pour conclure, ce travail de thèse fournit un point de départ pour l'étude de la dispersion d'autres pollens tels que ceux du colza ou de la betterave. Le cas du pollen de maïs est un cas "modèle" dans le sens où sa dispersion est strictement anémophile. Dans le cas du colza dont la pollinisation est mixte (anémophile et entomophile), la séparation de la dispersion liée au vent et celle liée aux insectes est souvent difficile. De plus, le pollen entomophile a pour caractéristique d'être collant et par voie de conséquence de favoriser la formation d'agrégats de pollen présentant des propriétés aérodynamiques différentes.

Dans le cas du maïs, les prochains développements pourraient résulter d'intégration comparée de démarches de modélisation physique et probabiliste, dans un effort d'analyse des résultats issus de l'écologie théorique et de la biophysique de l'environnement de manière à cerner les intérêts respectifs et la complémentarité des deux approches.

Références bibliographiques

- Aylor, D.E., 1975a. Deposition of particles in a plant canopy. *Journal of Applied Meteorology*, 14: 52-57.
- Aylor, D.E., 1975b. Force required to detach Conidia of *Helminthosporium maydis*. *Plant Physiology*, 55: 99-101.
- Aylor, D.E., 1982. Modeling spore dispersal in a barley crop. *Agricultural Meteorology*, 26(3): 215-219.
- Aylor, D.E., 1987. Deposition gradients of Urediospores of *Puccinia recondita* near a source. *Ecology and Epidemiology*, 77(10): 1142-1148.
- Aylor, D.E., 1990. The role of intermittent wind in the dispersal of fungal pathogens. *Annual Review of Phytopathology*, 28: 73-92.
- Aylor, D.E. & Flesch, T.K., 2001. Estimating spore release rates using a lagrangian stochastic simulation model. *Journal of Applied Meteorology*, 40: 1196-1208.
- Aylor, D.E., 2002. Settling speed of corn (*Zea mays*) pollen. *Journal of Aerosol Science*, 33: 1601-1607.
- Aylor, D.E., 2003. Rate of dehydration of corn (*Zea mays* L.) pollen in the air. *Journal of Experimental Botany*, in press.
- Aylor, D.E. & Ferrandino, F.J., 1985. Rebound of pollen and spores during deposition on cylinders by inertial impaction. *Atmospheric Environment*, 19(5): 803-806.
- Aylor, D.E. & Flesch, T.K., 2001. Estimating spore release rates using a lagrangian stochastic simulation model. *Journal of Applied Meteorology*, 40: 1196-1208.
- Aylor, D.E., Schultes, N.P. & Shields, E.J., 2003. An aerobiological framework for assessing cross-pollination in maize. *Agricultural and Forest Meteorology*, in press.
- Baltazar, B.M. & Schoper, J.B., 2002. Crop-to-crop gene flow: dispersal of transgenes in maize, during field tests and commercialization. *Proceedings of the Seventh International Symposium on the Biosafety of Bioengineered Organisms*, Beijing, China, October 10-16, 2002.
- Basseti, P. & Westgate, M.E., 1993a. Emergence, elongation, and senescence of maize silks. *Crop Science*, 33: 271-275.
- Basseti, P. & Westgate, M.E., 1993b. Senescence and receptivity of maize silks. *Crop Science*, 33: 275-278.
- Basseti, P. & Westgate, M.E., 1993c. Water deficit affects receptivity of maize silks. *Crop Science*, 33: 279-282.
- Bechar, A., Shmulevich, I., Eisikowitch, D., Vaknin, Y., Ronen, B. & Gan-mor, S., 1996. Simulation and testing electrostatic pollination system.
- Braaten, D.A., Paw U, K.T. & Shaw, R.H., 1990. Particle resuspension in a turbulent boundary layer-observed and modeled. *Journal of Aerosol Science*, 21(5): 613-628.
- British Aerobiology Federation (Editor), 1995. A guide to trapping and counting. c/o Dr J. Lacey, IACR-Rothamsted, Harpenden, Herts AL5 2JQ, UK.

Références bibliographiques

- Bruce, W.B., Edmeades, G.O. & Barker, T.C., 2002. Molecular and physiological approaches to maize improvement for drought tolerance. *Journal of Experimental Botany*, 53(366): 13-25.
- Brunet, Y., Foueillassar, X. & Garrigou, D., 2003. Evidence for the possibility of long-range transport of viable maize pollen. Third European Symposium on Aerobiology, Worcester, UK, August 30th - September 4th 2003.
- Buitink, J., Walters-Vertucci, C., Hoekstra, F.A. & Leprince, O., 1996. Calorimetric properties of dehydrating pollen: analysis of a desiccation-tolerant and intolerant species. *Plant Physiology*, 111(1): 235-242.
- Chèvre, A.M., Eber, F., Baranger, A. & Renard, M., 1997. Gene flow from transgenic crops. *Nature*, 389: 924.
- Christou, P., 2002. No credible scientific evidence is presented to support claims that transgenic DNA was introgressed into traditional maize landraces in Oaxaca, Mexico. *Transgenic Research*, 11: iii-v.
- Cionco, R., 1972. A wind-profile index for canopy flow. *Boundary-Layer Meteorology*, 3: 255-263.
- Csanady, G.T., 1973. Turbulent diffusion in the environment. *Geophysics and astrophysics monographs*. Reidel Publ. Co., Dordrecht, Holland, 248 pp.
- Dahneke, B., 1971. The capture of aerosol particles by surfaces. *Journal of Colloid and Interface Science*, 37: 342-347.
- Dale, P.J., 2002. The environmental impact of genetically modified (GM) crops: a review. *J Agr Sci*, 138: 245-248.
- Denmead, O.T., Harper, L.A., Freney, J.R., Griffith, D.W.T., Leuning, R. & Sharpe, R.R., 1998. A mass balance method for non-intrusive measurements of surface-air trace gas exchange. *Atmospheric Environment*, 32(21): 3679-3688.
- Di-Giovanni, F., Kevan, P.G. & Nasr, M.E., 1995. The variability in settling velocities of some pollen and spores. *Grana*, 34: 39-44.
- Doebley, J., 1990. Molecular evidence for gene flow among *Zea* species. Genes transformed into maize through genetic engineering could be transferred to its wild relatives, the Teosintes. *Bioscience*, 40: 443-448.
- Drouet, J.L., 2003. MODICA and MODANCA: modelling the three-dimensional shoot structure of graminaceous crops from two methods of plant description. *Field Crops Research*, 83: 215-222.
- Dumas, C., 1990. La fécondation chez le maïs, Physiologie et production du maïs. INRA, AGPM, Pau (France), pp. 189-194.
- Durham, O.C., 1943. The volumetric incidence of atmospheric allergens. I. Specific gravity of pollen grains. *Journal of Allergy*, 14: 455-461.
- Durham, O.C., 1946a. The volumetric incidence of atmospheric allergens. III. Rate of fall of pollen grains in still air. *Journal of Allergy*, 17: 70-78.
- Durham, O.C., 1946b. The volumetric incidence of atmospheric allergens. IV. A proposed standard method of gravity sampling, counting and volumetric interpretation. *Journal of Allergy*, 17: 79-86.
- Emberlin, J., 1999. A report on the dispersal of maize pollen, <http://www.soilassociation.org>, Bristol, UKpp.
- Feil, B. & Schmid, J.E., 2002. Dispersal of maize, wheat and rye pollen. A contribution to determining the necessary isolation distances for the cultivation of transgenic crops. Shaker Verlag, Aachen, Germany, 76 pp.
- Ferrandino, F.J. & Aylor, D.E., 1984. Settling speed of clusters of spores. *Ecology and Epidemiology*, 74(8): 969-972.
- Fitt, B.D.L., Gregory, P.H., Todd, A.D., McCartney, H.A. & MacDonald, O.C., 1987. Spore dispersal and plant disease gradients; a comparison between two empirical models. *Journal of Phytopathology*, 118: 227-242.
- Flesch, T.K., 1995. The footprint for flux measurements, from backward lagrangian stochastic models. *Boundary-Layer Meteorology*, 78: 399-404.

Références bibliographiques

- Flesch, T.K., Wilson, J.D. & Yee, E., 1995. Backward-time lagrangian stochastic dispersion models and their application to estimate gaseous emissions. *Journal of Applied Meteorology*, 34: 1320-1332.
- Flottum, P.K., Robacker, D.C. & Erickson, E.H.J., 1984. A quantitative sampling method for airborne sweet corn pollen under field conditions. *Crop Science*, 24: 375-377.
- Freeling, M. & Walbot, V. (Editors), 1994. *The maize handbook*. Springer-Verlag, New York, Inc., 759 pp.
- Gan-mor, S., Schwartz, Y., Bechar, A., Eisikowitch, D. & Manor, G., 1995. Relevance of electrostatic forces in natural and artificial pollination. *Canadian Agriculture Engineering*, 37(3): 189-194.
- Gash, J.H.C., 1986. Observation of turbulence downwind of a forest-heath interface. *Boundary-Layer Meteorology*, 36: 227-237.
- Gay, J.P., 1979. La fécondation chez le maïs, AGPM - ITCF, Montardon, 39 pp.
- Geagea, L., Huber, L. & Sache, I., 1997. Removal of urediospores of brown (*Puccinia recondita* f.sp. *tritici*) and yellow (*P. Striiformis*) rusts of wheat from infected leaves submitted to a mechanical stress. *European Journal of Plant Pathology*, 103: 785-793.
- Girardin, P., 1998. *Ecophysiologie du maïs*. AGPM, Pau, 323 pp.
- Gregory, P.H., 1973. *Microbiology of the atmosphere*. John Wiley & sons, New York, Toronto, 377 pp.
- Guyot, G., 1997. *Climatologie de l'environnement. De la plante aux écosystèmes*. Masson, 505 pp.
- Hall, A.J., Vilella, F., Trapani, N. & Chimenti, C., 1982. The effect of water stress and genotype on the dynamics of pollen shedding and silking in maize. *Field Crops Research*, 5: 349-363.
- Haskell, G. & Dow, P., 1951. Studies with sweet corn V. Seed-settings with distances from pollen source. *Empire Journal of Experimental Agriculture*, 19: 45-50.
- Hauptli, H. & William, S., 1988. Maize in vitro pollination with single pollen grains. *Plant Science*, 58: 231-237.
- Heisler, G.M. & DeWalle, D.R., 1988. Effects of windbreak structure on wind flow. *Agriculture, Ecosystems, and Environment*, 18(22/23): 41-69.
- Herrero, M.P. & Johnson, R.R., 1980. High temperature stress and pollen viability of maize. *Crop Science*, 20: 796-800.
- Hirst, J.M., 1952. An automatic volumetric spore trap. *Annals of Applied Botany*, 39: 257-265.
- Ibrahim, A.H., Dunn, P.F. & Brach, R.M., 2003. Microparticle detachment from surfaces exposed to turbulent air flow: controlled experiments and modeling. *Journal of Aerosol Science*, 34: 765-782.
- Irvine, M.R., Gardiner, B.A. & Hill, M.K., 1997. The evolution of turbulence across a forest edge. *Boundary-Layer Meteorology*, 84: 491-496.
- Itier, B. & Pauvert, P., 1979. Modélisation de transports horizontaux (spores, pollen). *Bull. OEPP*, 9(3): 251-264.
- James, C., 2002. Global status of commercialized transgenic crops: 2002. ISAAA Briefs n°26. International Service for the acquisition of agri-biotech applications, Ithaca, NY, <http://isaaa.org>
- Jarosz, N., Loubet, B., Durand, B., McCartney, H.A., Foueillassar, X. & Huber, L., 2003. Field measurements of airborne concentration and deposition of maize pollen. *Agricultural and Forest Meteorology*, 119(1-2): 37-51.
- Jarosz, N., Loubet, B. & Huber, L., 2003b. Modelling airborne concentration and deposition rate of maize pollen. *Atmospheric Environment*, in preparation.
- Jones, M.D. & Brooks, J.S., 1950. Effectiveness of distance and border rows in preventing outcrossing in corn. *Okla. Agr. Exp. Sta. Tech. Bull.*, T-38: 1-18.
- Jones, M.D. & Newell, L.C., 1946. Pollination cycles and pollen dispersal in relation to grass improvement. *Nebr. Agr. Exp. Sta. Tech. Bull.*, 148: 1-42.

Références bibliographiques

- Kerhoas, C., 1986. Approche biophysique et structurale de la déshydratation du pollen. Thèse de doctorat, Université Claude Bernard, Lyon 1, 79 pp.
- Kerhoas, C., Gay, G. & Dumas, C., 1987. A multidisciplinary approach to the study of the plasma membrane of *Zea mays* pollen during controlled dehydration. *Planta*, 17: 1-10.
- Klein, E., 2000. Estimation de la fonction de dispersion du pollen. Application à la dissémination de transgènes dans l'environnement. Thèse de doctorat, Université Paris Sud, 80 pp.
- Laaidi, K., Laaidi, M. & Besancenot, J.-P., 1997. Pollens, pollinoses et météorologie. *La météorologie*, 20(8): 41-55.
- Lacey, J. & Venette, J., 1995. Outdoor air sampling techniques. In: C.S. Cox and C.M. Wathes (Editors), *Bioaerosols Handbook*. Lewis, Boca Raton, FL., pp. 407-471.
- Lavigne, C., Klein, E.K., Vallée, P., Pierre, J., Godelle, B. & Renard, M., 1998. A pollen dispersal experiment with transgenic oilseed rape. Estimation of the average pollen dispersal of an individual plant within a field. *Theoretical and Applied Genetics*, 96(6/7): 886-896.
- Legg, B.J., 1983. Movement of plant pathogens in the crop canopy. *Philosophical Transaction of Royal Society of London, Serie B*, 302: 559-574.
- Legg, B.J. & Powell, F.A., 1979. Spore dispersal in a barley crop : a mathematical model. *Agricultural Meteorology*, 20: 47-67.
- Leuzzi, G. & Monti, P., 1998. Particle trajectory simulation of dispersion around a building. *Atmospheric Environment*, 32(2): 203-214.
- Loubet, B., 2000. Modélisation du dépôt sec d'ammoniac atmosphérique à proximité des sources. Thèse de doctorat, Université de Toulouse, 330 pp.
- Loubet, B., Cellier, P. & Sutton, M.A., 2003. A coupled dispersion and exchange model for short-range dry deposition of atmospheric ammonia (MODDAAS-2D). I- Model description. *Atmospheric Environment*, In preparation.
- Luna, S., Figueroa, J., Baltazar, B., Gomez, R., Townsend, R. & Schoper, J.B., 2001. Maize pollen longevity and distance isolation requirements for effective pollen control. *Crop Science*, 41: 1551-1557.
- Matsuoka, Y., Vigouroux, Y., Goodman, M.M., Sanchez, J., Buckler, E. and Doebley, J., 2002. A single domestication for maize shown by multilocus microsatellite genotyping. *Proceedings of the National Academy of Sciences*, 99: 6080-6084.
- May, K.R. & Clifford, R., 1967. The impaction of aerosol particles on cylinders, spheres, ribbons and discs. *The Annals of Occupational Hygiene*, 10: 83-95.
- McCartney, H.A., 1994. Dispersal of spores and pollen from crops. *Grana*, 33: 76-80.
- McCartney, H.A. & Aylor, D.E., 1987. Relative contributions of sedimentation and impaction to deposition of particles in a crop canopy. *Agricultural and Forest Meteorology*, 40: 343-358.
- McCartney, H.A., Bainbridge, A. & Stedman, O.J., 1985. Spore deposition velocities measured over a barley crop. *Phytopathology*, 114: 224-233.
- McCartney, H.A. & Fitt, B.D.L., 1985. Construction of dispersal models : Mathematical Modelling of Crop Science. In: C.A. Gilligan (Editor), *Advances in Plant Pathology*. Academic Press, London, pp. 107-143.
- McCartney, H.A., Fitt, B.D.L. & Schmechel, D., 1997. Sampling bioaerosols in plant pathology. *Journal of Aerosol Science*, 28(3): 349-364.
- McCartney, H.A. & Lacey, M.E., 1991. Wind dispersal of pollen from crops of oilseed rape (*Brassica napus* L.). *Journal of Aerosol Science*, 22(4): 467-477.
- Moutton, M., 2002. Mise au point d'une méthode expérimentale de mesure de la vitesse de sédimentation par caméra CCD. Mémoire de stage, IUT Mesures Physiques, Université de Paris XII, Créteil, 21 pp.

Références bibliographiques

- Nowakowski, J. & Morse, R., 1982. The behaviour of honey bees in sweet corn fields in New York state. *American Bee Journal*: 13-16.
- Ogden, E.C., Hayes, J.V. & Raynor, G.S., 1969. Diurnal patterns of pollen emission in *Ambrosia*, *Phleum*, *Zea* and *Ricinus*. *American Journal of Botany*, 56(1): 16-21.
- Panofsky, H.A. & Dutton, J.A., 1984. Atmospheric turbulence. Models and methods for engineering applications. John Wiley & sons, Inc., New York.
- Pasquill, F., 1962. Atmospheric diffusion. 1st Ed. Van Nostrand-reinhold, Princeton, New Jersey.
- Paw U, K.T., 1983. The rebound of particles from natural surfaces. *Journal of Colloid and Interface Science*, 93(2): 442-452.
- Percival, M., 1947. Pollen collection by *Apis mellifera*. *New Phytologist*, 46: 142-165.
- Percival, M., 1955. The presentation of pollen in certain angiosperms and its collection by *Apis mellifera*. *New Phytologist*, 54: 353-368.
- Quist, D. & Chapela, I.H., 2001. Transgenic DNA introgressed into traditional maize landraces in Oaxaca, Mexico. *Nature*, 29: 541-543.
- Rambert, A., Huber, L. & Gougat, P., 1998. Laboratory study of fungal spore movement using Laser Doppler Velocimetry. *Agricultural and Forest Meteorology*, 92: 43-53.
- Raupach, M.R., 1989. Applying lagrangian fluid mechanics to infer scalar source distributions from concentration profiles in plant canopies. *Agricultural and Forest Meteorology*, 47: 85-108.
- Raupach, M.R., Finnigan, J.J. & Brunet, Y., 1996. Coherent eddies and turbulence in vegetation canopies : the mixing-layer analogy. *Boundary-Layer Meteorology*, 78: 351-382.
- Raynor, G.S., Ogden, E.C. & Haynes, J.V., 1970. Dispersion and deposition of ragweed pollen from experimental sources. *Journal of Applied Meteorology*, 9: 885-895.
- Raynor, G.S., Ogden, E.C. & Haynes, J.V., 1972a. Dispersion and deposition of corn pollen from experimental sources. *Agronomy Journal*, 64: 420-427.
- Raynor, G.S., Ogden, E.C. & Haynes, J.V., 1972b. Dispersion and deposition of timothy pollen from experimental sources. *Agricultural Meteorology*, 9: 347-366.
- Reynolds, A.M., 1999. A lagrangian stochastic model for heavy particle deposition. *Journal of Colloid and Interface Science*, 215: 85-91.
- Reynolds, A.M., 2000. Prediction of particle deposition on to rough surfaces. *Agricultural and Forest Meteorology*, 104: 107-118.
- Roeckel-Drevet, P., Digonnet, C., Matthys-Rochon, E., Champiat, D. & Dumas, C., 1995. Fertility of *Zea mays* pollen during dehydration: : physiological steps outlined by nucleotide measurements. *plant Physiology and Biochemistry*, 33(3): 289-294.
- Sawford, B.L. & Guest, F.M., 1991. Lagrangian statistical simulation of the turbulent motion of heavy particles. *Boundary-Layer Meteorology*, 54: 147-166.
- Sawyer, A.J., Griggs, M.H. & Wayne, R., 1994. Dimensions, density, and settling velocity of entomophthorean Conidia : implications for aerial dissemination of spores. *Journal of Invertebrate Pathology*, 63: 43-55.
- Schooper, J.B., Lambert, R.J. & Vasilas, B.L., 1986. Maize pollen viability and ear receptivity under water and high temperature stress. *Crop Science*, 26: 1029-1033.
- Scott, R.K., 1970. The effect of weather on the concentration of pollen within sugar-beet seed crops. *Annals of Applied Biology*, 66: 119-127.
- Seinfeld, J.H. & Pandis, S.N., 1998. Atmospheric chemistry and physics. From air pollution to climate change. Wiley-Interscience, 1326 pp.

Références bibliographiques

- Shaw, R.H., Ward, D.P. & Aylor, D.E., 1979. Frequency of occurrence of fast gusts of wind inside a corn canopy. *Journal of Applied Meteorology*, 18: 167-171.
- Snyder, W.H. & Lumley, J.L., 1971. Some measurements of particle velocity autocorrelation functions in a turbulent flow. *Journal of Fluid Mechanics*, 48(1): 41-71.
- Squire, G.R. *et al.*, 2003. On the rationale and interpretation of the farm scale evaluations of genetically modified herbicide-tolerant crops. *Philosophical Transaction of Royal Society of London, Serie B*, 358: 1179-1799.
- Thomson, D.J., 1987. Criteria for the selection of stochastic models of particle trajectories in turbulent flows. *Journal of Fluid Mechanics*, 180: 529-556.
- Uribelarrea, M., Otegui, M.E. & Westgate, M.E., 2002. Pollen production, pollination dynamics and kernel set in maize. *Crop Science*, 42: 1910-1918.
- Walklate, P.J., 1986. A markov-chain particle dispersion model based on air flow data : extension to large water droplets. *Boundary-Layer Meteorology*, 37: 313-318.
- Westgate, M.E. & Boyer, J.S., 1986a. Reproduction at low silk and pollen water potential in maize. *Crop Science*, 26: 951-956.
- Westgate, M.E. & Boyer, J.S., 1986b. Silk and pollen water potentials in maize. *Crop Science*, 26: 947-951.
- White, S. & Doebley, J., 1998. Of genes and genomes and the origin of maize. *Trends in Genetics*, 14: 327-332.
- Wilson, J.D., 2000. Trajectory models for heavy particles in atmospheric turbulence : comparison with observations. *Journal of Applied Meteorology*, 39: 1894-1912.
- Wilson, J.D. & Sawford, B.L., 1996. Review of lagrangian stochastic models for trajectories in the turbulent atmosphere. *Boundary-Layer Meteorology*, 78: 191-210.
- Wilson, J.D. & Shum, W.K.N., 1992. A re-examination of the integrated horizontal flux method for estimating volatilisation from circular plots. *Agricultural and Forest Meteorology*, 57: 281-295.
- Zhuang, Y. & Wilson, J.D., 1993. Coherent motions in windbreak flow. *Boundary-Layer Meteorology*, 70: 151-160.

Abstract

Maize is one of the most cultivated plants in the world. For over five centuries people have been adapting it to better fit their needs. Selective breeding, cross-breeding and more recently, genetic engineering have led to numerous varieties of maize. Cross pollination has become a subject of scientific inquiry. In relation to co-existence of genetically modified crops with conventional and organic crops, it is now a major concern. This work aims at better understanding the release and dispersion processes of maize pollen through a mechanistic approach rather than the statistical approach typically used to evaluate outcrossing. The approach in this study is twofold. Firstly, because existing data do not include enough parameters, field experiments were set up and carried out. Secondly, a mechanistic model initially developed for atmospheric ammonia dispersion was adapted to maize pollen dispersion.

Three field experiments were carried out in Montargis in 2000, in Grignon in 2001 and in Sore in 2002. Pollen concentration and deposition rate measurements were taken up to 400 m downwind from different sized maize crops. Micrometeorological measurements and canopy structure were also recorded. Analysis of pollen release rate dynamics highlights the existence of a diurnal cycle of emission and shows correlation between emission and drying air. A high thermal stratification of the atmosphere is particularly favourable for pollen dispersion. However, rain or field irrigation almost suspends pollen release.

The adapted model, hereafter referred to as SMOP-2D (Stochastic Mechanistic mOdel for Pollen dispersion and deposition in 2 Dimensions) is a Lagrangian stochastic model which simulates wind dispersion of pollen by calculating individual pollen trajectories from their emission to their deposition. SMOP-2D predicts pollen concentrations and deposition rates downwind from a source and takes into account varied atmospheric turbulence and pollen aerodynamic characteristics as well as canopy structure. SMOP-2D correctly simulates concentration profiles but underestimates deposition near the source. The parametrisation of the turbulence in the transition zone between maize canopy and the area downwind could explain discrepancies between model predictions and measurements. SMOP-2D can also be used to predict the effect of turbulence and aerodynamic characteristics of pollen grains on transport and deposition.

One important model parameter is the distribution of pollen settling velocity. It has been characterised for different maize varieties and different pollen water content. No significant difference has been proved between the tested varieties. However, this study shows that pollen grain dehydration is correlated with decreasing settling velocity.

Lastly, the measurements constitute a large and complete available data set for the validation of other dispersion models. Moreover, with further work, the model would be a good predictive tool to forecast maize pollen dispersion as well as other biotic particles. In addition, this study provides a framework to compare mechanistic models of atmospheric pollen dispersion developed in environmental physics to statistical models of outcrossing developed in theoretical population ecology.

Keywords: pollen, release, transport, deposition, turbulence, experiments, modelling, *Zea mays*

Résumé

Le maïs est l'une des plantes les plus utilisées dans le monde. Le maïs cultivé aujourd'hui résulte de cinq siècles d'amélioration par l'homme. Les techniques d'hybridation ainsi que l'utilisation des biotechnologies ont abouti à une grande diversité de variétés de maïs, face auxquelles les croisements intervariétaux nécessitent d'être maîtrisés. En particulier, la coexistence entre maïs transgénique et non transgénique est actuellement au cœur du débat scientifique. Pour répondre à cette question, l'approche actuelle est de mesurer directement la fécondation croisée. Cependant, elle ne permet pas de fournir un outil prédictif car elle ne fait pas le lien avec les conditions de l'environnement physique, et plus particulièrement les conditions météorologiques. L'objet de ce travail est de mieux comprendre les processus de dispersion atmosphérique du pollen de maïs à l'aide d'une approche mécaniste à l'échelle de la parcelle. Dans un premier temps, un modèle mécaniste initialement développé pour étudier la dispersion atmosphérique de l'ammoniac a été adapté à la dispersion du pollen de maïs. Ensuite, pour valider le modèle, des mesures dispersion de pollen ont été effectuées.

Trois expérimentations au champ ont été menées à Montargis en 2000, Grignon en 2001 et enfin Sore en 2002. Les concentrations et dépôts de pollen ont été mesurés jusqu'à des distances de 400 m en aval de couverts de maïs de tailles différentes. Dans le même temps, les conditions micrométéorologiques ainsi que la structure du couvert ont été mesurées. L'analyse de la dynamique de libération du pollen a permis de confirmer l'existence d'un cycle diurne de l'émission maïs aussi de montrer la corrélation des émissions matinales avec le dessèchement de l'air ambiant. Une très forte instabilité thermique de l'atmosphère est particulièrement favorable à la dispersion du pollen. En revanche, une pluie ou une irrigation du champ peut quasiment interrompre la libération de pollen.

SMOP-2D (Stochastic Mechanistic mOdel for Pollen dispersion and deposition in 2 Dimensions) est un modèle Lagrangien Stochastique qui simule la dispersion par le vent du pollen en calculant les trajectoires individuelles des grains depuis leur émission jusqu'au dépôt. Ce modèle simule correctement la forme des profils de concentration mais sous-estime le dépôt proche de la source. Il semble que la paramétrisation de la turbulence dans la zone de transition entre le couvert de maïs et la zone en aval de celui-ci pourrait expliquer ces divergences et apparaît à ce jour le point faible du modèle.

Un paramètre important du modèle est la distribution de la vitesse de sédimentation du pollen. Elle a été caractérisée pour différentes variétés de maïs et teneurs en eau du grain. Cette étude a mis en évidence que la déshydratation du grain de pollen s'accompagne de la diminution de sa vitesse de sédimentation. En revanche, aucune différence significative n'a été mise en évidence entre les variétés testées.

Enfin, cet ensemble de mesures constitue un jeu de données important pour valider des modèles de dispersion de particules biotiques. Pour le futur, ce travail ouvre la voie à une analyse comparée de modèles physiques de dispersion atmosphérique du pollen développés en physique de l'environnement et de modèles statistiques de fécondation croisée issus de l'écologie théorique des populations.

Mots clés: pollen, libération, transport, dépôt, turbulence, expérimentation, modélisation, *Zea mays*