



HAL
open science

Scheduling of power system cells integrating stochastic power sources

Luis Costa

► **To cite this version:**

Luis Costa. Scheduling of power system cells integrating stochastic power sources. Electric power. École Nationale Supérieure des Mines de Paris, 2008. English. NNT : 2008ENMP1631 . tel-00409587

HAL Id: tel-00409587

<https://pastel.hal.science/tel-00409587>

Submitted on 13 Aug 2009

HAL is a multi-disciplinary open access archive for the deposit and dissemination of scientific research documents, whether they are published or not. The documents may come from teaching and research institutions in France or abroad, or from public or private research centers.

L'archive ouverte pluridisciplinaire **HAL**, est destinée au dépôt et à la diffusion de documents scientifiques de niveau recherche, publiés ou non, émanant des établissements d'enseignement et de recherche français ou étrangers, des laboratoires publics ou privés.



ED n° 432 : « Sciences des Métiers de l'Ingénieur »

N° attribué par la bibliothèque

||_|_|_|_|_|_|_|_|_|_|_|_|_|_|

THÈSE

pour obtenir le grade de :
DOCTEUR DE L'ÉCOLE NATIONALE SUPÉRIEURE DES MINES DE PARIS
Spécialité “Energétique”

présentée et soutenue publiquement par
Luís Miguel COSTA

le 18 décembre 2008

**SCHEDULING OF POWER SYSTEM CELLS
INTEGRATING STOCHASTIC POWER GENERATION**

*Gestion de Cellules des Systèmes Électriques
Intégrant des Sources de Production Stochastiques*

Directeur de thèse: Georges KARINIOTAKIS

Jury :

Pr.	Didier	MAYER	(ENSMP, FRANCE)	Président
Pr.	Manuel António	MATOS	(FEUP, PORTUGAL)	Rapporteur
Pr.	Gerald B.	SHEBLÉ	(PSU, ÉTATS-UNIS D'AMÉRIQUE)	Rapporteur
Dr.	Olivier	NORMAND	(EIFER, ALLEMAGNE)	Examinateur
Dr.	Georges	KARINIOTAKIS	(ENSMP, FRANCE)	Examinateur

Composition du Jury de Thèse :

Pr. Didier MAYER, École Nationale Supérieure des Mines de Paris, France (Président)
Pr. Manuel António MATOS, Faculdade de Engenharia da Universidade do Porto, Portugal (Rapporteur)
Pr. Gerald B. SHEBLÉ, Portland State University, États-Unis d'Amérique, (Rapporteur)
Dr. Olivier NORMAND, European Institute for Energy Research, Allemagne, (Examineur)
Dr. Georges KARINIOTAKIS, École Nationale Supérieure des Mines de Paris, France, (Examineur)

*To my parents, for their unconditional support
and to Manuela, for helping me to weather the storm.*

PEDRA FILOSOFAL

*Eles não sabem que o sonho
é uma constante da vida
tão concreta e definida
como outra coisa qualquer,
como esta pedra cinzenta
em que me sento e descanso,
como este ribeiro manso
em serenos sobressaltos,
como estes pinheiros altos
que em verde e oiro se agitam,
como estas aves que gritam
em bebedeiras de azul.*

*Eles não sabem que o sonho
é vinho, é espuma, é fermento,
bichinho álcree e sedento,
de focinho pontiagudo,
que fossa através de tudo
num perpétuo movimento.*

*Eles não sabem que o sonho
é tela, é cor, é pincel,
base, fuste, capitel,
arco em ogiva, vitral,
pináculo de catedral,
contraponto, sinfonia,
máscara grega, magia,
que é retorta de alquimista,
mapa do mundo distante,
rosa-dos-ventos, Infante,
caravela quinhentista,
que é Cabo da Boa Esperança,
ouro, canela, marfim,
florete de espadachim,
bastidor, passo de dança,
Colombina e Arlequim,
passarela voadora,
pára-raios, locomotiva,
barco de proa festiva,
alto-forno, geradora,
cisão do átomo, radar,
ultra-som, televisão,
desembarque em foguetão
na superfície lunar.*

*Eles não sabem, nem sonham,
que o sonho comanda a vida.
Que sempre que um homem sonha
o mundo pula e avança
como bola colorida
entre as mãos de uma criança.*

PORTO SENTIDO

*Quem vem e atravessa o rio
Junto à Serra do Pilar
Vê um velho casario
Que se estende até ao mar*

*Quem te vê ao vir da ponte
És cascata são-joanina
Erigida sobre um monte
No meio da neblina*

*Por ruelas e calçadas
Da Ribeira até à Foz
Por pedras sujas e gastas
E lampiões tristes e sós*

*Esse teu ar grave e sério
Num rosto de cantaria
Que nos oculta o mistério
Dessa luz bela e sombria*

*Ver-te assim abandonado
Nesse timbre pardacento
Nesse teu jeito fechado
De quem mói um sentimento*

*E é sempre a primeira vez
Em cada regresso a casa
Rever-te nessa altivez
De milhafre ferido na asa*

Carlos Tê, 1986.

Agradecimentos

Este manuscrito conclui simbolicamente um trabalho pessoal que resulta de um longo percurso. Tal percurso esteve frequentemente envolto de dificuldades diversas a vários níveis. Estas dificuldades teriam sido muito mais difíceis de vencer e de suportar sem a ajuda de várias pessoas. Estes agradecimentos servem de alguma forma para partilhar este sucesso pessoal com todas essas pessoas sem excepção.

Esta tese de doutoramento trata, entre outros, da gestão de risco. Nesta pequena nota de agradecimento enumerarei as pessoas que, a meu ver, mais contribuíram para a minha *chegada a bom porto* no final deste percurso pessoal aceitando correr o risco de deixar algumas de fora por omissão involuntária. A todas essas apresento desde já as minhas sinceras desculpas.

Os vários agradecimentos pessoais que se seguem serão redigidos nas línguas que utilizo mais frequentemente para comunicar com as pessoas em causa com o objectivo de personalizar ainda mais esta secção e, assim, tratar cada pessoa como a entidade única que é.

Um sincero abraço para todos(as) vós.

Remerciements

Ce manuscrit symbolise en quelque sorte la conclusion d'un travail personnel issu d'un long parcours. Ce parcours a souvent été enveloppé de plusieurs difficultés et ceci à plusieurs niveaux. Ces difficultés auraient été bien plus difficiles à supporter et à vaincre sans l'aide précieuse de plusieurs personnes. Cette partie vise à partager ce succès personnel avec toutes ces personnes sans exception aucune.

Cette thèse de doctorat s'attache, entre autres sujets, à la gestion du risque. Dans cette note de remerciements j'énumérerai les personnes qui, selon moi, ont contribué le plus à cet aboutissement personnel et j'assume le risque d'en laisser quelques unes en dehors de cette note par omission involontaire. À toutes ces personnes oubliées je présente mes plus sincères excuses.

Les plusieurs remerciements personnels qui suivront seront rédigés dans les langues que j'utilise le plus fréquemment pour communiquer avec les personnes en question. Ceci dans le but de personnaliser encore plus cette partie et ainsi traiter chacune de ces personnes comme l'entité unique qu'elle représente.

Je vous souhaite à toutes et à tous mes plus sincères salutations.

Acknowledgments

This manuscript concludes in some sense a personal work that was carried out over a large time span. The execution of this work was often hardened by many obstacles that appeared at many levels. These obstacles would have been much harder to face and overcome without the help of various persons. These acknowledgments aim to share this personal success with all of them with no exception.

This Ph.D. thesis deals with risk management (among other subjects). In these short acknowledgment notes I shall enumerate the various persons that, from where I stand, contributed the most to this personal accomplishment accepting the risk to leave some of them forgotten against my will. To all the forgotten persons, I present my most sincere apologies.

The several personal acknowledgments that follow will be written in the language I more often use for communicating with the addressed person. The objective is that of customizing this section to every one of these persons thus treating them as the unique entities they are.

I wish you all the best.

AGRADECIMENTOS/REMERCIEMENTS/ACKNOWLEDGMENTS

I would like to start by acknowledging all the elements of my Jury (Prof. Didier Mayer, Prof. Manuel António Matos, Prof. Gerald Sheblé, Dr. Olivier Normand, and Dr. George Kariniotakis) who managed to find the required time in their (very) busy schedules to read and comment this long manuscript as well as to attend my Ph.D. defense. I hold a special thought for those members that accepted to travel a long way (even from overseas) in order to be physically present on that important date.

I also thank all the partners of the various EU-Projects I had the chance to participate in (RESPIRE, RISE, MICROGRIDS, MORE-MICROGRIDS, ANEMOS.plus). Your remarks, suggestions and encouragement inspired me many times throughout the accomplishment of this thesis. In the same way, I thank the various peers (both researchers and engineers) the exchanged ideas, views, and opinions about my work during the several conferences in which I was fortunate to participate.

Agradeço agora aos então meus professores e hoje amigos Vladimiro Miranda e Cláudio Monteiro por, em 2004, terem acreditado em mim lançando-me nesta *loucura* de sair do País para alargar os meus horizontes e perseguir um sonho já que, parafraseando um conhecido autor, *o sonho comanda a vida*.

Je remercie ensuite aux professeurs Didier MAYER et François-Pascal NEIRAC de m'avoir accueilli dans le laboratoire du Centre Énergétique et Procédés (CEP ou, à l'époque, CENERG) de l'École des Mines de Paris à Sophia Antipolis et de m'avoir donné les moyens nécessaires au développement de mon travail. En même temps, je n'oublierai jamais la contribution de tout le corps administratif et informatique du centre (Roseline ADDEWALD, Christine GSCHWIND, Marie-Jeanne NAERT, Alain BRASSEUR et Patrick GATT) puisqu'elle a été décisive à plusieurs niveaux en ce qui concerne mon intégration optimale dans cette nouvelle réalité. J'ajouterai ici un mot spécial à Marie-Jeanne pour sa sympathie, compréhension et effort personnel dans tout ce qui avait trait à mon intégration depuis le départ de cette aventure en 2004 (des fois bien au-delà de ces obligations professionnelles).

Le déroulement de cette thèse a en effet été long... et de nouvelles personnes ont rejoint l'équipe administrative et informatique du CEP. Un grand merci pour elles aussi (Lyliane LOUAULT, Brigitte LEPRAT, Laurent SCHIATTI DE MONZA et Emmanuel LEVRAT). Je voudrai aussi laisser un mot de remerciement à Brigitte HANOT et à Sylvie MICHEL pour leur disponibilité et efficacité dans tout ce qui se rapporte à la gestion de la bibliothèque.

Arrive le moment de remercier très chaleureusement Georges KARINIOTAKIS même si le fait d'être Portugais et de débiter une thèse de doctorat avec un Grec en 2004 n'a pas été facile au départ, n'est-ce pas Georges? Plus sérieusement, au cours de notre collaboration, nous avons rencontré des obstacles et des difficultés diverses. Cependant, nous avons toujours réussi à les vaincre pleinement grâce, entre autres, à l'intelligence, perspicacité, capacité et humanité de Georges. Je finis cette thèse, et je clos ce chapitre de ma vie en étant assuré d'avoir gardé un ami pour toujours et cela est, pour moi, le plus important.

Je laisse à ce stade un sincère remerciement à Lucien WALD, à Thierry RANCHIN, à Laurent FULCHERI et à Rudolf METKEMEIJER pour toutes les remarques, contributions et conseils qu'ils m'ont apporté et qui ont servi à améliorer mon travail, mon esprit critique et mon mûrissement personnel. Je remercie aussi l'ensemble de mes collègues thésard(e)s pour toutes les discussions animées et activités réalisés. Celles-ci ont rendu mon passage au centre infiniment plus agréable.

AGRADECIMENTOS/REMERCIEMENTS/ACKNOWLEDGMENTS

Un grand merci également à mes collègues et amis Nils SIEBERT, Jérémie JUBAN, Christophe CHEVALLIER et Franck BOURRY pour toutes les contributions et discussions que j'ai pu avoir avec eux. Ces moments ont apporté un complément décisif à la qualité et à la clarté de mon travail. Je remercie plus particulièrement Jérémie et Nils une fois qu'ils ont été mes collègues de bureau pendant une longue période ce qui n'a peut-être pas toujours été évident...

Je laisse maintenant un mot pour mon ami breton... Alexis BOCQUET. Tu m'as accompagné dans ce voyage dès le départ quand les choses étaient les plus dures. Un grand merci pour cela... Cependant, j'attends encore les cours de planche à voile que tu m'as promis...

Un mot également pour mon ami Patrick LEROUX qui, avec Jérémie, m'ont permis de m'épanouir en jouant de la musique régulièrement dans une ambiance agréable et amicale. Merci à tous les deux pour les moments d'exception que vous m'avez offerts.

Agradeço agora aos meus amigos Hugues Digonnet e Luísa Silva pelos inúmeros momentos de amizade e de cumplicidade que passámos (e passaremos) juntos. Agradeço também à Catarina Ferreira da Silva, ao Erwan Le Patezour e ao Carlos Moreira por terem estado presentes sempre que possível. Uma palavra de apreço ainda para a Isabelle Fernandes pela sua motivação e disponibilidade permanente para ouvir e ajudar no que fosse necessário.

Queria ainda agradecer a duas pessoas que são para mim muito especiais: o Pedro Dias e o Domingos Mateus. Em momentos diferentes foram ambos cruciais neste meu percurso pela força, amizade e coragem que me transmitiram.

Queria agora agradecer em especial aos meus pais e à minha irmã bem como ao restante círculo familiar toda a força, energia e confiança que me transmitiram sempre que necessitei. Agradeço-lhes também o facto de me terem conseguido *aturar* em alguns dos momentos mais difíceis deste longo percurso.

Agradeço ainda aos pais, irmãos e restante círculo familiar da Manuela que sempre me acolheu e acolhe como se fosse minha.

Finalmente, deixo uma palavra de apreço à minha companheira de sempre nesta e noutras caminhadas. Só a Manuela saberá o quão difícil terá sido por vezes conviver comigo e não tenho palavras para lhe agradecer e reconhecer o seu permanente esforço e dedicação. À Manuela deixo aqui um singelo mas sincero obrigado.

LUÍS MIGUEL COSTA

AGRADECIMENTOS/REMERCIEMENTS/ACKNOWLEDGMENTS

Contents

<i>Contents</i>	xiii
<i>Overview of the Thesis</i>	xvii
<i>Abbreviations</i>	xix
<i>Main Definitions</i>	xxi
<i>List of Figures</i>	xxiii
<i>List of Tables</i>	xxv
<i>List of Algorithms</i>	xxvii
1 Introduction	1
1.1 Main Driving Forces of the Work	2
1.1.1 Large-Scale Integration of Renewable Energy Technologies into Power Systems	2
1.1.2 The Contribution of Distributed Generation and Information Technologies . . .	3
1.1.3 Electricity Markets and Power Systems	4
1.2 Objectives and Contribution of the Thesis	6
1.3 Outline of the Thesis	8
2 Context and Main Hypotheses of the Work	11
2.1 Vertically Integrated Power Systems	12
2.2 The 70's Oil Crisis and the Investment in Endogenous Resources	13

CONTENTS

2.3	The Present Situation	14
2.4	Decentralized Power Generation	17
2.5	Power System Cells	19
2.5.1	Combined Wind/Pumped-Hydro Systems	21
2.5.2	Microgrids	23
2.6	Short Discussion on Electricity Markets	30
2.7	Main Hypotheses of the Work	32
2.8	Conclusions of the Chapter	33
3	Power System Scheduling	35
3.1	The Power System Scheduling Problem	36
3.2	A Unified Formulation of the Power System Scheduling Problem	43
3.2.1	Formulation of the Classical Multi-Area Power System Scheduling Model	46
3.2.1.1	The Objective Function of the Problem	46
3.2.1.2	Constraints of the Problem	49
3.2.2	Derivation of a Single-Area Power System Scheduling Model	60
3.2.3	A Market-Player Power System Scheduling Model	60
3.2.3.1	Objective of the Problem	61
3.3	Conclusions of the Chapter	62
4	Decision Under Uncertainty	65
4.1	Why Decision Under Uncertainty?	66
4.2	Modeling Uncertainty	67
4.3	Decision Problems	70
4.4	Some Particularities of the Problem Addressed in This Work	72
4.5	Main Approaches for Making Decisions Under Risk	74
4.5.1	Expected Value	75
4.5.2	Utility Theory	77
4.5.3	Stochastic Dominance	79
4.5.4	Mean-Variance	85
4.5.4.1	The Mean-Variance Model as a Spot-Risk Model	88
4.5.5	Compromise Programming	88
4.5.5.1	Short Description of Minkowski Distances	89
4.5.5.2	Ranking of Alternatives Through the Use of Minkowski Distances	91
4.5.5.3	Discussion on the Use of Minkowski Distances for Decision-Making	92
4.6	Conclusions of the Chapter	94
5	Proposed Scheduling Model	95
5.1	Introduction	96
5.1.1	Some Possible Applications of the Proposed Model	99
5.2	Scheduling Scheme	100
5.3	Objective Function Description	101

5.4	Formulation of the Power System Cell Optimization Problem	104
5.4.1	Solution Method	109
5.4.2	Proposed Dynamic-Programming-Based Solution Method	113
5.4.2.1	Definition of Control and State Variables	114
5.4.2.2	Solution Procedure	117
5.4.2.3	The main algorithms	119
5.4.3	Discussion	121
5.5	Stochastic Extensions Applied to the Base Deterministic Scheduling Model	125
5.5.1	Integrating Energy-Related Uncertainties into the Proposed Scheduling Model	127
5.5.1.1	The Spot-Risk Model	127
5.5.1.2	Integrating the Spot-Risk Model into Multi-Stage Decision-Making Processes	129
5.5.1.3	Single-Stage Integration of the Spot-Risk Model	130
5.5.1.4	The Risk Measure	131
5.5.1.5	The Risk Perception Surface	134
5.5.2	Integration of Day-Ahead Market Price Uncertainty	146
5.5.2.1	Single-Stage Integration of Market Price Uncertainties Through the Use of Minkowski Distances	149
5.6	Conclusions of the Chapter	151
6	Case-Studies	153
6.1	Objectives	154
6.1.1	Forecasting Tools Used for Producing the Required Data	155
6.1.2	Electricity Market Description	157
6.1.2.1	Day-Ahead Market	158
6.1.2.2	Regulating Market	158
6.2	Microgrid Case-Study Description and Input Data	159
6.2.1	Results and Discussion	164
6.3	Wind/Pumped-Hydro Case-Study Description and Input Data	168
6.3.1	Intraday Operation of the Wind/Pumped-Hydro System	170
6.3.2	Overall Simulation Methodology	172
6.3.3	Deterministic Results and Discussion	174
6.3.3.1	Insight on the Value of Energy Storage	178
6.3.4	Results From Stochastic Approaches and Discussion	181
6.3.5	Results & Analysis	183
6.4	Conclusions of the Chapter	190
7	Conclusions and Perspectives for Further Research	191
7.1	Overall Conclusions	192
7.2	Perspectives for Further Research	195
	<i>Main Publications</i>	200

<i>Bibliography</i>	201
---------------------	------------

Appendices

A Résumé en Français	213
A.1 Chapitre 1 : Introduction	214
A.1.1 Principaux Axes d'Orientation	214
A.1.1.1 Intégration Grande-Échelle dans les Systèmes Électriques des Tech- nologies Renouvelables	214
A.1.1.2 La Contribution de la Production Décentralisée et des Technologies d'Information	216
A.1.1.3 Les Marchés d'Électricité et les Systèmes Électriques	217
A.1.1.4 Objectifs et Contributions de la Thèse	219
A.1.2 Structure de la Thèse	221
A.2 Chapitre 2 : Contexte et Hypothèses Principales du Travail	223
A.3 Chapitre 3 : Gestion des Systèmes Électriques	223
A.4 Chapitre 4 : Décision Sous Incertitude	224
A.5 Chapitre 5 : Modèle de Gestion Proposé	225
A.6 Chapitre 6 : Cas d'Études	226
A.7 Chapitre 7 : Conclusions et Perspectives de Recherche Additionnelle	226

Overview of the Thesis

The present manuscript summarizes the work that was made throughout the development of my Ph.D. thesis. It partially fulfills the requirements for obtaining the doctoral degree of the *École Nationale Supérieure des Mines de Paris*.

The work was carried out in the context of restructured power systems in which several independent actors interact with an electricity market for placing their energy production/consumption bids. Simultaneously, the EU targets for massively increasing the integration of endogenous resources like, for instance, renewable energies were kept in mind. The role of micro-generation and the active integration of such type of generation into power systems was analyzed. In addition, the possibility of coupling micro-generation with manageable loads and energy storage devices was also considered.

Throughout the work, the combined operation of a set of micro-generators, loads and energy storage devices was accounted for. The combined operation of the set was considered to behave as a controlled entity that forms an individual cell of the main power system. The general objective of the present work was to develop a scheduling methodology for operating such types of power system cells under electricity market conditions.

The approach developed here for addressing the management of power system cells operating under market conditions performs the optimal scheduling of the various elements that may take part on the defined power system cells. The scheduling is computed through a dynamic programming algorithm that was specifically tailored for the purpose of this work. Such algorithm is fully described within this document.

The power system cells considered here may comprise relatively high amounts of non-dispatchable elements, namely: photovoltaic panels, wind turbines, and loads. The incorporation of such elements in the scheduling procedure is made through the use of forecasts of their energy contributions to the power system cell operation. As such forecasts are not perfect, they lead to some amount of error. Consequently, they comprise a quantity of forecast uncertainty, which associates a level of trust to the corresponding point forecasts. Therefore, the proposed power system cell scheduling method was tailored for integrating such uncertainty into the scheduling procedure through the use of stochastic programming principles and decision under uncertainty models.

Results giving insight on the possible contributions of the proposed scheduling method are included in this manuscript. The document proceeds by drawing the main conclusions of the work, which comprehend a critical analysis of its main achievements. The document ends with the description of some perspectives for further research.

Abbreviations

CPU: Central Processing Unit (the core of any modern computer).

DSM: Demand Side Management

GENCO: Generating Company.

ISO: Independent System Operator.

IEEE: Institute of Electrical and Electronics Engineers

PBUC: Price-based Unit Commitment.

PV: Photovoltaic

SCUC: Security-Constrained Unit Commitment.

TSO: Transmission System Operator.

ABBREVIATIONS

Main Definitions

Dispatch: Decision process in which one determines the specific *setpoints* of any given generating unit in use at any point in time.

Economic Dispatch: Decision process in which one determines the specific *setpoints* of any given generating unit in use at any point in time with the objective of either minimizing the global operation cost of the power system, or maximizing the operation benefit yield.

Risk: a state of uncertainty where some of the possibilities involve a loss, a catastrophe, or other undesirable outcome.

Risk Perception: subjective evaluation of the risk associated to an uncertain future.

Setpoint: Target value that a generating unit will aim to reach.

Time-horizon: The period of time for which a set of sequential decisions is defined.

Time-step: The base amount of time used for discretizing the time-horizon into a number of time-stages.

Time-stage: A point in time whose position is defined relatively to the starting position of the time-horizon under analysis.

Unit Commitment: Decision process in which one determines which generating units are to be in use at each point in time of a future period.

List of Figures

2.1	Schematic presentation of a power system operated under a vertically integrated structure.	13
2.2	Schematic presentation of a possible microgrid configuration as proposed in [1].	26
2.3	Schematic presentation of the microgrid architecture proposed by CERTS in [2].	28
4.1	Schematic description of the main approaches to model uncertainty information.	69
4.2	Example of a decision-making problem comprising three alternative investments: A, B and C.	76
4.3	Illustration of the three possible risk attitudes that may characterize a Decision Maker	78
4.4	Verification of FSD conditions for the the three alternatives cases described in Figure 4.2	81
4.5	Example of a decision-making problem comprising three alternative example investments: A, B and C. In this case, the three options have equal expectancy but different variances, which distinguishes this case and the one presented in Figure 4.2.	82
4.6	Verification of FSD conditions for the the three alternatives cases described in Figure 4.5	83
4.7	Verification of SSD conditions for the the three alternatives cases described in Figure 4.5	83
4.8	Representation of three arbitrary options (<i>A</i> , <i>B</i> , and <i>C</i>) on the E-V plane	86
4.9	Representation of different Minkowski distance isolines	91
4.10	Representation of different Minkowski distance isoline surfaces	93
5.1	Schematic representation of the HL1 model of the power system cell.	100
5.2	General functional input/output schema of the scheduling procedure.	101
5.3	Example of the application of dynamic programming to the solution of the power system cell scheduling problem.	118
5.4	Three basic approaches for integrating demand side management (DSM) in the scheduling of the power system cell.	124

LIST OF FIGURES

5.5 Representation of the Boolean logic followed for building the Risk Perception surface \mathcal{P} 142

5.6 Representation of a possible global time-dependent rule $g^{rule}(t)$ that could be used for building the risk perception surface \mathcal{P} of the power system cell operator. 142

5.7 Representation of a state-of-charge preference rule in which the preferred state-of-charge is set to the constant value of 0.2 relatively to the maximum available energy storage capacity SOC_{max} 143

5.8 Representation of a state-of-charge preference rule in which the preferred state-of-charge is set to the constant value of 0.5 relatively to the maximum available energy storage capacity SOC_{max} 143

5.9 Representation of a state-of-charge preference rule in which the preferred state-of-charge is set to the constant value of 0.8 relatively to the maximum available energy storage capacity SOC_{max} 144

5.10 Representation of a possible global time-dependent rule $g^{rule}(t)$ that could be used for building the risk perception surface \mathcal{P} of the power system operator. 144

5.11 Examples of risk perception surfaces obtainable through algorithm 3. 147

6.1 Forecasted and measured microgrid load. 161

6.2 Normalized forecasted and measured microgrid wind power (WP) production. 161

6.3 Normalized forecasted and measured microgrid photovoltaic (PV) power production. 162

6.4 Forecasted and obtained day-ahead market prices. 162

6.5 Illustration of the price forecast discretization process. 163

6.6 Forecasted day-ahead single-stage market price scenarios. 164

6.7 Normalized mean absolute error at the point of common coupling (PCC). 166

6.8 Normalized mean absolute error improvement with respect to persistence at the point of common coupling (PCC). 167

6.9 Wind/Pumped-Hydro model. 169

6.10 Schematic representation of the overall wind/pumped-hydro simulation including both the scheduling and the intra-day operation phases. 173

6.11 Profits obtained for each of the six deterministic scenarios evaluated in the frame of the wind/pumped-hydro case-study. 176

6.12 Penalties associated to the six deterministic scenarios evaluated in the frame of the wind/pumped-hydro case-study. 178

6.13 Relative distribution of the obtained energy imbalances. 179

6.14 Total imbalance and revenue obtained for all the wind/pumped-hydro stochastic simulations. 184

6.15 Imbalance improvement (in the sense of reduction) *versus* obtained revenue for every wind/pumped-hydro stochastic simulation. 185

6.16 Energy imbalance improvement achieved in the wind/pumped-hydro case-study for different risk attitudes. 186

6.17 Revenue achieved in the wind/pumped-hydro case-study for different risk attitudes. 187

6.18 Comparison between the levels of contracted and produced energy in the wind/pumped-hydro case-study for the various simulation scenarios. 188

6.19 Day-ahead expected revenue achieved in the wind/pumped-hydro case-study for different risk attitudes. . 189

List of Tables

3.1	Example of possible system states (S_1, \dots, S_{15}) for meeting load level L_t at time stage t for a power system comprising 4 dispatchable generators.	38
3.2	Influence of the presence of time-coupling constraints in the complexity of the unit commitment problem.	39
3.3	Example of a unit commitment search-space description for the example presented in Table 3.1 for T time stages.	40
4.1	Schematic presentation of the four basic modes of deciding as proposed by Zeleny [3].	71
4.2	Example of application of the mean-variance decision principle for determining which of the alternatives described in Figure 4.8 can be considered as being the <i>best</i> one for three different arbitrary values of risk averse attitude	87
5.1	Control and state variable candidates of the power system scheduling problem.	115
5.2	Classification of the scheduling variables of the power system cell scheduling problem.	117
5.3	Parameters used for building the risk perception examples shown in Figure 5.11.	145
6.1	Main parameters used for running the tests.	160
6.2	Scenarios defined based on different PV and WT capacities.	165
6.3	Scenario grouping according to wind penetration.	166
6.4	Energy imbalance obtained throughout the simulated year of operation.	178
6.5	Comparison between the energy imbalance results obtained in the WPPred case and in its corresponding case in which no energy storage was considered.	178
6.6	Comparison between the revenue attained in the case where no energy storage is available and the realistic (WPPred, WPPred_SPPred) and perfect (WPPI, WPPI_SPPI) cases in which an energy storage device is considered.	180

LIST OF TABLES

6.7 Summary of the simulations performed in this work. 183
6.8 Summary of the different correlation results obtained. 184

List of Algorithms

1	Main procedure.	119
2	Backwards dynamic programming scheduling algorithm.	120
3	General description of the procedure followed for constructing the risk perception surfaces throughout this work.	141

LIST OF ALGORITHMS

CHAPTER 1

Introduction

CHAPTER OVERVIEW

THIS chapter introduces the present research work starting with a short description of the driving forces that motivated it. Then, the chapter proceeds with the definition of the main objectives and contributions of the thesis. At the end, an outline of the structure of the present document is provided.

1.1 Main Driving Forces of the Work

Three main driving forces are at the core of this research work. The first one is related to the political willingness for achieving a large-scale integration of renewable energy technologies into power systems with the objective of taking advantage of endogenous resources, thus reducing the pollution associated to electricity production and utilization while increasing both the energy mix and independence of countries worldwide. The second one is linked with the recent advances in both distributed generation and information technologies. The third one is related to the fact that, as opposed to the recent past, power systems are nowadays operated under electricity markets conditions, which implies some changes in the way they are planned and operated. A short discussion on each of such axes will thus be made for setting the basis and objectives of this work.

1.1.1 Large-Scale Integration of Renewable Energy Technologies into Power Systems

Increasing environmental concerns and the generally high dependency on fossil fuels for producing energy lead many countries to develop policies that aim to overcome such problems. The establishment of green certificate quotas for penalizing carbon emissions [4][†] and the enforcement of more restrictive laws on energy efficiency in buildings [6] constitute two examples of such policies.

Renewable energy technologies have the potential to directly contribute to the reduction of pollutant gas emissions. At the same time, being endogenous resources, they represent an opportunity for countries to increase their energy independence while simultaneously improving the energy mix of their economies. Consequently, countries worldwide are increasingly investing in the large-scale integration of renewable energy technologies into power systems. As an example, in 2004, only 6 % of the European Union (EU) overall gross inland energy consumption was fed from renewable energy sources despite their abundance throughout the territory [7]. However, this value is expected to increase in the next years. The target fixed by the European Union for the amount of gross renewable energy reaches the value of 12 % by 2010 [8]. The target for electricity power generation is even more ambitious. In 2004, only 14 % of the produced electricity came from renewable energy sources [9]. However, the

[†]In *Wallonie* (Belgium), each green certificate corresponds to the carbon emissions produced by a reference combined-cycle gas plant for producing 1 MWh of electricity [5] and companies have to have a number of certificates corresponding to their annual energy production. If they do not have enough certificates at the end of the year, then they are bound to pay a penalty for each green certificate missing worth 100 €. However, they have the option of either producing green certificates by using efficient energy production technologies, either by buying them on the green certificate market from third-party companies.

European Union target projects the value of 22.1 % by 2010 [8].

Because power systems were not originally designed for integrating large quantities of renewable energy technologies, new problems emerge for their operators and planners for mainly two reasons:

1. many of the renewable energy technologies are distributed throughout the power grid and may thus contribute to aggravate grid congestion and protection coordination problems;
2. many of such renewable energy technologies are based on stochastic, highly fluctuating resources such as the wind or the solar irradiation, which adds significant uncertainty to power system management.

Considerable research is carried out today to provide answers to these problems. This thesis aims at contributing to the optimization of power system management by developing power system scheduling tools suitable for distributed generation and taking into account the presence of stochastic generation and loads.

1.1.2 The Contribution of Distributed Generation and Information Technologies

Current power systems face many challenges like, for instance: the difficulty of installing new power transmission lines or reinforcing existing ones at the same time that the power system demand migrates and grows, the aging of power system transmission components and the need to re-invest in new ones, and the aging of conventional centralized power generation infrastructures. At the same time, new and increasingly improved types of distributed generation technologies appear in the electricity industry scene. These include microturbines, wind power generators, fuel cells, Stirling engines and others. A state of the art on distributed generation technologies can be found in [10]. In parallel, advances in information and communication technologies add novel capabilities to power system components making possible to rethink the way power systems are planned and operated.

In contrast to the large power plants that are usually integrated by large centralized generation systems, distributed generation technologies need less time to be installed. This fact, allied to their modularity, can make them a more efficient investment when compared to centralized generation technologies. Furthermore, if done properly, the adoption of distributed generation may allow to postpone or even

to avoid investments on new large power generation facilities which, according to [11], are capital-consuming, less efficient and difficult to license. However, distributed generation units may influence the development and operation of current power systems. In some countries, the penetration of distributed generation has to be limited to a maximum of 20 % [12] in order to limit the harm these may cause to the system. In fact, utilities fear [13] large-scale penetration of distributed generation in their grids as it could compromise their costs as well as the security and reliability of the power system. That is why, in the present, several studies are performed on how much penetration of distributed generation can be tolerated by the system before their collective impact begins to create problems. These may be, for example, excessive current flows following faults or voltage fluctuations [2].

At the light of the previous paragraphs, one of the main questions is then if one shall keep the classical centralized power system philosophy or adopt a decentralized one in which numerous new components are added to the power system. In a certain sense the previous question could even be if one should keep the power system more or less passive, or render it more and more active[†]. Both of the previous choices have advantages and drawbacks [11, 14] and the best choice is probably somewhere in-between the two. Either way, the power system industry has nowadays very mature methods and techniques for managing *passive* power systems, which is not the case for distributed generation technologies integrating advanced communication and control capabilities. Therefore, new methods, techniques, and tools are needed for an efficient management of large-scale shares of distributed power generators integrated into power systems. The scientific community and the power systems industry are already working in that direction [15, 16] and discussions like that in [17] are becoming more and more often. This research work aims to contribute to the field of large-scale distributed energy technology integration into power systems.

1.1.3 Electricity Markets and Power Systems

The restructuring of power systems in several countries led to the unbundling of vertically integrated power system structures and to the establishment of electricity markets. Electricity markets both facilitate and increase the transparency of commercial energy transactions between independent power producers and electricity consumers. This is achieved by establishing the electrical energy commodities that should be exchanged, the prices to be paid by such commodities, and the rules that should be

[†]Here, the word *active* means that the various components have some degree of intelligence (advanced communication — amongst themselves and/or with the main system — and control capabilities) which permits them to take some action (taken from a predefined set of actions) according to the communication signals they receive.

respected by electricity market participants [18, 19].

The establishment of electricity markets affects the way power systems are operated [19, 20]. The global goal of the power system is still that of supplying electrical loads with secure and reliable electrical power (technical constraints) at the least possible cost (economical constraints). However, under an electricity market framework, the enforcement of technical constraints is usually left to independent system operators, while market mechanisms are entrusted the task of minimizing the costs of electrical energy.

Independent system operators are one of the major electricity market participants and are responsible for ensuring that the technical constraints described above are respected at all times. Consequently, such market participants are held responsible for maintaining power system security and reliability levels as high as possible by verifying that:

- the energy bids placed and accepted in the market lead to technically acceptable power flows and voltages in every line/node of the transmission grid [18];
- the $N - 1$ (and, in some cases $N - 2$) security levels (from a contingency analysis standpoint) are respected.

As was previously stated, the minimization of the costs of electrical energy is entrusted to electricity market mechanisms. Such mechanisms generate price signals that are then interpreted by market participants like, for instance, the independent power producers. Indeed, independent power producers use market price signals for placing energy production bids according to their individual objectives. Such objectives often correspond to individual profit maximization. However, independent power producers no longer rely on the centralized day-ahead scheduling of their generators for attaining their individual objectives, but rather have to perform a complex series of new tasks. These tasks can be resumed to, basically, three main phases [20]:

1. performing the **scheduling** (day-ahead, week-ahead,...) of individual generating units;
2. **strategic bidding** of commodities in the electricity market for establishing the most profitable contracts for such commodities;
3. operation of their individual generators for respecting as closely as possible the previously established established contracts for commodities, thus avoiding possible penalties.

This research work is mainly focused on the day-ahead scheduling of independent power producers.

1.2 Objectives and Contribution of the Thesis

The general objective of this research work is to contribute to the large-scale integration of distributed generation technologies into power systems. Two main options for integrating distributed generation exist [21]. The first one (classical) consists in connecting distributed generators in a *passive* way and then withstand any possible consequences that such situation might cause. The second one consists in integrating such generators in an *active* way. Under such principle, the distributed generators possess some level of *intelligence* (from a power systems management perspective)[†], which allows them to cooperate with *intelligent* technologies for following some predefined operation strategy that seeks to actively reduce the harm that distributed generators may cause to the main system or even to contribute to the health of the main system.

The active integration of distributed generation into power systems poses challenges at many levels [22], such as:

- the increase of complexity of power system management due to the presence of many more actors than in the past, which increases the market competition between market participants, thus reducing individual profit margins;
- the need for bidirectional communications between the various actors, which allows them to receive signals (e.g.: market price signals received by generators) and to inform the remaining participants of their individual states and decisions (e.g.: a generator can place a bid directly to the market, inform a master controller of its intents to produce or not energy on a given hour, inform its environment of a malfunction, etc.);
- in the case of penetration of non-dispatchable generation (i.e.: certain renewables), the controllability of the power system is reduced (at least locally), which demands innovative methodologies for performing power system management;

[†]Such *intelligence* may be given by the capacity to communicate with other elements that operate at the same level of communication (e.g.: other generators) or that serve as interfaces between levels of communication (e.g.: aggregator). Another level of *intelligence* could be at the level of autonomy given to distributed generators for allowing them to respond autonomously to the occurrence of some predefined system events (e.g.: appearance of local under- or over-voltages).

- the integration of distributed elements comprising some level of *intelligence* leads to an increase of power system management and control possibilities, which potentially enables more advanced distributed power system management structures.

This thesis is devoted to the *active* integration of distributed generation into power systems. It investigates some potential management possibilities that may be associated to distributed generators. Such possibilities comprise:

- the coordination between the various distributed elements of the power system for pursuing a common goal;
- the use of energy storage devices for increasing the global controllability of the system as well as the benefits (e.g.: profits) of their respective operators;
- the integration of demand-side management techniques directly into energy managers.

Due to the specificities of electrical power, power system management is very complex and comprises many different time-frames and resolutions. This work focuses mainly on the day-ahead scheduling of cooperative distributed resources under day-ahead market conditions.

In this thesis, novel scheduling methods are proposed for performing the day-ahead scheduling of available distributed resources under market conditions. When operated in cooperation, such resources form *power system cells*[†]. This work considers the day-ahead scheduling of such cells, which may comprise different combinations of several elements, namely: non-dispatchable generators and loads, dispatchable generators and loads, and energy storage devices.

The *power system cells* considered in this work participate in the electricity market and include stochastic power generation such as wind power generators and PV arrays. Therefore, the management of such cells has to rely on forecasts of the electricity market prices as well as on forecasts of the non-dispatchable generation and load. All these forecasts are sources of uncertainty and, as a consequence, make the management problem more challenging than that of conventional power systems where the load is highly predictable whereas the penetration of non-dispatchable generation is usually very low.

[†]A *posteriori*, these cells could be named *intelligent power system cells* as a result of the various options they integrate at the communication, control, and management levels.

In this work, two types of *power system cell* scheduling methods are proposed: a deterministic one and a stochastic one comprising several variants. The deterministic one disregards the uncertainties associated to the forecasts of the various non-dispatchable elements. The different stochastic variants consider these uncertainties as a basis to estimate operation risks. Moreover, the integration of estimated energy-related risks into the scheduling process is made through the consideration of both the risk perception and the risk attitude of the cell operator. In other words, the operator is placed at the center of the scheduling process by taking into account his risk preferences. In both the deterministic and the stochastic approaches developed herewith, the energy storage device is a central element of the scheduling problem.

The proposed scheduling methods are evaluated on two case-studies comprising a microgrid and a wind/pumped-hydro system.

1.3 Outline of the Thesis

The present chapter provides a synthetic description of the framework of this work as well as its main objectives and contributions. Chapter 2 presents in detail the framework under which this work is developed. It starts with by developing a more complete description of the general context in which the present work is carried out. Then, it presents the description of the main hypotheses that are followed/used throughout the work.

Many aspects had to be studied and combined for accomplishing this work, like, for instance:

- electricity market concepts;
- power system day-ahead scheduling principles;
- optimization principles, methods and techniques;
- understanding and utilization principles of forecasts;
- uncertainty models and risk concepts;
- techniques for performing decision under uncertainty;
- etc.

Among these aspects, two stand out: the problem of power system scheduling and the areas related to decision under uncertainty. This is because the thesis elaborates on their respective fields. Hence, they are herewith analyzed in greater detail.

The power system scheduling problem is presented and analyzed in chapter 3. In the same chapter, the main approaches that can be followed for tackling power system scheduling problems are discussed and a generalized power system scheduling formulation proposed based on the literature review made on the topic. This formulation concerns the general case of multi-area scheduling. It is then adapted to the single-area and market-player cases. This development provides the necessary understanding and tools that are used later to develop the power system cell scheduling model proposed in chapter 5.

The areas of interest here related to decision under uncertainty comprise mainly the ways to model uncertainty and the models that permit to make decisions under uncertainty. Both of these points are analyzed in chapter 4. A discussion on methods and principles for performing decision under uncertainty is provided including a short description of the ways in which such uncertainty can be modeled as well as the main models that can be used for performing decision-making under uncertainty. The uncertainty modeling principles and the decision under uncertainty models presented in this chapter are used as a basis for incorporating the uncertainties associated to the power system cell scheduling problem considered in this work. Namely, they are included in the stochastic versions of the power system scheduling model proposed in chapter 5.

In chapter 5 a scheduling approach dedicated to the power system cells considered here is proposed. A first deterministic approach is proposed and used as reference. Then, a stochastic scheduling approach comprising several variants taking into account the above-mentioned uncertainties associated to the power system cell scheduling problem is proposed. In chapter 6, two case-studies illustrating some of the possible applications of the proposed scheduling methods as well as the results that can be obtained via the methodology developed in this work are presented and discussed. Finally, chapter 7 contains the general conclusions of the work as well as some of the main perspectives for further research resulting from this thesis.

CHAPTER 2

Context and Main Hypotheses of the Work

CHAPTER OVERVIEW

THIS chapter can be seen as the departing point of the present work. In the beginning, the chapter provides a somewhat chronological overview of the main happenings related to the power systems area. This permits to better understand the context and the motivations behind this research work. Namely, the role of distributed generation as well as some forms to integrate it into power systems operating under electricity markets is discussed. A discussion on the main hypotheses that were established for developing this work is also included for clarifying the framework of the present work.

2.1 Vertically Integrated Power Systems

The activities of power generation, transmission and distribution have begun near the end of the 19th century with the formulation by Thomas Edison [23] of the concept of a centrally located power station with distributed lighting serving a surrounding area. In its early days, the electric power sector was composed by small autonomous local grids. Such grids supported small amounts of power due to the low demand for electricity, to the high geographic dispersion of loads and to the existing generation technology. Gradually, load demand started to increase while, at the same time, technological advances were taking place. Both reasons led to the increase of the geographical extension and power capacity of existing local grids.

Back then, the technological advances that were taking place on the generation technologies, allowed to build hydroelectric dams that were usually located away from load centers. This led to the installation of transmission networks of growing lengths, power transmission capacities and voltage levels. In such way, the original small local power grids gradually gave place to large power systems usually covering whole countries.

In many European countries [18], the nationalization of power systems was carried out mainly after the 2nd World War according to the public service obligations that existed back then. The main objective was to finish the electrification of such countries. However, some countries like, for instance, Spain and Germany [18], opted not to nationalize their respective power systems. In such cases, instead of national companies, several private companies (utilities) were created in the fields of power generation, transmission and distribution. In countries having more than one utility, independent areas of operation for each one of them were established. Whatever was the case, in the process, single companies were created for managing the functions of electricity production, transmission and distribution as well as the relationship with end-users. Such single companies are usually called vertically integrated utilities and form the main part of the so-called vertically integrated power systems.

An example of a vertically integrated structure is depicted in Figure 2.1. In the figure, the blue color boxes represent the functions attributed to the a single vertically integrated power utility. In such a scheme, the vertically integrated utility holds a privileged position in the power sector. Under such type of structure normal low-voltage consumers do not have the possibility to choose their service provider, although independent generation and self-generation were allowed (green boxes in the fig-

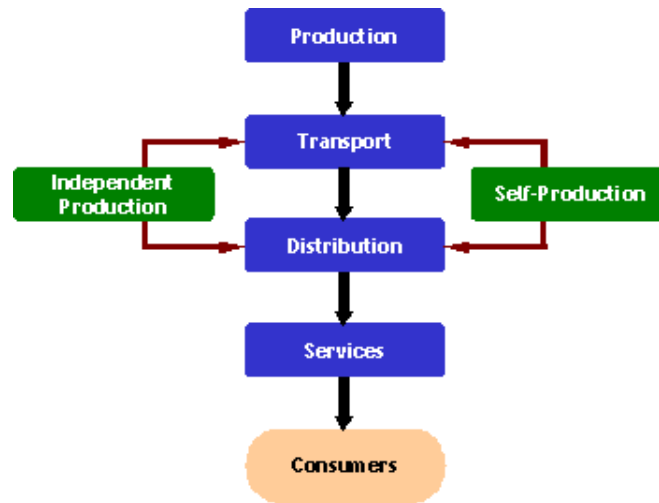

FIGURE 2.1: Schematic presentation of a power system operated under a vertically integrated structure.

ure). Moreover, on such vertically integrated structures, electricity prices were established through regulated tariffs, which were sometimes obtained through unclear processes due to the undefined boundary between the regulator and the entity being regulated (i.e.: the vertically integrated utility).

2.2 The 70's Oil Crisis and the Investment in Endogenous Resources

In the beginning, power systems planning was relatively simple for two main reasons: the vertically integrated power sector and the easy predictable economic environment[†]. The oil crisis that took place in the early 70's led to an increase of both inflation and interest rates making economy more volatile. As a consequence, power started to be consumed in a more erratic way. Therefore, the need to perform risk analysis studies when planning power systems gained importance. That crisis also led several countries to adopt policies favoring the exploitation of endogenous resources.

In the 80's, several economic activities related to services of social nature (some of them similar to the electric power distribution services) started to be deregulated or liberalized. The objective was to reduce the prices paid by customers and to increase the quality of the services proposed. Examples of such economic activities are found in [18] and include the air transportation industry, the

[†]Due to the low inflation and interest rates that were being practiced back then and to the constant and strong yearly increases of electric demand (7 % – 10 %) [24].

fixed telecommunication networks, the mobile telecommunication networks, and the gas distribution networks.

This deregulation and liberalization process introduced competition between the new actors that appeared in the market. At the same time, it gave consumers a more active role as they were now able to choose who their service provider would be. This has been used later on as guidelines for deregulating the electric sector.

The technological advances that have been achieved during the 80's and the 90's acted as a driving force for the deregulation of the electric sector. These advances took place in the information and telecommunication technologies and allowed the automation, supervision and real-time controlling of electric power grids.

2.3 The Present Situation

The conjuncture mentioned in section 2.2 created an interest on restructuring existing power systems by unbundling (i.e.: separating) the different sectors that constituted vertically integrated utilities. In order to accomplish this task, mainly three requirements are usually put forward as conditioning elements of the success power system restructuring processes [18]. The first one consists in unbundling the power system sector by creating several new electric power utilities working in the electric power distribution although, in a first step, still operating in regional monopolies. The second one consists in creating independent mechanisms which ensured the coordination between the various actors taking part in such an unbundled sector as well as the regulation of their activities. The third one is related to the way that the expansion of unbundled power system structures is planned. In several countries, such planning was left to the interest of investors.

This unbundling process allowed the creation of electricity markets, which are driven by the joint action of four forces [25]:

1. Customer choice;
2. Utility restructuring;

3. Technology innovation;
4. Societal issues and trends.

In such markets, business is separated into [18]:

- Production, which includes the production of energy in both normal and special regimes as well as the supply of ancillary services to the power system;
- Grid, which divides in:
 - Transmission Grid including the expansion, maintenance, construction and operation planning;
 - Distribution Grid including the expansion, maintenance, construction and operation planning;
 - Transactions which allow the relationship between producers, eligible consumers and commercial agents. It can be performed by centralized markets, by bilateral contracts or by financial contracts;
- Technical Coordination and Regulation, which is performed by the Independent System Operator.

The grid continues to be operated in a natural monopoly due to its specificity. In fact, it is not economically and environmentally viable to double the power grid existing in a given region. Hence, these natural monopolies are compensated through adequate regulatory rules (e.g.: service quality constraints).

Current power systems are well suited to supply multiple dispersed loads with electricity produced by large generators. These are in majority connected to the transmission system, which is responsible for conducting electricity to its consumers. Nowadays, however, power system planners have to respond to several challenges such as load growth, changes on the geographical distribution of loads, new policies and the pressures of the market. One solution could be to keep operating power systems in a centralized way. That would imply the need to perform improvements on the infrastructure in order to compensate changes such as new geographical distribution of loads or load growth. The problem of this option

would be that it is severely constrained by the policies in vigor and by market and profitability rules [26].

In the past, power systems relied on a centralized generation structure, which was sized for covering peak loads [27]. Large amounts of costly power reserves were scheduled for covering unexpected load variations or the occurrence of contingencies in the power system. Furthermore, centralized structures only considered unidirectional power flows and time-invariant electricity prices. Whenever the system was under stress, the customer loads could simply be curtailed. The customers did not have any information on the power grid status and, thus, were not generally aware of the energy saving or the peak-shaving needs of the system. This often led to over-sizing power systems in order for them to be able to cover peak loads. As a result, investment costs turned out to be larger and the installed capacities usage rates to be smaller. This increased the needed amount of time for obtaining the return of the investment.

Large power facilities imply, in a deregulated environment, investments with higher financial risks [11]. In fact, these larger investments will not be made under a monopoly, but under electricity market conditions, which partly explains why the risks involved are becoming higher. On the other hand, space for building new large power facilities is beginning to lac while public resistance to the realization of such investments tends to increase. This, in turn, tends to increase the capital one needs to invest. The arrival of new players to the power production sector is, therefore, limited.

Finally, nowadays, the environmental constraints are of growing importance [11]. Populations are becoming increasingly aware of existing environmental problems. Consequently, there are political pressures for maximizing energy efficiency without disregarding the prices to be paid for electricity services. The reason is that populations demand services that are simultaneously better in quality, cheaper and environmentally friendly. As a conclusion, both the expansion and the optimization of the power system infrastructure through the construction of new lines and of new power generation facilities turns out to be quite difficult.

2.4 Decentralized Power Generation

As power systems face expansion challenges, new options for generating power emerge. One of the solutions consists in changing the production sector paradigm from a centralized type to a distributed one in which power is produced in a geographically distributed way. This concept has been defined [13] as the integrated or stand-alone use of small, modular electric generation close to the point of consumption. In this new concept, the generation units are of smaller capacity when compared to the units of conventional power stations. Yet, the number of power sources connected to the power network increases considerably and each installation is placed closer to the loads it intends to feed.

One of the contributions of the distributed generation concept is that it allows to reduce the transmission and distribution losses of the system. Avoiding losses may contribute to avoiding part of the CO_2 emissions that usually correspond to the surplus of generation that would be needed to cover such losses. This fact is of great importance for reducing green house gas emissions especially if the Kyoto targets for 2010 are kept in mind. As an example, the European Community has to reduce its emissions by 8 % in the period between 1990 and 2010 [28]. Finally, distributed generation technology also helps to cut pollution by increasing the usage of clean renewable energy sources and by providing new fossil burning technologies which use fuels in a more efficient way (e.g.: co-generation).

Another contribution of the distributed generation concept, in relation to their participation in electricity markets, is that it favors the increase of competition between different power generation options, thus allowing, in principle, to lower electricity prices. Smaller electricity prices tend to favor an increase of industrial competitiveness on countries who adopt distributed generation technologies [25]. Moreover, the influence of the various individual power generating actors is also reduced with the adoption of distributed generation. The main reason for this is that the adoption of distributed generation allows to increase the number of players that can participate in the market.

Distributed generation technologies may use many different forms of energy for producing heat, cold, and electrical power. Thus, such technologies may contribute to the diversity of the energy mix of power systems. That could both limit the market power of individual fossil sources of energy and maximize the usage of renewable energy sources. As an example, in 2004, only 6 % of the European Union (EU) overall gross inland energy consumption was fed from renewable energy sources despite their abundance throughout the territory [7]. However, that value is predicted to increase because the

target fixed by the European Union for the amount of consumed renewable energy reaches the value of 12 % by 2010. The target for electricity power generation is even more ambitious. In 2004, only 14 % of the produced electricity power comes from renewable energy sources but the European Union target reaches the value of 26 % by 2010 [9].

As opposed to centralized systems, distributed generation systems usually need less time to be installed and commissioned. This fact, allied to their modularity can make them a more efficient investment when compared to centralized generation technologies. Furthermore, if done properly, the adoption of distributed generation technologies may allow to postpone or even to avoid investments on new large power generation facilities[11] which, still according to [11], are capital consuming, less efficient and difficult to license.

Distributed generation technologies may influence the development and operation of current power systems. In some countries, the distributed generation penetration rate has to be limited to a maximum of 20 % [12] in order to limit the harm these may cause to the system. In fact, utilities fear [13] large-scale penetration of distributed generation in their grids as it could compromise their costs as well as the security and reliability of the power system. That is why, in the present, several studies are performed on how much penetration of distributed generation technologies can be tolerated by the system before their collective impact begins to create problems. These may be, for example, excessive current flows following faults or voltage fluctuations [2].

Several distributed generation technologies are nowadays mature enough and can therefore be used in practice [29]:

- Gas turbines;
- Biomass-based generators;
- Concentrating solar power;
- Photovoltaic systems;
- Fuel cells;
- Wind turbines;
- Micro turbines;

- Reciprocating engines;
- Micro-hydro.

In order to improve both quality and reliability and to reduce the effects caused by the fluctuating nature of both renewable energy sources (such as the solar and the wind resources) and loads, energy storage devices may also be used. These can be based on several technologies such as:

- Flywheel storage;
- Batteries;
- Pumped-hydro;
- Superconducting magnetic energy storage;
- Super-capacitors.

A deep analysis on the details of such technologies is out of the scope of this thesis. Instead, a generic energy storage model is considered in this work. Such model may be extended and specialized in the future should such improvements be needed.

2.5 Power System Cells

Distributed generators may be integrated into power systems by following either a *passive* or an *active* philosophy. In the passive case, such generators are installed and operated in a rather independent way from each other. In the active case, distributed generators may be installed and operated as a whole for attaining some common goal (i.g.: maximization of global profits while maintaining power quality for coping with predefined operation requirements). Furthermore, they may be coupled with energy storage devices (e.g.: combined wind/pumped-hydro) and even with local loads on low-voltage distribution grids (e.g.: microgrids). In such cases, one can say that such combinations of distributed generators with energy storage devices and/or distributed loads form independent *societies* or power system cells.

In this work, the main focus is put on the management of such power system cells and, more specifically, on how to perform the day-ahead schedule of such power cells under day-ahead market conditions.

As said previously, such cells comprise distributed generators. Such generators may be *controllable* or *schedulable* like, for instance, microturbines and diesel generators, and *non-controllable* or *non-schedulable* like, for instance, wind power generators and photovoltaic arrays. In the first case, the controllability of generators allows the operator of the power system cell to determine the operation plan (i.e.: the schedule) that best fits the predefined set of operational objectives. In the second case, the non-controllability of the generators implies that no setpoints can be attributed to them because no control is associated to their inputs (i.e.: wind speed and solar radiation). Consequently, non-dispatchable generators cannot contribute directly to the establishment of an operation plan. In such cases, the operator must rely on energy production forecasts for establishing operation plans. However, such forecasts comprise some amount of error, which adds some uncertainty to the scheduling process. Therefore, scheduling methods able to take into account such uncertainty need to be designed. One of the main objectives of this work is develop a scheduling methodology suited for power system cells comprising large amounts of non-dispatchable renewable energy sources while taking into account the uncertainties associated to their corresponding forecasts.

Apart from dispatchable and non-dispatchable generators, the power system cells considered here comprise energy storage devices. Such storage is used for helping the operator to cope with the uncertainties associated to the scheduling process and, whenever possible, to generate additional profit by defining the best moments to store energy and to use stored energy according to electricity market prices. Two main types of power system cells are considered here:

1. combined wind/pumped-hydro systems;
2. microgrids.

Some insight on the fundamental aspects of such types of cells is given in the following sections.

2.5.1 Combined Wind/Pumped-Hydro Systems

As described in section 2.4, the goals for the large-scale integration of renewable energies are very ambitious. For reaching such goals in such a short amount of time one has, at least in the short term, to make use of power facilities based on renewable energy resources and disposing of a considerable power capacity. Two natural candidates fitting such criteria arise: large wind farms and large hydro stations comprising water reservoirs. Both have somewhat complementary characteristics and can thus be combined for obtaining an as good as possible behavior of the whole.

Large wind power generators are now a mature technology. However, one basic problem still subsists, one cannot control the input of such technology, which is the wind and the speed at which wind blows. Therefore, operators have to rely on forecasts of the power output of wind farms for managing their respective systems[†]. Such forecasts are however *imperfect* in the sense that they comprise an amount of forecast error, which adds uncertainty to such management problems.

Pumped-hydro systems consist of hydro power stations comprising a water reservoir as well as the possibility to pump water upstream. When operated in conjunction with wind farms, pumped-hydro systems may help to cope with the operational difficulties caused by the fluctuating nature of the wind resource. Indeed, such type of hydro facilities can store energy, in the form of potential energy, by simply storing water at a higher height upstream than downstream. When there is a lack of energy due, for instance, to lower than expected winds, the hydro facility can compensate that event up to a certain extent provided it has enough water stored. Conversely, such pumped-hydro power facility can compensate higher than expected winds by using excess wind energy for pumping water, provided it has enough reservoir slack for doing as such. Hence, pumped-hydro stations can be seen as complementary to wind farms in the sense that they also rely on renewable resources and that, contrary to wind farms, hydro stations can potentially compensate wind power fluctuations as well as the errors associated to wind power forecasts. In this work a contribution to the analysis of such potential is provided.

In the literature, cases in which the wind farm is coupled with some kind of energy storage have also been considered in an attempt to minimize the imbalance costs incurred by the wind farm owner when participating in an electricity market.

[†]As an example, TSOs have to manage the power system as a whole while, at the same time, that wind farm operators have to manage their respective wind farms according to some predefined operation strategy

In [30] a method for scheduling and operating an energy storage system coupled with a wind power plant under market conditions is proposed. However, the results obtained via such method used constant wind power forecasts throughout the scheduling period. In addition, the forecasts for the day-ahead market prices were assumed to be perfect (i.e.: implying that one has a precise knowledge of the future market prices when proposing a schedule) and equal for all days, which does not reflect a realistic situation.

In [31] an algorithm is proposed for calculating the optimal short-term dispatch of an energy storage facility coupled with a wind farm with the objective of minimizing the expected imbalance penalties incurred by the wind farm owner. However, such algorithm neglects the possibility of the wind farm owner to participate in the day-ahead market. This implies that the energy storage cannot be used for making additional profit (e.g.: by considering day-ahead market prices while performing its optimal day-ahead schedule) but rather as a mean to improve the technical behavior of the wind farm (by reducing the differences between the scheduled power output of the wind farm and its *actual* production).

In [32, 33] an optimization approach was proposed for determining the most probable range of the output production of a wind farm coupled with a hydro power plant containing a water pump system and a small reservoir.

In [34] some technological aspects of energy storage devices are discussed and the storage is used to *filter* the erratic power output of a stochastic power source (e.g.: wind power generator). In other words, the work developed in [34] aims at increasing the controllability of the wind power source.

Finally, in [35] two methods are proposed for minimizing the penalties due to imbalances of the wind farm power output. The first one considers the wind farm to bid alone in the day-ahead market trying to minimize the risk of the bid based on a statistical analysis of the expected production probability. The second couples a hydro power plant containing a water reservoir to the wind farm for minimizing the imbalance costs incurred by the wind farm owner. However, in contrast to our work, in this method the energy bids are placed in an intraday market, which means that wind power forecasts are by far more accurate thus implying a lesser degree of error to be dealt with.

Summarizing, the main motivation of the above referred works was to provide methods for using hydro storage facilities for increasing the controllability of wind farms and maximize the profits generated

by the wind farm. This is also analyzed here. However, in the present work, focus is put on the impact of performing the day-ahead schedule of the energy storage based on the available information (wind power forecasts, day-ahead market price forecasts, and the uncertainty associated to both types of forecasts). In addition, here the objective is that of maximizing the profit of the whole power system cell (wind farm plus pumped-hydro station).

2.5.2 Microgrids

Different microgrid definitions exist as a function of the followed approaches [2, 26]. In general, it can be defined as a part of the low-voltage grid integrating a combination of generation units, loads and energy storage devices interfaced through fast acting power electronics and interconnected with the main grid through a single interconnection point. The microgrid appears to the bulk power provider as a single dispatchable unit [26]. To the power utility, it may regarded as an independent yet controlled system cell [36]. Amongst others, microgrids have the possibility:

- To operate in islanded mode, which allows sections of a distribution system to continue operating when a faulted section is isolated;
- To increase the reliability of the system because microgrid customers can be fed not only by the distribution grid, but also by the distributed generators that take part in such microgrid;
- to accommodate the load that eventually exceeds the power rating of the microgrid interconnection to the distribution system;
- To perform voltage regulation by utilizing distributed generation voltage control;
- To enhance the stability of the system by providing reactive power support to loads within the distribution system.

A recent IEEE (Institute of Electrical and Electronics Engineers) standard, the P1547™, makes a first approach to the interface of distributed resources with electric power systems [37]. It does not actually mention the word *microgrid* to describe an active low-voltage cell but instead it mentions the term LEPS (Local Electric Power System) to describe a concept very similar to the microgrid one.

Large scale integration of distributed generation technologies can be interesting because it may imply an increase of the utilization of endogenous energy resources. To make this possible, further research on new solutions for interfacing distributed generation technologies with the grid is needed. Microgrids appear as a possible solution because they can respect the power system restrictions (e.g.: the system cell ensures electrical isolation to the connection between itself and the distribution system on the occurrence of fault [38]) and, in addition, provide all of the above mentioned benefits. For society, microgrids can help in reducing pollution, increasing the efficiency of the electricity market (i.e.: microgrids allow to increase the number of market participants) and improving global grid reliability and consumers' satisfaction. They would also contribute to the increase of consumers' proactiveness regarding the efficiency of their energy consumption pattern. As a conclusion, microgrids allow distributed generation technologies to be regarded by utilities either as good citizens, either as ideal (model) citizens.

If following a *good citizen* policy approach, microgrids behave as elements the main grid impact of which complies with rules and does no harm beyond what would be acceptable from a normal customer. The *ideal citizen* policy approach is an extension of the good citizen policy that presents the same functioning principles but also serves the main grid with ancillary services [39].

The implementation of microgrids is expected to occur mainly on low-voltage distribution networks. That way, microgrids are expected to form small power supply networks. As a consequence, they are expected to feed small communities and thus not to contain large amounts of installed power [24].

According to [36, 40], research efforts are required at different levels, in order to make possible the implementation and correct use of microgrids allowing these kinds of systems to become a good option for the future. These are related to:

- microsource electrical modeling;
- power system operational impact analysis;
- monitoring control;
- power quality and grid reliability;
- protection coordination;

- personnel safety;
- communications;
- economical and electrical market driven procedures;
- definition of new interconnection standards especially plug and play ones (e.g.: review the IEEE 1547™ Standard);
- address the issue of having multiple customers and interests to manage;
- handling unbalanced and/or non-linear load content.

This work focuses on the development of a day-ahead scheduling method suited for microgrids.

The European View

The former MICROGRIDS project[†] was the main research project in the European Union (EU) and developed a European view of the microgrid concept as opposed to the research activities that take place in the USA and in Japan. It supported the ability of the microgrid to act as a semi-autonomous system (i.e.: when the bulk power provider is not available the microgrid can still operate independently) as a feature of major importance [26].

The MICROGRIDS project investigated the concept of a hierarchical control structure for the microgrid that comprises the existence of a microgrid central controller (MGCC) (normally placed at the point of common coupling (PCC) - which is unique), microsource controllers and load controllers. Figure 2.2 depicts a possible microgrid configuration as was proposed in [1].

The project suggests a possible typical structure for the microgrid in which the power sources would be controlled locally but their setpoints would be given to them centrally by the MGCC. This last component has the role of optimizing the system by coordinating the power electronic interfaces present on the microgrid. It consists of a slow acting outer control loop having as main function to determine the balance of steady-state real and reactive power flows between the microgrid components and the bulk power provider. Some key functions of the MGCC are [1]:

[†]This project is entitled — Large Scale Integration of Micro-Generation to Low Voltage Grids — and was funded in part by the European Commission (EC) under contract No: ENK-CT-2002-00610

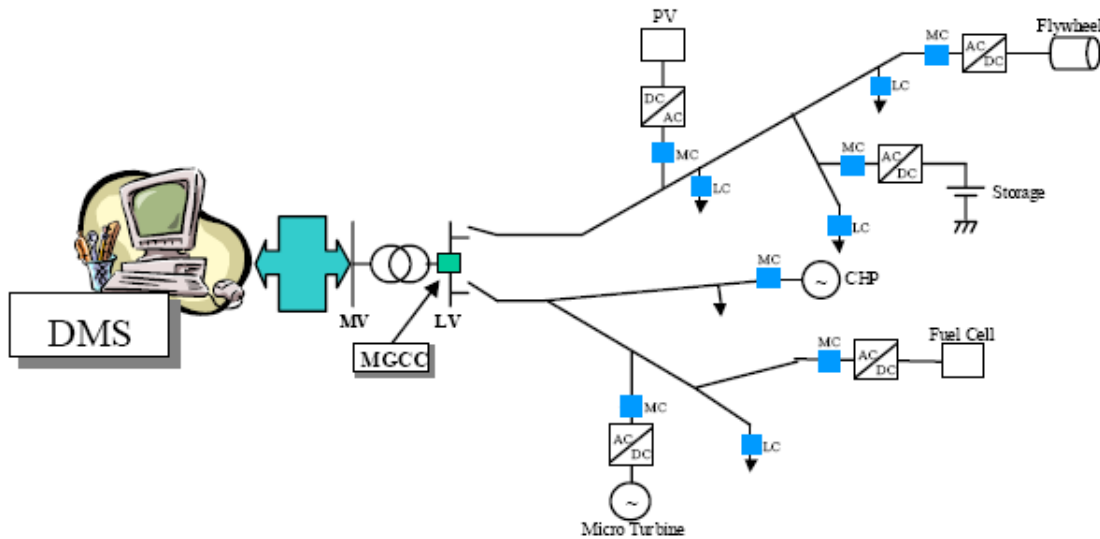

FIGURE 2.2: Schematic presentation of a possible microgrid configuration as proposed in [1].

- Providing the individual power and voltage setpoints for each microsource controller;
- Ensuring that heat and electrical loads are met;
- Ensuring that the microgrid satisfies operational requirements of the bulk power provider;
- Minimizing the produced emissions and the power transmission losses;
- Maximizing the operational efficiency of the microsourses;
- Providing logic and control for seamlessly islanding and reconnecting the microgrid respectively during and after events occurred on the main grid.

In order to perform the various management tasks, the MGCC integrates the following functionalities [1]:

- Short-term forecasting of the electricity consumption, heat consumption and power generation capabilities;
- Economic scheduling that also integrates the ability to aggregate small amounts of power generation into quantities which are large enough to allow bidding in the market;

- On-line security assessment for evaluating the security level of the operating solution given by the scheduling functions;
- DSM, which is integrated in the optimization of the microgrid operation;
- Interface Network Monitoring to make possible the determination of the interconnection status.

When the microgrid is connected to the main grid, the MGCC interacts with the signals supplied by the bulk power provider (power flow needs at the PCC), the heat and electricity needs, the status of the microsources (provided by each microsource controller) and the possibilities of load controlling (provided by each load controller).

When operating in islanded mode, the MGCC changes from an active/reactive power control mode to a frequency/voltage control mode to ensure that the balance between the microgrid load and generation is kept. The idea is to keep the frequency and voltage values of the microgrid as stable and as near as possible to their nominal values.

The CERTS View

The concept of microgrid developed by CERTS (Consortium for Electric Reliability Technology Solutions) in the USA, presents the microgrid as a component which is indistinguishable from other currently legitimate customer sites. To make such behavior possible the microgrid is supposed to rely on the capabilities of power electronics [2]. From the perspective of the main grid, the advantage of the CERTS microgrid is that it can be seen as a controlled entity within the power system that can be operated as a single aggregated load.

For CERTS, the microgrid structure assumes an aggregation of loads and microsources operating as a single system providing both power and heat, where the majority of the microsources must be power electronic based as this provides them with the required flexibility in order to ensure controlled operation as a single aggregated system [2]. The structure proposed by CERTS for establishing a microgrid is similar to the one proposed by the MICROGRIDS project. It has the same microsource controllers and load controllers that are taken into account in the EU MICROGRIDS concept that was previously described. The energy management is performed by a management system that corresponds to the microgrid central controller considered in the EU MICROGRIDS project. In Figure 2.3 the microgrid architecture proposed by CERTS in [2] is shown.

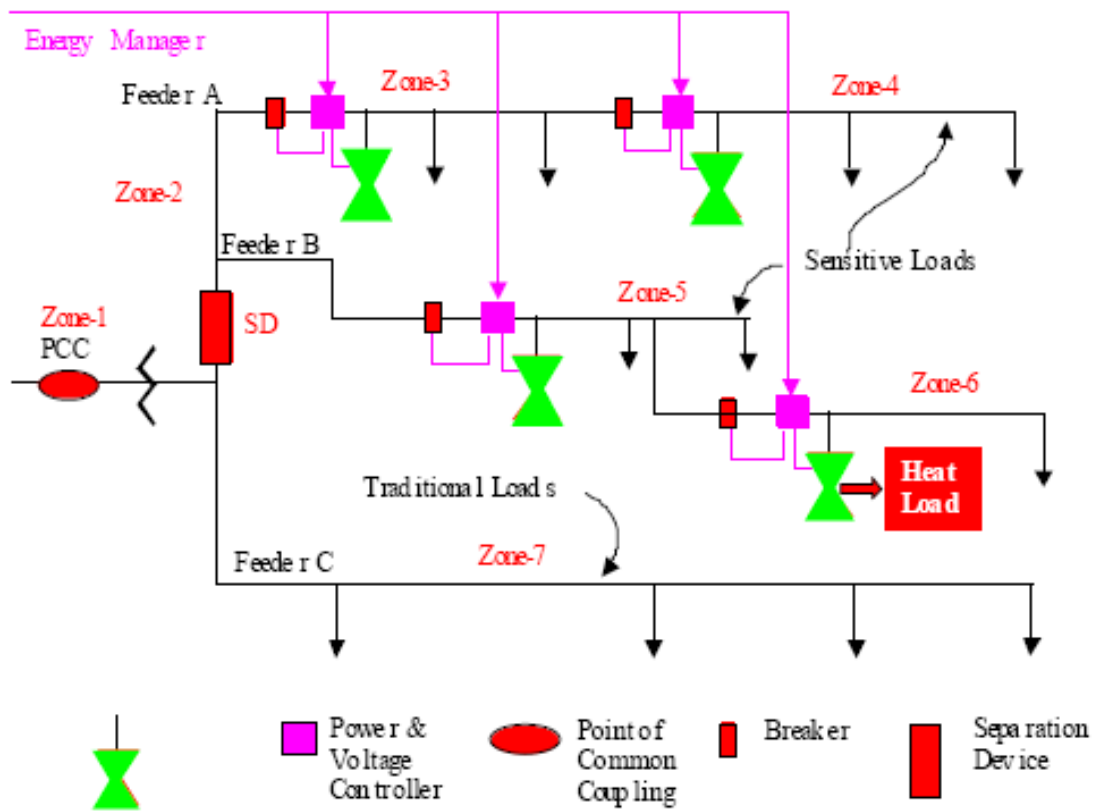

FIGURE 2.3: Schematic presentation of the microgrid architecture proposed by CERTS in [2].

According to CERTS, the key-distinguishing feature of the microgrid is that the microsources are controlled by microsource controllers which maintain the microgrid energy balance and power quality through passive plug and play power electronic inverter features. These features allow operation without tight central active control or fast communication (on time scales less than minutes) and connection or disconnection of devices without need for any reconfiguration of equipment, pre-existing or new [2].

The microgrid topology may be dictated by current design practices for secondary distribution systems. Such practices may be based on two different approaches: radial systems and meshed systems, each of these options having different protection and operational requirements.

Networked secondary systems are uncommon because they consist of low-voltage circuits that are supplied through network transformers. These transformers are installed along with network protectors which only allow the power to flow from the high side of the network transformer to its low side.

The microsources can be connected anywhere on the low-voltage network. The microgrid may have three-, two- or single-phase connections to the utility distribution system. CERTS considers that its energy manager may potentially use the following parameters to provide control of the microgrid:

- active power control;
- reactive power control;
- voltage control;
- frequency control;
- turbine speed (when applicable);
- power factor.

The parameters chosen as inputs for the energy manager are active power and voltage. The energy manager dispatches power level based on an economic assessment of fuel costs, electric power cost, weather conditions and anticipated process operation. Voltage is normally dispatched within a set band [39].

When operating in grid-connected mode, the only control signals of the energy manager will be the real power output of each microsource and local voltage. Any power delivered by the microgrid to the bulk power system should be at unity power factor [39]. The dispatched power may be either a setpoint, either a command to perform load following using a power sensor on the microgrid feeder to which the microturbine(s) is(are) connected to. The voltage is maintained within a set band and only on the buses within the microgrid where one or more microturbines are connected [39].

According to the CERTS philosophy, the control signals to be supplied by the energy manager would still be the real power output of each generation device and local voltage control [39] even if the microgrid is operating in islanded mode. Moreover, it is up to the microsource controllers to perform the control of the frequency and voltage values present on the microgrid. The microsource controllers accomplish such task through the use of fast control signals (droop controls) in order to ensure that the load and the generation are always balanced.

2.6 Short Discussion on Electricity Markets

This research work does not focus on electricity markets themselves, but rather develops a scheduling methodology adapted to the management of power system cells operating under day-ahead electricity market conditions. Since no advanced market modeling is made here, the present discussion will be kept very short and will only approach from a bird's eye perspective the main electricity market objectives, types, and principles. The interested reader may refer to [18, 19] for getting further information on the matter.

Electricity markets were created due to the restructuring of the electricity sector [18]. Such restructured design originated from the passage from a vertically integrated electricity sector to a horizontal electricity sector in which many agents participate. Some examples of such agents can be independent power producers, market aggregators, independent system operators (ISOs), transmission system operators (TSOs), distribution network operators (DNOs).

According to [19], there are two main objectives for electricity market operation: ensuring a secure operation and facilitating an economical operation. The first of these objectives is the most important as, independently from the presence or absence of a restructured electricity market, power system

operation security should be maintained at all times. The second objective is for the for electricity market to lead to the minimization of electricity costs.

Three main types of electricity market models exist:

1. Pool markets;
2. Bilateral contract markets;
3. Hybrid markets.

Pool markets are centralized marketplaces gathering producers and buyers of electrical energy. These markets usually operate in relatively short time-horizons following the basic principle of meeting the demand and the production sides. The equalization of demand and production offers is usually done for each time-step of operation by sorting production offers in a price-ascendant way and demand offers in a price-descendant way. In general, the point in which demand meets production fixes the amount of traded energy and the price at which it is traded.

Bilateral contract markets consist in direct energy transactions between energy producers and buyers. Under such market models, the contracts are settled independently from the ISO and the role of the ISO is to verify that such financial agreements are physically feasible (e.g.: leading to acceptable power flows and voltage levels in every lines).

Hybrid markets are a mix of the previously described pool markets with bilateral contract agreements. Under hybrid electricity markets, producers and buyers are not obliged to utilize the pool market and can rather choose to sign directly energy transaction contracts between themselves. Under hybrid markets, the pool market would thus only used by market participants that do not wish to participate in direct negotiations between energy buyers and sellers.

Although many subtypes of electricity markets exist [18, 19], here only the day-ahead energy exchange markets are considered in the development of the day-ahead power system cell scheduling model that is proposed in chapter 5.

Day-ahead electricity markets rules usually impose independent power producers and buyers to place

their energy production/consumption bids on day d till hour h_{GTC} , the day-ahead market clearance, which is usually referred to as *gate closure time*. Usually, each producer/buyer places 24 energy production/consumption bids, where each bid corresponds to a given hour of the next day $d + 1$. These considerations form the simple day-ahead electricity market model that is used in the remainder of the present document.

2.7 Main Hypotheses of the Work

- The electricity market is considered to be competitive and composed of a relatively high number of market participants.
- The power system cell is considered to be able to participate in the day-ahead electricity market both as a seller and as a buyer (but never both simultaneously).
- The total capacity of the power system cell (defined here as its interconnection capacity with the main grid) is considered to be *small enough* so that its owner does not possess sufficient market power. In such case, in the electricity market context, the power system cell is considered to be a *price taker*.
- The power system cell scheduling model considers the cell load as an aggregated one.
- The power system cell scheduling model considers aggregated non-dispatchable renewable generator outputs per type (e.g.: aggregated wind power production separated from aggregated photovoltaic production).
- No market bidding model is used. The energy bids of the power system cell are assumed to be always accepted.
- The power system cell is considered to pay the day-ahead market price when buying energy. Therefore, power transmission tariffs are neglected. While this seems not to correspond to the general case [41], the evaluation of the impact of such tariffs is out of the scope of this work. However, such costs may be easily integrated in the future as the scheduling model proposed in chapter 5 was designed bearing that purpose in mind.

2.8 Conclusions of the Chapter

This chapter provided the general context in which this Ph.D. work was developed. Such context comprised a short historical description of the most outstanding events that happened in the power systems area from the early days and up to the present situation. Such description hopefully allows to better understand the present state of things especially in what regards the role of distributed generation in the present power system context and the restructuring of the electricity sector. Indeed, these two aspects are the main driving forces of the present work and other works of the kind as they introduce novel dimensions, problems, and opportunities to the power system operation field.

The chapter also discusses some decentralized power generation integration aspects and options formulating the generic concept of power system cells, which is in part dealt with in this research work. Focusing on the case-studies presented in chapter 6, two examples (combined wind/pumped-hydro and microgrids) of such power system cells are given and discussed. A short discussion on electricity markets is made for giving the reader some insight on this field as well as for describing the day-ahead market model used in the remainder of this document. Finally, the main hypotheses established for performing this work are described.

The development of a day-ahead scheduling methodology suited to power system cells operating under electricity market conditions (problem addressed in the present work) and the characteristics of the physical systems involved (microgrids and wind/pumped-hydro) require knowledge contributions from two main fields: power system scheduling and decision under uncertainty. Both of these aspects are addressed in the following chapters. This provides a solid basis that allows to better understand the problem addressed and to develop suitable solutions for tackling it.

CHAPTER 3

Power System Scheduling

CHAPTER OVERVIEW

THIS chapter addresses one of the main fields of knowledge dealt with in this work: *power system scheduling*. The main idea is to provide the necessary background for the formulation of the specific power system cell scheduling problem, which is done in chapter 5.

Many power system scheduling formulations are available in the literature. However, in their majority they are either problem-specific or oriented mostly to the solution-techniques rather than to the actual formulation of the scheduling problem. Such characteristics render such formulations unsuitable for the purpose of this chapter, which has the main goal of providing a sufficiently high-level description and formulation of power system scheduling problems and not to analyze a given specificity of such problems nor the precise solution-techniques that are available. For this purpose, a general analysis of the characteristics of such type of problems is provided. In addition, a unified formulation of a generalized power system scheduling problem is proposed based on the literature review that was made.

Three main possibilities are identified for formulating power system scheduling problems, which are hereby referred to as: classical multi-area scheduling, classical single-area scheduling and the market-player scheduling. This chapter formulates a power system scheduling problem under the one that is considered to be the most general, which corresponds to the multi-area case. Afterwards, adaptations of such formulation to the remaining possibilities that were identified are suggested.

3.1 The Power System Scheduling Problem

Power systems have the fundamental purpose of generating, transporting and supplying their customers with the electrical power they need in a reliable and economical way. Electrical power is produced by a set of generators connected to the electrical grid of the power system. The customers connected to such grid are then fed with the electrical power they require. The number of generators is generally very small when compared with the number of loads of the power system. Moreover, those generators are commonly placed way from load centers. Hence, a more or less complex power grid is used for transporting generated electrical power from the generating units to the loads.

The general idea of what a power system is and of what is its purpose is a quite simple one. However, the process of feeding the loads of a power system can become quite complex when analyzed in detail. Such complexity may come from different factors like, to name a few, the inherent variability of the power system loads, the security of supply requirements imposed to the power system operator, and the climate (for instance, in power systems containing hydro generators it is important to take into account the future availability of the water resource for optimizing its utilization).

The power system operator may have to comply with many different operation objectives. A general high-level operation objective is for the power system to supply its load requirements at the lowest possible cost. Such objective would imply that a *set of setpoints* be provided to the generating units in use (i.e.: online) at different moments in time (i.e.: due to the variability characteristics of the power system load) for minimizing operation costs while meeting load requirements. Assuming that it is possible to attain such goal not only implies that such *set of setpoints* to exist, but also implies that one is actually capable of determining it.

The previous example consists of an *Economic Dispatch* problem in its simplest form. Such problem may be stated in a more formal manner as the process of determining the setpoints of the generators in use for supplying the power system demand at the lowest cost. However, economic dispatch problems are generally more complex than what is suggested by the previous example. For instance, while solving an economic dispatch problem one might neglect power system losses or consider them, which can dramatically change the complexity of the problem, and, obviously, the complexity of the economic dispatch algorithms that are used for solving it.

Two main types of economic dispatch algorithms exist: the online ones and the offline ones. Online economic dispatch algorithms are designed for online operation of the power system. Their goal is to economically distribute the *actual* load of the power system through the various generators in use [42]. Offline economic dispatch algorithms have the purpose of economically planning the sharing of the *predicted or forecasted* load of the power system through the various generators in use. In other words, online economic dispatch algorithms are run *in parallel* (i.e.: on-the-fly) with load variations, while offline economic dispatch algorithms are run *in advance* (i.e.: before the *actual* load is known). One should note that both types of algorithms need to dispose of the *set of generators in use* at the time period for which they are performing their calculations. Consequently, the *set of generators in use* at different time periods has to be determined by a procedure external to the economic dispatch one.

The determination of the *best set of generators in use* at a given point in time (i.e.: at a given time-stage) is named *Unit Commitment* and is usually a difficult and burden task. In classical power systems, for economical reasons, such task is performed mainly due to the variability of the power system load[†]. Indeed, the power system load varies throughout the day. Moreover, the load profiles of a given power system usually differ from day to day. A given set of generators might then be the best one for supplying a given amount of load at a specific moment in time of a given day, but might be unsuitable for different moments in time (and even for *equivalent* moments in time of different days). Consequently, the best generator schedule throughout a given day may be unsuitable for any other day. Hence, generally speaking, unit commitment models serve the purpose of optimally deciding which generators are to be in use at different moments in time [42] within a given time frame (i.e.: a day) in an as automatized as possible fashion for reducing the effort that the power system operator needs to put into the power system scheduling task. In other words, unit commitment models have the objective of selecting the set of generators that best suits the expected load profile within a given time-horizon, according to the operator's predefined objective (or set of objectives).

Unit commitment problems have been a research topic for the last few decades [43, 44]. Two main types of unit commitment models exist for different applications. Namely, there are unit commitment models for scheduling power system resources over relatively long periods [45] as well as for the next few hours or days [46, 47].

The idea behind the unit commitment concept is rather simple. Nonetheless, solving a unit commitment

[†]Other reasons may exist like, for instance, maintenance schedules, outages of one or several grid elements (i.e.: lines, transformers), or generator outages.

Generator	S_1	S_2	S_3	S_4	S_5	S_6	S_7	S_8	S_9	S_{10}	S_{11}	S_{12}	S_{13}	S_{14}	S_{15}
1	1	1	1	1	1	1	1	1	0	0	0	0	0	0	0
2	1	1	1	1	0	0	0	0	1	1	1	1	0	0	0
3	1	1	0	0	1	1	0	0	1	1	0	0	1	1	0
4	1	0	1	0	1	0	1	0	1	0	1	0	1	0	1

TABLE 3.1: Example of possible system states (S_1, \dots, S_{15}) for meeting load level L_t at time stage t for a power system comprising 4 dispatchable generators. Each generator may be set to one of 2 states: *ON* (1), or *OFF* (0). In this example the load is considered to always be greater than zero.

problem is generally very hard due to its inherent complexity, which may come from several factors. The most well-known one is related to the combinatorial nature of the problem. For illustrating this factor, let us consider a power system comprising N_{Gen} dispatchable generators where each generator may be set to n_u different states contained in state vector u . Then, on such a power system, a total of $n_u^{N_{Gen}}$ possible combinations of generators exists for meeting a given level of load (L_t) at time stage t , where each combination is usually called a system state. Considering the load of the power system to be always greater than 0 (which is quite reasonable), the number of possible combinations is reduced to $n_u^{N_{Gen}} - 1$. As an example, a power system comprising 4 generators, where each generator may be set to 2 states (e.g.: it may be disconnected from the main grid – set to an *OFF* state – or it may be connected to the main grid – set to an *ON* state) has $2^4 - 1 = 15$ possible system states (S_1, S_2, \dots, S_{15}) for feeding load L_t at time stage t . Table 3.1 contains the different possibilities given to the operator of such a power system for meeting L_t . One should note that the no-load case has been neglected in the present example, which explains why the all-zero combination was not included in Table 3.1.

Unit commitment problems may or not comprise time-coupling constraints. The simplest case is the one where no time-coupling constraints exist. In such a case, for a comprising T time stages and neglecting the no-load case, brute force methods will have to evaluate $T \times (n_u^{N_{Gen}} - 1)$ solutions for determining the best one. This result represents the worst-case scenario for solving a unit commitment problem that does not comprise (or that neglects) time-coupling constraints. In such a case, finding the best solution to the whole unit commitment problem is equivalent to finding the series of individual solutions of the T separate unit commitment problems, where each of the separate problems corresponds to one of the time stages of the original complete problem. However, if time-coupling constraints apply, the problem becomes more complex to solve. Indeed, in such a case, it can be shown that the worst-case scenario for brute-force methods applied to a problem comprising T time stages and neglecting the no-load case becomes $(n_u^{N_{Gen}} - 1)^T$. In this case, the individual problems per

time stage cannot be uncoupled (unless some applicable uncoupling/simplifying technique is used). Table 3.2 contains examples that illustrate the evolution of the complexity of unit commitment problems with their increase in size. For producing Table 3.2, only two possible dispatchable generator states were assumed to exist: the *ON* and the *OFF* states.

Time Coupling	N_{Gen}	T	No. Problems	N_{Gen}	T	No. Problems	N_{Gen}	T	No. Problems
No	2	6	$1,80 \times 10^{01}$	6	6	$3,78 \times 10^{02}$	18	6	$1,57 \times 10^{06}$
	2	12	$3,60 \times 10^{01}$	6	12	$7,56 \times 10^{02}$	18	12	$3,15 \times 10^{06}$
	2	24	$7,20 \times 10^{01}$	6	24	$1,51 \times 10^{03}$	18	24	$6,29 \times 10^{06}$
Yes	2	6	$7,29 \times 10^{02}$	6	6	$6,25 \times 10^{10}$	18	6	$3,25 \times 10^{32}$
	2	12	$5,31 \times 10^{05}$	6	12	$3,91 \times 10^{21}$	18	12	$1,05 \times 10^{65}$
	2	24	$2,82 \times 10^{11}$	6	24	$1,53 \times 10^{43}$	18	24	$1,11 \times 10^{130}$

TABLE 3.2: Influence of the presence of time-coupling constraints in the complexity of the unit commitment problem. Three main cases were considered by varying the number (N_{Gen}) of dispatchable generators. Then, for each case, three subcases were created by varying the number (T) of time-stages. Finally, in every case, each of the generators is restricted to reside in only one of two possible states: *ON*, or *OFF*. The power system load was considered to always be greater than zero.

By simple inspection of Table 3.2, one can easily verify that the number of candidate solutions of a given unit commitment problem can be huge. Therefore, power system generation possibilities are often described by an appropriate state-space, which has the role of facilitating the development of computer-based methods for tackling power system scheduling problems by describing all the possible states to which the power system may be set in an as efficient as possible manner. Defining an appropriate power system operation state-space description implies *encoding* all the possible operating points of the power system in a systematic way. This procedure represents an extremely important part of any unit commitment solution method based on a system state-space description.

Although being important, state-space descriptions do not suffice for solving power system scheduling problems. This is due to the fact that such descriptions do not comprise information on the structure of the scheduling problem. For instance, the transition from a given system state to another given system state[†] in a given amount of time may be infeasible. However, the state-space description does not necessarily contain such information as it usually describes the possible states but not the possible links between them. Hence, state-space scheduling tools disregarding this aspect will often supply infeasible solutions as they will often lead to infeasible state transitions. For overcoming this problem, an adequate search-space based on the power system operation state-space description needs to be built. Such search-space contains information enabling or not a given region to be “visited” (i.e.: tested or considered) departing from some other region. As a conclusion, one can say that search-spaces serve the purpose of linking system state-space descriptions sequentially in time.

[†] Usually referred to as *state transition*.

Time	System states														
1	S_1	S_2	S_3	S_4	S_5	S_6	S_7	S_8	S_9	S_{10}	S_{11}	S_{12}	S_{13}	S_{14}	S_{15}
2	S_1	S_2	S_3	S_4	S_5	S_6	S_7	S_8	S_9	S_{10}	S_{11}	S_{12}	S_{13}	S_{14}	S_{15}
...	...														
$T - 1$	S_1	S_2	S_3	S_4	S_5	S_6	S_7	S_8	S_9	S_{10}	S_{11}	S_{12}	S_{13}	S_{14}	S_{15}
T	S_1	S_2	S_3	S_4	S_5	S_6	S_7	S_8	S_9	S_{10}	S_{11}	S_{12}	S_{13}	S_{14}	S_{15}

TABLE 3.3: Example of a unit commitment search-space description for the example presented in Table 3.1 for T time stages. For each time-step, the state-space description of the system is repeated because, at the beginning of the algorithm, the system may be potentially set into any given state specified in its state-space description. Later on, a given state at time-step t , may be subject to additional state transition rules/constraints that determine the states to which it may be linked at time-step $t + 1$.

Designing appropriate search-spaces may become a rather difficult task depending on the nature of the unit commitment problem being considered. One of the main requirements that have to be ensured by a search-space is for it to describe all *feasible* state transitions throughout the time-horizon of the problem. Indeed, during the state-space design phase, all possible systems states are encoded and tagged as feasible. However, a subset of infeasible state transitions usually exists. For example, a given generator may be set to online or offline status, but after being set online, it might be impossible to set it back to offline status before its minimum up time requirements are fulfilled. Whatever is the reason that implies a state transition to be infeasible, avoiding the consideration of such transitions usually speeds up calculations while granting optimality or, at least, acceptability of the obtained solutions (in case a some meta-heuristics or approximations are used implying the possibility that a global optimum will not actually be found) rendering the search-space description of the power system more efficient.

For illustrating the composition of a typical unit commitment search-space, a choice to model a power system comprising a set \mathcal{S} of possible system states was made where $\mathcal{S} = \{S_1, S_2, \dots, S_{n_u^{N_{Gen}} - 1}\}$. The power system is to be scheduled for a set of T time-stages, where each time-stage is represented by $t \in \{1, 2, \dots, T\}$.

Such problem may be described by the two-dimensional space contained in Table 3.3. For building Table 3.3, a hypothetical power system comprising 5 dispatchable generators as the ones represented by Table 3.1 was considered.

The description of a unit commitment problem through a search-space like the one represented by Table 3.3 is suitable for unit commitment computer-based algorithms. Indeed, while describing a given unit commitment by a search-space, one is actually structuring the unit commitment problem in

a logical and systematic way. Such structure may then be treated by a computer program in an efficient manner. Depending on the structure obtained, and on the objective sought by the system operator, commercial or specifically tailored tools based on some unit commitment algorithm may be used for solving the problem.

After having processed the unit commitment search-space, the algorithm returns the best feasible path that was found[†]. Such path is hereby represented by the series of system states x_t yielding the best unit commitment result, where $t \in \{1, 2, \dots, T\}$. The complexity of different unit commitment algorithms may vary significantly depending on the solution quality requirements, on the size of the power system, and on the presence or not of uncertain inputs.

Unit commitment algorithms are usually executed prior to the operation of the power system (i.e.: offline), and may or not integrate offline economic dispatch algorithms. Indeed, performing the unit commitment of large power systems is in itself a very hard and time consuming task and, for that reason, the economic dispatch step may not be included. Instead, some kind of *rule-of-thumb* may be preferred for estimating the operation costs of generators and then some method (i.e.: for instance, a priority list) is applied for *committing* the subset of generators that best satisfies the problem requirements. A possible (and well-known) rule-of-thumb is to represent the operation costs of the dispatchable generators by their respective average incremental cost. However, if the power system in consideration is sufficiently small, it might prove worthy to use the actual cost curves of the generators while performing the unit commitment. Therefore, in such case, one can say that the unit commitment integrates an internal dispatch algorithm. Such types of unit commitment algorithms are sometimes named *Power System Scheduling* algorithms or, simply, *Scheduling* algorithms [43, 47]. Here, this name was adopted for distinguishing *standard* unit commitment problems/algorithms[‡] from those that not only supply the operator with the best sets of generators in use at different points in time, but that also affect such generators with the best set of setpoints, according to some objective or set of objectives.

Many power system scheduling approaches exist in the literature [20, 43, 44, 48]. Some of them seek to schedule the power system in an optimal manner, others in a near-optimal manner and, finally, others in a simple and efficient but not necessarily optimal manner. For the sake of clarity, these different approaches may be divided into three main types:

[†]Alternatively, the Unit Commitment algorithm may supply the operator with the best set of paths found, where the amount of paths may or not be predefined.

[‡]*Standard* unit commitment problems/algorithms are defined here as those having the single goal of determining the best set of *ON/OFF* states of the power system dispatchable generators according to some objective.

Rule-based: These types of methods use more or less complex rule-based systems to solve the power system scheduling problem. These rules may be static (i.e.: predefined and fixed through time) or they may evolve in time whenever machine learning techniques are employed. In addition, these rules may be simple rule-of-thumb ones (e.g.: successively commit generators having the lowest average incremental cost until the requirements of the problem are met) or they may be composed of more or less complex inference systems. These systems try to mimic the actions of an expert [49] based on actual human expert inputs (in which case they are commonly called expert systems) or they may be created from historical data. In this last case, inference systems based on artificial neural networks are widely used in the literature [50]. These inference systems may be static or they may evolve in time “learning” from experience [51]. Finally, the rules incorporated by these rule-based systems may take the form of single values (i.e.: *crisp* values) or by fuzzy numbers. In the first case, the single values may define, for instance, thresholds to respect. In the second case it is more or less the same with the difference that these thresholds are no longer represented by crisp values, but by fuzzy numbers. These fuzzy numbers may model the uncertainty around a given numeric value (e.g.: the system load will be between 200 MW and 250 MW), or they may translate some *qualitative measure* (e.g.: the system load will be average). Consequently, when fuzzy numbers are used, the scheduling process has to incorporate fuzzy logic (provided by fuzzy set theory) for scheduling the power system [52].

Optimization-based: In general terms, these methods approach power system scheduling problems through the search of the best possible solution within a given solution-space. In this case, the scheduling problem is formally written as a mathematical optimization problem, which is then solved through the use of some optimization technique [53] or combinations of optimization techniques as, for instance, in [54–57] where the power system scheduling problem is seen as a mixed-integer programming one. In the latter case, the original scheduling problem can be separated into an integer programming problem and a continuous optimization one. Then, some optimization technique (e.g.: branch-and-bound, dynamic programming) is used for solving the integer programming problem of deciding the ON/OFF states of generators, and another optimization technique (e.g.: sequential quadratic programming, linear programming, etc.) is used for determining the optimal setpoints of the selected generators to be in use at each moment in time. These two optimization techniques are then coupled through an algorithm specifically designed for the purpose such as the one proposed in [58]. The choice of the technique or set of techniques used depends mainly on the specific characteristics of the problem that is being formulated, on the available data, on the available tools for implementing the technique, on cal-

ulation time requirements, and on memory requirements. For instance, global optimization techniques may be employed for solving *small-enough* optimization problems [59].

Hybrid: These types of approaches combine two or more rule-based and optimization-based methods into a single power system scheduling algorithm. It should be stressed that such algorithm does not necessarily have the objective of attaining a global optimum (although it may eventually reach such an optimum), but rather to reach a “sufficiently good” solution (sometimes referred to as a suboptimal solution [60, 61]). The objective of hybrid method approaches is to simplify the solution method required for solving a given scheduling problem by dividing the problem into different sub-problems. Each of these sub-problems has specific characteristics distinguishing it from the remaining ones. Then, each one of the solution techniques previously chosen is employed for tackling a given type of sub-problem. Each sub-problem is solved separately (but not isolatedly) from the rest. The techniques are chosen so that their “strengths” are well-adapted to the characteristics of their respective sub-problems. At the end, a “sufficiently good” solution is obtained.

The development of Hybrid-based approaches may become necessary or, at least, interesting if the problem becomes *too large* [59, 62, 63] or if it presents some specificities suggesting that a hybrid approach is more suitable than a “classical” one (e.g.: problems having constraints that are difficult to respect using conventional approaches — ramp-rate limits [64, 65]). Examples of hybrid power system scheduling approaches may be found in [47, 60, 62, 63, 66, 67].

3.2 A Unified Formulation of the Power System Scheduling Problem

Many power system scheduling models exist in the literature. Indeed, power system scheduling problems have been a research topic for about four decades [44]. In this section, an effort is made for providing the reader with a generalized mathematical model of power system scheduling problems based on the models that can be found in the literature. Such model attempts to unify the three identified possibilities for power system scheduling models by starting with the formulation of the most general one (i.e.: classical multi-area scheduling) and then detailing the differences between that one and the remaining two (i.e.: classical single-area scheduling and the market-player scheduling).

Obviously, different power systems have different characteristics (i.e.: different load requirements,

different grid infrastructures, different generator mixes, etc.). In addition, the operators of such power systems may have different objectives (or sets of objectives) in mind while deciding the scheduling of their respective systems. Therefore, the formulation presented in this chapter does not aim to be exhaustive for every possible power system scheduling problem. It rather aims to provide a good insight and starting point on the “translation” of a power system scheduling problem into mathematical terms.

There are mainly two *visions* for power system scheduling problems: the classical vision and the market-player one. It is important to take this aspect into account prior to the development of a mathematical formulation of the problem as such formulation is strongly dependent on the vision adopted.

The *classical* vision addresses the problem of scheduling the power system system as a whole. The power system is operated as a monopoly in a vertically integrated structure. The optimal selection of the generators to be in use at each moment in time, and the determination of their setpoints is obtained while considering all of the available resources of the power system as well as all of the pertinent grid elements of the power system (e.g.: transmission power lines). Such optimization is usually carried out with the objective of minimizing the global operation and, eventually, the maintenance costs of the power system. This vision subdivides into two main approaches. In the first, all the elements constituting the power system are considered to belong to a single-area. In the second, the power system elements are divided into different areas, thus constituting smaller power systems aggregated together through inter-area interconnection power lines. In this case, the *commitment* of the generators is typically made per area while enforcing inter-area transmission interconnection constraints to be respected [63, 68]. The enforcement of transmission interconnection constraints can be ensured by running a global economic dispatch.

Nowadays, many power systems operate under horizontal structures [69] often under liberalized power market structures [70, 71]. Under such market structures, the power system scheduling is implicitly obtained by market clearing and settlement mechanisms. Therefore, no global optimization of the power system scheduling is made. However, in such structures, there is an important entity that is responsible for ensuring technical feasibility of the schedules obtained after market clearance takes place. Such entity is the independent system operator (ISO)[†] [18, 19]. It must be stressed that, in this case, the global power system scheduling no longer has the objective of scheduling the power system operation for attaining the least cost. It rather aims to detect infeasibility situations and to correct

[†]It may be the transmission system operator (TSO) depending on the power market structure [18].

them. Such a unit commitment is usually referred to as security-constrained unit commitment (SCUC) [19].

Under an electricity market, such as the one that was previously described, a *market-player* vision has to be adopted by market players (i.e.: market participants having the role of placing bids onto the market for buying or selling power). Some of such players consist of generating companies (GENCOs) that operate and maintain their own plants with the objective of maximizing their individual profits[†] [72]. This constitutes a first difference between this view and the classical one. However, other differences exist. Indeed, load supply constraints are no longer strict (i.e.: the GENCO available generation capacity does not have to match the total system demand — it can be inferior to that demand value) and both reserve and transmission losses are predefined by contracts [44]. Finally, transmission network constraints may be simplified to a large extent, or even be neglected, as the enforcement of such constraints is ensured by the ISO[‡].

From the two main types of power system scheduling problems that were previously described, the classical vision applied to the multi-area case seems to be the most general one because it can straightforwardly lead to the remaining ones through some simplifications as shall be seen later on. This section deals with the development of a generalized mathematical model designed for tackling such problem. The proposed mathematical model is mainly based on the conjunction of the works developed by Lee and Feng in [68] with that developed by Ouyang and Shahidehpour in [63], which were focused on the multi-area unit-commitment problem. The conjunction of such works seeks to provide a more general model combining the characteristics of the previous two. At the end of this section, some considerations and modifications to the developed multi-area power system scheduling model are drawn for obtaining the simpler single-area version. Finally, an extension to the obtained single-area power system scheduling model is proposed for obtaining the market-player power system scheduling model.

[†]This type of scheduling problems are usually referred to as price-based unit commitment (PBUC) [19].

[‡]However, it might be important for the GENCO to know if there will possibly be any transmission grid bottlenecks. In fact, the existence of bottlenecks may force the ISO to select more expensive generators for granting technical feasibility of the schedule. Therefore, from a strategic viewpoint, the GENCO may be interested in knowing in advance whether and where such bottlenecks are expected to appear (inside the area of influence of the GENCO or not). Such knowledge may eventually be used for developing market strategies aiming to take advantage of existing power grid inefficiencies for increasing the profits of the GENCO.

3.2.1 Formulation of the Classical Multi-Area Power System Scheduling Model

The classical multi-area power system scheduling model can be described as the following optimization problem,

$$\begin{aligned} \min_x \quad & f(x) \\ \text{subject to: } \quad & g(x) = G \\ & h(x) \leq H \end{aligned} \tag{3.1}$$

where x represents the vector of control variables of the scheduling problem and $f(x)$ represents the function to minimize. The set of equations $g(x) = G$ represents the equality constraints of the problem (e.g.: energy balance constraints), and the set $h(x) \leq H$ represents the set of inequality constraints of the problem (e.g.: generator setpoint boundaries). This general formulation represents the base structure of any power system scheduling optimization problem. Below, an example objective function is formulated for the multi-area power system scheduling problem. Afterwards, the section proceeds with the detailed formulation of the constraints of such problem.

3.2.1.1 The Objective Function of the Problem

The objective of the problem is, usually, to determine the set of control variables that minimizes the operation and maintenance costs of the power system throughout a given operation horizon. Let \mathcal{S} be the unit commitment state-space, where $\mathcal{S} = \{S_1, S_2, \dots, S_{n_u N_{Gen} - 1}\}$ and:

- S_k represents the k^{th} system state (i.e.: the k^{th} combination of generators of the system);
- n_u is the number of possible single generator states;
- N_{Gen} is the number of generators of the system.

If the operation and maintenance costs are given by $f(x_t)$, where x_t is the vector of control variables of the problem at any point in time t , the objective function of the problem may be expressed by Equation 3.2, where T represents the optimization horizon of the scheduling problem.

$$\min_x \sum_{t=1}^T f(x_t) \quad , x = \{x_1, x_2, \dots, x_T\} \quad (3.2)$$

Although simple to understand, the previous equation does not allow an *applicable* formulation of a power system scheduling problem to be easily made as the vector of control variables x lacks some detail. Hence, for incorporating such additional detail into Equation 3.2, vector x (the system state) shall be detailed the individual control variable vectors:

- $u_i(t)$ \longrightarrow state of dispatchable generator i at time t (a component of the system state S_t);
- $P_i(t)$ \longrightarrow power output of dispatchable generator i at time t ;
- $SR_i(t)$ \longrightarrow spinning reserve[†] made available by dispatchable generator i at time t ;
- $NSR_i(t)$ \longrightarrow non-spinning reserve[‡] supplied by dispatchable generator i at time t .

Moreover, for taking into account the existence of multiple areas, let us define \mathcal{M} as the set containing all areas of the power system. In addition, let us define \mathcal{G}_m as the set of all dispatchable generators comprised by area $m \in \mathcal{M}$. Under these definitions, the total per time-step operation and maintenance costs associated to the power system scheduling problem are given by f_t in Equation 3.3, where C_i represents the generating cost function of generator i comprising its operation and maintenance costs associated to $u_i(t)$, $P_i(t)$, $SR_i(t)$, $NSR_i(t)$. In the same equation, SD_i represents the shutdown cost associated to shutting down the i^{th} generator if it was previously in use, and SU_i represents the startup cost associated to starting up the i^{th} generator if it was not previously in use.

[†]Defined further ahead.

[‡]Defined further ahead.

$$f_t = \sum_{m \in \mathcal{M}} \sum_{i \in \mathcal{G}_m} \left[C_i(u_i(t), P_i(t), SR_i(t), NSR_i(t)) + SU_i(u_i(t), u_i(t-1)) + SD_i(u_i(t), u_i(t-1)) \right] \quad (3.3)$$

It should be noted that, in the present formulation, the fixed costs for starting up, or shutting down the i^{th} generator are being implicitly associated. This is due to the use of the operating states of the i^{th} generator at times t and $t - 1$ disregarding the amount of time in which the generator had remained on its previous state. This is one possible and quite simple approach for dealing with the particular startup and shutdown costs of any given generator. Of course, other approaches exist in the literature for dealing with these particular costs [20, 54–56, 73]. However, as it was previously stressed, our formulation is intended to be as general as possible. Therefore, it cannot aim to suit every possible multi-area power scheduling problem, but rather to supply a base structure of such problems facilitating the development of a problem-specific formulation. Moreover, the assumptions made for defining the startup and shutdown costs associated to the i^{th} generator allow to formulate the multi-area power system scheduling problem without any loss of generality as other cost structures may be included in a straightforward way. In other words, the present formulation remains generic from the startup and shutdown costs viewpoint because its structure remains the same even if the adopted structure of these costs differs from the one adopted here.

Equation 3.3 represents the total operation and maintenance cost associated to the t^{th} time-step of a given multi-area power system scheduling problem. In other words, this equation represents the single-stage operation and maintenance costs associated to any given time-step of the considered horizon. By adding the costs associated to each time-step of the scheduling problem one obtains the total costs associated to the scheduling horizon T (i.e.: global scheduling costs). The objective of the classical scheduling problem is to minimize these global scheduling costs, which is described by Equation 3.4.

$$\min_{u, P, SR, NSR} \sum_{t=1}^T f_t \quad (3.4)$$

3.2.1.2 Constraints of the Problem

The classical multi-area power system scheduling problem is subject to a wide variety of constraints. Such constraints may be generally classified as soft or hard. Soft constraints, are generally all the constraints that may be violated to some extent at the expense of paying some penalty. Such penalty is usually proportional the extent of the violation of the given constraint. Hard constraints are those that must be respected at all times. As opposed to their soft counterparts, no penalty costs due to violations of hard constraints are considered because no violation of such constraints whatsoever is permitted. For further information on the definitions of hard and soft constraints and for some applications of these concepts please refer to [74–76].

Power system scheduling optimization problems comprise both equality and inequality constraints. The equality constraints refer to those that are represented by an equation. In such case, as the type of the constraint suggests, an equality must be reached between the outcome of a prespecified function (usually placed in the left member of the equation) and a predefined quantity (usually placed in the right member of the equation). The prespecified function takes as inputs the set of variables of the optimization problem (or some subset of such variables). The inequality constraints are, as the name suggests, described by an inequality. Such inequalities are usually used for bounding the variables of the optimization problem to feasible or otherwise acceptable values[†].

System-Level Constraints

The most common equality constraint associated to power system scheduling problems is related to power balance. Such constraint enforces the total power generation to equal the system load plus the system losses at every moment in time. This is a hard constraint (in the sense defined in subsection 3.2.1.2) because it is imposed by the laws of physics [42]. This constraint may be described

[†]Some optimization problems may have design values having physical limits (i.e.: translated by feasible values) that are wider than those defined by the problem designer (i.e.: which are hereby referred to as acceptable values). As an example of such case, one can mention, for instance, the problem of building a hydro dam containing a reservoir where the amount of hydro storage of such dam is usually not limited by nature, but by design options aiming to limit the hydro dam impacts on, for instance, wildlife.

through Equation 3.5,

$$\sum_{i=1}^{N_{Gen}} (P_i(t)) = L(t) + P_L(t) \quad (3.5)$$

where, at every time-step t :

- $P_i(t)$ \longrightarrow power output of the i^{th} generator;
- $L(t)$ \longrightarrow total system load;
- $P_L(t)$ \longrightarrow total system losses;
- N_{Gen} \longrightarrow total number of generators of the power system.

The previous equation is valid for single-area scheduling problems. However, it can be extended to multi-area ones. The main difference between both is due to interconnection limits between the different areas belonging to the set of areas \mathcal{M} . Let $\mathcal{N}_m \subset \mathcal{M}$ be the subset of areas interconnected with area m , where m represents a given area of the multi-area scheduling problem. In addition, let $P_{T_{m,n}}(t)$ represent the power interchange between areas m and $n \in \mathcal{N}_m$ at time t , where a power flow interchange going from area m to area n is considered to be greater than zero. In such a case, the power balance equation for multi-area scheduling problems may be expressed through Equation 3.6, where $L_m(t)$ and $P_{L_m}(t)$ represent, respectively, the total load to be fed in and the total losses associated to area m at time t . Of course, $n \neq m$ (interconnections between adjacent areas are considered), and $\mathcal{N} \neq \emptyset$ (otherwise the problem becomes a single-area scheduling one).

$$\sum_{i \in \mathcal{G}_m} (P_i(t)) - \sum_{n \in \mathcal{N}_m} (P_{T_{m,n}}(t)) = L_m(t) + P_{L_m}(t) \quad , \forall m \in \mathcal{M} \quad (3.6)$$

Capacity constraints are also often incorporated into scheduling models. These constraints are used for ensuring that the system always has an amount of surplus capacity allowing it to withstand the

consequences of unforeseen events. Such unforeseen events can consist in system contingencies (e.g.: loss of an important power line, generator outages, ...), or in forecasting errors (e.g.: the predicted system load differs from the *actual* value it takes). These unforeseen events usually have to be dealt with within different time frames. In the first time frame, the system responds immediately to the contingency *via* an automatic local control. For achieving this, the system relies on the availability of fast acting reserves, which are capable of either absorbing momentary excess power, or generating momentary lacking power for maintaining the power balance of the system[†]. In the second time frame, the power system responds to the contingency in some tenths of seconds [77]. This type of reserves are usually coordinated in a central and automatic way by the TSO with the aim of bringing the system frequency back to its specified value (i.e.: the frequency is automatically deviated from this value on the occurrence of a momentary power unbalance). Finally, in the third time frame the power system is manually readjusted. Such readjustment consists in a manual redispatch and recommitment of the power system generators. This readjustment is made for re-establishing the levels of secondary control reserve. It can also be made for managing eventual congestions, and for bringing back frequency and the interchange programs to their target values whenever the amount of secondary control reserve is not sufficient [77].

Two main types of power reserves exist for enabling the power system to respond to unforeseen events: the so-called *spinning* and non-spinning reserve. In the present, no consensual definition of spinning reserve exists. A possible generic definition (inspired in the work developed by Rebours and Kirschen in [78]) could be: the spinning reserve is the unused capacity of the system which can be activated upon need due to some unforeseen event and which is provided by devices that were already synchronized with the power system *prior* to the occurrence of such event. However, other definitions exist as, for instance, in [19] where the authors state that “spinning reserve should be online and operate at less than the maximum output, and be ready to immediately serve load”. The non-spinning reserve could be defined as the unused capacity of the system that can be activated by the system operator in case of some unforeseen event and which is provided by power generators that were not synchronized with the power system *prior* to the occurrence of such event. In [19], the authors state that “non-spinning reserve should generate capacity for emergency conditions but not be available immediately” and that “non-spinning reserve capacity should be started up very quickly (usually in less than 10 minutes)”. Here, as previously defined, the spinning reserve requirements are represented by SR and their non-spinning counterparts are represented by NSR. For more information on other available definitions and types of power system reserves the reader may refer to [18, 77–80].

[†]Otherwise the power system could enter a "blackout" situation, or, in other words, it may shutdown.

For considering reserve requirements, in the multi-area scheduling framework, the set of capacity constraints may be defined by Equation 3.7, where $SR_m(t)$ stands for the spinning reserve requirements associated to area m , $NSR_m(t)$ represents the non-spinning reserve requirements associated to area m , and $P_i^{Max}(t)$ is the maximum possible power output of the i^{th} generator at time t .

$$\sum_{i \in \mathcal{G}_m} \left(P_i^{Max}(t) \right) - \sum_{n \in \mathcal{N}_m} \left(P_{T_{m,n}}(t) \right) \geq L_m(t) + P_{L_m}(t) + SR_m(t) + NSR_m(t) \quad , \forall m \in \mathcal{M} \quad (3.7)$$

where,

$$\sum_{i \in \mathcal{G}_m} SR_i(t) \geq SR_m(t) \quad , \forall m \in \mathcal{M} \quad (3.8)$$

and,

$$\sum_{i \in \mathcal{G}_m} NSR_i(t) \geq NSR_m(t) \quad , \forall m \in \mathcal{M} \quad (3.9)$$

In many cases, the values of $SR_m(t)$ and $NSR_m(t)$ are associated to the peak load $L_m^{Max}(t)$ occurring in area m within a given time-step t [77]. In such cases, Equation 3.7 may be simplified to Equation 3.10.

$$\sum_{i \in \mathcal{G}_m} \left(P_i^{Max}(t) \right) - \sum_{n \in \mathcal{N}_m} \left(P_{T_{m,n}}(t) \right) \geq L'_m(t) + P_{L_m}(t) \quad , \forall m \in \mathcal{M} \quad (3.10)$$

where:

$$L'_m(t) = L_m(t) + \mathcal{L}(L_m^{Max}(t)) \quad (3.11)$$

In Equation 3.11, $\mathcal{L}(L_m^{Max}(t))$ translates the impact of $SR_m(t)$ and $NSR_m(t)$ on the capacity constraint given by Equation 3.10. In practice, the values of $SR_m(t)$ and $NSR_m(t)$ will have the effect of increasing the predicted load by a given amount. Consequently, some security slack is added to the problem. In some cases, such slack is given by a constant value, whilst in others it is (as mentioned above) a function of the peak load that is expected to occur within a given amount of time [77, 78]. For illustrating this last case, let us admit the security slack for covering the occurrence of unforeseen events to be given by a constant percentage value of the predicted load[†]. For achieving this, let us define increment factors k_{SR} and k_{NSR} for representing, respectively, the percentage impacts of $SR_m(t)$ and $NSR_m(t)$ on the capacity constraint given by Equation 3.10. Then, the function $\mathcal{L}(L_m^{Max}(t))$ may be given by Equation 3.12.

$$\mathcal{L}(L_m^{Max}(t)) = (k_{SR} + k_{NSR}) \cdot L_m^{Max}(t) \quad (3.12)$$

If the security slack can be calculated as a whole for both the spinning reserve and the non-spinning reserve requirements, Equation 3.12 may be simplified to Equation 3.13, where k_R represents such global reserve factor.

$$\mathcal{L}(L_m^{Max}(t)) = k_R \cdot L_m^{Max}(t) \quad (3.13)$$

Equations 3.6 and 3.7 represent some of the most common restrictions to power system scheduling formulations, and can be called system-level constraints. However, many other restrictions may be

[†]If this is not the case, it will suffice to use the *actual* function that permits to calculate such load increment.

important to consider. For instance, one might be interested in limiting the amount of gas emissions associated to the scheduling decisions, or to limit the conventional fuel utilization. The inclusion of such types of constraints in the present model is quite straightforward. For more information on such emission and fuel constraints the reader may refer to [81].

Boundary Constraints

The system-level constraints are to be respected while setting the control variables of this optimization problem to appropriate values. These control variables are, however, often bounded. The enforcement of such boundaries to control variables is made by the employment of additional constraints that are usually referred to as *boundary constraints*.

Many boundary constraints may be associated to a given power system scheduling problem. Here, those related to inter-area transmission and to the generators of the system will be of particular interest.

Inter-Area Transmission Constraints

The inter-area transmission constraints serve the purpose of keeping inter-area power flows within an acceptable (feasible) range. Let $P_{T_{m,n}}^{Max}$ be the maximum power flowing from area m to area n . In such case, the inter-area constraints may be defined through Equation 3.14.

$$P_{T_{m,n}}(t) \leq P_{T_{m,n}}^{Max}, \forall m \in \mathcal{M}, \forall n \in \mathcal{N}_m, n \notin m, \mathcal{N}_m \neq \emptyset \quad (3.14)$$

Generator Constraints

The literature reveals several types of constraints applied to power system generators. Some examples of such constraints may be found in [43, 44, 56, 65, 81, 82]. Here, in the context of the present formulation, the following types will be addressed:

- generation capacity limits;

- ramp-rate power output limits;
- warm-up and cool-down power output limits;
- minimum up and minimum down time requirements;
- allowed up and down times throughout the optimization horizon;
- must-run and must-off units.

The power output of any physical generator is bounded by its physical characteristics. Two main types of power output limitations exist. The first one is usually called generator technical limit constraint and refers to the minimum \underline{P}_i and maximum \overline{P}_i power output that the i^{th} generator may produce whenever it is *in use* or *committed* at any moment in time. The second one is the so-called *ramp-rate* limits of dispatchable generators.

The generation capacity limit constraint may be formally expressed through Equation 3.15, where $P_i^{CAP}(t)$ represents the momentary constrained capacity of the i^{th} generator. This quantity is needed to account for the pre-warming and the cool-down phases of large thermal-based generators [73].

$$u_i(t) \cdot \underline{P}_i \leq P_i(t) \leq P_i^{CAP}(t), \forall i \in \mathcal{G}_m, m \in \mathcal{M} \quad (3.15)$$

In Equation 3.15, the value of $P_i^{CAP}(t)$ represents a function that models the maximum output of the i^{th} generator at a given time-step. For simplicity, such function may be described by Equation 3.16. However, other functions may also be utilized [73]. In Equation 3.16, $u_i^{WU}(t) \in \{0, 1\}$ and $u_i^{CD}(t) \in \{0, 1\}$ represent, respectively, the warm-up and cool-down states of the i^{th} generator. In the same equation, n_i^{WU} represents a counter of the number of time-steps that have passed from the moment the unit started the warm-up phase and n_i^{CD} represents a counter of the number of time-steps that have passed from the moment the unit started the cool-down phase. The function $p_i^{WU}(n_i^{WU})$ represents the constrained maximum generating capacity of the i^{th} generator during its warm-up phase. Similarly, the function $p_i^{CD}(n_i^{CD})$ represents the constrained maximum generating capacity of the i^{th} generator during its cool-down phase.

$$P_i^{\text{CAP}}(t) = \begin{cases} 0 & \Leftrightarrow u_i(t) = 0, \\ p_i^{\text{WU}}(n_i^{\text{WU}}) & \Leftrightarrow u_i^{\text{WU}}(t) = 1, \\ p_i^{\text{CD}}(n_i^{\text{CD}}) & \Leftrightarrow u_i^{\text{CD}}(t) = 1, \\ \bar{P}_i & \Leftrightarrow u_i(t) = 1 \wedge u_i^{\text{WU}}(t) = u_i^{\text{CD}}(t) = 0. \end{cases}$$

, $\forall i \in \mathcal{G}_m, m \in \mathcal{M}$ (3.16)

Of course, a warm-up of the i^{th} generator (i.e.: $u_i^{\text{WU}}(t) = 1$) implies it being online. This is translated through Equation 3.17.

$$u_i^{\text{WU}}(t) = 1 \Rightarrow u_i(t) = 1$$

, $\forall i \in \mathcal{G}_m, m \in \mathcal{M}$ (3.17)

Similarly to the warm-up phase, a cool-down phase of the i^{th} generator (i.e.: $u_i^{\text{CD}}(t) = 1$) also implies it being online, which is translated by Equation 3.18.

$$u_i^{\text{CD}}(t) = 1 \Rightarrow u_i(t) = 1$$

, $\forall i \in \mathcal{G}_m, m \in \mathcal{M}$ (3.18)

The ramp-rate constraints translate the physical impossibility of a generator to instantaneously change its power output within its feasible range (i.e.: respecting Equation 3.15) due, for instance, to the time-lag associated to its control equipment and to its mechanical inertia. This physical constraint implies the power output variation of the i^{th} generator at time t to be dependent of the power output of the same generator at time $t - 1$. Furthermore, such maximum variation may take different values depending on whether one is increasing or decreasing the power output of the generator. Let us define the maximum

allowed variation of power output of the i^{th} generator as $\underline{\Delta P}_i$, for cases in which one is reducing the power output of the generator, and as $\overline{\Delta P}_i$ to be, for cases in which one is increasing the power output of the generator. In such a case, the generator ramp-rate restrictions may be intuitively expressed by Equation 3.19.

$$P_i(t-1) - \underline{\Delta P}_i \leq P_i(t) \leq P_i(t-1) + \overline{\Delta P}_i$$

$$, \forall i \in \mathcal{G}_m, m \in \mathcal{M}, \underline{\Delta P}_i > 0 \text{ and } \overline{\Delta P}_i > 0 \quad (3.19)$$

Alternatively, Equation 3.20 may also be described by Equation 3.19, which is somewhat simpler.

$$-\underline{\Delta P}_i \leq P_i(t) - P_i(t-1) \leq \overline{\Delta P}_i$$

$$, \forall i \in \mathcal{G}_m, m \in \mathcal{M}, \underline{\Delta P}_i > 0 \text{ and } \overline{\Delta P}_i > 0 \quad (3.20)$$

Another type of generator constraints is linked to the operating status of the generators. Some examples of this type of restrictions may be found in [65, 81, 82].

The first one that is formulated here regards the minimum up time requirements that may be associated to the various generators. This constraint ensures that, whenever the i^{th} generator is set to an up status it remains up for at least MUT_i time-steps. This restriction essentially comes from some physical considerations related to steam units [53] in which a minimum up time helps to prevent high maintenance/repair costs due to excessive unit cycling. Such constraint may be enforced through Equation 3.21, where $X_i^{on}(t)$ stands for the number of time-steps that the unit has remained online since the last time it was set into that state.

$$\left(X_i^{on}(t-1) - MUT_i \right) \left(u_i(t-1) - u_i(t) \right) \geq 0$$

$$, \forall i \in \mathcal{G}_m, m \in \mathcal{M}, u_i(t) \in \{0, 1\} \quad (3.21)$$

Similarly to the minimum up time constraints, power generators may also be submitted to minimum down time constraints. These constraints are usually employed to avoid thermal stresses (e.g.: in case the electric generator is primarily moved by a steam turbine) and due to economic considerations [53]. In general terms, this constraint ensures that each time the i^{th} generator is set offline, it remains in that state for at least MDT_i time-steps. Such constraint may be applied through Equation 3.22, where $X_i^{off}(t)$ stands for the number of time-steps that the unit has remained offline since the last time it was set into that state.

$$\left(X_i^{off}(t-1) - MDT_i \right) \left(u_i(t) - u_i(t-1) \right) \geq 0$$

$$, \forall i \in \mathcal{G}_m, m \in \mathcal{M}, u_i(t) \in \{0, 1\} \quad (3.22)$$

Another generator constraint that is used for preventing the i^{th} generator from being put online for more than $MAUT_i$ time-steps of the time horizon T is usually referred to as: maximum allowed up time constraint. This constraint avoids to overuse a generator that is not intended to supply the base load of the power system. Such constraint is described by Equation 3.23.

$$\sum_{t=1}^T \left(u_i(t) \right) \leq MAUT_i$$

$$, \forall i \in \mathcal{G}_m, m \in \mathcal{M}, u_i(t) \in \{0, 1\}, MAUT_i \geq 0 \quad (3.23)$$

Conversely, the allowed down time constraint associated to the i^{th} generator prevents it from being put offline for more than $MADT_i$ time-steps of the time horizon T . This constraint avoids to underuse a

generator that is intended to supply the base load of the power system. Such constraint is described by Equation 3.24.

$$T - \sum_{t=1}^T (u_i(t)) \leq \text{MADT}_i$$

$$, \forall i \in \mathcal{G}_m, m \in \mathcal{M}, u_i(t) \in \{0, 1\}, \text{MADT}_i \geq 0 \quad (3.24)$$

For placing the control variables and their bounding limits in separate members, Equation 3.24 may be re-written as Equation 3.25.

$$\sum_{t=1}^T (u_i(t)) \geq T - \text{MADT}_i$$

$$, \forall i \in \mathcal{G}_m, m \in \mathcal{M}, u_i(t) \in \{0, 1\}, \text{MADT}_i \geq 0 \quad (3.25)$$

Some of the generators may be bound to remain online all the time either due to technical and/or economical reasons (e.g.: nuclear power plants that may take up to several days for starting-up/shutting-down and hydro generators that may have to run for avoiding spillage, which is considered to lower the global power generation costs). These are the so-called must-run units [61, 68]. Let $\mathcal{G}_m^{\text{MRU}} \subset \mathcal{G}_m$ be the subset of must-run units contained in area $m \in \mathcal{M}$. Then, the must-run constraints may be described by Equation 3.26.

$$u_i(t) = 1$$

$$, \forall t \in T \quad \forall i \in \mathcal{G}_m^{\text{MRU}}, m \in \mathcal{M} \quad (3.26)$$

Finally, some of the generators should remain offline throughout the scheduling horizon. These are the so-called must-off units [68]. These units can correspond, for instance, to units scheduled for

maintenance or being repaired. Let $\mathcal{G}_m^{\text{MOU}} \subset \mathcal{G}_m$ be the subset of must-off units contained in area $m \in \mathcal{M}$. In this case, the must-off constraints may be described by Equation 3.27.

$$u_i(t) = 0, \forall t \in T \quad \forall i \in \mathcal{G}_m^{\text{MOU}}, m \in \mathcal{M} \quad (3.27)$$

3.2.2 Derivation of a Single-Area Power System Scheduling Model

Up to now, a multi-area power system scheduling model was developed. However, as it was stated prior to the development of this multi-area formulation, a simple inspection of the obtained equations reveals that this model can easily deal with single-area power system scheduling problems through incorporation of some modifications. The needed modifications mainly consist in:

- eliminating the inter-area capacity constraints given by Equation 3.14;
- suppressing all m indexes;
- disregarding all n indexes;
- changing \mathcal{G}_m to \mathcal{G} , where \mathcal{G} is the set of all generators of the power system;
- neglecting the sets \mathcal{M} and \mathcal{N}_m as well as every consideration that was made on them;
- eliminating the term $-\sum_{n \in \mathcal{N}_m} (P_{T_{m,n}}(t))$ from Equations 3.6 and 3.7.

3.2.3 A Market-Player Power System Scheduling Model

The classical single-area power system scheduling model can also be extended to take into account the presence of the market. The main modifications that need to be done are linked to the objective function of the problem and, eventually to the power balance equation (i.e.: in case one wishes to consider a single power producer or buyer).

3.2.3.1 Objective of the Problem

In the context of a market-player, the objective of the GENCO while solving the power system scheduling problem is no longer to supply the system load at the least cost, but to maximize its profit while supplying the system load (or a part of it). Therefore, Equation 3.4 no longer holds, even when adapted to the single-area case, because it only considers generation costs neglecting associated revenues. Hence, Equation 3.4 has to be re-written for incorporating the revenues r associated to the scheduling. Equation 3.28 describes this new objective, where, for every time-step t , $\rho_P(t)$ represents the price paid by the power market for produced energy, $\rho_{SR}(t)$ represents the price paid by the power market for spinning reserve services, and $\rho_{NSR}(t)$ represents the price paid by the power market for non-spinning reserve services.

$$\max_{u,P,SR,NSR} \left\{ \sum_{t=1}^T \left(r(u(t), P(t), SR(t), NSR(t), \rho_P(t), \rho_{SR}(t), \rho_{NSR}(t)) - f(u(t), P(t), SR(t), NSR(t)) \right) \right\} \quad (3.28)$$

In Equation 3.28, the time-stage cost function f is given by Equation 3.29.

$$f(u(t), P(t), SR(t), NSR(t)) = \sum_{i=1}^{N_{Gen}} \left[C_i(u_i(t), P_i(t), SR_i(t), NSR_i(t)) + SU_i(u_i(t), u_i(t-1)) + SD_i(u_i(t), u_i(t-1)) \right] \quad (3.29)$$

The time-stage revenue r contained in Equation 3.28 is given by Equation 3.30.

$$r\left(u(t), P(t), SR(t), NSR(t), \rho_P(t), \rho_{SR}(t), \rho_{NSR}(t)\right) = \sum_{i=1}^{N_{Gen}} \left(\rho_P(t) \cdot P_i(t) + \rho_{SR}(t) \cdot SR_i(t) + \rho_{NSR}(t) \cdot NSR_i(t) \right) \quad (3.30)$$

Finally, under a market logic, a single GENCO no longer needs to feed the whole load of the power system, but only the part of it that maximizes the GENCO's profit. This implies a modification of the power balance equation that was defined through Equation 3.5. In fact, the GENCO no longer tries to supply the system load plus the system losses[†], but rather provides a part of the system load. This is translated through equation Equation 3.31, where \mathcal{G}_j is the set of dispatchable generators of the j^{th} GENCO.

$$\sum_{i \in \mathcal{G}_j} \left(P_i(t) \right) \leq L(t) \quad (3.31)$$

To conclude this section, it should be said that the present formulation of the market-player power system scheduling model is not generic as it neglects many options (e.g.: the eventual existence of bilateral contracts). However, the inclusion of such details is quite straightforward. For further reference on the subject the interested reader should refer to [81].

3.3 Conclusions of the Chapter

In chapter 2, the two main fields of knowledge related to this work were identified: power system scheduling and decision under uncertainty. The present chapter supplied the necessary background in what regards power system scheduling. This permits to better understand the concepts, complexity, and characteristics associated to power system scheduling problems. This is an important basis for the development of a day-ahead scheduling methodology suited to power system cells operating under

[†]In a market context, the system losses are dealt with by the ISO or TSO, whichever is applicable.

electricity market conditions.

The chapter started with a conceptual discussion on power system scheduling problems identifying their main characteristics as well as their complexity. A short insight on the main approaches that are usually followed for tackling problems of the kind was given. Then, a model suited for multi-area power system scheduling problems was developed. This model resulted from the unification of several models proposed in the literature, the most relevant of which are those developed by Lee and Feng in [68] and by Ouyang and Shahidehpour in [63]. The resulting model is therefore quite generic in the sense that it treats the most common restrictions that are usually associated to problems of the kind. Furthermore, the model is not a solution-oriented one in the sense that it does not focus on the solution-technique used to solve it but rather on the mathematical model that is behind multi-area power system scheduling problems. Therefore, the model can be applied on several types of multi-area power system scheduling problems while allowing the easy consideration of additional restrictions whenever needed as well as the modification and/or subtraction of the included restrictions.

Guidelines were then supplied so that the proposed multi-area power system scheduling model may be easily adapted to single-area power system scheduling cases. At the end, the case of an independent power producer who aims at participating in an optimal way on a day-ahead electricity market was also discussed. For covering this case, the necessary modifications to the single-area power system scheduling model were supplied. This last model is the one that best fits the requirements of the present work, thus serving as a basis for the power system cell scheduling model proposed in chapter 5.

So far, the analysis focused on deterministic scheduling problems. However, an important aspect of the particular power system cell scheduling problem is that the cell is subject to several uncertainties. These uncertainties are associated to the forecasts of both their non-dispatchable renewable energy production and to their local energy consumption. They may also come from the uncertainties associated to market price forecasts. The next chapter supplies the necessary background on the concepts and models that allow to incorporate such uncertainties into the scheduling process.

CHAPTER 4

Decision Under Uncertainty

CHAPTER OVERVIEW

TRADITIONALLY, power system scheduling decisions are made *prior* to the *actual* power system operation. Such scheduling decisions, as seen in the previous chapter, essentially prepare the power system for responding to its operational requirements according to some predefined operation objective or set of objectives. Consequently, such requirements must be estimated *prior* to their *actual* occurrence.

This research work addresses the problem of scheduling the operation of a power system cell subject to considerable uncertainties. This may represent the case of a microgrid or of a wind/pumped-hydro power plant in which the uncertainties are linked with the *imperfect* knowledge of the future conditions under which the power system cell will be operating, thus playing a important role in the scheduling decisions that are to be made.

This chapter discusses decision under uncertainty, which was identified in chapter 2 as being one of the the two main fields of knowledge related to this work (the other is that of power system scheduling, which was addressed in chapter 3). Therefore, in this chapter, a review of different ways to model uncertainty and to integrate such uncertainty in decision processes is given. This serves to establish the basis for modeling and taking into account the different uncertainties that are usually associated to the power system scheduling problems like the one addressed in this work.

4.1 Why Decision Under Uncertainty?

The main objective of this research work is to develop a methodology for scheduling the operation of a power system cell composed of an aggregation of several energy converters often having different characteristics. For instance, some of those energy converters may be *controllable* or *dispatchable* in the sense that one has the possibility to control their energy input and, consequently, their energy output at all times (e.g.: coal-fired power plant, hydro power plant containing a sufficient amount of water reservoir capacity). Conversely, some of those energy converters may be *partially dispatchable* or *non-dispatchable*, meaning that one has little or no control over their energy inputs, and, consequently, little or no control over their energy outputs. As an example, pitch controlled wind turbines and maximum power point tracking photovoltaic generators may be considered as *partially dispatchable* energy converters, while small wind turbines may be regarded as *non-dispatchable* generators.

While scheduling the operation of the power system cell, one is actually making several types of decisions according to some set of objectives. Some examples of possible decisions to make can be: which energy converter to use, when to use it, and (at least in the case of *dispatchable* ones) at which setpoint to place it.

Obviously, the previous examples of decisions are directly applicable to the conventional power system scheduling problem. However, in the case of a power system cell, making such types of decisions is usually more complex than in the conventional case. This may be due to several factors. To give an example, in large power systems, the penetration rate of *non-dispatchable* energy converters can be sufficiently small for their inherent collective variability to be absorbed by the power system. However, in the case of a power system cell, such penetration rate may be very high. Consequently, the controllability of the power system cell output is lower than that of the conventional power system. In other words, the uncertainty associated to the power system cell *actual* power output is higher than that of a conventional power system. This increases the probability of obtaining higher deviations between its expected and the measured power outputs, which are usually referred to as *imbalances*. In the present context, it is highly probable for such power system cell to operate under electricity market rules. These rules usually imply some amount of penalty to be paid for power imbalances. Hence, it is desirable to consider the power system cell output uncertainty in the scheduling procedure for managing the power imbalances it generates.

The focus in this chapter is on how to integrate the uncertainty associated to the power system cell output in the scheduling process, which may be seen as a decision problem. To do this, the development of a tailored decision under uncertainty scheduling model is required. However, such models usually consider some predefined way to model the uncertainties associated to the inherent decision problem. Therefore, the chapter proceeds with a short review of uncertainty modeling possibilities. Afterwards, some of the main models that exist for integrating uncertainty in decision processes are presented and discussed.

4.2 Modeling Uncertainty

Whenever the future outcomes associated to a given random (i.e.: stochastic) variable are not known with precision, some amount of uncertainty is associated to such variable. In other words, the *imperfect* knowledge of the future outcomes associated to any given random variable introduces some amount of uncertainty associated to how the future will be. Practical problems may comprise many sources of uncertainty. In power system related problems, some examples include: the possibility of a given generator to malfunction at a given moment in time, the evolution of the system load through time, and the future output of a wind farm.

Decision problems might consider or disregard (if this is considered as an acceptable choice) the uncertainty information associated to the forecasts of the future *states of the world*. Here one is looking at decision models integrating available uncertainty information on the future *states of the world*. However, firstly a short discussion on the main ways to model such uncertainty is made.

In [83], a unified view of the main ways to model uncertainty is proposed for a single-criterion decision problem under uncertainty. Under such unified view, the author proposes the following basic framework for describing each alternative of the single-criterion decision problem under uncertainty:

- a finite list of real numbers;
- a finite list of pairs (attribute value, probability);
- a probability distribution;

- a possibility distribution.

The preceding unified view of the main ways to model uncertainty may be straightforwardly extended to multi-criteria problems by performing some minor modifications to the basic framework described in the previous list. Thus, for describing each alternative of the multi-criterion decision problem under uncertainty one can use one of the following alternatives:

- a finite n by m matrix of real numbers, where n may represent the number of scenarios and m may represent the number of criteria;
- a finite n by m matrix of real numbers, where n may represent the number of scenarios and m may represent the number of criteria, plus a vector containing the n probability values associated to each of the n scenarios;
- a set of m probability distributions, each corresponding to the probable outcomes of the m^{th} attribute;
- a set of m possibility distributions, each corresponding to the possible outcomes of the m^{th} attribute.

According to [83], two *natural* ways exist for modeling uncertainty. The first one consists in the discrete points to which probability/possibility values may or not be associated. The second one consists in the use of intervals.

In a scenario approach, each possible future state of the world is identified, discretized and described by a real number. Such scenarios may be independent of each other (e.g.: n -point estimates of a given random variable) or not. The latter situation corresponds to the case where the scenario is built based on multiple dependent stochastic variables.

In an interval approach, the possible future states of the world are identified, discretized and described by ranges of real number values (e.g.: the internal rate of return associated to a given investment option will lie between 2 % and 3 %). In their basic formulation, intervals are not linked to probabilistic or possibilistic distributions [83]. However, in more advanced formulations, additional information may exist on the probability/possibility distribution of the values contained in interval.

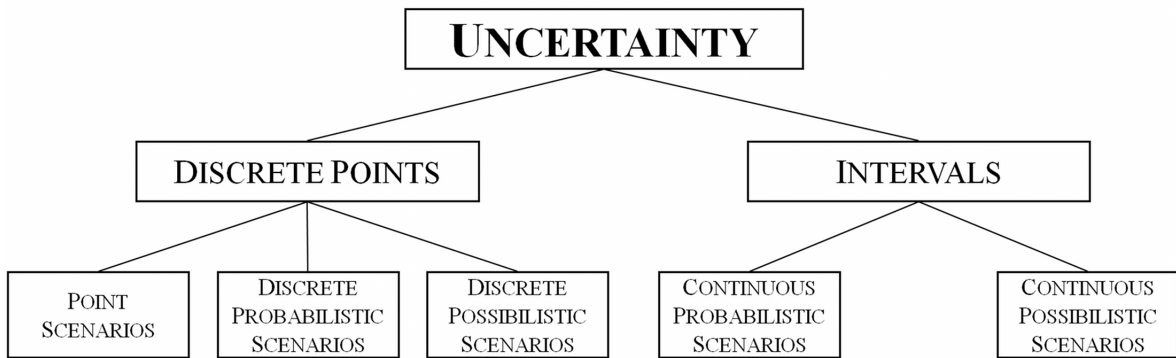

FIGURE 4.1: Schematic description of the main approaches to model uncertainty information.

The previous description suggests that the main approaches to model uncertainty may be schematically represented by Figure 4.1 in which one can find the two base approaches for modeling uncertainty. These approaches consist in modeling the uncertainty associated to a set of either discrete or continuous stochastic variables.

In the discrete case, the possible outcomes of the different feasible combinations of the stochastic variables (i.e.: scenarios) can be completely described by discrete points. Three sub-approaches exist. The first one (point scenarios) corresponds to uncertainty modeling situations in which scenarios are indistinguishable of each other, from a probabilistic/possibilistic viewpoint. The remaining approaches address the cases in which some amount of probability/possibility is associated to each of the identified scenarios.

In the continuous case, scenarios may be simply described by intervals of values as described previously. However, in many cases, some distinction is usually made between the values lying in such intervals. Such distinction may be given by the probability density function associated to the values contained in those intervals. In this case, one is actually defining continuous probabilistic scenarios. In cases where such distribution of values is given by a possibility distribution, one is actually defining continuous possibilistic scenarios.

Many other approaches may be found in the literature. However, such approaches either belong to one of the classes of approaches defined in Figure 4.1, or consist of some combination of those classes.

4.3 Decision Problems

In many situations, one needs to deal with the problem of choosing among a set of *optimal* or *good enough* concurrent alternatives. The entity that performs such choice is usually called *Decision Maker* [83, 84], but can also be called *agent* or *controller* [85]. In short, the Decision Maker's role is to choose a single alternative (i.e.: make a decision) among the identified alternatives set (i.e.: set of possible decisions). The problem of making such choices is usually called *Decision-Making Problem* [3].

For making decisions, especially in complex decision-making problems, the Decision Maker first needs to model the decision problem, which implies a good understanding of its characteristics. In a second step, the Decision Maker needs to follow some decision process for determining the decision to make [3]. Such decision corresponds to the decision that best fulfills the *decision criteria* defined by the Decision Maker.

The term *decision criteria* represents the “measures, rules, and standards that guide decision making” [3] and is composed of the attribute(s), the objective(s), and the goal(s) of the decision-making problem at stake. According to [3] the:

- **attributes** represent the descriptors of objective reality. For instance, the expected return and the risk associated to a given decision may be regarded as attributes of the decision, but the importance of such return and the impact of such risk may not.
- **objectives** represent the attributes to maximize/minimize. In the previous example, maximizing the expected return associated to the decision to make is an objective. However, it is surely not the *only* objective as the Decision Maker may prefer to minimize the risk associated to the decision that is made, or to maximize/minimize some combination of both attributes.
- **goals** may be seen as the *higher level* needs and desires of the Decision Maker. For instance, repaying an investment within n years may be seen as a goal. Goals are usually expressed in term of either the objectives, or the attributes of the decision problem.

Two main sub-types of decision problems may be defined, depending on the complexity and characteristics of the decision-making problem being dealt with by the Decision Maker. The first sub-type

Description of Alternatives	Criteria of Choice	
	Single	Multiple
Certain	Computation	Compromise
Uncertain	Judgment	Inspiration

TABLE 4.1: Schematic presentation of the four basic modes of deciding as proposed by Zeleny [3].

consists in supplying the set of *optimal* or *good enough* alternatives of the decision problem. These alternatives are the ones that respond at best to the set of decision criteria defined by the Decision Maker. Furthermore, such solutions said to be non-dominated either because they are Pareto-Optimal (i.e.: for each of the solutions, one cannot improve any single criterion without worsening another one [3]), either indistinguishable from each other. This type of decision problems are usually called *Decision-Aid Problems* in the sense that the subset containing the *best* alternatives is sought, rather than a single *best* alternative. In the end, it is up to the Decision-Maker to choose an alternative from the *best* alternatives according to additional criteria. The second sub-type of decision problems is usually called *Decision-Making Problem*. As opposed to Decision-Aid Problems, under Decision-Making Problems, a single *best* alternative corresponding to the criteria defined by the Decision Maker is sought. The choice between Decision-Aid or Decision-Making approaches is closely linked to the specificities and complexity of the decision problem, as well as to the nature of the decisions to make (i.e.: the frequency, similarity and number of decisions to be made). An interesting discussion on the subject may be found in [86].

According to Zeleny [3], there are four basic modes of deciding, which seem to be independent of whether one is developing a Decision-Aid or a Decision-Making approach for any given decision problem. These modes depend on two parameters. The first of such parameters is linked to the description of the decision alternatives, which can be certain or uncertain. In the first case (i.e.: certain alternatives), the decision alternatives are clearly described and their consequences can be measured. In the second case (i.e.: uncertain alternatives), the decision problem criteria characterizes decision alternatives in an imprecise way. In addition, in this latter case, the outcomes of each decision alternative are uncertain. The other parameter is linked to the number of choice criteria, which can be single or multiple. In the first case (i.e.: single criterion), the preferences of the Decision Maker are expressed as a single dominant criterion. In the second case (i.e.: multiple criteria), the preferences of the Decision Maker are expressed by a set of criteria containing more than one criterion.

In Table 4.1, the four basic modes of deciding are named: *Computation*, *Judgment*, *Compromise*, and

Inspiration. Based on what was proposed by Zeleny and for the sake of clarity, a brief description of each of these modes of deciding shall be provided. For further information the interested reader may refer to [3].

In the Computation deciding mode, a single clearly-defined and measurable criterion is used to assign each alternative a single number. Then, the alternative having the *best* value is determined.

In the Judgment deciding mode, the objective is usually single-dimensional and clearly stated, but poorly measurable. In this case, one is typically uncertain of which alternative will actually give the *best* outcome, and some direct human judgment of the causal relationships between alternatives and outcomes is required.

In the Compromise deciding mode, multiple competing objectives are defined and, contrary to the Judgment deciding mode, the causation may be quite clear. In this mode, each alternative is characterized by a multidimensional vector of numbers. Firstly, the subset of *good enough* alternatives corresponding to the criteria defined by the Decision Maker is determined. Then, it is usually up to the Decision Maker to make the final choice.

Finally, the Inspiration mode of deciding typically involves a mixture of quantitative and qualitative multiple criteria as well as uncertain causal relationships between each alternative and its possible outcome. Often, this mode requires some creativity from the Decision Maker who may need, for instance, to invent a new alternative, or create a new vision of the decision problem.

4.4 Some Particularities of the Problem Addressed in This Work

This work deals with the problem of scheduling a power system cell under electricity market conditions. Under such a problem, decisions about the setpoints and/or commitment of the dispatchable elements of such cell have to be taken for multiple points in time. Furthermore, in many cases, such decisions are taken *sequentially* in time in the sense that decisions taken now are influenced by the decisions taken previously and, in turn, influence decisions to be taken subsequently. One is therefore in the presence of a *sequential* decision problem.

Apart from the sequential structure of the decisions to be taken, such decisions are to be taken everyday during the whole lifetime of the power system cell. Therefore, this decision process will be run repeatedly for a large time span. This means that there will be a high number of *rather similar* scheduling decisions that will be made through the lifetime of the power system cell.

Once the scheduling problem criteria are well specified, the decision problem becomes somewhat (but not perfectly) a technical one [3] in the sense that the final decision can be *determined* based on an adequate optimization method taken from operations research theory. However, it should be said that the scheduling problem specifications may imply many *optimal* or *suboptimal* decisions to exist. In this case, the final decision will have to be taken by the Decision Maker. Nevertheless, the Decision Maker may be responsible for managing multiple power system cells each comprising a large amount of dispatchable elements (e.g.: a utility responsible for managing multiple microgrids). In such a case, it will be difficult for the Decision Maker to make decisions on the setpoints and/or commitment of each dispatchable element of every cell he/she owns and for each point in time (e.g.: each hour of the day).

The Decision Maker may follow either a decision-aid or decision-making approach. The first one implies identifying the subset of *good enough* decisions on the setpoints and/or commitment of each dispatchable element of every considered power system cell at each point in time. Although this approach permits to obtain a reduced set of *good enough* decisions, it implies the Decision Maker to be continuously involved in the decision process. In many cases, this may not be the best choice, because it implies the Decision Maker to spend a lot of time making *similar* decisions, when he/she often has other important and rather different decisions to make (e.g.: which investments to make; how, where and when to perform maintenance actions; quality assurance, etc.). Consequently, there seems to exist a need for automatic decision processes. We have therefore opted to tackle the power system cell scheduling problem through a decision-making approach, which seems more convenient for automatic decision processes as it reduces the need for the Decision Maker to *manually* make decisions. Under such approach, the scheduling problem characteristics and objectives (i.e.: criteria) are supposed to be fully specified by the Decision Maker. Furthermore, the outcomes of the decisions are also assumed to be sufficiently well-known. In such a case one falls into the Computational basic deciding mode introduced in section 4.3 and that usually resorts to some kind of mathematical-based approach for making decisions.

In the context of this work, the main mathematical approaches for solving power system scheduling

problems have been discussed in chapter 3. However, such approaches are meant to address *sufficiently* deterministic scheduling problems in the sense that the uncertainties associated to such problems do not have (or are *judged* not to have) a major importance in the scheduling decisions. This is usually not the case of the power system cell scheduling problem in which uncertainties may play an important role.

Many types of uncertainties may have an important impact on the outcome of the power system cell scheduling decisions. A first example may be the uncertainty associated to electricity market price forecast, which may imply the power system cell bids obtained through scheduling decisions to be accepted or not. This type of uncertainties may also imply reductions on the profit of the power system cell operator due to the selection of sub-optimal (or not optimal at all) schedules [87]. Another type of uncertainties that may be associated to the scheduling of the power system cell are linked with the variability of the outputs of the non-dispatchable elements (e.g.: wind turbine generators, solar-based electricity generators) of the cell, if such exist. It is impossible to know in advance which will be the *exact* amount of power output associated to these types of sources. Therefore, for performing the scheduling of the power system cell, one must rely on available power output forecasts associated to such non-dispatchable generators. However, such forecasts contain some amount of error, which implies some amount of uncertainty to be associated to them [88]. These are not the *only* types of uncertainties that may be associated to the power system cell scheduling problem. For instance, power system cells may be composed of an aggregation of elements that do not have a direct physical connection between them [21, 89]. In that case, the uncertainty associated to the possibility of network congestion may gain importance. However, such types of uncertainties are not considered in the present work.

4.5 Main Approaches for Making Decisions Under Risk

In the literature [90], one often finds the term *Decision-Making Under Uncertainty* for referring to the class of decision-making problems in which the *imperfect* knowledge of the future is incorporated in the decision process. However, the presence of uncertainties in a given decision problem does not necessarily imply the Decision Maker to incur negative impacts. As an example, in photovoltaic-hybrid isolated systems, the fact that tomorrow there might be no sunshine (which constitutes an uncertainty on the future solar radiation conditions) does not necessarily mean the isolated grid will shutdown if

it contains enough energy storage. This simple example clearly illustrates that there is a difference between the presence of uncertainties and the possibility of obtaining negative impacts due to the presence of such uncertainties. Such negative impacts are often named risks [91]. In this work, the focus was put on the negative impacts that may be caused by the uncertainties associated to the power system cell scheduling problem. Therefore, the term *Decision-Making Under Uncertainty* has been replaced by the term *Decision-Making Under Risk* in the remainder of the discussion. It should however be stressed that this term is not new and was also used in [3, 83].

Decision-making problems under risk can be seen as problems of betting in (i.e.: choosing) a given preferred decision alternative taken from a set containing all feasible *best* alternatives [90]. Intuitively, due to fact that the Decision Maker only holds an *imperfect* knowledge of the future, each of such *best* alternatives comprises some amount of risk (or else, uncertainties do not play an important role from a negative consequence viewpoint). Therefore, a *natural* way to integrate the uncertainty associated to any given alternative into a decision model is to define, evaluate and consider its associated amount of risk. Due to the particularities of the scheduling problem addressed in this work, which were described in section 4.4, such model should be simple enough for enabling its implementation and operation on a standard computer.

Numerous risk-based models may be designed and used for making decisions under risk (or for guiding the Decision Maker in the process of making such decisions). However, for making such decisions one must first define and follow some principle on the way to evaluate and compare decision alternatives as objectively as possible. Many principles for making decisions under risk exist in the literature [3, 90, 92–94] and a state of the art is presented in [83]. Here, the main principles are briefly described based on information taken essentially from [3, 83, 93].

4.5.1 Expected Value

Under the Expected Value decision principle, the *best* decision is taken as the one that maximizes the expected value of the decision attribute. As an example, let A , B and C be three different investments with expected returns $E(A)$, $E(B)$ and $E(C)$, respectively. Let the decision attribute be single and equal to the *expected return* of the investment. If $E(C) > E(B) > E(A)$, the expected value decision principle indicates that investment C has the greatest priority. This situation is illustrated in Figure 4.2.

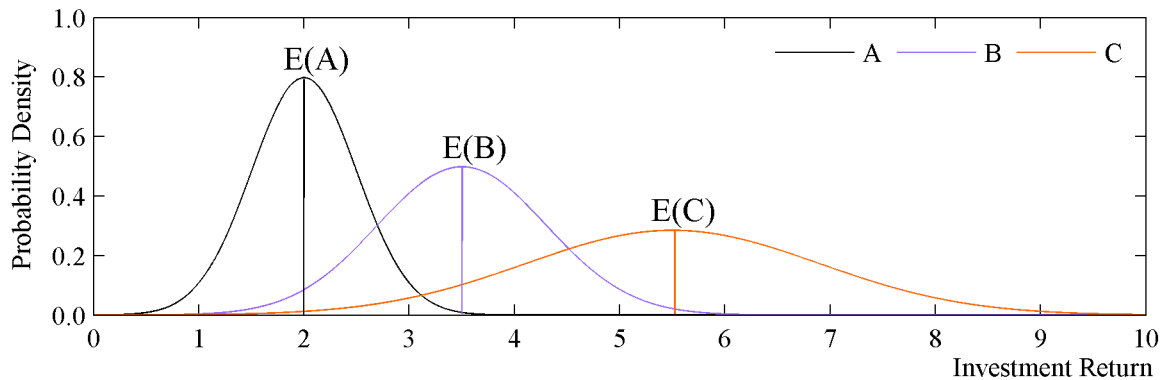

FIGURE 4.2: Example of a decision-making problem comprising three alternative investments: A, B and C.

In spite that investment C presents the highest expected return, it also comprises the highest variance, which implies it to present the highest *variability* of return to the Decision Maker [95, 96]. In this particular example, this does not pose a problem as investment option C *stochastically dominates* all others[†]. However, in many investment problems, this may pose a problem if the Decision Maker is *averse* to such variability, in the sense that he/she desires to avoid *as much as possible* the variability associated to the investment return.

It is clear that, however simple, this decision principle does not integrate a risk measure or variability measure associated to the possible outcomes of each possible decision. For instance, if one considers a distribution density dispersion measure as the variance to be a measure of risk and if the Decision Maker behaves as risk *averse*, then the investment choice may be different. In fact, depending on *how much* the Decision Maker is risk averse, investment option C may become uninteresting due to its larger variance. Of course, in this example, such behavior would not be rational, because the Decision Maker never incurs any losses, no matter the investment option that is made[‡].

Finally, the Expected Value decision principle is rather prescriptive disregarding any subjectivity or judgment that the Decision Maker might have [97]. This is due to the fact that this decision principle does not seek to integrate the Decision Maker's needs and desires in the decision-making process. Instead, it focuses on measuring the expected outcome of each decision (e.g.: expected profit) regardless of the Decision Maker's specific preferences. Hence, in situations in which preferences of the Decision Maker other than the expected return of an alternative are to be integrated, some other decision principle has to be used.

[†]The concept of Stochastic Dominance will be described in a later section.

[‡]For affirming this it is supposed that no *minimum* and *maximum* revenues are fixed by the Decision Maker

4.5.2 Utility Theory

Utility Theory was first proposed by Bernoulli in 1738 at the Imperial Academy of Sciences in Petersburg [97]. In such proposal, Bernoulli criticized the Expected Value decision principle for not incorporating the preferences of the Decision Maker in the decision process. Utility Theory responds to that weakness by putting the individual preferences of the Decision Maker at the center of the decision process. Under this principle, the *best* decision is taken as the one that maximizes the expected utility of the Decision Maker [3, 90].

The first version of Utility Theory, as presented by Bernoulli, suffered from one weakness [90]:

“Why should all rational individuals in making their choice abide by this theory?”

For overcoming such weakness, John von Neumann and Oskar Morgenstern [98] have provided a set of axioms. These axioms seemed to be reasonable enough [90] and, whenever satisfied, make it possible to construct a cardinal utility function on the outcome space. A description of such axioms may be found in [90].

An interesting characteristic of Utility Theory is that it does not integrate risk explicitly, but implicitly [83]. This is because measures of risk are not integrated directly in the utility function of the Decision Maker. However, once this function is determined, it intrinsically expresses the risk attitude profile of the Decision Maker. Three main types of risk attitudes exist: risk *proneness*, risk *neutrality* and risk *aversion* as described in Figure 4.3.

A Decision Maker is said to be risk prone if the corresponding utility function translates a willingness to give a premium to higher risk situations. This is translated by curve *RP* in Figure 4.3, where one can see that the utility function has a lower “velocity” in presence of lower returns, which are often linked to lower risk situations, and “accelerates” in presence of higher returns, which are often linked to higher risks.

A Decision Maker is said to be risk neutral if the corresponding utility function does not present a risk premium or penalty associated to any possible outcome. This is translated by the constant slope of curve *RN* in Figure 4.3. If the Decision Maker is risk neutral, and if the single attribute of the decision

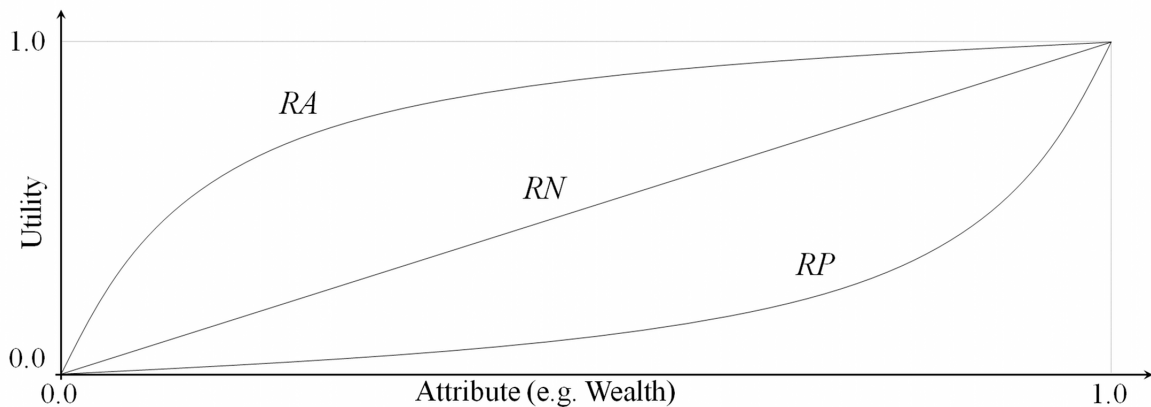

FIGURE 4.3: Illustration of the three possible risk attitudes that may characterize a Decision Maker: Risk Aversion (RA), Risk Neutrality (RN) and Risk Proneness (RP).

problem is the expected value of each decision, then the decision alternative selected by an approach based on Utility Theory is the same than that determined *via* an approach based on the Expected Value decision principle.

Finally, a Decision Maker is said to be risk averse if the corresponding utility function translates a willingness to penalize higher risk situations whilst favoring lower risk ones. This is translated by curve *RA* in Figure 4.3 where one can see that the utility function has a higher “velocity” in presence of lower returns, which are often linked to lower risk situations, and “decelerates” in presence of higher returns, which are often linked to higher risks.

The Utility Theory decision principle supplies a somewhat normative procedure for making decisions [83] making them appealing from an operational viewpoint. Indeed, once the risk attitude of the Decision Maker is defined by the corresponding utility function, alternatives can be chosen without further contribution from the Decision Maker.

Determining the utility function of a given Decision Maker is usually a hard task. In [3], five basic steps for performing utility assessment are proposed and described.

In spite of its intuitive appeal, Utility Theory has been criticized by several authors[†]. Indeed, in some cases, Utility Theory failed to explain the choice of individuals under uncertainty (e.g.: the so-called *Allais Paradox* in which individual choices violate Expected Utility Theory) [90, 100, 101]. This led to

[†]An example of such criticisms can be found in [99].

the development of several sub-approaches based on Utility Theory, but incorporating several types of problem-dependent corrections to such theory. These approaches are commonly named *Non-Expected Utility Theory* approaches [90, 101].

Non-Expected Utility Theories differ from Expected Utility ones mainly in the way their functionals are created. In [101], different Non-Expected Utility Theory functionals are presented (e.g.: a functional dedicated to “Prospect Theory”). It is out of the scope of this work to run a detailed analysis on these different functionals. For further reference on the subject, the interested reader may refer to [90, 101].

4.5.3 Stochastic Dominance

Stochastic Dominance is a term referring to a technique of comparison of different stochastic alternatives described by probability distributions [102]. The Stochastic Dominance concept may be used in many applications (e.g.: analysis of income distributions and financial economics). In simple terms, Stochastic Dominance techniques may be used for comparing different random variables and rank them according to their *size*. Hence, Stochastic Dominance represents an alternative way for ranking the Decision Maker’s preferences. However, it should be stressed that Stochastic Dominance is not in itself a decision principle as, for instance, Utility Theory.

As mentioned previously, the utility function of the Decision Maker is usually hard to determine. One of the main advantages of using Stochastic Dominance is that it does not need such function to be determined. Furthermore, under some conditions [3, 90], it guarantees that the resulting decisions are in line with those that would have been made by the Decision Maker. It is out of the scope of this work to run a deep analysis and discussion of such principles. Here, only the basic concepts behind the use of Stochastic Dominance for making decisions under risk will be presented. For further reference on the subject please refer to [3, 90, 102].

A short description of the Stochastic Dominance concept shall be hereby provided based on [3, 90, 102]. The Stochastic Dominance between random variables is determined in increasing orders. The first order is the so-called *First-order Stochastic Dominance* or, FSD. We shall begin by defining the FSD conditions, as subsequent Stochastic Dominance conditions are recursively defined by the FSD ones. Let $f(x)$ and $g(x)$ represent the probability density functions of the outcome $x \in \mathbb{R}$ associated to alternatives F and G , respectively. In such a case, alternative F is said to *stochastically dominate*

alternative G in the first order if and only if:

$$\int_{-\infty}^x f(z_1) dz_1 \leq \int_{-\infty}^x g(z_1) dz_1, \quad \forall x \in \mathfrak{R} \quad (4.1)$$

Equation 4.1 defines the FSD conditions for stochastic dominance. In many practical cases, when verifying the FSD conditions associated to outcome distributions of a set of alternatives, one or more conflict situations may exist. This indicates that there is no alternative that stochastically dominates all others at the first-order. In other words, whenever such conflicts exist, FSD conditions are not granted. In such cases, for determining the *dominant* alternative, under the Stochastic Dominance principle, one needs to resort to the evaluation of higher-level stochastic dominance conditions.

Higher-level stochastic dominance conditions are determined in basically the same way than that of FSD conditions. For instance, Second-order Stochastic Dominance (SSD) conditions can be determined by performing a second integration of both members of the inequality described by Equation 4.1. Equation 4.2 defines the way to determine SSD conditions.

$$\int_{-\infty}^x \int_{-\infty}^{z_2} f(z_1) dz_1 dz_2 \leq \int_{-\infty}^x \int_{-\infty}^{z_2} g(z_1) dz_1 dz_2, \quad \forall x \in \mathfrak{R} \quad (4.2)$$

Analogously, the n^{th} -order conditions may be determined by Equation 4.3.

$$\underbrace{\int_{-\infty}^x \cdots \int_{-\infty}^{z_2}}_n f(z_1) dz_1 \dots dz_n \leq \underbrace{\int_{-\infty}^x \cdots \int_{-\infty}^{z_2}}_n g(z_1) dz_1 \dots dz_n, \quad \forall x \in \mathfrak{R} \quad (4.3)$$

Equations 4.1, 4.2, and 4.3 make it clear that the verification of n^{th} -order conditions implies higher order Stochastic Dominance conditions to be also verified (i.e.: the verification of FSD conditions implies SSD conditions to be verified and the verification of SSD conditions implies Third-order Stochas-

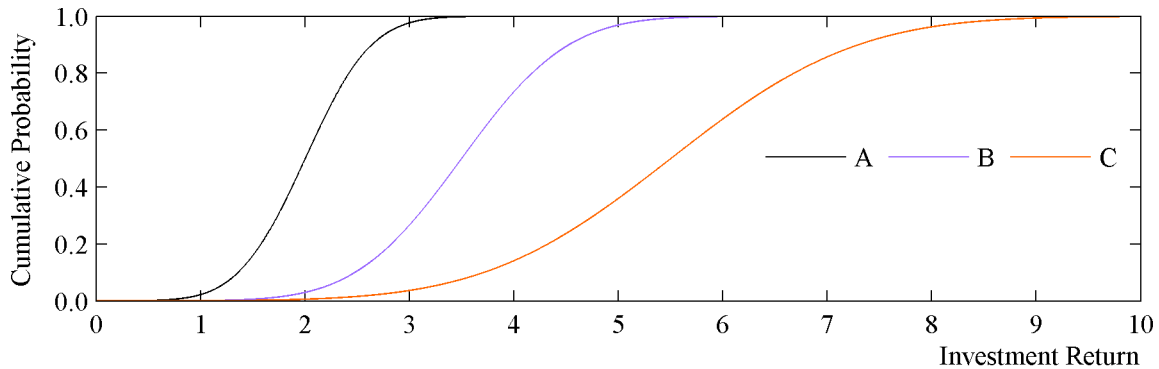

FIGURE 4.4: Verification of FSD conditions for the the three alternatives cases described in Figure 4.2.

tic Dominance conditions and so forth). However, higher-order conditions represent an ever weaker stochastic dominance of one random variable over another because the need to verify higher order Stochastic Dominance conditions comes from the increasing similarity between the random variables under consideration. We shall now proceed by incorporating some practical examples that better describe this idea.

In subsection 4.5.1, it was stated that alternative C depicted in Figure 4.2 *stochastically dominates* all others. If such statement is true, then some order of Stochastic Dominance must confirm it. In Figure 4.4, the results of the application of the FSD conditions described by Equation 4.1 to the three alternatives depicted in Figure 4.2 are described.

In Figure 4.4, one clearly sees that alternative C verifies FSD conditions relatively to both alternatives A and B , because the corresponding curve always takes values less than or equal to those corresponding to the other curves[†]. Because FSD conditions are verified, no higher-order conditions need to be checked and one can say that alternative C has a *strong* Stochastic Dominance (i.e.: the highest possible) in comparison to alternatives A and B , which confirms the statement made in subsection 4.5.1 regarding Figure 4.2.

We will now illustrate a somewhat extreme case, in which alternatives A , B , and C have equal expected values (i.e.: $E(A) = E(B) = E(C)$), but different variances. Figure 4.5, illustrates a case corresponding to such predefined conditions.

[†]The easiest way to see this graphically is to realize that, for any given order of Stochastic Dominance, if Stochastic Dominance conditions are checked for any given alternative, than its plot will either coincide with, either be placed to the right of the remaining alternatives but will never contain any part placed to the left of any other alternative.

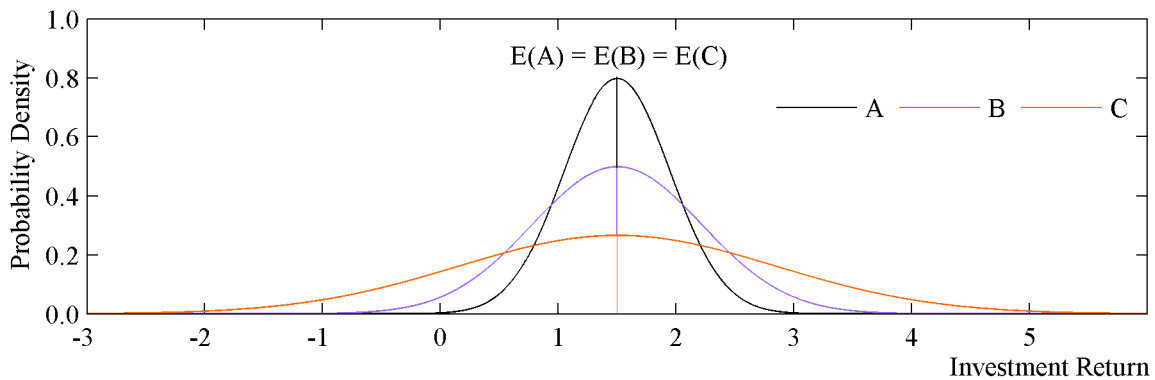

FIGURE 4.5: Example of a decision-making problem comprising three alternative example investments: A, B and C. In this case, the three options have equal expectancy but different variances, which distinguishes this case and the one presented in Figure 4.2.

In Figure 4.5, one can see that the sole utilization of the expectation value of the different alternatives is insufficient for distinguishing them. Hence, one has to resort to some additional information. In this case, such additional information may be given by the different variances that are associated to each of the revenue distributions. The consideration of variances may lead to the selection of different alternatives depending on the risk attitude of the Decision Maker. As previously discussed, three main options exist for characterizing the risk attitude of the Decision maker: risk neutrality, risk proneness and risk aversion. In case the Decision maker is risk neutral, an indifference between the distributions of return of the three alternatives exists ($E(A) = E(B) = E(C)$) and one can pick one of them at random. In case the Decision maker is risk prone, alternative C may be the preferred one as it allows to reach higher values of return. However, alternative C also implies a higher probability of obtaining revenue losses as well as higher absolute value of revenue losses (i.e.: it contains a higher amount of financial risk). Finally, in case the Decision Maker is risk averse, alternative A may be the preferred one because it has practically no probability of losses and a lower dispersion (i.e.: higher certainty associated to its outcome) for the same amount of expected value (i.e.: its the alternative that comprises the least amount of risk if the expected value is assumed as the *target* value of outcome).

In the frame of Stochastic Dominance, the distinction between the alternatives may be made by testing Stochastic Dominance Conditions sequentially starting from the first level ones (i.e.: FSD conditions). Figure 4.6 depicts the curves corresponding to the verification of FSD conditions on the three cases shown in Figure 4.5.

In Figure 4.6, one can see that all alternatives are perfectly indistinguishable under FSD conditions as

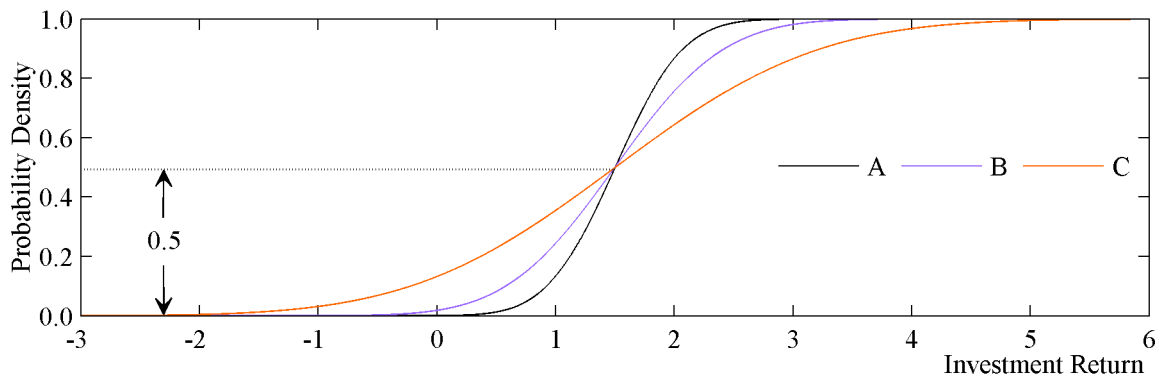

FIGURE 4.6: Verification of FSD conditions for the three alternative case described in Figure 4.5.

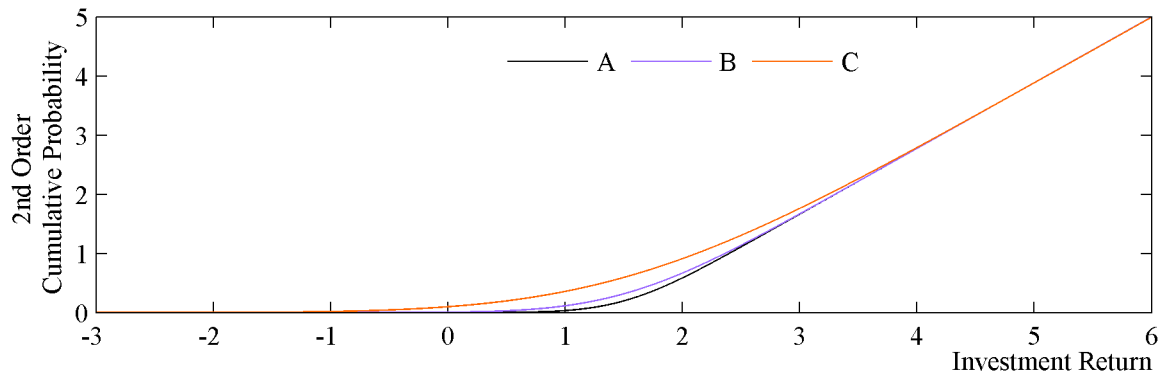

FIGURE 4.7: Verification of SSD conditions for the three alternative case described in Figure 4.5.

they cross each other at a single point. Furthermore, due to their normality, all three distributions are symmetric and cross at the point in which the investment revenue is equal to the expectancy of the distributions and where $P(\text{Revenue} \leq \text{Expectancy}) = 0.5$.

Figure 4.6 indicates that FSD conditions are not verified for the case depicted by Figure 4.5. Consequently, higher-order conditions must be checked in order to distinguish alternatives A , B , and C . The results obtained regarding the SSD conditions for this case are depicted in Figure 4.7.

It is clear that SSD conditions are verified (*vide* Figure 4.7), which enables to distinguish among alternatives A , B , and C . According to the SSD conditions definition given by Equation 4.2, alternative A stochastically dominates the remaining ones. This is in line with the choice that would have been

made by a risk averse Decision Maker[†]. However, SSD conditions are weaker[‡] than FSD ones which renders the distinction among the alternatives depicted in Figure 4.5 somewhat controversial. Indeed, if the Decision Maker is risk prone, then alternative C would likely be chosen, as was previously described, if Stochastic Dominance conditions were not checked. This simple example shows that the Stochastic Dominance principle should be used with some caution as the conclusions that one may draw under this principle can differ from those that would have been made by a Decision Maker.

The problem stated in the previous paragraph demonstrates also the main motivation for using Stochastic Dominance: the desire to avoid the often difficult process of determining the utility function of the Decision Maker. However, under this decision principle, some assumptions on the form of such utility function are implicitly made. One of them is that the Decision Maker is a *rational* one [90] and, as such, is averse to risk.

In spite of its inherent limitations, the Stochastic Dominance principle seems to be a good principle for decision-making problems under uncertainty. One of its main advantages is that it *only* imposes knowledge on the outcome probability density functions of the set of alternatives under analysis and no subjectivity whatsoever may condition the results. This *advantage* is also the main drawback of the method as it neglects the preferences of Decision Maker in the decision process. This is the same basic problem that was highlighted by Bernoulli in his proposal for using Utility Theory in decision-making processes [97].

Another limitation of Stochastic Dominance is that it needs to have knowledge of the complete probability density function of the outcome of each alternative. In many cases, it is hard (if not impossible) to determine such set of functions due, for instance, to lack of data. Furthermore, in multi-attribute decision processes Stochastic Dominance techniques become hard to use.

Due to the fact that they use complete probability density functions as inputs, Stochastic Dominance techniques often imply complex calculations which may be a limiting factor if one has to compare a large set of alternative prospects. However, Stochastic Dominance techniques may likely be used for

[†]Such Decision Maker is sometimes characterized as being a *rational* one [103, 104]. Nevertheless, in some cases, the so-called *rational* Decision Maker does not necessarily follow such a *conservative* pattern as stated by Allais in [100]: “Pour celui qui désire à tout prix une forte somme, le jeu peut être le seul moyen rationnel de se le procurer.”, which may well mean that in some situations, the risk-prone Decision Maker may be characterized as being *rational*, whilst following a non-conventional pattern in the decisions he/she makes.

[‡]This is always true in the sense that one only needs to check higher-order Stochastic Dominance conditions if lower-order ones are not enough for distinguishing the decision alternatives. In other words, the n^{th} -order Stochastic Dominance conditions are always *weaker* than any $(n - k)^{th}$ ones, where $n, k \in \mathbb{Z}^+$ and $n > k$.

reducing such set of alternatives by only calculating some orders of Stochastic Dominance and then storing the *best similar alternatives*.

Finally, the previous example seems to indicate that decisions that are at least similar to those that would have been made by Stochastic Dominance techniques are achievable by the use of somewhat simpler methods based on the moments of the probability density functions.

4.5.4 Mean-Variance

As was seen in previous sections, the Expected Value, the Utility Theory, and the Stochastic Dominance decision principles present several limitations. In short, the Expected Value principle is not well adapted to the incorporation of the eventual risk that might be associated to the decision alternatives. Although elegant and intuitive, the Utility Theory principle imposes the determination of the Decision Maker utility function, which can be time-consuming and hard to do. Finally, under the Stochastic Dominance principle, there is a natural tendency not to keep the Decision Maker close to the decision process, which may be unacceptable in some situations and lead to undesired alternative selection in others.

Due to the difficulties in accurately estimating the *utility* function of the Decision Maker[†], for keeping the Decision Maker closer to the decision-making problem (by using a risk attitude factor β corresponding to the risk attitude of the Decision Maker) and to incorporate the risks eventually associated to each alternative, decision problems may be resolved or, at least, simplified by following a Mean-Variance decision principle based on a mean-variance model [83, 94]. These types of models have first been used by Markowitz in [105, 106] for approximating the expected utility of the Decision Maker and are often used in portfolio management and optimization problems [94, 107–111]. Mean-variance models may be described by Equation 4.4[‡],

$$E(U(a)) = E(a) - \beta \cdot Var(a) \quad (4.4)$$

[†]In fact, in some cases many decision makers or Decision Agents may be involved in the decision process, which means that, at least in a first step, several utility functions need to be determined.

[‡]Equation 4.4 in fact approximates the expected utility of the Decision Maker $E(U(a))$ by a mean-variance model as discussed in the following paragraphs.

where:

- a represents the alternative under analysis;
- $U(a)$ represents the utility of the Decision Maker associated to alternative a ;
- $E(U(a))$ represents the expected utility of the Decision Maker associated to alternative a ;
- $E(a)$ represents the expected return associated to alternative a ;
- β represents the risk attitude of the Decision Maker;
- $Var(a)$ represents the variance of the return associated to alternative a .

Let us consider a simple example of application of the mean-variance model for illustrating how the risk attitude of the Decision Maker is captured. For instance, let us consider the example depicted in Figure 4.8 included below.

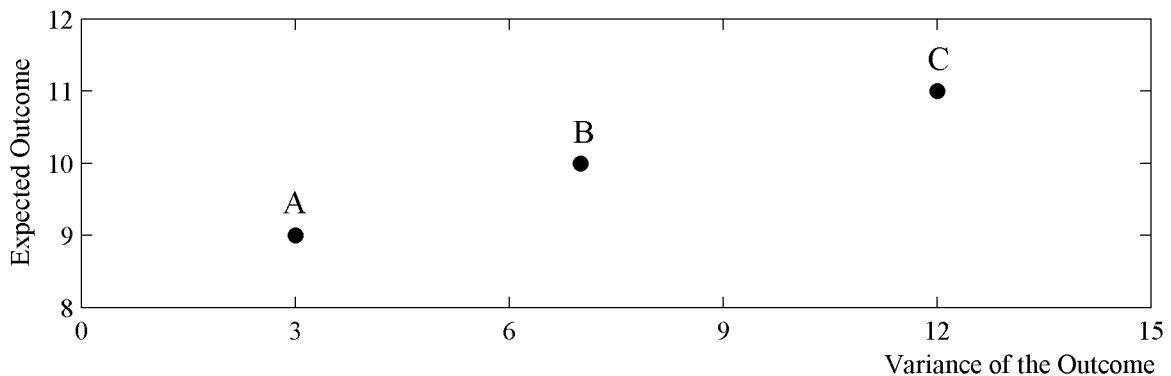

FIGURE 4.8: Representation of three arbitrary options (A , B , and C) on the E-V plane.

In Figure 4.8, three arbitrary options (A , B , and C) are described by their respective values of mean and variance on the E-V plane. In such example, the alternatives expectations follow the relation $E(C) > E(B) > E(A)$ with $Var(C) > Var(B) > Var(A)$. The goal is to choose *the best alternative* under the Mean-Variance decision principle from a set of Pareto-Optimal alternatives[†].

In Equation 4.4, one can see that, under the mean-variance decision principle, regarding a given alternative a , the Expected Utility $E(U(a))$ of the Decision Maker is approximated as a function of the

[†]Here, Pareto-Optimal alternatives are defined as those that are non-dominated in the sense that one cannot lower the Variance by changing from a given alternative to another without reducing the Expected Return and *vice versa*.

	Alternative a	$E(a)$	$Var(a)$	β	$E(U(a))$	Chosen Alternative
Decision Maker 1	A	9	3	0.12	8.64	C
	B	10	7	0.12	9.16	
	C	11	12	0.12	9.56	
Decision Maker 2	A	9	3	0.24	8.28	B
	B	10	7	0.24	8.32	
	C	11	12	0.24	8.12	
Decision Maker 3	A	9	3	0.48	7.56	A
	B	10	7	0.48	6.64	
	C	11	12	0.48	5.24	

TABLE 4.2: Example of application of the mean-variance decision principle for determining which of the alternatives $a \in \{A, B, C\}$ described in Figure 4.8 can be considered as being the best one for three different arbitrary values of risk averse attitude $\beta \in \{0.12; 0.24; 0.48\}$, where each value corresponds to one of three hypothetical decision makers.

expected outcome $E(a)$, of the variance of such outcome $Var(a)$, and of the Decision Maker risk attitude β . Hence, the decision on the best alternative can be determined once these three parameters are known. Furthermore, under these conditions and at the light of the mean-variance principle such alternative can be taken as being the *optimal* one. Consequently, *prior* to quantifying the risk attitude of the Decision Maker, every alternative described in Figure 4.8 can be considered as a *potentially optimal* one. This is illustrated in Table 4.2, where a fixed set of Pareto-Optimal alternatives is represented. In the same example, three different decision makers are modeled with respect to their risk attitudes and one can see that, under the mean-variance decision principle, the *best* alternative (the one that would be chosen) changes with each Decision Maker.

The use of mean-variance models for approximating the Expected utility of Decision Markers is quite simple as illustrated by the previous example. However, the literature contains many criticisms relative to the approximation of the Decision Maker utility function by mean-variance models [112–115]. It is not the objective of this work to run a thorough analysis of such criticisms. Here, only the criticisms that seem to be the most important for the present work are mentioned.

One of the criticisms made to the use of mean-variance models for approximating the utility function of the Decision Maker is related to the fact that such models use the variance as a risk measure [113, 114]. This is criticized in part because the variance penalizes the possibility of obtaining negative outcomes as well as the possibility of obtaining higher than expected gains. Furthermore, in many cases, the distributions of outcome are asymmetrical and the variance of the return becomes rather insufficient for measuring the risk associated to the outcome of a given alternative. As a conclusion, using the

variance as a risk measure is not recommended in general.

Another important criticism to using mean-variance Markowitz models for approximating utility functions is that such approximations imply the utility function of the Decision Maker to be quadratic. A consequence of such type of functions is that the absolute risk aversion of the Decision Maker increases with the outcome (e.g.: wealth), which does not seem to be plausible [115].

4.5.4.1 The Mean-Variance Model as a Spot-Risk Model

Some of the problems of mean-variance models may be solved or, at least, alleviated if variance is not imposed as a risk measure. Furthermore, in cases in which the distribution of the outcome of a given alternative is asymmetric, it may be preferable to use median point predictions at the place of mean point predictions for reducing the error between the prediction of the outcome of a given alternative and the *actual* realization of such outcome [88]. Hence, we suggest to replace the mean-variance model by a more generic one, which we name hereafter as spot-risk model. Similar to the mean-variance model, in the spot-risk model, the *spot* value SV may take the form of the expected outcome of the alternative, of the median outcome of the alternative or any other type of point prediction of the outcome of a given alternative a . At the same time, the risk measure \mathcal{R} used in such spot-risk model is generic in the sense that it may be adapted to the needs and desires of the Decision Maker. For instance, \mathcal{R} may take the form of a VaR (Value at Risk), of a CVaR (conditional Value at Risk), and of a function of the different moments (e.g.: variance, skewness, kurtosis, ...) associated to the distribution of outcomes associated to every alternative a . Analogously to Equation 4.4, the spot-risk model may be expressed by Equation 4.5, where β represents the risk attitude of the Decision Maker.

$$E(U(a)) = SV(a) - \beta \cdot \mathcal{R}(a) \tag{4.5}$$

4.5.5 Compromise Programming

Compromise Programming can be seen as a multi-criteria *transparent* [116] decision principle that performs a direct ranking through strong ordering of available alternatives. In [3], compromise is

defined as *an effort to approach or emulate the ideal solution as closely as possible*. This decision principle is based on the theory of the *Displaced Ideal* according to which alternatives that are *closer* to a given infeasible ideal are preferred to those that are *farther* away [117]. One can therefore consider that, under the Compromise Programming decision principle, the *closeness* of the different alternatives to a given *ideal* (yet unattainable) alternative is evaluated. Consequently, some measure of the distance between each alternative and the *best* feasible alternative, considered here to be the central point, needs to be used. Some of the most frequently used distance measures are the so-called *Minkowski distances* (also commonly named L_p -norms, L_p -metrics and L_p -distances) [3, 93, 116, 118–123].

4.5.5.1 Short Description of Minkowski Distances

Minkowski distances can be seen as composing a family of L_p distance measures with respect to parameter p between any two points $E \curvearrowright (x_1^E, x_2^E, \dots, x_n^E)$ and $F \curvearrowright (x_1^F, x_2^F, \dots, x_n^F)$, where $E, F \in \mathbb{R}^n$. Equation 4.6 defines such family of distances similarly to the definition found in [121].

$$L_p(E, F) = \left(\sum_{i=1}^n |(x_i^E - x_i^F)^p| \right)^{1/p} \quad n, p \in \mathbb{Z}^+ \quad (4.6)$$

The most well-known Minkowski distances are the so-called *Manhattan Distance* [124][†], the *Euclidean Distance* and the hereby named *Infinite Distance*. The Manhattan distance is obtained from Equation 4.6 with $p = 1$, which gives Equation 4.7.

$$L_1(E, F) = |x_1^E - x_1^F| + |x_2^E - x_2^F| + \dots + |x_n^E - x_n^F|, \quad n \in \mathbb{Z}^+ \quad (4.7)$$

[†]This distance is also commonly named *taxi-cab distance* [125].

The Euclidean distance is obtained from Equation 4.6 with $p = 2$, which gives Equation 4.8.

$$L_2(E, F) = \sqrt{(x_1^E - x_1^F)^2 + (x_2^E - x_2^F)^2 + \dots + (x_n^E - x_n^F)^2}, \quad n \in \mathbb{Z}^+ \quad (4.8)$$

Finally, the Infinite distance is from Equation 4.6 when $p \rightarrow \infty$, which gives Equation 4.9.

$$L_\infty(E, F) = \max \{|x_1^E - x_1^F|, |x_2^E - x_2^F|, \dots, |x_n^E - x_n^F|\}, \quad n \in \mathbb{Z}^+ \quad (4.9)$$

This last distance, the Infinite distance, is commonly used in *Robust Programming* [83], as it allows to select the alternative that better behaves in *worst-case* situations or scenarios as shown in [93, 119] and is especially well-suited for *single-shot* decision situations in which *eventual* bad outcomes of present decisions cannot be overcome by good outcomes of future decisions.

In Figure 4.9, different Minkowski distance isolines between points $E_{\curvearrowright}(0, 0)$ and $F_{\curvearrowright}(x_1, x_2)$ are represented for different values of p , where $x_1 \in [0; 1]$. For producing such isolines, a fixed value of Minkowski distance was used ($L_p = 1$), and the coordinate x_1 was taken as the independent variable. When $p = 1$, the behavior of the isoline is perfectly linear. For $p > 1$, the isolines become non-linear. Such non-linear behavior intensifies with the magnitude of p in the sense that the corresponding become increasingly farther away from the linear one with the increase of p . When x_1 increases, for obtaining points F at an exact distance of 1 from point E , the coordinate x_2 progressively decreases from 0.0 to -1.0 . Furthermore, the speed of such decrease strongly increases with the increase of p . Consequently, the distance between a given point $F_{\curvearrowright}(x_1, x_2)$ to the origin will take highly different values for slightly different values of p , which means that, as p increases, smaller differences in one of the coordinates are increasingly valued.

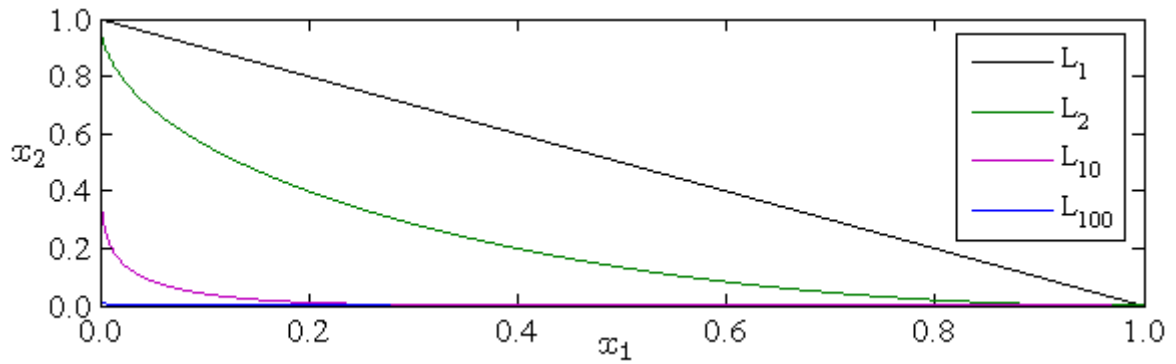

FIGURE 4.9: Representation of different Minkowski distance isolines.

4.5.5.2 Ranking of Alternatives Through the Use of Minkowski Distances

Methods for ranking alternatives through the use of Minkowski distances are not necessarily used for performing Decision-Making. In fact, such methods may also be used for selecting amongst alternatives or, at least, for reducing the alternative selection possibilities [3, 93, 116, 119] and examples of application may be found in [93, 116, 118–120, 122, 123].

From a decision-making viewpoint, one can consider a plausible set of future scenarios \mathcal{S} and of alternatives \mathcal{I} , where one can determine which of the available alternatives $x_{i,s}$, where $i \in \mathcal{I}$ and $s \in \mathcal{S}$, *best fits* each of the identified scenarios. Details on this process may be found in [93, 119]. The *a priori* alternative that best fits the s^{th} scenario, x_s^{Best} , is hereby referred to as the *ideal alternative* if scenario s with probability of occurrence λ_s *actually* realizes. Under such formulation, the decision-making problem may be formulated as: “find and select the decision alternative that minimizes a given predefined Minkowski distance to a given unfeasible *ideal* alternative”. This constitutes the Compromise Programming decision-making principle and may be defined by Equation 4.10 for some value of p .

$$\min_i \left\{ \left[\sum_s \left(\lambda_s^p \left| x_{i,s} - x_s^{\text{Best}} \right|^p \right) \right]^{1/p} \right\}, p \in \mathbb{Z}^+, i \in \mathcal{I}, s \in \mathcal{S} \quad (4.10)$$

In the case of the Infinite Minkowski distance (i.e.: $p \rightarrow \infty$), the Compromise Programming (Ro-

bust Programming) decision-making problem can be formulated in a simpler way, when compared to the general formulation given by Equation 4.10. In this case, such formulation may be replaced by Equation 4.11 [3, 83, 93, 119].

$$\min_i \left\{ \max_s (\lambda_s |x_{i,s} - x_s^{Best}|) \right\}, i \in \mathcal{I}, s \in \mathcal{S} \quad (4.11)$$

Figure 4.10 depicts different isoline surfaces for different values of p . The distances between the origin point $E_{\rightarrow} (0, 0)$ and a generic point $F_{\rightarrow} (x_1, x_2)$, with $x_1, x_2 \in [0; 1]$, are represented for different values of $p \in \{1, 2, 5, \infty\}$. As p is increased from 1 to ∞ , the coordinate bearing the higher value gains importance, which renders the different surfaces increasingly non-linear with p . This has obvious implications when Minkowski distances are used for solving decision-making problems in which each of the coordinates represents the outcome under a given scenario[†]. In such a case, when p is low (e.g.: $p = 1$), alternatives having average good performance under every scenario are preferred to those having good performances under some scenarios and bad performances under other scenarios. In case p is high (e.g.: $p \rightarrow \infty$), the alternative minimizing the worst possible case outcome considering every possible scenario is preferred. At the light of equations 4.10 and 4.11, this means that lower values of p favor alternatives having good overall performance. In contrast, high values of p may sacrifice alternatives with good overall performance for more *conservative* ones that minimize the worst possible outcome. In general terms, low values of p aim at identifying *central* alternatives and high values of p aim at avoiding alternatives comprising the possibility of high penalties.

4.5.5.3 Discussion on the Use of Minkowski Distances for Decision-Making

Below are given some remarks on the use of Minkowski distances for performing decision-making.

Remark 1: Figure 4.10 shows that for $p > 1$ but still rather small (i.e.: $p = 5$), the corresponding colored region starts to behave in approximately the same way than that of $p \rightarrow \infty$. At the light of Equation 4.10, this indicates that for small values of p (but with $p > 1$) one may potentially

[†]For facilitating the present discussion, only two future scenarios are supposed to exist. However, the argumentation herewith presented may be extended to any number of future scenarios.

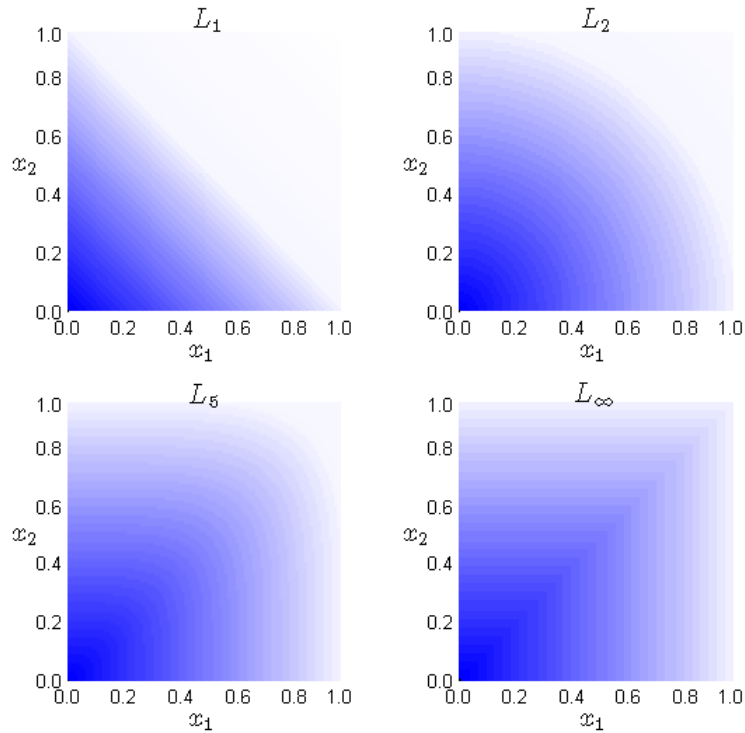

FIGURE 4.10: Representation of different Minkowski distance isoline surfaces.

obtain decisions that remain unchanged when p is pushed towards higher values.

Remark 2: It should be stressed that an alternative considered *ideal* under scenario s , can be far from being ideal under any scenario $k \neq s$. If this is not true, then there must be an alternative that dominates all others. In such cases, no *actual* decision problem exists, but one is rather faced with a *technical* problem of determining the dominant alternative [3].

Remark 3: As seen in the previous section, the particular formulation given by Equation 4.11 (Robust Programming) can be seen as rather *conservative* one. This is in line with what is stated in [83, 93, 119]. In fact, Robust Programming is especially well suited for *one-shot* decision situations in which the decision is only made once. Consequently, bad outcomes due to bad present decisions cannot be compensated by eventual future good outcomes. Therefore, such formulation is not in agreement with the Law of Large Numbers. Evaluation criteria based on frequency (e.g.: average outcome of decisions, standard-deviation analysis) are therefore not the most appropriate for evaluating the performance of decisions made under such formulation. Consequently, alternative criteria must be analyzed (e.g.: number of starts/stops of generating units, number of decisions having *large* bad outcomes, form of the outcome distributions).

4.6 Conclusions of the Chapter

In chapter 2, the two main fields of knowledge related to this work were identified: power system scheduling and decision under uncertainty. While chapter 3 discussed the scheduling problem (providing a generic scheduling model inspired by the literature review), this chapter supplied the necessary background in what regards decision under uncertainty. This permits to better understand the main concepts and decision principles enabling the consideration of uncertainties in decision processes, such as the one addressed in this work. Hence, this chapter provides an important basis for the integration of uncertainties associated to the various forecast inputs taken into account in the day-ahead power system cell scheduling methodology developed in this work, which is done in chapter 5.

Starting with a short discussion on the reasons that may justify the employment of methodologies based on decision under uncertainty, the chapter then proceeds with a discussion on the ways to model uncertainty. These first two points establish the necessary basis for the remainder of the chapter (and of the present work), which essentially deals with the decision principles that may be followed for integrating the uncertainties associated to decision-making problems in the decision process.

CHAPTER 5

Proposed Scheduling Model

CHAPTER OVERVIEW

IN this chapter, a model for performing the scheduling of a power system cell, which participates on an electricity market is proposed. The model is based on the problem characteristics described in chapter 2 and utilizes the power system scheduling concepts discussed in chapter 3.

In a first step, the proposed scheduling model is developed on a deterministic framework. As such, the model does not integrate any model of the uncertainties associated to non-dispatchable renewable energy sources forecasts, to demand forecasts, and to point price forecasts. Such deterministic scheduling model takes however into account some economical aspects of the scheduling problem (e.g.: generation costs, load remuneration, dispatchable load costs, market price forecasts, . . .) for maximizing the benefits of the power system cell operator, which in the present case correspond to the generated profits.

In a second step, the proposed deterministic model is extended for incorporating the stochastic component of the scheduling problem. For that purpose, various plug-in models for performing decision under uncertainty are proposed for accounting with the two main uncertainties of the scheduling problem, which are related to the day-ahead market prices and to the non-dispatchable energy sources and loads. Such decision under uncertainty models are based on the decision principles that were described and analyzed in chapter 4. The main goal of the models that are proposed for taking into account the uncertainties of the scheduling problem is to minimize energy deviations due to forecasts errors while taking advantage of the most interesting moments for using local energy resources in a cost-efficient way.

5.1 Introduction

As described in previous chapters, this research work is mainly focused on the management of power system cells (e.g.: microgrids, combined wind-hydro-storage facilities). Such cells may be composed of an association of various elements, such as: generators, loads, and energy storage devices. These different elements have different properties and must therefore be managed accordingly.

At the generation level, power system cells may include *dispatchable* generators (e.g.: microturbines) and *non-dispatchable* ones (e.g.: wind power generators and PV units).

Dispatchable and non-dispatchable generation can be seen as being *complementary* in some sense. Indeed, dispatchable generators may, for instance, serve for compensating the lack of controllability of their non-dispatchable counterparts. At the same time, non-dispatchable generators are often associated to the production of *green* electricity, which complements the pollution that may result from electricity production *via* dispatchable generators. Hence, some effort for combining the properties of dispatchable and non-dispatchable generators should be made. This is in line with the objective of better integrating non-dispatchable generation into power systems and could be achieved (or, at least, facilitated) by considering the production forecasts of non-dispatchable generators and associated uncertainty while scheduling their dispatchable counterparts.

The management of *dispatchable* generation has been extensively studied in the past decades and several approaches for managing such type of generators have been proposed [43, 44]. Regarding power system cells with controllable generators (e.g.: microgrid), approaches can be found in the literature [1]. On the other hand, the management of non-dispatchable generation and, more specifically, of power systems cells integrating such type of generation is more recent and challenging. Consequently, strategies and methods able to effectively integrate non-dispatchable generation are scarce, which indicates that efforts for better integrating such generation into power systems are needed.

At the demand (i.e.: consumers) level, innovative management methods[†] are also needed [1, 36, 39, 126] and start to be requested by the industry [127]. Power system cells are most likely expected to integrate metering systems [24] enabling the development and application of innovative demand-side management methods. In general, such methods should allow to increase the demand supply efficiency

[†]Such methods are often named *load management methods* or *demand-side management methods* [59].

by leveling the global power system demand throughout the day through either reducing the consumption, either transferring moments of consumption in time. In either case, such methods contribute to avoid or, at least, postpone investments on power system infrastructure[†] by modifying load profiles through the employment of peak-shaving and load-shifting techniques based on load metering data. Peak-shaving may be achieved by curtailing non-priority peak loads or by proposing consumers with electricity supply contracts that penalize electricity during expected peak-consumption periods. Load-shifting may be achieved by offering consumers incentives to move some of their peak consumption to low-consumption periods. However, it may also be achieved by enforcing electrical appliances to incorporate some load-shifting algorithm or some possibility of automatic remote control. Whichever is the case, in the context of power system cell management, the development of a scheduling algorithm that either complies, either is compatible with these advanced demand management requirements seems to be of significant importance.

Finally, novel management methods seem to be of utmost importance when considering for systems integrating energy storage devices. Classical power systems integrate very few (or even negligible) amounts of energy storage relatively to the total system capacity [59]. In addition, such power systems are managed on a least-cost basis (generally in the absence of an electricity market), which does not seek the maximization of the financial value generated by any particular component of the power system (e.g.: value of energy storage). The power system cells considered here are capable, in principle, to participate in electricity markets, which may well lead to changing their management objective from least-cost operation to, for instance, profit maximization based on market prices. Furthermore, they may integrate considerable amounts of non-dispatchable energy sources and non-dispatchable loads. In such a scenario, energy storage devices can be seen as elements with the potential to interpret market price signals for selecting, to some extent, the best energy generation and storage moments, thus smoothing out non-dispatchable energy production/consumption. This property may increase the controllability of the power system cell. Such increase in controllability may take two forms:

- the first one is related to the scheduling of the power system cell participating in the day-ahead electricity market as the energy storage potentially allows to:
 - store non-dispatchable energy production at lower-price periods for selling at higher-price periods thus:

[†]Examples of such investment may be building new power lines, reinforcement existing power lines, renewal or parallelization of power transformers, installation of FACTS (*Flexible Alternating Current Transmission System* [128]) devices and commissioning of large centralized power facilities.

- * reducing the costs associated to supplying the demand;
 - * contributing to the profit maximization of the power system cell operator;
 - set the energy storage to states that prepare the cell for risky moments (e.g.: moments when the forecasts of non-dispatchable energy production/consumption present a higher volatility).
- the second one is related to the intraday operation of the power system cell as the energy storage adds some slack to the cell allowing to:
 - serve as an energy filter for overcoming up to some extent the forecast errors associated to demand and non-dispatchable renewable production;
 - serve as an energy buffer for storing up to some extent any available excess energy for later use.

An analysis on whether these energy storage management possibilities can be advantageous to the management of a power system cell seems to be of paramount importance.

The objectives for developing the scheduling model proposed in this chapter were fixed following the discussion made previously. More specifically, the proposed model aims to:

1. explicitly integrate the energy storage in the scheduling process;
2. make it possible to manage any dispatchable loads that may integrate the power system cell;
3. integrate the non-dispatchable generators in the scheduling process.

The proposed model accounts for the existence of dispatchable generators. However, in this work, such consideration is quite limited in the sense that many possible operational constraints of dispatchable generators (as those described in chapter 3) have been disregarded in this work. However, the proposed scheduling model may be used in problems in which such constraints (e.g.: dispatchable generation ramp-rate limits, minimum up-time requirements...) can be disregarded (e.g.: microgrids management). Finally, the model can be extended later on for incorporating additional constraints.

5.1.1 Some Possible Applications of the Proposed Model

The proposed scheduling model is especially suited for an operator responsible for managing a power system cell. In such a case, the operator would use the model for producing schedules that maximize a given predefined objective function (e.g.: profit). The resulting schedules could then directly serve for placing bids to the day-ahead market or as an input to some post-treatment tool (e.g.: portfolio management tool of a power system cell aggregator).

As is, the proposed scheduling model is especially suited for problems comprising energy storage, small dispatchable and non-dispatchable generators, and dispatchable and non-dispatchable loads. In the proposed model, scheduling decisions are made according (amongst others) to electricity market prices. However, it can also be straightforwardly used in the absence of an electricity market (by considering market prices which are equal to zero at all times).

The previous specifications help to identify the main types of possible applications of the proposed scheduling model. Following those specifications, the model can be used, for instance, to perform the day-ahead market schedule of:

- microgrids;
- wind-hydro plants comprising energy storage (e.g.: pumped-hydro);
- wind/PV/wave plants combined with fuel cells and hydrogen storage systems;
- electrical vehicles comprising energy storage.

In this work we have applied the proposed model for scheduling the operation of two possible types of power system cells under day-ahead electricity market prices. The first of such options consists of a microgrid and the second consists of a wind-hydro plants comprising energy storage. The tested case-studies and the results obtained are presented and discussed in chapter 6.

5.2 Scheduling Scheme

In this work, the general case of a power system cell comprising dispatchable and non-dispatchable loads and generators, energy storage facilities and an interconnection with the main grid is considered. Based on the HL1-equivalent generic grid (i.e.: single node grid) proposed in [129], an model of such the power system cell considered in this work was built. Such model is depicted in Figure 5.1.

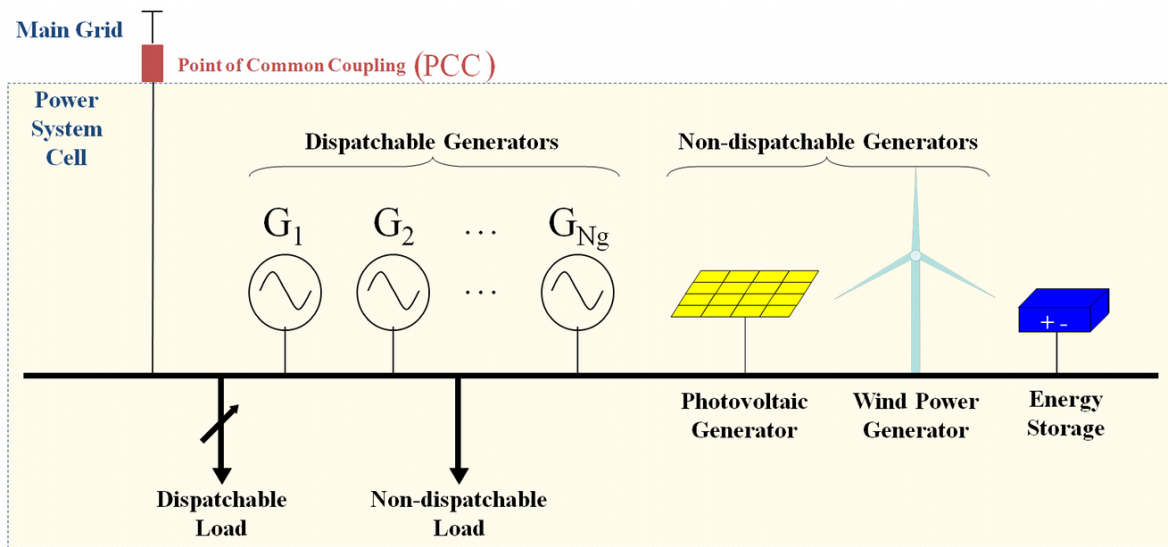

FIGURE 5.1: Schematic representation of the HL1 model of the power system cell.

In Figure 5.1 one can identify all the local elements that may form the power system cell. Such elements may be divided into three categories:

1. Non-dispatchable elements: non-dispatchable generation (e.g.: local PV/wind power production) and non-dispatchable (i.e.: conventional) loads;
2. dispatchable elements: dispatchable generation (e.g.: micro-turbines, diesel gensets), dispatchable loads (e.g.: contracted shedable loads) and energy storage devices (e.g.: batteries, hydro-storage);
3. Interconnection with the main grid: point of common coupling (PCC).

The objective of the present work is to develop a dispatch system capable of providing a day-ahead operation schedule for the various elements that compose the power system cell. The necessary input

information comprises static technical data on the various cell components (e.g.: dispatchable generation data, interconnection capacity) and forecasts of the non-dispatchable local energy production and consumption. This is schematically represented in Figure 5.2.

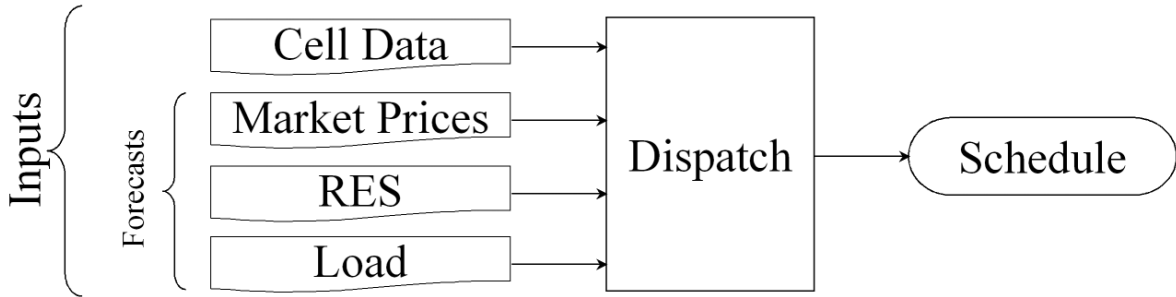

FIGURE 5.2: General functional input/output schema of the scheduling procedure.

5.3 Objective Function Description

Here, a power system cell owned by an independent producer participating in the day-ahead electricity market was considered. This is in line with the the single-area market-player power system scheduling model developed in subsection 3.2.3. The definition of the power system cell objective function (i.e.: dispatch function) was thus defined similarly to equations Equation 3.28 through Equation 3.30, which means that the scheduling model proposed here will seek to maximize the operational profit associated to day-ahead schedule of the power system cell. However, for fitting the specific needs of the power system cell some simplifications of such function were made (e.g.: no reserve requirements or start-up costs are considered).

The aim of the dispatch function is defined here as that of finding the operation set-points of the various dispatchable elements that maximize the total profit Π of the cell operator throughout horizon T , while taking into account the possibility of exporting power to the main grid[†]. Whenever the cell exports power to the main grid, the cell operator is paid an amount money corresponding to the exported power and to the contracted prices for energy. Thus, in such a case, the cell operator receives an *income* for exporting power to the main grid. However, in other moments, the cell imports power from the main grid. In such a case, the operator pays an amount of money for the imported power according to contracted market prices. We use the term *negative income* for describing such cases. The total

[†]Different objective functions may be straightforwardly integrated in the model.

profit is made up of the sum of the profits π_t obtained at every time-step t . The profit obtained on a single time-step is given by the following equation:

$$\underbrace{\pi_t}_{\text{Profit}} = \underbrace{(I_{PCC_t} + I_{L_t})}_{\text{Income}} - \underbrace{\left(\sum_{i=1}^{N_g} (C_{i,t}) + C_{LCon_t} + C_{LCur_t} + C_{Sto_t} + \sum_{j=1}^{N_{RES}} (C_{RES_{j,t}}) \right)}_{\text{Costs}} \quad (5.1)$$

where, for every time-step t :

- I_{PCC_t} represents the income due to exporting/importing power to/from the main grid at level P_{PCC_t} ;
- I_{L_t} represents the income due to supplying load L_t ;
- $C_{i,t}$ represents the cost of operating the dispatchable generator i at output power level $P_{i,t}^\dagger$;
- C_{LCon_t} represents the value paid for not supplying L_{Con_t} amount of dispatchable load;
- C_{LCur_t} represents the penalty paid for curtailing L_{Cur_t} amount of load (used only on emergency situations);
- C_{Sto_t} represents the cost of operating the energy storage at power output level $P_{Sto_t}^\ddagger$;
- N_{RES} represents the number of non-dispatchable renewable energy sources;
- $C_{RES_{j,t}}$ represents the cost of generating energy from the j^{th} non-dispatchable renewable energy source.

$$I_{PCC_t} = \begin{cases} p_{expt} \cdot P_{PCC_t} \cdot \Delta(t) & \Leftarrow P_{PCC_t} \leq 0 \\ p_{impt} \cdot P_{PCC_t} \cdot \Delta(t) & \Leftarrow P_{PCC_t} > 0 \end{cases} \quad (5.2)$$

[†]Here, a quadratic operating cost function was considered for representing the cost of generating power from dispatchable generators. Such function is defined in Equation 5.4.

[‡]A single energy storage device is considered here. Its operation cost is considered to vary according to a quadratic cost function. Such function is defined in Equation 5.7.

$$I_{L_t} = c_{l_t} \cdot L_t \cdot \Delta(t) \quad (5.3)$$

$$C_{i,t} = a_i \cdot (P_{i,t})^2 \cdot \Delta(t) + b_i \cdot P_{i,t} \cdot \Delta(t) + c_i \quad (5.4)$$

$$C_{Con_t} = c_{con_t} \cdot L_{Con_t} \cdot \Delta(t) \quad (5.5)$$

$$C_{Cur_t} = c_{cur_t} \cdot L_{Cur_t} \cdot \Delta(t) \quad (5.6)$$

$$C_{Sto_t} = a_{Sto} \cdot (P_{Sto_t})^2 \cdot \Delta(t) + b_{Sto} \cdot |P_{Sto_t}| \cdot \Delta(t) + c_{Sto} \quad (5.7)$$

with[†]:

- $\Delta(t)$ represents the duration of the time-step in h;
- c_{con_t} and c_{cur_t} , represent, respectively, the costs for dispatching and curtailing of 1 kWh of dispatchable/curtailable load €·kWh⁻¹;
- c_{l_t} is the remuneration paid by the load for being fed per kWh of electricity;
- p_{imp_t} and p_{exp_t} represent, respectively, the prices to buying and selling energy from/to the market in €·kWh⁻¹;

[†] Assuming Euro currency.

- $a_i, b_i,$ and c_i are the generating cost coefficients of the i^{th} dispatchable generator, in $\text{€} \cdot \text{kW}^{-2} \cdot \text{h}^{-1}, \text{€} \cdot \text{kW}^{-1} \cdot \text{h}^{-1},$ and $\text{€},$ respectively;
- $a_{Sto}, b_{Sto},$ and c_{Sto} are the cost coefficients of the energy storage device, in $\text{€} \cdot \text{kW}^{-2} \cdot \text{h}^{-1}, \text{€} \cdot \text{kW}^{-1} \cdot \text{h}^{-1},$ and $\text{€},$ respectively;
- P_{Sto_t} is the power output of the energy storage at time $t.$ Positive values of P_{Sto_t} mean that the energy storage device is working as a power generator. Negative values of P_{Sto_t} mean that the energy storage device is working as a load;
- P_{PCC_t} is the power interchange between the power system cell and the main grid at the point of common coupling. Positive values of P_{PCC_t} mean that the power system cell is importing power from the main grid. Negative values of P_{PCC_t} mean that the power system cell is exporting power to the main grid.

5.4 Formulation of the Power System Cell Optimization Problem

The power system cell optimization problem is that of finding the best values (i.e.: setpoints) of the various decision variables according to the defined objective function for each time-step t of the optimization horizon $T.$ The decision variables associated to such problem are:

- the *on/off* state of the i^{th} dispatchable generator $u_{i,t};$
- the power output setpoint of the i^{th} dispatchable generator $P_{i,t};$
- the state-of-charge setpoint of the energy storage $SOC_t;$
- the power setpoint of controllable load $L_{Con_t};$
- the power setpoint of curtailable load $L_{Cur_t}.$

Keeping the above defined decision variables in mind, the power system cell scheduling problem can be formulated through equations 5.8 through 5.15, as follows:

$$\max_t \left\{ \sum_{t=1}^T \pi_t \right\} \quad (5.8)$$

subject to

$$\sum_{i=1}^{N_g} (P_{i,t}) + P_{PCC_t} - L_{Net_t} = 0 \quad (5.9)$$

where L_{Net_t} represents the *net load*, which can be seen as the *effective* load of the power system cell. It is defined further ahead by Equation 5.17. Positive values of L_{Net_t} indicate that the power system cell has a positive effective load that needs to be fed either through the local dispatchable generation, either through the interconnection between the power system cell and the main grid. Negative values of L_{Net_t} indicate that the local non-dispatchable RES production plus the energy storage output surpass the local load forecasts. In such case, the power system cell either exports energy through its interconnection with the main grid, or dumps it in case the interconnection is not available. It can also only partially dump excess energy in case the local production exceeds the interconnection power capacity, which is expressed through Equation 5.19 and is further explained ahead.

$$-\mu_{pcc_t} \cdot PCC_{cap} \leq P_{PCC_t} \leq \mu_{pcc_t} \cdot PCC_{cap} \quad (5.10)$$

$$u_{i,t} \cdot P_{G_{i_{min}}} \leq P_{i,t} \leq u_{i,t} \cdot P_{G_{i_{max}}} \quad (5.11)$$

$$SOC_{min} \leq SOC_t \leq SOC_{max} \quad (5.12)$$

$$0 \leq L_{Con_t} \leq \mu_{con_t} \cdot \hat{L}_t \quad (5.13)$$

$$0 \leq L_{Cur_t} \leq (1 - \mu_{con_t}) \cdot \hat{L}_t \quad (5.14)$$

$$\Delta_{SOC_{min}} \leq \Delta_{SOC_{t,t+1}} \leq \Delta_{SOC_{max}} \quad (5.15)$$

where :

$$\mu_{pcc_t}, \mu_{con_t} \in [0; 1]$$

$$N_g, T \in \mathbb{N}$$

$$u_{i,t} \in \{0; 1\}$$

$$P_{G_{min}}, P_{G_{max}}, P_{CCAP}, \Delta_{SOC_{min}}, \hat{L}_t, \Delta_{SOC_{max}} \in \mathbb{R}$$

Equation 5.8 represents the objective function of the operator and equations 5.9 through 5.15 represent the constraints of the optimization problem. Such constraints may be described as follows:

- Equation 5.9 enforces the balance between production and consumption to be kept, where N_g represents the number of dispatchable microsources and L_{Net_t} represents the net load. It is similar to Equation 3.31, however, here the objective is not only to supply a part of the main grid load, but to also grant that the local load is satisfied. Therefore, an inequality type constraint

such as the one defined in Equation 3.31 does not seem to be adequate in the present case. Hence, here, the classical single-area version of such constraint was used. Such constraint can be obtained from Equation 3.5 by performing the adaptations described in subsection 3.2.2 and neglecting losses;

- Equations 5.10 to 5.14 force decision variables $(u_{i,t}, P_{i,t}, SOC_t, L_{Con_t}, L_{Cur_t})$ to be kept within feasible boundaries, where PCC_{cap} represents the interconnection capacity, and $P_{G_{i_{min}}}$ and $P_{G_{i_{max}}}$ represent the technical minimum and maximum capacity of the i^{th} dispatchable generator (when it is on):
 - The value of μ_{pcc_t} present on equation 5.10 permits to ensure that an amount of prespecified slack is kept at the PCC[†];
 - Equation 5.11 forces the dispatchable generator set-points $P_{i,t}$ to remain within technical boundaries $P_{G_{i_{min}}}$ and $P_{G_{i_{max}}}$, where the variable $u_{i,t}$ indicates whether that generator is to be set *on* at time-step t ($u_{i,t} = 1$), or *off* ($u_{i,t} = 0$);
 - Equation 5.12 keeps the state-of-charge SOC_t within the feasible boundaries given by SOC_{min} and SOC_{max} ;
 - Equation 5.13 ensures that the value of dispatched controllable load at time-step t (L_{Con_t}) does not exceed a predefined maximum. In the proposed formulation, such maximum has been defined relatively to the load forecast (\hat{L}_t) through the indexing parameter μ_{con_t} ;
 - Equation 5.14 imposes no more than the forecasted load (\hat{L}_t) is curtailed at all times. Such value of curtailment is given by L_{Cur_t} and represents the amount of load that will have to be unserved due to an emergency situation (e.g.: loss of the interconnection with the main grid combined with insufficient local production). In practice, its value is always zero because, as load curtailment is not desirable, a sufficiently high penalty is fixed as a compensation for curtailing load. Such penalty is always lower than the price paid for dispatching controllable load. Therefore, it supplies a way to check that the algorithm works as expected -i.e.: load can only be curtailed if the option to control load was used to its maximum possible extent. Also, the presence of L_{Cur_t} in the preceding formula serves to grant that the formula is always verified even if there is insufficient generation or energy importation capacity for whatever reason. Consequently, L_{Cur_t} grants feasibility of the optimization problem at all times, at least from an energy balance perspective;

[†]This variable may also allow the simulation of cases where the power system cell is operating at reduced or even nil interconnection capacity with the main grid.

- Equation 5.15 ensures that state-of-charge (SOC) variations of the energy storage device between time-steps t and $t + 1$ ($\Delta_{SOC_{t,t+1}}$) are kept within the feasible boundaries defined by $\Delta_{SOC_{min}}$ and $\Delta_{SOC_{max}}$. Such variations are given by equation 5.16.

$$\Delta_{SOC_{t,t+1}} = SOC_{t+1} - SOC_t \quad (5.16)$$

The value of L_{Net_t} present in Equation 5.9 considers the power output of the j^{th} non-dispatchable generator as a negative load and is calculated through Equation 5.17 as follows:

$$L_{Net_t} = \hat{L}_t - L_{Con_t} - L_{Cur_t} - \sum_{j=1}^{N_{RES}} \left(\hat{P}_{RES_{j,t}} \right) - P_{Sto_t} \quad (5.17)$$

As seen in Equation 5.17, the value of L_{Net_t} also comprises the values of energy storage power output P_{Sto_t} and dump load L_{Dump_t} . These values are calculated through equations 5.18 and 5.19, respectively.

$$P_{Sto_t} = \begin{cases} \frac{\Delta_{SOC_{t,t+1}}}{\eta_{ch} \cdot \Delta(t)} \Leftarrow \Delta_{SOC_{t,t+1}} < 0 \\ \frac{\eta_{dis} \cdot \Delta_{SOC_{t,t+1}}}{\Delta(t)} \Leftarrow \Delta_{SOC_{t,t+1}} \geq 0 \end{cases} \quad (5.18)$$

$$L_{Dump_t} = \begin{cases} 0 \Leftarrow PCC_{cap} \geq -L_{Net_t} \\ PCC_{cap} - L_{Net_t} \Leftarrow PCC_{cap} < -L_{Net_t} \end{cases} \quad (5.19)$$

In equation 5.18, η_{ch} and η_{dis} represent the energy storage charging and discharging efficiencies, respectively.

The variable L_{Dump_t} defined in Equation 5.19 is a part of L_{Net_t} and serves the purpose of dealing with cases where excessive local non-dispatchable production at a given time-step t exists. In such cases, the local load of the power system cell plus the capacity of the cell to store and export energy is inferior to the minimum local production, which may lead to infeasibility of the optimization problem. In the real world, such infeasibilities may be the result of situations in which the power system cell operates under reduced or nil energy transfer capacity conditions (e.g.: due to contingencies on one or more power lines interconnecting the cell with the main grid). This may also happen in cases where, for some reason, the local generation is oversized relatively to the local energy consumption needs and to the energy transfer capabilities of the cell, or when the local consumption is highly reduced. From a technical viewpoint, L_{Dump_t} grants that the optimization problem defined by equations 5.8 through 5.15 is always feasible. Consequently, any solution technique employed to solve such problem will always be able carry on with the necessary calculations throughout T and propose the *best possible solution* if finds. This grants that the cell operator always obtains an *as good as possible* solution. At the same time, situations in which $L_{Dump_t} \neq 0$ help the operator to identify *whenever* and *up to which extent* problematic situations might happen. Such information may ultimately help to decide which additional measures should be taken for overcoming such situations. As an example of such additional measures, the operator may choose to preventively shut-down some of the non-dispatchable generators of the power system cell thus avoiding excessive non-dispatchable generation situations.

5.4.1 Solution Method

An observation of the optimization problem defined by equations 5.8 through 5.15 indicates that the main difficulties to solve it come from equations 5.9 (due to the parameter L_{Net_t} that is influenced by equation 5.18) and 5.15. In fact, these equations couple the scheduling decisions taken at a given time-step of the optimization horizon T with those taken later on. Consequently, the optimization problem defined by equations 5.8 through 5.15 belongs to the class of *sequential decision problems* or *multistage decision problems* [130]. Several methods can be found in the literature for tackling problems of the kind. A vast state of the art can be found in [43, 44].

Many optimization methods can be employed for solving the optimization problem defined by equations 5.8 through 5.15 such as:

- meta-heuristics (e.g.: ant-colony search, genetic algorithms, particle swarms, simulated annealing);
- classical optimization methods based on duality principles used for simplifying difficult-to-implement constraints as the time-coupling constraints defined by equations 5.18 and 5.15 (e.g.: Lagrangean relaxation);
- global search methods (e.g.: branch-and-bound, exhaustive search, dynamic programming).

The inconvenient of the first two approaches included in the previous list is that they do not guarantee the solution of the optimization problem to represent a global optimum. However, meta-heuristics-based methods have the advantage of being problem independent. Such property could be of importance in case one desires to add future extensions to the base scheduling problem defined by equations 5.8 through 5.15 for dealing, for instance, with problems of higher complexity than those addressed in this work. The general disadvantage of methods based on global search is that the CPU-time needed by such methods for computing solutions increases very fast with the complexity of the scheduling problem due its inherent combinatorial characteristics.

The main aim of this work was to provide a scheduling methodology that guarantees the optimality of the scheduling solutions. For this purpose, global-search-based approaches were analyzed. From the available global search approaches found in the literature, a dynamic programming approach was preferred mainly because:

1. it is well suited for solving *sequential decision problems* [130, 131] like the one considered here;
2. it ensures that the scheduling problem can be formulated and tackled in a quite straightforward way as was illustrated by Grainger in [42];
3. it has been widely employed in the power systems scheduling literature as described in the literature reviews produced by Sheblé [43] and Padhy [44];
4. it guarantees that at least one optimal solution[†] is found[‡];

[†]Whenever such optimal solution exists.

[‡]Although this may not be the case when simplifications of the search-space based on heuristics (or meta-heuristics) are employed. This is the case, for instance, in [61] where DP-SC, DP-TC, and DP-STC methods led to sub-optimal schedules and in [64] where an enhanced dynamic programming method is proposed for solving the suboptimality/inefficiencies originated by the truncations made while solving each time-stage of the scheduling problem.

5. it allows to straightforwardly extend the base deterministic problem to the stochastic framework as will be seen in subsequent sections.

In general, dynamic programming permits to effectively solve a wide variety of problems each bearing a wide variety of sizes and characteristics [132, 133]. Methods based on dynamic programming solve the corresponding optimization problems in their primal version [134]. Optimization constraints that only affect a single stage of the multi-stage problem being addressed through dynamic programming can be easily modified, removed, and added.

However, methods based on dynamic programming require a strict state description of the system being optimized. Therefore, these methods are problem-dependent. Such methods make it quite hard to add or remove stage-coupling constraints to/from the optimization problem. It can also be hard to modify existing stage-coupling constraints. Finally, methods based on dynamic programming are subject to *the curse of dimensionality* [56, 131], which means that the complexity associated to finding optimal scheduling solutions increases dramatically up to prohibitive values with the increase of complexity of the optimization problem [135].

Dynamic programming is based on the principle of suboptimization and the principle of optimality[†]. The principle of suboptimization consists in breaking the whole multi-stage optimization problem in optimization subproblems that are easier to solve. Such principle is in itself general and applicable independently from whether one is developing a dynamic programming approach or any other as is the case, for instance, of Benders decomposition approaches [136, 137], of distributed optimization approaches [138], and of Lagrangian relaxation methods [60]. The principle of optimality first proposed by Bellman in [131] is actually the core principle of dynamic programming optimization methods. Such principle (of optimality) was plainly stated by Grainger in [42] as follows:

“If the best possible path from A to C passes through intermediate point B, then the best possible path from B to C must be the corresponding part of the best path from A to C.”

[†]In reality, in [130], Rao implicitly states that both of these principles are closely related in the sense that the suboptimization principle leads to the separation of the multi-stage optimization problem into a number of *subproblems*. The process used for solving such subproblems is based on backward programming and is named by Rao as *suboptimization process*. Such suboptimization process thus constitutes a practical application of the Bellman’s principle of optimality [131].

Based on the two principles described in the previous paragraph, dynamic programming problems may be solved by in two ways: the first one is based on calculus and the second one is based on tables. The calculus-based version analytically converts the multi-stage problem into a single stage problem that is solvable by classical optimizations approaches. However, this type of solutions quickly leads to extremely complex objective functions of multiple variables and the solution process thus becomes too hard or even practically impossible to solve for reasonable sized multi-stage problems. The tabular method helps to overcome this difficulty and, at the same time, is well adapted for computer-based solutions. In simple terms, this method consists in storing intermediate results in tables that are stored in the memory of the computer. Such tables are updated according to the dynamic programming principles discussed in the previous paragraph. and the end, the optimal solution (if it exists) is rebuilt from the information that was stored in those table throughout the dynamic programming search procedure. Both of these methods are discussed in detail in [130]. Here, the tabular version of the dynamic programming solution method was used as it permits easier computer implementation.

The tabular dynamic programming solution method may be implemented in two ways. The first one consists in performing a forward search of the state space (from the first stage of the multi-stage problem till the last one) and then perform a backward sweep (from the last stage of the multi-stage problem till the first one) to build the optimal multi-stage path. This first form of solving dynamic programming problems is often called *Forward Dynamic Programming* [139, 140]. The second one consists in performing a backward search of the state space (from the last stage till the first one) and then perform a forward sweep (from the first stage of the multi-stage problem till the last one) to build the optimal multi-stage path. This second form of solving dynamic programming problems is often called *Backward Dynamic Programming* [141, 142]. This approach seems to be more commonly used in power system scheduling problems [42] and is the one used in this work.

For applying dynamic programming to any given multi-stage sequential decision-making problem one has to define[†]:

- a set of states \mathcal{S} describing the different possibilities of the system at each stage t of the the horizon of sequential stages T of the multi-stage decision-making problem;
- a transition cost function \mathcal{T} between the current state s_t and the state to which it connects k_{t+1} ,

[†]The specific conditions presented herewith are meant for backward dynamic programming formulations. However, based on these conditions, the formulation of forward dynamic programming conditions can be straightforwardly made.

where $s_t, k_{t+1} \in \mathcal{S}$;

- a recursive cost-to-go function[†] \mathcal{F} that provides the cumulated costs associated with a given state s_t . Such cumulated costs are calculated from three components:
 - the cost associated to s_t , given by $\mathcal{C}(s_t)$;
 - the cost-to-go from state s_t to state k_{t+1} , given by $\mathcal{T}(s_t, k_{t+1})$;
 - the cumulated cost associated to state k_{t+1} , given by $\mathcal{F}(k_{t+1})$.

The recursive function (Bellman equation) then takes the form given by Equation 5.20.

$$\mathcal{F}(s_t) = \mathcal{C}(s_t) + \mathcal{T}(s_t, k_{t+1}) + \mathcal{F}(k_{t+1}) \quad (5.20)$$

5.4.2 Proposed Dynamic-Programming-Based Solution Method

In this work, the power system cell scheduling problem defined by equations 5.8 through 5.15 is seen as a multi-stage sequential decision problem in which the scheduling decisions are taken sequentially in time while being time-coupled[‡]. According to Rao [130], there are three subtypes of multi-stage decision Problems:

1. Initial Value Problems: prescribe the initial value of the state variable of the problem;
2. Final Value Problems: prescribe the final value of the state variable of the problem;
3. Boundary Value Problems: prescribe both the initial and final values of the state variable of the problem;

In the present work, the considered scheduling problem is seen as a *boundary value* multi-stage sequential decision problem. This implies that the initial and final states of the power system cell are

[†]The word *cost* stands for a dimensionless quantity measuring a distance. The objective of the multi-stage decision problem is taken as that of finding the set of single stage decisions that minimize the *overall* distance of the problem.

[‡]As explained in subsection 5.4.1, this is mainly due to the presence of the energy storage.

defined *prior* to performing its scheduling. Of course, other formulations would be possible (e.g.: initial value problem in which only the initial state of the cell is predefined). However, the following reasons justify, at least up to some extent, the modeling choice made in this work:

1. Boundary value problems may be seen as particular cases of initial and final value problems. For instance, an initial value problem having s possible final systems states/values can be calculated by formulating and solving s boundary value problems departing from the predefined initial state/value of the system and each arriving to one of the s possible final states/values of the system. The s *best* candidate solutions found in such a way may then be compared for selecting the global best one. Consequently, the consideration of the power system cell scheduling problem as a boundary value multi-stage decision-making problem is flexible because it potentially enables to solve the scheduling problem even in cases where the initial and/or final states/values of the power system cell are unknown *a priori*. This may not be as simple the other way around.
2. The consideration of the power system cell scheduling as a boundary value problem permits to avoid inter-day influences in the schedules by allowing to set equal initial (i.e.: beginning of the day) and final (i.e.: end of the day) power system cell states. This allows, in principle, to test various cell component combinations for determining the ones that lead to a well-balanced (e.g.: avoiding energy spillages and/or shortages) daily operation of the cell and may thus be applied to problems of optimal power system cell design and sizing.
3. The consideration of the power system cell scheduling as a boundary value problem leads to faster execution times of the optimization procedure because the search-space is reduced comparatively with initial and final value decision problems. Whenever possible, the decrease of execution times is mandatory for multi-stage decision problems solved through dynamic programming, which suffers from *curse of dimensionality* as was previously explained in section 5.4.1.

5.4.2.1 Definition of Control and State Variables

As previously stated, dynamic programming approaches use the principle of optimality for separating multi-stage problems into several dependent subproblems (one per each stage) that are easier to solve. The question therefore is on how to properly and efficaciously separate the complete scheduling prob-

Variable	Short Description	Interdependence	Time-coupled?
$u_{i,t}$	On/Off state of the i^{th} dispatchable generator	—	No
$P_{i,t}$	Power output of the i^{th} dispatchable generator	$u_{i,t}$	No
P_{PCC_t}	Power exchange at the PCC	—	No
P_{Sto_t}	Power output of the energy storage	$SOC_t, \Delta SOC_{t,t+1}$	Yes
SOC_t	Amount of stored energy	$P_{Sto_t}, \Delta SOC_{t,t+1}$	Yes
$\Delta SOC_{t,t+1}$	Variation of stored energy	P_{Sto_t}, SOC_t	Yes
L_{Con_t}	Amount of controlled (i.e.: reduced) load	—	No
L_{Cur_t}	Amount of curtailed (due to emergency) load	—	No
L_{Dump_t}	Amount of dumped energy	—	No

TABLE 5.1: Control and state variable candidates of the power system scheduling problem defined by equations 5.8 through 5.15. The table includes the interdependence between the various variable as well as their time-coupling characteristics.

lem into such subproblems for keeping the optimality of the produced schedules while determining such schedules in the simplest possible way.

For separating the scheduling problem into subproblems some selection needs to be made regarding which control variables should be kept as dynamic programming (master problem) control and state variables and which should be kept as control variables of the several subproblems. For doing this, a good criterion is to separate the variables according to their multi-stage influence. Then, the multi-stage (i.e.: time-coupled) variables are associated to the dynamic programming method and the single-stage (i.e.: time-decoupled) variables are affected to the single-stage subproblems. Such a procedure increases the computational efficiency of the dynamic programming algorithm without compromising the optimality of the produced schedules.

The main variables of the problem defined by equations 5.8 through 5.15 are summarized in Table 5.1 where t and $t + 1$ represent time-stages. In the table, a short description of the meaning of each of the variables is given[†]. In addition, the table resumes the existing interdependence between the variables as well as their respective stage influence (i.e.: their time-coupling) in the scheduling problem. All the variables described in Table 5.1 are possible candidates for being used as control variables of the power system scheduling model. However, not all of those variables can be used simultaneously as control variables of the optimization problem because some are correlated. So, some choice needs to be made in agreement with the developed solution-technique for efficaciously and optimally solving the power system cell scheduling problem.

[†]For a more detailed description please refer to sections 5.2, 5.3 ,and 5.4.

A first selection of a part of the subproblem control variables can be straightforwardly made based on the characteristics of the variables contained in Table 5.1. Indeed, all the variables that are decoupled in time and that are independent other variables can be directly affected to the subset of subproblem control variables. Such variables include: $u_{i,t}$, P_{PCC_t} , L_{Con_t} , L_{Cur_t} , and L_{Dump_t} . The remaining variables need a deeper look in order to determine whether they should constitute control or state variables and which subset (master problem or subproblem) they should integrate.

The first variable under analysis is $P_{i,t}$. This variable is decoupled in time, but depends from $u_{i,t}$ through the constraint defined by Equation 5.11. The variable $u_{i,t}$ is binary being able to take either 0 or 1 values. If it is set to 0, then the generator is set to an *OFF* state implying $P_{i,t}$ to be also 0. In this case, $P_{i,t}$ cannot be seen as control variable of the scheduling problem because it has no influence on the objective function ($P_{i,t}$ is a *stiff* variable that cannot be modified in this case). However, if $u_{i,t}$ is set to 1, then the generator is set to an *ON* state and $P_{i,t}$ loses its *stiffness*, thus gaining influence of the objective function of the scheduling problem. Consequently, in this case $P_{i,t}$ can be seen as a control variable because it represents the power output of the i^{th} dispatchable generator that can be set within the range defined by Equation 5.11. As a conclusion, the consideration of $P_{i,t}$ as a control variable that is subject to the setting of $u_{i,t}$ does not imply the possibility of creating optimization infeasibilities, or convergence problems. Therefore, one can include $P_{i,t}$ in the subset of single-stage control variables.

Finally, three scheduling variables, all referring to the energy storage device, remain to be analyzed: P_{Sto_t} , SOC_t , and $\Delta_{SOC_{t,t+1}}$. All of these variables are related to the time-coupling characteristics of the power system cell scheduling problem and are interdependent. Consequently, a selection based on some strategy/criteria needs to be made. It is interesting to note the variables P_{Sto_t} , and SOC_t are not by themselves coupling variables. However, such variables depend from the $\Delta_{SOC_{t,t+1}}$ variable, which, by itself, couples scheduling decisions in time. Hence, from a time-coupling viewpoint, the main variable is $\Delta_{SOC_{t,t+1}}$. For that reason, it is selected as the control variable of the multi-stage master problem. This variable ($\Delta_{SOC_{t,t+1}}$) has however a direct effect on the values of P_{Sto_t} , and SOC_t . The variable P_{Sto_t} concerns directly the single-stage subproblem through equations 5.9 and 5.17. Hence, P_{Sto_t} can be used as the interface variable between the master multi-stage optimization problem and the various subproblems. This leaves the variable SOC_t as a choice for describing the system state. In fact, this variable does not have a direct influence on the optimization subproblems, but is a direct consequence of the $\Delta_{SOC_{t,t+1}}$ control actions through Equation 5.16.

Following the explanations given in the previous paragraph, the different variables defined in Table 5.1,

Variable	Subset of variables	Role
$u_{i,t}$	Subproblem	Control variable
$P_{i,t}$	Subproblem	Control variable
P_{PCC_t}	Subproblem	Control variable
P_{Sto_t}	Subproblem	Interface variable
SOC_t	Master problem	State variable
$\Delta_{SOC_{t,t+1}}$	Master problem	Control variable
L_{Con_t}	Subproblem	Control variable
L_{Cur_t}	Subproblem	Control variable
L_{Dump_t}	Subproblem	Control variable

TABLE 5.2: Classification of the scheduling variables of the power system cell scheduling problem that were defined in Table 5.1. The classification was made according to respective roles of the variables in the optimization process as well as to their individual inclusion in the master problem or the subproblem subsets of variables.

their affectations to the master problem or to the subproblem subsets of variables, and their respective roles in the optimization process are summarized in Table 5.2.

5.4.2.2 Solution Procedure

A backward dynamic programming technique was developed for resolving the power system cell scheduling problem defined by equations 5.8 through 5.15. Such technique is schematically presented in Figure 5.3.

From a scheduling viewpoint and according to the control and state variables of the problem discussed in subsection 5.4.2.1 and resumed in Table 5.2, the cell state is defined by the amount stored energy at each scheduling time-step t . In this work the power system scheduling problem is defined as a *boundary value* one as was discussed in subsection 5.4.2. This is done by fixing the initial and final cell states that correspond to the power system cell states at t_0 and t_T , which are, respectively, SOC_{t_0} and SOC_{t_T} . In the example depicted by Figure 5.3, such states are considered to be the same, which may correspond to a daily cycle analysis for using/storing energy. The backward dynamic programming procedure works in two phases as described in subsection 5.4.1. The first phase is commonly called the *backwards step* and the second is called the *forward step* [42]. These phases are represented in Figure 5.3 by the outer-linked blue arrows. In the backwards step, the scheduling subproblem π_{s_t} associated to each feasible system state s on stage t is solved for each feasible transition $\mathcal{T}(s_t, k_{t+1})$ and considering the future cumulated benefit $\mathcal{F}(k_{t+1})$ associated to state k on stage $t + 1$. This is done

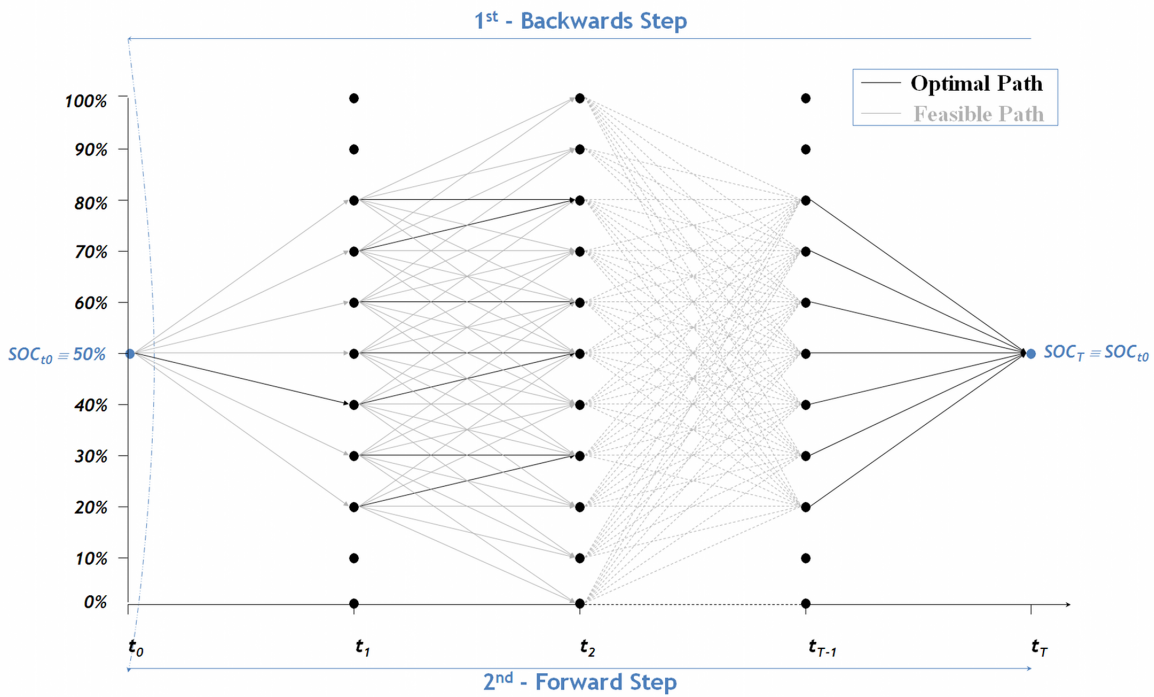

FIGURE 5.3: Example of the application of dynamic programming to the solution of the power system cell scheduling problem.

through Equation 5.21 defined below, where the transition cost function \mathcal{T} is given by Equation 5.7 associated with Equation 5.18.

$$\mathcal{F}(s_t) = \pi_{s_t} + \mathcal{T}(s_t, k_{t+1}) + \mathcal{F}(k_{t+1}) \quad (5.21)$$

Following Bellman’s principle of optimality, the best subproblem-transition-cumulated benefit that was found is associated to the current state (i.e.: s) and the procedure moves on to the next state (i.e.: $s + 1$) until no more feasible states exist for the present time-stage. Then, t is decremented and the procedure repeats until the first time-stage is solved (i.e.: $t < t_0$). Then, the optimal path is rebuilt according to the state-transition linkage information associated to every state while proceeding with the backwards step phase. This last step is quite straightforward and corresponds to the forward step phase of the backward dynamic programming routine. Figure 5.3 roughly illustrates this procedure. Initially[†], for time-stage t_{T-1} , every feasible state (i.e.: state able to link to the final state SOC_T) is evaluated. At

[†]Disregarding initializing needs of the procedure.

this point, every solution is *potentially optimal* and is therefore kept (this is illustrated by the black colored arrows depicted in Figure 5.3). This procedure is followed recursively for every feasible path. Such feasible paths are represented in the same figure by the gray dashed lines (comprising the omitted time-stages) and the gray arrows. Along the way and according to the principle of optimality, only the feasible paths that lead to potential optimal solutions are kept. On the final stage (from the algorithm viewpoint), the path that is kept automatically leads to the optimal path by the previously stored linkage (i.e.: given by the successive black arrows). This path is then easily rebuilt in the forward step.

5.4.2.3 The main algorithms

Two main phases were developed and implemented for solving the power system scheduling problem defined by equations 5.8 through 5.15. The first one consists on a main procedure that preprocesses the input data preparing it to be used by the dynamic programming recursion, calls the dynamic programming routine and stores the obtained schedule. At the end, the procedure stores the identified optimal schedule. The main parts of such preprocessing phase are described in algorithm 1.

Algorithm 1: Main procedure.

Data: Day-ahead price forecasts
Data: Non-dispatchable renewable energy sources forecasts
Data: Load forecasts
Data: Availability and characteristics of local dispatchable generators
Data: Static variables μ_{pcc_t} and μ_{con_t}
Data: SOC_{t_0} and SOC_{t_T}

- 1 **begin**
- 2 Initialize subproblem schedule while respecting equations 5.10, 5.11, 5.13, and 5.14
- 3 Build feasible search space according to SOC_{t_0} , to SOC_{t_T} , and to equations 5.12 and 5.15
- 4 Read price, load and non-dispatchable renewable generation forecasts
- 5 Call backward dynamic programming scheduling routine described in algorithm 2
- 6 Store optimal schedule
- 7 **end**

The main procedure described in Algorithm 1, contains a call to the backward dynamic programming scheduling function (i.e.: the second phase). Such function is described in detail in algorithm 2. The description contains the main requirements of the function and the detailed description of the backward and forward steps.

Algorithm 2: Backwards dynamic programming scheduling algorithm.

Data: Day-ahead price, load, and non-dispatchable renewable energy sources forecasts

Data: Availability and characteristics of local dispatchable generators

Data: Values of μ_{pcc_t} , μ_{con_t} , $\Delta(t)$, SOC_{t_0} , and SOC_{t_T} plus Initialized subproblem schedule

Result: Optimal power system cell schedule

```

1 begin
2   Initialize  $s, k, t, s^{max}, k^{max}$ , and  $t^{max}$ 
   // Start backward step
3   for  $t = t^{max}$  down to 1 do // For every time-stage  $t$ 
4     for  $s = 1$  to  $s^{max}$  do // Departing state  $s$ 
5       Determine  $x_{s_t}$ 
6       if  $x_{s_t}$  is feasible then // Last time-stage initialization
7         if  $t$  equal to  $t^{max}$  then
8            $k = s$  // Implies  $\Delta_{SOC_{t,t+1}} = 0$  and, therefore,  $P_{Stot} = 0$ 
9           forall the ON/OFF combinations of dispatchable generators do
10            Successively solve the subproblems given by equations 5.9 to 5.19
            keeping the best intrahour schedule  $\pi_{s_t}$ 
11          endfall
12           $\mathcal{F}(s_t) = \pi_{s_t}$ 
13        else // Normal procedure
14          for  $k = 1$  to  $k^{max}$  do // Arrival state  $k$ 
15            Determine  $x_{k_{t+1}}$ 
16            if Transition from state  $x_{s_t}$  to state  $x_{k_{t+1}}$  is feasible then
17               $\Delta_{SOC_{t,t+1}} = x_{k_{t+1}} - x_{s_t}$ 
18              Determine  $P_{Stot_t}$  according to equation 5.18
19               $C_{Stot_t} = a_{Stot} \cdot (P_{Stot_t})^2 \cdot \Delta(t) + b_{Stot} \cdot P_{Stot_t} \cdot \Delta(t) + c_{Stot}$ 
20               $\mathcal{T}(s, k) = C_{Stot_t}$ 
21              forall the ON/OFF combinations of dispatchable generators do
22                Successively solve the subproblems given by equations 5.9 to
                5.19 keeping the best intrahour schedule  $\pi_{s,t}$ 
23              endfall
24               $\mathcal{F}_{Temp}(s_t) = \pi_{s_t} + \mathcal{T}(s, k) + \mathcal{F}(k_{t+1})$ 
25              if  $\mathcal{F}_{Temp}(s_t)$  better than  $\mathcal{F}_{Best}(s_t)$  then
26                 $\mathcal{F}_{Best}(s_t) = \mathcal{F}_{Temp}(s_t)$ 
27              endif
28            endif
29          endfor
30        endif
31      endif
32    endfor
33  endfor
34  Build optimal schedule from linkage information // Forward step
35 end

```

The sub-optimization problems solved in line 21 of algorithm 2 were solved through the application of the generic Sequential Quadratic Programming function supplied by the Optimization Toolbox that complements Matlab® R2007b. In fact, the objective function of the each sub-problem is given in the present case by a sum of convex quadratic functions with, eventually, linear functions (e.g.: for each uncommitted dispatchable generator and for the load supply/control costs). This way, the resulting objective function is convex and, thus, the Sequential Quadratic Programming method becomes suitable for performing the optimization of each sub-problem.

5.4.3 Discussion

The dynamic programming based formulation proposed in the former sections has advantages and drawbacks. The solution method proposed here guarantees that the best possible schedule is found[†] among the available feasible schedules because the dynamic programming approach hereby proposed performs an exhaustive search of the solution-space is performed. However, in reality, such solutions are suboptimal because of the discretization imposed by the algorithm. Indeed, in the proposed solution method, the state-of-charge (SOC) of the energy storage is discretized, but, in reality, SOC is a continuous variable. Therefore, the proposed solution method will deliver schedules that approach the optimal schedule when the resolution of the SOC discretization tends to infinity. However, if one equals the SOC resolution to the maximum resolution allowed by a computer, the time needed to complete calculations would be prohibitive due to the well-known *curse of dimensionality* associated to dynamic programming algorithms [130]. Therefore, the solution method proposed in this work will deliver optimal schedules under some compromise between *state resolution requirements* and *calculation time constraints*.

As previously described, optimization approaches based on dynamic programming require a rather strict formulation of the optimization problem. Namely, such formulations require causality between solutions to exist [131] as well as a systematic description of the *states-of-the-world*, which comprises a state description of the system being optimized and state transition rules. This renders dynamic programming approaches problem-dependent, at least in what regards multi-stage control and state variables. In the long run, this work aims at dealing with problems of higher complexity than the one dealt with here. As an example, it is desirable to integrate generator ramp-rate constraints, minimum

[†]The formulation of the power system cell scheduling problem guarantees that at least one feasible solution to problem is always found as was discussed in section 5.4.

up/down requirements of dispatchable generators and limit the number start-stops of dispatchable generators, for enabling to realistically deal with higher capacity generators in a multi-stage framework (e.g.: generators rating the tenths of MW). If an approach based on dynamic programming is used for such problems, either some simplifications (e.g.: greedy methods, heuristic methods as - for instance - DP-SC/DP-TC/DP-STC [61, 67, 82]) are used, or it will simply be infeasible to apply such an approach in practical cases. Moreover, such approach will be very hard to design and implement if many multi-stage control and state variables exist. Hence, it would be advisable to use some type of problem-independent optimization technique for dealing with very complex optimization problems. Such approach could be based, for instance, on meta-heuristics allowing to reduce the searched solution-space, thus accelerating convergence while guaranteeing that at least *good-enough* schedules are determined. The application of genetic algorithms represents one valid candidate to such alternative scheduling approach.

The proposed power system cell scheduling model can be used for estimating the value of energy storage. A first analysis is provided in chapter 6. It could also be used for establishing good-enough rules for operating energy storage devices. For instance, simplifying energy storage operation rules could be found empirically by using the proposed model guaranteeing *good-enough* scheduling solutions may be found empirically by analyzing the energy storage schedules obtained for various cases and developing such rules accordingly. Such rules can then yield schedules comparable with the ones given by the proposed model and may ultimately be applied without having to perform a discretization of the SOC of the energy storage.

One type of dispatchable loads are the so-called *shiftable loads*. The main characteristic of such type of loads is that they can be displaced in time. For instance, shiftable loads can be displaced from periods where prices for energy are high to periods where such prices are low, or from high consumption periods to low consumption ones. Therefore, the optimal dispatch of such types of loads can be seen as an optimal multi-stage decision-making problem. Power system cells comprising advanced load controlling possibilities may integrate shiftable loads. Consequently, it is important to develop scheduling techniques bearing such purpose in mind, which could be achieved in basically three ways, as depicted in Figure 5.4:

1. The all-in-one approach consists in directly considering the optimal dispatch of dispatchable loads in the power system cell scheduling model;

2. The modular approach consists in completely separating load control from the power system cell scheduling. This allows to greatly reduce the complexity of the power system cell scheduler while permitting to perform both the optimal load control and the optimal scheduling in a separate way. However, such modular approach does not consider eventual interactions between the load control and power system cell scheduling. Therefore, it does not allow to guarantee that a global optimal schedule is found;
3. The hybrid approach can be seen as a merging of the previous two.

Under the hybrid approach depicted in Figure 5.4, the multi-stage load control (load shifting) is carried out independently from the power system cell scheduling and a modified load forecast integrating load shifts is supplied to the power system scheduler. This reduces the complexity of the scheduler, but renders the schedules sub-optimal. However, the inputs to the scheduling problem comprise an important component of uncertainty[†] rendering the problem an optimization under uncertainty one. Under such type of problems, one can no longer find an optimal solution but rather an optimal policy because the future is not known with precision *a priori*. This may therefore reduce the advantages of utilizing complex and time-consuming global optimization methods. Consequently, one can say that hybrid dispatchable load management approaches enable to obtain *good-enough* solutions in an efficient manner. In general terms, hybrid approaches can be seen as compromise approaches that allow to optimize a part of the dispatchable load and to deal with specialized load shifting algorithms at the possible cost of losing global optimality. This approach is the one adopted in this work.

As explained in the previous paragraph, hybrid dispatchable load management approaches permit to straightforwardly consider a part of the dispatchable load in the scheduling process. Such types of dispatchable loads may consist of intrahour load reduction services paid to customers. In such cases, the effects of reducing loads at a given moment in time are independent of the intra-hour load reductions that are made at adjacent time-stages. Hence, the optimization of such dispatchable loads is independent (i.e.: decoupled) in time. Consequently, such optimized load control can be easily integrated in an multi-stage optimization approach as the one proposed in this work.

For integrating the intrahour optimized load control that was discussed in previous paragraph, the scheduler needs to be informed of whether any intrahour load control possibilities exist within a specific

[†]Such uncertainty is associated to the various forecasts that are used as input for performing the power system cell scheduling.

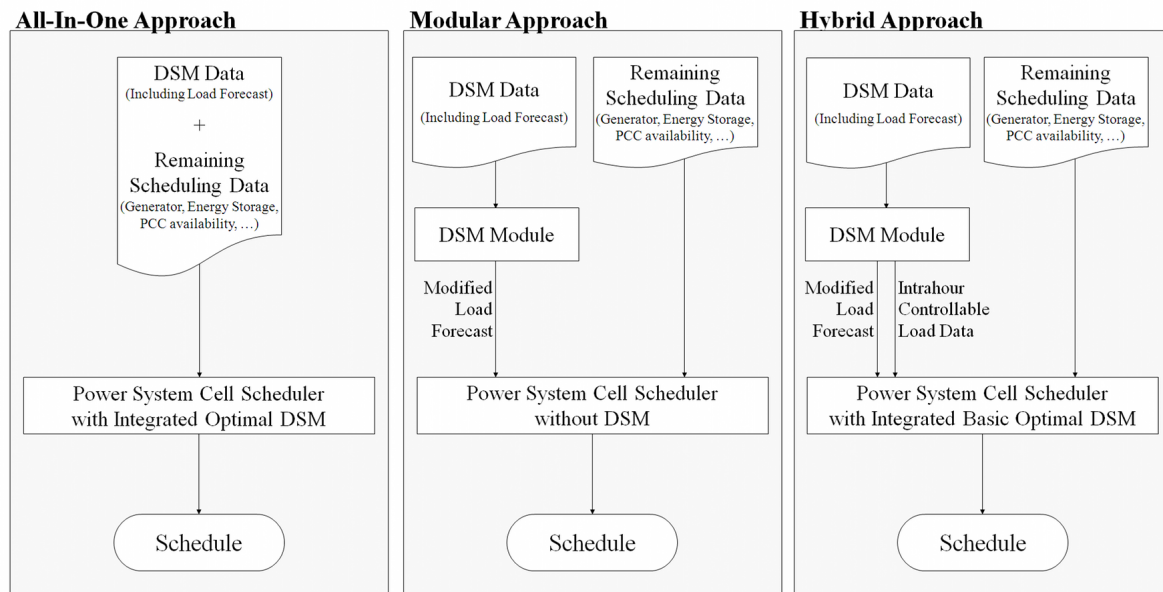

FIGURE 5.4: Three basic approaches for integrating demand side management (DSM) in the scheduling of the power system cell. The All-In-One Approach completely integrates DSM in the scheduling procedure. The Modular Approach completely separates DSM from the scheduling procedure. The Hybrid Approach is a mix of the previous ones separating the multi-stage DSM tasks (e.g.: definition load shifting actions) from the scheduling procedure. Such approach supplies the scheduler with data concerning intrahour load control possibilities, which enables the scheduler to perform optimal intrahour load control.

hour through intrahour dispatchable load data. Such data can comprise, for instance, the quantity of load that can be reduced within a given time-stage as well as the cost function giving the price to be paid to customers providing such service[†].

Finally, the scheduling approach proposed in this work allows to straightforwardly take into account forecast uncertainty into the scheduling process. This may be important, because such uncertainties may play an important role in the operation of power system cells. Indeed, such cells may integrate considerable amounts of renewable energy sources with variable production. Furthermore, such cells may be contained in relatively small geographical areas (e.g.: microgrids), which can reduce the smoothing effects between renewable energy generators and customers, thus rendering the corresponding load and renewable energy sources forecasts more volatile. On another angle, day-ahead market prices also fluctuate randomly. Such fluctuations may have important impacts on the management of power system cells. Hence, taking into account the uncertainty associated to the different forecasts used for performing the management of power system cells becomes increasingly important. The objective of

[†]Here, a linear cost function was considered for this purpose. However, other cost functions may be easily considered in the future.

the next section is to extend the proposed method in that direction.

5.5 Stochastic Extensions Applied to the Base Deterministic Scheduling Model

The power system cell scheduling model proposed in subsection 5.4.2 is well-adapted to a deterministic framework in which schedules are determined regardless of the consequences that may result from the uncertainty associated to the process inputs. In conventional power systems without significant non-dispatchable renewable energy penetration, such uncertainty is not of much importance mainly because:

- load uncertainties are small when compared to the total amount of load (1 % - 2 % [143]);
- uncertainties in power generation output are negligible[†] because most of the power system generators are dispatchable (e.g.: nuclear power plants, coal-fired power plants, hydro power plants comprising water reservoirs, gas-fired plants,...);
- the transmission system is usually considered as perfectly reliable in the unit commitment phase (sometimes it may be even neglected);
- the system is scheduled under a vertically integrated philosophy in which no electricity market exists and thus no price uncertainty exists as constant fuel costs are classically considered through the use of constant generator cost coefficients [43, 144][‡].

Regarding day-ahead power system scheduling, the situation of conventional differs from that of power systems integrating high shares of non-dispatchable renewable energy sources. Indeed, in the latter case, the day-ahead power output forecasts of such sources may add a significant component of uncertainty to the day-ahead scheduling problem. This is also the case of power system cells. For instance, power system cells such as microgrids, may comprise a relatively small number of energy consumers

[†]In the present analysis generator outages are disregarded. These can be dealt with either by enforcing enough reserve generation in the unit commitment phase, either by modifying the obtained unit commitment according to the result of a subsequent contingency analysis phase.

[‡]However, varying generator efficiencies are considered — usually through the employment of quadratic generation cost functions in which the function parameters include such information.

(i.e.: small number of loads). This reduces the load smoothing factor, which leads to a more erratic behavior of the global load of the microgrid in comparison to the load behavior of large power systems. This makes it harder to perform day-ahead forecasting of the microgrid load, and usually results in higher forecast errors. In addition, when the power system cell operates under electricity market conditions, as is the case considered in this work, electricity market price forecasts have to be considered as input in the scheduling process. Such forecasts involve errors that may have significant impacts on the quality of the scheduling process outputs, which may imply profit losses to their operators. Therefore, it appears necessary to consider all these types of uncertainty in the power system cell scheduling procedure. In such a case, the multi-stage scheduling problem can be seen as a multi-stage decision-making under uncertainty problem. Furthermore, the previously considered deterministic optimization problem becomes now a stochastic optimization one.

The main difference between stochastic optimization problems and deterministic ones concerns the way one defines the *optimal solution*. In the deterministic framework, the optimal solution is seen as the one that minimizes/maximizes a given objective function taking into account inputs that are supposed to be exact in the sense that they always verify. Therefore, the solutions to such optimization problems only comprise an evaluation of the current *state-of-the-world* disregarding possible evolutions of such states or non-verifications of the inputs of the problem. In other words, deterministic optimization formulations consider the input variables *as they are* and disregard the possible consequences that may come if such inputs are inaccurate or if the conditions of the optimization problem change (e.g.: if the expected future scenario does not happen). On the contrary, stochastic optimization approaches take into account the possible future consequences that might be associated to a given alternative directly in the objective function of the problem. In the majority of cases, under this framework, some risk is associated to each decision alternative and a compromise between the degree of satisfaction of each alternative and its associated risk is kept. For instance, deterministic approaches maximizing the *here-and-now* profit disregard the possible negative effects that might be caused by the *here-and-now* actions. On the other hand, stochastic approaches tend to select the *here-and-now* actions that maximize the *here-and-now* profits while trying to minimize the expected negative outcomes associated to such actions.

5.5.1 Integrating Energy-Related Uncertainties into the Proposed Scheduling Model

In this work, a spot-risk model similar to the mean-variance model that was presented and analyzed in chapter 4 is used for incorporating the uncertainties associated to the forecasts of the non-dispatchable renewable energy production and load for every hour of the scheduling horizon. Such uncertainties may lead to errors, which are given by the differences between forecasted energy production/consumption and measured values of such quantities. Such errors, may lead, for instance, to energy imbalances in the absence of further control actions (e.g.: dispatchable generation/consumption compensation, use of energy storage devices, ...), which are highly undesirable. Depending on their importance, energy imbalances may cause important frequency deviations that may lead to triggering frequency protections and even to cascaded triggering effects and should thus be avoided at all costs at the expense of having to bear with reduced grid stability and power quality. On the other hand, energy imbalances may lead to power flows that are substantially different from the forecasted power flows. This can lead to line overflows and to violations of voltage limits. Each of these phenomena may activate a subset of power system protections (e.g.: overcurrent and maximum/minimum voltage protections) and may thus also lead to problems of reduced grid stability and power quality. Finally, for avoiding such events, the system operator has to use power reserves of different types[†], which usually increases the operational costs of the power system. Under electricity markets, such additional costs often translate to reduced profits for market participants (e.g.: power system cell operator), which are often held as balance responsible actors. For all of these reasons, energy imbalances should be avoided. Such imbalances cannot be precisely known *in advance*. However, the power system cell operator can use the uncertainty information associated to the available power production/consumption forecasts of the non-dispatchable elements taking part in the cell as an input for estimating the amount of imbalance risk (i.e.: the possibility of incurring negative impacts due to forecast uncertainty) at every time-step of the scheduling horizon. Then, such risk can be taken into account in the scheduling process through the use of a spot-risk model. This corresponds to the principle followed in this work.

5.5.1.1 The Spot-Risk Model

A spot-risk model was developed for integrating the uncertainties associated to the inputs of the power system cell scheduling problem. The main advantage of such model is that it permits to consider

[†]Such types of reserves are discussed in [77, 78].

the return associated to a given alternative as well as the *eventual* risk associated to such alternative in a simple and straightforward manner. The return of the alternative is the objective to be attained (e.g.: a benefit, a stability level, ...). The risk is the quantification of the possible negative outcomes associated to such alternative. In [145], risk is defined as being a state of uncertainty where some of the possibilities involve a loss, catastrophe, or other undesirable outcome. In [91], risk is defined as the hazard to which a utility is exposed because of uncertainty. Both references consider risk to be a bi-dimensional characteristic of decisions having the following dimensions:

- the likelihood (probability, possibility, ...) of making a regrettable decision;
- the amount by which the decision can be regrettable.

Spot-risk models follow the same principles of the mean-variance models that were discussed in chapter 4. The adoption of the *spot-risk* term instead of the *mean-variance* one is due to the following reasons:

- In the literature, models using forecast values other than the mean have been used and have proven to give good results [146]. Hence, the term *mean* was replaced by the more general term *spot* in the designation of the mean-variance model, where the term *spot* should be understood as *single-value*;
- In the general case, the variance of the estimated outcome of a given decision possibility should not be used *per se* as a measure of the risk associated to such decision [3, 147][†]. Instead, an appropriate measure of the consequences that may be associated to any given decision alternative should be considered. Here, we consider such consequences to be either null or negative. Therefore they can be seen as a risk and expressed by an appropriate risk measure.

Spot-risk-based models have been widely used in decision-making processes [147–149]. One of the main reasons for this is that these models permit the decision-maker to integrate the uncertainty associated to a given random variable χ using a function f of only two criteria and one parameter. These criteria are:

[†]This was discussed in more detail in chapter 4.

- a *spot* prediction of the random variable outcome $\hat{\chi}$ (e.g.: its expected return $E(\chi)$);
- the amount of risk associated to the selection of such prediction, which is hereby given by $\mathcal{R}(\hat{\chi})$;

and the parameter is:

- parameter β representing the risk attitude of the decision-maker[†].

Equation 5.22 defines the spot-risk model.

$$f(\hat{\chi}, \mathcal{R}(\hat{\chi})) = \hat{\chi} - \beta \cdot \mathcal{R}(\hat{\chi}) \tag{5.22}$$

5.5.1.2 Integrating the Spot-Risk Model into Multi-Stage Decision-Making Processes

In chapter 4, several approaches for integrating uncertainties into decision-making problems were discussed. In the case of stochastic multi-stage decision-making, the integration of such uncertainties can be made in mainly two approaches. The first can be named as *master problem approach* and the second as *subproblem approach*.

The *master problem approach* consists in considering the multi-stage decisions and respective consequences as a whole. More precisely, the several single-stage decisions corresponding to a single multi-stage scenario are aggregated and their aggregated return evaluated as well as their aggregated estimated risks. In the case of the multi-stage power system cell scheduling problem, this could be translated to:

1. establishing a set of future scenarios for the hourly production/consumption based on the available forecasts and on the estimation of their uncertainty;
2. perform the deterministic cell scheduling and estimate the energy imbalance risks for each of the established scenarios;

[†]A discussion on the various risk attitudes was provided in section 4.5.

3. use the spot-risk approach to select the schedule that maximizes the expected revenue while minimizing the estimated risks.

This approach is particularly well-suited to multi-stage decision problems in which several possible future scenarios are available. However, it can lead to several quite different and competing multi-stage alternatives. This can lead to difficulties in selecting one of such alternatives as the best one and often implies the development of additional criteria for making the final choice. Hence, this approach seems to be better suited for decision-aid problems in which several *good-enough* options are presented to the decision-maker.

The *subproblem approach* consists in considering the multi-stage decisions and their respective consequences directly on each single-stage subproblem on a step-by-step basis. Hence, under this approach, the partial consequences of each subproblem decision are considered dynamically in a sequential manner. In one single step, this approach allows to obtain only one multi-stage solution to the multi-stage decision-making problem under uncertainty considered. At the same time it considers the whole search-space of alternatives considered. This is important in the frame of this work because it facilitates the development of automatized algorithms for obtaining a unique solution of the problem considered while taking full advantage of the dynamic programming global search method that is used[†] in the sense that the whole search-space is considered. Finally, due to the above advantages, the subproblem approach was selected for integrating the single-stage spot-risk model defined by Equation 5.22 in the power system cell scheduling model herewith proposed. This is further developed in the following section.

5.5.1.3 Single-Stage Integration of the Spot-Risk Model

The integration of the spot-risk model defined by Equation 5.22 into the power system cell scheduling problem was made following a subproblem approach as was described in the previous section. This is done by simply modifying the Bellman function defined by Equation 5.21. It is reminded that this function comprises three elements: π_{s_t} , $\mathcal{T}(s_t, k_{t+1})$, and $\mathcal{F}(k_{t+1})$. The first one, π_{s_t} , corresponds to the objective function of each subproblem of the multi-stage objective functional. Therefore, π_{s_t} is the element that should be modified for taking into account the risks that may be associated to each

[†]This is described in subsection 5.4.2.

subproblem alternative of the master problem.

The value of π_{s_t} may be seen as the expected profit associated to state s at time-step t subject to the transition to state k at time-step $t + 1$ under analysis as defined by Equation 5.21. Therefore, $\hat{\chi}$ in Equation 5.22 can be replaced by π_{s_t} thus yielding:

$$f(\pi_{s_t}, \mathcal{R}) = \pi_{s_t} - \beta \cdot \mathcal{R} \tag{5.23}$$

The integration of the spot-risk model into each scheduling subproblem is completed by replacing π_{s_t} in Equation 5.21 by $f(\pi_{s_t}, \mathcal{R})$ given by Equation 5.23 as shown below:

$$\mathcal{F}(s_t) = f(\pi_{s_t}, \mathcal{R}) + \mathcal{T}(s_t, k_{t+1}) + \mathcal{F}(k_{t+1}) \tag{5.24}$$

Equation 5.24 can be seen as a generalization of Equation 5.21 in the sense that one can obtain the latter from the former by considering a risk neutral attitude (by setting $\beta = 0$) but not the other way around. This is consistent with the general case of stochastic programming algorithms, which can be seen as generalizations of their deterministic counterparts [150].

5.5.1.4 The Risk Measure

Contrarily to Equation 5.22, the risk measure herewith proposed — \mathcal{R} — and included in Equation 5.23 is not a function of the subproblem return. Indeed, \mathcal{R} is a function of the next time-step $t + 1$, of the future system state under analysis k , and of some measure of the consequences that might result in the next time-step due to energy-related[†] uncertainties \mathcal{U}_{t+1} . The risk measure proposed here is detached from the objective of the problem (at least in an explicit manner). At the same time, it is strongly linked to the reality of the power system cell operation because it takes into account the operator's preferences,

[†]The *energy-related* refers to the forecast inputs of the power system cell scheduling problem that are related to both the non-dispatchable renewable energy production and the local load consumption.

which may be based on operational rules learnt from past operation situations. Therefore, the basic idea of such risk measure is to place the cell operator at the center of the scheduling procedure through the integration of the operational specificities of the cell in the decision-making under uncertainty process. This section discusses the components that are used for building \mathcal{R} . The integration of the operational specificities of the cell in the decision-making under uncertainty process will be illustrated in section 5.5.1.5 and follows a risk perception philosophy.

The value of \mathcal{U}_{t+1} may be more or less complex to calculate. For instance, it can be the result of classical VaR (Value at Risk) [151, 152] analysis, or CVaR (Conditional Value at Risk) analysis [153, 154]. It can also take the form of other risk measures. Here, the moments of the energy-related probability density function forecasts have been considered. More specifically, in this work, the second-order moment (i.e.: the variance)[†] of such distributions is assumed. Following this principle, the risk measure used in this work is composed by a multiplication of two factors as shown in Equation 5.25. These factors are the operator's perceived future risks $\mathcal{P}(k_{t+1})$ that is an element of the risk perception surface \mathcal{P}^\ddagger and the variance associated to the forecasted future non-dispatchable energy production/consumption Var_{t+1} .

$$\mathcal{R}(k_{t+1}) = \mathcal{P}(k_{t+1}) \cdot Var_{t+1} \quad (5.25)$$

Replacing \mathcal{R} in Equation 5.23 with the risk measure define by Equation 5.25 yields Equation 5.26.

$$f(\pi_{s_t}, \mathcal{R}(k_{t+1})) = \pi_{s_t} - \beta \cdot \mathcal{R}(k_{t+1}) \quad (5.26)$$

Finally, the updated Bellman function is obtained from Equation 5.26 by replacing $f(\pi_{s_t}, \mathcal{R})$ present

[†]The integration of the third-order moment can be straightforwardly made in the future. Some insight on this subject will be supplied as perspectives for further work.

[‡]The *risk perception surface* concept is discussed in subsection 5.5.1.5 together with the description of the specific algorithm that was used here for building it.

in Equation 5.24 by its updated version $f(\pi_{s_t}, \mathcal{R}(k_{t+1}))$, thus obtaining Equation 5.27.

$$\mathcal{F}(s_t) = f(\pi_{s_t}, \mathcal{R}(k_{t+1})) + \mathcal{T}(s_t, k_{t+1}) + \mathcal{F}(k_{t+1}) \quad (5.27)$$

It is clear from Equation 5.27 that each subproblem optimization takes into account the present condition of the system when making a decision *now* while, at the same time, taking into account the possible future consequences that such decision might have. This is consistent with one of the chief characteristics of any model based on stochastic programming [155] as the presence of $\mathcal{R}(k_{t+1})$ in Equation 5.27 potentially permits to consider the *eventual consequences* of each alternative in the decision-making process. Hence, provided that the risk measure is well-designed, Equation 5.27 is able to consider the *a posteriori* impact (e.g.: costs) associated to recourse actions (e.g.: paying energy imbalance penalties) due to the consequences (e.g.: energy imbalances) of having taken bad decisions *a priori*. At the same time, Equation 5.27 aims at enhancing the decision that is made *now* despite what might happen in the future. Hence, focus is put on the *here-and-know*, which is another of the chief characteristics of any model based on stochastic programming. Moreover, the probability distributions associated to the energy-related forecasts (the ones under analysis here) are independent of the scheduling decisions, which is another important characteristic of models based on stochastic programming. We can therefore conclude that Equation 5.27 is coherent with the stochastic programming philosophy. However, some additional considerations must be made at this point regarding the remaining chief characteristics of stochastic programming approaches described in [155]. Two of them (i.e.: *Optimization technology* and *Convexity*) should be seen more as observations related to existing stochastic programming formulations than to mandatory characteristics defining whether a given model can or not be considered as a stochastic programming one. The remaining one (i.e.: *Information Through Observations*) is analyzed in the following paragraph.

According to the principle of *information through observations* mentioned in [155], decisions should correspond to information that has become available since the initial decision through the observation of random variables. This is not done here because of the structure of the considered day-ahead electricity market. Such structure imposes that a set of bids is placed to the market up to the gate closure time (*vide* section 2.6). Therefore, in practice, one cannot wait for the uncertainties associated to each hour of the scheduling horizon to reveal thus constituting observations of the random events realiza-

tions reducing the uncertainty associated to the scheduling problem. Consequently, in the scope of this work (day-ahead scheduling), such observations are disregarded. However, the proposed model is not incompatible with the principle of making decisions based on the latest available observations. For instance, the proposed model can be used with some adaptations for the case of intra-day operation of the power system cell under a rolling scheme that always considers the latest observations in the decision-making process for reducing the uncertainty associated to the operation problem.

In fact, such forecasts are made, at maximum, for each element of the system, but independently of the herewith defined multi-stage system state descriptor (i.e.: energy storage state-of-charge). Therefore, the uncertainty information associated to the various non-dispatchable energy-related forecasts remains constant for each time-stage of the multi-stage scheduling problem. In addition, the uncertainty information associated to the t^{th} time-step is independent from the state upon which the power system cell resides on the preceding time-step (s_t). A direct consequence of this is that, while evaluating the transitions between s_t and every feasible future state k_{t+1} , the uncertainty taken into account is the same for each of such transitions, which makes such uncertainty information useless from both a decisional and an optimization viewpoint unless some additional system information is added. This is exactly one of the things that are achieved by the system dimension of the risk perception surface defined by the power system cell operator as will be seen in section 5.5.1.5.

5.5.1.5 The Risk Perception Surface

The risk measure discussed in the preceding subsection is composed of two main factors. One of such factors is some objective measure of the consequences that might be associated to any given alternative[†]. The other factor composing the proposed risk measure is given by the risk perception of the power system cell operator, which, as the name states is based on the operator's perception of risks.

Human perception of risks can be seen as an indicator of how human preferences behave in the presence of risk. In [156], risk perception is defined as an *intuitive risk judgment*. In other words, risk perception can be viewed as the sensitivity of the decision-maker to estimated risks.

The contributions of Tversky [157] and Slovic [156] have clearly shown the important role the way people understand risks can have on their preference ranking. This is also confirmed in [145] where

[†]In this work, the variance associated to non-dispatchable energy production/consumption forecasts was selected

the author defends that the way people perceive risks has an important role on how risks should be managed.

Here, the uncertainty information associated to non-dispatchable energy-related forecasts was complemented with a preference indicator depending on the state-of-charge of the energy storage device. Such preference indicator consists of a single-value reflecting the operator's perception of risks. The idea to use risk perception concepts for placing the operator's desires and past experience at the center of the scheduling process.

The set of risk perception values (or preference indicators) $\mathcal{P}(k_{t+1})$ constitutes a risk perception surface \mathcal{P} in the space of coordinates k (representing the system state) and t (representing the time-stage).

An interesting property that comes from using the risk perception values $\mathcal{P}(k_{t+1})$ in the the risk measure $\mathcal{R}(k_{t+1})$ comprised in Equation 5.25 is that it contributes to the differentiation between the state-transitions evaluated by the dynamic programming recursion described in Equation 5.27. Such differentiation is made according to the preferences under risk defined by the power system cell operator.

The differentiation between the state-transitions evaluated by the dynamic programming recursion described in Equation 5.27 is very important. Indeed, for each time-step, several energy storage levels (i.e.: states of charge) may be chosen and such choices do not affect the uncertainty associated to the input forecasts of the considered power system cell scheduling problem. The reason is that, such forecasts are made independently of the herewith defined multi-stage system state descriptor (i.e.: energy storage state-of-charge). Therefore, the uncertainty information associated to the various non-dispatchable energy-related forecasts remains constant for each time-stage of the multi-stage scheduling problem. At the same time, the uncertainty information associated to time-step $t + 1$ is independent from the state upon which the power system cell resides on the preceding time-step (s_t). A direct consequence of this is that, while evaluating the transitions between s_t and every feasible future state k_{t+1} , the input forecast uncertainty taken into account is the same for each of such transitions, which makes such uncertainty information useless if used *as is* from both a decisional and an optimization viewpoint. Therefore, from an uncertainty standpoint, all the state-of-charge transitions are equivalent mainly because such uncertainty is not calculated as a function of the system state or of the operating actions taken. Consequently, considering input forecast *per se* renders the problem equivalent to its deterministic version from a decisional perspective. However, the risk associated to each energy storage state transition (e.g.: the risk of obtaining energy imbalances) is not necessarily the same because the same

amount of uncertainty can be considered as *riskier* or *safer* depending, for instance, on the system state or on the preferences of the power system cell operator, which can be based, for instance, on past experience. Such conversion from risk to uncertainty can be achieved by an appropriate transfer function converting the measured forecast uncertainty to an amount of risk based on the preferences of the operator and on the system state. Here, we have used concepts of risk perception for building such function. Such risk perception aims to translate the level of risk *felt* by the power system operator under a given system state[†] in the presence of uncertainty.

As previously said, the risk perception surface \mathcal{P} is composed of an interaction between the preferences of the power system cell operator (translated by some set of rules) and the system state k_{t+1} at time-step $t + 1$. Here, both the time-steps and the system states are discrete variables. Hence, only some particular discrete points $\mathcal{P}(k_{t+1})$ of \mathcal{P} will be used. Each of such points constitutes a single-value aiming to represent the preferences of the power system cell operator, thus constituting a preference indicator. Such indicator therefore defines the perception of risk of the cell operator in a straightforward way, which is easy to integrate through equations 5.25 through 5.27 in the scheduling under uncertainty process.

A Method for Calculating the Risk Perception Surface

Here, an attempt was made for building the risk perception surface from the operational preferences of the power system cell operator by converting the latter into the former.

The operational preferences of the power system cell operator may be defined by a set of rules built from past operation experience. This can be done in a subjective way, in an objective way, or in some combination of both. As an example, in case the operator is responsible for the management of several cells, then, for instance, one strategic option might be to prefer to have stored energy in some specific moments in time on some of those cells for preventing energy shortages that usually happened on such specific cells at such moments in time (subjective determination of the operational preferences). Another option could be to use statistics for finding out which moments are riskier and which are safer regarding, for instance, the global energy imbalances of the set of cells, the global energy shortages/surpluses of the same set, the moments that translate to the highest imbalance penalties that were paid, and so on (objective determination of the operational preferences). It is straightforward to imagine a combination of the previous.

[†]Here, such state consists on the state-of-charge of the energy storage device.

From the previous examples it is obvious that the number of available options for defining the set of operational preference rules of the power system cell operator can be very large. Here, an approach was developed for converting such rules into risk perception rules. The proposed approach is used for illustrating how the the risk perception of the cell operators may be integrated in the scheduling process herewith proposed. It should therefore be kept in mind that the focus is not on the specific risk perception surface that is used for demonstrating the concept, but on the approach itself.

In general, one can say that formulations based on risk perception like the one proposed here allow to detect situations that tend to be more risky and those in which risks are expected to be lower, according to the risk definition of the operator. In the frame of this work, the operator defines a given risk perception associated to each possible future situation based on past experience, where the word *situation* can be translated as a combination between the present operation state of the system, the moment in time in which the system is operating under such state, and the future operation state of the system. Such risk perception penalizes proportionally the considered measure of uncertainty associated to non-dispatchable energy-related forecast inputs of the power system cell scheduling problem as shown in Equation 5.25[†] according to the operator's operational rule specifications. In other words, the same amounts of estimated uncertainty translate to different amounts of perceived risk depending on the *actual* situation of the system and on the risk perception definition of the operator.

Following the description that was made in the preceding paragraphs, for each time-step t of the scheduling horizon T and for each state s_t in which the power system cell may reside, a given preference value $\mathcal{P}(s_t)$ is calculated based on the risk perception of the cell operator[‡]. The whole set of preference indicators $\mathcal{P}(s_t)$ for every time-step $t \in \{1, \dots, T\}$ and for every state $s \in \mathcal{S}$ therefore defines a three-dimensional risk perception surface \mathcal{P} having as dimensions the energy storage state-of-charge s_t , the time axis, and the preference value associated to each s_t .

For determining the surface \mathcal{P} one needs to define a set of operating rules, as was described in previous paragraphs. But which set of rules? The answer depends on the type of system and on the preferences of the operator. In our case, two main principles were defined. The first of them is based on the the existence of a preferred level of energy storage state-of-charge. Such preferred level of energy storage can be the same throughout the several time-stages of the multi-stage power system cell scheduling

[†]As previously said, here, the variance associated to non-dispatchable energy-related forecasts was used. However, other moments may be integrated in the future or even complete probability density function forecasts.

[‡]On a more general case, one could design a risk perception value $\mathcal{P}(s_t, k_{t+1})$ that is dependent of the present system state s_t as well as of the future system state k_{t+1} .

problem. This principle is directly related to the state variable of the scheduling problem, which was defined in Table 5.2. The second principle is based on the existence of a global time-dependent rule[†]. This rule is built from historical data. For instance, for avoiding energy imbalances historical data per time-stage on such imbalances may be used (e.g.: average hourly energy imbalance on the last D days).

The Preferred Energy Storage State-of-Charge Principle

The preferred energy storage state-of-charge is taken here as the parameter that permits to define the operator's *technology-related* preferences. Indeed, the energy storage can directly compensate any energy imbalances that might result from non-dispatchable energy-related forecast errors. For instance, if the cell is producing too much energy at any given moment in time, the energy storage has the potential to absorb (at least in part) such excess and, thus, suppress up to some extent such energy surplus. However, in the same scenario, if the energy storage is already charged to its maximum energy capacity, then no compensation can be made, which may translate, for instance, to frequency deviations, to over-voltages, to over-currents and to the payment of imbalance energy penalties. If such type of events are seen as operation risks, then the energy storage capacity can be seen as a risk-hedging option whenever it is not fully charged/discharged depending on whether there is a local surplus or a lack of energy. However, the energy storage device has physical energy capacity limitations[‡]. Depending on such limitations, a given amount of estimated uncertainty may be more or less risky depending on the operating state of the power system cell. Whichever is the case, if no information on the probabilities of energy shortage and energy surplus associated to a given time-step exists, then the energy storage state that minimizes the risk is that in which the storage device may absorb as much energy as it can release. Such state is verified at 50 % for energy storage round-trip efficiencies of 100 %. Thus, if the operator wants to minimize energy imbalance risks, then the preferred energy storage state-of-charge may, for instance, be set to that value. Depending on the situation and on the preferences and objectives of the operator, other energy storage setpoints may be preferred. Therefore, in a more general case, the operator may specify a preferred energy state-of-charge state SOC_t^{Spec} per time-stage t of the multi-stage power system cell scheduling problem. This enables the operator to deal with the particular conditions of each time-step of the scheduling problem. For instance, in cases where no additional information exists on the most probable direction of the energy forecast error (e.g.: *energy storage is*

[†]Which can also be the result of a combination of time-dependent rules.

[‡]In some cases, like that of hydro storage, the energy storage may be seen as *large-enough* from a purely energy storage capacity perspective. Nevertheless, the *actual* energy storage capacity that can be used for performing energy imbalance corrective actions can be set to a small part of the base energy storage capacity due to many reasons like, for instance, the obligation to respect minimum water flows and the need to have enough water for allowing upstream/downstream and *vice versa* communication for ships.

more probable), the operator may define the same value of SOC^{Spec} for every time-stage. Conversely, the operator may define a different SOC_t^{Spec} per single time-stage if some information on the most probable direction of the error exists or if historical data on imbalance energy suggests it.

Here, a penalty function $q_t(s_t)$ was designed for penalizing states s_t that differ from the pre-specified (i.e.: preferred) ones s_t^{Spec} . This function is defined by Equation 5.28.

$$q_t(s_t) = d_t \cdot \frac{f_t(s_t)}{\max_{s_t} \{f_t(s_t)\}} + (1 - d_t) \quad \forall s \in \mathcal{S}, \forall t \in T, d_t \in [0; 1] \quad (5.28)$$

where,

$$f_t(s_t) = \left(s_t - s_t^{Spec}\right)^2 \quad (5.29)$$

The penalty function defined by Equation 5.28 is quadratic thus defining a convex parabola (from a minimization viewpoint). This permits to penalize states different that the specified ones in a manner that penalizes more intensely higher deviations than smaller ones. The speed of increase of $q_t(s_t)$ from its vertex (in which $s_t = s_t^{Spec}$) and its translation relatively to 1[†] is controlled per time-step by the *depth factor* d_t . Values of $d_t = 0$ imply that the risk perception of the operator does not change the objective estimation of volatility associated to the non-dispatchable energy-related forecasts. Consequently, if $d_1 = d_2 = \dots = d_T = 0$, then the scheduling method becomes purely deterministic because no differentiation is made between alternatives. In other words, as was explained in previously, every alternative is penalized of the same amount per time-step. High values of d_t increase the *depth* of the risk perception surface as can be seen in Equation 5.28. This increases the importance of the volatility associated to non-dispatchable energy-related forecasts forcing the optimization algorithm to maintain the energy storage state-of-charge equal to or as close as possible from s^{Spec} . In other words,

[†]Cases in which $\mathcal{P}(s_t) = 1$ can be seen as those in which by choice or due to past experience, the operator's perception of risks does not change the objective prediction of volatility associated to the non-dispatchable energy-related forecasts, or, in other words, as cases in which the risk measure yields the same value that the predicted forecast volatility does. This is due to Equation 5.25.

high values of d_t tend to over-value volatility. In such cases, the optimization algorithm may cease to work properly in the sense that it will tend to overreact to forecast volatility neglecting the estimations of the profits associated to the scheduling decisions. Hence, it is advisable to find some satisfactory compromise between these two extreme situations.

The Global Time-Dependent Rule Principle

The global time-dependent rule $g^{rule}(t)$ is taken here as a series of T values (i.e.: one value per time-step) reflecting the riskier and the safer time-steps. The utilization of this rule is not mandatory for differentiating the future state-transition alternatives because such differentiation can also be achieved by using variable preferred energy storage states per time-step as was discussed in the previous paragraph. Therefore, global time-dependent rules can be seen as complementary information given by the system operator whenever such information is judged as being important in the decision-making process. Such global time-dependent rules can be either inexistent, or the result of a single time-dependent rule or, finally, the result of the combined action of various single time-dependent rules. Examples of single time dependent rules can be:

- The per time-step forecasted levels of local non-dispatchable load, where higher levels of load may be seen as riskier situations that potentially increase the LOLP (loss of load probability) in the presence of energy imbalances. Alternatively, higher load levels can be often associated to market price peaks in which case energy imbalances may potentially lead to more severe imbalance penalties in comparison to low load periods;
- Forecasted per time-step day-ahead market price forecasts. Higher market prices may be, for instance, linked to power system congestions. In such cases, there is increased risk that the possible loss of certain transmission lines obliges to re-dispatch generation by using peakers. This may increase the regulation costs imposed to imbalance-responsible actors, which translates to increased financial risks;
- Past per time-step regulation costs of the system, for instance, in the form of weekly, monthly and yearly averages. Such averaged values may be seen as indicators of the financial risks to which the power system cell may be subjected in the presence of energy imbalances. In case some information on the skewness associated to the non-dispatchable energy-related forecasts is used, data on past per-time step shortage/surplus regulation costs of the system may be preferred;

- Some per time-step index or measure of the quality of day-ahead market price forecasts, which can give an information on the level of trust that can be associated to such forecasts. Higher levels of trust may be linked to less conservative attitudes of the power system operator aiming to maximize operational profits. Conversely, lower levels of trust may be linked to high conservative attitudes of the same operator.

Of course, many other single time-dependent rules or combinations of them can be selected/proposed by the operator and, subsequently, integrated in the construction of the risk perception surface.

Algorithm Used in This Work for Building the Risk Perception Surface

The algorithm proposed for constructing the risk perception surface according to the principles defined in the preceding paragraphs is described in Algorithm 3.

Algorithm 3: General description of the procedure followed for constructing the risk perception surfaces throughout this work.

Data: Number of time-steps T
Data: Maximum number of normalized energy storage states of charge \mathcal{S} to consider
Data: Vector containing values of s_t^{Spec} normalized by the maximum energy storage available capacity SOC_{max} where $t \in T$
Data: Vector containing per time-step values of global rule $g^{rule}(t)$
Data: Vector containing per time-step *depth* values d_t
Data: $g^{rule}(t)$ damping factor \mathcal{K}_g
Data: Constant global proportional gain \mathcal{K} (adjusted on a case by case basis)
Result: Risk perception surface $\mathcal{P}(s_t)$

```

1 begin
2   Obtain  $g^{norm}(t)$  by normalizing  $g^{rule}(t)$  according to the following equation:
   
$$g^{norm}(t) = \frac{g^{rule}(t)}{(\max(g^{rule}(t)) - \min(g^{rule}(t)))}$$

3   Calculate  $g^{damp}(t)$ , the damped version of  $g^{norm}(t)$  as  $g^{damp}(t) = \mathcal{K}_g \cdot g^{norm}(t)$ 
4   for  $t = 1$  up to  $t^{max}$  do // For every time-stage  $t$ 
5     for  $s = 1$  up to  $s^{max}$  do // For every possible system state  $s_t$ 
6        $\mathcal{P}^{Temp}(s_t) = q_t(s_t) \cdot g^{damp}(t)$  where  $q_t(s_t)$  is calculated from Equation 5.28 and
       Equation 5.29
7     endfor
8   endfor
9   
$$\mathcal{P}(s_t) = \mathcal{K} \cdot \frac{\mathcal{P}^{Temp}(s_t)}{\max(\mathcal{P}^{Temp}(s_t))}$$

10 end

```

The essence of Algorithm 3 follows a Boolean logic approach in which both the global time-dependent

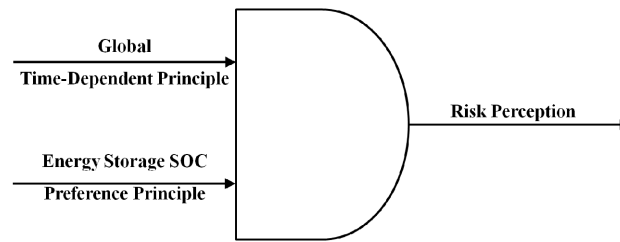

FIGURE 5.5: Representation of the Boolean logic followed for building the Risk Perception surface \mathcal{P} through the use of an AND logic gate. The represented logic schematically illustrates the functioning of Algorithm 3.

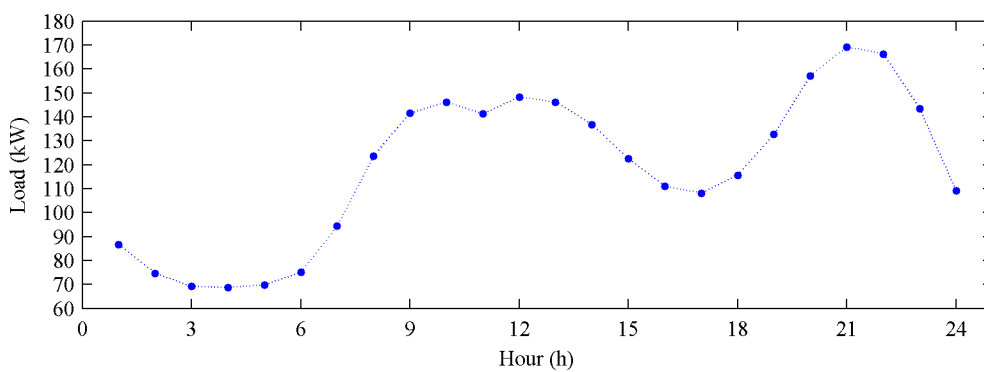

FIGURE 5.6: Representation of a possible global time-dependent rule $g^{rule}(t)$ that could be used for building the risk perception surface \mathcal{P} of the power system cell operator. Such rule corresponds to a series of load forecasts (point forecasts) obtained from data corresponding to conventional residential consumers, where higher levels of load translate to higher levels of risk perception of the operator and, conversely, lower levels of the load translate to lower levels of risk perception of the operator.

rule and the preferred energy storage state-of-charge principles are followed at all times. This may be schematically represented through the use of an AND logic gate as depicted in Figure 5.5.

Some examples are now supplied for visualizing the type of risk perception surfaces that can be obtained through Algorithm 3. For obtaining such examples, a load forecast of a hypothetical power system cell non-dispatchable load is used as the global time-dependent risk perception rule $g^{rule}(t)$. Such load forecast is represented in Figure 5.6. The choice of the load as an global time-dependent rule is in line with one of the examples of single time-dependent rule possibilities that were presented in the bulleted list above.

Four state-of-charge preference rules were considered. Three of them consider constant preferences of 0.2, 0.5, and 0.8 states of charge relatively to the nominal state-of-charge capacity of the storage device, which is given by SOC_{max} . Such preferences are respectively represented by figures 5.7, 5.8, and 5.9. The fourth state-of-charge preference rule consists of a variable state-of-charge preference, which was

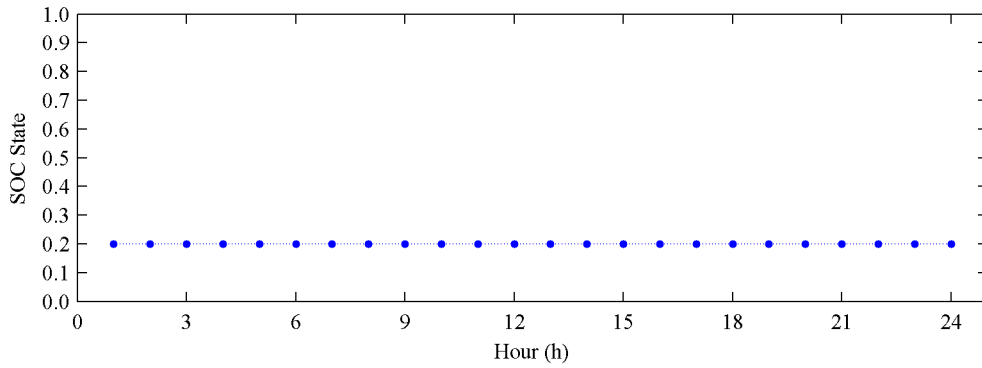

FIGURE 5.7: Representation of a state-of-charge preference rule in which the preferred state-of-charge is set to the constant value of 0.2 relatively to the maximum available energy storage capacity SOC_{max} .

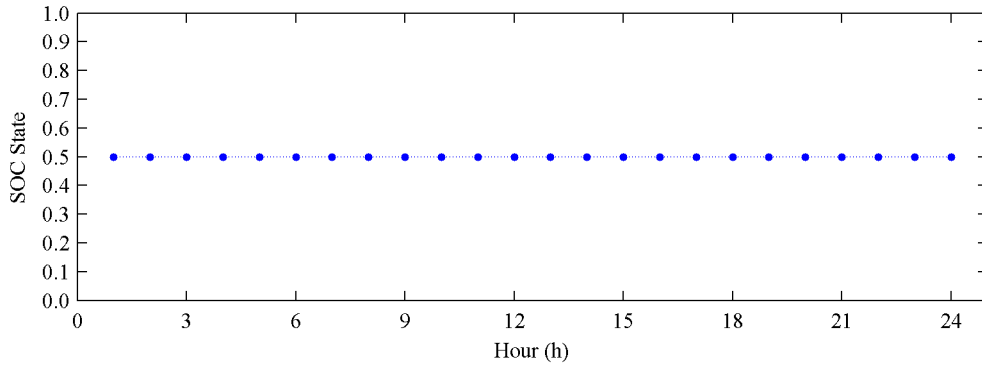

FIGURE 5.8: Representation of a state-of-charge preference rule in which the preferred state-of-charge is set to the constant value of 0.5 relatively to the maximum available energy storage capacity SOC_{max} .

defined based on Figure 5.6. This time-varying rule considers three discrete values of preferred state-of-charge: 0.2, 0.5, and 0.8. The lower value (0.2) is associated to low load periods. Accordingly, medium (0.5) and high (0.8) values are associated to medium and high load periods, respectively. The reasoning behind is simple and consists in considering that it is riskier to manage energy imbalances in the event of local peak loads because, under such events, one risks not being able to serve a higher amount of clients (and, possibly, more important/priority loads) than during valley hours. The resulting rule is depicted in Figure 5.10.

Finally, some additional parameters had also to be defined as these are inputs to the algorithm used for constructing the risk perception surface \mathcal{P} through the employment of Algorithm 3. These parameters are, the number of time-steps T , the maximum number of normalized energy storage states of charge \mathcal{S} , the global rule damping factor \mathcal{K}_g , the constant global proportional gain \mathcal{K} , and the depth risk perception sensitivity parameter d . The selected values for these various parameters are summarized

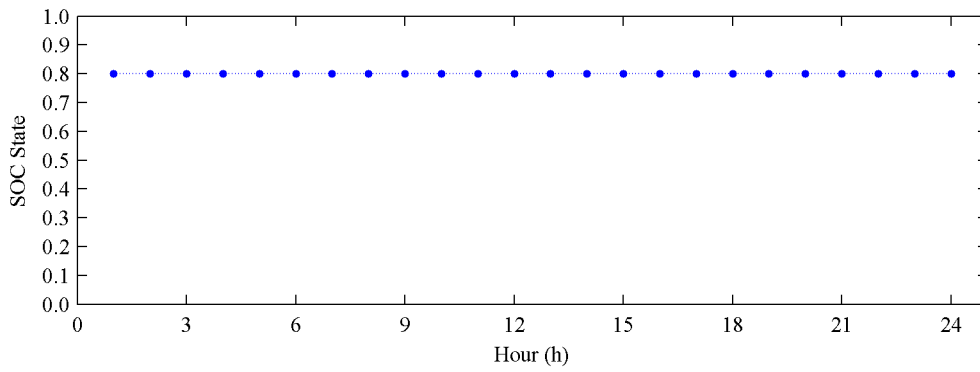

FIGURE 5.9: Representation of a state-of-charge preference rule in which the preferred state-of-charge is set to the constant value of 0.8 relatively to the maximum available energy storage capacity SOC_{max} .

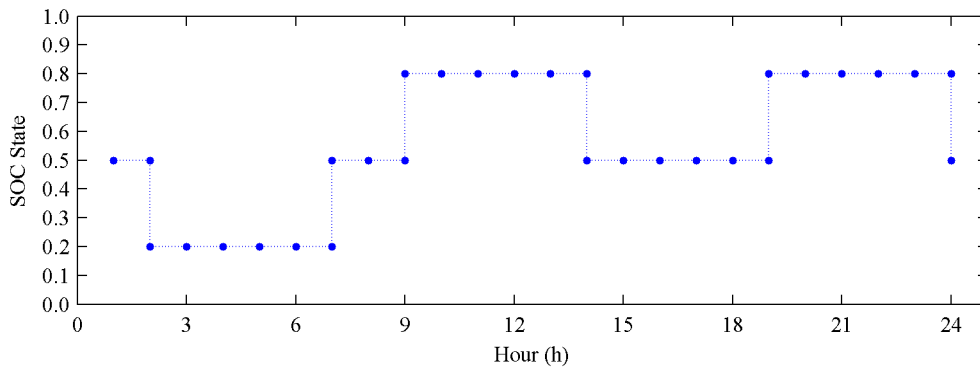

FIGURE 5.10: Representation of a state-of-charge preference rule in which the preferred state-of-charge is set to one of three predefined values (0.2, of 0.5, and of 0.8) while closely following the global time-dependent rule depicted in Figure 5.6.

T	\mathcal{S}	\mathcal{K}_g	d	\mathcal{K}
24	11	0.90	0.05	1.00

TABLE 5.3: Parameters used for building the risk perception examples shown in Figure 5.11.

in Table 5.3. It should be stressed that a constant rather than a variable value of depth d was used for building the present risk perception surface examples. Finally, on the present examples, the energy storage states of charge were discretized in 10 % steps relatively to the maximum energy storage capacity SOC_{max} .

The four risk perception surface examples obtained with the previously described inputs are depicted in Figure 5.11, which is composed of four subplots. These were obtained from the four different state-of-charge preference rules depicted in figures 5.7 through 5.10.

The top-left subplot (*Subplot 1*) corresponds to the case where the constant state-of-charge preference rule represented in Figure 5.7 was used. Such rule defines that the operator prefers to always keep the energy storage close to 20 % of its maximum capacity because this is the value that comprises the less amount of risk perception. One can see that the corresponding risk perception surface will always undervalue measured uncertainty in cases where the state-of-charge is close to 20 % comparatively to the cases where the same state-of-charge gets far from that value.

The inverse case is verified regarding the low-left subplot (*Subplot 3*) in which a constant state-of-charge preference was also used. However, in this case, a value of preference rule of 80 % energy storage capacity was used, which corresponds to the rule depicted in Figure 5.9. This value is symmetrical to the one used for obtaining *Subplot 1*, relatively to the middle-value of energy storage capacity (50 %). This is why the behavior of the corresponding risk perception surface is exactly opposite to the one that was obtained in *Subplot 1*.

The symmetrical property of Algorithm 3 mentioned in the previous paragraph is clearly verified in the top-right subplot where the constant state-of-charge preference rule of 50 % was used. Such rule is depicted in Figure 5.8. The risk perception surface of the corresponding subplot (*Subplot 2*) clearly shows that measured uncertainty will always be undervalued in cases where the state-of-charge is close to 50 % comparatively to cases where the same state-of-charge gets far from that value.

Finally, in the lower-right subplot (*Subplot 4*), the variable state-of-charge preference depicted in

Figure 5.10 was used. The risk perception surface obtained in this case can be seen as a mix of the previous ones, which was expected. The obtained surface therefore presents discontinuities in the points where the algorithm *leaped* from one state-of-charge preference to another. In the present work, this does not pose a problem because only one *next stage* is evaluated at a time. However, this may possibly cause problems if one wishes to increase the *stage-ahead visibility* for preparing the system to the uncertainties that are predicted more ahead in time.

To conclude the analysis of Figure 5.11, it should be noted that the global time-dependent rule that was considered for obtaining the different risk perception surfaces is clearly visible in the four plots if one keeps in mind the form of such rule, which is depicted in Figure 5.6.

As an ending note on the present matter, it should be said that in some cases the operators might prefer to supply their own risk perception surface instead of some design rules or principles. In such cases no algorithm for constructing such risk perception surface would be needed. However, no incompatibility issues should arise between such approach and the one proposed herewith if the state and time resolutions of the risk perception surface are compatible with those used by the power system cell scheduling algorithm.

5.5.2 Integration of Day-Ahead Market Price Uncertainty

An inspection of the power system scheduling problem defined in section 5.4 combined with the scheduling objective used in this work and described in section 5.3 reveals that the scheduling is performed for single valued prices issued from point price forecast methods. However, such point forecasts comprise a given amount of uncertainty due to the stochasticity of market prices. In a stochastic context, some uncertainty model needs to be considered so that a method for integrating market price uncertainties in the scheduling process can be designed.

Different ways to model uncertainty were discussed in section 4.2. From these, the probabilistic discrete scenarios[†] approach (*vide* Figure 4.1) was selected for modeling market price uncertainty. The scheduling model proposed here incorporates discrete market price values. Consequently, it is already suited for the utilization of discrete day-ahead electricity market price scenarios.

[†]In this section, for facilitating the discussion only probabilistic discrete scenarios are mentioned. However, the discussion and the approach followed in this work are also compatible with the case where possibilistic discrete scenarios are available.

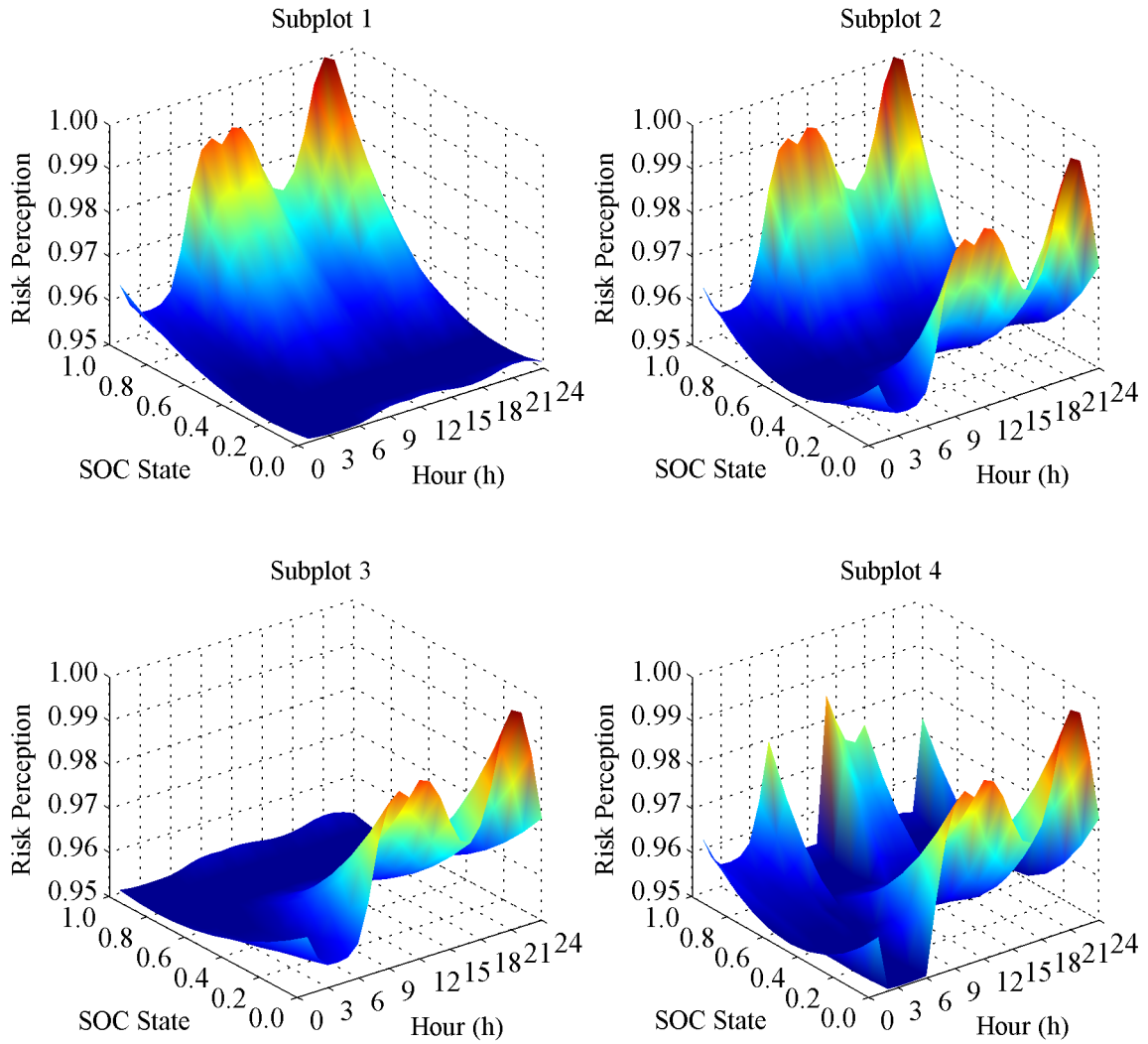

FIGURE 5.11: Examples of risk perception surfaces obtainable through algorithm 3.

In the scope of the problem dealt with in this work, single-stage market price scenarios were considered, where each market price realization at a given hour t represents a single-stage market price scenario $\hat{p}_{n,t}$, where $n \in \{1; 2; \dots; \mathcal{N}_t\}$ and \mathcal{N}_t represents the number of price scenarios available at hour t . Then, the estimated outcome obtained for each scenario $\hat{p}_{n,t}$ is weighted by the probability of occurrence of the corresponding scenario $p(\hat{p}_{n,t})$, where $\sum_{n=1}^{\mathcal{N}_t} (p(\hat{p}_{n,t})) = 1$. This is the option that was selected in the frame of this work, which corresponds to modeling day-ahead market price uncertainty through a probabilistic discrete scenario approach belonging to the *Discrete Points* uncertainty modeling class depicted in Figure 4.1.

Single-stage discrete market price forecasts can be obtained through the use of probabilistic price forecasting models capable to supply complete probability density function forecasts per time-stage. This can be achieved, for instance, through the use of probabilistic density function forecasting models based on kernel density estimators like the one proposed and used in [158]. However, such models supply continuous probability density functions, which therefore need to be discretized following some principle. In general, such distributions may be discretized according to three parameters:

1. the number discrete classes or bins per time-stage \mathcal{N}_t covering the complete domain of the original continuous probability density function;
2. the ordered cumulated probabilities of occurrence of each bin $p(\hat{p}_{n,t})$, where $n \in \{1; 2; \dots; \mathcal{N}_t\}$;
3. the principle to follow for associating a single discrete scenario $\hat{p}_{n,t}$ to each bin (e.g.: the point corresponding to the center of mass of each bin, the middle point, ...).

After having defined the parameter described in the previous list, the integral of each continuous probability density function is then computed in \mathcal{N}_t steps, where each integral computation phase stops when the value of the integral equals $p(\hat{p}_{n,t})$. Then, \mathcal{N}_t single-values (one per bin) are determined according to the principle selected for associating a single discrete scenario $\hat{p}_{n,t}$ to each bin. It should be noted that the time needed for computing the power system cell schedule tends to increase in a rather linear way with the number of single-stage price scenarios used.

If different day-ahead price scenarios per time-stage are available, then some principle needs to be followed for deciding which actions should be taken. Indeed, each price scenario will lead to a different set of optimal dispatchable generation and load levels and, consequently, to different scheduled power

interchanges at the PCC. The most basic way that was used for defining the *optimal* single-stage actions to take consisted in computing \mathcal{N}_t single-stage scheduling problems per state s_t and per future state k_{t+1} . Then, the schedule yielding the best *weighted return* was selected and such weighted return used as the *spot* input of the spot-risk model that was previously defined. However, some additional extensions to the proposed power system cell scheduling model were also developed. Such extensions were designed as options for deciding which single-stage scheduling actions should be taken. Such extensions are inspired in the works of Miranda in [93, 119] and are based on the Minkowski Distances that were presented in section 4.5.5.1 and on the alternative ranking methods based on such distances, which were described in section 4.5.5.2.

5.5.2.1 Single-Stage Integration of Market Price Uncertainties Through the Use of Minkowski Distances

The use of Minkowski Distances for performing the ranking of available alternatives was described in subsection 4.5.5.2. The application of this type of approaches into the power system cell scheduling model for determining and selecting the *optimal* single-stage actions to take is quite straightforward. It consists in applying the generic equations 4.10 and 4.11 to the specific case of determining and selecting the *optimal* single-stage actions to take. However, for applying the concepts that are behind such equations one needs to determine the *Ideal Point* [3], as was explained in 4.5.5.2 and then the set of *alternative actions*.

In this work, the so-called ideal point is considered as the one which yields the best possible result when no uncertainty exists. Following this consideration, one ideal reference point is determined per future day-ahead market price scenario. Such point therefore yields the optimal solution if its corresponding scenario *actually* occurs. The scenario is defined by each specific discrete realization possibility of the day-ahead market price $\hat{p}_{n,t}$.

The set of alternative actions is herewith considered as the set of energy storage state-of-charge transition options at each time-stage t of the scheduling horizon T leading to feasible future states of charge, where a given possible future state-of-charge is given by k_{t+1} . Therefore, the adapted formulations for determining the optimal transition $\nu_{s_t, k_{t+1}}^*$ between state s_t at time-stage t and state k_{t+1} at time-stage $t + 1$ are included below. For simplifying the speech, a transition to state k_{t+1} will be simply referred to as *alternative k*.

The integration into the power system cell scheduling model of a method based on Minkowski Distances for ranking and selecting amongst available alternatives may be achieved by modifying Equation 4.10 to Equation 5.30[†].

$$\min_k \left\{ \left[\sum_{n=1}^{\mathcal{N}_t} \left(p(\hat{p}_{n,t})^\alpha \left| \left(\pi_{k,t|n} - \pi_{t|n}^{Best} \right)^\alpha \right| \right) \right]^{1/\alpha} \right\} \quad \alpha \in \mathbb{Z}^+ \quad (5.30)$$

where,

- k represents the energy storage state transition alternative;
- n represents n^{th} day-ahead price scenario at time-stage t , where $n \in \mathcal{N}_t$;
- α is defines the order of the Lp -distance to be employed;
- $p(\hat{p}_{n,t})$ represents the probability of occurrence of the n^{th} day-ahead market price scenario at time-stage t ;
- $\pi_{k,t|n}$ represents the profit associated to alternative k at time-stage t under the event of scenario n ;
- $\pi_{t|n}^{Best}$ represents the best possible profit that could be achieved at time-stage t under scenario n .

In Equation 5.30, different values of α define different types of distances to be used, as was described in subsection 4.5.5.1. If $\alpha = 1$, the resulting distance is the so-called *Manhattan Distance*. The corresponding alternative ranking has been named *Probabilistic Choice* in [93, 119][‡]. If $\alpha = 2$, then one is using the well-known *Euclidian Distance*. The corresponding alternative ranking has been

[†]In Equation 5.30, the α symbol was preferred to the p symbol present in Equation 4.10 for avoiding confusion between this value and $\hat{p}_{n,t}$

[‡]This designation can be misleading because the remaining choice methods of the same family (obtainable through different selections of α) also use of probabilities. Moreover, all the choice methods can be used under a possibilistic framework. Hence, this method (Probabilistic Choice) is renamed *Expectancy Choice* because, in any case, its employment is equivalent to using the expected value decision-making paradigm that was described in subsection 4.5.1.

named *Euclidian Distance* in [93, 119][†]. If $\alpha \rightarrow \infty$, then one is using the *Infinite Distance*. The corresponding alternative ranking has been named *Risk Analysis* in [93, 119][‡]. Here, we described the most commonly used values for α . Of course, other values of α can also be used.

In the case of the infinite distance ($\alpha \rightarrow \infty$), the Robust Choice decision-making problem can be formulated in a simpler way, as defined through Equation 5.31 [3, 83, 93, 119], which is an adaptation of Equation 4.11 to the specific problem addressed here.

$$\min_k \left\{ \max_n \left\{ p(\hat{p}_{n,t}) \left| \pi_{k,t|n} - \pi_{t|n}^{Best} \right| \right\} \right\} \quad \alpha \in \mathbb{Z}^+ \quad n \in \mathcal{N}_t \quad (5.31)$$

5.6 Conclusions of the Chapter

This chapter proposed a complete model for performing the scheduling of a power system cell. Firstly, a modeling background was provided comprising a discussion on the many modeling possibilities and the description of the main objective of the model as well as some of its possible applications. Then, the power system cell scheduling problem formulated. Subsequently, a deterministic solution method for addressing such problem based on a deterministic Dynamic Programming approach was proposed. Such deterministic solution method was then extended for incorporating the energy- and day-ahead market-related uncertainties associated to the scheduling problem. For that specific purpose, a discussion on the uncertainty models that are used is given. Finally, several models for addressing such uncertainties were proposed, formulated and discussed. Such discussion was completed with illustrative examples.

In the next chapter, some case-studies are analyzed for giving some insight on the results that can

[†]This terminology can be confused with the well-known distance that is at its basis. Here, it is renamed *Euclidian Choice*. This contributes to eliminate the possibility of confusion by directly bearing the word *Choice* that intuitively indicates that it is a model for making choices. Moreover, this terminology is closer to the proposed Expectancy Choice one, which may facilitate the association of the two as belonging to the same family.

[‡]This term may lead to a confusion because many different things are named in the same way. Here, it is renamed *Robust Choice* because this decision paradigm corresponds to choosing the alternative leading to the least estimated future regret. In other words, alternatives selected through this last paradigm can be seen as those that are more robust for every possible scenario in the sense that they always lead to the minimum *a priori* estimations of absolute regret. Moreover, this terminology is closer to the *Expectancy Choice* and to the *Euclidian Choice* ones.

be obtained through the proposed power system scheduling model. Such case-studies comprise a microgrid and a combined wind-hydro power plant participating on the NordPool Elspot day-ahead market.

CHAPTER 6

Case-Studies

CHAPTER OVERVIEW

IN chapter 5, a methodology was developed for performing the day-ahead scheduling of power system cells operating under day-ahead electricity market conditions. Such methodology comprises several stochastic scheduling alternatives, which were elaborated and described. In this chapter, this methodology is tested on two case studies. The first case-study considers a microgrid while the second considers a combined wind/pumped-hydro system.

The chapter starts with a high-level description of the individual objectives of each case-study. Then, it proceeds with the description of the forecasting methods used for producing the necessary inputs. Finally, the considered case-studies and corresponding results are presented and analyzed.

6.1 Objectives

This chapter evaluates the the power system cell scheduling methodology proposed in chapter 5. The evaluation was made aims at illustrating the results that can be obtained through the use of the deterministic scheduling method as well as through the different stochastic extensions that were added to that base method. Its main objective is to analyze and compare such results.

The analyzes of the results are mainly based on two aspects. The first aspect concerns the revenue of the power system cell operator while the second concerns on the generated energy imbalances. Both aspects are analyzed for the different stochastic and deterministic approaches.

Two main case-studies are considered. One of them consists of a microgrid and is presented in section 6.2. The other one consists of a combined wind/pumped-hydro and is presented in section 6.3. The objectives of both case-studies are somewhat different.

The microgrid case-study is quite complete in the sense that it utilizes all the features of the proposed methodology. It aims at illustrating the type of results that can be obtained while scheduling a system comprising local dispatchable generation and loads. However, the available data used to build this case-study was scarce. Furthermore, the models used for producing the necessary forecasts[†] are quite basic. Therefore, only limited conclusions could be drawn. Still, this case-study allowed to have an insight of the merits of each decision-making method proposed in chapter 5 regarding the energy imbalances they generate.

The combined wind/pumped-hydro case-study considers not only the energy imbalances generated by the considered decision-making methods but also the *actual* revenue these yield. This was possible because relevant and enough real-world data was available and because forecasts produced through a state-of-the-art wind power forecasting model could be used as input to the scheduling tool. This allowed to perform a trade-off analysis between revenue and generated energy imbalance. However, the decision-making models based on Minkowski distances could not be employed here. This is due to the lack of a sufficiently accurate market price forecasting model permitting to build sufficiently good hourly market price scenarios.

[†]These models are described further ahead.

The proposed risk perception approach was used in both case studies.

The forecasting methods used for producing the various forecast inputs for both case-studies are quickly described in the next section.

6.1.1 Forecasting Tools Used for Producing the Required Data

Two forecasting tools were used for producing the various load and non-dispatchable renewable energy production forecasts needed as input for the two cases-studies considered in this chapter. The first one consists of an advanced wind power forecasting model developed at the Center for Energy and Processes based on kernel density estimators (KDE). This model was only used for forecasting wind power production delivering complete probability density function forecasts as output. For the purpose of the present case-studies, only the first two moments of such probability density function forecasts (i.e.: mean and variance) were used. For details on the KDE wind power forecasting model please refer to [158]. The second forecasting tool consists in a basic persistence-like method that was specifically developed for the purpose of the present case-studies. This method is detailed below and produces point and variance forecasts associated to the future values of the stochastic variable considered as output based on past data.

Details on the Persistence-Like Forecasting Method

The persistence-like method predicts the future value of a given stochastic variable \hat{x}^{sv} according to Equation 6.1.

$$\hat{x}_{d+1,t}^{sv} = x_{d-d^{lag},t}^{sv}, \quad d^{lag} \in \mathbb{Z}_0^+, t \in T \quad (6.1)$$

where,

- d is the present day (in which one is performing the day-ahead scheduling);

- t is the t^{th} time-step of the scheduling horizon T ;
- d^{lag} is the time-lag (in days) used for selecting the past occurrence of x^{sv} .

The forecast error $\epsilon_{d,t}^{sv}$ associated to the forecasted value $\hat{x}_{d,t}^{sv}$ is given by:

$$\epsilon_{d,t}^{sv} = x_{d,t}^{sv} - \hat{x}_{d,t}^{sv}, \quad d^{lag} \in \mathbb{Z}_0^+, t \in T \quad (6.2)$$

where, $x_{d,t}^{sv}$ is the *actual* occurrence of the the stochastic variable \hat{x}^{sv} at time-step t of day d .

The variance of the forecast error $Var(\epsilon_{d+1,t}^{sv})$ relatively to time-step t of day $d + 1$ is calculated as the square of the standard-deviation of the past series of errors as follows:

$$Var(\epsilon_{d+1,t}^{sv}) = \frac{1}{n^{sv} - 1} \cdot \sum_{n=1}^{n^{sv}} (\epsilon_{d-n+1,t}^{sv})^2, \quad n^{sv} \in \mathbb{Z}_0^+, t \in T \quad (6.3)$$

where, n^{sv} is the sample of past errors on which the variance is estimated.

For the present case n^{sv} was set to 50, which means that the last 50 measures were used for estimating $Var(\epsilon_{d+1,t}^{sv})$. This value results from a series of tests in which a compromise was sought between the number of samples used and the stability of the results obtained. The value of d^{lag} was set to: 7 in the case of load forecasts, 1 in the case of PV forecasts, and 1 in the case of price forecasts. These values were the ones that maximized the performance of the forecasting tool for the corresponding data time-series. Such performances were measured in terms of bias, mean absolute error (MAE), root mean square error (RMSE), and mean absolute percentage error (MAPE)[†].

In the microgrids case-study, the local non-dispatchable loads and the local non-dispatchable renewable energy productions were taken as independent random variables and, thus, the variance of their sum

[†]When applicable.

taken as equal to the sum of their variances [159]. This hypothesis may well be criticized. However, it is out of the scope of this work to consider the dependencies between forecasted variables. Instead, it is considered that either such forecasts are produced taking into account such dependencies, either a single forecast of the combined local non-dispatchable renewable energy production is made. In either case, the proposed power system cell scheduling model is only responsible for the processing of the forecast inputs.

6.1.2 Electricity Market Description

In the case-studies presented in sections 6.2 and 6.3, the operator of the power system cell is considered to participate on two subtypes of electricity markets[†]: the day-ahead market, and the regulating market[‡]. In the first case, the operator is considered to bid directly the obtained day-ahead schedule to the electricity market. In the second case, the operator is considered to pay any applicable regulation penalties established by the regulating market. The day-ahead market was considered on both case-studies (i.e.: microgrid and wind/pumped-hydro). The regulating market was only considered in the wind/pumped-hydro case-study because only this case evaluates the *actual* revenue obtained by the cell operator as was explained in section 6.1.

Each electricity market has its own rules, defining the way electricity is to be sold or purchased, how the prices are settled, and the obligations to which the participants are committed to. They are usually complex due the amount of energy trading possibilities they offer, to their rules, and to the way they operate, which is usually market-specific. An overview of different European electricity markets is given in [161].

The NordPool electricity market was considered in both case-studies presented in this chapter. In this electricity market, the prices and volumes are determined for the whole market area by matching purchasing and selling curves[§].

[†]Of course, the benefits of the power system cell could be increased by participating in additional markets (e.g.: intraday markets), but, in this case-study, only a participation in the first two is considered.

[‡]This terminology is in agreement with the one used, for instance, in [160]. Other designations for this type of markets exist as in [19] were they are called *Real-Time Markets*. It should be also said that there is controversy on whether they can actually be designated as being *markets*.

[§]For markets including different regions, regional day-ahead market prices are derived from system prices taking into account transmission bottlenecks.

The transmission system operator (TSO) is responsible for maintaining the physical balance between production and consumption. Independent power producers are taken as balance responsible actors that pay a given market imbalance price for any contribution to the global system imbalance when participating directly to the market. Consequently, under the NordPool electricity market, positive or negative imbalances may lead to regulation costs for independent power producers, which generally decrease their income. The determination of the regulation prices is the result of the regulating market, where actors with power reserves place bids for fast production increase or decrease. The upward regulation price is then determined as the most expensive production increase measure proposed on the market that was taken by the TSO. Inversely, the downward regulation price is determined as the cheapest production decrease measure taken by the TSO. It should be said that, in NordPool, the market participants are only penalized for their imbalances if these are opposite to the regulation measure taken by the TSO. The interested reader may refer to [70] for obtaining further information on NordPool market rules.

6.1.2.1 Day-Ahead Market

NordPool day-ahead electricity market rules (in the present case — Elspot) impose independent power producers to place their production bids on day d till noon, the day-ahead market clearance, which is usually referred to as *gate closure time*. However, the producers only start generating the corresponding energy on the first hour of day $d + 1$. This results on a time-lag of 12 h with respect to the forecasts that have to be used for preparing the bids. This time-lag corresponds to the best-case as, in fact, independent power producers will continue to generate energy till the end of day $d + 1$, which gives a total worst-case time-lag of 36 h. Any predictions the producers need to use for performing the day-ahead schedule of their respective systems will thus have to respect such time-lag constraints.

6.1.2.2 Regulating Market

The market model used in this work for representing the regulating market is similar to the ones used in [146, 160]. In general terms, for a given time-step t , the income I_t of a market participant bidding an amount of energy E_t but actually generating E_t^* can be formulated as the combination of the income

from the energy bid E_t traded at price p_t , minus the costs for regulation C_{REG_t} :

$$I_t = p_t \cdot E_t - C_{REG_t} \quad (6.4)$$

where the regulation cost C_{REG_t} relative to the imbalance energy d_t is given by an appropriate function $f(d_t)$ described below:

$$C_{REG_t} = f(d_t) = \begin{cases} p_t^+ \cdot d_t, & d_t \geq 0 \\ -p_t^- \cdot d_t, & d_t < 0 \end{cases} \quad (6.5)$$

$$d_t = E_t^* - E_t \quad (6.6)$$

with $p_t^+, p_t^- \geq 0$ being the upward and downward regulation prices for positive and negative energy imbalances, respectively.

6.2 Microgrid Case-Study Description and Input Data

The model proposed in section 5.4 was tested on a single-node microgrid comprising one microturbine rating 30 kW, a local load rating 200 kW, an interconnection capacity of 400 kW and energy storage facilities with a capacity of 500 kWh. The local load is composed of residential loads bearing an aggregated average value of 101 kW. The main parameters used for running the evaluation are described in table 6.1. The values of $\Delta_{SOC_{min}}$ and $\Delta_{SOC_{max}}$ were considered to be equal to Δ_{SOC} . The values of η_{dis} (discharging efficiency of the energy storage) and of η_{ch} (charging efficiency of the energy storage) were considered to be in the order of 95 %, which yields an overall round-trip efficiency of about $\eta = 90$ %. For creating the inputs, we have used:

μ_{pcc_t}	μ_{cont}	Δ_{SOC}	$P_{G_{min}}$	$P_{G_{max}}$	η	$\Delta(t)$
10 %	20 %	10 %	9 kW	30 kW	90 %	1 h

TABLE 6.1: Main parameters used for running the tests.

- residential load profiles corresponding to residential consumers in France;
- NordPool historical data;
- historical production data of a wind farm located in Central Europe. These were normalized by the installed capacity of the wind farm;
- historical production data of a photovoltaic installation operating in Central Europe. These were normalized by the installed peak capacity of the set of photovoltaic arrays.

For building the risk perception surface, two main principles were followed. The first one consists in considering that the microgrid operator always prefers to operate the energy storage as close as possible to its middle charging point (i.e.: $SOC_t^{Spec} = 50\%$, $\forall t \in T$). The second one consists in adopting the load forecast as an indicator of the riskier moments of the day, where higher load forecasts translate to higher risk perceptions than lower ones.

The data represented in Figure 6.1 was used as load input. One can see that the quality of the forecast is very high in the present case, however, this does not often happen in the real world. Here, the effect is due to the use of customer profile data built from the aggregation of many residential consumers distributed over a very large geographical area. On a microgrid, such aggregation can be much smaller (depending on the microgrid size), which can increase uncertainties. At the same time, customers are distributed over a relatively small geographical area. This may lead to an increased similarity of their respective load profiles, which may decrease the amount of uncertainty associated to load forecasts. Finally, microgrid customers may have access to smart metering systems and load managers, which could further increase the similarity between the profiles of the various microgrid customers.

The data represented in Figure 6.2 were used as wind power (WP) production input. Comparatively to the load case, the forecasts presented in Figure 6.2 comprise a higher amount of error despite the fact that an advanced forecasting model was used. This is because the uncertainty associated to the wind resource is much higher than the uncertainty associated to the load profiles that were used. The main reasons for this were explained in the previous paragraph. The average production of the wind farm

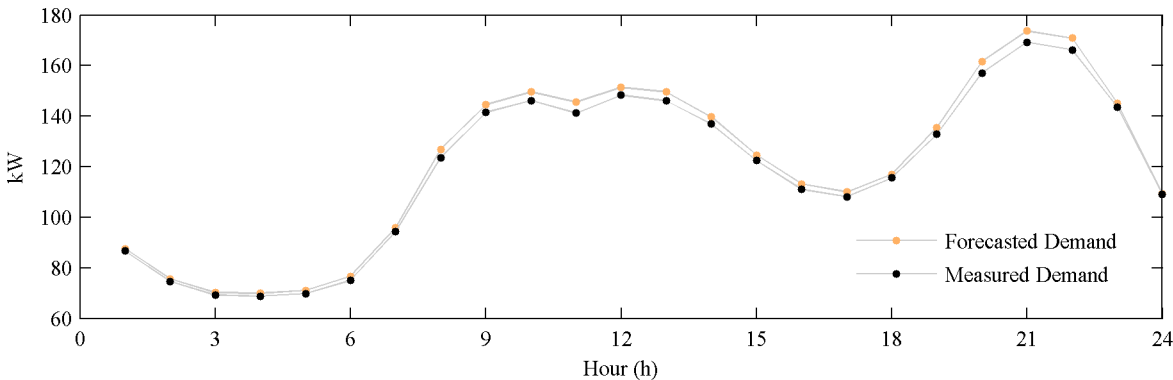

FIGURE 6.1: Forecasted and measured microgrid load.

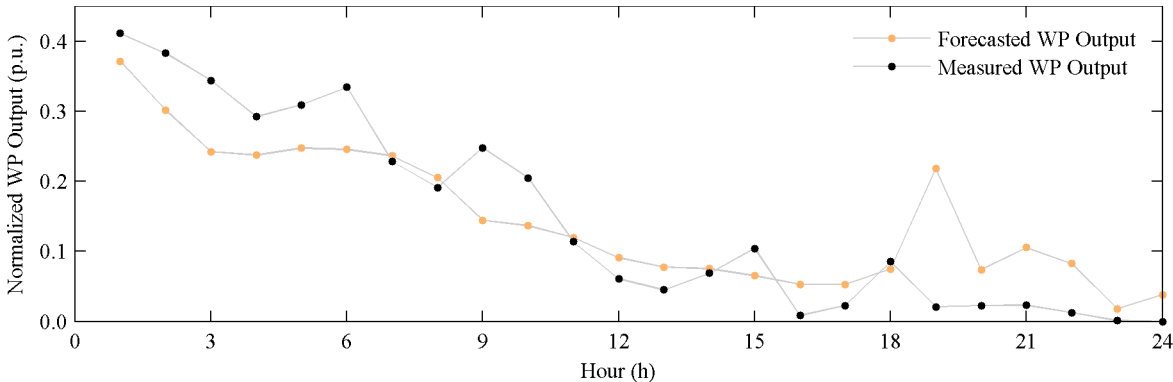

FIGURE 6.2: Normalized forecasted and measured microgrid wind power (WP) production. The normalization was made relatively to the installed capacity of the wind farm.

throughout the period represented in Figure 6.2 is of about 17 % of its nominal capacity.

The data represented in Figure 6.3 were used to represent photovoltaic (PV) units production in the microgrid. One can see that there are important differences between forecasted and measured PV production. This is most probably due to the uncertainty associated to the clearness of the sky and to the ambient temperature. The average production of the PV arrays throughout the period represented in Figure 6.3 is of about 3.6 %.

The data represented in Figure 6.4 were used as day-ahead market price input. It should be noted that the price curves have a quite similar shape in the sense that the position of their respective peak values and minimum values somewhat agree. This remains true even for the local peaks, at least for the most part of the considered time period.

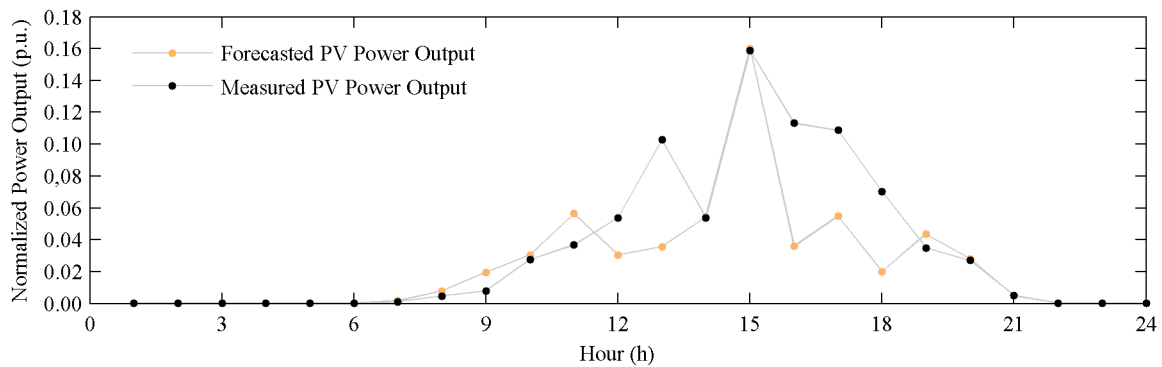

FIGURE 6.3: Normalized forecasted and measured microgrid photovoltaic (PV) power production. The normalization was made relatively to the installed peak capacity of the set of photovoltaic arrays.

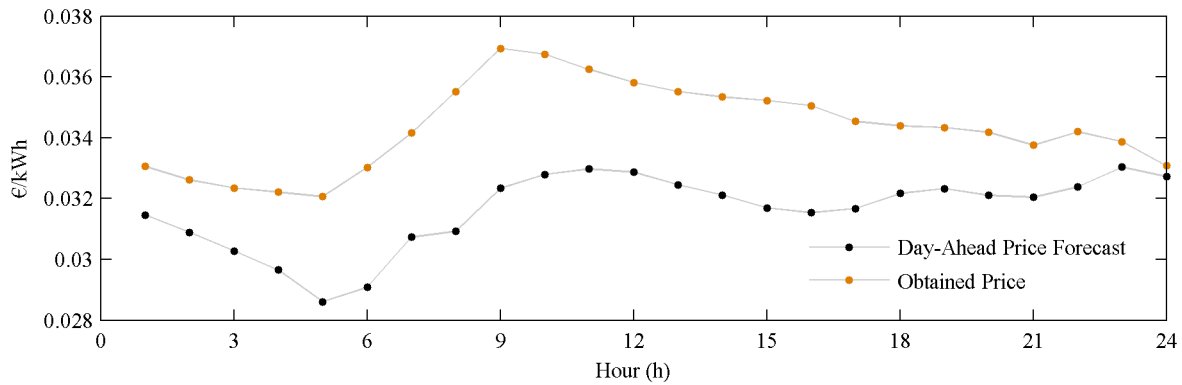

FIGURE 6.4: Forecasted and obtained day-ahead market prices.

The formulation of the power system cell scheduling herewith proposed, uses price information for taking single-stage decisions (level of dispatchable generation, level of controlled load,...) and multi-stage decisions (operation of the energy storage). Under a profit maximization operation objective (the present case), it should be noted that the latter is mostly dependent on the global behavior of the price curve. Indeed, if the quotient between the maximum and minimum values of the price series compensate the energy losses due to energy-storage cycling, then it is financially interesting to use the energy storage device [162]. Under such hypothesis, the only question is when to do what. Basically, one should use stored energy when prices are high and store it when prices are low. In other words, supposing that the use of the energy storage is compensated by price fluctuations, one only needs to know the price behavior for optimizing the operation of the energy storage. Consequently, the point forecasts used here are actually quite good for multi-stage scheduling purposes and not that good for single-stage scheduling purposes.

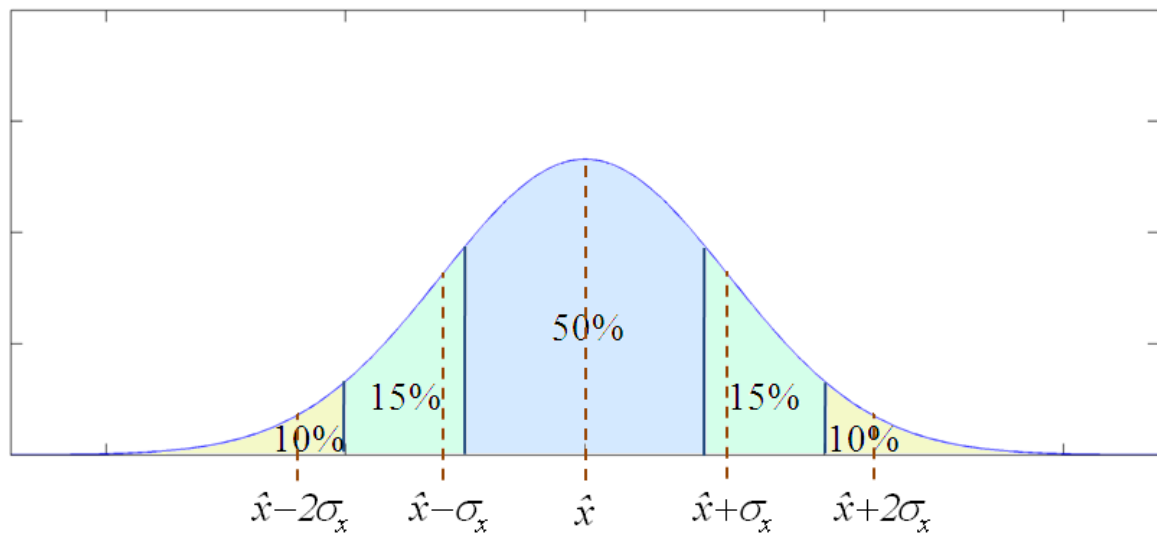

FIGURE 6.5: *Illustration of the price forecast discretization process.*

The present case-study utilizes the decision-making models based on Minkowski distances that were developed in subsection 5.5.2.1. Weighted market price scenarios are needed for that purpose. These were not available and so a simple method was developed to create them based on the available data, which are point market price forecasts and associated predictive variances as was described in subsection 6.1.1.

The method assumes normality on each single-stage price forecast. Each forecasted distribution is discretized in 5 different values as depicted in Figure 6.5. The central value corresponds to the point forecast. The remaining ones are calculated by using the forecasted standard-deviation information (square-root of the forecasted variance) as shown in the figure. Then qualitative probabilities were associated to each possible discrete realization of the market price. In this way, each different discrete market price forecast may be viewed as a single scenario. The resulting scenarios are represented in Figure 6.6.

As can be seen in Figure 6.6, a number of five single-stage market price scenarios per time-stage were built from the variance associated to the distribution of the past market price forecast errors comprising:

- A central scenario \hat{x} (black dots), corresponding to the mean forecast represented in Figure 6.6 and bearing a 0.50 probability of occurrence;

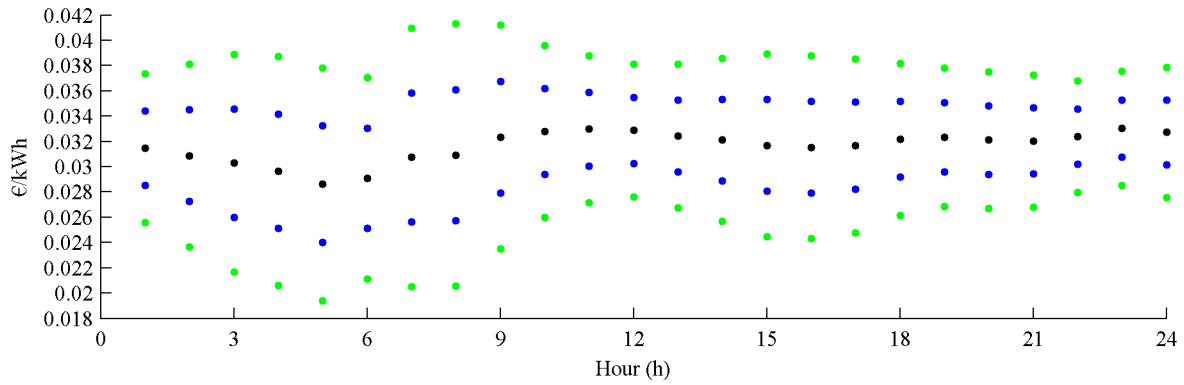

FIGURE 6.6: Forecasted day-ahead single-stage market price scenarios. Black dots correspond to day-ahead market price scenarios bearing a 0.50 probability of occurrence. Blue dots correspond to day-ahead market price scenarios bearing a 0.15 probability of occurrence. Green dots correspond to day-ahead market price scenarios bearing a 0.10 probability of occurrence.

- Two scenarios $\hat{x} \pm \sigma_x$ closer to the central one (blue dots), corresponding to deviations from the mean determined as a function of the forecasted variance associated to day-ahead market forecasts. Each of such scenarios bears a 0.15 probability of occurrence;
- Two scenarios $\hat{x} \pm 2\sigma_x$ farther way from the central one (green dots), corresponding to deviations from the mean determined as a function of the forecasted variance associated to day-ahead market forecasts. Each of such scenarios bears a 0.10 probability of occurrence.

6.2.1 Results and Discussion

Several simulations were run for different renewable energy source (RES) production scenarios. To build the scenarios, we considered different combinations of photovoltaic (PV) and wind turbine (WT) capacities as described in table 6.2. For each of the scenarios, six simulations have been made, from which two were deterministic and four were stochastic. The execution time was of about 11 s for deterministic simulations and of about 48 s for the stochastic ones on a PIV Centrino 1.73 GHz with 1 Gb of RAM.

Here, as was described in section 6.1, the focus was put on the energy imbalances that the different decision methods may imply on the operation of the main grid. In other words, the focus was put on the behavior of the microgrid relatively to the main grid. More precisely, the energy imbalances generated by the various decision-making methods at the point of common coupling (PCC) are evaluated. An

ID	PV (kWp)	WT (kW)	ID	PV (kWp)	WT (kW)
1	20	30	9	60	30
2	20	60	10	60	60
3	20	90	11	60	90
4	20	120	12	60	120
5	40	30	13	80	30
6	40	60	14	80	60
7	40	90	15	80	90
8	40	120	16	80	120

TABLE 6.2: Scenarios defined based on different PV and WT capacities.

indicator of such energy imbalances is the error between expected PCC power flows and measured PCC flows. For the whole period this is evaluated with the NMAE (normalized mean absolute error) criterion.

In Figure 6.7, one can verify that the deterministic method using perfect forecasts never leads to errors at the PCC (black bars always bear the value of 0 % NMAE), which was expected. However, the deterministic method using imperfect point forecasts led to NMAE values between 15 % and 18 %. The NMAE performance of the stochastic methods was comparable to that of deterministic methods improving it slightly in several scenarios with the exception of the *Robust Choice* method, which consistently underperformed greatly the deterministic method based on the use of imperfect point forecasts.

In Figure 6.7, it is clear that the main parameter affecting the NMAE performance of the various methods is the amount of considered wind power capacity for each scenario. Scenarios considering the same amounts of wind power capacity led to very similar results. This was expected because, as was described in section 6.2, the average production of the wind power is higher than that of the PV (17.5 % against 3.6 %), which makes the influence of wind power forecasts more important than the PV ones. Therefore, for simplifying the analysis, the initial 16 scenarios described in Table 6.2 were grouped according to their respective wind power capacities as described in Table 6.3.

The NMAE values corresponding to each decision method of each scenario group were taken as the average of the NMAE results obtained per single pair method/scenario contained in the scenario group. As an example, according to Table 6.3, the value of NMAE for the stochastic spot-risk method of scenario group A corresponds to the average value of the NMAE results obtained for the stochastic

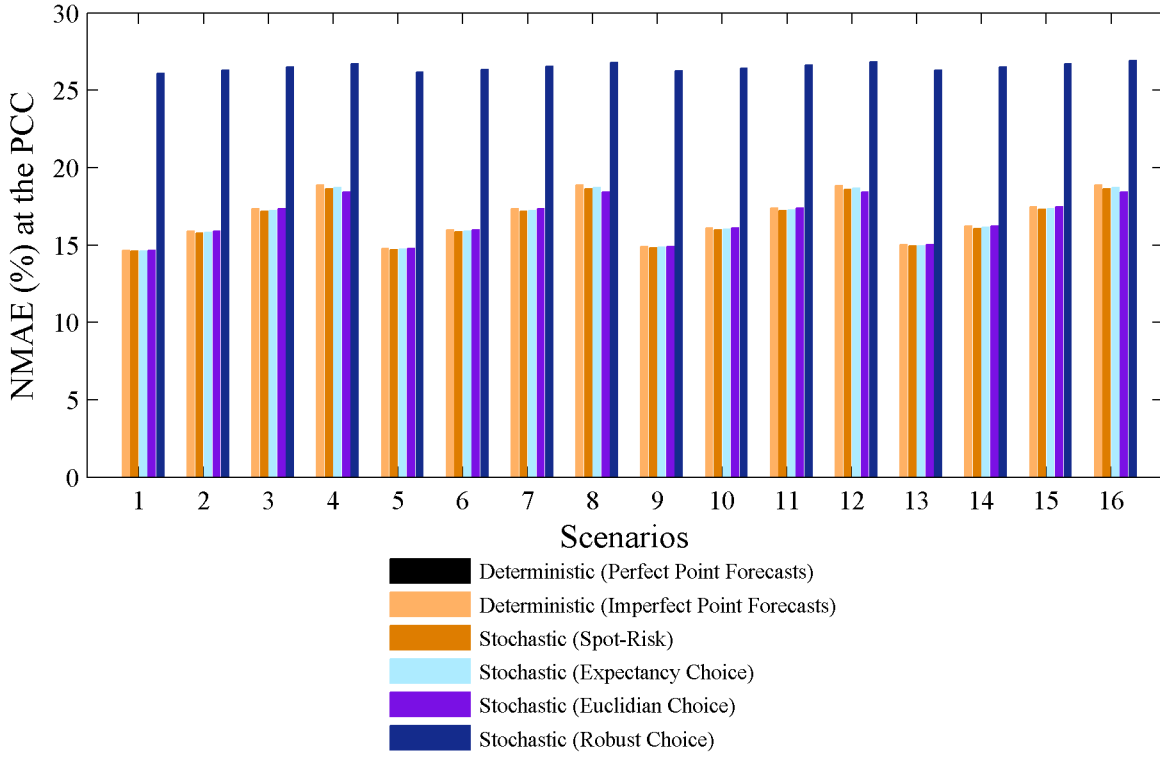

FIGURE 6.7: Mean absolute error at the point of common coupling (PCC) normalized by the peak PCC power flow that was obtained for the various decision-making options that were tested and for every scenario described in Table 6.2.

Group	Scenario ID
A	1, 5, 9, 13
B	2, 6, 10, 14
C	3, 7, 11, 15
D	4, 8, 12, 16

TABLE 6.3: Scenario grouping according to wind penetration.

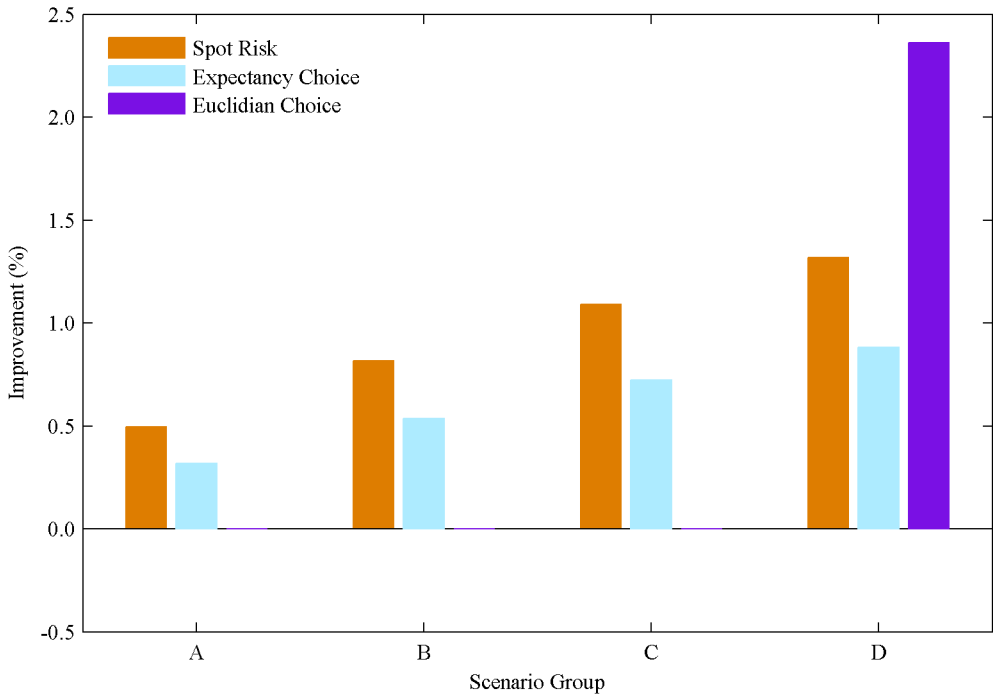

FIGURE 6.8: Mean absolute error improvement with respect to persistence at the point of common coupling (PCC) normalized by the peak PCC interchange that was obtained for the various decision-making options that were tested and for every scenario described in Table 6.2. Such improvement was calculated taking as reference the NMAE results obtained for the determinist decision-making method based on imperfect point forecasts that are depicted in Figure 6.7.

spot-risk method under scenarios 1, 5, 9, and 13.

The NMAE improvements obtained by the spot-risk, expectancy choice and euclidean choice methods relatively to the NMAE results obtained by the deterministic method based on imperfect point forecasts are depicted in Figure 6.8, which already considers the scenario grouping described in the previous paragraphs.

Figure 6.8 shows that the euclidean choice stochastic method outperformed the reference deterministic decision-making method using imperfect point forecasts by around 2.3 % on the scenarios with the highest wind penetration (i.e.: scenarios 4, 8, 12 and 16), which corresponds to scenario group D. However, this method had the same performance as the reference method on the remaining scenario groups. The spot-risk and the expectancy choice stochastic methods consistently outperformed the reference method in every scenario group proportionally to the considered wind power capacity. Moreover, both of these methods outperformed the euclidean choice stochastic method. However, the

spot-risk method slightly outperformed the expectancy choice one on every scenario group. Indeed, the improvements attained by the spot-risk method relatively to those obtained through the expectancy choice one ranged from 0.5 % up to 1.3 %. Hence, given that the spot-risk method is the simplest of the stochastic variants, then it seems to be the stochastic method of choice. Finally, due to their quite low NMAE performance (*vide* Figure 6.7), the robust choice stochastic decision method never improved the NMAE obtained through the deterministic decision-making method using imperfect point forecasts, which is used as the reference method in Figure 6.8. Therefore, the NMAE improvement results obtained through the robust choice method were not represented in Figure 6.8. In addition, it not interesting to depict the NMAE improvement results obtained through the unrealistic deterministic decision-making method using perfect point forecasts, as such results are unattainable in practice.

To conclude, the analysis of the results depicted in Figure 6.8 shows that the integration of the uncertainties associated to the microgrid scheduling problem through stochastic decision-making methods managed to improve the energy behavior of the microgrid relatively to their deterministic counterparts.

Considering the average of the errors between scheduled and measured power flows at the PCC, the schedules obtained through deterministic method using imperfect point forecasts and those obtained through the stochastic methods based on spot-risk, expectancy choice, and euclidean choice led to average errors of about 1.5 % for all the individual scenarios described in Table 6.2. The only exception was the robust choice stochastic method, that presented an average error of about 0.4 %. The energy storage utilization was approximately the same for both the deterministic and the stochastic cases. The only exception happened for the robust choice stochastic method, which used the storage on fewer occasions and amounts.

6.3 Wind/Pumped-Hydro Case-Study Description and Input Data

In this case-study, a real 21 MW wind farm located in the North West of Denmark for which power production data was available for the years 2000, 2001 and 2002 was considered. Numerical weather predictions by the Hirlam model, including wind speeds and direction for different heights corresponding to same time and area were also used as input for generating the wind power forecasts. The wind farm was considered to be coupled with an energy storage (pumped-hydro) rating 40 MWh and bearing 6 MWh/h up/down ramp-rates. The charge/discharge efficiencies of the storage device were set to

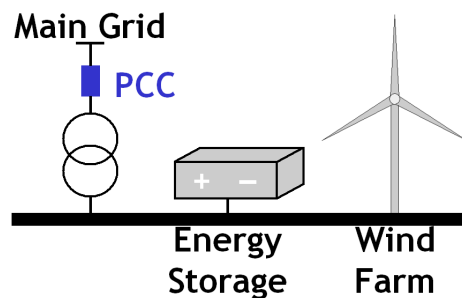

FIGURE 6.9: *Wind/Pumped-Hydro model.*

86.6 %, which yields a global efficiency of around 75 %. The combined wind/pumped-hydro system considered is depicted in Figure 6.9.

Historical data on NordPool electricity market [70] prices were used. Such market is divided in several market areas. The selected historical price data correspond to the market area incorporating the location of the wind farm used in this study (West Denmark).

In NordPool, the hourly contracts for each hour of the coming day are traded on the day-ahead market, named Elspot. The Elspot gate closure time is at 12:00 pm (local time) of the preceding day. Hence, the last available numerical weather predictions data (06:00 of the same day) were used as input to the wind power forecasting tool and forecast horizons were selected in order to get the hourly forecasts for the next day. The wind power forecasts were then used to calculate the bids to place to the market. During the delivery day, the energy storage was operated as described in subsection 6.3.1. The learning and testing of the wind power forecasting model were performed with the data corresponding to the years 2000 and 2001, respectively. The simulations of the market participation were performed with the data and forecasts corresponding to 2002.

In the present case-study, the optimization of the combined wind/pumped-hydro system under both day-ahead and regulating market conditions is done in two phases. The first focuses on the production of the day-ahead schedule of the wind/hydro system, based on its characteristics and on the available day-ahead hourly price and wind farm output forecasts. The second phase focuses on the short-term intraday operation of the wind/hydro system.

In the scheduling phase the optimal power output setpoints of the energy storage P_{Stot} are calculated at each time-step t of the scheduling horizon T to maximize the income of the combined wind/pumped-

hydro system operator, according to the methodology proposed in chapter 5. Forecasts of day-ahead prices and wind power are used as input to the scheduling process according to the methods described in subsection 6.1.1. In the operation phase, any existing energy imbalances between the scheduled power exchange and the *actual* or *real* power exchange at the point of common coupling (PCC) are compensated to the maximum possible extent through the operation model described below.

6.3.1 Intraday Operation of the Wind/Pumped-Hydro System

The approach that was followed for operating the energy storage device during the delivery day is based on a model similar to those used in [30, 34]. The reader should note that every equation presented in this section is time-independent and valid for every time-stage t . Hence, for simplifying the mathematical notation, the time index t shall be neglected in all equations presented in this section. Positive values of P_{PCC}^{Op} , P_{Sto}^{Op} , and P_{WF} mean that the corresponding elements are supplying power to the single node system model represented in Figure 6.9. Conversely, negative values of P_{PCC}^{Op} and $P_{Sto}^{Op\dagger}$ mean that the corresponding elements are extracting power from the single node system model represented in Figure 6.9.

In the operation phase, the power balance equation relative to the single-node system bus represented in Figure 6.9 is given by Equation 6.7, where P_{PCC}^{Op} and P_{Sto}^{Op} are the exchanged power at the PCC and the storage power contribution in the operation phase, respectively, and P_{WF} is the actual wind farm power production (i.e.: measured wind farm output).

$$P_{PCC}^{Op} + P_{Sto}^{Op} + P_{WF} = 0 \quad (6.7)$$

In the operation phase, the storage device is operated taking into account the actual wind power generation which will be different than the forecasted one. Different strategies could be adopted for managing the storage device. Here, the energy storage is used for reducing existing energy imbalances between the scheduled power flow at the PCC (given by P_{PCC}) and the *actual* power flow P_{PCC}^{Op} . Such imbalances are due to wind power forecast errors and are penalized by the market as explained

[†]It is considered that $P_{WF} \geq 0$ at all times.

in subsection 6.1.2. Under the adopted operation strategy, the required storage power P_{Sto}^{Req} is given by Equation 6.8, which is simply a different representation of Equation 6.7.

$$P_{Sto}^{Req} = - (P_{PCC} + P_{WF}) \quad (6.8)$$

The ability of the storage to fulfill the required P_{Sto}^{Req} depends both on its power rating and its actual state-of-charge (SOC). Consequently, P_{Sto}^{Req} is bounded by the storage charge and discharge power rating P_{ch} and P_{dis} and by the stored energy E_{Sto} . The latter will determine whether the storage device allows to deliver or absorb the required amount of power. In order to take into account the storage charging and discharging efficiencies η_{ch} and η_{dis} , the charge and discharge states are considered separately.

Whenever charging, or if the energy storage is not being used ($P_{Sto}^{Req} \leq 0$), the minimum feasible value of P_{Sto}^{Op} is given by the sequential application of equations 6.9 through 6.12, where E_{max} and E_{min} are the maximum and minimum energy capacity of the storage. Δt is the time step used for the operation process.

$$P_{Sto}^{Req} = \text{Max} \left(P_{ch}, P_{Sto}^{Req} \cdot \eta_{ch} \right) \quad (6.9)$$

$$E_{ch} = \text{Max} \left(P_{Sto}^{Req} \cdot \Delta t, E_{max} - E_{Sto} \right) \quad (6.10)$$

$$E_{Sto}^{Op} = E_{ch} \cdot \eta_{ch}^{-1} \quad (6.11)$$

$$P_{Sto}^{Op} = E_{Sto}^{Op} \cdot \Delta t^{-1} \quad (6.12)$$

Whenever discharging ($P_{Sto}^{Req} > 0$), the maximum feasible value of P_{Sto}^{Op} is given by the sequential application of equations 6.13 through 6.16.

$$P_{Sto}^{Req} = \text{Min} \left(P_{dis}, P_{Sto}^{Req} \cdot \eta_{dis}^{-1} \right) \quad (6.13)$$

$$E_{dis} = \text{Min} \left(P_{Sto}^{Req} \cdot \Delta t, E_{Sto} - E_{min} \right) \quad (6.14)$$

$$E_{Sto}^{Op} = E_{dis} \cdot \eta_{dis} \quad (6.15)$$

$$P_{Sto}^{Op} = E_{Sto}^{Op} \cdot \Delta t^{-1} \quad (6.16)$$

The above equations permit to simulate the utilization of the energy for coping with any power imbalances that may occur to the maximum possible extent.

The difference between P_{Sto}^{Op} and P_{Sto}^{Req} gives the energy imbalance at every moment in time, which takes negative values in case of power *shortage* and positive values in case of power *surplus*.

6.3.2 Overall Simulation Methodology

The methodology followed for estimating the annual profits generated by the wind/pumped-hydro system combines the scheduling and the operation phases needed for managing the system. Figure 6.10 depicts the overall simulation methodology that was followed. It describes the main inputs that were used, as well as the simulation structure that was followed for coordinating the scheduling phase with the operation one (represented by the *Decision Tool* box in the figure).

The methodology proposed in chapter 5 was used for performing the day-ahead schedule of the wind-pumped-hydro system. Namely, the scheduling problem was modeled as a dynamic programming *boundary value problem*. This means that both the initial and the final stored energy contained in the energy storage device of the dynamic programming recursion had to be specified *prior* to running the scheduling tool. For coping with this, the following procedure was followed:

- The storage device was assumed to start the simulation at 50 % of its maximum storage capacity;

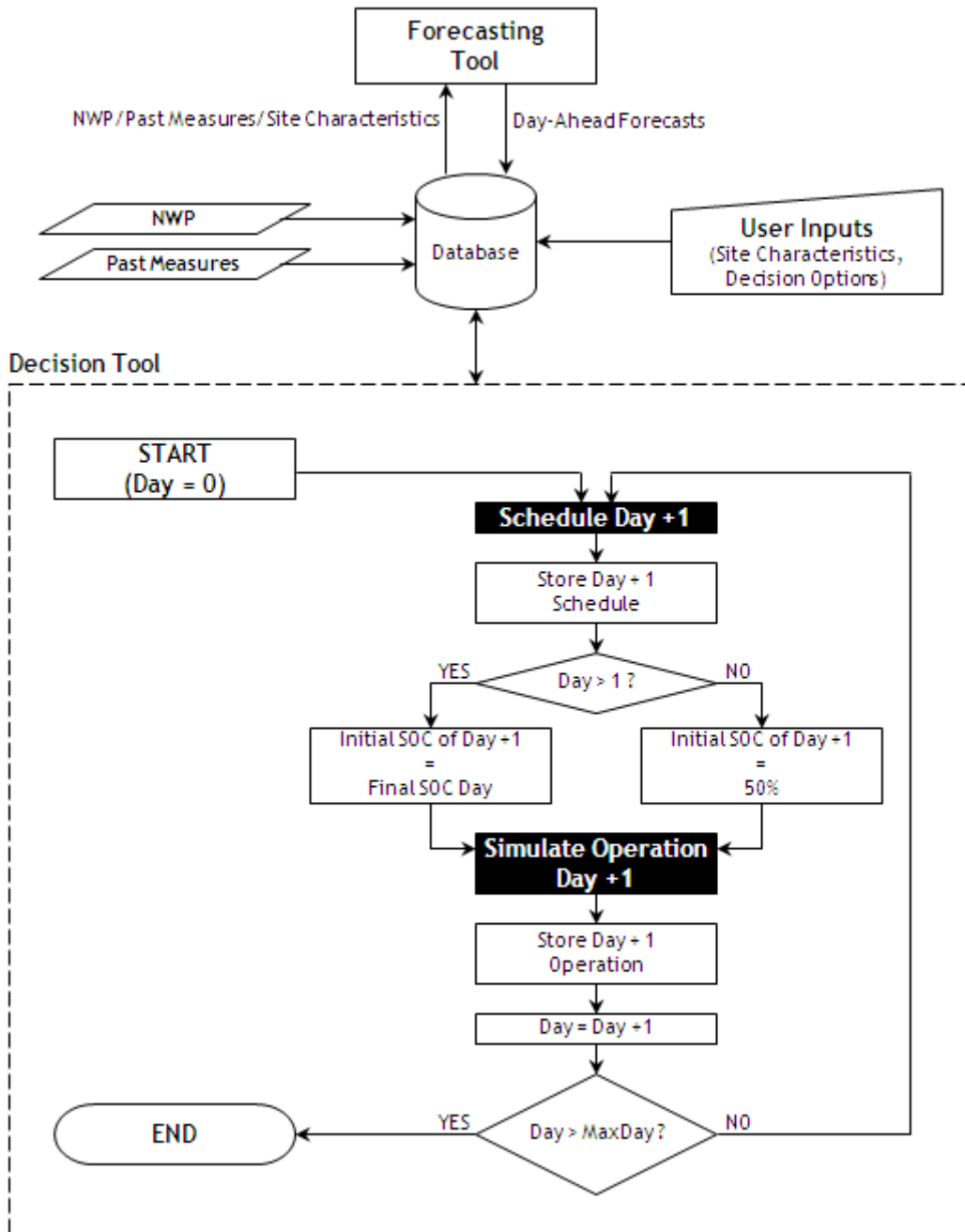

FIGURE 6.10: Schematic representation of the overall wind/pumped-hydro simulation including both the scheduling and the intra-day operation phases.

- The storage device was assumed to always reach a final state of 50 % of its maximum storage capacity;
- From the second day till the end of the simulations the energy storage device was initialized at the final SOC that was obtained after the previous day operation takes place. As a result, the dependency between the scheduling and the operation phases could be somewhat captured.

6.3.3 Deterministic Results and Discussion

Here, the deterministic version of the power system cell scheduling method proposed in chapter 5 is tested. For evaluating the performance of such method, six different scenarios have been simulated. In each of them different approaches were considered for evaluating the impact of the uncertainties associated to wind power and day-ahead price forecasts. The storage is used in different ways so as to be able to evaluate its contribution for reducing the imbalance penalties. Below, each scenario is described in detail while a code is associated (indicated in bold characters) serving as reference in the presentation of the results later on:

1. **WPPI_SPPI**: Perfect knowledge of the future values of both the wind farm output and the day-ahead prices. The energy storage is taken into account in both the scheduling procedure and in the operation phase. Therefore, this case supplies the upper bound of the potential profit when both the schedule and the operation procedures are used.
2. **WPPI**: Perfect knowledge of the future values of the wind farm output. No advanced day-ahead scheduling method is used for taking decisions regarding the energy storage. Thus, the day-ahead scheduled power exchange at the PCC corresponds to the available wind power forecasts. Such schedule is independent of day-ahead market prices because, as previously said in section 2.7, the system operator is considered as a price taker. The storage device is used however during the operation to smooth out imbalances that occur due to the wind power forecast errors. Therefore, this case supplies the upper bound of the potential profit when the scheduling procedure is not used.
3. **WPPred_SPPred**: Forecasts of wind power and day-ahead day-ahead prices are considered. The energy storage is taken into account in both the scheduling procedure and in the operation

phase. Therefore, this case supplies the potential profit when both the schedule and the operation procedures are used in a realistic case.

4. **WPPred**: Forecasts of wind power output are considered. No advanced day-ahead scheduling method is used for taking decisions regarding the energy storage. Therefore, as in case 2, this scenario is independent of day-ahead market prices. Consequently, the day-ahead scheduled power exchange at the PCC corresponds to the available wind power forecasts. The storage device is used however during the operation to smooth out imbalances that occur due to the wind power forecast errors. Hence, this case supplies the lower bound of the potential profit when the scheduling procedure is not used.
5. **WPPI_SPPred**: Perfect knowledge of the future values of the wind power and forecasts of the day-ahead day-ahead prices is considered. The energy storage is taken into account in both the scheduling procedure and in the operation phase. This case supplies the potential profit loss due to the errors contained in day-ahead price forecasts.
6. **WPPred_SPPI**: Perfect knowledge of the future values of both the day-ahead day-ahead prices and forecasts of the wind power is considered. The energy storage is taken into account in both the scheduling procedure and in the operation phase. This case supplies the potential profit loss due to the errors contained in wind power forecasts.

Figure 6.11 summarizes the results obtained for the six previously described simulations. One can see that, in the realistic case (WPPred_SPPred) the obtained profit is improved by using the proposed scheduling tool relatively to the base realistic case case (WPPred), which did not use it. Such improvement is of about 4.63 %. This represents a considerable amount bearing in mind that the SP-Pred_WPPred and the WPPred cases contain the same type of energy storage facilities. Hence, the improvement is obtained by intelligently operating them. However, Figure 6.11 clearly shows that the WPPred_SPPred results are still far from the maximum obtainable profit given by WPPI_SPPI. More specifically, an extra 17.73 % income could be achieved by improving the forecast inputs of the tool, which would reduce the penalties applied to the day-ahead market profit (also represented by Figure 6.11 by the dashed bars for each simulation).

It should also be said that the expected revenue in the WPPred_SPPI case surpasses the maximum attainable revenue that is given by the WPPI_SPPI case using only perfect forecasts as input. This is because despite the fact that the day-ahead schedules are optimal from a profit generation viewpoint,

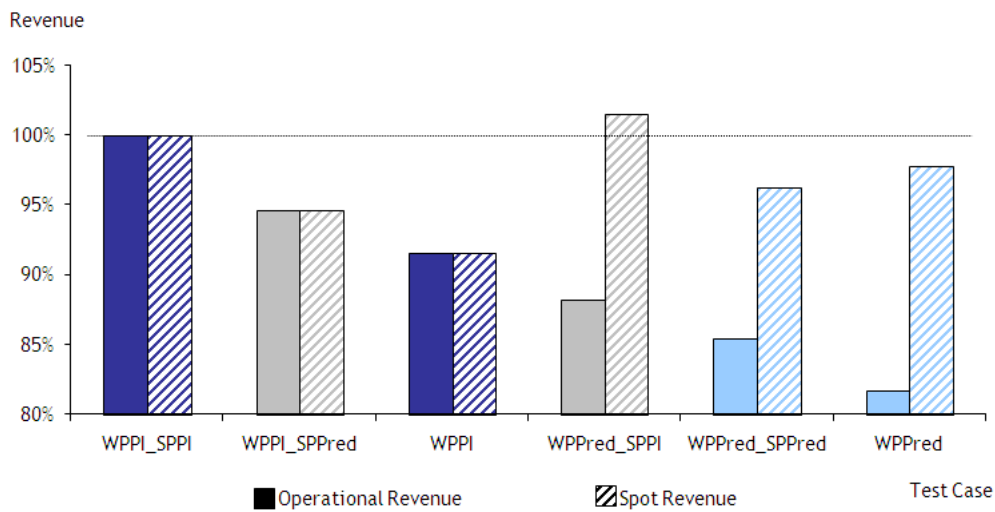

FIGURE 6.11: Profits obtained for each of the six simulated scenarios. The dashed bars represent the day-ahead market profits due to day-ahead market participation. The filled bars, represent the obtained operation profit, which is given by the per-case day-ahead market profit minus the penalties associated to each case.

they are based on imperfect forecasts for wind that are biased forecasting on average more wind power production than the one that is actually produced. As the price input is the same in the WPPred_SPPI and in the WPPI_SPPI cases, then it is normal that the expected profits associated to the WPPred_SPPI case be higher than those associated to the WPPI_SPPI case because the forecasted wind energy production is also higher in the former case than in the latter one.

Uncertainty in wind power forecasts is behind most of the income losses. This is illustrated in Figure 6.11 by the gray filled bar associated to the WPPred_SPPI case, which says that, relatively to the WPPI_SPPI case, 11.74 % of the profits are lost due to the uncertainty in such forecasts. At the same time, the grey filled bar associated to the WPPI_SPPred case says that, relatively to the WPPI_SPPI case, 5.37 % of the profits are lost due uncertainty in day-ahead price forecasts. However, the previous income losses were not additive, as their sum (17.11 %) is smaller than the income loss obtained using both day-ahead price and wind power forecasts (14.55 %), which is given by the WPPred_SPPred realistic case.

Finally, in Figure 6.11 one can see that the penalties in the regulating market are reduced by using the proposed tool. This is further analyzed in Figure 6.12.

In Figure 6.12, the dark blue bars represent the amount of penalties relatively to the maximum possible profit that is obtained by the ideal WPPI_SPPI case (perfect forecasts). It can be seen that the WPPred

case is the one with the highest penalties level. It can also be seen that the level of penalties of the WPPred_SPPred case is unexpectedly lower than that of the WPPred_SPPI case. Hence, the combined use of wind power and day-ahead price forecasts (WPPred_SPPred) reduced in fact the amount of imbalance probably due to some compensation existing between spot price and wind power forecast errors. This may be due to the fact that wind production is not perfectly independent from market prices, which may lead to some compensation between the errors associated to the forecasts of both variables in the long run. Nevertheless, the use of day-ahead price forecasts renders the energy storage scheduling sub-optimal. This results in loss of part of the income as is illustrated in Figure 6.11 where the grey filled bar associated to the WPPI_SPPred case shows that, relatively to the WPPI_SPPI case, 5.37 % of the profits are lost due to the uncertainty associated to day-ahead price forecasts.

Figure 6.12 also contains for each simulated case the amount of penalties relative to the revenue in the day-ahead market (light blue dashed bars) and the amount of penalties relative to the operational revenue (light blue filled bars). These values are in general greater than those associated to the dark blue bars (relative to the upper bound revenue). The only exception is the value associated to the dashed bar corresponding to the WPPred_SPPI case, which is the only one using perfect information of the day-ahead price as inputs and the only one in which the expected revenue surpasses the maximum possible revenue.

The light blue filled bars in Figure 6.12 indicate that the penalties associated to the base case (SPPred), in which the proposed tool is not used, are of approximately 20 % of the obtained operation revenue. This value drops to approximately 13 % in the case where the proposed tool is used with realistic inputs (WPPred_SPPred). Finally, no penalties are associated to the WPPI_SPPI, WPPI and WPPI_SPPred results. This is expected because all of these cases used perfect information of wind power production as inputs, and, therefore, never generate energy imbalances.

Lastly, it is interesting to note that the profit improvements achieved by the proposed method are not due to imbalance reduction, but rather to reduction of imbalance bias. This is shown in Table 6.4 and Figure 6.13. Specifically, from Table 6.4 it is concluded that the total energy imbalance obtained throughout the simulated year of operation remains practically the same in every case with a small improvement (2.28 %) in the WPPred_SPPred (realistic) case relatively to the base realistic case (WP-Pred). In Figure 6.13, one can see that through the use of the proposed tool (WPPred_SPPI and WP-Pred_SPPred cases), the energy imbalance structure changes in the sense that the symmetry between energy shortage and energy surplus increases relatively to the case in which the optimization tool is not

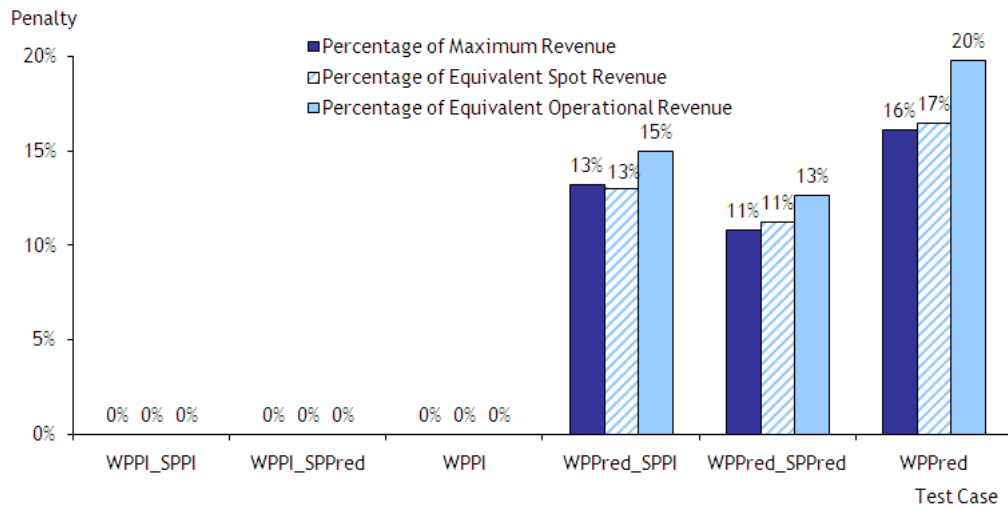

FIGURE 6.12: Penalties associated to each of the six analyzed test cases.

WPPred_SPPI	WPPred_SPPred	WPPred
10.830 GWh	10.589 GWh	10.836 GWh

TABLE 6.4: Energy imbalance obtained throughout the simulated year of operation.

used (WPPred).

6.3.3.1 Insight on the Value of Energy Storage

In order to further assess the value of energy storage, the operation of the system was simulated with and without energy storage. The main results are summarized in Table 6.5, where the case with energy storage is compared to the case where the scheduling tool proposed in chapter 5 is not used and, thus, the storage is only used for overcoming the energy imbalances generated by the wind farm.

	Shortage	Surplus	Total
With Storage (WPPred)	6.697 GWh	4.139 GWh	10.836 GWh
No Energy Storage Available	10.886 GWh	9.723 GWh	20.601 GWh

TABLE 6.5: Comparison between the energy imbalance results obtained in the WPPred case and in its corresponding case in which no energy storage was considered.

The energy imbalances generated by the wind farm in the absence of energy storage are much higher than in the case where the storage is used in coordination with the wind farm.

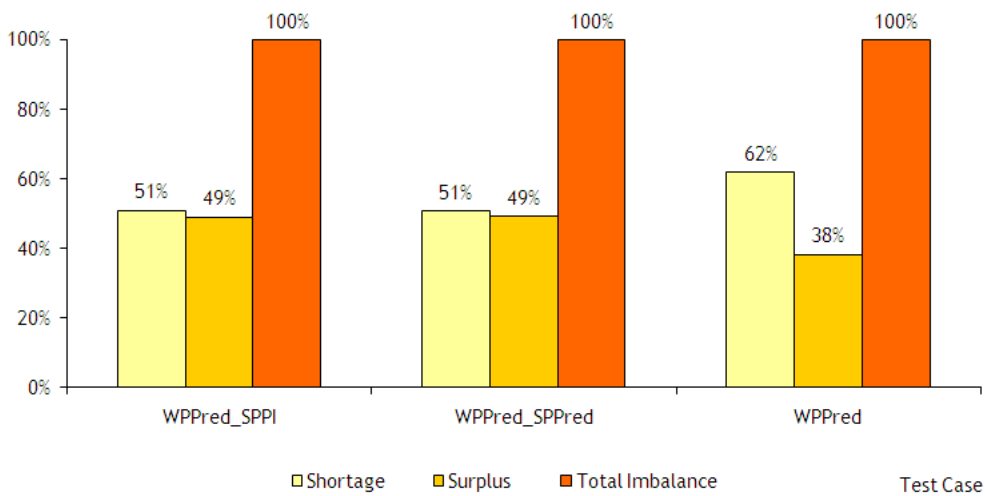

FIGURE 6.13: Relative distribution of the obtained energy imbalances.

The results included in Table 6.5 show some interesting findings. On the one hand, the utilization of the storage for overcoming the energy imbalances generated by the wind farm led to a total of 48.62 % of reductions of such imbalances, which is quite considerable. Looking into more detail, both the energy shortages and surpluses generated by the wind farm were reduced considerably. However, on the other hand, the imbalance structure worsens considerably when the energy storage is employed.

Without being perfect due to the bias of wind power forecasts, the symmetry of the energy imbalance structure is very good when no energy storage is used. However, such symmetry is highly degraded when using the energy storage for overcoming the energy imbalances generated by the wind farm. Consequently, energy shortages become much more often than energy surpluses as 62 % of the total energy imbalances represent energy shortages.

In the WPPred case with storage, the storage device is used on an hourly basis for reacting to system stresses caused by wind power forecast errors. Hence, no vision on the future is available and, consequently, no advanced operation strategy is employed, as opposed to the case where storage is scheduled on a day-ahead basis or operated according to some advanced operation strategy. Therefore, in the absence of an adequate operation strategy, the small bias associated to wind power forecasts tends to force the storage towards one of its extremes (in this case, to fully discharge) more often. In the long run, this leads to increases of one type of energy imbalance over another (in this case, energy shortages are considerably higher than energy surpluses). In other words, if no advanced operation strategy is used, then the energy storage tends to amplify the effects of the bias associated to wind power forecasts

	WPPred	WPPred_SPPred	WPPI	WPPI_SPPI
No Energy Storage Available	96.51 %	92.24 %	86.12 %	78.82 %

TABLE 6.6: Comparison between the revenue attained in the case where no energy storage is available and the realistic (WPPred, WPPred_SPPred) and perfect (WPPI, WPPI_SPPI) cases in which an energy storage device is considered.

as shown in Table 6.5.

To further verify the effect mentioned in the previous paragraph, it can be said that, when the energy storage was not used, the energy shortage rose up to about 53 % of the total energy imbalances generated by the wind farm (i.e.: about 3 % of wind power forecast bias). This value is close (but worse) to the values obtained when the proposed scheduling tool is applied for performing the day-ahead schedule of the energy storage, which were of about 51 % (*vide* Figure 6.13).

As a general conclusion, the utilization of energy storage contributed to the reduction of the total imbalances generated by the wind farm. The day-ahead strategic scheduling of the storage device contributed to the improvement (symmetry) of the energy imbalance structure and even to the reduction of the impacts of the bias associated to wind power forecasts.

The results obtained regarding the revenue of the wind farm operator in the case where no energy storage is used are summarized in Table 6.6. These results compare the revenue attained in the case where no energy storage is available with the realistic (WPPred, WPPred_SPPred) and perfect (WPPI, WPPI_SPPI) cases in which an energy storage device is considered. One can see that the revenue obtained is always smaller when no energy storage is used. In all cases considered, the revenue losses due to the absence of energy storage were higher for the cases where the methods proposed in chapter 5 are used (i.e.: WPPred_SPPred and WPPI_SPPI cases) than for those in which no day-ahead scheduling of the energy storage is performed (i.e.: WPPred and WPPI cases). This shows that it is possible to increase the revenues of systems comprising energy storage devices by using the methods proposed in this work. More specifically, the realistic WPPred_SPPred case in which both a day-ahead schedule and an energy imbalance filtering as the one described in subsection 6.3.1 are performed presented a revenue that is 8.41 % higher than the revenue attained in the absence of an energy storage device.

As a global conclusion, the previous results show that the combined use of the methods proposed in this work with the application of energy imbalance filtering through the employment of energy storage can increase the revenue of power system cells like the one considered here while considerably reducing

the energy imbalances due to forecast errors.

6.3.4 Results From Stochastic Approaches and Discussion

This part of the case-study complements the deterministic analysis that was made by testing the proposed stochastic approach based on the concepts proposed in subsection 5.5.1. These concepts take into account both the risk attitude and the risk perception of the operator of the power system cell. The single-stage spot-risk model is used for integrating the energy-related uncertainties associated to the day-ahead scheduling problem. In addition, point forecasts of day-ahead electricity market prices are used.

In this part of the case study a sensitivity analysis of the main parameters described in subsection 5.5.1 (i.e.: d and β) is made. This creates a large number of scenarios to analyze and to compare with a base reference case. For reducing the complexity in the presentation of the results, only the realistic scenario WPPred_SPPred described in subsection 6.3.3 is considered and used as reference scenario for the sensitivity analysis.

The risk metric used here uses the risk perception concepts described in subsection 5.5.1.5 by considering a risk perception surface \mathcal{P} . The risk of obtaining energy imbalances due to wind power forecast errors was considered and the objective was to reduce energy imbalances at the point of common coupling (PCC) while maximizing the revenue of the power system cell.

For minimizing the risk of obtaining imbalances at the point of common coupling (PCC) between the power system cell and the main grid, the risk perception surface \mathcal{P} was calculated using Algorithm 3 (*vide* subsection 5.5.1.5). the next two main principles were followed:

1. Global time-dependent rule principle: the degree of risk perception of the operator was assumed to be proportional to the average day-ahead price curve over a year. This is because the dispersion of imbalance costs of the same year is higher than that of day-ahead market prices while it was observed that a rather close association (a high correlation) existed between the average imbalance cost curve and the average day-ahead price one;
2. Preferred energy storage state-of-charge principle: the plant operator was assumed to prefer

maintaining the storage as close as possible to a given state s^{Spec} . This means that the risk perception of the operator is minimized when the next storage state k_{t+1} equals s^{Spec} . In the scope of this case-study, we have further assumed such state to take the constant value of 50 %, as this state-of-charge assures equal slack exists for charging and discharging energy, thus facilitating, in principle, the minimization of energy imbalances.

For facilitating the comprehension of the remainder of the analysis, it should be remembered[†] that a value of $d = 0$ implies risk indifference, which is equivalent to say that the scheduling method becomes purely deterministic. Higher values of d increase the *depth* of the risk perception surface. This increases the importance of estimated risks forcing the optimization algorithm to maintain the energy storage state-of-charge equal or as close as possible to s^{Spec} . Under such behavior, the optimization algorithm ceases to work properly in the sense that it tends to overreact to estimated risks neglecting scheduling outcomes. Hence, it is advisable to find some satisfactory compromise between these two extreme situations, as was described in subsection 5.5.1.5.

Regarding the simulation scenarios, a total of 30 were evaluated. Two of them are deterministic reference scenarios that only consider day-ahead price and wind power point forecasts produced with the models described in subsection 6.1.1. The remaining 28 scenarios also take into account the uncertainties associated to the considered point forecasts by using the proposed spot-risk model.

The two deterministic reference scenarios comprise a base scenario (D) that uses all of the available energy capacity of the energy storage. This scenario corresponds to scenario WPPred_SPPred described in subsection 6.3.3. A modified version of this scenario, called *bounded* base scenario (DB), where the energy storage capacity is considered smaller in the scheduling phase than its real value (i.e.: the storage energy capacity (SOC) boundaries are narrowed) is also considered.

In the base deterministic simulation (D), the storage device is operated with its energy capacity limits equal to those defined in its specifications. However, in the *bounded* deterministic simulation (DB), the storage energy capacity limits are reduced artificially in the scheduling phase (but not in the operation phase). This way, the DB simulation constitutes a rule-of-thumb approach for decreasing the imbalances caused by the power system cell because a minimum amount of storage capacity slack is always guaranteed to exist.

[†]This is defined by equations 5.28 and 5.29 and explained in section 5.5.1.5.

<i>TYPE</i>	<i>D</i>	<i>DB</i>	<i>SR</i>	<i>SRB</i>	d_i		
Bounding	No	Yes	No	Yes	<i>i</i>	1	2
Stochastic	No	No	Yes	Yes	Value of d_i	0.05	0.01
β_j							
Attitude	Prone		Averse				
<i>j</i>	1	2	3	4	5	6	7
Value of β_j	-0.2	-0.1	0.2	0.4	0.6	0.8	1.0

TABLE 6.7: Summary of the simulations performed in this work.

The remaining 28 simulations may be separated into two main approaches:

- the ones tagged as *SR* in which the proposed Spot-Risk model was used *as is*;
- the ones tagged as *SRB* in which the proposed Spot-Risk was used in parallel with the same bounding strategy that was used in the *DB* base simulation described above.

Each of the two approaches (*SR* and *SRB*) comprises 14 different simulations. These simulations were obtained by varying the d and the β parameters. The d parameter (referring to *depth* of the risk perception surface) was allowed to take two values. The β parameter (referring to the risk attitude of the power system cell operator) was allowed to take seven different values. Two of the β values are negative, corresponding to risk-prone attitudes of the plant operator. The remaining five β values are positive, representing risk-averse attitudes of the plant operator.

For facilitating the analysis of the results, the different types of stochastic simulations (where *TYPE* = *SR* or *SRB*) are named as *TYPE i,j* , where $i \in \{1, 2\}$ and $j \in \{1, 2, \dots, 7\}$. So, for instance, in the case in which *TYPE* = *SR*, $i = 2$ and $j = 4$ (i.e.: *SR2, 4*) corresponds to a case using the simple spot-risk model (i.e.: without *bounding*) with d_i equaling 0.01 and β_j equaling 0.4. Table 6.7 summarizes all the simulations that were performed containing the indexes that correspond to the different values of the d and β parameters that were used in the simulations.

6.3.5 Results & Analysis

Figure 6.14 summarizes the total imbalance and revenue results obtained for the 30 simulations normalized by the base deterministic case (*D*) that was described above. We can see that imbalance

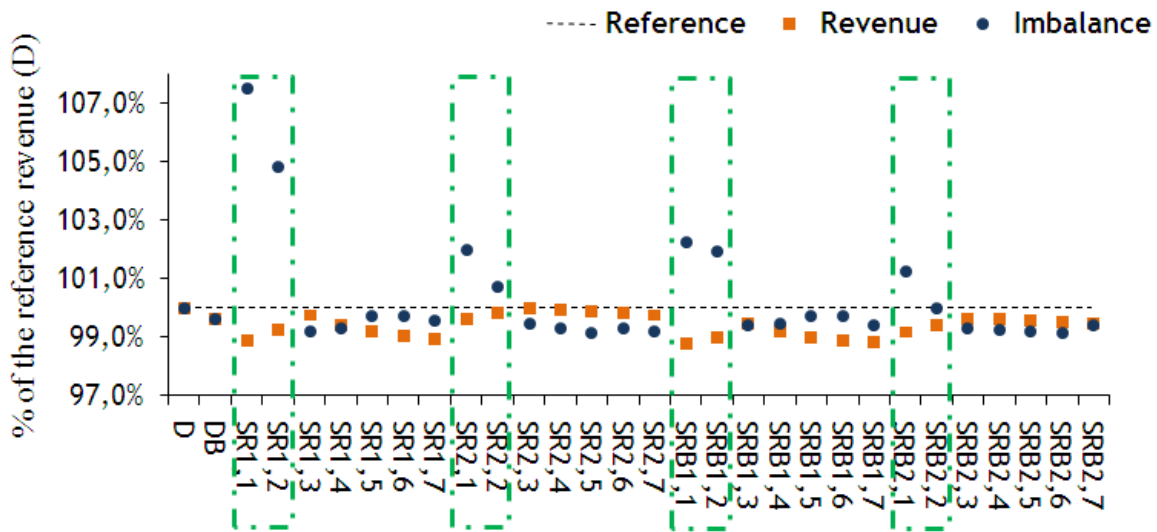

FIGURE 6.14: Total imbalance and revenue obtained for all the wind/pumped-hydro stochastic simulations. The reference deterministic simulations are the ones denoted by *D* and *DB*.

energy improvements were attained in almost every simulation. The only exceptions to this rule were the eight simulations corresponding to the risk prone attitudes (bounded in Figure 6.14 by the green-dashed rectangles) because these reward risky situations. The base deterministic case corresponding to the rule-of-thumb for reducing imbalances (*DB*) also achieved an imbalance reduction. All the risk averse simulations reduced the imbalances in different amounts. As for the revenue, Figure 6.14 shows that the reference revenue (*D*) was never surpassed (not even by the risk prone simulations). However, such revenue was always quite close to the reference value.

The correlation results shown above indicate that there is a weak link between the imbalance reduction and the obtained revenue. This is also the case for the correlations between the revenue and the surplus energy and between the revenue and the improvement (i.e.: decrease) of energy imbalance. The correlation between the obtained revenue and the shortage energy takes the highest value. Table 6.8 summarizes the correlation results obtained.

Correlation between:	Value
Revenue & Imbalance	0.402
Revenue & Shortage	0.651
Revenue & Surplus	0.137
Revenue & Imbalance Improvement	0.493

TABLE 6.8: Summary of the different correlation results obtained.

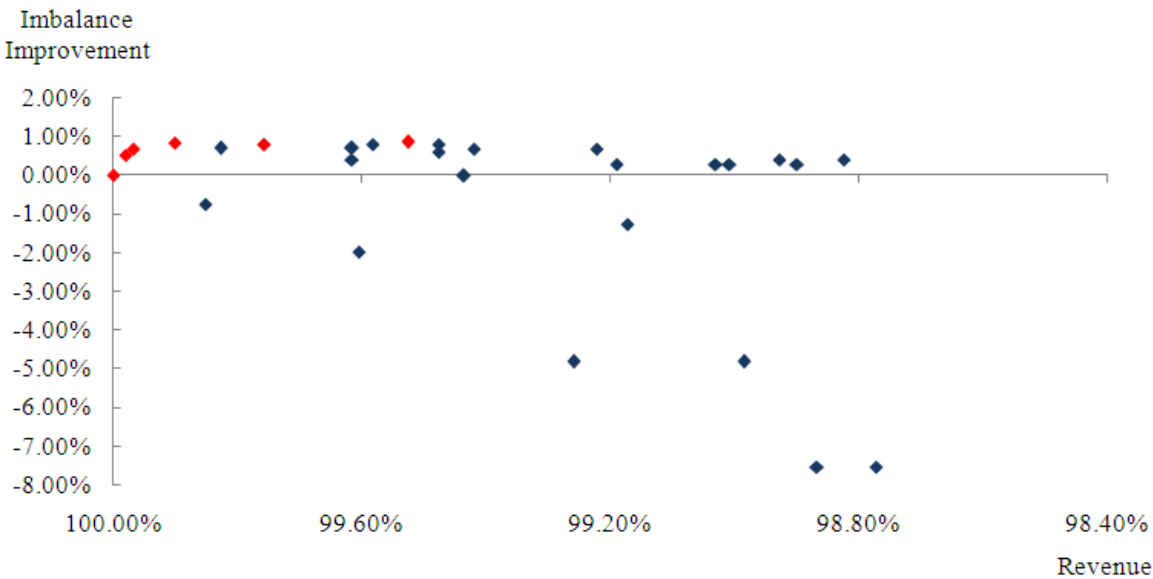

FIGURE 6.15: Imbalance improvement (in the sense of reduction) versus obtained revenue for every wind/pumped-hydro stochastic simulation. The points in red represent the Pareto-Optimal solutions obtained.

These correlation results are clearly confirmed by the relatively high dispersion depicted in Figure 6.15. The same figure also highlights the Pareto-optimal solutions that were obtained. One can see that some improvement of the imbalance was obtained without significantly reducing the revenue. The cases in which imbalances worsen with the use of the proposed method correspond to risk prone attitudes as described above.

The general behavior of the results obtained through the stochastic approach will now be analyzed in more detail. For this, the results shall be divided according to the d parameter, thus obtaining four major groups of cases: $SR1$, $SR2$, $SRB1$ and $SRB2$. In these cases, the numerical index corresponds to the defined value of d in Table 6.7.

The imbalance improvement results obtained with the proposed tool are detailed in Figure 6.16. In that figure we can see that the imbalances between the simulations corresponding to the proposed Spot-Risk method (SR) are approximately superposed with those obtained with the alternative Spot-Risk method (SRB) for the same values of d . In the SRB method, aiming to further reduce imbalances, the Spot-Risk model was submitted to narrower storage capacity boundaries. Such narrower bounds seem to work well when wind power forecast uncertainties are disregarded. However, they do not seem to influence the imbalance results in the presence of such uncertainties in the sense that they do not generally lead to further reductions of energy imbalance in comparison to the respective SR

simulations in which no reduced boundaries were imposed to the energy storage capacity limits in the scheduling phase. Therefore, under a stochastic paradigm considering the uncertainties associated to forecasts of wind power production, the *SR* model seems to outperform the *SRB* one in the sense that it leads to the same amount of imbalance reductions while being simpler.

In Figure 6.16 we can also verify that using lower values of d (i.e.: $d_i = 2$) allows to obtain better energy imbalance results in the sense that the resulting imbalances are always lower than those resulting from both deterministic simulations as well as those resulting from the stochastic simulations in which higher values of d (i.e.: $d_i = 1$) were used. This is because, as was explained in subsection 5.5.1.5, lower values of d imply the risk perception surface \mathcal{P} to be less *deep*, which helps to reduce the difference between possible decisions in the scheduling phase because the dynamic programming routine becomes less sensitive to the variance associated to wind power forecasts.

In Figure 6.16, under risk averse attitudes, one can also verify that the imbalance improvement obtained with the proposed method was always slightly better than the one obtained *via* the *DB* reference method. Finally, in the same figure it can be seen that risk averse attitudes always lead to energy imbalance reductions while the opposite is true for the risk prone attitudes.

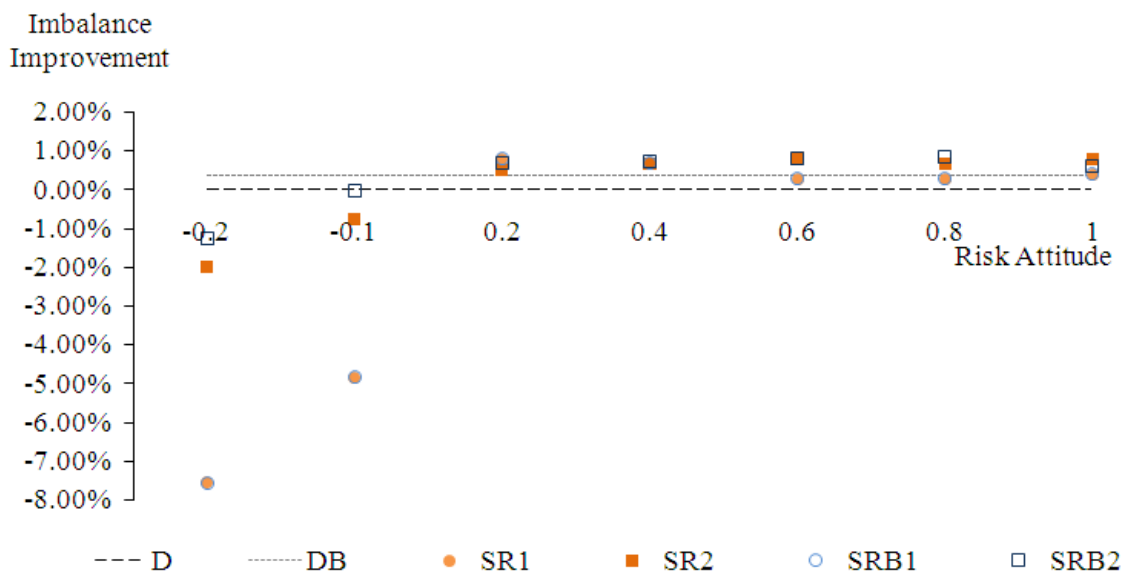

FIGURE 6.16: Energy imbalance improvement (in the sense of reduction) achieved in the wind/pumped-hydro case-study for different risk attitudes (β).

Regarding the revenue, in Figure 6.17 we can see the detailed results that were obtained. The figure shows that the revenues obtained with the *SRB* simulations are always lower than the revenues of

the *equivalent SR* simulations. Given that the corresponding *SR* and *SRB* simulations led to almost identical imbalance results (*vide* Figure 6.16), the *SRB* approach can be disregarded. This is further confirmed regarding the revenue generated by both stochastic approaches. Indeed, the revenue obtained with the *SRB* approach seems to be limited to that obtained with the simpler *DB* deterministic approach (*vide* Figure 6.17). However, things seem to be a bit different in what regards the *SR* approach. In fact, this approach may or not lead to revenue improvements relatively to the *DB* reference approach. In the case where the d is equal to 0.01 (i.e.: $d_i = 2$), the revenue never attains the base reference revenue given by simulation *D*, but almost always surpasses the revenue obtained with the reference *DB* approach. This further confirms that the *SRB* approach should be disregarded.

The *SR2* approach permitted to simultaneously obtain the best energy imbalance improvements (*vide* Figure 6.16) and the best revenue results relatively to the cases aiming to reduce energy imbalances (*DB*, *SR* and *SRB*). Moreover, the *SR2* approach permitted in some cases to almost attain the reference revenue (*D*) while improving the energy imbalance of the system. Therefore, spot-risk models taking into account low values of d seem to be good choices for improving the energy behavior of power system cells without leading to substantial losses of revenue relatively to the case in which forecast uncertainties are disregarded.

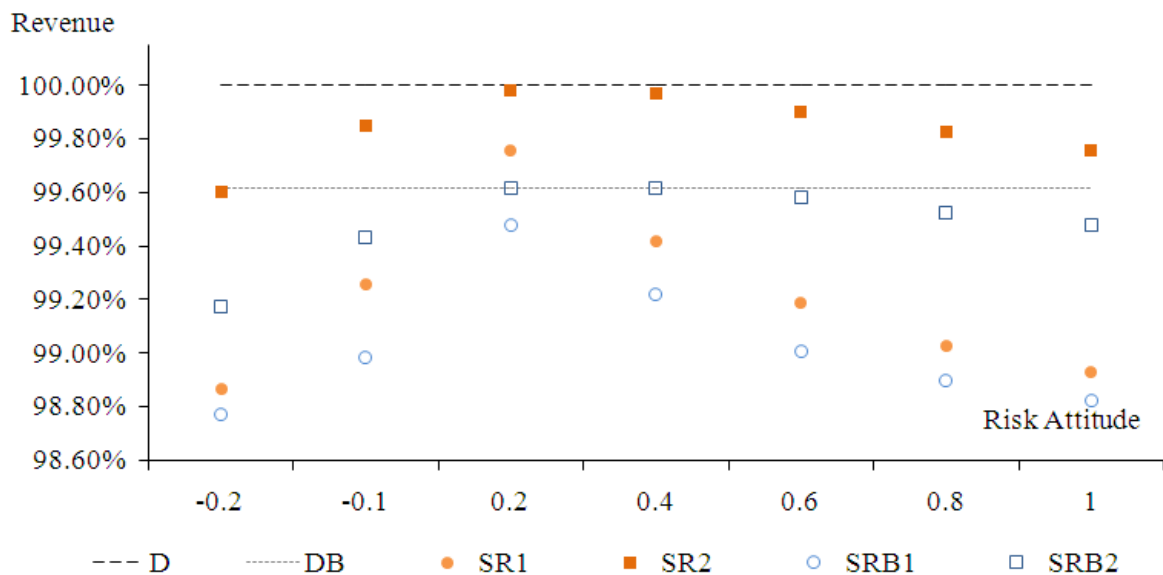

FIGURE 6.17: Revenue achieved in the wind/pumped-hydro case-study for different risk attitudes β .

Looking into some more detail on the imbalances implied by the various methods one can gain some more insight on their implications. For this, a comparison between the levels of contracted and pro-

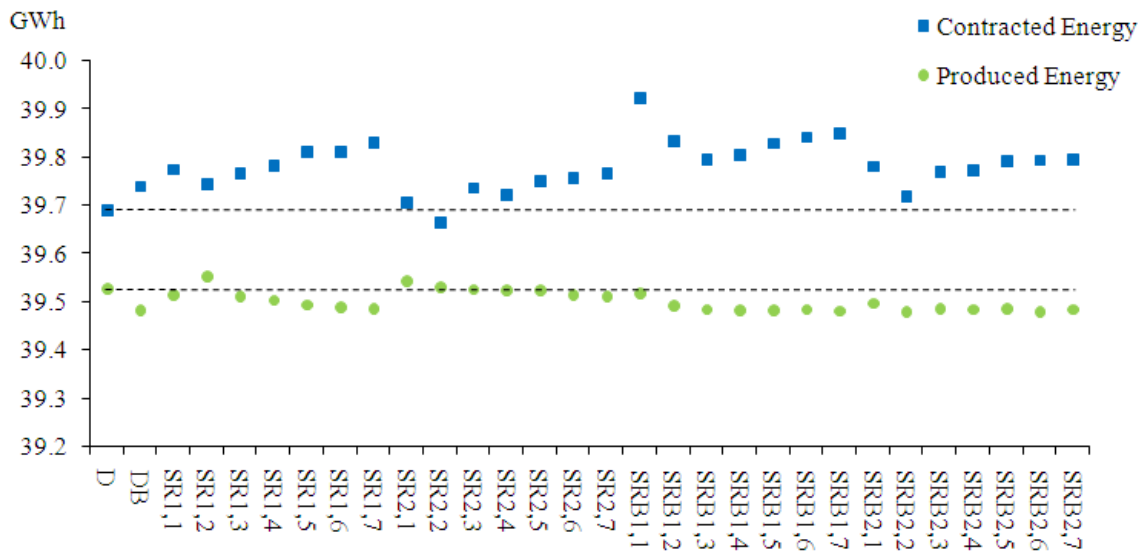

FIGURE 6.18: Comparison between the levels of contracted and produced energy for the various simulation scenarios.

duced energy for the various simulation scenarios is depicted in Figure 6.18. As it can be seen in the figure, all the methods led to more contracted energy than the base reference deterministic method (D) with the sole exception of the $SR2, 2$ (case with small risk proneness). In addition, all the methods led to more contracted than actually produced energy.

Let us now look back at figures 6.16 and 6.17. In these figures, it can be seen that the $SR2$ set of simulations yielded the best overall results (at least in comparison with the remaining stochastic simulations). Looking now back to Figure 6.18, one can see that the scheduling decisions obtained through the $SR2$ set of simulations always led to a high stability of the produced energy in the sense that the corresponding green dots are always very close to the constant dashed line starting at the reference value of produced energy given by the green dot corresponding to the reference case (D). Regarding the contracted energy, the $SR2$ set of simulations generally led to higher amounts of contracted energy than that of the reference case D . This can be seen by analyzing the vertical position of the blue squares corresponding to the $SR2$ set of simulations relatively to the constant dashed line starting at the reference value of contracted energy given by the blue square corresponding to the reference case (D).

Finally, Figure 6.19 contains the results on the expected day-ahead revenue for each simulation scenario. This revenue represents the income that would have been attained if no penalties had been

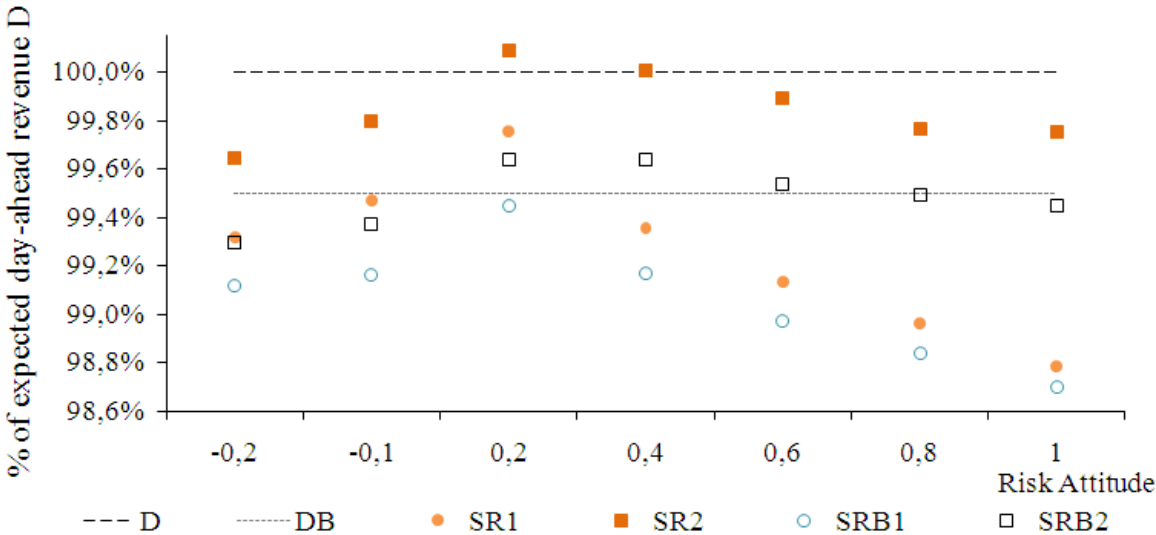

FIGURE 6.19: Day-ahead expected revenue achieved in the wind/pumped-hydro case-study for different risk attitudes β .

applied. In the figure, the revenue values are normalized by the day-ahead revenue of the base reference method (D). As it can be seen in the figure, all the simulations yielded, in general, lower values of expected day-ahead revenue comparatively to the reference simulation. The only exception was the $SR2$ simulation where a risk attitude of 0.2, which resulted to a higher value of day-ahead revenue than simulation D . Moreover, a visual inspection of figures 6.17 and 6.19 seems to suggest that there is a rather strong link between the expected day-ahead revenue and the actual revenue that was obtained. Indeed, the correlation between these two equals 0.933.

Summarizing, the results show that the proposed stochastic approach (SR) is able to reduce energy imbalances. However, the imbalance reduction remains quite small, which leads us to believe that further improvement of the approach is possible. With the proposed approach such reduction can be higher than the one obtained with the rule-of-thumb deterministic reference approach (DB). Nevertheless, the revenue losses obtained with the proposed approach (SR) are lower than the ones obtained with the reference deterministic approach (DB). However, in this case-study the proposed approach was as good as the base deterministic approach (D) regarding the revenue obtained.

6.4 Conclusions of the Chapter

This chapter presented two case-studies illustrating the results that can be obtained through the methods proposed in chapter 5. The case-studies consisted of a microgrid and a wind/pumped-hydro system.

In the microgrid case, the different variants of the scheduling methodology developed in this work were tested. From these, the deterministic and the single-stage spot-risk ones are selected for further testing in the frame of the second case-study (i.e.: wind/pumped-hydro system).

In the wind/pumped-hydro case-study, an extensive analysis of the developed approaches is carried out by using real-world historical data on day-ahead electricity market prices as well as historical data on the hourly average power output of a real-world wind farm. The added-value of the developed scheduling methods is quantified in terms of revenue and energy imbalance reduction. It is shown that the methods proposed in this work may lead to increased money returns for investors. At the same time, it is also shown that operators of non-dispatchable renewable energie units may become *better behaved* (from a TSO perspective) if methods such as the ones proposed here are employed.

CHAPTER 7

Conclusions and Perspectives for Further Research

CHAPTER OVERVIEW

IN the previous chapters, the description of the objectives and context of this thesis, the associated theoretical background, our contribution to the solution of the problem as well as numerical evaluation results were presented and analyzed. This chapter summarizes the main partial conclusions of this work (presented at the end of each chapter) drawing general conclusions. In addition, some perspectives for further research on the field of the present Ph.D. thesis, or in closely related ones, are also suggested.

7.1 Overall Conclusions

This work was carried out in the context of restructured power systems in which several independent actors interact with an electricity market for placing their energy production/consumption bids. At the same time, the EU targets for integrating large amounts of endogenous resources like, for instance, renewable energies were kept in mind. Regarding this specific point, the role of distributed generation for helping to reach those targets as well as its active integration into power systems was analyzed. More specifically, the possibility to couple micro-generation with loads and energy storage devices was taken into account. The ensemble was considered to behave as a controlled entity, which forms an individual cell of the main power system. The general objective of the present work was to develop a scheduling methodology for operating such types of power system cells under electricity market conditions.

For reaching the defined general objective, the first step was to understand in depth the general context behind this work. This was done in chapter 2, where a short historical description of the most outstanding events that happened in the power systems area from the early days up to the present situation was made. This description allowed to better understand the present context especially in what regards the role of distributed generation and the restructuring of the electricity sector, which were the two main driving forces of this work. The description of the general context of the work ended with a discussion on some decentralized power generation integration aspects and options that lead to the formulation of the generic concept of power system cells, which are the specific entities dealt with in this work.

The objective of developing a day-ahead power system cell scheduling methodology suited to cells that operate under electricity market conditions required knowledge contributions from two main fields: power system scheduling and decision under uncertainty. These two prerequisites were analyzed in chapters 3 and 4 for providing a solid basis leading to a better understanding of the problem addressed here. In addition, this analysis permitted to develop the solutions proposed in this work for tackling the day-ahead power system cell scheduling problem.

In chapter 3, the necessary background on what regards power system scheduling was given permitting to better understand the concepts, complexity, and characteristics associated to power system scheduling problems. This background consisted in a characterization of power system scheduling problems comprising: a conceptual discussion on the subject, the identification of the main characteristics and complexity that are typically associated to such problems, and a short insight on the main approaches

that are usually followed for tackling problems of the kind. Following this characterization, a model suited for multi-area power system scheduling problems was developed. This model consists on an unification of several models proposed in the literature. As a result, the proposed model is quite generic in the sense that it is able to integrate the most common restrictions that are usually associated to problems of the kind.

The developed multi-area power system scheduling model is not a solution-oriented one in the sense that it only focuses on the mathematical model that is behind multi-area power system scheduling problems in general and not on the solution-techniques that may be used to solve them. Hence, the model can be applied to a vast type of multi-area power system scheduling problems, while allowing the easy consideration of additional constraints as well as the modification and/or subtraction of the included constraints.

After having developed the multi-area power system scheduling model, guidelines were supplied for straightforwardly converting it into a single-area one. The single-area model was then modified for considering the case of an independent power producer participating in a day-ahead electricity market, thus obtaining a market-player formulation version of the power system scheduling problem. This formulation is the one that best fits the requirements of the present work and was therefore used as a basis for developing the proposed power system cell scheduling model in chapter 5.

In chapter 4, the necessary background on decision under uncertainty problems was given. This permitted to better understand the nature of such problems, the ways to model uncertainty, and the main models that are available for making decisions in the presence of uncertainty. The characteristics of the decision-making models were described and discussed, which permitted to better understand behavior of the models. This was important because the types of power system cells considered herewith may be subject to several types of uncertainty, which are associated to the several types of forecasts used as inputs to the power system cell scheduling model herewith proposed[†]. Therefore, the analysis carried out in chapter 4 permitted to develop the necessary tools as well as to understand them for reaching one of the central objectives of this work, which was that of developing a power system cell scheduling model capable of dealing with such types of uncertainties. This development was done in chapter 5.

In chapter 5, a model for performing the day-ahead scheduling of a power system cell under electricity

[†]Other uncertainties could be, for instance, the possibility of occurrence of generator failures, the possibility of loosing the interconnection with the main grid, and so on.

market conditions was proposed. Firstly, a modeling background was provided comprising a discussion on the many modeling possibilities, the description of the main objective of the model, and some possible applications of the proposed model. Then the scheduling scheme was described and the power system cell scheduling problem formulated. The chapter proceeded with the proposal of a solution method for addressing the scheduling problem based on a deterministic dynamic programming optimization approach. This deterministic formulation was then extended for incorporating the energy-related and day-ahead market-related uncertainties associated to the inputs of the power system cell scheduling problem. Several models for addressing such uncertainties were proposed, formulated and discussed.

The day-ahead electricity market conditions impose that the bids for each time-step of the next day be placed into the market up to the gate closure time (typically at noon of the present day). This means that scheduling decisions relative to later stage cannot consider what actually happened in previous stages. In other words, no updated information can be made available between the various time-stages of the scheduling problem. This creates an independence between the schedules made at different time-stages of the multi-stage decision-making problem regarding the uncertainty associated to the various forecasts used as input. This is also true the other way round because the uncertainties associated to the various forecasts that are used as input to the scheduling problem are forecasted independently from the system state. Consequently, regarding uncertainty, the transitions from a system state at a given time-step to all possible alternatives available in the next time-step are equivalent. This may lead to believe that there is no interest in integrating uncertainty information into the scheduling process, as it would only contribute to render it more complex without added benefit. Regarding day-ahead market participation, this may well be true in many situations. However, as was argued in chapter 5, it seems natural to think that, from an operator's viewpoint, the same amount of uncertainty may lead to different perceptions of how good or bad a given transition may be. In other words, the operator's past experience and knowledge of how the system behaves as well as the current system state may contribute to a more or less high valuation of the predicted uncertainty. Bearing this in mind, an approach based on concepts of Risk Perception was developed for integrating the energy-related uncertainties associated to the inputs of the power system scheduling problem in the decision-making process. The developed approach is based on two principles that lead to separate risk perception rules. An appropriate algorithm was proposed for mixing them. This algorithm yields a risk perception surface that is used for valuing predicted uncertainty according to the operator's requirements, thus placing the operator at the center of the decision-making process.

A scenario approach was followed for integrating the uncertainties associated to day-ahead market price forecasts. This permitted to consider a discrete probability distribution of day-ahead market prices per time-step of the scheduling horizon, where each possibility of market price represents a possible future scenario. Several methods based on Minkowski distances were adapted from the existing literature for integrating such market price scenarios.

In chapter 6, two case-studies were developed for giving some insight on the results that can be obtained through the proposed power system scheduling model. One consists of a microgrid and the other of a combined wind/pumped-hydro power plant. In both cases a participation in the NordPool Elspot day-ahead market was considered. The microgrid case served to test the different variants of the scheduling methodology developed in this work. From these, the deterministic and the single-stage spot-risk ones were selected for further testing in the frame of the second case-study. In this case-study, an extensive analysis of some of the developed approaches was carried out by using real-world historical data on day-ahead electricity market prices as well as the hourly average power output data of a real-world wind farm. The added value of the developed scheduling methods was quantified in terms of revenue and energy imbalance reduction. It was shown that the methods proposed in this work may lead to increased money returns for investors. At the same time, it was also shown that independent operators of systems based on non-dispatchable renewable energies may become *better behaved* (from a TSO perspective) if methods such as the ones proposed here are employed.

7.2 Perspectives for Further Research

In this work, different approaches based on dynamic programming were proposed for performing the scheduling of power system cells. While dynamic programming represents an elegant mathematical principle that is judged appropriate for performing the global optimization of systems bearing relatively low time-dependence complexity, it quickly becomes a burden for even medium-sized systems due to its well-known *curse of dimensionality* [130]. Moreover, dynamic programming computer-based solution-methods generally imply some discrete description of the *states of the world*. If, as in the present case, such description is made by discretizing continuous variables, then some approximation error is expected to be obtained. Therefore, alternative methods should be considered for systems bearing higher time-dependence complexities than the one considered here and/or continuous state variables. Such alternative methods could make use of *loss functions*, meta-heuristics, or some

wise combination of the deterministic and stochastic variants herewith proposed (thus obtaining hybrid deterministic/stochastic methods).

The use of loss functions, as proposed in [154], would most probably reduce both the CPU resources needed for performing the calculations and the algorithmic complexity associated to the scheduling methods while avoiding the need for discretizing the states-of-charge (SOC) of the energy storage device. However, the use of loss functions could imply the energy storage device to be used more as a passive element and less as an active one as in the case of this work. So, comparisons between scheduling methods based on loss functions with the ones developed here should be made for determining the implications that such *simplifications* might have on the scheduling results.

The use of meta-heuristics-based methods, based on evolutionary programming for instance, for performing the scheduling of power system cells as the ones considered in this work could also be investigated. Indeed, meta-heuristics-based methods may represent a good compromise between the computational time needed for performing calculations and the sub-optimality of the obtained scheduling solutions. Therefore, such methods could be interesting for systems bearing higher time-dependence complexities than the ones considered here.

Finally, the results obtained for the case-study evaluated in section 6.3, seem to show that the stochastic methods involve some compromise between the energy imbalance risks that were considered and the benefit attained under their deterministic counterparts. It seems natural to think that time-steps for which the energy-related forecasts are *more-or-less certain* should be treated through the base deterministic method (for maximizing profits) and time-steps in which the uncertainties associated to energy-related forecasts are high should be addressed by stochastic-based methods. This could be achieved by simply defining thresholds of uncertainty that trigger the use of either deterministic scheduling methods when uncertainties are low or stochastic scheduling methods when uncertainties are high. Such could well mean that, without having to develop alternative scheduling methods or improving the quality of input data, the profits generated in the case-study developed in section 6.3 could be potentially increased while further reducing the energy imbalances caused by energy-related forecast uncertainties.

The concept of risk perception was used here for incorporating the experience and preferences of the operators when scheduling a power system cell under uncertainty. This concept seems promising and has the potential enable the definition of complex decisional behaviors from the combination of

very simple principles. Therefore, more work should be devoted to this field for further testing the applicability and potential associated to the use of risk perception principles for making decisions under risk. Possible directions for such work comprise:

- The incorporation of higher moments of energy-related uncertainties (e.g.: their skewness, kurtosis, ...) in the construction/selection of adequate risk perception surfaces. For instance, various risk perceptions can be built for a given problem and the skewness associated to the energy-related forecasts could be used for determining which of them should be used.
- The study of risk perception rules other than the one that was used throughout this work and that serves as an illustration of the applicability of the concept. Some examples of possible global time-dependent risk perception rules can be: the forecasted local load, the forecasted main system load, some quality index associated to day-ahead/regulation market price forecast quality transmitting a degree of belief on the considered forecasts, the previous day up-regulation/down-regulation prices transmitting quantifying possibilities of economic losses, the average regulation prices obtained in the past. Regarding the technology-dependent rule (*vide* section 5.5.1.5), variable state-of-charge (SOC) preferences can be determined based on operator's specifications or calculated from some basic principles. As an example, such SOC preferences can be calculated for preparing the cell for overcoming detected energy imbalance trends, or as a function of the local load, of the experience of the operator, of the absolute value of historical economic losses, of the historical value of historical energy up- and down-regulation values, to mention a few examples. Another option would be to use the skewness for determining the preferred energy storage state at each time-step by using one of three options:
 1. normalize skewness by the maximum absolute forecasted skewness value throughout the scheduling horizon and then modify the preferred SOC state proportionally to each forecasted skewness;
 2. define fuzzy regions (large positive skewness, large negative skewness, positive skewness, negative skewness, too small skewness) imposing each of them a given amount of change to the predefined energy storage state, and then determine the preferred SOC state based on such value and on the predefined SOC value preference;
 3. use a hybrid approach in which for *sufficiently small* values of skewness, option 1 of the present list is used (i.e.: normalize skewness) and for *sufficiently large* value option 2 of the present list is selected (i.e.: fuzzy regions).

- Working with potential users of the methods herewith developed and proposed with the objective of determining if such methods are judged as being interesting and, if this is the case, determine which risk perception rules and principles are judged by such potential users as being the best ones.
- Evaluating whether the risk perception principles used here can be seen as a way for determining dynamic utility functions, which could help to explain the variations in attitude of decision-makers faced with similar types of problems of decision-making under risk each bearing different impacts of possible negative consequences. Ultimately, if risk perception surfaces are found to be similar to dynamic utility functions (at least in some cases), then the procedure proposed here for combining simple principles in order to obtain risk perception surfaces can be adopted as a procedural way for determining complex dynamic utility functions.

The special case where the storage device is part of an electric vehicle can be considered as a case-study of interest. In this case, the adequacy of the proposed scheduling principles to the determination of optimal charge/discharge actions of electric vehicles could be evaluated. Other applications might concern the possibility of scheduling thermal energy storages, of combined heat and power units, and of reactive power production/consumption actions. In addition, the transition from interconnected modes of operation of, as an example, a microgrid, to isolated modes of operation, for instance, for coping with maintenance actions taken at the point of common coupling could also be studied.

As a general perspective, more case-studies differing from the ones tested here, and considering other system compositions and types as well as other geographical locations should be tested. Simulations of microgrids over long periods could be of high interest as they can permit to evaluate the economic interest of the microgrid concept. This could be of high value provided that measurements from a real microgrid are used. However, such data are not readily available today. Should real-world microgrid data become available, then a more complete microgrids case-study considering a sequence of scheduling and operation cycles (like the ones used here on the wind/pumped-hydro case study) over a long period of time could be built and analyzed. For that purpose, a microgrids operation model like, for instance, the one developed in [163] could be used for performing the its intraday operation.

Forecasting electricity market prices is very difficult. However, when the cell includes energy storage devices and once these in operation, only the relation between peak and minimum prices is important for determining the best storage operating strategies to use [162]. In other words, for optimally

operating storage devices it seems to be best to accurately know the shape (or profile) that the price curve takes throughout the scheduling horizon rather than the actual values of prices that will occur. Therefore, emphasis could be given in methods that forecast such profiles.

Finally, the results presented in section 6.3 show that considerable energy imbalance reductions can be obtained by increasing the controllability of wind power through the utilization of energy storage devices. However, such reductions are not explicitly considered by present electricity markets as grid services. This does not motivate independent power producers that rely on non-dispatchable power sources to render these more dispatchable by combining them with dispatchable options such as energy storage devices. Therefore, a discussion on how to measure and remunerate such energy imbalance reductions seems to be of importance as such reductions contribute, for instance, to the increase of grid stability.

Main Publications

L. M. Costa and G. Kariniotakis, "An Estimation of the Cost Reduction Associated to the Use of Microgrids," 6th Mediterranean Conference and Exhibition on Power Generation, Transmission and Distribution - MedPower'08, Thessaloniki, Greece, 2nd - 5th of November 2008.

L. M. Costa, J. Juban, F. Bourry, and G. N. Kariniotakis, "Management of energy storage coordinated with wind power under electricity market conditions," in Conference on Probabilistic Methods Applied to Power Systems, Rincon, Puerto Rico, 25th - 29th of May 2008.

L. M. Costa, F. Bourry, J. Juban, and G. N. Kariniotakis, "A spot-risk-based approach for addressing problems of decision-making under uncertainty," in Conference on Probabilistic Methods Applied to Power Systems, Rincon, Puerto Rico, 25th - 29th of May 2008.

L. M. Costa, F. Bourry, and G. N. Kariniotakis, "Stochastic optimization techniques for the optimal combination of wind power generation and energy storage in a market environment," in European Wind Energy Conference, Brussels, Belgium, 31st of March - 3rd of April 2008. Available Online.

F. Bourry, J. Juban, L. M. Costa, and G. Kariniotakis, "Advanced strategies for wind power trading in short-term electricity markets," in EWEC Brussels, 31st March - 3rd April 2008. Available Online.

L. M. Costa and G. Kariniotakis, "A stochastic dynamic programming model for optimal use of local energy resources in a market environment," in IEEE Powertech. École Polytechnique Fédérale de Lausanne, Switzerland: IEEE Power Engineering Society, 1st - 5th of July 2007. Available Online.

M. Mesnage, Y. Souilmi, and L. M. Costa, "Towards peer-to-peer energy: ICT as enabler of smart, decentralized grid," in 2nd International Eden Conference on Innovation and Energy Awareness. Sophia Antipolis, France: EDEN, 13th and 14th of October 2005, Synthesis of work group #3 of EDEN workshop. Available Online.

Bibliography

- [1] N. Hatziargyriou, A. Tsikalakis, J. Vlachogiannis, K. Papadogiannis, G. Kariniotakis, J. P. Lopes, J. Oyarzabal, C. Moreira, A. Madureira, and I. Cobelo, "Microgrid central controller strategies and algorithms," National Technical University of Athens, Deliverable (DC1) of the MicroGrids EU Research Project (Contract Number: ENK5-CT-2002-00610), 24th February 2004, updated 10th May 2005 2004, final version. [Online]. Available: http://microgrids.power.ece.ntua.gr/micro/micro2000/delivarables/Deliverable_DC1_part1.pdf
- [2] R. Lasseter, A. Akhil, C. Marnay, J. Stephens, J. Dagle, R. Guttromson, A. S. Meliopoulos, R. Yinger, and J. Eto, "White paper on integration of distributed energy resources — the certs microgrid concept," Consortium for Electric Reliability Technology Solutions, Tech. Rep. LBNL-50829, April 2002. [Online]. Available: <http://certs.lbl.gov/pdf/50829.pdf>
- [3] M. Zeleny, *Multiple Criteria Decision Making*. McGraw Hill, 1982, ISBN: 0-07-072795-3.
- [4] "Quotas de certificats verts," July 2008, Commission Wallonne Pour L'Énergie — (CWaPE). [Online]. Available: <http://www.cwape.be>
- [5] "Les certificats verts: pour un effort énergétique "mesuré"," July 2008, Commission Wallonne Pour L'Énergie — (CWaPE). [Online]. Available: <http://www.cwape.be>
- [6] "The global renewable energy policies and measures database," July 2008, International Energy Agency (IEA). [Online]. Available: <http://renewables.iea.org>
- [7] "Energy for the future: Renewable energy sources of energy — white paper for a community strategy and action plan," 26th of November 1997, communication from the European Commission: COM(97)599 (Final Version). [Online]. Available: http://ec.europa.eu/energy/library/599fi_en.pdf
- [8] "Directive 2001/77/ec of the european parliament and of the council of 27 september 2001 on the promotion of electricity produced from renewable energy sources in the internal electricity market," *Official Journal of the European Communities*, no. L 283/33, p. 8, 27th of October 2001, The European Parliament and the Council of the European Union. [Online]. Available: <http://eur-lex.europa.eu/LexUriServ/LexUriServ.do?uri=OJ:L:2001:283:0033:0040:EN:PDF>

BIBLIOGRAPHY

- [9] “Green paper — towards a european strategy for the security of energy supply,” 29th of November 2000, communication from the Commission of the European Communities: COM(2000) 769 (Final Version). [Online]. Available: http://ec.europa.eu/comm/energy_transport/es/lpi_lv_es1.html
- [10] L. M. Costa, G. Kariniotakis, A. Kamarinopoulos, and N. Hatzargyriou, “WP2 Ú investigation of low-cost, innovative res and wastewater treatment solutions,” ARMINES and ICCS/NTUA, Deliverable of the RISE EU Project (Contract No: INCO-CT-2004-509161) D2.1 (v03), 20th of July 2005.
- [11] M. W. Davis, “Distributed resource electric power systems offer significant advantages over central station generation and T&D power systems. Part I,” in *IEEE Power Engineering Society Summer Meeting*, vol. 1, Chicago, IL, USA, 25th of July 2002, pp. 54 – 61. [Online]. Available: <http://ieeexplore.ieee.org/iel5/8076/22348/01043177.pdf?tp=&isnumber=22348&arnumber=1043177&punumber=8076>
- [12] M. Crappe, “RTD needs for the integration of renewable and other decentralised energy sources,” European Conference on Integration of Renewable Energy Sources and Distributed Generation in European Sectors, 25th and 26th of September 2001, Brussels.
- [13] “Distributed generation: System interfaces — an Arthur D. Little white paper,” Arthur D. Little, Tech. Rep., 1999. [Online]. Available: http://www.eere.energy.gov/de/pdfs/distributed_generation_interfaces.pdf
- [14] M. W. Davis, “Distributed resource electric power systems offer significant advantages over central station generation and T&D power systems. Part II,” in *IEEE Power Engineering Society Summer Meeting*, vol. 1, Chicago, IL, USA, 25th of July 2002, pp. 62 – 69. [Online]. Available: <http://ieeexplore.ieee.org/iel5/8076/22348/01043178.pdf?tp=&isnumber=22348&arnumber=1043178&punumber=8076>
- [15] “European technology platform for the electricity networks of the future (smartgrids),” July 2008. [Online]. Available: <http://www.smartgrids.eu/>
- [16] “Illinois smart grid initiative,” July 2008, Sustainable Communities Attainable Results (CNT). [Online]. Available: <http://www.ilsmartgrid.org/>
- [17] M. Mesnage, Y. Souilmi, and L. M. Costa, “Towards peer-to-peer energy: ICT as enabler of smart, decentralized grid,” in *2nd International Eden Conference on Innovation and Energy Awareness*. Sophia Antipolis, France: EDEN, 13th and 14th of October 2005, Synthesis of work group #3 of EDEN workshop. [Online]. Available: <http://www.accenture.com/NR/rdonlyres/588195B8-B52E-45E3-8C48-1AE1439CFE7A/0/WorkGroup3synthesis.pdf>
- [18] J. P. T. Saraiva, J. L. P. P. da Silva, and M. T. P. de Leão, *Mercados de Electricidade - Regulação e Tarificação de Uso das Redes*, 1st ed., F. Edições, Ed. Porto: FEUP Edições, 2002, ISBN: 972-752-053-7.
- [19] M. Shahidehpour, H. Yamin, and Z. Li, *Market Operations in Electric Power Systems - Forecasting, Scheduling and Risk Management*, IEEE, Ed. John Wiley and Sons, 2002, ISBN: 0-471-44337-9.
- [20] C. W. R. Jr. and G. B. Sheblé, *The Next Generation of Electric Power Unit Commitment Models*, ser. Operations Research & Management Science (International), B. F. Hobbs, M. H. Rothkopf, R. P. O’Neil, and H. po Chao, Eds. Kluwer Academic Publishers, 2001, ISBN: 0-7923-7334-0, "Papers that were presented at a workshop entitled, The next generation of unit commitment models, held September 27-28, 1999 at the Center for Discrete Mathematics and theoretical Computer Science, DIMACS, Rutgers University".
- [21] D. Pudjanto, C. Ramsay, and G. Strbac, “Virtual power plant and system integration of distributed energy resources,” *IET Renewable Power Generation*, vol. 1, no. 1, pp. 10–16, 2007.

-
- [22] J. Svensson, "Active distributed power systems — functional structures for real-time operation of sustainable energy systems," Doctoral Dissertation in Industrial Automation, Lund University - Department of Industrial Electrical Engineering and Automation, Lund, Sweden, 2006, ISBN: 91-88934-43-8.
- [23] J. D. Glover and M. Sarma, *Power System Analysis and Design - With Personal Computer Applications*, C. D. (Manuscript) and R. P. (Sponsoring), Eds. Boston: PWS-KENT Publishing Company, 1989, ISBN: 0-534-07860-5.
- [24] S. Abu-Sharkh, R. Li, T. Markvart, N. Ross, P. Wilson, R. Yao, K. Steemers, J. Kohler, and R. Arnold, "Microgrids: Distributed on-site generation," Tyndall, Tech. Rep., March 2005.
- [25] R. Vigotti, "Integration of re & dg in energy systems — key issues and challenges," in *European Conference on Integration of Renewable Energy Sources and Distributed Generation in European Sectors*, Brussels, 25th and 26th of September 2001.
- [26] A. Engler, O. Osika, M. Barnes, N. Jenkins, and A. Arulampalam, "Micro source controller strategies and algorithms," Large Scale Integration of Micro-Generation to Low Voltage Grids (MicroGrids), Project Deliverable — DB1, 25th of February 2004, contract No: ENK-CT-2002-00610. [Online]. Available: http://microgrids.power.ece.ntua.gr/micro/micro2000/delivarables/Deliverable_DB1.pdf
- [27] "DISPOWER — distributed generation with high penetration of renewable energy sources," European Conference on Integration of Renewable Energy Sources and Distributed Generation in European Sectors, 25th and 26th of September 2001, Brussels.
- [28] "Kyoto protocol to the united nations framework convention on climate change," 11th of December 1998. [Online]. Available: <http://unfccc.int/resource/docs/convkp/kpeng.pdf>
- [29] *Fuel Cell Handbook*, 6th ed. Morgantown, West Virginia: U. S. Department of Energy — Office of Fossil Energy, November 2002, no. DOE/NETL-2002/1179, Under Contract No.: DE-AM26-99FT40575. [Online]. Available: http://www.ansaldofuelcells.com/sito-giorgio/files/fuel_cells_handbook.pdf
- [30] M. Korpaas, A. T. Holen, and R. Hildrum, "Operation and sizing of energy storage for wind power plants in a market system," *International Journal of Electrical Power and Energy Systems*, vol. 25, no. 8, pp. 599–606, October 2003.
- [31] G. N. Bathurst and G. Strbac, "Value of combining energy storage and wind in short-term energy and balancing markets," *Electric Power Systems Research*, vol. 67, no. 1, pp. 1–8, October 2003.
- [32] E. Castronuovo and J. A. P. Lopes, "Bounding active power generation of a wind-hydro power plant," in *Probabilistic Methods Applied to Power Systems, 2004 International Conference on*. Porto, Portugal: Instituto de Engenharia de Sistemas e Computadores do Porto, 12-16 September 2004, pp. 705–710, ISBN: 0-9761319-1-9.
- [33] E. D. Castronuovo and J. A. P. Lopes, "On the optimization of the daily operation of a wind-hydro power plant," *IEEE Transactions on Power Systems*, vol. 19, no. 3, pp. 1599–1606, August 2004.
- [34] B. Kockl, P. Stricker, and G. Koeppel, "On the properties of stochastic power sources in combination with local energy storage," in *CIGRÉ Symposium on Power Systems with Dispersed Generation*, Athens, April 2005, pp. 1–4.
- [35] J. M. Angarita and J. G. Usaola, "Combining hydro-generation and wind energy biddings and operation on electricity spot markets," *Electric Power Systems Research*, vol. 77, no. 5–6, pp. 393–400, April 2007.
- [36] P. Lopes, J. A. Saraiva, and J. T. Hartziargyriou, "Management of microgrids," in *JIEEC2003*, Bilbao, October 2003.
-

BIBLIOGRAPHY

- [37] IEEE, "Interconnecting distributed resources with electric power systems," IEEE Standard 1547, last modified on the 21st of December of 2007, last access: 30th of August of 2008. [Online]. Available: http://grouper.ieee.org/groups/scc21/dr_shared/
- [38] R. Lasseter, A. Akhil, C. Marnay, J. Stevens, J. Dagle, R. Guttromson, A. S. Meliopoulos, R. Yinger, and J. Eto, "White paper on integration of distributed energy resources — the certs microgrid concept — appendices," Consortium for Electric Reliability Technology Solutions, Tech. Rep. LBNL-50829, April 2002. [Online]. Available: <http://certs.lbl.gov/pdf/50829-app.pdf>
- [39] J. D. Kueck, R. H. Staunton, S. D. Labinov, and B. J. Kirby, "Microgrid energy management system," Consortium for Electric Reliability Technology Solutions (CERTS), Tech. Rep. ORNL/TM-2002/242, 29th January 2003.
- [40] "Microgrid workshop," Workshop Proceedings PIER, 2nd of May 2002.
- [41] I. J. Pérez-Arriaga, F. P. Montero, and F. J. R. Odérix, "Benchmark of electricity transmission tariffs," Instituto de Investigación Tecnológica - Universidad Pontificia Comillas, Madrid, Final Report, October 2002, prepared for the Directorate-General for Energy and Transport / European Commission.
- [42] J. J. Grainger and J. William D. Stevenson, *Power System Analysis*, ser. Electrical and Computer Engineering, A. B. Akay and E. Castellano, Eds. McGraw Hill International Editions, 1994, ISBN: 0-07-061493-5, ISBN (for ordering): 0-07-113338-0.
- [43] G. Sheblé and G. Fahd, "Unit commitment literature synopsis," *Power Systems, IEEE Transactions on*, vol. 9, no. 1, pp. 128–135, Feb. 1994.
- [44] N. Padhy, "Unit commitment—a bibliographical survey," *Power Systems, IEEE Transactions on*, vol. 19, no. 2, pp. 1196–1205, May 2004.
- [45] T. Rotting and A. Gjelsvik, "Stochastic dual dynamic programming for seasonal scheduling in the norwegian power system," *Power Systems, IEEE Transactions on*, vol. 7, no. 1, pp. 273–279, Feb. 1992.
- [46] G. Contaxis and J. Kabouris, "Short term scheduling in a wind/diesel autonomous energy system," *Power Systems, IEEE Transactions on*, vol. 6, no. 3, pp. 1161–1167, Aug. 1991.
- [47] A. Bakirtzis and P. Dokopoulos, "Short term generation scheduling in a small autonomous system with unconventional energy sources," *Power Systems, IEEE Transactions on*, vol. 3, no. 3, pp. 1230–1236, Aug. 1988.
- [48] S. Salam, "Unit commitment solution methods," *Proceedings of World Academy of Science, Engineering and Technology*, vol. 26, pp. 600–605, December 2007, ISSN: 1307-6884. [Online]. Available: <http://www.waset.org/pwaset/v26/v26-114.pdf>
- [49] S. Mokhtari, J. Singh, and B. Wollenberg, "A unit commitment expert system," *IEEE Transactions on Power Systems*, vol. 3, no. 1, pp. 272–277, February 1988.
- [50] H. Sasaki, M. Watanabe, J. Kubokawa, N. Yorino, and R. Yokohama, "A solution method of unit commitment by artificial neural networks," *IEEE Transactions on Power Systems*, vol. 7, no. 3, pp. 974–981, August 1992.
- [51] M. H. Wong, T. S. Chung, and Y. K. Wong, "An evolving neural network approach in unit commitment solution," *Microprocessors and Microsystems*, vol. 24, pp. 251–262, 2000.
- [52] C.-C. Su and Y.-Y. Hsu, "Fuzzy dynamic programming: An application to unit commitment," *IEEE Transactions on Power Systems*, vol. 6, no. 3, pp. 1231–1237, August 1991.

-
- [53] G. S. Lauer, N. R. Sandell, D. P. Bertsekas, and T. A. Posbergh, "Solution of large-scale optimal unit commitment problems," *IEEE Transaction on Power Apparatus and Systems*, vol. PAS-101, no. 1, pp. 79–86, January 1982.
- [54] W. L. Peterson and S. R. Brammer, "A capacity based lagrangian relaxation unit commitment with ramp rate constraints," *IEEE Transaction on Power Systems*, vol. 10, no. 2, pp. 1077–1084, May 1995. [Online]. Available: <http://ieeexplore.ieee.org/iel1/59/8797/00387954.pdf?tp=&isnumber=&arnumber=387954>
- [55] F. Zhuang and F. D. Galiana, "Towards a more rigorous and practical unit commitment by lagrangian relaxation," *IEEE Transactions on Power Systems*, vol. 3, no. 2, pp. 763–773, May 1988. [Online]. Available: <http://ieeexplore.ieee.org/iel1/59/4977/00192933.pdf?tp=&isnumber=4977&arnumber=192933>
- [56] C. C. A. Rajan and M. R. Mohan, "An evolutionary programming-based tabu search method for solving the unit commitment problem," *IEEE Transactions on Power Systems*, vol. 19, no. 1, pp. 577–585, February 2004.
- [57] J. A. Muckstadt and S. A. Koenig, "An application of lagrangean relaxation to scheduling in power-generation systems," *Operations Research*, vol. 25, no. 3, pp. 387–403, May-June 1977.
- [58] T. S. Dillon, K. W. Edwin, H. D. Kochs, and R. J. Taud, "Integer programming approach to the problem of optimal unit commitment with probabilistic reserve determination," *IEEE Transactions on Power Apparatus and Systems*, vol. PAS-97, no. 6, pp. 2154–2166, November/December 1978.
- [59] B. F. Wollenberg, *The Electric Power Engineering Handbook*, ser. CRC/Press Handbook. IEEE Press and CRC Press, 2001, hardcover 12, p. 800.
- [60] H. Chen and X. Wang, "Cooperative coevolutionary algorithm for unit commitment," *IEEE Transactions on Power Systems*, vol. 17, no. 1, pp. 128–133, February 2002.
- [61] C. K. Pang, G. B. Sheble, and F. Albuyeh, "Evaluation of dynamic programming based methods and multiple area representation for thermal unit commitments," *IEEE Transactions on Power Apparatus and Systems*, vol. PAS-100, no. 3, pp. 1212–1218, March 1981.
- [62] W. Ongsakul and N. Petcharakas, "Unit commitment by enhanced adaptive lagrangian relaxation," *IEEE Transactions on Power Systems*, vol. 19, no. 1, pp. 620–628, February 2004.
- [63] Z. Ouyang and S. M. Shahidehpour, "Heuristic multi-area unit commitment with economic dispatch," *IEE Proceedings - Generation, Transmission and Distribution*, vol. 138, no. 3, pp. 242–252, May 1991.
- [64] W. J. Hobbs, G. Hermon, S. Warner, and G. B. Sheblé, "An enhanced dynamic programming approach for unit commitment," *IEEE Transactions on Power Systems*, vol. 3, no. 3, pp. 1201–1205, August 1988.
- [65] J. M. Arroyo and A. J. Conejo, "A parallel repair genetic algorithm to solve the unit commitment problem," *IEEE Transactions on Power Systems*, vol. 17, no. 4, pp. 1216–1224, November 2002.
- [66] R. H. Liang and F. C. Kang, "Thermal generating unit commitment using an extended mean field annealing neural network," *IEE Proceedings - Generation, Transmission and Distribution*, vol. 147, no. 3, pp. 164–170, May 2000.
- [67] F. N. Lee, "The application of commitment utilization factor (cuf) to thermal unit commitment," *IEEE Transactions on Power Systems*, vol. 6, no. 2, pp. 691–698, May 1991.
- [68] F. N. Lee and Q. Feng, "Multi-area unit commitment," *IEEE Transactions on Power Systems*, vol. 7, no. 2, pp. 591–599, May 1992.
-

BIBLIOGRAPHY

- [69] G. Papaefthymiou, "Integration of stochastic generation in power systems," Ph.D. dissertation, Delft University of Technology, 2007.
- [70] "Nord pool website." [Online]. Available: <http://www.nordpool.com/>
- [71] "Amsterdam power exchange website." [Online]. Available: <http://www.apxgroup.com/>
- [72] C. W. R. Jr. and G. B. Sheblé, *The Next Generation of Electric Power Unit Commitment Models*, ser. Operations Research & Management Science (International). Iowa State University: Kluwer Academic Publishers, 2001, ch. 11, p. 319, ISBN: 0-7923-7334-0, "Papers that were presented at a workshop entitled, The next generation of unit commitment models, held September 27-28, 1999 at the Center for Discrete Mathematics and theoretical Computer Science, DIMACS, Rutgers University".
- [73] C. Wang and S. M. Shahidehpour, "Effects of ramp-rate limits on unit commitment and economic dispatch," *IEEE Transactions on Power Systems*, vol. 8, no. 3, pp. 1341–1350, 1993. [Online]. Available: http://ieeexplore.ieee.org/xpls/abs_all.jsp?arnumber=260859
- [74] J. Darlington, C. C. Pantelides, B. Rustem, and B. A. Tanyi, "An algorithm for constrained nonlinear optimization under uncertainty," *Automatica*, vol. 35, pp. 217–228, 1999.
- [75] M. H. Gomes and J. T. Saraiva, "A fuzzy decision model for the active and reactive dispatch in market environment," in *9th International Conference on Probabilistic Methods Applied to Power Systems*. Stockholm, Sweden: KTH, June 11-15 2006.
- [76] G. Hug-Glanzmann, R. R. Negenborn, G. Andersson, B. De Schutter, and J. Hellendoorn, "Multi-area control of overlapping areas in power systems for facts control," in *Proceedings of the Powertech 2007 Conference*. Lausanne, Switzerland: EPFL, July 1-5 2007.
- [77] Y. Rebours and D. Kirschen, "A survey of definitions and specifications of reserve services," The University of Manchester, Tech. Rep., October 2005, release 2.
- [78] —, "What is spinning reserve?" The University of Manchester, Tech. Rep., September 2005, release 1.
- [79] F. L. Alvarado, "Spectral analysis of energy-constrained reserves," in *Proceedings of the 35th Annual Hawaii International Conference on System Sciences*, 7-10 January 2002, pp. 749–756, ISBN : 0-7695-1435-9.
- [80] B. J. Kirby, "Demand response for power system reliability: FAQ," Oak Ridge National Laboratory, Oak Ridge, Tennessee 37831-6070, Tech. Rep. ORNL/TM-2006/565, December 2006, prepared for the Office of Electricity Delivery and Energy Reliability of U. S. Department of Energy under contract DE-AC05-00OR22725.
- [81] M. Shahidehpour, H. Yamin, and Z. Li, *Market Operations in Electric Power Systems - Forecasting, Scheduling and Risk Management*. John Wiley and Sons, 2002, ch. 4, p. 115/116, ISBN: 0-471-44337-9.
- [82] M. Wang, B. Zhang, and Y. Deng, "A novel unit commitment method considering various operation constraints," in *Power Engineering Society Winter Meeting, 2000. IEEE*, vol. 3, January 2000, pp. 1778–1783.
- [83] M. A. Matos, "Decision under risk as a multicriteria problem," *European Journal of Operational Research*, vol. 181, no. 3, pp. 1516–1529, September 2007.
- [84] V. Miranda and C. Monteiro, "Modeling a decision maker," in *Proc. 13th International Conference on Intelligent Systems Application to Power Systems*, C. Monteiro, Ed., 2005, p. 7.

-
- [85] A. Gosavi, *Simulation-Based Optimization: Parametric Optimization Techniques and Reinforcement Learning*, 1st ed. Norwell, Massachusetts, USA: Kluwer Academic Publishers, 30th June 2003, ISBN: 1-4020-7454-9 (Hardcover).
- [86] B. Roy, "Decision-aid and decision-making," *European Journal of Operational Research*, vol. 45, pp. 324–331, 1990.
- [87] T. Li, M. Shahidehpour, and Z. M. Li, "Risk-constrained bidding strategy with stochastic unit commitment," *IEEE Transactions on Power Systems*, vol. 22, no. 1, pp. 449–458, February 2007, ISSN: 0885-8950. [Online]. Available: <http://ieeexplore.ieee.org/iel5/59/4077088/04077143.pdf?tp=&isnumber=&arnumber=4077143>
- [88] P. Pinson, "Estimation of the uncertainty in wind power forecasting," Ph.D. Thesis, École des Mines de Paris, Center for Energy and Processes, Sophia Antipolis, France, 23th March 2006.
- [89] M. J. N. van Werven and M. J. J. Scheepers, "DISPOWER. the changing role of energy suppliers and distribution system operators in the deployment of distributed generation in liberalised electricity markets," ECN Policy Studies, Netherlands, ECN Publication ECN-C-05-048, June 2005, pp. 48. [Online]. Available: <http://www.ecn.nl/publications/default.aspx?nr=ECN-C--05-048>
- [90] T. Biswas, *Decision-Making Under Uncertainty*. McMillan Press Ltd., 1997, ISBN: 0-312-17577-9.
- [91] H. M. Merrill and A. J. Wood, "Risk and uncertainty in power system planning," *Electrical Power and Energy Systems*, vol. 13, no. 2, pp. 81–90, April 1991, originally presented in the 10th Power Systems Computation Conference, Graz, Austria, 19–24 August 1990.
- [92] L. de Boer, E. Labro, and P. Morlacchi, "A review of methods supporting supplier selection," *European Journal of Purchasing and Supply Management*, vol. 7, no. 2, pp. 75–89, November 2001.
- [93] V. Miranda and L. Proenca, "Probabilistic choice vs. risk analysis-conflicts and synthesis in power system planning," *Power Systems, IEEE Transactions on*, vol. 13, no. 3, pp. 1038–1043, Aug. 1998.
- [94] H. Levy and H. M. Markowitz, "Approximating expected utility by a function of mean and variance," *The American Economic Review*, vol. 69, no. 3, pp. 308–317, June 1979.
- [95] N. Mugeot, *Volatility Investing Handbook*, BNP Paribas - Equities & Derivatives Research, 28th September 2005.
- [96] [Online]. Available: <http://www.investopedia.com/terms/v/volatility.asp>
- [97] D. Bernoulli, "Exposition of a new theory for the measurement of risk," *Econometrica*, vol. 22, no. 1, pp. 23–36, January 1954. [Online]. Available: <http://links.jstor.org/sici?sici=0012-9682%28195401%2922%3A1%3C23%3AE0ANTO%3E2.0.CO%3B2-X>
- [98] J. von Neumann and O. Morgenstern, *Theory of Games and Economic Behavior*. Princeton University Press, 1944.
- [99] J. Barzilai, "Notes on utility theory," in *Systems, Man and Cybernetics, 2004 IEEE International Conference on*, vol. 1. IEEE, 10th - 13th October 2004, pp. 1000–1005, ISBN: 0-7803-8566-7.
- [100] M. Allais, "Le comportement de l'homme rationnel devant le risque: Critique des postulats et axiomes de l'école américaine," *Econometrica*, vol. 21, no. 4, pp. 503–546, October 1953, École Nationale Supérieure des Mines et Institut de Statistique de l'Université de Paris.
-

BIBLIOGRAPHY

- [101] M. J. Machina, “Nonexpected utility theory,” *Encyclopedia of Actuarial Science*, vol. 2, pp. 1173–1179, 2004, ISBN: 0-470-84676-3, Ed. Jozef L. Teugels and Bjørn Sundt. [Online]. Available: http://econ.ucsd.edu/~mmachina/papers/Machina_Encyc_of_Actuarial_Science.pdf
- [102] R. Davidson, “Stochastic dominance,” March 2006, discussion paper version of an entry in the New Palgrave Dictionary of Economics, 2nd Edition, published by Palgrave Macmillan, 2006. [Online]. Available: <http://russell-davidson.arts.mcgill.ca/articles/stochdomdp.pdf>
- [103] D. Duchon, K. J. Dunegan, and S. L. Barton, “Framing the problem and making decisions: The facts are not enough,” *IEEE Transactions on Engineering Management*, vol. 36, no. 1, pp. 25–27, February 1989.
- [104] D. Protopopescu, “Qualitative analysis of fundamental tools employed in modelling decision making problems,” GREQAM — École des Hautes Études en Sciences Sociales — Universités d’Aix-Marseille II et III, Marseille, Working Paper 2006-10, January 2006, submitted to the *Journal of Economic Science* for publication.
- [105] H. Markowitz, “Portfolio selection,” *Journal of Finance*, vol. 7, no. 1, pp. 77–91, 1952.
- [106] ———, *Portfolio Selection*, C. F. Monograph, Ed. New York: John Wiley and Sons, Inc., 1959.
- [107] A.-P. N. Refenes, A. N. Burgess, and Y. Bentz, “Neural networks in financial engineering: a study in methodology,” *IEEE Transactions on Neural Networks*, vol. 8, no. 6, pp. 1222–1267, November 1997, invited Paper.
- [108] M. C. Steinbach, “Markowitz revisited - mean-variance models in financial portfolio analysis,” *Society for Industrial and Applied Mathematics*, vol. 43, no. 1, pp. 31–85, Published Electronically on the 2nd of February 2001.
- [109] K. K. Lai, L. Yu, and S. Wang, “Mean-variance-skewness-kurtosis-based portfolio optimization,” in *Computer and Computational Sciences, 2006. IMSCCS '06. First International Multi-Symposiums on*, vol. 2, 20–24 April 2006, pp. 292–297.
- [110] M.-P. Cheong, G. Sheblé, D. Berleant, C.-C. Teoh, J.-P. Argaud, M. Dancre, L. Andrieu, and F. Barjon, “Second order stochastic dominance portfolio optimization for an electric energy company,” in *PowerTech Conference*. Lausanne, Switzerland: IEEE, 1st - 5th July 2007.
- [111] L. Yu, S. Wang, and K. K. Lai, “Neural network-based mean-variance-skewness model for portfolio selection,” *Computers and Operation Research*, vol. 35, no. 1, pp. 34–46, January 2008, ISSN: 0305-0548.
- [112] J. L. Dillon, “An expository review of bernoullian decision theory in agriculture: Is utility futility?” *Review of Marketing and Agricultural Economics*, vol. 39, pp. 3–77, 1971, ISSN/ISBN: 0034-6616.
- [113] G. C. Philippatos, *Alternatives to Mean-Variance for Portfolio Selection*, ser. North-Holland Economics Handbooks. Amsterdam, North Holland: North-Holland Publishing Company, 1979 - Second Printing 1981, Handbook of Financial Economics 17, pp. 365–386, ISBN: 0-444-85224-7. [Online]. Available: bus.utk.edu/finance/fac_staff/Philippatos/425reservematerials/Ph_chap_17.pdf
- [114] E. Korn and R. Korn, “Portfolio-optimization by the mean-variance approach,” Electronically, 2001, EU Socrates Project MaMaEuSch — Management Mathematics for European Schools. [Online]. Available: http://optimierung.mathematik.uni-kl.de/mamaesch/veroeffentlichungen/ver_texte/bm_portfolio_e.pdf
- [115] T. Hens, “Advanced portofolio theory (lecture notes),” Electronically, October 2004, Norwegian School of Economics and Business Administration. [Online]. Available: http://www.iew.unizh.ch/study/courses/downloads/Lecture_Notes_NHH_405.pdf

-
- [116] K. D. W. Nandalal and S. P. Simonovic, "State-of-the-art report on systems analysis methods for resolution of conflicts in water resources management," UNESCO, A Report Prepared for the Division of Water Sciences UNESCO SC-2003/WS/60, 2003.
- [117] M. Zeleny, *The Theory of the Displaced Ideal*, ser. Operations Research (Berlin). Kyoto, Japan: Springer Verlag, 24th – 25th July 1976, Multiple Criteria Decision-Making (Lecture Notes in Economics and Mathematical Systems - 123) 8, pp. 153 – 206, consists of 15 papers originally prepared for a session of the 22nd international meeting of TIMS in 1975, ISBN: 3-540-07684-0.
- [118] A. Teclé, M. Fogel, and L. Duckstein, "Multicriterion forest watershed resources management," in *Vancouver Symposium*, ser. Forest Hydrology and Watershed Management. Beaver Creek watersheds: IAHS-AISH, August 1987, pp. 617–625, publication no. 167.
- [119] V. Miranda and L. Proenca, "Why risk analysis outperforms probabilistic choice as the effective decision support paradigm for power system planning," *Power Systems, IEEE Transactions on*, vol. 13, no. 2, pp. 643–648, May 1998.
- [120] N. Rolander, A. Ceci, and M. Berdugo, "A framework for MCDM method selection," Georgia Institute of Technology, Tech. Rep., 5th December 2003.
- [121] D. Josselin, "Une piste pour la recherche de la "valeur centrale optimale". Discussion autour de la robustesse et du comportement de la "médiante", combinaison de normes L_p ," *Cybergeog: Revue Européenne de Géographie*, no. 282, pp. 1–22, 25th August 2004, thequant. [Online]. Available: <http://www.cybergeog.eu/docannexe/file/2636/282.pdf>
- [122] T. Rakotoarivelo, P. Senac, A. Seneviratne, and M. Diaz, "A structured peer-to-peer method to discover QoS enhanced alternate paths," in *Third International Conference on Information Technology and Applications*, vol. 2. IEEE, 4th – 7th July 2005, pp. 671 – 676.
- [123] A. Matveev, "Development of methods, algorithms and software for optimal design of switched reluctance drives," Ph.D. Thesis, Technische Universiteit Eindhoven, Eindhoven, 17th January 2006, ISBN: 90-386-1783-6.
- [124] P. Linares, "Multiple criteria decision making and risk analysis as risk management tools for power systems planning," *IEEE Transaction on Power Systems*, vol. 17, no. 3, pp. 895–900, August 2002.
- [125] "Wolfram website." [Online]. Available: <http://mathworld.wolfram.com>
- [126] R. Firestone and C. Marnay, "Energy manager design for microgrids," Ernest Orlando Lawrence Berkeley National Laboratory, University of California, Berkeley, Tech. Rep. LBNL-54447, January 2005.
- [127] "Master controller for perfect power systems," Internet, 20th February 2007, request for Proposals by Galvin Electricity Initiative.
- [128] A.-A. Edris, R. Adapa, M. H. Baker, L. B. K. Clark, K. Habashi, L. Gyugyi, J. Lemay, A. S. Mehraban, A. K. Myers, J. Reeve, F. Sener, D. R. Torgerson, and R. R. Wood, "Proposed terms and definitions for flexible ac transmission system(facts)," *IEEE Transactions on Power Delivery*, vol. 12, no. 4, pp. 1848–1853, October 1997.
- [129] R. Allan and R. Billinton, "Power system reliability and its assessment. i. background and generating capacity," in *Power Engineering Journal [see also Power Engineer]*, vol. 6, no. 4, July 1992, pp. 191–196.
- [130] S. S. Rao, *Engineering Optimization - Theory and Practice*, 3rd ed. United States of America: Wiley-Interscience, 1996, ISBN: 0-471-55034-5.
-

BIBLIOGRAPHY

- [131] R. Bellman, *Dynamic Programming*, P. U. Press, Ed. New Jersey: Princeton University Press, 1957.
- [132] R. Nieva, A. Inda, and J. Frausto, "Cht: A digital computer package for solving short term hydro-thermal coordination and unit commitment problems," *IEEE Transaction on Power Systems*, vol. 1, no. 3, pp. 168 – 174, August 1986.
- [133] W. L. Snyder, H. D. Powell, and J. C. Rayburn, "Dynamic programming approach to unit commitment," *IEEE Transactions on Power Systems*, vol. 2, no. 2, pp. 339 – 348, May 1987.
- [134] F. N. Lee, J. Huang, and R. Adapa, "Multi-area unit commitment via sequential method and a dc power flow network model," *IEEE Transactions on Power Systems*, vol. 9, no. 1, pp. 276 – 287, February 1994.
- [135] S. Sahni, *Data Structures, Algorithms and Applications in C++*. WBC/McGraw-Hill, 1998, ch. 15, p. 823, ISBN: 0-07-115595-3.
- [136] W. Huang and B. F. Hobbs, "Optimal SO_2 compliance planning using probabilistic production costing and generalized benders decomposition," *IEEE Transactions on Power Systems*, vol. 9, no. 1, pp. 174 – 180, 1994.
- [137] P. Tsamasphyrou, "Optimisation des investissements sur le réseau électrique," Ph.D. Thesis in Mathématiques et Automatique, École Nationale Supérieure des Mines de Paris - Centre d'Automatique et Systèmes, 12 juillet 1999.
- [138] J. Contreras, A. Losi, M. Russo, and F. F. Wu, "Simulation and evaluation of optimization problem solutions indistributed energy management systems," *IEEE Transactions on Power Systems*, vol. 17, no. 1, pp. 57 – 62, 2002.
- [139] A. El-Abiad and Y. Dusonchet, "Discrete optimization and the planning of electric power networks," *IEEE Transaction on Circuits Theory*, vol. 20, no. 3, pp. 230 – 238, May 1973, ISSN: 0098-4094.
- [140] C.-P. Chen, C.-W. Liu, and C.-C. Liu, "Unit commitment by Lagrangian relaxation and genetic algorithms," *IEEE Transactions on Power Systems*, vol. 15, no. 2, pp. 707 – 714, May 2000.
- [141] M. Sun, "Improved dynamic programming algorithms for sequential decision processes with applications to economic dispatches of power systems," in *Twenty-Fifth Southeastern Symposium on System Theory*. Alabama University, Tuscaloosa, AL, USA: Department of Mathematics, 7th – 9th of March 1993, pp. 135 – 139.
- [142] C.-H. Wang and K. J. Min, "Electric power generation planning for interrelated projects: a real options approach," *IEEE Transaction on Engineering Management*, vol. 53, no. 2, pp. 312 – 322, May 2006.
- [143] D. W. Bunn, "Forecasting loads and prices in competitive power markets," *Proceedings of the IEEE*, vol. 88, no. 2, pp. 163 – 169, February 2000.
- [144] J. D. Guy, "Security constrained unit commitment," *IEEE Transaction on Power Systems*, vol. PAS-90, no. 3, pp. 1985 – 1390, May 1971.
- [145] R. T. Clemen, *Making Hard Decisions : An Introduction to Decision Analysis*, 2nd ed. Duxbury Press, 1996, ch. 3, pp. 56–58, ISBN: 0-534-26034-9.
- [146] P. Pinson, C. Chevallier, and G. N. Kariniotakis, "Trading wind generation from short-term probabilistic forecasts of wind power," *IEEE Transactions on Power Systems*, vol. 22, no. 3, pp. 1148–1156, August 2007.
- [147] W. Ogryczak and A. Ruszczyński, "Dual stochastic dominance and related mean-risk models," RUTCOR, Piscataway, New Jersey, Research Report, January 2001.

-
- [148] —, “From stochastic dominance to mean-risk models: Semideviations as risk measures,” *European Journal of Operational Research*, vol. 116, no. 1, pp. 333–50, 1st July 1999.
- [149] K. A. Parton and P. S. Carberry, “Stochastic dominance and mean-standard deviation analysis: Some critical issues,” *Agricultural Research*, vol. 46, pp. 1487–1491, 1995.
- [150] S. Takriti, J. R. Birge, and E. Long, “A stochastic model for the unit commitment problem,” *IEEE Transactions on Power Systems*, vol. 11, no. 3, pp. 1497–1508, August 1996.
- [151] A. Schreiner and G. Balzer, “Value at risk method for asset management of power transmission systems,” in *IEEE Lausanne Powertech*, 2007.
- [152] G. Sheblé and D. Berleant, “Bounding the composite value at risk for energy service company operation with denv, an interval-based algorithm,” in *SIAM Workshop on Validated Computing*, Toronto, May 23rd – 25th 2002, pp. 166–171, extended Abstracts. [Online]. Available: <http://class.ee.iastate.edu/berleant/home/me/cv/papers/ESCOValueAtRiskRevised.pdf>
- [153] M. Carrión, A. B. Philpott, A. J. Conejo, and J. M. Arroyo, “A stochastic programming approach to electric energy procurement for large consumers,” *IEEE Transactions on Power Systems*, vol. 22, no. 2, pp. 744–754, May 2007.
- [154] F. Bourry, J. Juban, L. M. Costa, and G. Kariniotakis, “Advanced strategies for wind power trading in short-term electricity markets,” in *EWEC Brussels*, 31st March - 3rd April 2008. [Online]. Available: http://www.ewec2008proceedings.info/ewec2008/allfiles2/22_EWEC2008fullpaper.pdf
- [155] R. T. Rockafellar, “Optimization under uncertainty,” 2001, lecture Notes. [Online]. Available: <http://www.math.washington.edu/~rtr/uncertainty.pdf>
- [156] P. Slovic, “Perception of risk,” *Science*, vol. 236, pp. 280–285, 17 April 1987.
- [157] A. Tversky and D. Kahneman, “The framing of decisions and the psychology of choice,” *Science*, vol. 211, no. 4481, pp. 453–458, 30th 1981.
- [158] J. Juban, N. Siebert, and G. N. Kariniotakis, “Probabilistic short-term wind power forecasting for the optimal management of wind generation,” in *2007 IEEE Lausanne Power Tech*, Lausanne, Switzerland, 1st–5th of July 2007, pp. 683–688.
- [159] P. L. Meyer, *Probabilidade — Aplicações à Estatística*, 2nd ed., L. T. e Científicos Editora, Ed. Rio de Janeiro, Brazil: Addison-Wesley Publishing Company, 1983 (reprinted 1995), ISBN: 85-216-0294-4, Translated to portuguese by: Ruy de C. B. Lourenço Filho, Original title: Introductory Probability and Statistical Applications.
- [160] J. Matevosyan and L. Söder, “Minimization of imbalance cost trading wind power on the short-term power market,” *IEEE Transactions on Power Systems*, vol. 21, no. 3, pp. 1396–1404, August 2006.
- [161] P. E. Morthorst, “Detailed investigation of electricity market rules,” TradeWind, Tech. Rep., 2007.
- [162] P. D. Brown, “Evaluation of integration of pumped storage units in an isolated network,” Master of Science in Electrical Engineering (Area of Specialization in Power Systems), Faculdade de Engenharia da Universidade do Porto, Porto, May 2006 2004, in English. [Online]. Available: <http://pdb.homelinux.net/files/thesis/thesis.pdf>
- [163] A. G. Tsikalakis and N. Hatziargyriou, “Centralized control for optimizing microgrids operation,” *IEEE Transaction on Energy Conversion*, vol. 23, no. 1, pp. 241–248, March 2008.
-

BIBLIOGRAPHY

APPENDIX *A*

Résumé en Français

VUE GÉNÉRALE

LES travaux de cette thèse ont été menés au Centre Énergétique et Procédés de l'École des Mines de Paris (pôle de Sophia-Antipolis, France). Ce chapitre inclut un résumé étendu en français du contenu de ce mémoire de thèse de doctorat (rédigé en anglais) conformément aux obligations de l'École des Mines de Paris pour l'obtention du grade de Docteur. Ce chapitre s'oriente, donc, au public francophone susceptible de s'intéresser aux sujets et résultats de recherche abordés/obtenus au long de ce travail.

Ce résumé se divise en plusieurs parties. D'abord, une traduction intégrale du chapitre introductif de cette thèse est fournie dans la première section du chapitre. Ensuite, les introductions partielles de chaque chapitre qui suit sont aussi incluses dans des sections dédiées à l'exception du chapitre 7. En effet, vu la particularité ce chapitre, non seulement l'introduction partielle est traduite en français, mais aussi la section contenant les conclusions générales de ce travail de thèse.

A.1 Chapitre 1 : Introduction

A.1.1 Principaux Axes d'Orientation

Ce chapitre introduit ce travail de recherche par une description des axes principaux qui ont motivé son exécution. Ensuite, le chapitre procède avec la définition des objectifs et contributions de la thèse. La structure du mémoire est décrite à la fin du chapitre.

Trois axes principaux sont à la base de ce travail de recherche. Le premier est lié à la volonté politique d'atteindre une intégration à grande échelle dans les systèmes électriques des technologies de production d'électricité à partir des ressources renouvelables (dorénavant nommées *technologies renouvelables* pour simplicité d'usage) dans le but de profiter des ressources endogènes disponibles en vue de réduire la pollution associée à la production et à l'utilisation de l'électricité et d'accroître le *mix* et l'indépendance énergétique des pays à l'échelle mondiale. Le deuxième est associé aux avancées récentes dans les secteurs de la production décentralisée et des technologies d'information. Le troisième est issu du fait que, en opposition avec le passé récent, les systèmes électriques sont aujourd'hui exploités sous conditions de marché libéralisé d'électricité, ce qui implique des modifications et adaptations au niveau de la planification, de la gestion et de l'exploitation des systèmes électriques actuels. Une discussion courte sur chacun de ces axes sera faite en vue d'établir la base et les objectifs de ce travail.

A.1.1.1 Intégration Grande-Échelle dans les Systèmes Électriques des Technologies Renouvelables

Les inquiétudes environnementales croissantes et la haute dépendance générale des ressources fossiles pour produire de l'énergie ont mené les gouvernements de plusieurs pays à développer de nouvelles politiques pour prendre en compte ces nouvelles réalités. L'établissement de quotas de certificats *verts* pour pénaliser les émissions de carbone excessives et la mise en place de lois plus restrictives en ce qui concerne l'efficacité énergétique des bâtiments constituent deux exemples concrets de telles politiques.

Les technologies renouvelables ont le potentiel de contribuer à la réduction des émissions des gaz polluants. Simultanément, en utilisant des ressources endogènes, ces technologies permettent aux

pays qui les utilisent de renforcer leur indépendance énergétique et, en même temps, améliorer le *mix* énergétique de leurs économies. Par conséquent, il y a des pays à l'échelle mondiale qui sont de plus en plus en train d'investir dans l'intégration à grande échelle des technologies renouvelables dans leurs systèmes électriques. À titre d'exemple, en 2004, seulement 6 % de la consommation globale d'énergie de l'Union Européenne était fournie à partir de ressources renouvelables malgré leur abondance dans le territoire. Cependant, cette valeur est prévue d'augmenter dans les prochaines années. L'objectif fixé par l'Union Européenne pour la quantité d'énergie issue de sources renouvelables produites dans le territoire atteint 12 % en 2010. L'objectif pour la production d'électricité est encore plus ambitieux. En effet, en 2004, seulement 14 % de l'électricité produite était issue des ressources renouvelables. Néanmoins, l'Union Européenne prévoit d'atteindre la valeur de 22,1 % de production d'électricité à partir de ressources renouvelables en 2010.

Les systèmes électriques n'ont pas été originalement conçus pour intégrer des grandes quantités de production d'énergie à partir des ressources renouvelables. Par conséquent, l'intégration massive de ce type de production d'électricité crée des sérieux défis pour les acteurs responsables pour la planification, la gestion et l'exploitation des systèmes électriques. Les causes de ces défis sont principalement deux :

1. la plupart des technologies renouvelables se distribue un peu partout dans le réseau électrique ce qui peut mener à une augmentation des situations de congestion au niveau du réseau de transport ainsi qu'à la dégradation de la qualité de la coordination des systèmes de protection du réseau ;
2. la plupart des technologies renouvelables utilise des ressources stochastiques et fortement variables (tels que le vent et le rayonnement solaire effectif) ce qui ajoute de l'incertitude significative au processus de gestion des systèmes électriques.

Des nombreux travaux de recherche sont menés au présent avec l'objectif de donner des réponses à ces défis. Un des objectifs de cette thèse et celui de contribuer à l'optimisation de la gestion du système électrique en proposant des outils de gestion des systèmes électriques qui soient adaptés à l'intégration de la production décentralisée et qui prennent en compte la présence des sources et charges stochastiques dans le processus de gestion.

A.1.1.2 La Contribution de la Production Décentralisée et des Technologies d'Information

Les systèmes électriques actuels sont face à de nombreux défis comme, par exemple : la difficulté d'installer de nouvelles lignes de transport d'électricité et de renforcer les lignes existantes tout en devant fournir une demande électrique qui accroit et qui se déplace en permanence, le vieillissement des composants du système de transport d'électricité et le besoin de réinvestir dans de nouveaux composants et, comme dernier exemple, le vieillissement des infrastructures de production centralisée actuelles. Simultanément, des technologies de production décentralisée nouvelles et/ou améliorées entrent en scène. Celles-ci incluent, entre autres, les microturbines, les turbines éoliennes, les piles à combustible et les moteurs Stirling. En parallèle, des avancées au niveau des technologies d'information et communication permettent d'ajouter de nouvelles capacités aux composants électriques ce qui rend possible à la fois de repenser la façon de planifier, gérer et exploiter les systèmes électriques.

Contrastant avec les grandes centrales électriques qui intègrent les grands systèmes électriques, les technologies de production décentralisée ont besoin de moins de temps pour leur installation. Ce fait, allié à leur modularité, peut rendre l'investissement plus efficace en comparaison avec des technologies de production centralisée. De plus, si faite correctement, l'adoption de la production décentralisée peut permettre de reporter ou même d'éviter des investissements dans de nouveaux moyens de production d'électricité souvent coûteux, moins efficaces et pour lesquels les permis de construction sont difficiles à obtenir. Néanmoins, les unités de production décentralisée peuvent influencer le développement, la gestion et l'exploitation des systèmes électriques. Dans quelques pays, la pénétration des moyens de production décentralisée doit se limiter à 20 % pour restreindre les effets adverses que ce type de moyens de production peut infliger au système électrique. En effet, les compagnies d'électricité craignent la pénétration massive des moyens de production décentralisée dans le réseau électrique une fois que des valeurs pénétrations excessives peuvent hausser les coûts globaux d'exploitation et baisser les niveaux de sécurité et de fiabilité du système électrique. Voilà pourquoi, au présent, plusieurs études sont faites dans le but d'estimer les niveaux maximum de moyens de production décentralisée dans un système donné avant que leur impact collectif ne soit problématique, par exemple, au niveau des courants électriques de défaut excessifs ou au niveau des fluctuations excessives des niveaux de tension.

À la lumière des paragraphes précédents, une des questions principales est si l'on doit maintenir les structures classiques des systèmes électriques ou adopter une nouvelle structure décentralisée du sys-

tème électrique dans laquelle de nombreux composants lui sont additionnés à plusieurs niveaux. Dans un certain sens la question précédente pourrait être si l'on doit maintenir le système plus ou moins *passif* ou les rendre de plus en plus *actif*[†]. Les deux options mises en évidence précédemment ont des avantages et des inconvénients et le meilleur choix doit probablement être quelque part au milieu des deux. De toute façon, l'industrie des systèmes électriques possède à ce jour des méthodes et techniques établies pour gérer les systèmes électriques *passifs*, ce qui n'est pas le cas des moyens de production décentralisée intégrant des capacités de contrôle et communication avancées. Donc, de nouvelles méthodes, techniques et outils sont nécessaires pour gérer efficacement des grandes quantités de moyens de production décentralisée intégrés dans les systèmes électriques. La communauté scientifique et l'industrie des systèmes électriques travaillent déjà dans cette direction et des discussions sur le sujet sont de plus en plus fréquentes. Ce travail de recherche a pour objectif de contribuer à la connaissance existante dans le domaine de l'intégration à grande-échelle dans les systèmes électriques des technologies de production décentralisée.

A.1.1.3 Les Marchés d'Électricité et les Systèmes Électriques

La restructuration des systèmes électriques mise en œuvre dans plusieurs pays a mené à la séparation des systèmes électriques *verticalement structurés* et à l'établissement par la suite de marchés d'électricité. Les marchés d'électricité facilitent et augmentent la transparence des transactions commerciales d'énergie électrique entre les producteurs indépendants et les consommateurs d'électricité. Cela s'achève en établissant les commodités d'électricité qui doivent être échangées, les prix à payer pour ces commodités et les règles à respecter par tous les participants au marché d'électricité en question.

L'établissement des marchés d'électricité modifie la façon de gérer les systèmes électriques. L'objectif global du système électrique reste celui de fournir sa demande avec de l'énergie électrique sûre et fiable (contraintes techniques) au moindre coût (contraintes économiques). Cependant, sous conditions de marché libéralisé d'électricité, le respect des contraintes techniques est souvent garanti par l'opérateur indépendant du système[‡] alors que la minimisation du coût de l'énergie électrique est confiée aux mécanismes de marché.

[†] Ici, le mot *actif* signifie que les plusieurs composants du système électrique ont un niveau donné d'intelligence (communication avancée – entre eux et/ou avec le système principal – et capacité de contrôle) qui leur permet de prendre des actions (choisies à partir d'un ensemble d'actions prédéfini) en accord avec les signaux de communication qu'ils reçoivent.

[‡] La désignation officielle en anglais est : *Independent System Operator – ISO*.

Les opérateurs indépendants du système représentent un des acteurs majeurs des marchés d'électricité et ont la responsabilité d'assurer que les contraintes techniques décrites ci-dessus soient respectées en permanence. Par conséquent, ces acteurs sont tenus responsables de la maintenance des niveaux de sûreté et de fiabilité du système électrique aussi élevés que possible en vérifiant que :

- les offres de production d'énergie électrique placées sûres et acceptées par le marché mènent à des flux d'énergie et à des niveaux de tension acceptables au niveau de chaque ligne/nœud du réseau de transport d'électricité ;
- les niveaux de sûreté $N - 1$ (dans quelques cas, $N - 2$ et ceci d'un point de vue de l'analyse de contingences) soient respectées.

Comme décrit auparavant, la minimisation des coûts de l'énergie électrique est confiée aux mécanismes du marché. Ces mécanismes génèrent des signaux de prix qui sont par la suite interprétés par les participants du marché comme, par exemple, les producteurs indépendants d'électricité. En effet, les producteurs indépendants d'électricité utilisent ces signaux de prix pour placer ses offres de production d'énergie électrique en accord avec ses objectifs individuels. Ces objectifs correspondent souvent à la maximisation de ses profits individuels. Cependant, pour ce faire, sous conditions de marché libéralisé d'électricité, les producteurs indépendants d'électricité n'ont plus accès aux décisions de production obtenues la veille avec une gestion centralisée optimale du système électrique pour atteindre ses objectifs individuels, mais doivent réaliser une série complète de nouvelles tâches. Ces tâches peuvent se résumer principalement en trois phases :

1. gérer les niveaux de production des différents générateurs (pour le lendemain, au cours de la semaine qui suit,...) ;
2. placer des offres stratégiques de commodités dans le marché d'électricité en vue d'établir les contrats les plus rentables pour les commodités définies ;
3. opérer les différents générateurs pour respecter aussi bien que possible les contrats préétablis pour les commodités et ainsi éviter le paiement de pénalités.

Ce travail de recherche se focalise surtout dans la gestion individuelle d'un producteur indépendant d'électricité pour le lendemain.

A.1.1.4 Objectifs et Contributions de la Thèse

L'objectif général de ce travail de recherche est celui de contribuer à l'intégration grande-échelle des technologies de production décentralisée dans les systèmes électriques. Deux options existent pour intégrer la production décentralisée. La première (classique) consiste à la connexion *passive* de la production décentralisée et à subir les conséquences possibles qui peuvent éventuellement arriver par la suite. La deuxième consiste à intégrer cette production décentralisée de façon *active*. Sous ce principe, la production décentralisée possède un niveau donné *d'intelligence* (d'un point de vue du système électrique[†]) lui permettant de coopérer avec des technologies *intelligentes* pour suivre une stratégie d'opération donnée cherchant activement à réduire le mal qui peut être causé par la production décentralisée au système électrique principal ou même à contribuer à la bonne santé du système principal.

L'intégration active de la production décentralisée dans les systèmes électriques est en train de créer des défis à plusieurs niveaux tels que :

- l'augmentation de la complexité de la gestion du système électrique due à la présence de beaucoup plus d'acteurs que dans le passé ce qui augmente la compétition entre les participants du marché et réduit la marge de profit individuel ;
- le besoin de communication bidirectionnelle entre plusieurs acteurs ce qui leur permet de recevoir des signaux (ex. : les signaux de prix du marché reçus par les différents générateurs) et d'informer les autres participants de leurs états et décisions individuelles (ex. : un générateur peut placer une offre directement dans le marché, informer son contrôleur de ces intentions de produire ou non de l'énergie électrique à une heure donnée, informer son entourage d'une panne éventuelle, etc.) ;
- dans le cas de pénétration de la génération non-dispatchable (ex. : certaines énergies renouvelables), la contrôlabilité du système électrique décroît (au moins localement) ce qui demande des méthodologies innovantes pour gérer le système électrique ;
- l'intégration d'éléments distribués incluant un niveau donné d'intelligence offre des opportunités

[†]Cette *intelligence* peut être donnée par la capacité de communiquer soit avec d'autres éléments qui opèrent au même niveau de communication (ex. : autres générateurs), soit avec des éléments d'interface entre niveaux de communication (ex. : assembleur). Un autre niveau d'intelligence pourrait être au niveau de l'autonomie donnée à la production décentralisée pour leur permettre de répondre de façon autonome à des occurrences d'événements prédéfinies (ex. : survenance de sous-tensions ou de surtensions locales).

nouvelles au niveau du contrôle et de la gestion du système électrique ce qui peut permettre le développement de structures de gestion plus avancées du système électrique.

Cette thèse se focalise dans l'intégration *active* de la production décentralisée dans les systèmes électriques. Au cours de cette thèse, des possibilités de gestion du système électrique potentiellement applicables au cas des générateurs distribués ont été investiguées. Ces possibilités incluent :

- la coordination entre plusieurs éléments du système électrique pour atteindre un objectif commun ;
- l'utilisation de dispositifs de stockage d'énergie pour accroître la contrôlabilité globale du système ainsi que les bénéfices (ex. : profits) de ses opérateurs respectifs ;
- l'intégration de techniques de gestion de la charge directement dans les gestionnaires d'énergie.

Dû aux spécificités de l'énergie électrique, la gestion du système est très complexe et intègre plusieurs échelle et résolutions temporelles. Ce travail se focalise surtout dans la gestion pour le lendemain sous conditions de marché libéralisé d'électricité de ressources distribuées coopérant entre eux. Quand elles sont mises en coopération, ces ressources forment des *cellules du système électrique*[†]. Ce travail considère la gestion pour le lendemain de ce type de cellules qui peuvent intégrer de combinaisons variées de plusieurs éléments : des générateurs et des charges non-dispatchables, des générateurs et des charges dispatchables et des dispositifs de stockage d'énergie.

Les *cellules du système électrique* prises en compte dans ce travail de thèse sont considérées pour participer au marché d'électricité et incluent des sources de production stochastique telles que les turbines éoliennes et les panneaux photovoltaïques. Par conséquent, la gestion de ce type de cellules doit se baser sur des prédictions des prix de l'énergie électrique sur le marché et sur des prédictions de production/consommation des générateurs/charges non-dispatchables. Toutes ces prédictions injectent de l'incertitude dans le processus de gestion et les rendent plus difficile que celles des systèmes électriques conventionnelles où la charge est fortement prédictible et où la pénétration de la production non-dispatchable est en règle générale réduite.

[†]A *posteriori*, ces cellules pourraient être nommées de *cellules intelligentes du système électrique* grâce aux options variées qu'elles intègrent aux niveaux de leur contrôle, de leur gestion et de leur capacité de communication.

Dans ce travail, deux méthodes de gestion de *cellules du système électrique* sont proposées : une déterministe et une stochastique avec plusieurs variantes. La méthode déterministe ignore les incertitudes liées aux prédictions des différents éléments non-dispatchables. Les différentes variantes de la méthode stochastique considèrent ces incertitudes comme base pour l'estimation du risque lié à l'opération de la cellule. De plus, l'intégration des risques d'origine énergétique estimés dans le processus de gestion est faite par la considération de la perception du risque et de l'attitude en face du risque de l'opérateur de la *cellule du système électrique*. En d'autres termes, l'opérateur est placé au centre du processus de gestion par la prise en compte de ses préférences en face d'un niveau de risque donné. Aussi bien dans la méthode déterministe que dans les variantes de la méthode stochastique, le stockage est un élément central du problème de gestion.

Les méthodes proposées sont évaluées dans deux cas d'étude. Un de ces cas d'étude considère un micro-réseau et l'autre considère un système composé d'une centrale hydraulique gravitaire réversible couplée à une ferme éolienne.

A.1.2 Structure de la Thèse

Le premier chapitre de la thèse décrit synthétiquement le cadre du travail réalisé ainsi que ses principaux objectifs et conclusions. Le chapitre 2 présente plus en détail le cadre de développement de ce travail. Il commence par le développement d'une description plus complète du contexte général dans lequel ce travail a été développé. Ensuite, le chapitre présente la description des hypothèses principales qui ont été suivies/utilisées au cours de ce travail.

Plusieurs aspects ont du être étudiés et combinés pour mener à bout ce travail tels que, par exemple :

- les concepts liés aux marchés d'électricité ;
- les principes de gestion des systèmes électriques ;
- les principes, méthodes et techniques d'optimisation ;
- la compréhension et principes d'utilisation de prédictions ;
- les modèles de représentation de l'incertitude et les concepts de risque ;

- les techniques pour prendre des décisions sous incertitude ;
- etc.

Parmi ces aspects, deux ressortent : le problème de gérer le système électrique et les domaines associés à la décision sous incertitude. La raison découle du fait que ces deux points sont centraux dans cette thèse. Par conséquent, ils sont analysés plus en détail dans ce manuscrit.

La problématique liée à la gestion du système électrique est présentée et analysée au cours du chapitre 3. Dans ce même chapitre, les approches principales qui peuvent être utilisées pour résoudre les problèmes de gestion des systèmes électriques sont discutées et une formulation généralisée de la gestion des systèmes électriques est proposée se basant sur le travail bibliographique qui a été réalisé sur le sujet. Cette formulation concerne le cas général de la gestion multi-zonale . Elle est ensuite adaptée au cas d'une seule région et du participant individuel au marché. Ce développement fournit la compréhension nécessaire et les outils qui seront utilisés plus tard pour développer le modèle de gestion des *cellules du système électrique* proposé dans le chapitre 5.

Ici, les domaines d'intérêt associés à la décision sous incertitude se composent principalement de différentes façons de modéliser l'incertitude et les modèles permettant de prendre des décisions sous incertitude. Ces deux points sont analysés au cours du chapitre 4. Une discussion sur les méthodes et principes pour prendre des décisions sous incertitude est fournie incluant une description courte des façons selon lesquelles l'incertitude peut être modélisée et les modèles principaux utilisables dans le cadre de la prise de décision sous incertitude. Les principes de modélisation de l'incertitude et les modèles de prise de décision sous incertitude présentés dans ce chapitre servent de support à l'intégration des incertitudes associées au problème de gestion de *cellules du système électrique* considéré dans ce travail. En effet, ils sont inclus dans les variantes de la méthode de gestion stochastique proposée dans le chapitre 5.

Le chapitre 5 développe l'approche de gestion des *cellules du système électrique* proposée dans ce travail. Une première approche déterministe est proposée et utilisée comme référence et point de départ pour le développement de plusieurs variantes de la méthode stochastique proposée par la suite. Cette méthode stochastique prend en compte les incertitudes liées au problème de gestion de *cellules du système électrique* mentionnées ci-dessus. Dans le chapitre 6, deux cas d'étude illustrant quelques applications possibles des méthodes de gestion proposées ainsi que les résultats atteignables avec la

méthodologie développée dans ce travail sont proposés et discutés. Finalement, le chapitre 7 contient les conclusions générales du travail ainsi que quelques unes des perspectives principales de recherche issues de ce travail de thèse.

A.2 Chapitre 2 : Contexte et Hypothèses Principales du Travail

VUE GÉNÉRALE

Ce chapitre peut être vu comme le point de départ de ce travail. Au début, le chapitre fournit une évolution chronologique simplifiée des déroulements principaux qui sont survenus dans le domaine des systèmes électriques. Cela permet de mieux comprendre le contexte et les motivations qui supportent ce travail de recherche. En détail, le rôle de la production décentralisée et les formes de l'intégration dans les systèmes électriques sont discutés. Une discussion sur les hypothèses de travail définies est aussi incluse pour mieux clarifier le cadre de ce travail.

A.3 Chapitre 3 : Gestion des Systèmes Électriques

VUE GÉNÉRALE

Ce chapitre aborde un des principaux domaines de connaissance nécessaires pour ce travail : celui de la *gestion des systèmes électriques*. L'idée principale est de fournir les bases nécessaires pour la formulation du problème spécifique de la gestion de *cellules du système électrique* traité dans le contexte du chapitre 5.

Plusieurs formulations des problèmes de gestion des systèmes électriques sont accessibles dans la littérature. Cependant, dans sa majorité elles sont soit spécifiques à un problème donné, ou orientées surtout vers les techniques de solutions du problème de gestion et non purement vers la formulation mathématique du problème de gestion des systèmes électriques. Ces caractéristiques rendent ces formulations désadaptées à l'objectif de ce chapitre qui est celui de fournir des descriptions et formulations suffisamment génériques des problèmes de gestion des systèmes électriques et non pas d'analyser une

spécificité donnée de ces problèmes ni les techniques de solutions précises qui sont accessibles dans la littérature spécialisée. Pour cette fin, une analyse générale des caractéristiques de ce type de problèmes est fournie. De plus, une formulation unifiée du problème généralisé de la gestion du système électrique est proposée utilisant les résultats du travail bibliographique mené dans le sujet.

Trois possibilités sont identifiées pour formuler les problèmes de gestion des systèmes électriques : gestion classique multi-zonale du système électrique, gestion classique mono-zonale du système électrique et la gestion du participant individuel au marché. En premier lieu, ce chapitre présente la formulation du problème de gestion le plus général qui est celui de la gestion classique multi-zonale du système électrique. Ensuite, des modifications de cette formulation initiale sont suggérées en vue de l'adapter aux autres cas qui ont été identifiés auparavant.

A.4 Chapitre 4 : Décision Sous Incertitude

VUE GÉNÉRALE

Traditionnellement, les décisions de gestion du système électrique sont prises *avant* l'opération *effective* du système. Telles décisions de gestion, en accord avec ce qui a été discuté dans le chapitre précédent, servent essentiellement à préparer le système électrique pour répondre à ces besoins opérationnels en accord avec un objectif ou un ensemble d'objectifs d'opération prédéfini(s). Par conséquent, ces besoins doivent eux aussi être estimés *avant* leur occurrence *effective*.

Ce travail de recherche traite le problème de la gestion d'une *cellule du système électrique* assujettie à des incertitudes considérables. Ceci peut représenter le cas d'un micro-réseau ou celui d'un système combiné éolien/centrale hydraulique gravitaire réversible dans lesquels les incertitudes sont liées à la connaissance *imparfaite* des conditions futures sous lesquelles la *cellule du système électrique* va fonctionner. Ces incertitudes jouent, donc, un rôle majeur dans les décisions de gestion à prendre.

Ce chapitre discute de la décision sous incertitude qui a été identifiée dans le chapitre 2 comme un des deux principaux domaines de connaissance nécessaires à l'exécution de ce travail (l'autre est celui de la gestion des systèmes électriques qui a été traité dans le cadre du chapitre 3). De cette façon, ce chapitre passe en revue les différentes façons de modéliser l'incertitude et de l'intégrer dans les

processus de prise de décision. Ceci sert à établir la base de modélisation prenant en compte les incertitudes typiquement liées aux problèmes de gestion des systèmes électriques tels que celui traité dans ce travail.

A.5 Chapitre 5 : Modèle de Gestion Proposé

VUE GÉNÉRALE

Dans ce chapitre, un modèle adapté à la gestion d'une *cellule du système électrique* participant dans un marché d'électricité est proposé. Le modèle se base dans les caractéristiques du problème décrit dans le chapitre 2 et utilise les concepts de gestion des systèmes électriques discutés dans le chapitre 3.

Dans une première phase, le modèle de gestion proposé est développé dans un cadre déterministe. Comme tel, le modèle n'intègre pas un quelconque modèle des incertitudes liées aux prédictions des ressources d'énergie renouvelable non-dispatchables, aux prédictions des demandes non-dispatchables et aux prédictions-point des prix du marché d'électricité. Ceci dit, le modèle déterministe prend en compte quelques aspects économiques liés au problème de gestion (ex. : coûts de production de l'énergie, rémunération liée à la fourniture de la demande, coûts liés aux ordres de contrôle donnés aux demandes dispatchables, prédictions-point des prix du marché,...) pour maximiser le bénéfice de l'opérateur de la *cellule du système électrique* qu'ici correspond aux profits générés.

Dans une deuxième phase, le modèle déterministe proposé est étendu dans le but d'incorporer la composante stochastique du problème de gestion. Pour ce faire, plusieurs modules d'extension pour prendre des décisions sous incertitude sont proposés pour prendre en compte les deux incertitudes principales du problème de gestion qui sont liées aux prix du marché du lendemain et aux charges et ressources d'énergie non-dispatchables. Ces modèles de décision sous incertitude se basent sur les principes de décision décrits et analysés dans le chapitre 4. L'objectif principal des modèles proposés pour prendre en compte les incertitudes liées au problème de gestion traité est celui de minimiser les déviations d'énergie dues aux erreurs des prédictions tout en profitant des moments les plus avantageux pour utiliser les ressources d'énergie locales d'un point de vue de l'efficacité économique.

A.6 Chapitre 6 : Cas d'Études

VUE GÉNÉRALE

Au cours du chapitre 5, une méthodologie a été développée pour réaliser la gestion du lendemain de *cellules du système électrique* fonctionnant sous condition de marché d'électricité. Cette méthodologie intègre plusieurs alternatives de gestion prenant en compte les variables stochastiques du problème. Dans ce chapitre, cette méthodologie est testée dans deux cas d'études. Le premier considère un micro-réseau tandis que le deuxième considère un système combiné éolien/centrale hydraulique gravitaire réversible.

Le chapitre commence avec une description générale des objectifs individuels de chaque cas d'étude. Ensuite, le chapitre procède avec la description des méthodes de prédiction utilisées pour produire les entrées nécessaires. Finalement, les cas d'étude considérés et les résultats obtenus sont présentés et analysés.

A.7 Chapitre 7 : Conclusions et Perspectives de Recherche Additionnelle

VUE GÉNÉRALE

Dans les chapitres précédents, la description des objectifs et le contexte de ce travail de thèse, les bases théoriques associées à ce travail, notre contribution à la solution du problème traité et les résultats issus des évaluations numériques ont été présentés et analysés. Ce chapitre résume les conclusions partielles de ce travail (présentées à la fin de chaque chapitre) et tire des conclusions générales. De plus, quelques perspectives de recherche additionnelle dans le domaine dans lequel cette thèse de doctorat a été réalisée, ou dans des domaines associés, sont aussi suggérées.

CONCLUSIONS GÉNÉRALES

Ce travail a été réalisé dans le cadre des systèmes électriques restructurés dans lesquels plusieurs ac-

teurs interagissent avec un marché d'électricité pour placer leurs offres de production/consommation d'énergie. En même temps, les objectifs de l'Union Européenne qui vont dans le sens de l'intégration massive de ressources endogènes telles que, par exemple, les énergies renouvelables ont été gardés à l'esprit. En ce qui concerne ce point spécifique, le rôle de la production décentralisée pour aider à atteindre ces objectifs ainsi que son intégration active dans les systèmes électriques a été analysé. Plus spécifiquement, la possibilité de coupler de la micro-génération avec des charges et des dispositifs de stockage d'énergie a été prise en compte. L'ensemble a été analysé et considéré comme une entité contrôlée formant une cellule individuelle du système électrique. L'objectif général de ce travail a été celui de développer une méthodologie de gestion de ce type de *cellules du système électrique* opérant sous conditions de marché libéralisé d'électricité.

Pour atteindre l'objectif général défini, la première phase a consisté à comprendre en profondeur le contexte général de ce travail. Ceci a été réalisé au cours du chapitre 2 où une courte description historique des événements les plus marquants qui sont survenus dans le domaine des systèmes électriques dès leur création et jusqu'à présent. Cette description a permis de mieux comprendre le contexte actuel surtout en ce qui concerne le rôle de la production décentralisée et la restructuration du secteur électrique, lesquelles ont été les principales forces agissantes de ce travail. La description du contexte général du travail a abouti sur une discussion de quelques aspects et options liés à l'intégration de la production décentralisée qui ont eux mêmes mené à la formulation du concept générique des *cellules du système électrique*, lesquels représentent les entités spécifiques traitées dans ce travail.

L'objectif de développer une méthodologie de gestion de *cellules du système électrique* pour le lendemain adaptée à des cellules opérant sous condition de marché d'électricité requiert l'utilisation de la connaissance existante sur deux domaines principaux : celui de la gestion des systèmes électriques et celui de la décision sous incertitude. Ces deux sujets ont été analysés dans les chapitres 3 et 4 dans le but de fournir une base solide menant à une meilleure maîtrise du problème traité ici. De plus, cette analyse a permis de développer les solutions proposées dans ce travail pour résoudre le problème de la gestion de *cellules du système électrique* pour le lendemain.

Au cours du chapitre 3, les bases nécessaires en ce qui concerne la gestion des systèmes électriques ont été données permettant de mieux comprendre les concepts, complexité et caractéristiques associés à ce type de problèmes de gestion. Ces bases ont consisté à la caractérisation des problèmes de gestion des systèmes électriques intégrant : une discussion conceptuelle sur le sujet, l'identification des ses caractéristiques principales et à la complexité qui lui sont associées et, finalement, un aperçu court

des approches principales qui sont souvent suivies pour résoudre les problèmes de ce type. Ensuite, un modèle adapté aux problèmes de gestion multi-zonale de systèmes électriques a été développé. Ce modèle unifie plusieurs modèles proposés dans la littérature. Comme résultat, le modèle proposé est assez générique dans le sens où il est capable d'intégrer les restrictions plus typiquement associées aux problèmes du type.

Le modèle de gestion multi-zonale de systèmes électriques développé n'est pas orienté vers une solution précise de ce type de problèmes de gestion dans le sens où il se focalise purement sur le modèle mathématique qui les représente en général et non pas dans les techniques de solution qui peuvent être utilisées pour résoudre un problème de gestion multi-zonale donné. De là, le modèle peut être appliqué à une multitude de problèmes de gestion multi-zonale de systèmes électriques tout en permettant de considérer facilement des contraintes additionnelles ainsi que la modification et/ou soustraction des contraintes incluses dans le modèle proposé.

Ensuite, des instructions ont été données pour simplifier le modèle de gestion multi-zonale de systèmes électriques et ainsi l'adapter au cas de la gestion mono-zonale fournie. Finalement le modèle de gestion mono-zonale est lui-même modifié et adapté au cas d'un producteur indépendant participant au marché d'électricité. Cette dernière formulation est celle qui a été retenue comme base pour le développement de la solution de gestion de *cellules des systèmes électriques* proposées dans le chapitre 5.

Au cours du chapitre 4, les bases nécessaires en ce qui concerne la décision sous incertitude ont été données. Cela a permis de mieux comprendre la nature de ce type de problèmes, les façons de modéliser l'incertitude et les modèles principaux qui existent à ce jour pour prendre des décisions en présence d'incertitude. Les caractéristiques des modèles de prise de décision ont été décrites et discutées ce qui a permis de mieux comprendre les enjeux derrière ces modèles. Ceci a été très important une fois que le type de *cellules des systèmes électriques* considérées dans le cadre de ce travail peut comporter des niveaux d'incertitude importants dus aux plusieurs types de prédictions utilisés comme entrées du modèle de gestion proposé[†]. De cette façon, l'analyse menée dans le chapitre 4 a servi à développer et maîtriser les outils nécessaires pour atteindre un des objectifs principaux de ce travail qui a été celui de développer un modèle de gestion de *cellules du système électrique* capable de traiter ce type d'incertitude. Ce développement a été réalisé dans le chapitre 5.

[†]D'autres incertitudes pourraient être, par exemple, la possibilité de pannes de ses générateurs et la possibilité de perte de l'interconnexion avec le réseau principal.

Au cours du chapitre 5, un modèle pour réaliser la gestion pour le lendemain d'une *cellule du système électrique* sous conditions de marché libéralisé d'électricité a été proposé. D'abord, les bases de la modélisation ont été présentées intégrant une discussion sur plusieurs possibilités de modélisation, la description de l'objectif principal du modèle et quelques applications possibles du modèle proposé. Ensuite, le schéma de gestion a été décrit et le problème de gestion de la *cellule du système électrique* a été formulé. Le chapitre continue avec la proposition d'une méthode de solution du problème de gestion formulé, basée sur une approche d'optimisation utilisant les principes de la programmation dynamique déterministe. Cette formulation déterministe a ensuite été étendue pour incorporer les différentes incertitudes considérées. Plusieurs modèles ont été proposés, formulés et discutés pour prendre en compte ces incertitudes.

Dû à la spécificité du problème de gestion traité et à la technique de solution développée, comme expliqué et justifié au cours du chapitre 5, une nouvelle technique utilisant les principes de la perception du risque encouru par l'opérateur de la *cellule du système électrique* a été développée pour intégrer les incertitudes liés aux prédictions des demandes et productions non-dispatchables. Cette approche est basée sur deux principes qui mènent à des règles de perception du risque séparées. Un algorithme approprié a été proposé pour les mélanger. Cet algorithme donne comme résultat une surface de perception du risque qui est utilisée pour valoriser le niveau d'incertitude prédit en accord avec les besoins de l'opérateur ce qui le place au centre du processus de décision.

Une approche utilisant des scénarios a été suivie pour intégrer les incertitudes associées aux prédictions des prix du marché d'électricité. Ceci a permis de considérer la distribution discrète de probabilité des prix du marché à chaque pas de temps de l'horizon de gestion où chaque possibilité de prix de marché représente un scénario futur. Plusieurs méthodes basées sur les distances de Minkowski ont été adaptées à partir de la littérature existante pour intégrer ces scénarios du prix du marché dans le processus de décision sous incertitude.

Au cours du chapitre 6, deux cas d'études ont été développés pour donner un aperçu du type de résultats qui peuvent être obtenus avec la méthodologie de gestion proposée dans ce travail. L'un des deux cas d'études utilise un micro-réseau et l'autre utilise un système combinant une ferme éolienne avec une centrale hydraulique gravitaire réversible. La valeur ajoutée des méthodes de gestion proposées a été quantifiée en termes de revenu et de réduction des déséquilibres entre la production et la consommation d'énergie. Il a été montré que les méthodes proposées dans ce travail peuvent mener à des augmentations de profit d'éventuels investisseurs dans des *cellules des systèmes électriques* du type

considéré. En même temps, il a aussi été montré que les opérateurs indépendants de systèmes basés sur des ressources énergétiques non-dispatchables peuvent devenir *mieux comportés* (d'un point de vue du GRT[†]) quand ils utilisent des méthodes telles que celles qui ont été proposées dans le cadre de ce travail de thèse.

[†]Gestionnaire du Réseau de Transport

GESTION DE CELLULES DES SYSTÈMES ÉLECTRIQUES INTÉGRANT DES SOURCES DE PRODUCTION STOCHASTIQUES

Résumé

L’approvisionnement en énergie et le changement climatique représentent aujourd’hui deux problèmes remarquables qui doivent être surmontés par la société dans un contexte de croissance de la demande d’énergie. La reconnaissance de ces problèmes par l’opinion publique encourage la volonté politique de prendre différentes actions pour les surmonter de façon aussi rapide qu’efficace. Ces actions se basent sur l’augmentation de l’efficacité énergétique, la diminution de la dépendance sur les énergies fossiles et la réduction des émissions de gaz à effet de serre. Dans ce contexte, les systèmes électriques subissent des changements importants au niveau de leur planification et de leur gestion. D’une part, les structures verticalement intégrées sont en train d’être remplacées par des structures de marché d’électricité donnant naissance à plusieurs acteurs au niveau du fonctionnement des marchés et de la production, distribution et commercialisation d’électricité. D’autre part, les systèmes électriques qui se basaient sur la production d’énergie issue de grandes centrales génératrices voient arriver aujourd’hui la fin de vie de ces grandes centrales. Le rôle de la production répartie d’électricité à partir de technologies telles que l’éolien et le solaire devient de plus en plus important dans ce contexte. Cependant, l’intégration à grande échelle de ces types de ressources réparties pose plusieurs défis liés, par exemple, aux incertitudes associées à la variabilité de la production de ces ressources. Toutefois, des systèmes combinant des outils avancés de prédiction de l’éolien ou du solaire peuvent être combinés avec des éléments contrôlables tels que des moyens de stockage d’énergie, des turbines à gaz ou de la demande électrique contrôlable, peuvent être créés dans le but de réduire les impacts associés à ces incertitudes. Ce travail de thèse traite de la gestion, sous conditions de marché libéralisé d’électricité, de ce type de systèmes qui fonctionnent comme des sociétés indépendantes qui sont ici nommées cellules des systèmes électriques. À partir de la bibliographie existante, une vision unifiée des problèmes de gestion des systèmes électriques est proposée comme un premier pas vers la gestion d’ensembles de cellules des systèmes électriques dans un cadre de gestion multi-cellule. Des méthodologies pour la gestion journalière et optimale de ce type de cellules sont proposées, discutées et évaluées dans un cadre à la fois déterministe et stochastique, ce dernier intégrant dans le processus de gestion les incertitudes liées au problème. Les résultats obtenus montrent que l’utilisation des approches proposées peut conduire à des avantages importants pour les opérateurs chargés de la gestion de cellules des systèmes électriques.

Mots clés : Gestion des Systèmes Électriques, Prise de Décision, Production Décentralisée, Cellule du Système Électrique, Micro-réseau, Centrale Virtuelle, Incertitude, Risque, Marché d’Électricité, Énergies Renouvelables.

SCHEDULING OF POWER SYSTEM CELLS INTEGRATING STOCHASTIC POWER SOURCES

Synopsis

Energy supply and climate change are nowadays two of the most outstanding problems which societies have to cope with under a context of increasing energy needs. Public awareness of these problems is driving political willingness to take actions for tackling them in a swift and efficient manner. Such actions mainly focus in increasing energy efficiency, in decreasing dependence on fossil fuels, and in reducing greenhouse gas emissions. In this context, power systems are undergoing important changes in the way they are planned and managed. On the one hand, vertically integrated structures are being replaced by market structures in which power systems are unbundled. On the other, power systems that once relied on large power generation facilities are witnessing the end of these facilities’ life-cycle and, consequently, their decommissioning. The role of distributed energy resources such as wind and solar power generators is becoming increasingly important in this context. However, the large-scale integration of such type of generation presents many challenges due, for instance, to the uncertainty associated to the variability of their production. Nevertheless, advanced forecasting tools may be combined with more controllable elements such as energy storage devices, gas turbines, and controllable loads to form systems that aim to reduce the impacts that may be caused by these uncertainties. This thesis addresses the management under market conditions of these types of systems that act like independent societies and which are herewith named power system cells. From the available literature, a unified view of power system scheduling problems is also proposed as a first step for managing sets of power system cells in a multi-cell management framework. Then, methodologies for performing the optimal day-ahead scheduling of single power system cells are proposed, discussed and evaluated under both a deterministic and a stochastic framework that directly integrates the uncertainty information into the scheduling process. Results show that the utilization of the proposed approaches may lead to important advantages for operators managing these types of power system cells.

Keywords : Power System Management, Decision-Making, Distributed Generation, Power System Cell, Microgrid, Virtual Power Plant, Uncertainty, Risk, Electricity Market, Renewable Energies.

Laboratoire d’accueil : Centre Énergétique et Procédés – École Nationale Supérieure des Mines de Paris
Rue Claude Daunesse – B.P.207 — F-06904 Sophia-Antipolis Cedex

Thèse présentée par : Luís Miguel COSTA, le : 18 décembre 2008

Discipline : « Énergétique » – École Nationale Supérieure des Mines de Paris
