



HAL
open science

Management of uncertainties related to renewable generation participating in electricity markets

Franck Bourry

► **To cite this version:**

Franck Bourry. Management of uncertainties related to renewable generation participating in electricity markets. Electric power. École Nationale Supérieure des Mines de Paris, 2009. English. NNT : . tel-00508345

HAL Id: tel-00508345

<https://pastel.hal.science/tel-00508345>

Submitted on 3 Aug 2010

HAL is a multi-disciplinary open access archive for the deposit and dissemination of scientific research documents, whether they are published or not. The documents may come from teaching and research institutions in France or abroad, or from public or private research centers.

L'archive ouverte pluridisciplinaire **HAL**, est destinée au dépôt et à la diffusion de documents scientifiques de niveau recherche, publiés ou non, émanant des établissements d'enseignement et de recherche français ou étrangers, des laboratoires publics ou privés.



Distributed under a Creative Commons Attribution - NonCommercial - NoDerivatives 4.0 International License



ED n° 432: "Sciences des Métiers de l'Ingénieur"

N° attribué par la bibliothèque

|_|_|_|_|_|_|_|_|_|_|_|_|_|_|_|_|

T H E S E

pour obtenir le grade de :

**DOCTEUR DE L'ÉCOLE NATIONALE SUPÉRIEURE DES MINES
DE PARIS**

Spécialité "Énergétique"

présentée et soutenue publiquement par

Franck BOURRY

le 8 décembre 2009

**MANAGEMENT OF UNCERTAINTIES RELATED TO
RENEWABLE GENERATION PARTICIPATION IN
ELECTRICITY MARKETS**
(GESTION DES INCERTITUDES LIÉES À LA PRODUCTION D'ÉNERGIE
RENOUVELABLE DANS LE CADRE DES MARCHÉS DE L'ÉLECTRICITÉ)

Directeur de thèse: George Kariniotakis

Jury :

Prof. Didier Mayer	Président
Prof. Lennart Söder	Rapporteur
Prof. Julio Usaola García	Rapporteur
Prof. Xavier Guillaud	Examinateur
Prof. Margaret Armstrong	Examinateur
Dr. Joseph Maire	Examinateur
Dr. George Kariniotakis	Examinateur

Composition du Jury de Thèse :

Prof. Didier MAYER, MINES ParisTech, France (Président)

Prof. Lennart SÖDER, KTH Royal Institute of Technology, Suède (Rapporteur)

Prof. Julio USAOLA GARCÍA, Universidad Carlos III de Madrid, Espagne ,
(Rapporteur)

Prof. Xavier GUILLAUD, École Centrale de Lille, France, (Examineur)

Prof. Margaret ARMSTRONG, MINES ParisTech, France, (Examineur)

Dr. Joseph MAIRE, Électricité de France (EDF), France, (Examineur)

Dr. Georges KARINIOTAKIS, MINES ParisTech, France, (Examineur)

Remerciements

Le travail de thèse présenté dans ce mémoire a été réalisé au Centre Energétique et Procédés (CEP), laboratoire de MINES-Paristech à Sophia Antipolis.

Je tiens tout d'abord à remercier chaque membre de l'équipe Energies Renouvelables du CEP pour l'accueil et l'atmosphère de travail très agréable au cours de ces trois années de thèse. J'espère retrouver dans ma carrière cette ambiance conviviale propice aux échanges scientifiques. J'en profite pour remercier toute l'équipe administrative du centre pour leur patience et leur disponibilité.

Je remercie aussi Jérôme Adnot, Jérôme Gosset et François-Pascal Neirac pour m'avoir lancé dans cette belle aventure que fût cette thèse, ainsi que Didier Mayer et Thierry Ranchin pour m'avoir accueilli dans leur laboratoire.

J'exprime ma profonde gratitude à Georges Kariniotakis, d'abord pour m'avoir fait confiance, ensuite pour m'avoir encadré, et finalement pour m'avoir guidé minutieusement jusque la soutenance de cette thèse. Je te remercie de m'avoir transmis une partie de ton expertise dans le domaine de l'éolien et de la production décentralisée.

Je remercie ensuite les membres du jury de ma thèse, et notamment Prof. Didier Mayer pour m'avoir fait l'honneur de présider mon jury de thèse. Mes remerciements vont aussi à Messieurs les professeurs Lennart Söder et Julio Usaola García pour leur examen détaillé de ce travail et les remarques pertinentes dont ils m'ont fait part. Leurs commentaires et suggestions me sont précieux pour la suite de mon travail.

Lennart Söder a comparé, dans une publication, l'équilibre d'un système électrique avec celui d'un tandem. En poursuivant dans le thème du vélo, je trouve qu'une longue randonnée en vélo décrit assez bien, de manière imagée, ces trois années de thèse. Tout d'abord, dans cette aventure, je n'ai pas été laissé seul pour décider

de ma route. Des avis d'experts m'ont encouragé et m'ont permis de garder un cap fixe. Merci Georges. Aussi, cette randonnée s'est faite avec des compagnons de voyage : dans l'équipe, il y avait déjà Christophe, Jérémie, Nils et Luis. J'ai profité de l'aspiration pour les premiers tours de pédales et ils m'ont accompagné tout au long du parcours, jusqu'au sprint final. Tout au long du parcours, le groupe s'est agrandi, et j'ai reçu des coups de pouce pour finir de gravir certains cols. Je pense notamment à Mathilde et Robin. Merci. Mais aussi, pendant ces trois années de voyage, j'ai fait beaucoup de rencontres. J'espère pouvoir refaire un tronçon de chemin avec certains d'entre eux. Guillaume, on va où ? Je ne suis pas parti vraiment complètement sans bagage ; j'avais déjà dans mes sacoches les amis de Jean Moulin, de Poitiers, des Mines, de Véleurope. Ils m'ont bien aidé. Au fil du voyage, les sacoches se sont complétées. Je pense aux amis qui m'ont permis de passer trois superbes années dans le Sud : l'équipe de volley, celle de voile mais aussi celle de karaoké ! Aussi, la randonnée est ponctuée de pauses pour reprendre des forces. C'est la coloc de Roquefort qui s'est très bien chargée de ces pauses. Pour mener à bien un long voyage, il faut un cadre résistant. Ce cadre, c'est ma famille. Merci à vous pour le soutien toujours solide, et même renforcé pour l'arrivée ! Enfin, une roue ne suffit pas. Une deuxième roue permet de trouver l'équilibre pour aller de l'avant. Merci Sabine.

Franck Bourry

Contents

<i>Contents</i>	vii
<i>Abbreviations</i>	xii
<i>Notations and Mathematical Symbols</i>	xv
1 Introduction : Renewable energy sources in a liberalized electricity sector	1
1.1 General energy context and renewable energy sources	1
1.1.1 Energy context	1
1.1.2 Renewable energy sources as a solution	2
1.2 Renewable energy sources in power generation	3
1.2.1 Electricity generation based on RES	4
1.2.2 Characteristics of power generation from RES	4
1.2.3 RES in power systems in Europe	9
1.3 Challenges about large scale integration of renewable energy sources	10
1.3.1 Overview of issues regarding large scale integration of RES .	10
1.3.2 Impacts of large scale integration of renewable production on the power system management	11
1.3.3 Challenges related to the participation of renewable generation in electricity markets	14
1.4 Objectives of the thesis	15
1.5 Structure of the thesis	16
2 Solutions for the management of renewable energy sources in electricity markets	19
2.1 Electricity markets	19
2.1.1 Liberalization of the electricity sector	20

CONTENTS

2.1.2	Electricity market types	21
2.1.3	Overview of the electricity markets	22
2.1.4	Electricity market operation	26
2.2	Description of participation in an electricity market	30
2.2.1	Renewable energy sources and regulatory framework	30
2.2.2	Electricity markets considered in this study	32
2.2.3	Participation of renewable units in electricity markets as independent power producers	33
2.2.4	Details of the description of the participation of an independent power producer in electricity markets	35
2.2.5	Balance responsibility	36
2.2.6	Summary	39
2.3	State of the art of existing solutions for the management of renewable generation in electricity markets	40
2.3.1	Financial solutions for the imbalance management	40
2.3.2	Physical solutions for imbalance management	44
2.4	Conclusions	53
3	Generic model of imbalance penalty	55
3.1	Formulation of the imbalance penalty	56
3.1.1	Main hypotheses	56
3.1.2	Formulation of the participation in the day-ahead market	57
3.2	Modeling the imbalance management based on financial solutions	61
3.2.1	Formulation of the sequential participation in day-ahead and intraday markets	61
3.2.2	Formulation of the trading of electricity market derivatives: the case of options	64
3.3	Modeling the imbalance management based on physical solutions	66
3.3.1	Formulation of the control of renewable generation	66
3.3.2	Generic model of a Virtual Power Plant	68
3.3.3	Formulation of the imbalance penalty resulting from aggregation of RES units	69
3.3.4	Formulation of the imbalance penalty resulting from the combination of renewable generation with energy storage	74
3.3.5	Formulation of the imbalance penalty resulting from the combination of renewable with conventional generation	80
3.3.6	Similarities between the formulations of the different physical solutions for managing the imbalance penalties	84
3.4	Generalization of the imbalance penalty model to the combination of solutions for the management of imbalance penalties	85
3.5	Application: Evaluation of the imbalance reduction related to RES generation in the frame of virtual power plant	88
3.5.1	Presentation of the study	88
3.5.2	Description of the VPP operation	90

CONTENTS

3.5.3	Imbalance penalty results and sensitivity analysis	95
3.6	Conclusions	103
4	Formulation of the decision-making problem	105
4.1	Description of the decisions relative to the trading of renewable generation in electricity markets	106
4.1.1	General presentation of decision-making problems	106
4.1.2	The reference participation in the day-ahead market	106
4.1.3	Decisions associated with the physical solutions for imbalance management	107
4.1.4	Decisions associated with the financial solutions for imbalance management	109
4.2	Generic formulation of the decision-making problem related to the management of renewable generation in electricity markets	109
4.2.1	Formulation of the optimization problem	109
4.2.2	Decision-making under uncertainty	111
4.3	Proposition of an approach based on a loss function for the decision-making problem	112
4.3.1	Concept of loss function: relation between loss, utility and regret	112
4.3.2	Formulation of the proposed loss function	113
4.3.3	Estimation of the future imbalance penalty and energy production	115
4.3.4	Formulation of the consequences of the decisions on the imbalance penalty	116
4.3.5	Discussion about the norm relative to the optimization problem	117
4.4	Application of the decision-making method for trading renewable generation in the day-ahead market	118
4.4.1	Main hypotheses	118
4.4.2	Formulation of the specific problem	120
4.4.3	Illustration of the loss function of the problem	121
4.4.4	Resolution of the specific problem	122
4.4.5	Case study	122
4.4.6	Conclusions	125
4.5	Application of the decision-making method for the combined participation in the day-ahead and intraday markets	127
4.5.1	Main hypotheses	127
4.5.2	Formulation and proposal of a solution for the specific problem	128
4.5.3	Illustration of the loss function of the problem	132
4.5.4	Case study	136
4.5.5	Conclusions	140
4.6	Application of the decision-making method for the strategic operation of a Virtual Power Plant composed of a renewables combined with storage	142
4.6.1	Main hypotheses	142

CONTENTS

4.6.2	Formulation of the specific decision-making problem	144
4.6.3	Illustration of the loss function	146
4.6.4	Formulation of the technical constraints and temporal dependence of the storage management	148
4.6.5	Modeling the real time operation	150
4.6.6	Case study	151
4.6.7	Conclusions	158
4.7	Conclusions	158
5	Risk-based approach for renewable generation in electricity markets	161
5.1	Estimation of uncertainties associated with the participation of renewable generation in electricity market	162
5.1.1	Sources of uncertainties	162
5.1.2	State of the art of the approaches for modeling uncertainty	163
5.1.3	Estimation of the uncertainty related to a forecasted variable	165
5.2	Overview of the state of the art of decision-making methods under uncertainty with focus on risk-based approaches	168
5.2.1	Examples of decision-making methods under uncertainty in power system management	169
5.2.2	Formulation of the state-of-the-art probabilistic methods for decision-making under uncertainty	170
5.2.3	Focus on risk-based methods	174
5.3	Formulation of a risk-based approach for the management of renewable generation in electricity markets	179
5.3.1	Concept of risk management	179
5.3.2	Details about the considered risk	180
5.3.3	Modeling of the quantity-price risk	182
5.3.4	Formulation of the spot-risk decision-making method	184
5.4	Hedging imbalance penalty risk through combination of renewables with storage	185
5.4.1	Derivation of the specific loss function relative to the storage combination	185
5.4.2	Results: Analysis of the influence of the risk attitude on the decisions	187
5.5	Application: risk-based trading of wind generation in day-ahead electricity markets	193
5.5.1	Main hypotheses	193
5.5.2	Formulation of the risk-based decision-making method in the case of day-ahead trading	193
5.5.3	Estimation of the loss distribution from probabilistic forecasts of wind energy and market prices	194
5.5.4	Discussion about the expected value of the loss distribution	195
5.5.5	Case study	196

CONTENTS

5.5.6 Results	198
5.6 Conclusions	202
6 General conclusions and perspectives	205
6.1 General Conclusions	205
6.2 Perspectives	208
A List of publications	211
B Renewable generation forecasting methods	213
B.1 Overview of the state of the art of renewable generation forecasting .	213
B.2 Example of approaches for wind generation forecasting	215
B.3 Probabilistic forecasting of wind generation	218
B.3.1 Overview of the state of the art of the methods for probabilistic forecasting of wind generation	218
B.3.2 Discussion about spatial and temporal dependence of the probabilistic wind generation forecast	220
C Market price forecasting methods	223
C.1 Characterization of electricity market prices	223
C.2 Overview of the state of the art of electricity market price forecasting	225
C.2.1 Day-ahead market price forecasting	226
C.2.2 Regulation price forecasting	227
C.3 Simplification of the price forecasting problem and formulation of a discrete probabilistic forecast	227
C.3.1 Reformulation of the requested price forecast	227
C.3.2 Formulation of a discrete probabilistic forecast for imbalance penalty price	230
C.4 Proposition of a simulation approach for market price forecasts and errors	231
C.4.1 Formulation of the considered simulation approaches	231
C.4.2 Evaluation of the considered simulation approaches	234
D Estimation of the loss distribution from the predictive energy and price distribution	235
D.1 Formulation of the loss	235
D.2 General solution of the problem	236
D.2.1 Formulation of the variable substitution problem	237
D.2.2 Summary	238
D.3 Solution of the simplified problem	239
<i>Bibliography</i>	241

ABBREVIATIONS

Abbreviations

APX	Amsterdam Power eXchange
CAES	Compressed Air Energy Storage
BRP	Balance Responsible Party
CCGT	Combined-Cycle Gas Turbine
CEP	Center For Energy and Processes
CHP	Combined Heat and Power
CO ₂	Carbon Dioxide
CVPP	Commercial Virtual Power Plant
DER	Distributed Energy Resources
DG	Distributed Generation
EDF	Electricité de France
EREC	European Renewable Energy Council
ESD	Energy Storage Device
ETSO	European Transmission System Operator
EU	European Union
EWEA	European Wind Energy Association
FENIX	Flexible Electricity Networks to Integrate the eXpected energy evolution
GENCO	GENerating COmpany
ICT	Information and Communication Technology
IEA	International Energy Agency

ABBREVIATIONS

IPP	Independent Power Producer
IRS	Imbalance Reduction System
ISO	Independent System Operator
KDE	Kernel Density Estimators
MAE	Mean Absolute Error
MCP	Market Clearing Price
NETA	day-ahead market in United Kingdom
NMAE	Normalized Mean Absolute Error
NRMSE	Normalized Root Mean Square Error
OMEL	day-ahead market in Spain
OTC	Over-The-Counter
PTU	Program Time Unit
PV	Photovoltaic
RES	Renewable Energy Sources
REWP	Renewable Energy Working Party
RMSE	Root Mean Square Error
RO	Renewables Obligation
RPC	Regressive Power Curve
SQP	Sequential Quadratic Programming
SSD	Second-order Stochastic Dominance
UNFCCC	United Nation Framework Convention on Climate Change
VPP	Virtual Power Plant
TSO	Transmission System Operator

Notations and Mathematical Symbols

c	cost associated to a decision-making problem
\mathcal{C}	set of constraints
Cap_{st}	energy capacity of an energy storage device
CVaR	Conditional Value at Risk
δ^{DA}	reference imbalance penalty function for the participation in the day-ahead market
δ_S^{DA}	imbalance penalty function for the participation in the day-ahead market, when a solution S is used for reducing the imbalance penalty
$\Delta(t)$	time step
Δ^Π	market price difference
d	day
ϵ	parameter related to the uncertainty about the regulation state of the TSO
e_{agg}	energy compensation volume in the case of aggregation
e_{cv}	adjustment energy volume delivered by the conventional unit
E_{T_i}	energy E for the time step T_i
E_{VPP}	energy relative to the Virtual Power Plant
E_{ref}	energy relative to the reference wind farm
E_i	energy relative to wind farm i
$E_{T_i}^{BM}$	energy bid volume for the market M and the time period T_i . The market M can be the day-ahead market $_{DA}$ or the intraday market $_{ID}$

NOTATIONS AND MATHEMATICAL SYMBOLS

E^C	total contracted energy
E^{DA}	energy contract volume resulting from the day-ahead market participation ($E^{\text{DA}} = E^{C_{\text{DA}}}$)
E^{ID}	energy contract volume resulting from the intraday market participation ($E^{\text{ID}} = E^{C_{\text{ID}}}$)
E^{Op}	underlying (electrical energy)
\tilde{E}	delivered energy
\tilde{E}_{dw}	renewable generation decrease
\tilde{E}_{up}	renewable generation increase
\tilde{E}_l	limited delivered energy
\tilde{E}_{st}	energy delivered by the energy storage device
\tilde{E}_{cv}	energy delivered by the conventional generation unit
E^*	optimal value of energy in an optimization problem
\mathbb{E}	expected value of a probability distribution
$\hat{E}_{T_i t_d}$	estimation of the energy for the time period T_i at the decision time t_d
η	round-trip efficiency of the energy storage device
η_{ch}	charging efficiency of the energy storage device
η_{dis}	discharging efficiency of the energy storage device
λ_S^{DA}	loss function relative to the participation in the day-ahead market when a solution S is activated
Φ	objective function for a given decision-making problem
f_X	probability density function of the random variable X
F_X	cumulated distribution function (cdf) of the random variable X
μ	mean of a probability distribution
$\mathcal{N}_p(X)$	p-norm of a vector X
Π^{DA}	day-ahead market price
Π^{ID}	intraday market price
Π^K	strike price (for options)
Π^P	premium price (for options)
Π^+	price for positive imbalance
Π^-	price for negative imbalance
Π_{cv}	marginal operation cost of the conventional unit
$\Pi_{T_i}^{B_M}$	market bid price for the market M and the time period T_i . The market M can be the day-ahead market DA or the intraday market ID

NOTATIONS AND MATHEMATICAL SYMBOLS

Π^Δ	difference between the day-ahead market and the regulation prices
p_{T_i}	imbalance penalty for a given time period T_i
$P_{wf_i}^{\text{nom}}$	nominal power of a wind farm i
q_X^α	α -quantile of the random variable X
ρ	spot-risk measure
r_{dis}^{nom}	nominal discharging rate of the energy storage device
r_{ch}^{nom}	nominal charging rate of the energy storage device
R_S^{DA}	revenue from the participation in the day-ahead when a solution S is used for reducing the imbalance penalty
\mathcal{R}	risk measure
σ	standard deviation
S_x	financial solution for reducing imbalance penalty $S_x = \text{ID}$: participation in the intraday market $S_x = \text{Op}$: option trading
S_y	physical solution for reducing imbalance penalty $S_y = dw$: down regulation of the renewable generation $S_y = agg$: aggregation of renewable energy sources $S_y = st$: combination with an energy storage device $S_y = cv$: combination with a conventional generation unit
SOC	state of charge of the energy storage device
$SOC_{T_i}^{Sch}$	scheduled state of charge of the energy storage device for the time period T_i
SV	spot value of a probability distribution
τ	phase error
t_d	decision time
T_i	time period i
u	decision variable related to a financial solution (bid)
\tilde{u}	contract associated to a bid u
U	decision vector relative to a financial solution for n consecutive periods
\mathcal{U}	utility function
v	decision variable related to a physical solution (schedule)
\tilde{v}	real energy output associated to a schedule v
V	decision vector relative to a physical solution for n consecutive periods
VaR	Value at Risk

NOTATIONS AND MATHEMATICAL SYMBOLS

wf_i	wind farm i
x	energy contract volume relative to the financial solution S_x
X	additional cost relative to the financial solution S_x
y	energy contract volume relative to the physical solution S_y
Y	additional cost relative to the physical solution S_y

Introduction : Renewable Energy Sources in a Liberalized Electricity Sector

Chapter overview

This chapter introduces the research work realized in the frame of this thesis by starting with a short description of the actual energy context and the development of renewable energy sources. The issues concerning the large scale integration of renewable generation in power systems, in a liberalized context, are presented. The chapter then focuses on the challenges related to the participation of renewable generation in electricity markets, which is the core of the thesis. Finally, the main objectives and the contribution of the thesis, as well as an outline of the structure of the present document, are given.

1.1 General energy context and renewable energy sources

1.1.1 Energy context

In recent energy policies, special attention is given to three main aspects: security of supply, market efficiency and environmental friendliness. These three dimensions are specifically covered in the 2007 Energy Package for Europe, which aims at establishing a new energy policy for the European Union [1]. The three aspects are explained as follows, and depicted in Figure 1.1:

- In the actual energy context, the **security of supply of energy resources** is

a key point which has to be guaranteed. To achieve this goal, the energy supply has to be diversified, from the geographical source of energy point of view, and from the nature of the energy product point of view, in order to guarantee long-term primary energy availability. Focus is given to the reliability and quality of the energy supply, and the guarantee of the required energy capacity.

- **Market efficiency** in the energy sector results from the liberalization of this sector. Competition has been introduced in the sector by significantly reducing the governments' role in the ownership and management of domestic energy industries, especially in the gas and electricity sector. Regarding the European Union, the directive 96/92/CE relative to electricity market rules [2] confirms the objective of liberalization of the electricity market. This is seen as a possibility for increasing the efficiency of electric energy production and distribution, for offering a lower price, as well as a higher quality and secured supply.
- Reducing the **environmental impact** consists in limiting the pollution relative to the energy use and reducing the possible contribution to climate change and the impact on nature and wildlife. The objective of reducing the environmental impact of human activities, and more particularly greenhouse gases, was initiated in the United Nation Framework Convention on Climate Change (UNFCCC) of 1992. Binding limitations were negotiated in Kyoto where more than 160 nations met in 1997. The outcome of the meeting was the Kyoto Protocol, in which the developed nations agreed to limit their greenhouse gas emissions, relative to the levels emitted in 1990.

Figure 1.1 describes the energy policy triangle where the objectives of security of supply, market efficiency and environmental friendliness are the major policy competitors ¹.

1.1.2 Renewable energy sources as a solution

In the current energy context, where security of supply and environmental aspects have become major concerns, the development of energy technologies based on renewable energies is seen as an indispensable solution for these main issues.

¹The three main aspects are often illustrated as the Moscow-Lisbon-Kyoto triangle; Moscow refers to the concept of security of supply due to the recent gas crisis between some countries of the European Union and Russia [3]; Lisbon refers to the European Council held in 2000 in this city during which the objective of liberalization of many sectors in Europe was given; Kyoto refers to the Kyoto protocol.

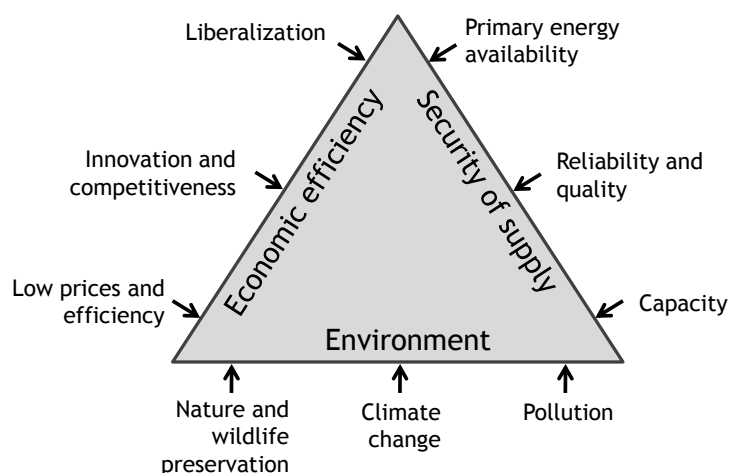

Figure 1.1: *Energy context*

National and international bodies use a variety of definitions for renewable energy. The Renewable Energy Working Party (REWP) of the International Energy Agency set down the following broad definition [4]:

“Renewable Energy is energy that is derived from natural processes that are replenished constantly. In its various forms, it derives directly or indirectly from the sun, or from heat generated deep within the earth. Included in the definition is energy generated from solar, wind, biomass, geothermal, hydropower and ocean resources, and biofuels and hydrogen derived from renewable resources”.

In this work, the term *Renewable Energy Sources (RES)* is by extension used to denote energy sources based on the conversion of renewable energy. The development of RES first takes advantage of endogenous resources. It permits to reduce the fossil fuel consumption, which in turn increases the security of supply of the country where RES are installed. A consequence of the reduction of fossil fuel consumption is the reduction of the impact on the environment, namely greenhouse gas emissions and fossil fuel depletion.

1.2 Renewable energy sources in power generation

This section first presents the electricity generation technologies based on Renewable energy sources (RES). Then, the characteristics of the RES production, which highly depend on the converted resource properties, are presented. In particular, the variability, the limited predictability and the geographical distribution of RES power

generation are characteristics that distinguish RES from conventional generation. Finally, this section describes the fast development of RES in Europe.

1.2.1 Electricity generation based on RES

Electricity generation accounts for approximately one third of the world's primary energy demand [5]. As a consequence, the energy context is of particular importance for the current evolution of the electricity sector. Regarding security of supply, efforts are made to promote generation technologies which increase the variety of the energy mix and the independence of countries on resources used for power generation. In order to increase economic efficiency, power systems are nowadays operated within a liberalized electricity sector, under market conditions. Electricity is thus treated as a tradable product, characterized by its quality and reliability. Finally, technologies which reduce pollution associated with electricity generation are encouraged. Importance is given to the reduction of CO_2 emissions and more generally reduction of greenhouse gases.

This context motivates the development of power generation units based on RES. An overview of different technologies available for power generation from RES is proposed in [6]: hydro power, wind power, photovoltaic power, solar thermodynamic power, geothermal power and power from biomass. The RES power units are based on the conversion from primary renewable energy to electrical energy. For instance, hydro power and wind power convert the mechanical energy from the water and the wind, respectively, to electrical power. Photovoltaic cells convert solar irradiation to electric power using the photoelectric effect.

In this case, the term **RES unit** does not necessarily refer to only one generation unit such as a wind turbine or a PV panel, but is extended to a power plant composed of several RES-based units, such as a wind farm or a PV plant. This extended definition of the RES unit is kept for the rest of the thesis.

In opposition to RES units, conventional power generation units refer to units based on non-renewable energy conversion. These units include the nuclear power plants and the power generation units which are based on energy conversion from fossil fuel such as coal-fired, gas-fired and oil-fired units.

1.2.2 Characteristics of power generation from RES

Variability and limited predictability of the renewable generation

The electricity generation from RES results from the energy conversion of non-regulated resources, from existing flows of energy from on-going processes. Depending on the type of their resource, RES units can generate electricity constantly or

in a variable way, with fluctuations. In particular, wind, photovoltaic and wave power generation are characterized by the natural variability of the energy resource, whereas biomass and hydro power generation (excepting the run-of-the river hydro) can be dispatched based on system requirements [6]. Biomass and hydro power units can thus be considered as conventional units from the power generation management point of view.

Regarding generation from wind, photovoltaic, and wave power, this generation can be more precisely described as intermittent generation. The term intermittent refers here to the interruption or periodic stopping of the resource, from the definition in [7]. The intermittency is due to the atmospheric dynamics. The study of the different effects resulting from atmosphere dynamics is a complex subject which refers to meteorology.

The intermittency level depends on the RES technology and the natural cycles of the renewable sources [8]. Details are given below for the photovoltaic (PV) and wind power sources.

- Regarding PV power generation, natural cycles have three dimensions. There is first a seasonal variation in potential electricity production with the peak in summer, although in principle PV cells operating along the equator have an almost constant exploitable potential throughout the year. Secondly, production varies on a diurnal basis from dawn to dusk peaking during mid day. Finally, short-term fluctuation of weather conditions, including clouds and rain fall, impact on the inter-hourly amount of electricity that can be harvested.

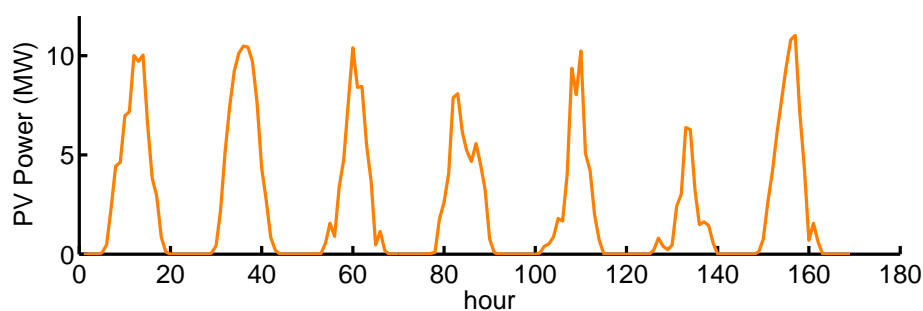

Figure 1.2: Example of power production from a 12.8 MWp photovoltaic power plant from 03/07/04 00h00 to 09/07/04 23h00, in France.

Figure 1.2 shows an example of the hourly power production from a 12.8 MWp photovoltaic power plant located in France for a week from 03/07/04 00h00 to 09/07/04 23h00. The unit MWp stands for MegaWatt peak, which is a measurement unit for the electrical power delivered by a PV unit for standard solar irradiance conditions. The figure clearly demonstrates the diurnal

variations of the production. The variations between the production for the different days result from variations of meteorological conditions.

- Wind power generation is subject to seasonal variations of peak electricity production in winter or summer depending on the region, as well as diurnal and hourly changes. Generally, very short-term fluctuations - in the intra-minute and inter-minute timeframe - are small relative to installed capacity, compared to hourly or daily variations. However, it has also to be noted that wind turbines become unavailable at times of very high wind speed, when they need to be shut down in order to avoid damage to equipment. This disconnection leads to an extreme variation of the produced electricity. The disconnection of wind turbines resulting from voltage dips also leads to a steep generation drop.

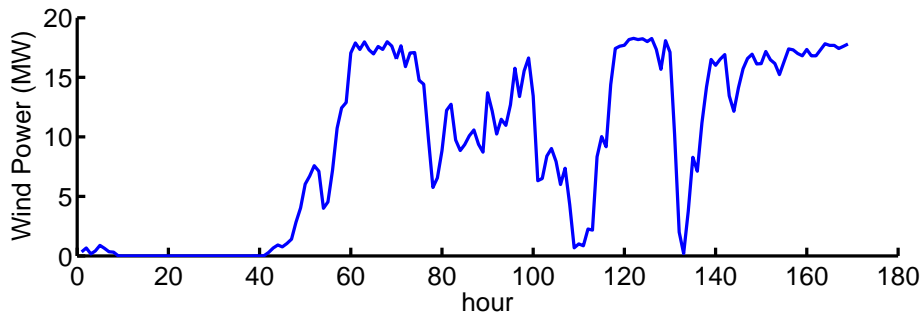

Figure 1.3: Example of power production from a 18 MW wind power plant from 09/01/03 07h00 to 06/01/03 06h00, in Western Denmark.

Figure 1.3 shows an example of the hourly power production from a 18 MW wind power plant for a week from 09/01/03 07h00 to 06/01/03 06h00, in Western Denmark. The figure clearly shows the short-term variations of the production. An important production drop from nominal power production to nearly zero production can be noted in the period between hour 132 and 135 in the graph. The production variations illustrated in Figure 1.3 are related to variations of the meteorological conditions, mainly the wind speed.

In order to analyze the wind power variability, the operational data measured from the 160 MW Horns Rev I offshore wind farm in Western Denmark were analyzed in [9]. The authors showed that the power output of the wind farm was characterized by intense, rapid and repeating fluctuations due to unsteady wind conditions. In certain wind conditions, the power output from the offshore wind farm changes between zero and rated power levels in less than a quarter of an hour. However, the degree of variability depends on the consi-

dered geographical scale. The European Wind Energy Association (EWEA) explains in [10] that the variability of the wind energy resource is important to consider only in the context of the power system, rather than in the context of an individual wind farm or turbine. When considering wind energy in the scale of the power system, individual energy variations may compensate which results in a less variable production. This phenomenon is denoted as *statistical smoothing* and is analyzed into detail in [11].

- In comparison, the biomass natural cycle length varies between several generations for wood to a single season for purposefully planted biomass crops. Large hydro systems are based on the conversion of a seasonal resource, the rain, but the dam makes the hydro unit able to control their energy delivery and, as a result, limits such seasonality. Run-of-the river units are subject to variability in precipitation.

In addition to the variability, the production from some RES technologies may not be completely predictable. This can be the case for wind, photovoltaic and wave power. Limited predictability results from the atmosphere dynamics which are not deterministic. For instance, the wind power will depend on the wind speed, which in turn depends on the solar radiation, evaporation of water, cloud cover, and surface roughness among others.

The limited predictability of RES generation leads to some uncertainty about the production in the next period of time (i.e. minutes, hours or days). The notion of uncertainty here refers to the decision-making science, and is defined as “a state of having limited knowledge where it is impossible to exactly describe existing state or future outcome, more than one possible outcome” [12]. Another term for describing the limited predictability of the RES generation consists in defining it as a **stochastic generation**.

The degree of variability and the degree of predictability are the two main aspects characterizing time series of RES generation. They can be derived from real time series of RES production in order to be used for generating realistic time series of RES production when needed, such as in [13].

The variability and limited predictability of the RES generation result to an additional property: its limited dispatchability. A generation unit is said to be dispatchable if it can be controlled at the request of power grid operators. Biomass-based units and hydro power units may be controlled and be operated as a dispatchable unit. However, RES generation units, which are based on the conversion of existing flows of energy from on-going processes, have a limited dispatchability. Wind power, PV power and wave power are examples of such units. Recent advances in

RES technologies have enabled some of these units to reduce their power output when needed. This control is denoted as “down regulation”.

Geographical distribution of the RES units

Some RES technologies are based on the conversion of energy resources which are found in huge quantities in nature, but geographically distributed and presenting a low density on each position site. This is the case for wind or photovoltaic power. In order to capture this energy and convert it to electricity, small-scale converters are spread in many sites and connected into the power system. In the case of the power generation from biomass, the resource cannot be transported long distances without incurring unreasonable cost, because of its low energy density, and, consequently, most biomass units are small-scale units [14]. As a result, most geographically spread RES power units are connected to the distribution network.

A definition of *Distributed Generation (DG)* is proposed in [15] as “an electric power source connected directly to the distribution network or on the customer site of the meter”. Given this definition, most RES power units are DG units. In particular, the technology or capacity of the RES unit is not considered for characterizing it as a DG unit, but only its network connection [16]. From this definition, the distributed generation units are separated from the units which are connected directly to the transmission network. Different aspects distinguish distribution from transmission networks. First, distribution networks are operated at medium or low voltage contrary to transmission networks which are operated at high voltage ². Also, the goal of the two networks is different: the transmission network aims at transporting power generation over long distances, whereas the distribution network aims at delivering the power generation to the consumers. Finally, the two networks are distinguished on a legal definition, as explained in [16]: in most competitive markets, an electricity network is legally defined as a transmission network if it contributes to the electricity market regulation. Any other network can be regarded as distribution network.

The capacity of the distributed generation units is limited by the connection to the distribution network, which in turn is limited by the voltage level of this network. Consequently, the distributed power plants have a capacity limited to several hundred MW [15]. Regarding RES, large hydro power plants may have a capacity in the order of GW, and are thus connected to the transmission network. The same happens for large wind farms.

²In the case of France, the transmission network as it is considered in this thesis, is composed of the transmission and repartition networks. The voltage limit between the distribution networks and the repartition and transmission networks is 63 kV.

When connected to the distribution network, distributed RES units contribute to the improvement of the voltage level management; they may increase the flexibility of the power systems while reducing transmission losses; they may also be an alternative to transmission grid reinforcement. More general benefits and issues resulting from DG deployment are explained in [16].

1.2.3 RES in power systems in Europe

In March 2007, the 27 EU member states adopted a binding target of 20 % renewable energy from final energy consumption by 2020. This target is associated with a commitment to increase energy efficiency by 20 % until 2020.

In January 2008, the European Commission presented a draft Directive on the promotion of the use of energy from Renewable Energy Sources (RES). This sets the legislative framework that should ensure the increase of the 8.5 % renewable energy share of final energy consumption in 2005 to 20 % in 2020 [17]. In order to reach this objective, the European Renewable Energy Council (EREC) proposes in [17] a target of 40 % of EU electricity coming from RES in 2020. An intermediate target has been formulated in the Directive 2001/77/EC on the promotion of renewable electricity aiming at having 21 % of EU electricity coming from RES by 2010. Table 1.1 describes the projections for the installed capacity of RES units till 2020.

Type of energy	Inst. capacity (2006)	Projection 2010	Projection 2020
Wind	47.7 GW	80 GW	180 GW
Hydro	106.1 GW	111 GW	120 GW
Photovoltaic	3.2 GW _p	18 GW _p	150 GW _p
Biomass	22.3 GW	30 GW	50 GW
Geothermal	0.7 GW	1 GW	4 GW
Solar thermal elect.	-	1 GW	15 GW
Ocean	-	0.5 GW	2.5 GW

Table 1.1: *Renewable electricity installed capacity projections, from [17].*

Among the various RES technologies, wind power benefits from a high reduction of production costs. The wind power industry is considered as one of the fastest growing ones. For example in Europe, 57 GW were installed at the end of 2008. The European Wind Energy Association (EWEA) regularly revises its own target for the next few years. The projections for 2020 and 2030 are 180 and 300 GW respectively [18]. However, it has to be noted that EWEA presented an upgraded target at the EWEC 09 conference which is 230 GW including 40 GW offshore. This corresponds to 600 TWh per year by 2020, covering 14-18 % of EU electricity demand. Similar projections are made for the United States by the American Wind

Energy Association (AWEA) [19].

1.3 Challenges about large scale integration of renewable energy sources

This section presents the main challenges related to the large scale integration of RES in power systems. First, an overview of the issues regarding large scale integration of RES is given and examples are presented. Then, the main impacts of the RES on the power system management are described. Finally, this section draws the link between the impact of the RES on the power system management and the challenges related to the integration of the renewable generation in the electricity markets, which is the core of the thesis.

1.3.1 Overview of issues regarding large scale integration of RES

The current policy of installing RES has focused on connection rather than integration. This approach is denoted in [20] as a “fit and forget” approach. In particular, RES units have been treated as exceptions for the management of the power systems. For example, the E.ON Netz Grid Code in Germany exempts renewable energy generation units from providing primary control power [21, 22]. These exemptions have been allowed to encourage the deployment of RES. As a result, several GWs of RES capacity have been installed in some areas, such as wind power in Northern Germany.

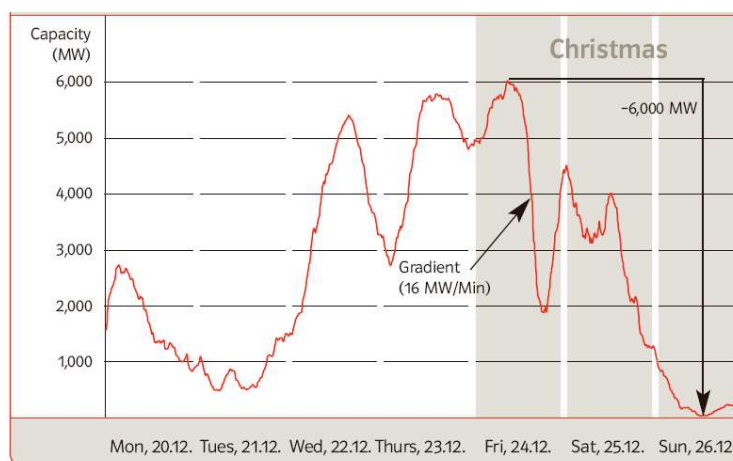

Figure 1.4: Short-term drop in wind power feed-in in December 2004, from [23].

The variability of the wind power production results in large power variations in the power system. Figure 1.4 depicts the variation of the wind power production

in the E.ON control area in Northern Germany during the week from 20th to 26th December 2004. Whilst wind power output at 9.15 am 24th December reached its maximum for the year at 6024 MW, it fell to below 2000 MW within only 10 hours, with a difference of over 4000 MW. This reduction corresponds to 58% of the installed wind capacity in the area. In comparison, this also corresponds to the capacity of eight 500 MW coal-fired power station blocks. On 26th December, the wind power output fell to below 40 MW.

Future RES developments are expected to include larger RES units, such as several hundred MW offshore wind farms. Such large developments on relatively small areas will generate large output variations. Handling these variations of RES power output leads to major challenges for managing the power system.

A number of technical factors resulting from specific RES characteristics, detailed in section 1.2.2, lead to difficulties for a large scale integration of RES generation in power systems [4]:

- **Limited dispatchability:** RES generation can only be dispatched down rather than up;
- **Variability:** RES generation can exhibit extreme ramp up or down rates;
- **Limited predictability:** uncertainty associated with RES generation increases the need of ancillary services;
- **Geographical distribution:** RES units may be located far from demand, in remote locations.

Handling these combined technical factors introduces several challenges to reliable operation and may lead to power system control and balancing problems.

An analysis presented in [8] summarizes the issues that are likely to be encountered as wind power penetration into power systems progressively increases. The study explains that for low levels of wind penetration, the added variability due to wind is not significantly noticed on the system, and wind can be treated as negative load. However, as the penetration level increases, additional operational and capacity reserve may become necessary. Also, grid reinforcements might become necessary, depending on wind farm location and demand centers.

1.3.2 Impacts of large scale integration of renewable production on the power system management

Large scale RES integration is raising a long list of important consequences on the power system management [24]. For example, the study in [25] lists the impacts of

wind power on the power system reliability and efficiency and proposes a classification of these impacts based on the time and geographical scales. In this section, focus is given on the impact relative to the operation of the power system, and more specifically on functions such as unit commitment, grid congestion management and grid regulation. This limited list of impacts is related to the geographical scale of the power system and time scales ranging from minutes to days. In particular, local issues, such as the ones related to the connection of RES to the grid, are not considered. Also, very short term impacts referring to as power quality, as well as long term impacts such as adequacy of power and adequacy of the grid, are not considered in the present work.

Unit commitment and economic dispatch

The unit commitment problem aims at deciding for an upcoming period which electricity generation units should be running, and deciding the way the units are operated so as to satisfy a predictably varying demand for electricity [26]. The economic dispatch defines the exact level of production of each generator for this upcoming period, based on economic criteria. The considered upcoming period ranges from several hours to several days. In the case of large scale integration of RES units, the unpredicted variations of output power of these RES units may impact the power system unit commitment.

Moreover, the available deterministic software tools for the optimal scheduling of conventional power plants are not appropriate when considering an energy mix with high share of intermittent sources [25]. Current unit commitment or economic dispatch algorithms consider RES generation as a “negative load” and foresee usually a fixed margin to account for the variability and uncertainty associated with RES generation. In cases of high penetration, operators often consider high reserve margins leading to a less economic operation of the power system.

Grid congestion management

The location of RES units, especially of hydro power plants and of wind farms, are conditioned by regional conditions. Most of the hydro plants and wind farms are erected in areas with low population density. This means that the production of energy by RES is often much higher than the local demand. Therefore the electricity must be transported via the transmission grid to regions of high demand. Because the grid was originally designed to cover the relatively low load in these regions, it has to be extended and reinforced for this new task. Regarding wind power, the high development of offshore wind and the repowering of old wind farms contribute to the need of grid extension and reinforcement.

Again, the variability and the uncertainty associated with RES generation require special attention. First, these characteristics make it difficult to determine the optimal grid reinforcement. The standard practice is to enforce the grid by building new power lines and connectors based on the worst-case scenarios of maximum RES production. Also, from an operational point of view, high concentration of RES generation can lead to grid points congestions. Actual load-flow calculations and daily congestion forecasts do not systematically take into account the uncertainty associated with RES generation. Consequently, RES generation may be curtailed on demand to ensure grid stability, and connections of new RES units in areas with frequent congestions may be restricted. Examples of congestion issues resulting from a high wind penetration and a limited transmission capability are given in [27], for the case of Greece. The same article also gives some simple ideas, based on the control of the generation from the wind farms, which are currently being applied to the Hellenic Interconnected System, in order to increase the wind-power penetration.

Reserve management

The equilibrium between the power generation and the load is one of the prerequisite for stable and reliable operation of a power system. This equilibrium can be perturbed by an unexpected variation of either the demand or the generation [28]. The unpredicted variations of output power of these RES units is one example of such perturbation. The Transmission System Operator (TSO) is responsible for maintaining the balance between power generation and load and, thereby for keeping frequency and voltage within acceptable limits.

The power system balance is obtained from two types of control, which are the primary and secondary control [29, 30]. The primary control results from the automatic regulation of synchronous generators. From this control, an unpredicted decrease of the generation from a RES unit, which is similar to an increase of the demand, leads to a decrease of the rotating speed of the synchronous generators, which results to a decrease of the grid frequency. Conversely, an unpredicted increase of the RES generation leads to an increase of the frequency. The time constant relative to this control is in the order of a few seconds. Such primary control is possible only if a given amount of power, denoted as **primary reserve** is available from the synchronous generators.

Then, the secondary control aims at restoring the grid frequency to its nominal value. In case the grid frequency is lower than its nominal value, the TSO activates **up-regulation**. This consists in sending a signal for increasing the delivered power to the generators which are involved in the secondary control. Similarly, the TSO activates **down-regulation**, which consists in sending signals to decrease the

delivered energy, when the grid frequency is higher than its nominal value. The amount of power available from the generator for the secondary reserve is denoted as **secondary reserve**. Secondary reserve consists of spinning reserve (e.g. hydro or thermal plants in part load operation) and standing reserve (e.g. rapidly starting gas turbine power plants and load shedding). Also, the activation of the secondary reserve can be done through a real-time market where the participants can propose bids for up or down-regulation. The details about these markets are given in section 2.1. The time constant relative to this control is in the order of a few minutes. A third category of reserve is sometimes denoted as “tertiary reserve” or long term reserve. Such reserve is similar to the secondary reserve, but with a time constant in the order of 15 minutes.

The large scale integration of RES in a power system leads to unexpected variations of the overall electricity generation in the region where the RES units are located, which increases the need of power reserves. This impact of RES units on power reserves depends on the region size relevant for balancing, the initial load variations and how concentrated or distributed the RES units are sited [25]. The costs resulting from the increase of the reserve need will depend on the marginal costs of the units which provide regulation for the power system. Such cost is sometimes denoted as “intermittency cost”, and is cited as an argument from opponents to the large scale integration of RES [31]. Also, these additional costs resulting from the integration of RES generation can lead to a reduction of the competitiveness of the power producer if the latter is responsible for balancing of its generation. This important point is discussed in the next section.

1.3.3 Challenges related to the participation of renewable generation in electricity markets

With the liberalization of the electricity sector, power producers have the possibility to trade their production in electricity markets. This section presents the main challenges related to the trading of RES production in these markets. Contrary to the previous section which focused on the consequences of RES integration on the management of the power system, this section describes the consequences from the power producer’s point of view.

When participating in an electricity market, the power producers are economically responsible for the regulation costs, which result from any imbalance between the contracted energy in the market and the delivered energy. Such market participants are said to be **balance responsible parties**. For trading in an electricity market, participants have to make decisions about their energy contracts before the delivery. Consequently, power producers which include RES units in their genera-

tion portfolio have to consider the specific characteristics of these units for market participation. In particular, the limited predictability and controllability of RES units make them particularly sensitive to regulation costs. This issue is the main driving force of the research work in this thesis.

The regulation costs which are applied to the power producer as a penalty for its imbalance between the contracted energy and the delivered energy, result from the costs of the activation of the control mechanisms presented in the previous section 1.3.2. More precisely, an imbalance between the contracted and delivered energy corresponds to a perturbation of the equilibrium between generation and load, and the regulation cost is the cost of the power reserve used by the TSO to maintain the equilibrium. In other words, the balance responsibility of the power producer can be interpreted as an economic responsibility of some of the technical impacts of the RES units on the power system management.

Finally, it has to be noted that this main challenge about the competitiveness of RES in electricity markets arises in the case of full integration of RES generation in these markets. This means that RES generation is treated on equal terms with other conventional producers regarding balance responsibility. More details on this hypothesis are given in the discussion in section 2.2.1.

1.4 Objectives of the thesis

The main purpose of the thesis is related to the challenging participation of renewable generation in electricity markets. This can be formulated as the proposition of methods for the management of uncertainties related to the renewable power production under electricity markets. Details are given in the three following points:

- The first objective is to list and model the different existing solutions for the management of renewable generation in electricity market. More precisely, the list of solutions should consider both physical solutions, which are relative to the management of the delivered energy by the RES units, and financial solutions, which are relative to the management of the contracted energy by the market participant operating the RES units. Each one of these solutions enables the power producer to reduce its imbalance penalty resulting from an imbalance between the contracted and delivered energy. Also, the aim is to develop a model of the imbalance penalty that is generic enough for taking into account the different solutions.
- The second objective is to propose a decision-making method, which can be used by a power producer with renewable generation for making decisions

about its optimal participating in electricity markets. Such a decision-making method has to be generic enough for taking into account the different physical and financial solutions. From a theoretical point of view, the aim is to formulate a decision-making problem as an optimization problem, where the variables of the problem are the decisions to make. The proposed advanced decision-making approach is applied to the financial solution consisting in a combined participation in day-ahead and intraday markets. The same method is also applied to the physical solution which aims at strategically combining a RES unit with a storage device for managing the imbalance penalties.

- Finally, the third objective is to generalize this decision-making method for trading renewable generation in electricity markets, so that it can take into account the uncertainty related to the renewable generation. The general problem is denoted as a **decision-making under uncertainty** problem. The proposed approach is a risk-based method, where the risk is related to the imbalance penalties. Such risk is derived from the uncertainty related to renewable generation and measured with methods taken from the financial domain. This risk measure is then integrated in the decision-making method. The physical and financial imbalance management solutions are seen as hedging methods which reduce the risk related to the imbalance penalties. The benefits related to the consideration of the risk in the decision-making method are evaluated from simulations based on real world data.

It is important to notice that the above objectives are related to the problematic of the power producer, which aims at managing the uncertainty related to its electricity generation. Also, this objective is only related to the economic challenge regarding the competitiveness of a renewable portfolio in electricity markets, and not to other technical challenges related to the large scale integration of RES in power system, presented in section 1.3.2. However, as it was explained before, this specific challenge can be related to the economic responsibility for some of the technical challenges.

1.5 Structure of the thesis

The present thesis is organized as follows:

- Chapter 2 presents the management of renewable generation in electricity markets. A detailed description of the electricity markets is first provided. This presentation permits to better understand what “participating in an electricity market” means for a given power producer including renewable generation.

This chapter also defines the key concepts of an independent power producer (IPP) and balance responsibility, which are used throughout the thesis. Then, we propose a classification of the different existing solutions for the management on renewable generation in electricity markets. This overview of the state of the art distinguishes the **financial and the physical solutions**: financial solutions are related to the contracted energy resulting from the participation in consecutive electricity markets, while physical solutions are related to the management of energy delivered by the power producer. The concept of virtual power plants (VPP) is presented as a framework for the physical solutions.

- In chapter 3, we propose a **generic formulation** of the imbalance penalty model δ for an IPP including renewable generation. This formulation is based on a reference case which is related to the participation of a reference RES unit in a day-ahead electricity market. Then, the different financial and physical solutions, which have been classified in the previous chapter, are modeled from the reference case. In particular, a generic model for a commercial VPP is proposed for modeling the physical solutions. A discussion about the similarities between the financial and physical solutions is provided. The last part of this chapter presents the application of the generic formulation of imbalance penalty to three physical solutions, which are three different configurations of a generic VPP model. Each one of the configurations is based on a **reference RES unit**. A real-world test case is considered for this purpose. Also, for the coherence of the results, this reference wind farm is the same one which is used for all the case studies presented in this thesis.
- Chapter 4 focuses on the decision-making problems relative to the management of renewable generation in electricity markets. Initially, the decisions which an IPP has to make when using financial or physical solutions are presented: the financial solutions require bidding decisions, while the physical solutions require scheduling decisions. Then, a **generic decision-making method** which is valid for both types of decision is proposed. This chapter explains that such method is based on a **loss function** λ , which is constructed from the generic imbalance penalty model δ given in the previous chapter. The method also relies on estimates of renewable generation and market prices given by forecasting methods. Although these methods are of high importance in the thesis, they are presented in the appendix sections so that the focus in this chapter is on the derivation of the decision-making method. Results from the application of the method for the strategic trading in intraday markets (i.e. financial solution) and for the strategic operation of the combined wind-hydro power plant (i.e. physical solution), are presented.

- Chapter 5 extends the methodology proposed in the previous chapter to account for the uncertainty associated with the decision-making problem. The two sources of **uncertainties** (i.e. renewable generation and market prices) related to the present problem, are examined. Also, this chapter presents general definitions and approaches from the state of the art, for modeling the uncertainty. Particular attention is paid to the **probabilistic models**. These models are used for representing the uncertainty associated with the probabilistic forecasts of renewable generation or market prices. Then, the chapter proposes an overview of the state-of-the-art methods for decision-making under uncertainty. Focus is given to risk-based approaches and different risk measures are explained. Following this review, the chapter proposes a **formulation for a risk-based method** adapted to the general problem of participation of renewable generation in electricity markets. This approach is based on a probabilistic loss function, which is an extension of the loss function given in the previous chapter. Also, in this approach, the financial and physical solutions correspond to **risk hedging** methods. Chapter 5 illustrates this hedging in the case of a given physical solution (i.e. combination with storage device). Finally, the chapter gives numerical results relative to the application of the risk-based decision-making approach for the trading of wind generation in a day-ahead market. The different results presented in this chapter include sensitivity analysis results, which permit to better understand the coherence of the proposed methodology.
- Finally, chapter 6 presents the general conclusions of this work as well as some of the main perspectives for further research resulting from this thesis.

Solutions for the Management of Renewable Energy Sources in Electricity Markets

Chapter overview

This chapter presents the challenges related to the management of renewable generation in electricity markets. First, this chapter gives an overview of the electricity markets, and adds some precisions about short-term electricity markets which are considered in the rest of the thesis. The next section of this chapter presents the main concepts of independent power producer and balance responsibility. Special attention is paid to the imbalance penalization. The chapter finally provides a state of the art about existing solutions for the management of imbalance penalties. These solutions are classified into two categories: financial solutions are related to the contracted energy resulting from the participation in consecutive electricity markets, while physical solutions are related to the management of energy delivered by the power producer.

2.1 Electricity markets

The main goal of this section is to present the electricity markets which will be considered for the rest of the thesis. First, the general principles of electricity markets, resulting from the liberalization of the electricity sector, and the different market types, are described. The different market structures are then explained, and the main market clearing processes are detailed. Such general definitions about market

principles and structures are essential for understanding the challenges related to the participation of renewable generation in such markets. Finally, the distinction between the markets which take place before the delivery and the real-time markets is explained. The operation of these markets is modeled in the next chapter.

2.1.1 Liberalization of the electricity sector

History of the electricity sector

This section first presents a short summary of the history and evolution of electric power systems for better understanding the actual context. This summary is based on the analyses presented in [32] and [33].

From, 1870 to 1885, the first electric power systems were small hydropower and thermal power units under 100 kW. These first units were Direct Current (DC) ones directly connected to the consumption units. In 1884, Tesla invented the electric alternator which is an electric generator which produces Alternative Current (AC). The first transmission line was a 175 km long and 25 kV line and was constructed in 1891. From then, electrical power plants and transmission gradually enlarged under centralized system. After the second World War, in many countries, for strategic reasons, the electricity industry was gathered in a single, national company. This situation was common in Europe and Latin America. The electric industry used to vertically integrate production, transmission and distribution.

Process of liberalization

A restructuration of the electricity sector has been observed for the past decades [32]. The sector has been gradually deregulated. Utilities have been unbundled to introduce competition, and vertical integration has been replaced by competitive markets comprising multiple players. Under such competition, the interaction of many buyers and sellers yields a market price which equals the production cost of the last unit sold. Electricity is treated as a tradable commodity like any other market commodity. In the European Union, the competition has been introduced with accordance to the EU directive 96/92/CE relative to electricity market rules [2].

The following points are some of the reasons for restructuring electricity sector:

- New generation technologies, such as combined-cycle gas turbines (CCGT), have reduced the optimal size of an electricity generator [34]. In particular, the installation of distributed units, which may be based on renewables or not, is increasing significantly.
- Information technologies and communication systems make possible the exchange of huge volumes of information needed to manage electricity markets.

- Electricity is a primary input for many industries, and the competitive global economy requires input cost reduction. In this context, privatization is considered as a way to increase the efficiency of the response of the sector to economic and technological change [32].
- Competition is seen as a necessary condition for increasing the efficiency of electric energy production and distribution, offering a lower price, higher quality and secured supply. It puts downward pressure on the profit margin of market participants, which attempts to keep costs and prices down. [35]

However, electricity is a specific commodity which cannot be stored to a large extent: at any time, the total amount of produced electricity must meet consumption. Despite the consensus to introduce competition into wholesale and retail markets by deregulating generation and opening retail, regulation is still needed regarding network activities. Transmission, distribution and system operation exhibit natural monopoly characteristics and must be regulated or remain government monopolies [32]. Also, as mentioned in [35], liberalization is more a process than an event, and governments which started deregulation are continuously revising their regulations.

2.1.2 Electricity market types

With the liberalization of energy markets, generation and supply have become decoupled from grid operation. The competitive markets which replace the vertically integrated systems are related to different functions of the power system management. Energy market, ancillary services market and transmission market are the three main power markets [36].

System ancillary services are services required to ensure that the system operator meets its responsibilities in relation to the safe, secure and reliable operation of the interconnected power system. These services are provided by generation, transmission and control equipment [37]. In particular, ancillary services are included in balancing services which are used to ensure balance between supply and demand in real time through reserve mechanisms, as detailed in section 1.3.2. In the regulated industry, ancillary services are bundled with energy and are mandatory services. In the restructured industry, ancillary services may be procured through market, such as in some States in the USA.

Transmission markets are markets where the traded commodity is a transmission right. Such right can be the right to transfer power, the right to inject power into the network or the right to extract power from the network. The importance of the transmission right is mostly observed when congestion occurs in the transmission

network. Such markets are already active in the USA for example. However, in most European countries, transmission networks are managed by a Transmission System Operator (TSO), responsible for the secure and efficient operation of the network. The TSO is also responsible for open access to the grid; it ensures that all network users (generators, traders, suppliers, customers) can have non discriminatory access and use the network to move their power.

The energy market is where the competitive trading of electricity occurs. It is a centralized mechanism that facilitates energy trading between buyers and sellers. The energy market's prices are reliable prices indicators, not only for market participants but for other financial markets and consumers of electricity as well. The energy market has a neutral and independent clearing and settlement function.

Energy markets can be considered as the main power markets, where the traded commodity is electricity. Ancillary services and transmission markets are related to the secure and reliable operation of the power system. In the following sections, focus is given only to energy markets.

2.1.3 Overview of the electricity markets

Electricity market structures

Two main structures for electricity markets can be found in the literature [36]: pool markets and bilateral markets. These two structures are illustrated in Figure 2.1, and described as follows:

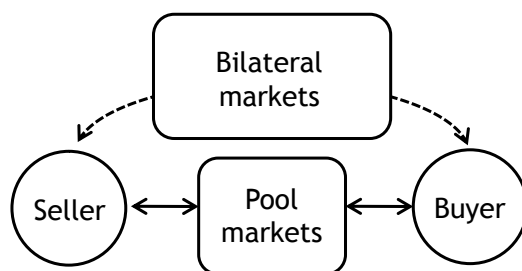

Figure 2.1: *Overview of an electricity market model showing the flow between the market participants.*

- Pool markets: A pool market is defined as a centralized marketplace which clears the market for buyers and sellers. Sellers and buyers submit bids to the pool for the amount of power that they are willing to trade in the market, as shown in Figure 2.1. Sellers compete for the right to supply energy to the grid, and not for specific customers. If a market participant bids too high, it may

not be able to sell. On the other hand, buyers compete for the buying power, and if their bid is too low, they may not be able to purchase.

- **Bilateral markets:** In bilateral markets, also called Over-The-Counter (OTC) markets, buyers and sellers trade directly with each other, as shown in Figure 2.1. Bilateral contracts are negotiable agreements on delivery and receipt of power between the two traders. The bilateral market structure is very flexible as trading parties specify their desired contract terms, regarding prices, quantities, duration or quality. However, its main disadvantages are the high cost of negotiating and writing contracts, and the risk of creditworthiness of counterparties.

A hybrid structure is mentioned in [36]. It combines various features of the previous two models.

Physical and financial markets

The value of electricity within a network is a variable depending on the time and the location. Uncertainty arises from a wide range of contingencies such as equipment failure, external factors like weather, or behavior of market participants. Electricity markets are designed according to this uncertainty. In particular, the liberalized electricity sector uses a combination of physical and financial markets to manage the short-term uncertainty and network costs [38]. Two kinds of contracts can be traded on such markets. Contracts which cover the real physical delivery of electricity are traded in physical markets. These contracts entail physical and cash delivery on expiry. The hub is the grid. The schedules of all the deliveries relative to physical contracts must be approved by the Transmission System Operator, to prevent constraints. Also, the real-time deliveries relative to physical contracts may lead to differences between feed-ins and take-outs which have to be managed to ensure the operation of the grid.

Alternatively, some contracts can entail only cash delivery on expiry. These contracts are denoted as financial contracts and are traded in financial markets. Such financial products are based on an index which is the price obtained in the physical power exchange. They were designed for market participants to hedge against the risk related to high variability of this index. The negotiated products are similar to those traded in other commodity markets. They include, among others, futures, forwards, swaps and options. These products can be combined to construct either contracts at fixed prices, contracts indexed to electricity prices, with cap and floor, or contracts indexed to other commodity prices. Usually, supplier of these combined products manages a portfolio including the different available products. Because

financial products do not entail physical delivery on delivery, the volumes traded in financial markets can exceed the physical volumes. For example, in the Nordic countries, the financial volumes traded in the NordPool electricity market reached 150% of the yearly consumption in 2003 [39].

It is important to note that the type of settlement does not predetermine the aim of the contract. For example, a generator can hedge its production with a financial contract. The dispatch of the plant is not modified by the contract and this contract only fixes the incomes of the plant. Also, a trader can speculate with physical contracts. They only need capacity to deliver power into the grid or to have signed an additional back up physical contract with a physical agent.

Market clearing processes

For participating in a pool-based market, buyers and sellers propose bids. Sellers propose bids to sell a given amount of energy at a given price, and buyers propose bids to purchase a given amount of electricity at a given price. The market settlement results in contracts for both buyers and sellers. Buy and sell contracts consist in a given amount of electricity at a given price. Two main mechanisms are used for market settlement: the single price market clearing process and the pay-as-bid market clearing process [40, 41].

Single price market clearing process Markets which are based on a single price clearing process are organized in power exchange sessions. Participants in such markets have to submit their quantity-price bid during the period between the gate opening and the gate closure time. The time delivery scope may vary depending on the considered market. The bid time unit is often denoted as Program Time Unit (PTU).

For the market settlement, all bids are aggregated to form a curve for purchases and a curve for sales for each PTU. The point at which the two curves intersect within each PTU determines the Market Clearing Price (MCP), also called system price or spot price, which in turn establishes the trading result for each participant for that PTU. This process is described in Figure 2.2.

Once the market clearing price is determined, all bids to sell with offer prices lower than or equal to the MCP and all bids to purchase with offer prices greater than or equal to the MCP are accepted. All bids to sell with higher offer prices or bids to purchase with lower offer prices are rejected. Regarding contract prices, all the sellers receive the MCP for their electricity, even if their bid price is lower than the MCP price and all buyers pay the MCP, even if their bid price is higher than the MCP price.

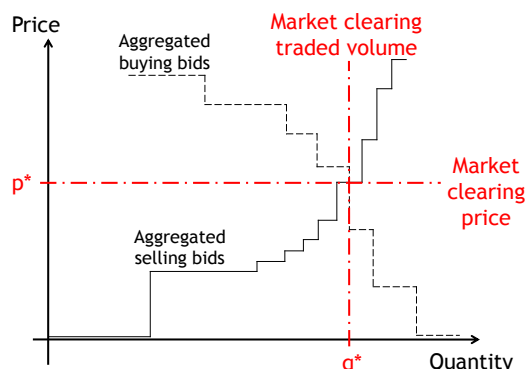

Figure 2.2: Single price market clearing process

Such single price market clearing process is based on *marginal pricing* of electricity. The participation of a generation unit in such market will be beneficial only if the MCP is higher than its marginal cost. Therefore, the price bid is based on the marginal cost. Marginal pricing is considered as a way to reach the lowest total cost to generate a given amount of electricity. For markets including different regions, regional spot market prices are derived from system prices taking into account transmission bottlenecks [42].

Pay-as-bid market clearing process A second alternative is to design the system to pay bidders the price they bid, rather than to pay them the MCP. Such trading mechanism takes place in a central exchange where standard products are traded on a “first come first serve” basis: the first matching offer to a bid (or vice versa) is rewarded and fixed into two bilateral transactions between the seller and the buyer. Such a pricing mechanism is denoted as *pay-as-bid pricing* which takes place in a power exchange continuous mechanism.

Generation units under the pay-as-bid system are remunerated at their bid price. Consequently, their bid price has to be higher than their marginal cost for the participation to be beneficial. However, a bid with a price too high will not be matched by any purchasing bid. The highest price of the matched bids is called the cut-off price. If all participants could guess the cut-off price perfectly, each participant whose marginal cost is lower than the cut-off would bid the cut-off price and each would be paid the cut-off price. The cut-off price would then be the same as the market-clearing price. However, this analysis is based on a “perfect guessing” hypothesis.

In real world, the pay-as-bid system may increase the total cost of generating electricity and can therefore be less efficient than a one-price market-clearing system. A discussion about the efficiency of the pay-as-bid market clearing process is given

in [43].

Finally, it is important to note that the decision relative to the bid in an electricity market depends on the clearing process of the considered market. The difference in terms of decision for these two clearing processes will be explained later in this thesis, more precisely in section 4.5.

2.1.4 Electricity market operation

Most of the electricity markets are organized in a succession of markets that adjust the balance between production and demand. This section describes the general time frame for the operation of electricity markets. A main distinction is made between markets which take place prior to the delivery and real-time markets [44].

Markets prior to delivery

Long term markets The largest energy volume is traded in long-term markets. In these markets, large blocks of electrical energy are traded for periods ranging from several days to several years. These periods correspond to the time between the contract settlement and the real delivery.

Most of these contracts are financial ones. More generally, they are market derivatives. Derivatives are defined as financial contracts or instruments whose values are derived from the value of an underlying [45]. An underlying can be an asset, like a commodity, or index, like a rate, whose value is considered as a basis for derivatives. In electricity energy markets, the underlying is electrical energy.

Derivatives are mainly used to mitigate the risk of economic loss arising from changes in the value of the underlying. This activity is known as **hedging**. In particular, regarding electricity markets, derivatives are used by market parties as methods to manage the risk relative to the price variability on the real-time market [40]. Also, derivatives can be used by investors to increase the profit arising if the value of the underlying moves in the direction they expect. This activity is known as speculation, and is not considered in the present work. The interested reader may refer to [45] for further details. The main derivatives in electricity markets are forward contracts, future contracts and options:

- **Forward contract** is an agreement between two parties, e.g. between two financial institutions or between a financial institution and one of its clients, to buy or sell electricity at a certain future point in time for a certain price [45]. Forward contracts are bilateral agreements settled in bilateral markets.
- **Future contract**, also called a future, is a standardized agreement between two parties on an exchange to buy or sell electricity at a certain price at

a certain time in the future. Futures contracts are thus similar to forward contracts, but instead of being traded in bilateral markets, they are traded on an exchange. This explains why futures are standardized products.

- **Options** are contracts that give the owner the right, but not the obligation, to buy (in the case of a call option) or sell (in the case of a put option) electricity. The price at which the sale takes place is known as the strike price, and is specified at the time the parties enter into the option. The option contract also specifies a maturity date. In the case of a European option, the owner has the right to require the sale to take place on (but not before) the maturity date; in the case of an American option, the owner can require the sale to take place at any time up to the maturity date. The buyer (holder) of the option pays the seller (writer) an option premium for this right. The option writer's obligation is to complete the transaction if the holder so demands (exercises the option). The option writer has received a premium for taking on the obligation.

Day-ahead markets Most electricity markets include a day-ahead market, which is a physical market where the bids are submitted and the market is cleared on the day before the actual delivery. Most day-ahead markets are based on a single price market clearing process. The resulting spot price is often used as a reference for financial markets.

Day-ahead market participants (sellers and buyers) have to propose before gate closure time in the day d their quantity-price bids for the different delivery periods of the following day $d + 1$. Delivery periods are often referred to as Program Time Unit (PTU). Generally, the PTU is one hour, and the bids can be either hourly bids or block bids when they cover a number of successive hours. More precisely, block bids allow the participation of generation units with starting ramp.

Based on a single price market clearing process as described in section 2.1.3, the bids are all matched through a single auction process for determining the market clearing price (also referred to as spot price) and the program of the participants for each PTU, which is the volume being sold or purchased during each PTU, for each participant.

Each day-ahead market has its own rules, defining the way electricity is to be sold or purchased, how the prices are settled, and the obligations the participants are committed to. The specific trading rules regarding European day-ahead markets can be found in [46, 47].

Intraday markets Due to the long time span between the settlement of contracts on the day-ahead market and the physical delivery, exchanges sometimes offer an intra-day market, also referred to as hour-ahead or adjustment market. An intraday market is defined here as a physical market, which gives the possibility for transactions between market parties between the day-ahead market gate closure time and the final notification [41]. This notification is the last moment in time where a market party is allowed to change the energy program which will form the basis of the imbalance calculation. Intraday markets gate closure time occurs between half an hour and two hours before time of delivery.

The participation in intraday markets enables the participants to improve their balance of physical contracts in the short term. In particular, they can take into account non-scheduled outages, updated load forecasts and updated forecasts of RES generation. This justifies why these markets are often called adjustment markets.

These markets can be based on single price or pay-as-bid market clearing processes. An overview and a classification of the European intraday markets is given in [41].

Real-time markets

At gate closure time, all trading for the physical delivery of electrical energy ceases: at that point, market parties have their final energy schedules fixed. At the same point, the control over the power system is passed to the Transmission System Operator (TSO) which is responsible for the continuous balance between supply and demand, including possible import/export from neighboring grids.

In open electricity markets, the real-time market is the physical market whose main function is to provide reserve power by market parties to the TSO through a bidding process. Only the TSO manages the demand of the real-time market and the actors on the supply side of the real-time market can be both producers and consumers.

Two kinds of bids can be proposed from a market party in the real-time market. Bids can first consist in a proposition of a price required to increase its generation or decrease its consumption for a specific volume immediately. Alternatively, bids can also consist in a proposition of a price offered to take the opposite action, which is to decrease its generation or increase its consumption for a specific volume immediately (i.e. in the following minutes). The first type of bid will be activated when demand exceeds supply while the second when supply exceeds demand. Such balancing services are part of ancillary services. The following paragraph describes the example of the real-time market operated by TenneT in Netherlands [48]: up to one hour ahead of operation, market parties may offer bids for regulating and

reserve power to TenneT. TenneT will use as much regulating and reserve power as is needed in order to maintain or restore the system balance. Units providing upward or downward power are remunerated at the price of the highest bid used for balancing the system, with a different price for upward and downward power. This price is the penalty price that the parties responsible for imbalance have to pay for their energy imbalance.

The term *balancing market* generally combines the real-time market with the imbalance penalty rules [44]:

- Balancing market first refers to the balancing mechanism which defines the features of the real-time market, such as the bidding rules, the constraints or the requirements on the balancing market participants, the way of payment to the bidders or the constraints on the TSO. A market entity providing balancing power/energy to a TSO is denoted as “balancing market participant”.
- Balancing market may also refer to the rules defining the way the TSO determines the price for the market parties responsible for the imbalance between demand and supply. Market parties which are financially responsible for balancing their injections and withdrawals (including possible purchases and selling) of energy are denoted as balancing responsible parties.

Imbalance pricing arrangements can be used to encourage market players to maximize their efforts to be in balance. Balancing markets therefore form an integral part of the overall wholesale electricity trading arrangements and timetable. Balancing markets represent the transition from a rule-based mechanism to a market-based mechanism. Although the TSO will be a single purchaser in such mechanism, efforts have been made to base the procurement of capacity required to balance the system in real-time on market-based actions whenever possible [49]. It is seen as a way to ensure the transparency and the competitiveness of the mechanism. Some grid operators in Europe have already started to procure capacity required to balance the system in real-time via a real-time market, and balancing markets are expected to become increasingly integrated in the near future.

Summary of the electricity market operation

Figure 2.3 summarizes the electricity market operation considered. The long-term, day-ahead and intraday markets are illustrated as a possibility for market parties to trade electricity prior to delivery. The participation in one of these markets is related to the proposition of a bid. This is illustrated by the vertical line which precedes the trading period (represented by the rectangle). In opposition to these markets prior to delivery, the balancing market is a real-time market which occurs

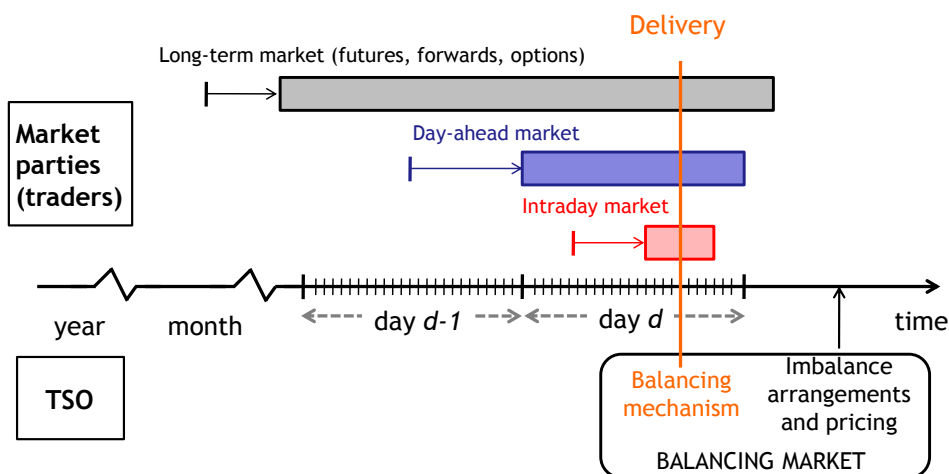

Figure 2.3: Time frames of different markets

at delivery. This market is related to the difference between the energy contracted by the different market parties and the actual delivered energy. The TSO is the main participant of this later market.

2.2 Description of participation in an electricity market

This section explains in what a participation in an electricity market consists from the power producer point of view. The regulatory framework of the renewable energy sources is first recalled, and the hypothesis relative to the participation of renewable generation in electricity market is discussed. Then, the electricity markets considered in this thesis are specified, and the participation in these markets is presented through the concept of **independent power producer**(IPP). The following key concept which is defined is the one relative to the **balance responsibility** of the IPP.

2.2.1 Renewable energy sources and regulatory framework

In the EU Directive (2001/77/EC) on the promotion of electricity produced from Renewable Energy Sources (RES), each Member State is expected to reach a given share of its production based on RES in 2010. This specific share is based on the percentage of each country's consumption of electricity. In order to achieve these goals, support mechanisms may be used to promote the large scale integration of RES in each Member State's power system. Morthorst in [50] proposes an analysis and an evaluation of the different mechanisms used in EU to promote RES. Overviews of the current support schemes to promote RES are given in [28, 51, 52] by the European

Transmission System Operator (ETSO), the International Energy Agency (IEA), and the European Wind Energy Association (EWEA), respectively.

The main goal of support schemes is to bring the RES technology development to a stage in the future where RES no longer support is needed. More precisely, most of RES technologies (excepting hydropower generation) are recent technologies compared to conventional generation, and need additional research for decreasing their generation cost. Also, most of the electricity markets today underestimate the environmental cost of production related to conventional generation, which leads to a competitive disadvantage for RES participating in the same markets. The aim of support mechanisms is to recognize the additional benefits of renewable energies such as support to rural economies and mitigation of environmental impacts, and consequently to offset such competitive disadvantages.

Support mechanisms can be divided into two categories, as suggested in [53]:

- *quantity-based* mechanisms are systems where a quota for the level of renewable energy that should be produced is set. The regulator defines a reserved market for a given amount of RES and organizes competition between RES producers to allocate this amount. Electric utilities are then obliged to purchase the electricity from the selected power producers. These mechanisms are denoted as tendering systems or competitive bidding systems. For example, the Renewables Obligation (RO) mechanism in UK consists in an obligation on licensed electricity suppliers to buy a certain percentage of their supply in each 1-year compliance period [54]. Another example of quantity-based mechanism is the green certificate scheme, where a fixed quota of the electricity sold by operators on the market has to be generated from RES.
- *price-based* mechanisms are systems that are relative to the payment of the RES production. Payment mechanisms can be viewed as compensation for the lack of internalization of external costs in the production costs of the producing companies. The level of the payment incentive depends on the RES production cost compared to other technologies and the market prices for electricity. More precisely, the market price for electricity settled by conventional technologies might be too low to make RES competitive. Two main payment mechanisms are predominant in Europe [50,55]: the feed-in tariffs and the feed-in premium:
 - the feed-in tariff scheme involves an obligation for a given electric utility to purchase the electricity produced by renewable energy producers in their service area at a tariff determined by the public authorities and guaranteed for a specified period of time.

- the feed-in premium is an incentive paid on top of the market price to the RES producers. This premium can be either independent of the market price, or limited in case of high market price. The aim of the feed-in premium is to introduce upper and lower boundaries for the renewable energy price.

A comparison of the feed-in tariff and the feed-in premium is proposed in [55] for the wind power in Germany and Spain respectively. Regarding price-based mechanisms, feed-in tariff and feed-in premium schemes correspond to two different attitudes towards the integration of RES generation in electricity market [51]. The feed-in tariff mechanism consists in setting special conditions for RES generation and providing relief from *market risks*. On the contrary, the feed-in premium mechanism consists in supporting the costs related to the market integration. Feed-in premiums can thus be seen as a transition to a full market integration, where support mechanisms are removed. Full market integration would be possible if the RES generation is competitive with conventional generation. This can be achieved either with a decreasing cost of the RES technology or with the integration of additional products in the current market mechanisms, such as carbon credits regarding environmental issues.

The present work aims at proposing methods for RES generators for the management of their production in electricity markets. More precisely, the proposed method aims at managing the risk related to the balance responsible RES generators when they are integrated in electricity markets and responsible for their production. Regarding support mechanisms, the proposed method is not valid for RES generators under feed-in tariffs, but the method would remain valid for RES generators under feed-in premiums. The hypothesis to consider renewable generation integrated in electricity markets is justified by the temporary nature of support mechanism: as stated in their definition, a support mechanism is designed to support a technology development to a stage in the future where the technology no longer needs support. Moreover, a number of feed-in tariff mechanisms have been switched to feed-in premium mechanisms in recent years [52]. This observed trend confirms the transition to the situation where RES generators are responsible for their generation.

2.2.2 Electricity markets considered in this study

In the present work, the RES production is supposed to be sold in a competitive electricity market. A relatively high number of participants is supposed to participate in the market.

The considered RES generation is traded ahead of delivery, via bilateral contracts or on the power exchange. Focus is given on the day-ahead market, which is most of

the time the reference market for all forward trades. The participation in intraday markets is also considered. Day-ahead and intraday markets are denoted as short-term electricity markets.

The participation in long-term electricity markets is not considered in this work. Such markets are forward markets, where the transactions relate to distant deliveries which can range from the following month to several years in advance. The assumption to participate only in markets for which the period between the transaction and the delivery does not exceed the one relative to the day-ahead is justified by the RES generators characteristics: the limited predictability of the renewable production makes its trading difficult in long term contracts.

Also the participation in real-time market is not considered. Generators participating in such markets propose a price required to increase their generation. This bid can be activated by the TSO to regulate the grid and consequently, must be reliable. Consequently, the uncertainty associated to the RES generation and its limited dispatchability limits its participation in real-time markets. However, recent improvements in very short-term RES power forecasting models could overcome this limit.

2.2.3 Participation of renewable units in electricity markets as independent power producers

Definition of an independent power producer

An Independent Power Producer (IPP) is an electricity generator delivering power in a deregulated structure [40]. The concept of IPP appears as soon as the electricity generation industry structure is not a vertically integrated monopoly. The IPPs are indeed competing generators. They can sell their generation either to a single buyer or a wholesale market. The second case is considered as a fully competitive generating sector.

IPPs are generating companies, also called *GENCOs* in the US [36]. They operate and maintain existing generating plants. An IPP may own a plant or interact on behalf of plant owners with the short-term market. An IPP can include RES units.

IPPs have the opportunity to sell electricity to entities with which they have already negotiated sales contracts through bilateral contracts; they may also opt to sell their generation in short-term electricity markets. IPP may offer electric power at several locations that will ultimately be delivered through the transmission or distribution networks. Since an IPP is an entity which exists in the liberalized framework, its selling price is not regulated. Finally, the IPPs' objective is to maximize profits. To achieve such a goal, IPPs may choose to take part in whatever market. It is the IPP's own responsibility to consider possible risks.

Interaction of an independent power producer with other entities of the power system

In the context of a fully competitive generating sector, the IPPs have the possibility to trade their generation in wholesale electricity markets. As explained in section 2.2.2, only the participation in short-term electricity market (i.e. day-ahead and intraday) is considered.

When participating in such markets, IPPs interact with other market entities. First, the Independent System Operator (ISO) is the leading entity in a market and determines the market rules [36]. The ISO administers transmission tariffs, maintains the system security and coordinates maintenance scheduling. The ISO should function independently of any market participants, such as generators or end-users, and should provide non-discriminatory open access to all system users.

Two options can be found regarding the relationship between the system operator and the transmission owner [40]. A first option is to have an ISO which combines ownership of the transmission with system operation. The ISO is then called Transmission System Operator (TSO). The TSO is a regulated company. The second option separates the system operator (ISO) from transmission companies which are independent entities which own the transmission network. Transmission companies transmit electricity using a high-voltage transport system from generators to distribution companies for delivery to customers. Transmission companies have the role of building, owning, maintaining, and operating the transmission system in a certain geographical region for providing services for maintaining the overall reliability of the electrical system. A detailed comparison of the two options can be found in [40]. The second option is more common in the US power system while the TSO option can be found in most of EU countries.

Other market entities include distribution companies, retail companies, aggregators, brokers, marketers and customers [36]. Distribution companies distribute electricity to the customers in a certain geographical region. These customers are the end-users of electricity. They can be connected to the distribution system in the case of small consumers and to the transmission system in case of bulk customers. Retail companies are legally able to sell retail electricity. The retailers can either deal directly with end-user customers or through aggregators, who combine customers into a buying group. Brokers of electric energy services are entities that act as middlemen in a marketplace in which these services are priced, purchased and traded. They facilitate transactions between buyers and sellers. Finally marketers are entities that buy and re-sell electric power but do not own generating facilities.

2.2.4 Details of the description of the participation of an independent power producer in electricity markets

General definition of the participation of an IPP in electricity markets

In the competitive framework, the IPP is responsible for trading its generation. More precisely, the IPP has to “decide on the amount of each electricity service that should be supplied, at which moment it should be produced, at what price it should be sold, and by which units it should be provided” [56].

The market participation consists in designing hourly offer curves that are submitted to the auctions relative to the different markets. Quantity-price pairs are examples of offer curves, where a given amount of energy is proposed at a corresponding price. These offer curves are based on short-term generation scheduling. More precisely, the decision about the quantity-price bids has to take into account technical constraints of the generation units such as ramps. These units might be profitable to operate if they received at least a certain level price for a large period. The operation of the same unit only for a short period may not be profitable since the fixed costs of ramping up may be greater than the profits earned during the period [43]. In order to take into account these features, market parties can use block bids, which consists in a series of n bids relative to n consecutive market period units.

The market participation of the IPP can be interpreted as a shift of the responsibility of the power system management from the central operator to the market players. This view is defended in [57]. In that book, Rau explains that unit commitment generally done by the central operator for the next days or weeks “contravenes deregulation philosophy”, in which the power system is managed through the market. The dispatch is shifted to the perspective of market players, and becomes a question of determining the optimal bidding strategies as related to maintenance, risk of forced outage and loss of revenue, and decision to start and stop generators. This position assumes a reliable operation of the market.

Price taker versus price maker

In the case of a market with a single price clearing process, as defined in section 2.1.3, two different approaches of bidding can be observed for the IPP:

- The first approach consists in submitting quantity-price bids which indicate how much electricity the IPP is prepared to deliver at a given price. Then, the market clearing price and clearing volume for the considered IPP, result from the aggregation of the offer and demand curves. The IPP is said to be a *price maker*.

- In the approach, the IPP submits price-independent bids. The bid energy quantity is constant for the whole range of possible prices. The IPP is said to be **price taker**. For the market settlement, this bid is taken at zero price when aggregating the offer curves. The bid quantity is always traded in the market as a result of the zero price, and the IPP receives, or “takes”, the market clearing price.

Renewable generation units have low marginal costs, since their production is not based on a fuel consumption. Consequently, the market participation for a IPP including renewable power units aims at trading as much as energy as delivered by the renewable units. Consequently, the considered IPP in the study is taken to be a price taker.

2.2.5 Balance responsibility

Definition of balance responsible party

Balance responsibility is considered as a way to enable the functioning of the market while keeping technical integrity of the system in a decentralized way. Under this mechanism, market parties are economically responsible for their imbalance.

A balance responsible party (BRP) is a market party which is “responsible for keeping the net balance on all the connections within its control and [which] faces the liability consequences if this is not achieved. The liability in case of imbalance involves the payment of an imbalance charge to the operator of the market area who is responsible for keeping the balance in the area. The imbalance charge consists of an imbalance price for every MWh of imbalance that has occurred during a predefined settlement period” [41].

Imbalance is generally defined per balance responsible party per settlement period as the difference between net programmed values and metered values of feed-ins and take-outs on the set of connections the party is responsible for, corrected with net programmed trade with other program responsible parties. If the set of connections is empty the imbalance is per definition equal to the net programmed trade [41].

Imbalance settlement for an independent power producer

The imbalance settlement is made *a posteriori* to production and consumption, and is based on metered data. It often involves an imbalance penalty which is determined by multiplying the imbalance energy volumes with the imbalance price. This section gives the definition of the imbalance volume and price, which are formulated in the next chapter 3.

Imbalance volume The imbalance volume of a balance responsible party is the difference between the metered delivered energy and the net contracted energy. Such volume can be positive or negative. The contracted energy results from the participation in electricity markets prior to delivery as described in section 2.2.2.

Positive energy imbalance occurs when the delivered energy is greater than the contracted energy, while negative energy imbalance occurs when the delivered energy is lower than the contracted energy and negative energy.

Imbalance price The real-time regulation operated by the TSO results from the sum of the imbalance volumes from all the BRPs in the TSO control zone. In order to ensure the equilibrium between production and consumption, the TSO counterbalances the total real-time imbalance by applying secondary reserve and tertiary reserve. These secondary and tertiary reserves may be obtained from the real-time market as described in sections 1.3.2 and 2.1.4. If the real-time imbalance is positive, production exceeds consumption and down-regulation is activated. If the real-time imbalance is negative, production is lower than consumption and up-regulation is activated.

BRPs are responsible for the payment of the energy traded in the real-time market by the TSO for adjusting its own energy imbalance. Many options exist for the design of the imbalance price mechanism. First, the payment of providers of imbalance service and the charge of users can be done through a fixed regulated price or a real-time market-based price [40]. Also, when the imbalance price is based on real-time, the imbalance price can be based either on a dual pricing mechanism, where a different price is applied to positive and negative imbalance volumes respectively, or on a single pricing mechanism, where a single imbalance price is used for all imbalance volumes. Finally, imbalance pricing based on real-time market can consider either the average or the marginal price of energy balancing actions [41].

When a dual pricing mechanism is used, a distinction is made between BRP imbalance volumes which are in the same direction as the TSO regulation and BRP imbalance volumes which are in the opposite direction. A BRP has its imbalance in the same direction as the TSO regulation when its imbalance volume is positive while the TSO is down-regulating, or negative while the TSO is up-regulating.

The different imbalance pricing options generally lead to a penalization of the imbalance volumes, which reduces the IPP's market revenue. More generally, the imbalance settlement mechanism is designed to encourage market participants to minimize energy imbalances. This is done through price signals for the imbalance energy. Figure 2.4¹ describes the dual price mechanism in the Western Denmark

¹Note that, due to editing problems, the currency unit € is denoted as *eur*. This remark is valid for all the figures of the present thesis.

area, with the up regulation, day-ahead market and down regulation prices during the 24 h of the 5th of October 2003. The up regulation price is the “main” price for generators being “short” (i.e. which have their production lower than their contract). Such up regulation price is higher or equal to the day-ahead market price, which is the “reverse” price. In other words, they are required to pay the “missing” energy at a price higher than the spot price. Similarly, the down regulation price is the “main” price for generators being “long”. Such up regulation price is higher or equal to the day-ahead market price, which is the “reverse” price.

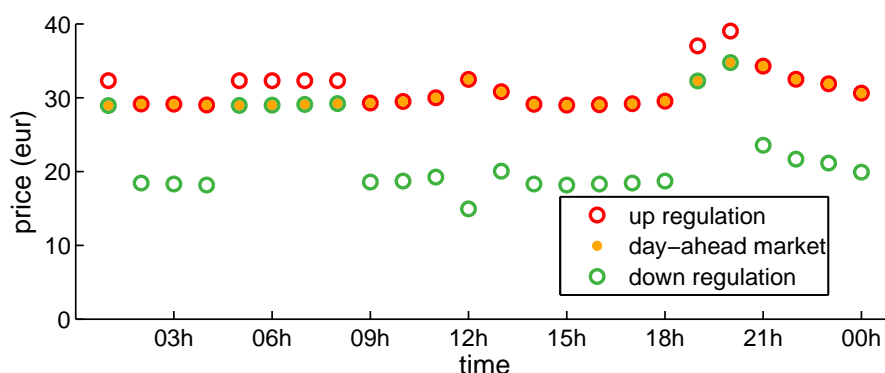

Figure 2.4: Day-ahead electricity market price in the Elspot market for the Western Denmark area, the 05/10/2003, and the associated up and down regulation price for the same area.

In a dual pricing mechanism, the energy imbalance in the “right” sign for the TSO are not penalized. For very infrequent periods, the energy imbalance in the “right” sign for the TSO may even be remunerated. This situation may happen during down-regulation from the TSO, where negative imbalances are then remunerated at a price greater than the day-ahead market price. These situations can also be associated to negative prices for positive imbalance. Electricity in this condition becomes a “waste good” [58]. This phenomenon happens very infrequently. It is explained by the “must-run” character of some inflexible generators [59]. For these power suppliers, the costs of a shutdown period are generally higher than the loss resulting from negative price, which explains why they accept these negative prices.

More generally, imbalance prices are highly variable and hardly predictable [60]. Such characteristics will be further discussed in section C. The high variability and low predictability contribute to discourage power producers to plan imbalances and to prevent from speculation in these markets [61].

Balance responsibility and renewable generation

The balance responsibility is particularly critical for IPP with RES units in their generating portfolio. More precisely, when participating in a market, the IPP has to propose bids prior to the delivery, taking into account the limited predictability of the RES units. Energy contracts are thus based on an estimation of the future energy generation. At delivery time, the errors relative to these generation estimations and the limited dispatchability of the RES units may lead to significant energy imbalance, which in turn make them particularly sensitive to imbalance penalties. This sensitivity reduces the competitiveness RES-based portfolios in electricity markets and lead to financial risks [62].

This sensitivity is a reason why RES have benefited from support mechanisms, which counterbalance the reduction of competitiveness resulting from imbalance penalties due to the limited predictability of RES generation. The feed-in tariff mechanism completely eliminates the balance responsibility. The feed-in premium mechanism modifies the market price perceived by the IPP, which distorts the market price seen by the RES units, reducing the influence of the imbalance costs on the RES units operation [38]. Specific support mechanisms reducing the balance responsibility for RES have also been settled. In Belgium for example, offshore wind energy can enjoy specific tolerance margins [63]. If the imbalance volumes are lower than 30% of their nominal power per PTU, the negative and positive imbalance prices are levelled out by the TSO at prices of respectively 110 or 90 % of the day-ahead spot market price [63]. For deviations beyond these margins, the prices are determined according to the TSO's imbalance tariff.

The present work considers the participation of an Independent Power Producer operating RES generation as a balance responsible Party. Under these conditions, the management of the uncertainty related to renewable generation is a cornerstone for improving the integration of RES in electricity markets.

2.2.6 Summary

Figure 2.5 summarizes the sequence of the participation of an IPP in an electricity market, and the interaction with other entities of the power system. In a first step, the IPP proposes bids in the day-ahead and eventually in the intraday electricity markets. The bids are submitted to the market operator. They result in energy contracts for the IPP, which in turn are considered as energy programs by the TSO.

The second step is the real-time operation. At this time, the IPP delivers electricity to the grid. The TSO operates the real-time market and maintains the equilibrium of the grid. Regulation is activated by the TSO with electricity available from the real-time market.

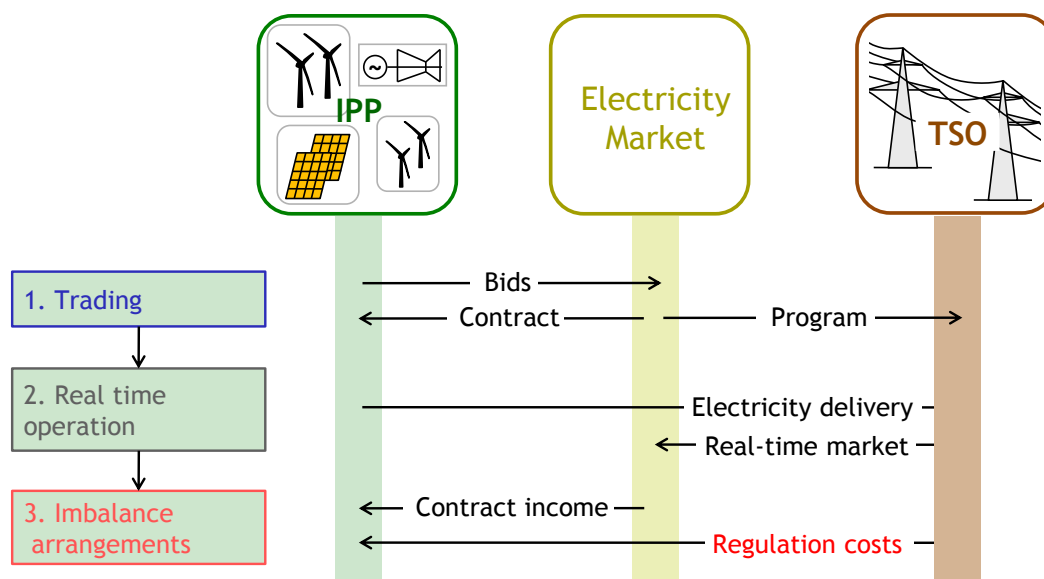

Figure 2.5: Model of the participation of a balance responsible IPP in an electricity market.

Finally, the imbalance penalties are applied to the IPP by the TSO for the difference between the contracted and delivered energy.

The imbalance penalization will be formulated in the next chapter. The next section presents the state of the art of existing solutions to manage the imbalance penalties for an IPP including RES units.

2.3 State of the art of existing solutions for the management of renewable generation in electricity markets

The following section proposes to classify the solutions which reduce imbalance penalties into two categories: the *financial* solutions which are relative to the management of the contracted energy, and the *physical* solutions which are relative to the management of the delivered energy. It reminded that the imbalance penalties depend on the difference between the delivered energy and the contracted energy.

2.3.1 Financial solutions for the imbalance management

The aim of this section is to present the *financial* solutions available from the literature for the management of imbalance penalties. These solutions are relative to the management of the contracted energy, which refers to the total amount of energy which has been traded through different markets or bilateral contracts before delivery. Energy traded in the real-time market for balancing the position of the IPP is

not included in the considered contracted energy. The participation in day-ahead and intraday markets, as well as the trading of market derivatives, are presented. The particular role of renewable generation forecasting in the financial solutions is also explained.

Renewable generation trading in short-term electricity markets

Short-term electricity markets include day-ahead and intraday markets. For trading their generation in these markets, IPPs must propose their energy quantity-price bids during a period which ends at the gate closure time. The proposed bids are then settled by the market and result in energy contracts which are notified to the TSO as expected physical position at real time. The imbalance energy at delivery time is calculated as the difference between the delivered and the contracted energy from the IPP. Since most imbalance settlement mechanisms are designed to penalize imbalance energy, the total contracted energy should be as close as possible to the delivered energy in order to avoid imbalance penalties. In some systems only, IPPs are allowed to self-balance after gate closure time [41]. However, this possibility is normally prohibited or is subject to an information imbalance charge.

The participation in the day-ahead market. A day-ahead market, as its name implies, operates one day in advance of the delivery. The participation of renewable units in such market necessitates the use of short-term forecasts of the output of these units. Numerous studies consider the participation of IPP including wind power in day-ahead markets in European countries. For example, the participation of a wind farm in the OMEL day-ahead market in Spain is considered in [64–66]. The participation of a wind farm in the APX day-ahead market in Netherlands is considered in [67]. In [68], the participation of a wind farm in the NordPool Elspot day-ahead market in Denmark is described. In United Kingdom, the participation of a wind farm in the NETA day-ahead market is considered in [62]. The participation of wind power in the Italian day-ahead market is simulated in [69].

Moreover, the day-ahead market is considered as a reference market for the imbalance pricing mechanisms. In particular, for dual imbalance pricing regime, the price for imbalance volumes in the same direction as the TSO regulation measure is the day-ahead price for many European countries [41]. In other words, imbalance volumes which help the TSO to guarantee the equilibrium between load and generation are paid the day-ahead price. If the imbalance volume is relative to a day-ahead energy contract, this means that the penalty associated to such imbalance volume is null.

Additional trading in intraday markets. Intraday markets offer the possibility for IPPs to get additional trade and a change of position after the day-ahead market gate closure time. Participation in the intraday market can be done using updated power forecasts which are generally more accurate than the ones used for trading in the day-ahead market. This forecasting error reduction is explained by the reduction of the period between the prediction and the operation time in the case of intraday market. Consequently, more recent inputs, such as measurements and numerical weather predictions, can be used for generating updated forecasts.

Participating in an intraday market using updated power forecasts can thus be considered as a solution for reducing imbalance penalties. The benefits from the participation in such a market have been verified in [70] for the Spanish market. For the NordPool market, the possibility to reduce imbalance penalties through the intraday market participation has been studied in [71].

Trading strategies for managing imbalance penalties. For an IPP, market participation consists in determining the amount and the price of the bids which it proposes to the market. This quantity and price will determine the total contracted energy and the resulting energy imbalance. As a consequence, the strategy adopted by the IPP for trading in the market is crucial regarding their competitiveness towards the other market participants.

The problem relative to strategic bidding refers to both decision making about the quantity-price bid and market clearing models. A wide range of approaches can be found in the literature. A general framework is proposed in [72] for strategic bidding in electricity spot markets under uncertainty. This study is based on a wide review of the state of the art. In particular, the different spot market mechanisms are described, as well as some approaches used to model bidding strategies, and different representations of the generation system. Examples of strategic bidding studies can be found in [73–75].

Management of imbalance penalties with market derivatives: the case of options

In electricity markets, options are financial market derivatives which give the owner the right, but not the obligation, to buy (in the case of a call option) or sell (in the case of a put option) electricity. Regarding IPPs including RES, call options can be used to manage negative imbalance: call options can be exercised when the delivered energy is lower than the contracted energy. Similarly, put options can be used to manage positive imbalance: they can be exercised when the delivered energy is greater than contracted energy.

For using options to manage short-term energy imbalance, the IPP has to be able to trade options which are relative to the delivery of electricity for a short period, such as several hours. However, the existing option purchasing markets may not be adequate for managing energy imbalance from wind power. For example, in the Nordic Power Exchange, the proposed power options are based on season forward contracts and year forward contracts [76]. No option relative to short-term contracts is proposed.

As already mentioned, long-term contracts are not considered in this work due to the limited predictability of RES generation. However, the development of derivative products aiming at reducing the risk related to the market participation is fast, and short-term options or similar products could appear rapidly in electricity markets. Thus, using option for managing imbalance penalties remains theoretical now, but may soon appear for real cases.

The role of renewable generation forecasting in the financial solutions

The financial solutions are related to the trading of energy volumes in electricity market. This participation in markets generally consists in the proposition of quantity-price bids prior to delivery, as illustrated in Figure 2.5. Due to the limited predictability of the renewable generation, forecasting methods are often used. In this case, the forecast of the renewable generation is used as a basis to determine the energy bid volume. This results in a decrease of the imbalance penalty. This reduction of imbalance penalty, and the resulting revenue increase, is thus a measure of the value of the RES generation forecast. The following paragraphs give the example of the value of wind generation forecast in electricity markets.

Usaola and Angarita [65], in a simulation study, used the OMEL Spanish market example to demonstrate the value of forecasting: he draws a relation between the accuracy of wind power prediction tools and the resulting revenue. The case of the Spanish electricity market is also examined in [64] where the authors show that the prediction error would cost roughly 10% of the wind farm's revenue from electricity market when using a wind power forecasting model. The reduction of imbalance penalties from using short-term forecasting for trading wind energy in the UK electricity market is shown in [77].

In a study described in [67, 78], the authors present the simulation of the participation of a wind farm in the Dutch APX electricity market. The authors compare the imbalance penalties from using an advanced wind power forecasting model with the ones obtained using persistence. The persistence, in this case, consists in using the latest available wind power measurement as a forecast for the future production. When using the persistence model, imbalance penalties represent a reduction of 21 %

of the revenue which could be obtained by using perfectly accurate forecasts, with null imbalance. Using the advanced wind power forecasting model decreases the imbalance penalties to 13% of the revenue obtained with perfectly accurate forecasts.

2.3.2 Physical solutions for imbalance management

This section presents the *physical* solutions available from the literature for the management of imbalance penalties related to renewable generation. These solutions concern the management of the delivered energy by the IPP which includes the considered renewable generation. The first solution is the control of the generation from the RES unit itself. The three following solutions consist in combining the RES unit either with other RES units (i.e. aggregation), with energy storage devices or with conventional units. The general concept of virtual power plant is finally presented from the literature. This concept corresponds to the framework for the three power system combinations previously given.

Control of the renewable generation

RES generation based on solar plants and wind farms result from the conversion of solar irradiation and wind respectively, which are non-controllable resources. As a result, the dispatchability of RES units is low, as already discussed in section 1.2.2. Such dispatchability has been improved with the development of new RES technologies.

In this work, the automatic control of electrical machines is distinguished from the control possibilities which permit to increase the dispatchability of the RES plant output. This distinction is illustrated with the case of wind power. For modern wind turbines, the automatic power control can be realized with pitch control, which gives the possibility to turn the blades out or into the wind as the power output becomes too high or too low, respectively [79]. Another automatic control is the active stall control, which consists in pitching the blades slightly into the direction opposite to the pitch control in order to decrease high power fluctuations, and to compensate variations in air density. The second control, which permits to increase the dispatchability of the RES plant output, is denoted as **generation control**. Such control includes for example the possibility for a wind farm to reduce its total generation output. This generation control can be a request from the TSO for avoiding grid congestion in case of high wind power production. This control is sometimes denoted as down-regulation. Technically, the output reduction can be achieved either by shutting down a single wind turbine of the wind farm, or by limiting the output generation of each wind turbine of the wind farm.

In the present work, focus is given to the generation control, and the possibility to use this control for reducing the imbalance penalties. The automatic power control is more related to the electrical machine functioning, and is thus not considered in this work. Regarding generation control, the “down-regulation” techniques presented in the previous paragraph are solutions for reducing the positive energy imbalance of the IPP. They are described as the *generation management* concept in [80]. For negative energy imbalance, two solutions are proposed in [80] for reducing them: reducing the wind power feed-in permanently below the technical optimum or shutting down a single wind turbine in advance just of being in position to switch it on in case of negative imbalance. However, a large share of available wind power is wasted when applying such solutions.

An example of technical implementation of generation management can be found in the patent description in [81]. This solution is a wind power management system for monitoring performance of wind turbine generators.

Aggregation of renewable units

The aggregation of RES units consists in combining different RES units. In this case, the concerned IPP (or other actor that acts as an aggregator) operates the aggregated RES units as a single unit. The energy imbalance for this IPP is defined as the difference between the energy delivered by the different generation units of the IPP and the energy contracted by the IPP in the electricity markets.

Such energy imbalance for aggregated RES units is smaller or equal than the sum of the energy imbalance relative to the different unit. More precisely, aggregating RES units offers the possibility to smooth out the energy imbalances from the different units. For example, a positive energy imbalance from a RES unit taken individually may be compensated by a negative imbalance from another unit taken individually, and *vice versa*. The reduction of energy imbalances has already been studied from a forecasting problem point of view. For example, the reduction of the wind power forecasting error resulting from wind farm aggregation is described in [82]. The imbalance reduction resulting from the aggregation of wind farms that are spread over a large area is also mentioned in [83]. This compensation results from the decorrelation of the individual outputs.

One way to consider decorrelated RES outputs is to consider RES units spread over a large geographical area. The link between the distance between the RES units and the RES output decorrelation has been analyzed in [11]. However, the decorrelation of the wind farm outputs is reduced for offshore aggregation: large ocean fronts regularly stretch for hundreds of kilometres, so a wider geo-spread is necessary before output correlation reduces. Another way to consider decorrelated

RES outputs is to consider RES units based on different renewable resources, such as the combination of wind and photovoltaic power plants. However, the different aggregated technologies have to be of the same order of magnitude regarding energy delivery.

In addition to the compensation of opposite energy imbalances, the RES unit aggregation permits to decrease the aggregated output variability [84]. This variability reduction is denoted as the *smoothing effect* and is quantified and analyzed in [11]. The reduction of the fluctuations of the output from a wind farm aggregation in time intervals ranging from a few seconds to five minutes are analyzed in [85]. The smoothing effect relative to the aggregation of RES units based on different renewable resources is described in [84]. On a seasonal basis, combining photovoltaic power plants with wind farms is a way to decrease the aggregated output variability: the wind energy production is generally higher in winter due to high wind, whereas the photovoltaic production is higher in summer as a consequence to higher solar irradiation in summer. In other studies mentioned in [84], in the United Kingdom for example, wave and wind power time series have been found to have a low correlation on a daily basis. This combination could be interesting for reducing short-term variability, for the time periods ranging from around one to four hours before delivery.

Combination with energy storage devices

The energy delivered by RES unit is hardly predictable and hardly controllable. These characteristics make them sensitive to imbalance penalties. A solution to reduce this sensitivity is to combine the RES units with other units which are able to compensate this lack of controllability. The Energy Storage Devices (ESDs) are an example of power units which reduce the sensitivity of IPPs including RES towards imbalance penalties [84].

ESDs are power units which can store a given amount of electrical energy. More precisely, ESDs can be charged in case of positive imbalance (when RES delivered energy is greater than the contracted energy) and discharged in case of negative imbalance (when the delivered energy by the RES units is lower than the contracted energy). As a result, the energy imbalance from the combined RES and ESD units can be reduced. From the system operator point of view, ESD can reduce operating costs and improve the operating flexibility of power systems because they are able of providing non-spinning reserve to the utility system [84].

Whichever technology is considered, common characteristics can be defined for the existing storage technologies [86]. In particular, the maximum amount of energy that can be stored is denoted as the storage capacity. When charging, the ESD

is converting the electrical energy into another form of energy, such as potential energy, kinetic energy or chemical energy, which is storable. When discharging, the stored energy is converted back to electrical energy. Each conversion implies energy losses; the charging efficiency is defined as the ratio of stored energy over the absorbed electrical energy and the discharging efficiency is defined as the ratio of the delivered electrical energy over the consumed energy.

Different ESD technologies are suitable for different applications [86]. The storage time, which is defined as the time to discharge the storage device starting from full capacity, at nominal rate, is a way to classify the different technologies. A storage time of less than one minute tends to be required for power quality improvement, and transmission grid stability. Contribution to spinning reserve and frequency and voltage regulation requires a storage time in the range of minutes, whereas load leveling, peak shaving and imbalance management may require hours to days worth of energy storage. A complete description of the existing ESD technologies is provided in [87, 88] and the benefits of the combination of ESD with wind power is discussed in [89]. The present work will only consider technologies suitable for imbalance management (i.e. storage time from hours to days). Examples are given below.

- Pumped-hydro storage has long been established as the primary type of energy storage plant for electric utilities, and its operations and economics are well understood. They offer storage time from hours to days with charging and discharging rates which can be up to several thousands of MWh/h, depending on location. Their response time is fast and their operating costs are relatively low.
- Compressed Air Energy Storage (CAES) systems consist in compressing air in geologic structures under the ground, such as coal mines or salt domes, and releasing when necessary. A number of projects have been developed in the USA and Europe for the purpose of energy management, where the aim is to store energy during non-peak hours and release during peak hours. The storage time varies between hours to days.
- Batteries are based on the conversion of electrical to chemical energy. Their technical feasibility for electric utilities has been demonstrated. However, no commercially viable solutions for large-scale battery storage has been demonstrated to the market yet. Till now, batteries used to be operated on small-scale systems, such as photovoltaic systems. Using hydrogen obtained from an electrolyzer to store energy is a promising way [90].

Beyond pumped-hydro storage, there has been very few commercially available storage technologies that operate on today's electricity grids [8]. This can be ex-

plained by their high operating costs. An analysis of the cost per kWh of stored electricity is proposed in [91]. In this study, the cost added to electricity stored and discharged is evaluated for various battery technologies and compared with the cost of conventional pumped-hydro storage. The cost relative to the different batteries considered is between 3 to 12 times the pumped-hydro storage costs. However, the different storage technology maturation is evolving rapidly. The development of renewable generation and market liberalization itself acts as powerful incentives to intensify R&D efforts in this field. For example, batteries which charging and discharging power rate is in the order of a few MW have been recently installed in some island systems which include a large share of renewable generation. The transition to balance responsibility for IPP including RES units could lead to the development of ESD solutions for reducing the imbalance penalties. Also, the full pricing of emissions of conventional units providing energy in the balancing market would improve the relative economics of storage as an alternative.

The combination of a wind farm with an ESD for reducing the imbalance costs when participating in an electricity market has already been considered. In [90] a method for scheduling and operating an energy storage system coupled with a wind power plant under market conditions is proposed. In [92] an algorithm is proposed for calculating the optimal short-term dispatch of an energy storage facility coupled with a wind farm with the objective of minimizing the expected imbalance penalties incurred by the wind farm owner. In [93,94] an optimization approach was proposed for determining the most probable range of the output production of a wind farm coupled with a hydro power plant containing a water pump system and a small reservoir. The main motivation of such works was to use the hydro storage facility for increasing the controllability of the wind farm and maximize profits. In [95] some technological aspects of energy storage devices are discussed and the storage is used to *filter* the erratic power output of a stochastic power source (e.g.: wind power generator). In other words, the work developed in [95] aims at increasing the controllability of the wind power source. The same idea is described in [83]. Finally, in [66] two methods are proposed for minimizing the penalties due to imbalances of the wind farm power output. The first one considers the wind farm to bid alone in the day-ahead market trying to minimize the risk of the bid based on a statistical analysis of the expected production probability. The second couples a hydro power plant containing a water reservoir to the wind farm for minimizing the imbalance costs incurred by the wind farm owner.

Combination with a conventional generation unit

Another solution to reduce the sensitivity of the IPP including RES units towards imbalance penalties is to combine the RES units with dispatchable conventional generation units. When combined with RES units, dispatchable conventional units can increase or decrease their output for reducing negative or positive imbalance, respectively.

The case of distributed generation (DG) conventional units have been considered by utilities as a solution for peak shaving [96,97]. By definition, operating a unit for peak shaving consists in running it for reducing the system peak demand, which reduces the stress on the utility network and eases the loading of the utility generators. Combining a conventional DG unit with a RES unit for reducing imbalance is a similar problem to the peak shaving one: the unit is used by the IPP only when negative imbalance occurs. The strategic combination of a conventional DG unit with wind power for reducing balancing costs has already been studied in [98]. The considered units have to be flexible enough to be dispatched according to the RES imbalance. If a dispatchable source is switched on to counterbalance RES negative energy imbalance, the time period to get the unit fully operational, also called start-up time, has to be low enough. Also, the imbalance penalty reduction resulting from the combination depends on the costs associated to these conventional units. More precisely, the marginal operation costs of these units have to be lower than the avoided penalties. An overview of the main DG unit characteristics is given in [96]. The compared DG units are diesel engines, natural gas engines, gas turbines, microturbines, fuel cells and Stirling engines.

The two commonly used technologies are distributed generation units based on gas turbines and diesel engines. Gas turbine generators are available in the size range from 3 to 200 MW, and require about ten minutes to one hour to be brought online. Diesel generators are generally much smaller than gas turbines, typically in the size range from 0.05 to 5 MW, and can be connected in less than a minute [97]. Such a low starting time is of particular importance for the imbalance minimization problem. Diesel engine technology has progressed in the past few years, and has greatly improved with respect to efficiency and emission standards. A recent development is the option to fuel modern diesel gen-sets on biodiesel, a renewable and sustainable alternative to fossil diesel.

Concept of a virtual power plant and state of the art of the related research

Definition of the concept Combining RES with other DG units into a single independent power producer is a method for reducing the imbalance penalties which

potentially may improve the competitiveness of the RES units in electricity markets, as described in the previous section. More generally, the limited size of DG units makes their individual market participation difficult. For example, most individual DG units have to use specific bilateral contracts with an energy trader, because their rated power does not reach the threshold for the electricity pool participation. A large-scale integration of DG units in electricity markets may thus encourage the combination of DG units.

In such context, the concept of *Virtual Power Plant* (VPP) was introduced by Awerbuch in 1997 [99]. The author uses the term *Virtual Utility* to describe the concept. It is defined as “a framework to enhance the visibility and control of distributed energy resources to system operators and other market actors by providing an appropriate interface between these system components”. It consists in a flexible collaboration of independent and market-driven entities which efficient energy services in a more efficient way.

The concept of Virtual Power Plant (VPP) can be described as a generalization of the aggregation of DG units. VPPs are described in [100] as the highest level of aggregation of DG units:

- The reference level is the case without aggregation, where each local generation plant output power is regulated through bilateral contracts;
- The first level is the simple aggregation of DG plants. Considering RES units, this level corresponds to the combination described in section 2.3.2. Such aggregation is a way to reduce the imbalance penalties and the intermittency of the RES output power.
- The following level is the aggregation of different types of Distributed Energy Resources (DER) units into VPP. The considered DER can be either generators or controllable loads connected to the network [15]. In this context, controllable electrical loads, which are combined with generation units, improve the controllability of the whole system; they are thus viewed as distributed “energy resources”.

It is important to note that the term of Virtual Power Plant can be used in the power system area with a different meaning. In particular, it is also used to denote the access provided by predominant utilities of generation capacity to competitors. For example, such access to competitors is a measure that was asked to EDF by the European Union, which judged EDF to be anti-competitive in the French electricity market. For further details, the interested reader may refer to [101]. Similarly, in Belgium, antitrust authorities obliged the incumbent to sell financial Virtual Power Plants, while in the Netherlands regulators have been discussing the use of physical

Virtual Power Plants [102]. The sense given to the concept of VPP is different from the one given by [99], which is the one adopted for the present work.

Integration of a virtual power plant in electricity markets From the definition in the previous section, a VPP can be described as an IPP having a portfolio which includes a number of Distributed Energy Resources (DER). DER can be DG units and controllable load units. The DER aggregation into VPP takes place through Information and Communication Technology (ICT). The significant developments in ICT have led to new forms of DER control and electricity market interfaces; advanced ICT architectures are now able to cope with the increasing complexity of interaction required to facilitate decentralized system management and VPP activity.

Two different aspects of the VPP are considered in [20]. The VPP can first be used to facilitate DER trading in wholesale energy markets. This activity relative to market participation is denoted as *commercial* VPP activity. The VPP can also facilitate the technical integration of DER in power systems. This activity relative to system management refers to the *technical* VPP.

- The general goal of a technical VPP is to manage DER for providing as much ancillary and network management services as the conventional generators do. Such services include various types of reserve, frequency and voltage regulation. The technical VPP activity consists in internally dispatching power and energy flows from the units included in the VPP, for providing these ancillary services in an efficient way, and also for managing technical issues which can arise when integrating DER in power systems. These issues include for example network congestions and voltage variations.
- A commercial VPP is a representation of a portfolio of DER that can be used to participate in energy markets as a single IPP, and which thus facilitates the participation of DG units in the electricity markets. Characteristics from the combined DER, such as generation schedules, generation limits or operating costs, are aggregated into a single profile of characteristics. Commercial VPPs reduce the imbalance risk associated to individual participation in the market and benefits from diversity of resource and increased capacity achieved through aggregation. In the framework associated to such VPP, the energy imbalance has to be considered for the whole portfolio, and not for the individual units. The energy imbalance of individual units can be internally compensated, which reduces the imbalance management cost, and thus increases the revenue. Also, within a commercial VPP, DER units can achieve economies of scale in market participation and benefit from intelligence on market participation to maximize

revenue opportunities. An illustration of the concept of commercial VPP is given in Figure 2.6. In this scheme, the VPP includes several RES units, an energy storage device and a conventional generation plant.

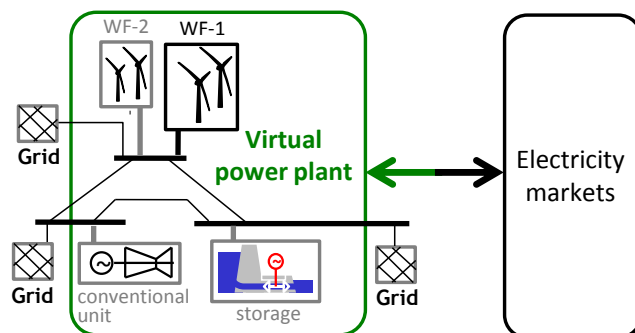

Figure 2.6: Description of a commercial VPP which includes RES

A commercial VPP can combine DER from any geographic location in the system if the contracts do not consider any locational constraints. However, for locational marginal pricing-based markets or for market where a zonal approach is considered, the CVPP portfolio will be restricted to include only DER from the same distribution network area or transmission network node.

The VPP concept fits in with the different solutions relative to the management of the delivered energy, which have been described in section 2.3.2. The combination of the RES units with either other RES units, storage units or conventional DG units can be considered as three distinct VPP configurations.

However, many questions still remain open about the practical business operation of a VPP: the concept of unit aggregation to participate in a market is described but there is still some uncertainty about contractual issues. The commercial and regulatory framework is not clearly defined. Controllability and compulsory services offered by VPP needs to be clarified. Most VPP projects are still research or demonstration projects.

Research and demonstration projects about virtual power plants Several research and development projects and demonstration projects about VPP have been carried out in the last years.

The FENIX project is a R&D European collaborative project, partly funded by the European Union within the 6th Framework Programme for Research [20, 103]². The aim of this project is to design and demonstrate a technical architecture

²The acronym FENIX stands for Flexible Electricity Networks to Integrate the eXpected energy evolution.

and commercial framework which would enable DER based systems to be further integrated in power systems. The FENIX approach is to fully integrate a large number of different DER technologies, responsive loads and storage devices using the concept of a large-scale Virtual Power Plant. A large-scale VPP has a resulting flexibility and controllability similar to large conventional power plants.

The Imbalance Reduction System (IRS) is a project which was developed to minimize the energy imbalance of a VPP [104]. The VPP portfolio considered consists of two wind farms combined with DER which are industrial and residential consumers and producers: Combined Heat and Power (CHP) for district heating, residential heat pumps, industrial cold store, emergency generators. The two wind farms operate on the day-ahead market using wind power prediction. Imbalance energy between the delivered wind energy and the contracted energy are balanced (when possible) by the DER. IRS uses the PowerMatcher concept, which is a coordination system for supply and demand of electricity. It is a multi-agent system which combines microeconomic principles [105]. The benefits in terms of reduction of imbalance are presented in [104].

The Renewable Combi-Plant is a demonstration project carried out by the German Renewable Energy Agency [106]. This VPP aggregates and controls the power generation of distributed wind farms, photovoltaic plants, biogas-fired CHP and a pumped-hydro storage device in such a way that the output matches a specified load at each time. The generation of the different plants is balanced with a typical energy demand for Germany. The difference between the load and the generation mix of wind farms and photovoltaic plants is compensated by fast controllable biogas-fired CHP plants and the pumped-hydro storage device. The wind farms are controlled to avoid extreme gradients and generation peaks. The algorithms created for the concept were verified and a prototype of this VPP is in operation since May 2007. The scenarios, concepts, algorithms and the results of the pilot phase are described in [107].

2.4 Conclusions

Physical and financial solutions are two approaches with a common goal: reducing the imbalance penalty.

The physical solutions impact the real power system and the delivered energy by the generation units. Each physical solution is related to a technical solution: the control of the RES output is related to the technology of the RES unit; the RES aggregation and the combination with storage or with a conventional unit consists in including additional generation units in the generation portfolio. Also, the virtual power plant concept offers this possibility to manage a portfolio of renewable units

as a conventional unit. In the past, renewable generation used to benefit from exceptions in order to facilitate its development. These exceptions are technical, such as the exclusion of some requirements regarding grid codes, or economic such as the establishment of feed-in tariff as a support mechanism. However, the large scale integration of renewable generation forces the renewable generation to be treated as conventional power plants [83].

Financial solutions leave the physical system unchanged. These solutions consist in modifying the contractual position of the IPP. Instead of modifying the power unit portfolio for providing services to integrate the renewable generation characteristics, financial solutions consist in buying this service from other market participants through electricity markets. The investment related to technical solutions is avoided.

A comparison between physical and financial solutions for the management of imbalance is proposed in [108]. In this study, the solution consisting in combining a wind farm with pumped-hydro storage is compared to the solution consisting in using call options. The study demonstrated the similarities between the physical and the financial solutions for the management of imbalance, from an IPP point of view.

Following this classification of solutions in this chapter, the aim is then to define a unified formulation of the imbalance penalty resulting from each of these solutions. This is proposed in the following chapter.

Development of a Generic Model for the Participation of Renewable Generation in Electricity Markets

Chapter overview

This chapter proposes a formulation of the imbalance penalty model for a power producer including renewable generation. The case of participation in an electricity market as a balance responsible party is considered. The formulation of the imbalance penalty is first given for the reference case of the participation in a day-ahead market. The imbalance settlement is modeled as a penalization function. Then, the financial and physical solutions for managing the imbalances, which have been presented in the previous chapter, are modeled as a modification of the reference penalization function in the sections 3.2 and 3.3 respectively. In particular, a generic model of commercial virtual power plant is proposed for the physical solutions. The proposed model relies on a generic formulation which is valid for both physical and financial solutions, and which can be extended to a combination of these solutions. The imbalance reduction relative to the use of each solution is assessed through a case study using real-world data.

3.1 Formulation of the imbalance penalty

3.1.1 Main hypotheses

Hypotheses about the Independent Power Producer

The Independent Power Producer (IPP) considered hereafter includes Renewable Energy Sources (RES) generation units in its portfolio. More precisely, it is supposed to include a main RES unit with stochastic output. This unit can be a wind farm or a PV power plant. This is denoted as “reference unit”. Different generation units can be combined with the reference unit; each combination results in a specific IPP configuration.

In the thesis, “the reference unit” which will be used for the evaluation of the proposed formulations and methods, is taken to be a wind farm. This can be justified by the fact that wind power has been the fastest growing RES and, consequently, specific attention is paid to the management of uncertainties related to the power generation from this specific RES. However, it is important to note that the general approach followed in this thesis is generic, and can thus be directly applied to other renewable energy sources, such as PV.

The reference configuration is when the IPP is only composed of the main RES unit. The IPP is in this case the wind farm or PV plant operator, which participates in the electricity market for trading its production. When the reference unit is combined with other units, the resulting unit combination is considered as a commercial Virtual Power Plant (VPP) as described in section 2.3.2. The IPP is then the operator of such VPP. Three VPP configurations are considered, corresponding to three proposed physical solutions for the management of imbalances in section 2.3.2. The first VPP configuration is the aggregation of RES units, the second is the combination of the reference RES unit with an energy storage device, and the third is the combination of the reference RES unit with a conventional dispatchable unit.

Hypotheses about electricity markets

The participation of the IPP in the day-ahead market is taken as the **reference** participation. In general, the electricity market is assumed to include an intraday market and market derivative trading. The participation in the intraday market and the trade of options are considered as two alternatives and correspond to the two proposed financial solutions for the management of imbalances presented in section 2.3.1. The additional trading in the intraday market or the additional option trading will be evaluated as a function of the reference case which is the participation only in the day-ahead market.

The management of the real-time operation of the power system is ensured by the Transmission System Operator (TSO). Imbalances on the TSO's control area are counterbalanced through a real-time market. The imbalance settlement is assumed to be based on a dual pricing mechanism, where a different price is applied to positive imbalance volumes and negative imbalance volumes (as explained in section 2.2.5). The IPP does not propose any bid for participating in the real-time market. However, the IPP is a Balance Responsible Party and is thus economically responsible for the regulation measures taken by the TSO to counterbalance its imbalance.

3.1.2 Formulation of the participation in the day-ahead market

Formulation of the reference penalization function

The revenue of an IPP which participates in an electricity market can be formulated as the sum of the incomes from the contracts on the day-ahead and intraday markets, and of the incomes from the real-time market; the contracts are established in markets which take place prior to the delivery. Such market revenue decomposition can be found in [62,67,68]. It is important to note that this revenue is related to the participation in the electricity market, and does not include any other income such as the ones that could be associated with the supply of ancillary services. Also, the operating and maintenance costs, as well as the investment costs are not included in the market revenue.

For a given market time unit T_i , the energy contract resulting from the day-ahead market participation consists in an energy volume $E_{T_i}^{\text{DA}}$ traded at a price $\Pi_{T_i}^{\text{DA}}$. Also, in the real-time market, the price for positive imbalance for the same time unit T_i is $\Pi_{T_i}^+$ and the price for negative imbalance is $\Pi_{T_i}^-$. The imbalance volume at the delivery is defined as the difference between the energy \tilde{E}_{T_i} delivered during the period T_i and the contracted energy $E_{T_i}^{\text{C}}$. In the reference case, the contracted energy is the energy contract volume in the day-ahead market $E_{T_i}^{\text{C}} = E_{T_i}^{\text{DA}}$. However, such contracted energy more generally includes all the contracted volumes prior to real-time delivery. Consequently, the revenue $R_{T_i}^{\text{DA}}$ relative to the time period T_i can be written as the sum of the income which results from the day-ahead trading of the energy volume $E_{T_i}^{\text{DA}}$ at the price $\Pi_{T_i}^{\text{DA}}$ and the income which results from the imbalance volume $(\tilde{E}_{T_i} - E_{T_i}^{\text{C}})$ in the real-time market.

$$R_{T_i}^{\text{DA}} = E_{T_i}^{\text{DA}} \times \Pi_{T_i}^{\text{DA}} + (\tilde{E}_{T_i} - E_{T_i}^{\text{C}}) \times \Pi_{T_i}^{+/-} \quad (3.1)$$

with

$$\begin{cases} \Pi_{T_i}^{+/-} = \Pi_{T_i}^- \Leftarrow \tilde{E}_{T_i} < E_{T_i}^C \text{ (negative imbalance)} \\ \Pi_{T_i}^{+/-} = \Pi_{T_i}^+ \Leftarrow \tilde{E}_{T_i} \geq E_{T_i}^C \text{ (positive imbalance)} \end{cases} \quad (3.2)$$

In order to simplify the mathematical expressions, the index which refers to the considered time period T_i is omitted in the following equations. Also, the contracted energy E^C equals the day-ahead energy contract E^{DA} in this case, and the revenue R^{DA} can be rewritten as:

$$R^{\text{DA}} = E^{\text{DA}} \times \Pi^{\text{DA}} + (\tilde{E} - E^{\text{DA}}) \times \Pi^{+/-} \quad (3.3)$$

$$= \tilde{E} \times \Pi^{\text{DA}} + (E^{\text{DA}} - \tilde{E}) \times \Pi^{\text{DA}} + (\tilde{E} - E^{\text{DA}}) \times \Pi^{+/-} \quad (3.4)$$

$$= \underbrace{\tilde{E} \times \Pi^{\text{DA}}}_a + \underbrace{(E^{\text{DA}} - \tilde{E}) \times (\Pi^{+/-} - \Pi^{\text{DA}})}_b \quad (3.5)$$

In the formulation given in Equation 3.5, the market revenue is formulated as the sum of the income resulting from the delivered energy \tilde{E} (part a) and a function of the imbalance volume (part b). In this second part of the formulation, the imbalance volume is multiplied by the difference between the imbalance price and the day-ahead price, also called spot price. The interest of this formulation is related to the design of the balancing market. In the so called **dual-price imbalance price settlement**, a different price is applied to positive and negative imbalance volumes, and the price for positive imbalance is lower than the spot price while the price for negative imbalance is higher than the spot price, as explained in section 2.2.5. Consequently, for such balancing market design, when the imbalance volume is positive, the difference between the imbalance price and the spot price is negative ($(\Pi^+ - \Pi^{\text{DA}}) \leq 0$), and, when imbalance volume is negative, the difference between the imbalance price and the spot price is positive ($(\Pi^- - \Pi^{\text{DA}}) \geq 0$). Also the part b of the formulation given in Equation 3.5 is always negative. From this analysis, the market revenue can be formulated as:

$$R^{\text{DA}} = \tilde{E} \times \Pi^{\text{DA}} - \delta^{\text{DA}} \left(\tilde{E}, E^{\text{DA}} \right) \quad (3.6)$$

where δ^{DA} is a function of the delivered and contracted energy $\left(\tilde{E}, E^{\text{DA}} \right)$ which is formulated as:

$$\begin{aligned}
 \delta^{\text{DA}}(\tilde{E}, E^{\text{DA}}) &= \begin{cases} (\tilde{E} - E^{\text{DA}}) \times (\Pi^{\text{DA}} - \Pi^-) \Leftarrow \tilde{E} < E^{\text{DA}} \\ (\tilde{E} - E^{\text{DA}}) \times (\Pi^{\text{DA}} - \Pi^+) \Leftarrow \tilde{E} \geq E^{\text{DA}} \end{cases} \\
 &= |\tilde{E} - E^{\text{DA}}| \times \Delta^{\Pi}
 \end{aligned} \tag{3.7}$$

with

$$\Delta^{\Pi} = \begin{cases} \Delta_{-}^{\Pi} = \Pi^- - \Pi^{\text{DA}} \Leftarrow \tilde{E} < E^{\text{DA}} \\ \Delta_{+}^{\Pi} = \Pi^{\text{DA}} - \Pi^+ \Leftarrow \tilde{E} \geq E^{\text{DA}} \end{cases} \quad \text{with} \quad \Pi^+ \leq \Pi^{\text{DA}} \leq \Pi^- \tag{3.8}$$

In this formulation, the price Δ^{Π} is positive and, consequently, the function δ^{DA} is positive. This can be interpreted as the penalization function of the real-time imbalance relative the participation in the day-ahead market. This penalization is coherent with balancing market design aiming at encouraging market participants to minimize imbalance energy volumes. Also, in case of no imbalance, this penalization function equals zero and the market revenue equals the contract income.

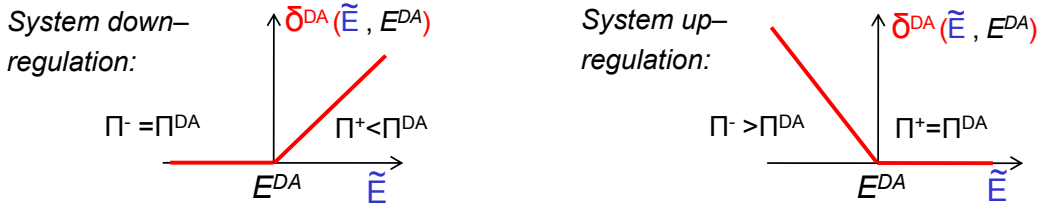

Figure 3.1: Examples of the penalization function δ^{DA} in the case of a dual-price imbalance price settlement.

A graphical example of the function δ^{DA} is given in Figure 3.1 in the case of dual-price imbalance price settlement. The values of the function δ^{DA} are represented for a constant contracted energy E^{DA} and a variable delivered energy \tilde{E} . Consequently, the represented function δ^{DA} is a function of only one variable \tilde{E} . A distinction is made between TSO up-regulation and down-regulation states: when the TSO is down-regulating, only positive imbalance are penalized. These imbalances are said to be “in the direction” as the TSO regulation state. Conversely, when the TSO is up-regulating, the imbalances in the direction as the TSO regulation state, are the negative ones and are thus penalized.

Main properties of the penalization function

If the price for negative imbalance is higher than the spot price and the price for negative imbalance lower than the spot price, the imbalance penalization function δ^{DA} can be written as:

$$\delta^{\text{DA}}(x, y) = \begin{cases} a \times |x - y| & \Leftarrow x < y \\ b \times |x - y| & \Leftarrow x \geq y \end{cases} \quad (3.9)$$

with $a, b \geq 0$.

The function $\delta^{\text{DA}}: \mathbb{R}^2 \rightarrow \mathbb{R}$ is a real-valued function on \mathbb{R}^2 satisfying the following properties:

- Non-negativity: for all $(x, y) \in \mathbb{R}^2$, $\delta^{\text{DA}}(x, y) \geq 0$;
- Homogeneity: for all $(x, y) \in \mathbb{R}^2$, and all $\lambda \geq 0$,
 $\lambda \cdot \delta^{\text{DA}}(x, y) = \delta^{\text{DA}}(\lambda \cdot (x, y)) = \delta^{\text{DA}}(\lambda \cdot x, \lambda \cdot y)$;
- Triangle inequality: for all $(x_1, y_1), (x_2, y_2) \in \mathbb{R}^2$,
 $\delta^{\text{DA}}((x_1, y_1) + (x_2, y_2)) \leq \delta^{\text{DA}}(x_1, y_1) + \delta^{\text{DA}}(x_2, y_2)$,
 where $(x_1, y_1) + (x_2, y_2) = (x_1 + x_2, y_1 + y_2)$.

The first two properties are straightforwardly derived from Equation 3.9. The triangle inequality property is demonstrated by considering all the different possible values of x_1, y_1, x_2 and y_2 . These properties characterize the function δ^{DA} as an *asymmetric seminorm*, as defined in [109]. If $a > 0$ and $b > 0$, the function δ^{DA} has the following additional property:

- Positive definiteness:
 $\delta^{\text{DA}}(x, y) = 0$ if and only if $x = y$.

When this additional property is verified, the function is a norm, while when it is not verified, the function is a seminorm. The concept of asymmetric norms or seminorms is a generalization of the concept of a norm.

In addition to being an asymmetric seminorm, the function δ^{DA} has also the following property, denoted as anti-symmetry:

- Anti-symmetry:
 for all $a \in \mathbb{R}$, $\delta^{\text{DA}}(x + a, y) = \delta^{\text{DA}}(x, y - a)$.

3.2 Modeling the imbalance management based on financial solutions

3.2.1 Formulation of the sequential participation in day-ahead and intraday markets

This section proposes a formulation of the market revenue of an IPP who participates sequentially in the day-ahead market and in the corresponding intraday market. In this case, the market revenue is the sum of the incomes from the contracts established in the day-ahead and intraday markets and the incomes from the real-time market. The additional energy contract in the intraday market consists in an energy volume E^{ID} traded at the price Π^{ID} . Consequently, the energy contract volume is the sum of the energy volumes from both the day-ahead and the intraday markets: $E^{\text{C}} = E^{\text{DA}} + E^{\text{ID}}$. The revenue $R_{\text{ID}}^{\text{DA}}$ is formulated as:

$$R_{\text{ID}}^{\text{DA}} = E^{\text{DA}} \times \Pi^{\text{DA}} + E^{\text{ID}} \times \Pi^{\text{ID}} + (\tilde{E} - E^{\text{C}}) \times \Pi^{+/-} \quad (3.10)$$

The revenue can be reformulated as:

$$\begin{aligned} R_{\text{ID}}^{\text{DA}} &= \tilde{E} \times \Pi^{\text{DA}} + E^{\text{ID}} \times (\Pi^{\text{ID}} - \Pi^{\text{DA}}) + (E^{\text{DA}} + E^{\text{ID}} - \tilde{E}) \times \Pi^{\text{DA}} \\ &\quad + (\tilde{E} - E^{\text{C}}) \times \Pi^{+/-} \\ &= \tilde{E} \times \Pi^{\text{DA}} - E^{\text{ID}} \times (\Pi^{\text{DA}} - \Pi^{\text{ID}}) \\ &\quad - (\tilde{E} - E^{\text{C}}) \times \Pi^{\text{DA}} + (\tilde{E} - E^{\text{C}}) \times \Pi^{+/-} \\ &= \tilde{E} \times \Pi^{\text{DA}} - E^{\text{ID}} \times (\Pi^{\text{DA}} - \Pi^{\text{ID}}) \\ &\quad - (\tilde{E} - E^{\text{DA}} - E^{\text{ID}}) \times (\Pi^{\text{DA}} - \Pi^{+/-}) \\ &= \tilde{E} \times \Pi^{\text{DA}} - E^{\text{ID}} \times (\Pi^{\text{DA}} - \Pi^{\text{ID}}) - \delta^{\text{DA}}(\tilde{E}, E^{\text{DA}} + E^{\text{ID}}) \end{aligned} \quad (3.11)$$

Finally, the revenue from the combined participation in the day-ahead and intraday markets can be written in a similar formulation as Equation 3.6:

$$R_{\text{ID}}^{\text{DA}} = \tilde{E} \times \Pi^{\text{DA}} - \delta_{\text{ID}}^{\text{DA}}(\tilde{E}, E^{\text{DA}}) \quad (3.12)$$

with

$$\delta_{\text{ID}}^{\text{DA}}(\tilde{E}, E^{\text{DA}}) = E^{\text{ID}} \times (\Pi^{\text{DA}} - \Pi^{\text{ID}}) + \delta^{\text{DA}}(\tilde{E}, E^{\text{DA}} + E^{\text{ID}}) \quad (3.13)$$

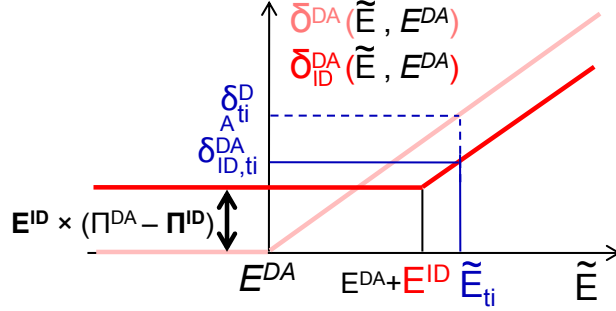

Figure 3.2: Imbalance penalization for the combined participation in the day-ahead and intraday markets, in the case of a dual-price imbalance price settlement, when the TSO is down-regulating.

From Equation 3.13, the additional participation in the intraday market can be interpreted as a modification of the reference penalization function δ^{DA} . The modification of the penalization function is illustrated in Figure 3.2. The presented example corresponds to a dual-price imbalance price settlement, where the TSO is down-regulating. The functions $\delta^{\text{DA}}(\tilde{E}, E^{\text{DA}})$ and $\delta_{\text{ID}}^{\text{DA}}(\tilde{E}, E^{\text{DA}})$ are functions of the delivered energy \tilde{E} . In the case of the participation only in the day-ahead market, only positive imbalance volumes are penalized, as described with the function δ^{DA} . The modification of the penalization function comports two aspects: the first term $E^{\text{ID}} \times (\Pi^{\text{DA}} - \Pi^{\text{ID}})$ is a constant cost added to the function δ^{DA} and the second term $\delta^{\text{DA}}(\tilde{E}, E^{\text{DA}} + E^{\text{ID}})$ corresponds to a variable change of the δ^{DA} function, which is represented as a shift by E^{ID} . Reducing the imbalance penalty can be graphically interpreted as getting the function $\delta_{\text{ID}}^{\text{DA}}$ lower than δ^{DA} . Such reduction is illustrated in Equation 3.13 for a delivered energy \tilde{E}_{T_i} at a given time T_i . The penalty $\delta_{T_i}^{\text{DA}}$ obtained when participating only in the day-ahead market is reduced to $\delta_{\text{ID}, T_i}^{\text{DA}}$ with the intraday participation. It is important to note that the sign of the constant cost depends on the contracted volume and the price in the intraday market. In Equation 3.13, the energy contract E^{ID} is taken positive, and the intraday market price is taken lower than the day-ahead market price $\Pi^{\text{DA}} < \Pi^{\text{ID}}$, which results to a positive constant cost.

The figure 3.2 shows a reduction of imbalance for a delivered energy \tilde{E}_{T_i} . However, the combined participation in the intraday market leads to an increase of the imbalance penalty for negative values of delivered energy, where the red plot is higher than the pink plot. More generally, Figure 3.3 presents the impact of the participation in intraday market on the reduction of imbalance as a function of the contracted volume E^{ID} and the price Π^{ID} in the intraday market. This figure aims at determining the $(\Pi^{\text{ID}}, E^{\text{ID}})$ combinations which reduce the imbalance penalty resulting from the day-ahead market participation. Note that these combinations $(\Pi^{\text{ID}}, E^{\text{ID}})$

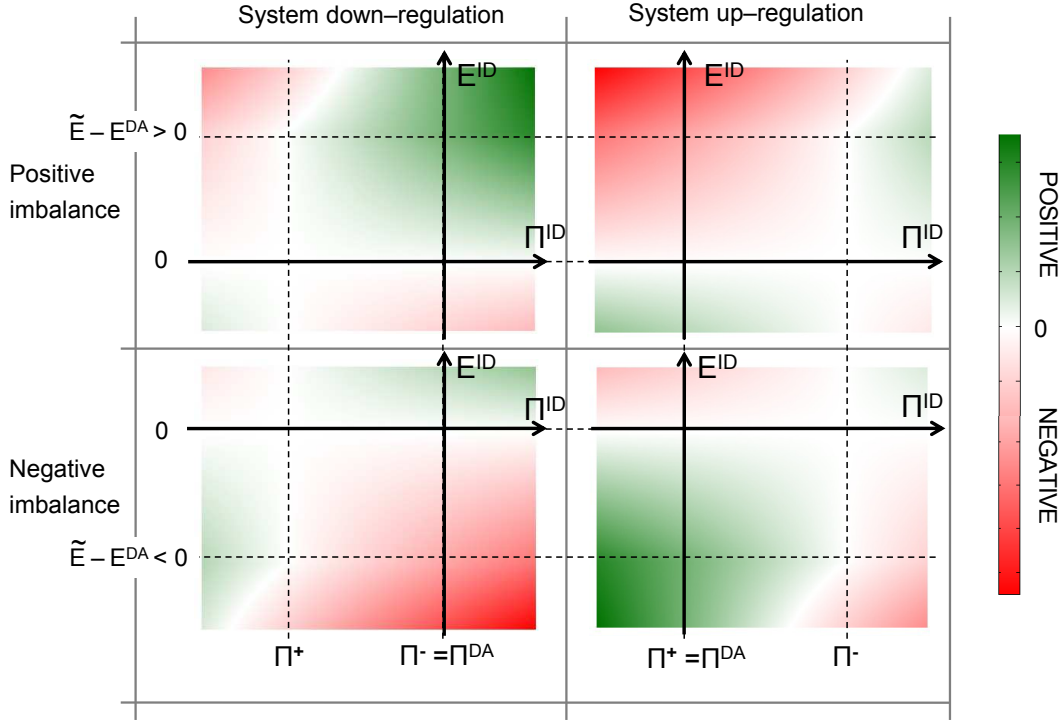

Figure 3.3: Imbalance penalty reduction resulting from the combined participation in the day-ahead and intraday markets: $\delta^{DA} - \delta_{ID}^{DA}$.

result from the intraday bid, and are thus established prior to delivery, when the IPP does not know if the system will be down or up regulating. The imbalance reduction is measured through the difference between the imbalance penalty from the day-ahead participation and the imbalance penalty obtained in the combined participation in day-ahead and intraday markets: $\delta^{DA} - \delta_{ID}^{DA}$. The (Π^{ID}, E^{ID}) combinations corresponding to a positive reduction ($\delta_{ID}^{DA} \leq \delta^{DA}$) are represented in green. Conversely, the combinations corresponding to a negative reduction (i.e. penalty increase: $\delta_{ID}^{DA} \geq \delta^{DA}$) are represented in red. A distinction is made between up and down regulation from the TSO, and also between positive and negative imbalance between the delivered energy and the day-ahead contract $\tilde{E} - E^{DA}$. These distinctions lead to four cases. In each case, the intraday contract volume is taken positive when energy is sold in the market and negative when energy is bought from the market.

As a first general comment, it can be observed that the participation in intraday market can result to either a decrease or an increase of the imbalance penalties. The volume E^{ID} and price Π^{ID} combinations resulting in imbalance penalty increase correspond to a decrease of revenue, and have to be avoided. The two main positive

areas are:

- The case of positive imbalance in a down-regulation system state (top left). In this case, the intraday market offers the possibility to sell energy when the delivered energy is expected to be higher than the day-ahead energy contract;
- The case of negative imbalance in a up-regulation system state (down right). In this case, the intraday market offers the possibility to buy energy when the delivered energy is expected to be lower than the day-ahead energy contract.

3.2.2 Formulation of the trading of electricity market derivatives: the case of options

As already mentioned in section 2.3.1, options are market derivatives which give the owner the right to adjust its contractual position. They may be complex derivatives, but they usually contain the following specifications [45]:

- Options can be *call* options when the option holder has the right to buy, or *put* options when the option holder has the right to sell;
- Options are relative to a quantity of a given *underlying*. Here, the underlying is electrical energy, and the quantity is denoted as E^{Op} ;
- The *strike* price Π^K , also denoted as the exercise price, is the price at which the underlying transaction will occur upon exercise;
- The *premium* Π^P is the price paid by the holder of an option to get the option.

An option is said to be *exercised* when the holder uses his right to buy (sell) electricity in the case of call (put) option. Also, options have an expiration date, or expiry, which is the last date the option can be exercised. If the option is exercised, the traded volume $E^{Op,*}$ equals the underlying quantity E^{Op} : $E^{Op,*} = E^{Op}$. If the option is not exercised, the traded volume is zero: $E^{Op,*} = 0$.

Call options can be used to manage negative imbalance: they can be exercised when the delivered energy is lower than the contracted energy. The underlying quantity E^{Op} is taken positive when the IPP buys electricity in the option market. Similarly, put options can be used to manage positive imbalance. The underlying quantity E^{Op} is then negative.

The benefits from option trading for an IPP are formulated here considering as reference the day-ahead market participation. The revenue R_{Op}^{DA} from the combined option trading and day-ahead trading can be formulated as:

$$R_{Op}^{DA} = E^{DA} \times \Pi^{DA} - \Pi^P + E^{Op,*} \times \Pi^K + (\tilde{E} - E^C) \times \Pi^{+/-} \quad (3.14)$$

where the energy contract volume is the sum of the energy volumes from both day-ahead trading and option trading: $E^C = E^{DA} + E^{Op,*}$. In a similar way as in Equation 3.11, this revenue can be reformulated as:

$$R_{Op}^{DA} = \tilde{E} \times \Pi^{DA} - \delta_{Op}^{DA}(\tilde{E}, E^{DA}) \quad (3.15)$$

with

$$\delta_{Op}^{DA}(\tilde{E}, E^{DA}) = \Pi^P + E^{Op,*} \times (\Pi^{DA} - \Pi^K) + \delta^{DA}(\tilde{E}, E^{DA} + E^{Op,*}) \quad (3.16)$$

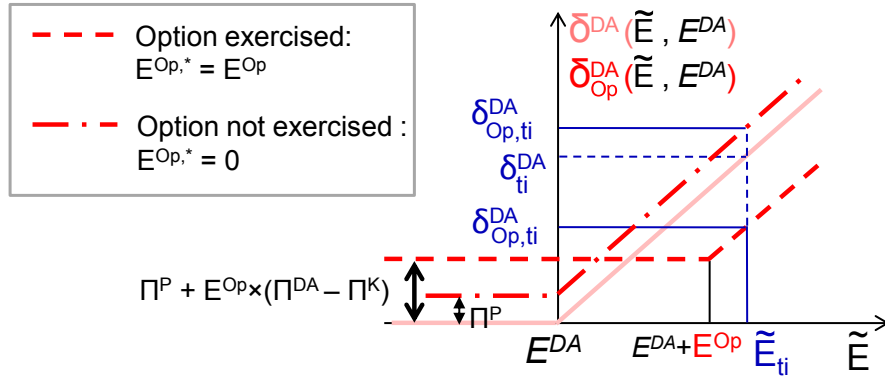

Figure 3.4: Imbalance penalty for the participation in the day-ahead market with a call option.

From the last Equation 3.16, the option trading can be also interpreted as a modification of the penalization function δ^{DA} . The additional constant cost equals $\Pi^P + E^{Op,*} \times (\Pi^{DA} - \Pi^K)$ and the function δ^{DA} is shifted by $E^{Op,*}$.

Figure 3.4 illustrates the modification of the penalization function resulting from the trading of a call option in a down-regulating system, with a constant contracted energy E^{DA} . The strike price is taken inferior to the day-ahead price. Two cases are presented, depending on if the option is exercised or not. In the example, the delivered energy at a given time T_i is \tilde{E}_{T_i} , which is higher than the contracted energy in the day-ahead market E^{DA} . The resulting imbalance is positive. When the option is exercised, the resulting imbalance penalty δ_{Op,T_i}^{DA} is reduced. On the contrary, the imbalance penalty is increased by the premium Π^P if the option is not exercised. However, in the case of negative imbalance, the penalty is higher when the option is activated compared to when the option is not activated. The premium is the price to pay by the IPP for having the possibility to reduce its imbalance penalty just before delivery.

The imbalance reduction depends on the energy quantity E^{Op} , the premium Π^P and the strike price Π^K . The influence of these three parameters on the imbalance penalty reduction could be represented similarly to Figure 3.3 for the intraday market participation.

The proposed formulation of the option trading for reducing the imbalance penalties is based on the assumption that these derivatives are available in the market. However, today, the proposed options only refer to long-term contracts, and are consequently not adapted to the short-term imbalance management problem. Consequently, the solution relative to the option trading remain theoretical, which explains why *this solution is not further considered in the present thesis*.

However, short-term options or similar products could rapidly appear in electricity markets as possible tools for the management of stochastic generation in electricity markets. Also, the general concept of premium, which quantifies the additional cost for having the right to activate a solution, can be extended to the case of physical solutions for reducing the imbalance penalties. These similarities between financial and physical solutions are further detailed in the next sections.

3.3 Modeling the imbalance management based on physical solutions

This section proposes a generic formulation of the solutions relative to the management of the **delivered energy** which reduce imbalance penalties for an IPP operating RES units. These solutions are physical solutions, as opposed to the financial solutions formulated in the previous section for the contracted energy. As already detailed in section 2.3.2, they include the control of the RES generation, the aggregation of RES units as well as the combination of RES units with an energy storage device or with a dispatchable generation unit.

3.3.1 Formulation of the control of renewable generation

The control of renewable generation consists in the possibility to decrease or increase the renewable generation and is a solution for reducing the imbalance penalties. Generation control methods have been presented in section 2.3.2.

The formulation of the imbalance penalty when using the generation control solution is given for the participation of reference RES unit with a contracted volume E^C and a delivered volume before control \tilde{E} . The delivered energy \tilde{E} is considered as the available output energy which can be obtained from the RES plant given the meteorological conditions and technical constraints, for a given market time unit.

Two cases are examined: the decrease and the increase of the renewable generation. In the case of generation decrease, also called down-regulation, the RES generation is reduced from \tilde{E} to $\tilde{E} - \tilde{E}_{dw}$, where \tilde{E}_{dw} is positive. Regarding the case of generation increase, it has been explained in section 2.3.2 that such an increase is possible only if the production has already been previously decreased. For example, it is possible to increase the production from a wind farm either if at least one of the turbines was shut down so that it can be switched on for increasing the production, or if the generation output from some of the turbines was limited so that it can be increased. The limited delivered energy is denoted as \tilde{E}_l and is lower than the energy delivered in the reference case \tilde{E} . Then, the generation increase consists in increasing the generation to $\tilde{E}_l + \tilde{E}_{up}$, where \tilde{E}_{up} is positive. Such increased generation $\tilde{E}_l + \tilde{E}_{up}$ is inferior to \tilde{E} , which gives:

$$0 \leq \tilde{E}_{up} \leq (\tilde{E} - \tilde{E}_l) \quad (3.17)$$

In other words, a generation increase of \tilde{E}_{up} in case of limited energy \tilde{E}_l is equivalent, in terms of delivered energy, to a generation decrease $\tilde{E}_{dw,eq}$ given by:

$$\tilde{E} - \tilde{E}_{dw,eq} = \tilde{E}_l + \tilde{E}_{up} \Leftrightarrow \tilde{E}_{dw,eq} = \tilde{E} - (\tilde{E}_l + \tilde{E}_{up}) \quad (3.18)$$

Consequently, the generation increase is taken as a particular case of down-regulation for the following formulation.

The revenue from the market participation in the day-ahead market in case of down-regulation can be written as:

$$\begin{aligned} R_{dw}^{DA} &= (\tilde{E} - \tilde{E}_{dw}) \times \Pi^{DA} - \delta^{DA}(\tilde{E} - \tilde{E}_{dw}, E^{DA}) \\ &= \tilde{E} \times \Pi^{DA} - \tilde{E}_{dw} \times \Pi^{DA} - \delta^{DA}(\tilde{E} - \tilde{E}_{dw}, E^{DA}) \\ &= \tilde{E} \times \Pi^{DA} - \delta_{dw}^{DA}(\tilde{E}, E^{DA}) \end{aligned} \quad (3.19)$$

with

$$\delta_{dw}^{DA}(\tilde{E}, E^{DA}) = \tilde{E}_{dw} \times \Pi^{DA} + \delta^{DA}(\tilde{E} - \tilde{E}_{dw}, E^{DA}) \quad (3.20)$$

The RES generation control can thus be formulated as a modification of the reference penalization function δ^{DA} . When replacing the delivered energy \tilde{E} by the delivered energy using generation control ($\tilde{E} - \tilde{E}_{dw}$) in Equation 3.7, the penalization function δ_{dw}^{DA} can be rewritten as:

$$\begin{aligned}
\delta_{dw}^{\text{DA}}(\tilde{E}, E^{\text{DA}}) &= \tilde{E}_{dw} \times \Pi^{\text{DA}} + \begin{cases} (\tilde{E} - \tilde{E}_{dw} - E^{\text{DA}}) \times (\Pi^{\text{DA}} - \Pi^-) \Leftarrow (\tilde{E} - \tilde{E}_{dw}) < E^{\text{DA}} \\ (\tilde{E} - \tilde{E}_{dw} - E^{\text{DA}}) \times (\Pi^{\text{DA}} - \Pi^+) \Leftarrow (\tilde{E} - \tilde{E}_{dw}) \geq E^{\text{DA}} \end{cases} \\
&= \begin{cases} (\tilde{E} - E^{\text{DA}}) \times (\Pi^{\text{DA}} - \Pi^-) + \tilde{E}_{dw} \times \Pi^- \Leftarrow (\tilde{E} - \tilde{E}_{dw}) < E^{\text{DA}} \\ (\tilde{E} - E^{\text{DA}}) \times (\Pi^{\text{DA}} - \Pi^+) + \tilde{E}_{dw} \times \Pi^+ \Leftarrow (\tilde{E} - \tilde{E}_{dw}) \geq E^{\text{DA}} \end{cases} \\
&= \delta^{\text{DA}}(\tilde{E}, E^{\text{DA}}) + \begin{cases} \tilde{E}_{dw} \times \Pi^- \Leftarrow (\tilde{E} - \tilde{E}_{dw}) < E^{\text{DA}} \\ \tilde{E}_{dw} \times \Pi^+ \Leftarrow (\tilde{E} - \tilde{E}_{dw}) \geq E^{\text{DA}} \end{cases} \tag{3.21}
\end{aligned}$$

The energy quantity \tilde{E}_{dw} is taken positive in this formulation, and consequently, the imbalance with generation control δ_{dw}^{DA} will be lower than the reference imbalance δ^{DA} only for negative prices of electricity in the real-time market. Negative values of price for positive imbalance may occur, as already discussed in section 2.2.5, but very seldom. Consequently, control of renewable generation in general increases the imbalance penalties, which explains why *this solution is not further considered in the present thesis*.

However, generation control reduces the imbalance energy volumes, which can be a solution for other issues related to large scale integration of RES units in power systems described in section 1.3.2.

3.3.2 Generic model of a Virtual Power Plant

The other three physical solutions, which are the aggregation of RES units and the combination of RES units with an energy storage device or with a dispatchable generation unit, are modeled in the frame of a Virtual Power Plant (VPP), defined in section 2.3.2. The VPP is a framework for enhancing the visibility and control of distributed energy resources to system operators and other market actors by providing an appropriate interface between the involved system components. This concept is thus well suited to physical solutions. More precisely, focus is given to the Commercial activity of the VPP (CVPP). The CVPP is defined in section 2.3.2 as a representation of a portfolio of DER that can be used to participate in energy markets as a single IPP.

In the present work, different configurations of a VPP are considered, with each configuration corresponding to a specific physical solution. First, the reference configuration of the VPP includes only one reference RES unit. This unit has a stochastic output, and can be a wind farm or a PV plant for example. Then, three configurations are defined based on the combination of the reference RES unit (1) with other RES units in the case of aggregation, (2) with an energy storage device and

finally (3) with a dispatchable generation unit.

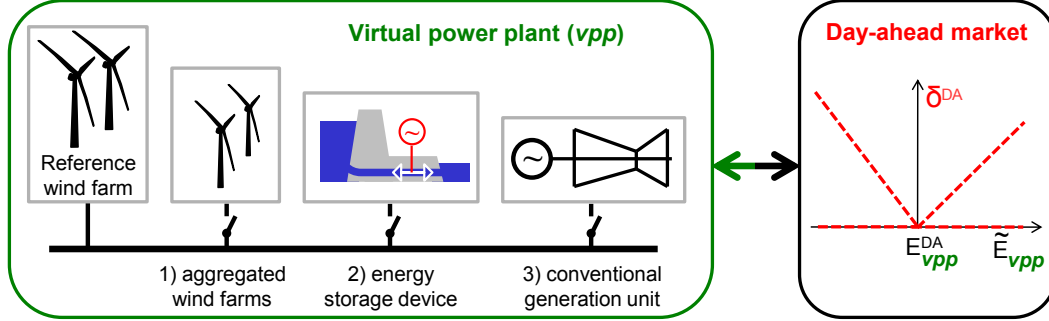

Figure 3.5: The proposed VPP model: three VPP configurations for participating in the day-ahead market.

In order to evaluate the benefits of each solution in terms of imbalance penalty reduction, all the VPP configurations are assumed to participate only in a day-ahead electricity. Figure 3.5 describes the three configurations of the VPP which participate in the day-ahead electricity market. Thus, similarly to section 3.2, the day-ahead market is taken here too as a reference. It is important to note that each configuration considers only one combination, in order to evaluate the imbalance reduction relative to each combination. Also, for each combination, a single-node model is used and the different generation units are assumed to be in the same bus. This model is also known as an HL1 (i.e.: Hierarchical Level 1) model [110] where the power system is analyzed from the generation facilities viewpoint.

In the frame of the VPP, there is only one day-ahead contract volume E_{VPP}^{DA} for all the units included in the VPP. The energy \tilde{E}_{VPP} delivered is the sum of the delivered energy by each generation unit. The aim of the next paragraphs is to model the physical solutions corresponding to the three VPP configurations as a modification of the reference penalization, as this has already been done for the financial solutions. These three configurations correspond to:

- The aggregation of RES unit;
- The combination of a RES unit with an energy storage device;
- The combination of a RES unit with a conventional unit.

3.3.3 Formulation of the imbalance penalty resulting from aggregation of RES units

The aggregation of RES units is the first VPP configuration considered in this thesis. In this case, the VPP is composed in total of n RES units, including the reference

RES unit. The energy \tilde{E}_{VPP} delivered by the VPP is the sum of the energy \tilde{E}_i which would be individually delivered by the RES units. Also, the VPP energy contract $E_{\text{VPP}}^{\text{DA}}$ of the aggregation is assumed to be equal to the sum of the contracts E_i^{DA} that the RES units would establish if they participated individually in the day-ahead market.

$$\tilde{E}_{\text{VPP}} = \sum_{i=1}^n \tilde{E}_i, \text{ and } E_{\text{VPP}}^{\text{DA}} = \sum_{i=1}^n E_i^{\text{DA}} \quad (3.22)$$

The following formulation demonstrates the reduction of imbalance penalties when the aggregated RES units participate as a single VPP in the day-ahead market, compared to the case where each RES unit participates individually. Then, this comparison will be used to derive the reduction of imbalance relative to only one of the RES unit (the reference one) which is included in the aggregation.

The revenue from the VPP is denoted as $R_{\text{VPP}}^{\text{DA}}$ while the sum of the revenues from individual units is denoted as $R_{\text{ind}}^{\text{DA}}$.

$$R_{\text{VPP}}^{\text{DA}} = \tilde{E}_{\text{VPP}} \times \Pi^{\text{DA}} - \delta^{\text{DA}}(\tilde{E}_{\text{VPP}}, E_{\text{VPP}}^{\text{DA}}) \quad (3.23)$$

$$R_{\text{ind}}^{\text{DA}} = \sum_{i=1}^n \left(\tilde{E}_i \times \Pi^{\text{DA}} - \delta^{\text{DA}}(\tilde{E}_i, E_i^{\text{DA}}) \right) \quad (3.24)$$

Consequently, the difference between the revenue from the aggregation and the one obtained when each RES unit participates individually in the market is given from Equation 3.23 and Equation 3.24 and from the definition of \tilde{E}_{VPP} and $E_{\text{VPP}}^{\text{DA}}$ in Equation 3.22.

$$R_{\text{VPP}}^{\text{DA}} - R_{\text{ind}}^{\text{DA}} = \sum_{i=1}^n \delta^{\text{DA}}(\tilde{E}_i, E_i^{\text{DA}}) - \delta^{\text{DA}}(\tilde{E}_{\text{VPP}}, E_{\text{VPP}}^{\text{DA}}) \quad (3.25)$$

$$= \sum_{i=1}^n \left(\delta^{\text{DA}}(\tilde{E}_i, E_i^{\text{DA}}) \right) - \delta^{\text{DA}} \left(\sum_{i=1}^n \tilde{E}_i, \sum_{i=1}^n E_i^{\text{DA}} \right) \quad (3.26)$$

Equation 3.26 shows that the revenue improvement in the case of aggregation is the difference between the sum of the penalties related to each RES unit imbalance and the penalty related to the sum of the imbalance. The sign of this difference depends on the penalization function properties. In section 3.1.2, the penalization δ^{DA} has been characterized as an asymmetric seminorm. One of the properties of a

asymmetric seminorm is the triangle inequality. Consequently, the quantity derived in Equation 3.26 is always positive, which means that the imbalance penalty in the case of aggregated units is always lower than the imbalance penalty relative to each unit taken individually.

The aim of the formulation is to derive the reduction of imbalance penalty for a given unit j when this unit is aggregated in the VPP. First, the part of the VPP revenue which is relative to the generation of the unit j is denoted as $R_{j,\text{agg}}^{\text{DA}}$. Note that this revenue could be more generally written as $R_{j,\text{VPP}}^{\text{DA}}$, but the VPP is in this case an aggregation, which explains why the index VPP is changed to agg . In the present formulation, the revenue from the aggregated units is allocated to the different units with respect to their delivered energy volume:

$$R_{j,\text{agg}}^{\text{DA}} = \alpha_j \times R_{\text{VPP}}^{\text{DA}}, \text{ with } \alpha_j = \frac{\tilde{E}_j}{\tilde{E}_{\text{VPP}}}, \sum \alpha_j = 1 \quad (3.27)$$

Consequently, the revenue relative to the generation of the unit j is formulated as:

$$\begin{aligned} R_{j,\text{agg}}^{\text{DA}} &= \alpha_j \times \left(\tilde{E}_{\text{VPP}} \times \Pi^{\text{DA}} - \delta^{\text{DA}}(\tilde{E}_{\text{VPP}}, E_{\text{VPP}}^{\text{DA}}) \right) \\ &= \alpha_j \times \tilde{E}_{\text{VPP}} \times \Pi^{\text{DA}} - \alpha_j \times \delta^{\text{DA}}(\tilde{E}_{\text{VPP}}, E_{\text{VPP}}^{\text{DA}}) \\ &= \tilde{E}_j \times \Pi^{\text{DA}} - \alpha_j \times \delta^{\text{DA}}(\tilde{E}_{\text{VPP}}, E_{\text{VPP}}^{\text{DA}}) \end{aligned} \quad (3.28)$$

In the considered VPP, only generation units are aggregated; consequently, the delivered volume \tilde{E}_j is positive for each unit j and α_j is positive for all j . Considering the homogeneity property of the function δ^{DA} detailed in section 3.1.2, the second term in Equation 3.28, which is relative to the imbalance penalty, can be written as follows:

$$\begin{aligned} \alpha_j \times \delta^{\text{DA}}(\tilde{E}_{\text{VPP}}, E_{\text{VPP}}^{\text{DA}}) &= \delta^{\text{DA}}(\alpha_j \times \tilde{E}_{\text{VPP}}, \alpha_j \times E_{\text{VPP}}^{\text{DA}}) \\ &= \delta^{\text{DA}}(\alpha_j \times \tilde{E}_{\text{VPP}}, \alpha_j \times E_{\text{VPP}}^{\text{DA}}) \\ &= \delta^{\text{DA}}(\tilde{E}_j, \alpha_j \times E_{\text{VPP}}^{\text{DA}}) \end{aligned} \quad (3.29)$$

Finally, the revenue $R_{ref,\text{agg}}^{\text{DA}}$ from the participation of a reference unit aggregated in a VPP is derived by combining Equation 3.28 and Equation 3.29, for the case of the reference unit : ($j : ref$):

$$R_{ref,\text{agg}}^{\text{DA}} = \tilde{E}_{\text{ref}} \times \Pi^{\text{DA}} - \delta^{\text{DA}}(\tilde{E}_{\text{ref}}, \alpha_{\text{ref}} \times E_{\text{VPP}}^{\text{DA}}) \quad (3.30)$$

with $\alpha_{\text{ref}} = \tilde{E}_{\text{ref}}/\tilde{E}_{\text{VPP}}$.

In comparison, the revenue from the individual participation of the reference unit is denoted as $R_{\text{ref}}^{\text{DA}}$ and is formulated as follows:

$$R_{\text{ref}}^{\text{DA}} = \tilde{E}_{\text{ref}} \times \Pi^{\text{DA}} - \delta^{\text{DA}} \left(\tilde{E}_{\text{ref}}, E_{\text{ref}}^{\text{DA}} \right) \quad (3.31)$$

By comparing Equation 3.30 and Equation 3.31, the aggregation solution for a reference RES unit is formulated as a modification of the contracted energy from $E_{\text{ref}}^{\text{DA}}$ to $\alpha_{\text{ref}} \cdot E_{\text{VPP}}^{\text{DA}}$. However, the aggregation of RES units has been presented in section 2.3.2 as a physical solution which gives the possibility to internally compensate the delivered energy. Consequently, it is more logical to model the aggregation solution as a modification of the delivered energy. From Equation 3.29, and by considering the anti-symmetry property of the function δ^{DA} explained in section 3.1.2, the imbalance penalty relative to the reference unit can be reformulated as follows:

$$\begin{aligned} \delta^{\text{DA}} \left(\tilde{E}_{\text{ref}}, \alpha_{\text{ref}} \times E_{\text{VPP}}^{\text{DA}} \right) &= \delta^{\text{DA}} \left(\tilde{E}_{\text{ref}}, E_{\text{ref}}^{\text{DA}} + (\alpha_{\text{ref}} \cdot E_{\text{VPP}}^{\text{DA}} - E_{\text{ref}}^{\text{DA}}) \right) \\ &= \delta^{\text{DA}} \left(\tilde{E}_{\text{ref}} - (\alpha_{\text{ref}} \cdot E_{\text{VPP}}^{\text{DA}} - E_{\text{ref}}^{\text{DA}}), E_{\text{ref}}^{\text{DA}} \right) \\ &= \delta^{\text{DA}} \left(\tilde{E}_{\text{ref}} + \underbrace{(E_{\text{ref}}^{\text{DA}} - \alpha_{\text{ref}} \cdot E_{\text{VPP}}^{\text{DA}})}_{e_{\text{agg,ref}}}, E_{\text{ref}}^{\text{DA}} \right) \end{aligned} \quad (3.32)$$

This energy $e_{\text{agg,ref}}$, which can be positive or negative, quantifies the energy compensation volume relative to the reference unit. Also, the volume $(\tilde{E}_{\text{ref}} + e_{\text{agg,ref}})$ is the *equivalent* production of the reference unit when this unit is aggregated. It is important to note that this equivalent generation is not the real generation, which still equals \tilde{E}_{ref} . The equivalent generation models the repartition of the imbalance reduction between the several wind farms included in the aggregation. It is important to note that this proposed repartition model based on the delivered energy by each unit is one possibility for modeling the equivalent generation. Other possibilities, such as the distribution the VPP revenue based on the nominal power of each unit, are possible, but they are not considered in this work.

The proposed repartition model is illustrated in the following example where two wind farms, WF1 and WF2, are aggregated. The aggregated wind farms are denoted as (WF1 + WF2). For each of the wind farms taken individually and for the aggregation, Table 3.1 presents an example of the contracted energy E^{DA} , the delivered energy \tilde{E} , the resulting imbalance volume d and the imbalance penalty δ . In the example, only negative imbalances are penalized, and the penalty price for negative price is set to 2 €/MWh.

	E^{DA} (MWh)	\tilde{E} (MWh)	d (MWh)	δ (€)
WF1	14	10	-4	8
WF2	8	10	2	0
(WF1 + WF2)	22	20	-2	4

Table 3.1: Example of the aggregation of two wind farms WF1 and WF2 and resulting imbalance penalties.

In the example given in Table 3.1, the sum of the imbalance penalties relative to WF1 and WF2 equals 8 €. In the case of aggregation, the resulting imbalance penalty is reduced to 4 €, since the surplus production from WF2 compensates the shortage from WF1.

	E^{DA} (MWh)	α	e_{agg} (MWh)	$\tilde{E} + e_{\text{agg}}$ (MWh)	d (MWh)	δ (€)
WF1 _{agg}	14	0.5	3	13	1	2
WF2 _{agg}	8	0.5	-3	7	1	2

Table 3.2: Example of the repartition of the imbalance volume and imbalance penalty between the two aggregated wind farms, derived from the previous formulation.

Then, Table 3.2 shows the parameter α , defined in Equation 3.27, and the balancing volume e_{agg} for each of the two aggregated wind farms WF1_{agg} and WF2_{agg}. The resulting imbalance volume d and imbalance penalty δ are also presented. In this case, both wind farms produce the same amount of energy and, consequently, the α ratio which models the revenue repartition equals 0.5 for both wind farms. It is interesting to note that the same ratio models the repartition of the imbalance penalty. In this example, the 4 € penalty is distributed equally between the two wind farms. This is actually a more general result. If we consider a given unit j , this unit is responsible for the proportion α_j of the VPP imbalance:

$$\tilde{E}_j + e_{\text{agg},j} - E_j^{\text{DA}} = \alpha_j \times \left(\tilde{E}_{\text{VPP}} - E_{\text{VPP}}^{\text{DA}} \right) \quad (3.33)$$

Also, it has to be noted that, although the total imbalance penalty is always lower in the case of aggregation compared to the case of individual participation, the imbalance penalty for a given unit is not always reduced. In the example, the imbalance penalty for the WF2 is increased from 0 to 2 €. Further numerical examples of the reduction of imbalance penalties in the case of aggregation are given in section 3.5.

Finally, by combining Equation 3.30 and Equation 3.32, the revenue $R_{\text{ref,agg}}^{\text{DA}}$ from

the participation of a reference unit aggregated in a VPP is formulated as follows:

$$R_{\text{ref,agg}}^{\text{DA}} = \tilde{E}_{\text{ref}} \times \Pi^{\text{DA}} - \delta^{\text{DA}} \left(\tilde{E}_{\text{ref}} + e_{\text{agg,ref}}, E_{\text{ref}}^{\text{DA}} \right) \quad (3.34)$$

By comparing Equation 3.31 and Equation 3.34, the aggregation solution can be modeled as a modification of the penalization function δ^{DA} ; the resulting penalization function is $\delta_{\text{agg}}^{\text{DA}}$.

$$\delta_{\text{agg}}^{\text{DA}} \left(\tilde{E}_{\text{ref}}, E_{\text{ref}}^{\text{DA}} \right) = \delta^{\text{DA}} \left(\tilde{E}_{\text{ref}} + e_{\text{agg,ref}}, E_{\text{ref}}^{\text{DA}} \right) \quad (3.35)$$

3.3.4 Formulation of the imbalance penalty resulting from the combination of renewable generation with energy storage

This section formulates the imbalance penalty function related to the second VPP configuration considered here. In this case, the reference RES unit is combined with an Energy Storage Device (ESD).

For modeling the combination of the ESD with the renewable units, the following assumptions are made:

- The energy delivered by the ESD is denoted as \tilde{E}_{st} . This variable is taken positive when energy is delivered by the ESD (i.e. discharging), and negative when energy is delivered by the ESD (i.e. charging);
- The storage capacity Cap_{st} is the maximum amount of energy that can be stored in the device. The state-of-charge SOC is defined as the proportion of energy charged in the device to the maximum storage capacity. At any time of the operation the SOC is bounded by its minimum and maximum levels, respectively SOC_{min} and SOC_{max} . These two levels correspond to the minimum and maximum amount and energy which can be stored in the storage device.
- The charging and discharging efficiencies are denoted as η_{ch} and η_{dis} , respectively. The round trip efficiency is denoted as η and defined as $\eta = \eta_{ch} \times \eta_{dis}$;
- The energy delivered or absorbed by the ESD is bounded by the storage nominal charging and discharging rates, respectively r_{ch}^{nom} and r_{dis}^{nom} . Because \tilde{E}_{st} is positive when discharging and negative when charging, $r_{ch}^{nom} \leq 0$ and $r_{dis}^{nom} \geq 0$.

The ESD technologies considered for the present work have to be suitable for imbalance management. This means that the storage time constant, defined in section 2.3.2 as the time to completely discharge at nominal rate the storage device

starting from full capacity, is taken in the range of several hours. Also, the storage nominal discharging rate is taken as non negligible compared to the nominal power of the RES unit. A storage nominal discharging rate ranging approximately from 5 to 50% of the RES nominal power is reasonable for the management of energy imbalances. The storage time, which is defined as the time to discharge the storage device starting from full capacity, at nominal rate, has to be in the order of several hours. For example, for wind farms with nominal power in the order of several tens of MW, the combined storage unit will have a nominal discharging rate in the order of several MWh/h and a storage capacity in the order of several tens of MWh. Such storage units can be pumped-storage hydro or compressed air units, as described in section 2.3.2. Further considerations about the choice of the storage technology are out of the scope of the present work.

In the present work, the fixed costs of the storage unit, such as the investment costs, are not taken into account in the formulation of the revenue from the participation of the combined RES and storage units in electricity market. This is coherent with the reference formulation of the revenue from the reference RES unit in Equation 3.1 which does not consider the fixed costs relative to the reference unit. Also, the operation of the storage unit is not based on the use of fuel, and the operation costs are thus relatively low compared to the operation costs of a fuel-based conventional generation. Consequently, the operation costs of the storage unit are not considered in the proposed formulation. A possibility to consider these costs in the formulation is to integrate them through a reduction of the charging and discharging efficiencies, which increases the energy losses relative to the storage device.

When the reference RES unit, which delivers the energy quantity \tilde{E}_{ref} , is combined with an energy storage device which delivers the energy quantity \tilde{E}_{st} , the VPP composed of the combined RES and storage units is considered as a unique entity delivering the quantity $(\tilde{E}_{\text{ref}} + \tilde{E}_{\text{st}})$. Also, the storage unit is considered in this work to be entirely devoted to the reduction of imbalance penalties, and as a consequence, the storage device is not considered for the day-ahead trading. In other words, the day-ahead energy contract for the VPP equals the one relative to the reference unit. Then, the delivered energy \tilde{E}_{VPP} by the VPP and the day-ahead energy contract $E_{\text{VPP}}^{\text{DA}}$ are written as:

$$\tilde{E}_{\text{VPP}} = \tilde{E}_{\text{ref}} + \tilde{E}_{\text{st}}, \text{ and } E_{\text{VPP}}^{\text{DA}} = E_{\text{ref}}^{\text{DA}} \quad (3.36)$$

The VPP revenue $R_{\text{VPP}}^{\text{DA}}$ is formulated from the generic formulation of the day-ahead revenue in Equation 3.6, where the delivered energy is \tilde{E}_{VPP} and the contracted

energy is E_{VPP}^{DA} :

$$R_{VPP}^{DA} = \tilde{E}_{VPP} \times \Pi^{DA} - \delta^{DA} \left(\tilde{E}_{VPP}, E_{VPP}^{DA} \right) \quad (3.37)$$

Such revenue can be reformulated as:

$$\begin{aligned} R_{VPP}^{DA} &= (\tilde{E}_{ref} + \tilde{E}_{st}) \times \Pi^{DA} - \delta^{DA} \left(\tilde{E}_{ref} + \tilde{E}_{st}, E_{ref}^{DA} \right) \\ &= \tilde{E}_{ref} \times \Pi^{DA} + \tilde{E}_{st} \times \Pi^{DA} - \delta^{DA} \left(\tilde{E}_{ref} + \tilde{E}_{st}, E_{ref}^{DA} \right) \end{aligned} \quad (3.38)$$

$$= \tilde{E}_{ref} \times \Pi^{DA} - \delta_{st}^{DA} \left(\tilde{E}_{ref}, E_{ref}^{DA} \right) \quad (3.39)$$

with

$$\delta_{st}^{DA} \left(\tilde{E}_{ref}, E_{ref}^{DA} \right) = -\tilde{E}_{st} \times \Pi^{DA} + \delta^{DA} \left(\tilde{E}_{ref} + \tilde{E}_{st}, E_{ref}^{DA} \right) \quad (3.40)$$

From Equation 3.40, the influence of the combination of a storage unit with a reference RES unit can be modeled as a modification of the reference penalization function δ^{DA} . The second term of Equation 3.40 corresponds to a shift of the δ^{DA} by the quantity \tilde{E}_{st} which can be positive or negative. The additional cost is $C = -\tilde{E}_{st} \times \Pi^{DA}$. Based on a positive day-ahead market price Π^{DA} , the cost C is positive when the storage energy \tilde{E}_{st} is negative (i.e. charging), and the cost is negative for negative values of storage energy (i.e. discharging). This cost has a cyclic value and depends on the storage unit operation cycles.

In order to assess the real cost relative to the operation of the storage unit, regardless of the charging cycles, the proposed model consists in considering the total storage cost C_{tot} over a large period τ including several storage cycles.

$$C_{tot} = \sum_{i=1}^n (-\tilde{E}_{st,T_i} \times \Pi_{T_i}^{DA}) \quad (3.41)$$

where n is the number of market time units included in the considered operation period τ .

Such total cost C_{tot} is then distributed for each market time unit T_i , based on the use of the energy storage during the market time unit T_i . Such storage unit use relative to the market time unit T_i is quantified by the absolute value of the storage output energy $|\tilde{E}_{st,T_i}|$. The resulting storage cost C_i relative to the market time unit

T_i is derived as follows:

$$C_i = \frac{|\tilde{E}_{st,T_i}|}{\sum_{i=1}^n |\tilde{E}_{st,T_i}|} \times C_{tot} = |\tilde{E}_{st,T_i}| \times \Pi_{T_i}^{DA} \times \Gamma_{st} \quad (3.42)$$

where Γ_{st} is a dimensionless quantity defined by:

$$\Gamma_{st} = \frac{C_{tot}}{\sum_{i=1}^n |\tilde{E}_{st,T_i}| \times \Pi_{T_i}^{DA}} = \frac{\sum_{i=1}^n (-\tilde{E}_{st,T_i} \times \Pi_{T_i}^{DA})}{\sum_{i=1}^n |\tilde{E}_{st,T_i}| \times \Pi_{T_i}^{DA}} \quad (3.43)$$

In order to better understand the structure of the cost C_{tot} , this cost is calculated for a cycle period including a charging phase during the market time unit T_{ch} and a discharging phase during the market time unit T_{dis} . The cost C_{tot} is then defined as follows:

$$C_{tot} = -\tilde{E}_{st,T_{ch}} \times \Pi_{T_{ch}}^{DA} - \tilde{E}_{st,T_{dis}} \times \Pi_{T_{dis}}^{DA} \quad (3.44)$$

$$= -(\tilde{E}_{st,T_{ch}} + \tilde{E}_{st,T_{dis}}) \times \Pi_{T_{ch}}^{DA} - \tilde{E}_{st,T_{dis}} \times (\Pi_{T_{dis}}^{DA} - \Pi_{T_{ch}}^{DA}) \quad (3.45)$$

The energy delivered by the storage $\tilde{E}_{st,T_{dis}}$ when discharging is the result from the conversion of the energy which is stored when charging $\tilde{E}_{st,T_{ch}}$. The energy losses during charge and discharge result to:

$$\tilde{E}_{st,T_{dis}} = -\eta \cdot \tilde{E}_{st,T_{ch}} \quad (3.46)$$

Consequently, the total cost can finally be written as:

$$C_{tot} = -(1 - \eta) \times \tilde{E}_{st,T_{ch}} \times \Pi_{T_{ch}}^{DA} + \tilde{E}_{st,T_{dis}} \times (\Pi_{T_{ch}}^{DA} - \Pi_{T_{dis}}^{DA}) \quad (3.47)$$

Equation 3.47 is a sum of two terms. The first term is positive because $\tilde{E}_{st,T_{ch}}$ is negative, and the round-trip efficiency η is lower than 1. This term corresponds to the penalty due to energy losses. The second term is a function of the difference of day-ahead market price between the charging and discharging phases. This term is positive if the day-ahead market price is higher when charging than when discharging. This term formulates the benefits from using the storage unit to store energy when the market price is low in order to sell it when the market price is high.

When the day-ahead market price during the charging phase equals the one during the discharging phase $\Pi_{T_{dis}}^{DA} = \Pi_{T_{ch}}^{DA} = \Pi^{DA}$, the cost C_{tot} is simplified to the

following expression:

$$C_{tot} = -(1 - \eta) \times \tilde{E}_{st, Tch} \times \Pi^{DA} = \frac{(1 - \eta)}{\eta} \times \tilde{E}_{st, Tdis} \times \Pi^{DA} \quad (3.48)$$

The cost relative to the charging period is then derived from combining Equation 3.42 with Equation 3.48 and Equation 3.46:

$$C_{ch} = -\frac{|\tilde{E}_{st, Tch}|}{|\tilde{E}_{st, Tch}| + |\tilde{E}_{st, Tdis}|} \times (1 - \eta) \times \tilde{E}_{st, Tch} \times \Pi^{DA} \quad (3.49)$$

$$= \frac{1 - \eta}{1 + \eta} \times \Pi^{DA} \times |\tilde{E}_{st, Tch}| \quad (3.50)$$

Similarly, the cost relative to the discharging period is derived from combining Equation 3.42 with Equation 3.48 and Equation 3.46:

$$C_{dis} = \frac{|\tilde{E}_{st, Tdis}|}{|\tilde{E}_{st, Tch}| + |\tilde{E}_{st, Tdis}|} \times \frac{(1 - \eta)}{\eta} \times \tilde{E}_{st, Tdis} \times \Pi^{DA} \quad (3.51)$$

$$= \frac{1 - \eta}{1 + \eta} \times \Pi^{DA} \times |\tilde{E}_{st, Tdis}| \quad (3.52)$$

When considering Equation 3.50 and Equation 3.52, the formulations of the cost are identical for the charging or discharging state of the storage. For both cases, the quantity Γ_{st} defined in Equation 3.42 can be written as:

$$\Gamma_{st} = \frac{1 - \eta}{1 + \eta} \quad (3.53)$$

and the imbalance penalty resulting from the storage combination can be written as:

$$\delta_{st}^{DA} \left(\tilde{E}_{ref}, E_{ref}^{DA} \right) = \Gamma_{st} \times \Pi^{DA} \times |\tilde{E}_{st}| + \delta^{DA} \left(\tilde{E}_{ref} + \tilde{E}_{st}, E_{ref}^{DA} \right) \quad (3.54)$$

The final discussion is related to the comparison between the imbalance penalty resulting from the storage combination δ_{st}^{DA} and the reference imbalance penalty δ^{DA} . For analyzing the difference between these two quantities, the example of a negative imbalance energy from the reference RES unit is taken, with an up-regulation state regarding the TSO. The delivered energy by the storage \tilde{E}_{st} is taken as positive in this example. This energy storage reduces the absolute value of the reference imbalance energy. The resulting imbalance energy when considering the storage combination is considered to be still negative or zero. In this situation, the reference imbalance penalty δ^{DA} and the imbalance penalty in the case of the

storage combination δ_{st}^{DA} are formulated from Equation 3.7 as:

$$\delta^{\text{DA}} \left(\tilde{E}_{\text{ref}}, E_{\text{ref}}^{\text{DA}} \right) = -(\tilde{E}_{\text{ref}} - E_{\text{ref}}^{\text{DA}}) \times \Delta_{-}^{\Pi} \quad (3.55)$$

$$\delta_{st}^{\text{DA}} \left(\tilde{E}_{\text{ref}}, E_{\text{ref}}^{\text{DA}} \right) = \Gamma_{st} \times \Pi^{\text{DA}} \times \tilde{E}_{st} - \left(\tilde{E}_{\text{ref}} + \tilde{E}_{st} - E_{\text{ref}}^{\text{DA}} \right) \times \Delta_{-}^{\Pi} \quad (3.56)$$

The difference between the imbalance penalty resulting from the storage combination and the reference imbalance penalty is given by :

$$\delta_{st}^{\text{DA}} \left(\tilde{E}_{\text{ref}}, E_{\text{ref}}^{\text{DA}} \right) - \delta^{\text{DA}} \left(\tilde{E}_{\text{ref}}, E_{\text{ref}}^{\text{DA}} \right) = \left(\Gamma_{st} \times \Pi^{\text{DA}} - \Delta_{-}^{\Pi} \right) \times \tilde{E}_{st} \quad (3.57)$$

Because \tilde{E}_{st} is positive, the sign of this difference depends on the difference between $\Gamma_{st} \times \Pi^{\text{DA}}$ and Δ_{-}^{Π} . More precisely, this difference will be negative (i.e. the imbalance penalty will be reduced) if:

$$\Gamma_{st} \times \Pi^{\text{DA}} \leq \Delta_{-}^{\Pi} \quad (3.58)$$

In order to compare $\Gamma_{st} \times \Pi^{\text{DA}}$ and Δ_{-}^{Π} , the formulation of Γ_{st} is simplified. Γ_{st} is written as a function of $u = (1 - \eta)$. The efficiency η is considered to be close to 1, and consequently, u is closed to 0. The simplification of Γ_{st} then consists in neglecting the orders of u greater than 1:

$$\Gamma_{st}(u) = \frac{u}{2 - u} = \frac{u}{2} \times \frac{1}{1 - u/2} \quad (3.59)$$

$$\approx \frac{u}{2} \times \left(1 + \frac{u}{2} \right) \approx \frac{u}{2} \quad (3.60)$$

which gives $\Gamma_{st} \approx (1 - \eta)/2$. Finally, from the previous assumptions, the combination with the storage device will reduce the imbalance penalty only if:

$$\frac{1 - \eta}{2} \times \Pi^{\text{DA}} \leq \Delta_{-}^{\Pi} \quad (3.61)$$

$$\eta \geq 1 - 2 \cdot \frac{\Delta_{-}^{\Pi}}{\Pi^{\text{DA}}} \quad (3.62)$$

A similar analysis can be done in the case of positive imbalance in down-regulation TSO state. Consequently, the condition on the storage efficiency can generally be written as:

$$\eta \geq 1 - 2 \cdot \frac{\Delta_{-}^{\Pi}}{\Pi^{\text{DA}}} \quad (3.63)$$

This condition states that the combination of the RES unit with the storage device will reduce the imbalance penalties only if the price for positive (respectively negative) imbalance is low (respectively high) compared to the day-ahead price.

3.3.5 Formulation of the imbalance penalty resulting from the combination of renewable with conventional generation

This section formulates the imbalance penalty related to the third VPP configuration, where the reference RES unit is combined with a conventional dispatchable unit. In order to formulate the impact of the combination for the reference RES unit, the market revenue obtained when the units are combined is compared to the market revenue which would be obtained without combination. It is important to note that, in this case, the operation of the conventional unit is not entirely devoted to the reduction of imbalance penalty from the reference unit, as opposed to the storage device in the previous section. The part of the conventional unit devoted to the reduction of imbalance is an adjustment delivered energy, which is possible given the dispatchability of the unit.

If the RES and conventional units are considered as participating individually in the day-ahead market, the revenue from the market participation of the reference unit is denoted as $R_{\text{ref},ind}^{\text{DA}}$, and the one relative to the conventional unit as $R_{\text{cv},ind}^{\text{DA}}$. The participation of the conventional unit is supposed to be based on its variable costs. The market price Π^{DA} is thus the cost per unit of the contracted generation $E_{\text{cv}}^{\text{DA}}$. Since the unit is dispatchable, the delivered energy \tilde{E}_{cv} is assumed to be equal to the contracted energy $E_{\text{cv}}^{\text{DA}}$ and the imbalance penalty is zero. In particular, the possible limits regarding the availability and the reliability of the unit are not considered.

$$\begin{aligned} R_{\text{ref},ind}^{\text{DA}} &= \tilde{E}_{\text{ref}} \times \Pi^{\text{DA}} - \delta^{\text{DA}} \left(\tilde{E}_{\text{ref}}, E_{\text{ref}}^{\text{DA}} \right) \\ R_{\text{cv},ind}^{\text{DA}} &= E_{\text{cv}}^{\text{DA}} \times \Pi^{\text{DA}} \end{aligned} \quad (3.64)$$

Also, when the RES and conventional units are combined in a VPP, the dispatchable generation may be adjusted to reduce the imbalance volume of the VPP. The adjustment energy volume delivered by the conventional unit is e_{cv} , and the total energy delivered by the conventional unit is then $(\tilde{E}_{\text{cv}} + e_{\text{cv}})$. The marginal operation cost of the conventional unit for the adjustment volume e_{cv} is denoted as Π_{cv} . This quantity represents the operation costs for the generation of the energy volume e_{cv} , and its dimension is a cost per unit of energy, which is similar to a price. This is why the notation Π is used.

The following equations first formulate the market revenue of the VPP, and then distribute such revenue between the RES unit and the conventional unit. Even if the methodology followed for deriving these equations is similar to the one proposed in the previous sections, the derivation of the equations is detailed for clarity and

precision. Considering the market participation of the VPP as a single entity, the delivered and contracted energy is the sum of the energy delivered and contracted by RES and conventional units :

$$\tilde{E}_{\text{VPP}} = \tilde{E}_{\text{ref}} + \tilde{E}_{\text{cv}} + e_{\text{cv}} \quad (3.65)$$

$$E_{\text{VPP}}^{\text{DA}} = E_{\text{ref}}^{\text{DA}} + E_{\text{cv}}^{\text{DA}} \quad (3.66)$$

Consequently, the revenue relative to the participation of the VPP in the day-ahead market is written as:

$$\begin{aligned} R_{\text{VPP}}^{\text{DA}} &= \tilde{E}_{\text{VPP}} \times \Pi^{\text{DA}} - \delta^{\text{DA}} \left(\tilde{E}_{\text{VPP}}, E_{\text{VPP}}^{\text{DA}} \right) \\ &= \left(\tilde{E}_{\text{ref}} + \tilde{E}_{\text{cv}} + e_{\text{cv}} \right) \times \Pi^{\text{DA}} - \delta^{\text{DA}} \left(\tilde{E}_{\text{ref}} + \tilde{E}_{\text{cv}}^{\text{DA}} + e_{\text{cv}}, E_{\text{ref}}^{\text{DA}} + E_{\text{cv}}^{\text{DA}} \right) \end{aligned} \quad (3.67)$$

Regarding the conventional unit, the day-ahead energy contract equals the delivered energy $E_{\text{cv}}^{\text{DA}} = \tilde{E}_{\text{cv}}$, and the imbalance penalization in Equation 3.67 can be simplified by using the anti-symmetry property of the δ^{DA} function explained in section 3.1.2:

$$\begin{aligned} \delta^{\text{DA}} \left(\tilde{E}_{\text{ref}} + \tilde{E}_{\text{cv}}^{\text{DA}} + e_{\text{cv}}, E_{\text{ref}}^{\text{DA}} + E_{\text{cv}}^{\text{DA}} \right) &= \delta^{\text{DA}} \left(\tilde{E}_{\text{ref}} + e_{\text{cv}}, E_{\text{ref}}^{\text{DA}} + E_{\text{cv}}^{\text{DA}} - \tilde{E}_{\text{cv}}^{\text{DA}} \right) \\ &= \delta^{\text{DA}} \left(\tilde{E}_{\text{ref}} + e_{\text{cv}}, E_{\text{ref}}^{\text{DA}} \right) \end{aligned} \quad (3.68)$$

and consequently, the market revenue formulation is simplified as:

$$R_{\text{VPP}}^{\text{DA}} = \left(\tilde{E}_{\text{ref}} + \tilde{E}_{\text{cv}} + e_{\text{cv}} \right) \times \Pi^{\text{DA}} - \delta^{\text{DA}} \left(\tilde{E}_{\text{ref}} + e_{\text{cv}}, E_{\text{ref}}^{\text{DA}} \right) \quad (3.69)$$

Then, the aim is to model the repartition of the VPP revenue between the reference and the conventional units. For this, the VPP revenue $R_{\text{VPP}}^{\text{DA}}$ is reformulated as follows:

$$R_{\text{VPP}}^{\text{DA}} = A + B \quad (3.70)$$

with

$$\begin{aligned} A &= \tilde{E}_{\text{cv}} \times \Pi^{\text{DA}} + e_{\text{cv}} \times \Pi_{\text{cv}} \\ B &= \tilde{E}_{\text{ref}} \times \Pi^{\text{DA}} + e_{\text{cv}} \times (\Pi^{\text{DA}} - \Pi_{\text{cv}}) - \delta^{\text{DA}} \left(\tilde{E}_{\text{ref}} + e_{\text{cv}}, E_{\text{ref}}^{\text{DA}} \right) \end{aligned} \quad (3.71)$$

The quantity A corresponds to the costs of the conventional unit associated with the delivered energy $\tilde{E}_{\text{cv}} + e_{\text{cv}}$. This quantity can thus be considered as the equivalent conventional unit revenue $A = R_{\text{cv,VPP}}^{\text{DA}}$. The second quantity B is then the

equivalent reference unit revenue, which is rewritten as:

$$\begin{aligned} R_{\text{ref,VPP}}^{\text{DA}} &= \tilde{E}_{\text{ref}} \times \Pi^{\text{DA}} + e_{cv} \times (\Pi^{\text{DA}} - \Pi_{cv}) - \delta^{\text{DA}} \left(\tilde{E}_{\text{ref}} + e_{cv}, E_{\text{ref}}^{\text{DA}} \right) \\ &= \tilde{E}_{\text{ref}} \times \Pi^{\text{DA}} - \delta_{cv}^{\text{DA}} \left(\tilde{E}_{\text{ref}}, E_{\text{ref}}^{\text{DA}} \right) \end{aligned} \quad (3.72)$$

with

$$\delta_{cv}^{\text{DA}} \left(\tilde{E}_{\text{ref}}, E_{\text{ref}}^{\text{DA}} \right) = e_{cv} \times (\Pi_{cv} - \Pi^{\text{DA}}) - \delta^{\text{DA}} \left(\tilde{E}_{\text{ref}} + e_{cv}, E_{\text{ref}}^{\text{DA}} \right) \quad (3.73)$$

From Equation 3.73, the combination of a conventional dispatchable unit with a reference RES unit can be modeled as a modification of the reference penalization function δ^{DA} . The additional cost $e_{cv} \times (\Pi_{cv} - \Pi^{\text{DA}})$ depends on the energy volume adjustment and on the difference between the marginal cost of the conventional unit and the day-ahead market price. The second term of Equation 3.73 corresponds to a shift of the δ^{DA} by the quantity e_{cv} which can be either positive or negative.

The quantity e_{cv} is bounded by the technical limits of the unit. The operation of most conventional units can be represented by two states, depending if the unit is switched on or off. As a result, the operating constraints of the unit can be formulated as follows:

$$\begin{cases} \tilde{E}_{cv} = 0 \text{ and } e_{cv} = 0 \Leftarrow \text{State: OFF} \\ E_{cv,\min} \leq \tilde{E}_{cv} + e_{cv} \leq E_{cv,\max} \Leftarrow \text{State: ON} \end{cases} \quad (3.74)$$

where $E_{cv,\min}$ and $E_{cv,\max}$ are the minimum and maximum energy output of the conventional unit during a market time step. These limits correspond to the minimum and maximum capacity the unit is authorized to operate (i.e. in order to be in economically or technically acceptable limits). For example, some units can be either switched off or operated between 50 % and 100 % of their nominal power.

The above formulation is valid for the combination of a RES unit with a large conventional unit which can decrease or increase its production to reduce positive or negative imbalances. In this case, the conventional unit is not entirely devoted to the reduction of imbalance penalties. This unit participates in the day-ahead market and the resulting day-ahead energy contract is $E_{cv}^{\text{DA}} > 0$. The adjustment energy volume e_{cv} can take positive or negative values.

The formulation is also valid for the combination of a RES unit with an conventional unit which would be switched on only to reduce negative imbalances. In this case, $E_{cv}^{\text{DA}} = 0$, and the total output of the conventional output is devoted to the reduction of imbalance penalties. This corresponds to $\tilde{E}_{cv} = 0$ and $e_{cv} = \tilde{E}_{cv}$ in the previous formulation. In the proposed model, the starting costs of the conventional

unit are supposed to be integrated in the marginal costs and are not considered as separate costs. If the starting costs were separated, the formulation should consider a whole running cycle of the conventional unit from the time it is started to the time it is switched off. Such formulation is not considered in the present work. An alternative for taking into account these starting costs can be the settlement of a minimum period duration during which the unit has to remain switched on. Such minimum period is then taken as a constraint for the scheduling of the conventional unit.

A final discussion is related to the comparison between the imbalance penalty δ_{cv}^{DA} resulting from the combination with the conventional unit and the reference imbalance penalty δ^{DA} . This analysis is similar to the one proposed for the imbalance penalty reduction resulting from the storage combination. For analyzing the difference between δ_{cv}^{DA} and δ^{DA} , the example of a negative imbalance energy from the reference RES unit is taken, with an up-regulation state regarding the TSO. The adjustment energy volume e_{cv} is taken positive in this example, which reduces the absolute value of the reference imbalance energy. The energy imbalance when considering the conventional unit combination is considered to be still negative or zero. In this situation, the reference imbalance penalty δ^{DA} and the imbalance penalty in the case of the conventional unit combination δ_{cv}^{DA} are formulated from Equation 3.7 as:

$$\delta^{\text{DA}}(\tilde{E}_{\text{ref}}, E_{\text{ref}}^{\text{DA}}) = -(\tilde{E}_{\text{ref}} - E_{\text{ref}}^{\text{DA}}) \times \Delta_{-}^{\Pi} \quad (3.75)$$

$$\delta_{cv}^{\text{DA}}(\tilde{E}_{\text{ref}}, E_{\text{ref}}^{\text{DA}}) = e_{cv} \times (\Pi_{cv} - \Pi^{\text{DA}}) - (\tilde{E}_{\text{ref}} + e_{cv} - E_{\text{ref}}^{\text{DA}}) \times \Delta_{-}^{\Pi} \quad (3.76)$$

where Δ_{-}^{Π} is the difference between the price for negative imbalance and the day-ahead price: $\Delta_{-}^{\Pi} = \Pi^{-} - \Pi^{\text{DA}}$.

The difference between the imbalance penalty resulting from the conventional unit combination and the reference imbalance penalty is given by :

$$\delta_{cv}^{\text{DA}}(\tilde{E}_{\text{ref}}, E_{\text{ref}}^{\text{DA}}) - \delta^{\text{DA}}(\tilde{E}_{\text{ref}}, E_{\text{ref}}^{\text{DA}}) = e_{cv} \times (\Pi_{cv} - \Pi^{-}) \quad (3.77)$$

In this case where e_{cv} is taken positive, this difference will be negative if the marginal cost of the conventional unit is lower than the price for negative imbalance. In other words, in this situation, the combination with the conventional unit will reduce the imbalance penalty only if $(\Pi_{cv} < \Pi^{-})$. Similarly, in the case of a down regulation TSO state and a negative energy adjustment volume e_{cv} , the combination with the conventional unit will reduce the imbalance penalty only if $(\Pi_{cv} > \Pi^{+})$.

3.3.6 Similarities between the formulations of the different physical solutions for managing the imbalance penalties

In the previous sections, four different physical solutions for reducing the imbalance penalty of a generation portfolio including RES, have been described. These solutions are:

- the control of the RES generation;
- the aggregation of RES units;
- the combination of a RES unit with a storage device;
- the combination of a RES unit with a conventional dispatchable unit.

They have been modeled as a modification of the reference penalization function δ^{DA} . In all cases, this modification can be expressed by the following generic relation:

$$\delta_{S_y}^{\text{DA}}(\tilde{E}, E^{\text{DA}}) = Y + \delta^{\text{DA}}(\tilde{E} + y, E^{\text{DA}}) \quad (3.78)$$

where S_y indicates the considered physical solution. Y is the additional cost and y is the energy volume associated with the physical solution. The energy volume corresponds to the internal balancing volume. To summarize:

$$\left\{ \begin{array}{l} y = -\tilde{E}_{dw} \text{ and } Y = \tilde{E}_{dw} \times \Pi^{\text{DA}} \Leftarrow \text{generation control} \\ y = e_{\text{agg}} \text{ and } Y = 0 \Leftarrow \text{RES aggregation} \\ y = \tilde{E}_{st} \text{ and } Y = |\tilde{E}_{st}| \times \Pi^{\text{DA}} \times \Gamma_{st} \Leftarrow \text{combination with a storage unit} \\ y = e_{cv} \text{ and } Y = e_{cv} \times (\Pi^{\text{DA}} - \Pi_{cv}) \Leftarrow \text{combination with a conventional unit} \end{array} \right. \quad (3.79)$$

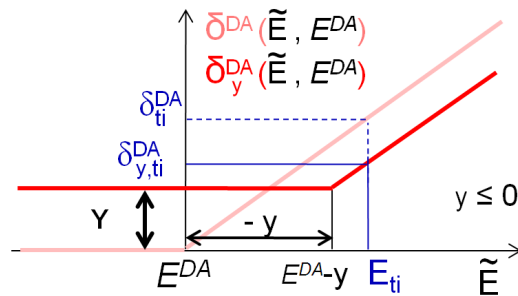

Figure 3.6: Imbalance penalization when a physical solution is used.

Further details about Equation 3.79 can be obtained by considering Equation 3.20, Equation 3.35, Equation 3.40 and Equation 3.73. The modification of the penalization function derived in Equation 3.78 is illustrated in Figure 3.6. In the given example, the system is down regulating and only positive imbalance are penalized. In this case, only negative internal balancing volumes y can reduce the imbalance penalty.

3.4 Generalization of the imbalance penalty model to the combination of solutions for the management of imbalance penalties

In section 3.1.2, the penalization of the imbalance related to the participation of a RES unit has been formulated by the function $\delta^{\text{DA}}(\tilde{E}, E^{\text{DA}})$, where \tilde{E} is the delivered energy and E^{DA} the energy contracted in the day-ahead market. This imbalance penalty is taken as a reference for modeling the reduction of imbalance penalty which results from the use of financial or physical solutions.

In section 3.2, the financial solutions for the management of imbalance have been modeled as a modification of the reference penalization function δ^{DA} . If S_x is a given financial solution, which can be either the participation in the intraday market or the use of option in trading, the imbalance penalty reduction related to the use of S_x can be written as:

$$\delta_{S_x}^{\text{DA}}(\tilde{E}, E^{\text{DA}}) = X + \delta^{\text{DA}}(\tilde{E}, E^{\text{DA}} + x) \quad (3.80)$$

where X and x are the additional cost and energy contract volume relative to the financial solution S_x , which are given in Equation 3.13 and Equation 3.16 for the participation in the intraday market and the option trading, respectively.

It is interesting to note that the reference penalty function relative to the participation in the day-ahead market can be considered as a particular case of financial decision, where the day-ahead energy contract is zero $E^{\text{DA}} = 0$, the additional cost is zero $X = 0$ and the energy contract volume equals the day-ahead contract energy $x = E^{\text{DA}}$. In this case, the financial solution is denoted as $S_x : \text{DA}$:

$$\delta^{\text{DA}}(\tilde{E}, E^{\text{DA}}) = \delta_{\text{DA}}^{\text{DA}}(\tilde{E}, 0) = 0 + \delta^{\text{DA}}(\tilde{E}, 0 + E^{\text{DA}}) \quad (3.81)$$

Similarly, the physical solutions modify the penalization function as already summarized in section 3.3.6. For a given physical solution S_y , the imbalance penalty

function can be written as:

$$\delta_{S_y}^{\text{DA}}(\tilde{E}, E^{\text{DA}}) = Y + \delta^{\text{DA}}(\tilde{E} + y, E^{\text{DA}}) \quad (3.82)$$

where Y and y are respectively the additional cost and the energy volume associated with the physical solution S_y .

Consequently, both financial and physical solutions can be modeled as a function composition of the reference penalty function δ^{DA} made of two steps: either a translation of the contracted volume by x followed by the addition of the constant X (i.e. financial solutions), or a translation of the delivered volume by y followed by the addition of the constant Y (i.e. physical solutions).

From the anti-symmetry property of the function δ^{DA} explained in 3.1.2, Equation 3.82 can be rewritten as:

$$\delta_{S_y}^{\text{DA}}(\tilde{E}, E^{\text{DA}}) = Y + \delta^{\text{DA}}(\tilde{E}, E^{\text{DA}} - y) \quad (3.83)$$

Equation 3.83 demonstrates that a physical solution S_y with an energy volume y and a fixed cost Y is equivalent to a financial solution with an energy volume $-y$ and a fixed cost Y . More generally, the financial and physical have a similar impact on the reference imbalance penalty: they offer the possibility to reduce the imbalance volume by x or $-y$ with a fixed cost X or Y respectively.

Finally, all the solutions have been modeled by considering the use of only one solution associated with the reference case. If we consider the use of two solutions $S = \{S_x, S_y\}$, the resulting imbalance penalty is modeled by a composition of the reference function relative to the solution S_x followed by a composition relative to the solution S_y . The resulting function for the two solutions S consists in a translation of the contracted volume by x followed by an addition by X , and a translation of the delivered volume by y followed by an addition by Y . Finally, the resulting function δ_S^{DA} for the two solutions S_x, S_y is formulated as:

$$\delta_{S_x, S_y}^{\text{DA}}(\tilde{E}, E^{\text{DA}}) = X + Y + \delta^{\text{DA}}(\tilde{E} + y, E^{\text{DA}} + x) \quad (3.84)$$

Consequently, the proposed model of the different solutions is valid when considering the combination of different solutions. The model can be generalized for the use of m financial solutions $S_X = \{S_{x_i}\}$, $i = 1..m$ and n physical solutions

$S_Y = \{S_{y_j}\}, j = 1..n$:

$$\delta_{S_X, S_Y}^{\text{DA}}(\tilde{E}, E^{\text{DA}}) = \sum_{i=1}^m X_i + \sum_{j=1}^n Y_j + \delta^{\text{DA}}\left(\tilde{E} + \sum_{j=1}^n y_j, E^{\text{DA}} + \sum_{i=1}^m x_i\right) \quad (3.85)$$

For example, the combination of the participation in an intraday market $S_x : \text{ID}$ and the coupling with a conventional generation unit $S_y : cv$ results to the following imbalance penalization function:

$$\begin{aligned} \delta_{\text{ID}, cv}^{\text{DA}}(\tilde{E}_{\text{ref}}, E_{\text{ref}}^{\text{DA}}) &= X_{\text{ID}} + Y_{cv} + \delta^{\text{DA}}(\tilde{E}_{\text{ref}} + y_{cv}, E_{\text{ref}}^{\text{DA}} + x_{\text{ID}}) \\ &= E^{\text{ID}} \times (\Pi^{\text{DA}} - \Pi^{\text{ID}}) + e_{cv} \times (\Pi^{\text{DA}} - \Pi_{cv}) \\ &\quad + \delta^{\text{DA}}(\tilde{E}_{\text{ref}} + e_{cv}, E_{\text{ref}}^{\text{DA}} + E^{\text{ID}}) \end{aligned} \quad (3.86)$$

To conclude, the proposed generic formulation of the imbalance penalty is valid for a combination of both physical and financial solutions. The next section gives numerical results of this formulation for the physical solutions. Results of this formulation for financial solutions are given in the next chapter, in the case of the participation in the intraday market. Also, the generic imbalance penalty formulation will be used for the definition of a generic decision-making method relative to the management of RES generation in electricity market, in the next chapter.

3.5 Application: Evaluation of the imbalance reduction related to RES generation in the frame of virtual power plant

This section presents the results obtained from the simulation of the **participation in a day-ahead electricity market** of a reference RES unit which uses the physical solutions for the management of the imbalance penalty. Three physical solutions are presented: the aggregation of the reference unit with other RES units, the combination of the reference unit with an energy storage device and the combination of the reference unit with a conventional generation unit. These three physical solutions are considered in the frame of a virtual power plant, described in section 2.3.2 and modeled in section 3.3. The results obtained are based on real world data. They evaluate the reduction of imbalance penalty relative to each solution.

3.5.1 Presentation of the study

Simulation methodology

The simulation methodology is presented in Figure 3.7. The reference RES unit is in this case a wind farm. The wind farm power generation is traded in the day-ahead market, and the wind farm operator is considered to be a balance responsible party. This participation is based on available wind power forecasts, and results to the contracted energy E^{DA} . The aggregation case consists in combining other wind farms for participating in the day-ahead market as virtual power plant (VPP). Similarly, the reference wind farm can be combined with a storage unit or a conventional generation unit for participating as a single entity (VPP). The energy \tilde{E}_{VPP} delivered by the VPP results from the operation of the units in the VPP.

Description of the case study

In the present study, the reference RES unit is a 18 MW wind farm located in Western Denmark. The wind farm generation is traded in the NordPool market during the period between the 01/10/2003 and the 31/06/2004. In NordPool, the contracts for the coming day are traded on the day-ahead market, named Elspot [42]. The market time step equals 1 h. The Elspot gate closure time is at 12:00 pm (local time) of the preceding day. Hence, we used the last available wind power forecasts (11:00 am of the same day) as input to day-ahead market participation module. Forecast horizons are selected in order to get the forecasts for 24 hours of the next day.

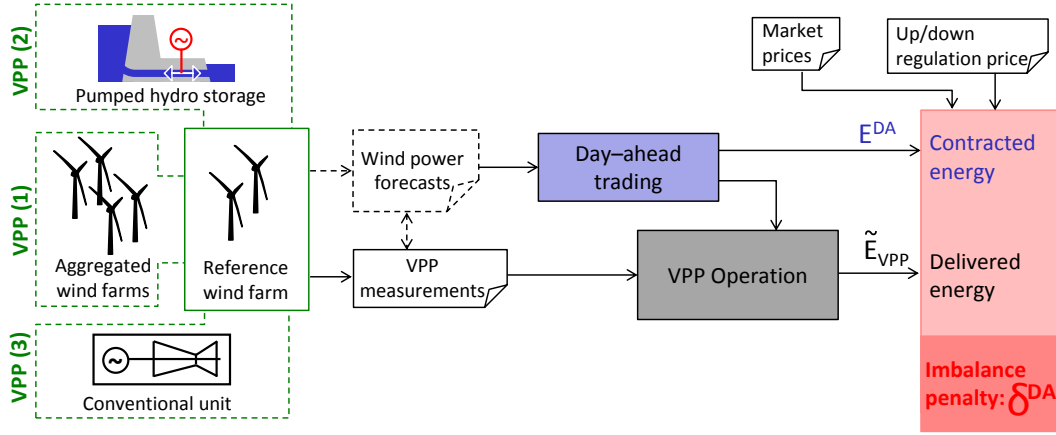

Figure 3.7: Schematic representation of the overall simulation scheme of the participation of the virtual power plant in the day-ahead electricity market.

The wind power forecasts are obtained from a statistical forecasting method, denoted as the “Regressive Power Curve (RPC)” model [111]. This method uses Hirlam Numerical Weather Predictions, as well as measured wind power as inputs. The tuning of the model is done on the first nine months of the year 2003. Details about the wind power forecasting model are given in the next chapter in section B.2, and the trading approach in day-ahead market from power forecasts is further detailed in section 4.4.

The reference case corresponds to the participation of only the reference wind farm in the day-ahead market.

For the aggregation case, 20 wind farms are considered, including the reference one. These wind farms are also located in Western Denmark and their nominal power ranges between 1.6 and 23.4 MW. Consequently, the reference wind farm can be combined with n other wind farms, with n varying between 0 (reference case) and 19. This corresponds to 524288 potential cases of aggregation.

The storage unit considered in this study is a pumped-hydro storage. In order to evaluate the impact of the storage energy capacity and storage round-trip efficiency on the results, different values of these two characteristics are considered. The energy capacity ranges between 0 and 30 MWh, and the efficiency ranges between 70 and 95 %. The nominal charging rate is determined so that the time period for charging the storage from the empty state to full capacity at nominal charging rate equals 5 hours. Storage units with this time constant are appropriate for imbalance management, as explained in section 2.3.2. Similarly, the nominal discharging rate is determined so that the time period for discharging the storage from full capacity to empty state at nominal discharging rate equals 5 hours. This corresponds to

nominal charging and discharging rates ranging from 0 to 1/3 of the reference wind farm nominal power.

The conventional generation unit considered in this study can be a diesel generator or a small gas turbine unit. This unit is completely devoted to the reduction of the energy imbalance relative to the trading of the generation from the reference unit in the day-ahead market. Consequently, this unit does not participate in the day-ahead market by itself. In order to evaluate the impact of the nominal power and the marginal operation cost of the unit on the results, different values of these two characteristics are considered. The nominal power ranges between 0 and 3 MW, and the marginal cost at nominal power ranges from 25 to 30 €/MWh.

3.5.2 Description of the VPP operation

This section presents the operation relative to the three proposed VPP configurations. Each configuration gives the possibility to balance internally the VPP. More precisely, the delivered energy by the reference unit is \tilde{E}_{ref} in the reference case, while it is $\tilde{E}_{\text{ref},S_y} = \tilde{E}_{\text{ref}} + y$ when a physical solution S_y is used. The quantity y depends on the solution and is detailed in the following paragraphs. Note from the fourth graph that, for this example, the day-ahead market price equals the down-regulation price, which corresponds to an up-regulation state for the TSO, as explained in section 2.2.5.

Internal balancing in the case of aggregation

This paragraph describes the **internal energy balancing** for the first VPP configuration (i.e. RES aggregation). In section 3.3.3, the aggregation of n wind farms, including the reference wind farm, has been modeled as an additional internal energy balance quantity from the point of view of the reference wind farm, denoted as $e_{\text{agg,ref}}$:

$$\tilde{E}_{\text{ref,agg}} = \tilde{E}_{\text{ref}} + e_{\text{agg,ref}} \quad (3.87)$$

with $e_{\text{agg,ref}} = E_{\text{ref}}^{\text{DA}} - \alpha_{\text{ref}} \times E_{\text{VPP}}^{\text{DA}}$ and $\alpha_{\text{ref}} = \tilde{E}_{\text{ref}} / \tilde{E}_{\text{VPP}}$.

The energy \tilde{E}_{VPP} is the energy delivered by the aggregated wind farms and equals the sum of the delivered energy by each aggregated wind farm. Also, $E_{\text{VPP}}^{\text{DA}}$ is the energy contract relative to the aggregated wind farms, and equals the sum of the energy contracts relative to each aggregated wind farm.

Figure 3.8 illustrates the internal balancing in the case of two aggregated wind farms during the 24 hours of the day 29/10/2003. The reference wind farm is denoted as WF1 and the aggregated wind farm is denoted as wind farm WF2. The

nominal power of WF1 and WF2 is respectively 18 and 16.5 MW. The distance between the two wind farms is 84 km. From the first two graphs on the left, we can observe that during the period between hour 9 and 12, the delivered energy is greater than the contracted energy for WF1, whereas it is the contrary for WF2. The period between hour 9 and 12 is illustrated in Figure 3.8 as the period between the two vertical dashed lines. Consequently, during this period, the imbalance for the aggregated wind farms (WF1+WF2) is close to 0, as shown in the bottom left plot. During this period, the energy balance volume for WF1 denoted as $e_{agg,1}$ is negative. This corresponds to the equivalent production of WF1 when aggregated with WF2 lower than the WF1 production, as shown in the top right plot.

The imbalance penalty for WF1 is not always reduced when WF1 is aggregated with WF2. For example during the period between hour 1 and hour 4, the energy imbalance after aggregation is greater than before aggregation, as shown in the top right plot. This increase of imbalance energy results from the repartition model of aggregated imbalance, which distributes the aggregated energy imbalance according to the delivered energy.

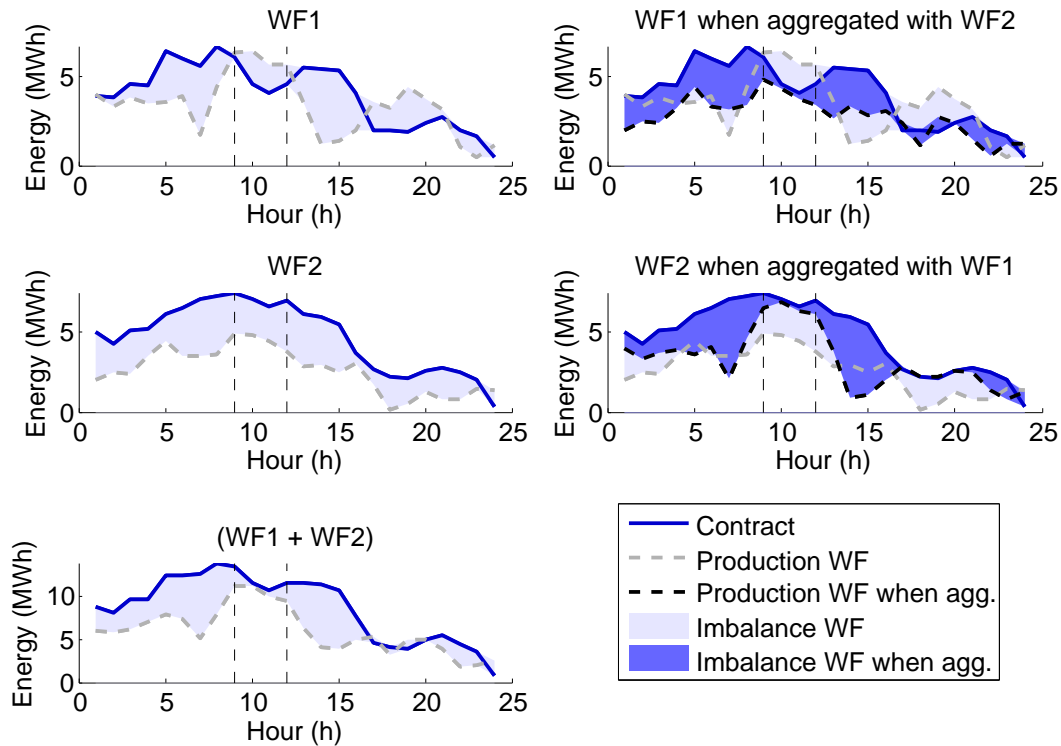

Figure 3.8: Energy imbalance resulting from the aggregation of wind farms

Operation model of the combination with a storage device

The energy delivered by the reference wind farm combined with a storage unit, for a market time unit T_i , is written as:

$$\tilde{E}_{\text{ref},st,T_i} = \tilde{E}_{\text{ref},T_i} + \tilde{E}_{st,T_i} \quad (3.88)$$

In this example, the operation mode applied to the storage unit consists in a “filter” mode, where the role of the storage device is to reduce the instantaneous absolute energy imbalance between the delivered energy $\tilde{E}_{\text{ref},T_i} + \tilde{E}_{st,T_i}$ and the contracted energy $E_{T_i}^{\text{DA}}$. Consequently, the energy delivered by the storage during the period T_i is formulated as the following optimization problem:

$$\tilde{E}_{st,T_i} = \arg \min_{E_{st}} \left| \tilde{E}_{\text{ref},T_i} + E_{st} - E_{T_i}^{\text{DA}} \right|, \text{ subject to } \mathcal{C}_{st,T_i} \quad (3.89)$$

where \mathcal{C}_{st,T_i} are the technical constraints related to the operation of the storage for the period T_i and are expressed as:

$$\mathcal{C}_{st,T_i} : \begin{cases} r_{dis}^{nom} \times \Delta t \leq \tilde{E}_{st,T_i} \leq r_{ch}^{nom} \times \Delta t \\ SOC_{min} \leq SOC_{T_i} \leq SOC_{max} \end{cases} \quad (3.90)$$

where Δt is the time duration of the market time unit. r_{dis}^{nom} and r_{ch}^{nom} are the nominal discharging and charging rates respectively. SOC_{min} and SOC_{max} are the minimum and maximum state-of-charge respectively. The state-of-charge SOC_{T_i} at the end of the period T_i is derived from the state-of-charge at the end of the previous time period T_{i-1} and the energy delivered by the storage unit during T_i . The charging and discharging cases are distinguished as follows:

$$SOC_{T_i} = SOC_{T_{i-1}} + \begin{cases} 1/\eta_{dis} \times \tilde{E}_{st,T_i}/Cap^{ESD} & (\text{discharging : } \tilde{E}_{st,T_i} < 0) \\ \eta_{ch} \times \tilde{E}_{st,T_i}/Cap^{ESD} & (\text{charging : } \tilde{E}_{st,T_i} \geq 0) \end{cases} \quad (3.91)$$

where Cap^{ESD} is the nominal energy capacity of the storage unit; η_{dis} and η_{ch} are the storage discharging and charging efficiencies, respectively. The round trip efficiency η is defined by $\eta = \eta_{dis} \times \eta_{ch}$.

Figure 3.10(a) illustrates the operation of the combination of the reference wind farm with a storage unit during the 24 hours of the day 29/10/2003. The round-trip efficiency of the considered storage unit is 75 %; the storage capacity is 15 MWh and the charge and discharge rate equal respectively -3 and 3 MWh/h. The initial

state-of-charge is close to 20 %, and is the result from the operation of the storage unit the day before. The limited capacity of the storage is illustrated in the operation of the unit between hour 2 and hour 10. Between hour 2 and hour 7, the storage unit is discharged for reducing the negative imbalance, until it is completely empty. Between hour 7 and hour 10 the storage unit is completely empty and cannot reduce the negative imbalance anymore.

Note that the operation defined by Equation 3.89 corresponds to an optimization per timestep. More advanced operation strategies, where the temporal correlation on the decisions can be taken into account, can be envisaged .

Operation model of the combination with a conventional unit

In this example, the conventional considered unit is operated only for reducing the energy imbalance relative to the reference unit. As explained in section 3.3.5, this corresponds to $e_{cv} = \tilde{E}_{cv}$ in the formulation of the imbalance penalty given in Equation 3.73. Then, the energy delivered by the reference wind farm combined with a conventional generation unit, for a market time unit T_i , is written as:

$$\tilde{E}_{\text{ref},cv,T_i} = \tilde{E}_{\text{ref},T_i} + \tilde{E}_{cv,T_i} \quad (3.92)$$

In this study, the conventional unit is operated for reducing the absolute energy imbalance between the delivered energy $\tilde{E}_{\text{ref},T_i} + \tilde{E}_{cv,T_i}$ and the contracted energy E^{DA,T_i} , similarly to the storage device operation. Consequently, the energy delivered by the conventional unit during the period T_i is formulated as :

$$\tilde{E}_{cv,T_i} = \arg \min_{E_{cv}} \left| \tilde{E}_{\text{ref},T_i} + E_{cv} - E_{T_i}^{\text{DA}} \right|, \text{ subject to } \mathcal{C}_{cv,T_i} \quad (3.93)$$

where \mathcal{C}_{cv,T_i} are the technical constraints related to the operation of the conventional unit for the period T_i . In this study, the conventional unit is supposed to be switched on permanently, and its output power can vary between a minimum output power and the nominal power P_{cv}^{nom} . The minimum output power is defined as the proportion α_{cv} of the nominal power. Consequently, the technical constraints of the unit are formulated as follows:

$$\mathcal{C}_{cv,T_i} : \alpha_{cv} \times P_{cv}^{\text{nom}} \times \Delta t \leq E_{cv,T_i} \leq P_{cv}^{\text{nom}} \times \Delta t \quad (3.94)$$

where Δt is the time duration of the market time unit.

Also, we propose to model the marginal cost of the conventional unit as the function of the delivered energy by this unit. Such marginal cost will be used in the evaluation of the imbalance penalty given in Equation 3.73. The aim of the cost

model is to take into account the increase of the marginal cost when the conventional unit is operated at partial load, which reduces the unit efficiency. The simplest approach is to consider a linear variation of the marginal cost for any variation of delivered energy \tilde{E}_{cv} . The marginal cost Π_{cv} for a given delivered energy \tilde{E}_{cv} is then given by :

$$\Pi_{cv} = \Pi_{cv}^* \times \left(1 + \beta_{cv} \times \left(1 - \frac{E_{cv}}{P_{cv}^{nom} \times \Delta t} \right) \right) \quad (3.95)$$

where Π_{cv}^* is the marginal cost at nominal power and β_{cv} is a price parameter which is greater than zero for accounting the unit efficiency reduction when operating at partial load. Such model is illustrated in Figure 3.9, with $\alpha_{cv} = 0.5$ and $\beta_{cv} = 0.5$.

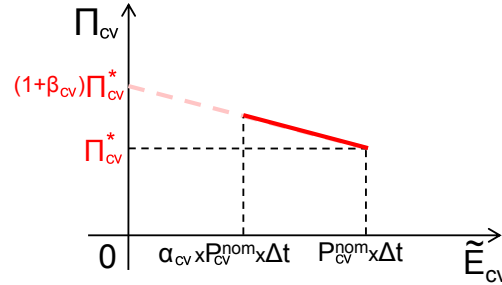

Figure 3.9: Proposed model for the conventional unit marginal cost.

Figure 3.10(b) describes the operation of the combination of the reference wind farm with a conventional unit during the 24 hours of the day 29/10/2003. The nominal power of the considered conventional unit is $P_{cv}^{nom} = 2$ MW; the marginal cost at nominal power is $\Pi_{cv}^* = 25$ €/MWh. The coefficient α_{cv} defining the output power range of the unit is set to 0.5. Also the marginal cost coefficient is taken equal to 0.5.

Between hour 3 and hour 10, the negative energy imbalance relative to the trading of the wind farm generation is reduced by the output energy of the conventional generation. Similarly, the negative imbalance is reduced between hour 14 and hour 17. However, the output generation from the conventional unit cannot be reduced lower than 1 MWh for each hour, and consequently, the VPP energy imbalance is increased when the generation from the wind farm is greater than the contracted energy. This happens for example between hour 1 and 2 and between hour 10 and 13. Also, in the bottom figure, two levels of conventional unit marginal cost can be observed. The marginal cost equals 25 €/MWh when the unit is generating at nominal power (2 MWh/h) whereas the marginal cost equals 31.25 €/MWh when the unit is generating 1 MWh/h. This later level of generation corresponds to the minimum generation given by $\alpha_{cv} = 0.5$, and the corresponding marginal cost results

from the price model given by Equation 3.95.

3.5.3 Imbalance penalty results and sensitivity analysis

The imbalance penalty $\delta_{S_y}^{\text{DA}}$ resulting from the participation of the reference unit in the day-ahead electricity market with a physical solution S_y has been generically formulated in Equation 3.78 and Equation 3.79 as follows :

$$\delta_{S_y}^{\text{DA}} \left(\tilde{E}_{\text{ref}}, E^{\text{DA}} \right) = Y + \delta^{\text{DA}} \left(\tilde{E}_{\text{ref}} + y, E^{\text{DA}} \right) \quad (3.96)$$

where Y and y are the additional cost and the energy volume associated with each physical solution given by:

$$\begin{cases} y = 0 \text{ and } Y = 0 \Leftarrow \text{reference case} \\ y = e_{\text{agg}} \text{ and } Y = 0 \Leftarrow \text{wind farm aggregation} \\ y = \tilde{E}_{st} \text{ and } Y = |\tilde{E}_{st}| \times \Pi^{\text{DA}} \times \Gamma_{st} \Leftarrow \text{combination with a storage unit} \\ y = \tilde{E}_{cv} \text{ and } Y = \tilde{E}_{cv} \times (\Pi^{\text{DA}} - \Pi_{cv}) \Leftarrow \text{combination with a conventional unit} \end{cases} \quad (3.97)$$

The function δ^{DA} models the penalization of the energy imbalance between the delivered and contracted energy. Such penalization is based on the difference between the day-ahead market price and the up or down regulation price. The function is formulated in Equation 3.7.

Figure 3.11 illustrates the energy volume y , the additional cost Y and the imbalance penalty δ for the reference case, and for the three considered physical solutions for reducing imbalance penalties. The same day used for the illustration of the operation of the VPP in the previous figures is also considered, that is the 29/10/2003.

- For the aggregation case, the additional cost Y is zero. The imbalance penalty is reduced when the energy imbalance is reduced, for example between hour 14 and hour 17.
- In the case of the combination with a storage unit, the additional cost Y corresponds to the penalization of the energy losses during the storage operation and the difference of day-ahead market price between charging and discharging phases, as already explained in subsection 3.3.4. The results for the storage case illustrate the difference between the energy imbalances and the imbalance penalties. First, the energy imbalance resulting from the storage combination is always lower than the one without storage. However, from the third plot, it

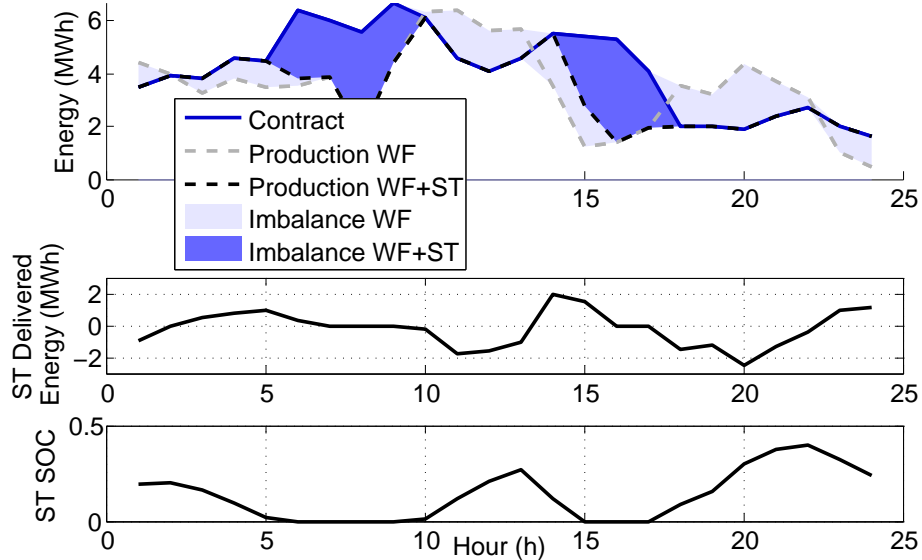

(a) Combination with an energy storage unit.

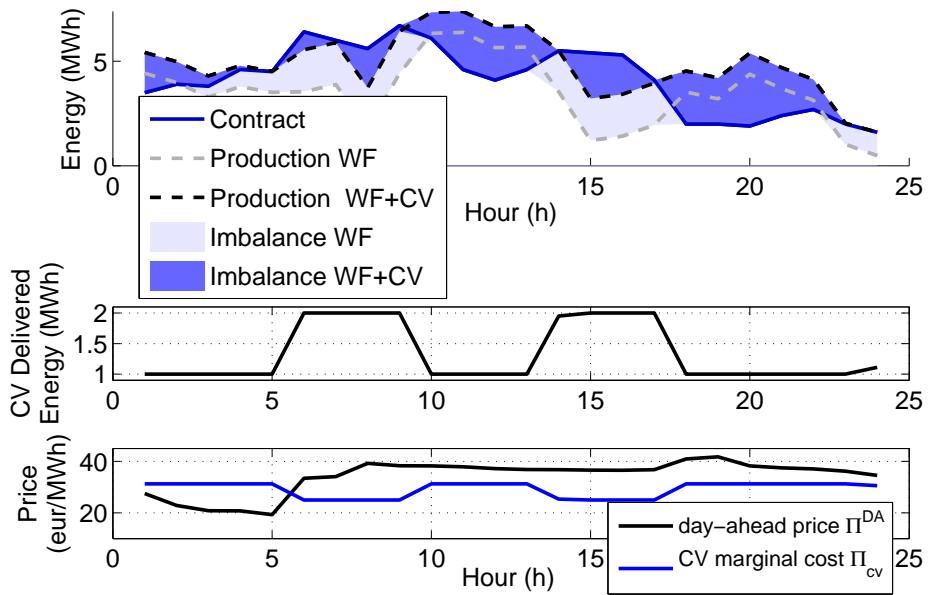

(b) Combination with a conventional generation unit.

Figure 3.10: Operation of the combination of the reference wind farm with an energy storage device (top) or with a conventional generation unit (bottom) during the day of 29/10/2003.

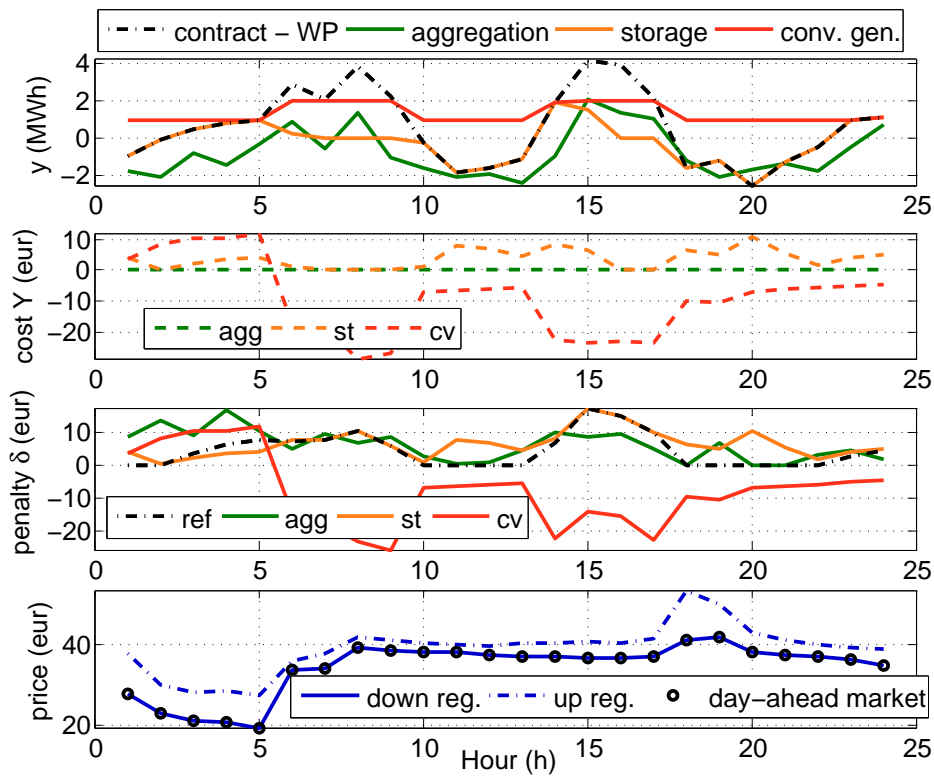

Figure 3.11: Analysis of the imbalance penalty in the cases of aggregation, combination with a storage unit and combination with a conventional unit, during the day of 29/10/2003.

can be observed that the imbalance penalty is most of the time increased compared to the reference case, for these 24 hours. This is particularly true in the two periods between hour 10 and hour 14 and between hour 17 and hour 22. This is explained by the fact that during these periods, the TSO is only penalizing negative energy imbalances. This can be deduced from the fourth graph where the up regulation price is greater than the day-ahead market price and the down regulation price equals the day-ahead market price. During these two periods, the storage is operated for reducing the positive imbalances, but these imbalances are not penalized by the TSO. Consequently, the operation of the storage increases the resulting imbalance penalty due to the energy losses (i.e. additional cost Y). Such a situation could be avoided if the storage unit was operated from an advanced schedule which takes into account the regulation state of the TSO. Actually, in the later case, the storage would be operated only for reducing the energy imbalances which are penalized by the TSO. Such strategic operation of the storage device is described in the next chapter.

- Finally, in the case of combination with a conventional unit, the additional cost Y is positive during the first 6 hours and negative during the following hours. This is explained by the sign of the difference between the day-ahead market price and the conventional unit marginal cost. During the first 6 hours, the day-ahead price is lower than the marginal cost, as described in the bottom graph of figure 3.10(b), and conversely for the following hours. The dashed red curve in the second plot of Figure 3.11 shows that the additional cost Y is further lower during the period when the unit is generating at nominal power, since its marginal cost is lower during these periods. These periods are between hour 6 and 9 and between hour 14 and 17.

The results of the imbalance penalty presented in Figure 3.11 refer to only one day of simulation. Consequently, these results are highly dependent on the specific conditions during that day, such as the regulation state of the TSO and the day-ahead market prices. In order to evaluate in the long term the imbalance penalty reduction, the operation of the three VPP configurations has been simulated for a period of 274 days between the 01/10/2003 and the 30/06/2004. The results are presented in Figure 3.12. The three plots give the total imbalance penalty obtained during the simulation period, normalized by the imbalance penalty obtained in the reference case (i.e. of the reference wind farm trading by itself). The total reference imbalance penalty relative to this period equals 45.370 k€ and represents 6.98 % of the revenue which would have been obtained without imbalance penalty.

The first graph 3.12(a) is relative to the **aggregation** case. This graph describes the influence of the number of aggregated wind farms on the total normalized imbal-

ance penalty. For a given number of aggregated wind farms $n > 1$, all the possible combinations of the reference wind farm with $n - 1$ wind farms among the 19 other wind farms are simulated. For example, the case of aggregating 9 wind farms with the reference one gives $\binom{19}{9} = 92378$ possibilities. Totally, 524288 simulations are represented on the graph. In addition to all the combinations described as green points, the black squares give the mean imbalance penalty obtained for all the possible combinations with the same number of aggregated wind farms. From the results in the figure, it is firstly concluded that the imbalance penalty resulting from aggregation is in general lower than the reference one. However, when aggregating 2, 3 or 4 wind farms, there are some cases when the resulting imbalance penalty is greater than the reference one. Also, the range of normalized imbalance penalty decreases when the number of aggregated wind farms increases. The mean imbalance penalty is reduced when the number of aggregated wind farms increases. It rapidly decreases from 100 % of the reference penalty to 81 % when 5 wind farms are aggregated. Then, it slowly decreases till 75 % when 20 wind farms are aggregated. The lowest imbalance penalty is obtained when aggregating a given combination of 7 wind farms with the reference one, and the resulting imbalance penalty is then reduced to 68 % of the reference one.

The second graph 3.12(b) is relative to the combination with an **energy storage unit**. This graph is the result of a parametric analysis and describes the combined influence of the storage energy capacity and of the round-trip efficiency η on the total normalized imbalance penalty. The graph shows that, in this case study, the imbalance penalty is highly dependent on the storage round-trip efficiency. More precisely, for efficiencies lower than 0.8, the storage combination increases the imbalance penalty, whatever the storage capacity is. This increase of penalty is due to the high additional cost Y related to the energy losses for the storage operation. In these cases, this additional cost Y is higher than the benefits related to the reduction of the energy imbalance from the storage energy y . When the efficiency is greater than 0.8, the additional cost is reduced and the imbalance penalty δ_{st}^{DA} is thus reduced. This reduction increases as the storage capacity increases. For the simulation $\eta = 0.8$, the resulting imbalance penalty is higher than the reference one for storage capacity lower than 20 MWh, and lower than the reference one for storage capacity greater than 20 MWh. In section 3.3.4, a condition has been formulated on the storage efficiency for the reduction of imbalance penalties:

$$\eta \geq 1 - 2 \cdot \frac{\Delta^{\Pi}}{\Pi^{DA}} \quad (3.98)$$

This condition is based on hypotheses which are detailed in section 3.3.4. The mean penalization factor Δ^{Π}/Π^{DA} during the simulation period is 7.51 %. Consequently,

the efficiency condition for reducing the imbalance penalty gives $\eta \geq 85$ %, which is coherent with the observations from the graph 3.12(b).

The third graph 3.12(c) is relative to the combination of the reference wind farm with a **conventional unit**. This graph describes the combined influence of the conventional unit nominal power and of the marginal cost at nominal power Π_{cv}^* on the total normalized imbalance penalty. These results have been obtained with a coefficient α_{cv} defining the output power range equal to 0.5. Also the β_{cv} coefficient referring to the marginal cost model equals 0.5. Similarly to the efficiency for the storage case, this graph shows that, in this case study, the imbalance penalty is highly dependent on the conventional unit marginal cost. The imbalance penalty increases as the marginal cost increases. For the simulation with $\Pi_{cv}^* = 30$ €/MWh, the imbalance penalty is greater than the reference one whatever the nominal power is. For marginal cost lower than 30 €/MWh, the imbalance penalty decreases as the nominal power increases till a minimum imbalance penalty is reached, and then increases as the nominal power increases. For example, the minimum imbalance penalty obtained when combining the reference wind farm with a conventional unit having a 25 €/MWh marginal cost is reached for a nominal power equal to 1.35 MW. This minimum imbalance penalty equals 70 % of the reference penalty. These simulation results depend on the day-ahead market and regulation prices over the simulation period. In particular, the relative position of the conventional unit marginal cost compared to the day-ahead market price highly influences the resulting penalty, as already observed in Figure 3.11. Also, in section 3.3.5, it has been demonstrated that a condition for the conventional unit combination to reduce the imbalance penalty is to have the marginal cost lower than the price for negative imbalance: $\Pi_{cv} < \Pi^-$. During the simulation, the mean price for negative imbalance equals 31.08 €/MWh. However, this theoretical condition is derived from considering only up-regulation situations, where negative imbalance are penalized. Also, during down-regulation, the conventional unit combination may increase the imbalance penalty. This explains why the presented results show a decrease of the imbalance penalty only for marginal costs lower than approximately 29 €/MWh.

Finally, the combination of the three graphs in Figure 3.12 enables to compare the imbalance penalty resulting from the different virtual power plant configurations. For example, the mean imbalance penalty in the case of aggregating the reference wind farm with 5 other wind farms equals 80 % of the reference imbalance penalty. From the simulation results, the same imbalance reduction can be obtained by combining the reference wind farm with a 26 MWh energy capacity and 0.9 round-trip efficiency storage unit. The same imbalance reduction can also be obtained by combining the reference wind farm with a 1.3 MW nominal power and 26 €/MWh marginal cost conventional unit.

This parametric analysis may even be used as a basis for comparing different dimensioning options of a given VPP configuration. For example, regarding the combination with storage, the reduction of imbalance penalty resulting from the combination with a storage device having a 26 MWh energy capacity and 0.9 round-trip efficiency, is equivalent to the one obtained from the combination with a storage device having a 15 MWh energy capacity and 0.95 round-trip efficiency.

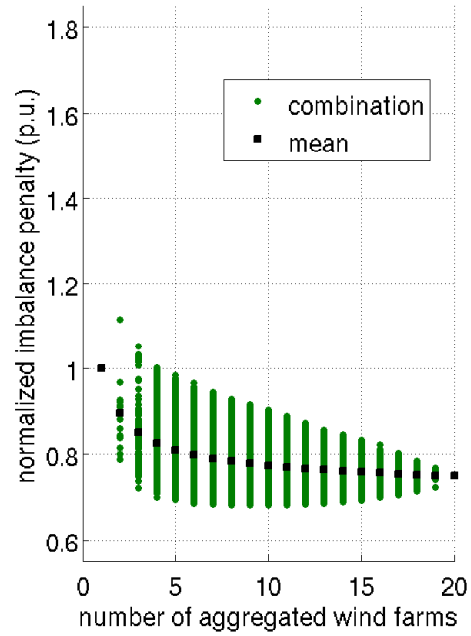

(a) Aggregation of wind farms.

(b) Combination with an energy storage unit with efficiencies η ranging between 0.7 and 0.95.(c) Combination with a conventional generation unit with marginal cost Π_{cv}^* ranging from 25 to 30 €/MWh, with $\alpha_{cv} = 0.5$ and $\beta_{cv} = 0.5$.

Figure 3.12: Imbalance penalty resulting from the simulation of the participation of the VPP in the day-ahead market during the period between the 01/10/2003 and the 30/06/2004.

3.6 Conclusions

- In this chapter, we proposed a generic imbalance penalty model, which is valid for both physical and financial solutions for reducing the imbalance penalty. The physical and financial solutions are modeled as a modification of the reference imbalance penalty model. This reference model refers to the participation of a reference RES unit in a day-ahead electricity market.
- For each solution, the modification of the reference imbalance penalty model consists in an additional cost and an adjustment of either the delivered or the contracted energy volume. Both the additional cost Y and the adjustment energy volume y are formulated as a function of the main quantities which model each solution. For example, the values of the price and of the volume for the intraday contract determine Y and y in the case of the participation in intraday market. Similarly, the energy delivered by the storage unit determines Y and y in the case of the combination with storage. These quantities may be the results of a decision-making process, and the decision-making problem relative to the use of these physical or financial solutions is the object of the following chapter.
- Results relative to the physical solutions in the frame of the virtual power plant have been presented. The models used for the operation of the storage unit and the conventional unit are presented, and illustrated using real world data. The results from a 9 month simulation of the participation in a day-ahead market are presented. The imbalance penalties resulting from the different solutions were compared. Finally it was illustrated how, through a parametric analysis, the approach can be used for the general problem of unit dimensioning in the context of virtual power plants.

Generic model of imbalance penalty

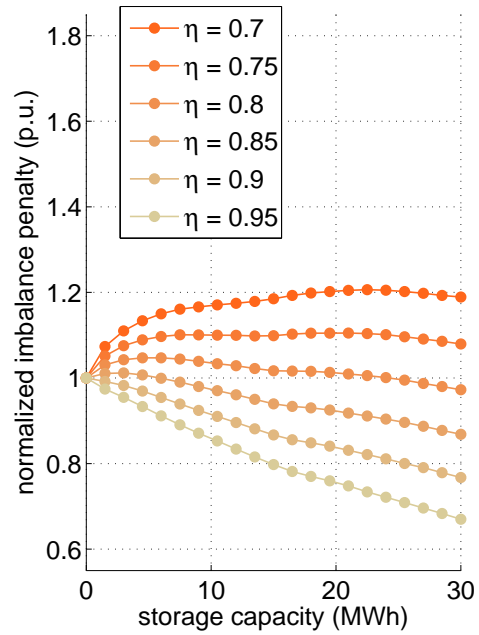
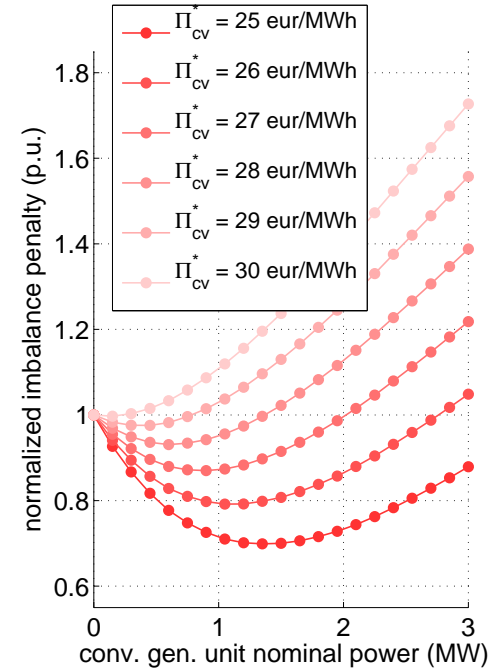
Management of Renewable Generation in Electricity Markets: a Decision-Making Problem

Chapter overview

The participation in an electricity market consists in proposing bids to the market prior to the delivery, with imperfect knowledge about future energy and prices. In case physical or financial solutions are applied for reducing imbalances, they have to be activated before delivery. Regarding physical solutions, the strategic operation of the virtual power plant is based on a schedule which aims to optimally operate the virtual power plant for minimizing the imbalance penalties. This schedule is determined before the operation of the virtual power plant. Also, the financial solutions are based on the participation in additional markets, and also require to propose bids prior to delivery.

This chapter presents the different types of decisions associated with both physical and financial decisions. A generic decision-making model, which is suited to the different types of decisions, is proposed. This method is based on a cost function which is derived from the generic penalization function model given in the previous chapter.

The benefits from the decision-making method are demonstrated through the example of the strategic participation in the intraday market, and the example of strategic operation of the combination of a wind farm with a pumped hydro storage unit.

4.1 Description of the decisions relative to the trading of renewable generation in electricity markets

4.1.1 General presentation of decision-making problems

A decision-making problem consists in choosing a single alternative among a set of identified alternatives [112]. In complex decision-making problems, the first step is to model the decision problem. The second step is the definition of a decision process, which aims at determining the decision to make. The decision process is based on a decision criterion, defined by the decision maker.

The decision criterion is a term defined in [112] as the “measures, rules, and standards that guide decision-making” and is composed of the attributes, the objectives and the goals of the decision-making problem. An explanation and a distinction between these three concepts are also given in [112]:

- The attributes are perceived as characteristics of concepts relative to the decision. The amount of energy imbalance or the imbalance penalty are examples of attributes relative to a given participation in the electricity market.
- The objectives are a specification of the attributes to maximize or to minimize. Objectives are not themselves attributes but they derive from one or more attributes. Minimizing the imbalance penalties is an example of objective.
- The goal refers to the decision maker’s needs and desires. A goal can be for example a specific level of the objective relative to the decision-making problem.

Also, a distinction can be made between decision-aid problems and decision-making problems [113]. In decision-aid problems, the decision process results in a set of alternatives which are the ones which respond at best to the set of decision criteria. Conversely, decision-making consists in determining a single best alternative corresponding to the criteria. The choice between decision-aid or decision-making approaches depends on the specificities and complexity of the decision problem, as well as on the nature of the decisions to make.

The following sections describe the attributes of the decision-making problem relative to the participation of renewable generation in short-term electricity markets.

4.1.2 The reference participation in the day-ahead market

In this section, the term “reference” refers to the participation of a reference RES unit with stochastic generation in the day-ahead market. This reference case is taken

as a basis for comparing the benefits in terms of imbalance penalty reduction related to the physical and financial solutions, as already proposed in the previous chapter.

For participating in day-ahead electricity markets, an Independent Power Producer (IPP) has to propose a bid during the period between the gate opening time and the gate closure time at a day d for a period covering the whole following day $d + 1$. The bids covering the period of the day $d + 1$ are given for each market time unit of the period. Usually, the length of a market time unit is one hour.

Most day-ahead markets have a single price market clearing process, which is explained in section 2.1.3. In this process, a generation bid consists of a set of non-decreasing blocks of energy-price for each market time unit [26]. For a given market time, the bid involves a decision-making problem since a decision has to be made by the IPP on both the energy quantity to propose to the market and the price at which this quantity is proposed. The participation in a day-ahead market is in turn a decision-making problem about the quantity-price values to propose for consecutive bids of the market periods of the next day.

A single market price is calculated from the aggregation of all the offer and buy bids. Then, the contracted energy quantity following a bid depends on the position of the bid price relatively to the market price.

4.1.3 Decisions associated with the physical solutions for imbalance management

This section presents the decisions which are necessary for the operation of the three physical solutions for reducing the imbalance penalty, which were presented in the generic model of the virtual power plant. These three solutions are the aggregation of RES units and the combination with either a storage unit or a conventional unit.

In order to obtain the maximum possible reduction of imbalance penalty, the operation of the physical solutions has to be based on decisions such as scheduling or economic dispatch, which are provided prior to the operation. These decisions are then used as setpoints during operation. This advanced operation mode is said to be “strategic”.

First, the reduction of imbalance penalties related to the aggregation of RES units is based on the combination of units which are supposed to be non-dispatchable. The imbalance reduction results from the compensation of individual imbalances, as already presented in the previous chapter. No operating decision is thus considered for this solution.

In contrast, storage units and conventional units are dispatchable units. Their limited characteristics force the VPP operator to manage their operation for reducing imbalance penalties. Two main kinds of decision-making problems are associated

with this management:

- The unit commitment problem consists in determining, for a given generation portfolio, which unit will be in operation at each time step of a given period. This decision has to take into account the technical constraints, such as possible ramps for increasing the production, or the minimum time each unit has to be off.
- The economic dispatch consists in determining the level at which each unit has to be operated for each time step of a given period. The decision is made with the objective to maximize an economic benefit or minimize an economic cost. An example of the economic dispatch problem relative to the participation of a generation portfolio including renewable and conventional units in the NETA market is given in [34].

In the solution based on energy storage, the energy delivered or absorbed by the storage unit for a given time step depends on the amount of energy already stored in the device which, in turn, depends on the delivered energy at the previous time steps. In this case, the decision associated with the strategic combination of storage and renewable units consists in determining the delivered energy by the storage unit or the state-of-charge of the unit for the consecutive time steps of a given period, where the objective is to minimize the imbalance penalties. When no strategic decision is available, the reference operation mode for the storage unit consists in a “filter” mode, where the storage energy output is set for reducing the instantaneous energy imbalance of the RES unit. Such an approach was used for modeling the storage operation in the previous section 3.5.

In the solution based on conventional generation, the ability to increase or decrease the conventional unit output, for reducing the imbalance penalty relative to a RES unit, depends on the operating state of the conventional unit. If the considered unit can be switched off, the decision to switch it on is a unit commitment problem. Also, scheduling the output energy from the conventional unit enables the VPP operator to dispatch the delivered energy with the objective of having operating costs of the conventional unit lower than the avoided imbalance penalties. When no unit commitment method is used, the reference operating mode consists in maintaining the unit as a “must-run” unit, always switched on. The unit output then ranges between the minimum and maximum power output. This reference operating mode is the one which has been used for modeling the conventional unit operation in the previous section 3.5. However, the operating costs associated with this reference operating mode may be higher than the avoided imbalance penalties.

4.1.4 Decisions associated with the financial solutions for imbalance management

In section 3.2, the solution based on option trading has been formulated. In the same section, it has been explained that this solution is still theoretical and is thus not further considered in this thesis.

Regarding the participation in an intraday market, this solution consists in trading its generation in an additional electricity market. This market takes place after the day-ahead one, and offers the possibility to adjust the IPP's contractual position relative to the day-ahead trading.

Intraday markets can be based either on a single price market clearing process, as is the case in Spain where the intraday market consists in six sessions, or on a continuous trading mechanism with pay-as-bid market clearing process, as is the case for the Elbas market in the Nordic countries. If the intraday market is based on a single price market clearing process, the decision-making problem is similar to the one relative to the participation in the day-ahead market, already detailed in section 4.1.2. In the case of the pay-as-bid process, the bid also consists in a set of quantity-price values for each market time of the intraday market, and the decision is therefore similar to the case of single price market clearing process.

4.2 Generic formulation of the decision-making problem related to the management of renewable generation in electricity markets

4.2.1 Formulation of the optimization problem

The reference participation in the day-ahead market and the use of financial solutions refer to a decision-making problem, where the operator has to decide the quantity and the price of the electricity bid it proposes to the markets. Also, the strategic operation of the physical solutions is based on a schedule which is a decision about the operation setpoints relative to the combined units.

The proposed physical and financial solutions are in general used by the independent power producer for reducing the imbalance penalties. Consequently, in this work, we consider that the decisions relative to these solutions are made with such objective of reducing the imbalance penalties. Such objective is purely economic, and is related only to the independent power producers' point of view. Nevertheless, the same physical and financial solutions, proposed here for reducing the imbalance penalties, may be used as solutions for other issues related to the integration of renewable generation in power systems. For example, the combination of a wind farm

with a storage unit can be used as a solution for both reducing the imbalance penalties and managing the grid congestions which could be caused by the wind power generation, as described in [114]. In this case, the scheduling of the storage unit could be done with a combined economic objective of reducing imbalance penalties and a technical objective of managing grid congestion. However, such multi-objective decision-making process is out of the scope of the present work. Focus is given only on the imbalance penalty management.

The decision variables of the considered problem are divided into two categories. First, decisions related to the use of financial solutions have a decision variable, u , which is related to the market participation. Similarly, decisions related to the use of physical solutions have a decision variable v related to scheduling. Note that the reference participation in the day-ahead market can be considered as a particular case of financial solution, as explained in section 3.4, and the associated decision variable is also denoted as u . For a given time period T_i , the decision variable u_{T_i} can be for example the quantity-price bid in a day-ahead market $u_{T_i} = (E_{T_i}^{BDA}, \Pi_{T_i}^{BDA})$, or in an intraday market $u_{T_i} = (E_{T_i}^{BID}, \Pi_{T_i}^{BID})$. The decision variable v_{T_i} can be the scheduled state-of-charge of the storage unit $v_{T_i} = SOC_{T_i}^{sch}$ or the scheduled energy from the conventional unit $v_{T_i} = E_{cv, T_i}^{sch}$.

In a general way, the independent power producer may have to make a combined decision at time t_d about market and scheduling variables (u_{T_i}, v_{T_i}) . Also, the decisions may not be for a single time period T_i but rather for n consecutive time periods $[T_1, T_2, \dots, T_n]$. Such problems are defined in [115] as sequential or multistage decision problems. For these problems, the interdependence between the consecutive decisions has to be taken into account. The multistage decision approach proposed in this thesis is presented in the case of the combination with storage in section 4.6. The time t_d when the decision is made is taken prior to the beginning of the first period T_1 . The decision vectors U and V , relative to the n consecutive periods, are denoted as:

$$\begin{aligned} U &= [u_{T_i}]_{i=1}^n = [u_{T_1}, u_{T_2}, \dots, u_{T_n}] \\ V &= [v_{T_i}]_{i=1}^n = [v_{T_1}, v_{T_2}, \dots, v_{T_n}] \end{aligned} \quad (4.1)$$

Note that in the proposed formulation, the symbol t is used to represent a position in time, while the symbol T is used to represent a period of time.

Figure 4.1 illustrates the decision vectors U and V . The vertical red lines represent the time t_d when the decision is made.

The imbalance penalty cost resulting from the decisions (U, V) is derived through a function Φ which gives a real number associated with the decisions. Finally, the decision-making problem is formulated as an **optimization problem**, which

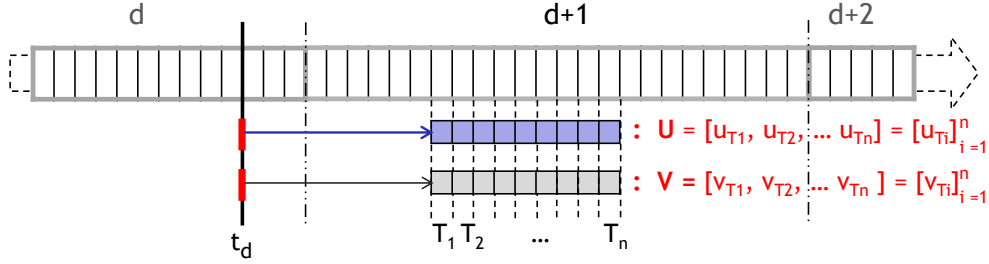

Figure 4.1: Description of the generic decision problem relative to the variables U and V . d stands for the day.

consists in determining the decision variables values which minimize the imbalance penalty cost:

$$(U^*, V^*) = \arg \min_{(U, V)} \Phi(U, V), \text{ subject to } \mathcal{C}_{U,V} \quad (4.2)$$

where $\mathcal{C}_{U,V}$ are the **constraints** related to the variables U and V . The constraints relative to the decisions U for the use of financial solutions model the limits imposed by the market rules. Such constraints include for example the minimum and maximum energy bid that a given IPP can propose for each time unit. Similarly, the constraints relative to the decisions V for the use of physical solutions model the technical limits imposed by the power units which are combined with the reference unit. The lower and upper bounds for the state-of-charge of a storage unit is an example of technical constraints in the case of combination with storage. The details of the constraints $\mathcal{C}_{U,V}$ in the case of (1) the reference participation in the day-ahead market, (2) the additional participation in the intraday market and (3) the combination with a storage device, are given in the next sections.

Finally, the decision variables U and V considered in this thesis are supposed to be **continuous**. In other words, they are allowed to take on any values permitted by the constraints $\mathcal{C}_{U,V}$. By contrast, the decisions which are related to discrete variables are not treated in this thesis. This discrete decision could be, for example, the unit commitment decision concerning a conventional unit combined with renewable generation, where two states are possible: on or off. Consequently, the general resolution of the optimization problem given in Equation 4.2 is solved with continuous optimization methods.

4.2.2 Decision-making under uncertainty

The general decision-making problem presented in Equation 4.2 consists for the IPP in determining alternatives which minimize the imbalance penalty cost. However,

this cost depends on factors which are determined only after the decision, such as the amount of delivered energy by the renewable power units and the market prices.

Consequently, at the decision time t_d , the IPP has make a decision about the variables (U, V) in order to minimize a cost which is not perfectly known at t_d . Such decision-making problems are denoted as **decision-making under uncertainty** problems [116], because the outcomes of each decision alternative are uncertain. At the decision time t_d , the amount of delivered energy by the renewable power units and the market prices are considered as random variables or stochastic variables, and consequently introduce some amount of uncertainty associated with how the future will be.

Decision-making problems under uncertainty are based on estimation of the future outcomes. Such estimations are forecasts which are available at the decision time. Generally, the term of *deterministic forecast* is used to describe a forecast which simply consists in an estimation of the future value of the forecasted variable. Conversely, the term *probabilistic forecast* is used to describe a forecast which includes uncertainty information of the future variable in addition to the estimation of the future value.

Decision-making problems under uncertainty may disregard or consider the uncertainty associated with the forecasts. In a first step of the present work, the uncertainty associated with the forecasts is disregarded and the estimation of the future value only is considered. The consideration of the uncertainty information will be the focus of the next chapter 5.

4.3 Proposition of an approach based on a loss function for the decision-making problem

This section focuses on the derivation of the objective function Φ from the optimization problem given in Equation 4.2, which gives a real number associated with the decisions $[u_{T_i}]_{i=1}^n$ and $[v_{T_i}]_{i=1}^n$. This function Φ models the objective of the decision as defined in section 4.1.1. It maps a given alternative onto a real number representing the economic penalty associated with the alternative. The next paragraph presents the general considerations used to develop the objective function Φ based on the loss function concept.

4.3.1 Concept of loss function: relation between loss, utility and regret

This paragraph presents the general concept of the loss function, and describes the distinctions between this concept and two others related to decision-making, which

are the utility theory and the regret theory.

The concept of loss function is closely linked to the concept of utility. The utility theory has been proposed by Bernoulli in [117] as a decision method for considering the satisfaction of the decision maker relatively to an alternative. A utility function is thus a measure of such satisfaction which integrates the preferences of the decision maker. Under this principle, the best decision is taken as the one that maximizes the utility of the decision maker [116]. Further details about the utility theory are given in the next chapter, more precisely in section 5.2.2.

Contrary to the utility function which is maximized for a given decision, the loss function inversely models the dissatisfaction associated with a decision and is minimized for a given decision. A possibility to derive a loss function is to consider the opposite of the utility function; however, the determination of the utility theory for a given decision maker is usually a hard task [118].

Finally, regret theory is a particular case of the concept of the loss function [119]. In this case, the decision process is modeled as the minimization of a function of a regret vector. This regret vector is a particular case of loss, and is defined as the difference between the outcome yielded by a given choice and the best outcome that could have been achieved in that state of nature.

In this thesis, the proposed method for the derivation of the loss function λ is based on the modeling of the cost related to the decisions. The objective function Φ is then derived from the loss function λ . The distinction between the objective function Φ and the loss function λ is described in the formulation of the problem in the next section.

4.3.2 Formulation of the proposed loss function

In order to formulate the loss function, the general cases of a financial solution S_x and a physical solution S_y are considered. The decision relative to the financial solution S_x is the vector $U = [u_{T_i}]_{i=1}^n$ and the decision relative to the physical solution S_y is the vector $V = [v_{T_i}]_{i=1}^n$.

In chapter 3, and more precisely in Equation 3.84, the imbalance penalty p_{T_i} , for a given time period T_i , has been formulated as a function of the delivered energy by the IPP \tilde{E}_{T_i} and the contracted energy in the day-ahead market $E_{T_i}^{\text{DA}}$:

$$p_{T_i} = \delta_{S_x, S_y, T_i}^{\text{DA}} \left(\tilde{E}_{T_i}, E_{T_i}^{\text{DA}} \right) \quad (4.3)$$

where $\delta_{S_x, S_y, T_i}^{\text{DA}}$ is the imbalance penalty function relative to the solutions S_x and S_y , derived in section 3.4, for the market time unit T_i . This function is given from

the generic imbalance penalty model in Equation 3.84:

$$\delta_{S_x, S_y, T_i}^{\text{DA}} \left(\tilde{E}_{T_i}, E_{T_i}^{\text{DA}} \right) = X_{T_i} + Y_{T_i} + \delta_{T_i}^{\text{DA}} \left(\tilde{E}_{T_i} + y_{T_i}, E_{T_i}^{\text{DA}} + x_{T_i} \right) \quad (4.4)$$

The proposed decision-making approach is based on a loss function λ which gives the imbalance penalty cost c relative to a given alternative (u, v) . For a given time period T_i , the cost c_{T_i} is formulated as:

$$c_{T_i} = \lambda_{T_i}(u_{T_i}, v_{T_i}) \quad (4.5)$$

The given formulation consists in defining the cost c_{T_i} relative to the loss function λ_{T_i} , from the penalty p_{T_i} relative to the imbalance penalty function $\delta_{S_x, S_y, T_i}^{\text{DA}}$. At the decision time t_d , the penalty p_{T_i} , which is based on the delivered energy volumes and the observed market prices, is not perfectly known. The estimated penalty at the decision time is denoted as \hat{p}_{T_i} , and is derived from the estimated penalization function $\hat{\delta}_{T_i}^{\text{DA}}$ and the estimated delivered energy $\hat{E}_{T_i|t_d}$ as follows:

$$\hat{p}_{T_i} = \hat{\delta}_{S_x, S_y, T_i}^{\text{DA}} \left(\hat{E}_{T_i|t_d}, E_{T_i}^{\text{DA}} \right) \quad (4.6)$$

Then, the cost c_{T_i} is defined as the estimated penalty \hat{p}_{T_i} : $c_{T_i} = \hat{p}_{T_i}$. By combining Equation 4.5 with Equation 4.6 and Equation 4.4, this gives:

$$\begin{aligned} \lambda_{T_i}(u_{T_i}, v_{T_i}) &= \hat{\delta}_{S_x, S_y, T_i}^{\text{DA}} \left(\hat{E}_{T_i|t_d}, E_{T_i}^{\text{DA}} \right) \\ &= X(h_{S_x, T_i}(u_{T_i})) + Y(h_{S_y, T_i}(v_{T_i})) \\ &\quad + \hat{\delta}_{T_i}^{\text{DA}} \left(\hat{E}_{T_i|t_d} + y(h_{S_y, T_i}(v_{T_i})), E_{T_i}^{\text{DA}} + x(h_{S_x, T_i}(u_{T_i})) \right) \end{aligned} \quad (4.8)$$

The details about the functions h_{S_x, T_i} and h_{S_y, T_i} which model the consequences of the decisions u_{T_i} and v_{T_i} on the energy volumes (x_{T_i}, y_{T_i}) and additional cost (X_{T_i}, Y_{T_i}) , are explained in the section 4.3.4. Also, the derivation of the estimated imbalance penalty function $\hat{\delta}_{T_i}^{\text{DA}}$ and the estimated delivered energy $\hat{E}_{T_i|t_d}$ are detailed in the next section.

Then, the proposed objective function Φ relative to the decision vectors (U, V) is a norm \mathcal{N} of the cost c_{T_i} associated with each time period T_i :

$$\Phi(U, V) = \mathcal{N}([c_{T_i}]_{i=1}^n) = \mathcal{N} \left([\lambda_{T_i}(u_{T_i}, v_{T_i})]_{i=1}^n \right) \quad (4.9)$$

A discussion about the norm \mathcal{N} is also given in the following section 4.3.5. Finally, the decision-making problem is modeled through the following optimization

problem:

$$\left[(u_{T_i}^*, v_{T_i}^*) \right]_{i=1}^n = \arg \min_{\left[(u_{T_i}, v_{T_i}) \right]_{i=1}^n} \mathcal{N} \left(\left[\lambda_{T_i}(u_{T_i}, v_{T_i}) \right]_{i=1}^n \right), \text{ subject to } \mathcal{C}_{U,V} \quad (4.10)$$

The following paragraphs give some details for the derivation of the loss function λ .

4.3.3 Estimation of the future imbalance penalty and energy production

The penalization function $\delta_{S_x, S_y, T_i}^{\text{DA}}$ in Equation 4.3 models the evaluation of the imbalance penalty *after delivery*. At this time, the market prices which define the quantity $\Delta_{T_i}^{\Pi}$ are known. Such market price difference is defined in Equation 3.8 and is used for the definition of the δ^{DA} function. Also the delivered energy \tilde{E}_{T_i} is measured and the contracted energy $E_{T_i}^{\text{DA}}$ is already settled. In contrast, the loss function is designed for the decision-making problem *prior to delivery*. The decision time is anterior to the beginning of the time period T_i and consequently, the delivered energy and market prices for T_i are not perfectly known and are estimated through forecasting methods. The hat operator $\hat{\cdot}$ is used to describe the different forecasts:

- $\hat{E}_{T_i|t_d}$ is the estimated value of the delivered energy during the period T_i ; this estimation is available at the decision time t_d . The considered IPP includes renewable generation units and the estimation of future energy delivery is obtained through forecasting models described in the appendix B.
- $\hat{\Delta}_{T_i|t_d}^{\Pi}$ is similarly the estimation of the value of Δ^{Π} for the time period T_i available at the decision time t_d . Such estimation is based on the estimation of the difference between the day-ahead market price and the regulation prices. A discussion about the price forecasting problem is proposed in the appendix C.

The estimated reference imbalance penalty function $\hat{\delta}_{T_i}^{\text{DA}}$ used in Equation 4.8 is obtained from the definition of $\delta_{T_i}^{\text{DA}}$ in Equation 3.7 by replacing \tilde{E} and Δ^{Π} by the estimations $\hat{E}_{T_i|t_d}$ and $\hat{\Delta}_{T_i|t_d}^{\Pi}$:

$$\hat{\delta}_{T_i}^{\text{DA}} \left(\hat{E}_{T_i|t_d}, E^{\text{DA}} \right) = \left| \hat{E}_{T_i|t_d} - E^{\text{DA}} \right| \times \hat{\Delta}_{T_i|t_d}^{\Pi} \quad (4.11)$$

4.3.4 Formulation of the consequences of the decisions on the imbalance penalty

For any financial or physical solution, a distinction has to be made between the decision and the realization associated with such decision. Such distinction is described for both financial and physical solutions:

- In the case of a financial solution S_x , the decision u is relative to market participation and is a bid proposed to the market. The quantity-price contract is a function h_{S_x} of the such bid u , where the function h_{S_x} models the market settlement. The quantity-price contracts are denoted as $\tilde{u} = h_{S_x}(u)$. Also, the impact of a financial solution on the imbalance penalty has been modeled in section 3.4 through the quantities (x, X) , and these quantities depend on the realization \tilde{u} . In other words, the quantities (x, X) do not directly depend on the bid u , but on the contract \tilde{u} .

$$x = x(\tilde{u}) = x(h_{S_x}(u)) \quad (4.12)$$

$$X = X(\tilde{u}) = X(h_{S_x}(u)) \quad (4.13)$$

- In the case of a physical solution S_y , the decision v is relative to the scheduling of either a storage unit or a conventional unit. The operation variables are the real outputs from units, and result from the application of the schedule. In particular, additional technical constraints or a temporary modification of the operation rules, may lead to a difference between the schedule v and the resulting energy output denoted \tilde{v} . The relation between the schedule and the real output is modeled through a function h_{S_y} and so, $\tilde{v} = h_{S_y}(v)$. Also, the impact of a physical solution on the imbalance penalty is modeled through the quantities (y, Y) , as explained in section 3.4, which depend on the realization \tilde{v} of the solution. In other words, the quantities (y, Y) do not directly depend on the schedule v , but on the real energy output \tilde{v} .

$$y = y(\tilde{v}) = y(h_{S_y}(v)) \quad (4.14)$$

$$Y = Y(\tilde{v}) = Y(h_{S_y}(v)) \quad (4.15)$$

Figure 4.2 summarizes the differences between the loss function λ and the penalization function δ . First, the loss function is based on an estimation of the future energy delivery and price whereas the penalization function evaluates the realizations. Also, the loss function is a function of the decision variables whereas the penalization function only considers the results of these decisions.

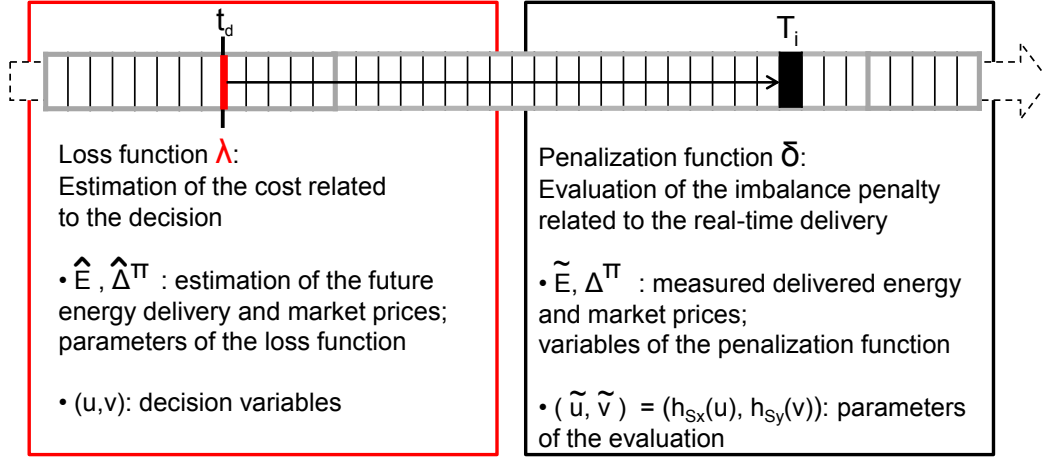

Figure 4.2: Comparison between the loss and penalization functions, in terms of parameters and variables

4.3.5 Discussion about the norm relative to the optimization problem

The decision-making problem is formulated for n consecutive time periods in Equation 4.1. The proposed objective function is formulated in Equation 4.9 as a norm \mathcal{N} of the vector of the cost c_{T_i} relative to each time period T_i .

The considered norm here is a real-valued function on \mathbb{R}^n satisfying the set of properties which defines a function as a norm [109]. Using such norm, the objective function Φ of the optimization problem becomes a real-valued function.

Some of the most frequently used norms are the p -norms [109, 112]. For $p \leq 1$ a given real number, the p -norm \mathcal{N}_p of a vector $[c_{T_i}]_{i=1}^n$ is defined as:

$$\mathcal{N}_p([c_{T_i}]_{i=1}^n) = \left(\sum_{i=1}^n |c_{T_i}|^p \right)^{1/p} \quad (4.16)$$

The most well-known p -norms are the so-called *Manhattan* norm, the *Euclidian* norm and the *Maximum* norm which are obtained with $p = 1$, $p = 2$ and $p \rightarrow \infty$ respectively:

$$\mathcal{N}_1([c_{T_i}]_{i=1}^n) = |c_{T_1}| + |c_{T_2}| + \dots + |c_{T_n}| \quad (4.17)$$

$$\mathcal{N}_2([c_{T_i}]_{i=1}^n) = \sqrt{|c_{T_1}|^2 + |c_{T_2}|^2 + \dots + |c_{T_n}|^2} \quad (4.18)$$

$$\mathcal{N}_\infty([c_{T_i}]_{i=1}^n) = \max(|c_{T_1}|, |c_{T_2}|, \dots, |c_{T_n}|) \quad (4.19)$$

The choice of the norm depends on the objective of the decision-making problem.

For example, the norm \mathcal{N}_1 focuses on the total cost for the period $[T_1, T_2, \dots, T_n]$ and is related to *expectancy choice*, as defined in [120]. Conversely, the last norm \mathcal{N}_∞ is relative to *robust choice*. This norm is used in Robust Programming [121] since it aims at selecting the alternative that better behaves in worst-case situations or scenarios as shown in [122,123]. This norm is especially well-suited for single-shot decision situations in which eventual bad outcomes of present decisions cannot be overcome by good outcomes of further decisions.

In the present work, the influence of the different norms on the resulting decisions is illustrated in the case study relative to the strategic combination of a RES unit with storage, in section 4.6.

The following sections present the application of the generic decision-making proposed in section 4.3.2 to three different cases: the reference participation in the day-ahead market, the participation in the intraday market as a financial solution and the combination with a storage unit as a physical solution.

4.4 Application of the decision-making method for trading renewable generation in the day-ahead market

This section focuses on the participation of an IPP in a day-ahead electricity market. The generation units of the IPP are considered to be only renewable power sources. The participation in the day-ahead market can be considered as a particular case of financial solution where the decision U^{DA} consists in a quantity-price bid for each time period of the next day. For a given period T_i , the decision $u_{T_i}^{\text{DA}}$ is the combination of the quantity bid $E_{T_i}^{B_{\text{DA}}}$ and the price bid $\Pi_{T_i}^{B_{\text{DA}}}$

$$u_{T_i}^{\text{DA}} = \left(E_{T_i}^{B_{\text{DA}}}, \Pi_{T_i}^{B_{\text{DA}}} \right), \text{ and } U^{\text{DA}} = \left[\left(E_{T_i}^{B_{\text{DA}}}, \Pi_{T_i}^{B_{\text{DA}}} \right) \right]_{i=1}^n \quad (4.20)$$

In most day-ahead markets, the time period T_i is one hour and the number of time periods is thus 24.

4.4.1 Main hypotheses

Price-taker hypothesis

The day-ahead market is supposed to be based on a single price market mechanism, where the market clearing price and traded volumes are determined through marginal pricing. Also, the IPP is supposed to be “price-taker”. This notion has been defined in section 2.2.4. When the IPP is a price taker, the bid is price-

independent and the decision only deals with the energy quantity to propose:

$$U_{price\ taker}^{DA} = \left[E_{T_i}^{B_{DA}} \right]_{i=1}^n \quad (4.21)$$

Independence of the decisions

Also, the IPP is supposed to propose n consecutive energy bids relative to the n time periods of the following day, where n is the number of time periods. In this case, the IPP includes only RES units, whose generation is supposed to be non-dispatchable. Also the generation ramps are not considered. Consequently, the energy bid for a given time period T_i is supposed to be independent from the other energy bids relative to the time periods T_j , $j \neq i$. In other words, the day-ahead market bidding is supposed to be done **independently for each market-time unit**. Note that the consideration of the temporal dependence between consecutive decisions will be the main focus of section 4.6 relative to the operation of a storage unit combined with RES unit.

Based on these hypotheses, the general decision problem relative to the quantity-price bid for the n market times can be simplified to n independent decision problems relative to the energy bid for one market time. For a given market time unit T_i , this decision is denoted as $U_{T_i}^{DA}$ and is derived as:

$$U_{T_i}^{DA} = u_{T_i}^{DA} = E_{T_i}^{B_{DA}} \quad (4.22)$$

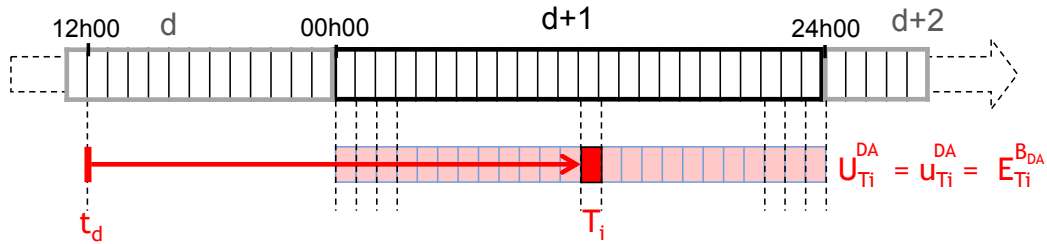

Figure 4.3: Example of the participation in the Elspot day-ahead market (NordPool).

Figure 4.3 presents the decision relative to the trading in the Elspot day-ahead market, in the Nordic countries. This decision takes into account the price taker hypothesis and the independence of the decisions. The gate closure time is the time t_d when the decision is made. This time is at 12h00 the day d in the example. The market time unit is one hour. The vertical red line represents the instant when the decision is made.

4.4.2 Formulation of the specific problem

The participation in the day-ahead market is considered as a particular case of financial solution in the generic decision-making method. The loss function specific to the day-ahead trading for a market time unit T_i is denoted as $\lambda_{T_i}^{\text{DA}}$ and is derived from the generic loss function λ given in Equation 4.8. In this case, the day-ahead market participation is considered as a financial solution (i.e. $S_x : DA$) and no physical solution is considered (i.e. $S_y : \{\}$), which leads to $Y_{T_i} = 0$ and $y_{T_i} = 0$. Also, in the particular case of the day-ahead market participation, the quantity $E_{T_i}^{\text{DA}}$ is taken as zero in Equation 4.8, in a similar way as already demonstrated in Equation 3.81 for the derivation of the generic imbalance penalty function. Still from Equation 3.81, the energy volume x and the additional cost X are set to:

$$X_{T_i} = 0, \text{ and } x_{T_i} = E_{T_i}^{\text{CDA}} \quad (4.23)$$

where $E_{T_i}^{\text{CDA}}$ is the energy contract in the day-ahead market for the market time T_i . This contract is a function of the energy bid $E_{T_i}^{\text{BDA}}$. This function is denoted as h_{DA} and models the day-ahead market settlement. Also, in the case of price taker IPP, the quantity bid is always traded and accepted in the market and consequently, the day-ahead energy contract equals the day-ahead quantity bid:

$$E_{T_i}^{\text{CDA}} = h_{\text{DA}, T_i} \left(E_{T_i}^{\text{BDA}} \right) = E_{T_i}^{\text{BDA}} \quad (4.24)$$

Consequently, the loss function $\lambda_{T_i}^{\text{DA}}$ is derived from Equation 4.8, with $u_{T_i} = E_{T_i}^{\text{BDA}}$, $v_{T_i} = 0$, and the h_{DA, T_i} function defined in Equation 4.24, as follows:

$$\lambda_{T_i}^{\text{DA}}(u_{T_i}, v_{T_i}) = \lambda_{T_i}^{\text{DA}}(E_{T_i}^{\text{BDA}}, 0) \quad (4.25)$$

$$= \widehat{\delta}_{T_i}^{\text{DA}} \left(\widehat{E}_{T_i|t_d}, E^{\text{CDA}}(h_{\text{DA}}(E^{\text{BDA}})) \right) \quad (4.26)$$

$$= \widehat{\delta}_{T_i}^{\text{DA}} \left(\widehat{E}_{T_i|t_d}, E_{T_i}^{\text{BDA}} \right) \quad (4.27)$$

Then, the optimal day-ahead energy bid $E_{T_i}^{\text{BDA},*}$ for the period T_i is given by the optimization problem formulated in Equation 4.10. The decision problem is for only one time unit (i.e. $n = 1$) and thus the norm in Equation 4.10 \mathcal{N} is the identity function: $\mathcal{N}(x) = x$:

$$E_{T_i}^{\text{BDA},*} = \arg \min_{E_{T_i}^{\text{BDA}}} \lambda_{T_i}^{\text{DA}}(E_{T_i}^{\text{BDA}}, 0), \text{ subject to } \mathcal{C}_{\text{DA}} \quad (4.28)$$

with $\lambda_{T_i}^{\text{DA}}(E_{T_i}^{\text{BDA}}, 0) = \widehat{\delta}_{T_i}^{\text{DA}} \left(\widehat{E}_{T_i|t_d}, E_{T_i}^{\text{BDA}} \right)$. The constraints \mathcal{C}_{DA} on the day-ahead

market energy bid are given by the market rules. These constraints depend on the considered day-ahead market. The main bidding constraints for day-ahead bids refer to price-dependent bids. However, in this application, the price-taker IPP is proposing a price-independent bid. Consequently, these constraints do not apply to the decision $E^{B_{DA}}$. The optimization problem in this formulation is thus taken as an unconstrained one: $C_{DA} = \emptyset$.

Also, by considering Equation 4.11, the loss function given in the previous equation can be rewritten as:

$$\lambda_{T_i}^{DA}(E_{T_i}^{B_{DA}}, 0) = \left| \widehat{E}_{T_i|t_d} - E_{T_i}^{B_{DA}} \right| \times \widehat{\Delta}_{T_i|t_d}^{\Pi} \quad (4.29)$$

The energy forecast $\widehat{E}_{T_i|t_d}$ and price forecast $\widehat{\Delta}_{T_i|t_d}^{\Pi}$ taken in this decision-making problem are the latest available forecasts at decision time t_d . The short-term generation forecasting methods for obtaining the energy forecast $\widehat{E}_{T_i|t_d}$ are detailed in section B.2. Similarly, the price forecast $\widehat{\Delta}_{T_i|t_d}^{\Pi}$ is obtained from approaches which are described in section C.4.

4.4.3 Illustration of the loss function of the problem

The expression of the loss function λ^{DA} given in Equation 4.29 can be developed by taking into account the definition of the market price $\widehat{\Delta}^{\Pi}$ given in Equation 3.8. In the present example, the IPP is supposed to participate in the day-ahead market only for selling energy and consequently, $E^{B_{DA}} \geq 0$. Consequently, the loss function λ^{DA} is a piecewise linear function defined as follows:

$$\lambda^{DA}(E^{B_{DA}}, 0) = \begin{cases} \widehat{\Delta}_+^{\Pi} \times \widehat{E} - \widehat{\Delta}_+^{\Pi} \times E^{B_{DA}} \Leftarrow 0 \leq E^{B_{DA}} \leq \widehat{E} \\ -\widehat{\Delta}_-^{\Pi} \times \widehat{E} + \widehat{\Delta}_-^{\Pi} \times E^{B_{DA}} \Leftarrow \widehat{E} \leq E^{B_{DA}} \end{cases} \quad (4.30)$$

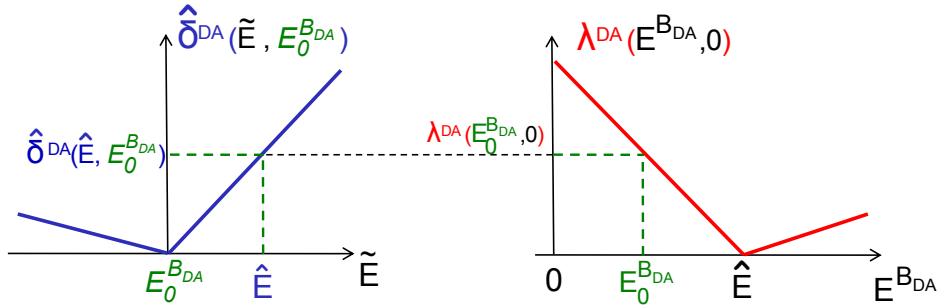

Figure 4.4: Relation between the functions λ^{DA} and $\widehat{\delta}^{DA}$

Such λ^{DA} function is represented in Figure 4.4. This figure also illustrates the relation between the loss function λ^{DA} and the corresponding estimated penalization function $\hat{\delta}^{\text{DA}}$, given in Equation 4.27. More precisely, the figure illustrates that, for a given energy bid E_0^{BDA} :

$$\hat{\delta}^{\text{DA}}(\hat{E}, E_0^{\text{BDA}}) = \lambda^{\text{DA}}(E_0^{\text{BDA}}, 0) \quad (4.31)$$

Note that the previous plots of the function δ^{DA} in the preceding chapter take E^{DA} as reference value, and not E^{BDA} as shown in Figure 4.4. Actually, the quantity E^{DA} used in the previous chapter corresponds to the contracted volume $E^{\text{DA}} = E^{\text{CDA}}$, and in this example, $E^{\text{CDA}} = E^{\text{BDA}}$ as a result of the price-taker hypothesis. This explains why the volume E^{BDA} is taken as the reference value for the estimated penalization function $\hat{\delta}^{\text{DA}}$ in this figure. Also, in the example taken for the figure, the estimated penalization of negative imbalance is lower than the one for positive imbalance: $0 < \hat{\Delta}_{-}^{\text{II}} < \hat{\Delta}_{+}^{\text{II}}$, which explains why the absolute value of the slope of the $\hat{\delta}^{\text{DA}}$ function is lower for negative imbalances than the one for positive imbalances.

4.4.4 Resolution of the specific problem

This paragraph presents the resolution of the optimization problem given in Equation 4.28, by considering the formulation of the loss function in Equation 4.30.

The generation forecast \hat{E} is assumed to be positive. Also, the price forecasts $\hat{\Delta}_{-}^{\text{II}}$ and $\hat{\Delta}_{+}^{\text{II}}$ for negative and positive imbalance, respectively, are positive. Then, the analysis of the loss function λ^{DA} from Equation 4.30 shows that this function is positive, and reaches its minimum for $E^{\text{BDA}} = \hat{E}$. The function λ^{DA} is zero at this minimum.

Consequently, the optimal day-ahead energy bid $E^{\text{BDA},*}$ given by the decision-making problem formulated in Equation 4.28 equals the estimation \hat{E} of the delivered energy: $E^{\text{BDA},*} = \hat{E}$. This optimal energy bid is in this case independent from the forecast of the price for imbalance.

4.4.5 Case study

Description of the case study

This section presents the simulation results obtained for the participation of a wind farm as a balance responsible party in the day-ahead market. The methodology followed is described in Figure 4.5. It is similar to Figure 3.7 presented in the case study relative to the evaluation of the solutions for reducing the imbalance penalties, in section 3.5.

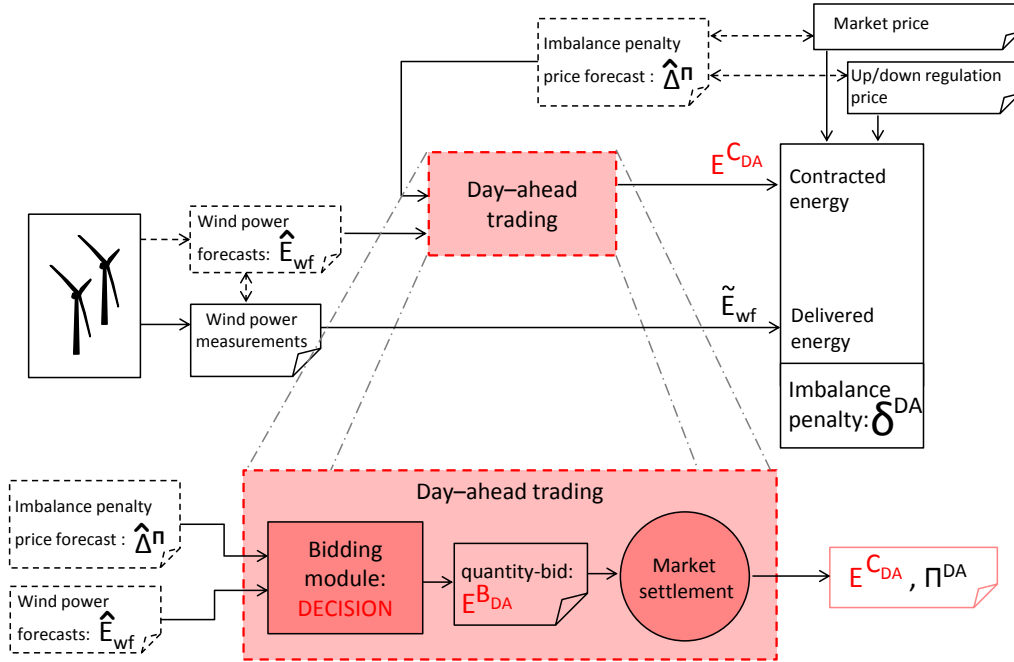

Figure 4.5: Schematic representation of the overall simulation, including the decision-making method relative to the trading in the day-ahead market.

In Figure 4.5, the day-ahead energy bid $E^{B_{DA}}$ is presented as the result of a decision-making method which takes into account the latest available wind power forecast \hat{E}_{wf} and imbalance penalty price forecast $\hat{\Delta}^\Pi$. The energy bid is derived from the optimization problem formulated in Equation 4.28. In this particular case, the analysis of the loss function for the specific problem in the previous paragraph has demonstrated that the energy bid is actually independent from the penalty price forecast $\hat{\Delta}^\Pi$. However, this conclusion is specific to this particular simplification of the day-ahead trading problem and is not true in the general case. Consequently, the penalty price forecast $\hat{\Delta}^\Pi$ is maintained as an input for the general problem of day-ahead trading.

The contracted energy $E^{C_{DA}}$ and price Π^{DA} result from the market settlement. Because the wind farm is participating as a “price-taker”, the contracted energy equals the energy bid. The imbalance penalty δ^{DA} results from the penalization of the energy imbalance.

Results

The case study is based on the same wind farm as the reference wind farm taken in section 3.5. This wind farm is a 18 MW wind farm located in Western Denmark. The

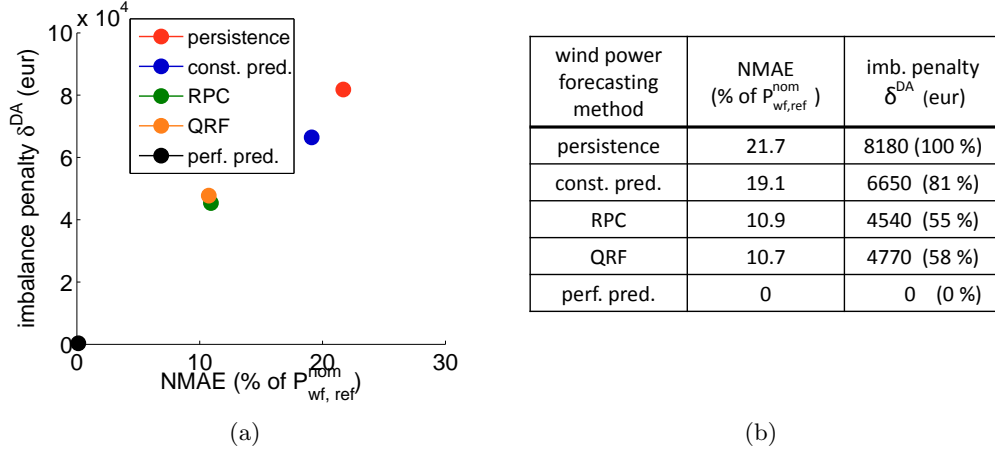

Figure 4.6: Normalized Mean Absolute Error for five wind power forecasting models (i.e. persistence, constant prediction, RPC, QRF and perfect prediction models) and resulting imbalance penalties δ^{DA} .

wind farm production is traded on the NordPool Elspot day-ahead market during the period between the 01/10/2003 and the 30/06/2004. In NordPool, the contracts for the coming day are traded on the day-ahead market, named Elspot [42]. The market time step equals 1 h. The Elspot gate closure time is at 12:00 pm (local time) of the preceding day.

Figure 4.6 presents the influence of the forecasting performance, described here through the Normalized Mean Absolute Error (NMAE), on the total imbalance penalty obtained using five different wind power forecasting approaches. These approaches are the same as the ones presented in section B.2, where the NMAEs resulting from each of these models are compared. The imbalance penalty and NMAE are naturally zero in the case of perfect prediction. Regarding the advanced statistical approaches “Regressive Power Curve (RPC)” and “Quantile Regression Forest (QRF)”, the resulting forecasts are based on Hirlam Numerical Weather Predictions. The training data set covers the first nine months of the year 2003. Figure 4.6(a) shows that the relation between the NMAE and the imbalance penalty is nearly linear. The numerical values of the NMAE and imbalance penalty relative to the figure 4.6(a) are given in the table 4.6(b). In particular, the imbalance penalty when using “RPC” is similar to the one obtained when using “QRF”, and is close to 55 % of the one obtained when using the persistence approach for wind power forecasting.

Figure 4.7 also describes the influence of the NMAE on the imbalance penalty. The results presented in this graph are taken from the aggregation case study already presented in 3.5. The wind farm selected for the previous results in Figure 4.6

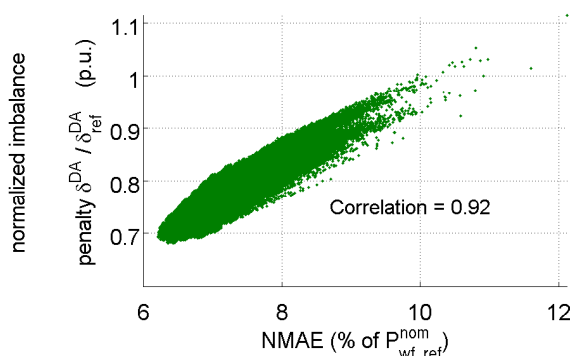

Figure 4.7: Normalized Mean Absolute Error and normalized imbalance penalty relative to the aggregation of n wind farms, with $n = 1 \dots 20$.

is taken as the reference wind farm. Each point corresponds to a given combination of the reference wind farm with n other wind farms which are also located in Western Denmark. The number n of wind farms varies between 0 and 19, which gives a total of 524288 cases. Generally, the wind farm aggregation reduces the power forecasting errors since the errors relative to the aggregated wind farms may compensate each other. This forecasting error reduction depends for example on the number of aggregated wind farms, and also on the geographical dispersion of the wind farms. Consequently, the NMAE relative to the reference wind farm in the case of aggregation varies according to the aggregation combinations, and ranges from 6.2 % to 12.1 % of the nominal power of the reference wind farm. From these simulations, we conclude that the imbalance penalty is highly correlated with the NMAE, with a correlation coefficient equal to 0.92. In other words, these results confirm that using wind power forecasting methods with low NMAE for day-ahead trading generally reduces the resulting imbalance penalty.

4.4.6 Conclusions

In this section, the generic decision method proposed in the previous section 4.3 has been applied to the reference case of trading renewable generation in the day-ahead market. When considering the given market rules, the optimization approach demonstrated that the day-ahead energy bid which minimizes the imbalance penalty coincides with the value of the wind energy forecast.

Consequently, the participation in the day-ahead market can be considered as a specific evaluation of the performance of the wind power forecasting tools. The results obtained from the simulation of the participation of a given wind farm with five different forecasting models clearly demonstrate the value of the wind power

Formulation of the decision-making problem

forecasting, in terms of imbalance penalty reduction.

Finally, these results have been obtained without considering any information about the uncertainty related to the wind power forecasts. Such information, combined with information about the imbalance penalty price, could be useful for further improving the strategic participation of renewable generation in day-ahead electricity market. This approach is developed in the next chapter.

4.5 Application of the decision-making method for the combined participation in the day-ahead and intraday markets

This section focuses on the strategic participation of an IPP in an intraday market for reducing the imbalance penalty related to the trading in the day-ahead market. The generation portfolio of the IPP is supposed to include only RES units. The strategic additional participation in the intraday market is one of the **financial solutions** which has been described in section 2.3.1 and formulated in section 3.2.1. This section presents the application of the generic decision-making method proposed in section 4.3 to this specific financial solution.

4.5.1 Main hypotheses

Day-ahead market

The considered day-ahead market is based on a single market price clearing process. Also, similarly to the previous example, the IPP participates in the day-ahead market as a price taker entity, and the quantity bid is proposed based on the latest available estimations of RES generation for the different market time periods.

Intraday market

The considered intraday market is based on a pay-as-bid market clearing process, which is a continuous trading mechanism. Trading takes place in a central exchange where standard products are traded on a “first-come-first-serve” basis: the first matching offer to a bid (or vice versa) is rewarded and fixed into two bilateral transactions between the seller and the buyer. Such a pricing mechanism is denoted as *pay-as-bid* pricing. Contrary to single price market mechanism, where the IPP can participate as a price taker entity, the intraday bid price is part of the decision in the pay-as-bid mechanism since it will influence the amount of traded energy.

Figure 4.8 describes the proposed decision scheme relative to the combined participation in day-ahead and intraday markets. The instants when decisions relative to the intraday participation are made, are represented by the vertical red lines. The possibility to trade electricity in the continuous market is offered after the day-ahead gate closure time, and lasts till one hour before delivery. These periods are represented by the horizontal light-red lines. The bids are proposed independently for each market time period T_i .

The method is illustrated with the Elspot day-ahead market and the Elbas intraday market, in the Nordic countries. The Elspot market is based on a single price

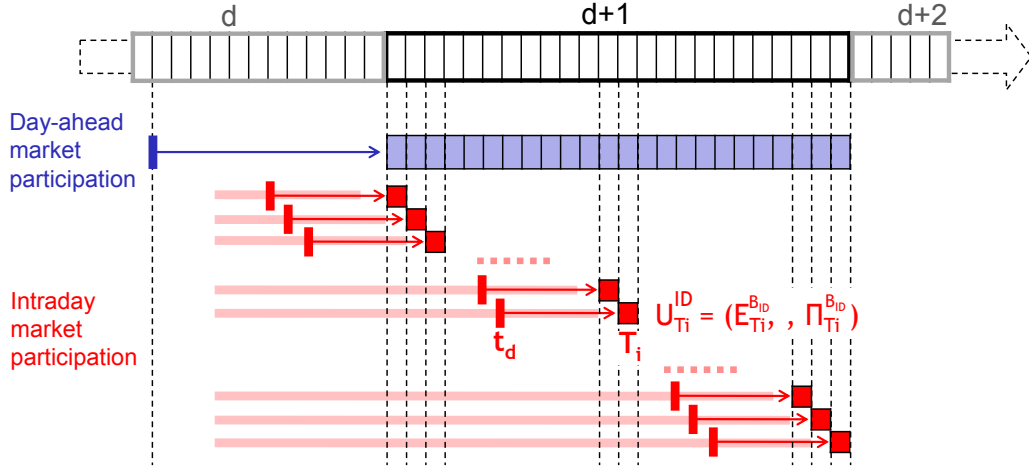

Figure 4.8: Example of a combined participation in the Elspot day-ahead and Elbas intraday markets (NordPool). Bids in the Elbas market are proposed 6 hours before the delivery time.

clearing process while the Elbas is based on continuous trading with pay-as-bid process. In the example, the bids in the Elbas are proposed 6 hours before delivery. The instant when bids are proposed is also strategic: early bids offer more trading possibilities while late bids offer the possibility to benefit from updated RES generation forecasts for proposing a bid which can reduce the exposition of the IPP to imbalance penalties.

In the present study, the bids proposed by the IPP for the intraday markets are only selling, and not buying bids. The proposition of selling bids is a solution to reduce the positive energy imbalance resulting from the day-ahead market participation, but not the negative imbalances. The reduction of negative imbalances would be possible if the trading of buying bids was considered.

4.5.2 Formulation and proposal of a solution for the specific problem

Formulation of the optimization problem

The formulation of the participation in the day-ahead market is similar to the one given in the previous section: the quantity bid for a given time period equals the estimate of the energy delivered for the same period, which is available at the day-ahead closure time. The resulting day-ahead energy contract $E_{T_i}^{C_{DA}}$ and price $\Pi_{T_i}^{DA}$ are settled before trading in the intraday market, and are thus considered as known in the following decision-making problem relative to the intraday trading.

The participation in the intraday market consists in determining, for a given

market time period T_i , the quantity price bid $u_{T_i}^{\text{ID}} = (E_{T_i}^{B_{\text{ID}}}, \Pi_{T_i}^{B_{\text{ID}}})$. Also, the decision $u_{T_i}^{\text{ID}}$ is made independently for each time period T_i , and similarly to the day-ahead bid, the intraday bid decision is given by:

$$U_{T_i}^{\text{ID}} = u_{T_i}^{\text{ID}} = (E_{T_i}^{B_{\text{ID}}}, \Pi_{T_i}^{B_{\text{ID}}}) \quad (4.32)$$

The optimal participation in the intraday market is then determined from the generic optimization problem given in Equation 4.10, for the case of the financial solution. More precisely, the loss function in the case of intraday trading, for a given market time unit T_i , is denoted as $\lambda_{\text{ID},T_i}^{\text{DA}}$ and is derived from the generic loss function λ given in Equation 4.8.

In this case, the financial solution is the intraday trading (i.e. $S_x : \text{ID}$) and no physical solution is considered (i.e. $S_y : \{\}$), which leads to $Y_{T_i} = 0$ and $y_{T_i} = 0$. Also, in this case, the energy volume x and the additional cost X are given by Equation 3.13. The intraday energy volume E^{ID} and intraday price Π^{ID} mentioned in the latter equation are implicitly the intraday contract volume $E^{C_{\text{ID}}}$ and intraday contract price $\Pi^{C_{\text{ID}}}$, since Equation 3.13 is derived for the evaluation of the penalty based on these contracts, and does not focus on the decision relative to these contracts. Then, Equation 3.13 can be written as:

$$\begin{cases} X_{T_i} = E_{T_i}^{C_{\text{ID}}} \times (\Pi_{T_i}^{\text{DA}} - \Pi_{T_i}^{C_{\text{ID}}}) \\ x_{T_i} = E_{T_i}^{C_{\text{ID}}} \end{cases} \quad (4.33)$$

Moreover, the intraday contract energy $E^{C_{\text{ID}}}$ and price $\Pi^{C_{\text{ID}}}$ are given from the intraday bid $(E_{T_i}^{B_{\text{ID}}}, \Pi_{T_i}^{B_{\text{ID}}})$ by the functions h_{ID,T_i}^E and h_{ID,T_i}^{Π} :

$$\begin{cases} E_{T_i}^{C_{\text{ID}}} = h_{\text{ID},T_i}^E(E_{T_i}^{B_{\text{ID}}}, \Pi_{T_i}^{B_{\text{ID}}}) \\ \Pi_{T_i}^{C_{\text{ID}}} = h_{\text{ID},T_i}^{\Pi}(E_{T_i}^{B_{\text{ID}}}, \Pi_{T_i}^{B_{\text{ID}}}) \end{cases} \quad (4.34)$$

These functions model the intraday market settlement, and are presented in the next paragraph.

Finally, the loss function $\lambda_{\text{ID},T_i}^{\text{DA}}$ is derived from the considerations given above in Equation 4.8. In particular, the quantities x and X are obtained by combining Equation 4.34 with Equation 4.33:

$$\lambda_{\text{ID},T_i}^{\text{DA}}(u_{T_i}, v_{T_i}) = \lambda_{\text{ID},T_i}^{\text{DA}}((E_{T_i}^{B_{\text{ID}}}, \Pi_{T_i}^{B_{\text{ID}}}), 0) \quad (4.35)$$

$$\begin{aligned} &= h_{\text{ID},T_i}^E(E_{T_i}^{B_{\text{ID}}}, \Pi_{T_i}^{B_{\text{ID}}}) \times (\Pi_{T_i}^{\text{DA}} - h_{\text{ID},T_i}^{\Pi}(E_{T_i}^{B_{\text{ID}}}, \Pi_{T_i}^{B_{\text{ID}}})) \\ &\quad + \widehat{\delta}_{T_i}^{\text{DA}}(\widehat{E}_{T_i|t_d}, E^{C_{\text{DA}}} + h_{\text{ID},T_i}^E(E_{T_i}^{B_{\text{ID}}}, \Pi_{T_i}^{B_{\text{ID}}})) \end{aligned} \quad (4.36)$$

Then, the optimal intraday bid $(E_{T_i}^{B_{ID}}, \Pi_{T_i}^{B_{ID}})^*$ for the period T_i is given by the optimization problem formulated in Equation 4.10. Similarly to the decision for the day-ahead trading, the decision problem is for only one time unit (i.e. $n = 1$) and thus the norm in Equation 4.10 \mathcal{N} is the identity function: $\mathcal{N}(x) = x$:

$$(E_{T_i}^{B_{ID}}, \Pi_{T_i}^{B_{ID}})^* = \arg \min_{(E_{T_i}^{B_{ID}}, \Pi_{T_i}^{B_{ID}})} \lambda_{ID, T_i}^{DA} (E_{T_i}^{B_{ID}}, \Pi_{T_i}^{B_{ID}}), \text{ subject to } \mathcal{C}_{ID} \quad (4.37)$$

where λ_{ID, T_i}^{DA} is given in Equation 4.36. The constraints \mathcal{C}_{ID} on the intraday bid are given by the market rules. They are similar to the constraints \mathcal{C}_{DA} relative to the day-ahead market, and the impact of these constraints on the proposed solutions is explained in the next paragraph.

The generation forecast $\hat{E}_{T_i|t_d}$ and the price forecast $\hat{\Delta}_{T_i|t_d}^{\Pi}$ which is used for the derivation of the $\hat{\delta}^{DA}$ function are the latest available forecasts.

Model of the intraday market settlement

In the pay-as-bid market process, a trade occurs when the selling and buying bids match. The contract price then equals the bid price:

$$\Pi^{C_{ID}} = \Pi^{B_{ID}} \quad (4.38)$$

In other words, the function h_{ID}^{Π} given in Equation 4.34 is the identity function.

The intraday energy contract $E^{C_{ID}}$ depends on the buying bids of the other participants. This contract has been modeled as a function h_{ID}^E of the quantity-price bid $(\Pi^{B_{ID}}, E^{B_{ID}})$ in Equation 4.34. In this work, we propose to model the energy contract $E^{C_{ID}}$ as a proportion of the bid energy quantity $E^{B_{ID}}$. This proportion models the bid acceptance and is expressed by a coefficient α which depends on the bid price $\Pi^{B_{ID}}$:

$$E^{C_{ID}} = h_{ID}((E^{B_{ID}}, \Pi^{B_{ID}})) = \alpha(\Pi^{B_{ID}}) \times E^{B_{ID}} \quad (4.39)$$

For a given delivery period, the price of the energy transactions in the intraday market is not fixed and depends on the proposed bids. The available public information from the market operator for the intraday trading prices consists of the minimum, the maximum and the mean of the intraday trading price Π^{ID} of the energy traded for each delivery time period. These values inform about the distribution of this trading price for each delivery period. Here, the intraday trading price Π^{ID} is modeled as a random variable which follows a triangular distribution. This

distribution is completely defined by the minimum, mean and maximum prices. An example of such a distribution is shown in the upper plot of Figure 4.9.

The proposed market settlement model consists in modeling the proportion α of accepted energy by the probability of having the bid accepted for a given bid price. Since a trade occurs when the selling and buying bids match, this probability can be estimated through the probability of having the bid price Π^{BID} inferior to the trading price Π^{ID} :

$$\begin{aligned}\alpha &= \text{prob}(\Pi^{BID} < \Pi^{ID}) \\ &= 1 - \text{prob}(\Pi^{ID} \leq \Pi^{BID}) \\ &= 1 - F_{\Pi^{ID}}(\Pi^{BID})\end{aligned}\quad (4.40)$$

where $F_{\Pi^{ID}}$ is the cumulated distribution function (cdf) of the trading price Π^{ID} . This model is illustrated in the lower part of Figure 4.9. In the example, the proposed bid price (38.5 €/MWh) leads to a proportion $\alpha = 0.25$ of accepted bid. Consequently, in for example, the energy bid E^{BID} equals 4 MWh, the resulting energy contract E^{CID} will be of 1 MWh.

Finally, this model only considers the bid price to determine whether the bid is accepted or not, and does not consider either the market liquidity or the time when the intraday bid is proposed.

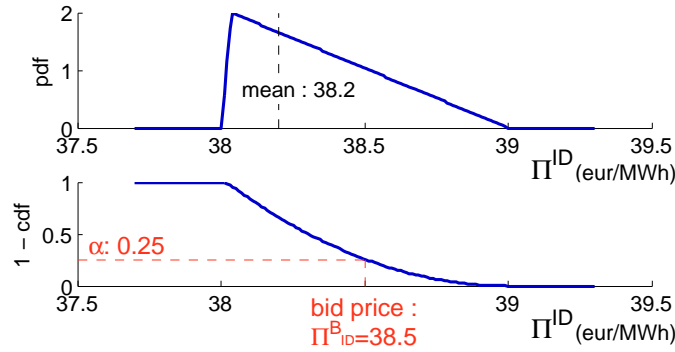

Figure 4.9: Upper: Example of modeling the intraday trading price through a triangular distribution. Lower: Resulting estimation of the α proportion. This example correspond to the data from the Elbas intraday market (NordPool) the 27/10/2003 at 18h00.

By considering the proposed market settlement model from Equation 4.39 and Equation 4.38, the formulation of the loss function λ_{ID}^{DA} given in Equation 4.36 can be simplified as:

$$\lambda_{ID}^{DA}((E^{BID}, \Pi^{BID}), 0) = \alpha \cdot E^{BID} \times (\Pi^{DA} - \Pi^{BID}) + \hat{\delta}^{DA}(\hat{E}, E^{CDA} + \alpha \cdot E^{BID}) \quad (4.41)$$

where α is the proportion of accepted bid given in Equation 4.40. In this formulation, the loss is given as the sum of a cost $\alpha \cdot E^{B_{ID}} \times (\Pi^{DA} - \Pi^{B_{ID}})$, which represents the cost related to the participation in the intraday market, and the estimation of the imbalance penalties.

4.5.3 Illustration of the loss function of the problem

This section gives an illustration of the loss function λ_{ID}^{DA} for a given market time unit T_i for better understanding its structure. If we combine the definition of the function $\hat{\delta}_{ID}^{DA}$ given in Equation 4.11 with the previous loss formulation in Equation 4.41, the loss function can further be expressed as follows:

$$\lambda_{ID}^{DA}((E^{B_{ID}}, \Pi^{B_{ID}}), 0) = \begin{cases} \hat{\Delta}_+^{\Pi} \times (\hat{E} - E^{C_{DA}}) - (\hat{\Delta}_+^{\Pi} - (\Pi^{DA} - \Pi^{B_{ID}})) \times \alpha \cdot E^{B_{ID}} \Leftarrow 0 \leq E^{B_{ID}} \leq \frac{\hat{E} - E^{C_{DA}}}{\alpha} \\ -\hat{\Delta}_-^{\Pi} \times (\hat{E} - E^{C_{DA}}) + (\hat{\Delta}_-^{\Pi} + (\Pi^{DA} - \Pi^{B_{ID}})) \times \alpha \cdot E^{B_{ID}} \Leftarrow \frac{\hat{E} - E^{C_{DA}}}{\alpha} \leq E^{B_{ID}} \end{cases} \quad (4.42)$$

The specific value $\frac{\hat{E} - E^{C_{DA}}}{\alpha}$ is obtained when $\alpha \cdot E^{B_{ID}} = \hat{E} - E^{C_{DA}}$ which corresponds to $E^{C_{ID}} = \hat{E} - E^{C_{DA}}$. For this specific value, the total contract energy $E^C = E^{C_{DA}} + E^{C_{ID}}$ equals the generation forecast \hat{E} , and consequently the estimated energy imbalance is null.

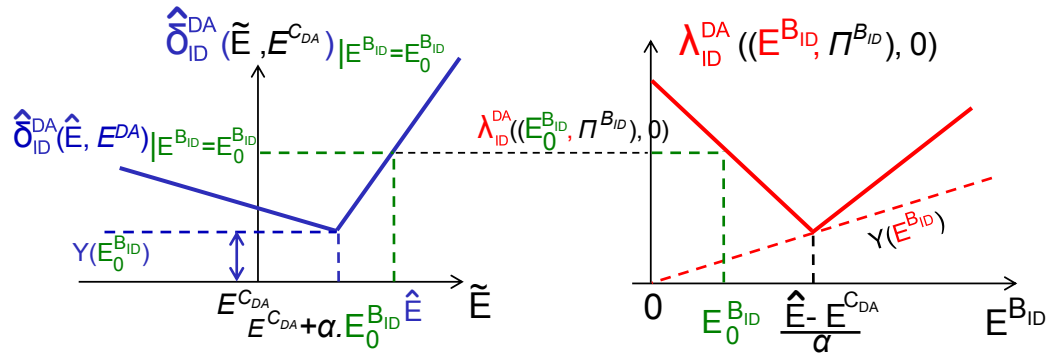

Figure 4.10: Relation between λ_{ID}^{DA} and $\hat{\delta}_{ID}^{DA}$

The formulation of the loss function λ_{ID}^{DA} given in is Equation 4.42 is illustrated in the right part of Figure 4.10. This plot is made with a fixed value of bid price $\Pi^{B_{ID}}$, and consequently, the loss function λ_{ID}^{DA} is a piecewise linear function of the quantity bid $E^{B_{ID}}$. Figure 4.10 more generally illustrates the relation between the estimated penalization function $\hat{\delta}_{ID}^{DA}$ and the loss function λ_{ID}^{DA} , which is the application of the general relation given in Equation 4.7 for the specific problem of intraday trading.

For a given energy bid E_0^{BID} , such relation is given by:

$$\widehat{\delta}_{ID}^{DA} |_{(E^{BID}=E_0^{BID})}(\widehat{E}, E^{CDA}) = \lambda_{ID}^{DA} \left((E_0^{BID}, \Pi^{BID}), 0 \right) \quad (4.43)$$

This figure 4.10 shows how the penalization function $\widehat{\delta}_{ID}^{DA}$ which was proposed for evaluating the imbalance penalty from the delivered energy \widehat{E} , is used for the definition of the loss function λ_{ID}^{DA} , which is used for the decision of the bid (E^{BID}, Π^{BID}) . This figure is the follow-up of the example illustrated in Figure 4.4. The same values of regulation prices are taken: the penalization of negative imbalance is lower than the penalization of positive imbalance: $0 < \widehat{\Delta}_{-}^{\Pi} < \widehat{\Delta}_{+}^{\Pi}$. Also for this example, the intraday price is taken lower than the day-ahead price $\Pi^{BID} < \Pi^{DA}$.

Proposal of a simplified solution of the decision-making problem

In general, the resolution of the optimization problem given in Equation 4.37, where the objective function is the cost function λ_{ID}^{DA} given in Equation 4.42, is based on the generation forecast \widehat{E} , the forecast of the price for positive and negative imbalance $\widehat{\Delta}_{+}^{\Pi}$ and $\widehat{\Delta}_{-}^{\Pi}$, and also on estimations of the distribution of the intraday price for the market settlement α -model. In this work, the generation forecasts are given by short-term forecasting methods which are presented in section B.1. However, forecasting the distribution of the intraday price is not a trivial task, and is out of the scope of the present work. Also the results from the resolution of this decision-making problem might be sensitive to the price forecast errors.

Consequently, the proposed approach is not based on a resolution of the general problem described through the loss function in Equation 4.37, but is based on particular values of the loss function, which are determined from the analysis of the loss function. **The proposed simplified approach consists in bidding in the intraday market in order to *adjust* the contracted production using updated wind power forecasts.** Consequently, the intraday bid quantity for a delivery period T_i equals the difference between the forecasted energy $\widehat{E}_{T_i|t_d}$ for the period T_i available at time t_d , and the energy contracted in the day-ahead market $E_{T_i}^{CDA}$ for the same period. Also, the quantity bid is positive since the wind power producer is assumed to participate in the electricity market only with selling (offer) bid.

$$E_{T_i}^{BID} = \begin{cases} \widehat{E}_{T_i|t_d} - E_{T_i}^{CDA}, & \widehat{E}_{T_i|t_d} > E_{T_i}^{DA} \\ 0, & \widehat{E}_{T_i|t_d} \leq E_{T_i}^{CDA} \end{cases} \quad (4.44)$$

t_d is the decision time relative to the participation in the intraday market for the delivery period T_i . The proposed energy bid given by Equation 4.44 is supposed to be in accordance with the constraints \mathcal{C}_{ID} associated with the intraday trading.

If the α parameter which models the proportion of accepted bid equals 1, then $E_{T_i}^{B_{\text{ID}}} = E_{T_i}^{C_{\text{ID}}}$, and the proposed bid in Equation 4.44 corresponds to the specific value $\frac{\widehat{E} - E^{C_{\text{DA}}}}{\alpha}$ described in the analysis of the loss function in the previous paragraph. Also, in the proposed model, α depends on the bid price $\Pi^{B_{\text{ID}}}$, and thus, we consider different values of bid price $\Pi^{B_{\text{ID}}}$ for analyzing the influence of this price on the decision. Two specific values of $\Pi^{B_{\text{ID}}}$ have to be noted:

- $\Pi^{B_{\text{ID}}} = \Pi^{\text{DA}}$: in this case, the additional cost $\alpha \cdot E^{B_{\text{ID}}} \times (\Pi^{\text{DA}} - \Pi^{B_{\text{ID}}})$ is zero. Also, in the case of perfect prediction of the RES generation, the loss $\lambda_{\text{ID}}^{\text{DA}}$ is reduced to 0 after the intraday market participation if the intraday energy contract equals the difference between the estimated energy and the day-ahead energy contract: $E^{C_{\text{ID}}} = \widehat{E} - E^{C_{\text{DA}}}$.
- $\Pi^{B_{\text{ID}}} = \widehat{\Pi}^+$, where $\widehat{\Pi}^+$ is the forecast regulation price for positive imbalance. In the case of positive imbalance, the energy imbalance is penalized through the function $\delta^{\widehat{\text{DA}}}$ by the price difference $\widehat{\Delta}_{\Pi}^{\text{DA},+} = \Pi^{\text{DA}} - \widehat{\Pi}^+$. If $\Pi^{B_{\text{ID}}} = \widehat{\Pi}^+$, Equation 4.42 shows that the loss $\lambda_{\text{ID}}^{\text{DA}}$ is independent from the intraday quantity bid. In other words, the loss is unchanged by the participation in the intraday market: $\lambda_{\text{ID}}^{\text{DA}} = \lambda^{\text{DA}}$.

Finally, the intraday bid price is formulated from the two prices Π^{DA} and $\widehat{\Pi}^+$ as follows:

$$\Pi^{B_{\text{ID}}} = \widehat{\Pi}^+ + \beta \times (\Pi^{\text{DA}} - \widehat{\Pi}^+), \beta \in [-0.2, 2.2] \quad (4.45)$$

In this bid decision, the parameter β enables to get different values of bid price. The proposed bid prices given by Equation 4.45 are supposed to be in accordance with the constraints \mathcal{C}_{ID} associated with the intraday trading. More precisely, $\Pi^{\text{DA}} \geq \widehat{\Pi}^+$ and thus the bid price increases as β increases. Also, the two specific prices $\widehat{\Pi}^+$ and Π^{DA} are obtained for $\beta = 0$ and $\beta = 1$ respectively. The lower and upper bounds for the β values are determined so that the variations of β are symmetric around Π^{DA} . Finally, the different proposed values for β permit to perform a sensitivity analysis on the bid price $\Pi^{B_{\text{ID}}}$ in order to evaluate the influence of the bid price value on the reduction of imbalance penalty.

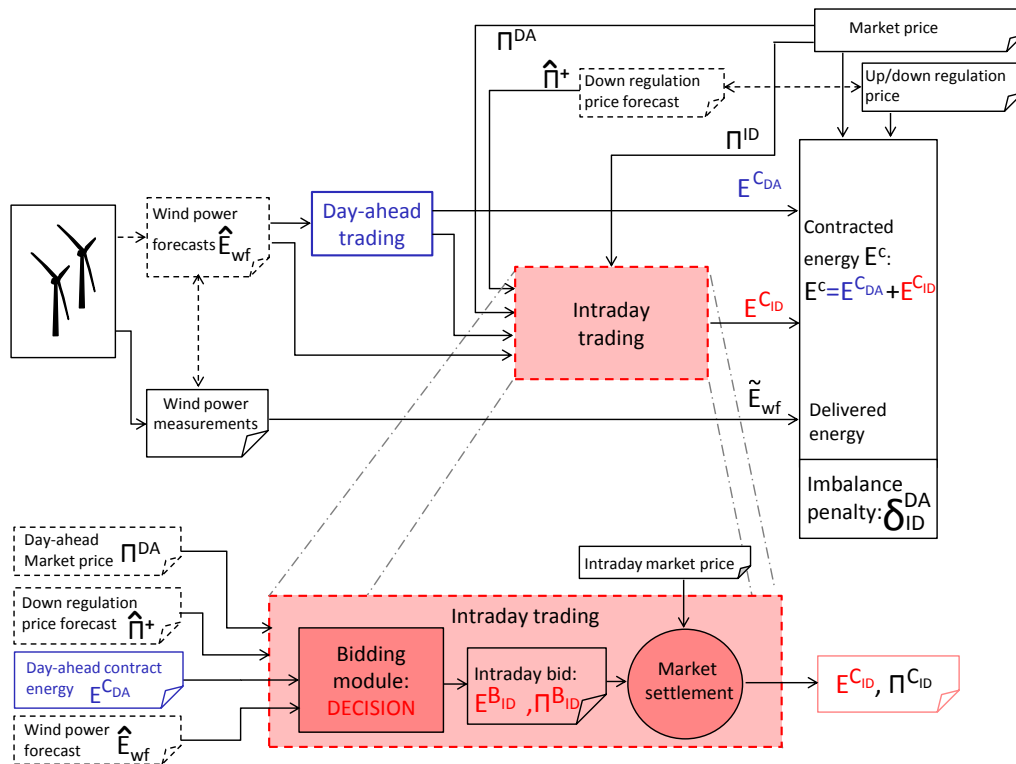

Figure 4.11: Schematic representation of the overall simulation, including the trading in the day-ahead market and the decision-making method relative to the trading in the intraday market.

4.5.4 Case study

Description of the case study

This section presents the results obtained from simulation of the participation of a wind farm in a day-ahead market, and in the corresponding intraday market. The simulation methodology followed for obtaining these results is described in Figure 4.11. This figure is similar to the scheme presented in the reference participation in the day-ahead market in section 4.4, or the evaluation of the solutions for reducing the imbalance penalties, in section 3.5.

In Figure 4.11, the intraday quantity-price bid results from the decision given in Equation 4.44 for the energy quantity $E^{B_{ID}}$ and in Equation 4.45 for the price $\Pi^{B_{ID}}$. The intraday market settlement results from the model proposed in section 4.5.2. The imbalance penalty δ_{ID}^{DA} results from the penalization of the energy imbalance between the delivered energy \tilde{E}_{wf} and the total contracted energy $E^C = E^{C_{DA}} + E^{C_{ID}}$.

The case study is based on the same wind farm as the one taken for the case study corresponding to the reference participation in the day-ahead market in section 4.4. This wind farm is a 18 MW wind farm located in Western Denmark. The wind farm generation is traded in the NordPool Elspot day-ahead market and in the Elbas intraday market during the period between the 01/10/2003 and the 31/06/2004. The Elbas market is a contract based market, with a pay-as-bid market settlement mechanism. The intraday market closes one hour before the delivery period. In the present case, the wind farm operator is supposed to propose the intraday bids 6 hours before the delivery period.

The wind power forecasting approach used for this case study is a power curve modeling approach, denoted as “regressive power curve” (RPC) model. This model is one of the models which have been used in the previous case study, referring to the day-ahead trading. Details about this model are given in appendix B.2.

Regarding the forecast of the regulation price for positive imbalance (also called down regulation price) $\hat{\Pi}^+$, two methods are considered. The first one is a realistic and basic approach where $\hat{\Pi}^+$ equals a constant ratio of the day-ahead price. This ratio is lower than one because regulation price for positive imbalance is lower than the day-ahead price, and this ratio is calculated as the mean value of the ratio between the regulation price for positive imbalance and the day-ahead price, for a learning period during the first 9 months of 2003. Such constant equals 0.79. The second approach assumes a perfect prediction for $\hat{\Pi}^+$.

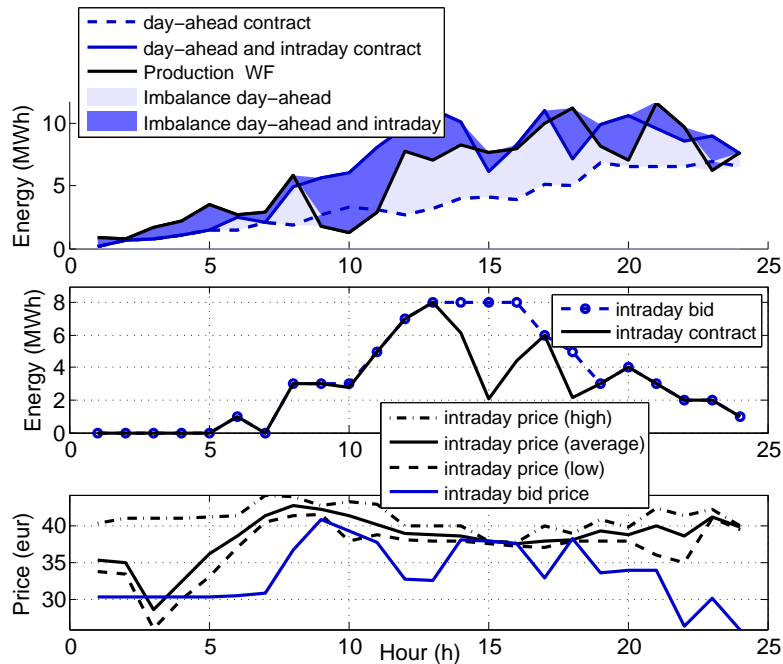
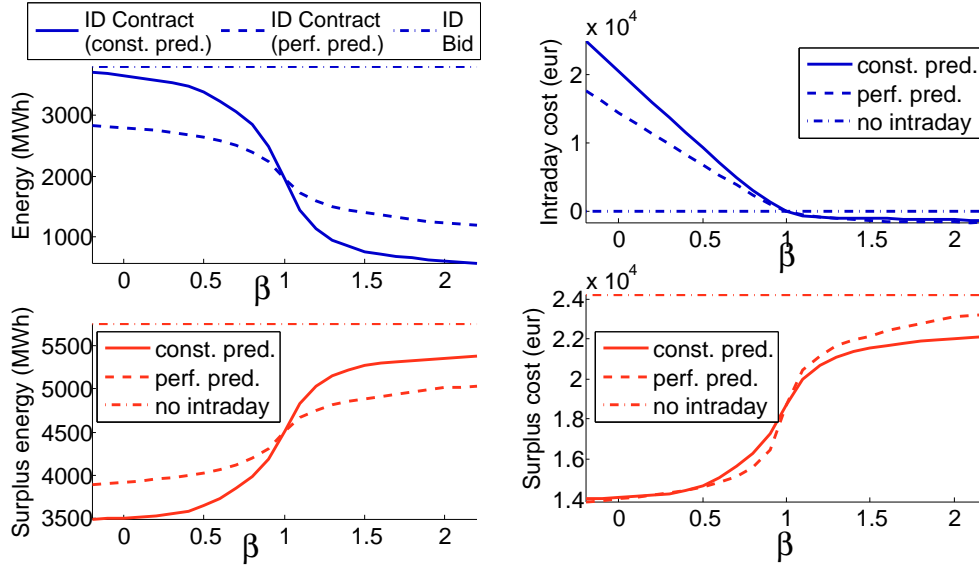

Figure 4.12: Example of the reduction of energy imbalance resulting from the combined participation in the day-ahead and intraday market.

Results and discussion

This section gives the results from the simulation of the combined participation in the day-ahead and intraday markets. First, Figure 4.12 illustrates the intraday energy bid and contract for a given day of the simulation, the 27/10/2003. The intraday energy bid aims at reducing the energy imbalance between the day-ahead contract and the wind farm energy delivery. This bid is determined based on the latest available wind power forecast. The wind power forecast used for the intraday bid may have an error greater than the one used for the day-ahead trading. In this case, the energy imbalance resulting from the combined day-ahead and intraday trading is greater than the one relative to the trading only in the day-ahead market. This phenomenon can be observed in the first graph of Figure 4.12 between hour 8 and hour 11. However, the wind power forecast used for trading in intraday market, which is obtained 6 hours before delivery, is generally more accurate than the one used for trading in day-ahead, which is obtained between 14 and 37 hours before the delivery. This results from the fact that the forecasting error increases as the forecasting horizon increases, as described in Figure B.2. The reduction of energy imbalance is particularly clear in the first graph, between hour 12 and hour 19.

Also, still in Figure 4.12, the second graph illustrates the intraday market settle-



(a) Intraday contract energy and resulting imbalance energy.

(b) Intraday cost and surplus cost.

Figure 4.13: Results from the simulation of the combined participation in the day-ahead and intraday market during the period between the 01/10/2003 and the 30/06/2004.

ment model proposed in section 4.5.2. This graph plots the intraday energy bid and the resulting contract. The difference between the bid and the contract is explained by the relative position of the intraday bid price compared to the distribution of the intraday price proposed by all the market participants for the same time step (third plot). When the proposed intraday bid price is lower than the minimum intraday price, the whole energy bid is accepted. In other words, the coefficient α equals one. However, when the proposed price ranges between the minimum and maximum intraday price, only a proportion $0 \leq \alpha \leq 1$ is accepted. This can be observed for hours 14 – 16.

The next results focuses on the influence of the decision-making parameter β on the imbalance penalties. The results are presented for both the constant and perfect prediction methods regarding the forecast of the regulation price for positive imbalance $\hat{\Pi}^+$. The reference results are the one obtained when trading only in the day-ahead market.

The graph at the top of figure 4.13(a) describes the influence of the intraday bid price parameter β on the intraday contract energy. The horizontal line shows the intraday bid energy which is independent of the parameter β . The ratio between the contracted energy and the bid energy represents the α proportion. The simulation shows that increasing the bid price (through the β parameter) decreases the α pro-

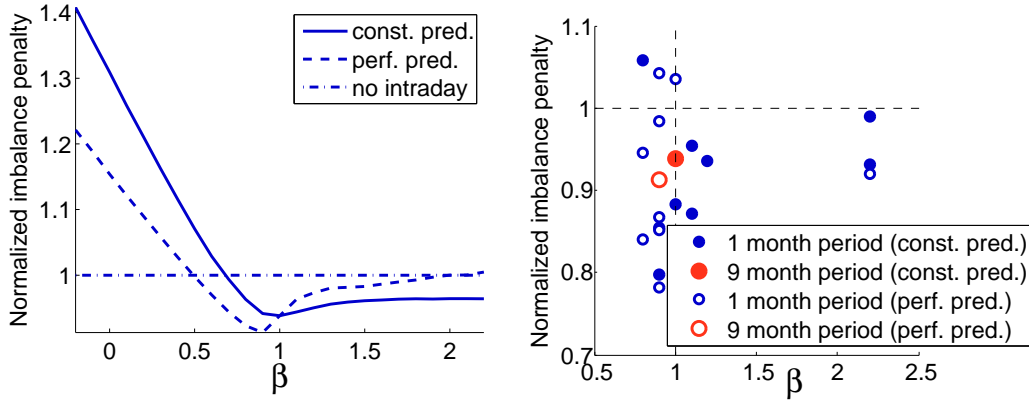

(a) Imbalance penalty reduction during the simulation period between the 01/10/2003 and the 30/06/2004. (b) Imbalance penalty reduction related to 9 consecutive periods.

Figure 4.14: Results from the simulation of the combined participation in the day-ahead and intraday market during the period between the 01/10/2003 and the 30/06/2004.

portion of contracted energy, for both the realistic and the perfect prediction cases. The second plot shows the influence of the β parameter on the surplus energy. First, this graph illustrates the reduction of surplus energy imbalance (also called positive imbalance) resulting from the energy selling in the intraday market. This reduction is influenced by β . Low values of β lead to high values of intraday contracts and, consequently, high reduction of surplus energy. Conversely, high values of β lead to a lower reduction of surplus energy. Generally, the results using the perfect prediction for $\hat{\Pi}^+$ are less sensitive to the β parameter, but the main analyses are valid for both constant and perfect prediction approaches.

Figure 4.13(b) describes the influence of the β parameter on the constant cost $E^{\text{ID}} \times (\Pi^{\text{DA}} - \Pi^{\text{ID}})$, and on the positive imbalance penalties. When the β parameter increases, the intraday bid price increases and the intraday contracted energy decreases, which decreases the intraday cost as shown with figure 4.13(a). The intraday cost markedly decreases for the $\beta \leq 0$, and is zero for $\beta = 0$. The lower graph of figure 4.13(b) corresponds to the equivalent in terms of imbalance penalty of the second graph of figure 4.13(a) on the left, which plots the positive imbalance energy. For low values of β , the surplus cost, which is the penalty for positive imbalance energy, is reduced to nearly 50 % of the reference surplus cost. The surplus cost rapidly increases for β values around 1, and reaches more than 90 % of the reference surplus cost for $\beta \geq 2$.

Finally, Figure 4.14 describes the consequences of the decision parameter β variation on the imbalance penalties. The imbalance penalty results from the intraday

cost, in addition to the surplus and shortage costs. It is thus the combination of the two graphs of figure 4.13(b). The left figure 4.14(a) describes the imbalance penalty normalized by the reference one. For both constant and perfect prediction of $\hat{\Pi}^+$, the imbalance penalty is reduced as β increases, for $\beta \leq 1$ and $\beta \leq 0.9$ respectively. A minimum imbalance penalty is reached for $\beta = 1$ and $\beta = 0.9$, respectively for the constant and perfect prediction. Then the imbalance penalty increases for greater values of β . The minimum imbalance penalty represents 91 and 94 % of the reference penalty for the perfect and constant prediction of $\hat{\Pi}^+$, respectively. The reference imbalance penalty equals 45370 € in this case study, and the imbalance reduction thus represents approximately 2800 and 4000 € for the constant and perfect prediction of $\hat{\Pi}^+$.

The figure 4.14(b) shows how reproducible the obtained results are. Instead of considering the whole 9 month period as the simulation period, this period is split into 9 one-month periods. For each of these one-month periods, the minimum obtained imbalance penalty is plotted, as well as the β value corresponding to this minimum. The graph demonstrates that most of the simulations show a reduction of the imbalance penalty. Also, most of the minimum imbalance penalties are obtained with a β parameter close to 1. The three cases with $\beta = 2.2$ correspond to a decreasing function of the imbalance penalty, where no minimum is reached. The results tend to confirm that the β values which gives the minimum imbalance penalty are slightly lower in the case of perfect prediction of $\hat{\Pi}^+$ than for the constant prediction case. This is explained by the fact that the average bias of the constant prediction of $\hat{\Pi}^+$ is slightly positive, and consequently, the constant prediction approach is overestimating $\hat{\Pi}^+$.

4.5.5 Conclusions

This case study presents the imbalance energy and penalty results related to the strategic participation in the day-ahead and intraday market. They illustrate the reduction of imbalance penalties relative the intraday market participation. They confirm that the participation in an intraday market can be considered as a financial solution for reducing the imbalance penalty, as proposed in section 2.3.1. More precisely, the imbalance penalty reduction for the present case study reaches 9% of the reference imbalance penalty obtained when participating only in the day-ahead market. Also, the obtained results demonstrate a low sensibility of the results regarding the regulation price forecasting approach.

In order to obtain these results, a model for the settlement of continuous trading market is proposed. This model is based on the available data of market prices; further work should consider the market liquidity. The influence of the time when

the intraday bid is proposed should be considered as well.

4.6 Application of the decision-making method for the strategic operation of a Virtual Power Plant composed of a renewables combined with storage

This section presents the application of the generic decision-making method proposed in section 4.3 to the case of the strategic operation of a virtual power plant composed of a RES unit combined with a storage unit. This combination is one example of the proposed physical solutions for reducing the imbalance penalty, and has been described in section 2.3.2 and formulated in section 3.3.4. This example aims at demonstrating the benefits that might be obtained from the application of an advanced intraday scheduling of the virtual power plant operation. This is done by performing a rolling-window approach for dispatching the energy storage device with the objective of minimizing the imbalance penalty risks associated with the RES power forecast uncertainty.

4.6.1 Main hypotheses

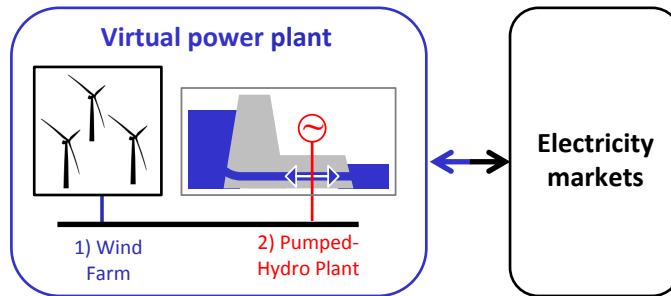

Figure 4.15: Commercial VPP composed of a combination of a wind farm and a pumped-hydro plant

As already stated, commercial Virtual Power Plants (CVPPs) consist in an aggregation of different generation units in order to participate in the electricity market as single entity. The Independent Power Producer (IPP) considered for this section is the operator of a CVPP composed of a wind farm combined with a pumped-hydro storage unit, as shown in Figure 4.15.

The priority in the management and operation of the storage is given to the reduction of energy imbalances. As a consequence, the energy storage device is not used either for buying energy in periods where the market price is considered to be low enough, or for selling it back in periods where the market price is estimated to be sufficiently high. Such a possibility is considered in [124] for example. More generally, in the present study, the CVPP operator is considered to be only an

energy producer, and not an energy consumer. In other words, the operator is not able to buy energy from the market for charging the storage device. The storage is solely charged by the RES power production when produced RES generation exceeds contracted energy.

Finally, in this work the virtual power plant is supposed to participate only in the day-ahead market and the CVPP operator is considered to be a *price taker*.

Description of the intraday scheduling and operation of the VPP

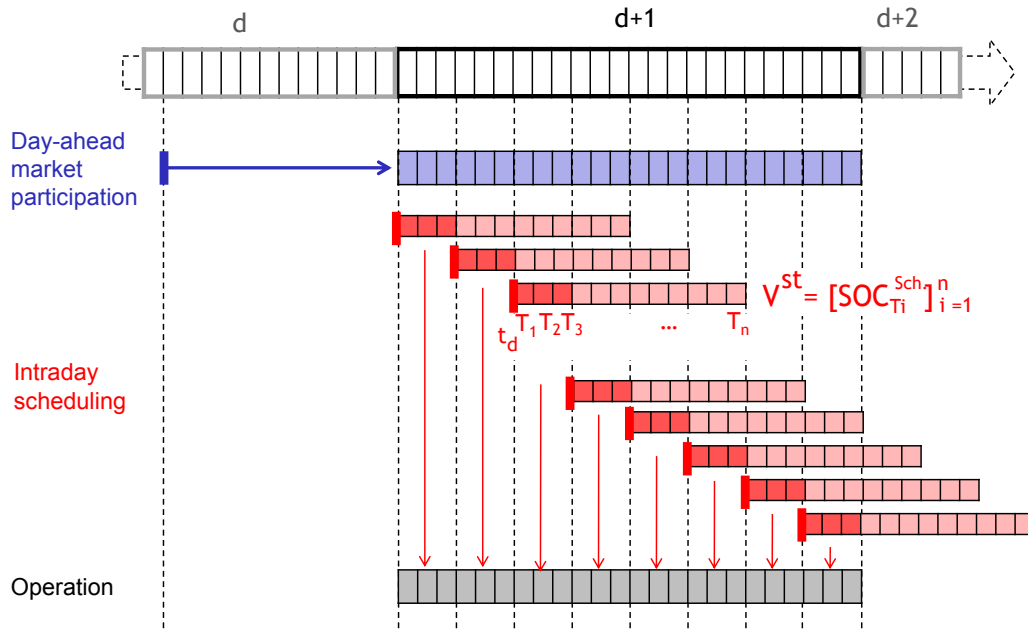

Figure 4.16: Coordination of the day-ahead market participation, intraday scheduling and operation of the VPP. The vertical black lines indicate the instants when decisions are made.

The formulation of the participation in the day-ahead market is similar to the one given for the day-ahead trading in section 4.4: the quantity bid for a given time period equals the estimation of the energy delivered for the same period, which is available at the day-ahead closure time. The resulting day-ahead energy contract $E_{T_i}^{CDA}$ and price $\Pi_{T_i}^{DA}$ are settled before the intraday scheduling, and are thus considered as known in the following decision-making problem. Note that in the present study, the storage device is combined with the RES power unit only for reducing the imbalance penalty, and, consequently, is not considered for the day-ahead market participation. The first blue line in Figure 4.16 illustrates the day-ahead bid with a gate closure time at 12h00.

Energy imbalance results from errors of the energy estimation used for the day-

ahead market participation, and the storage unit is used for reducing such an imbalance. During the operation stage, the limited capacity of the device implies that the possibility to store or to deliver energy depends on the state-of-charge (SOC) level of the device. The SOC level depends on the previous operation of the device. The temporal dependence of the storage operation leads to the need of an *anticipation* of the management of the storage device. For example, if the VPP operator wants to avoid extreme energy imbalances, the intraday storage management will permit to adapt the SOC level so that the storage device has the ability to store or inject power at that critical point of time. For achieving this goal, updated wind power forecasts are used to estimate the expected imbalance between the energy contracted in the day-ahead market and the future delivery. The resulting storage schedule is continuously updated for anticipating these imbalances.

The scheduling method is dynamic and based on a rolling-window approach as shown in Figure 4.16. In other words, the method is carried out for a period of time (i.e. window) which is then moved forward by an increment. The window width is denoted as T_w . The increment time is denoted as T_{inc} . The example illustrates the rolling-window approach with $T_w = 12$ h and $T_{inc} = 3$ h. The length of the rolling-window is of particular importance for integrating the temporal dependence of the storage operation into the decision.

Each schedule consists in deciding the future state-of-charge (SOC) of the storage unit. In the present rolling-window approach, one schedule is calculated at every increment and each schedule covers the n time periods of the window width T_w . The instant when a scheduling decision is made is represented by a vertical red line in Figure 4.16. The decision V^{st} is formulated as the following vector:

$$V^{st} = [v_{T_i}^{st}]_{i=1}^n, \text{ with } v_{T_i}^{st} = SOC_{T_i}^{Sch} \quad (4.46)$$

where $SOC_{T_i}^{Sch}$ is the scheduled SOC at the end of the market time unit T_i .

The operation of the VPP is then based on the storage SOC schedule. More precisely, the *latest available* storage intraday schedule is considered as a series of storage SOC setpoints for the operation of the VPP. These setpoints correspond to the first 3 hours of each schedule and are represented in dark red in Figure 4.16. The operation points are represented as the last grey line.

4.6.2 Formulation of the specific decision-making problem

Formulation of the optimization problem

This paragraph presents the formulation of the decision-making problem relative to the scheduling of an energy storage device for minimizing the imbalance penalty.

The aim of the decision-making approach is to determine the value of the storage SOC setpoints for the period of the rolling-window T_w . The formulation of this decision-making problem is a particular case of the generic optimization problem derived in Equation 4.2, with $U = 0$ and $V = V^{st} = [SOC_{T_i}^{Sch}]_{i=1}^n$:

$$\left([SOC_{T_i}^{Sch}]_{i=1}^n \right)^* = \arg \min_{[SOC_{T_i}^{Sch}]_{i=1}^n} \Phi_{st} \left([SOC_{T_i}^{Sch}]_{i=1}^n \right), \text{ subject to } \mathcal{C}_{st} \quad (4.47)$$

where \mathcal{C}_{st} is the set of constraints associated with the storage technical limits, and the objective function Φ_{st} is derived from Equation 4.9 with $u_{T_i} = 0$ and $v_{T_i} = v_{T_i}^{st} = SOC_{T_i}^{Sch}$:

$$\Phi_{st} \left([SOC_{T_i}^{Sch}]_{i=1}^n \right) = \mathcal{N} \left(\lambda_{st, T_i}^{DA} \left(0, SOC_{T_i}^{Sch} \right) \right) \quad (4.48)$$

\mathcal{N} is the norm associated with the decision-making problem, discussed in section 4.3.5 and λ_{st, T_i}^{DA} is the loss function associated with the storage scheduling for the time period T_i .

Formulation of the loss function λ_{st}^{DA}

The loss function associated with the present problem is derived from the generic loss function derived in Equation 4.8 for the case of the physical solution $S_y : st$, and no financial solution: $S_x : \{\}$.

The generic h_{S_y, T_i} function considered in Equation 4.8 corresponds in this case to the function h_{st, T_i} which models the relation between the observed state-of-charge \widehat{SOC}_{T_i} and the scheduled one $SOC_{T_i}^{Sch}$. In this example, the storage SOC schedule is directly considered as setpoints for the operation, and consequently, the observed storage SOC equals the scheduled SOC, which gives:

$$SOC_{T_i} = h_{st, T_i}(SOC_{T_i}^{Sch}) = SOC_{T_i}^{Sch} \quad (4.49)$$

Regarding the energy volume y and the cost Y relative to the loss formulation in Equation 4.8, these quantities are given for the case of the storage combination by Equation 3.40. The energy volume y is the energy delivered by the storage unit E_{st} , which gives, by considering Equation 4.49:

$$y(h_{st, T_i}(SOC_{T_i}^{Sch})) = E_{st, T_i}(SOC_{T_i}^{Sch}) \quad (4.50)$$

The cost Y is the additional cost associated with the storage solution. The structure of this cost is discussed in section 3.3.4. In this discussion, it has been

demonstrated that, if the day-ahead market prices during the charging and the discharging phases are equal, the cost Y can be simplified to the following expression:

$$Y(h_{st,T_i}(SOC_{T_i}^{Sch})) = |E_{st,T_i}(SOC_{T_i}^{Sch})| \times \Gamma_{st} \times \Pi_{T_i}^{DA} \quad (4.51)$$

with $\Gamma_{st} = \frac{1 - \eta}{1 + \eta}$

where η is the round-trip efficiency of the storage unit, which is defined from the charging and discharging efficiencies η_{ch} and η_{dis} by $\eta = \eta_{ch} \times \eta_{dis}$. Also the hypothesis of equal day-ahead prices when charging and discharging is coherent with the objective of not using the storage for charging energy when the price is low and discharging when the price is high.

Finally, by combining Equation 4.51 and Equation 4.50 in the loss definition from Equation 4.8, the loss function λ_{st,T_i}^{DA} can be written as:

$$\lambda_{st,T_i}^{DA}(0, SOC_{T_i}^{Sch}) = |E_{st,T_i}(SOC_{T_i}^{Sch})| \times \Gamma_{st} \times \Pi_{T_i}^{DA} + \widehat{\delta}_{T_i}^{DA} \left(\widehat{E}_{T_i|t_d} + E_{st,T_i}(SOC_{T_i}^{Sch}), E_{T_i}^{CDA} \right) \quad (4.52)$$

Similarly to the previous application relative to the intraday trading, the generation forecast $\widehat{E}_{T_i|t_d}$ and the price forecast $\widehat{\Delta}_{T_i|t_d}^{\Pi}$ which is used for the derivation of the $\widehat{\delta}^{DA}$ function are the latest available forecasts.

Norm relative to the optimization problem

The optimization problem given in Equation 4.47 is based on a norm \mathcal{N} . In this study, two norms are considered: the Manhattan norm \mathcal{N}_1 and the Maximum norm \mathcal{N}_∞ .

- The norm $\mathcal{N}_1([c_{T_i}]_{i=1}^n) = |c_{T_1}| + |c_{T_2}| + \dots + |c_{T_n}|$ defined in Equation 4.17 focuses on the total cost for the period $[T_1, T_2, \dots, T_n]$ and refers to an *expectancy choice*.
- The norm $\mathcal{N}_\infty([c_{T_i}]_{i=1}^n) = \max(|c_{T_1}|, |c_{T_2}|, \dots, |c_{T_n}|)$ focuses on extreme values of imbalance penalties and refers to a *robust choice*.

4.6.3 Illustration of the loss function

This section focuses on the loss function λ_{st}^{DA} , and more precisely gives an illustration of this function for a given market time unit T_i to better understand its structure. In order to simplify the mathematical expressions, the loss function λ_{st}^{DA} is represented as a function of the energy delivered by the storage $E_{st} = E_{st}(SOC^{Sch})$. The

combination of loss function formulation given in Equation 4.52, with the definition of the function $\widehat{\delta}^{\text{DA}}$ given in Equation 4.11 gives:

$$\lambda_{st}^{\text{DA}}(0, E_{st}) = \quad (4.53)$$

$$\begin{cases} -\widehat{\Delta}_{-}^{\Pi} \times (\widehat{E} - E^{\text{CDA}}) - (\widehat{\Delta}_{-}^{\Pi} + \Gamma_{st} \times \Pi^{\text{DA}}) \times E_{st} \Leftarrow \underline{E}_{st} \leq E_{st} \leq -(\widehat{E} - E^{\text{CDA}}) \\ \widehat{\Delta}_{+}^{\Pi} \times (\widehat{E} - E^{\text{CDA}}) + (\widehat{\Delta}_{+}^{\Pi} - \Gamma_{st} \times \Pi^{\text{DA}}) \times E_{st} \Leftarrow -(\widehat{E} - E^{\text{CDA}}) \leq E_{st} \leq 0 \\ \widehat{\Delta}_{+}^{\Pi} \times (\widehat{E} - E^{\text{CDA}}) + (\widehat{\Delta}_{+}^{\Pi} + \Gamma_{st} \times \Pi^{\text{DA}}) \times E_{st} \Leftarrow 0 \leq E_{st} \leq \overline{E}_{st} \end{cases}$$

where \underline{E}_{st} and \overline{E}_{st} are the lower and upper bounds for the energy delivered by the storage unit. These limits are related to the constraints \mathcal{C}_{st} , and a discussion about these constraints is given in the next paragraph. The expanded formulation

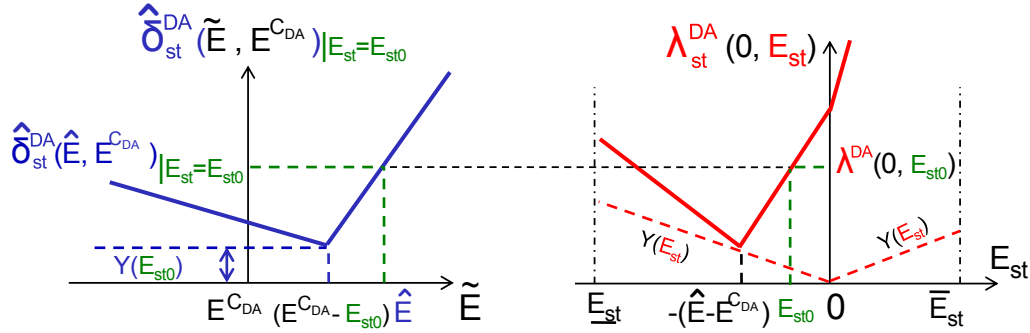

Figure 4.17: Definition of the function λ_{st}^{DA} from $\widehat{\delta}_{st}^{\text{DA}}$

of the loss function in Equation 4.53 shows that this function λ_{st}^{DA} is a piecewise linear function of the storage output energy E_{st} . This function is represented in the right part of Figure 4.17. In this example relative to the plot, the expected energy imbalance relative to the trading in the day-ahead market $(\widehat{E} - E^{\text{CDA}})$ is taken positive. This figure more generally illustrates the relation between the estimated penalization function $\widehat{\delta}_{st}^{\text{DA}}$ and the loss function λ_{st}^{DA} , which is the application of the general relation given in Equation 4.7 for the specific problem of the scheduling of the storage unit. For a given energy storage E_{st0} , this relation is:

$$\widehat{\delta}_{st}^{\text{DA}}|_{(E_{st}=E_{st0})}(\widehat{E}, E^{\text{CDA}}) = \lambda_{st}^{\text{DA}}(0, E_{st0}) \quad (4.54)$$

This figure is the follow-up of the example illustrated in Figure 4.4. The same values of regulation prices are taken: the penalization of negative imbalance is lower than the penalization of positive imbalance: $0 < \widehat{\Delta}_{-}^{\Pi} < \widehat{\Delta}_{+}^{\Pi}$.

4.6.4 Formulation of the technical constraints and temporal dependence of the storage management

The constraints \mathcal{C}_{st} on the vector $[SOC_{T_i}^{Sch}]_{i=1}^n$, in the optimization problem given in Equation 4.47, are related to the storage unit characteristics presented in the formulation of the imbalance penalty reduction in section 3.3.4.

The SOC at the end of the period T_i (i.e. $SOC_{T_i}^{Sch}$) is bounded by the minimum and maximum SOC levels, respectively SOC_{min} and SOC_{max} . Also, the storage output energy E_{st,T_i} is bounded by the storage nominal charging and discharging rates, respectively r_{ch}^{nom} and r_{dis}^{nom} . These two technical limits define the constraint set \mathcal{C}_{st,T_i} relative to the market time unit T_i :

$$\mathcal{C}_{st,T_i} : \begin{cases} SOC_{min} \leq SOC_{T_i}^{Sch} \leq SOC_{max} \\ r_{ch}^{nom} \times \Delta t \leq E_{st,T_i} \leq r_{dis}^{nom} \times \Delta t \end{cases} \quad (4.55)$$

where Δt is the constant time length of the market time period T_i . The storage output energy is assumed to be positive when discharging and negative when charging. Consequently, $r_{ch}^{nom} \leq 0$ and $r_{dis}^{nom} \geq 0$. Regarding the second constraint relative to the delivered energy, this energy is derived from the difference between the SOC level $SOC_{T_i}^{Sch}$ at the end of the period T_i and $SOC_{T_{i-1}}^{Sch}$ which is the one at the end of the period T_{i-1} . Charging and discharging modes are considered separately:

$$E_{st,T_i} = \begin{cases} -(SOC_{T_i}^{Sch} - SOC_{T_{i-1}}^{Sch}) \times Cap_{st} \times \eta_{dis}, & SOC_{T_i}^{Sch} < SOC_{T_{i-1}}^{Sch} \text{ (discharging)} \\ -(SOC_{T_i}^{Sch} - SOC_{T_{i-1}}^{Sch}) \times Cap_{st} \times 1/\eta_{ch}, & SOC_{T_i}^{Sch} \geq SOC_{T_{i-1}}^{Sch} \text{ (charging)} \end{cases} \quad (4.56)$$

By considering this equation in the constraint set given in Equation 4.55, it appears that the second constraint on the E_{st,T_i} is actually a constraint on both $SOC_{T_i}^{Sch}$ and $SOC_{T_{i-1}}^{Sch}$. Recursively, the constraint on E_{st,T_i} is thus a constraint on the vector $[SOC_{T_j}^{Sch}]_{j=1}^i$. Such constraint demonstrates the **temporal dependence** of the decisions.

Also, the two cases considered in the derivation of the delivered energy E_{st,T_i} in Equation 4.57 make its general expression from $[SOC_{T_j}^{Sch}]_{j=1}^i$ quite complex. However, if the storage charging and discharging efficiencies are assumed to be 100 %, the distinction between charging and discharging cases in the derivation of E_{st,T_i} is not needed anymore, and the delivered energy is given by:

$$E_{st,T_i} = -(SOC_{T_i}^{Sch} - SOC_{T_{i-1}}^{Sch}) \times Cap_{st}, i \geq 2 \quad (4.57)$$

$$E_{st,T_1} = -(SOC_{T_1}^{Sch} - SOC_{t_0}) \times Cap_{st} \quad (4.58)$$

where SOC_{t_0} is the value of the state-of-charge at the time step t_0 , which is the beginning of the first market period T_1 . SOC_{t_0} is considered as a given value for the present decision-making problem.

By combining the constraint definition in Equation 4.55 and the derivation of the delivered energy in Equation 4.58, the constraints can be formulated as linear constraints on the vector $V^{st} = [SOC_{T_i}^{Sch}]_{i=1}^n$ as follows:

$$\mathcal{C}'_{st} : \begin{cases} SOC_{min} \cdot \mathbb{1} \leq V^{st} \leq SOC_{max} \cdot \mathbb{1} \\ \underline{\mathbf{b}} \leq \mathbf{A} \cdot V^{st} \leq \underline{\mathbf{b}} \end{cases} \quad (4.59)$$

where $\underline{\mathbf{b}}$ and $\underline{\mathbf{b}}$ are $n \times 1$ vectors defined by:

$$\underline{\mathbf{b}} = \begin{bmatrix} r_{ch}^{nom} \times \Delta t / Cap_{st} - SOC_{t_0} \\ r_{ch}^{nom} \times \Delta t / Cap_{st} \\ r_{ch}^{nom} \times \Delta t / Cap_{st} \\ \vdots \\ r_{ch}^{nom} \times \Delta t / Cap_{st} \end{bmatrix}, \bar{\mathbf{b}} = \begin{bmatrix} r_{dis}^{nom} \times \Delta t / Cap_{st} - SOC_{t_0} \\ r_{dis}^{nom} \times \Delta t / Cap_{st} \\ r_{dis}^{nom} \times \Delta t / Cap_{st} \\ \vdots \\ r_{dis}^{nom} \times \Delta t / Cap_{st} \end{bmatrix} \quad (4.60)$$

\mathbf{A} is a $n \times n$ matrix and $\mathbb{1}$ is the $n \times 1$ unity vector defined by:

$$\mathbb{1} = \begin{bmatrix} 1 \\ 1 \\ \vdots \\ 1 \end{bmatrix}, \mathbf{A} = \begin{bmatrix} -1 & 0 & 0 & \dots & 0 \\ 1 & -1 & 0 & \dots & 0 \\ \vdots & \vdots & \vdots & \vdots & \vdots \\ 0 & 0 & \dots & 1 & -1 \end{bmatrix} \quad (4.61)$$

Finally, the simplified decision-making problem can thus be formulated as the following linear optimization problem:

$$\left([SOC_{T_i}^{Sch}]_{i=1}^n \right)^* = \arg \min_{[SOC_{T_i}^{Sch}]_{i=1}^n} \mathcal{N} \left([\lambda_{st,T_i}^{DA}(0, SOC_{T_i}^{Sch})]_{i=1}^n \right), \text{ subject to } \mathcal{C}'_{st} \quad (4.62)$$

where $\lambda_{st,T_i}^{DA}(0, SOC_{T_i}^{Sch})$ is formulated in Equation 4.52.

It is important to note that the hypothesis about the 100 % round-trip efficiency is only used in the formulation of the constraints relative to the optimization problem. The real efficiency is still taken into account in the loss function for the definition of the Γ_{st} factor in λ_{st,T_i}^{DA} , as described in Equation 4.52, and also in the operation model, which is presented in the next paragraph. The 100 % round-trip efficiency hypothesis used in the constraints formulation may lead to SOC setpoints which are slightly different to the operation SOC which takes into account the energy losses due to the real efficiency lower than 100 %.

4.6.5 Modeling the real time operation

This section formulates a real-time operation model of the VPP, for a given time unit T_{op} . This operation is based on the schedule available for period T_i , with $T_i = T_{op}$. During this time period, the energy delivered by the VPP $\tilde{E}_{VPP,T_{op}}$ is the sum of the energy $\tilde{E}_{wf,T_{op}}$ delivered by the wind farm and the energy $\tilde{E}_{st,T_{op}}$ delivered by the energy storage device :

$$\tilde{E}_{VPP,T_{op}} = \tilde{E}_{wf,T_{op}} + \tilde{E}_{st,T_{op}} \quad (4.63)$$

In the scope of this study, the output energy from the wind farm is assumed to be non-dispatchable. The output power delivered by the storage device is assumed to be dispatchable with respect to the technical constraints $\mathcal{C}_{st,T_{op}}$, which are obtained by transforming Equation 4.55 into Equation 4.64. The measured SOC at the end of the period T_{op} is denoted as $\widetilde{SOC}_{T_{op}}$.

$$\mathcal{C}_{st,T_{op}} : \begin{cases} SOC_{min} \leq \widetilde{SOC}_{T_{op}} \leq SOC_{max} \\ r_{dis}^{nom} \times \Delta t \leq \tilde{E}_{st,T_{op}} \leq r_{ch}^{nom} \times \Delta t \end{cases} \quad (4.64)$$

The delivered energy $\tilde{E}_{st,T_{op}}$ is derived from the SOC, similarly to Equation 4.57. However, for the real-time operation of the VPP, the SOC values for the time periods prior to the current time period T_{op} are known. More precisely, $\widetilde{SOC}_{T_{op}-\Delta t}$ is known, and the delivered energy $\tilde{E}_{st,T_{op}}$ only depends on $\widetilde{SOC}_{T_{op}}$:

$$\begin{aligned} \tilde{E}_{st,T_{op}}(\widetilde{SOC}_{T_{op}}) = & \quad (4.65) \\ \begin{cases} -(\widetilde{SOC}_{T_{op}} - \widetilde{SOC}_{T_{op}-\Delta t}) \times Cap_{st} \times \eta_{dis}, & \widetilde{SOC}_{T_{op}} < \widetilde{SOC}_{T_{op}-\Delta t} \text{ (dis.)} \\ -(\widetilde{SOC}_{T_{op}} - \widetilde{SOC}_{T_{op}-\Delta t}) \times Cap_{st} \times 1/\eta_{ch}, & \widetilde{SOC}_{T_{op}} \geq \widetilde{SOC}_{T_{op}-\Delta t} \text{ (ch.)} \end{cases} \end{aligned}$$

Furthermore, the operation model distinguishes two cases: the reference opera-

tion and the strategic operation:

Reference Operation

The reference case is the case without strategic intraday storage schedule. In this case, the operation mode for the storage unit consists in a “filter” mode, where the storage energy output is so as to reduce the instantaneous absolute energy imbalance between the delivered energy $\tilde{E}_{wf} + \tilde{E}_{st}$ and the contracted energy E^{CDA} . This approach is the one which has already been used in the evaluation of the reduction of imbalance penalties in section 3.5. In this case, the storage energy is given by:

$$\tilde{E}_{st,Top} = \arg \min_{E_{st}} \left| (\tilde{E}_{wf,Top} + E_{st}) - E_{Top}^{CDA} \right|, \text{ subject to } \mathcal{C}_{st,Top} \quad (4.66)$$

Strategic Operation

Conversely, the strategic coordination of the energy storage with the wind farm considers the *latest available* storage SOC schedule $SOC_{Top}^{Sch,*}$ resulting from the optimization in Equation 4.62. In this case, the storage unit is operated by considering the SOC schedule as setpoints. In other words, the storage unit is operated in order to have its SOC as close as possible to the SOC schedule, while respecting the technical constraints:

$$\tilde{E}_{st,Top} = \arg \min_{E_{st}} \left| \widetilde{SOC}_{Top}(E_{st}) - SOC_{Top}^{Sch,*} \right|, \text{ subject to } \mathcal{C}_{st,Top} \quad (4.67)$$

where

$$\widetilde{SOC}_{Top}(E_{st}) = \widetilde{SOC}_{Top-\Delta t} + \begin{cases} 1/\eta_{dis} \times E_{st}/Cap^{ESD} & (E_{st} < 0) \\ \eta_{ch} \times E_{st}/Cap^{ESD} & (E_{st} \geq 0) \end{cases} \quad (4.68)$$

4.6.6 Case study

Description of the case study

This section presents the followed methodology evaluating the strategic combination of a pumped-hydro storage unit with a wind farm, for the participation in a day-ahead market. The methodology for obtaining these results is described in Figure 4.18. More precisely, this consists in an improvement of the storage case study in section 3.5, where the only operation mode was the reference mode. In this case, the benefits from the strategic combination are compared to this reference approach.

The data necessary for the scheduling approach are presented as inputs of the storage scheduling and operation module. The day-ahead contract directly results

Formulation of the decision-making problem

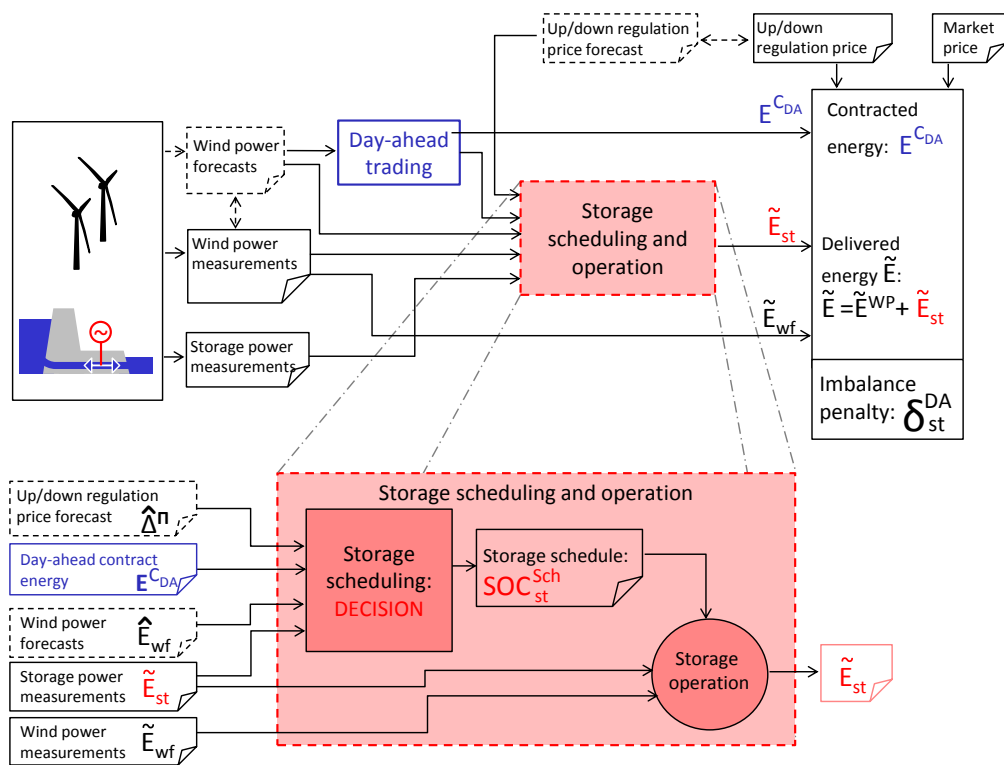

Figure 4.18: Schematic representation of the overall simulation, including the scheduling and the operation of the storage unit.

from the available wind power forecasts, as already explained in the previous case study in section 4.4. The storage SOC setpoints are determined using the decision-making method formulated in Equation 4.62, and the delivered energy is derived from the strategic or reference operation mode described in section 4.6.5. The imbalance penalty δ_{st}^{DA} results from the penalization of the energy imbalance between the delivered energy $\tilde{E}_{wf} + \tilde{E}_{st}$ and the contracted energy $E^C = E^{\text{CDA}}$.

The case study is based on the same wind farm as the one taken for the case study corresponding to the reference participation in the day-ahead market in section 4.4. This wind farm is a 18 MW wind farm located in Western Denmark. The wind farm generation is traded in the NordPool Elspot day-ahead market during the period between the 01/04/2004 and the 31/06/2004. The pumped-hydro storage unit is a 30 MWh capacity unit, with a 80 % round-trip efficiency. The nominal charge and discharge rates are taken respectively equal to -6 and 6 MWh/h.

Wind power forecasts are used as input for both the trading in day-ahead market and the storage scheduling. The wind power forecasting approach used for this case study is a power curve modeling approach, denoted as “regressive power curve” (RPC) model. This model is the same one as the one used in the previous case study, referring to the intraday trading. Details about this model are given in appendix B.2.

The derivation of the loss function λ_{st}^{DA} in Equation 4.53 demonstrates that this function is based on forecasts of the imbalance penalty price $\hat{\Delta}^{\Pi}$. In this study, two approaches are considered for the forecasting of this price: the perfect and constant prediction approaches.

- In the case of perfect prediction, the forecasts of the imbalance penalty price $\hat{\Delta}^{\Pi}$ correspond to the observed values, and are used as such for deriving the loss function given in Equation 4.52.
- In the case of the constant prediction approach, the forecasts of the penalty price for negative and positive imbalance ($\hat{\Delta}_{-}^{\Pi}$ and $\hat{\Delta}_{+}^{\Pi}$ respectively) are equal and constant for all the different forecasting runs and horizons. In this case, the definition of the reference penalization function $\hat{\delta}^{\text{DA}}$ in Equation 4.11 shows that such function is proportional to the absolute value of the energy imbalance. This function corresponds to the second term of the loss function λ_{st}^{DA} given Equation 4.52. Also, for this price prediction approach, the first term of the loss function is neglected in order to focus only on the minimization of energy imbalance. This simplification is coherent with the hypothesis about constant and equal predictions of the penalty price, which considers that no information is available about the price for positive and negative imbalance.

Consequently, the imbalance penalty minimization problem is simplified to an **imbalance energy minimization problem**.

Finally, the results obtained from both approaches are compared and discussed in the following paragraphs.

Results and discussion

The results are obtained using a simulation tool developed in Matlab®. In particular, the linear optimization problem is solved using a sequential quadratic programming (SQP) method already implemented in Matlab®. The presented results have been obtained considering a rolling-window width T_w equal to 12 h and the increment time T_{inc} equal to 1 h. The results are computed for the two different norms \mathcal{N}_1 and \mathcal{N}_∞ . The reference case where the storage is operated with a “filter” approach is denoted \mathcal{N}_0 .

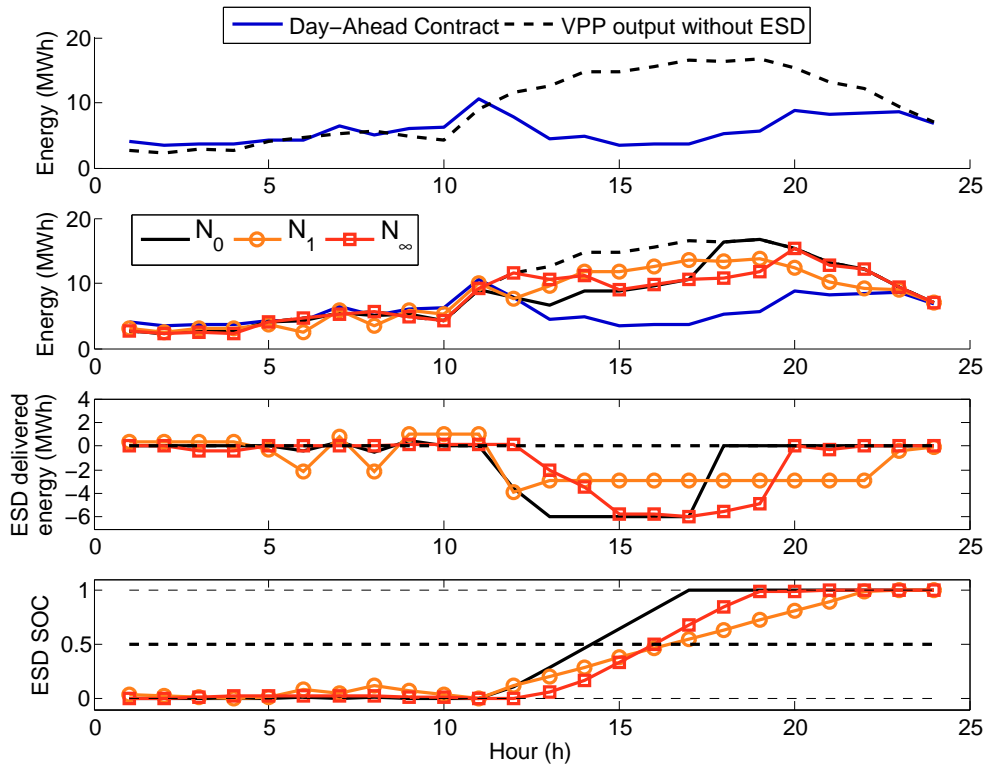

Figure 4.19: Influence of the strategy on the operation of the combined wind-hydro plant, during the 04/04/04.

Figure 4.19 shows the operation of the virtual power plant during the 24 hours of the 4 April 2004. The results presented in this figure are obtained using the constant approach for the forecast of the imbalance penalty price, and consequently, focus is given to the energy imbalance. On the top graph, the blue line represents the energy contract related to the day-ahead market participation and the dashed black line represents the energy output of the wind farm. The area between the black line and the blue line represents the energy imbalance without considering the storage. The imbalance energy is relatively low for the first 11 hours. From hour 12 to hour 24, the wind farm output is greater than the contracted energy, which leads to positive energy imbalance for that period.

On the second graph, black line represents the energy output from the combined plant energy output for the reference case \mathcal{N}_0 . Similarly, the orange line marked with circles and the red line marked with squares represent the energy output from the combined plant for the strategies \mathcal{N}_1 and \mathcal{N}_∞ , respectively. The two last graphs plot the storage energy output and SOC level for the various cases.

The second graph first shows that the combination of the storage device with the wind farm reduces the (positive) energy imbalance for the period from hour 12 to hour 24, for all the three cases. However, for this period, the storage operation highly depends on the strategy:

- In the reference case \mathcal{N}_0 , the surplus energy is stored till the energy storage device is completely loaded, at hour 16. Note that, from hour 13 to hour 17, the storage charge is limited by its nominal charging rate equal to $r_{ch}^{nom} = -6 \text{ MWh/h}$. For hours 18 to 24, the storage device is completely loaded (the SOC level is equal to 1). Consequently, no more energy can be stored and the storage output power is null.
- In the \mathcal{N}_1 case, the storage charging power remains approximately constant for the period between hour 12 and hour 22. The storage charging power is then reduced for hour 23 and hour 24 since the energy imbalance is reduced for the same hours.
- In the \mathcal{N}_∞ case, the second graph shows that the difference between the red line and the blue line remains approximately constant from hour 13 to hour 20. In other words, the charging energy is set so that the imbalance is kept constant and as small as possible. This analysis is in line with the objective of this \mathcal{N}_∞ strategy which is to minimize the maximum imbalance energy.

Figure 4.20 describes the operation of the combined wind-hydro unit for the same period as the one described in the previous figure. However, in this case, focus is given to the influence of the approach regarding imbalance penalty price forecasting.

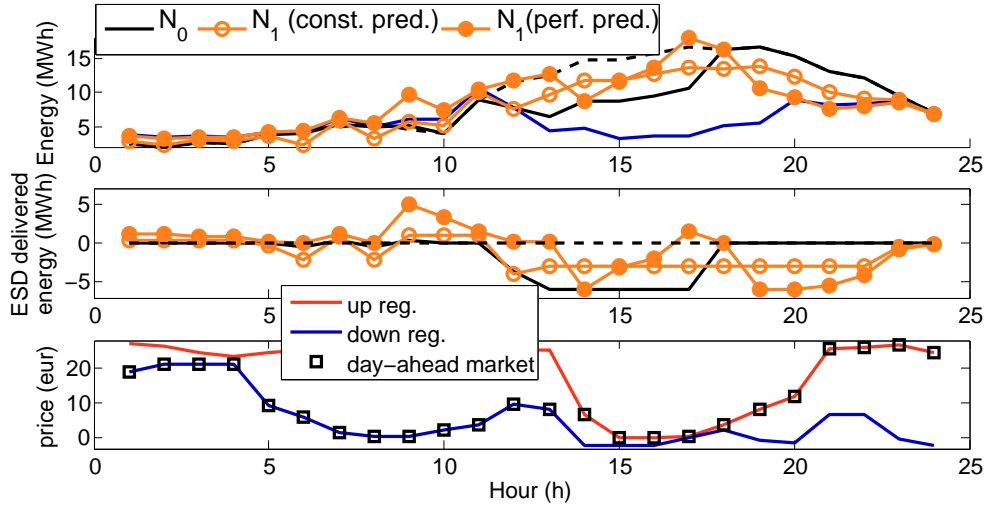

Figure 4.20: Management of the storage unit with perfect knowledge of the imbalance penalty price, during the 04/04/04.

Figure 4.20 compares the results obtained in the \mathcal{N}_1 case, using either the “constant prediction” approach or the “perfect prediction” approach for imbalance price forecasting. Figure 4.20 shows that the operation resulting from the two approaches is completely different. Contrary to the constant prediction case, where the absorbed energy is rather constant between hour 13 and 22, the operation in case of perfect prediction varies according to the imbalance penalty price. From the third graph, we can observe only negative energy imbalance are penalized for hours 12 and 13, because the up-regulation price is higher than the day-ahead price, which equals the down-regulation price. Then, the storage is not charged during this period in the perfect prediction case. The empty storage capacity is kept for the period between hour 19 and 24 where positive imbalance are penalized.

Figure 4.21 presents results about the distribution of the hourly absolute energy imbalances $|d|$ and the hourly imbalance penalty δ obtained from the simulation of the participation of the combined wind/pumped-hydro plant in the day-ahead market for the period between the 01/04/2004 and the 31/06/2004. The results from the strategies \mathcal{N}_1 and \mathcal{N}_∞ are compared to the reference case \mathcal{N}_0 . Also both basic and perfect prediction approaches for the imbalance penalty price are represented. The *mean* gives the average of the value for each hour of operation. The q^{99} presents the 99%–quantile of the distributions of the hourly energy imbalance $|d|$ or imbalance penalties δ . This quantity gives an estimate of extreme values. It is defined as the value $q^{99}(x)$ for which the number of occurrences of x greater than $q^{99}(x)$ is equal

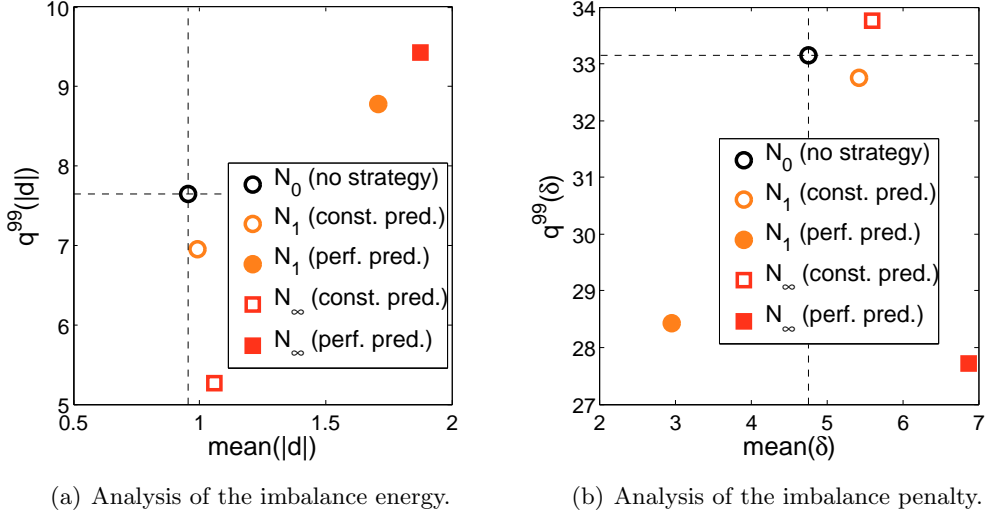

Figure 4.21: Analysis of the distribution of the imbalance energy and the imbalance penalty.

to 99% of the total number of occurrences:

$$n(x < q^{99}(x)) = 99\% \times n_{tot} \quad (4.69)$$

The mean criterion is rather related to the evaluation of the \mathcal{N}_1 strategy, while the 99%–quantile is related to extreme events and is thus more appropriate for evaluating the \mathcal{N}_∞ strategy.

The plot 4.21(a) focuses on the absolute energy imbalance, while 4.21(b) focuses on the imbalance penalty. The two figures show that the strategy \mathcal{N}_∞ decreases extreme values of absolute energy imbalance by 31 % in the case of constant prediction of imbalance penalty price, and extreme values of imbalance penalty in the case of perfect prediction by 16 %. Regarding the \mathcal{N}_1 strategy, the mean absolute energy imbalance is slightly increased by 11 % in the case of constant prediction of imbalance penalty price, but the mean imbalance penalty is highly reduced by 38 % in the case of perfect prediction.

Finally, the results illustrate the difference of objectives relative to the two proposed norms \mathcal{N}_1 and \mathcal{N}_∞ . For example, the results obtained with the \mathcal{N}_1 strategy and perfect prediction approach highly reduces the mean imbalance penalty, but increases the extreme values of absolute energy imbalance. Conversely, the results obtained with the \mathcal{N}_∞ strategy and constant prediction approach highly reduces the extreme values of absolute energy imbalance, but increases the mean imbalance penalty.

4.6.7 Conclusions

In this section, a novel method is proposed for the management of a combined wind/pumped-hydro power plant under electricity market. The method focuses on the intraday management of the energy storage device in order to reduce the penalty risk associated with energy imbalances, for the combined power plant operator.

The method was presented in detail and applied to a realistic test case, where real-world measured data and forecasts obtained by a state-of-the-art wind power forecasting model are used.

The results clearly show that a strategic coordination of the energy storage device is a way to manage the energy imbalances as well as the penalties associated with these imbalances. The results also demonstrate the strong influence of the scheduling strategies on the risk associated with the imbalance penalties.

4.7 Conclusions

In this chapter, different decision-making problems relative to the management of renewable energy sources in electricity markets have been described. Similarly to the previous chapter 3, the decision-making problems have been classified into two categories: the first one is related to decisions relative to financial decisions and the second one is related to decisions relative to physical decisions.

A generic formulation of the decision-making problem, valid for the two kinds of decisions, has been proposed. Such formulation is based on the minimization of a norm of a loss function. This loss function is specific to the physical or financial solution and is derived from the penalization function proposed in the previous chapter 3. Also, this loss function is based on estimations of delivered energy by the RES units, combined with estimations of market prices and regulation prices. The decision-making approach has been evaluated for three specific problems:

- The participation in the day-ahead market has been considered as an approach for evaluating the forecasting performance of renewable power forecasting methods. More precisely, the presented case study demonstrated that the imbalance penalties could be reduced by nearly a half when advanced forecasting models were used, compared to the imbalance penalties obtained when using basic forecasting approaches.
- The decision-making method has also been applied to the strategic sequential trading in day-ahead and intraday markets. The influence of the intraday bid decision on the resulting imbalance penalty has been analyzed. Results from

a case study demonstrated that the strategic trading in intraday market can reduce the imbalance penalty by up to 9 %.

- Finally, the decision-making method was applied to the management of the combination of a wind farm with a hydro storage device. This management based on a rolling-window approach. The study analyzed the influence of the decision strategy on the distribution of the imbalance energy volumes and imbalance penalties. The results obtained with a strategy which aims at reducing the sum of the imbalance penalty during the period of the rolling-window, lead to a reduction of 38 % of the total imbalance penalty as well as a reduction by 14 % of the extreme values of imbalance penalties.

Formulation of the decision-making problem

A Risk-Based Approach for the Management of Uncertainty associated with Renewable Generation in Electricity Markets

Chapter overview

This chapter extends the methodology proposed in the previous chapter to account for the uncertainty associated with the decision-making problem related to the participation of renewable generation in electricity markets.

First, the uncertainties associated with the present decision-making problem are described. General definitions and approaches for modeling the uncertainty are given from the state of the art. Special attention is paid to the estimation of the uncertainty related to renewable generation forecasts and to the market price forecasts, given by probabilistic forecasting methods. An overview of the state of the art of the methods for decision-making under uncertainty is presented in the second section. Focus is given to risk-based approaches and different risk measures are explained.

Then, the third section of this chapter gives the formulation of the risk-based decision-making method. This method is an extension of the one which has been formulated in the previous chapter in the case of deterministic forecasts (i.e. point forecasts) of future variables, to the case of probabilistic forecasts.

Finally, the two last sections present illustrations and application results of the risk-based methodology. The fourth section illustrates the hedging resulting from

the combination of a storage unit with a wind farm, and the fifth section gives the benefits from the application of the method to the participation of wind generation in electricity markets.

5.1 Estimation of uncertainties associated with the participation of renewable generation in electricity market

This section first presents the main sources of uncertainties in our decision-making problem, which are renewable generation and market prices. Then, an overview of the existing methods for representing the uncertainty, in a general way, is given. These representations are used in the case of probabilistic forecasting models which are able to provide information about the uncertainty associated with the forecasts. Finally, the last part of this section gives examples of probabilistic forecasting models for wind power and market prices which are available from the literature.

5.1.1 Sources of uncertainties

In general, the management of power systems has to take into account a wide range of factors and parameters which may be uncertain. For example, the study in [125] presents the main sources of uncertainty for a utility regarding operational-planning; more precisely, the uncertainties about the load, the operating costs, the power transmission are discussed.

In the present work, only the uncertainties relative to the participation of renewable generation in electricity markets are considered. From this point of view, the two main sources of uncertainty are the electricity market prices and the renewable generation. Note that these two sources of uncertainties correspond to the two forecasted quantities in the decision-making problem formulated in chapter 4.

- **Renewable generation:** the limited predictability of the generation from some RES units has already been presented as one of the main properties of renewable generation in section 1.2.2. This is mainly the result of the dependence of this production on weather conditions, which in turn have a limited predictability. This characteristic results to some uncertainty about the future renewable generation.
- **Electricity market prices:** they are determined according to the fundamental economic rule of supply and demand, which makes them highly sensitive to demand and supply variations. Such sensitivity results to a very high variability and volatility of the market prices. Also market prices may exhibit

spikes, which are extreme variations during a very short time period. The brief characterization of market price time series from the literature in section C.1 gives further details about such volatility. Moreover, market prices depend on a wide range of factors, which can be technical, meteorological or psychological. Such complex structure makes price forecasting a difficult problem. The uncertainty associated with a given price forecast is consequently high.

5.1.2 State of the art of the approaches for modeling uncertainty

This section presents the different existing approaches to model and represent the uncertainty related to a random variable. The classification into three main categories for representing uncertainty, which are scenarios, fuzzy sets and probabilistic models, is taken from [121]. Special attention is paid to probabilistic models, which will be used for the development of the decision-making approach proposed in this chapter.

Scenarios

Scenarios are possible future instances of data. Representing the uncertainty with scenarios is considered as a “natural” approach, where the main uncertain variables are globally estimated and different possible futures are constructed. A possible way to generate scenarios for the output of a process is to consider slight variations of the value of one of the input parameters. The resulting scenarios are said to be equi-probable when all the scenarios have the same probability to occur.

An important characteristic of the scenario approach is the “outside-in” aspect. This means that the possible future course of a scenario is determined by outside influences. Hence, the function of scenarios is not to predict the future but to explore it. Since scenario approaches can become too exhaustive, work has been done about the optimization of scenario building. Scenario reduction algorithms for determining a subset of the initial scenario set, and assigning new probabilities to the preserved scenarios, are proposed in [126]. In these methods, the scenario tree construction algorithms successively reduce the number of nodes for a fan of individual scenarios, by modifying the tree structure and by bundling similar scenarios.

Intervals and fuzzy sets

Using intervals is another “natural” way of dealing with uncertainty, where the data are described by intervals instead of a single real number. In their basic formulation, intervals are not linked to a probabilistic distribution but only try to capture every possible future value of the relevant data [121].

Fuzzy sets is another way to model the uncertainty with qualitative descriptions corresponding to expert declarations about the data or the impact of the alternatives. Fuzzy sets can thus be described as extension of intervals, where additional information besides the range of possible values is given. The general fuzzy number can be seen as a set of nested intervals, with increasing degrees of membership, also called possibility values. The fuzzy set theory is fully described in [127].

Probabilistic models

Probabilistic models include information about the probability relative to each outcome of the uncertain variable. The most complete information about uncertainty is the probability distribution which is given by the probability density function. In the case of a continuous random variable X , the probability density function of X is denoted as f_X . This function gives the probability for the variable X to be included in the interval $[x, x + dx]$:

$$f_X(x) = \text{prob}(X \in [x, x + dx]) \quad (5.1)$$

The cumulative distribution function F_X of a random variable X gives the probability for the variable X to be lower or equal than a given value x . Such function is sometimes denoted as “cdf”. It can be derived as the integral of the probability density function f_X :

$$F_X(x) = \text{prob}(X \leq x) = \int_{-\infty}^x f_X(u) du \quad (5.2)$$

The probability density function f_X is positive, and consequently, F_X is an increasing function. If f_X is strictly positive, F_X is a strictly increasing function and is thus invertible.

Several quantities can be derived from the probability distribution of the random variable X . In particular, a α -quantile q_X^α , where $0 \leq \alpha \leq 1$ is defined as the minimum value such that the probability for the variable X to be lower or equal to this value equals α .

$$q_X^\alpha = \min(x | \text{prob}(X \leq x) = \alpha) \quad (5.3)$$

If F_X is invertible, the α -quantile q_X^α can also be written as $q_X^\alpha = F_X^{-1}(\alpha)$.

The mean outcome μ of the random variable X with the probability density function f_X , is the defined as the expected value of X , and is calculated as follows:

$$\mu = \mathbb{E}(X) = \int_{-\infty}^{\infty} x f_X(x) dx \quad (5.4)$$

where \mathbb{E} is the expectation operator. The expected value is sometimes referred to as the first moment of X . More generally, the k^{th} central moment μ_k of the variable X is defined as:

$$\mu_k(X) = \mathbb{E} \left((X - \mathbb{E}(X))^k \right) = \int_{-\infty}^{\infty} (x - \mu)^k f_X(x) dx \quad (5.5)$$

where k is a positive integer. For $k = 0$, the central moment is one $\mu_0 = 1$; the first central moment is zero $\mu_1 = 0$. The second central moment μ_2 is called the variance and is usually denoted as $\mu_2 = \sigma^2$, where σ is the standard deviation. The variance or standard deviation measures the dispersion of the variable X , and represents the amount by which X tends to deviate from its expected value. Details about higher moments can be found in [128].

5.1.3 Estimation of the uncertainty related to a forecasted variable

Deterministic versus probabilistic forecasting

A deterministic forecast of a stochastic variable for a given time in the future is an estimation of the value of this variable for the given time. The deterministic forecasts are also called point forecasts or spot forecasts, and provide a single value for each forecast horizon. Most of the deterministic forecasting tools are based on minimum least square estimation. For example, let consider x_{T_i} the estimation of a random variable X for the period T_i , and \hat{x}_{T_i} the point forecast issued at time t_d for the period T_i , based on the model M , the model parameters ϕ_{t_d} , and the information set Ω_{t_d} gathering the available information on the process up to time t_d . The point forecast \hat{x}_{T_i} based on minimum least squares is formulated in [78] as:

$$\hat{x}_{T_i} = \mathbb{E} [X_{T_i} | M, \phi_{t_d}, \Omega_{t_d}] \quad (5.6)$$

Such deterministic forecasting models provide a single predicted value related to a given random variable. Conversely, *probabilistic forecasting* methods consist in providing the future probability related to the same random variable [129]. This additional information about uncertainty may take the form of quantile, interval or probability density function forecasts. These different representation models have been presented in the previous section 5.1.2.

A distinction is made between parametric probabilistic forecasting methods which are based on an underlying assumption about the shape of the forecasted distribution, and non-parametric probabilistic forecasting methods which do not rely on such assumption [78]. Non-parametric methods are also called distribution-free methods. They permit to obtain a more precise description of the uncertainty, compared to

parametric methods.

Quantile forecasting is an example of non-parametric probabilistic forecasting methods. For a given stochastic variable X , the α -quantile forecast for the period T_i , issued at time t_d , is denoted as $\widehat{q}_{X_{T_i|t_d}}^\alpha$. Such quantile forecast can be obtained using the quantile regression method, described in [130]. In particular, this method is based on a minimization of a check function ρ_α , which is a piecewise linear and asymmetric function given by:

$$\rho_\alpha(x) = \begin{cases} (1 - \alpha) \cdot |x|, & x < 0 \\ \alpha \cdot |x|, & x \geq 0 \end{cases} \quad (5.7)$$

A discussion about the similarities between this check function ρ_α and the reference loss function λ^{DA} given in Equation 4.27 is proposed in the last section 5.5.4 of this chapter.

Then, the non-parametric forecast $\widehat{f}_{X_{T_i|t_d}}$ of the density function of the variable of interest during the period T_i can then be produced by gathering a set of m quantile forecasts:

$$\widehat{f}_{X_{T_i|t_d}} = \left[\widehat{q}_{X_{T_i|t_d}}^{\alpha_j} \right] \quad \text{with } 0 \leq \alpha_1 < \dots < \alpha_j < \dots < \alpha_m \leq 1 \quad (5.8)$$

where the nominal proportions α_j are spread on the unit interval. This type of probabilistic forecasts are denoted as predictive distribution. Other statistical methods such as kernel density estimation directly provide the uncertainty in the form of a predictive distribution. Further details on kernel density estimation can be found in [131]. A prediction interval forecast, such as reported in [78], corresponds to the specific case for which only two quantiles are quoted with nominal proportions chosen to be symmetric around the median.

Finally, probabilistic forecasts may be very useful in decision-making applications. Consequently, probabilistic forecasting has been developed in several fields. Meteorology and economics are the two domains that have been most active. Probabilistic forecasting has spread from these fields into other fields such as power system management (i.e. wind power or load forecasting).

Probabilistic forecasting of the renewable generation: the example of wind power

In this thesis, the proposed decision-making methods have been applied to the case of wind generation only, and consequently only probabilistic models relative to wind generation are requested. However, as already mentioned in the introduction of chapter 3, it is important to note that the general approach followed in this thesis

could be directly applied to photovoltaic or other renewable energy sources.

The general methods which can be found in the literature for the general problem of probabilistic forecasting of wind generation are presented given in the appendix B.3. An example of forecasts obtained with one of these methods is described in Figure 5.1. This figure illustrates the typical probabilistic wind generation forecasts which are requested for the decision-making methods. In this example, the method is based on Kernel Density Estimators (KDE), and provides a predictive distribution for each forecast horizon. The time step between two consecutive horizons is 3 hours, and the wind power production is forecasted for the next 60 hours. The corresponding measurement is represented by the black line.

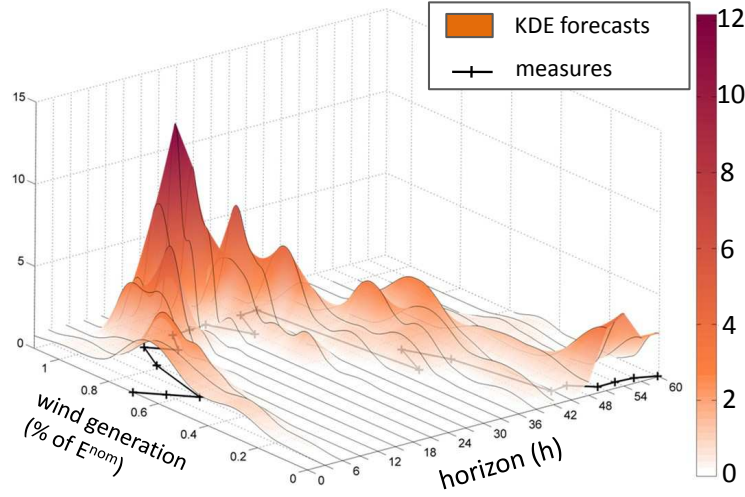

Figure 5.1: Example of probabilistic wind power forecasts obtained with the KDE method, from [132].

Finally, the methods which are used for the two case studies of this chapter, are presented in the sections relative to the description of these case studies (i.e. in section 5.4 and 5.5).

Probabilistic forecasting of electricity market price

In the decision problem relative to the participation of renewable generation in electricity market, the price quantity which is considered by the IPP is the penalty price for positive or negative energy imbalance Δ^Π , as explained in section 4.3.3. The definition of Δ^Π in Equation 3.8 shows that this price quantity depends on the sign of the energy imbalance, which makes it more difficult to forecast.

In the hypothesis of a dual price imbalance settlement mechanism, the forecasting of Δ^Π can be simplified to the forecasting of the price quantity Π^Δ , which is

independent from the energy imbalance, and only depends on the regulation state of the TSO. Π^Δ is defined by

$$\Pi^\Delta = \Pi^{\text{DA}} - \Pi^s \quad (5.9)$$

where $\Pi^s = \Pi^+$ if only positive imbalances are penalized (i.e. TSO is down-regulating), $\Pi^s = \Pi^-$ if only negative imbalances are penalized (i.e. TSO is up-regulating), and $\Pi^s = \Pi^{\text{DA}}$ if no regulation is needed by the TSO. The details of the definition of Π^Δ , as well as the relation between Δ^Π and Π^Δ , are given in section subsection C.3.2.

Then, for the work presented in this thesis, we propose to represent of the uncertainty related to Π^Δ through a discrete probabilistic forecast based on three possible outcomes. Each outcome is associated with a TSO regulation state : up-regulation, no regulation, and down-regulation. These three regulation states correspond to negative, null and positive values for $\hat{\Pi}^\Delta$, respectively. Each state is assigned a probability α :

$$\hat{\Pi}^\Delta = \begin{cases} \left(\hat{\Pi}_-^\Delta < 0, \alpha_- \right) \\ \left(\hat{\Pi}_o^\Delta = 0, \alpha_o \right) \\ \left(\hat{\Pi}_+^\Delta > 0, \alpha_+ \right) \end{cases} \quad (5.10)$$

This discrete probabilistic forecast can be obtained from advanced price forecasting methods, as described in section C.2. However, given the difficulty of price forecasting, a method for simulating the price forecast $\hat{\Pi}^\Delta$ is proposed. This method permits to obtain different levels of forecasting error, and to evaluate their impact on the decision-making. The details of this simulation approach are detailed in the appendix C.4.1. In particular, the level of forecasting error is based on two parameters which are a phase error τ and a parameter ϵ related to the uncertainty about the regulation state of the TSO.

5.2 Overview of the state of the art of decision-making methods under uncertainty with focus on risk-based approaches

This section first gives examples of decision-making problems related to the management of power systems. Then, an overview of the existing approaches for the general problem of decision-making under uncertainty is presented. These general decision-making approaches are formulated for the case of our problem. Special

attention is paid to the risk-based methods. In particular, different risk measures, taken from the financial area, are defined.

5.2.1 Examples of decision-making methods under uncertainty in power system management

The management of a power system involves several decision-making problems under uncertainty. Generation planning and scheduling are two examples of such problems. Generation planning is a decision-making problem relative to the long-term investment for new generation facilities, while generation scheduling refers to unit commitment and economic dispatch problems, which are related to the power system operation as introduced in section 4.1.3. The following paragraphs present examples, taken from the literature, of different approaches used for the management of the uncertainty in these planning and scheduling problems.

A literature survey of the methodologies for accounting for uncertainty in power system management is proposed in [133]. Although the survey is related to the problem of planning electricity generation, the described methods are general and could be used for more general power system management problems. A first method is denoted as the *deterministic equivalent* method; in this method, the uncertainty information is reduced to a deterministic value which is used in the decision-making problem. The *robustness analysis* is a second method particularly adapted to the problem relative to power system reliability. This method aims at finding a so called robust decision with a trade-off analysis among conflicting objectives. Also, the *stochastic optimization* is a method adapted from mathematical programming which is frequently applied in multi-stage planning problems under uncertainty.

Using scenarios for representing the uncertainty related to future variables is widely used in planning decision-making problems [133, 134]. These scenario-based approaches have been extended to the operation problems. For example, in [135], a multistage stochastic model is proposed for the optimal operation of a wind farm combined with a pumped storage unit and thermal power plants. The wind farm output generation and the electrical demand are considered as two independent stochastic processes, which evolution is modeled with a scenario tree. Also, in [136], an operation scheduling and contract management method is described, in which the uncertainty related to market price is described using scenarios. The operating tool described in the patent [137] is another example of stochastic generation scheduling tool, where the uncertainty related to the load is described through scenarios.

Scenario-based models which consider all possible realizations of the stochastic process lead to a huge set of scenarios. Consequently, scenario reduction methods are often used. A scenario reduction algorithm based on a particle swarm optimization is

used in [135]. More generally, in [138], the scenario reduction problem is formulated as the determination a subset of preserved scenarios which is the “closest” to the original set of scenarios using a given probability metric. The distance defined by this metric takes into account the scenario probabilities and the distances between scenario values.

Another alternative to scenarios for representing uncertainty is the consideration of probabilistic forecasts. Historically, probabilistic methods relative to power systems have been first developed to analyze the reliability of the systems and the problem of reserve setting. In this context, the uncertainty is associated with the possibility of a default in the generation portfolio. The distribution of the value of the system margin, which is the difference between the available generation power and the load, is derived from the default distribution. Then, the loss of load probability (LOLP) is one reliability measure, which is defined by the probability to have a negative margin of the system. The amount of reserve is then settled in order to have the LOLP lower than a given threshold. In [139], a method for quantifying the reserve needed for a power system including wind generation, is proposed. In this advanced method, the uncertainty related to the wind generation is estimated through probabilistic forecasts.

5.2.2 Formulation of the state-of-the-art probabilistic methods for decision-making under uncertainty

The decision-making methods, which are based on probabilistic forecasts are denoted as probabilistic methods. These methods are distinguished from scenario-based methods, which are not considered in this work. The general principle about decision-making under uncertainty refers to the class of decision-making problems in which the imperfect knowledge of the future is incorporated in the decision process [116]. In addition to this reference, the probabilistic methods for decision-making under uncertainty presented hereafter are based on the state of the art of these methods in [121], which proposes a unified view over the issue, as well as on [112]. The proposed classification of the methods for decision-making under uncertainty is inspired from the one proposed in [120].

In this section, we propose to formulate the general decision-making methods which are presented from the literature, for our specific problem. The formulation of the decision-making methods is valid for both financial and physical decisions presented in section 4.1.1. In this section, the formulation is proposed for a decision v related to a physical solution, but would be similar for a decision u related to a financial solution. The alternative v is supposed to be continuous. The attribute of the decision (the concept of attribute is explained in section 4.1.1) is the associated

loss is $\lambda(0, v)$, where λ is the loss function defined in Equation 4.8. In order to simplify the mathematical expressions, the notation of the loss is simplified as follows: $\lambda(0, v) = \lambda(v)$.

In this case, this loss is a random variable, and its distribution is estimated by its probability density function $f_{\lambda(v)}$. In this section, this probability density function is supposed to be known. The derivation of this function is detailed in the next section 5.3. For a given decision-making method, the chosen alternative is denoted as v^* . The constraints on the decision v are denoted as \mathcal{C}_v . Finally, note that this decision v is relative to a given market time unit T_i , but the index T_i is omitted for simplifying the mathematical expressions.

Note that similarly to section 5.2.2, the considered decision v_{T_i} is relative to a physical hedging solution, but the formulation would be similar in the case of a financial decision u_{T_i} .

Expected value method

The expected value method consists in choosing the alternative which maximizes (or minimizes, according to the type of problem) the expected value of the attribute. The chosen alternative v^* is derived as follows:

$$v^* = \arg \min_v \int_{-\infty}^{\infty} x \cdot f_{\lambda(v)}(x) dx, \text{ subject to } \mathcal{C}_v \quad (5.11)$$

This method assumes implicitly that a number of similar decision situations will be repeated over time. Also, the expected value method does not integrate the decision maker needs and desires in the decision-making process [112]. The method is rather prescriptive disregarding any subjectivity or judgment that the decision maker might have [140]. In particular, it does not take into account the risk related to extreme events.

Expected utility theory

The concept of utility has already been presented in section 4.3.1. In this section, the concept is reminded, and is presented more precisely in the context of decision under uncertainty.

Utility theory was first proposed in 1738 by Bernoulli [140] as a response to the critic of the expected value decision method which does not incorporate the preferences of the decision maker in the decision process. Later, a set of axioms have been proposed in 1944 by von Neumann and Morgenstern in [141] for defining the expected utility theory. In particular, these axioms can be used as a base for

constructing a cardinal utility function [116]. A utility function is a function of the attribute of the decision-making problem, such as the benefits or the loss.

The utility function of the loss $\lambda(v)$ is denoted as $\mathcal{U}(\lambda(v))$. In the expected utility theory, the chosen alternative v^* is the one which maximizes the expected utility $\mathcal{U}(\lambda(v))$. The distribution of the utility is assumed to be known for each possible alternative value v . This distribution is modeled by the probability density function $f_{\mathcal{U}(\lambda(v))}$, and the chosen alternative v^* is derived as follows:

$$v^* = \arg \max_v \mathbb{E} (\mathcal{U}(\lambda(v))) = \arg \min_v \int_{-\infty}^{\infty} x \cdot f_{\mathcal{U}(\lambda(v))}(x) dx \quad (5.12)$$

$$\text{subject to } \mathcal{C}_v \quad (5.13)$$

The risk related to the attribute $\lambda(v)$ is implicitly integrated in the utility function, and consequently, in the decision process. Three main risk attitudes exist and correspond to three types of utility functions [120, 121].

- A decision maker is said to be *risk prone* if the corresponding utility function translates a willingness to give a premium to higher risk situations. The risk proneness attitude of a decision maker corresponds to convex utility functions.
- A decision maker is said to be *risk neutral* if the corresponding utility function does not present any risk premium or penalty associated with any possible outcome. This corresponds to a linear utility function. In this case, the decision alternative selected by the expected utility theory is the same as the one determined via the expected value decision method.
- A decision maker is said to be *risk averse* if the corresponding utility function translates a willingness to penalize higher risk situations whilst favoring lower risk ones. The risk aversion attitude of a decision maker corresponds to concave utility functions.

Decision-making methods based on the utility theory result in a somewhat normative procedure for making decision. Once the decision maker risk attitude is modeled in the utility function, decision can be made without further interference of the decision maker. However, the determination of the utility function for a given decision maker might be a time-consuming and hard task [112].

Spot-risk model

Alternative decision-making methods based on explicit risk measures have been proposed in the literature for overcoming the difficulty of deriving a specific utility

function. One of the most generic approaches is the *spot-risk* approach. The denomination of the approach is taken from [120]. The spot-risk methods formulate the expected utility as a function of the spot value (SV), which is an estimation of the outcome of the alternative, and a risk measure \mathcal{R} , which quantifies the risk related to the distribution of outcomes associated with every alternative. The risk attitude of the decision maker is modeled through a risk parameter β . Also, the expected utility theory is based on the *maximization* of the expected utility and consequently, the opposite spot value is considered when low values of the attribute are preferred. This is the case when the attribute is the loss. In that case, we propose to formulate the expected utility $\mathbb{E}(U(\lambda(v)))$ associated with the alternative v as:

$$\mathbb{E}(U(\lambda(v))) = -SV(\lambda(v)) - \beta \cdot \mathcal{R}(\lambda(v)) \quad (5.14)$$

where $SV(\lambda(v))$ and $\mathcal{R}(\lambda(v))$ are respectively the spot value and the risk measure associated with the alternative v . The spot value can be the mean or the median of a beneficial outcome of a given alternative. The risk measure \mathcal{R} used in this spot-risk model is generic and can be adapted to the needs and desires of the decision maker. An overview of the main risk measures found in the literature is given in the next section.

For simplifying the mathematical expressions in the rest of the work, the spot-risk measure ρ is defined as follows:

$$\rho(\lambda(v)) = SV(\lambda(v)) + \beta \cdot \mathcal{R}(\lambda(v)) \quad (5.15)$$

The alternative v^* , which is determined in the expected utility theory, is the one which minimizes the spot-risk measure ρ :

$$v^* = \arg \min_v \rho(\lambda(v)), \text{ subject to } \mathcal{C}_v \quad (5.16)$$

Stochastic dominance approach

Stochastic dominance is a term referring to a comparison technique between the distributions of the decision attributes which are relative to different alternatives [116]. This method is an alternative way for ranking the decision maker's preferences, but is not itself a decision principle such as, for instance, utility theory. More precisely, the stochastic dominance method relies on an axiomatic model of risk-averse preferences. The decision attributes are compared using performance functions constructed from their distribution functions [142]. Technically, the stochastic dominance between decision alternatives is determined in increasing orders. In particular, the Second-

order Stochastic Dominance (SSD) is based on the comparison between the double integral of the probability density functions of the attributes.

The relation between SSD and risk measures is explained in [143]. In particular, the concept of consistency between a risk measure and the SSD approach is defined as follows: a risk measure is said to be consistent with SSD if, in the case of two alternatives, the alternative which is chosen by minimizing the risk measure is the same as the one which is dominated under SSD. Further details about consistency between stochastic dominance and risk measures can be found in [143].

However, the main limit regarding stochastic dominance is the absence of consideration of the decision maker risk preferences in the method. More precisely, this method assumes that the decision maker is risk averse [116], and this method does not permit to analyze the influence of the risk attitude of the decision maker on the resulting decisions. Consequently, this decision method is not further considered in the rest of the present work.

5.2.3 Focus on risk-based methods

This section focuses on the definition of the risk which is considered in the spot-risk approach formulated in Equation 5.15 and Equation 5.16. Initially, a general definition of the concept of risk is given. Then this definition is used to derive the definition of the risk considered in this work related to the participation of renewable generation in electricity markets. The second part of this section presents an overview of the state of the art of risk measures.

Concept of risk

The concept of risk is widely used in many fields such as finance, mathematics, psychology or decision sciences. This concept highly depends on the discipline. In a general way, the notion of risk is associated with the possibility of an unfavorable outcome [118,144]. This definition shows the close relation between uncertainty and risk. In order to define more precisely the risk, a distinction between uncertainty and risk is proposed in [145]:

- The notion of **uncertainty** refers to the decision-making science, and is defined as “a state of having limited knowledge where it is impossible to exactly describe future outcome” [12]. Uncertainty is also described as the existence of more than one possibilities. A probabilistic measure of uncertainty is a set of possibilities, to which is assigned a set of probabilities.
- The **Risk** is then defined as a state of uncertainty where some of the possibilities involve a loss, catastrophe, or other undesirable outcome. A risk

measurement is a set of possibilities each with quantified probabilities and quantified losses.

From these definitions, we conclude that uncertainty without risk is possible if none of the possibilities involves a loss, but risk without uncertainty is impossible. The uncertainty measure only refers to the probabilities assigned to outcomes, while the risk measure requires both probabilities for outcomes and quantified losses for each outcome.

Risk measures

Variance The first historic risk measure was the variance or standard deviation, which was introduced by Markowitz in portfolio selection [146]. Portfolio selection discusses the general problem of the capital allocation to a large number of securities so that the investment can bring a most profitable return. Before introducing any risk measure, investors used to talk about risk, but there was no measurable term to define it. In 1952, Markowitz stated that variance could be regarded as risk. Since Markowitz, mathematical analysis on portfolio management has greatly developed, and variance has become the most popular mathematical definition of risk for portfolio selection [121, 147]. In order to obtain a risk measure which is homogeneous in terms of unity to the spot value in the spot-risk decision method, the standard deviation σ is often preferred to the variance. For a given random loss $\lambda(v)$ associated with a decision v , the risk measure \mathcal{R} based on standard deviation σ is formulated as:

$$\mathcal{R}(\lambda(v)) = \sigma(\lambda(v)) \quad (5.17)$$

The use of variance or standard deviation for estimating the risk is quite simple. However, this risk approximation has several limitations [148]. The standard deviation risk measure is based on a normal distribution hypothesis for the loss. In this case, the loss is assumed to be symmetric and the risk measure penalizes the possibility of obtaining extremely high losses as much as the possibility of obtaining extremely low losses. However, in many practical cases, the loss distributions are asymmetrical and the variance of the loss distribution becomes rather insufficient for measuring the risk associated with the loss for a given alternative.

Value at Risk

Definition Since the definition of Markowitz in 1952, advanced risk measures based on the knowledge of the possible losses have been proposed. In particular, the Value at Risk (VaR) is a measure of the risk of loss for a given portfolio of financial

assets, widely used in financial mathematics and financial risk management [149]. The Value at Risk (VaR) is defined as the minimum value of loss that will not be exceeded with an α confidence level. In other words, with respect to a specified confidence level α , the α -VaR of a portfolio is the lowest loss value l such that the probability that the loss $\lambda(v)$ exceeds l is lower than $(1 - \alpha)$:

$$\mathcal{R}_\alpha(\lambda(v)) = \alpha\text{-VaR}(\lambda(v)) \quad (5.18)$$

$$= \inf \{l \in \mathbb{R} : \text{prob}(\lambda(v) > l) \leq 1 - \alpha\} \quad (5.19)$$

$$= \inf \{l \in \mathbb{R} : \text{prob}(\lambda(v) \leq l) \geq \alpha\} \quad (5.20)$$

$$= \inf \{l \in \mathbb{R} : F_{\lambda(v)}(l) \geq \alpha\} \quad (5.21)$$

The cumulated density function $F_{\lambda(v)}$ is an increasing function and consequently, Equation 5.21 is equivalent to

$$\inf \{l \in \mathbb{R} : \text{prob}(\lambda(v) \leq l) = \alpha\} \quad (5.22)$$

which is the definition of the α -quantile of the loss distribution.

For a given loss distribution, the α -VaR depends on the confidence level α which is a parameter of the risk measure. The α -VaR is a level of loss. In a symmetric way, Roy in [150] defined a risk measure called *Probability of an Adverse Outcome (PAO)*, which is based on a level of loss l_0 as a parameter, and measures the probability to have a loss equal or greater than the accepted level:

$$PAO_{l_0} = \text{prob}(\lambda(v) \geq l_0) = 1 - \text{prob}(\lambda(v) \leq l_0) \quad (5.23)$$

$$PAO_{l_0} = 1 - F_{\lambda(v)}(l_0) \quad (5.24)$$

where $F_{\lambda(v)}$ is the cumulated density function of the loss $\lambda(v)$ associated with the decision v .

The VaR is a popular risk measure which is widely used in finance. However, the large use of this measure demonstrated that it has undesirable mathematical characteristics [151]. In particular, the VaR measure does not inform about the extent of the losses that might be suffered beyond the amount indicated by this measure. Indeed, the VaR measure provides a lowest bound for losses in the tail of the loss distribution and has a bias towards optimism instead of the conservatism that ought to prevail in risk management.

From a theoretical point of view, a risk measure can be considered as a function which gives a real number from a probability space. Such a function has to satisfy

two conditions which are *monotonicity* and *translation invariance*. The interested reader may refer to [152] for obtaining further information about these conditions.

In addition to these two properties, when considering two portfolios A and B , the *subadditivity* property states that the risk of the sum of the portfolios $A+B$ is smaller than or equal to the sum of their individual risks. This property is important when different business units calculate their risks independently and when an estimation of the total risk is required. More generally, a risk measure which satisfies the four conditions of monotonicity, translation invariance, convexity and subadditivity is defined as a *coherent risk measure* [153].

The VaR measure has a lack of subadditivity. More precisely, it is subadditive only in the case of normal distributions, when the VaR is a multiple of the standard deviation [154]. The VaR has also a lack of convexity, which can be a major handicap when trying to determine the VaR of a mix of portfolios. These limits relative to the VaR measure justify the proposition of alternative risk measures.

Conditional Value at Risk

Considering the limits of the VaR as a risk measure, Rockafellar in [151, 154] proposes the Conditional Value at Risk (CVaR). The CVaR is also denoted as expected shortfall or average VaR. For a given probability level α , the α -CVaR is defined as the conditional expectation of losses above the α -VaR:

$$\mathcal{R}_\alpha(\lambda(v)) = \alpha\text{-CVaR}(\lambda(v)) \tag{5.25}$$

$$= \mathbb{E}(\lambda(v) : \lambda(v) \geq \alpha\text{-VaR}) \tag{5.26}$$

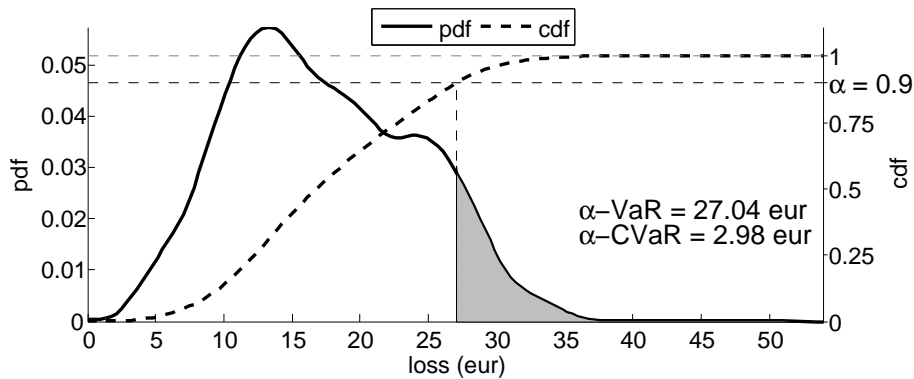

Figure 5.2: Illustration of the α -VaR and α -CVaR for a given loss distribution.

The definition of the α -VaR and α -CVaR is illustrated in Figure 5.2. The prob-

ability density function f_λ of a given random loss λ is plotted in plain line and the corresponding cumulative density function F_λ is plotted in dash line. The α -VaR value is determined from the F_λ function and the α -CVaR is derived as the measure of the grey area under the f_λ function.

Other formulas for CVaR may be operationally more convenient in some situations [151]. For example, the CVaR can be formulated as follows:

$$\alpha\text{-CVaR}(\lambda(v)) = \frac{1}{1-\alpha} \int_\alpha^1 \beta\text{-VaR}(\lambda(v)) d\beta \quad (5.27)$$

The CVaR may also be formulated as the result from a minimization:

$$\alpha\text{-CVaR}(\lambda(v)) = \arg \min_{l \in \mathbb{R}} \{l + (1-\alpha)^{-1} \mathbb{E}[\max\{0, \lambda(v) - l\}]\}, \quad (5.28)$$

More precisely, Equation 5.28 show that the CVaR calculation can be formulated as an expectation-based problem with additional variables. As a consequence, several properties of expectation-based stochastic programs remain valid when the CVaR risk measure is used. Most of these results are essentially based on the linearity of the expected value operator \mathbb{E} . From a more theoretical point of view, the CVaR is an example of a polyhedral risk measure, where polyhedral risk measures are defined as optimal values of linear stochastic programs [155].

Also, for a given loss $\lambda(v)$, α -CVaR is a continuous function of $\alpha \in [0, 1]$, with:

$$\lim_{\alpha \rightarrow 1} \alpha\text{-CVaR}(\lambda(v)) = \sup(\lambda(v)) \quad (5.29)$$

$$\lim_{\alpha \rightarrow 0} \alpha\text{-CVaR}(\lambda(v)) = \mathbb{E}(\lambda(v)) \quad (5.30)$$

Multistage Risk measures

The different risk measures described in the previous paragraphs consider the risk associated with a loss $\lambda(v)$ relative to a single decision v . The loss $\lambda(v)$ is a random variable itself. However, for multistage stochastic problems, the above definitions might not be sufficient. For such problems, it is necessary to define multistage or multiperiod risk measures, which evaluate the risk relative to consecutive decisions. The n consecutive decisions are denoted as $[v_{T_1}, v_{T_2}, \dots, v_{T_n}] = [v_{T_i}]_{i=1}^n$ and the multistage risk measure \mathcal{R}_α gives the risk relative to the loss associated with the n decisions $[\lambda_{T_1}(v_{T_1}), \lambda_{T_2}(v_{T_2}), \dots, \lambda_{T_n}(v_{T_n})] = [\lambda_{T_i}(v_{T_i})]_{i=1}^n$

The polyhedral risk measure class is extended to the multistage case in [155]. An example of a multistage polyhedral risk measure is the weighted sum of the CVaR

values relative to each period:

$$\mathcal{R}_\alpha([\lambda_{T_i}(v_{T_i})]_{i=1}^n) = \sum_{i=1}^n \gamma(i) \alpha\text{-CVaR}(\lambda_{T_i}(v_{T_i})) \quad (5.31)$$

where $\gamma(i)$ is a positive weight relative to the period T_i , and α is the confidence level associated with the risk measure \mathcal{R}_α . A first basic approach is to consider a constant weight for all periods: $\gamma(i) = \frac{1}{n}$. More advanced approaches for the determination of the weight $\gamma(i)$ are proposed in [156].

5.3 Formulation of a risk-based approach for the management of renewable generation in electricity markets

The aim here is to apply the general risk-based approach presented in the previous section, to the management of the uncertainties related to the renewable power generation and to the market prices, which have been described in the first section of the chapter. The methodology proposed in this section is presented through the concept of risk management, which is explained into detail for our specific problem.

5.3.1 Concept of risk management

The concept of *risk management*, relative to a given entity, comes from the finance area and defines a process which can be divided into four different general steps, as proposed in [157]. Each of these steps is presented below while reference to our specific problem is made.

- The first step is the definition of the risks incurred by a given actor. This definition also determines which loss is considered for the given risk, and also the time frame relative to the risk management process. In our specific problem, the risk is related to the imbalance penalty for an Independent Power Producer (IPP) including RES power units, who participates as a balance responsible party in short-term electricity markets. Further details about the definition of the risk associated with imbalance penalty, the considered time frame, and the associated loss, are given in the next section.
- The second step of the general risk management process focuses on the quantification of the risk. Also, at this stage, the different solutions for reducing this risk are reviewed. The reduction of risk relative to each solution is quan-

tified, based on a specific risk measure. The existing solutions for reducing the risk are called **hedging solutions**.

In our problem, the risk is modeled using the generic loss function λ derived in the previous chapter 4. Based on this loss function, a probabilistic prediction of the loss is derived using probabilistic forecasts of both the delivered energy and the market prices. Such loss also depends on the financial or physical solutions which are used. These solutions are considered as the hedging solutions of the problem. Then, the risk is measured from the loss distribution using explicit risk measures, defined in section 5.2.3.

- The next step in risk management is the decision step about the hedging solutions. The decisions (U, V) relative to the use of a physical or financial solutions are made using a spot-risk approach, where the attitude of the decision maker towards risk is considered through a risk parameter β .
- Finally, the last step is the evaluation of the risk management approach. This corresponds to the two last sections of the chapter. The risk management is illustrated in the case of the physical solution which consists in the storage combination. The benefits from the application of the risk-based approach for the participation of wind generation in a day-ahead market are also presented.

The term of “hedging solution” is taken from the financial domain, where it designates generic contracts which are designed for transferring the financial risks between participants [158–160]. They can be sophisticated financial products, and are mainly based on forward contracts, swap contracts or options. In this work, the concept of hedging is extended to both the physical and financial solutions, which have been formulated in chapter 3. Such generalization is justified by the conclusion given in chapter 3 that the impact of both physical and financial solutions can be modeled in a similar way when considering the imbalance penalty model given by the function δ . Similar considerations can also be found in the literature, such as in [160] or [108].

5.3.2 Details about the considered risk

Focus on the quantity-price risk

The concept of risk considered is the one defined in section 5.2.3 where the risk is defined as a state of uncertainty where some of the possibilities involve a loss. In section 5.1.1, two main sources of uncertainty have been described: the renewable generation and the electricity market prices. Consequently, these two sources of uncertainty result in two types of risk:

- The *quantity risk* results from the penalization of the uncertainty associated with the renewable generation output. The quantity risk is also called volumetric risk [161]. The same concept of volumetric risk for a conventional power producer is presented in [162], and is related to plant outage or fuel shortages. In [163], the quantity risk is related to the uncertain wind power generation, and is estimated through a measure called “WindGen at Risk”, which is based on the concept of the Value at Risk measure. In the example, this risk is used for the integration of the wind resource capacity into unit commitment scheduling.
- The *price risk* results from the uncertainty related to the market prices. In general, fluctuating market prices in electricity pools lead to financial risks for power producers [158, 164]. In the particular case of the risk related to imbalance penalties, the IPP is sensitive to the uncertainty related to the penalty price Π^Δ , which is defined in Equation 5.9. Such price is the difference between two volatile prices, and can reach extreme values, the occurrence of which is hard to forecast. Also, the sign of Π^Δ depends on the regulation state of the TSO, which is also hard to forecast. These characteristics lead to a high uncertainty about Π^Δ , which in turn leads to a high price risk.

Finally, the risk considered in the present work can be denoted as a “quantity-price” risk, which is a combination between the quantity risk and price risk concepts. However, it is important to note that many other kinds of risk are related to the participation in an electricity market. These risks include counter-party credit risks, transaction risks, regulatory risks, operational risks and liquidity risks [157, 165]. Also, for renewable power producers, the income from energy trading in electricity markets may vary as a result of the varying resource. Such variation, which is mainly seasonal, could represent a risk for the renewable power unit operator in terms of cash flow. However, this risk is not considered in this work. The only risk we consider here is the one associated with the imbalance penalties in the case of direct participation of renewable generation in liberalized electricity markets.

Discussion about the relation between the risk and the time frame

The risk considered in the proposed decision-making approach is related to the extreme imbalance penalties for a given market time unit. If the market time unit is one hour, the risk thus focuses on extreme values of hourly imbalance penalties. Also, such extreme penalties are partly due to “spike” occurrences in market price time series, which are steep increases shortly followed by steep decreases. The resulting extreme imbalance penalties may thus occur for very short periods, in the order of a few hours.

period	mean(δ) (€)	$q^{95}(\delta)$ (€)	$q^{95}(\delta)/\text{mean}(\delta)$
1 hour	7	34	5.0
1 day	166	637	3.8
1 week	1162	2960	2.5

Table 5.1: Analysis of the extreme imbalance penalty time series, for various temporal resolutions. In this example, the imbalance penalties result from the participation of a wind farm in a day-ahead market for the period between 01/10/2003 and 30/06/2004.

As a consequence, the extreme imbalance penalties will be smoothed out when a longer time period is taken for the quantification of extreme penalties. Table 5.1 presents the analysis of extreme imbalance penalty values obtained during the simulation period between 01/10/2003 and 30/06/2004. These imbalance penalties are the ones obtained for the reference case of all the examples of this thesis, which is the participation of a 18 MW wind farm in the Elspot day-ahead market. The q^{95} presents the 95%–quantile of the distributions of the hourly, daily and weekly imbalance penalty δ . This quantity gives an estimate of extreme values. Table 5.1 shows that the extreme penalty values, relatively to the mean values, decrease as the temporal resolution decreases.

The relation between risk and time frame is important for the definition of the risk sensitivity factor β relative to the spot-risk approach in Equation 5.15. In the present thesis, the IPP is supposed to be sensitive to the risk relative to hourly imbalance. However, the market bidding decisions are hourly decisions, which are repeated a large number of times, and this high number of decisions may reduce to risk sensitivity of the IPP.

5.3.3 Modeling of the quantity-price risk

The risk definition in section 5.2.3 highlights the fact that the concept of risk is based on a given loss. In this section, we formulate the risk related to a given decision v_{T_i} for the market time unit T_i . The associated loss is modeled through the generic loss function λ_{T_i} derived in the previous chapter. Note that similarly to section 5.2.2, the decision v_{T_i} considered is relative to a physical hedging solution, but the formulation would be similar in the case of a financial decision u_{T_i} . Also, similarly to section 5.2.2, the formulation of the loss is simplified by setting $\lambda_{T_i}(0, v_{T_i}) = \lambda_{T_i}(v_{T_i})$. This loss is given by considering only the case of physical solution in the generic loss formulation given in Equation 4.8:

$$\lambda_{T_i}(v_{T_i}) = \widehat{\delta}_{S_y, T_i}^{\text{DA}}(\widehat{E}_{T_i|t_d}, E_{T_i}^{\text{DA}}) = Y(\tilde{v}_{T_i}) + \widehat{\delta}_{T_i}^{\text{DA}}\left(\widehat{E}_{T_i|t_d} + y(\tilde{v}_{T_i}), E_{T_i}^{\text{DA}}\right) \quad (5.32)$$

where \tilde{v}_{T_i} is the realization associated with the decision v_{T_i} . $\hat{E}_{T_i|t_d}$ is the forecast of the energy delivered for the period T_i , available at the decision time t_d . $E_{T_i}^{\text{DA}}$ is the day-ahead energy contract relative to the period T_i . $Y(\tilde{v}_{T_i})$ is the additional cost associated with the physical solution and $y(\tilde{v}_{T_i})$ is the energy balance provided by the physical solution.

By considering the definition of the price Π^Δ given in Equation 5.9, the estimated reference imbalance penalty function $\hat{\delta}^{\text{DA}}$ can be reformulated as:

$$\hat{\delta}_{T_i}^{\text{DA}}(\hat{E}_{T_i|t_d}, E_{T_i}^{\text{DA}}) = \max\left(0, (\hat{E}_{T_i|t_d} - E_{T_i}^{\text{DA}}) \times \hat{\Pi}_{T_i|t_d}^\Delta\right) \quad (5.33)$$

The details about such reformulation are given in section C.3.1. Also, based on this reformulation, Equation 5.32 can be rewritten as:

$$\lambda_{T_i}(v_{T_i}) = Y(\tilde{v}_{T_i}) + \max\left(0, (\hat{E}_{T_i|t_d} + y(\tilde{v}_{T_i}) - E_{T_i}^{\text{DA}}) \times \hat{\Pi}_{T_i|t_d}^\Delta\right) \quad (5.34)$$

This formulation shows that the loss $\lambda_{T_i}(v_{T_i})$ associated with the decision v_{T_i} depends on both the energy forecast $\hat{E}_{T_i|t_d}$ and the price forecast $\hat{\Pi}_{T_i|t_d}^\Delta$. In a similar way, in the case of a financial decision u_{T_i} , the loss would be:

$$\lambda_{T_i}(u_{T_i}) = Y(\tilde{u}_{T_i}) + \max\left(0, (\hat{E}_{T_i|t_d} - (E_{T_i}^{\text{DA}} + y(\tilde{u}_{T_i}))) \times \hat{\Pi}_{T_i|t_d}^\Delta\right) \quad (5.35)$$

In the case of deterministic power and price forecasts, the quantities $\hat{E}_{T_i|t_d}$ and $\hat{\Pi}_{T_i|t_d}^\Delta$ are real numbers estimating the value of the delivered energy and market price for the given period T_i . Consequently, the estimated loss $\lambda_{T_i}(v_{T_i})$ is also a real value. However, in the case of probabilistic power and price forecasts, the quantities $\hat{E}_{T_i|t_d}$ and $\hat{\Pi}_{T_i|t_d}^\Delta$ include additional information about uncertainty. In the present formulation, these two quantities are random values, and their distribution is supposed to be given by probability density function (pdf), namely \hat{f}_E and \hat{f}_{Π^Δ} . These pdfs are in this work predictive pdfs which are obtained using probabilistic forecasting method.

Then, in the probabilistic case, the loss $\lambda_{T_i}(v_{T_i})$ is a function of two random variables $\hat{E}_{T_i|t_d}$ and $\hat{\Pi}_{T_i|t_d}^\Delta$, and is consequently also a random variable. The technique developed in the frame of this thesis for deriving the loss pdf $f_{\lambda(v)}$ from the two pdf \hat{f}_E and \hat{f}_{Π^Δ} is presented in appendix D.

Then, the risk associated with the decision v_{T_i} can be estimated by considering one of the risk measures presented in section 5.2.3. For example, if we consider the conditional value at risk (CVaR), the risk is given by:

$$\mathcal{R}_\alpha(\lambda_{T_i}(v_{T_i})) = \alpha\text{-CVaR}(\lambda_{T_i}(v_{T_i})) \quad (5.36)$$

5.3.4 Formulation of the spot-risk decision-making method

In the previous chapter, the general decision-making problem has been formulated as an optimization problem in Equation 4.10. In particular, the decision-making problem relative to n consecutive physical decisions $V = [v_{T_1}, v_{T_2}, \dots, v_{T_n}]$ is formulated on the basis of Equation 4.10 as following:

$$V^* = \arg \min_V \mathcal{N} \left([\lambda_{T_i}(0, v_{T_i})]_{i=1}^n \right), \text{ subject to } \mathcal{C}_V \quad (5.37)$$

where \mathcal{N} is the norm associated with the decision-making problem, as detailed in section 4.3.5, and $\lambda_{T_i}(0, v_{T_i})$ is the estimated loss for the decision v_{T_i} . Hereafter, for sake of simplicity, it will be set $\lambda_{T_i}(0, v_{T_i}) = \lambda_{T_i}(v_{T_i})$. This formulation is valid if the loss $\lambda_{T_i}(v_{T_i})$ is a real value. However, in the probabilistic case, this loss is a random variable which is estimated through its pdf, as explained in the previous section.

From the overview of the state of the art of decision-making methods under uncertainty proposed in section 5.2.2, it appears that the spot-risk approach which is the most appropriated one to our problem. In fact, this method is a generalization of the expected value method, which corresponds to a neutral risk attitude (i.e. $\beta = 0$) in the spot risk approach. Also, the spot-risk method does not rely on a complex utility function which is hard to derive. Moreover, this approach considers as input a probabilistic representation of the loss associated with a given decision, which is consistent with the available renewable generation probabilistic forecast. Finally, the justification of the choice of this approach will become even more evident later in the discussion. Based on this analysis, we propose to use a **spot-risk approach** for considering the uncertainty relative to the loss in the decision-making problem. This approach has been presented in section 5.2.2, and is based on a spot-risk function ρ given from Equation 5.15:

$$\rho(\lambda_{T_i}(v_{T_i})) = SV(\lambda_{T_i}(v_{T_i})) + \beta \cdot \mathcal{R}(\lambda_{T_i}(v_{T_i})) \quad (5.38)$$

In the present formulation, the ‘‘spot’’ estimation (SV) of the loss is taken to be the expected value \mathbb{E} . Also, the considered risk measure (\mathcal{R}) is the Conditional Value at Risk relative to the confidence level α (α -CVaR). The parameter β models the decision maker attitude towards risk. It is assumed that the risk attitude is the same for consecutive decisions, thus, β is taken to be constant. Consequently, the generic decision-making problem formulated in Equation 5.37 can be rewritten as following,

for a physical solution:

$$V^* = \arg \min_V \mathcal{N} \left(\left[\mathbb{E} (\lambda_{T_i}(v_{T_i})) + \beta \cdot \alpha\text{-CVaR} (\lambda_{T_i}(v_{T_i})) \right]_{i=1}^n \right) \quad (5.39)$$

subject to \mathcal{C}_V

and straightforwardly, it can be written as following for a financial solution:

$$U^* = \arg \min_U \mathcal{N} \left(\left[\mathbb{E} (\lambda_{T_i}(u_{T_i})) + \beta \cdot \alpha\text{-CVaR} (\lambda_{T_i}(u_{T_i})) \right]_{i=1}^n \right) \quad (5.40)$$

subject to \mathcal{C}_U

This formulation relies on the risk management concept, which is illustrated in the next section, for the physical solution based on storage combination. Finally, the last section of this chapter illustrates the benefits from this risk-based method for the participation of wind generation in a day-ahead market.

5.4 Hedging imbalance penalty risk through combination of renewables with storage

This section analyzes the risk hedging in the case of the combination of a wind farm with a storage device. Such combination is considered as a physical solution for the management of the imbalance penalties related to the participation of the wind farm itself in the day-ahead electricity market. This specific physical solution has already been modeled in section 4.6, where the decision-making problem relative to the strategic scheduling of the storage unit was presented. The loss relative to the scheduling decision was estimated from deterministic forecasts; no information on uncertainty was considered and consequently, the risk was not taken into account.

Here, the distribution of the loss relative to the scheduling decision is estimated from probabilistic forecasts of the wind generation and market prices. Initially, the general method for the derivation of the loss function given in section 5.3.3 is applied to the specific physical solution. Then the influence of the risk attitude of the decision-maker on the resulting decisions is analyzed.

5.4.1 Derivation of the specific loss function relative to the storage combination

In the study presented in section 4.6, the scheduling decision consisted in n consecutive setpoints for the storage state-of-charge (SOC) level. However, here we focus on the scheduling decision for a given single market time unit, and consequently, the decision v is relative to the energy output E_{st} from the storage device during this

market time unit: $v = E_{st}$. The index T_i for the time unit is omitted hereafter for sake of simplicity. Also, the actual energy delivered by the storage device, which is the realization \tilde{v} associated with the decision v , is supposed to be equal to the decision. This consists in considering the scheduling decision about the storage energy output E_{st} directly as a setpoint for the operation of the storage device, which gives:

$$\tilde{v} = \tilde{E}_{st} = E_{st} = v \quad (5.41)$$

where \tilde{E}_{st} is the energy which is really delivered by the storage unit. Then, the loss $\lambda(E_{st})$ is derived from Equation 5.34:

$$\lambda(v) = \lambda(E_{st}) = Y(E_{st}) + \max\left(0, \left(\hat{E}_{wf} + y(E_{st}) - E^{\text{DA}}\right) \times \hat{\Pi}^{\Delta}\right) \quad (5.42)$$

The quantities $Y(E_{st})$ and $y(E_{st})$ have been defined in section 4.6.2, and more precisely from Equation 4.50 and Equation 4.51, as:

$$Y(E_{st}) = |E_{st}| \times \frac{1 - \eta}{1 + \eta} \times \Pi^{\text{DA}} \quad (5.43)$$

$$y(E_{st}) = E_{st} \quad (5.44)$$

where η is the round trip efficiency of the storage unit. In this application, the decision about the storage schedule is determined after the day-ahead trading decision, similarly to section 4.6, and consequently, the day-ahead market price Π^{DA} and the energy volume E^{DA} are known values in this problem since .

The probabilistic forecast of the wind generation \hat{E}_{wf} is given in the form of a predictive probability density function (pdf), which is denoted as $\hat{f}_{E_{wf}}$. Also, the price forecast $\hat{\Pi}^{\Delta}$ is taken as a discrete distribution as explained in Equation 5.10.

The price forecast is supposed to be independent from wind generation forecast. Then, the pdf of the loss $\lambda(E_{st})$ is denoted as $f_{\lambda(E_{st})}$, and is obtained from the technique proposed in the appendix section D.3. The formulation of $f_{\lambda(E_{st})}$ is more precisely obtained from the application of the general solution given in Equation D.17 with $a = Y(E_{st})$ and $b = E^{\text{DA}} - E_{st}$, which gives:

$$f_{\lambda(E_{st})}(z) = A \cdot d(z - Y(E_{st})) + B \cdot \hat{f}_E(\gamma_{\hat{\Pi}_{\Delta}^{-}}^{-, -1}(z)) + C \cdot \hat{f}_E(\gamma_{\hat{\Pi}_{\Delta}^{+}}^{+, -1}(z)) \quad (5.45)$$

The quantities A , B and C are detailed in section D.3. The functions $\gamma_{\hat{\Pi}_{\Delta}^{-}}^{-}$ and $\gamma_{\hat{\Pi}_{\Delta}^{+}}^{+}$

are defined on the intervals I_{wf}^- and I_{wf}^+ respectively, with:

$$I_{wf}^- = [0, E^{DA} - E_{st}] \quad \text{and} \quad I_{wf}^+ = [E^{DA} - E_{st}, E_{wf}^{max}] \quad (5.46)$$

This formulation of the loss pdf given in Equation 5.45 is valid for every storage output energy E_{st} lower than the maximum storage output energy E_{st}^{max} and greater than the minimum one E_{st}^{min} . These boundaries are determined by the technical constraints of the storage device. Finally, the results of the application of this formulation for the case study considered in this thesis are illustrated in the next section.

5.4.2 Results: Analysis of the influence of the risk attitude on the decisions

The wind farm considered in this case study is the reference wind farm taken for all the previous case studies. It is a 18 MW wind farm located in Western Denmark. It is assumed to be combined with a 30 MWh capacity pumped-hydro storage unit. The storage charging and discharging nominal rate r_{ch}^{nom} and r_{dis}^{nom} are taken equal to -6 MWh/h and 6 MWh/h respectively. The storage round-trip efficiency is taken equal to 75 %.

The results are obtained using real world data. The considered time period is between 11h00 and 12h00 the 22/12/2003. The wind farm operator is supposed to have participated the day before, the 21/12/2003, in the Elspot day-ahead market, and the resulting contract for this period is a 10.7 MWh energy contract at 29.84 €/MWh. Such contract results from the day-ahead bid established the day before using wind power forecasts available at that time.

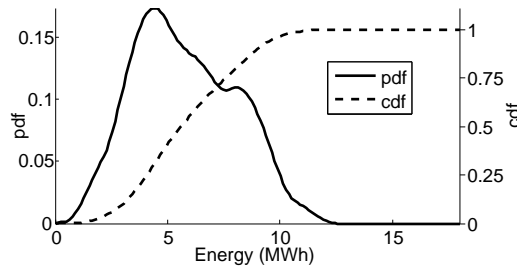

Figure 5.3: Probabilistic wind power forecast obtained from a KDE method, for the period between 11h00 and 12h00 the 22/12/2003.

In the example, the storage operation is scheduled from updated wind power probabilistic forecasts, which are obtained from a method based on kernel density estimator (KDE). This method aims at directly estimating the future conditional

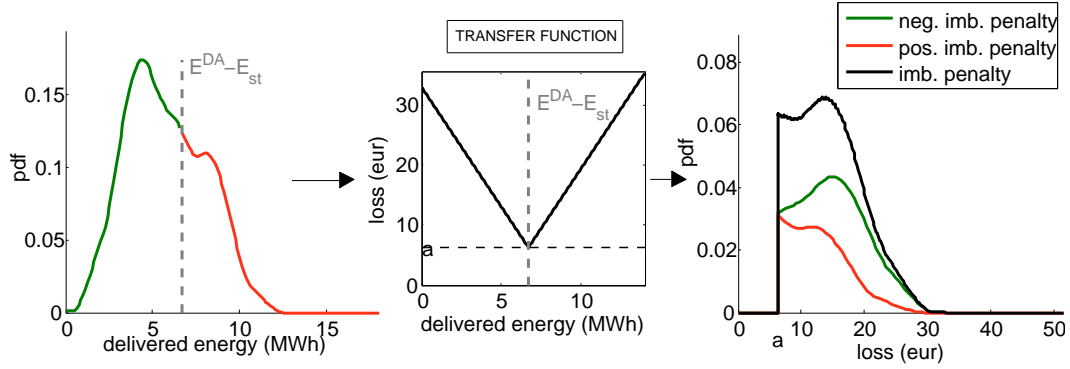

Figure 5.4: Estimation of the loss distribution from the delivered energy distribution.

probability density functions of the variable to be predicted based on a kernel density estimator. Such estimator computes a smooth density estimation from data samples by placing on each sample point a function representing its contribution to the density. The distribution is then obtained by summing all these contributions. The model is presented in detail in [129,166]. Figure 5.3 illustrates the forecasted probability density function and the cumulated density function for the time period between 11h00 and 12h00 on 22/12/2003. This forecast was issued at 06h00 on 22/12/2003. From the pdf curve, it can be observed that the obtained probabilistic forecast is non-symmetric. The mean wind power generation forecast is 5.77 MWh.

The price forecasts $\hat{\Pi}^\Delta$ are obtained by considering the reference constant forecasting approach proposed in section C.4.1. In this application, we assume equal positive and negative imbalance penalization:

$$\hat{\Pi}^\Delta = \begin{cases} \left(\hat{\Pi}^\Delta = -10 \text{ €/MWh}, \alpha_- = 0.40 \right) \\ \left(\hat{\Pi}_o^\Delta = 0 \text{ €/MWh}, \alpha_o = 0.20 \right) \\ \left(\hat{\Pi}_+^\Delta = 10 \text{ €/MWh}, \alpha_+ = 0.40 \right) \end{cases} \quad (5.47)$$

Figure 5.4 illustrates the application of Equation 5.45 to estimate the loss distribution. This figure more precisely shows the “transfer” from the energy distribution represented by its pdf \hat{f}_E , to the loss distribution represented by its pdf $f_{\lambda(E_{st})}$. The energy delivered by the storage is in this example 4 MWh. The left graph describes the predictive pdf of the wind generation, which is identical to the one presented in Figure 5.3. A distinction is made between the part of the distribution that corresponds to wind energy values lower than $b = (E^{\text{DA}} - E_{st}) = 6.7$ MWh, in green, and higher, in red. The green values coincide with the interval I_{wf}^- , defined in Equation 5.46, and correspond to cases of negative energy imbalance. By contrast,

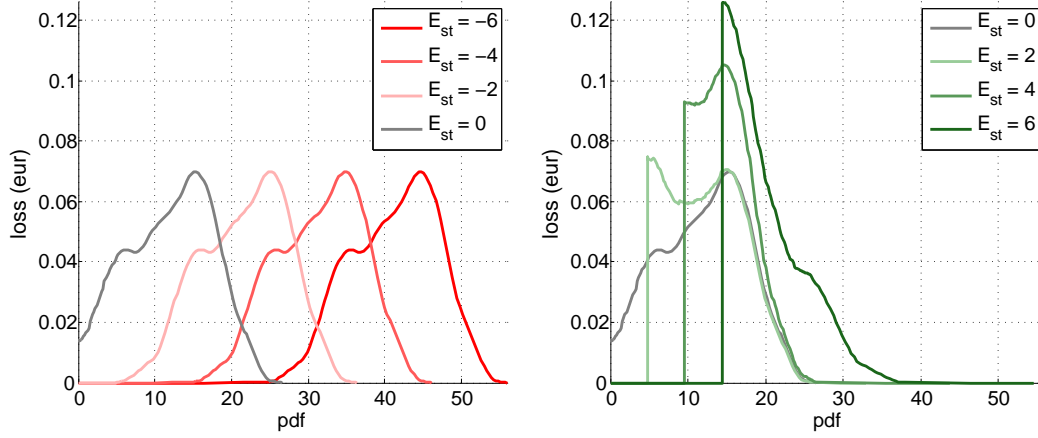

Figure 5.5: Influence of the delivered energy from storage E_{st} on the loss distribution. (left) situations when storage is charging. (right) situations when storage is discharging.

the red values coincides with the interval I_{wf}^+ , also defined in Equation 5.46, and correspond cases of positive energy imbalance.

The center graph represents the loss function based on its formulation given in Equation 5.42. As shown in the figure, it has the role of a *transfer function*. The wind generation forecast is the input. The energy imbalance between the forecasted energy and the energy quantity b is penalized by the price $\alpha_- \cdot \hat{\Pi}_-^\Delta$ or $\alpha_- \cdot \hat{\Pi}_+^\Delta$ depending on the sign of the imbalance. The constant cost $a = Y(E_{st})$ corresponding to the storage energy losses is also represented.

Finally, the right graph represents the loss distribution, derived from Equation 5.45. The three terms of Equation 5.45 are represented: the Dirac corresponding to the loss value $a = Y(E_{st})$ is illustrated by the “jump” of the distribution. This term is the first one of Equation 5.45. The penalty for negative energy imbalance, corresponding to the interval I_{wf}^- for the wind generation forecast, is plotted in green. This term is the second one of Equation 5.45. The penalty for positive energy imbalance, corresponding to the interval I_{wf}^+ for the wind generation forecast, corresponds to the third term of Equation 5.45 and is plotted in red. Finally, the loss distribution is the sum of these three terms, and is plotted in black.

It is of interest to assess the influence of the energy delivered by the storage device E_{st} on the loss distribution. In Figure 5.5, the left graph describes cases when the storage device is charged and the right one describes discharge cases, for the same time unit of simulation. The grey plot on both graphs corresponds to the reference case where no energy is delivered or absorbed by the storage unit. From cases when storage is charging, it is observed that the loss distribution is shifted to higher values, without any modification of its shape. In the discharging case,

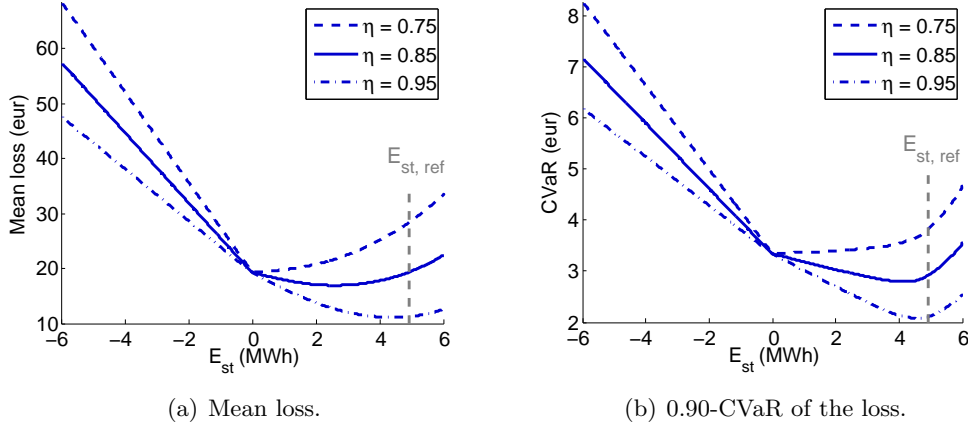

Figure 5.6: Mean and 0.90-CVaR of the loss distribution resulting from the delivered energy by the storage E_{st} .

the loss distribution is shifted to higher values of loss, but the resulting distribution width is reduced. For both cases, such shift is the illustration of the constant cost added by the storage operation. This cost is derived in Equation 5.43; it is a linear function of the absolute value of the storage energy E_{st} , which explains the shift to higher values of loss for high charging or discharging values. The width reduction of the loss distribution illustrates the reduction of imbalance penalties, which results from the energy imbalance decrease. In the example, the day-ahead contract energy is 10.7 MWh, and the mean of the forecast of the energy delivered by the wind farm is 5.77 MWh. The storage energy which minimizes the mean energy imbalance is denoted by the reference storage energy $E_{st,ref}$, and is given by:

$$E_{st,ref} = E^{DA} - \mathbb{E}(\hat{E}_{wf}) = 4.93 \text{ MWh} \quad (5.48)$$

If for that time unit, the storage device is charging, then the absolute energy imbalance, and consequently the loss, will increase. Conversely, if the storage device is discharging, then the absolute energy imbalance will be reduced, and the loss width distribution will be reduced as well. The mean and the risk measure relative the loss distributions shown in Figure 5.5 are detailed in the next figure.

Figure 5.6(a) describes the variation of the mean of the loss distribution for different values of energy E_{st} delivered by the storage device. In order to better understand the impact of the storage round-trip efficiency η , three different values of round-trip efficiency are considered $\eta = 0.75, 0.85$ and 0.95 . For negative values of E_{st} , the shift to higher values of loss observed in Figure 5.5 corresponds to an increase of the mean loss, for the three cases of efficiency. However, for positive

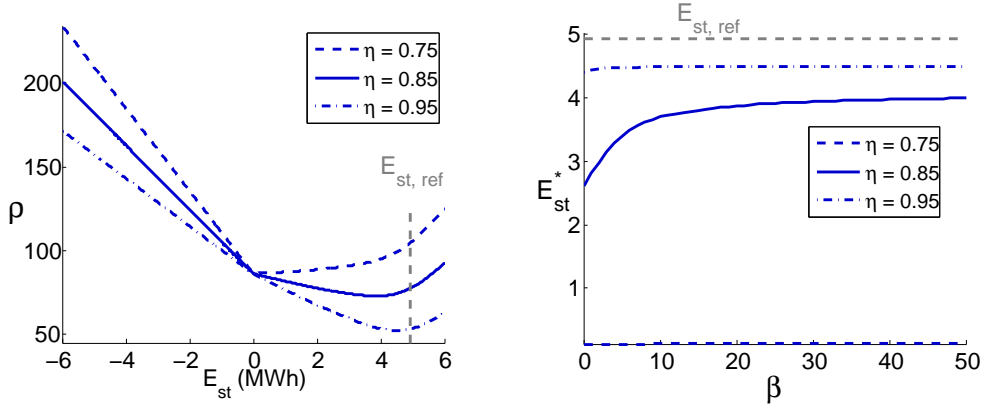

(a) Example of spot-risk measure ρ , with $\beta = 20$. (b) Storage energy which minimizes the spot-risk measure ρ .

Figure 5.7: Influence of the consideration of the risk in the decision relative to the energy delivered by the storage device.

storage energy, the variation of the mean loss depends on the efficiency value. In the case of low efficiency ($\eta = 0.75$), the cost resulting from the storage energy losses, modeled in the quantity $Y(E_{st})$, is higher than the reduction of imbalance penalty. Consequently, the mean loss increases as the storage energy increases and the minimum mean loss is reached when no energy is delivered from the storage unit. As the storage efficiency increases, the mean loss is reduced. Also, the value of storage energy which leads to the minimum mean loss gets higher as the storage efficiency gets higher, and is bounded by $E_{st,ref}$ defined in Equation 5.48. Most of the analyses regarding the mean loss remain valid for the risk measure, in figure 5.6(b). The α -CVaR is the risk measure; it is evaluated from each distribution by applying Equation 5.26, with $\alpha = 0.90$. The main point to notice is that the value of E_{st} which minimizes the CVaR gets higher as the storage efficiency increases. For example, the storage value E_{st} which minimizes the CVaR is close to 0 MWh when $\eta = 0.75$, this value is close to $E_{st,ref}$ when $\eta = 0.95$.

Figure 5.7 describes the impact of the consideration of the risk on the decision relative to the energy delivered by the storage device. The decision is made using a *spot-risk* approach already described in section 5.2.2. More precisely, the storage energy is determined as follows:

$$E_{st}^* = \arg \min_{E_{st}} \rho(\lambda(E_{st})), \text{ subject to } \mathcal{C}_{st} \quad (5.49)$$

with

$$\rho(\lambda(E_{st})) = \mathbb{E}(\lambda(E_{st})) + \beta \cdot \alpha\text{-CVaR}(\lambda(E_{st})) \quad (5.50)$$

and \mathcal{C}_{st} is the set of constraints modeling the technical limits of the storage device. In this example, we assume that there are no limits imposed by the minimum or maximum SOC for this given market time unit. The only constraints thus come from the charging and discharging nominal rates, which gives:

$$\mathcal{C}_{st} : \quad r_{ch}^{nom} \leq E_{st} \leq r_{dis}^{nom} \quad (5.51)$$

$$-6 \text{ MWh/h} \leq E_{st} \leq 6 \text{ MWh/h} \quad (5.52)$$

In this example, the parameter α for the risk measure is taken equal to 0.90. β is the parameter which models the importance which is given to the risk in the decision-making. The range of value for β is determined so that the two terms of Equation 5.50 are of the same order. The risk is not considered when $\beta = 0$.

Figure 5.7(a) gives one example of the function $\rho(E_{st})$ with $\beta = 20$. This figure results from the combination of the two plots from Figure 5.6. In this example, for $\eta = 0.85$, the minimum spot-risk value is reached for $E_{st}^* = 3.84$ MWh. Figure 5.7(b) gives the influence of β on the quantity E_{st}^* . The three cases of efficiency lead to three different decisions. For low value of efficiency $\eta = 0.75$, the energy storage value which minimizes the spot-risk is nearly independent from the risk parameter β and is close to 0 MWh. It can be explained from Figure 5.6 where the storage energy which minimizes both mean value and CVaR is close to 0 MWh. Also, for high efficiency ($\eta = 0.95$), the value which minimizes the spot-risk measure is nearly independent from the risk parameter β and is close to $E_{st,ref}$. However, for $\eta = 0.85$, the optimal storage value E_{st}^* highly depends on β . E_{st}^* is close to 2.7 MWh for $\beta = 0$, and rapidly increases as β increases. In other words, the consideration of the risk in the decision-making method leads to a higher storage energy schedule E_{st} . In this example, the energy delivered by the storage is considered as a method for preventing from extreme values of loss.

Finally, three main concluding remarks can be formulated from this example based on the combination of a wind farm with a storage unit: first, this example permits to understand the formulation of the loss, which has been proposed in a generic way in the previous section, especially with the graphical illustration given in Figure 5.4. Also, this example clearly demonstrates the risk **hedging** provided by the storage device: the energy delivered by the storage unit reduces the risk related to imbalance penalties. Finally, the influence of the risk parameter β on the resulting decision has been analyzed. In this case, a risk averse attitude (i.e. high

values of β) leads to higher values of energy delivered by the storage for reducing the risk of imbalance penalty.

5.5 Application: risk-based trading of wind generation in day-ahead electricity markets

This section presents the benefits from the application of the generic risk-based method formulated in Equation 5.40 to the particular case of trading wind generation in a day-ahead electricity market. More precisely, the spot-risk approach is used to determine the optimal energy bid from probabilistic wind power forecasts. The imbalance penalties resulting from such advanced method are compared to the imbalance penalties obtained when no information about uncertainty associated with the wind generation is available.

5.5.1 Main hypotheses

This case study is the follow-up of the case study presented in section 4.4.5. We recall that the independent power producer (IPP) is assumed to be operating a wind farm and to trade the whole electricity production to the day-ahead market. The IPP is also assumed to participate as a price taker party, which means that the bids proposed by the IPP are price independent bids, with a zero price. Consequently, the bidding decision only consists in the quantity bid. Further details about the price taker hypothesis are given in section 2.2.4.

The quantity bid the IPP proposes to the market for a given market period T_i is denoted as $E_{T_i}^{BDA}$. Also, similarly to the case study in section 4.4.5, the general bidding decision for the n consecutive market periods covering the following day is simplified to n independent decision-making problems relative to a single market period. The following formulation is valid for any market time unit T_i of the trading period. However, for simplifying the mathematical expressions, the index T_i is omitted.

5.5.2 Formulation of the risk-based decision-making method in the case of day-ahead trading

Similarly to the approach followed in section 4.4, the derivation of the specific spot-risk approach from the generic formulation is based on the specificities of the present decision-making problem. The decision in the case of day-ahead trading is a financial decision $u = E^{BDA}$. Then, the spot-risk approach for the day-ahead trading is a particular case of the generic formulation relative to financial decisions V in

Equation 5.40. Also, the decision is relative to only one market time unit, which corresponds to $n = 1$ in Equation 5.40. The norm \mathcal{N} is the identity function. Based on these hypotheses, the optimal bid quantity $E^{B_{DA},*}$ is derived from Equation 5.40:

$$E^{B_{DA},*} = \arg \min_{E^{B_{DA}}} (\mathbb{E} (\lambda(E^{B_{DA}})) + \beta \cdot \alpha\text{-CVaR} (\lambda(E^{B_{DA}}))) \quad (5.53)$$

subject to $\mathcal{C}_{E^{B_{DA}}}$

where β is the risk parameter which models the importance which is given to risk in the decision-making. $\mathcal{C}_{E^{B_{DA}}}$ is the constraint associated with the energy bid. In this example, the energy bid is supposed to be positive and lower or equal to the maximum energy delivered by the wind farm during the period of a market time unit. This maximum is denoted as E_{wf}^{max} , and corresponds to the energy delivered by the wind farm generating at nominal power P_{wf}^{nom} during the duration Δt of the market time unit: $E_{wf}^{max} = P_{wf}^{nom} \times \Delta t$. Then, the constraints are written as:

$$\mathcal{C}_{E^{B_{DA}}} : 0 \leq E^{B_{DA}} \leq E_{wf}^{max} \quad (5.54)$$

5.5.3 Estimation of the loss distribution from probabilistic forecasts of wind energy and market prices

The loss distribution $\lambda(E^{B_{DA}})$ relative to the imbalance penalty for a given day-ahead energy bid $E^{B_{DA}}$ is derived from the generic loss formulation in Equation 5.35. The realization associated with the energy bid decision is the energy contract. This energy contract equals the energy bid as a result of the price-taker hypothesis. Consequently, $u = \tilde{u} = E^{B_{DA}}$. Also, in the particular case of day-ahead trading, the quantity E^{DA} is taken null, as already explained in section 4.4.2. Consequently, Equation 5.35 becomes:

$$\lambda(E^{B_{DA}}) = Y(E^{B_{DA}}) + \max \left(0, \left(\widehat{E}_{wf} - y(E^{B_{DA}}) \right) \times \widehat{\Pi}^\Delta \right) \quad (5.55)$$

As already explained in section 4.4.2, the cost $Y(E^{B_{DA}})$ is null and the energy volume $y(E^{B_{DA}})$ equals the energy bid $E^{B_{DA}}$, which gives:

$$\lambda(E^{B_{DA}}) = \max \left(0, \left(\widehat{E}_{wf} - E^{B_{DA}} \right) \times \widehat{\Pi}^\Delta \right) \quad (5.56)$$

In this case, the forecast of the wind generation \widehat{E}_{wf} is supposed to be a probabilistic forecast, represented by a predictive pdf $\widehat{f}_{E_{wf}}$. The price forecast $\widehat{\Pi}^\Delta$ is assumed to be a discrete probabilistic forecast, similarly to the previous example in section 5.4. Then, the pdf of the loss for a given energy bid $E^{B_{DA}}$ is denoted as $f_{\lambda(E^{B_{DA}})}$. The derivation of this loss pdf is a particular case of the generic formula-

tion given in Equation D.17. The derivation of $f_{\lambda(E^{B_{DA}})}$ is similar to the one which has been detailed in the previous section, with $Y(E^{B_{DA}}) = 0$. More precisely, this gives:

$$f_{\lambda(E^{B_{DA}})}(z) = A \cdot d(z) + B \cdot \widehat{f}_E(\gamma_{\widehat{\Pi}_-^\Delta}^{-,-1}(z)) + C \cdot \widehat{f}_E(\gamma_{\widehat{\Pi}_+^\Delta}^{+,-1}(z)) \quad (5.57)$$

The quantities A , B and C are detailed in section D.3. The functions $\gamma_{\widehat{\Pi}_-^\Delta}^-$ and $\gamma_{\widehat{\Pi}_+^\Delta}^+$ are defined on the intervals I_{wf}^- and I_{wf}^+ respectively, with:

$$I_{wf}^- = [0, E^{DA}] \quad \text{and} \quad I_{wf}^+ = [E^{DA}, E_{wf}^{max}] \quad (5.58)$$

5.5.4 Discussion about the expected value of the loss distribution

The optimal energy bid $E^{B_{DA},*}$ obtained from the spot-risk method is formulated as the result of the optimization problem given in Equation 5.53. However, in the particular case of $\beta = 0$, the spot-risk approach is similar to the expected value approach:

$$E^{B_{DA},*} = \arg \min_{E^{B_{DA}}} \mathbb{E}(\lambda(E^{B_{DA}})) \quad (5.59)$$

subject to $\mathcal{C}_{E^{B_{DA}}}$

The formulation of the loss $\lambda(E^{B_{DA}})$ in Equation 5.56 shows that this loss is a function of the two random variables \widehat{E}_{wf} and $\widehat{\Pi}^\Delta$. The discrete distribution of $\widehat{\Pi}^\Delta$ is given by Equation 5.10. Using Bayes' theorem, the expected value $\mathbb{E}(\lambda(E^{B_{DA}}))$ can be written as:

$$\mathbb{E}(\lambda(E^{B_{DA}})) = \sum_{s=\{-,o,+\}} \alpha_s \cdot \mathbb{E}(\lambda(E^{B_{DA}})_{\widehat{\Pi}^\Delta = \widehat{\Pi}_s^\Delta}) \quad (5.60)$$

By considering the formulation of the loss given in Equation 5.56, Equation 5.60 can be simplified to:

$$\mathbb{E}(\lambda(E^{B_{DA}})) = \begin{cases} \alpha_- \cdot \widehat{\Pi}_-^\Delta \times |\widehat{E}_{wf} - E^{B_{DA}}|, & (\widehat{E}_{wf} - E^{B_{DA}}) < 0 \\ \alpha_+ \cdot \widehat{\Pi}_+^\Delta \times |\widehat{E}_{wf} - E^{B_{DA}}|, & (\widehat{E}_{wf} - E^{B_{DA}}) \geq 0 \end{cases} \quad (5.61)$$

which leads to:

$$\mathbb{E}(\lambda(E^{B_{DA}})) \propto \begin{cases} (1 - \mu) \times |\widehat{E}_{wf} - E^{B_{DA}}|, & (\widehat{E}_{wf} - E^{B_{DA}}) < 0 \\ \mu \times |\widehat{E}_{wf} - E^{B_{DA}}|, & (\widehat{E}_{wf} - E^{B_{DA}}) \geq 0 \end{cases} \quad (5.62)$$

with $\mu = \frac{\alpha_+ \cdot \hat{\Pi}_+^\Delta}{\alpha_+ \cdot \hat{\Pi}_+^\Delta + \alpha_- \cdot \hat{\Pi}_-^\Delta}$.

It is then interesting to note that Equation 5.62 corresponds to the check function $\rho_\mu(\hat{E}_{wf} - E^{BDA})$ defined in Equation 5.7. Such function is used to derive the μ -quantile of a random value in the quantile regression method, as explained in section 5.1.3. More precisely, the minimum of this function is reached for the μ -quantile of $(\hat{E}_{wf} - E^{BDA})$. Consequently, the optimal energy bid $E^{BDA,*}$ given by Equation 5.59 is in this particular case of $\beta = 0$, the μ -quantile of the distribution of the wind generation forecast \hat{E}_{wf} :

$$E_{|\beta=0}^{BDA,*} = \hat{q}_{E_{wf}}^\mu \quad (5.63)$$

This result is coherent with the one obtained in [60]. In other words, the trading strategy based on quantile regression, as it is proposed in [60], is a particular case of the more general decision-making method proposed in this work.

5.5.5 Case study

This section gives the results from the application of the risk-based decision-making approach given in Equation 5.53 for the participation of a wind farm in a day-ahead market. The considered wind farm is the reference wind farm taken for all the previous case studies. It is a 18 MW wind farm located in Western Denmark. The results are related to the trading of the wind farm generation in the Elspot day-ahead market during the period between the 01/10/2003 to the 30/06/2004. These results are obtained using real world data. The forecasting approaches for both the wind energy and the market price are detailed in the following paragraphs.

Forecasting of the wind generation

In this example, the wind power probabilistic forecasts are obtained from a statistical model based on quantile regression forest (QRF). This method is a particular case of quantile regression models, which includes a random input selection phase. It is specially designed to manage large input dimensionality [167]. More precisely, this is an extension of Random Forests methods, which rely on classification and regression trees (CARTs). The application of the QRF method for probabilistic wind power forecasting is detailed in [132]. For each forecast horizon, a forecast in the form of a set of quantiles is provided. In this case study, the set includes 21 α -quantiles, where α is:

$$\alpha = [0.01, 0.02, \dots, 0.05, 0.10, 0.15, 0.20, 0.30, \dots, 0.80, 0.85, 0.90, 0.95, 0.96, \dots, 0.99]$$

Such set of quantiles permits to focus on the tails of the distribution (i.e. quantiles close to 0 and close to 1) for evaluating more precisely the risk related to these tails.

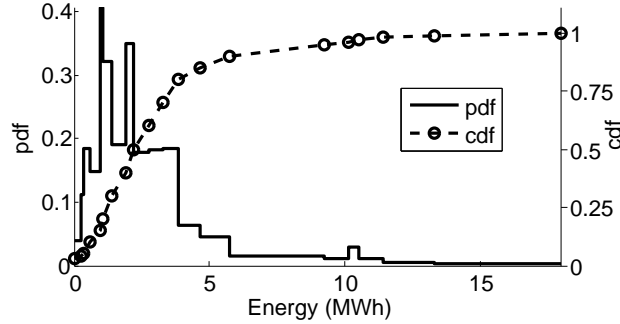

Figure 5.8: Step probability density function obtained from the quantiles.

The predictive cumulated density function (cdf) is derived as a piecewise linear function from the quantiles, which corresponds to given points of this cdf. The example of the forecast for a one-hour period of the case study is described in Figure 5.8. The forecast is relative to the delivered energy the 04/11/2003 between 03h00 and 04h00. The forecast was obtained 28 hours before, that is on the 03/11/2003 at 00h00. In this figure, the quantiles are represented by the circles and the cdf is the dashed line. Then, the predictive pdf of the wind power production $\hat{f}_{E_{WF}}$ is computed as a step function from the cdf. For each interval between two consecutive quantiles, the step value equals the constant value of the derivative of the cdf, as shown in Figure 5.8.

Forecasting of the imbalance penalty price

Given the difficulty of price forecasting, a method for simulating the price forecast $\hat{\Pi}^\Delta$ is proposed. This method permits to obtain different levels of forecasting error, and to evaluate their impact on the decision-making. The details of this simulation approach are developed in section C.4.1.

First, two reference model are considered: the “constant prediction” model, which gives a constant forecast for all the horizons, and the “perfect prediction” model which gives the observed price for each horizon. These two models define the lower and upper bounds, respectively, of the price forecasting errors. Then the simulated price forecast are based on two parameters which model the forecasting error, and which are applied to the “perfect prediction” model. The first parameter is a phase error τ , and the second one is a parameter ϵ which is related to the uncertainty about the regulation state of the TSO. The “perfect prediction” model is a particular case of such (ϵ, τ) -model, with $(\epsilon, \tau) = (0, 0)$. An increase of τ or ϵ

leads to an increase of the forecasting error, and the “constant prediction” model corresponds to $(\epsilon, \tau) = (0.5, 0)$. Further details about this simulation approach, as well as the performance associated with these models, are given in section C.4. Here, three different simulated price forecasts are used from the (ϵ, τ) -model with $(\epsilon, \tau) = (0.75, 0), (0.75, 3), (0.6, 3)$.

In total, five approaches are considered, including the constant and perfect prediction together with the above three (ϵ, τ) -models, while the imbalance penalty price $\hat{\Pi}^\Delta$ is given as a discrete probabilistic forecast, given by Equation 5.10.

5.5.6 Results

The results are obtained using a simulation tool developed in Matlab®. In particular, the optimization problem given in Equation 5.53 is solved using a sequential quadratic programming (SQP) method already implemented in Matlab®.

The first results of this case study focus on the relation between the risk and the observed imbalance penalties. The aim is to demonstrate that the risk measured from the loss distribution gives some information about the extreme imbalance penalties. For this analysis (and only for this one), the day-ahead energy bid does not take into account the risk related to imbalance penalties, and is taken equal to the mean of the probabilistic forecast. Then, the risk associated with this specific decision is calculated from the distribution of the loss, which in turn is derived from the probabilistic forecast of the wind power production.

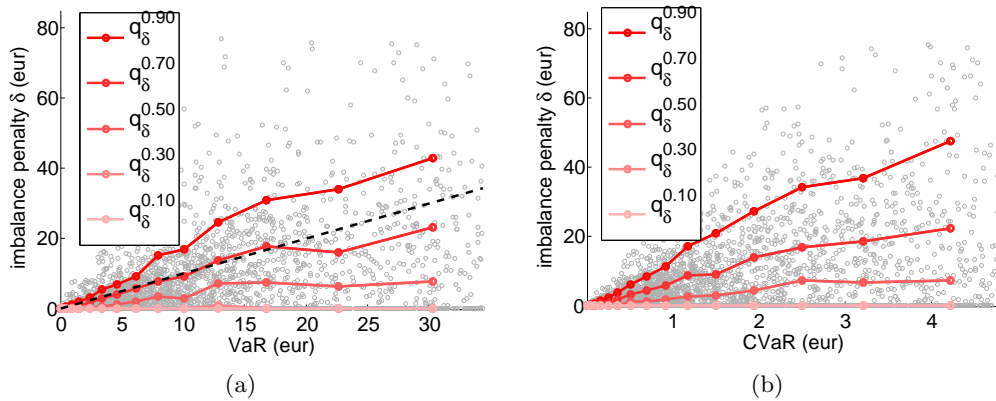

Figure 5.9: Relation between the risk, measured through the VaR or the CVaR, and the obtained imbalance penalty δ . The results are obtained from the trading simulation period from the 01/10/2003 to the 30/06/2004.

Figure 5.9 describes the relation between the risk level and the obtained imbalance penalty. The α -VaR and α -CVaR were calculated with the confidence level α

equal to 0.90. The price model for calculating the loss distribution was the (ϵ, τ) -model with $(\epsilon, \tau) = (0.75, 0)$. For better analyzing the influence of the risk level on the imbalance penalty, the distribution of the imbalance penalty is represented for different risk levels. A risk level is in this case an interval of risk so that all the levels have the same number of observations. For each risk level, a distribution of the penalty values is produced. Such distribution is represented through five α -quantiles with $\alpha = [0.1, 0.3, 0.5, 0.7, 0.9]$. The first two quantiles $\alpha = [0.1, 0.3]$ equal 0 for all the different risk level values. This is explained by the dual imbalance pricing mechanism, which penalizes only positive *or* negative imbalances. Consequently, a high proportion (i.e. 30 %) of the hourly imbalance penalties are null.

For both the VaR and the CVaR measures, Figure 5.9 shows an increase of the dispersion of the imbalance penalty as the risk measure increases. More precisely, the extreme imbalance penalties, which are represented by the 0.90-quantile, increase as the risk measure increases. This analysis confirms that both the VaR and the CVaR measures inform about extreme penalties, and are thus acceptable risk measures. Regarding the VaR, this risk measure has been defined in section 5.2.3 as the α -quantile of the loss distribution, where α is the confidence level. In case of perfect estimation of the loss distribution, the 0.90-quantile of the imbalance penalty should be equal to the 0.90-VaR measure. Graphically, this means that the dark red line would be superposed on the black dashed line, which gives the identity function. However, figure 5.9(a) shows that the 0.90-quantile of the imbalance penalty is higher than the 0.90-VaR measure. In other words, the VaR is slightly underestimated. This is the result from a combined underestimation of the extreme wind power production and of the imbalance price penalty. This underestimation more generally refers to the problem of *reliability* of probabilistic forecasts, which aims at evaluating how close to the reality the probabilistic forecasts are. The interested reader can refer to [78] for further details about reliability.

Based on the analysis that the proposed risk is an acceptable measure of extreme imbalance penalty, the following results focus on the influence of such risk on the decision-making results for day-ahead trading. The results below are obtained by applying the spot-risk decision-making method given in Equation 5.53 for determining the optimal energy bid. Figure 5.10 presents the influence of the risk parameter β on the distribution of the imbalance penalties. The graph on the left gives the histograms of the penalty distributions in the reference case and for three different β values: $\beta = 0, 15, 75$. The reference case does not consider any risk. This case consists in setting the energy bid as the mean of the probabilistic forecast of the wind generation. The results from the risk-based method have been obtained taking the (ϵ, τ) -model with $(\epsilon, \tau) = (0.60, 3)$ as price prediction approach. The influence of the (ϵ, τ) parameters is discussed in further results. From the histograms of Figure 5.10,

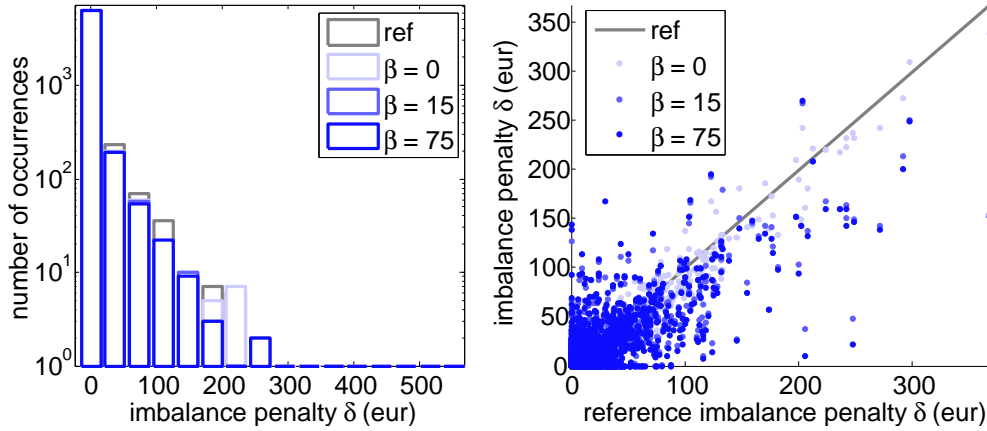

Figure 5.10: Analysis of the distribution of the imbalance penalties resulting from the risk-based trading method.

it can be observed that the number of occurrences of extreme imbalance penalties is reduced by using the risk-based approach, compared to the reference case. Also, this reduction gets higher when high β values are taken. The right graph of Figure 5.10 also describes the impact of the risk-based approach on the imbalance penalty distribution. This graph plots the hourly imbalance penalty resulting from the risk-based approach, with blue points, against the one obtained in the reference case. The grey line represents the reference imbalance penalties against themselves, and is thus the identity function. The reduction of extreme imbalance penalties is illustrated by the fact that most of the blue points for high values of imbalance penalties are under the grey line. Consequently, the results presented in Figure 5.10 show the benefits of the risk-based method in terms of reduction of extreme penalty values.

Figure 5.10 completes the analysis of the influence of the risk parameter on the imbalance penalty distribution. This figure gives the mean and 0.95-quantile of the penalty distribution obtained with various β values. First the two graphs show that both the mean and the 0.95-quantile are reduced by the risk-based approach compared to the reference approach, and this for all the considered β values. For values of β lower than 40, the mean and the 0.95-quantile have similar trends. This signifies that both the average and the extreme values of the imbalance penalty are reduced with the risk-based approach. They reach of minimum value when β is close to 10. For β values greater than 40, the 0.95-quantile of the penalty slightly decreases as the risk parameter increases, whereas the mean penalty increases. This is coherent with the definition of the risk parameter β , which models the risk aversion of the decision maker. High values of β mean that the decision maker is highly sensitive to the extreme penalties, and the consideration of this risk aversion in the

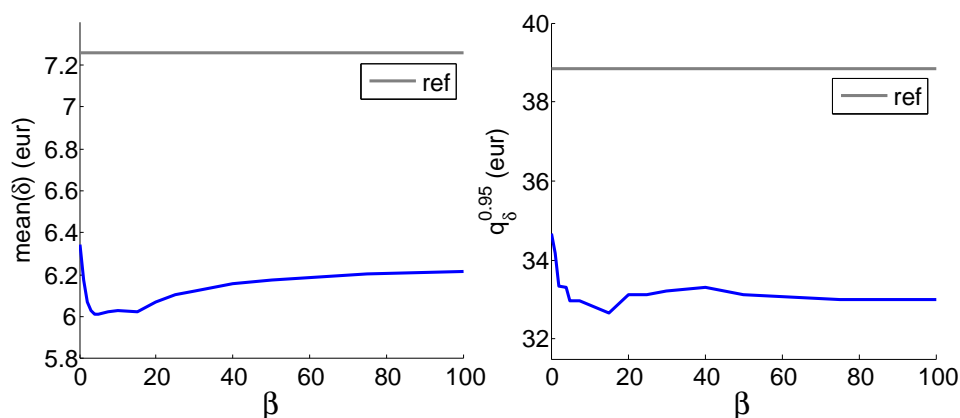

Figure 5.11: Mean and 0.95-quantile of the imbalance penalty distribution obtained from the risk-based trading method.

decision-making leads to decisions which reduce the extreme penalties. However, this **risk hedging** increases the average value of the penalty. This example is a particularly clear illustration of the difference of objective between the minimization of the average or the extreme penalty. The spot-risk approach can thus be considered as a multi-objective approach, and the risk parameter β corresponds to the weight given to the objective relative to the minimization of extreme penalties.

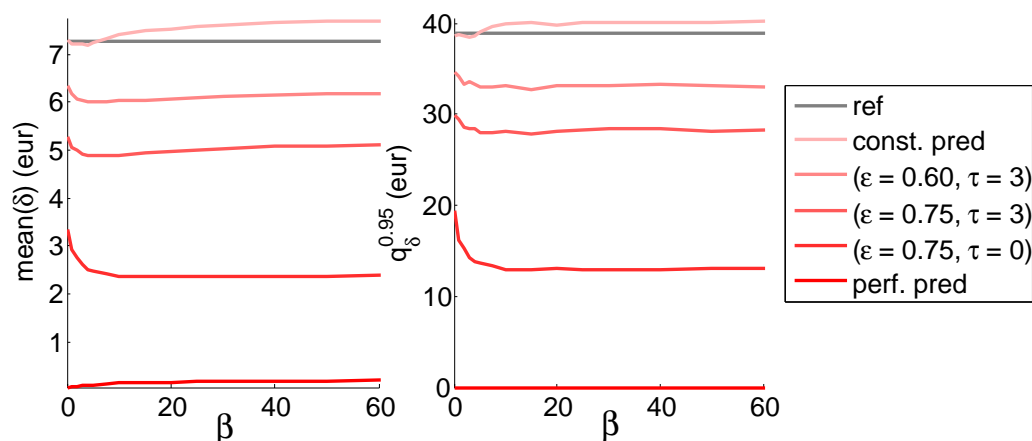

Figure 5.12: Influence of the imbalance price prediction approach on the mean and 0.95-quantile of the imbalance penalty distribution obtained from the risk-based trading method.

The results presented in figures 5.10 and 5.11 have been obtained with the (ϵ, τ) -model with $(\epsilon, \tau) = (0.60, 3)$ as price prediction approach. The last figure 5.12 shows the mean and 0.95-quantile of the imbalance penalty, obtained with five different

price prediction approaches. These two plots clearly demonstrate the high sensitivity of the results towards the price prediction approach considered. The perfect prediction of the imbalance penalty price reduces practically to zero the imbalance penalty, even without perfect prediction of the wind generation. This results from the dual-price mechanism for the imbalance penalty settlement. When the penalty prices are perfectly known, the energy bid equals the maximum bid when the TSO is down-regulating so that the IPP has only negative energy imbalances which are not penalized. Similarly, the energy bid equals zero when the TSO is up-regulating so that the IPP has only positive energy imbalances which are not penalized. Similar analysis was made in the study in [68]. Contrary to the perfect prediction, the constant prediction leads to an increase of both the mean and the 0.95-quantile of the imbalance penalty for β greater than 7. Also, for the different values of (ϵ, τ) shown in Figure 5.12, the reduction of the mean and 0.95-quantile increases as the accuracy of the price prediction approach increases. Finally, Figure 5.12 shows that the influence of the β parameter on the mean and 0.95-quantile of the penalty, is higher for more accurate price prediction model (e.g. the case $(\epsilon, \tau) = (0.75, 0)$) than for less accurate model (e.g. the case $(\epsilon, \tau) = (0.60, 3)$).

To conclude, the application of the risk-based approach for the participation of wind generation in a day-ahead market permits to illustrate to benefits of the method, compared to the reference approach which consists in bidding the energy quantity corresponding to the deterministic forecast of the wind power production. In this application, the role of the VaR and CVaR measures for informing about extreme values of imbalance penalty has been confirmed. Also, the integration of such information in the decision-making process through a spot-risk approach, demonstrated a reduction of the average and extreme imbalance penalty. Finally, the results have demonstrated that the proposed risk-based approach can be considered as a multi-objective approach, where the first objective is to reduce the average penalty and the second one is to reduce the extreme penalties.

5.6 Conclusions

In this chapter, a method for better accounting for the uncertainty related to the participation of renewable generation in electricity markets has been proposed and evaluated. The proposed approach is an extension of the general decision-making method proposed in the previous chapter.

An overview of the state of the art of the **uncertainty models**, as well as of the general methods for decision-making under uncertainty, has been carried out. The method which has been selected for this work is a risk-based approach, which permits to explicitly measure the risk related to the imbalance penalty from the

available probabilistic forecasts of renewable power production.

Then, the different physical and financial solutions for reducing the imbalance penalties, which have been described and modeled in the previous chapters, are integrated in the general risk management problem as **hedging methods**. These solutions aim at reducing the risk associated with a given decision. The example of the combination with a storage device as a physical hedging method is presented.

Finally, the proposed risk-based decision-making method has been applied for the participation of wind generation in a day-ahead electricity market, and the results obtained demonstrate a reduction of both the average and the extreme values of imbalance penalties in general. The results also illustrate the compromise between the reduction of the average penalty, and the reduction of the extreme penalties.

Risk-based approach for renewable generation in electricity markets

General Conclusions and Perspectives

This chapter summarizes the main partial conclusions which have been given at the end of each chapter, and also adds some general conclusions about the whole research work. In addition, some perspectives for further research related to this Ph.D. thesis are also suggested.

6.1 General Conclusions

The work presented in this thesis has proposed methods for the management of the uncertainty related to the participation of renewable generation in electricity markets. This work has been carried out in the context of an increasing share of electricity generation coming from renewables, in an electricity sector which evolves from a centralized to a liberalized system. This new environment leads to the need of tools and methods for the management of the large scale integration of renewable generation in power systems. The problem considered in this thesis is taken from the power producer's point of view, which aims at minimizing the imbalance penalties relative to its participation in short-term electricity markets.

The first objective was to understand in depth the challenges related to the participation of a power producer including RES units in its generation portfolio, in a short-term electricity market. This was done in chapter 2, where a detailed presentation of the structure of the electricity markets has been proposed. This description permitted to point out the specificities related to the short-term electricity markets, which are the main focus of this work. Also, the definitions of the concepts of “inde-

pendent power producer” (IPP) and **balance responsible parties** were given, and used as a base for the formulation of the imbalance penalties given in the following chapter. A last contribution of chapter 2 was the overview provided on the state of the art of existing solutions that an IPP can use for reducing its imbalance penalties. The presented solutions have been classified into two main categories: the **financial solutions**, which are relative to the management of the contracted energy by the market participant operating the RES units, and the **physical solutions** which are relative to the management of the delivered energy by the RES units. Despite their distinctions coming from their definition, the similarities between these solutions have been discussed all along the thesis.

In chapter 3, **models for the imbalance penalty** resulting from the participation of an IPP in electricity markets have been proposed for different physical and financial solutions. The reference imbalance penalty for each solution corresponds to the case of the participation of a reference renewable unit in a day-ahead electricity market. Then, the different physical and financial solutions have been modeled as a modification of this reference imbalance penalty. Three physical solutions, each corresponding to a given technical solution, have been modeled. Namely, these solutions are the aggregation of RES units and the combination of RES units with either a storage device or with a conventional unit. These solutions have been modeled in the framework of the concept of **commercial virtual power plants**, which offers the possibility for combined units to participate in the market as a single entity. Regarding financial solutions, the case of the additional participation in the intraday market has been modeled. The trading of market derivatives (options) has been discussed.

Having followed a common framework for the above formulations, we made evident the similarity between the financial and physical solutions about their impact on the imbalance penalty. Both financial and physical solutions have been modeled by two parameters which modify the reference imbalance penalty: an additional cost and a balance energy volume. The additional cost can be interpreted as the cost to pay to benefit from the balance energy volume, which permits to reduce the imbalance penalty. In the case of a financial solution, this balance service is bought from other market participants through electricity markets, whereas this service is provided by the combined units in the case of the physical solutions. In other words, for the operator of a RES unit, an adjustment participation in an intraday market is similar, from the imbalance penalty point of view, to the combination with a storage unit. Based on this, we developed a generic formulation of the imbalance penalty that integrates both physical and financial solutions. This **unified formulation** permits to generalize the model for a combination of solutions. In fact, in an industrial context, physical solutions may be combined with financial solutions, and the

generic formulation permits to develop the necessary simulation tools for evaluating, dimensioning and operating these solutions. Finally, the application given in section 3.5 has illustrated how a parametric analysis based on this unified model can be used for the general problem of unit dimensioning in the context of virtual power plants.

In the following chapter, the different problems related to the participation of an IPP in an electricity market, and more generally the activation of financial and physical solutions, have been formulated as **decision-making problems under uncertainty**. A generic method has been proposed for solving these problems based on a loss function, which is defined from the estimation of the generic imbalance penalty model previously detailed. In other words, the generic aspect of the decision-making method is based on the generic aspect of the imbalance penalty model itself. It is important to note that if the formulation of the imbalance penalty was specific to each considered solution (i.e. not generic), it would have been necessary to derive different decision-making methods which would be appropriate to each different solution. In the present work, the generic decision-making method is applied to the reference case of day-ahead trading, to the case of intraday trading (i.e. financial solution) and to the case of a storage combination (i.e. physical solution). Also, the application of the advanced decision-making method for the strategic operation of a combined wind-hydro plant has demonstrated the importance of the decision approach on the obtained results. This example has illustrated the difference between the two paradigms: the minimization of the average imbalance penalty for a period, and the minimization of the extreme values of imbalance penalty for the same period. In particular, a solution which is acceptable for one paradigm is not always acceptable for the second paradigm, and *vice versa*.

The consideration of this compromise between the average and extreme values in a decision-making problem is the core of the **risk-based approach** proposed in this thesis. In this method, the risk associated with a given decision is modeled from the statistical distribution of the imbalance penalty obtained for this decision. Such imbalance penalty distribution is derived from the probabilistic forecasts of the energy delivered by the RES unit, as well as from market price forecasts. Since advanced price forecasting is not a trivial task, we proposed to simulate the price forecast uncertainty. The resulting price forecasts have a level of forecasting error which can be adjusted by the simulation, which permit to analyze the influence of the accuracy of the price forecasts on the decision results. The risk associated with a decision is then evaluated from risk measures taken from the financial literature, and integrated in the decision-making problem. The sensitivity of the IPP to extreme imbalance penalties is modeled in the proposed approach through a risk parameter. In this context, the physical and financial imbalance management solutions are seen

as **hedging methods**, which reduce the risk related to the imbalance penalties. The risk hedging is illustrated for the case of the combination with storage, which is an example of physical solution. Also, the benefits from the risk-based approach, in terms of reduction of the average and extreme imbalance penalties, are demonstrated from simulations based on real world data.

Finally, the main contribution of the thesis relies on the proposed general methodology, which can be seen as a roadmap for step-by-step building a generic decision-making method adapted to the considered problem. The first step consists in modeling the outcome of the decision; then a generic decision-making is proposed based on this model, and finally the method is extended for taking into account the uncertainty related to the decisions. Finally, a number of results on selected real-world cases demonstrate the applicability and the usefulness of this methodology.

6.2 Perspectives

The first and obvious perspective of this research work consists in applying the proposed decision-making method to other case studies for obtaining further results about the benefits of the method. In particular, these additional case studies could consist in considering either different simulation time periods, different reference RES units, or different electricity markets for the case study. These additional results could be given in the form of a sensitivity analysis of the main parameters which define the case studies. Another extension of this work consists in applying the risk-based decision-making method in the case of a financial solution other than day-ahead trading, such as intraday trading, or in the case of physical solutions, such as strategic operation of a combined wind-hydro plant. Finally another direct application of this work would be to consider different risk measures in the spot-risk approach.

Another more technical perspective of this present work is related to the optimization algorithms used for solving the decision-making problem. In this thesis, the optimization problems have been simplified so that they could be solved by classic continuous optimization techniques already implemented in several numerical solvers. For example, in the application of the management of a combined wind-hydro plant in section 4.6, the constraints of the optimization problem have been simplified so that the problem becomes a linear optimization problem. It would be interesting to develop adapted optimization techniques which could be used for solving the problem without having to simplify it. Moreover, only continuous decision problems have been taken into account in this work. The extension of this decision approach to discrete decision problems is an interesting perspective of this work. Technically, optimization techniques such as dynamic programming, used in [120],

could be considered.

Regarding the uncertainty management, the proposed approach for the derivation of the loss distribution used in the risk-based approach, assumes that both renewable generation and market prices are independent. However, in areas with a high share of electricity generation coming from renewables, such as in Denmark, renewable generation really impacts the electricity market prices. Furthermore, the correlation between these two stochastic quantities may increase the imbalance penalty risk for the IPP. For considering such dependence, a possibility consists in using conditional forecasts of the renewable generation which are respective to given levels of market prices.

The generic decision-making method which has been proposed in this work is based on the concept of virtual power plant (VPP) which combine different generation units. A perspective concerns the possibility of integrating **controllable loads** in the VPP. In this case, the VPP includes loads in addition to the generation units, and consequently, the participation in the market does not consist only in selling power production, but may also consist in buying electricity for some market time units. The VPP operator is then denoted as an *aggregator*. Indeed, controllable loads are loads which can be displaced in time, or curtailed. They consequently represent another possibility for the VPP operator to manage its imbalance penalties. For instance, a controllable load can be adjusted so that the period of this load corresponds to the period when the renewable generation exceeds the contract volume. In other words, a controllable load can be considered as an additional physical solution which can reduce the positive energy imbalance. In this case, this corresponds to an extension of the VPP model.

Regarding the **financial solutions**, the case of option trading has been disregarded, based on the analysis that specific options adapted to the short-term management of energy imbalance are not available products in today's markets. However, the evolution of the regulatory framework for renewable generation, from feed-in tariffs to full market integration, leads to the need of new solutions to be proposed to IPPs for managing their renewable generation. In this context, new actors, which propose hedging solutions specifically designed for IPPs to manage their imbalance penalty risk, are emerging. One example is "virtual storage", which takes the form of a limited amount of energy available during a given period, and usable by the IPP when needed. Such virtual storage can be delivered by a real operator of hydro power units. The possibility to consider the management of these innovative hedging solutions in the proposed generic decision-making method would be an interesting perspective of the work. Another interesting extension of the method would be the possibility to take into account long-term contracts in the decision, which have been excluded in the case of the present formulation.

A more general perspective of this work is related to the **objective** of the decisions made by the VPP. In this thesis, the only objective considered for the decisions is an economic one which consists in minimizing the imbalance penalty. However, in general, the decisions may be relative to several objectives, which are not only economic but also technical. This is explained by the fact that the solutions proposed for the management of imbalance penalties can be simultaneously used for different purposes. For example, the decision about the storage scheduling could be a multi-objective decision which aims at reducing both the imbalance penalty of the IPP and the risk of grid congestion.

List of Publications Issued from This Thesis

Conference Proceedings

1. **F. Bourry**, L. M. Costa, and G. Kariniotakis, “Risk-based strategies for wind/pumped-hydro coordination under electricity markets,” in *2009 IEEE PowerTech Conference Proceedings*, Bucharest, June 2009. [Online]. Available: <http://ieeexplore.ieee.org>
2. **F. Bourry** and G. Kariniotakis, “Strategies for wind power trading in sequential short-term electricity markets,” in *European Wind Energy Conference 2009 Proceedings*, Marseille, March 2009.
3. **F. Bourry**, L. M. Costa, and G. Kariniotakis, “Management of uncertainty related to renewable generation under electricity markets,” in *3rd International Conference on Integration of Renewable Energy Sources & Distributed Energy Resources*, Nice, France, December 2008. Poster.
4. **F. Bourry**, J. Juban, L. M. Costa, and G. Kariniotakis, “Advanced strategies for wind power trading in short-term electricity markets,” in *European Wind Energy Conference 2008 Proceedings*, Brussels, March 2008.
5. L. M. Costa, J. Juban, **F. Bourry**, and G. N. Kariniotakis, “A spot-risk-based approach for addressing problems of decision-making under uncertainty,” in *Probabilistic Methods Applied to Power Systems (PMAPS) Proceedings*, Rincon, Puerto Rico, May 2008. [Online]. Available: <http://ieeexplore.ieee.org>

List of publications

6. L. M. Costa, **F. Bourry**, J. Juban, and G. N. Kariniotakis, “Management of energy storage coordinated with wind power under electricity market conditions,” in *Probabilistic Methods Applied to Power Systems (PMAAPS) Proceedings*, Rincon, Puerto Rico, May 2008. [Online]. Available: <http://ieeexplore.ieee.org>
7. L. M. Costa, **F. Bourry**, and G. N. Kariniotakis, “Stochastic optimization techniques for the optimal combination of wind power generation and energy storage in a market environment,” in *European Wind Energy Conference 2008 Proceedings*, Brussels, Belgium, April 2008.

Articles in progress

1. **F. Bourry**, N. Siebert, and G. Kariniotakis, “Advantages of virtual power plants composed of aggregated wind farms for trading in short-term electricity markets,” to be submitted to *Power Systems, IEEE Transactions on*.
2. **F. Bourry** and G. Kariniotakis, “Virtual power plant as a hedging method for wind power trading in short-term electricity markets,” to be submitted to *Renewable Power Generation, IET*.

Renewable Generation Forecasting Methods

This section gives details about the forecasting of renewable generation. The first section presents an overview of the state of the art of renewable generation forecasting. Such overview is general and is valid for any stochastic renewable source, such as photovoltaic or wind generation. The second section gives some illustrations in the particular case of wind generation forecasting. Finally, the third section focuses on probabilistic forecasting of wind generation. The information about uncertainty, provided by these probabilistic methods, is used in chapter 5 for estimating the risk associated to decision-making problems.

B.1 Overview of the state of the art of renewable generation forecasting

Renewable generation forecasting aims at providing end-users with estimates of the likely energy output of a RES unit at a given time in the future. The considered RES unit can be a wind farm, a photovoltaic plant or another RES unit. In general, forecasting tools provide an estimation of the future generation based on Numerical Weather Predictions (NWP), on onsite measurements and on power unit characteristics. Either power or energy can be forecasted as a function of the end-user requirements.

The two mainstream approaches for RES power forecasting are the so-called physical and the statistical approaches [78].

- In the physical approach, the model chain includes two steps: in a first step, the

NWP data available at the nodes of the meteorological model are extrapolated to the location of the RES unit. Such step is denoted as “downscaling”. In the case of wind generation forecasting, this can be done by modeling the wind profile at the location of the RES unit and by using a Computational Fluid Dynamic code which considers the full description of the terrain close to the wind farm. The second step consists in converting the downscaled NWP to power.

- Statistical approaches are based on models which try to establish the relation between historical values of explanatory variables and historical values of RES production. The same relation is then used to forecast the expected RES production from the new explanatory variables. The physical phenomena are not modeled in this approach. However, one of the main challenges related to these approaches is the selection of the explanatory variables.

The most common output of RES generation forecasting models are spot forecasts, also called point forecasts, where a single power value is provided for each time step in the future. However, probabilistic forecasting models are being developed. Such models provide additional information on the expected distribution of RES production, and will be discussed in the next section B.3. The reference model used for assessing the performance of advanced power forecasting models is often the persistence. Such approach consists in using the last measured power value as a constant prediction for the next period.

Renewable production forecasts time scales

The forecast horizon is the period between the time when the prediction is done and the given time in future to which the prediction refers. Power forecasting can be done for different time scales of horizons. A classification of power forecasting time scales is proposed in [78,168]. This classification has been established for wind generation forecasting, but remains valid for other variable RES:

- Very short-term power forecasts estimate the future power from seconds up to a few minutes. These forecasts can be used for the power unit active control.
- Short-term power forecasts are available for the following 48-72 hours. Such forecasts are used for various power system management functions such as unit commitment, economic dispatch, reserve estimation or network congestion management. These forecasts are also used for trading generation in short-term electricity markets. Regarding day-ahead markets for example, power forecasts are necessary at day d for the whole duration of the day $d + 1$.

- Medium-term power forecasts estimate the future power for longer time scales, up to 5-7 days ahead. These forecasts can be used for maintenance planning for example.

The present thesis focuses on the imbalance penalties related to the participation in short-term electricity markets, and, thus, only short-term power forecasts are considered in this work.

A forecasting run is defined as a time series of the estimated variable (i.e. RES production), for consecutive horizons separated by a constant timestep. This timestep, or temporal resolution, is often imposed by the timestep of the NWP, since they are used as direct input. Temporal resolution for short-term power forecasts is generally between 1 and 3 hours. If the temporal resolution of RES forecasts is lower than the one requested for the application (e.g. trading), simple interpolation can be an acceptable solution to increase the temporal resolution. The update time is defined as the period between two forecasting runs. Similarly, the power forecasting update time is generally imposed by the NWP update time, which is generally 6, 12 or 24 hours. However, statistical models which use the measurements of RES generation as input can be updated more frequently (i.e. every 30 or 60 min). Consequently, power forecasts can be described as rolling windows, where the window length is determined by the series of horizons and the shift between two windows is the update time.

B.2 Example of approaches for wind generation forecasting

This section focuses on approaches from the state of the art regarding wind generation forecasting. This specific RES is of particular importance, since its fast development has led to major issues for the management of electricity networks including a large share of wind generation. These issues are related to the high variations of the wind power generation, as well as the difficulty to forecast them. In this context, wind generation forecasting methods have been considered as a useful solution for the management of such variations, and short-term wind generation forecasting tools have been in use for more than 15 years [169]. A state of the art of the wind generation forecasting methods can be found in [168,170]. Also, a comparison between various wind generation forecasting methods, based on statistical or physical approaches, can be found in [171]. The objective of this section is double: the first one is to give an illustration of typical forecasts of wind generation obtained by state-of-the-art forecasting methods. The second objective is to present and compare the level of forecast errors obtained with these methods.

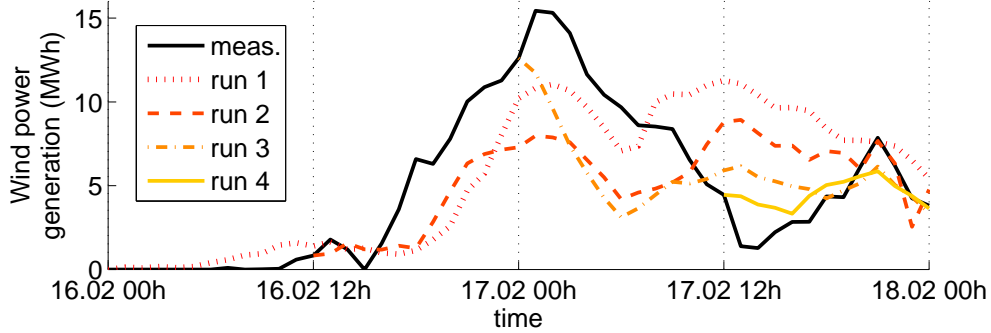

Figure B.1: Consecutive forecasting runs and related measurements for the power generation of a 18 MW wind farm in Western Denmark the 16 and 17 February 2004.

Figure B.1 presents the results of four consecutive forecasting runs for the power generation from a wind farm located in Western Denmark. The first run is produced the 16/02/04 at 00 h and the forecast is then updated every 12 h. The measured wind generation is illustrated with the black curve. The forecasting runs give the estimation of the wind generation for the next 48 h. The wind generation forecasts are produced using an advanced statistical power forecasting model described in [11, 111]. This model is denoted as the "Regressive Power Curve" (RPC) model, and aims at modeling the relationship between the wind speed forecasts and the power outputs of the wind farm. Such kind of approaches are often referred as power curve modeling. In this model, the power curve is modeled using a piecewise least square linear fitting of the wind-speed to power relation.

The different existing forecasting models are usually evaluated based on the "distance" between the provided forecast value and the measured value. Generally, these forecast performances are evaluated on a sample of N_T forecast values which have the same horizon index j but with different run time t_k . The wind generation forecasting error $e_{j,k}$ for a given horizon j and a run time t_k is the difference between the measured and forecasted values : $e_{j,k} = \tilde{P}_{j,k} - \hat{P}_{j,k}$.

Two main performance evaluation criteria are commonly used [11, 78]. The *Normalized Mean Absolute Error* (NMAE) is the average of the errors in their absolute values, normalized by the energy delivered by the wind farm at nominal power during a market time unit. Such energy volume is denoted as E^{nom} . The *Normalized Root Mean Square Error* (NRMSE) is the square root of the average of the squared errors, normalized by E^{nom} :

$$NMAE_j = \frac{1}{E^{nom}} \frac{1}{N_T} \sum_{k=1}^{N_T} |e_{j,k}|, \text{ and } NRMSE(j) = \frac{1}{E^{nom}} \sqrt{\frac{1}{N_T} \sum_{k=1}^{N_T} (e_{j,k})^2} \quad (\text{B.1})$$

The choice of the NMAE or NRMSE as a main evaluation criterion depends on the sensitivity of the end-users to the errors. The RMSE measure will be preferred for applications sensible to quadratic penalization of the errors whereas the NMAE measure will be preferred for applications sensible to linear penalization of the error. Note that the NMAE for a period is equivalent to the normalized mean of the absolute energy imbalance for this period.

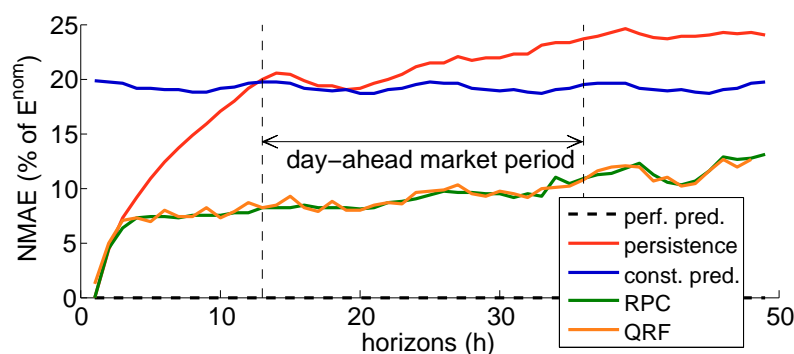

Figure B.2: Mean Absolute Error per horizon for five wind generation forecasting models: perfect prediction, persistence, constant prediction, RPC and QRF models.

Figure B.2 compares the performance of five wind generation forecasting approaches. These results corresponds to a 9 month period from 01/10/2003 to 30/06/2004. During this period, a forecasting run is calculated every 12 hours, for the 48 coming hours. Figure B.2 shows the Normalized Mean Absolute Error (NMAE) defined in Equation B.1 for the 48 horizons. First, the NMAE relative to perfect prediction is always null, since the error is always null. Also, the model denoted as “constant prediction” which NMAE is plotted with the blue curve in Figure B.2 is an second basic reference model which consists in delivering a constant value for all the different horizons for all the runs. Such constant value is in the presented example the mean of the wind generation measurements during a period in the past (often denoted as “climatology”). Here it is calculated based on the training period which corresponds to the first 9 months of the available data (01/01/2003-30/09/2003). The RPC model is the power curve modeling approach already presented in Figure B.1 [11,111], and its NMAE is described with the green curve. Finally, the “QRF” model corresponds to a second advanced statistical model based on quantile regression forest. Such approach provides an estimation of the distribution of the future wind power production, through quantiles [167]. A further discussion on this kind of probabilistic models which inform on the uncertainty related to the forecast is given in the following chapter 5. In this example, the considered forecast is the median of the distribution.

From Figure B.2, it can be observed that the constant prediction method results to a nearly constant NMAE slightly varying around 19 % of the nominal power of the considered wind farm. The persistence NMAE is lower than the one resulting from the constant prediction for the first 12 horizons, and greater for the following horizons. Also, the “RPC” and “QRF” models have a very close NMAE for the considered period. This NMAE is close to the persistence NMAE for the first 3 horizons and is highly reduced for the further horizons. Finally, Figure B.2 described the forecasting period relative to the trading in day-ahead markets, where the bidding decision has to be made at 12h00 the day before for the 24 hours of the following day. The NMAE relative to this period varies between 8 and 10 % of the E^{nom} for the two advanced models.

B.3 Probabilistic forecasting of wind generation

B.3.1 Overview of the state of the art of the methods for probabilistic forecasting of wind generation

The previous section has presented deterministic forecast of the wind generation. The present section aims at completing the presentation with probabilistic methods. Focus is given only to methods developed for the forecasting of wind generation.

The uncertainty provided by probabilistic wind generation methods is a useful information for decision-making applications related to the large scale integration of wind power. For example, the uncertainty information can be used for estimating the optimal level of reserves that needs to be allocated to compensate wind variability [139]. Energy bidding in a day-ahead electricity market is another emerging application. It has been shown that, when trading future production on an electricity market, the use of probabilistic wind generation forecasts can lead to higher benefits than those obtained by only using deterministic forecasts [67]. Finally, wind generation probabilistic forecasts can be used for the optimal operation of combined wind-hydro power plants [94].

Two main approaches have been used for probabilistic wind generation forecasting: the prediction error approach and the direct approach. Such classification is taken from the state of the art of probabilistic forecast methods presented in [129].

- The *prediction error approach* consists in providing probabilistic forecasts of the errors of an existing deterministic forecasting model. An example of this approach is given in [78] where the proposed method estimates the distribution of the errors depending on the weather situations. The fuzzy set theory is used to overcome the problem of class discontinuity, and the error distributions

associated to different fuzzy sets are then combined using one of two methods: linear opinion pool or adapted resampling. Another example of prediction error approach is proposed in [172]. Such method is based on quantile regression based on cubic spline regression and provides quantiles of the prediction error using various explanatory variables.

- The second approach is denoted as the *direct approach*, and aims at directly providing probabilistic forecasts of the considered variable. The following examples of direct approaches are recent studies and demonstrate the active research activity in this field. First, a method where probabilistic forecasts can be derived from meteorological ensembles is provided in [173]. In [174], the probabilistic forecasts are based on physical considerations. Local quantile regression is used in [175] to compute specific quantiles of the power production. A comparison of three quantile approaches, namely local quantile regression, local Gaussian modeling and, the Nadaraya-Watson estimator, is performed in [176]. Also, a method based on kernel density estimation (KDE) is proposed in [129, 166]. Such method provides predictions in the form of probability density functions, which can be used as such or transformed into different sub-products depending on the application (e.g. point prediction, variance, prediction intervals or quantiles).

The two probabilistic methods which are used in the present thesis for the forecasting of wind generation are the KDE and the QRF methods. They are presented in section 5.1.3.

Based on these probabilistic forecasts, statistical measures have been developed for informing on the confidence one may have about the point forecast associated to the considered probabilistic forecasts. Such numerical value is called Prediction Risk Index (PRI) in [177]. In this article, the PRI is calculated from wind power ensemble forecasts. Also, in [174], indicators of weather dynamics are defined using methods from synoptic climatology. These indicators are used for classifying the local weather conditions and for relating them to different levels of forecast uncertainty. Such classification is based on measurements of wind speed, wind direction and atmospheric pressure.

Finally, it is important to note that the resulting probabilistic forecasts from these two approaches are generated on a per look-ahead time basis, and, consequently, do not inform about the temporal dependence between consecutive forecasts. Also, such forecast are obtained from a given RES unit. Consequently, they do not inform about the spatial dependence between forecasts relative to different units located at different locations, which is useful in the case of aggregation. Examples of existing methods for considering these temporal and spatial dependences

are presented in the next section.

B.3.2 Discussion about spatial and temporal dependence of the probabilistic wind generation forecast

This section focuses on the information relative to the spatial and temporal dependence included in probabilistic forecasts of wind generation.

Temporal dependence of the probabilistic forecast of wind generation

Scenarios based forecasts provide a possible future course of the forecasted variable. However, the other probabilistic forecasting methods presented in the previous paragraphs are generated on a per look-ahead time basis. They consequently do not inform on the development of the prediction errors through prediction series, since they neglect their temporal interdependence structure. Moreover, such information is of particular importance for many time-dependent and multi-stage decision-making processes such as the strategic operation of a combined wind-hydro storage unit.

Based on this need for temporal dependence information, a method is proposed in [178] for generating statistical scenarios of wind generation from non-parametric probabilistic forecasts. The resulting scenarios respect the predictive densities and account for the interdependence structure of prediction errors. Consequently, they can be used in time-dependent processes. For deriving these scenarios, the set of random variables composing probabilistic series is transformed into a single multivariate normal variable. The normal property for the new variable is the simplest assumption one can make, and this assumption is analyzed in the study as well. Then, the multivariate normal variable covariance matrix is tracked with recursive estimation. Finally, the scenarios are constructed using the covariance matrix and the normal variable.

Spatial dependence of the probabilistic forecast of wind generation This paragraph focus on the dependence between stochastic variables in the case of aggregated wind power sources. Spatial interdependence of stochastic variables is often underestimated in literature, where stochastic variables are assumed to be independent. Such independence assumption can lead to a severe underestimation of the system risk, corresponding to the case of minimum variability of the aggregate stochastic generation. In [179], a method is proposed for considering the spatial interdependence structure in the case of aggregated power sources.

The modeling approach is based on the distinction between the one-dimensional marginal distribution which represents the output spectrum of each stochastic input,

and the multi-dimensional stochastic dependence structure which determines the mutual interaction between the stochastic inputs and the direct impact on their aggregate. The approach is generally referred to as *copula theory*. In particular, the method enables to define uncertainty bounds of the stochastic model and to define worst-case scenario for the aggregated stochastic variables. This uncertainty analysis and model is used for considering various problems related to aggregated stochastic power generation, ranging from stability issues to generation expansion studies [180].

Market Price Forecasting Methods

This appendix gives some additional details about market price forecasting. First, the main characteristics of the electricity market are presented. These characteristics are explained from the literature. Then, a second section gives an overview of the state of the art of existing market price forecasting methods. Due to the complexity relative to market price forecasting, an approach for simulating forecasts of the market price is proposed. The price quantity which is necessary for making the decisions relative to the trading of renewable generation in electricity market is identified from the model of the imbalance penalty given in chapter 3. Then, the simulated prices permits to obtain a discrete probabilistic forecast of the market price with different levels of forecasting error.

C.1 Characterization of electricity market prices

Before the liberalization of the electricity sector, electricity prices were set by regulators on the basis of the costs of generation, transmission and distribution. In that setting, power prices used to change rarely, and in an essentially deterministic manner. Over the last ten years, several countries have been experiencing deregulation in generation and supply activities, as described in section 2.1.1. One of the important consequences of this restructuring is that prices for electricity are now determined, like any other commodity, according to the fundamental economic rule of supply and demand [181,182].

However, electricity is a commodity which has the particularity of a very lim-

ited storability; the main storage units are now the hydro power units. Another characteristic of electricity is the high inelasticity of the demand in the short-term markets. Consequently, the electricity prices are highly sensitive to demand and supply variations [183].

An analysis of the structure of electricity prices is proposed in [182], and identifies three main characteristics:

- A first characteristic of electricity prices is the mean reversion towards a level that represents a marginal cost and may be constant, periodic or periodic with a trend. A variable is said to be characterized by mean reversion when high and low values of this variable are temporary, and are expected to tend to an average trend. When the current market price is less than the average price, the commodity is considered attractive for purchase, and price is expected to increase. Similarly, when the current market price is above the average price, the market price is expected to decrease.
- A second feature of the price process is the existence of small random moves around the average trend, which represent the temporary imbalances between supply and demand in the network.
- A third and intrinsic feature of price process is the presence of so-called “spikes”, which are steep price increases shortly followed by a steep decrease. Such spikes may occur as a result of a generation unit outage, when a large generation unit is disconnected. Figure C.1 describes the hourly time series of the day-ahead market price for the period between 01/10/2003 and 30/06/2004. The average price during this period is 29.14 €/MWh. However, this price can reach extreme values during very short periods, such as on the 21/06/2004 at 14h00 when the day-ahead price reaches 89.67 €/MWh.

Without considering the spike effects, the main parameters which influence the market price can be classified into three categories [183]:

- Influence relative to the electricity demand: The electricity demand first depends on the considered period (i.e. season, day, hour) and also on meteorological conditions such as cloudiness and temperature, which are stochastic variables.
- Influence relative to the power supply: The power supply first depends on the characteristics and operation of the generation units involved in the considered electricity markets. Power supply also depends on stochastic factors such as unit outages, variations of delivered energy by renewable units or meteorological conditions.

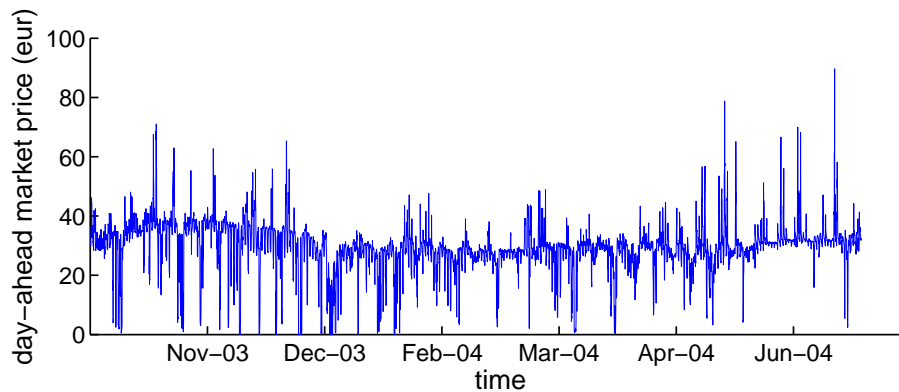

Figure C.1: Day-ahead electricity market price in the Elspot market for the Western Denmark area, from 01/10/2003 to 30/06/2004.

- More general factors influence the energy prices which in turn impact the electricity prices: such factors are for example the geopolitical context or the regulation framework.

C.2 Overview of the state of the art of electricity market price forecasting

The main characteristics of the structure of the electricity market prices which have been described above make them hardly predictable. Three main reasons of the difficulties relative to price forecasting are given in [181,184]:

- Firstly, the seasonality regarding daily, weekly and annual timescales, is low.
- Secondly, many quantifiable exogenous variables may be considered for price forecasting. Loads and network constraints are two examples of such exogenous variables.
- Psychological and sociological factors can cause an unexpected and irrational buyout of certain contracts leading to price spikes.

However, several recent studies propose forecasting models for electricity prices. The paper [185] gives a review of some of the main methodological issues and techniques relative to price forecasting in the new competitive power markets. Also the review paper [184] documents the main issues and recent research on modeling and forecasting electricity prices. In the same article, the special microstructure of electricity market is described as an explanation stochastic properties of electricity price time series.

Many approaches for modeling electricity price time series are based on autoregressive moving average (ARMA) models. Such models are also called Box-Jenkins models after the iterative Box-Jenkins methodology usually used to estimate the considered time series [186]. ARMA models generally consist of two parts, an autoregressive (AR) part and a moving average (MA) part. Autoregressive integrated moving average (ARIMA) models consist in a generalization of the ARMA model. Such models may be applied in some cases where data show evidence of non-stationarity. An initial differencing step (corresponding to the "integrated" part of the model) can be applied to remove the non-stationarity. An example of price scenario generation method based on ARIMA models is presented in [187]. Also, the autoregressive moving average model with exogenous inputs model (ARMAX) is an extension of ARMA models including exogenous inputs terms. An example of electricity price forecasting method based on ARMAX model is given in [188, 189], with system load considered as the exogenous variable. Finally, many stochastic models are inspired by the financial literature and consist in adaptations of well known and widely applied in practice approaches. Such adaptations involve the addition of some of the electricity price characteristics, like price spikes or mean-reversion [181, 184].

These price forecasting techniques are methods related to electricity market price in general and are not specific to any given market. In the proposed decision-making formulation, the loss function is based on a forecast of the price quantity Δ^{Π} which is defined as the difference between the day-ahead price and the regulation price. Consequently, specific attention is paid in the following paragraph to these two categories of electricity price.

C.2.1 Day-ahead market price forecasting

A wide survey about of electricity price forecasting techniques developed over the last fifteen years is given in [190]. The main focus of this survey is given to the methods for forecasting electricity prices on a pool-style energy market including day-ahead market. Most of the presented approaches for forecasting day-ahead market prices are based on time series models as described in the previous paragraph. A specific example is presented in [191]. In this study, different time series models are explained and compared from real-world case studies based on the electricity markets of mainland Spain and California.

A conditional parametric model of the day-ahead market price as a function of external variables is proposed in [192]. The considered external variable is the wind power forecasted production converted into a forecasted wind power penetration. Conditional parametric models of two different dimensions are constructed. One models the price as a function of time of day and wind power penetration and the

other one has an additional input variable, indicating the weekday. For the dynamic part, Recursive Pseudo Linear Regression is used. Results based on the NordPool day-ahead market price in the Western Denmark area are presented.

C.2.2 Regulation price forecasting

Regulation prices are settled in the real-time market, where the transmission system operator (TSO) takes regulation measures for ensuring the overall equilibrium between production and consumption in the considered regulation area. Consequently, the regulation prices are used for the calculation of the penalty that an Independent Power Producers (IPP) has to pay as a result from its energy imbalance.

Regulation markets are closely linked to the reliable operation of the grid, and thus precaution is taken regarding the design of such markets. More precisely, regulation markets are designed for preventing gaming in these markets, which could jeopardize the grid reliability [61]. The extremely high volatility of regulation market prices and the resulting hard predictability is a consequence of such anti-gaming design [60, 61, 193]. If regulation prices were easily predictable, gaming methods could lead the IPP to intend energy imbalance. Conversely, regulation markets are designed for encouraging the IPP to reduce their energy imbalance.

Recent models have been proposed for better understanding the regulation price structure. In [187], a method for generating time series of real-time balancing market price is described. Such method combines a seasonal auto regressive integrated moving average (SARIMA) approach with discrete Markov processes. The resulting scenario trees aim at representing possible realization of the stochastic prices. Such scenario trees can be used in planning models based on stochastic optimization to generate bid sequences to the balancing market. The application of such approach to the real-time Nordic power market example demonstrates the consistency of the approach used to model real-time balancing power prices. In a previous paper, the same authors proposed a method based on autoregressive integrated moving average (ARIMA) for generating regulating power price scenarios [194].

C.3 Simplification of the price forecasting problem and formulation of a discrete probabilistic forecast

C.3.1 Reformulation of the requested price forecast

The decision-making method proposed in the previous section is based on a forecast of the price quantity Δ^{II} , which is derived from the difference between the day-ahead price and the regulation price, and the sign of the IPP energy imbalance in

Equation 3.8:

$$\Delta^{\Pi}(\tilde{E}, E^C) = \begin{cases} \Delta_{-}^{\Pi} = \Pi^{-} - \Pi^{\text{DA}} \Leftarrow \tilde{E} < E^C \\ \Delta_{+}^{\Pi} = \Pi^{\text{DA}} - \Pi^{+} \Leftarrow \tilde{E} \geq E^C \end{cases} \quad (\text{C.1})$$

where \tilde{E} and E^C are the delivered and contracted energy volumes respectively. Π^{DA} is the day-ahead market price, and Π^{+} and Π^{-} are the regulation prices for positive and negative imbalance respectively. From such formulation, it appears that the requested forecast $\hat{\Delta}^{\Pi}$ depends on the sign of the forecast of the energy imbalance ($\tilde{E} - E^C$), which increases the difficulty relative to the forecasting. However, in the case of dual price imbalance settlement mechanism, the problem can be simplified as follows.

The dual price imbalance settlement mechanism has already been explained in section 2.2.5. In this mechanism, the regulation prices for positive and negative imbalance depend on the regulation state of the TSO, and three main states can be determined, from the overall energy imbalance in the balancing area:

1. The overall energy imbalance is negative and the TSO is up-regulating. In that case, only negative energy imbalances are penalized. In other words, $\Pi^{-} > \Pi^{\text{DA}}$ and $\Pi^{+} = \Pi^{\text{DA}}$.
2. The overall energy imbalance is small enough so that no regulation is needed. Because the regulation need is defined from the overall imbalance in the system, the occurrence of no regulation need is not negligible [195]. In that case, $\Pi^{-} = \Pi^{\text{DA}}$ and $\Pi^{+} = \Pi^{\text{DA}}$.
3. The overall energy imbalance is positive and the TSO is down-regulating. In that case, only positive energy imbalances are penalized. In other words, $\Pi^{-} = \Pi^{\text{DA}}$ and $\Pi^{+} < \Pi^{\text{DA}}$.

An additional fourth state consists in a simultaneous need, in the same market time period, of up-regulation and down-regulation. Such situations may happen [195], but remain infrequent.

An example of the repartition of the TSO regulation states in the Western Denmark area, for the period from 01/10/2003 to 30/06/2004 is given in Table C.1. This example shows that the two main states are the up and down regulation states, which correspond to a non null overall energy imbalance. The frequency of absence of regulation need reaches 21.70 %. Also, the frequency of simultaneous up and down regulation state is less than 1 %. Finally, it can be verified from the same example that the four states cover all the possibilities of regulation states, since the sum of the four relative frequencies equals one.

TSO regulation state	frequency
up regulation	42.69 %
down regulation	35.69 %
no regulation	21.70 %
up and down regulation	0.08 %

Table C.1: Repartition of the TSO regulation states in the Western Denmark area, for the period from 01/10/2003 to 30/06/2004.

Based on the three main TSO regulation states, we define the price quantity Π^Δ as the price time series given by:

$$\Pi^\Delta = \begin{cases} \Pi^{\text{DA}} - \Pi^- , & \text{up-regulation} \\ \Pi^{\text{DA}} - \Pi^+ , & \text{down-regulation} \\ 0 & , \text{no regulation} \\ \text{sign}(|\Pi^{\text{DA}} - \Pi^+| - |\Pi^{\text{DA}} - \Pi^-|) \cdot \max(|\Pi^{\text{DA}} - \Pi^+|, |\Pi^{\text{DA}} - \Pi^-|) & , \text{both up and down regulation} \end{cases} \quad (\text{C.2})$$

In the fourth case corresponding to both up and down regulation, only the regulation price which deviates from the day-ahead price with the greatest extent is taken. This corresponds to considering only the main regulation state. This assumption is necessary for representing the quantity Π^Δ as a time series, otherwise the variable Π^Δ would have two possible values for the same time step.

The price quantity Δ^Π is then formulated from the price time series Π^Δ as follows:

$$\Delta^\Pi(\hat{E}, E^c) = \begin{cases} |\Pi^\Delta| , & \text{sign}(\Pi^\Delta) = \text{sign}(\hat{E} - E^c) \\ 0 & \text{else} \end{cases} \quad (\text{C.3})$$

Also, given such time series Π^Δ , the estimated reference imbalance penalty function $\hat{\delta}^{\text{DA}}$ derived in Equation 4.11 can be rewritten as follows:

$$\hat{\delta}^{\text{DA}}(\hat{E}, E^{\text{DA}}) = |\hat{E} - E^{\text{DA}}| \times \hat{\Delta}^\Pi \quad (\text{C.4})$$

$$= \max\left(0, (\hat{E} - E^{\text{DA}}) \times \hat{\Pi}^\Delta\right) \quad (\text{C.5})$$

To conclude, the forecasting of the combined price quantity Δ^Π , based on three market prices, can be reformulated as the forecasting of only one time series Π^Δ . The main advantage of this formulation is the consideration of only one price value, but the forecasting of such quantity remains a hard task.

C.3.2 Formulation of a discrete probabilistic forecast for imbalance penalty price

Forecasting the sign of Π^Δ consists in forecasting the TSO regulation state, which is a difficult task [60]. Moreover, the estimated imbalance penalty derived in Equation C.5 is highly sensitive to the sign of $\hat{\Pi}^\Delta$: if $\hat{\Pi}^\Delta$ has the same sign as the estimated energy imbalance ($\hat{E} - E^{\text{DA}}$), the imbalance penalty equals the product of these two quantities. If these two quantities have an opposite sign, the penalty is null. Consequently, the decision relative to the day-ahead quantity bid is highly sensible to such price forecast. In other words, an error about the sign of this price forecast may lead to bidding or scheduling decisions which increase the imbalance penalty, instead of reducing it.

In order to manage the high uncertainty related to this price forecast, a discrete probabilistic forecast representation with three possible outcomes is proposed. Each outcome is associated to a TSO regulation state : up-regulation, no regulation, and down-regulation. These three regulation states respectively correspond to negative, null and positive values for $\hat{\Pi}^\Delta$, from Equation C.2. Each state is assigned a probability α , and the sum of the three probabilities equals one.

$$\hat{\Pi}^\Delta = \begin{cases} \left(\hat{\Pi}_-^\Delta < 0, \alpha_- \right) \\ \left(\hat{\Pi}_o^\Delta = 0, \alpha_o \right) \\ \left(\hat{\Pi}_+^\Delta > 0, \alpha_+ \right) \end{cases}, \text{ with } \alpha_- + \alpha_o + \alpha_+ = 1 \quad (\text{C.6})$$

The determination forecasts in the form of Equation C.6 is a difficult task. However, for the purposes of our study, we need realistic price forecasts in the decision-making methods. In the work presented in this thesis, instead of using a specific price forecasting method, we propose to **simulate different levels of price forecasting error**. These different levels permit to evaluate the influence of the accuracy of the price forecasts on the results of the decision-making. As a starting point, we define two reference approaches, which are the *perfect prediction* forecasting method, and the *constant prediction* forecasting method. Also, we propose a third method which permits to simulate different levels of forecasting errors. The obtained levels of error are bounded by the performance of the two reference approaches. These three methods are presented and evaluated in the next section.

Before explaining the details of these approaches, it is interesting to derive the relation between the price $\hat{\Pi}^\Delta$ formulated in Equation C.6 and the original price $\hat{\Delta}^\Pi$. This relation is obtained as follows:

$$\widehat{\delta}^{\text{DA}}(\widehat{E}, E^{\text{DA}}) = \sum_{s=\{-,o,+\}} \alpha_s \cdot \widehat{\delta}^{\text{DA}}(\widehat{E}, E^{\text{DA}})_{|\widehat{\Pi}^\Delta = \widehat{\Pi}_s^\Delta} \quad (\text{C.7})$$

$$= \sum_{s=\{-,o,+\}} \alpha_s \cdot \max\left(0, (\widehat{E} - E^{\text{DA}}) \times \widehat{\Pi}_s^\Delta\right) \quad (\text{C.8})$$

$$= \begin{cases} |\widehat{E} - E^{\text{DA}}| \times \left(\alpha_- \cdot |\widehat{\Pi}_-^\Delta|\right) & \widehat{E} < E^{\text{DA}} \\ |\widehat{E} - E^{\text{DA}}| \times \left(\alpha_+ \cdot |\widehat{\Pi}_+^\Delta|\right) & \widehat{E} \geq E^{\text{DA}} \end{cases} \quad (\text{C.9})$$

By comparing the later equation with the formulation of $\widehat{\delta}^{\text{DA}}$ given in Equation 4.11, we obtain $\widehat{\Delta}_-^\Pi = \alpha_- \cdot |\widehat{\Pi}_-^\Delta|$ and $\widehat{\Delta}_+^\Pi = \alpha_+ \cdot |\widehat{\Pi}_+^\Delta|$.

C.4 Proposition of a simulation approach for market price forecasts and errors

C.4.1 Formulation of the considered simulation approaches

The perfect prediction approach

In the perfect prediction approach, the TSO regulation state is perfectly known and either α_- or α_o or α_+ equals one. The corresponding price quantity $\widehat{\Pi}_s^\Delta$, where s is the state so that $\alpha_s = 1$, is equal to the observed imbalance penalty price Π^Δ . For example, in the case of TSO up-regulation, the perfect prediction forecast for the market time unit T_i is:

$$\left(\widehat{\Pi}_-^\Delta, T_i = \Pi_{T_i}^\Delta < 0, \alpha_-, T_i = 1\right) \quad (\text{C.10})$$

The constant prediction approach

In the constant prediction approach, the discrete probabilistic forecast is constant for all the different runs and horizons. This approach is similar to the constant approach relative to wind generation forecasting, described in section B.2. The approach also consists in assuming equal positive and negative imbalance penalization. Consequently, for any market time unit T_i , the constant forecast $\widehat{\Pi}_{T_i}^\Delta$ is given by:

$$\widehat{\Pi}_{T_i}^\Delta = \begin{cases} \left(\widehat{\Pi}_-^\Delta = -10, \alpha_- = 0.40\right) \\ \left(\widehat{\Pi}_o^\Delta = 0, \alpha_o = 0.20\right) \\ \left(\widehat{\Pi}_+^\Delta = 10, \alpha_+ = 0.40\right) \end{cases} \quad (\text{C.11})$$

The probabilities α and prices $\hat{\Pi}_{+/-}^{\Delta}$ proposed here are obtained by considering the observed prices in the NordPool market during the years 2003 and 2004.

With this constant price forecast, the estimated imbalance penalty $\hat{\delta}^{\text{DA}}$ is proportional to the estimated absolute energy imbalance, as can be straightforwardly obtained from Equation C.9:

$$\hat{\delta}^{\text{DA}} \propto |\hat{E} - E^{\text{DA}}| \quad (\text{C.12})$$

In other words, the decision-making methods which aim at minimizing the expected imbalance penalty $\hat{\delta}^{\text{DA}}$ based on this constant price forecast, are actually methods which aim at minimizing the expected absolute energy imbalance $|\hat{E} - E^{\text{DA}}|$. This point is discussed in the section 4.6 relative to the strategic combination of a storage unit with a wind farm. Finally, the performance of this baseline approach is evaluated in the next section C.4.2.

Proposal of a method for simulating imbalance penalty price forecasting errors

The two forecasting approaches presented above correspond to the upper and lower bounds of the forecasting problem: in the perfect prediction approach, all the information about future price is available in the forecast whereas the constant prediction provides the minimal information about the future price. This section gives a method for simulating price forecasts with a level of error between these two references. The simulated forecast is derived from the perfect prediction forecast based on two error parameters :

- A first parameter ϵ is a constant which is related to the uncertainty about the TSO regulation state. For example, in the case of up-regulation, instead of having a probability $\alpha_- = 1$ and $\alpha_+ = 0$ in the perfect prediction case, the proposed ϵ -model will give $\alpha_- = \epsilon$ and $\alpha_+ = (1 - \epsilon)$. Similarly, in the case of down-regulation, instead of having a probability $\alpha_- = 0$ and $\alpha_+ = 1$ in the perfect prediction case, the proposed ϵ -model will give $\alpha_- = (1 - \epsilon)$ and $\alpha_+ = \epsilon$. The constant parameter ϵ models the uncertainty about the TSO regulation state. The perfect prediction approach is a particular case of the model with $\epsilon = 1$. The ϵ -model does not affect the situations where there is no regulation (i.e. $\alpha_o = 1$). Also, the price forecast values $\hat{\Pi}_+^{\Delta}$ and $\hat{\Pi}_-^{\Delta}$ are equal in the proposed model.
- The second parameter τ models a phase error. Such parameter is a time period duration and corresponds to a delay. It is also a constant for a given

τ -model. For example, instead of considering the perfect prediction for a given market time T_i , the τ -model gives the perfect prediction relative to the market time $T_i - \tau$. Such approach corresponds to the so-called *persistence* model, already described in the wind power forecasting section. The perfect prediction approach is a particular case of the τ -model with $\tau = 0$.

The (ϵ, τ) -model combines the two parameters. For example, if the regulation state corresponding to the market time $T_i - \tau$ is up-regulation, the (ϵ, τ) forecast for the market time T_i is given by:

$$\widehat{\Pi}_{T_i}^{\Delta} = \begin{cases} \widehat{\Pi}_{-, T_i}^{\Delta} = \widehat{\Pi}_{-, T_i - \tau}^{\Delta} & , \alpha_- = \epsilon \\ \widehat{\Pi}_{o, T_i}^{\Delta} = 0 & , \alpha_o = 0 \\ \widehat{\Pi}_{+, T_i}^{\Delta} = \widehat{\Pi}_{-, T_i - \tau}^{\Delta} & , \alpha_+ = 1 - \epsilon \end{cases} \quad (\text{C.13})$$

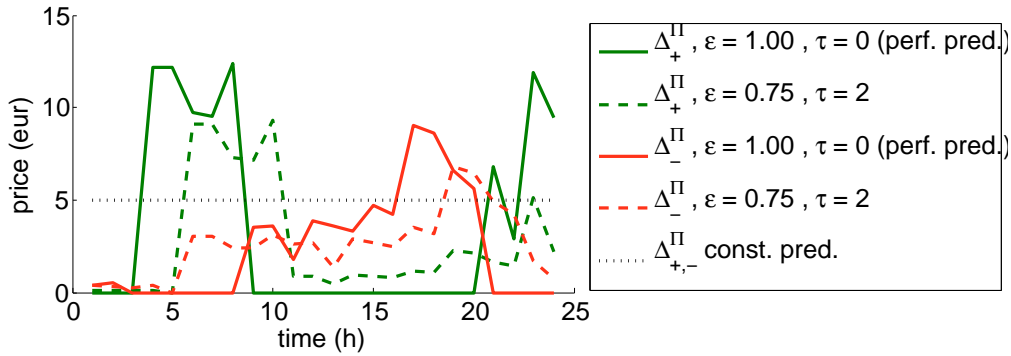

Figure C.2: Example of results of simulated forecasts of the imbalance penalty price $\Delta_{+/-}^{\Pi}$, based on an uncertainty parameter $\epsilon = 0.75$ and the phase error $\tau = 3$ h. Note that the real value of the prices coincides to the perfect prediction.

Figure C.3 illustrates the imbalance penalty price resulting from the (ϵ, τ) -model. The prices $\widehat{\Delta}_{+}^{\Pi}$ $\widehat{\Delta}_{-}^{\Pi}$ described in the figure are obtained from the distribution of $\widehat{\Pi}^{\Delta}$ from the relation given in section C.3.2:

$$\widehat{\Delta}_{+}^{\Pi} = \alpha_{+} \cdot |\widehat{\Pi}_{+}^{\Delta}| \quad \text{and} \quad \widehat{\Delta}_{-}^{\Pi} = \alpha_{-} \cdot |\widehat{\Pi}_{-}^{\Delta}| \quad (\text{C.14})$$

and the perfect predictions are illustrated with plain lines while the (ϵ, τ) -forecasts are illustrated with dashed lines. Regarding the perfect prediction, either the price for positive imbalance Δ_{+}^{Π} , or the price for negative imbalance Δ_{-}^{Π} , is non null. In

¹Note that, due to editing problems, the price forecast $\widehat{\Delta}_{-}^{\Pi}$ is denoted as Δ_{-}^{Π} in the figure; similarly, the price forecast $\widehat{\Delta}_{+}^{\Pi}$ is denoted as Δ_{+}^{Π} . This comment is also valid for the next figure C.3.

the case of the (ϵ, τ) -forecast, the non null price $\Delta_{+/-}^{\Pi}$ is reduced to $\epsilon = 75\%$ of the non null price. Also, the price which was null in the case of perfect prediction equals $(1 - \epsilon) = 25\%$ of the non null price. Also the (ϵ, τ) -forecast is delayed by $\tau = 2 h$.

C.4.2 Evaluation of the considered simulation approaches

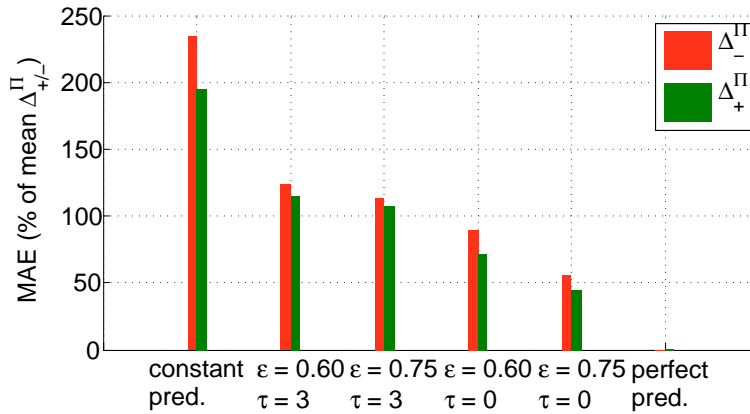

Figure C.3: Mean absolute error of the (ϵ, τ) -price forecasting model, and comparison with the constant prediction and the perfect prediction.

Figure C.3 presents the performance of the different imbalance penalty price forecasting models. The forecasting performance is evaluated through the Mean Absolute Error, as a fraction of the mean imbalance penalty price $\hat{\Delta}_{+/-}^{\Pi}$. The constant and perfect prediction approaches are represented as the upper and lower bounds: the perfect prediction has a null error, while the constant prediction has a high MAE, reaching 200 % of the mean imbalance penalty price. Figure C.3 also shows that, regarding the (ϵ, τ) -model, the MAE increases as ϵ increases, and that, similarly, the MAE increases as τ increases.

Finally, Figure C.3 demonstrates the interest of the proposed method for simulating imbalance penalty price forecasts. More precisely, the resulting forecasts have a level of performance which can be adjusted in order to reach a given level of error. Such a method is particularly useful for evaluating the influence of the price forecasting performance on the decision relative to the trading of renewable generation in short-term electricity market, such as in section 5.5.

Estimation of the Loss Distribution from the Predictive Energy and Price Distribution

The aim of this section is to explain the derivation of loss distribution from the energy and price distributions. In a first step, the loss is formulated as a function of the energy and market price. Then, the general formulation of the loss distribution is given in the case of continuous probabilistic distribution for both the energy and the market price. The simplified formulation in the case of discrete probabilistic forecast of the market price is presented in the last section.

D.1 Formulation of the loss

For a decision v , the loss $\lambda(v)$ associated to this decision is formulated in Equation 5.34 as:

$$\lambda(v) = Y(\tilde{v}) + \max\left(0, \left(\hat{E} + y(\tilde{v}) - E^{DA}\right) \times \hat{\Pi}^\Delta\right) \quad (\text{D.1})$$

where \hat{E} and $\hat{\Pi}^\Delta$ are the energy and price forecasts. \tilde{v} is the realization associated to v . $Y(\tilde{v})$ and $y(\tilde{v})$ are the additional cost and balance energy volume associated to the realization \tilde{v} , respectively. The quantities \tilde{v} , $Y(\tilde{v})$ and $y(\tilde{v})$ depend on the decision v . In the present formulation, the decision v is supposed to be given (i.e. to have a fixed value), and consequently, the loss can be rewritten as:

$$\lambda(v) = a + \max\left(0, (\hat{E} - b) \times \hat{\Pi}^\Delta\right) \quad (\text{D.2})$$

with the parameters a and b defined by $a = Y(\tilde{v})$ and $b = E^{DA} - y(\tilde{v})$. In Equation D.3, the loss is a function of the energy forecast \hat{E} and price forecast $\hat{\Pi}^\Delta$. Such function is denoted as γ , which is defined by:

$$\gamma(\hat{E}, \hat{\Pi}^\Delta) = a + \max\left(0, (\hat{E} - b) \times \hat{\Pi}^\Delta\right) \quad (\text{D.3})$$

The function γ does not aim at modeling a different loss, but rather at reformulating the loss as a function of the energy forecast \hat{E} and price forecast $\hat{\Pi}^\Delta$.

D.2 General solution of the problem

The loss λ is formulated in Equation D.3 as a function of the energy forecast \hat{E} and the price forecast $\hat{\Pi}^\Delta$. For simplifying the mathematical expressions, the price quantity Π^Δ is simplified to Π . In the general case, the energy and price forecasts are considered to be probabilistic forecasts in the form of predictive probability density function (pdf). The pdf associated to the energy forecast is denoted as \hat{f}_E and the one for the price forecast as \hat{f}_Π .

The determination of the distribution of a random variable λ then consists in determining its pdf denoted as f_λ . The formulation of the loss given Equation D.3, combined with Bayes' theorem for continuous distributions, gives:

$$f_\lambda(z) = f_{\gamma(E, \Pi)}(z) = \int_{A_\Pi} f_{\gamma(E, \Pi)|\Pi=y}(z) \cdot \hat{f}_\Pi(y) dy \quad (\text{D.4})$$

where A_Π is the set of possible price Π . Then, the main objective is to obtain the pdf $f_{\gamma(E, \Pi)|(\Pi=y)}$. For a given price Π set to $\Pi = y$, the function $\gamma(E, \Pi)|_{(\Pi=y)}$ is a function of only one variable: the energy E . For simplifying the mathematical expressions, the function $\gamma(E, \Pi)|_{(\Pi=y)}$ is denoted as γ_y :

$$\gamma(E, \Pi)|_{(\Pi=y)} = \gamma_y \quad (\text{D.5})$$

$$f_{\gamma(E, \Pi)|(\Pi=y)} = f_{\gamma_y(E)} \quad (\text{D.6})$$

The derivation of the pdf $f_{\gamma(E, \Pi)|(\Pi=y)}$ can thus be interpreted as a variable substitution problem, from the variable E to the variable $\gamma(E, \Pi)|_{(\Pi=y)}$. Then, the new variable $\gamma(E, \Pi)|_{(\Pi=y)}$ is simplified by considering three cases: $y < 0$, $y = 0$ and $y > 0$.

$$y < 0 : \gamma(E, \Pi)_{|\Pi=y} = \gamma_y(E) = \begin{cases} a + (E - b) \times y, & E < b \\ a, & E \geq b \end{cases} \quad (\text{D.7})$$

$$y = 0 : \gamma(E, \Pi)_{|\Pi=y} = \gamma_y(E) = a \quad (\text{D.8})$$

$$y > 0 : \gamma(E, \Pi)_{|\Pi=y} = \gamma_y(E) = \begin{cases} a, & E < b \\ a + (E - b) \times y, & E \geq b \end{cases} \quad (\text{D.9})$$

E is the energy delivered by the RES unit and is positive; the maximum delivered energy is denoted as E^{max} . Consequently, the function γ_y is defined on the interval $I = [0, E^{max}]$. Also, the interval I is divided into two interval I^- and I^+ defined as follows:

$$I = I^- \cup I^+, \text{ with } \begin{cases} I^- = [0, b] \\ I^+ = [b, E^{max}] \end{cases} \quad (\text{D.10})$$

Such decomposition is valid for $0 \leq b \leq E^{max}$. If $b < 0$, $I^- = \emptyset$ and $I^+ = I$. If $b > E^{max}$, $I^- = I$ and $I^+ = \emptyset$.

D.2.1 Formulation of the variable substitution problem

The following equations give the derivation of the pdf $f\gamma_y(E)$ for the three cases: $y > 0$, $y > 0$ and $y = 0$. For each case, the derivation of the pdf $f\gamma_y(E)$ is then based on the decomposition of the definition interval $I = I^- \cup I^+$. For each one of these two sub intervals, the variable substitution problem is simplified.

- $y > 0$

- $I^- = [0, b]$: the function γ_y on the interval I^- , is a constant function equal to a . The image of the interval I^- by the function γ_y is the singleton $\{a\}$;
- $I^+ = [b, E^{max}]$: the function γ_y is an affine function, which is derivable and invertible;

The restriction of γ_y on I^+ is denoted as γ_y^+ ;

The inverse function of γ_y on I^+ is denoted as $\gamma_y^{+,-1}$;

The derivative function of γ_y is denoted as $\gamma_y^{+'}$;

The image of the interval I^+ is the interval $\gamma_y(I^+) = [a, a + (E^{max} - b) \cdot y]$.

The resulting pdf $f\gamma_{y(E)}$ is defined for $z \in \gamma_y(I^+)$ as:

$$f\gamma_{y(E)}(z) = \int_0^b \widehat{f}_{E|\Pi=y}(x)dx \cdot d(z-a) + \frac{1}{|\gamma_y^+{}'(z)|} \cdot \widehat{f}_{E|\Pi=y}(\gamma_y^{+,-1}(z)) \quad (\text{D.11})$$

where d is the Dirac delta function, defined by:

$$d(z-a) = \begin{cases} 1 & \text{if } z = a \\ 0 & \text{if } z \neq a \end{cases}$$

The first term of Equation D.11 is relative to the variable substitution for the interval I^- , while the second term is relative to the interval I^+ . Also, in the present case, $\gamma_y^+{}' = y$. The function $f\gamma_{y(E)}$ is considered to be null for $z \notin \gamma_y(I^+)$.

- $y < 0$

Similarly to the case $y > 0$, the pdf $f\gamma_{y(E)}$ is defined for $z \in \gamma_y(I^-)$ as:

$$f\gamma_{y(E)}(z) = \int_b^{E^{max}} \widehat{f}_{E|\Pi=y}(x)dx \cdot d(z-a) + \frac{1}{|\gamma_y^-{}'(z)|} \cdot \widehat{f}_{E|\Pi=y}(\gamma_y^{-,-1}(z)) \quad (\text{D.12})$$

where γ_y^- is the restriction of γ_y on I^- . Also the function $f\gamma_{y(E)}$ is considered to be null for $z \notin \gamma_y(I^-)$.

- $y = 0$

The function γ_y is a constant function equal to a on both intervals I^- and I^+ . Consequently,

$$f\gamma_{y(E)}(z) = d(z-a) \quad (\text{D.13})$$

D.2.2 Summary

Finally, the pdf $f\gamma_{(E,\Pi)|\Pi=y}$ has been formulated for the different possible values of y as a function of the conditional distribution of the delivered energy: $\widehat{f}_{E|\Pi\Delta=y}$. Then, the final loss pdf f_λ can be obtained from Equation D.4 by decomposing the set A_Π into three domains where $\Pi < 0$, $\Pi = 0$ and $\Pi > 0$. For each domain, the conditional loss pdf $f\gamma_{(E,\Pi)|\Pi=y}$ is given from Equation D.11, Equation D.12, Equation D.13.

The loss pdf f_λ is not explicitly formulated here. However, the explicit formulation is given in the simplified case of discrete probabilistic forecast of the price.

D.3 Solution of the simplified problem

The general problem discussed in the previous paragraph is simplified when considering a discrete probabilistic forecast of the market price. Also, the forecast of the delivered energy is supposed to be independent from the price Π^Δ , and consequently, for all $y \in A_\Pi$, $\hat{f}_{E|\Pi^\Delta=y} = \hat{f}_E$.

The discrete distribution of the market price $\Pi = \Pi^\Delta$ is the one given in Equation C.6:

$$\hat{\Pi}^\Delta = \begin{cases} \left(\hat{\Pi}_-^\Delta < 0, \alpha_- \right) \\ \left(\hat{\Pi}_o^\Delta = 0, \alpha_o \right) \\ \left(\hat{\Pi}_+^\Delta > 0, \alpha_+ \right) \end{cases} \quad (\text{D.14})$$

Based on this discrete price distribution, the loss pdf can be rewritten from Equation D.4 as:

$$f\gamma_{(E,\Pi)}(z) = \sum_{s=\{-,o,+\}} \alpha_s \cdot f\gamma_{(E,\Pi)|\Pi=\Pi_s^\Delta}(z) \quad (\text{D.15})$$

with $\Pi_-^\Delta < 0$, $\Pi_+^\Delta > 0$ and $\Pi_o^\Delta < 0$

The expressions of $f\gamma_{(E,\Pi)|\Pi=\Pi_s^\Delta}$ are given from the previous paragraph, according to the sign of the price $\Pi = \Pi_s^\Delta$:

- $f\gamma_{(E,\Pi)|\Pi=\Pi_+^\Delta}$ is determined using Equation D.11;
- $f\gamma_{(E,\Pi)|\Pi=\Pi_-^\Delta}$ is determined using Equation D.12;
- $f\gamma_{(E,\Pi)|\Pi=\Pi_o^\Delta}$ is determined using Equation D.13.

Equation D.11 and Equation D.12 are simplified by using cumulated density function \hat{F}_E of the delivered energy \hat{E} :

$$\int_0^b \hat{f}_E(x)dx = \hat{F}_E(b) \quad \text{and} \quad \int_b^{E^{max}} \hat{f}_E(x)dx = 1 - \hat{F}_E(b) \quad (\text{D.16})$$

which gives:

$$f_\lambda(z) = A \cdot d(z - a) + B \cdot \hat{f}_E(\gamma_{\hat{\Pi}_-^\Delta}^{-,-1}(z)) + C \cdot \hat{f}_E(\gamma_{\hat{\Pi}_+^\Delta}^{+,-1}(z)) \quad (\text{D.17})$$

with

$$A = \alpha_- \cdot (1 - \widehat{F}_E(b)) + \alpha_0 + \alpha_+ \cdot \widehat{F}_E(b) \quad (\text{D.18})$$

$$B = \alpha_- \cdot \frac{1}{|\widehat{\Pi}_-^\Delta|} \quad (\text{D.19})$$

$$C = \alpha_+ \cdot \frac{1}{|\widehat{\Pi}_+^\Delta|} \quad (\text{D.20})$$

The functions $\gamma_{\widehat{\Pi}_-^\Delta}^-$ and $\gamma_{\widehat{\Pi}_+^\Delta}^+$ are affine functions defined by:

$$\gamma_{\widehat{\Pi}_-^\Delta}^- : [0, b] \mapsto [a, a - b \cdot \widehat{\Pi}_-^\Delta] \quad (\text{D.21})$$

$$z \mapsto \gamma_{\widehat{\Pi}_-^\Delta}^-(z) = a + \widehat{\Pi}_-^\Delta \times (z - b) \quad (\text{D.22})$$

and

$$\gamma_{\widehat{\Pi}_+^\Delta}^+ : [b, E^{max}] \mapsto [a, a + (E^{max} - b) \cdot \widehat{\Pi}_+^\Delta] \quad (\text{D.23})$$

$$z \mapsto \gamma_{\widehat{\Pi}_+^\Delta}^+(z) = a + \widehat{\Pi}_+^\Delta \times (z - b) \quad (\text{D.24})$$

The first term of the loss pdf in the first line of Equation D.17 is the weighted dirac function $d(z - a)$. The last two terms correspond to the penalization of the negative and positive imbalance energy.

Consequently, in the case of the simplified problem based on discrete distribution of the market price $\widehat{\Pi}^\Delta$, and independent from the energy forecast \widehat{E} , the pdf of the loss can be explicitly derived from the predictive pdf of the delivered energy and the function γ . The predictive pdf for delivered energy E is given from RES power forecasting methods. Example of loss pdf are given in section 5.4, where the risk management related to the storage combination is analyzed.

Bibliography

- [1] J. de Jong, *European Energy Law Report V*. Intersentia, 2008, ch. The 2007 Energy package: the start of a new area?, pp. 95–108.
- [2] EU, “Directive 96/92/ce du parlement européen et du conseil du 19 dcembre 1996 concernant des rgles communes pour le march intrieur de l’électricit,” 1996.
- [3] G. Bahgat, “Europe’s energy security: challenges and opportunities,” *International Affairs*, vol. 82, no. 5, pp. 961–975, 2006. [Online]. Available: <http://dx.doi.org/10.1111/j.1468-2346.2006.00580.x>
- [4] IEA-REWP, “Renewable energy ... into the mainstream,” International Energy Agency Renewable Energy Working Party, Tech. Rep., 2002.
- [5] IEA, “World energy outlook 2004,” IEA, Tech. Rep., 2005.
- [6] C. d. Armines, G. CRES, (Centre pour les énergies renouvelables, and A. ZREU, (Centre pour l’Utilisation Rationnelle de l’Energie et l’Environnement, “Production d’électricité à partir des énergies renouvelables - les différentes filières technologiques,” CRES and Armines and ZREU, Tech. Rep., 2001.
- [7] M. Ding, *Encyclopedia of Nonlinear Science*. Routledge, 2000, ch. Intermittency.
- [8] IEA, “Variability of wind power and other renewables: Management options and strategies,” International Energy Agency, Tech. Rep., 2005, prepared by Timur Gul and Till Stenzel.
- [9] V. Akhmatov, J. P. Kjaergaard, and H. Abildgaard, “Announcement of the large offshore wind farm horns rev b and experience from prior project in denmark,” in *European Wind Energy Conference 2004 Proceedings*, 2004.
- [10] EWEA, “Large scale integration of wind energy in the european power supply: analysis, issues and recommendations,” European Wind Energy Association, Tech. Rep., 2005.
- [11] N. Siebert, “Development of methods for regional wind power forecasting,” Ph.D. dissertation, Ecole des Mines de Paris, 2008.

BIBLIOGRAPHY

- [12] D. Hubbard, *How to Measure Anything: Finding the Value of Intangibles in Business*. John Wiley & Sons, 2007.
- [13] M. Gibescu and A. Brand, "Estimation of system balancing requirements due to the integration of large-scale wind energy," in *Sixth International Workshop on Large-scale Integration of Wind Power and Transmission Networks for Offshore Wind Farms*, 2006.
- [14] S. Payyala and T. Green, "Sizing of distributed generation plant through techno-economic feasibility assessment," in *Power Engineering Society General Meeting, 2006. IEEE*, 2006, pp. 8 pp.-.
- [15] T. Ackermann, G. Andersson, and L. Sder, "Distributed generation: a definition," *Electric Power Systems Research*, vol. 57, no. 3, pp. 195 – 204, 2001. [Online]. Available: <http://www.sciencedirect.com/science/article/B6V30-433P80D-8/2/9e30df9b3779106926f671f6c28e3660>
- [16] G. Pepermans, J. Driesen, D. Haeseldonckx, R. Belmans, and W. D'haeseleer, "Distributed generation: definition, benefits and issues," *Energy Policy*, vol. 33, no. 6, pp. 787 – 798, 2005. [Online]. Available: <http://www.sciencedirect.com/science/article/B6V2W-4B28VPS-5/2/afa21b5e6bb1cc86a9f191a2121fdd35>
- [17] EREC, "Renewable energy technology roadmap 20% by 2020," European Renewable Energy Council, Tech. Rep., 2008.
- [18] EWEA, "Pure power, wind energy scenarios up to 2030," European Wind Energy Association, Tech. Rep., 2008.
- [19] AWEA, "Annual wind industry report - year ending 2008," American Wind Energy Association, Tech. Rep., 2009.
- [20] D. Pudjianto, C. Ramsay, and G. Strbac, "Virtual power plant and system integration of distributed energy resources," *Renewable Power Generation, IET*, vol. 1, no. 1, pp. 10–16, 2007.
- [21] I. Erlich and U. Bachmann, "Grid code requirements concerning connection and operation of wind turbines in germany," in *Power Engineering Society General Meeting, 2005. IEEE*, 2005, pp. 1253–1257 Vol. 2.
- [22] *Grid Code High and Extra High Voltage*, E.ON Netz GmbH, August 2003. [Online]. Available: <http://www.eon-netz.com>
- [23] E.ON, "Wind report 2005," E.ON Netz GmbH, Tech. Rep., 2006.
- [24] A. Suwannarat, B. Bak-Jensen, Z. Chen, H. Nielsen, J. Hjerrild, P. Sorensen, and A. D. Hansen, "Power system operation with large scale wind power integration," in *Power Tech, 2007 IEEE Lausanne*, 2007, pp. 671–676.
- [25] H. Holttinen, P. Meibom, C. Ensslin, L. Hofmann, J. McCann, J. Pierik, J. O. Tande, E. Hagstrm, A. Estanqueiro, H. Amaris, L. Sder, G. Strbac, and B. Parsons, "Design and operation of power systems with large amounts of wind power production, iea collaboration," in *European Wind Energy Conference 2006 Proceedings*, 2006.
- [26] S. Stoft, *Power System Economics, Designing Markets for Electricity*. IEEE Press, 2002.

BIBLIOGRAPHY

- [27] J. Kabouris and C. Vournas, "Application of interruptible contracts to increase wind-power penetration in congested areas," *Power Systems, IEEE Transactions on*, vol. 19, no. 3, pp. 1642–1649, 2004.
- [28] ETSO, "Report on renewable energy sources (res)," European Transmission System Operators, Tech. Rep., 12 2003.
- [29] P. Juston, F. Guy, S. Henry, and P. Bertolini, "Contrôle de la participation des groupes de production français aux réglages de fréquence et de tension," *REE. Revue de l'électricité et de l'électronique*, vol. 5, pp. 23–30, 2008.
- [30] "Ucte (union for the co-ordination of transmission of electricity) website." [Online]. Available: <http://www.ucte.org/>
- [31] V. L. Biez, "Eoliennes: nouveau souffle ou vent de folie?" Institut Montaigne, Tech. Rep., 2008.
- [32] G. Rothwell and T. Gómez, *Electricity Economics*, IEEE, Ed. Wiley-IEEE Press, 2003.
- [33] M. Bayegan, "A vision of the future grid," *Power Engineering Review, IEEE*, vol. 21, no. 12, pp. 10–12, 2001.
- [34] N. M. Bhandari, G. Burt, K. P. Dahal, S. Galloway, and M. Jim, "Dispatch optimisation of renewable energy generation participating in a liberalised electricity market," *International Journal of Emerging Electric Power Systems*, vol. 8, p. 1, 2007.
- [35] IEA, "Lessons from liberalised electricity markets," International Energy Agency, Tech. Rep., 2007.
- [36] M. Shahidehpour, H. Yamin, and Z. Li, *Market Operations in Electric Power Systems - Forecasting, Scheduling and Risk Management*, J. Wiley and Sons, Eds. IEEE, 2002.
- [37] M. Braun, "Provision of ancillary services by distributed generators," Ph.D. dissertation, University of Kassel, Faculty of electrical engineering-computer science, 2008.
- [38] J. R. Abbad, V. M. Quezada, and T. G. S. Román, "Limits in the integration of wind farms in the spanish wholesale electrical market," in *Sixth International Workshop on Large-scale Integration of Wind Power and Transmission Networks for Offshore Wind Farms*, 2006.
- [39] "Nord pool website." [Online]. Available: <http://www.nordpool.com/>
- [40] S. Hunt, *Making Competition Work in Electricity*. John Wiley & Sons, 2002.
- [41] ETSO, "Current state of intraday markets in europe," European Transmission System Operators, Tech. Rep., 2007.
- [42] *Trade at the Nordic Spot Market (Nord Pool Spot AS)*, Nord Pool ASA, 2004.
- [43] S. Singh and I. Erlich, "Wind power trading options in competitive electricity market," in *Power Engineering Society General Meeting, 2006. IEEE*, 2006, pp. 7 pp.–.
- [44] ERGEG, "Ergeg guidelines of good practice for electricity balancing markets integration," European Regulators' Group for Electricity and Gas, Tech. Rep., 2006.
- [45] J. C. Hull, *Options, Futures, and Other Derivatives*. 4th Edition, 2000.

BIBLIOGRAPHY

- [46] P. E. Morthorst, S. Wagemans, K. Purchala, A. Woyte, A. Cena, H. Cleijne, C. Kleinschmidt, and N. Moldovan, “Detailed investigation of electricity market rules,” TradeWind, Tech. Rep., 2007.
- [47] R. Madlener and M. Kaufmann, “Power exchange spot market trading in europe: theoretical considerations and empirical evidence,” OSCOGEN (Optimisation of Co-generation Systems in a Competitive Market Environment), Deliverable 5.1b, Tech. Rep., 2002.
- [48] TenneT, “The imbalance pricing system as at 1 january 2001,” TenneT, Tech. Rep., 2001.
- [49] F. Boisseleau and R. Hakvoort, “The liberalisation of the european electricity market(s): An unstructured restructuring process?” *The Energy Studies Review*, vol. 13, no. 2, pp. 15–21, 2005.
- [50] P. Morthorst, B. Jorgensen, H. Chandler, and C. Kjaer, “Evaluation of renewable support schemes,” Re-Xpansion project, Work Package 2, Final Report, Tech. Rep., 2005. [Online]. Available: http://www.ewea.org/fileadmin/ewea_documents/documents/projects/rexpansion/050531_Rex-final.report.pdf
- [51] IEA-RETD, “Innovative electricity markets to incorporate variable production,” International Energy Agency - Renewable Energy Technology Deployment, Tech. Rep., 2008.
- [52] EWEA, “Support schemes for renewable energy - a comparative analysis of payment mechanisms in the eu,” European Wind Energy Association, Tech. Rep., 2005.
- [53] P. Menanteau, D. Finon, and M.-L. Lamy, “Prices versus quantities: choosing policies for promoting the development of renewable energy,” *Energy Policy*, vol. 31, no. 8, pp. 799 – 812, 2003. [Online]. Available: <http://www.sciencedirect.com/science/article/B6V2W-46YBNVJ-1/2/fc6957b25f6f206240d6c4b9d26892a6>
- [54] C. Mitchell, D. Bauknecht, and P. Connor, “Effectiveness through risk reduction: a comparison of the renewable obligation in england and wales and the feed-in system in germany,” *Energy Policy*, vol. 34, no. 3, pp. 297 – 305, 2006, renewable Energy Policies in the European Union. [Online]. Available: <http://www.sciencedirect.com/science/article/B6V2W-4DGMRS3-1/2/9528d299e8856b28129631aef943812a>
- [55] C. Klessmann, C. Nabe, and K. Burges, “Pros and cons of exposing renewables to electricity market risks—a comparison of the market integration approaches in germany, spain, and the uk,” *Energy Policy*, vol. 36, no. 10, pp. 3646 – 3661, 2008. [Online]. Available: <http://www.sciencedirect.com/science/article/B6V2W-4T3TR1B-3/2/a88bec6283bf0fc3fcd5e8b3894c47f>
- [56] A. Baillo, M. Ventosa, A. Ramos, M. Rivier, and A. Canseco, *The Next Generation of Electric Power Unit Commitment Models*. Kluwer Academic Publishers, 2001, ch. Strategic unit commitment for generation in deregulated electricity markets, pp. 227–248.
- [57] N. S. Rau, *Optimization Advances in Electric Power Systems*. Nova Science Publishers, 2008, ch. Chapter 3: The Impact of Deregulation on Mathematical Models Using Optimization Techniques to Aid System Planning and Operations, pp. 53–58.

BIBLIOGRAPHY

- [58] Y.-M. S. Drenant, “Wind power predictions analysispart 1: Tennet imbalance price system. development of a model for tennet imbalance price system,” Energy Research Center of the Netherlands, ECN, Tech. Rep. report-ECN-I-02-010, 2002.
- [59] M. Sewalt and C. de Jong, “Negative prices in electricity markets,” *Commodities Now*, June 2003.
- [60] U. Linnet, “Tools supporting wind energy trade in deregulated markets,” Master’s thesis, Informatics and Mathematical Modelling, Technical University of Denmark, DTU, Richard Petersens Plads, Building 321, DK-2800 Kgs. Lyngby, 2005, supervised by Prof. Henrik Madsen, IMM, and Assoc. Prof. Henrik Aalborg Nielsen, IMM. [Online]. Available: <http://www2.imm.dtu.dk/pubdb/p.php?3969>
- [61] A. Boogert and D. Dupont, “On the effectiveness of the anti-gaming policy between the day-ahead and real-time electricity markets in the netherlands,” *Energy Economics*, vol. 27, no. 5, pp. 752–770, Sep. 2005. [Online]. Available: <http://www.sciencedirect.com/science/article/B6V7G-4GBWJGB-1/2/8c2a625dd75a877a5e32dcb7d5b8880f>
- [62] G. Bathurst, J. Weatherill, and G. Strbac, “Trading wind generation in short term energy markets,” *Power Systems, IEEE Transactions on*, vol. 17, no. 3, pp. 782–789, 2002.
- [63] A. Woyte, G. Palmers, and L. Dewilde, “Balancing costs for large wind farms: the influence of short-term forecasting and the regulatory framework,” in *Sixth International Workshop on Large-scale Integration of Wind Power and Transmission Networks for Offshore Wind Farms*, 2006.
- [64] A. Fabbri, T. GomezSanRoman, J. RivierAbbad, and V. MendezQuezada, “Assessment of the cost associated with wind generation prediction errors in a liberalized electricity market,” *Power Systems, IEEE Transactions on*, vol. 20, no. 3, pp. 1440–1446, 2005.
- [65] J. Usaola and J. Angarita, “Benefits of short term wind power prediction programs for the integration of wind energy in electricity markets,” in *European Wind Energy Conference 2006, Athens, Greece, 27/2-2/3 2006*, 2006.
- [66] J. M. Angarita and J. G. Usaola, “Combining hydro-generation and wind energy: Biddings and operation on electricity spot markets,” *Electric Power Systems Research*, vol. 77, no. 5-6, pp. 393–400, Apr. 2007. [Online]. Available: <http://www.sciencedirect.com/science/article/B6V30-4K48M73-1/2/9072a85cb57b6fa1d9c5de42944a804f>
- [67] P. Pinson, C. Chevallier, and G. Kariniotakis, “Trading wind generation from short-term probabilistic forecasts of wind power,” *Power Systems, IEEE Transactions on*, vol. 22, no. 3, pp. 1148–1156, 2007.
- [68] J. Matevosyan and L. Soder, “Minimization of imbalance cost trading wind power on the short-term power market,” *Power Systems, IEEE Transactions on*, vol. 21, no. 3, pp. 1396–1404, Aug. 2006.
- [69] C. Brunetto, M. Nicita, and G. Tina, “Wind generation in day-ahead energy markets in italy: Imbalances penalties,” in *Power Tech, 2007 IEEE Lausanne*, 2007, pp. 938–942.
- [70] J. Usaola and J. Angarita, “Bidding wind energy under uncertainty,” in *Clean Electrical Power, 2007. ICCEP '07. International Conference on*, 2007, pp. 754–759.

BIBLIOGRAPHY

- [71] H. Holttinen, "Optimal electricity market for wind power," *Energy Policy*, vol. 33, pp. 2052–2063, 2004.
- [72] A. Baillo, S. Cerisola, J. Fernandez-Lopez, and R. Bellido, "Strategic bidding in electricity spot markets under uncertainty: a roadmap," in *Power Engineering Society General Meeting, 2006. IEEE*, 2006, pp. 8 pp.–.
- [73] M. Plazas, A. Conejo, and F. Prieto, "Multimarket optimal bidding for a power producer," *Power Systems, IEEE Transactions on*, vol. 20, no. 4, pp. 2041–2050, 2005.
- [74] M. Pereira, S. Granville, M. Fampa, R. Dix, and L. Barroso, "Strategic bidding under uncertainty: a binary expansion approach," *Power Systems, IEEE Transactions on*, vol. 20, no. 1, pp. 180–188, 2005.
- [75] A. Ugedo, E. Lobato, A. Franco, L. Rouco, J. Fernandez-Caro, and J. Chofre, "Strategic bidding in sequential electricity markets," *Generation, Transmission and Distribution, IEE Proceedings-*, vol. 153, no. 4, pp. 431–442, 2006.
- [76] *Trade at Nord Pools Financial Market*, Nord Pool ASA, Oslo Stockholm Fredericia - Helsinki, April 2004.
- [77] R. Barthelmie, F. Murray, and S. Pryor, "The economic benefit of short-term forecasting for wind energy in the uk electricity market," *Energy Policy*, vol. 36, no. 5, pp. 1687 – 1696, 2008. [Online]. Available: <http://www.sciencedirect.com/science/article/B6V2W-4S035F8-4/2/d3794ee6868493f47aa4bb898f4d105c>
- [78] P. Pinson, "Estimation of the uncertainty in wind power forecasting," Ph.D. dissertation, Ecole des Mines de Paris, Center for Energy and Processes, Rue Claude Daunesse, Sophia Antipolis, 2006.
- [79] A. D. Hansen, *Wind Power in Power Systems*. Thomas Ackermann, 2005, ch. Generators and Power Electronics for Wind Turbines, pp. 53–78.
- [80] P. Siemes, "Current policies and activities to improve the integration of wind energy into the german interconnected system," in *European Wind Energy Conference 2007*, 2007.
- [81] "Wind power management system and method," 2005, uS Patent 6925385. [Online]. Available: <http://www.freepatentsonline.com/6925385.html>
- [82] U. Focken, M. Lange, K. Mnnich, H.-P. Waldl, H. G. Beyer, and A. Luig, "Short-term prediction of the aggregated power output of wind farms—a statistical analysis of the reduction of the prediction error by spatial smoothing effects," *Journal of Wind Engineering and Industrial Aerodynamics*, vol. 90, no. 3, pp. 231–246, Mar. 2002. [Online]. Available: <http://www.sciencedirect.com/science/article/B6V3M-44Y0X3R-1/2/e22ae2cbfc04e5d029065a3ad14b20fe>
- [83] B.-J. Sustromk, "Making a wind power plant," in *UK Offshore Wind 2006 Conference*, 2006.
- [84] IEA, "Empowering variable renewables - options for flexible electricity systems," International Energy Agency, Tech. Rep., 2008, prepared by Hugo Chandler.
- [85] B. Ernst, "Analysis of wind power ancillary services characteristics with german 250 mw wind data," NREL, Tech. Rep. TP-500-26969, 1999. [Online]. Available: www.nrel.gov/publications/

BIBLIOGRAPHY

- [86] A. Ruddell, *Future Electricity Technologies and Systems*. Tooraj Jamasb and William J. Nuttall and Michael G. Pollitt, 2006, ch. Electrical energy storage, pp. 303–330.
- [87] P. Biczal, *Power Electronics in Smart Electrical Energy Networks*. Springer, 2008, ch. Energy Storage Systems, pp. 269–302.
- [88] S. Faias, P. Santos, J. Sousa, and R. Castro, “An overview on short and long-term response energy storage devices for power systems applications,” in *Proceedings of the International Conference on Renewable Energies and Power Quality (ICREPQ’08)*, 2008.
- [89] M. Aten, J. Barton, and R. Hair, “Benefits of energy storage device for a wind farm,” in *Sixth International Workshop on Large-scale Integration of Wind Power and Transmission Networks for Offshore Wind Farms*, 2006.
- [90] M. Korpaas, R. Hildrum, and A. Holen, “Optimal operation of hydrogen storage for energy sources with stochastic input,” in *Power Tech Conference Proceedings, 2003 IEEE Bologna*, vol. 4, 23-26 June 2003, p. 8pp.Vol.4.
- [91] P. Poonpun and W. Jewell, “Analysis of the cost per kilowatt hour to store electricity,” *Energy conversion, iee transactions on*, vol. 23, no. 2, pp. 529–534, 2008.
- [92] G. N. Bathurst and G. Strbac, “Value of combining energy storage and wind in short-term energy and balancing markets,” *Electric Power Systems Research*, vol. 67, no. 1, pp. 1–8, Oct. 2003. [Online]. Available: <http://www.sciencedirect.com/science/article/B6V30-498TY0F-1/2/36b63dc5cd320a545713b82577211f50>
- [93] E. Castronuovo and J. Lopes, “Bounding active power generation of a wind-hydro power plant,” in *Probabilistic Methods Applied to Power Systems, 2004 International Conference on*, 2004, pp. 705–710.
- [94] J. Castronuovo, E.D.; Lopes, “On the optimization of the daily operation of a wind-hydro power plant,” *Power Systems, IEEE Transactions on*, vol. 19, no. 3, pp. 1599–1606, 2004.
- [95] B. Klockl and G. Papaefthymiou, “An effort to overcome the chronological modeling methods for energy storage devices,” in *Future Power Systems, 2005 International Conference on*, 2005, pp. 6 pp.–.
- [96] B. Hedman and T. Kaarsberg, *Distributed Generation - The Power Paradigm for the New Millennium*. CRC Press, 2001, ch. Combined heat and (CHP), p. 274.
- [97] K. Pandiaraj, B. Fox, D. Morrow, S. Persaud, and J. Martin, “Centralised control of diesel gen-sets for peak shaving and system support,” *Generation, Transmission and Distribution, IEE Proceedings-*, vol. 149, no. 2, pp. 126–132, 2002.
- [98] J. Kennedy, B. Fox, and D. Morrow, “Distributed generation as a balancing resource for wind generation,” *Renewable Power Generation, IET*, vol. 1, no. 3, pp. 167–174, 2007.
- [99] S. Awerbuch, *The Virtual Utility: Accounting, Technology & Competitive Aspects of the Emerging Industry*, Springer, Ed. Shimon Awerbuch, Alistair Preston, 1997.
- [100] F. Bignucolo, R. Caldon, V. Prandoni, S. Spelta, and M. Vezzola, “The voltage control on mv distribution networks with aggregated dg units (vpp),” in *Universities Power Engineering Conference, 2006. UPEC '06. Proceedings of the 41st International*, vol. 1, 2006, pp. 187–192.

BIBLIOGRAPHY

- [101] M. Armstrong, A. Galli, and A. Kapoor, “French vpp: Are buyers making a profit?” 2007, working paper.
- [102] B. Willems, “Physical and financial virtual power plants,” 2005, discussions Paper Series (DPS).
- [103] “Fenix project website.” [Online]. Available: <http://www.fenix-project.org/>
- [104] C. Warmer, M. Hommelberg, I. kamphuis, Z. Derzsi, and J. Kok, “Wind turbines and heat pumps - balancing wind power fluctuations using flexible demand,” in *Sixth International Workshop on Large-scale Integration of Wind Power and Transmission Networks for Offshore Wind Farms*, 2006.
- [105] M. Hommelberg, C. Warmer, I. Kamphuis, J. Kok, and G. Schaeffer, “Distributed control concepts using multi-agent technology and automatic markets: An indispensable feature of smart power grids,” in *Power Engineering Society General Meeting, 2007. IEEE*, 2007, pp. 1–7.
- [106] A. fr Erneuerbare Energien (German Renewable Energy Agency), “Background paper: The combined power plant,” Agentur fr Erneuerbare Energien (German Renewable Energy Agency), Tech. Rep., 2008. [Online]. Available: <http://www.kombikraftwerk.de>
- [107] R. Mackensen, K. Rohrig, L. Adzic, and Y.-M. Saint-Drenan, “No limits for a full electricity supply by renewables,” in *European Wind Energy Conference 2008 Proceedings*, 2008.
- [108] K. W. Hedman and G. B. Sheblé, “Comparing hedging methods for wind power: Using pumped storage hydro units vs. options purchasing,” in *Probabilistic Methods Applied to Power Systems*, 2006.
- [109] N. Bourbaki, *Elements of Mathematics*. Springer, 1987, ch. Topological Vector Spaces.
- [110] R. Allan and R. Billinton, “Power system reliability and its assessment. i. background and generating capacity,” *Power Engineering Journal*, vol. 6, no. 4, pp. 191–196, 1992.
- [111] N. Siebert and G. Kariniotakis, “Reference wind farm selection for regional wind power prediction models,” in *European Wind Energy Conference 2006, Athens, Greece, 27/2-2/3 2006*, 2006.
- [112] M. Zeleny, *Multiple Criteria Decision Making*, M. K. Starr, Ed. Mc-Graw Hill Book Company, 1982, ISBN: 0-07-072795-3.
- [113] B. Roy, “Decision-aid and decision-making,” *European Journal of Operational Research*, vol. 45, p. 324331, 1990.
- [114] J. O. G. Tande, “Grid integration of wind farms,” *Wind Energy*, vol. 6, no. 3, pp. 281–295, 2003. [Online]. Available: <http://dx.doi.org/10.1002/we.91>
- [115] S. S. Rao, *Optimisation theory and applications*. Wiley Eastern Ltd., 1978.
- [116] T. Biswas, *Decision-Making Under Uncertainty*, M. P. Ltd., Ed. T. Biswas, 1997.
- [117] D. Bernoulli, “Exposé d’une théorie nouvelle sur l’évaluation du risque,” *Revue de statistique appliquée*, vol. 19, no. 3, pp. 5–18, 1971, translated from “Specimen Theoriae Novae de Mensura Sortis”, 1738.
- [118] R. T. Clemen, *Making Hard Decisions : An Introduction to Decision Analysis*, 2nd ed., C. Hinrichs, Ed. Duxbury Press, 1996, ISBN: 0-534-26034-9.

BIBLIOGRAPHY

- [119] G. Loomes and R. Sugden, “Regret theory: An alternative theory of rational choice under uncertainty,” *The Economic Journal*, vol. 92, no. 368, pp. 805–824, December 1982.
- [120] L. M. Costa, “Scheduling of power system cells integrating stochastic power generation,” Ph.D. dissertation, MINES ParisTech, 2008. [Online]. Available: onlinesoon
- [121] M. A. Matos, “Decision under risk as a multicriteria problem,” *European Journal of Operational Research*, vol. 181, no. 3, pp. 1516–1529, Sep. 2007. [Online]. Available: <http://www.sciencedirect.com/science/article/B6VCT-4K1X5KR-1/2/f0cc43c3ae3f3ed52f63353ed649628d>
- [122] V. Miranda and L. Proenca, “Probabilistic choice vs. risk analysis-conflicts and synthesis in power system planning,” *Power Systems, IEEE Transactions on*, vol. 13, no. 3, pp. 1038–1043, 1998.
- [123] —, “Why risk analysis outperforms probabilistic choice as the effective decision support paradigm for power system planning,” *Power Systems, IEEE Transactions on*, vol. 13, no. 2, pp. 643–648, 1998.
- [124] L. M. Costa, F. Bourry, J. Juban, and G. N. Kariniotakis, “Management of energy storage coordinated with wind power under electricity market conditions,” in *Probabilistic Methods Applied to Power Systems (PMAAPS) Proceedings*, Rincon, Puerto Rico, May 2008. [Online]. Available: <http://ieeexplore.ieee.org>
- [125] P. Schulte, “Problems associated with unit commitment in uncertainty,” *IEEE Transactions on Power Apparatus and Systems*, vol. 104, pp. 2072–2078, 1985.
- [126] N. Growe-Kuska, H. Heitsch, and W. Romisch, “Scenario reduction and scenario tree construction for power management problems,” in *Power Tech Conference Proceedings, 2003 IEEE Bologna*, vol. 3, 2003, pp. 7 pp. Vol.3–.
- [127] D. J. Dubois and H. Prade, *Fuzzy Sets and Systems : Theory and Applications (Mathematics in Science and Engineering)*. Academic Press, 1980.
- [128] G. Grimmett and D. Stirzaker, *Probability and Random Processes*, 3rd ed. Oxford University Press, 2001.
- [129] J. Juban, N. Siebert, and G. N. Kariniotakis, “Probabilistic short-term wind power forecasting for the optimal management of wind generation,” in *In Proc. of the IEEE PowerTech Conference*, Lausanne, Switzerland, July 2007.
- [130] R. Koenker and G. Bassett, “Regression quantiles,” *Econometrica*, vol. 46, pp. 33–50, 1978.
- [131] B. W. Silverman, *Density Estimation Silverman*, 1st ed. Chapman & Hall/CRC, 1986.
- [132] J. Juban, L. Fugon, and G. Kariniotakis, “Uncertainty estimation of wind power forecasts: Comparison of probabilistic modelling approaches,” in *In Proc. of the European Wind Energy Conference*, 2008.
- [133] N. Sun and A. V. Derk Jan Swider, “A comparison of methodologies incorporating uncertainties into power plant investment evaluations,” in *29th International Association for Energy Economics Conference Proceedings*, 2006.

BIBLIOGRAPHY

- [134] N. Sun, I. Ellersdorfer, and D. Swider, "Model-based long-term electricity generation system planning under uncertainty," in *Electric Utility Deregulation and Restructuring and Power Technologies, 2008. DRPT 2008. Third International Conference on*, 2008, pp. 1298–1304.
- [135] V. Pappala, I. Erlich, and S. Singh, "Unit commitment under wind power and demand uncertainties," in *Power System Technology and IEEE Power India Conference, 2008. POWERCON 2008. Joint International Conference on*, 2008, pp. 1–6.
- [136] B. Mo, A. Gjelsvik, and A. Grundt, "Integrated risk management of hydro power scheduling and contract management," *Power Systems, IEEE Transactions on*, vol. 16, no. 2, pp. 216–221, 2001.
- [137] "Risk management system for electric utilities," 2000, uS Patent 6021402. [Online]. Available: <http://www.patentstorm.us/patents/6021402.html>
- [138] H. Heitsch and W. Romisch, "Scenario reduction algorithms in stochastic programming," *Computational Optimization and Applications*, vol. 24, no. 2, pp. 187–206, Feb. 2003. [Online]. Available: <http://dx.doi.org/10.1023/A:1021805924152>
- [139] R. Doherty and M. O'Malley, "A new approach to quantify reserve demand in systems with significant installed wind capacity," *Power Systems, IEEE Transactions on*, vol. 20, no. 2, pp. 587–595, 2005.
- [140] D. Bernoulli, "Exposition of a new theory on the measurement of risk," *Econometrica*, vol. 22, pp. 23–36, 1954.
- [141] J. V. Neumann and O. Morgenstern, *Theory of games and economic behavior*. Princeton University Press, 1944.
- [142] W. Ogryczak and A. Ruszczyński, "On stochastic dominance and mean-semideviation models," Rutgers Center for Operations Research (RUTCOR), Tech. Rep., 1998.
- [143] W. Ogryczak and A. Ruszczyński, "From stochastic dominance to mean-risk models: Semideviations as risk measures," *European Journal of Operational Research*, vol. 116, pp. 33–50, 1999. [Online]. Available: citeseer.ist.psu.edu/ogryczak97from.html
- [144] X. Huang, "Portfolio selection with a new definition of risk," *European Journal of Operational Research*, vol. 186, no. 1, pp. 351–357, Apr. 2008. [Online]. Available: <http://www.sciencedirect.com/science/article/B6VCT-4N6FFRK-1/2/4ca59b385559cfd1e4de67f1a4d8d96d>
- [145] D. W. Hubbard, *How to Measure Anything: Finding the Value of "Intangibles" in Business*. John Wiley & Sons, 2007, ch. 2, p. 46.
- [146] H. Markowitz, "Portfolio selection," *The journal of finance*, vol. 7, pp. 77–91, 1952.
- [147] H. Levy and H. M. Markowitz, "Approximating expected utility by a function of mean and variance," *American Economic Review*, vol. 69, pp. 308–317, 1979.
- [148] G. C. Philippatos, *Handbook of Financial Economics*. North-Holland Publishing Company, 1979, ch. Alternatives to mean-variance for portfolio selection, pp. 365–386.
- [149] P. Jorion, *Value at risk*. McGraw-Hill, 1997.
- [150] A. Roy, "Safety first and the holding of assets," *Econometrica*, vol. 20, p. 431–449, 1952.

BIBLIOGRAPHY

- [151] R. T. Rockafellar and S. Uryasev, "Conditional value-at-risk for general loss distributions," *Journal of Banking & Finance*, vol. 26, no. 7, pp. 1443–1471, July 2002. [Online]. Available: <http://ideas.repec.org/a/eee/jbfina/v26y2002i7p1443-1471.html>
- [152] H. Föllmer and A. Schied, "Convex measures of risk and trading constraints," *Finance and Stochastics*, vol. 6, no. 4, pp. 429–447, 2002.
- [153] P. Artzner, F. Delbaen, J. M. Eber, and D. Heath, "Coherent measures of risk," *Mathematical Finance*, vol. 9, pp. 203–228, 1999.
- [154] R. T. Rockafellar and S. Uryasev, "Optimization of conditional value-at-risk," *Journal of Risk*, vol. 3, no. 2, pp. 21–41, 2000.
- [155] A. Eichhorn and W. Römisch, "Polyhedral risk measures in stochastic programming," *SIAM Journal on Optimization*, vol. 16, no. 1, pp. 69–95, 2005. [Online]. Available: <http://link.aip.org/link/?SJE/16/69/1>
- [156] A. Eichhorn, W. Römisch, and I. Wegner, "Polyhedral risk measures in electricity portfolio optimization," in *PAMM - Proc. Appl. Math. Mech.*, vol. 4, 2004, pp. 7–10.
- [157] B. Blaesig and H.-J. Haubrich, "Methods of risk management in the generation and trading planning," in *Power Tech, 2005 IEEE Russia*, 2005, pp. 1–7.
- [158] R. Dahlgren, C.-C. Liu, and J. Lawarree, "Risk assessment in energy trading," *Power Systems, IEEE Transactions on*, vol. 18, no. 2, pp. 503–511, 2003.
- [159] E. Tanlapco, J. Lawarree, and C. C. Liu, "Hedging with futures contracts in a deregulated electricity industry," *Power Engineering Review, IEEE*, vol. 22, no. 7, pp. 54–54, 2002.
- [160] R. Bjorgan, C.-C. Liu, and J. Lawarree, "Financial risk management in a competitive electricity market," *Power Systems, IEEE Transactions on*, vol. 14, no. 4, pp. 1285–1291, 1999.
- [161] P. D. Martini, "A survey of volumetric risk," *The Journal of New Ideas, Strategies and Techniques in Energy Trading Risk Management*, vol. 2, pp. 21–23, 2002.
- [162] Y. Oum and S. Oren, "Optimal static hedging of volumetric risk in a competitive wholesale electricity market," Working Paper, University of California, Berkeley, Tech. Rep., 2007.
- [163] K. Methaprayoon, C. Yingvivanapong, W.-J. Lee, and J. Liao, "An integration of ann wind power estimation into unit commitment considering the forecasting uncertainty," *Industry Applications, IEEE Transactions on*, vol. 43, no. 6, pp. 1441–1448, 2007.
- [164] G. Shrestha, B. Pokharel, T. Lie, and S. Fleten, "Price-based unit commitment for bidding under price uncertainty," *Generation, Transmission & Distribution, IET*, vol. 1, no. 4, pp. 663–669, 2007.
- [165] M. Pereira, M. McCoy, and H. Merrill, "Managing risk in the new power business," *Computer Applications in Power, IEEE*, vol. 13, no. 2, pp. 18–24, 2000.
- [166] J. Juban, L. Fugon, and G. N. Kariniotakis, "Probabilistic short-term wind power forecasting based on kernel density estimators," in *In Proc. of the European Wind Energy Conference*, Milan, Italy, May 2007.

BIBLIOGRAPHY

- [167] N. Meinshausen, “Quantile regression forests,” *Journal of Machine Learning Research*, vol. 7, pp. 983–999, 2006.
- [168] G. Giebel, L. Landberg, G. Kariniotakis, and R. Brownword, “State-of-the-art on methods and software tools for short-term prediction of wind energy production,” in *European Wind Energy Conference 2003 Proceedings*, 2003.
- [169] A. Costa, A. Crespo, J. Navarro, G. Lizcano, H. Madsen, and E. Feitosa, “A review on the young history of the wind power short-term prediction,” *Renewable and Sustainable Energy Reviews*, vol. 12, no. 6, pp. 1725–1744, Aug. 2008. [Online]. Available: <http://www.sciencedirect.com/science/article/B6VMY-4NGM15F-2/2/3f86452592e3b464634390ab3e07c63c>
- [170] G. Giebel, R. Brownword, and G. Kariniotakis, “State of the art on short term wind power prediction,” ANEMOS Project Deliverable D1.1, June 2003, available online: <http://anemos.cma.fr>.
- [171] I. Marti, G. Kariniotakis, P. Pinson, and I. Sanchez, “Evaluation of advanced wind power forecasting models - the results of the anemos project,” in *In Proc. of the European Wind Energy Conference 2006*, vol. 27/2-2/3, Athens, Greece, 2006.
- [172] H. A. Nielsen, H. Madsen, and T. S. Nielsen, “Using quantile regression to extend an existing wind power forecasting system with probabilistic forecasts,” *Wind Energy*, vol. 9, no. 1-2, pp. 95–108, 2006.
- [173] H. Nielsen, T. Nielsen, H. Madsen, G. Giebel, J. Badger, L. Landberg, K. Sattler, L. Voulund, and J. Tofting, “From wind ensembles to probabilistic information about future wind power production results from an actual application,” in *Probabilistic Methods Applied to Power Systems, 2006. PMAPS 2006. International Conference on*, 2006, pp. 1–8.
- [174] M. Lange and U. Focken, *Physical Approach to Short-Term Wind Power Prediction*. Springer, 2005.
- [175] J. B. Bremnes, “Probabilistic wind power forecasts using local quantile regression,” *Wind Energy*, vol. 7, no. 1, pp. 47–54, 2004. [Online]. Available: <http://dx.doi.org/10.1002/we.107>
- [176] —, “A comparison of a few statistical models for making quantile wind power forecasts,” *Wind Energy*, vol. 9, no. 1-2, pp. 3–11, 2006. [Online]. Available: <http://dx.doi.org/10.1002/we.182>
- [177] P. Pinson and G. Kariniotakis, “On-line assessment of prediction risk for wind power production forecasts,” *Wind Energy*, vol. 7, no. 2, pp. 119–132, 2004. [Online]. Available: <http://dx.doi.org/10.1002/we.114>
- [178] P. Pinson, G. Papaefthymiou, B. Klockl, and H. Nielsen, “Generation of statistical scenarios of short-term wind power production,” in *Power Tech, 2007 IEEE Lausanne*, 2007, pp. 491–496.
- [179] G. Papaefthymiou, “Integration of stochastic generation in power systems,” Ph.D. dissertation, Delft University of Technology, 2007.
- [180] G. Papaefthymiou, P. Schavemaker, L. van der Sluis, W. Kling, D. Kurowicka, and R. Cooke, “Integration of stochastic generation in power systems,” *International*

BIBLIOGRAPHY

- Journal of Electrical Power & Energy Systems*, vol. 28, no. 9, pp. 655–667, Nov. 2006. [Online]. Available: <http://www.sciencedirect.com/science/article/B6V2T-4K42DN8-1/2/08f7d178e7cfc75d6b6495d17af6d140>
- [181] R. Weron, *Modeling and Forecasting Electricity Loads and Prices: A Statistical Approach*, R. Weron, Ed. Wiley (The Wiley Finance Series), October 2006.
- [182] H. Geman and A. Roncoroni, “Understanding the fine structure of electricity prices,” *Journal of Business*, vol. 79, no. 3, p. 1, 2006.
- [183] D. Bunn, *Modelling Prices in Competitive Electricity Markets*, D. Bunn, Ed. John Wiley & Sons, 2004.
- [184] N. V. Karakatsani and D. W. Bunn, “Forecasting electricity prices: The impact of fundamentals and time-varying coefficients,” *International Journal of Forecasting*, vol. 24, no. 4, pp. 764–785, Oct. 2008. [Online]. Available: <http://www.sciencedirect.com/science/article/B6V92-4TTDYR8-1/2/92e7b2dcb4ad1cb6ed0bcffb723dc86c>
- [185] D. Bunn, “Forecasting loads and prices in competitive power markets,” *Proceedings of the IEEE*, vol. 88, no. 2, pp. 163–169, 2000.
- [186] G. Box, G. M. Jenkins, and G. Reinsel, *Time Series Analysis: Forecasting and Control*. Prentice Hall, 1994.
- [187] M. Olsson and L. Soder, “Modeling real-time balancing power market prices using combined sarima and markov processes,” *Power Systems, IEEE Transactions on*, vol. 23, no. 2, pp. 443–450, 2008.
- [188] R. Weron and A. Misiorek, “Forecasting spot electricity prices with time series models,” in *International conference on the European Electricity Market EEM Proceedings*, Lodz, Poland, May 2005.
- [189] —, “Forecasting spot electricity prices: A comparison of parametric and semiparametric time series models,” *International Journal of Forecasting*, vol. 24, no. 4, pp. 744–763, Oct. 2008. [Online]. Available: <http://www.sciencedirect.com/science/article/B6V92-4TK7X4B-1/2/a896065e90784e6e5e2437d8841dc8a6>
- [190] T. Niimura, “Forecasting techniques for deregulated electricity market prices - extended survey,” in *Power Systems Conference and Exposition, 2006. PSCE '06. 2006 IEEE PES*, 2006, pp. 51–56.
- [191] F. Nogales, J. Contreras, A. Conejo, and R. Espinola, “Forecasting next-day electricity prices by time series models,” *Power Systems, IEEE Transactions on*, vol. 17, no. 2, pp. 342–348, 2002.
- [192] T. Jónsson, P. Pinson, and H. Madsen, “The effect of wind power forecasts on electricity prices in denmark,” in *European Wind Energy Conference 2008 Proceedings*, 2008.
- [193] K. Skytte, “The regulating power market on the nordic power exchange nord pool: an econometric analysis,” *Energy Economics*, vol. 21, no. 4, pp. 295–308, Aug. 1999. [Online]. Available: <http://www.sciencedirect.com/science/article/B6V7G-3WS6PNX-1/2/93f57a3ca04a954dcde677572bd72270>
- [194] M. Olsson and L. Soder, “Generation of regulating power price scenarios,” in *Probabilistic Methods Applied to Power Systems, 2004. PMAAPS 2004. International Conference on*, 2004, pp. 26–31.

BIBLIOGRAPHY

- [195] T. Jónsson, “Forecasting of electricity prices accounting for wind power predictions,” Master’s thesis, Technical University of Denmark, Informatics and Mathematical Modelling, 2008.

GESTION DES INCERTITUDES LIÉES À LA PRODUCTION RENEUVABLE DANS LE CADRE DES MARCHÉS D'ÉLECTRICITÉ

Résumé

L'intégration de production d'électricité renouvelable dans les réseaux d'électricité est rendue difficile à cause du caractère variable et aléatoire de cette production. Le travail de cette thèse se penche sur la participation des producteurs d'énergie renouvelable aux marchés d'électricité, et plus précisément sur les coûts de régulation imputés à ces producteurs pour tout écart entre la production délivrée et la production contractée sur ces marchés. Dans ce contexte, l'objectif de cette thèse est de modéliser et d'évaluer les différentes méthodes de gestion de ces pénalisations d'écarts liées à la participation de producteurs d'énergie renouvelable dans les marchés court-terme d'électricité. Ce travail propose d'abord une classification des méthodes existantes pour la diminution de ces pénalités. Les solutions dites physiques, liées au portefeuille de production, sont distinguées par rapport aux solutions dites financières, qui sont basées sur des produits de marché tels que les options. Les solutions physiques sont abordées dans le cadre des centrales virtuelles. Un modèle générique de la pénalisation des écarts d'énergie est proposé. Le problème de prise de décision relatif à ces diverses solutions est ensuite formulé en tant que problème d'optimisation sous incertitude. Cette approche est basée sur une fonction de coût qui est exprimée à partir du modèle générique de pénalités. Enfin, l'incertitude liée à la production renouvelable est considérée à travers une méthode basée sur le risque, qui est mesuré à partir d'outils financiers. Les différentes méthodes sont illustrées avec des cas d'étude basés sur des données réelles.

Mot clés : Energies Renouvelables, Marché d'Électricité, Mécanisme d'Ajustement, Centrale Virtuelle, Gestion des Systèmes Électriques, Prise de Décision, Incertitude, Risque.

MANAGEMENT OF UNERTAINTIES RELATED TO RENEWABLE GENERATION PARTICIPATING IN ELECTRICITY MARKETS

Synopsis

The operation of Renewable Energy Sources (RES) units, such as wind or solar plants, is intrinsically dependent on the variability of the wind or solar resource. This makes large scale integration of RES into power systems particularly challenging. The research work in the frame of this thesis focuses on the participation of renewable power producers in liberalized electricity markets, and more precisely on the management of the regulation costs incurred by the producer for any imbalance between the contracted and delivered energy. In such context, the main objective of the thesis is to model and evaluate different methods for the management of imbalance penalties related to the participation of renewable power producers in short-term electricity markets. First, the thesis gives a classification of the existing solutions for the management of these imbalance penalties. A distinction is made between physical solutions which are related to the generation portfolio, and financial solutions which are based on market products. The physical solutions are considered in the frame of a Virtual Power Plant. A generic model of the imbalance penalty resulting from the use of physical or financial solutions is formulated, based on a market rule model. Then, the decision-making problem relative to both physical and financial solutions is formulated as an optimization problem under uncertainty. The approach is based on a loss function derived from the generic imbalance penalty model. Finally, the uncertainty related to the RES production is considered in the risk-based decision making process. The methods are illustrated using case studies based on real world data.

Keywords : Renewable Energies, Electricity Market, Balancing Mechanism, Virtual Power Plant, Power System Management, Decision-Making, Uncertainty, Risk.

Laboratoire d'accueil :	Centre Énergétique et Procédés (CEP) Ecole Nationale Supérieure des Mines de Paris Rue Claude Daunesse - B.P.207 - F-06904 Sophia-Antipolis Cedex
Thèse présentée par :	Franck BOURRY, le 8 décembre 2009
Ecole Doctorale :	ED N°432: "Sciences des Métiers de l'Ingénieur"
Discipline :	"Énergétique" - ENSMP
