



HAL
open science

Modelling the immune response to the Porcine Respiratory and Reproductive Syndrome virus

Natacha Go

► **To cite this version:**

Natacha Go. Modelling the immune response to the Porcine Respiratory and Reproductive Syndrome virus. Automatic Control Engineering. AgroParisTech, 2014. English. NNT : . tel-01100983v1

HAL Id: tel-01100983

<https://pastel.hal.science/tel-01100983v1>

Submitted on 7 Jan 2015 (v1), last revised 29 Jun 2015 (v2)

HAL is a multi-disciplinary open access archive for the deposit and dissemination of scientific research documents, whether they are published or not. The documents may come from teaching and research institutions in France or abroad, or from public or private research centers.

L'archive ouverte pluridisciplinaire **HAL**, est destinée au dépôt et à la diffusion de documents scientifiques de niveau recherche, publiés ou non, émanant des établissements d'enseignement et de recherche français ou étrangers, des laboratoires publics ou privés.

Doctorat ParisTech

THÈSE

pour obtenir le grade de docteur délivré par

**L'Institut des Sciences et Industries
du Vivant et de l'Environnement**

(AgroParisTech)

Spécialité : Sciences du vivant

présentée et soutenue publiquement par

Natacha GO

le 8 décembre 2014

Modélisation de la réponse immunitaire au virus du Syndrome Dysgénésique et Respiratoire Porcin

Directrice de thèse : **Suzanne TOUZEAU**

Co-directrice de thèse : **Catherine BELLOC**

Jury :

M. Thomas HAGENAARS	Chercheur sénior, CVI of Wageningen UR, Lelystad, Pays-Bas	Rapporteur
M. François LEFÈVRE	Directeur de recherche, unité VIM, INRA, Jouy-en-Josas, France	Rapporteur
Mme Andrea WILSON	Chef d'équipe, Roslin Institute, R(D)SVS, University of Edinburgh, Royaume-Uni	Examineur
M. Éric PARENT	Professeur, UMR MIA, AgroParisTech/INRA, Paris, France	Examineur
M. Olivier BOURRY	Chef de projet, unité VIP, Anses, laboratoire de Ploufragan, France	Invité
Mme Suzanne TOUZEAU	Chargée de recherche, UMR ISA, INRA/UNS/CNRS & BIOCORE, Inria, Sophia Antipolis, France	Directrice
Mme Catherine BELLOC	Maître de conférence, UMR BioEPaR, LUNAM/INRA/Oniris, Nantes, France	Co-directrice

PhD THESIS

by

Natacha Go

Modelling the immune response to the Porcine
Respiratory and Reproductive Syndrome virus

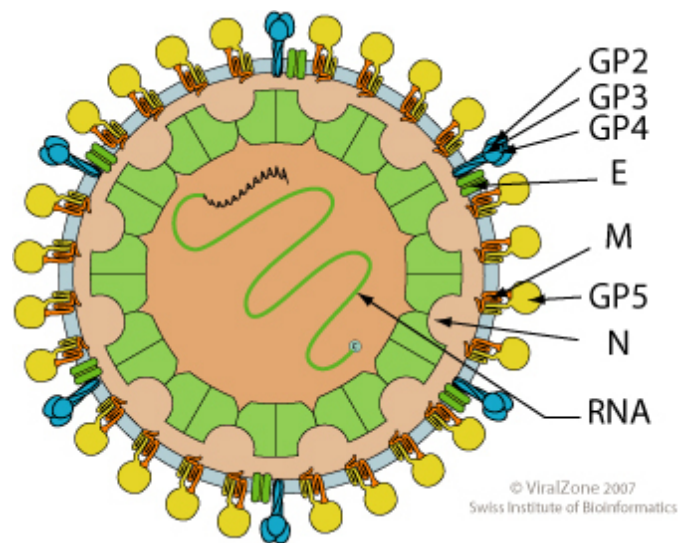

8th December 2014

PhD thesis carried out in the INRA laboratory *Mathématiques et Informatiques Appliquées* (UR 341 MIA, F-78350 Jouy-en-Josas, France) and in the INRA/Oniris laboratory *Biologie, Epidémiologie et Analyse de Risque en Santé Animale* (UMR 1300 BioEpaR, F-44307 Nantes, France)

Chaque homme dans sa nuit s'en va vers sa lumière.

[...]

Pourquoi regardes-tu par-dessus la muraille ?

Où vas-tu ? d'où viens-tu ? qui te rends si hardi ?

Depuis qu'on ne t'a vu, qu'as-tu fait ? —

J'ai grandi.

Victor Hugo, *Les Contemplations*, 1846, pp.274-275



L'envol – par Natacha Go

Remerciements

Ce travail de thèse représente une étape toute particulière de ma progression scientifique et personnelle. Je tiens à remercier en premier lieu mes deux encadrantes de thèse Suzanne TOUZEAU et Catherine BELLOC. Tout d’abord, pour avoir “misé” sur moi, bien que mon parcours universitaire m’orientait à priori plutôt vers le grand domaine de l’écologie. Et bien évidemment, pour la qualité de leur encadrement, qui m’a permis non seulement de mener à bien ce projet, mais également de me former réellement à la recherche scientifique. Je tiens également à souligner leur soutien d’un point de vu humain grâce auquel j’ai effectué ce parcours avec enthousiasme. Je remercie également Caroline BIDOT qui, bien que n’étant pas officiellement dans mon encadrement de thèse, m’a apporté un appuis considérable, aussi bien scientifique qu’administratif et personnel.

Je souhaite également exprimer ma reconnaissance à mes deux rapporteurs de thèse Thomas HAGENAARS et François LEFÈVRE, pour avoir pris le temps de lire et d’évaluer mon travail avec rigueur et bienveillance. Je remercie également Olivier BOURRY, Eric PARENT Andrea WILSON et d’avoir accepté de participer à mon jury de thèse. Dans le cadre de cette thèse interdisciplinaire, je tiens à souligner l’investissement de chacun pour aboutir à une compréhension globale de mon travail et ce quelque soit leur expertise. En conséquence, nous avons tous pu apprécier la discussion post-présentation, durant laquelle chacune des expertises a montré une fort effet propre mais également de multiples interactions, participant grandement à la qualité de la soutenance.

Je suis particulièrement reconnaissante des nombreuses opportunités de rencontres qui m’ont été offerte durant ces trois années. Tout d’abord, *via* le choix concerté et réfléchi de l’ensemble des membres de mon comité de thèse : François BEAUDEAU, Yves DUMONT, Benoît DURAND, Béatrice LAROCHE, François MEURENS et Nicolas ROSE ; que je souhaite remercier pour m’avoir accompagnée durant ces trois années. J’ai pu bénéficier d’un suivi multi-disciplinaire constructif et de qualité.

Ensuite, *via* les différentes écoles-chercheur et réseaux auxquelles j’ai pu participer, où le plaisir scientifique a toujours été au rendez-vous. Ma toute première expérience fût lors de l’école M3D (*Mathématiques et Décision pour le Développement Durable*) à Oléron, où j’ai eu le plaisir d’échanger avec Gauthier SALLET, Emmanuelle AUGERAUD, Jean-Baptiste LECOMPTE et Elsa ROUSSEAU ainsi que de retrouver Frédéric HAMELIN, qui m’avait initié à la modélisation lors de mon parcours universitaire. Les deux semaines partagées à Casablanca à l’occasion d’Epi-Casa2012 (*Introduction à l’épidémiologie : Modèles et méthodes mathématiques et statistiques*) furent elles aussi très riches scientifiquement et personnellement. Je remercie tous les intervenants pour la qualité de leur enseignement, avec une pensée toute particulière à Gauthier SALLET, Abderrahman IGGIDR, Nathanaël LAPIDUS et Joël CHADŒUF. Bien évidemment, je remercie Suzanne TOUZEAU et Patricia LAPLAGNE qui ont su braver de nombreuses difficultés pour mener à bien cette école chercheur, et sans qui l’expérience aurait été toute autre ! Mes pensées amicales vont également aux personnes qui ont suivi cette formation avec moi et ont

donné à ces deux semaines une saveur inoubliable. Enfin, j'ai eu le plaisir de suivre la formation ASPEN (*Analyse de sensibilité, propagation d'incertitudes et exploration numérique de modèles en sciences de l'environnement*). Je remercie là encore l'ensemble des intervenants, et tout particulièrement Hervé MONOD, Robert FAIVRE et David MAKOWSKI qui ont grandement participé à la qualité de cette formation ainsi qu'à son ambiance joyeuse et animée!

Enfin, *via* les différents congrès auxquelles j'ai assisté. Je garde un souvenir particulièrement ému du tout premier, ICARIS (*International Conference on Artificial Immune Systems*), durant lequel j'ai pu appréhender cette atmosphère atypique, amplifiée par la magie de Taormina. J'ai eu l'occasion de rencontrer de nombreuses personnes (qui sauront se reconnaître) durant ces congrès que je tiens à remercier chaleureusement.

Je tiens également à souligner mon plaisir à avoir effectué cette thèse au sein de mes deux unités d'accueil : MIA-jouy et BioEPaR. Je remercie chaleureusement les directeurs d'unité respectifs : Alain TRUBIL et Hervé MONOD à MIA-jouy et Henri SEEGERS et Christine FOURICHON à BioEPaR. Tous quatre m'ont témoigné montré une grande attention et j'ai pu apprécier la qualité des échanges humains au sein de ces deux unités. Je tiens à remercier Pauline EZANNO qui m'a permis d'avoir une expérience d'enseignement enrichissante ainsi que tous les intervenants avec lesquels j'ai eu pu interagir à cette occasion. Je remercie également l'ensemble des personnes impliquées dans le projet de recherche Mihmes (*Multi-scale modelling, from animal Intra-Host to Metapopulation, of mechanisms of pathogen spread to Evaluate control Strategies*) auquel j'ai participé durant ma thèse. Enfin, je renouvelle mes remerciements à l'ensemble du personnel de ces deux unités, qui a montré une très grande gentillesse à mon égard et qui m'a été d'un soutien (scientifique et personnel) indispensable.

Je ne saurais terminer ces remerciements sans une pensée affectueuse à ma famille, proches et amis, qui ont tous su m'accompagner tout au long de cette épreuve parfois douloureuse, et quelque soit leur connaissance de ce milieu si particulier.

Table des matières

Remerciements/Acknowledgements	v
Table des matières	vii
Table des figures	xiii
Liste des tableaux	xv
Introduction	1
1 Within-host scale	2
1.1 Controlling animal infectious diseases: inputs from between- and within-host scales	2
1.2 Within-host scale: immune response dynamics	3
2 Porcine Reproductive and Respiratory Syndrome virus	4
2.1 PRRSv epidemiology outlines	4
2.2 PRRSv immunology outlines	5
2.3 Variability in PRRSv strain virulence and pig susceptibility	7
2.4 Current control strategies	8
3 Three major issues	8
4 Our modelling approach	10
4.1 Why a model?	10
4.2 Which model?	11
4.3 Our models	11
5 Thesis contents	12
References	14
I Background on the immune response and models at the between-cell scale	19
I.1 Immune response to respiratory pathogens targeting antigen presenting cells	20
I.1.1 Immune response at the between-cell scale	20
I.1.1.1 Innate response	21
I.1.1.2 Adaptive response	21
I.1.2 PRRSv infection at the within-host scale	23
I.1.2.1 Pathogenesis	23
I.1.2.2 Target cells	24
I.1.2.3 Infection duration	24
I.1.3 Interactions between the pathogen and its target cells	27
I.1.3.1 PRRSv specificities	28
I.1.4 Innate immune response	29
I.1.4.1 PRRSv specificities	30
I.1.5 Adaptive immune response	32

I.1.5.1	PRRSv specificities	34
I.1.6	Synthesis of the immune response to PRRSv	36
I.2	Immunological models for respiratory pathogens targeting APC	38
I.2.1	Model selection	38
I.2.2	Pathogen-target cell interactions	40
I.2.3	Regulations by immune cells	40
I.2.4	Regulations by cytokines	43
I.2.5	Our modelling approach	46
References	52
II Integrative model of the immune response to a pulmonary macrophage infection: what determines the infection duration?		63
II.1	Introduction	65
II.2	Methods	67
II.2.1	Model description	67
II.2.2	Model calibration	72
II.2.3	Sensitivity analysis	73
II.2.4	Variability in host susceptibility and strain virulence	76
II.3	Results	77
II.3.1	Model calibration and sensitivity analysis	77
II.3.2	Impact of host susceptibility and strain virulence on the infection resolution and associated immune mechanisms	79
II.4	Discussion	83
II.4.1	Modelling approach	83
II.4.2	Model calibration and scenario definition	83
II.4.3	Assessing the impact of variability in host susceptibility and strain virulence	85
II.4.3.1	Innate response	85
II.4.3.2	Adaptive response	85
II.4.4	Conclusion	87
References	89
III Why, when and how should exposure be considered at the within-host scale?		
A modelling contribution to PRRSv infection		95
III.1	Introduction	97
III.2	Materials and methods	98
III.2.1	Model overview	98
III.2.2	Exposure functions	102
III.2.3	Designs of numerical experiments	103
III.2.4	Characteristics of the viral and immune dynamics	106
III.2.5	Analyses	107
III.3	Results	108
III.3.1	Exploring the influence of simple exposures	112
III.3.2	Looking at the impact of exposure simplifications	117
III.4	Discussion	120
III.4.1	Scope and limits of our approach	120
III.4.2	Exposure has an impact on PRRSv spread	121
III.4.3	When and how to take PRRSv exposure into account?	121
References	123
IV Towards an exploration of vaccine efficiency <i>in silico</i>		127
IV.1	Introduction	129

IV.2 Model description	131
IV.2.1 Overview of the within-host dynamics	131
IV.2.2 Cytokine regulations	137
IV.2.3 Antigen presenting cells	137
IV.2.3.1 Macrophages	138
IV.2.3.2 Dendritic cells	139
IV.2.4 Free viral particles	141
IV.2.5 Helper T cells	141
IV.2.6 Cytotoxic cells	143
IV.2.6.1 Natural killers	143
IV.2.6.2 Cytotoxic T cells	143
IV.2.7 B lymphocytes and antibodies	143
IV.2.7.1 B cells	144
IV.2.7.2 Antibodies	144
IV.2.8 Cytokines	145
IV.2.8.1 Pro-inflammatory cytokines	147
IV.2.8.2 Antiviral cytokines	147
IV.2.8.3 Immuno-regulatory cytokines	148
IV.3 Model validation and numerical exploration	149
IV.3.1 Reference scenario	149
IV.3.1.1 Calibration method	149
IV.3.1.2 Simulations	149
IV.3.1.3 Within-host dynamics	153
IV.3.1.4 On/off immune mechanisms	155
IV.3.2 Exposure and virulence scenarios	156
IV.3.2.1 Scenario definition	156
IV.3.2.2 Results and discussion	158
IV.4 Within-host dynamics of a vaccinated pig after PRRSv exposure	162
IV.4.1 Vaccination strategy	162
IV.4.1.1 Immune protection induced by vaccination	162
IV.4.1.2 Current PRRSv vaccines	162
IV.4.1.3 Vaccination scenarios	163
IV.4.2 Results	165
IV.4.2.1 Viral dynamics	165
IV.4.2.2 Immune response determining the infection resolution	168
IV.5 Discussion	173
IV.5.1 Modelling approach	173
IV.5.2 Vaccine efficiency: preliminary results	174
IV.5.2.1 Immune protection induced by vaccination	174
IV.5.2.2 Within-host dynamics of vaccinated pigs after PRRSv exposure	174
References	177
Conclusion	183
1 Insights from the within-host approach to better understand and control PRRSv infection	184
1.1 Which immune mechanisms determine PRRSv infection resolution?	185
1.1.1 Regarding isolated pigs	185
1.1.2 Regarding infection in field	186
1.1.3 Synthesis	186
1.2 Efficiency of the current commercial PRRSv vaccines	187

1.3	Common limits of our modelling approaches: model calibration and validation	187
1.3.1	Experimental infection	188
1.3.2	Future work	189
2	Towards a multi-strain approach to guide the development of more efficient vaccines	189
2.1	Experimental approach to guide the development of PRRSv universal vaccines	189
2.2	Modelling approach to guide the development of more efficient vaccines	190
3	Towards an immuno-epidemiological approach	191
3.1	Introduction to immuno-epidemiological models	192
3.2	From the viral exposure to the pig infectiousness	193
3.3	From the immune dynamics to the health status	194
3.4	Vaccination strategies at the herd level	196
4	Synthesis	196
	References	198
Appendices		203
A	Complete description of the lung-based model, used in Chapter II	205
A.1	Complete model description	206
A.1.1	Cytokine regulations	207
A.1.2	Macrophage dynamics	207
A.1.3	Viral dynamics	209
A.1.4	Natural killer dynamics	210
A.1.5	Adaptive effector dynamics	210
A.1.6	Cytokine dynamics	212
	References	216
A.2	Supplementary figures	220
B	Complete description of the simplified lung-based model, used in Chapter III	225
B.1	Model presentation	226
B.2	Cytokine regulations	227
B.3	Macrophage dynamics	228
B.4	Viral dynamics	229
B.5	Natural killer dynamics	230
B.6	Adaptive effector dynamics	230
B.7	Cytokine dynamics	232
	References	235
C	Supplementary figures of the within-host model outputs, related to Chapter IV	239
C.1	Outputs of the reference scenario	240
C.1.1	PRRSv and antigen presenting cells	240
C.1.2	Adaptive effectors, natural killers and antibodies	241
C.1.3	Cytokines	242
C.2	Outputs of the 54 scenarios of exposure, virulence and vaccination strategy	243
C.2.1	PRRSv and antigen presenting cells	243
C.2.2	Adaptive effectors, natural killers and antibodies	244
C.2.3	Cytokines	245

Bibliography	247
Publication list	263
1 Journal publications	263
2 Oral presentations in conferences	264
3 Posters in conferences	267
PhD defense	271
Résumé & Abstract	291

Table des figures

1	PRRSv virion	6
I.1	State variables of the lung-based model ❶	48
I.2	State variables of the simplified lung-based model ❷	49
I.3	Simplified scheme of the within-host model ❸	51
II.1	Functional diagram of the immune response in the lung to a virus targeting macrophages – Model ❶	68
II.2	Conceptual model: state variables and flows without regulations – Model ❶	69
II.3	Conceptual scheme focused on the susceptible macrophage dynamics with cytokine regulations – Model ❶	70
II.4	Generalised sensitivity indices (GSI) for the three outputs of interest – Model ❶	78
II.5	Immune and infection dynamics for variable host susceptibility and strain virulence – Model ❶	80
II.6	Linear regressions between the infection duration and immune components of interest – Model ❶	82
III.1	Functional diagram of the immune response in the lung to a virus targeting macrophages – Model ❷	99
III.2	Simple exposure function (semi-log graph) and its characteristics – Model ❷	103
III.3	Exposure functions (semi-log graphs) used in designs D₁ and D₂ (selection) – Model ❷	105
III.4	Designs of numerical experiments for the simple (design D₁) and combined (design D₂) exposure scenarios – Model ❷	105
III.5	Shape of the viral titer curve over time (semi-log graph) and its characteristics – Model ❷	106
III.6	Dynamics of the viral titer and key immune outputs for all scenarios – Model ❷	109
III.7	Infection duration as a linear function of the exposure intensity logarithm for both designs – Model ❷	111
III.8	Infection duration as a function of the global immune characteristics for all scenarios – Model ❷	112
III.9	Multivariate sensitivity analysis for the viral titer dynamics based on simple exposure scenarios (design D₁) – Model ❷	113
III.10	Impact of scenario parameters on viral and immune characteristics for simple exposures (design D₁) – Model ❷	115
III.11	Influence of the exposure peak on the viral peak – Model ❷	116
III.12	Total viral dose and relative errors depending on the exposure intensity for combined scenarios – Model ❷	118
IV.1	Simplified scheme of the within-host model ❸	133

IV.2	Synthesis of the infection and immune dynamics for the reference scenario of the within-host model ③	154
IV.3	Immune mechanisms efficiency on infection resolution for the reference scenario – Model ③	156
IV.4	Viral dynamics for the virulence and exposure scenarios – Model ③	159
IV.5	Within-host characteristics for the virulence and exposure scenarios – Model ③	161
IV.6	Dynamics of infection, adaptive effectors and antibodies induced by vaccination – Model ③	164
IV.7	Viral titre for the virulence, exposure and vaccination scenarios – Model ③	166
IV.8	Viral characteristics for the virulence, exposure and vaccination scenarios – Model ③	167
IV.9	Infection duration as a function of the innate immune characteristics for the virulence, exposure and vaccine scenarios – Model ③	170
IV.10	Infection duration as a function of the adaptive immune characteristics for the virulence, exposure and vaccination scenarios – Model ③	172
A.1	Preliminary sensitivity analysis – Model ❶	220
A.2	Parameter space exploration: viral titer – Model ❶	221
A.3	Parameter space exploration: cumulative number of phagocytosing macrophages – Model ❶	222
A.4	Parameter space exploration: Parameter space exploration: percentage of infected macrophages – Model ❶	223
B.1	Scheme of the model: state variables and flows (without regulations) – Model ❷	227
C.1	PRRSv and antigen presenting cells dynamics for the reference scenario – Model ③	240
C.2	Dynamics of adaptive effectors, natural killers and antibodies for the reference scenarios – Model ③	241
C.3	Dynamics of cytokines for the reference scenario – Model ③	242
C.4	PRRSv and antigen presenting cells dynamics for the 54 scenarios tested. – Model ③	243
C.5	Dynamics of adaptive effectors, natural killers and antibodies for the 54 scenarios tested – Model ③	244
C.6	Dynamics of cytokines for the 54 scenarios tested – Model ③	245

Liste des tableaux

I.1	Overview of the immune response to a respiratory pathogen	22
I.2	PRRSv viral titer characteristics from published experimental data	25
I.3	Synthesis of the within-host infection and immune response induced by PRSSv	37
I.4	Selected immunological models at the between-cell scale for influenza, TB and PRRSv	41
I.5	Interactions between the pathogen and its target cells in immunological models	42
I.6	Regulations by immune cells in immunological models	44
I.7	Cytokine regulations in immunological models	45
I.8	Synthesis of our modelling approach for PRRSv within-host infection and immune dynamics	46
II.1	Model parameters – Model ❶	74
II.2	Definition of the host susceptibility and strain virulence scenarios – Model ❶	77
II.3	Generalised sensitivity indices and influence of the key parameters on the three outputs of interest – Model ❶	79
II.4	Summary of the virus and immune dynamics for variable host susceptibility and strain virulence – Model ❶	81
III.1	Model parameters – Model ❷	101
III.2	Model parameter values for the three virulence levels used in designs \mathbf{D}_1 and \mathbf{D}_2 – Model ❷	104
III.3	Exposure parameter values for the simple exposures used in design \mathbf{D}_1 – Model ❷	104
III.4	Exposure intensity values for the combined exposures used in design \mathbf{D}_2 – Model ❷	104
III.5	Summary of the viral titer and key immune outputs compared with literature data – Model ❷	110
III.6	Sensitivity analyses for the within-host characteristics based on simple exposure scenarios (design \mathbf{D}_1) – Model ❷	114
III.7	Relative errors on the viral characteristics due to approximations of combined exposures by simple exposures – Model ❷	119
IV.1	Overview of PRRSv within-host model – Model ❸	134
IV.2	Cytokine regulations – Model ❸	146
IV.3	Parameters of the within-host model – Model ❸	150
IV.4	Model parameter values for the three virulence levels – Model ❸	157
A.1	Cytokine regulations – Model ❶	213
A.2	Cytokine syntheses – Model ❶	214
B.1	Cytokine regulations – Model ❷	233
B.2	Cytokine syntheses – Model ❷	234

Introduction

Contents

1	Within-host scale	2
1.1	Controlling animal infectious diseases: inputs from between- and within-host scales	2
1.2	Within-host scale: immune response dynamics	3
2	Porcine Reproductive and Respiratory Syndrome virus	4
2.1	PRRSv epidemiology outlines	4
2.2	PRRSv immunology outlines	5
2.3	Variability in PRRSv strain virulence and pig susceptibility	7
2.4	Current control strategies	8
3	Three major issues	8
4	Our modelling approach	10
4.1	Why a model?	10
4.2	Which model?	11
4.3	Our models	11
5	Thesis contents	12
	References	14

The control of numerous infectious diseases is still a challenge for animal health. To address this challenge, understanding the within-host dynamics, *i.e.* the interactions between the pathogen and the immune response, is a prerequisite (Section 1). It is even more so for pathogens that target immune cells, such as the porcine respiratory and reproductive syndrome virus (PRRSv), on which we focused in this thesis. PRRSv is a respiratory pathogen with a major impact of the swine industry worldwide (Section 2). There are still many gaps in the knowledge and the understanding of PRRSv within-host dynamics. It involves complex interactions and can vary depending on several factors, such as the animal susceptibility to the pathogen, its infection past, its infectious environment... We hence identified three major issues, which we tackled in this thesis (Section 3). Given the complexity of the immune mechanisms and their potential variability, we chose a modelling approach, as it is a powerful tool to explore the within-host dynamics, to test biological hypotheses or to assess the impact of control strategies, which would not be feasible or would be too expensive by experimentation (Section 4).

At the end of this introduction, we provide a description of the thesis organisation and contents (Section 5).

1 Within-host scale

1.1 Controlling animal infectious diseases : inputs from between- and within-host scales

Understanding the pathogen spread in a population and its development in the host is essential to develop effective prevention and control strategies. At the between-host scale, the infection spread, the infectiousness of infected individuals and the host contact structure determine the exposure of susceptible individuals, which can trigger new infections. At the within-host scale, the exposure, the individual susceptibility and the pathogen virulence drive the immune dynamics, which dictates the infection duration and severity, as well as the infectiousness of infected individuals. Exposure hence links the between-host to the within-host dynamics, whereas infectiousness links the within-host to the between-host dynamics.

Control strategies include (i) treatment of infected animals to cure them or at least reduce their symptoms; (ii) limitation of contacts between infectious and susceptible individuals to reduce the infection spread at the herd level; (iii) management measures and genetic selection to reduce the susceptibility to the pathogen; and (iv) vaccination to protect the animals from infection or at least limit their susceptibility and infectiousness, and consequently the pathogen spread. Vaccination is a strategy currently used to control numerous animal infectious diseases, which has an impact at both the within- and between-host scales. At the within-host scale, the vaccine efficiency depends on the immune response and subsequent host protection it induces. At the between-host scale, the vaccine efficiency depends on how many and which animals are efficiently vaccinated. So a first step to evaluate a vaccination strategy is to determine the vaccine efficiency at the within-host scale before the between-host scale. Similarly, an infectious disease control at the herd level first requires a good understanding of the within-host dynamics. However, our knowledge of the immune response to respiratory animal pathogens is still partial and needs more insight.

1.2 Within-host scale : immune response dynamics

The immune system is a system of biological structures and processes within an organism that protect from diseases. It consists of layered defences of increasing specificity. First, physical barriers prevent pathogens from entering the organism. If a pathogen breaches these barriers, the innate immune system provides an immediate, but non-specific response. If pathogens successfully evade the innate response, a second layer of protection is provided by the adaptive immune system, which is activated by innate cells and confers specific long-lasting protective immunity to the host. The adaptive response also provides an immunological memory, which is then retained after the pathogen has been eliminated and improves the pathogen elimination in case of re-exposure thanks to a quick, specific and strong re-activation of the adaptive response. The immune cells exhibit specific immune functions, which are activated and/or regulated by (i) the binding with a pathogen, (ii) the binding with another immune cell and (iii) various cytokines, which are extra-cellular proteins synthesised by activated immune cells. Activation induces cascaded reactions within the cell, including the regulation of RNA expression. So the immune response involves complex reactions at the within- and between-cell scales.

In a context of disease control at the within-host scale, one needs to take into account the exposure of the animal and to infer its infectiousness, which derives from the within-host pathogen dynamics. Moreover, vaccination, which is a control measure of particular interest, mainly involves the adaptive immune response. The latter is initiated and interacts with the innate immune response. Consequently, an integrative view of the pathogen dynamics and the immune response at the between-cell scale is required to define the host infectiousness and to assess vaccine efficiency.

Respiratory pathogens, which enter the body through the mucosal surfaces of the respiratory tract, are responsible for local inflammation and tissue damages [1, 2]. The first interaction between the pathogen and the immune system involves the innate immune cells. The innate cells mainly consist of pulmonary macrophages, dendritic cells and natural killers. Macrophages and dendritic cells, which are antigen presenting cells (APC), induce the inflammation process, destroy the pathogen through phagocytosis and activate the adaptive cells, whereas natural killers destroy the infected cells. The adaptive immune system mainly involves the cellular, the humoral and the regulatory responses. The cellular effectors destroy the infected cells, whereas the humoral effectors release antibodies, which are responsible for the neutralisation of free viral particles. The regulatory response mainly inhibits the adaptive response. The best strategy to control the severity of respiratory pathogens at the within-host scale is to limit the inflammation, while maintaining an efficient immune response.

Some respiratory pathogens, such as influenza viruses, *Mycobacterium tuberculosis* or the porcine reproductive and respiratory syndrome virus (PRRSv), replicate in the cells of the respiratory tract, including APC. They hinder the immune functions of the APC and consequently reduce the efficacy of the immune response. With these pathogens, activated APC (i) either phagocyte and destroy the pathogen, or are infected and excrete the pathogen; (ii) produce cytokines that promote the migration of immune cells to the infection site; (iii) synthesise cytokines that regulate the adaptive immunity; (iv) express antigen proteins on their cell surface that activate the adaptive response. In turn, the adaptive cell effectors and cytokines regulate the immune functions of the APC. However, the influence of APC–pathogen interactions on the immune response has been poorly studied and needs more insights [1–4]. Among the pathogens targeting pulmonary macrophages, we focused on PRRSv.

2 Porcine Reproductive and Respiratory Syndrome virus

The porcine reproductive and respiratory syndrome virus (PRRSv), also named blue ear disease, is a widespread disease affecting domestic pigs. The symptoms include reproductive failure, pneumonia and increased susceptibility to secondary bacterial infections. PRRSv is a major concern for the swine industry, as it is responsible for significant economic losses worldwide, impacting commercial pig production in North America, Europe and Asia [5–7]. There is no treatment for PRRSv and current vaccines are efficient to limit the symptoms, but of limited use to control and eliminate the disease [7–11].

Our incapacity to better control this disease is due to our incomplete understanding of the immune response induced by PRRSv [8, 11, 12] :

- PRRSv exhibits a strong tropism for the pulmonary macrophages [5, 6, 12, 13], resulting in a prolonged viraemia (viral titer in the blood) thanks to its ability to hamper the immune response [5, 6, 14]. However, the ways PRRSv interferes with the immune response and the immune mechanisms determining the infection resolution are not yet fully identified [8, 11, 12].
- The infection and immune dynamics are highly variable among hosts [15] and viral strains [12]. Consequently, apparent inconsistencies in terms of immune mechanisms determining the infection resolution may appear among experimental studies, which usually involve a single strain and few animals.

In this section, we first give outlines for PRRSv epidemiology (Section 2.1) and immunology (Section 2.2). Then we focus of PRRSv variability factors, namely strain virulence and pig susceptibility (Section 2.3). Finally we present PRRSv current control measures (Section 2.4).

2.1 PRRSv epidemiology outlines

PRRSv was first recognised in the United States in 1987 and the virus was identified in the Netherlands in 1991 [16]. Diagnostic assays became available during the 1990s [6]. PRRSv is now found in most intensive livestock production areas [7]. The estimated prevalence within infected regions reaches 60–80% of herds [6]. After an initial epidemic period, characterised by a high incidence lasting two to three months, the infection is either eradicated or it becomes endemic. Most farms are chronically infected.

PRRSv is highly infectious, *i.e.* the exposure of the animal to relatively few virus particles results in transmission, but not highly contagious [17]. Transmission requires that the pathogen successfully exits an infected host, survives potential threats in the environment, avoids the host defence system of its new susceptible host and reaches its replication site in the host. PRRSv transmission can occur vertically and horizontally [6]. Vertical transmission is defined as transmission from one generation to the next by infection of the embryo or fetus in utero. PRRSv vertical transmission occurs most readily during the third trimester of pregnancy [6]. Horizontal transmission is defined as transmission either from physical contacts with infected animals (direct transmission) or *via* an intermediate vehicle (indirect transmission), which can be the environment (*e.g.* water, food, soil), living carriers (wildlife reservoirs, vectors) or aerosols. PRRSv transmission most commonly occurs by direct horizontal transmission, *i.e.* close nose-to-nose contacts between animals [6]. Infection of susceptible animals results in the virus shedding in saliva, nasal secretions, urine, semen, and possibly faeces. Shedding occurs simultaneously from many sites at low levels or intermittently [6].

PRRSv spread in a herd depends on PRRSv prevalence, the pig contact network, the pig infectiousness and the pig susceptibility [18, 19]. The contact network, combined with the herd prevalence, defines the probability of a susceptible pig to be in contact with an infected pig. The pig infectiousness results from its within-host dynamics and determines the probability for an infected pig to transmit the pathogen to a susceptible pig in contact. The pig susceptibility (or resistance) results from its own characteristics (linked to its genotype or management) and its previous contacts with pathogens; it determines the probability for a susceptible pig to be infected by an infectious pig in contact.

2.2 PRRSv immunology outlines

Our knowledge of PRRSv immune response is detailed in reviews based on experimental studies [5, 6, 8–12, 15], presented in Section I.1. Here, we just synthesise the main characteristics of PRRSv within-host dynamics, partly based on more synthetic reviews [13, 14, 20, 21], also detailed in Section I.1.

Immune response characteristics PRRSv enters the pig through the mucosal surfaces and infects antigen presenting cells (APC), consisting of pulmonary macrophages and dendritic cells, through its binding with the internalisation cellular receptors. Within one day, it has infected macrophages throughout the body, especially in the lung and lymph nodes, which are the two main infection sites. As mentioned in Section 1.2, antigen presenting cells belong to the innate immune response and have key immune functions which are expressed after the pathogen recognition involving various receptors :

- first, APC (mainly the macrophages) destroy the viral particles *via* phagocytosis, involving principally the Fc-receptors ;
- then, the recognition of the viral nucleic acids by the toll-like receptors (TLR) induces the synthesis of various cytokines. Cytokines regulate numerous immune mechanisms including pro-inflammatory, antiviral and immuno-regulatory functions ;
- finally, APC (mainly the dendritic cells) present the viral antigens to the naive adaptive cells, corresponding to the adaptive response activation step.

The interactions between PRRSv and APC initiate consequently both infection and immune response. Their interactions and dynamics are regulated in a complex way by other immune cells (such as cytotoxic lymphocytes), cytokines (such as antiviral and immuno-modulatory cytokines) and antibodies (in particular neutralising antibodies). All these mechanisms need to be considered in order to understand what determines the infection resolution.

Moreover, the APC infection by PRRSv hampers its immune functions. In particular, PRRSv amplifies the target cell permissiveness, promotes the synthesis of immuno-modulatory over antiviral cytokines and inhibits the adaptive response activation. PRRSv is responsible for a slow and weak innate immune response. Some studies defend the hypothesis that the altered adaptive response only results from the altered innate response, whereas others assume that PRRSv could also directly hamper the adaptive mechanisms [5, 8–12, 15]. The adaptive response to PRRSv is characterised by a delayed and weak production of neutralising antibodies and cytotoxic T cells. The viraemia generally lasts between 28 and 42 days [6, 8, 22], but the virus can remain for even longer durations in the lungs and lymph nodes. The viraemia reaches a peak within about a week and diminishes steadily. Neutralising antibodies and cytotoxic T cells are protective against a wide variety of viral infections, but seemingly not against PRRSv infections [8, 9]. The virus is largely eliminated before neutralising antibodies are detected and animals lack effective

cytotoxic T cells. However, the mechanisms determining PRRSv resolution are still controversial [5, 8–12, 15].

The virus PRRSv belonging to the *Arterivirus* genus [5–7] is an enveloped RNA virus [23, 24]. As illustrated in FIGURE 1, the virion consists of a nucleocapsid, composed of a positive-strand RNA genome and the nucleocapsid protein (N), which is surrounded by a lipid bilayer envelope. The virion expresses 14 functional non-structural proteins (nsp) and the lipid envelope consists of six embedded structural proteins : the glycoproteins GP2 to GP5, and the non-glycosylated proteins M and N. These structural proteins defined the viral epitopes, which is the part of an antigen that is recognized by the adaptive immune system and are involved in the immune response activation and differentiation. The major envelope proteins GP5 and M may be the basic protein matrix of the virion envelope. The most abundant N protein is a highly basic protein. The three main structural proteins GP5, M and N are indispensable for both virion formation and viral infectivity, whereas the minor proteins (GP2, GP3 and GP4) only for infectivity. GP5/M heterodimers, GP4 and GP2 protein have been suggested to play roles in PRRSv entry into the target cells. GP5/M heterodimers are involved in virus attachment and internalisation through binding with heparan sulphate and sialoadhesin cellular receptors [25, 26]. GP4 and GP2 interact with CD163, which is considered as a receptor for viral uncoating and genome release.

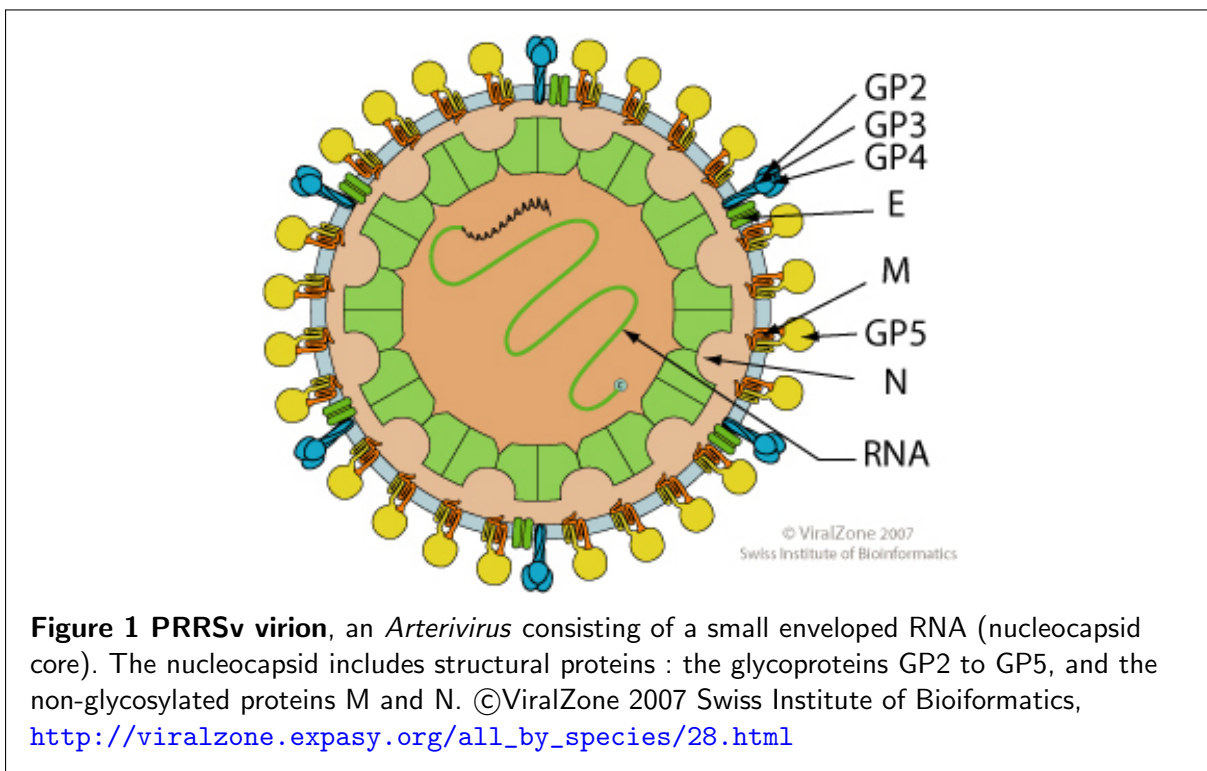

Viral epitopes that are capable of inducing neutralising antibodies appear to reside on the M, GP2a, GP3, GP4 and GP5 proteins [9]. Among these, GP5 neutralising antibodies appear to be the most relevant for protection. Antibodies directed against the N protein are most abundant, but these are not neutralising and do not correlate with protection.

2.3 Variability in PRRSv strain virulence and pig susceptibility

PRRSv infection severity and induced immune response are highly variable between hosts and PRRSv strains, which probably partly explains the apparent inconsistencies among experimental results, which usually involve a single strain and few animals [11, 15].

PRRSv strains As many other RNA viruses, PRRSv exhibits a large genetic variability, which is amongst other things reflected in variation in virulence, interaction with the immune system and antigenic properties of viral proteins [6, 12]. Virus strains are usually classified as type 1 or European-like genotype (prototype Lelystad) and type 2 or North American-like (prototype VR-2332) genotype, sharing only 55–70% nucleotide identity [23]. European genotypes are globally less virulent than American genotypes. A high genetic diversity and so various virulence levels can be found within each genotype [23, 27, 28]. PRRSv virulence level, which determines the infection severity, is not only related to the global level of the immune response activation, but also to differences including the relative levels of antiviral over immuno-modulatory cytokines, neutralising antibodies and cytotoxic T cells levels, suggesting various influences of PRRSv strains on the immune mechanisms.

Complete viral genome studies of a given PRRSv strain are limited and most studies focused on a single or a few set of strains [27]. Most of the papers deal with variations in GP5 and N proteins to explore the PRRSv genetic diversity. Among PRRSv proteins, the non structural proteins are the most variable among PRRSv strains. They are involved in the interplay between the virus and the host response, by down-regulating the regulations of interferons and other cytokines [27].

GP5, the major envelope protein is highly variable, with only 50–55% identity between the two genotypes. It is involved in inducing neutralising antibodies and different levels of cross-neutralisation [9]. Because each PRRSv structural protein carries common and type-specific antigenic determinants, European and North American strains can be differentiated from each other. The neutralising ability of GP3-specific antibodies is interesting, because the GP3 protein was reported as a non-structural protein for some North American PRRSv isolates, while it was described as a structural protein for some European PRRSv isolates [29].

Activated T cells appear to be directed against GP2 to GP7, but their protective role is virtually unknown [9]. Among the structural proteins of the virus, M and N proteins, followed by GP4, are the stronger inducers of the cellular response [5]. The M protein is the most potent inducer of T cell proliferation [9]. For most proteins, T cell epitopes have not yet been identified at amino acid level. Consequently, it is unknown whether conserved T cell epitopes might provide cross-protection against different PRRSv strains. Two distinct regions on GP5 for the North American genotype appear to contain immunodominant T-cell epitopes based on their ability to stimulate cytotoxic T-cells [9]. These two sites appear to be relatively conserved among American genotypes.

Host susceptibility PRRSv infection and host immune dynamics differ among pig breeds [15, 30–34]. For instance, Duroc, Pietrain or Hampshire × Duroc pigs exhibit more severe infections than Meishan, Miniature pigs and pigs selected for improved reproductive traits [15, 33]. These differences in infection severity are associated with qualitative and quantitative differences of the immune response. Experimental results suggest that cytokines are key contributors to the

genetic control of the innate immune response [15, 30]. The more susceptible pigs develop prolonged viraemia, with lower titers of neutralising antibodies [32, 35], probably linked to a high macrophage permissiveness and/or specific cytokine profiles [34].

Synthesis Both viral virulence and pig susceptibility seem linked to (i) the virus capacity to infect a cell and replicate, (ii) the host capacity to synthesise antiviral *vs* immuno-modulatory cytokines in response to PRRSV infection and (iii) the activation and orientation of the adaptive response. Recent studies hypothesise that these variations of the immune dynamics are due to cascaded reactions initiated by the macrophage–virus interactions [9, 15, 28, 34].

2.4 Current control strategies

Specific treatments for PRRSV are not available and none of the current vaccines fully protects against PRRSV infection. PRRSV transmission occurs within and between herds [6, 10]. Therefore, the objective for PRRSV control is to limit the effect of the virus [6] and to prevent its spread [10].

In general, fading out of PRRSV infection can be expected in small herds [10]. The probability of PRRSV persistence at the herd level increases exponentially with increased herd size. Basically, sufficient numbers of susceptible and infectious pigs are always present to maintain the chain of infection in the endemic herds with sporadic outbreaks.

Several management techniques implemented to control the PRRSV spread consist in reducing both vertical and horizontal transmissions [10]. Briefly, management techniques aim either to protect PRRSV-free farms against infected animal introduction or to limit the between-host transmission and to stop introducing new PRRSV strains in PRRSV-positive farms. Limiting the between-host transmission requires (among other strategies) the homogenisation of the health status within PRRSV-positive farms (through sow herd stabilisation, all in/all out batch management, medicated early weaning, segregated early weaning and nursery depopulation, as well as vaccination with incomplete success).

For the chronically infected farms, management strategies aim to reduce vertical transmission from infected sows and horizontal transmission among pigs in order to decrease pre- and post-weaning mortality [10]. The PRRSV stable sow herd is characterised by successful stabilisation of sow herds and seronegative weaned pigs (or sero-positive due to maternal antibodies) and fattening pigs up to 16 weeks of age. This is the most wanted status with no or possibly low virus shedding from immunised sows.

Finally, the ultimate status is PRRSV-free, which requires many strict control strategies [10]. Without vaccination, PRRSV was successfully eliminated from positive herds using costly measures such as depopulation/re-population and later, an intensive surveillance system. However, a depopulation/re-population method is very costly. It can be used in chronically infected herd and the partial depopulation/re-population is particularly interesting following early PRRSV detection in a previously negative herd.

3 Three major issues

If the factors determining PRRSV spread at the herd level are well identified, its control remains a challenge, as many gaps in the knowledge and the understanding of the within-host dynamics

during PRRSv infection persist. We focused on three major issues related to PRRSv within-host dynamics.

First, the mechanisms determining PRRSv infection duration are still poorly understood and exhibit a strong variability among PRRSv strains and hosts. Depending on the studies, various components of the immune response have been highlighted as having an impact on PRRSv infection duration : (i) the macrophage permissiveness and the viral excretion rate ; (ii) the levels of antiviral and immuno-modulatory cytokines ; and (iii) the balance between the cellular (related to the cytotoxic T cells), humoral (related to the antibodies) and regulatory responses [8]. Clearly, the mechanisms underlying protective immunity have not been firmly established. Neutralising antibodies are defined as important determinants of immunity, but the implication of the cellular response is less understood. Further knowledge on the determinants of neutralising antibodies and cytotoxic T cells by different PRRSv strains is therefore needed for the development of improved vaccines [9]. Moreover, PRRSv infection in the field involves various pig susceptibility and potentially various PRRSv strains in the same farm and at the same time. Consequently, the identification of the immune mechanisms which determine PRRSv infection resolution whatever (or for various) PRRSv strains and host susceptibilities would provide significant inputs to better control PRRSv infection. We tackled this issue in Chapter II.

Secondly, as PRRSv is mainly transmitted by direct contact, exploring the impact of variable PRRSv exposures on the within-host dynamics is a key issue [36–38]. The pig infectiousness and susceptibility are influenced by several factors, which probably interact in a complex way [39] : PRRSv strain virulence [8–10, 40], the pig genetic resistance to PRRSv infection [8, 15, 33], as well as the exposure intensity and transmission route [41–43]. Experimental studies found that (i) the infectiousness is a log-normal-like function of the time post-infection [41] and that (ii) PRRSv infection probability is a logistic function of the initial inoculum dose [42]. Studies on other viruses showed that the initial inoculum dose determines the within-host immune dynamics and course of infection [36, 37]. However, no such studies were conducted for PRRSv. We tackled this issue in Chapter III.

Thirdly, current PRRSv vaccines exhibit are not efficient enough to resolve and protect against PRRSv infection. PRRSv vaccination is a challenge that has been discussed in numerous studies [8–10, 44]. Increasing evidence is provided that PRRSv uses multiple strategies to evade the host immune system. Each of them could seriously hamper the adaptive immunity induced by vaccination. Vaccination strategies anticipating these escape mechanism are warranted. With regard to PRRSv pathogenesis and immunity there are still a number of unresolved issues that need to be considered to improve vaccine efficiency. One of these is the contribution of host susceptibility and strain virulence on the course of infection and the induction of immunity. An exploration of vaccination efficiency at the within-host scale requires the consideration of such factors, which can differ between hosts and which impact the within-host dynamics. We tackled this issue in Chapter IV.

These three issues require an integrative view of the within-host dynamics, detailed enough to consider the various immune mechanisms involved in infection resolution and immunity. Given the high complexity of the immune system and the high variability linked to the strain virulence and host susceptibility, experimental approaches would be limited and expensive. Consequently, we chose a modelling approach, based on knowledge acquired from experimental approaches.

4 Our modelling approach

4.1 Why a model?

Mathematical models are powerful tools to represent and explore the complex mechanisms involved in the infection and immune dynamics [3, 45]. They complement experimental and field studies. On the one hand, they are based on experimental data. On the other hand, they can be used to test biological hypotheses or assess the impact of control strategies, which would not be feasible or would be too expensive by experimental and field studies. They can also guide experimentation by identifying key parameters or mechanisms that need further exploration.

Strengths and limits of experimental approaches Recent advances in molecular and genomic tools have added another dimension to our knowledge base, by providing a detailed insight of the genes and pathways involved in the host immune response. However, results from empirical studies are often limited in scope and validity as they are constrained by physical boundaries. The stark contrast between the large body of research findings and the sparse translation of these findings into practical disease control strategies points to substantial knowledge gaps that need to be overcome. Successful disease control strategies not only require knowledge about individual components of the host or pathogen dynamics, but also some understanding of the system as it functions as a whole [46].

Published experimental data on PRRSV infection, reviewed in [5, 6, 8–10, 15, 20, 27, 47], are highly heterogeneous and differ on : (i) the monitoring duration, (ii) the measured immune components, (iii) the viral strain and (iv) the pig genotype. Moreover, among the immune variables assumed to determine the infection resolution, only a few were monitored in each experimental study and there were few measures over time. Key limitations include : (a) inability to identify the immune mechanisms which confer an efficient protection over PRRSV infection whatever the strain and the host ; and (b) inability to extrapolate the immune system efficiency for a given PRRSV strain and host susceptibility [8].

Strengths and limits of modelling approaches Models are based on knowledge acquired from experimental approaches and provide a powerful tool to integrate diverse empirical findings into a holistic quantitative framework [46, 48]. Modelling studies should be developed in close collaboration with experimentalists [49].

Moreover, models are free from physical constraints, thus enabling to test a wide spectrum of scenarios that may be difficult to test experimentally. The possibility to calculate the state of all system components represented in the model for any desired duration of time and at any desired frequency may provide the information needed to explain the phenomena observed in empirical studies in which only limited amounts of measurements can be taken.

Finally, models not only help to test hypotheses emerging from experimental studies, but can also reveal and fill important knowledge gaps leading to the generation of new hypotheses that can be tested in future experiments.

However, models need to be calibrated and validated by comparing simulated and experimental data. They can consequently not be considered independently from experimental approaches.

4.2 Which model ?

There are numerous dynamic immunological models in the literature, which describe the evolution over time, and possibly space, of immune variables and their interactions. We were interested in developing models that describe the host immune response in a rather comprehensive manner to account for its complex regulations. The criteria we used to determine our modelling approach, detailed in Section I.2.1, are (i) the biological scale, (ii) the immune processes represented and (iii) the mathematical formalism.

Biological scale We focused on the between-cell scale, *i.e.* we did not detail the intra-cellular mechanisms but represented between-cell and cell–pathogen interactions. Indeed, an integrative model at the within-cell scale would include too many processes and an integrative model at the immune function scale would be too simplified to meet our goals.

Processes represented Our approach corresponds to host–pathogen interaction models describing the within-host infection and immune system dynamics [50]. Such models represent the host–pathogen interactions and include at least some immune components from the innate and/or adaptive response, such as immune cells, cytokine syntheses and regulations, *etc.* We chose to represent the dynamics of innate effectors (antigen presenting cells and natural killers) effectors, adaptive effectors (T cells and antibodies) and major cytokines (pro-inflammatory, antiviral and immuno-regulatory).

Mathematical formalism We were not interested neither in spatially-explicit models, as we assumed that the lungs and lymph nodes were both rather homogeneous environments, nor in individual-based models, which would be too computation-intensive as each cell or free viral would need to be represented. Moreover, most published models at the between-cell scale are deterministic continuous time models based on ordinary differential equations (ODE). So we also chose this ODE formalism.

4.3 Our models

We synthesise here the main points of our models, detailed in Chapter I. We built our models from the review of immunological knowledge on the within-host dynamics during PRRSV infection (detailed in Section I.1) and published integrative immunological models at the within-host and between-cell scales with an ODE formalism (detailed in Section I.2).

These mathematical models were developed to explore the immune and infection dynamics for various human and animal diseases. However, very few models represent the innate mechanisms explicitly and APC–pathogen interactions need to be better represented in models [51]. There is only one published model applied to PRRSV disease [52], but it does not detail the immune mechanisms enough to address our issues. Several models describe pathogens targeting APC, such as influenza viruses (reviewed in [45, 51, 53]) and *Mycobacterium tuberculosis* (reviewed in [54, 55]). These models focus more on the adaptive than on the innate response, which is represented in a very simplified manner or even fully ignored. In particular, few of these models include the immune functions of innate cells explicitly and the cytokine regulations are simplified. Moreover, none takes into account the regulatory adaptive response.

We clearly needed to develop adapted models to address our issues. So we propose in this thesis three original models of the immune response to a respiratory virus infecting APC, applied to the PRRSv :

1. The first is an integrative model of the immune and infection dynamics in PRRSv first infection site, the lungs (denoted by ❶ in Section I.2). We considered with particular attention the macrophage–virus interactions. We highly detailed the mechanisms of the innate response and the cytokine regulations. We included the cellular, the humoral and the regulatory orientation of the adaptive response, as well as their main functions. We represented the interactions between innate and adaptive components. This model was used to address our first issue (Chapter II) : identification of the immune mechanisms that determine the infection duration, taking into account the variability in pathogen virulence and host susceptibility.
2. The second is a simplified version of the first model (denoted by ❷ in Section I.2). The modifications mainly consist in grouping some variables and using simpler cytokine regulation functions. This model was used to address our second issue (Chapter III) : exploration of PRRSv exposure influence on the within-host infection and immune dynamics for various strain virulence levels.
3. The third and last model is an integrative model of the immune and infection dynamics in the whole pig (denoted by ❸ in Section I.2). It extends the first two models with a detailed representation of the adaptive response. This extension was required to address our third and last issue (Chapter IV) : exploration of vaccination strategies at the within-host scale, taking into account the variability in strain virulence and exposure.

5 Thesis contents

The **global objective** of this thesis is the exploration of the within-host dynamics to a respiratory pathogen targeting antigen presenting cells by a modelling approach, in the perspective to better control the pathogen spread.

Background This thesis couples mathematical modelling and immunology and so requires an overview of each field regarding our objective and our application, the porcine reproductive and respiratory syndrome virus (PRRSv). Chapter I aims at providing the biological (Section I.1) and modelling (Section I.2) bases as well as the specificities linked to PRRSv.

Within our global objective, we identified three issues, each addressed in a separate chapter (II to IV). These chapters can be read separately, but are ordered according to perspective of coupling immunological to epidemiological approaches to better control PRRSv spread at the population level.

Infection resolution The first issue, addressed in Chapter II, tackles the immune mechanisms determining the infection resolution of a PRRSv infected pig whatever the PRRSv strain virulence or pig susceptibility. We built an original and integrative model of the immune response in the lung to the PRRSv. This model provides an interesting framework to explore the macrophage–pathogen interactions for pathogens targeting antigen presenting cells. Our integrative model allowed to simulate contrasted dynamics in terms of immune response and infection duration, suggesting hypotheses to explain the apparent contradictions between experimental

data. We also identified some indicators to characterise the immune dynamics and guide the interpretation of experimental data. This work was published in *PLoS ONE* (September 2014) [56].

Exposure The second issue, addressed in Chapter III, tackles the influence of various PRRSv exposure on the within-host dynamics whatever the PRRSv strain virulence. The exposure influence has not been fully explored yet, neither in experimental infections, nor in modelling studies, which mostly represent exposure by a punctual dose. We built designs of numerical experiments to explore the impact of exposure intensity, duration and peak, as well as strain virulence, on characteristics of the viral and immune dynamics. We found that the exposure (intensity and duration) strongly impacted various components of the immune response and hence the viral dynamics. Moreover, the exposure interacted in complex and various ways with the virulence level. We discussed our results regarding in a prospect of coupling immunological and epidemiological approaches, the exposure linking the between-host to the within-host dynamics. This work was submitted to *Veterinary Research* (October 2014).

Vaccination The last issue, addressed in Chapter IV, tackles vaccination efficiency on the within-host dynamics, whatever the PRRSv strain virulence and PRRSv exposure. This part is a preliminary work to illustrate how our model can be used to test the efficiency of current vaccines and guide the development of more efficient vaccines. The immune response induced by preventive vaccination was estimated by a model simulation as there is few published experimental data to inform it. Then the immune response to PRRSv infection of vaccinated and non-vaccinated pigs were compared. We showed that, depending on the strain virulence and PRRSv exposure, the vaccination efficiency varied and the immune mechanisms involved were different.

Conclusion We conclude in this thesis, in Chapter Conclusion, by summarising the main results of our within-host approach, their insights and limits to better understand and control PRRSv infection. We then discuss prospects offered by extending our approach to multi-strain infections and immuno-epidemiological models.

Bibliography References are listed at the end of each chapter in their order of appearance, but a global bibliography grouping all references in author alphabetical order is given at the end of the manuscript (p. 262). It is followed by our publication list, including journal articles, as well as conference presentations and posters ([Publication list](#)).

PhD defense I included the slides of the [PhD defense](#) at the end of the manuscript.

References

- [1] BRACIALE T.J., SUN J., KIM T.S., 2012. Regulating the adaptive immune response to respiratory virus infection. *Nat. Rev. Immunol.* **12**(4) :295–305. doi:10.1038/nri3166.
- [2] KOHLMEIER J.E., WOODLAND D.L., 2009. Immunity to respiratory viruses. *Annu. Rev. Immunol.* **27**(1) :61–82. doi:10.1146/annurev.immunol.021908.132625.
- [3] HEFFERNAN J.M., 2011. Mathematical immunology of infectious diseases. *Math. Popul. Stud.* **18**(2) :47–54. doi:10.1080/08898480.2011.564559.
- [4] ROUSE B.T., SEHRAWAT S., 2010. Immunity and immunopathology to viruses : what decides the outcome? *Nat. Rev. Immunol.* **10**(7) :514–526. doi:10.1038/nri2802.
- [5] DARWICH L., DÍAZ I., MATEU E., 2010. Certainties, doubts and hypotheses in porcine reproductive and respiratory syndrome virus immunobiology. *Virus Res.* **154**(1-2) :123–132. doi:10.1016/j.virusres.2010.07.017.
- [6] ZIMMERMAN J., BENFIELD D.A., MURTAUGH M.P., OSORIO F., STEVENSON G.W., TORREMORELL M., 2006. Porcine reproductive and respiratory syndrome virus (porcine arterivirus). In *Diseases of swine*, edited by B.E. STRAW, J.J. ZIMMERMAN, S. D'ALLAIRE, D.L. TAYLOR, Blackwell (Oxford, UK), 9th edn., chap. 24, pp. 387–418.
- [7] ROWLAND R.R.R., LUNNEY J., DEKKERS J., 2012. Control of porcine reproductive and respiratory syndrome (PRRS) through genetic improvements in disease resistance and tolerance. *Front. Genet.* **3** :260. doi:10.3389/fgene.2012.00260.
- [8] MURTAUGH M.P., GENZOW M., 2011. Immunological solutions for treatment and prevention of porcine reproductive and respiratory syndrome (PRRS). *Vaccine* **29**(46) :8192–8204. doi:10.1016/j.vaccine.2011.09.013.
- [9] KIMMAN T.G., CORNELISSEN L.A., MOORMANN R.J., REBEL J.M.J., STOCKHOFER-ZURWIEDEN N., 2009. Challenges for porcine reproductive and respiratory syndrome virus (PRRSV) vaccinology. *Vaccine* **27**(28) :3704–3718. doi:10.1016/j.vaccine.2009.04.022.
- [10] THANAWONGNUWECH R., SURADHAT S., 2010. Taming PRRSV : Revisiting the control strategies and vaccine design. *Virus Res.* **154**(1-2) :133–140. doi:10.1016/j.virusres.2010.09.003.
- [11] BUTLER J.E., LAGER K.M., GOLDE W., FAABERG K.S., SINKORA M., LOVING C., ZHANG Y.I., 2014. Porcine reproductive and respiratory syndrome (PRRS) : an immune dysregulatory pandemic. *Immunologic research* **59**(1-3) :81–108. doi:10.1007/s12026-014-8549-5.
- [12] GÓMEZ-LAGUNA J., SALGUERO F.J., PALLARÉS F.J., CARRASCO L., 2013. Immunopathogenesis of porcine reproductive and respiratory syndrome in the respiratory tract of pigs. *Vet. J.* **195**(2) :148–155. doi:10.1016/j.tvjl.2012.11.012.
- [13] MURTAUGH M.P., 2005. PRRSV/host interaction. In *PRRS fatti vs speculazioni*, Università degli Studi di Parma, Dipartimento di Salute Animale (Parma, Italy), pp. 73–80. http://medvet.unipr.it/cgi-bin/campusnet/documenti.pl/Show?_id=7d0d
- [14] MURTAUGH M.P., XIAO Z., ZUCKERMANN F., 2002. Immunological responses of swine to porcine reproductive and respiratory syndrome virus infection. *Viral Immunol.* **15**(4) :533–547. doi:10.1089/088282402320914485.

- [15] LUNNEY J.K., CHEN H., 2010. Genetic control of host resistance to porcine reproductive and respiratory syndrome virus (PRRSV) infection. *Virus Res.* **154**(1–2) :161–169. doi: [10.1016/j.virusres.2010.08.004](https://doi.org/10.1016/j.virusres.2010.08.004).
- [16] Porcine reproductive and respiratory syndrome. OIE. Animal Disease Information Summaries. http://www.oie.int/fileadmin/Home/eng/Media_Center/docs/pdf/Disease_cards/PPRS-EN.pdf
- [17] ZIMMERMAN J., 2003. Epidemiology and ecology. In *2003 PRRS Compendium : A Comprehensive Reference on Porcine Reproductive and Respiratory Syndrome for Pork Producers, Veterinary Practitioners, and Researchers*, edited by J. ZIMMERMAN, K.J. YOON, National Pork Board (Des Moines, Iowa, USA), 2nd edn., chap. 4, pp. 25–34.
- [18] MONDACA-FERNÁNDEZ E., MEYNS T., MUÑOZ-ZANZI C., TRINCADO C., MORRISON R.B., 2007. Experimental quantification of the transmission of Porcine reproductive and respiratory syndrome virus. *Can. J. Vet. Res.* **71**(2) :157.
- [19] NODELIJK G., NIELEN M., DEJONG M.C.M., VERHEIJDEN J.H.M., 2003. A review of porcine reproductive and respiratory syndrome virus in Dutch breeding herds : population dynamics and clinical relevance. *Prev. Vet. Med.* **60** :37–52. doi: [10.1016/S0167-5877\(03\)00081-3](https://doi.org/10.1016/S0167-5877(03)00081-3).
- [20] MATEU E., DÍAZ I., 2008. The challenge of PRRS immunology. *Vet. J.* **177** :345–351. doi: [10.1016/j.tvjl.2007.05.022](https://doi.org/10.1016/j.tvjl.2007.05.022).
- [21] MURTAUGH M.P., 2004. PRRS immunology : what are we missing? In *35th Annual Meeting of the American Association of Swine Veterinarians*, Des Moines, Iowa, USA, pp. 359–367.
- [22] DUAN X., NAUWYNCK H.J., PENZAERT M.B., 1997. Virus quantification and identification of cellular targets in the lungs and lymphoid tissues of pigs at different time intervals after inoculation with porcine reproductive and respiratory syndrome virus (PRRSV). *Vet. Microbiol.* **56**(1–2) :9–19. doi: [10.1016/S0378-1135\(96\)01347-8](https://doi.org/10.1016/S0378-1135(96)01347-8).
- [23] VANHEE M., VAN BREEDAM W., COSTERS S., GELDHOF M., NOPPE Y., NAUWYNCK H., 2011. Characterization of antigenic regions in the porcine reproductive and respiratory syndrome virus by the use of peptide-specific serum antibodies. *Vaccine* **29**(29-30) :4794–4804. doi: [10.1016/j.vaccine.2011.04.071](https://doi.org/10.1016/j.vaccine.2011.04.071).
- [24] HU J., ZHANG C., 2012. Porcine reproductive and respiratory syndrome virus vaccines : current status and strategies to a universal vaccine. *Transbound. Emerg. Dis.* doi: [10.1111/tbed.12016](https://doi.org/10.1111/tbed.12016).
- [25] DELPUTTE P.L., VANDERHEIJDEN N., NAUWYNCK H.J., PENZAERT M.B., 2002. Involvement of the matrix protein in attachment of porcine reproductive and respiratory syndrome virus to a heparinlike receptor on porcine alveolar macrophages. *J. Virol.* **76**(9) :4312–4320. doi: [10.1128/JVI.76.9.4312-4320.2002](https://doi.org/10.1128/JVI.76.9.4312-4320.2002).
- [26] VAN BREEDAM W., DELPUTTE P.L., VAN GORP H., MISINZO G., VANDERHEIJDEN N., DUAN X., NAUWYNCK H.J., 2010. Porcine reproductive and respiratory syndrome virus entry into the porcine macrophage. *J. Gen. Virol.* **91**(7) :1659–1667. doi: [10.1099/vir.0.020503-0](https://doi.org/10.1099/vir.0.020503-0).

- [27] DARWICH L., GIMENO M., SIBILA M., DÍAZ I., DE LA TORRE E., DOTTI S., KUZEMTSEVA L., MARTIN M., PUJOLS J., MATEU E., 2011. Genetic and immunobiological diversities of porcine reproductive and respiratory syndrome genotype I strains. *Vet. Microbiol.* **150**(1–2) :49–62. doi:10.1016/j.vetmic.2011.01.008.
- [28] GIMENO M., DARWICH L., DÍAZ I., DE LA TORRE E., PUJOLS J., MARTIN M., INUMARU S., CANO E., DOMÍNGO M., MONTOYA M., MATEU E., 2011. Cytokine profiles and phenotype regulation of antigen presenting cells by genotype-I porcine reproductive and respiratory syndrome virus isolates. *Vet. Res.* **42**(9). doi:10.1186/1297-9716-42-9.
- [29] MEULENBERG J., BESTEN A., 1996. Identification and characterization of a sixth structural protein of Lelystad virus : The glycoprotein GP₂ encoded by ORF2 is incorporated in virus particles. *Virology* **225**(1) :44–51. doi:10.1006/viro.1996.0573.
- [30] PETRY D.B., LUNNEY J., BOYD P., KUHAR D., BLANKENSHI E., JOHNSON R.K., 2007. Differential immunity in pigs with high and low responses to porcine reproductive and respiratory syndrome virus infection. *J. Anim. Sci.* **85** :2075–2092. doi:10.2527/jas.2006-721.
- [31] VINCENT A.L., THACKER B.J., HALBUR P.G., ROTHSCHILD M.F., THACKER E.L., 2006. An investigation of susceptibility to porcine reproductive and respiratory syndrome virus between two genetically diverse commercial lines of pigs. *J. Anim. Sci.* **84**(1) :49–57.
- [32] DOESCHL-WILSON A.B., KYRIAZAKIS I., VINCENT A., ROTHSCHILD M.F., THACKER E., GALINA-PANTOJA L., 2009. Clinical and pathological responses of pigs from two genetically diverse commercial lines to porcine reproductive and respiratory syndrome virus infection. *J. Anim. Sci.* **87** :1638–1647. doi:10.2527/jas.2008-1447.
- [33] REINER G., FRESEN C., BRONNERT S., WILLEMS H., 2009. Porcine reproductive and respiratory syndrome virus (PRRSV) infection in wild boars. *Vet. Microbiol.* **136**(3) :250–258. doi:10.1016/j.vetmic.2008.11.023.
- [34] AIT-ALI T., WILSON A.D., CARRÉ W., WESTCOTT D.G., FROSSARD J.P., MELLENCAMP M.A., MOUZAKI D., MATIKA O., WADDINGTON D., DREW T.W., BISHOP S.C., ARCHIBALD A.L., 2011. Host inhibits replication of European porcine reproductive and respiratory syndrome virus in macrophages by altering differential regulation of type-I interferon transcriptional responses. *Immunogenetics* **63**(7) :437–448. doi:10.1007/s00251-011-0518-8.
- [35] REINER G., WILLEMS H., PESCH S., OHLINGER V.F., 2010. Variation in resistance to the porcine reproductive and respiratory syndrome virus (PRRSV) in Pietrain and Miniature pigs. *J. Anim. Breed. Genet.* **127** :100–106. doi:10.1111/j.1439-0388.2009.00818.x.
- [36] LI Y., HANDEL A., 2014. Modeling inoculum dose dependent patterns of acute virus infections. *J. Theor. Biol.* **347** :63–73. doi:10.1016/j.jtbi.2014.01.008.
- [37] MAROIS I., CLOUTIER A., GARNEAU É., RICHTER M.V., 2012. Initial infectious dose dictates the innate, adaptive, and memory responses to influenza in the respiratory tract. *J. Leukocyte Biol.* **92**(1) :107–121. doi:10.1189/jlb.1011490.
- [38] STEINMEYER S.H., WILKE C.O., PEPIN K.M., 2010. Methods of modelling viral disease dynamics across the within-and between-host scales : the impact of virus dose on host population immunity. *Philos T. R. Soc. B* **365**(1548) :1931–1941. doi:10.1098/rstb.2010.0065.

- [39] HICKSON R.I., ROBERTS M.G., 2014. How population heterogeneity in susceptibility and infectivity influences epidemic dynamics. *J. Theor. Biol.* **350** :70–80. doi:10.1016/j.jtbi.2014.01.014.
- [40] JOHNSON W., ROOF M., VAUGHN E., CHRISTOPHER-HENNINGS J., JOHNSON C.R., MURTAUGH M.P., 2004. Pathogenic and humoral immune responses to porcine reproductive and respiratory syndrome virus (PRRSV) are related to viral load in acute infection. *Vet. Immunol. Immunop.* **102**(3) :233–247. doi:10.1016/j.vetimm.2004.09.01.
- [41] CHARPIN C., MAHÉ S., KERANFLEC’H A., BELLOC C., CARIOLET R., LE POTIER M.F., ROSE N., 2012. Infectiousness of pigs infected by the porcine reproductive and respiratory syndrome virus (PRRSV) is time-dependent. *Vet. Res.* **43**(1) :69. doi:10.1186/1297-9716-43-69.
- [42] HERMANN J.R., MUNOZ-ZANZI C.A., ROOF M.B., BURKHART K., ZIMMERMAN J.J., 2005. Probability of porcine reproductive and respiratory syndrome (PRRS) virus infection as a function of exposure route and dose. *Vet. Microbiol.* **110**(1) :7–16. doi:10.1016/j.vetmic.2005.06.012.
- [43] YOON K.J., ZIMMERMAN J.J., CHANG C.C., CANCEL-TIRADO S., HARMON K.M., MCGINLEY M.J., 1999. Effect of challenge dose and route on porcine reproductive and respiratory syndrome virus (PRRSV) infection in young swine. *Vet. Res.* **30**(6) :629–638.
- [44] CHARERNTANTANAKUL W., 2009. Adjuvants for porcine reproductive and respiratory syndrome virus vaccines. *Vet. Immunol. Immunop.* **129**(1) :1–13. doi:10.1016/j.vetimm.2008.12.018.
- [45] BEAUCHEMIN C., HANDEL A., 2011. A review of mathematical models of influenza A infections within a host or cell culture : lessons learned and challenges ahead. *BMC Public Health* **11**. doi:10.1186/1471-2458-11-S1-S7.
- [46] PERELSON A.S., 2002. Modelling viral and immune system dynamics. *Nat. Rev. Immunol.* **2**(1) :28–36. doi:10.1038/nri700.
- [47] NAUWYNCK H.J., VAN GORP H., VANHEE M., KARNIYCHUK U., GELDHOF M., CAO A., VERBEECK M., VAN BREEDAM W., 2012. Micro-dissecting the pathogenesis and immune response of PRRSV infection paves the way for more efficient PRRSV vaccines. *Transbound. Emerg. Dis.* **59** :50–54. doi:10.1111/j.1865-1682.2011.01292.x.
- [48] NOWAK M., MAY R.M., 2000. *Virus Dynamics : Mathematical Principles of Immunology and Virology*. Oxford University Press.
- [49] YATES A., CHAN C.C.W., CALLARD R.E., GEORGE A.J.T., STARK J., 2001. An approach to modelling in immunology. *Brief. Bioinform.* **2**(3) :245–257. doi:10.1093/bib/2.3.245.
- [50] DOESCHL-WILSON A.B., 2011. The role of mathematical models of host-pathogen interactions for livestock health and production – a review. *Animal* **5**(6) :895–910. doi:10.1017/S1751731110002557.
- [51] SMITH A.M., PERELSON A.S., 2011. Influenza A virus infection kinetics : quantitative data and models. *Wiley Interdiscip. Rev. Syst. Biol. Med.* **3**(4) :429–445. doi:10.1002/wsbm.129.

- [52] DOESCHL-WILSON A., GALINA-PANTOJA L., 2010. Using mathematical models to gain insight into host-pathogen interaction in mammals : porcine reproductive and respiratory syndrome. In *Host-pathogen interactions : genetics, immunology and physiology*, edited by A.W. BARTON, Immunology and Immune System Disorders, Nova Science Publishers (New York, USA), chap. 4, p. 109–131.
- [53] DOBROVOLNY H.M., REDDY M.B., KAMAL M.A., RAYNER C.R., BEAUCHEMIN C.A.A., 2013. Assessing mathematical models of influenza infections using features of the immune response. *PLoS ONE* **8**(2) :e57088. [doi:10.1371/journal.pone.0057088](https://doi.org/10.1371/journal.pone.0057088).
- [54] GAMMACK D., GANGULI S., MARINO S., SEGOVIA-JUAREZ J., KIRSCHNER D., 2005. Understanding the immune response in tuberculosis using different mathematical models and biological scales. *Multiscale Model. Sim.* **3**(2) :312–345. [doi:10.1137/040603127](https://doi.org/10.1137/040603127).
- [55] MARINO S., LINDERMAN J.J., KIRSCHNER D.E., 2011. A multifaceted approach to modeling the immune response in tuberculosis. *Wiley Interdiscip. Rev. Syst. Biol. Med.* **3**(4) :479–489. [doi:10.1002/wsbm.131](https://doi.org/10.1002/wsbm.131).
- [56] GO N., BIDOT C., BELLOC C., TOUZEAU S., 2014. Integrative model of the immune response to a pulmonary macrophage infection : what determines the infection duration ? *PLoS ONE* **9**(9) :e107818. [doi:10.1371/journal.pone.0107818](https://doi.org/10.1371/journal.pone.0107818).

Chapitre I

Background on the immune response and models at the between-cell scale

Contents

I.1 Immune response to respiratory pathogens targeting antigen presenting cells	20
I.1.1 Immune response at the between-cell scale	20
I.1.1.1 Innate response	21
I.1.1.2 Adaptive response	21
I.1.2 PRRSv infection at the within-host scale	23
I.1.2.1 Pathogenesis	23
I.1.2.2 Target cells	24
I.1.2.3 Infection duration	24
I.1.3 Interactions between the pathogen and its target cells	27
I.1.3.1 PRRSv specificities	28
I.1.4 Innate immune response	29
I.1.4.1 PRRSv specificities	30
I.1.5 Adaptive immune response	32
I.1.5.1 PRRSv specificities	34
I.1.6 Synthesis of the immune response to PRRSv	36
I.2 Immunological models for respiratory pathogens targeting APC	38
I.2.1 Model selection	38
I.2.2 Pathogen-target cell interactions	40
I.2.3 Regulations by immune cells	40
I.2.4 Regulations by cytokines	43
I.2.5 Our modelling approach	46
References	52

In this thesis, we aim at representing the within-host response to a respiratory pathogen at the between-cell scale, by a mathematical modelling approach, with a focus on PRRSv. Prior to presenting our work, we need to provide some background on the immune mechanisms induced by respiratory pathogens. Because of the scale chosen, we do not detail the intra-cellular mechanisms, but we focus on the numerous interactions among immune cells and the pathogen, as well as their regulations. We also need to situate our work among the dynamic immunological models developed at the between-cell scale. As we want to represent the whole immune response, we do not consider models that detail specific mechanisms. As PRRSv is a respiratory pathogen targeting pulmonary macrophages and dendritic cells, which are antigen presenting cells (APC) with key immune functions, we focus our literature review on respiratory pathogens targeting APC.

In Section I.1, we synthesise knowledge on the interactions between respiratory pathogens and the immune system. We present the specificities linked to our application, PRRSv. Then in Section I.2, we present the most relevant published immunological models. We point out their interests and limits regarding our objectives and application. Finally in Section I.2.5, we give an overview of our models, which are used in chapters II, III and IV.

I.1 Immune response to respiratory pathogens targeting antigen presenting cells

We first give an overview of the main mechanisms involved in the immune response to a pathogen targeting antigen presenting cells (APC) at the between-cell scale (Section I.1.1). Then we present PRRSv infection at the within-host scale, in terms of pathogenesis, target cells and infection duration (Section I.1.2). Following these two introductory sections, we detail the interactions between the pathogen and its target cells (Section I.1.3), the innate immune response (Section I.1.4) and the adaptive immune response (Section I.1.5). In each of these three detailed sections, PRRSv specificities are highlighted. Finally we conclude by a synthesis of PRRSv immune response (Section I.1.6).

Sections I.1.1, I.1.2 and I.1.6 provide a good summary to readers who wish to skip the details of the immune response. TABLE I.1 lists the various immune components, their activation and their immune functions. TABLE I.3 gives a synthetic description of PRRSv within-host infection and the immune response to PRRSv.

I.1.1 Immune response at the between-cell scale

Respiratory pathogens, which enter the body through the mucosal surfaces of the respiratory tract, are responsible for local inflammation and tissue damages. They initiate the infection and the immune response. The first interaction between the pathogen and the immune system involves the innate immune system. This first line of defence provides an immediate but non-specific response. If pathogens successfully evade the innate response, a second layer of protection is provided by the adaptive immune system, which is activated by the innate response and confers specific long-lasting protective immunity to the host. The immune system adapts its response during an infection to improve its recognition of the pathogen. This improved response is then retained after the pathogen has been eliminated, in the form of an immunological memory, and allows the adaptive immune system to mount faster and stronger attacks each time this pathogen is encountered. Innate and adaptive immune cells synthesise cytokines, small extra-cellular proteins which regulate the immune mechanisms in complex ways.

The main components of the immune response at the between-cell scale, as well as their functions and activation/synthesis, are presented in TABLE I.1. It is based on reviews focusing on the immune response to a respiratory pathogen targeting antigen presenting cells [1–8].

I.1.1.1 Innate response

The innate response includes anatomical barriers, the inflammation process, the complement system and innate cells. The innate immune cells mainly consists of antigen presenting cells (APC), including macrophages and dendritic cells, and natural killers.

Antigen presenting cells (APC) recognise the pathogen through its binding with Toll-like receptors (TLR), which are pattern recognition receptors directed against key pathogen-associated molecules. Through the recognition of pathogens or their products, TLR can induce the production of cytokines in APC [9]. These cytokines drive the differentiation of the adaptive response. Pathogens are also captured by phagocytosis *via* TLR themselves [9]. Captured pathogens are then processed and presented to naive adaptive T cells as major histocompatibility complex–antigen (MHC) [9]. In the cases of pathogens targeting APC, the APC–pathogen interactions involve either Toll-like receptors or internalisation receptors that initiate the cell infection. Both ways induce APC activation, but infection can hamper the cell immune functions, which have consequences on the whole immune response :

- Activated APC participate in the regulation of the immune mechanisms *via* the synthesis of various cytokines.
- Activated APC (mainly macrophages) destroy the pathogen *via* the phagocytosis.
- Activated APC (mainly dendritic cells) partly migrate from the infection site to the lymph nodes, where they activate the adaptive response *via* the expression of major histocompatibility complex (MHC).

Natural killers are an important cellular feature of innate immunity. They respond in an antigen-independent manner to help contain viral infections before the development of adaptive immune responses [10, 11]. They are responsible for the destruction of infected cells and the synthesis of IFN_γ and TNF_α , which are antiviral cytokines [10, 11].

I.1.1.2 Adaptive response

The activation of the adaptive response starts with the activation and proliferation of helper T cells (also known as CD_4^+ T cells/lymphocytes). They differentiate into type 1 helper T_{h1} , type 2 helper T_{h2} , regulatory T_{reg} or memory T cells and they orientate the adaptive response.

- The cellular response is associated with T_{h1} ; it is characterised by the activation and proliferation of cytotoxic T cells T_c , which destroy the infected cells, and by the synthesis of the antiviral and immuno-regulatory cytokine IFN_γ .
- The humoral response is associated with T_{h2} ; it is characterised by the synthesis of antibodies A produced by B lymphocytes and by the synthesis of the immuno-modulatory cytokine IL_{10} .
- The regulatory response is associated with T_{reg} ; it is characterised by the synthesis of the immuno-modulatory cytokine TGF_β , which inhibits numerous immune functions.

The orientation of the adaptive response towards the cellular, humoral or regulatory response is determined in a complex way by the cytokine environment.

Cytokines Cytokines have three major functions :

- Pro-inflammatory cytokines (P_i) amplify the recruitment of innate cells (macrophages, dendritic cells and natural killers) to the infection place.
- Antiviral cytokines ($\%(A_i + \text{IFN}_\gamma)$) inhibit the cells infection and the viral replication.
- Immuno-regulatory cytokines (I_r) orientate the adaptive response. Among these cytokines, the immuno-modulatory cytokines inhibit various immune functions.

Table I.1 Overview of the immune response to a respiratory pathogen targeting antigen presenting cells [1–8].

Component	Immune functions	Activated by...
Innate effectors		
Macrophages (M)	Phagocytosis ($P_i, A_v, \text{IL}_{12}, \text{IL}_{10}$) synthesis Antigen presentation	Pathogen
Dendritic cells (D)	(P_i, A_v, I_r) synthesis Antigen presentation	Pathogen
Natural killers (NK)	Cytolysis ($\text{TNF}_\alpha, \text{IFN}_\gamma$) synthesis	$\text{IL}_{12}, \text{IFN}_\gamma$
Adaptive effectors		
Helper T cells (T_h)		
Type 1 helper T cell (T_{h1})	(T_c, B_G) activation ($\text{IFN}_\gamma, \text{IL}_2$) synthesis	$D + (\text{IFN}_\gamma, \text{IL}_{12})$
Type 2 helper T cell (T_{h2})	(B_G, B_M) activation ($\text{IL}_4, \text{IL}_{10}$) synthesis	$D + (\text{IL}_4, \text{IL}_6)$
Regulatory T cell (T_{reg})	B_A activation ($\text{TGF}_\beta, \text{IL}_{10}$) synthesis	$D + (\text{TGF}_\beta)$
Cytotoxic T cells (T_c)	Cytolysis ($\text{IFN}_\gamma, \text{IL}_{12}, \text{TNF}_\alpha$) synthesis	T_{h1}
B lymphocytes (B)		
(B_M)	IgM antibody synthesis	T_{h2}
(B_G)	IgG antibody synthesis	T_{h1}, T_{h2}
(B_A)	IgA antibody synthesis	T_{reg}
(B_E)	IgE antibody synthesis	T_{h2}
Antibodies		
Neutralising IgM, IgG, IgA (A_N)	Neutralisation	B_M, B_G, B_A
Marker IgM, IgG, IgA (A_M)	Marking	B_M, B_G, B_A
Cytokines		
Pro-inflammatory (P_i)		
Interleukin-1 β ($\text{IL}_{1\beta}$)	(IL_6, IL_8) synthesis	M, D
Tumor necrosis factor (TNF_α)	(IL_6, IL_8) synthesis	M, D, T_c
Interleukin-6 (IL_6)	$\nearrow (M, D, \text{NK})$ recruitment	$(M, D) + (\text{IL}_{1\beta}, \text{TNF}_\alpha)$
Interleukin-8 (IL_8)	$\nearrow (M, D, \text{NK})$ recruitment	$(M, D) + (\text{IL}_{1\beta}, \text{TNF}_\alpha)$
Antiviral (A_v)		
Tumour necrosis factor (TNF_α)	Cell apoptosis \nearrow Antigen presentation, phagocytosis \searrow Cell infection, pathogen replication	M, D, T_c
Interferon- α (IFN_α)	\nearrow Antigen presentation, phagocytosis \searrow Cell infection, pathogen replication	Infected M, D
Colour code : innate, adaptive, innate & adaptive components \nearrow amplification, \searrow inhibition		
Continued on next page...		

TABLE I.1 – continued from previous page

Component	Immune functions	Activated by...
Interferon- γ (IFN $_{\gamma}$)	↗ Antigen presentation, phagocytosis ↘ Cell infection, pathogen replication	D, NK, T_{h1}, T_c
<hr style="border-top: 1px dashed black;"/>		
Immuno-regulatory (I_r)	(NK, T_{h1}) activation	
Interleukin 12 (IL $_{12}$)	↗ (T_h, T_c) proliferation ↗ IFN $_{\gamma}$ synthesis	M, D, T_c
<hr style="border-top: 1px dashed black;"/>		
Interferon- γ (IFN $_{\gamma}$)	(NK, T_{h1}) activation ↗ (IFN $_{\gamma}, IL_{12}$) synthesis	D, NK, T_{h1}, T_c
Interleukin 6 (IL $_6$)	T_{h2} activation	$(M, D) + (IL_{1\beta}, TNF_{\alpha})$
<hr style="border-top: 1px dashed black;"/>		
Immuno-modulatory		
Interleukin 4 (IL $_4$)	T_{h2} activation	T_{h2}
<hr style="border-top: 1px dashed black;"/>		
Transforming growth factor- β (TGF $_{\beta}$)	T_{reg} activation ↘ Antigen presentation, phagocytosis ↘ Cell infection ↘ (T_h, T_c, B) proliferation ↘ (IFN $_{\gamma}, IL_{10}$ by T_{h2}) synthesis ↗ IL $_{10}$ by T_{reg} synthesis	D, T_{reg}
<hr style="border-top: 1px dashed black;"/>		
Interleukin-10 (IL $_{10}$)	↘ Antigen presentation, phagocytosis ↗ Cell infection ↘ NK activation ↘ (P_i, A_v, IL_{12}) synthesis ↗ IL $_{10}$ synthesis	M, D, T_{h2}, T_{reg}

Colour code : innate, adaptive & innate and adaptive components ↗ amplification, ↘ inhibition

I.1.2 PRRSv infection at the within-host scale

PRRSv induces a prolonged viremia (viral titer in the blood) due to its ability to hamper the immune response [12–14]. The immune response is not efficient enough to control PRRSv replication, as the virus has developed a certain number of anti-immune tricks to escape from elimination.

I.1.2.1 Pathogenesis

PRRSv infection dynamics is not yet fully known [15–17]. However, it is thought that in the course of PRRSv infection, the virus replicates and persists mostly in the lungs and lymph nodes [13, 15]. Immunofluorescence techniques allowed to identify three infection steps [16]. First, an early acute infection predominantly in macrophages of lymphoid tissues and lungs developed within the first week. Second, a delayed acute infection of the lung was observed, which was most pronounced during the second and third week post infection. The acute infection of lymph nodes was resolved at this time. Highly virulent virus isolates reached a peak of infection more rapidly than isolates with moderate or low virulences. Third, a late persistent infection with restricted virus replication lasted several months. The virus persisted in lymph nodes and in the lung, but the viremia was resolved between 28 and 42 days post infection. At this step, attempts to isolate the virus were in most cases unsuccessful. Indications for a re-occurrence of acute infection were observed in restricted areas of the lung.

I.1.2.2 Target cells

Macrophages, particularly Porcine Alveolar Macrophages (PAM), are considered to be the primary targets for PRRSv infection and replication [13, 15, 18].

PRRSv can also infect dendritic cells. There are several dendritic cell sub-types, including the conventional D^c and plasmacytoid D^p sub-types, which are supposed to play a key role in PRRSv infection [19, 20]. Different types of dendritic cells, including bone marrow-derived and monocyte-derived dendritic cells (D^c model), may support PRRSv replication, whereas the plasmacytoid dendritic cells (D^p) do not [21–24]. In *in vitro* PRRSv infections, mature monocyte-derived dendritic cells are considered as a good model for conventional dendritic cells [21–25]. Plasmacytoid dendritic cells are professional IFN_α and TNF_α producing cells and these innate antiviral cytokines are assumed to play a key role for PRRSv resolution [26–28]. Moreover, D^p ability to synthesise innate antiviral cytokines is altered by PRRSv and seems strain-dependent [19].

The immune function modulations induced by PRRSv infection are similar for the macrophages and the D^c [27]. The D^c permissiveness to PRRSv is lower than the macrophage permissiveness [21], but all published studies point out a similar PRRSv replication rate in D^c and macrophages once infected [21, 22, 25]. PRRSv replication in macrophages occurs within twelve hours and infected pigs are viremic (virus detected in the blood) 24 hours post infection [29]. Thus, within one day post infection, the virus is disseminated throughout the body.

I.1.2.3 Infection duration

PRRSv viremia lasts between 28 to 42 days in the blood [14, 15, 26] and around 56 days in the lung [14]. However, the infection duration is highly variable between pigs and viral strains and can be higher than 200 days [26, 30]. Comparatively, pig influenza infection lasts around 10 to 14 days and pig foot-and-mouth disease virus infection lasts around 14 to 21 days [26]. Interestingly, viremia is undetectable in the blood of most animals after 28 to 42 days, although the virus may still be isolated months later in lymph nodes or lung due to continued low-level replication [31–33]. Consequently, animals can still shed the virus at the end of their infection period, suggesting an inefficient viral clearance by adaptive response [26]. Comparing the viral titer data from published experimental studies is tricky as experimental protocols exhibit a strong variability (inoculated PRRSv strain, pig breed, age at infection, monitoring duration, viral titration method...) as illustrated in TABLE I.2.

Table I.2 PRRSv viral titer characteristics from published experimental data, which monitored and measured the viral titer during at least 14 days post infection (dpi). Three quantitative characteristics (mean value and/or range) of the viral titer were extracted : the infection duration D_I (in dpi), the viral peak V_{max} (default unit in TCID₅₀/ml, or *copy/ml, †CCID₅₀/ml) and the date of the viral peak T_{max} (in dpi). The PRRSv strain (type 1 European or type 2 American genotype), pig breed (Landrace Lr, Large White LW, Yorkshire Yk, Pietrin Pi, Miniature Mi, Hampshire Hs, Duroc Du, NE Index line NE or conventional Co) and pig ages at infection (in days; † : non pregnant, third parity) are specified. The main outlines of the experimental protocol are also specified : sample origin (blood or broncho-alveolar lavage BAL), viral titration method (viral isolation VI, quantitative RT-PCR or Immuno Fluorescence Monolayer Assay IFMA), inoculation dose (default unit in TCID₅₀/ml, or *copy/ml, †CCID₅₀/ml) and route (intranasal IN, intramuscular IM, intranasal and intravenous IN-IV, intranasal and intramuscular IN-IM or through aerosol A). ∅ : not informed in the published studies.

PRRSv strain x Pig breed x Pig age		Viral titer characteristics				Protocol outlines			Ref.				
Strain	Breed	Age	D_I mean	V_{max} range	T_{max} mean	range	Sample method	Titration method		Inoculation Route			
<i>Type 1 European genotypes</i>													
LV (Lelystad)	∅	28 – 35	∅	35-52	∅	10 ^{4.5} – 10 ^{7.3}	∅	7	BAL	IFMA	10 ⁶	IN	[34]
	Lr	42	26	21 – 35	10 ^{2.7}	10 ² – 10 ^{3.6}	10.5	7 – 14	blood	VI	10 ⁵	A	[15]
	Yk x Lr	49	35	∅	10 ^{7*}	∅	7	∅	blood	RT-PCR	10 ⁵	IN	[35]
	Yk x Lr x LW	42	27	21 – 33	10 ^{3.8}	10 ⁴	7	7	blood	VI	10 ⁵	IN	[36]
	∅	27	∅	> 21	∅	10 ^{3.8} – 10 ^{4.2}	∅	12	blood	VI	10 ^{5.7}	IN	[37]
LV (Sp-3/1992)	∅	27	∅	> 21	∅	10 ^{3.7} – 10 ^{4.3}	∅	6 – 12	blood	VI	10 ^{5.7}	IN	[37]
LV (Sp-13/2000)	∅	27	∅	> 21	∅	10 ^{3.8} – 10 ^{4.2}	∅	12	blood	VI	10 ^{5.7}	IN	[37]
LV (Sp-22/2002)	∅	27	∅	> 21	∅	10 ^{3.8} – 10 ^{4.2}	∅	12	blood	VI	10 ^{5.7}	IN	[37]
Belgium A	Yk x Lr x LW	42	29	26 – > 33	10 ⁴	10 ^{3.8} – 10 ^{4.2}	10	10	blood	VI	10 ⁵	IN	[36]
	Co	42	∅	21-35	∅	10 ^{2.4} – 10 ^{4.6}	∅	10	blood	IFMA	10 ⁶	IN	[38]
215-06	Yk x Lr	49	35	∅	10 ^{5.8*}	∅	7	∅	blood	RT-PCR	10 ⁵	IN	[35]
SUI-bel	Yk x Lr	49	35	∅	10 ^{5.5*}	∅	7	∅	blood	RT-PCR	10 ⁵	IN	[35]
SDRP-15D	∅	56	∅	21 – 49	∅	10 ^{2.8} – 10 ^{3.7}	∅	14	blood	VI	10 ⁴	IN-IV	[30]
3262	∅	28	22	14 – 35	10 ^{3.1}	10 ^{2.5} – 10 ^{3.7}	7	7	blood	VI	10 ^{5.7}	IN	[39]
3267	∅	28	49	42 – 63	10 ^{3.7}	10 ^{3.4} – 10 ⁴	7	7	blood	VI	10 ^{5.7}	IN	[39]
2982	∅	45	∅	14 – > 24	∅	10 ^{2.3} – 10 ^{4.5}	∅	14	blood	VI	10 ³	IM	[40]
	∅	35	22	14 – > 24	10 ^{3.28}	10 ^{2.6} – 10 ^{3.9}	14	14	blood	VI	10 ³	IM	[41]
Lena	Yk x Lr x LW	42	31	21 – > 33	10 ^{5.4}	10 ^{3.8} – 10 ^{5.6}	∅	7 – 10	blood	VI	10 ⁵	IN	[36]
	Co	42	∅	35	∅	10 ^{4.3} – 10 ^{6.1}	∅	10 – 14	blood	IFMA	10 ⁶	IN	[38]
<i>Type 2 American genotypes</i>													
<i>Continued on next page...</i>													

TABLE 1.2 – continued from previous page

Strain	Breed	Age	Viral titer characteristics					Protocol outlines			Ref.		
			D _I mean range	V _{max} mean range	T _{max} mean range	Sample from	Titration method	Inoculation Dose	Route				
VR-2332	Lr x LW	21	62	$10^{7.1} * 10^{6.5} - 10^{7.7} *$	\emptyset	7-14	blood	RT-PCR	10^4	IM	[42]		
	Co	14-21	28	10^4	\emptyset	7	blood	VI	$10^{3.4}$	IN	[43]		
Ingelvac MLV	LW or Pi	42	> 21	$\frac{10^5}{10^{4.2}} \frac{10^{3.5} - 10^{6.3}}{10^{2.8} - 10^{5.3}}$	14	14	BAL blood	IFMA	10^5	IN	[44]		
	\emptyset	21-28	42	35-42	10^4	$10^1 - 10^5$	7	blood	RT-PCR	10^5	IM	[45]	
Ingelvac MLV	Co	14-21	35	\emptyset	$10^{0.8}$	\emptyset	7	blood	VI	$10^{3.4}$	IN	[43]	
	Mi	35	23	9-35	$10^{2.5}$	\emptyset	12	blood	IFMA	10^5	IM	[46]	
Ingelvac MLV	Pi	35	58	9-72	$10^{3.7}$	\emptyset	6	blood	IFMA	10^5	IM	[46]	
	Co	14-21	28	\emptyset	10^4	\emptyset	7	blood	VI	$10^{3.1}$	IN	[43]	
JA-142	\emptyset	35	\emptyset	22-36	\emptyset	$10^{4.3}$	\emptyset	5	blood	VI	$10^{4.3}$	IN	[47]
	\emptyset	21	35	\emptyset	$10^{4.5}$	\emptyset	1	blood	RT-PCR	10^3	IN-IM	[48]	
Ingelvac ATP	\emptyset	112-140	11	\emptyset	10^3	\emptyset	3	blood	RT-PCR	10^3	IN-IM	[48]	
	\emptyset	> 140†	14	\emptyset	$10^{2.8}$	\emptyset	3	blood	RT-PCR	10^3	IN-IM	[48]	
Ingelvac ATP	Co	14-21	35	\emptyset	$10^{1.2}$	\emptyset	7	blood	VI	$10^{4.1}$	IN	[43]	
	\emptyset	21	63	\emptyset	$10^{3.5}$	\emptyset	21	blood	RT-PCR	10^3	IN-IM	[48]	
Ingelvac ATP	\emptyset	112-140	14-28	\emptyset	$10^{0.8}$	\emptyset	3	blood	RT-PCR	10^3	IN-IM	[48]	
	\emptyset	> 140†	14	\emptyset	$10^{1.5}$	\emptyset	8	blood	RT-PCR	10^3	IN-IM	[48]	
97-7985	NE	\emptyset	\emptyset	> 14	\emptyset	$10^{4.1} - 10^{4.5} \ddagger$	\emptyset	4-14	blood	RT-PCR	$10^2 \ddagger$	IN	[49]
	Hs x Du	\emptyset	\emptyset	> 14	\emptyset	$10^{3.7} - 10^{5.4} \ddagger$	\emptyset	7-14	blood	RT-PCR	$10^2 \ddagger$	IN	[49]
97-7985	\emptyset	27	\emptyset	> 21	\emptyset	$10^{3.8} - 10^{4.6}$	\emptyset	6-9	blood	VI	$10^{5.7}$	IN	[37]
	Lr x LW	18-29	\emptyset	21- > 42	$10^{6.4}$	$10^5 - 10^7$	7	4-11	blood	RT-PCR	10^5	IN-IM	[50]
SDSU-73	Co	14-21	> 35	\emptyset	$10^{3.5}$	\emptyset	7	\emptyset	blood	VI	$10^{2.8}$	IN	[43]
	\emptyset	35	\emptyset	36	\emptyset	$10^{4.3}$	\emptyset	5	blood	VI	$10^{4.3}$	IN	[47]
Abst-1	Co	14-21	7	\emptyset	$10^{0.2}$	\emptyset	3	\emptyset	blood	VI	$10^{4.2}$	IN	[43]
MN-184	Co	14-21	35	\emptyset	$10^{4.6}$	\emptyset	7	\emptyset	blood	VI	$10^{4.1}$	IN	[43]
17198-6	Co	14-21	35	\emptyset	$10^{2.8}$	\emptyset	15	\emptyset	blood	VI	$10^{2.8}$	IN	[43]
16244 B	\emptyset	27	\emptyset	> 21	\emptyset	$10^{3.2} - 10^{3.8}$	\emptyset	6-9	blood	VI	$10^{5.7}$	IN	[37]
761040 0	\emptyset	27	\emptyset	> 21	\emptyset	$10^{3.7} - 10^{4.7}$	\emptyset	9	blood	VI	$10^{5.7}$	IN	[37]

Depending on the studies, various components of the immune response have been highlighted as having an impact on PRRSV infection duration [26–28] :

- the macrophage permissiveness and excretion rate ;
- the levels of antiviral and immuno-modulatory cytokines ;
- the balance between the cellular, humoral and regulatory responses.

It is well established that PRRSV infection usually induces low levels of innate antiviral cytokines, in particular IFN_α and TNF_α , as well as a delayed and inefficient adaptive immune response [26–28]. In particular, PRRSV infection in pigs leads to a weak and delayed production of neutralising antibodies [34], as well as a weak cellular adaptive immune response [51].

I.1.3 Interactions between the pathogen and its target cells

The pathogen recognition through the toll-like receptors (TLR) of APC, which are pattern recognition receptors directed against key pathogen-associated molecules, initiate the innate response. When a TLR ligand binds to the receptor, an intracellular signal transduction cascade is triggered, altering the pattern of gene expression in the cell. Activation of the TLR leads not only to the induction of inflammatory responses, but also to the development of the adaptive immunity [9, 10, 52]. The TLR family is known to consist of 10 members (TLR1–TLR10), which can be divided into five subfamilies : TLR3, TLR4, TLR5, TLR2 (including TLR1, TLR2, TLR6, and TLR10) and TLR9 (including TLR7, TLR8, and TLR9) [9, 10, 52]. Microbial products such as peptidoglycan, LPS or flagellin are known to be the ligands of TLR2, TLR4, TLR5 and TLR9 subfamilies, while TLR3, TLR7 and TLR8 subfamilies are related on recognition of viral nucleic acids [9, 10, 52, 53]. TLR family members are expressed differentially among immune cells and appear to respond to different stimuli [9, 10, 52].

The interaction between the pathogen and APC involves either internalisation receptors resulting in the APC infection or TLR resulting in the APC activation. These interactions result in cascaded reactions within the cell which allow to either induce/promote or block/limit each immune function. Obviously, from the virus (APC) point of view, the target cell binding should result in promoting (limiting) the cell permissiveness and the viral replication, while limiting (promoting) the antiviral immune functions. Pathogens develop numerous strategies to evade the immune system. For instance, the pathogen internalisation could result in the regulation of the TLR expression and so modify the APC immune functions, such as cytokine synthesis or MHC expression, which consequently hamper the whole immune response. Moreover, the internalisation induces the expression of viral epitopes by APC within the MHC, which induce an adaptive immune response specific to the pathogen, expressing in turn the viral epitopes. These epitopes can also alter the adaptive immune functions.

When a pathogen encounters a susceptible antigen presenting cell, it activates the cell : the pathogen is either phagocyted (APC activation through TLR receptors), resulting in pathogen destruction, or it infects the cell (APC activation through internalisation receptors), resulting in pathogen replication. Activated APC display a fragment of the pathogen antigen (called epitope) bound to a major histocompatibility complex (MHC) molecule on their membrane, which can be recognised and can activate helper T cells. Unless they are infected, activated APC can lose their activation and revert to a susceptible status. However, infected cells remain infected, *i.e.* they cannot eliminate the pathogen.

The dynamics of the pathogen, its target APC and their interactions are regulated by cytokines and immune cells :

- pathogens can be neutralised by antibodies, which prevent cell infection ;

- infected cells can be destroyed by cytolytic cells, *i.e.* natural killers and cytotoxic lymphocytes;
- APC are subject to apoptosis induced by TNF_α [27, 54];
- the recruitment of APC to the infection site is amplified by pro-inflammatory cytokines [1, 10, 55, 56];
- the activation of APC through TLR receptors is amplified by antiviral cytokines (TNF_α , IFN_α and IFN_γ) and inhibited by immuno-modulatory cytokines (IL_{10} and TGF_β) [52];
- the infection of APC, linked to their permissiveness, can be modulated by cytokines. For instance, APC infection by PRRSv is amplified by IL_{10} and inhibited by innate antiviral cytokines (IFN_α , TNF_α) and TGF_β [13, 41].

Whatever the pathogen, the infection of APC necessarily impacts their immune functions, and hence the innate immune response. As APC are responsible for the activation of the adaptive immune response, their infection has consequences on the adaptive immune response.

I.1.3.1 PRRSv specificities

PRRSv (*Arteriviridae* family within the genus *Arterivirus*, order *Nidovirales*) developed various strategies to evade the innate immune systems by the regulation of Toll-like receptor expression.

Immune functions of APC PRRSv mainly targets macrophages and so reduces the phagocytosis activity, since infected macrophages cannot phagocytose anymore [57]. PRRSv also increases the permissiveness of non-infected APC [58]. Moreover, PRRSv replication in infected APC has multiple effects [13, 26–28, 59–61] :

- it induces apoptosis;
- it down-regulates the expression of major histocompatibility complex (MHC);
- it up-regulates the synthesis of IL_{10} and IL_{12} ;
- it down- or up-regulates the synthesis of pro-inflammatory and innate antiviral (TNF_α and IFN_α) cytokines depending on experimental results.

However, PRRSv influence on the host ability to synthesise the various cytokines must be interpreted with caution, since the absence of one cytokine may influence the production and action of another.

TLR involved in PRRSv-APC binding Published information about the involvement or regulation of TLR in PRRSv is limited [13]. TLR3 recognises double stranded RNA and Nidovirales are known to produce dsRNA which accumulate in the cell during the replication cycle [13]. In consequence, interactions between TLR3 and PRRSv could be expected. Published data are divided on the interactions between the various TLR and PRRSv [13]. Some reported a transient inhibition of TLR3 and TLR7 expression by macrophages and dendritic cells after *in vitro* PRRSv infection, whereas *in vivo* PRRSv infection results suggested the opposite [13]. Liu *et al.* [62] reported an increase in the expression of TLR3 — as well as TLR2, TLR4, TLR7 and TLR8 — in lymphoid tissues of infected pigs and Miguel *et al.* [63] showed that TLR3, TLR4 and TLR7 expression increased in the lymph nodes.

Several TLR including TLR3, TLR7/8 and TLR9 are involved in antiviral responses by triggering the production of cytokines such as type I interferons (IFN) [64]. PRRSv seems able to regulate the expression of these TLR, which can explain the observed down- or up-regulation of innate antiviral cytokines. Moreover, the non-structural proteins (nsp) of the virus is a strong

inhibitor of IFN_α production, by inhibiting one part of the pathway of IFN_α induction upon TLR3 activation [13, 26]. As the non-structural proteins are the most variable parts of the viral genome among PRRSV strains, different PRRSV isolates might interfere differently with TLR3 and may account for the up or down-regulation of the innate antiviral responses [13].

TLR3 seems to be an important element in controlling viral replication : the activation of TLR3 resulted in a lower PRRSV viral multiplication and conversely, low TLR3 expression increased the viral replication [13]. Finally, Calzada-Nova *et al.* [65] indicated that PRRSV failed to induce secretion of a number of cytokines in plasmacytoid dendritic cells, suggesting some interference with TLR7 and TLR9 signalling.

Synthesis To summarise, PRRSV dynamics directly depends on its interactions with the target cells, but is also impacted by other immune components (antibodies, cells and cytokines) and impacts other immune components (cells, cytokines). Consequently, PRRSV is linked to the dynamics of the immune components in a complex way, involving many interactions.

I.1.4 Innate immune response

The host innate immune response plays a key role against early viral infection [61]. The innate immune response (i) is the first line of defence against a pathogen, (ii) is activated within a few hours and (iii) is not pathogen-specific. Apart from the physical barriers, the innate response consists of :

- the pathogen destruction by phagocytosing cells, the macrophages and dendritic cells ;
- the infected cell destruction by non specific cytolytic cells, the natural killers ;
- the inflammation induction by the synthesis of pro-inflammatory cytokines and chemokines, which amplify the recruitment of innate cells to the infection site ;
- the inhibition of the target cell permissiveness (*i.e.* the virus ability to circumvent the host defences and to replicate) and the pathogen replication by the synthesis of antiviral cytokines ;
- the complement system, which helps or “complements” antibodies and phagocytic cells to clear pathogens from the host ;
- the adaptive response activation by the expression of MHC on the APC surface.

The major innate cells are the macrophages, the dendritic cells and the natural killers. Their functions are detailed below.

Macrophages Macrophages phagocyte and destroy the pathogen. Activated macrophages (either phagocytosing or infected) synthesise innate cytokines : pro-inflammatory (P_i : $\text{IL}_{1\beta}$, IL_6 , IL_8), antiviral (A_i : IFN_α , TNF_α) and immuno-regulatory (IL_{12} , IL_{10} , TGF_β) cytokines [1].

Dendritic cells The mature dendritic cells polarise the adaptive response *via* the synthesis of various cytokines. Their ability to synthesise cytokines differs depending on their sub-types, the cytokine environment, their activation way (internalisation receptors or TLR), but also the pathogen strains and the hosts. The conventional D^c and the plasmacytoid D^p dendritic cells are two major sub-types. The main immune functions of D^c dendritic cells are the antigen presentation to the naive adaptive helper T cells and the synthesis of various cytokines ($\text{IL}_{1\beta}$, IL_6 , IL_8 , IFN_α , TNF_α , IL_{12} , IFN_γ , IL_{10} , TGF_β). The main immune function of the D^p dendritic cells is the synthesis of innate antiviral cytokines (IFN_α , TNF_α).

Natural killers Natural killers are effectors of the innate response. Their main immune functions are the destruction of infected cells and IFN_γ synthesis [1, 10, 11, 66]. These cytotoxic cells are recruited to the infection site by pro-inflammatory cytokines. Their proliferation and immune functions are activated by several cytokines (IFN_γ , IL_{12} , IL_{15} , IL_{18} , IL_{21} , $\text{IFN}_{\alpha\beta}$), whereas IL_{10} inhibits the natural killer differentiation and their immune functions [66].

I.1.4.1 PRRSv specificities

An hypothesis to explain the prolonged infection induced by PRRSv is that the viral dynamics is more determined by the target cell permissiveness and the early events of the immune response than by the adaptive response mechanisms [51, 67]. The dynamics and mechanisms of virus–host interactions during the first two weeks post infection are indeed critical for the subsequent immunological and clinical outcomes. However, our knowledge on virus–host interactions during this acute infection period is sparse [60]. Previous reports demonstrated various negative effects of PRRSv on innate immune functions : alteration of the cytolysis function by natural killers, suppression of phagocytic and antigen presentation activities and alteration of the cytokine patterns [13, 14, 26–28, 59–61, 68].

Down-regulation of pro-inflammatory cytokine synthesis Pro-inflammatory cytokines ($\text{IL}_{1\beta}$, IL_6 and IL_8) peak around 14 days after PRRSv infection [69]. Pro-inflammatory cytokines amplify the recruitment of APC to the infection site [12, 70]. In contrast to other viral respiratory diseases of pigs, production of pro-inflammatory cytokines is limited with PRRSv [71]. Infected pigs fail to elicit any significant $\text{IL}_{1\beta}$ synthesis in the lung. Most studies found that PRRSv induces IL_8 synthesis. Regarding IL_6 , some studies indicated production [13, 62, 70], while others did not [13, 67, 72]. Low expression of pro-inflammatory cytokines has been reported in pigs infected with type 1 (European genotype) and type 2 (American genotype) PRRSv strains. Increases in expression of $\text{IL}_{1\beta}$, IL_6 and TNF_α in the lungs of pigs infected with type 1 PRRSv strain are correlated with the development of interstitial pneumonia [69]. There appears to be a correlation between the virulence of the PRRSv strain, the severity of clinical signs and the expression of pro-inflammatory cytokines. The ability to synthesise IL_8 is highly variable among hosts ; high abilities have been associated with high host resistances to PRRSv [73].

Down-regulation of IFN_α and TNF_α PRRSv replication seems to be highly susceptible to both IFN_α and TNF_α , but their synthesis by PRRSv-infected pigs is not adequate [12, 13, 70, 74–76]. The down-regulation of IFN_α and TNF_α is assumed to be a crucial step of PRRSv pathogenesis [27]. It is postulated that at least one of the mechanisms for viral persistence may be related to the modulation of IFN_α production by PRRSv [77].

IFN_α significantly inhibits PRRSv replication [30] and is important for the induction of IFN_γ -producing adaptive immune cells [78]. Interestingly, the expression of IFN_α in PRRSv infected pigs reaches its maximum expression after the viremic phase [69], suggesting an inhibitory effect of PRRSv on IFN_α production. In some studies, IFN_α was not detected in the lungs of pigs where PRRSv is actively replicating. In addition, PRRSv-exposed plasmacytoid dendritic cells (D^p), the major IFN_α producer following viral infection, fail to induce IFN_α production. Different PRRSv isolates appear to have different abilities to induce or inhibit IFN_α synthesis by D^p [79].

Most PRRSv strains are weak inducers of TNF_α [28]. Some PRRSv strains induce the synthesis of TNF_α at variable levels, whereas others fail to induce TNF_α synthesis [80]. TNF_α

plays an important role in the inflammatory and antiviral responses, protecting cells from infection against viruses or enhancing selective elimination of virus-infected cell. *In vitro* infections showed that TNF_α inhibited PRRSV replication and that PRRSV-infected macrophages had reduced expressions of TNF_α . Moreover, the percentage of macrophages was reduced by 40% 48 hours post infection [81] and most apoptotic cells (induced by TNF_α) were non-infected macrophages [82, 83]. Even if low levels of apoptosis are encountered in *in vivo* experiments, it plays an important role in the PRRSV infection [82].

Up-regulation of IL_{10} Most studies indicate that PRRSV up-regulates the synthesis of IL_{10} [13, 21, 22, 70, 77, 84, 85]. However, some studies found no significant IL_{10} response to PRRSV infection [25, 86]. The host ability to synthesise IL_{10} is highly variable between hosts and PRRSV strains : highly virulent strains and highly susceptible pigs exhibited high levels of IL_{10} [28, 49, 59, 80]. A transcriptional analysis of PRRSV-infected macrophages [87] and dendritic cells [21] revealed IL_{10} up-regulation only few hours post infection. Different viral strains were able to induce different IL_{10} responses in macrophages of PRRSV-naive pigs [67] and the stimulation of dendritic cells with different type 1 strains (European genotype) induced different IL_{10} syntheses [24].

Most papers suggest that IL_{10} plays a crucial role in PRRSV infection. IL_{10} is responsible for the inhibition of pro-inflammatory and antiviral cytokines [69], it inhibits the phagocytosis by macrophages and the dendritic cell activation and it amplifies the APC permissiveness to PRRSV [13, 60, 88]. IL_{10} concentration and PRRSV replication rate are strongly correlated [69]. IL_{10} may be involved in the inhibition of TNF_α gene expression in PRRSV-infected pulmonary macrophages [87]. In an *in vitro* experiment, the neutralisation of IL_{10} resulted in an enhanced production of TNF_α by macrophages co-cultured with PRRSV [85]. However, another *in vivo* experimental study found that, depending on the PRRSV strain, infected pigs were able to synthesise IL_{10} , TNF_α or both [80]. These experiments suggest that low levels of TNF_α synthesis are not always due to IL_{10} .

Down-regulation of natural killers The modulation of the innate immune response in PRRSV-infected pigs under field conditions is associated with a decrease in the cytotoxicity, but not in the percentage of natural killers (NK) [12, 89]. Their concentration starts increasing five days post infection [12]. The reduced cytotoxic function of NK cells is associated with increased plasma concentrations of IL_4 , IL_{10} and IL_{12} , suggesting a role for these cytokines in modulating the host immune response [89].

Down-regulation of MHC expression MHC are required for the adaptive response activation. The effects of PRRSV on the expression of MHC are far from being clearly understood. Dendritic cells are the best cell type for examining such effects, since they are the major antigen presenting cells. PRRSV replication in dendritic cells down-regulates the expression of MHC [21, 22, 25]. As a consequence, the adaptive response to PRRSV is likely to be delayed or even deficient. It has been previously shown the IFN_α together with TNF_α induce an effective up-regulation of MHC expression [90]. The presence of exogenous recombinant porcine IFN_α could reverse the down-regulation of MHC by PRRSV infection [32]. The secretion of IL_{10} down-regulates MHC expression, as do costimulatory and other surface molecules that induce depressed antigen presentation and a suppressed immune response [22].

I.1.5 Adaptive immune response

The adaptive immune system is considered as determining for the infection resolution against numerous pathogens. The adaptive immune response (i) is triggered when a pathogen evades the innate immune system, (ii) is delayed compared to the innate response and (iii) is composed of highly specialised cells and processes that eliminate or prevent pathogen growth. The adaptive response consists of :

- the helper T cells, which orientate the adaptive system towards the cellular, humoral or regulatory responses (detailed below) ;
- the cellular response, characterised by cytotoxic T cells, which destroy infected cells (detailed below), and by the antiviral cytokine IFN_γ ;
- the humoral response, characterised by antibodies, which either mark the pathogen and infected cells or neutralise the pathogen (detailed below), and by the immuno-modulatory cytokine IL_{10} ;
- the regulatory response, characterised by TGF_β , an immuno-modulatory cytokine which inhibits numerous immune functions ; the regulatory response down-regulates the functions of immune effector cells and hence suppresses excessive responses that could harm the host more than the pathogen itself.

The major adaptive cells are the helper T cells, the cytotoxic T cells and the B lymphocytes. Their functions are detailed below, as well as the role of memory cells and immunity.

Helper T cells [1–8, 91, 92]

Naive helper T cells are activated by mature dendritic cells *via* a major histocompatibility complex, resulting in the expression of T CD_4 membrane proteins and the synthesis of IL_{12} . Then helper T cells proliferate and this proliferation is amplified by IL_{12} and inhibited by TGF_β . CD_4^+ T cells differentiate into effectors or memory cells. The three main effectors are the type 1 helper (T_{h1}), type 2 helper (T_{h2}) and the regulatory (T_{reg}) T cells. TNF_α induce T_h apoptosis.

The mechanisms determining the differentiation towards the various effectors are not yet fully identified, but differentiation was shown to depend on the cytokine environment [3, 6, 8].

- Differentiation towards T_{h2} seems to be the default and is amplified by IL_4 [3]. IL_6 blocks the differentiation towards the other two orientations. T_{h2} synthesise IL_4 and IL_{10} cytokines and induce the synthesis of IgG, IgE and IgM antibodies by B lymphocytes.
- Differentiation towards T_{h1} is induced by IL_{12} and amplified by IFN_γ . IL_{12} synthesis by dendritic cells is amplified by IFN_γ and inhibited by IL_{10} . T_{h1} synthesise IFN_γ and IL_2 , induce the activation of cytotoxic lymphocytes T_c and the synthesis of IgG antibodies by B lymphocytes.
- Differentiation towards T_{reg} is induced by TGF_β . T_{reg} are responsible for the synthesis of two immuno-modulatory cytokines, IL_{10} and TGF_β and the synthesis of IgA antibodies by B lymphocytes.

Differentiation was also shown to depend on dendritic cell subsets $\text{CD}8\alpha^+$ or $\text{CD}8\alpha^-$ [3]. $\text{CD}8\alpha^+$ dendritic cells induce the activation of cells secreting IL_{12} and IFN_γ and so polarise T_h towards T_{h1} , whereas the other subset $\text{CD}8\alpha^-$ induce the activation of cells secreting high levels of IL_{10} , IL_4 and IL_5 and so polarise T_h towards T_{h2} . $\text{CD}8\alpha^+$ drive the development of T_{h1} through the production of IL_{12} . However, whatever the dendritic cell subset, the cytokine environment can determine the T_h differentiation [3]. For instance, the absence of IFN_γ or IL_{12} results in the induction of T_{h2} by the $\text{CD}8\alpha^+$ subset and the absence of IL_{10} results in the induction of T_{h1} by

the CD8 α^- subset. Consequently, the differentiation of T_h induced by the dendritic cell subsets depends on their ability to synthesise the various cytokines, which is in turn influenced by the cytokine environment.

Another helper T cell, T_{h17} , was identified more recently [93, 94]. T_{h17} cells, which produce proinflammatory cytokine IL₁₇, play an important role in the induction of inflammation [94]. T_{h17} and T_{reg} differentiation are interconnected [93]. The differentiation towards T_{reg} requires the presence of TGF β . However, in the presence of TGF β plus IL₆, the helper differentiation switches to T_{h17} [93]. Moreover, high levels of TGF β seem to inhibit the differentiation towards T_{h17} , which then requires IL_{1 β} and IL₆ cytokines [94]. T_{h17} were proposed as a pathogenetic mechanism in autoimmune diseases and acute transplant rejection. In contrast, T_{reg} cells play central roles for immunoregulation and induction of tolerance [94]. T_{reg} cells are now known to inhibit proliferation and cytokine production in both CD4⁺ and CD8⁺ T cells, antibody production by B cells, cytotoxic activity of natural killers and maturation of dendritic cells, resulting in the induction of tolerance [94]. Various pathogens, including *Mycobacterium tuberculosis*, can trigger a strong T_{h17} response [93].

Cytotoxic T cells [6–8]

Cytotoxic T cells (T_c) express the CD8 glycoprotein at their surface and are also known as CD8⁺ T cells. The naive T_c are activated by licensed dendritic cells. The dendritic cell licensing is a preliminary step consisting in the binding of an activated dendritic cell and a T_{h1} ; it results in the expression of dendritic cell membrane proteins which allow the binding of licensed dendritic cells to naive T_c . Then T_c proliferate, amplified by IL₁₂ and inhibited by TGF β . T_c are responsible for the synthesis of two antiviral cytokines, IFN γ and TNF α , and for the destruction of infected cells by cytolysis. TNF α induces T_c apoptosis.

B lymphocytes and antibodies [6–8]

The preliminary step for the activation of a naive B lymphocyte is the binding with a free viral particle, inducing the expression of MHC by the B lymphocyte. The B lymphocyte then becomes a plasmocyte by binding to a T_h cell, which induces cytokine syntheses by the T_h cell. Plasmocytes proliferate and differentiate into effector or memory plasmocytes. The proliferation of effector plasmocytes is inhibited by TGF β . Effector plasmocytes first secrete IgM antibodies (Ig for immunoglobulin). Depending on the cytokines synthesised by T_h (*i.e.* depending on the T_h sub-type : T_{h1} , T_{h2} or T_{reg}), the effector plasmocytes then switch to secrete one of the following antibody isotypes : IgG, IgA or IgE. IgM-secreting plasmocytes (B_M) require IL₂ or IL₄, produced by T_{h1} or T_{h2} lymphocytes. Switching to IgG-secreting plasmocytes (B_G) requires IFN γ , IL₄ or TGF β , produced by T_{h1} , T_{h2} or T_{reg} lymphocytes. Switching to IgA-secreting plasmocytes (B_A) requires TGF β , produced by T_{reg} lymphocytes. Switching to IgE-secreting plasmocytes (B_E) requires IL₄, produced by T_{h2} lymphocytes.

Antibodies can have either a neutralising or a marking function. Firstly, antibodies can directly neutralise the pathogen and prevent cell infection. For instance, by binding to the virus, they can block the uptake into cells or cause aggregation of virus particles. Secondly, antibodies can mark the pathogen : by binding to surface antigens, they facilitate the pathogen phagocytosis by APC (opsonization) ; marker antibodies can also activate the complement system and directly lyse the pathogen . Finally, antibodies can mark infected cells : they facilitate the binding of cytotoxic cells to infected cells and hence amplify the cytolysis (ADCC : antibody-dependent cell-mediated cytotoxicity).

- IgM appear at an early stage of the humoral response and circulate in blood serum. They mainly activate the complement system as marker antibodies, but they can also clump and hence neutralise pathogens (agglutination).
- IgG are the most abundant antibodies, found in serum and other extra-cellular fluids. They are versatile immunoglobulins, as they have neutralising and marking functions.
- IgA are found in mucosal areas such as the gut, the respiratory tract and the urogenital tract, as well as in mucous secretions such as tears, saliva, sweat and colostrum. Their main function is to neutralise the pathogen, but they are also involved in ADCC.
- IgE are the least abundant antibodies and are mainly involved in allergic reactions.
- Little IgD is produced at any time. The role of IgD is uncertain.

Memory, vaccination and immunity During their proliferation phase, activated T cells and B lymphocytes differentiate into effector and memory cells. These memory cells are long-lived and pathogen-specific. They confer active long-term immunity to the host. When the host is re-infected by the pathogen, due to these memory cells, the adaptive response is stronger and builds up faster.

Active immunity can also be induced by vaccination. Vaccines challenge the host with the pathogen antigen and so trigger the immune response to the pathogen, but they do not cause the disease. Most vaccines are based on live attenuated pathogens (especially for viruses), inactivated pathogens or fragments of the pathogens. Vaccines do not always induce a strong adaptive immune response. Their efficiency may be improved by the addition of adjuvants, which activate the APC.

Passive short-time immunity is acquired from the transfer of maternal antibodies across the placenta (IgG) or by colostrum intake (IgG and IgA) for humans. Concerning pigs, the transfer of maternal antibodies occurs only by colostrum intake and mainly consists of IgA and in a lesser extend IgG antibodies. Passive immunity protects the young host against infection until its immune system can produce its own antibodies. It lasts up to a few months.

I.1.5.1 PRRSv specificities

A dominating concept of the immunopathogenesis of PRRSv infection is the immunosuppression or dysregulation of the adaptive immune response. PRRSv infection in pigs leads to a weak cellular immune response, as well as a delayed production and low titers of neutralising antibodies while the humoral response is highly activated [13, 14, 26–28, 59–61, 68]. While neutralising antibodies can control the spread of the free viral particles, T_c are needed to eliminate virus-infected cells. Overall, there is insufficient information as to whether and to which extent the B cell or the T cell systems are affected by PRRSv [61].

The characteristics of the adaptive response to PRRSv and the hypotheses proposed to explain the prolonged viremia are detailed below, based on the most recent reviews [13, 14, 26–28, 59–61, 68].

Weak and delayed cellular response activation The induction of virus-specific cytotoxic T lymphocytes T_c in PRRSv-infected pigs is very weak and slow to develop. A transient T cell response is detected between 4 and 12 weeks post infection and lasts two to three additional months. However, the long-term persistence of the virus in the host suggests that the cellular response is ineffective. Moreover, a live attenuated PRRSv vaccine that induced high titers of

cytotoxic T cells protected pigs against viremia [27]. Consequently, it appears that the cellular response could be protective against PRRSV, but it is too weakly activated.

In general, the cellular response is the most efficient response against viruses because (i) IFN_{γ} reduces the target cell permissiveness and the viral replication and (ii) T_c kill infected cells and stop the generation of new viral particles. However, increasing the T_c level may not significantly improve PRRSV infection resolution [61]. Furthermore, T_c cells are difficult to track, *in vitro* and *in vivo* [61]. In practice, the activation level of the cellular response is deduced from the levels of IFN_{γ} , as T_c and T_{h1} are the major IFN_{γ} -producing cells. Reported IFN_{γ} levels induced by PRRSV infection are usually low, whereas IL_{10} levels are high. IL_{10} , synthesised by APC, T_{h2} and T_{reg} , is a potent immunosuppressive cytokine that interacts with numerous immune cells, resulting in the inhibition of the innate and adaptive responses and most particularly of the cellular adaptive response. This suggests that PRRSV is capable of shifting the immune response towards a less effective T_{h2} -mediated immune response, explaining the low cellular response and hence the prolonged infection. However, this conclusion may not always hold, since the synthesis of IFN_{γ} is highly variable between hosts : a high IFN_{γ} synthesis ability is associated with a high pig resistance to PRRSV. Moreover, the different capacity of PRRSV strains to induce protective immunity is assumed to depend on their different capacity to induce a strong cellular immune response [72]. Among the structural proteins of the virus, M and N proteins followed by GP4 are the stronger inducers of IFN_{γ} responses [13].

Significant but inefficient humoral response PRRSV infection produces abundant antibodies in the infected animal, detectable from day 5 post infection (pi). Initially, antibodies mostly belong to the IgM class. Day 21 pi, a switch towards a predominance of IgG is noticeable. However, PRRSV antibodies are mostly marker antibodies. Neutralising antibodies appear between 2 and 4 weeks pi, persist at low levels and may not peak until 10 to 18 weeks pi [12, 13, 68]. PRRSV neutralising antibodies block the infection by preventing the interaction of the virus with the sialoadhesin internalisation receptor on macrophages [95]. Failure to produce neutralising antibodies is not a direct consequence neither of the low adaptive response activation (antibodies are abundant), nor of its orientation towards the humoral response (which favours antibody production), so it is probably due to the virus itself. Indeed, delay in the neutralising antibody response to PRRSV has been postulated to be due to the presence of a nearby immunodominant decoy epitope [96], which may evoke a robust, early, and non-protective immune response that masks or impairs the response to the major neutralising epitope [27]. Early antibodies (which are devoid of neutralising capacity) are directed against the nucleocapsid and non-structural proteins (nsps), whereas antibodies against M protein and GP5 develop later [27]. Because each of the PRRSV structural proteins carries common and type-specific antigenic determinants, European and North American strains can be differentiated from each other [27].

Neutralising antibodies play a critical role in immunological control of a wide variety of viral infections in general and are believed to be crucial for PRRSV as well [97, 98]. However, a variety of studies show that PRRSV viremia is often resolved before neutralising antibodies are detected [68]. Moreover, PRRSV can be isolated from blood of pigs which have neutralising antibodies [27, 72]. Animals lacking neutralising antibodies are sometimes resistant to re-infection [67]. It is clear that porcine neutralising antibodies are not essential for PRRSV immunity and their precise role in the clearance of the primary infection and in the prevention of reinfection is uncertain [26, 27].

Furthermore, antibodies could be responsible for an antibody-dependent enhancement (ADE) of viral replication [99] : non-neutralising antibodies mark the virus and facilitate its internalisation into the macrophages, where it replicates. The epitopes responsible for inducing antibodies

participating in ADE would be located in the N protein and in GP5 [13].

Regulatory response Studies looking into the role of T_{reg} in PRRSv infection were recently published, but they are still few results [13, 20, 24, 26, 41, 60, 61, 100]. TGF $_{\beta}$ -dependent induction of T_{reg} by PRRSv-infected dendritic cells was reported and the infection of dendritic cells seemed sufficient to induce T_{reg} [24]. PRRSv prolonged infection duration, the weak activation of the immune response and the fact that the infection can be extremely persistent in very young pigs have been considered as indirect evidences of an active regulatory response [13]. Indeed, T_{reg} inhibits numerous immune functions and hence contribute to delaying the clearance of the infection.

An experimental infection by an American PRRSv strain induced T_{reg} starting 28 days post infection [100]. Interestingly, the T_{reg} concentration and the viremia were positively correlated. This suggests that T_{reg} could be involved in the persistence of the infection. However, regulatory T cells induced by genotype 2, but not genotype 1, impair the host immune response [20, 24, 100]. Although genotype 2 increases the percentage of T_{reg} , its effect on the immune response *in vivo* is not yet clear [41]. Differences were in the ability of genotype 1 (European) and genotype 2 (American) strains to generate T_{reg} . This suggests that different PRRSv strains induce various regulatory responses.

Infection by an American PRRSv strain induced the synthesis of TGF $_{\beta}$ and IL $_{10}$ by T_{reg} [100]. The capacity of PRRSv to modulate the immune response through the infection of APC, in particular the enhanced synthesis of immuno-modulatory cytokines (IL $_{10}$ and TGF $_{\beta}$), can promote the induction and maintenance of T_{reg} . Whereas no increase in TGF $_{\beta}$ expression was reported after vaccination or infection with European PRRSv genotypes [20, 67], an increase in TGF $_{\beta}$ expression was observed in infections with North American genotypes [24]. The expression of TGF $_{\beta}$ may either favour or hinder the onset of an efficient host immune response [41]. On the one hand, TGF $_{\beta}$ may be able both to avoid over-production of pro-inflammatory cytokines at the tissue level and to hinder PRRSv replication by down-regulating the expression of PRRSv internalisation receptors. The late regulatory response would then be responsible for limiting the inflammation and hence protecting the host against severe PRRSv infection. On the other hand, TGF $_{\beta}$ may impair the host immune response by (i) inhibiting an efficient expression of antiviral cytokines, and/or (ii) inducing the differentiation of T_h towards T_{reg} . Experimental results suggest that that PRRSv-infected APC promote the synthesis of IL $_{10}$ and/or TGF $_{\beta}$ [41]. Consequently, the early immune mechanisms would be responsible for the inefficient host immune response and the induction of T_{reg} cells, which in turn maintain the immuno-modulatory cytokine environment.

Concerning T_{h17} , the presence of IL $_{17}$ secreting lymphocytes in the lung and peripheral blood of pigs was reported [101]. However, we found no information about T_{h17} during PRRSv infection so we neglected them.

I.1.6 Synthesis of the immune response to PRRSv

Immune response to PRRSv is characterised by a weak innate response associated with (i) a high inflammation, (ii) a low phagocytosis activity, (iii) a down(up)-regulation of antiviral (immuno-modulatory) cytokines, (iv) a high PRRSv replication rate, (v) a down-regulation of natural killer functions and (vi) a down-regulation of MHC expression in APC. All these regulations result in an inefficient adaptive response associated with (i) a weak and delayed cellular response, (ii) a high but inefficient humoral response with low neutralising antibodies

and (iii) the regulatory response activation, which maintains low levels of antiviral cytokines and high levels immuno-modulatory cytokines. A synthetic summary is provided in TABLE I.3.

The impairment of the immune response evoked during PRRSV infection is one of the major paradigms of the immunology in the modern research of porcine diseases. Several efforts are being conducted to elucidate the mechanisms used by the virus to evade the host immune response.

Some published studies assume that neutralising antibodies and the antiviral cytokine IFN_{γ} have protective functions [13]. However, the vaccine efficiency against PRRSV does not seem to depend on its ability to induce either neutralising antibodies or IFN_{γ} [68]. Vaccines promoting the IFN_{γ} synthesis allow to increase the activation of the adaptive response [12]. Nonetheless, these assumptions remain controversial, partly due to the high variability of the immune response depending on the PRRSV strains and hosts.

Table I.3 Synthesis of the within-host infection and immune response induced by PRSSv, focused on PRRSV specificities.

Porcine Respiratory and Reproductive Syndrome virus (PRSSv)

Infection long and variable, persistence of the virus in the lungs and lymph nodes

Duration between 28 to 42 days in the blood, around 56 days in the lungs

Variability in host susceptibility, depending on the host genotype and housing conditions ; in pathogen virulence, with generally moderately virulent genotype 1 strains (European) and highly virulent genotype 2 strains (American)

Target cells pulmonary macrophages (M) & conventional dendritic cells (D^c), which are antigen presenting cells (APC)

Innate response impaired by the infection of APC

High levels of pro-inflammatory cytokines ($IL_{1\beta}$, IL_6 and IL_8) → high severity of clinical signs

Low levels of innate antiviral cytokines (IFN_{α} and TNF_{α}) → high target cell permissiveness, high replication rate, low target cell apoptosis and MHC expression

High levels of immuno-modulatory cytokine IL_{10} → low levels of antiviral and pro-inflammatory cytokines, low phagocytosis rate, high target cell permissiveness

Low MHC expression in APC → low activation of the adaptive response

Adaptive response weakly activated by the innate response, whose low (high) levels of antiviral (immuno-modulatory) cytokines promote the humoral response

Weak and delayed cellular response activation → low infected cell destruction & low levels of adaptive antiviral cytokines

Significant but inefficient humoral response → low neutralisation of PRRSV, high levels of adaptive immuno-modulatory cytokines, antibody-dependent enhancement (ADE) of viral replication

Regulatory response activation → limitation of inflammation, cell permissiveness, antiviral cytokines, adaptive cell proliferation, amplification of immuno-modulatory cytokines

I.2 Immunological models for respiratory pathogens targeting APC

We singled out three main issues to be addressed in this thesis by a modelling approach (Section 3), *i.e.* identify the immune mechanisms that determine the infection duration (Chapter II), study the exposure impact (Chapter II) and explore vaccine efficiency (Chapter IV), in a host and strain variability context. So we scanned the literature to find models on which we could base our studies.

We first describe the criteria we used to determine the most relevant models to meet our goals (Section I.2) and present the models hence identified in the literature (TABLE I.2). Then we synthesise the immune components and mechanisms included in the selected models. To this end, a series of synthetic tables are provided and commented. They describe the interactions between the pathogen and its target cells (Section I.2.2 and TABLE I.5), the regulations by immune cells (Section I.2.3 and TABLE I.6) and the cytokine regulations (Section I.2.4 and TABLE I.7). Finally, we present the broad lines and characteristics of the three models we developed (Section I.2.5) : the lung-based model published in [102], presented in Chapter II (denoted by ❶), the simplified lung-based model presented in Chapter III (denoted by ❷) and the within-host model presented in Chapter IV (denoted by ❸). These three models are described in the above-mentioned synthetic tables, along with the selected models, so as to situate them among the literature.

We based our model review on immune components and mechanisms that characterise PRRSv within-host infection and immune dynamics (Section I.1.6) and that we deemed relevant to meet our goals. However, the models we selected from the literature were developed to address different issues. When discussing their features in terms of immune components and mechanisms represented, we do not assess the relevance of the models to address their issues, but their relevance to achieve our goals.

I.2.1 Model selection

There are numerous dynamic immunological models in the literature, which describe the evolution over time, and possibly space, of immune variables and their interactions. We are interested in developing models that describe the host immune response in a rather comprehensive manner to account for its complex regulations, at the between-cell scale, in the lung and the lymph nodes. The criteria we used to select the most relevant models in the literature are, *i.e.* : (i) the biological scale, (ii) the immune processes represented and (iii) the mathematical formalism. We had to add an extra criterion, (iv) the pathogen, to identify a reasonable number of models.

Biological scale The spectrum of mathematical models representing host–pathogen interactions, in particular immunological processes, is extremely rich [103–107]. Narang *et al.* [107] give a global and comprehensive overview of the immunological modelling field. Published immunological models proceed from a fine view, representing immune mechanisms at the molecular and gene/protein scales, to a large and integrative view, representing the immune response at the organism or population scale [107]. Finer scales are adapted to explore intra-cellular mechanisms, such as the recognition of pathogen molecular patterns by immune cells or the phagocytosis of the pathogen by macrophages. Larger scales are adapted to explore the immune mechanisms determining the infection resolution at the within-host scale or the pathogen spread in the host population, considering different strains and host conditions.

Our approach is clearly at an intermediate scale, considering the immune mechanisms at the between-cell scale. Integrative model at the within-host scale would include too many processes and an integrative model at the immune function scale would be too simplified to meet our goals. However, representing the immune response at the between-cell scale may require the integration of phenomena at finer scales, for instance for the up- and down-regulations by cytokines. At the finer scale, gene expression in response to activators and inhibitors is described using Michaelis–Menten enzyme kinetics and the Hill function. These equations reproduce the characteristic sigmoid-shaped dynamics of gene transcription. At a larger but cell-based scale, models do not represent these mechanisms explicitly, but usually consider sigmoid-shaped cytokine regulation functions based on a Michaelis–Menten formalism [108–110].

Processes represented The most basic model of the immune response to a pathogen represents the interaction between free pathogen particles and their target cells [111] : susceptible cells (target cells) become infected when they encounter the pathogen ; infected cells produce new pathogen particles and die. Such a model is too simplified to meet our goals.

Indeed, PRRSv mainly targets pulmonary macrophages, a key component of the innate immune response, and hence alters the innate and subsequent adaptive immune responses in complex ways (Section I.1.6). Moreover, immune mechanisms responsible for the infection resolution and host protection are strongly variable between hosts and PRRSv strains. To identify the mechanisms that determine the infection duration or to explore vaccine efficiency in a host and strain variability context, components of the innate and adaptive responses need to be included in the models.

Mathematical formalism Some immunological models explicitly represent the space and follow the evolution over time and space of the immune variables [112]. These model usually require the use of partial differential equations [113]. PRRSv infection is mainly localised in the lungs and lymph nodes. The bloodstream links the two infection sites. We assume that the lungs and lymph nodes are both rather homogeneous environments, in terms of immune cells, antibodies and cytokines. Moreover, the circulation in the bloodstream is fast. Therefore, we can neglect PRRSv within-host spatial dynamics and focus on the temporal dynamics to address our issues.

Some immunological models are individual-based models (IBM, *i.e.* agent-based models, cellular automata). These computer science models consist of a set of individuals, each individual being characterised by a number of variables. Individuals interact and their characteristics evolve over time (and space) according to given rules. These models are quite intuitive but would require intensive computation at the between-cell scale, as each cell or free viral particle would be considered as an individual. These models could fit our criteria in terms of biological scale and processes represented, but their formalism is too far from our modelling choice.

IBM generally are stochastic discrete time models, but most immunological models are continuous time deterministic models. We assume that the immune response to PRRSv infection at the within-host scale is determined for a given strain virulence, host susceptibility and viral exposure. Consequently, we selected continuous time deterministic models.

Such models consist of a set of ordinary differential equations (ODE). Each ODE describes the evolution of an entity, called state variable, over time (*e.g.* the concentration of pathogen particles during the infection duration). The equation represents the processes that affect the state variable in the course of time, such as production and decay processes of the state variable,

as well as interactions with the other state variables. Equations include parameters, which are usually constant over time (*e.g.* the viral excretion rate).

Pathogen As we only identified one PRRSv model meeting the criteria described above [114], we broadened our search to similar pathogens, *i.e.* respiratory pathogens targeting antigen presenting cells. So we also considered models representing the infection and immune dynamics induced by *Mycobacterium tuberculosis*, the usual bacteria that causes TB, and influenza viruses. As a sideline, this allows us to gain on genericity in our modelling approach.

Models selected We identified six models on *Mycobacterium tuberculosis* infection [109, 110, 115–118], reviewed in [108, 112]; eight models on influenza virus infection [119–126], reviewed in [113, 127–129]; and only one study on PRRSv infection (our models excepted) [114]. These models, plus our three PRRSv models, are presented in TABLE I.4.

I.2.2 Pathogen-target cell interactions

In Section I.1.3, we pointed out the importance of the interactions PRRSv and antigen presenting cells for the infection dynamics. Among the selected published models, the level of detail of the immune mechanisms involved in these interactions is highly variable (TABLE I.5).

Epithelial and antigen presenting cells are target cells for influenza viruses [130]. However, among the selected models, the infection of APC is not represented and only three out of eight models incorporate these cells [119, 120, 122]. Macrophages are the only target cell for *Mycobacterium tuberculosis*, so all six Tb models represent macrophage infection and three of them also consider dendritic cells [109, 116, 118]. The only PRRSv model (ours excepted) represents macrophages but not dendritic cells [114].

Almost all models represent pathogen replication. Among the ten models that incorporate APC (ours excepted) [109, 110, 114–120, 122], the immune functions represented vary, with slight differences in the status of the immune cells involved. Eight out of ten models represent antigen presentation, but only five phagocytosis (Tb models). All ten models consider the production of antiviral cytokines, six only the production of immuno-regulatory cytokines (Tb models) and none the production of pro-inflammatory cytokines.

Consequently, from the pathogen–APC point of view, the selected Tb models globally fit our needs, except for the inflammation process which could play a key role during PRRSv infection (Section I.1.4).

From this same point of view, our three models are understandably quite comprehensive. They do not include a resistant status for APC as found in [114], but they allow to regulate their permissiveness according to the host susceptibility or PRRSv strain virulence. Our lung-based models (1 and 2) do not represent the dendritic cell dynamics, but their functions are globally represented. This particular point is discussed in more details in Section II.4.

I.2.3 Regulations by immune cells

PRRSv and APC dynamics are regulated by cellular innate effectors (natural killers), by cellular and humoral adaptive effectors and by antibodies, which are assumed to play a key role in PRRSv infection resolution (Section I.1.3). The inclusion of these immune cells and antibodies is highly variable among selected published models (TABLE I.6).

Table I.4 Selected immunological models at the between-cell scale for influenza viruses (*Iv*), *Mycobacterium tuberculosis* (*Tb*) and Porcine Respiratory and Reproductive Syndrome virus (*PRRSv*). The biological scale, the number of variables and the number of parameters are indicated for each model.

References	Biological scale	# Variables	# Parameters
Human, mice or horse infection with influenza viruses (<i>Iv</i>)			
Bocharov and Romanyukha, 1994 [119]	Whole organism	13	54
Hancioglu <i>et al.</i> 2007 [120]	Whole organism	10	27
Lee <i>et al.</i> 2009 [122]	Lung + lymph nodes	15(5+10)	48
Handel <i>et al.</i> 2010 [121]	Whole organism	7	13
Tridane and Kuang, 2010 [124]	Epithelium	5	10
Miao <i>et al.</i> 2010 [123]	Lung	3	9
Saenz <i>et al.</i> 2010 [125]	Whole organism	8	11
Palwelek <i>et al.</i> 2012 [126]	Whole organism	5	9
Human infection with <i>Mycobacterium tuberculosis</i> (<i>Tb</i>)			
Wigginton and Kirschner, 2001 [110]	Lung	12	66
Sud <i>et al.</i> , 2006 [117] (based on [110])	Lung	16	103
Marino <i>et al.</i> 2007 [115] (based on [117])	Granuloma	16	122
Day <i>et al.</i> 2009 [118] (based on [110, 116, 117])	Lung	11	58
Marino and Kirschner, 2004 [116] (based on [110])	Lung + lymph nodes	17 (13+4)	76
Marino <i>et al.</i> 2010 [109] (based on [116])	Lung + lymph nodes	32 (18+20)	210
Pig infection with the Porcine Respiratory and Reproductive Syndrome virus (<i>PRRSv</i>)			
Doelsch-Wilson and Galina-Pantoja, 2010 [114]	Whole organism	[4;3;5]	[8;9;15]
❶ Go <i>et al.</i> [102]	Lung	18	30
❷ Go <i>et al.</i> 2014 [submitted] (based on [102])	Lung	14	29
❸ Go <i>et al.</i> 2014 [in preparation] (based on [102])	Whole organism	28	78

Table 1.5 Integrations between the pathogen and its target cells in immunological models : immune components and mechanisms represented in selected models at the between-cell scale for influenza viruses (I_v), *Mycobacterium tuberculosis* (T_b) and PRRSv ($PRRS_v$).

Status :	Epithelial cells I_v	Antigen presenting cells (APC)					
		I_v	Macrophages T_b	PRRSv	Dendritic cells T_b	PRRSv	Unspecified I_v
– Naive (susceptible)	[120-126]	\emptyset	[109, 110, 115-117]	[114] ①②③	[122] [109, 116]	③	\emptyset
– Activated (not infected)	n/a	[119]	[109, 110, 115-118]	①②③	[122] [109, 116, 118]	③	[120]
– Infected and non-excreting	[121, 125]	\emptyset	\emptyset	①	\emptyset	\emptyset	\emptyset
– Infected and excreting	[119-126]	\emptyset	[109, 110, 115-118]	[114] ①②③	\emptyset	③	\emptyset
– Resistant (nonpermissive)	[119, 120, 125, 126]	\emptyset	\emptyset	[114]	\emptyset	\emptyset	\emptyset
Immune functions :							
– Pathogen replication	[119-126]	\emptyset	[109, 110, 115-117]	[114] ①②③	\emptyset	③	\emptyset
– Phagocytosis	n/a	\emptyset	[110, 115-118]	①②③	\emptyset	③	\emptyset
– A_v synthesis by	n/a	[119]	[109, 115, 117, 118]	①②③	\emptyset	③	[120]
– P_i synthesis by	[125, 126]	\emptyset	[109, 115, 117, 118]	①②③	n/a	③	\emptyset
– I_r synthesis by	n/a	\emptyset	\emptyset	①②③	\emptyset	③	\emptyset
– Antigen presentation by activated infected	n/a	\emptyset	[109, 110, 115-118]	①②③	\emptyset	③	\emptyset
– Antigen presentation by activated infected	n/a	\emptyset	[109, 115, 117, 118]	①②③	[109, 116, 118]	③	\emptyset
– Antigen presentation by activated infected	n/a	[119]	[110, 115, 117]	①②	[109, 118]	③	[120]
– Antigen presentation by activated infected	n/a	\emptyset	[110, 115, 117]	[114] ①②	n/a	③	\emptyset

n/a : not applicable

 \emptyset : no references found

Concerning the innate effectors, no model represents the dynamics of natural killers. [120] take the into account the cytolysis of infected cells by natural killers by way of an increased mortality rate.

Concerning the adaptive effectors, the cellular response is globally more detailed than the humoral response. The level of detail for the activation and differentiation steps varied among the models. Some models use qualitative components to represent immune functions (Unspecified columns in TABLE I.6), others only include certain T cells and others distinguish each adaptive component.

The cellular response is represented in ten models out of fifteen reviewed (ours excepted). Most of these ten models include both the helper and cytotoxic T cells. Most represent cytolysis. However, the synthesis of adaptive antiviral cytokines, particularly IFN_γ , is only included in the six Tb models (TNF_α only in three).

The humoral response is represented in eight models out of fifteen reviewed (ours excepted). All include helper T cells, but half of them only include B lymphocytes and antibodies (influenza models). Five influenza models represent viral neutralisation, the major immune function of the humoral response. Tb models do not, which is logical as tuberculosis is induced by a bacteria. Four models only (Tb models) represent the synthesis of IL_{10} , a key immuno-modulatory cytokine, by the adaptive humoral effectors.

As a result, the representation of the adaptive humoral response is partial in all selected models, so they do not fit our needs.

Our lung-based models (❶ and ❷) propose a simplified adaptive response, with qualitative adaptive effectors fulfilling the cytolysis and neutralisation functions and producing the two major cytokines, IFN_γ and IL_{10} . As adaptive effector dynamics are mostly active in the lymph nodes, this simplification is valid. This point is discussed in Section II.4. In our within-host model (❸), we detail the dynamics of each adaptive effector. We do not include the naive status of these effectors, but we take into account the cytokine regulations that control their recruitment and activation.

I.2.4 Regulations by cytokines

PRRSv and APC dynamics are also regulated by innate and adaptive cytokines. The cytokine environment is not static during the infection. Cytokines are produced by activated immune cells. In turn, they modulate the cellular functions through their recognition by specific receptors, inducing cascade reactions within the cells. Consequently, they play a major role in the regulation of the immune response. They are classified according to their immune functions : pro-inflammatory, antiviral and immuno-regulatory cytokines. During PRRSv infection, several cytokines are assumed to play a key role : $\text{IL}_{1\beta}$, IL_6 and IL_8 for the inflammation process, IFN_α , TNF_α and IFN_γ for their antiviral functions and IL_{12} , IFN_γ , IL_{10} and TGF_β for the orientation of the adaptive response towards the cellular, humoral and regulatory responses (Section I.1.6).

The cytokines and functions included in the selected models are contrasted according to the pathogen (TABLE I.7). None of the selected models represent the pro-inflammatory cytokines. The PRRSv model [114] (ours excepted) does not include cytokines.

The antiviral cytokine TNF_α and its impact on the cell permissiveness are only represented in four to five influenza models. In contrast, most Tb models represent TNF_α and IFN_γ and their impact on antigen presentation, as well as the impact of TNF_α on cell apoptosis.

Table 1.6 Regulations by immune cells in immunological models : immune components and mechanisms represented in selected models at the between-cell scale for influenza viruses (I_v), *Mycobacterium tuberculosis* (T_b) and PRRSv (PRRSv).

Cellular response	Natural killers (NK)			Type 1 helper T cells (T_{h1})			Cytotoxic T cells (T_c)			Unspecified (R_c)			
	I_v	T_b	PRRSv	I_v	T_b	PRRSv	I_v	T_b	PRRSv	I_v	T_b	PRRSv	
Status :													
- Naive	\emptyset	\emptyset	\emptyset	\emptyset	[109, 110, 115-117]	\emptyset	[122]	[109, 115, 117]	\emptyset	\emptyset	\emptyset	\emptyset	
- Activated	\emptyset	\emptyset	1 2 3	[119, 122]	[109, 110, 115-117]	3	[119, 122, 124]	[109, 115, 117, 118]	[114] 3	[120]	\emptyset	1 2	
Immune functions :													
- Cytolysis	[120]	\emptyset	1 2 3		n/a			[119, 122-124]	[109, 110, 117]	[114] 3	[120]	\emptyset	1 2
- IFN $_{\gamma}$ synthesis	\emptyset	\emptyset	1 2 3		[109, 110, 115-117]	3		\emptyset	[109, 110, 115, 117, 118]	3	\emptyset	\emptyset	1 2
- TNF $_{\alpha}$ synthesis	\emptyset	\emptyset	3		n/a			\emptyset	[109, 115, 117]	3	\emptyset	\emptyset	\emptyset
- IL $_{12}$ synthesis		n/a			n/a			\emptyset	\emptyset	3	\emptyset	\emptyset	\emptyset
- T_c activation		n/a		[119, 120, 122]	[109, 115-118]	3		n/a	n/a		\emptyset	\emptyset	n/a
Humoral response	Type 2 helper T cells (T_{h2})			B lymphocytes (B)			Antibodies (A)			Unspecified (R_h)			
	I_v	T_b	PRRSv	I_v	T_b	PRRSv	I_v	T_b	PRRSv	I_v	T_b	PRRSv	
Status :													
- Naive	[119, 120, 122]	\emptyset	\emptyset	[119]	\emptyset	\emptyset	\emptyset	\emptyset	\emptyset	\emptyset	\emptyset	\emptyset	
- Activated	[119, 120, 122]	[110, 115-117]	3	[119, 120, 122]	\emptyset	3	[119-122]	\emptyset	3	\emptyset	\emptyset	1 2	
Immune functions :													
- B activation	[119, 120, 122]	\emptyset	3		n/a			n/a	n/a		n/a		
- IL $_{10}$ synthesis	\emptyset	[110, 115-117]	3		n/a			n/a	n/a		\emptyset	1 2	
- IL $_4$ synthesis	\emptyset	[115, 116, 118]	3		n/a			n/a	n/a		\emptyset	\emptyset	
- A synthesis		n/a		[119, 120, 122]	\emptyset	3		n/a	n/a		n/a		
- Neutralisation		n/a			n/a			n/a	n/a		\emptyset	\emptyset	1 2
- Marking		n/a			n/a			n/a	n/a		\emptyset	\emptyset	\emptyset
n/a	: not applicable			\emptyset : no references found									

Immuno-regulatory cytokines are included in almost all Tb models, except for TGF_{β} , which is found in none of the selected models. TGF_{β} plays a major role in the regulatory response, which is not represented in selected models.

Consequently, the cytokine regulations are only partially represented in the selected models, so they do not fit our needs from this point of view.

In our three models, the cytokine regulations are represented in a comprehensive way.

I.2.5 Our modelling approach

Table I.8 Synthesis of our modelling approach for PRRSv within-host infection and immune dynamics

Our PRRSv immunological models

Aims : identify the immune mechanisms that determine the infection duration (Chapter II), study the exposure impact (Chapter III) and explore vaccine efficiency (Chapter IV), in a host and strain variability context.

Biological scale : within-host and between-cell scale, in the lung or lung + lymph nodes.

Focus : host-pathogen interactions, *i.e.* interactions between PRRSv and its target cells (macrophages and dendritic cells).

Main processes : target cell infection and virus excretion ; innate response ; adaptive response and its orientation towards the cellular, humoral and regulatory responses ; cytokine syntheses and regulations.

Outputs : evolution over time of the concentrations in free viral particles, innate and adaptive effectors, cytokines.

Formalism : deterministic, non spatial, continuous time dynamic model \rightarrow ordinary differential equations (ODE).

We set our modelling framework in accordance with the issues we raised (TABLE I.8). As published models did not fit our needs (Sections I.2.2, I.2.3 and I.2.4), we developed our own PRRSv immunological models. Compared to the immunological models developed for PRRSv or similar pathogens targeting pulmonary macrophages, such as influenza viruses or tuberculosis (TABLE I.4), the strengths of our models are : (i) the explicit and detailed representation of the innate immune mechanisms (in particular, the interactions between the virus and its target cells) ; (ii) the orientation of the adaptive response towards the cellular, humoral and regulatory responses, whereas no published immunological models represent the regulatory response and only few represent both the cellular and the humoral responses ; (iii) the explicit representation of the main innate and adaptive cytokine syntheses and their complex regulations of the immune mechanisms.

① The lung-based model This model represents PRRSv infection and immune dynamics in the lungs. The interactions between the pathogen and its target cells, the cytokine regulations

and the innate response are fairly detailed. The dendritic cells are not included. Moreover, the adaptive response is simplified : it is represented by qualitative effectors (one for each adaptive response orientation), which perform the basic adaptive functions : cytolysis of infected cells, neutralisation of free viral particles and cytokine synthesis.

The model is characterised by 18 state variables (illustrated in [FIGURE I.1](#)) : the free viral particles (V) ; five effectors of the innate response : four macrophage states and the natural killers (NK) ; three effectors of the adaptive response and nine cytokines. A macrophage can either be susceptible (M_s), phagocytosing (M_p), or infected ; in this latter case, it is either latent (M_l) or excreting the virus (M_e). For the adaptive response, the effectors represent the regulatory (R_r), humoral (R_h) and cellular (R_c) responses. The nine cytokines included are the major pro-inflammatory ($IL_{1\beta}$, IL_6 , IL_8), the innate antiviral (TNF_α , IFN_α) and the immuno-regulatory (IFN_γ , IL_{10} , TGF_β , IL_{12}) cytokines.

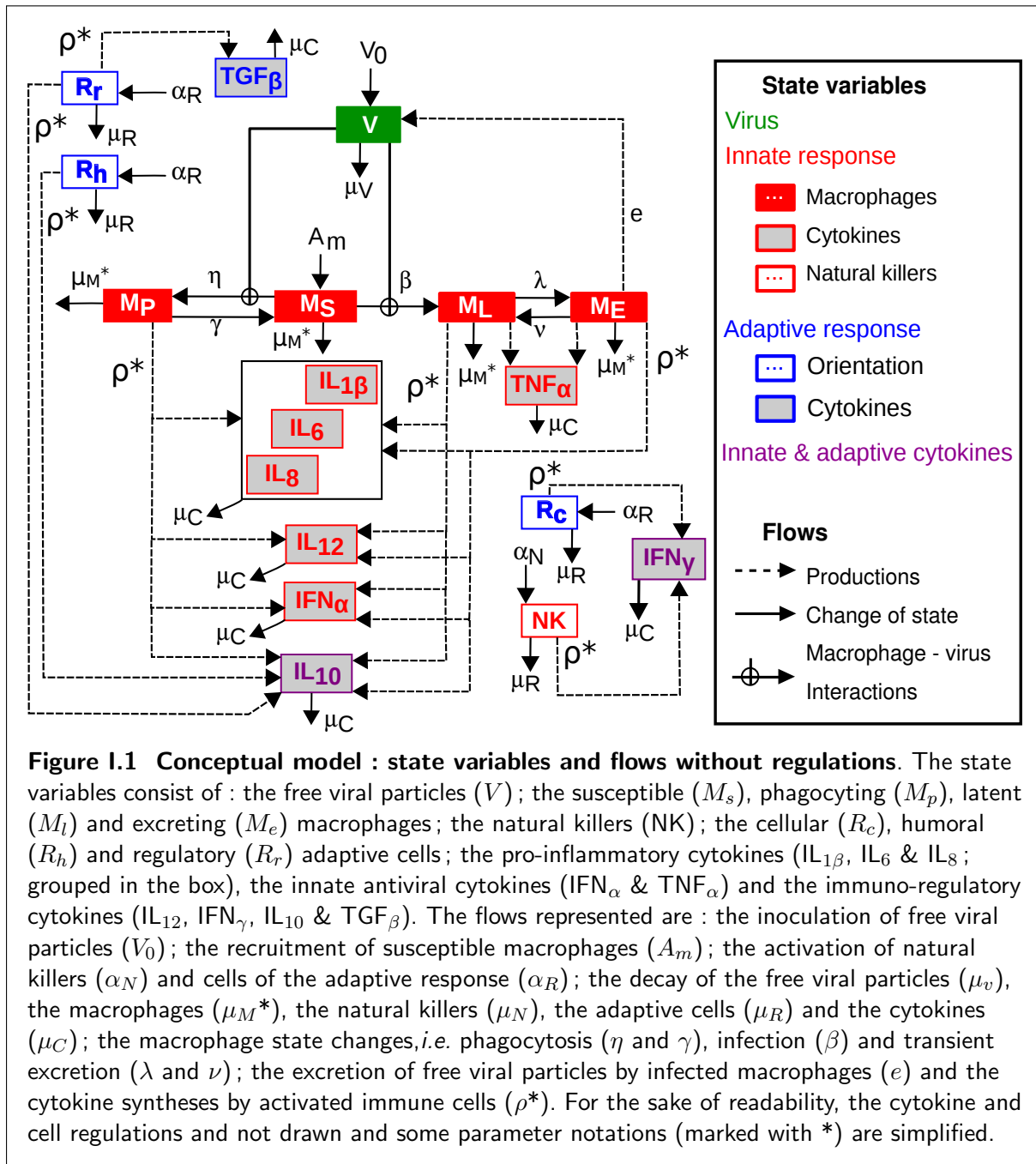

② **The simplified lung-based model** This model is based on ① with the following simplifications on the state variables : the latent infected macrophage state is neglected ; the pro-inflammatory cytokines $IL_{1\beta}$, IL_6 and IL_8 are grouped in P_i ; the innate antiviral cytokines IFN_α and TNF_α are grouped in A_i . Moreover the functions used for the cytokine regulations are also simplified. Despite these simplifications both lung-based models exhibit comparable behaviours and outputs.

The model is hence characterised by 14 state variables instead of 18 (illustrated in FIGURE I.2).

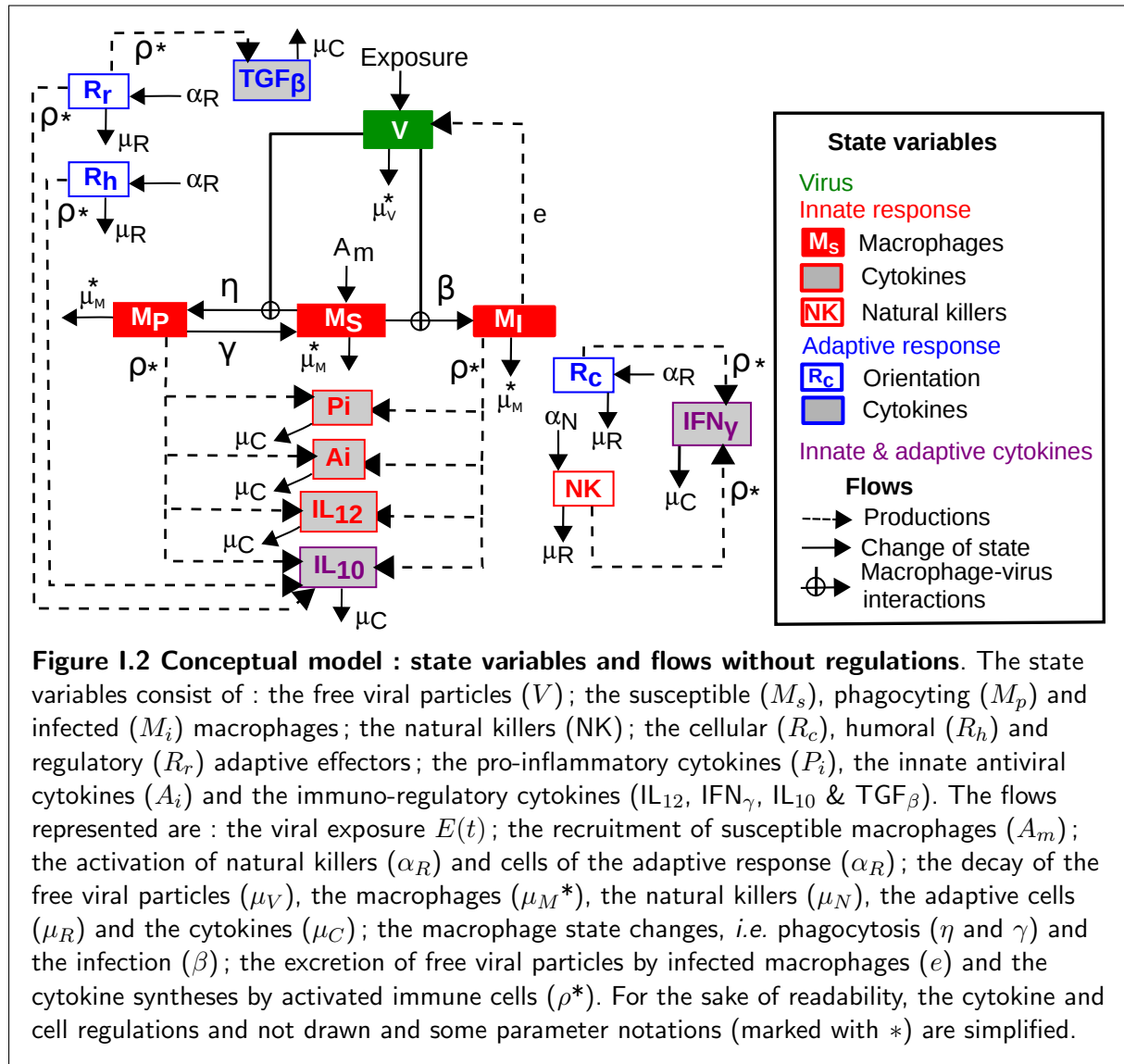

③ **The within-host (or individual) model** This model represents PRRSv infection and immune dynamics in the lungs and the lymph nodes. It extends the lung-based model by integrating a detailed adaptive response. Instead of qualitative effectors, the actual adaptive effectors (T cells and antibodies) are included. The dendritic cells are included. The simplifications made for ③ are partially retained : the latent infected macrophage state is neglected and the functions used for the cytokine regulations are simplified, but the cytokines are not grouped.

The model is characterised by 28 state variables (illustrated in FIGURE 1.3) :

- the free viral particles V ;
- nine effectors of the innate response composed of three macrophage states M (susceptible M_s , phagocytosing M_p and infected M_i) ; three states for conventional dendritic cells D^c (susceptible D_s^c , mature D_m^c and infected D_i^c) ; two states for plasmacytoid dendritic cells D^p (susceptible D_s^p and mature D_m^p) ; the activated natural killers NK ;
- six effectors of the adaptive response composed of three T CD_4^+ lymphocyte states (type 1 helper T_{h1} , type 2 helper T_{h2} and regulatory T_{reg} T cells) ; the cytotoxic lymphocytes T_c ; two B lymphocyte states (producing IgM and IgG antibodies B_{MG} and producing IgA antibodies B_A) ;
two functional types of antibodies composed of the neutralising (A_N : IgM or IgG) and the marking antibodies (A_M : IgM, IgG or IgA) ;
- ten cytokines composed of the major pro-inflammatory (P_i : $IL_{1\beta}$, IL_6 , IL_8) ; antiviral (innate A_i : TNF_α , IFN_α and adaptive IFN_γ) ; and immuno-regulatory (IL_{12} , IFN_γ , IL_{10} , IL_4 , TGF_β) cytokines.

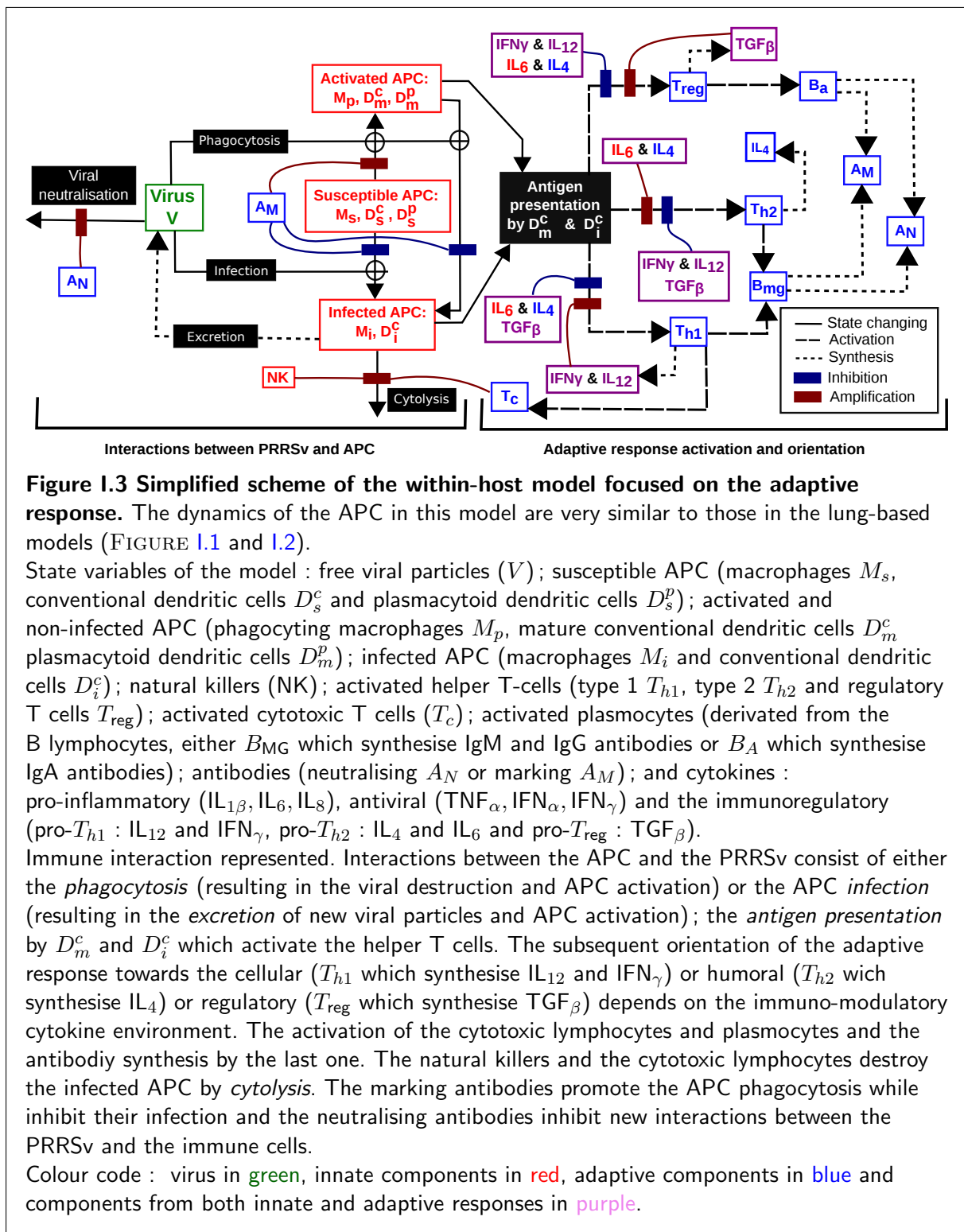

References

- [1] ROUSE B.T., SEHRAWAT S., 2010. Immunity and immunopathology to viruses : what decides the outcome? *Nat. Rev. Immunol.* **10**(7) :514–526. doi:10.1038/nri2802.
- [2] BRACIALE T.J., SUN J., KIM T.S., 2012. Regulating the adaptive immune response to respiratory virus infection. *Nat. Rev. Immunol.* **12**(4) :295–305. doi:10.1038/nri3166.
- [3] COQUERELLE C., MOSER M., 2010. DC subsets in positive and negative regulation of immunity. *Immunol. Rev.* **234**(1) :317–334. doi:10.1111/j.0105-2896.2009.00887.x.
- [4] BORGHETTI P., 2005. Cell-mediated immunity and viral infection in pig. In *PRRS fatti vs speculazioni*, Università degli Studi di Parma, Dipartimento di Salute Animale (Parma, Italy), pp. 27–46.
http://medvet.unipr.it/cgi-bin/campusnet/documenti.pl/Show?_id=7d0d
- [5] BOSCH A.A.T.M., BIESBROEK G., TRZCINSKI K., SANDERS E.A.M., BOGAERT D., 2013. Viral and bacterial interactions in the upper respiratory tract. *PLoS Pathog.* **9**(1) :e1003057. doi:10.1371/journal.ppat.1003057.
- [6] KIDD P., 2003. Th1/Th2 balance : the hypothesis, its limitations, and implications for health and disease. *Altern. Med. Rev.* **8**(3) :223–246.
- [7] LEROITH T., AHMED S.A., 2012. Regulatory T cells and viral disease. In *Inflammation, Chronic Diseases and Cancer : Cell and Molecular Biology, Immunology and Clinical Bases*, edited by M. KHATAMI, InTech (Rijeka, Croatia), chap. 6, pp. 121–144. doi:10.5772/28502.
- [8] KNOSP C.A., JOHNSTON J.A., 2012. Regulation of CD4+ T-cell polarization by suppressor of cytokine signalling proteins. *Immunology* **135**(2) :101–111. doi:10.1111/j.1365-2567.2011.03520.x.
- [9] AKIRA S., TAKEDA K., KAISHO T., 2001. Toll-like receptors : critical proteins linking innate and acquired immunity. *Nat. Immunol.* **2**(8) :675–680. doi:10.1038/90609.
- [10] TOSI M.F., 2005. Innate immune responses to infection. *J. Allergy Clin. Immun.* **116**(2) :241–249. doi:10.1016/j.jaci.2005.05.036.
- [11] VIDAL S.M., KHAKOO S.I., BIRON C.A., 2011. Natural killer cell responses during viral infections : flexibility and conditioning of innate immunity by experience. *Curr. Opin. Virol.* **1**(6) :497–512. doi:10.1016/j.coviro.2011.10.017.
- [12] MURTAUGH M.P., XIAO Z., ZUCKERMANN F., 2002. Immunological responses of swine to porcine reproductive and respiratory syndrome virus infection. *Viral Immunol.* **15**(4) :533–547. doi:10.1089/088282402320914485.
- [13] DARWICH L., DÍAZ I., MATEU E., 2010. Certainties, doubts and hypotheses in porcine reproductive and respiratory syndrome virus immunobiology. *Virus Res.* **154**(1-2) :123–132. doi:10.1016/j.virusres.2010.07.017.
- [14] ZIMMERMAN J., BENFIELD D.A., MURTAUGH M.P., OSORIO F., STEVENSON G.W., TOR-REMORELL M., 2006. Porcine reproductive and respiratory syndrome virus (porcine arterivirus). In *Diseases of swine*, edited by B.E. STRAW, J.J. ZIMMERMAN, S. D'ALLAIRE, D.L. TAYLOR, Blackwell (Oxford, UK), 9th edn., chap. 24, pp. 387–418.

- [15] DUAN X., NAUWYNCK H.J., PENSAERT M.B., 1997. Virus quantification and identification of cellular targets in the lungs and lymphoid tissues of pigs at different time intervals after inoculation with porcine reproductive and respiratory syndrome virus (PRRSV). *Vet. Microbiol.* **56**(1–2) :9–19. doi:10.1016/S0378-1135(96)01347-8.
- [16] BEYER J., FICHTNER D., SCHIRRMER H., POLSTER U., WEILAND E., WEGE H., 2000. Porcine reproductive and respiratory syndrome virus (PRRSV) : kinetics of infection in lymphatic organs and lung. *J. Vet. Med. B Infect. Dis. Vet. Public Health* **47**(1) :9–25. doi:10.1046/j.1439-0450.2000.00305.x.
- [17] TEIFKE J.P., DAUBER M., FICHTNER D., LENK M., POLSTER U., WEILAND E., BEYER J., 2001. Detection of european porcine reproductive and respiratory syndrome virus in porcine alveolar macrophages by two-colour immunofluorescence and in-situ hybridization-immunohistochemistry double labelling. *J. Comp. Pathol.* **124**(4) :238–245. doi:10.1053/jcpa.2000.0458.
- [18] WENSVOORT G., DE KLUYVER E.P., LUIJTZE E.A., DEN BESTEN A., HARRIS L., COLLINS J.E., CHRISTIANSON W.T., CHLADEK D., 1992. Antigenic comparison of lelystad virus and swine infertility and respiratory syndrome (SIRS) virus. *J. Vet. Diagn. Invest.* **4**(2) :134–138. doi:10.1177/104063879200400203.
- [19] BAUMANN A., MATEU E., MURTAUGH M.P., SUMMERFIELD A., 2013. Impact of genotype 1 and 2 of porcine reproductive and respiratory syndrome viruses on interferon- α responses by plasmacytoid dendritic cells. *Vet. Res.* **44**(1) :33. doi:10.1186/1297-9716-44-33.
- [20] SILVA-CAMPA E., CORDOBA L., FRAILE L., FLORES-MENDOZA L., MONTOYA M., HERNÁNDEZ J., 2010. European genotype of porcine reproductive and respiratory syndrome (PRRSV) infects monocyte-derived dendritic cells but does not induce Treg cells. *Virology* **396**(2) :264–271. doi:10.1016/j.virol.2009.10.024.
- [21] CHANG H.C., PENG Y.T., CHANG H.L., CHAUNG H.C., CHUNG W.B., 2008. Phenotypic and functional modulation of bone marrow-derived dendritic cells by porcine reproductive and respiratory syndrome virus. *Vet. Microbiol.* **129**(3–4) :281–293. doi:10.1016/j.vetmic.2007.12.002.
- [22] FLORES-MENDOZA L., SILVA-CAMPA E., RESÉNDIZ M., OSORIO F.A., HERNÁNDEZ J., 2008. Porcine reproductive and respiratory syndrome virus infects mature porcine dendritic cells and up-regulates interleukin-10 production. *Clin. Vaccine Immunol.* **15** :720–725. doi:10.1128/CVI.00224-07.
- [23] PARK J.Y., KIM H.S., SEO S.H., 2008. Characterization of interaction between porcine reproductive and respiratory syndrome virus and porcine dendritic cells. *J. Microbiol. Biotechnol.* **18**(10) :1709–1716.
- [24] SILVA-CAMPA E., FLORES-MENDOZA L., RESÉNDIZ M., PINELLI-SAAVEDRA A., MATA-HARO V., MWANGI W., HERNÁNDEZ J., 2009. Induction of T helper 3 regulatory cells by dendritic cells infected with porcine reproductive and respiratory syndrome virus. *Virology* **387**(2) :373–379. doi:10.1016/j.virol.2009.02.033.
- [25] WANG X., EATON M., MAYER M., LI H., HE D., NELSON E., CHRISTOPHER-HENNINGS J., 2007. Porcine reproductive and respiratory syndrome virus productively infects monocyte-derived dendritic cells and compromises their antigen-presenting ability. *Arch. Virol.* **152**(2) :289–303. doi:10.1007/s00705-006-0857-1.

- [26] MURTAUGH M.P., GENZOW M., 2011. Immunological solutions for treatment and prevention of porcine reproductive and respiratory syndrome (PRRS). *Vaccine* **29**(46) :8192–8204. doi:10.1016/j.vaccine.2011.09.013.
- [27] KIMMAN T.G., CORNELISSEN L.A., MOORMANN R.J., REBEL J.M.J., STOCKHOFE-ZURWIEDEN N., 2009. Challenges for porcine reproductive and respiratory syndrome virus (PRRSV) vaccinology. *Vaccine* **27**(28) :3704–3718. doi:10.1016/j.vaccine.2009.04.022.
- [28] GÓMEZ-LAGUNA J., SALGUERO F.J., PALLARÉS F.J., CARRASCO L., 2013. Immunopathogenesis of porcine reproductive and respiratory syndrome in the respiratory tract of pigs. *Vet. J.* **195**(2) :148–155. doi:10.1016/j.tvjl.2012.11.012.
- [29] MURTAUGH M.P., 2005. PRRSV/host interaction. In *PRRS fatti vs speculazioni*, Università degli Studi di Parma, Dipartimento di Salute Animale (Parma, Italy), pp. 73–80. http://medvet.unipr.it/cgi-bin/campusnet/documenti.pl/Show?_id=7d0d
- [30] ALBINA E., PIROU L., HUTET E., CARIOLET R., L'HOSPITALIER R., 1998. Immune response in pigs infected with porcine reproductive and respiratory syndrome virus (PRRSV). *Vet. Immunol. Immunop.* **61** :49–66. doi:10.1016/S0165-2427(97)00134-7.
- [31] ALLENDE R., LAEGREID W.W., KUTISH G.F., GALEOTA J.A., WILLS R.W., OSORIO F.A., 2000. Porcine reproductive and respiratory syndrome virus : description of persistence in individual pigs upon experimental infection. *J. Virol.* **74**(22) :10834–10837. doi:10.1128/JVI.74.22.10834-10837.2000.
- [32] LOVING C.L., BROCKMEIER S.L., SACCO R.E., 2007. Differential type I interferon activation and susceptibility of dendritic cell populations to porcine arterivirus. *Immunology* **120**(2) :217–229. doi:10.1111/j.1365-2567.2006.02493.x.
- [33] WILLS R.W., DOSTER A.R., GALEOTA J.A., SUR J.H., OSORIO F.A., 2003. Duration of infection and proportion of pigs persistently infected with porcine reproductive and respiratory syndrome virus. *J. Clin. Microbiol.* **41**(1) :58–62. doi:10.1128/JCM.41.1.58-62.2003.
- [34] LABARQUE G.G., NAUWYNCK H.J., VAN REETH K., PENSART M.B., 2000. Effect of cellular changes and onset of humoral immunity on the replication of porcine reproductive and respiratory syndrome virus in the lungs of pigs. *J. Gen. Virol.* **81**(5) :1327–1334.
- [35] MORGAN S.B., GRAHAM S.P., SALGUERO F.J., SÁNCHEZ CORDÓN P.J., MOKHTAR H., REBEL J.M.J., WEESENDORP E., BODMAN-SMITH K.B., STEINBACH F., FROSSARD J.P., 2013. Increased pathogenicity of European porcine reproductive and respiratory syndrome virus is associated with enhanced adaptive responses and viral clearance. *Vet. Microbiol.* **163**(1) :13–22. doi:10.1016/j.vetmic.2012.09.013.
- [36] WEESENDORP E., MORGAN S., STOCKHOFE-ZURWIEDEN N., GRAAF D.J., GRAHAM S.P., REBEL J.M.J., 2013. Comparative analysis of immune responses following experimental infection of pigs with european porcine reproductive and respiratory syndrome virus strains of differing virulence. *Vet. Microbiol.* **163** :1–12. doi:10.1016/j.vetmic.2012.09.013.
- [37] MARTÍNEZ-LOBO F.J., DÍEZ-FUERTES F., SEGALÉS J., GARCÍA-ARTIGA C., SIMARRO I., CASTRO J.M., PRIETO C., 2011. Comparative pathogenicity of type 1 and type 2 isolates of porcine reproductive and respiratory syndrome virus (PRRSv) in a young pig infection model. *Vet. Microbiol.* **154**(1) :58–68. doi:10.1016/j.vetmic.2011.06.025.

- [38] KARNIYCHUK U., GELDHOF M., VANHEE M., VAN DOORSSELAERE J., SAVELEVA T., NAUWYNCK H., 2010. Pathogenesis and antigenic characterization of a new East European subtype 3 porcine reproductive and respiratory syndrome virus isolate. *Vet. Res.* **6**(1) :30. doi:10.1186/1746-6148-6-30.
- [39] DÍAZ I., GIMENO M., DARWICH L., NAVARRO N., KUZEMTSEVA L., LÓPEZ S., GALINDO I., SEGALÉS J., MARTÍN M., PUJOLS J., MATEU E., 2012. Characterization of homologous and heterologous adaptive immune responses in porcine reproductive and respiratory syndrome virus infection. *Vet. Res.* **43**(1) :30. doi:10.1186/1297-9716-43-30.
- [40] GÓMEZ-LAGUNA J., SALGUERO F., PALLARÉS F., FERNÁNDEZ DE MARCO M., BARRANCO I., CERÓN J., MARTÍNEZ-SUBIELA S., VAN REETH K., CARRASCO L., 2010. Acute phase response in porcine reproductive and respiratory syndrome virus infection. *Comp. Immunol. Microb.* **33**(6) :e51–e58. doi:10.1016/j.cimid.2009.11.003.
- [41] GÓMEZ-LAGUNA J., RODRÍGUEZ-GÓMEZ I.M., BARRANCO I., PALLARÉS F.J., SALGUERO F.J., CARRASCO L., 2012. Enhanced expression of TGF β protein in lymphoid organs and lung, but not in serum, of pigs infected with a European field isolate of porcine reproductive and respiratory syndrome virus. *Vet. Microbiol.* **158**(1) :187–193. doi:10.1016/j.vetmic.2012.02.003.
- [42] MOLINA R.M., CHA S.H., CHITTICK W., LAWSON S., MURTAUGH M.P., NELSON E.A., CHRISTOPHER-HENNINGS J., YOON K.J., EVANS R., ROWLAND R.R.R., ZIMMERMAN J.J., 2008. Immune response against porcine reproductive and respiratory syndrome virus during acute and chronic infection. *Vet. Immunol. Immunop.* **126** :283–292. doi:10.1016/j.vetimm.2008.08.002.
- [43] JOHNSON W., ROOF M., VAUGHN E., CHRISTOPHER-HENNINGS J., JOHNSON C.R., MURTAUGH M.P., 2004. Pathogenic and humoral immune responses to porcine reproductive and respiratory syndrome virus (PRRSV) are related to viral load in acute infection. *Vet. Immunol. Immunop.* **102**(3) :233–247. doi:10.1016/j.vetimm.2004.09.01.
- [44] DOESCHL-WILSON A.B., KYRIAZAKIS I., VINCENT A., ROTHSCHILD M.F., THACKER E., GALINA-PANTOJA L., 2009. Clinical and pathological responses of pigs from two genetically diverse commercial lines to porcine reproductive and respiratory syndrome virus infection. *J. Anim. Sci.* **87** :1638–1647. doi:10.2527/jas.2008-1447.
- [45] MULUPURI P., ZIMMERMAN J.J., HERMANN J., JOHNSON C.R., CANO J.P., YU W., DEE S.A., MURTAUGH M.P., 2008. Antigen-specific B-cell responses to porcine reproductive and respiratory syndrome virus infection. *J. Virol.* **82**(1) :358–370. doi:10.1128/JVI.01023-07.
- [46] REINER G., FRESEN C., BRONNERT S., WILLEMS H., 2009. Porcine reproductive and respiratory syndrome virus (PRRSV) infection in wild boars. *Vet. Microbiol.* **136**(3) :250–258. doi:10.1016/j.vetmic.2008.11.023.
- [47] WESLEY D.R., LAGER K.M., KEHRLI M.E., 2006. Infection with porcine reproductive and respiratory syndrome virus stimulates an early gamma interferon response in the serum of pig. *Can. J. Vet. Res.* **70**(3) :176–182.
- [48] KLINGE K.L., VAUGHN E.M., ROOF M.B., BAUTISTA E.M., MURTAUGH M.P., 2009. Age-dependent resistance to porcine reproductive and respiratory syndrome virus replication in swine. *Virol. J.* **6**(1) :177. doi:10.1186/1743-422X-6-177.

- [49] PETRY D.B., LUNNEY J., BOYD P., KUCHAR D., BLANKENSHI E., JOHNSON R.K., 2007. Differential immunity in pigs with high and low responses to porcine reproductive and respiratory syndrome virus infection. *J. Anim. Sci.* **85** :2075–2092. doi:10.2527/jas.2006-721.
- [50] BODDICKER N., WAIDE E.H., ROWLAND R.R.R., LUNNEY J.K., GARRICK D.J., REECY J.M., DEKKERS J.C.M., 2012. Evidence for a major QTL associated with host response to porcine reproductive and respiratory syndrome virus challenge. *J. Anim. Sci.* **90**(6) :1733–1746. doi:10.2527/jas.2011-4464.
- [51] XIAO Z., BATISTA L., DEE S., HALBUR P., MURTAUGH M.P., 2004. The level of virus-specific T-cell and macrophage recruitment in porcine reproductive and respiratory syndrome virus infection in pigs is independent of virus load. *J. Virol.* **78** :5923–5933. doi:10.1128/JVI.78.11.5923-5933.2004.
- [52] TAKEDA K., KAISHO T., AKIRA S., 2003. Toll-like receptors. *Annu. Rev. Immunol.* **21**(1) :335–376. doi:10.1146/annurev.immunol.21.120601.141126.
- [53] ROACH J.C., GLUSMAN G., ROWEN L., KAUR A., PURCELL M.K., SMITH K.D., HOOD L.E., ADEREM A., 2005. The evolution of vertebrate Toll-like receptors. *Proc. Natl. Acad. Sci. U.S.A.* **102**(27) :9577–9582. doi:10.1073/pnas.0502272102.
- [54] CHOI C., CHAE C., 2002. Expression of tumour necrosis factor alpha is associated with apoptosis in lungs of pigs experimentally infected with porcine reproductive and respiratory syndrome virus. *Res. Vet. Sci.* **72**(1) :45–49. doi:10.1053/rvsc.2001.0519.
- [55] VAN REETH K., VAN GUCHT S., PENSART M., 2002. In vivo studies on cytokine involvement during acute viral respiratory disease of swine : troublesome but rewarding. *Vet. Immunol. Immunop.* **87**(3-4) :161–168. doi:10.1016/S0165-2427(02)00047-8.
- [56] ROTH A.J., THACKER E.L., 2006. Immune system. In *Diseases of swine*, edited by B.E. STRAW, J.J. ZIMMERMAN, S. D'ALLAIRE, D.L. TAYLOR, Blackwell (Oxford, UK), 9th edn., chap. 2, pp. 15–36.
- [57] THANAWONGNUWECH R., 1999. Pulmonary intravascular macrophages (PIMs) : What do we know about their role in PRRSV infection in pigs. *Wetchasan Sattawaphaet (The Thai journal of veterinary medicine)* **29**.
- [58] GAUDREAU N., ROWLAND R., WYATT C., 2009. Factors affecting the permissiveness of porcine alveolar macrophages for porcine reproductive and respiratory syndrome virus. *Arch. Virol.* **154** :133–136. doi:10.1007/s00705-008-0271-y.
- [59] LUNNEY J.K., CHEN H., 2010. Genetic control of host resistance to porcine reproductive and respiratory syndrome virus (PRRSV) infection. *Virus Res.* **154**(1-2) :161–169. doi:10.1016/j.virusres.2010.08.004.
- [60] THANAWONGNUWECH R., SURADHAT S., 2010. Taming PRRSV : Revisiting the control strategies and vaccine design. *Virus Res.* **154**(1-2) :133–140. doi:10.1016/j.virusres.2010.09.003.
- [61] BUTLER J.E., LAGER K.M., GOLDE W., FAABERG K.S., SINKORA M., LOVING C., ZHANG Y.I., 2014. Porcine reproductive and respiratory syndrome (PRRS) : an immune dysregulatory pandemic. *Immunologic research* **59**(1-3) :81–108. doi:10.1007/s12026-014-8549-5.

- [62] LIU C.H., CHAUNG H.C., CHANG H.L., PENG Y.T., CHUNG W.B., 2009. Expression of Toll-like receptor mRNA and cytokines in pigs infected with porcine reproductive and respiratory syndrome virus. *Vet. Microbiol.* **136**(3) :266–276. doi:10.1016/j.vetmic.2008.11.016.
- [63] MIGUEL J.C., CHEN J., VAN ALSTINE W.G., JOHNSON R.W., 2010. Expression of inflammatory cytokines and Toll-like receptors in the brain and respiratory tract of pigs infected with porcine reproductive and respiratory syndrome virus. *Vet. Immunol. Immunop.* **135**(3) :314–319. doi:10.1016/j.vetimm.2010.01.002.
- [64] TAKEDA K., AKIRA S., 2004. TLR signaling pathways. *Semin. Immunol.* **16**(1) :3–9. doi:10.1016/j.smim.2003.10.003.
- [65] CALZADA-NOVA G., SCHNITZLEIN W., HUSMANN R., ZUCKERMANN F.A., 2010. Characterization of the cytokine and maturation responses of pure populations of porcine plasmacytoid dendritic cells to porcine viruses and toll-like receptor agonists. *Vet. Immunol. Immunop.* **135**(1) :20–33. doi:10.1016/j.vetimm.2009.10.026.
- [66] DEFranco A.L., LOCKSLEY R.M., ROBERTSON M., CUNIN R., 2009. *Immunité : la réponse immunitaire dans les maladies infectieuses et inflammatoires*. DeBoeck (Bruxelles, Belgium). 2nd edn.
- [67] DIAZ I., DARWICH L., PAPPATERRA G., PUJOLS J., MATEU E., 2005. Immune responses of pigs after experimental infection with a european strain of porcine reproductive and respiratory syndrome virus. *J. Gen. Virol.* **86**(7) :1943–1951. doi:10.1099/vir.0.80959-0.
- [68] MATEU E., DÍAZ I., 2008. The challenge of PRRS immunology. *Vet. J.* **177** :345–351. doi:10.1016/j.tvjl.2007.05.022.
- [69] GÓMEZ-LAGUNA J., SALGUERO F.J., BARRANCO I., PALLARES F.J., RODRIGUEZ-GOMEZ I.M., BERNABE A., CARRASCO L., 2009. Cytokine expression by macrophages in the lung of pigs infected with the porcine reproductive and respiratory syndrome virus. *J. Comp. Pathol.* **142**(1) :51–60. doi:10.1016/j.jcpa.2009.07.004.
- [70] PENG Y.T., CHAUNG H.C., CHANG H.L., CHANG H.C., CHUNG W.B., 2009. Modulations of phenotype and cytokine expression of porcine bone marrow-derived dendritic cells by porcine reproductive and respiratory syndrome virus. *Vet. Microbiol.* **136**(3-4) :359–365. doi:10.1016/j.vetmic.2008.11.013.
- [71] VAN REETH K., NAUWYNCK H., 2000. Proinflammatory cytokines and viral respiratory disease in pigs. *Vet. Res.* **31**(2) :187–213. doi:10.1051/vetres:2000113.
- [72] DIAZ I., DARWICH L., PAPPATERRA G., PUJOLS J., MATEU E., 2006. Different European-type vaccines against porcine reproductive and respiratory syndrome virus have different immunological properties and confer different protection to pigs. *Virology* **351**(2) :249–259. doi:10.1016/j.virol.2006.03.046.
- [73] VINCENT A.L., THACKER B.J., HALBUR P.G., ROTHSCHILD M.F., THACKER E.L., 2005. In vitro susceptibility of macrophages to porcine reproductive and respiratory syndrome virus varies between genetically diverse lines of pigs. *Viral Immunol.* **18**(3) :506–512. doi:10.1089/vim.2005.18.506.
- [74] ALBINA E., 2000. Le point sur le dernier-né des arterivirus : le virus du syndrome dysgénésique et respiratoire porcin (SDRP). *Virologie* **4**(2) :113–121.

- [75] LOPEZ-FUERTES L., CAMPOS E., DOMENECH N., EZQUERRA A., CASTRO J.M., DOMINGUEZ J., ALONSO F., 1999. Porcine reproductive and respiratory syndrome (PRRS) virus down-modulates TNF- α production in infected macrophages. *Virus Res.* **69**(269) :41–46. doi:10.1016/S0168-1702(00)00172-6.
- [76] MILLER L.C., LAEGREID W.W., BONO J.L., CHITKO-MCKOWN C.G., FOX J.M., 2004. Interferon type I response in porcine reproductive and respiratory syndrome virus-infected MARC-145 cells. *Arch. Virol.* **149** :2453–2463. doi:10.1007/s00705-004-0377-9.
- [77] YOO D., SONG C., SUN Y., DU Y., KIM O., LIU H.C., 2010. Modulation of host cell responses and evasion strategies for porcine reproductive and respiratory syndrome virus. *Virus Res.* **154**(1–2) :48–60. doi:10.1016/j.virusres.2010.07.019.
- [78] ROYAEI A.R., HUSMANN R.J., DAWSON H.D., CALZADA-NOVA G., SCHNITZLEIN W.M., ZUCKERMANN F.A., LUNNEY J.K., 2004. Deciphering the involvement of innate immune factors in the development of the host response to PRRSV vaccination. *Vet. Immunol. Immunop.* **102**(3) :199–216. doi:10.1016/j.vetimm.2004.09.018.
- [79] LEE S.M., SCHOMMER S.K., KLEIBOEKER S.B., 2004. Porcine reproductive and respiratory syndrome virus field isolates differ in in vitro interferon phenotypes. *Vet. Immunol. Immunop.* **102**(3) :217–231. doi:10.1016/j.vetimm.2004.09.009.
- [80] GIMENO M., DARWICH L., DÍAZ I., DE LA TORRE E., PUJOLS J., MARTIN M., INUMARU S., CANO E., DOMÍNGO M., MONTOYA M., MATEU E., 2011. Cytokine profiles and phenotype regulation of antigen presenting cells by genotype-I porcine reproductive and respiratory syndrome virus isolates. *Vet. Res.* **42**(9). doi:10.1186/1297-9716-42-9.
- [81] OLEKSIEWICZ M.B., NIELSEN J., 1999. Effect of porcine reproductive and respiratory syndrome virus (PRRSV) on alveolar lung macrophage survival and function. *Vet. Microbiol.* **66**(1) :15–27. doi:10.1016/S0378-1135(98)00309-5.
- [82] LABARQUE G., VAN GUCHT S., NAUWYNCK H., VAN REETH K., PENZAERT M., 2003. Apoptosis in the lungs of pigs infected with porcine reproductive and respiratory syndrome virus and associations with the production of apoptogenic cytokines. *Vet. Res.* **34** :249–260. doi:10.1051/vetres:2003001.
- [83] MILLER L.C., FOX J.M., 2004. Apoptosis and porcine reproductive and respiratory syndrome virus. *Vet. Immunol. Immunop.* **102**(3) :131–142. doi:10.1016/j.vetimm.2004.09.004.
- [84] SURADHAT S., THANAWONGNUWECH R., POOVORAWAN Y., 2003. Upregulation of IL-10 gene expression in porcine peripheral blood mononuclear cells by porcine reproductive and respiratory syndrome. *J. Gen. Virol.* **84** :453–459. doi:10.1099/vir.0.18698-0.
- [85] CHARERNTANTANAKUL W., PLATT R., ROTH J.A., 2006. Effects of porcine reproductive and respiratory syndrome virus-infected antigen-presenting cells on T cell activation and antiviral cytokine production. *Viral Immunol.* **19**(4) :646–661. doi:10.1089/vim.2006.19.646.
- [86] THANAWONGNUWECH R., YOUNG T.F., THACKER B.J., THACKER E.L., 2001. Differential production of proinflammatory cytokines : in vitro PRRSV and *Mycoplasma hyopneumoniae* co-infection model. *Vet. Immunol. Immunop.* **79**(1) :115–127. doi:10.1016/S0165-2427(01)00243-4.

- [87] GENINI S., DELPUTTE P.L., MALINVERNI R., CECERE M., STELLA A., NAUWYNCK H.J., GIUFFRÀ E., 2008. Genome-wide transcriptional response of primary alveolar macrophages following infection with porcine reproductive and respiratory syndrome virus. *J. Gen. Virol.* **89**(10) :2550–2564. doi:10.1099/vir.0.2008/003244-0.
- [88] CAFRUNY W.A., DUMAN R.G., WONG G.H., SAID S., WARD-DEMO P., ROWLAND R.R., NELSON E.A., 2006. Porcine reproductive and respiratory syndrome virus (PRRSV) infection spreads by cell-to-cell transfer in cultured MARC-145 cells, is dependent on an intact cytoskeleton, and is suppressed by drug-targeting of cell permissiveness to virus infection. *Virol. J.* **3** :90. doi:10.1186/1743-422X-3-90.
- [89] DWIVEDI V., MANICKAM C., BINJAWADAGI B., LINHARES D., MURTAUGH M.P., RENUKARADHYA G.J., 2012. Evaluation of immune responses to porcine reproductive and respiratory syndrome virus in pigs during early stage of infection under farm conditions. *Virol. J.* **9** :45. doi:10.1186/1743-422X-9-45.
- [90] GUZYLACK-PIRIOU L., PIERSMA S., MCCULLOUGH K., SUMMERFIELD A., 2006. Role of natural interferon-producing cells and T lymphocytes in porcine monocyte-derived dendritic cell maturation. *Immunology* **118**(1) :78–87. doi:10.1111/j.1365-2567.2006.02343.x.
- [91] YATES A., BERGMANN C., VAN HEMMEN J.L., STARK J., CALLARD R., 2000. Cytokine-modulated regulation of helper T cell populations. *J. Theor. Biol.* **206**(4) :539–560. doi:10.1006/jtbi.2000.2147.
- [92] MALDONADO-LÓPEZ R., MOSER M., 2001. Dendritic cell subsets and the regulation of Th1/Th2 responses. *Semin. Immunol.* **13**(5) :275–282. doi:10.1006/smim.2001.0323.
- [93] KORN T., BETTELLI E., OUKKA M., KUCHROO V.K., 2009. IL-17 and Th17 cells. *Annu. Rev. Immunol.* **27** :485–517. doi:10.1146/annurev.immunol.021908.132710.
- [94] SAITO S., NAKASHIMA A., SHIMA T., ITO M., 2010. Th1/Th2/Th17 and regulatory T-cell paradigm in pregnancy. *Am. J. Reprod. Immunol.* **63**(6) :601–610. doi:10.1111/j.1600-0897.2010.00852.x. Review article.
- [95] DELPUTTE P.L., MEERTS P., COSTERS S., NAUWYNCK H.J., 2004. Effect of virus-specific antibodies on attachment, internalization and infection of porcine reproductive and respiratory syndrome virus in primary macrophages. *Vet. Immunol. Immunop.* **102**(3) :179–188. doi:10.1016/j.vetimm.2004.09.007.
- [96] OSTROWSKI M., GALEOTA J.A., JAR A.M., PLATT K.B., OSORIO F.A., LOPEZ O.J., 2002. Identification of neutralizing and nonneutralizing epitopes in the porcine reproductive and respiratory syndrome virus GP5 ectodomain. *J. Virol.* **76**(9) :4241–4250. doi:10.1128/JVI.76.9.4241-4250.2002.
- [97] OSORIO F.A., GALEOTA J.A., NELSON E., BRODERSEN B., DOSTER A., WILLS R., ZUCKERMANN F., LAEGREID W.W., 2002. Passive transfer of virus-specific antibodies confers protection against reproductive failure induced by a virulent strain of porcine reproductive and respiratory syndrome virus and establishes sterilizing immunity. *Virology* **302**(1) :9–20. doi:10.1006/viro.2002.1612.
- [98] LOPEZ O.J., OSORIO F.A., 2004. Role of neutralizing antibodies in PRRSV protective immunity. *Vet. Immunol. Immunop.* **102**(3) :155–163. doi:10.1016/j.vetimm.2004.09.005.

- [99] YOON K.J., WU L.L., ZIMMERMAN J.J., PLATT K.B., 1997. Field isolates of porcine reproductive and respiratory syndrome virus (PRRSV) vary in their susceptibility to antibody dependent enhancement (ADE) of infection. *Vet. Microbiol.* **55**(1) :277–287. doi:10.1016/S0378-1135(96)01338-7.
- [100] SILVA-CAMPA E., MATA-HARO V., MATEU E., HERNANDEZ J., 2012. Porcine reproductive and respiratory syndrome virus induces CD4⁺CD8⁺CD25⁺Foxp3⁺ regulatory T cells (Tregs). *Virology* **430** :73–80. doi:10.1016/j.virol.2012.04.009.
- [101] KIROS T.G., VAN KESSEL J., BABIUK L.A., GERDTS V., 2011. Induction, regulation and physiological role of IL-17 secreting helper T-cells isolated from PBMC, thymus, and lung lymphocytes of young pigs. *Vet. Immunol. Immunop.* **144**(3) :448–454. doi:10.1016/j.vetimm.2011.08.021.
- [102] GO N., BIDOT C., BELLOC C., TOUZEAU S., 2014. Integrative model of the immune response to a pulmonary macrophage infection : what determines the infection duration? *PLoS ONE* **9**(9) :e107818. doi:10.1371/journal.pone.0107818.
- [103] DELISI C., 1983. Mathematical modeling in immunology. *Annu. Rev. Biophys. Bioeng.* **12**(1) :117–138. doi:10.1146/annurev.bb.12.060183.001001.
- [104] YATES A., CHAN C.C.W., CALLARD R.E., GEORGE A.J.T., STARK J., 2001. An approach to modelling in immunology. *Brief. Bioinform.* **2**(3) :245–257. doi:10.1093/bib/2.3.245.
- [105] ANDREW S.M., BAKER C.T.H., BOCHAROV G.A., 2007. Rival approaches to mathematical modelling in immunology. *J. Comput. Appl. Math.* **205**(2) :669–686. doi:10.1016/j.cam.2006.03.035.
- [106] HEFFERNAN J.M., 2011. Mathematical immunology of infectious diseases. *Math. Popul. Stud.* **18**(2) :47–54. doi:10.1080/08898480.2011.564559.
- [107] NARANG V., DECRAENE J., WONG S.Y., AISWARYA B.S., WASEM A.R., LEONG S.R., GOUAILLARD A., 2012. Systems immunology : a survey of modeling formalisms, applications and simulation tools. *Immunol. Res.* **53**(1-3) :251–265. doi:10.1007/s12026-012-8305-7.
- [108] GAMMACK D., GANGULI S., MARINO S., SEGOVIA-JUAREZ J., KIRSCHNER D., 2005. Understanding the immune response in tuberculosis using different mathematical models and biological scales. *Multiscale Model. Sim.* **3**(2) :312–345. doi:10.1137/040603127.
- [109] MARINO S., MYERS A., FLYNN J.L., KIRSCHNER D.E., 2010. TNF and IL-10 are major factors in modulation of the phagocytic cell environment in lung and lymph node in tuberculosis : A next-generation two-compartmental model. *J. Theor. Biol.* **265**(4) :586–598. doi:10.1016/j.jtbi.2010.05.012.
- [110] WIGGINTON J.E., KIRSCHNER D., 2001. A model to predict cell-mediated immune regulatory mechanisms during human infection with Mycobacterium tuberculosis. *J. Immunol.* **166** :1951–1967.
- [111] PERELSON A.S., 2002. Modelling viral and immune system dynamics. *Nat. Rev. Immunol.* **2**(1) :28–36. doi:10.1038/nri700.
- [112] MARINO S., LINDERMAN J.J., KIRSCHNER D.E., 2011. A multifaceted approach to modeling the immune response in tuberculosis. *Wiley Interdiscip. Rev. Syst. Biol. Med.* **3**(4) :479–489. doi:10.1002/wsbm.131.

- [113] SMITH A.M., PERELSON A.S., 2011. Influenza A virus infection kinetics : quantitative data and models. *Wiley Interdiscip. Rev. Syst. Biol. Med.* **3**(4) :429–445. doi:[10.1002/wsbm.129](https://doi.org/10.1002/wsbm.129).
- [114] DOESCHL-WILSON A., GALINA-PANTOJA L., 2010. Using mathematical models to gain insight into host-pathogen interaction in mammals : porcine reproductive and respiratory syndrome. In *Host-pathogen interactions : genetics, immunology and physiology*, edited by A.W. BARTON, Immunology and Immune System Disorders, Nova Science Publishers (New York, USA), chap. 4, p. 109–131.
- [115] MARINO S., SUD D., PLESSNER H., LIN P.L., CHAN J., FLYNN J.L., KIRSCHNER D.E., 2007. Differences in reactivation of tuberculosis induced from anti-TNF treatments are based on bioavailability in granulomatous tissue. *PLoS Comput. Biol.* **3**(10) :e194. doi:[10.1371/journal.pcbi.0030194](https://doi.org/10.1371/journal.pcbi.0030194).
- [116] MARINO S., KIRSCHNER D.E., 2004. The human immune response to Mycobacterium tuberculosis in lung and lymph node. *J. Theor. Biol.* **227** :463–486. doi:[10.1016/j.jtbi.2003.11.023](https://doi.org/10.1016/j.jtbi.2003.11.023).
- [117] SUD D., BIGBEE C., FLYNN J.L., KIRSCHNER D.E., 2006. Contribution of CD8+ T cells to control of Mycobacterium tuberculosis infection. *J. Immunol.* **176**(7) :4296–4314.
- [118] DAY J., FRIEDMAN A., SCHLESINGER L.S., 2009. Modeling the immune rheostat of macrophages in the lung in response to infection. *Proc. Natl. Acad. Sci. U.S.A.* **106**(27) :11246–11251. doi:[10.1073/pnas.0904846106](https://doi.org/10.1073/pnas.0904846106).
- [119] BOCHAROV G.A., ROMANYUKHA A.A., 1994. Mathematical model of antiviral immune response. III. Influenza A virus infection. *J. Theor. Biol.* **167**(4) :323–360. doi:[10.1006/jtbi.1994.1074](https://doi.org/10.1006/jtbi.1994.1074).
- [120] HANCIOGLU B., SWIGON D., CLERMONT G., 2007. A dynamical model of human immune response to influenza A virus infection. *J. Theor. Biol.* **246**(1) :70–86. doi:[10.1016/j.jtbi.2006.12.015](https://doi.org/10.1016/j.jtbi.2006.12.015).
- [121] HANDEL A., LONGINI I.M., ANTIA R., 2010. Towards a quantitative understanding of the within-host dynamics of influenza A infections. *J. R. Soc. Interface* **7**(42) :35–47.
- [122] LEE H.Y., TOPHAM D.J., PARK S.Y., HOLLENBAUGH J., TREANOR J., MOSMANN T.R., JIN X., WARD B.M., MIAO H., HOLDEN-WILTSE J., PERELSON A.S., ZAND M., WU H., 2009. Simulation and prediction of the adaptive immune response to influenza A virus infection. *J. Virol.* **83**(14) :7151–7165. doi:[10.1128/JVI.00098-09](https://doi.org/10.1128/JVI.00098-09).
- [123] MIAO H., HOLLENBAUGH J.A., ZAND M.S., HOLDEN-WILTSE J., MOSMANN T.R., PERELSON A.S., WU H., TOPHAM D.J., 2010. Quantifying the early immune response and adaptive immune response kinetics in mice infected with influenza A virus. *J. Virol.* **84**(13) :6687–6698. doi:[10.1128/JVI.00266-10](https://doi.org/10.1128/JVI.00266-10).
- [124] TRIDANE A., KUANG Y., 2010. Modeling the interaction of cytotoxic T lymphocytes and influenza virus infected epithelial cells. *Math. Biosci. Eng.* **7**(1) :171–185. doi:[10.3934/mbe.2010.7.171](https://doi.org/10.3934/mbe.2010.7.171).
- [125] SAENZ R.A., QUINLIVAN M., ELTON D., MACRAE S., BLUNDEN A.S., MUMFORD J.A., DALY J.M., DIGARD P., CULLINANE A., GRENFELL B.T., MCCAULEY J.W., WOOD J.L.N., GOG J.R., 2010. Dynamics of influenza virus infection and pathology. *J. Virol.* **84**(8) :3974–3983. doi:[10.1128/JVI.02078-09](https://doi.org/10.1128/JVI.02078-09).

- [126] PAWELEK K.A., HUYNH G.T., QUINLIVAN M., CULLINANE A., RONG L., PERELSON A.S., 2012. Modeling within-host dynamics of influenza virus infection including immune responses. *PLoS Comput. Biol.* **8**(6) :e1002588. doi:10.1371/journal.pcbi.1002588.
- [127] DOBROVOLNY H.M., REDDY M.B., KAMAL M.A., RAYNER C.R., BEAUCHEMIN C.A.A., 2013. Assessing mathematical models of influenza infections using features of the immune response. *PloS ONE* **8**(2) :e57088. doi:10.1371/journal.pone.0057088.
- [128] BEAUCHEMIN C., HANDEL A., 2011. A review of mathematical models of influenza A infections within a host or cell culture : lessons learned and challenges ahead. *BMC Public Health* **11**. doi:10.1186/1471-2458-11-S1-S7.
- [129] MURILLO L.N., MURILLO M.S., PERELSON A.S., 2013. Towards multiscale modeling of influenza infection. *J. Theor. Biol.* **332** :267–290. doi:10.1016/j.jtbi.2013.03.024.
- [130] CRISCI E., MUSSÁ T., FRAILE L., MONTOYA M., 2013. Review : influenza virus in pigs. *Mol. Immunol.* **55**(3) :200–211. doi:10.1016/j.molimm.2013.02.008.

Chapitre II

Integrative model of the immune response to a pulmonary macrophage infection : what determines the infection duration ?

Contents

II.1 Introduction	65
II.2 Methods	67
II.2.1 Model description	67
II.2.2 Model calibration	72
II.2.3 Sensitivity analysis	73
II.2.4 Variability in host susceptibility and strain virulence	76
II.3 Results	77
II.3.1 Model calibration and sensitivity analysis	77
II.3.2 Impact of host susceptibility and strain virulence on the infection resolution and associated immune mechanisms	79
II.4 Discussion	83
II.4.1 Modelling approach	83
II.4.2 Model calibration and scenario definition	83
II.4.3 Assessing the impact of variability in host susceptibility and strain virulence	85
II.4.3.1 Innate response	85
II.4.3.2 Adaptive response	85
II.4.4 Conclusion	87
References	89

Integrative Model of the Immune Response to a Pulmonary Macrophage Infection : What Determines the Infection Duration ?

Natacha Go^{*,†}, Caroline Bidot^{*}, Catherine Belloc[†] and Suzanne Touzeau^{‡,§}

* INRA, UR341 MIA, F-78352 Jouy-en-Josas, France

† LUNAM Université, Oniris, INRA, UMR1300 BioEpAR, F-44307 Nantes, France

‡ INRA, Université Nice Sophia Antipolis, UMR1355 ISA ; CNRS, UMR 7254 ; F-06903 Sophia Antipolis, France

§ Inria, BIOCORE, F-06902 Sophia Antipolis, France

Citation : Go N, Bidot C, Belloc C, Touzeau S (2014) Integrative Model of the Immune Response to a Pulmonary Macrophage Infection : What Determines the Infection Duration ? PLoS ONE 9(9) : e107818. doi :10.1371/journal.pone.0107818

Abstract

The immune mechanisms which determine the infection duration induced by pathogens targeting pulmonary macrophages are poorly known. To explore the impact of such pathogens, it is indispensable to integrate the various immune mechanisms and to take into account the variability in pathogen virulence and host susceptibility. In this context, mathematical models complement experimentation and are powerful tools to represent and explore the complex mechanisms involved in the infection and immune dynamics. We developed an original mathematical model in which we detailed the interactions between the macrophages and the pathogen, the orientation of the adaptive response and the cytokine regulations. We applied our model to the Porcine Respiratory and Reproductive Syndrome virus (PRRSv), a major concern for the swine industry. We extracted value ranges for the model parameters from modelling and experimental studies on respiratory pathogens. We identified the most influential parameters through a sensitivity analysis. We defined a parameter set, the reference scenario, resulting in a realistic and representative immune response to PRRSV infection. We then defined scenarios corresponding to graduated levels of strain virulence and host susceptibility around the reference scenario. We observed that high levels of antiviral cytokines and a dominant cellular response were associated with either short, the usual assumption, or long infection durations, depending on the immune mechanisms involved. To identify these mechanisms, we need to combine the levels of antiviral cytokines, including IFN_{γ} , and IL_{10} . The latter is a good indicator of the infected macrophage level, both combined provide the adaptive response orientation. Available PRRSV vaccines lack efficiency. By integrating the main interactions between the complex immune mechanisms, this modelling framework could be used to help designing more efficient vaccination strategies.

Author Summary

Some respiratory pathogens infect immune cells and consequently hamper the immune system through complex mechanisms compromising the vaccine efficiency. The development of more efficient vaccines requires a better understanding of the interactions between pathogens and immune cells. The immune response exhibits a high variability between hosts and pathogen strains. In this context, a global exploration by experimentation is even more difficult. We proposed an alternative approach : an integrative mathematical model of the immune and infection dynamics. Having chosen the example of an animal virus, we identified the immune components that

determine the infection duration. First, we found that promoting an efficient innate response reduces the infection duration. This had already been suggested, but not proved. Second, we found that, depending on the host and the viral strain, various immune mechanisms can result in the same infection duration. These results provide explanations for the apparent contradictions between experimental results and point out the interest of such an integrative approach. Consequently, our model constitutes (i) a framework to explore the efficiency of current vaccines as well as (ii) a tool to design new and more efficient vaccines.

II.1 Introduction

Respiratory pathogens, which enter the body through the mucosal surfaces of the respiratory tract, are responsible for local inflammation and tissue damages [1, 2]. They initiate the infection and the immune response. The first interaction between the pathogen and the immune system involves the innate immune system. This first line of defence, which includes epithelial surfaces, inflammation process, complement system and innate cells, provides an immediate but non-specific response. The innate cells mainly consist of the pulmonary macrophages, the dendritic cells and the natural killers. Macrophages and dendritic cells phagocytose the pathogens, whereas the natural killers destroy the host infected cells. If pathogens successfully evade the innate response, a second layer of protection is provided by the adaptive immune system, which is activated by the innate response and confers specific long-lasting protective immunity to the host. The adaptive immune system mainly involves the cellular, the humoral and the regulatory responses. The cellular effectors destroy the infected cells, whereas the humoral effectors release antibodies, which are responsible for the neutralisation of free viral particles. The regulatory response mainly inhibits the adaptive response. Innate and adaptive immune cells synthesise cytokines, small proteins which regulate the immune mechanisms in complex ways.

The best strategy to control the severity of respiratory pathogens is to limit the inflammation while maintaining an efficient immune response. Some pathogens, such as influenza viruses, *Mycobacterium tuberculosis* or the Porcine Reproductive and Respiratory Syndrome virus, replicate in the cells of the respiratory tract, including pulmonary macrophages. They hinder the immune functions of the macrophages and consequently reduce the efficacy of the immune response. With these pathogens, activated macrophages (i) either phagocytose and destroy the pathogen, or are infected and excrete the pathogen; (ii) produce cytokines that promote the migration of immune cells to the infection site; (iii) synthesise cytokines that regulate the adaptive immunity; (iv) express antigen proteins on their cell surface that activate the adaptive response. In turn, the adaptive cell effectors and cytokines regulate the immune functions of macrophages. However, the influence of macrophage–pathogen interactions on the immune response has been poorly studied and needs more insight [1–4]. The two major reasons are that the innate mechanisms are very difficult to explore by experimentation *in vivo* and that they have been considered as having little impact compared to the adaptive response.

Here, we were interested in identifying the immune mechanisms which determine the infection duration induced by pathogens targeting pulmonary macrophages. The immune response is a highly complex system involving numerous interactions between cells and cytokines. An additional level of complexity is due to the between-host and between-pathogen variability. Pathogens use multiple strategies, that vary among pathogens but also among strains, resulting in various virulence levels. The host response depends on the host genotype or housing conditions, resulting in various susceptibility levels to a given pathogen. Consequently, to explore the impact of pathogens targeting pulmonary macrophages, it is indispensable to integrate the various

immune mechanisms and to take into account the variability in pathogen virulence and host susceptibility.

In this context, mathematical models are powerful tools to represent and explore the complex mechanisms involved in the infection and immune dynamics [3, 5]. They complement experimentation. On the one hand, they are based on experimental data. On the other hand, they can be used to test biological hypotheses or assess the impact of control strategies, which would not be feasible or would be too expensive by experimentation. They can also guide experimentation by identifying key parameters or mechanisms that need further exploration. Mathematical models have been developed to explore the immune and infection dynamics for various human and animal diseases. However, very few models represent the innate mechanisms explicitly and macrophage–pathogen interactions need to be better represented in models [6]. Several models describe pathogens targeting macrophages, such as influenza viruses [5–7], *Mycobacterium tuberculosis* [8, 9], or Porcine Respiratory and Reproductive Syndrome virus [10]. These models focused more on the adaptive than on the innate response, which was fairly simplified or even missing. In particular, none of these models included the macrophage and natural killer immune functions explicitly and innate the cytokine regulations were simplified. Moreover, none took into account the regulatory adaptive response.

So we proposed an original model of the immune response to a virus infecting pulmonary macrophages in the lung. We considered with particular attention the macrophage–virus interactions. We highly detailed the mechanisms of the innate response and the cytokine regulations. We included the cellular, the humoral and the regulatory orientation of the adaptive response, as well as their main functions. We represented the interactions between innate and adaptive components. We applied our model to the Porcine Respiratory and Reproductive Syndrome virus (PRRSv). PRRSv is a major concern for the swine industry, as it is responsible for significant economic losses worldwide [11, 12]. This pathogen is of particular interest because : (i) it exhibits a strong tropism for the pulmonary macrophages [11–14]; (ii) it induces a prolonged viremia due to its ability to hamper the immune response [11, 12, 15]; and (iii) the infection and immune dynamics are highly variable between hosts and viral strains. Depending on the studies, various components of the immune response have been highlighted as having an impact on PRRSv infection duration : (i) the macrophage permissiveness and excretion rate; (ii) the levels of antiviral and immuno-modulatory cytokines; and (iii) the balance between the cellular, humoral and regulatory responses [16]. We used our integrative model to identify the immune mechanisms determining the infection duration and to explore the relevance of these three assumptions, taking into account the variability in pathogen virulence and host susceptibility.

First, we built our model by synthesising knowledge on the immune mechanisms from published studies on PRRSv. Experimental studies on PRRSv are numerous, but cannot provide all our model parameter values. So we compiled data from the literature by reviewing experimental and modelling studies on pathogens targeting pulmonary macrophages and obtained large value ranges for our model parameters. We explored the influence of these parameters on the viral and macrophage dynamics by a sensitivity analysis. We then identified a parameter set resulting in realistic infection and immune dynamics. Finally, we explored the influence of host susceptibility and viral virulence on the infection outcome and we identified the associated immune mechanisms.

II.2 Methods

In this section, we first present the dynamic model and its calibration, based on literature data. We then describe the sensitivity analysis method used to quantify the influence of model parameters on outputs of interest, among which the viral titer. Finally, we define scenarios which represent the variability in host susceptibility and strain virulence, in order to assess the impact of this variability on the model outputs.

II.2.1 Model description

We built a deterministic dynamic model of ordinary differential equations to simulate the infection and immune dynamics induced by a pathogen targeting pulmonary macrophages in the lung. The functional diagram of the model appears in FIGURE II.1. We selected the immune components and their interactions from current knowledge on the immune mechanisms induced by pathogens targeting pulmonary macrophages. Our modelling assumptions are detailed and justified in the complete model description given in Appendix A. In particular, the cytokine regulations and syntheses represented in our model, as well as the related literature references, are summarised in Table A.1 and Table A.2 respectively.

The model is characterised by 18 state variables : the free viral particles (V) ; five effectors of the innate response : four macrophage states and the natural killers (NK) ; three effectors of the adaptive response and nine cytokines. A macrophage can either be susceptible (M_s), phagocytosing (M_p), or infected ; in this latter case, it is either latent (M_l) or excreting the virus (M_e). For the adaptive response, the effectors represent the regulatory (R_r), humoral (R_h) and cellular (R_c) responses. The nine cytokines included are the major pro-inflammatory ($IL_{1\beta}$, IL_6 , IL_8), the innate antiviral (TNF_α , IFN_α) and the immuno-regulatory (IFN_γ , IL_{10} , TGF_β , IL_{12}) cytokines. IFN_γ also exhibits an antiviral function. TNF_α is generally considered as a pro-inflammatory cytokine, but we were here more interested in its antiviral function. The model describes the evolution over time of the state variable concentrations in the lung.

The main processes that drive the evolution of these state variables and that are integrated in the model are : the phagocytosis of the viral particles by the macrophages (rate η) ; the macrophage infection by the virus (rate β) ; the excretion of free viral particles by the infected macrophages (rate e) ; the recruitment (rate A_m) and decay/migration of the macrophages (rates μ_M) ; the activation (rates α) and decay/migration of the other effectors (rates μ) ; the cytokine productions by the immune cells (rates ρ) and their decay (rates μ_C) ; the cytokine regulations (functions κ). FIGURE II.2 gives a schematic representation of the model (without regulations). Parameter descriptions and values are synthesised in TABLE II.1. A complete description of the model and the corresponding equations is given in Appendix A. Here we describe the main components of the model, illustrated by a few representative equations.

When a free viral particle encounters a susceptible macrophage (1 in FIGURE II.1), it can either be phagocytosed (rate η , 2a in FIGURE II.1), resulting in viral destruction (3a in FIGURE II.1), or it can infect the cell (rate β , 2b in FIGURE II.1), resulting in viral replication (3b in FIGURE II.1). The phagocytosis is amplified by antiviral cytokines (TNF_α , IFN_α and IFN_γ) and inhibited by immuno-modulatory cytokines (IL_{10} and TGF_β , 2a in FIGURE II.1). The infection (linked to the macrophage permissiveness) is amplified by IL_{10} and inhibited by innate antiviral cytokines (IFN_α , TNF_α) and TGF_β (2b in FIGURE II.1). Phagocytosing macrophages revert to a susceptible status after viral destruction (rate γ) ; it is amplified by the antiviral cytokines and inhibited by IL_{10} (2a in FIGURE II.1). Activated macrophages (infected or phagocytosing macrophages) produce pro-inflammatory cytokines (3d in FIGURE II.1), which amplify the recruitment

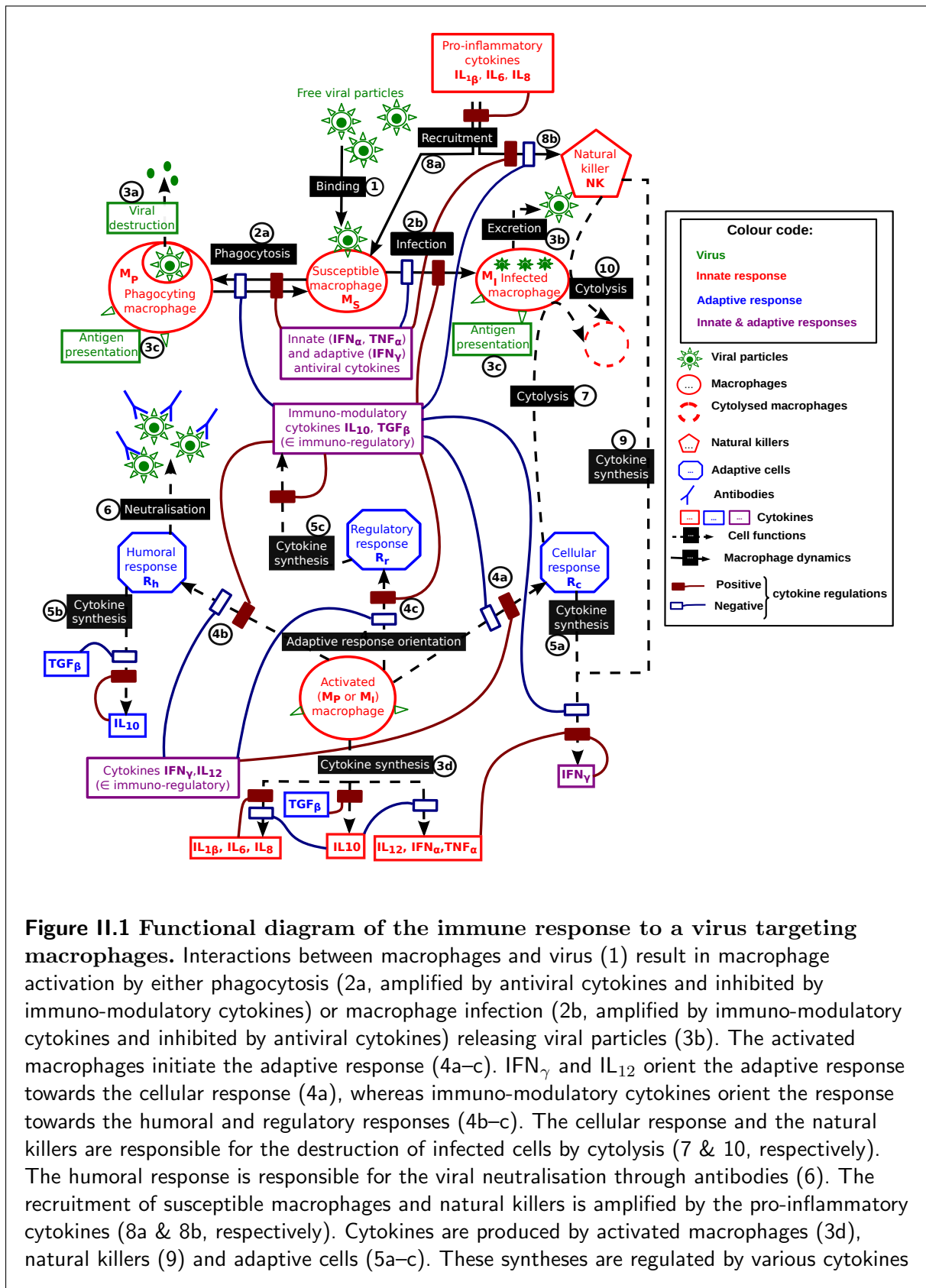
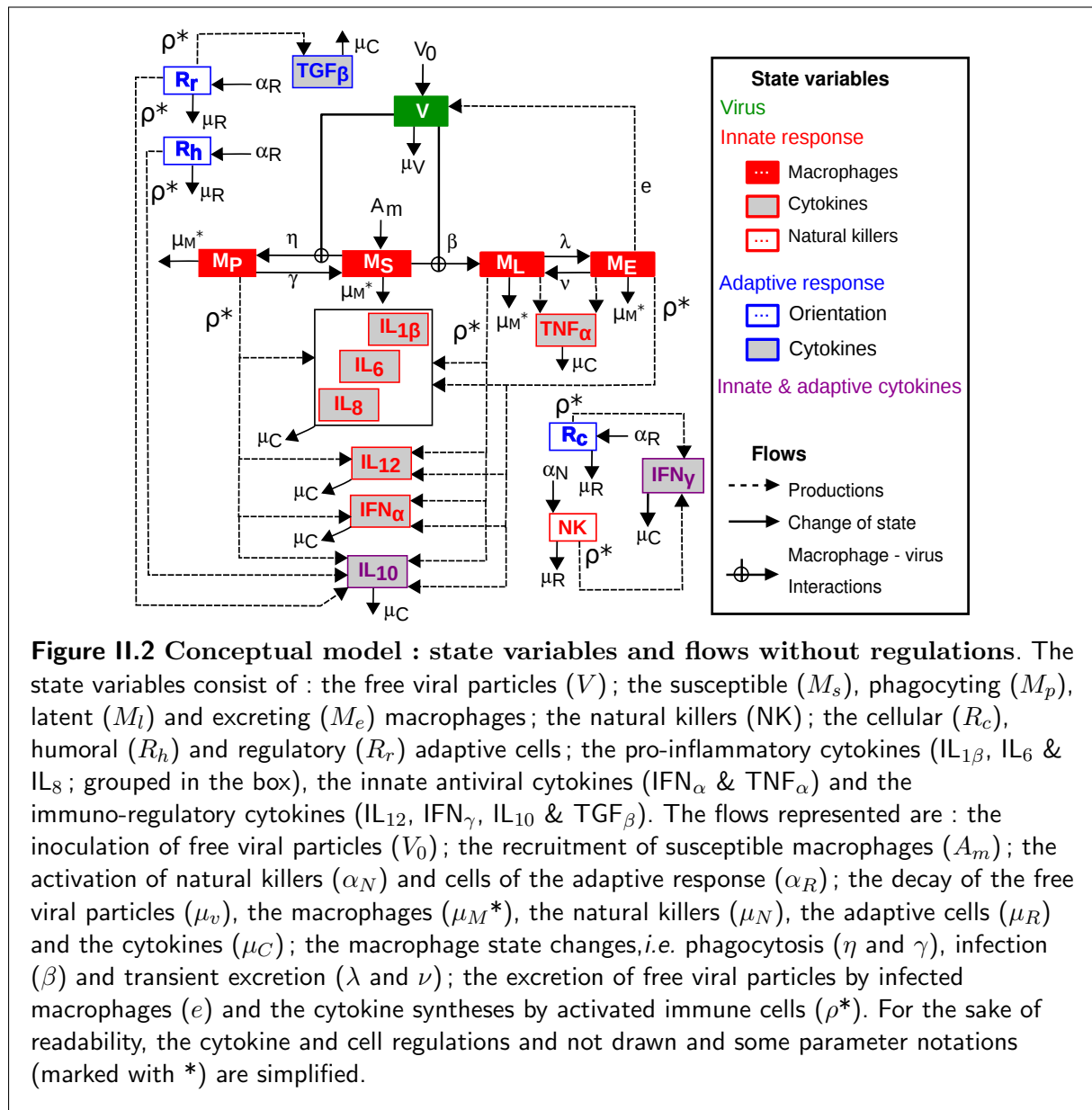
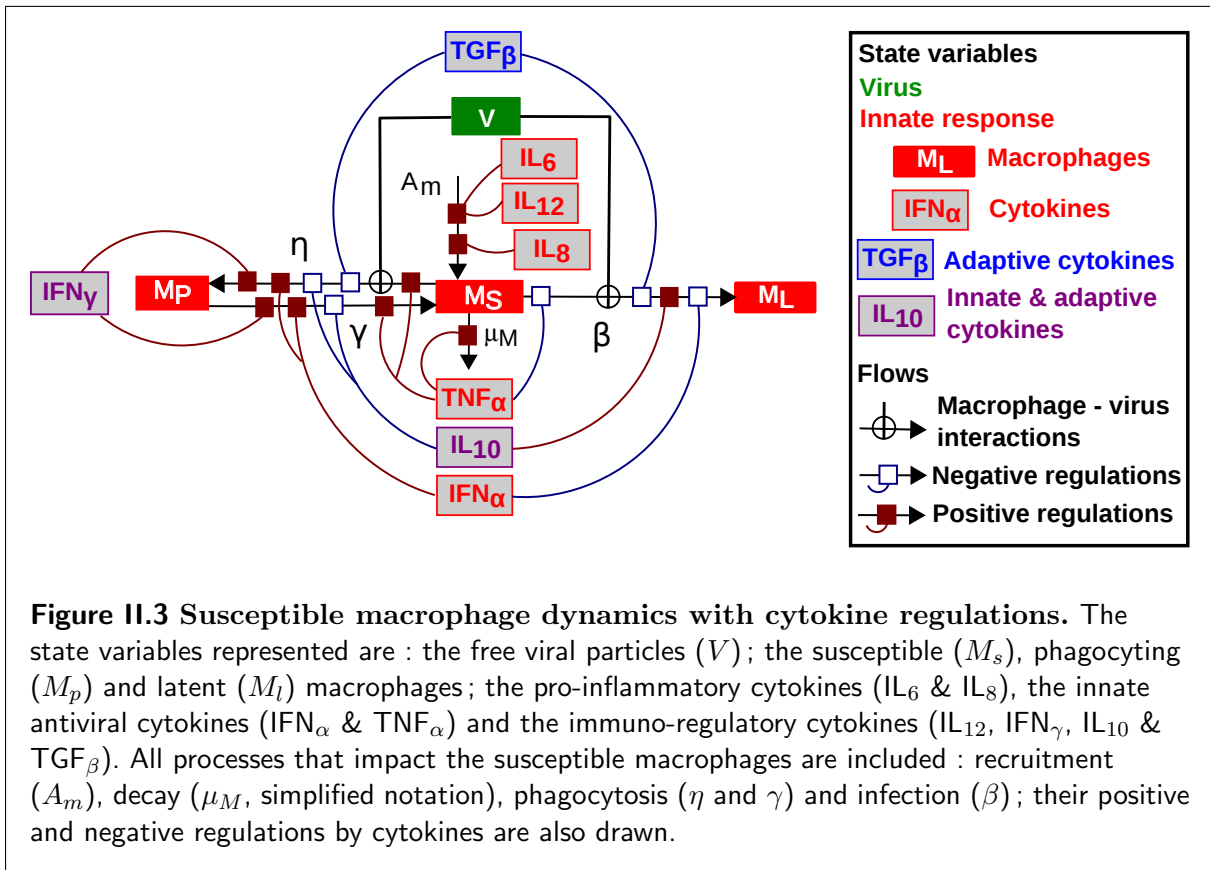

Figure II.1 Functional diagram of the immune response to a virus targeting macrophages. Interactions between macrophages and virus (1) result in macrophage activation by either phagocytosis (2a, amplified by antiviral cytokines and inhibited by immuno-modulatory cytokines) or macrophage infection (2b, amplified by immuno-modulatory cytokines and inhibited by antiviral cytokines) releasing viral particles (3b). The activated macrophages initiate the adaptive response (4a–c). IFN_{γ} and IL_{12} orient the adaptive response towards the cellular response (4a), whereas immuno-modulatory cytokines orient the response towards the humoral and regulatory responses (4b–c). The cellular response and the natural killers are responsible for the destruction of infected cells by cytolysis (7 & 10, respectively). The humoral response is responsible for the viral neutralisation through antibodies (6). The recruitment of susceptible macrophages and natural killers is amplified by the pro-inflammatory cytokines (8a & 8b, respectively). Cytokines are produced by activated macrophages (3d), natural killers (9) and adaptive cells (5a–c). These syntheses are regulated by various cytokines



of susceptible macrophages (inflow A_m , 8a in FIGURE II.1) [4, 17–19]. Finally, susceptible macrophages undergo natural decay (rate μ_M^{nat}) and TNF_α -induced apoptosis (rate μ_M^{inf}) [20]. The resulting susceptible macrophage dynamics is shown in Equation (II.1) and FIGURE II.3.

$$\begin{aligned}
 \dot{M}_s = & A_m [1 + \kappa(\text{IL}_{12}, \text{IL}_6)] [1 + \kappa(\text{IL}_8)] && \leftarrow \text{recruitment} \\
 & - \eta M_s V \frac{[1 + \kappa(\text{TNF}_\alpha)] [1 + \kappa(\text{IFN}_\alpha)] [1 + \kappa(\text{IFN}_\gamma)]}{[1 + \kappa(\text{IL}_{10})] [1 + \kappa(\text{TGF}_\beta)]} && \leftarrow \text{phagocytosis} \\
 & + \gamma M_p \frac{[1 + \kappa(\text{TNF}_\alpha)] [1 + \kappa(\text{IFN}_\alpha)] [1 + \kappa(\text{IFN}_\gamma)]}{1 + \kappa(\text{IL}_{10})} && \leftarrow \text{phagocytosis ending} \\
 & - \beta M_s V \frac{1 + \kappa(\text{IL}_{10})}{[1 + \kappa(\text{TNF}_\alpha)] [1 + \kappa(\text{IFN}_\alpha)] [1 + \kappa(\text{TGF}_\beta)]} && \leftarrow \text{infection} \\
 & - M_s (\mu_M^{\text{nat}} + \mu_M^{\text{inf}} \text{TNF}_\alpha) && \leftarrow \text{decay}
 \end{aligned} \tag{II.1}$$



The cytokine environment is not static in our model, as we explicitly represented the evolution of the cytokine concentrations over time. Cytokines are produced by activated immune cells. In turn, they modulate the cellular functions through their recognition by specific receptors, inducing cascaded reactions within the cells. The higher the cytokine concentration, the stronger the effect. However, there is a limited number of cytokine receptors on the cell surface, so the effect saturates above a given cytokine concentration. We formalised the cytokine effects

by a Michaelis–Menten function (κ) of the cytokine concentration (C_i) [8, 21, 22] as follows :

$$\kappa(C_i) = \frac{K C_i}{C_i + k},$$

where K represents the saturation factor and k the half-saturation concentration. A cytokine can have three possible effects listed below on a given flow (R).

- Activation : $R \kappa(C_i)$. The flow is only possible in the presence of the cytokine and it increases with the cytokine concentration.
- Amplification : $R [1 + \kappa(C_i)]$. The flow increases with the cytokine concentration.
- Inhibition : $R/[1 + \kappa(C_i)]$. The flow decreases with the cytokine concentration.

Regulations often involve several cytokines (C_i and C_j), which can act

- either independently : $R [\kappa(C_i) + \kappa(C_j)]$ for an activation, $R [1 + \kappa(C_i)] [1 + \kappa(C_j)]$ for an amplification, or $R/([1 + \kappa(C_i)] [1 + \kappa(C_j)])$ for an inhibition ;
- or in synergy : $R \kappa(C_i, C_j) = R \kappa(C_i) \kappa(C_j)$ for an activation, $R [1 + \kappa(C_i, C_j)]$ for an amplification, or $R/[1 + \kappa(C_i, C_j)]$ for an inhibition.

For example, the recruitment of susceptible macrophages (8a in FIGURE II.1) is amplified by three cytokines, as shown in Equation (II.1) : two act in synergy (IL₁₂ and IL₆) and the third one acts independently (IL₈).

The dynamics of natural killers, given by Equation (II.2), offers a more complex example of cytokines acting independently and in synergy. We represented the dynamics of activated natural killers and only included the regulations by the most influential cytokines [4, 19, 23, 24]. The recruitment of natural killers from the bloodstream (rate α_N , 8b in FIGURE II.1) is activated by pro-inflammatory cytokines : IL₁₂ and IL₆ co-activate the recruitment, whereas IL₈ acts independently. Natural killers are then activated by IFN_γ and IL₁₂, whereas IL₁₀ inhibits the activation. They are subject to natural death or/and migration (rate μ_R). Activated natural killers destroy infected cells (10 in FIGURE II.1) and synthesise IFN_γ (9 in FIGURE II.1) [4, 19, 23, 24].

$$\begin{aligned} \dot{\text{NK}} &= \alpha_N \frac{[\kappa(\text{IL}_{12}, \text{IL}_6) + \kappa(\text{IL}_8)] [\kappa(\text{IFN}_\gamma) + \kappa(\text{IL}_{12})]}{[1 + \kappa(\text{IL}_{10})]} && \longleftarrow \text{recruitment \& activation} \\ &- \mu_R \text{NK} && \longleftarrow \text{decay} \end{aligned} \quad (\text{II.2})$$

Activated macrophages present the viral antigens to the adaptive cells (3c in FIGURE II.1). The subsequent orientation of the adaptive response depends on the immuno-regulatory cytokines (4a – c in FIGURE II.1). We represented the adaptive response by three effectors corresponding to the three main orientations : cellular, humoral and regulatory responses [1, 4, 13, 25–31]. As for the natural killers, we only represented the dynamics of the activated effectors. Based on the model proposed by Yates *et al.* for the regulation of T helper cell populations [31], we synthesised the dynamics of each adaptive effector by three steps : activation by activated macrophages (rate α_R), proliferation (rate p_R) and decay. We represented the regulations of the activation and proliferation steps by the most influential cytokines : IFN_γ, IL₁₂, IL₁₀ and TGF_β (assumptions and references detailed in Appendix A). The decay includes the natural decay (rate μ_R) and the Activation Induced Cell Death (AICD) induced by the interaction with a type 1 T helper cell from the R_c compartment (basic rate δ_{R_c}) [31].

- Cellular response : R_c represents the type 1 T helper cells and the cytotoxic lymphocytes. Its dynamics is described in Equation (II.3). Activation is amplified by IFN_γ and IL₁₂ and inhibited by IL₁₀ ; proliferation is activated by IFN_γ and IL₁₂ and inhibited by IL₁₀ and

TGF $_{\beta}$ (4a in FIGURE II.1). R_c synthesises IFN $_{\gamma}$ (5a in FIGURE II.1) and destroys infected macrophages (7 in FIGURE II.1).

$$\begin{aligned}
 \dot{R}_c = & \alpha_R [M_p + M_l + M_e] \frac{[1 + \kappa(\text{IFN}_{\gamma})] [1 + \kappa(\text{IL}_{12})]}{1 + \kappa(\text{IL}_{10})} \leftarrow \text{activation} \\
 & + p_R R_c \frac{[\kappa(\text{IFN}_{\gamma}) + \kappa(\text{IL}_{12})]}{[1 + \kappa(\text{IL}_{10})] [1 + \kappa(\text{TGF}_{\beta})]} \leftarrow \text{proliferation} \\
 & - \mu_R R_c - \delta_{R_c} R_c^2 \leftarrow \text{decay}
 \end{aligned} \tag{II.3}$$

- Humoral response : R_h represents the type 2 T helper cells, the B lymphocytes and the antibodies. Activation is amplified by IL $_{10}$ and inhibited by IFN $_{\gamma}$ and IL $_{12}$; proliferation is activated by IL $_{10}$ and inhibited by IFN $_{\gamma}$, IL $_{12}$ and TGF $_{\beta}$ (4b in FIGURE II.1). R_h synthesises IL $_{10}$ (5b in FIGURE II.1) and neutralises free viral particles through antibodies (6 in FIGURE II.1).
- Regulatory response : R_r represents the regulatory T cells. Activation is amplified by IL $_{10}$ and TGF $_{\beta}$ and inhibited by IFN $_{\gamma}$ and IL $_{12}$; proliferation is activated by TGF $_{\beta}$ and inhibited by IL $_{10}$, IFN $_{\gamma}$ and IL $_{12}$ (4c in FIGURE II.1). R_r synthesises IL $_{10}$ and TGF $_{\beta}$ (5c in FIGURE II.1).

Simulations The model was implemented in Scilab 5.3.3 ¹. For all simulations, the initial conditions were set to represent an initial viral inoculation in a PRRSv-naive host and were chosen as follows : $V(0) = V_0 \in [10^4, 10^7]$ TCID $_{50}$ /ml for the viral titer ; $M_s(0) = 5 \cdot 10^5$ cells/ml for the susceptible macrophages ; all remaining variables were set to zero. The model parameters are summarised in TABLE II.1.

II.2.2 Model calibration

Published experimental data on PRRSv infection (reviewed in [11, 12, 16, 32–37]) are highly heterogeneous and differ on : (i) the monitoring duration, (ii) the measured immune components, (iii) the viral strain, (iv) the pig genotype. Moreover, among the variables included in our model, only a few were monitored in each experimental study and there were few measures over time. Consequently, based on these data, classical parameter estimation methods were not suitable to calibrate our model and we had to design an *ad hoc* procedure.

The first step of the calibration procedure was to synthesise data from experimental infections to identify the variation ranges of our model parameters. When PRRSv studies could not provide parameter values, we reviewed models applied to tuberculosis and influenza. The value ranges obtained for the model parameters and the corresponding references are given in TABLE II.1 (ranges defined by the minimum and maximum tested values). The second step was to explore the parameter space defined by these value ranges. We used a design of experiments which is described in the Sensitivity analysis section below. The simulations resulting from this exploration exhibited very contrasted outputs (Figures S2–S4). So the third step was to define the characteristics of the infection and immune dynamics corresponding to a realistic response to PRRSv infection. We chose to represent an average response as our reference scenario (S0). This step is detailed below. Finally, the fourth step was to select a parameter set corresponding

¹Scilab : <http://www.scilab.org/>

to this reference scenario. We used the sensitivity analyses presented below to focus first on the most sensitive parameters, *i.e.* parameters which had the greatest impact on the model outputs.

For the reference scenario, we chose to represent the infection of a weaned pig by a single PRRSv inoculation. Weaned pigs are supposed to be naive to PRRSv and to have lost their maternal immunity. In experimental PRRSv infection studies, the inoculation dose ranged between 4 and 7 $\log_{10}(\text{TCID}_{50}/\text{ml})$ [41, 42]; we chose an inoculation dose of 6.3 $\log_{10}(\text{TCID}_{50}/\text{ml})$. PRRSv infection usually lasts between 28 to 42 days in the blood [12, 16, 43] and around 56 days in the lung [12]. However, the infection duration is highly variable between pigs and viral strains and can be higher than 200 days [16, 44]. So we chose an infection duration in the lung of around 70 days. Few quantitative data are available for the immune dynamics. The cytokine levels are highly variable between studies [11, 13] and poorly documented in the lung. Their magnitude ranges between 10^{-1} and 10^3 pg/ml. IL₁₀ levels in response to PRRSv infection and other respiratory pathogens are similar. They are higher than the levels of pro-inflammatory, antiviral (innate and adaptive) and other immuno-regulatory (IL₁₂, IFN_γ and TGF_β) cytokines. Without infection, macrophage concentrations in the lung were observed around 10^5 cells/ml. To our knowledge, only one experimental study tracked infected macrophages, which peaked during the first days of PRRSv infection at around 40% among all macrophages [42]. Little is known about the phagocytosing macrophages, except that the phagocytosing state is transient and that PRRSv promotes macrophage infection over phagocytosis [45, 46]. Reported levels of natural killers during PRRSv infection were low compared to other respiratory pathogens [15, 33]. The humoral response to PRRSv infection is similar to other respiratory pathogens, whereas the cell-mediated immunity is delayed and weak. The regulatory response has been poorly studied and results are controversial [13, 47–49]. Moreover, the orientation of the adaptive response varied considerably between studies. Consequently, we chose a balanced adaptive response orientation for our reference scenario.

II.2.3 Sensitivity analysis

We were interested in identifying the most influential parameters on the infection dynamics using a global sensitivity analysis. Consequently, the first two outputs selected were the viral titer (V) and the percentage of infected macrophages among the total concentration of macrophages ($\%M_i = \%(M_l + M_e)$). We were also interested in characterising the phagocytosis activity, which directly limits the macrophage infection. The phagocytosis is a transient macrophage state, which explains why, whatever the parameter combination selected in the parameter ranges, the percentage of phagocytosing macrophages ($\%M_p$) was low compared to the percentage of infected macrophages ($\%M_i$) at any time during the course of infection (FIGURE A.1). However, it does not mean that the phagocytosis activity was necessarily low. We compared the phagocytosis flow (susceptible macrophages becoming phagocytosing macrophages per unit of time) and the infection flow (susceptible macrophages becoming infected macrophages per unit of time) during the course of infection. Depending on the parameter values, the phagocytosis inflow was higher or lower than the infection inflow (FIGURE A.1). Consequently, the cumulative number of phagocytosing macrophages (cM_P), which corresponds to the phagocytosis flow integrated over time, is a good representation of the phagocytosis activity. So we selected this variable as the third output of interest. We used a design of experiments to define which simulations to run. The resulting outputs were analysed to produce the sensitivity indices, which quantify the influence of the parameters on the model outputs. We used the R software², version 3.0.2, for

²<http://www.r-project.org/>

Table II.1 Model parameters. The minimal and maximal values tested were issued from the literature when we found some information, otherwise they were assumed (-). Macrophages : susceptible (M_S), latent (M_L), excreting (M_E), infected ($M_I = M_L + M_E$), phagocytosing (M_P), activated ($M_a = M_L + M_E + M_P$). Adaptive cells R : cellular (R_c), humoral (R_h) and regulatory (R_r) effectors.

* The unit of η and β is given for the macrophage equation and is different in the virus equation (ml/(d.TCID₅₀)); nevertheless, the parameter values are the same since we considered that the phagocytosis and macrophage infection consume one TCID₅₀ of virus per macrophage.

Parameter	Description	Tested values			Reference value	Unit	References
<i>Macrophage dynamics</i>							
A_m	recruitment rate of M_s	$5 \cdot 10^4$	10^5	$1.5 \cdot 10^5$	$5 \cdot 10^4$	(ml.d) ⁻¹	[21, 38]
η	phagocytosis rate	10^{-10}	10^{-8}	10^{-6}	$5 \cdot 10^{-7}$	ml/d*	[39]
β	infection rate	10^{-10}	10^{-8}	10^{-6}	10^{-6}	ml/d*	[14]
γ	1/ phagocytosis duration	24	48	96	96	d ⁻¹	[23]
λ	1/ duration of M_I state	6	12	24	6	d ⁻¹	[14]
ν	1/ duration of M_e state	6	12	24	6	d ⁻¹	-
μ_M^{nat}	natural death rate	0.1	0.2	0.3	0.2	d ⁻¹	[22]
δ_μ	over-mortality rate of M_i	0.9	1	1.1	1.1	no unit	-
μ_M^{ap}	apoptosis rate by TNF $_\alpha$	10^{-7}	$10^{-4.5}$	10^{-2}	10^{-2}	ml/(pg.d)	[40]
μ_M^{inn}	cytolysis rate of M_i by NK	10^{-8}	$10^{-5.5}$	10^{-3}	10^{-3}	ml/d	[40]
μ_M^{ad}	cytolysis rate of M_i by R_c	10^{-8}	$10^{-5.5}$	10^{-3}	10^{-3}	ml/d	[40]
<i>Virus dynamics</i>							
V_0	initial viral inoculation	10^4	10^5	10^7	$2 \cdot 10^6$	TCID ₅₀ /ml	[41, 42]
e	excretion rate	0.1	1	10	0.2	TCID ₅₀ /d	-
μ_V^{nat}	natural death rate	0.1	0.2	0.3	0.2	d ⁻¹	-
μ_V^{ad}	neutralisation rate by R_h	10^{-4}	10^{-3}	10^{-2}	10^{-4}	ml/d	-
<i>Adaptive cell (R) and natural killer (NK) dynamics</i>							
α_R	activation rate of R by M_a	10^{-6}	10^{-5}	10^{-4}	10^{-5}	d ⁻¹	[21]
α_N	activation rate of NK	0.1	1	10	10	(ml.d) ⁻¹	[21]
p_R	proliferation rate of R		0.05		0.05	d ⁻¹	-
δ_{R_c}	death rate of R by AICD	10^{-3}	10^{-2}	10^{-1}	10^{-1}	ml/d	-
μ_R	natural death rate	0.01	0.03	0.05	0.05	d ⁻¹	-
<i>Cytokine dynamics</i>							
ρ_{P_i}	synthesis rate of P_i by M_a	10^{-2}	10	10^2	10^{-2}	pg/d	-
$\rho_{\text{IL}_{12}}$	synthesis rate of IL ₁₂ by M_a	10^{-2}	10	10^2	10^{-2}	pg/d	-
ρ_{A_i}	synthesis rate of A_i by M_a	10^{-2}	10	10^2	$5 \cdot 10^{-2}$	pg/d	-
$\rho_{\text{IL}_{10}}^{\text{inn}}$	synthesis rate of IL ₁₀ by M_a	10^{-2}	10	10^2	$2 \cdot 10^{-2}$	pg/d	-
$\rho_{\text{IL}_{10}}^{\text{ad}}$	synthesis rate of IL ₁₀ by R	10^{-2}	10	10^2	2	pg/d	-
$\rho_{\text{IFN}_\gamma}^{\text{inn}}$	synthesis rate of IFN $_\gamma$ by NK	10^{-2}	10	10^2	10	pg/d	-
$\rho_{\text{IFN}_\gamma}^{\text{ad}}$	synthesis rate of IFN $_\gamma$ by R	10^{-2}	10	10^2	10	pg/d	-
ρ_{TGF_β}	synthesis rate of TGF $_\beta$ by R	10^{-2}	10	10^2	10	pg/d	-
μ_C	natural death rate	10	20	40	20	d ⁻¹	[22]
k	half-saturation concentration	5	10^2	$1.5 \cdot 10^3$	30	pg/ml	[22]
K	saturation factor	0.5	1	1.5	1.5	no unit	-

these analyses.

We selected 30 among the 31 model parameters for the sensitivity analysis. We did not include the proliferation rate of the adaptive effectors (p_R), because the combination of high p_R and high IL_{10} synthesis rates led to the explosion of the R_h and R_r dynamics, which resulted in a numerical integration failure of the model. For each of the 30 parameters, we chose to test three values among the value range identified in the calibration procedure : the lower and upper bounds of the range, as well as an intermediate value (TABLE II.1). Testing all parameter combinations, *i.e.* a complete factorial design, would have required 3^{30} simulations, which was not feasible. Consequently, fractional factorial designs were used instead. A preliminary analysis was conducted to estimate the main effects of the 30 parameters on the model outputs, without taking into account the interactions between parameters. A fractional design of size 243, determined as the minimum size to correctly estimate the main effects, was implemented : 243 parameter combinations were defined and the corresponding simulations were performed and analysed. From this preliminary analysis, the ten most influential parameters on each of the three outputs were identified. We then performed a sensitivity analysis on each output, aiming at estimating the main effects and two-parameter interactions of the corresponding ten most influential parameters, to which we potentially added extra parameters assumed to have an impact on the corresponding output. For instance, we added the macrophage mortality rates for the $\%M_i$ output. We selected 17 parameters for the viral titer, 10 parameters for the cumulative M_p and 21 parameters for the percentage of infected macrophages (FIGURE II.4). The smallest design that correctly estimates the main effects and two-parameter interactions for 21 parameters ($\%M_i$ output) requires $3^8 = 6561$ parameter combinations. We chose to use the same design size for all outputs, so 6561 simulations were performed and analysed for each of the three outputs. The Planor R package³ was used to construct the fractional designs.

Sensitivity indices were calculated for each parameter on each output in the preliminary analysis (30 parameters \times 3 outputs) and the subsequent analyses taking into account two-factor interactions. Sensitivity indices quantify the fraction of output variance among simulations explained by the variation of each parameter within its value range [50]. Our model outputs being time-dependent variables, we used a method adapted to multivariate outputs, which is based on a decomposition of the variable using a principal component analysis (PCA) [51]. As a result of the PCA, an inertia proportion is attributed to each component. It represents the variability among simulations carried by the component. Moreover, each simulation is given a “score” on each component, a scalar which represents the projection of the simulation on the component. Then, for each component, an ANOVA is performed on these scores to estimate the influence of each parameter on the output. The sensitivity index associated with each term, main effect of a parameter or interaction between parameters, is defined as the ratio between the sum of squares corresponding to that term and the total sum of squares. Finally, a generalised sensitivity index (GSI) is calculated for each term (main effect or interaction) as the the sum of the sensitivity indices corresponding to that term on each PCA component, weighted by the inertia of the component. The total generalised sensitivity index (tGSI) of a parameter is defined as the sum of the sensitivity indices corresponding to this parameter (main effect mGSI plus sum of interactions involving the parameter iGSI). We used the Multisensi R package⁴ for this analysis.

³Planor R package : <http://cran.r-project.org/web/packages/planor/index.html>

⁴Multisensi R package : <http://cran.r-project.org/web/packages/multisensi/index.html>

GSI results are presented below. For each output, key parameters are defined as the most influential parameters for which the cumulative total GSI is higher than 75%.

II.2.4 Variability in host susceptibility and strain virulence

PRRSv exhibits an important genotypic diversity associated with various virulence levels [13]. The European genotype is less virulent than the American genotype [35], but the virulence also differs among strains within a genotype [52]. The highly virulent strains are associated with a prolonged viremia, a high viral replication rate and a high humoral response [53]. Moreover, the genetic component of the host susceptibility to PRRSV has been demonstrated [54, 55]. Pig susceptibility can also depend on other factors such as herd management. The more susceptible pigs develop prolonged viremia, with low titers of neutralising antibodies [10, 55], probably linked to a high macrophage permissiveness and/or specific cytokine profiles [54].

Both viral virulence and pig susceptibility seem linked to : (i) the virus capacity to infect the cell and replicate, (ii) the host capacity to synthesise antiviral *vs* immuno-modulatory cytokines in response to PRRSV infection, and (iii) the activation and orientation of the adaptive response. Recent studies hypothesise that these variations of the immune dynamics are due to cascaded reactions initiated by the macrophage–virus interactions [33, 34, 52, 54]. Consequently, we focused on the macrophage infection and cytokine synthesis capacities. Both macrophage permissiveness and viral replication impact the cytokine synthesis, which in turn regulates them. Discriminating the respective influence of the macrophage permissiveness and the cytokine synthesis rate is very difficult experimentally, but it can be achieved by a modelling approach. To explore the influence of both mechanisms, scenarios were defined by varying a selection of parameters chosen according to the sensitivity analysis results and to the hypotheses presented above. We tested 19 graduated values of : (i) the macrophage permissiveness, promoting either the phagocytosis (scenarios S0 to S1 : S0→S1), or the macrophage infection and viral excretion (scenarios S0→S2); and (ii) the cytokine synthesis rates, promoting either the antiviral cytokine synthesis (scenarios S0→SB), or the immuno-modulatory cytokine synthesis (scenarios S0→SA). Scenarios are defined in TABLE II.2. Compared to the reference scenario (S0), scenarios S0→S1 and S0→SB correspond to low host susceptibility and strain virulence, whereas scenarios S0→S2 and S0→SA correspond to high susceptibility and virulence. The parameter ranges were set to cover the variation range of the viral titer reported in the literature.

We used the area under the curve (AUC) to synthesise our model outputs. As the shapes of the immune and viral output curves were similar across the scenarios, characterising each curve by a well-chosen number was appropriate and facilitated the comparisons between scenarios. Choosing the AUC was relevant, as it reflects the entire curve [56]. Relative AUC were defined as percentages of output AUC among a group of outputs.

Several linear regressions were performed to extract trends from our results and facilitate the interpretations. In particular, to highlight the links between immuno-regulatory cytokines and the orientation of the adaptive response, we performed linear regressions between (i) the relative AUC of relevant cytokines and (ii) the relative AUC of the adaptive response effectors (R_c , R_h & R_r). To highlight the immune mechanisms determining the infection duration, we performed linear regressions between (i) the AUC of relevant immune components, which are assumed to have a strong influence on the infection duration in the literature and (ii) the infection duration. We used the R software, version 3.0.2, for these analyses.

The infection duration is defined as the time elapsed between the initial viral inoculation and the virus clearance. In our model, we assumed that there was no more infection when the virus titer was below 0.01 TCID₅₀/ml.

Table II.2 Definition of the host susceptibility and strain virulence scenarios. Scenarios S1 and S2 differ from the reference scenario S0 by their respectively low and high macrophage permissiveness. Scenarios S1→S2 correspond to 19 intermediate scenarios (including S0) obtained by gradually varying the following parameter values : excretion rate (e), macrophage infection rate (β) and phagocytosis rate (η). Scenarios SB and SA differ from the reference scenario S0 by their cytokine synthesis capacities : scenario SB promotes antiviral over immuno-modulatory cytokine synthesis, and *vice versa* for scenario SA. Scenarios SB→SA correspond to 19 intermediate scenarios (including S0) obtained by varying gradually the synthesis rates of the following cytokines : the innate antiviral cytokines IFN $_{\alpha}$ and TNF $_{\alpha}$ (both ρ_{A_i}); the immuno-regulatory cytokines IFN $_{\gamma}$ ($\rho_{\text{IFN}_{\gamma}}^{\text{inn}}$ & $\rho_{\text{IFN}_{\gamma}}^{\text{ad}}$), IL $_{10}$ ($\rho_{\text{IL}_{10}}^{\text{inn}}$ & $\rho_{\text{IL}_{10}}^{\text{ad}}$) and TGF $_{\beta}$ ($\rho_{\text{TGF}_{\beta}}$). Low/high susceptibility and virulence levels correspond to scenarios with low/high macrophage permissiveness (S1/S2) and scenarios which promote the antiviral/immuno-modulatory cytokine synthesis (SB/SA). The parameter values corresponding to the reference scenario are in boldface.

Scenarios	Macrophage permissiveness			Cytokine synthesis capacities					
	e	β	η	ρ_{A_i}	$\rho_{\text{IFN}_{\gamma}}^{\text{inn}}$	$\rho_{\text{IFN}_{\gamma}}^{\text{ad}}$	$\rho_{\text{IL}_{10}}^{\text{inn}}$	$\rho_{\text{IL}_{10}}^{\text{ad}}$	$\rho_{\text{TGF}_{\beta}}$
S1	0.15	$5 \cdot 10^{-7}$	10^{-6}	0.05	10	10	0.02	2	10
SB	0.2	10^{-6}	$5 \cdot 10^{-7}$	0.5	100	100	0.005	0.5	2.5
S0	0.2	10^{-6}	$5 \cdot 10^{-7}$	0.05	10	10	0.02	2	10
SA	0.2	10^{-6}	$5 \cdot 10^{-7}$	0.005	0.1	0.1	0.08	8	40
S2	0.25	$2 \cdot 10^{-6}$	$2.5 \cdot 10^{-7}$	0.05	10	10	0.02	2	10

II.3 Results

II.3.1 Model calibration and sensitivity analysis

The reference scenario (S0) was characterised by a 72-day infection duration, an infected macrophage peak at 40% of the total macrophage concentration, a balanced adaptive response orientation and high IL $_{10}$ levels compared to antiviral and pro-inflammatory cytokine levels. Its parameter values are given in TABLE II.1 and it is represented in FIGURE II.5 (black curves).

In the preliminary sensitivity analysis, with all 30 parameters but no interactions between parameters, the variance explained by the parameters retained for the main sensitivity analysis on each output was 89% for the viral titer, 89% for the cumulative number of phagocytosing macrophages and 70% for the percentage of infected macrophages. The results of the main sensitivity analyses with two-parameters interactions are shown in FIGURE II.4; for each output, the total global sensitivity index defined for each parameter is split into the parameter main effect and its interactions. At least 92% of the total output variance was explained by the parameters and two-parameter interactions for all three outputs. Three key parameters (explaining together more than 75% of the variance) were identified for each output. Their impact is detailed in TABLE II.3. Most of them were involved in macrophage–virus interactions. The infection rate β was a key parameter for the three outputs of interest. The excretion rate e was a key parameter for the viral titer and the percentage of infected macrophages. The phagocytosis rate η was a key parameter for the viral titer and the cumulative number of phagocytosing macrophages. The remaining key parameters were the inoculation dose V_0 for the cumulative number of phagocytosing macrophages and the synthesis rate of innate antiviral cytokines ρ_{A_i} for the percentage of infected macrophages. The main effects of the key parameters ranged between 0.4% (β on the viral titer) and 28% (η on the viral titer). Key parameters also exhibited high interactions (*e.g.* 27% for interactions involving β on the percentage of infected macrophages), in particular between two

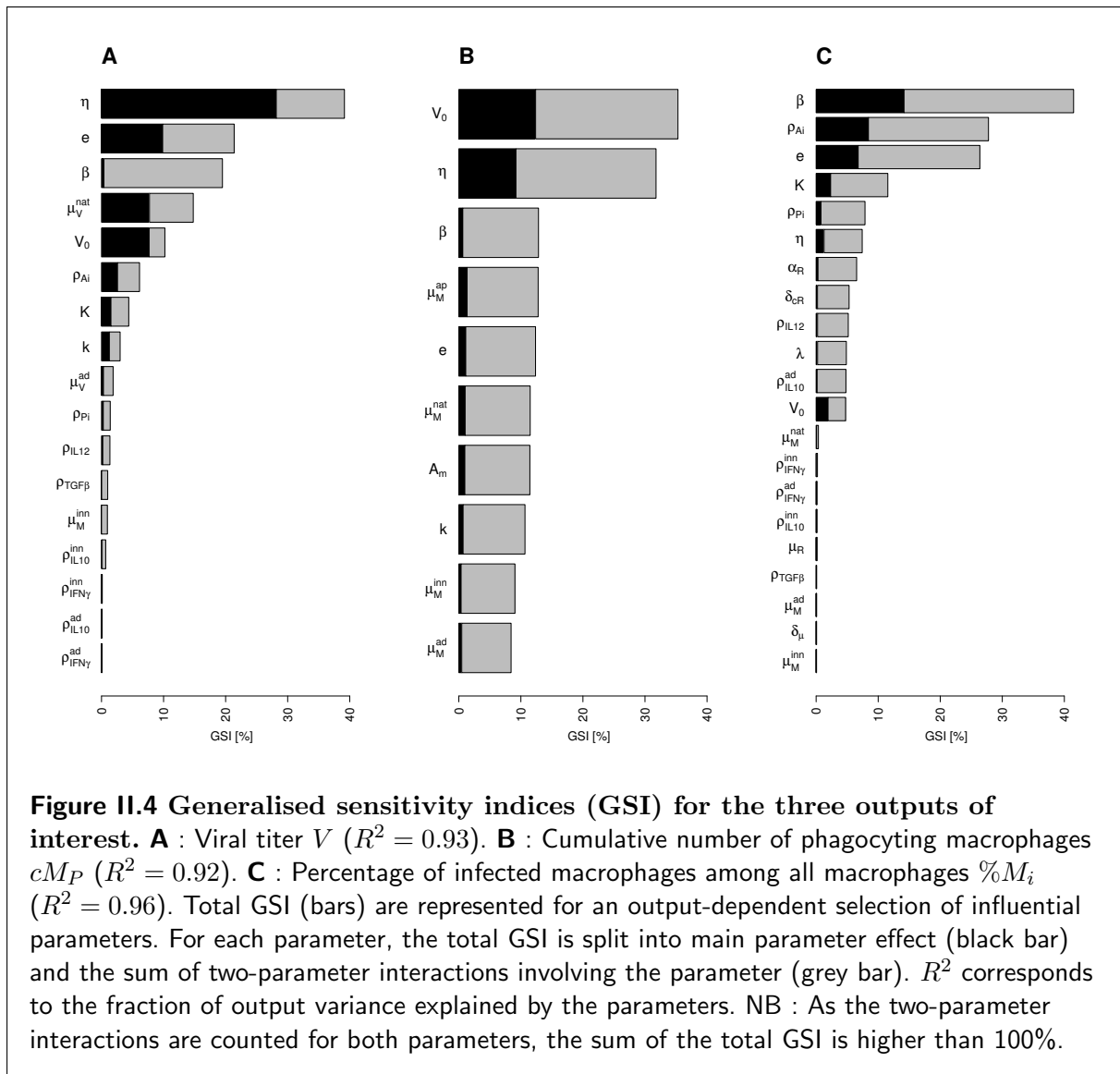

key parameters (results not shown).

The initial inoculation dose V_0 was a key parameter for the cumulative number of phagocytosing macrophages (tGSI=35%), but neither for the viral titer (tGSI=11%), nor for the percentage of infected macrophages (tGSI=5%). This result can be explained by the fact that the phagocytosis activity mostly occurs during the first days of the infection, whereas the viral titer and infected macrophages are impacted all along the infection course (FIGURE A.2, FIGURE A.3 and figurename A.4).

The infection rate β had less impact on the viral titer variability (tGSI=19.4%, mGSI=0.4%) than the phagocytosis rate η (tGSI=39%, mGSI=28%) and the excretion rate e (tGSI=22%, mGSI=10%). Macrophage infection results in viral excretion and has a positive impact on the free viral particles, but it is attenuated by the virus mobilisation by infected macrophages.

The infection rate β and the excretion rate e exhibited a strong interaction on the viral titer and the percentage of infected macrophages (GSI around 8%). Indeed, the viral replication needs macrophages to be infected and conversely, macrophage infection is induced by free viral

Table II.3 Generalised sensitivity indices and influence of the key parameters on the three outputs of interest. The outputs are the viral titer (V), the cumulative number of phagocytosing macrophages (cM_P), and the percentage of infected macrophages among all macrophages ($\%M_i$). Three key parameters were identified for each output (corresponding GSI in bold). For each parameter and each output, the generalised sensitivity index of the parameter main effect (mGSI, in %) and of the sum of two-parameter interactions involving the parameter (iGSI, in %) are given. Increasing the parameter value can induce an increase (\uparrow) or decrease (\downarrow) of the output.

Key parameters	V			cM_P			$\%M_i$		
	mGSI	iGSI	Influence	mGSI	iGSI	Influence	mGSI	iGSI	Influence
Initial inoculation V_0	8	3	\uparrow	12	23	\uparrow	2	3	\uparrow
Excretion rate e	10	12	\uparrow	1	11	\uparrow	7	20	\uparrow
Infection rate β	0.4	19	\uparrow	0.6	12	\downarrow	14	27	\uparrow
Phagocytosis rate η	28	11	\downarrow	9	23	\uparrow	1	6	\downarrow
A_i synthesis rate ρ_{A_i}	3	4	\uparrow	–	–	\uparrow	8	19	\downarrow

particles which are released through viral excretion.

II.3.2 Impact of host susceptibility and strain virulence on the infection resolution and associated immune mechanisms

The 37 scenarios corresponding to graduated levels of host susceptibility and strain virulence were simulated. The results are illustrated in FIGURE II.5 and summarised in TABLE II.4. The infection durations (52–118 days according to the scenario) were consistent with literature data [12, 16, 43, 44]. All scenarios had a notable impact on the infection duration. The scenarios related to macrophage permissiveness ($S1 \rightarrow S2$) induced higher differences in infection duration than the scenarios related to the cytokine synthesis ($SB \rightarrow SA$), even if the parameter variations were lower for scenarios $S1 \rightarrow S2$ than for scenarios $SB \rightarrow SA$ (TABLE II.2). Consequently, the infection duration seems more sensitive to the parameters involved in the macrophage permissiveness than the antiviral cytokine synthesis rate.

The dynamics of immune components were similarly bell-shaped but differed quantitatively. More severe and longer infections were overall associated with higher levels of immune responses (FIGURE II.5), but the relative proportions of the immune components varied (TABLE II.4).

Concerning the innate response, we found a significant and positive correlation ($R^2 = 0.97$) between the levels of infected macrophages and IL_{10} , a cytokine which amplifies macrophage permissiveness and viral replication (results not shown).

There was no evidence of a link between the proportions of IL_{12} and TGF_β and the orientation of the adaptive response. The proportions of IL_{10} and IFN_γ , however, were linked to the adaptive response orientation (TABLE II.4 & FIGURE II.5). The proportion of IL_{10} among IL_{10} and IFN_γ was negatively correlated with the percentage of cellular response ($R^2 = 0.91$) and positively correlated with both the humoral ($R^2 = 0.94$) and regulatory responses ($R^2 = 0.84$).

Scenarios $S1 \rightarrow S2$ resulted in immune dynamics rather close to the reference scenario, except for IFN_γ levels (FIGURE II.5). On the one hand, high infection capacities ($S0 \rightarrow S2$) resulted in long infection durations despite high levels of IFN_γ (FIGURE II.5) and the adaptive response was oriented towards the cellular response ($\%R_c = 40\%$, TABLE II.4). However, IFN_γ percentages were similar to the reference scenario. On the other hand, low infection capacities ($S1 \rightarrow S0$)

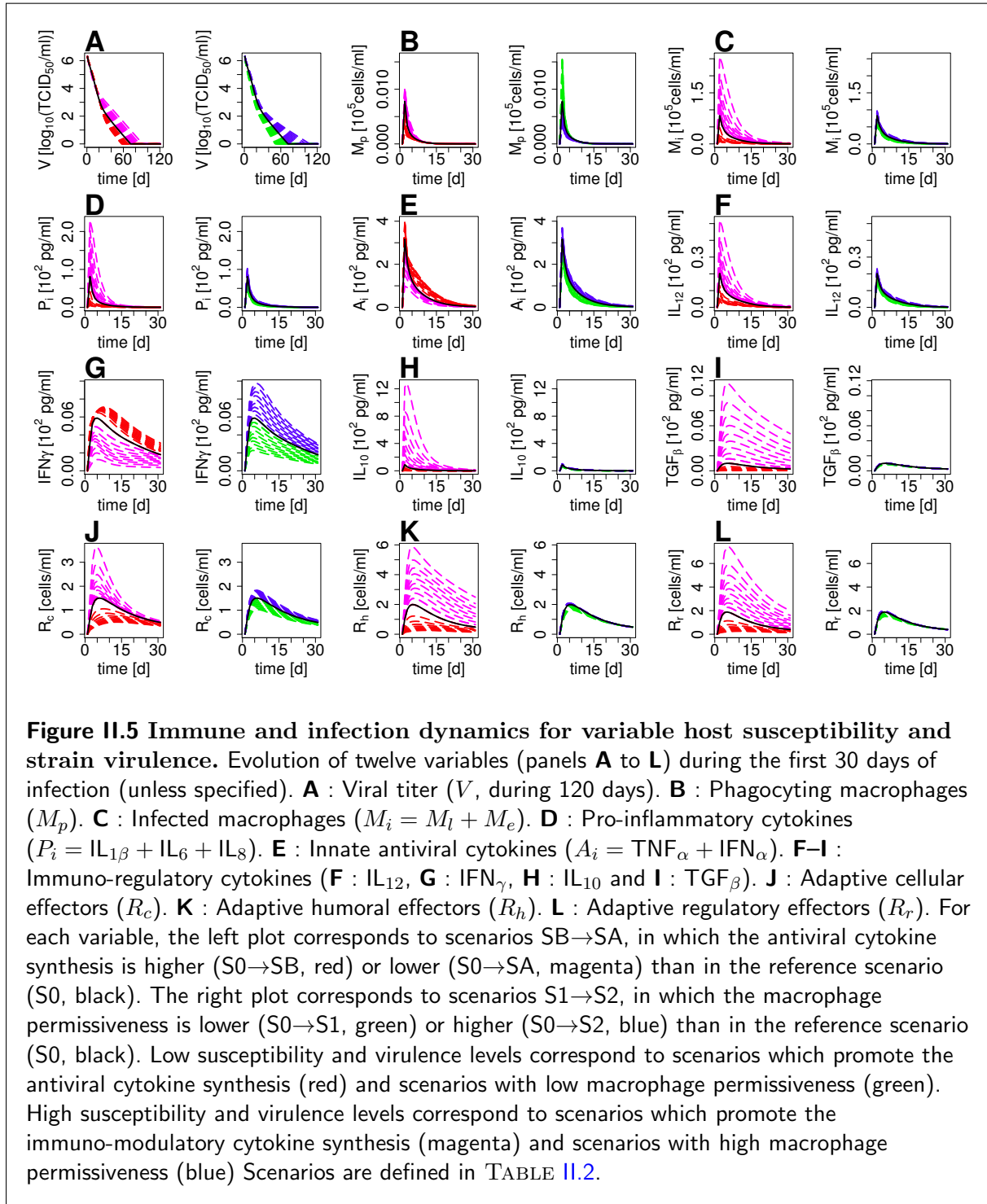

Table II.4 Summary of the virus and immune dynamics for variable host susceptibility and strain virulence. Scenarios S1 : low macrophage permissiveness ; SB : high antiviral and low immuno-modulatory cytokine synthesis ; S0 : reference ; SA : high macrophage permissiveness ; S2 : low antiviral and high immuno-modulatory cytokine synthesis. AUC (area under the curve) units : macrophages [10^5 d/ml], other cells [d/ml], cytokines [10^2 pg.d/ml]. Macrophages : infected (M_I), phagocytosing (M_P). Adaptive effectors : cellular (R_c), humoral (R_h) and regulatory (R_r) orientations.

* Relative AUC are defined within a group of outputs (e.g. the four cytokines IL₁₂, IFN_γ, IL₁₀ and TGF_β) as the AUC of the outputs expressed as percentages of the sum of the AUC within the group.

	<i>Susceptibility and virulence :</i>				
	low		reference	high	
	S1	SB	S0	SA	S2
Virus – Infection duration [d]	52	57	72	93	118
Innate response – AUC					
$M_p/(M_i + M_p)$ [%]	1.4	1.6	0.5	0.2	0.2
M_p	0.030	0.008	0.009	0.030	0.008
M_i	2.1	0.48	3.5	18	5.1
NK	71	15	225	866	559
$P_i = \text{IL}_{1\beta} + \text{IL}_6 + \text{IL}_8$	1.2	0.28	2.4	10.8	3.6
$A_i = \text{IFN}_\alpha + \text{TNF}_\alpha$	9	26	16	7	23
Adaptive response – AUC					
$\text{IL}_{12} + \text{IFN}_\gamma + \text{IL}_{10} + \text{TGF}_\beta$	3.2	2.5	6.6	107	10.3
$R_c + R_h + R_r$	108	36	124	455	146
Cytokines – relative AUC [%]*					
IL ₁₂	21	9	16	2.8	14
IFN _γ	1	85	22	0.2	30
IL ₁₀	71	4.5	59	93	54
TGF _β	7	0.5	3	4	2
Orientation – relative AUC [%]*					
R_c	23	54	32	14	40
R_h	41	23	36	43	32
R_r	36	23	32	43	28

resulted in short infection durations despite high percentages of IL₁₀ and the adaptive response was oriented towards the humoral response ($\%R_h = 41\%$, TABLE II.4). IL₁₀ levels were similar to the reference scenario (FIGURE II.5).

Scenarios SB→SA resulted in more contrasted immune dynamics (FIGURE II.5) and influenced the adaptive response orientation more than scenarios S1→S2 (TABLE II.4). Low antiviral capacities (S0→SA) resulted in long infection durations associated with high levels (FIGURE II.5) and percentages of IL₁₀, and co-dominant humoral and regulatory responses (TABLE II.4). High antiviral capacities (SB→S0) resulted in short infection durations associated with high levels (FIGURE II.5) and percentages of IFN_γ, and an orientation towards the cellular response (TABLE II.4).

To extract trends more easily from these results, we investigated the correlations between

the infection duration and the levels of seven key immune components of interest : infected and phagocytosing macrophages, innate antiviral and pro-inflammatory cytokines and percentages of IL₁₀ and IFN_γ (FIGURE II.6). Considering all scenarios together, no significant correlations could be extracted. Consequently, we split the scenarios in two groups : those with varying macrophage capacities (S1→S2) and those with varying cytokine synthesis capacities (SB→SA). All correlations were significant. The AUC of infected macrophages and pro-inflammatory cytokines were positively correlated with the infection duration for both groups. Otherwise, both groups exhibited opposite correlations.

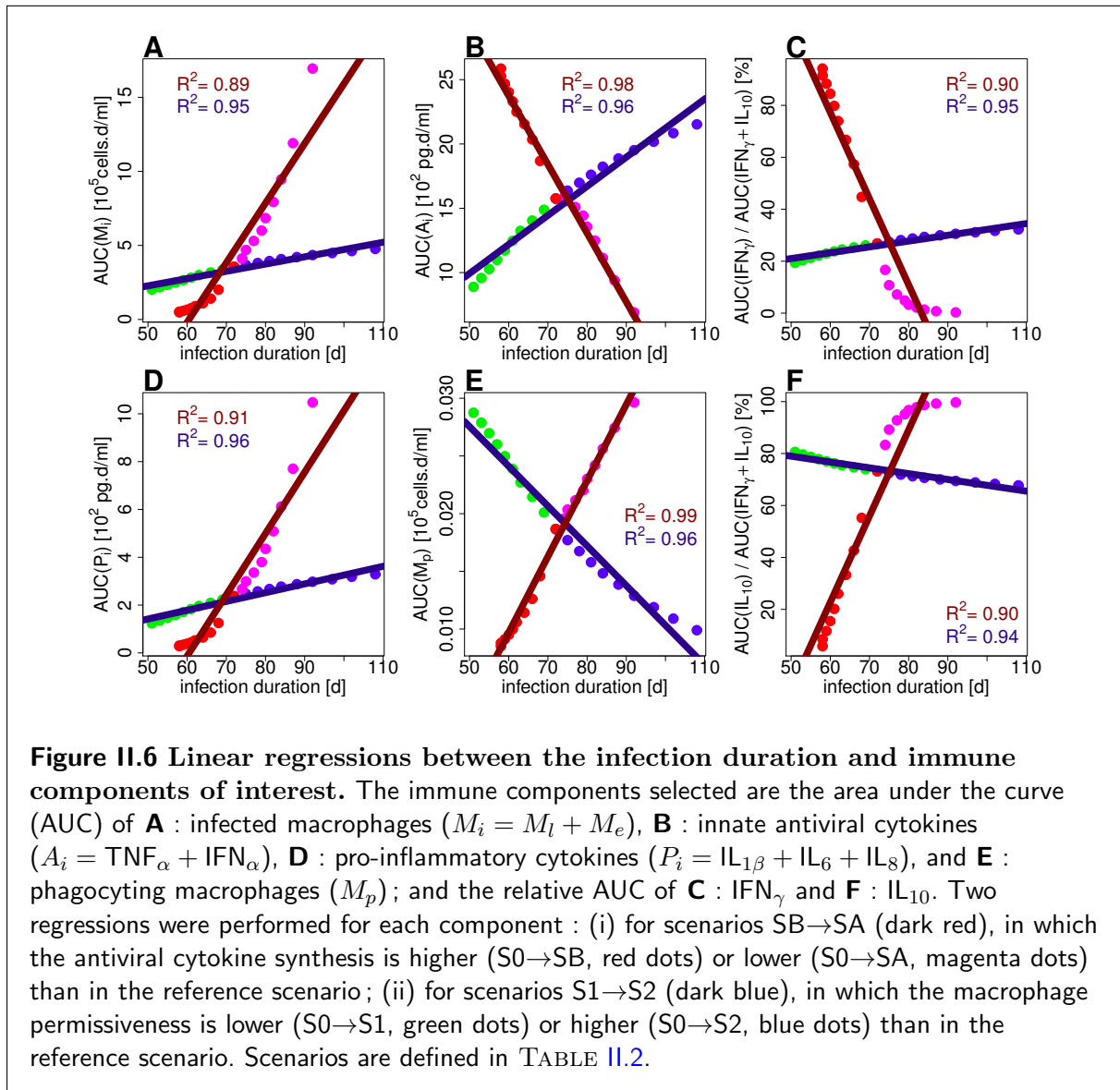

In summary, low virulence and susceptibility scenarios induced short infection durations by promoting the phagocytosis or the synthesis of antiviral cytokines. On the contrary, high virulence and susceptibility scenarios resulted in long infection durations by promoting the infection and viral excretion or the synthesis of immuno-modulatory cytokines. Infection durations were always positively correlated with the levels of infected macrophages and pro-inflammatory cytokines. We observed that longer durations were associated with higher percentages of infected

macrophages among activated macrophages. However, high levels of antiviral cytokines compared to immuno-regulatory cytokines, inducing a dominant cellular response, can be associated with either (i) long (scenarios related to macrophage permissiveness) or (ii) short infection durations (scenarios related to cytokine synthesis capacities).

II.4 Discussion

II.4.1 Modelling approach

In this paper, we presented an integrative dynamic model of the immune response in the lung to a virus targeting pulmonary macrophages : the PRRSV. The complexity level of the model is a good compromise between detailed intra-cellular models which focus on specific immune mechanisms and global models which give general trends [8]. Our model offers a comprehensive representation of the interactions between the virus and the immune response, which is necessary to explore the influence of the immune mechanisms on the infection duration. It is an original approach that takes into account the innate mechanisms, the adaptive response orientation and their complex interactions and regulations involving cytokines. We chose to represent the activation and orientation of the adaptive response, even if they occur outside the lung, because they interact with the immune and infection dynamics. Therefore, we did not detail the intermediate differentiation and proliferation steps of the adaptive response, but we represented its main immune functions and regulations. We hence obtained a realistic qualitative dynamic of the adaptive response. We did not represent the dendritic cells, major antigen presenting cells which influence the adaptive response activation and orientation. These cells mature during their migration from the infection site to the lymph nodes, where they synthesise cytokines. They influence the infection dynamics through the cytokines they synthesise, which is consequently negligible in the lung. Moreover, dendritic cells and macrophages drive the adaptive response orientation in a similar way. As our model does intend to represent the orientation of the adaptive response between the different types and not the quantitative levels of adaptive cells, we trust that our simplification did not distort the results. This simplification is even more appropriate when dealing with PRRSV, as the virus also infects dendritic cells. Dendritic cells and macrophages hence have very similar dynamics and impacts during PRRSV infection [57, 58].

The model was built to describe a single infection by a stable pathogen at the within-host scale. We used it to study the impact of PRRSV strains, which exhibit various virulence levels. Our model could be easily adapted to other pathogens targeting pulmonary macrophages, such as influenza viruses. As influenza also infects epithelial cells, these target cells would have to be included in the model. As for other pathogens, the immune dynamic part of our model constitutes a good basis to study the innate response, given the fact that it is strongly simplify in most of the published models.

II.4.2 Model calibration and scenario definition

The variation range of our model parameters were based on literature data. To complement these data and deal with the high variability on the parameter values and output levels, we developed an *ad hoc* method based on large parameter space exploration and sensitivity analysis. We defined a reference scenario, which corresponds to an average dynamics within the observed immune and infection dynamics. To study the impact of host and strain variability, we also defined parameter sets based on published assumptions and resulting in infection durations

which were consistent with the literature [12, 16, 43, 44]. However, a quantitative calibration based on the viral dynamics and immune response data was not feasible. The levels of strain virulence and susceptibility of pigs are not quantified, the viral strains and pig breeds are not always informed and only few combinations of breeds and strains have been tested, so the comparisons between our scenarios and the literature are limited, especially for the immune response.

The sensitivity analysis highlighted five key parameters with a strong influence on the macrophage and virus dynamics : the viral inoculation dose V_0 , the viral excretion rate e , the macrophage infection rate β , the phagocytosis rate η and the antiviral cytokine synthesis rate ρ_{A_i} . The inoculation dose is measured in experimental studies but is difficult to assess in field conditions. The other three key parameters are not easy to inform. Distinguishing between infected and phagocytosing macrophages is an experimental challenge, so their dynamics are rarely observed and the related parameter values are not measured in the literature. Further experimentation would be needed to track the dynamics of our outputs of interest, especially viral titer and ideally both infected and phagocytosing macrophages, or at least activated macrophages. The sensitivity analysis also exhibited high interactions between parameters, which partly explain the difficulties encountered to calibrate the model.

In terms of viral dynamics, the simulated infection durations ranged between 52 and 118 days according to the scenarios. Experimental studies show that the resolution generally occurs in the serum between 28 and 42 days after a PRRSv infection [12, 16, 43] and in the lung after 56 days on average [12, 59–62]. Infections longer than 240 days have been observed [16]. Consequently, the variation range of the simulated infection durations is realistic. Few studies measure the infection duration in the sera and in the lung simultaneously [43, 63, 64]. Combining these studies, we estimated that the infection duration in the lung is around 1.6 times longer than in the sera. This approximation allowed us to compare the infection duration in the lung from our simulation results to the infection duration in the blood (viremia) from experimental results. Few experimental studies focus on the response variability due to the viral strain or pig breed susceptibility. In a resistant pig breed, the viral load was around 35 days in the sera (estimated around 56 days in the lung) [55] and around 52 days in the lung with a low virulent strain [38]. Conversely, a more susceptible pig breed showed a 72-day viremia (estimated around 115 days in the lung) [55]. Infections by a highly virulent strain resulted in a viremia of 36 days (estimated around 58 days in the lung) [62] or the presence of viral particles in the lung for more than 67 days [65]. Our results were consistent with these data, but exhibited a larger range of infection durations.

In terms of immune response, the main trends found in the literature are the following : high virulence and susceptibility are associated with (i) a high activation of the immune response [66] ; (ii) a dominant humoral response [41] with high levels of IL_{10} ; (iii) a lower cellular response with low levels antiviral cytokines [33, 34, 53, 66, 67]. However, trends (ii) and (iii) do not always hold. Some reviews point out that levels of antiviral and IL_{10} cytokines are highly variable between hosts and viral strains [11, 13]. An infection by a highly virulent strain can result in high levels of IFN_{γ} [62]. A strong cellular response is not necessarily correlated with a short infection duration [60]. Our results are qualitatively consistent with these data : high virulence and susceptibility scenarios were associated with high levels of the immune response and various orientations of the adaptive response. A common trend detected throughout all scenarios was the correlation between IL_{10} and the infected macrophages. Unlike the infected macrophages, IL_{10} can be easily be measured. However, this result should be confirmed by experimentation before using IL_{10} as a proxy for infected macrophages. We also found that high levels of pro-inflammatory cytokines were associated with longer infections. It has been suggested that inflammatory responses in the lung are an indicator of the severity and duration of the PRRSv infection rather than an

indicator of the immune response efficacy [17].

II.4.3 Assessing the impact of variability in host susceptibility and strain virulence

The strain virulence and pig susceptibility variability impact the infection duration, but the underlying mechanisms are still incompletely understood. Several hypotheses are formulated to explain PRRSv infection duration. Early immunological findings link prolonged viremia with (i) a weak innate antiviral response, (ii) high levels of immuno-modulatory cytokines (IL_{10} and TGF_{β}) and (iii) low levels of IFN_{γ} , resulting in the orientation towards an inefficient humoral response; in contrast the cellular response could be protective. These results are challenged in more recent studies. All this knowledge is synthesised and discussed in terms of between-host and between-strain variability in recent reviews [16, 33, 34, 37]. In the following discussion sections, we confront our simulation results to the above-mentioned hypotheses.

II.4.3.1 Innate response

PRRSv has been reported to have various negative effects on innate immune functions, which probably contribute to the long survival of the virus in infected pigs. It suppresses the phagocytosing activity, it fails to elicit any significant innate antiviral cytokines and it alters of the innate cytokine patterns compared to other respiratory pathogens [33, 37]. Consequently, we could expect negative correlations between the infection duration and both innate antiviral cytokines (A_i) and phagocytosing macrophages (M_p). However, we found that long PRRSv infections were correlated as follows : either positively with A_i and negatively with M_p , or positively with M_p and negatively A_i . To explain these puzzling results, we need to consider the levels of the other immune components and the parameter values used.

For scenarios S1→S2, we gradually promoted the infection and excretion while limiting the phagocytosis. It resulted in longer infection durations, a high increase of A_i , a decrease of M_p and a moderate increase of infected macrophages (M_i). As A_i are mainly synthesised by M_i , promoting infection results in increasing A_i . In turn, A_i inhibits the infection and should reduce M_i . However, promoting the excretion and limiting the phagocytosis increase the free viral particles (V) and M_i . This last mechanism was dominant in these scenarios and countered the effect of A_i .

For scenarios SB→SA, we gradually promoted the synthesis of immuno-modulatory cytokines (IL_{10} and TGF_{β}) and limited the synthesis of A_i and IFN_{γ} . It resulted in longer infection durations, an increase of M_p and a high increase of M_i and IL_{10} . Promoting IL_{10} and TGF_{β} should increase the infection and reduce the phagocytosis, both contributing to an increase of V . In turn, V activates the phagocytosis and infection. This last mechanism was dominant in these scenarios and countered the cytokine effect. As a net result, M_p increased.

Our results suggest that despite high correlations between components of the innate response and the infection duration, measuring the innate response alone is insufficient to explain and predict the infection duration.

II.4.3.2 Adaptive response

The orientation towards the cellular, humoral or regulatory responses is supposed to have a high influence on the infection duration, but the mechanisms governing the orientation still need more

insight. In experimental studies, the orientation towards the humoral and cellular responses is usually approximated by the levels of IL₁₀ and IFN_γ respectively. However, few studies consider the cellular and humoral responses simultaneously, as well as the associated cytokines, and most studies neglect the regulatory response. Reviews on PRRSV infection suggest that high levels of IL₁₀ are capable of shifting the immune response towards a humoral response and that in the absence of IFN_γ, there is no cellular response [16, 33]. As the neutralisation of IL₁₀ inhibits the regulatory response [37], levels of IL₁₀ and regulatory response are assumed to be linked. In our model, the three orientations were represented, as well as their regulations and interactions. We found that the orientation of the adaptive response did not depend on specific cytokine levels, but on the proportions of IFN_γ and IL₁₀. This result is consistent with the literature, as it points out the crucial role of IFN_γ and IL₁₀ on the adaptive response orientation. However, it also points out the limits of the usual approximation of the adaptive response orientation by IFN_γ or IL₁₀ levels.

The cellular response is considered as protective against a wide variety of viral infections but its influence is controversial in the case of PRRSV infections [16, 33]. Reviews suggest that the suppression of IFN_γ may have little influence on the *in vivo* disease progression [16, 68]. Moreover, long-term persistence of the virus in the host associated with a strong cellular response has been observed [33]. Both findings suggest that the cellular response alone cannot curtail the infection. Correlations between the strength of the cellular response and the PRRSV infection duration are highly variable between hosts and strains [34]. We also found that a dominant cellular response and high percentages of IFN_γ can be associated with either long or short infection durations. Scenarios SB→SA are consistent with the usual assumption that confers a protective role to the cellular response. However, in scenarios S1→S2, long infection durations were associated with a dominant cellular response. To explain this result, we need to consider simultaneously the levels of the other immune components and the parameter values used. Long infection durations were associated with high levels of IFN_γ and A_i , moderate levels of IL₁₀ and infected macrophages, as well as an orientation towards the cellular response. We previously explained the high increase of A_i and the moderate increase of M_i (see Innate response above). Being produced by M_i , IL₁₀ also increases, but less than A_i (lower production rate). As M_i increases, the activation of the immune response also increases. In particular, the natural killers increase. They synthesise IFN_γ, which promotes the cellular response, whose effectors synthesise IFN_γ, resulting in the orientation towards the cellular response. IL₁₀ does not increase enough to prevent this orientation. As A_i , the cellular response and IFN_γ inhibit the infection, but not enough to compensate the high excretion and infection rates.

The high influence of the excretion rate on the infection duration is consistent with the results of the sensitivity analysis. The scenarios explored could correspond to real conditions. Indeed, an experimental study showed that pig genotypes can influence the alveolar macrophage ability to suppress the viral replication [69]. Moreover, virulent strains vary in their ability to induce the synthesis of antiviral [16] and IL₁₀ [37] cytokines. So scenarios S0→S2 could correspond to a pig that is not able to inhibit the viral replication and that is infected by a highly virulent type 2 PRRSV field strain, inducing a strong antiviral response and a moderate IL₁₀ production.

Neutralising antibodies play a key role in the immunological control of a wide variety of viral infections [16, 33]. Consequently, a strong humoral response, should result in a short infection duration. PRRSV infections induce high levels of IL₁₀ compared to the other cytokines and the humoral response levels are similar to the levels encountered in other viral infection. However, the levels of neutralising antibodies remain low. The combination of high levels of IL₁₀ and a strong but inefficient humoral response is often proposed to explain the long infection duration [11]. Indeed, IL₁₀ is a major regulator of the immune response and its inhibitory effects on numerous immune functions could explain several immunological phenomena observed in PRRSV

infection [33, 34, 37]. However, the variability in host susceptibility and viral virulence challenges this hypothesis. PRRSV infections by virulent or attenuated strains showed no correlation between the IL_{10} levels and the infection duration [16]. In a variety of studies, PRRSV infection resolution was observed without the development of neutralising antibodies [16]. We found that a dominant humoral response and high percentages of IL_{10} can be associated with either long or short infection durations. Scenarios $SB \rightarrow SA$ are consistent with the usual assumption of the ineffective humoral response. However, scenarios $S1 \rightarrow S0$ associated short infection durations with a dominant humoral response. This result is due to the low excretion and macrophage infection rates, despite the low levels of innate and adaptive antiviral cytokines.

Concerning TGF_{β} and the regulatory response, few studies explored their influences on the immune dynamics and the subsequent infection resolution. The induction of regulatory T lymphocytes (T_{reg}) during the early stages of infection is considered as one of the mechanisms that establish chronic or persistent viral infections [16, 33]. According to this hypothesis, our results showed that a strong regulatory response was associated with very high levels of IL_{10} and that it resulted in a prolonged infection (scenarios $S0 \rightarrow SA$). Further experimentation considering the T_{reg} cells and TGF_{β} cytokines are needed to validate our model results.

II.4.4 Conclusion

We built an original and integrative model of the immune response in the lung to a pathogen targeting pulmonary macrophages, applied here to PRRSV. This model provides an interesting framework to explore the macrophage–pathogen interactions while representing the adaptive response. We used the model to explore the influence of macrophage permissiveness and cytokine synthesis capacities on the infection duration and immune dynamics. A recent review suggests that the concepts proposed to explain prolonged PRRSV infection have not been experimentally proved; in particular, the roles of the cytokines and the orientation of the adaptive response need to be more clearly elucidated [16]. Our integrative model allowed to simulate contrasted dynamics in terms of immune response and infection duration, suggesting hypotheses to explain the apparent contradictions between published results.

In addition, we extracted some synthetic and original elements from our work.

1. Among the immune variables that can be easily measured, some were found to characterise immune mechanisms : (a) the proportions of IL_{10} and IFN_{γ} were good indicators of the adaptive response orientation ; and (b) the level of IL_{10} was a good indicator of the level of infected macrophages.
2. Whatever the strain virulence and host susceptibility, the infection duration was linked to some immune variables : (a) the level of pro-inflammatory cytokines was a good indicator of the infection duration ; and (b) a dominant regulatory response was associated with a prolonged infection.

However, to identify and understand the immune mechanisms responsible for the infection duration, the entire immune response had to be considered. At least (i) the levels of innate antiviral cytokines, (ii) the level of IL_{10} , and (iii) the relative levels of IL_{10} and IFN_{γ} were needed.

We found that the macrophage permissiveness and the cytokine synthesis capacities both influence the infection duration through various immune mechanisms. Promoting antiviral cytokines or limiting the macrophage permissiveness and viral replication in order to reduce the infection duration has only been suggested [33, 34, 60]. Classically, two main approaches are

associated to limit the infection : (i) appropriate housing conditions to reduce the pig susceptibility and (ii) vaccination to improve the immune response efficiency. Moreover, it has been shown that pig genotypes can influence the alveolar macrophage ability to suppress viral replication [54]. Our results suggest that the viral replication rate is highly influential on the infection duration. So selecting resistant pigs should be efficient to prevent severe infections. Concerning the vaccination strategies, vaccines capable of promoting the synthesis of antiviral cytokines or minimising IL₁₀ production have been considered in the literature and numerous experimentation have been carried out, but the current results are not convincing (reviewed in [16, 37]). Obviously, vaccination strategies need more insight. Our integrative model provides a powerful framework to go beyond experimental constraints. In particular, such an approach could be used to help designing efficient vaccination strategies.

References

- [1] BRACIALE T.J., SUN J., KIM T.S., 2012. Regulating the adaptive immune response to respiratory virus infection. *Nat. Rev. Immunol.* **12**(4) :295–305. doi:10.1038/nri3166.
- [2] KOHLMEIER J.E., WOODLAND D.L., 2009. Immunity to respiratory viruses. *Annu. Rev. Immunol.* **27**(1) :61–82. doi:10.1146/annurev.immunol.021908.132625.
- [3] HEFFERNAN J.M., 2011. Mathematical immunology of infectious diseases. *Math. Popul. Stud.* **18**(2) :47–54. doi:10.1080/08898480.2011.564559.
- [4] ROUSE B.T., SEHRAWAT S., 2010. Immunity and immunopathology to viruses : what decides the outcome? *Nat. Rev. Immunol.* **10**(7) :514–526. doi:10.1038/nri2802.
- [5] BEAUCHEMIN C., HANDEL A., 2011. A review of mathematical models of influenza A infections within a host or cell culture : lessons learned and challenges ahead. *BMC Public Health* **11**. doi:10.1186/1471-2458-11-S1-S7.
- [6] SMITH A.M., PERELSON A.S., 2011. Influenza A virus infection kinetics : quantitative data and models. *Wiley Interdiscip. Rev. Syst. Biol. Med.* **3**(4) :429–445. doi:10.1002/wsbm.129.
- [7] DOBROVOLNY H.M., REDDY M.B., KAMAL M.A., RAYNER C.R., BEAUCHEMIN C.A.A., 2013. Assessing mathematical models of influenza infections using features of the immune response. *PLoS ONE* **8**(2) :e57088. doi:10.1371/journal.pone.0057088.
- [8] GAMMACK D., GANGULI S., MARINO S., SEGOVIA-JUAREZ J., KIRSCHNER D., 2005. Understanding the immune response in tuberculosis using different mathematical models and biological scales. *Multiscale Model. Sim.* **3**(2) :312–345. doi:10.1137/040603127.
- [9] MARINO S., LINDERMAN J.J., KIRSCHNER D.E., 2011. A multifaceted approach to modeling the immune response in tuberculosis. *Wiley Interdiscip. Rev. Syst. Biol. Med.* **3**(4) :479–489. doi:10.1002/wsbm.131.
- [10] DOESCHL-WILSON A.B., KYRIAZAKIS I., VINCENT A., ROTHSCHILD M.F., THACKER E., GALINA-PANTOJA L., 2009. Clinical and pathological responses of pigs from two genetically diverse commercial lines to porcine reproductive and respiratory syndrome virus infection. *J. Anim. Sci.* **87** :1638–1647. doi:10.2527/jas.2008-1447.
- [11] DARWICH L., DÍAZ I., MATEU E., 2010. Certainties, doubts and hypotheses in porcine reproductive and respiratory syndrome virus immunobiology. *Virus Res.* **154**(1-2) :123–132. doi:10.1016/j.virusres.2010.07.017.
- [12] ZIMMERMAN J., BENFIELD D.A., MURTAUGH M.P., OSORIO F., STEVENSON G.W., TORREMORELL M., 2006. Porcine reproductive and respiratory syndrome virus (porcine arterivirus). In *Diseases of swine*, edited by B.E. STRAW, J.J. ZIMMERMAN, S. D'ALLAIRE, D.L. TAYLOR, Blackwell (Oxford, UK), 9th edn., chap. 24, pp. 387–418.
- [13] GÓMEZ-LAGUNA J., SALGUERO F.J., PALLARÉS F.J., CARRASCO L., 2013. Immunopathogenesis of porcine reproductive and respiratory syndrome in the respiratory tract of pigs. *Vet. J.* **195**(2) :148–155. doi:10.1016/j.tvjl.2012.11.012.
- [14] MURTAUGH M.P., 2005. PRRSV/host interaction. In *PRRS fatti vs speculazioni*, Università degli Studi di Parma, Dipartimento di Salute Animale (Parma, Italy), pp. 73–80. http://medvet.unipr.it/cgi-bin/campusnet/documenti.pl/Show?_id=7d0d

- [15] MURTAUGH M.P., XIAO Z., ZUCKERMANN F., 2002. Immunological responses of swine to porcine reproductive and respiratory syndrome virus infection. *Viral Immunol.* **15**(4) :533–547. doi:10.1089/088282402320914485.
- [16] MURTAUGH M.P., GENZOW M., 2011. Immunological solutions for treatment and prevention of porcine reproductive and respiratory syndrome (PRRS). *Vaccine* **29**(46) :8192–8204. doi:10.1016/j.vaccine.2011.09.013.
- [17] VAN REETH K., VAN GUCHT S., PENSAERT M., 2002. In vivo studies on cytokine involvement during acute viral respiratory disease of swine : troublesome but rewarding. *Vet. Immunol. Immunop.* **87**(3-4) :161–168. doi:10.1016/S0165-2427(02)00047-8.
- [18] ROTH A.J., THACKER E.L., 2006. Immune system. In *Diseases of swine*, edited by B.E. STRAW, J.J. ZIMMERMAN, S. D'ALLAIRE, D.L. TAYLOR, Blackwell (Oxford, UK), 9th edn., chap. 2, pp. 15–36.
- [19] TOSI M.F., 2005. Innate immune responses to infection. *J. Allergy Clin. Immun.* **116**(2) :241–249. doi:10.1016/j.jaci.2005.05.036.
- [20] CHOI C., CHAE C., 2002. Expression of tumour necrosis factor alpha is associated with apoptosis in lungs of pigs experimentally infected with porcine reproductive and respiratory syndrome virus. *Res. Vet. Sci.* **72**(1) :45–49. doi:10.1053/rvsc.2001.0519.
- [21] MARINO S., MYERS A., FLYNN J.L., KIRSCHNER D.E., 2010. TNF and IL-10 are major factors in modulation of the phagocytic cell environment in lung and lymph node in tuberculosis : A next-generation two-compartmental model. *J. Theor. Biol.* **265**(4) :586–598. doi:10.1016/j.jtbi.2010.05.012.
- [22] WIGGINTON J.E., KIRSCHNER D., 2001. A model to predict cell-mediated immune regulatory mechanisms during human infection with Mycobacterium tuberculosis. *J. Immunol.* **166** :1951–1967.
- [23] DEFRANCO A.L., LOCKSLEY R.M., ROBERTSON M., CUNIN R., 2009. *Immunité : la réponse immunitaire dans les maladies infectieuses et inflammatoires*. DeBoeck (Bruxelles, Belgium). 2nd edn.
- [24] VIDAL S.M., KHAKOO S.I., BIRON C.A., 2011. Natural killer cell responses during viral infections : flexibility and conditioning of innate immunity by experience. *Curr. Opin. Virol.* **1**(6) :497–512. doi:10.1016/j.coviro.2011.10.017.
- [25] BOSCH A.A.T.M., BIESBROEK G., TRZCINSKI K., SANDERS E.A.M., BOGAERT D., 2013. Viral and bacterial interactions in the upper respiratory tract. *PLoS Pathog.* **9**(1) :e1003057. doi:10.1371/journal.ppat.1003057.
- [26] BORGHETTI P., 2005. Cell-mediated immunity and viral infection in pig. In *PRRS fatti vs speculazioni*, Università degli Studi di Parma, Dipartimento di Salute Animale (Parma, Italy), pp. 27–46. http://medvet.unipr.it/cgi-bin/campusnet/documenti.pl/Show?_id=7d0d
- [27] COQUERELLE C., MOSER M., 2010. DC subsets in positive and negative regulation of immunity. *Immunol. Rev.* **234**(1) :317–334. doi:10.1111/j.0105-2896.2009.00887.x.
- [28] KIDD P., 2003. Th1/Th2 balance : the hypothesis, its limitations, and implications for health and disease. *Altern. Med. Rev.* **8**(3) :223–246.

- [29] LEROITH T., AHMED S.A., 2012. Regulatory T cells and viral disease. In *Inflammation, Chronic Diseases and Cancer : Cell and Molecular Biology, Immunology and Clinical Bases*, edited by M. KHATAMI, InTech (Rijeka, Croatia), chap. 6, pp. 121–144. doi:10.5772/28502.
- [30] KNOSP C.A., JOHNSTON J.A., 2012. Regulation of CD4+ T-cell polarization by suppressor of cytokine signalling proteins. *Immunology* **135**(2) :101–111. doi:10.1111/j.1365-2567.2011.03520.x.
- [31] YATES A., BERGMANN C., VAN HEMMEN J.L., STARK J., CALLARD R., 2000. Cytokine-modulated regulation of helper T cell populations. *J. Theor. Biol.* **206**(4) :539–560. doi:10.1006/jtbi.2000.2147.
- [32] DARWICH L., GIMENO M., SIBILA M., DÍAZ I., DE LA TORRE E., DOTTI S., KUZEMTSEVA L., MARTIN M., PUJOLS J., MATEU E., 2011. Genetic and immunobiological diversities of porcine reproductive and respiratory syndrome genotype I strains. *Vet. Microbiol.* **150**(1–2) :49–62. doi:10.1016/j.vetmic.2011.01.008.
- [33] KIMMAN T.G., CORNELISSEN L.A., MOORMANN R.J., REBEL J.M.J., STOCKHOFE-ZURWIEDEN N., 2009. Challenges for porcine reproductive and respiratory syndrome virus (PRRSV) vaccinology. *Vaccine* **27**(28) :3704–3718. doi:10.1016/j.vaccine.2009.04.022.
- [34] LUNNEY J.K., CHEN H., 2010. Genetic control of host resistance to porcine reproductive and respiratory syndrome virus (PRRSV) infection. *Virus Res.* **154**(1–2) :161–169. doi:10.1016/j.virusres.2010.08.004.
- [35] MATEU E., DÍAZ I., 2008. The challenge of PRRS immunology. *Vet. J.* **177** :345–351. doi:10.1016/j.tvjl.2007.05.022.
- [36] NAUWYNCK H.J., VAN GORP H., VANHEE M., KARNIYCHUK U., GELDHOF M., CAO A., VERBEECK M., VAN BREEDAM W., 2012. Micro-dissecting the pathogenesis and immune response of PRRSV infection paves the way for more efficient PRRSV vaccines. *Transbound. Emerg. Dis.* **59** :50–54. doi:10.1111/j.1865-1682.2011.01292.x.
- [37] THANAWONGNUWECH R., SURADHAT S., 2010. Taming PRRSV : Revisiting the control strategies and vaccine design. *Virus Res.* **154**(1-2) :133–140. doi:10.1016/j.virusres.2010.09.003.
- [38] LABARQUE G.G., NAUWYNCK H.J., VAN REETH K., PENZAERT M.B., 2000. Effect of cellular changes and onset of humoral immunity on the replication of porcine reproductive and respiratory syndrome virus in the lungs of pigs. *J. Gen. Virol.* **81**(5) :1327–1334.
- [39] GAMMACK D., DOERING C.R., KIRSCHNER D.E., 2004. Macrophage response to Mycobacterium tuberculosis infection. *J. Math. Biol.* **48** :218–242. doi:10.1007/s00285-003-0232-8.
- [40] MARINO S., KIRSCHNER D.E., 2004. The human immune response to Mycobacterium tuberculosis in lung and lymph node. *J. Theor. Biol.* **227** :463–486. doi:10.1016/j.jtbi.2003.11.023.
- [41] JOHNSON W., ROOF M., VAUGHN E., CHRISTOPHER-HENNINGS J., JOHNSON C.R., MURTAUGH M.P., 2004. Pathogenic and humoral immune responses to porcine reproductive and respiratory syndrome virus (PRRSV) are related to viral load in acute infection. *Vet. Immunol. Immunop.* **102**(3) :233–247. doi:10.1016/j.vetimm.2004.09.01.

- [42] LABARQUE G., VAN GUCHT S., NAUWYNCK H., VAN REETH K., PENSAERT M., 2003. Apoptosis in the lungs of pigs infected with porcine reproductive and respiratory syndrome virus and associations with the production of apoptogenic cytokines. *Vet. Res.* **34** :249–260. doi:10.1051/vetres:2003001.
- [43] DUAN X., NAUWYNCK H.J., PENSAERT M.B., 1997. Virus quantification and identification of cellular targets in the lungs and lymphoid tissues of pigs at different time intervals after inoculation with porcine reproductive and respiratory syndrome virus (PRRSV). *Vet. Microbiol.* **56**(1–2) :9–19. doi:10.1016/S0378-1135(96)01347-8.
- [44] ALBINA E., PIROU L., HUTET E., CARIOLET R., L'HOSPITALIER R., 1998. Immune response in pigs infected with porcine reproductive and respiratory syndrome virus (PRRSV). *Vet. Immunol. Immunop.* **61** :49–66. doi:10.1016/S0165-2427(97)00134-7.
- [45] COSTERS S., DELPUTTE P.L., NAUWYNCK H.J., 2006. Porcine reproductive and respiratory syndrome virus-infected alveolar macrophages contain no detectable levels of viral proteins in their plasma membrane and are protected against antibody-dependent, complement-mediated cell lysis. *J. Gen. Virol.* **87** :2341–2351. doi:10.1099/vir.0.81808-0.
- [46] GAUDREAU N., ROWLAND R., WYATT C., 2009. Factors affecting the permissiveness of porcine alveolar macrophages for porcine reproductive and respiratory syndrome virus. *Arch. Virol.* **154** :133–136. doi:10.1007/s00705-008-0271-y.
- [47] GÓMEZ-LAGUNA J., RODRÍGUEZ-GÓMEZ I.M., BARRANCO I., PALLARÉS F.J., SALGUERO F.J., CARRASCO L., 2012. Enhanced expression of TGF β protein in lymphoid organs and lung, but not in serum, of pigs infected with a European field isolate of porcine reproductive and respiratory syndrome virus. *Vet. Microbiol.* **158**(1) :187–193. doi:10.1016/j.vetmic.2012.02.003.
- [48] SILVA-CAMPA E., FLORES-MENDOZA L., RESÉNDIZ M., PINELLI-SAAVEDRA A., MATA-HARO V., MWANGI W., HERNÁNDEZ J., 2009. Induction of T helper 3 regulatory cells by dendritic cells infected with porcine reproductive and respiratory syndrome virus. *Virology* **387**(2) :373–379. doi:10.1016/j.virol.2009.02.033.
- [49] WONGYANIN P., BURANAPRADITKUN S., CHOKESHAI-USAHA K., THANAWONGUWECH R., SURADHAT S., 2010. Induction of inducible CD4+CD25+Foxp3+ regulatory T lymphocytes by porcine reproductive and respiratory syndrome virus (PRRSV). *Vet. Immunol. Immunop.* **133**(2-4) :170–182. doi:10.1016/j.vetimm.2009.07.012.
- [50] SALTELLI A., CHAN K., SCOTT E.M. (eds.) 2000. *Sensitivity analysis*. Wiley Series in Probability and Statistics. Wiley (Chichester, UK).
- [51] LAMBONI M., MONOD H., MAKOWSKI D., 2011. Multivariate sensitivity analysis to measure global contribution of input factors in dynamic models. *Reliab. Eng. Syst. Safe.* **96**(4) :450–459. doi:10.1016/j.ress.2010.12.002.
- [52] GIMENO M., DARWICH L., DÍAZ I., DE LA TORRE E., PUJOLS J., MARTIN M., INUMARU S., CANO E., DOMÍNGO M., MONTOYA M., MATEU E., 2011. Cytokine profiles and phenotype regulation of antigen presenting cells by genotype-I porcine reproductive and respiratory syndrome virus isolates. *Vet. Res.* **42**(9). doi:10.1186/1297-9716-42-9.
- [53] DÍAZ I., GIMENO M., DARWICH L., NAVARRO N., KUZEMTSEVA L., LÓPEZ S., GALINDO I., SEGALÉS J., MARTÍN M., PUJOLS J., MATEU E., 2012. Characterization of homologous and heterologous adaptive immune responses in porcine reproductive and respiratory syndrome virus infection. *Vet. Res.* **43**(1) :30. doi:10.1186/1297-9716-43-30.

- [54] AIT-ALI T., WILSON A.D., CARRÉ W., WESTCOTT D.G., FROSSARD J.P., MELLENCAMP M.A., MOUZAKI D., MATIKA O., WADDINGTON D., DREW T.W., BISHOP S.C., ARCHIBALD A.L., 2011. Host inhibits replication of European porcine reproductive and respiratory syndrome virus in macrophages by altering differential regulation of type-I interferon transcriptional responses. *Immunogenetics* **63**(7) :437–448. doi:10.1007/s00251-011-0518-8.
- [55] REINER G., WILLEMS H., PESCH S., OHLINGER V.F., 2010. Variation in resistance to the porcine reproductive and respiratory syndrome virus (PRRSV) in Pietrain and Miniature pigs. *J. Anim. Breed. Genet.* **127** :100–106. doi:10.1111/j.1439-0388.2009.00818.x.
- [56] DUAN F., SIMEONE S., WU R., GRADY J., MANDOIU I., SRIVASTAVA P.K., 2012. Area under the curve as a tool to measure kinetics of tumor growth in experimental animals. *J. Immunol. Methods* **382**(1) :224–228. doi:10.1016/j.jim.2012.06.005.
- [57] FLORES-MENDOZA L., SILVA-CAMPA E., RESÉNDIZ M., OSORIO F.A., HERNÁNDEZ J., 2008. Porcine reproductive and respiratory syndrome virus infects mature porcine dendritic cells and up-regulates interleukin-10 production. *Clin. Vaccine Immunol.* **15** :720–725. doi:10.1128/CVI.00224-07.
- [58] PARK J.Y., KIM H.S., SEO S.H., 2008. Characterization of interaction between porcine reproductive and respiratory syndrome virus and porcine dendritic cells. *J. Microbiol. Biotechn* **18**(10) :1709–1716.
- [59] MOLINA R.M., CHA S.H., CHITTICK W., LAWSON S., MURTAUGH M.P., NELSON E.A., CHRISTOPHER-HENNINGS J., YOON K.J., EVANS R., ROWLAND R.R.R., ZIMMERMAN J.J., 2008. Immune response against porcine reproductive and respiratory syndrome virus during acute and chronic infection. *Vet. Immunol. Immunop.* **126** :283–292. doi:10.1016/j.vetimm.2008.08.002.
- [60] MURTAUGH M.P., 2004. PRRS immunology : what are we missing? In *35th Annual Meeting of the American Association of Swine Veterinarians*, Des Moines, Iowa, USA, pp. 359–367.
- [61] PETRY D.B., HOLL J.W., WEBER J.S., DOSTER A.R., OSORIO F.A., JOHNSON R.K., 2005. Biological responses to porcine respiratory and reproductive syndrome virus in pigs of two genetic populations. *J. Anim. Sci.* **83** :1494–1502.
- [62] WESLEY D.R., LAGER K.M., KEHRLI M.E., 2006. Infection with porcine reproductive and respiratory syndrome virus stimulates an early gamma interferon response in the serum of pig. *Can. J. Vet. Res.* **70**(3) :176–182.
- [63] BEYER J., FICHTNER D., SCHIRRMER H., POLSTER U., WEILAND E., WEGE H., 2000. Porcine reproductive and respiratory syndrome virus (PRRSV) : kinetics of infection in lymphatic organs and lung. *J. Vet. Med. B Infect. Dis. Vet. Public Health* **47**(1) :9–25. doi:10.1046/j.1439-0450.2000.00305.x.
- [64] KARNIYCHUK U., GELDHOF M., VANHEE M., VAN DOORSSELAERE J., SAVELEVA T., NAUWYNCK H., 2010. Pathogenesis and antigenic characterization of a new East European subtype 3 porcine reproductive and respiratory syndrome virus isolate. *Vet. Res.* **6**(1) :30. doi:10.1186/1746-6148-6-30.
- [65] XIAO Z., BATISTA L., DEE S., HALBUR P., MURTAUGH M.P., 2004. The level of virus-specific T-cell and macrophage recruitment in porcine reproductive and respiratory syndrome virus infection in pigs is independent of virus load. *J. Virol.* **78** :5923–5933. doi:10.1128/JVI.78.11.5923-5933.2004.

- [66] PETRY D.B., LUNNEY J., BOYD P., KUCHAR D., BLANKENSHI E., JOHNSON R.K., 2007. Differential immunity in pigs with high and low responses to porcine reproductive and respiratory syndrome virus infection. *J. Anim. Sci.* **85** :2075–2092. doi:10.2527/jas.2006-721.
- [67] WEESENDORP E., MORGAN S., STOCKHOFE-ZURWIEDEN N., GRAAF D.J., GRAHAM S.P., REBEL J.M.J., 2013. Comparative analysis of immune responses following experimental infection of pigs with european porcine reproductive and respiratory syndrome virus strains of differing virulence. *Vet. Microbiol.* **163** :1–12. doi:10.1016/j.vetmic.2012.09.013.
- [68] MOGLER M., 2012. *Evaluation of replicon particle vaccines for porcine reproductive and respiratory syndrome virus*. PhD thesis, Iowa State University. <http://lib.dr.iastate.edu/etd/12841>
- [69] AIT-ALI T., WILSON A.D., WESTCOTT D.G., CLAPPERTON M., WATERFALL M., MELLENCAMP M.A., DREW T.W., BISHOP S.C., ARCHIBALD A.L., 2007. Innate immune responses to replication of porcine reproductive and respiratory syndrome virus in isolated swine alveolar macrophages. *Viral Immunol.* **20**(1) :105–118. doi:10.1089/vim.2006.0078.

Chapitre III

Why, when and how should exposure be considered at the within-host scale? A modelling contribution to PRRSv infection

Contents

III.1 Introduction	97
III.2 Materials and methods	98
III.2.1 Model overview	98
III.2.2 Exposure functions	102
III.2.3 Designs of numerical experiments	103
III.2.4 Characteristics of the viral and immune dynamics	106
III.2.5 Analyses	107
III.3 Results	108
III.3.1 Exploring the influence of simple exposures	112
III.3.2 Looking at the impact of exposure simplifications	117
III.4 Discussion	120
III.4.1 Scope and limits of our approach	120
III.4.2 Exposure has an impact on PRRSv spread	121
III.4.3 When and how to take PRRSv exposure into account?	121
References	123

Why, when and how should exposure be considered at the within-host scale ? A modelling contribution to PRRSv infection

Natacha Go^{*,†}, Catherine Belloc[†], Caroline Bidot^{*} and Suzanne Touzeau^{‡,§}

* INRA, UR341 MIA, F-78352 Jouy-en-Josas, France

† LUNAM Université, Oniris, INRA, UMR1300 BioEpAR, F-44307 Nantes, France

‡ INRA, Université Nice Sophia Antipolis, UMR1355 ISA ; CNRS, UMR 7254 ; F-06903 Sophia Antipolis, France

§ Inria, BIOCORE, F-06902 Sophia Antipolis, France

Submitted to *Veterinary Research*
September 2014

Abstract

Understanding the impact of exposure on the within-host dynamics and its outcome in terms of infectiousness is a key issue to better understand and control the infection spread. It has not been fully explored yet, neither in experimental infections, nor in modelling studies, which mostly represent exposure by a punctual dose. We tackled this issue by a modelling approach focused on the Porcine Reproductive and Respiratory Syndrome virus (PRRSv), a major concern for the swine industry. PRRSv immune response is partially understood and highly variable depending on viral strains and host susceptibilities.

We used a mathematical model representing PRRSv immune and infection dynamics in the lung ; we built designs of numerical experiments to explore the impact of exposure intensity, duration and peak, as well as strain virulence, on characteristics of the viral and immune dynamics ; we then quantified their impact by sensitivity analyses and descriptive statistics.

We found that the infection severity was fully determined by the exposure intensity. The infection duration increased with the strain virulence and, for a given strain, exhibited a positive linear correlation with the exposure intensity logarithm and the exposure duration.

Exposure simplifications should hence at least preserve the exposure intensity. Besides, representing the exposure due to contacts by short or even punctual exposures would tend to underestimate the infection duration. As the infection severity and duration both contribute to the pig infectiousness, a prolonged exposure of the adequate intensity would be recommended in an immuno-epidemiological context.

III.1 Introduction

Understanding the pathogen spread in a population is essential to develop effective prevention and control strategies. In this context, modelling approaches coupling between and within-host dynamics offer new perspectives [1, 2]. At the between-host scale, the infection spread, the infectiousness of infected individuals and the host contact structure determine the exposure of susceptible individuals, which can trigger new infections. At the within-host scale, the exposure, the individual susceptibility and the pathogen virulence drive the immune dynamics, which dictates the infection duration and severity, as well as the infectiousness of infected individuals. Exposure hence links the between-host to the within-host dynamics, whereas infectiousness links the within-host to the between-host dynamics. In this paper, we focused on the impact of exposure on the within-host dynamics, which is regarded as a key issue [1, 3, 4].

We based our study on the Porcine Respiratory and Reproductive Syndrome virus (PRRSv), a major concern for the swine industry, responsible for significant economic losses worldwide [5, 6]. There is no specific treatment and the vaccines are not efficient enough to eradicate the infection [7, 8]. PRRSv is mainly transmitted by close contact with an infected pig [6]. Some epidemiological studies pointed out that the spread of PRRSv depends on the pig contact network, the pig infectiousness and the pig susceptibility [9, 10]. The infectiousness and susceptibility are influenced by several factors, which probably interact in a complex way [11] : the PRRSv strain virulence [7, 8, 12, 13], the pig genetic resistance to PRRSv infection [8, 14, 15], as well as the exposure intensities and inoculation routes [16–18]. Experimental studies found that (i) the infectiousness is a log-normal-like function of the time post-infection [16] and that (ii) PRRSv infection probability is a logistic function of the initial inoculum dose [17]. Studies on other viruses showed that the initial inoculum dose determines the within-host immune dynamics and course of infection [3, 4]. However, no such studies were conducted for PRRSv.

A modelling approach is a relevant tool to study the exposure impact on the within-host dynamics for two main reasons. Firstly, experimental infections by inoculation, considered as proxies for natural infections, usually allow to explore the influence of a single and short exposure. Varying the exposure duration and intensity, as well as the strain virulence, would be difficult and costly by experimental infection. Secondly, PRRSv mainly targets pulmonary macrophages, a key component of the innate immune response, and hence alters the innate and the subsequent adaptive immune responses in complex ways. Moreover, immune mechanisms responsible for the infection resolution and host protection are strongly variable between hosts and PRRSv strains [7, 8, 12, 14]. So we used a model which details the interactions between the virus and the immune mechanisms, based on a previous study [19]. Compared to immunological models developed for PRRSv [20] or similar pathogens targeting pulmonary macrophages, such as influenza viruses [21–23], or tuberculosis [24, 25], the strengths of this model are : (i) the explicit and detailed representation of the innate immune mechanisms (in particular, the interactions between the virus and its target cells); (ii) the orientation of the adaptive response towards the cellular, humoral and regulatory responses, whereas no published immunological models represent the regulatory response and only few represent both the cellular and the humoral responses; (iii) the explicit representation of the main innate and adaptive cytokine syntheses and their complex regulations of the immune mechanisms.

Using such a modelling approach to explore PRRSv exposure influence on the within-host infection and immune dynamics for various strain virulence levels should fill in some gaps in current knowledge. Moreover, it should help us apprehend the pig response to a given exposure and its subsequent infectiousness, which are needed to better understand, predict and control PRRSv spread at the between-host scale.

In this paper, we first gave an overview of the immunological model used and defined the designs of numerical experiments built to explore the impact of virulence level, exposure intensity and duration on characteristics of the viral and immune dynamics. We then quantified their impact by sensitivity analyses and descriptive statistics. We compared our results with the literature and assessed the errors made on the various characteristics when approximating exposure by simplified functions. Finally, we discussed our results, highlighting the impact of exposure on the between-host dynamics and suggesting when and how to take exposure into account.

III.2 Materials and methods

III.2.1 Model overview

We used a deterministic dynamic model of ordinary differential equations to simulate the infection and immune dynamics induced by PRRSv in the lung. It is a simplified version of a recently developed model [19], in which we grouped some state variables and simplified the cytokine regulation functions. The functional diagram of the model appears in FIGURE III.1. The model describes the evolution over time of 14 state variable concentrations : the free viral particles (V) ; four effectors of the innate response : three macrophage states and the natural killers (NK) ; three effectors of the adaptive response and six cytokines. A macrophage can either be susceptible (M_s), phagocytosing (M_p), or infected (M_i). For the adaptive response, the effectors represent the regulatory (R_r), humoral (R_h) and cellular (R_c) responses. The six cytokines included are the pro-inflammatory (P_i , grouping $IL_{1\beta}$, IL_6 and IL_8), the innate antiviral (A_i , grouping IFN_α and TNF_α) and the immuno-regulatory (IL_{12} , antiviral IFN_γ , immuno-modulatory IL_{10} and TGF_β) cytokines. Our modelling assumptions are detailed and justified in Appendix B, which gives a complete description of the model and the corresponding equations. Here we describe the main components of the model, illustrated by a few representative equations.

Exposure to PRRSv results in free viral particles entering the lung (function $E(t)$). When a free viral particle encounters a susceptible macrophage, it can either be phagocytosed (rate η), resulting in viral destruction, or it can infect the cell (rate β), resulting in viral replication (rate e). The phagocytosis is amplified by antiviral cytokines (A_i and IFN_γ) and inhibited by immuno-modulatory cytokines. The infection is amplified by IL_{10} and inhibited by A_i and TGF_β . Phagocytosing macrophages revert to a susceptible status after viral destruction (rate γ); it is amplified by the antiviral cytokines and inhibited by IL_{10} . The excretion (rate e) is inhibited by antiviral cytokines. Pro-inflammatory cytokines amplify the recruitment of susceptible macrophages (inflow A_m) and natural killers. Macrophages undergo natural decay (rate μ_M^{nat}) and TNF_α -induced apoptosis (rate μ_M^{inf}). Infected macrophages are cytolysed by natural killers (rate μ_M^{inn}) and cellular effectors (rate μ_M^{ad}). The viral particles undergo natural decay (rate μ_V^{nat}) and are neutralised by the humoral response (rate μ_V^{ad}). Corresponding equations are (III.1) & (III.2).

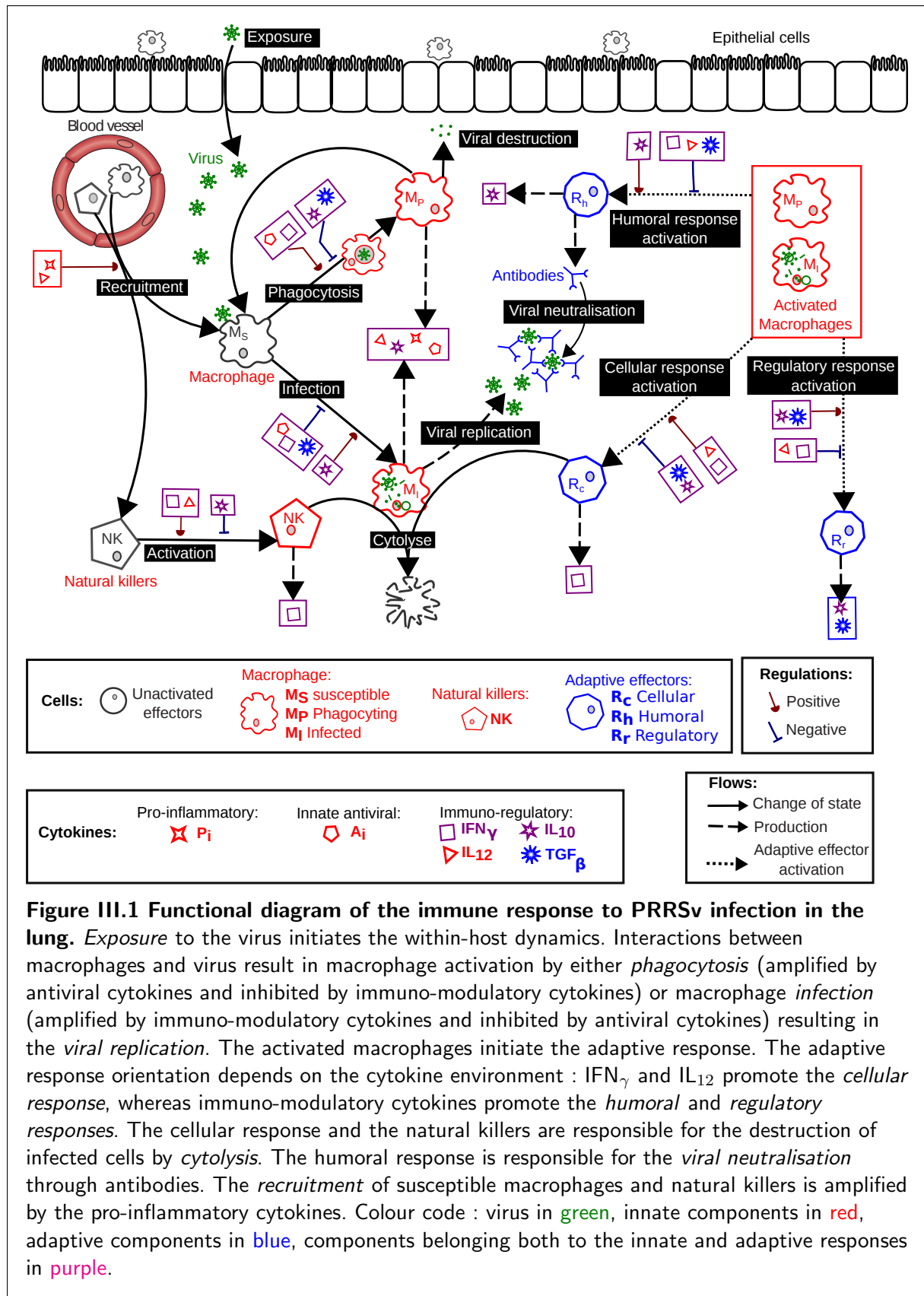

$$\begin{aligned}
\dot{M}_s &= A_m [1 + \kappa^+(P_i \text{IL}_{12})] && \leftarrow \text{recruitment} && \text{(III.1)} \\
&\quad - \eta M_s V \kappa^-(\text{IL}_{10} + \text{TGF}_\beta) [1 + \kappa^+(A_i + \text{IFN}_\gamma)] && \leftarrow \text{phagocytosis} \\
&\quad + \gamma M_p \kappa^-(\text{IL}_{10}) [1 + \kappa^+(A_i + \text{IFN}_\gamma)] && \leftarrow \text{end of phag.} \\
&\quad - \beta M_s V \kappa^-(A_i + \text{TGF}_\beta) [1 + \kappa^+(\text{IL}_{10})] && \leftarrow \text{infection} \\
&\quad - M_s [\mu_M^{\text{nat}} + \mu_M^{\text{inf}} \kappa^+(A_i)] && \leftarrow \text{decay}
\end{aligned}$$

$$\begin{aligned}
\dot{V} &= E(t) && \leftarrow \text{exposure} && \text{(III.2)} \\
&\quad - \eta M_s V \kappa^-(\text{IL}_{10} + \text{TGF}_\beta) [1 + \kappa^+(A_i + \text{IFN}_\gamma)] && \leftarrow \text{phagocytosis} \\
&\quad - u \beta M_s V \kappa^-(A_i + \text{TGF}_\beta) [1 + \kappa^+(\text{IL}_{10})] && \leftarrow \text{infection} \\
&\quad + e M_i \kappa^-(A_i + \text{IFN}_\gamma) && \leftarrow \text{excretion} \\
&\quad - V [\mu_V^{\text{nat}} + \mu_V^{\text{adap}} R_h] && \leftarrow \text{decay/migration}
\end{aligned}$$

Cytokines drive the model dynamics by a complex feedback system, as illustrated in FIGURE III.1. We selected the cytokines that better represent the pro-inflammatory, antiviral and immuno-regulatory functions. The cytokine dynamics consist of two steps : synthesis by activated innate and adaptive cells and decay. The synthesis can be regulated by cytokines. Cytokine regulations (up κ^+ and down κ^-) are based on the Michaelis–Menten function [24, 26, 27]. The higher the cytokine concentration (C_i), the stronger the effect, which saturates above a threshold concentration :

$$\kappa^+(C_i) = \frac{v_m C_i}{k_m + C_i}; \quad \kappa^-(C_i) = \frac{k_m}{k_m + C_i}.$$

A given rate (r) can either be activated ($r \kappa^+(C_i)$), amplified ($r [1 + \kappa^+(C_i)]$) or inhibited ($r \kappa^-(C_i)$) by a cytokine. Regulations often involve several cytokines (C_i and C_j), which can act independently ($\kappa(C_i + C_j)$) or in synergy ($\kappa(C_i C_j)$).

We represented the adaptive response by three effectors corresponding to the cellular R_c , humoral R_h and regulatory R_r responses (FIGURE III.1). The adaptive response orientation depends on the immuno-regulatory cytokines. The dynamics of each effector consists of three steps : activation by activated macrophages (phagocytosing or infected), proliferation and decay. R_c synthesises IFN_γ and destroys infected macrophages. R_h synthesises IL_{10} and neutralises free viral particles through antibodies. R_r synthesises IL_{10} and TGF_β .

We previously calibrated the model to simulate an average response of an experimentally infected and isolated pig to a moderately virulent PRRSv strain [19]. In published PRRSv studies, experimental conditions are highly heterogeneous. Moreover, among the variables included in our model, few were monitored in each study and there were few measures over time. Consequently, based on these data, we had to design an *ad hoc* procedure to estimate the model parameters : (i) definition of parameter ranges from experimental and modelling studies on pathogens targeting pulmonary macrophages ; (ii) exploration of the hence defined parameter space based on sensitivity analysis methods ; (iii) definition and selection of a relevant parameter set. The model parameters are summarised in TABLE III.1.

We simulated the infection of a PRRSv-naive pig at the post-weaning stage, *i.e.* with no maternal antibodies, during 300 days. The initial conditions were set as follows : $M_s(0) = 5 \cdot 10^5$ cells/ml for the susceptible macrophages and all remaining variables were set to zero. The model was implemented in Scilab 5.3.3 [28].

Table III.1 Model parameters.

Parameter	Description	Value	Unit*
Macrophages : susceptible (M_s), infected (M_i), phagocytosing (M_p)			
A_m	recruitment rate of M_s	$5 \cdot 10^4$	$[\text{Ce}]\text{day}^{-1}$
η	phagocytosis rate	$5 \cdot 10^{-7}$	$[\text{V}]^{-1}\text{day}^{-1}$
β	infection rate	10^{-6}	$[\text{V}]^{-1}\text{day}^{-1}$
γ	1/phagocytosis duration	96	day^{-1}
μ_M^{nat}	natural decay rate	0.2	day^{-1}
δ_μ	over-mortality rate of M_i	1.1	no unit
μ_M^{ap}	apoptosis rate by TNF_α	0.8	day^{-1}
μ_M^{inn}	cytolysis rate of M_i by NK	10^{-3}	$[\text{Ce}]^{-1}\text{day}^{-1}$
μ_M^{ad}	cytolysis rate of M_i by R_c	10^{-3}	$[\text{Ce}]^{-1}\text{day}^{-1}$
Free viral particles (V)			
u	macrophage-virus interaction rate	1	$[\text{V}][\text{Ce}]^{-1}$
e	excretion rate	0.2	$[\text{V}][\text{Ce}]^{-1}\text{day}^{-1}$
μ_V^{nat}	natural decay rate	0.2	day^{-1}
μ_V^{ad}	neutralisation rate by R_h	10^{-4}	$[\text{Ce}]^{-1}\text{day}^{-1}$
Adaptive effectors : cellular (R_c), humoral (R_h), regulatory (R_r) & natural killers (NK)			
α_R	activation rate of R_c , R_h and R_r by M_p and M_i	10^{-5}	day^{-1}
α_N	activation rate of NK	10	$[\text{Ce}]\text{day}^{-1}$
p_R	proliferation rate of R_c , R_h and R_r	0.05	day^{-1}
δ_{R_c}	decay rate of R_c , R_h and R_r by AICD	10^{-1}	$[\text{Ce}]^{-1}\text{day}^{-1}$
μ_R	natural decay rate	0.05	day^{-1}
Cytokines : pro-inflammatory ($P_i = \text{IL}_{1\beta} + \text{IL}_6 + \text{IL}_8$), innate antiviral ($A_i = \text{TNF}_\alpha + \text{IFN}_\alpha$), immuno-regulatory (IL_{12} , IFN_γ , IL_{10} , TGF_β)			
ρ_{P_i}	synthesis rate of P_i by M_p and M_i	10^{-2}	$[\text{Cy}][\text{Ce}]^{-1}\text{day}^{-1}$
$\rho_{\text{IL}_{12}}$	synthesis rate of IL_{12} by M_p and M_i	0.02	$[\text{Cy}][\text{Ce}]^{-1}\text{day}^{-1}$
ρ_{A_i}	synthesis rate of A_i by M_p and M_i	0.05	$[\text{Cy}][\text{Ce}]^{-1}\text{day}^{-1}$
$\rho_{\text{IL}_{10}}^{\text{inn}}$	synthesis rate of IL_{10} by M_p and M_i	0.02	$[\text{Cy}][\text{Ce}]^{-1}\text{day}^{-1}$
$\rho_{\text{IL}_{10}}^{\text{ad}}$	synthesis rate of IL_{10} by R_h and R_r	2	$[\text{Cy}][\text{Ce}]^{-1}\text{day}^{-1}$
$\rho_{\text{IFN}_\gamma}^{\text{inn}}$	synthesis rate of IFN_γ by NK	10	$[\text{Cy}][\text{Ce}]^{-1}\text{day}^{-1}$
$\rho_{\text{IFN}_\gamma}^{\text{ad}}$	synthesis rate of IFN_γ by R_c	10	$[\text{Cy}][\text{Ce}]^{-1}\text{day}^{-1}$
ρ_{TGF_β}	synthesis rate of TGF_β by R_r	10	$[\text{Cy}][\text{Ce}]^{-1}\text{day}^{-1}$
μ_C	natural decay rate among the 54 scenarios	20	day^{-1}
k_m	half-saturation concentration	30	$[\text{Cy}]$
v_m	saturation factor	1.5	no unit
*cell unit $[\text{Ce}] = \text{cells/ml}$, virus unit $[\text{V}] = \text{TCID}_{50}/\text{ml}$, cytokine unit $[\text{Cy}] = \text{pg/ml}$			

III.2.2 Exposure functions

To represent natural and experimental infections of a naive weaner without passive immunity, we identified three kinds of exposure : a short (E_s), a prolonged (E_p) and a combination of the two exposures (E_{s+p}). E_s represents an experimental infection by a single inoculation of an isolated pig and could also correspond to a single contact with an infected pig under natural conditions. E_p represents repeated contacts with infected pigs and corresponds to natural infection of a susceptible pig in an infected herd or in an experimental batch. E_{s+p} represents an experimental infection of non-isolated pigs.

It has been shown that lymphoid tissues and lungs became infected 12 to 24 hours post experimental inoculation by both intranasal and intramuscular routes [6, 29]. Natural infections occur mainly through the nasal and oral routes. Viral particles then have to migrate to the lungs and are exposed to the first line of defence of the organism (physical barriers and epithelial cells), which slow down the progression. So we supposed that E_s corresponds to a narrow bell-shaped input of viral particles in the lung that lasts one day.

The first case of prolonged exposure E_p corresponds to contacts in a herd. When PRRSv is introduced in a batch of susceptible post-weaner pigs, it spreads rapidly. The resulting outbreak is often associated with a bell-shaped prevalence curve in the batch [6]. Furthermore, pigs have frequent contacts with other animals in their batch, so their exposure can be approximated by a bell-shaped curve. Depending on the pig susceptibility, strain virulence and management conditions, the infection can have variable lengths [10]. The post-weaning stage usually lasts 40 to 50 days, so the exposure duration should not exceed 50 days. The second case of prolonged exposure corresponds to an experimental batch, in which a susceptible pig usually has close contacts with a single inoculated pig. The infectiousness curve of a PRRSv-infected pig is very close to the viral titer from nasal swabs and is strongly correlated with the viremia, which follows bell-shaped curves throughout the infection duration [16]. The infectiousness is shorter than the infection duration. For instance, infection durations around 77 days and infectiousness duration around 56 days were reported [16]. PRRSv mean infection duration in the lung is 56 days [6]. So in both cases, we approximated the exposure E_p by a bell-shaped curve, which we assumed to last between 10 and 50 days.

Experimental data showed that the viral peak occurs between 7 and 14 days post-inoculation [6]. Infection dates are difficult to monitor in natural conditions. To our knowledge, there are no data on viral peak for natural infections. We assumed that the viral peak dates from natural and experimental infections were fairly similar. The exposure peak should not occur after the viral peak, so we set the former at 7 days. It is consistent with the infectiousness peak and the peak of viral particles from nasal swabs reported in the literature for inoculated pigs as well as pigs infected by contacts [16].

To represent the simple exposures (short and prolonged), we chose a function of time $E(t)$ based on the Beta distribution (FIGURE III.2) :

$$E(t) = \begin{cases} \mathcal{N}_E \frac{t^{a-1} (D_E - t)^{b-1}}{\int_0^{D_E} t^{a-1} (D_E - t)^{b-1} dt} & \text{if } 0 < t < D_E \\ 0 & \text{else} \end{cases} \quad (\text{III.3})$$

with $\left| \begin{array}{ll} 1 < a < b & \text{shape parameters (no unit) for a left-shifted bell-shaped curve,} \\ \mathcal{N}_E & \text{exposure intensity (in TCID}_{50}/\text{ml),} \\ D_E & \text{exposure duration (in days).} \end{array} \right.$

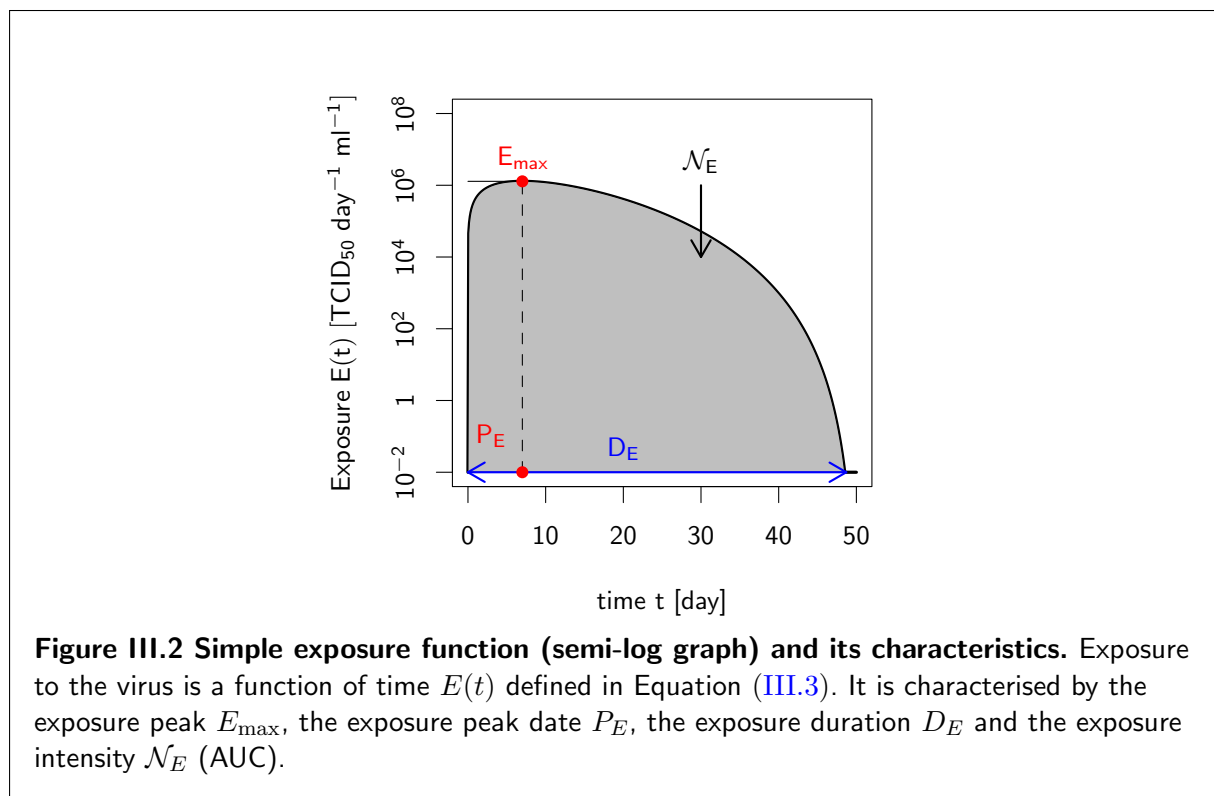

The curve peaks at : $P_E = \frac{D_E(a-1)}{a+b-2}$, which was set to 0.35 day for E_s and 7 days for E_p . The higher the b (resp. a), the flatter the curve at the end (resp. at the beginning) of the exposure. We set b in order to obtain a rather flat curve at the end : for prolonged exposures, we set $E(D_E - 1) \simeq 0.01$ TCID₅₀/ml day⁻¹; for the short one-day exposure, we chose $b = 5$. We deduced a from P_E and b : $a = \frac{P_E(b-2)+D_E}{D_E-P_E}$. The exposure intensity \mathcal{N}_E corresponds to the total number of viral particles received through exposure *i.e.* the area under the curve (AUC). It varied between $10^{4.3}$ and $10^{9.3}$ TCID₅₀/ml as reported in experimental inoculations [13].

The combined exposure is the sum of the corresponding simple exposure functions : $E_{s+p} = E_s + E_p$. It is therefore characterised by an exposure duration $D_{E_{s+p}} = D_{E_p}$ and by an exposure intensity $\mathcal{N}_{E_{s+p}} = \mathcal{N}_{E_s} + \mathcal{N}_{E_p}$ that also corresponds to the total exposure intensity received.

III.2.3 Designs of numerical experiments

Highly virulent strains are assumed to (i) efficiently infect the cells and replicate, (ii) promote the host capacity to synthesise immuno-modulatory over antiviral cytokines and (iii) reduce the activation of the adaptive response [8, 30, 31]. So we defined three virulence levels S_{vir} by varying $\pm 35\%$ the reference values in TABLE III.1 for (i) the parameters related to the macrophage permissiveness (e , η and β), (ii) the cytokine synthesis rates ($\rho_{\text{IFN}\gamma}^{\text{inn}}$, $\rho_{\text{IFN}\gamma}^{\text{ad}}$, $\rho_{\text{IL}10}^{\text{inn}}$, $\rho_{\text{IL}10}^{\text{ad}}$, $\rho_{\text{TGF}\beta}$) and (iii) the rate of adaptive response activation (α_R). The low (S_1), reference (S_2) and high (S_3) virulence levels and their parameter values are given in TABLE III.2.

Table III.2 Model parameter values for the three virulence levels used in designs \mathbf{D}_1 and \mathbf{D}_2 . The reference value (ref.) corresponds to TABLE III.1, in which the parameters are defined.

	e	η	β	ρ_{A_i}	$\rho_{\text{IFN}_\gamma}^{\text{inn}}$	$\rho_{\text{IFN}_\gamma}^{\text{ad}}$	$\rho_{\text{IL}_{10}}^{\text{inn}}$	$\rho_{\text{IL}_{10}}^{\text{ad}}$	ρ_{TGF_β}	α_R
low S_1	0.13	$6.75 \cdot 10^{-7}$	$0.35 \cdot 10^{-6}$	0.0675	13.5	13.5	0.013	1.3	6.5	$1.35 \cdot 10^{-5}$
ref. S_2	0.2	$5 \cdot 10^{-7}$	10^{-6}	0.05	10	10	0.02	2	10	10^{-5}
high S_3	0.27	$3.25 \cdot 10^{-7}$	$1.35 \cdot 10^{-6}$	0.0325	6.5	6.5	0.027	2.7	13.5	$0.35 \cdot 10^{-5}$
units	$e : [\text{V}][\text{Ce}]^{-1}\text{day}^{-1}$		$\eta, \beta : [\text{Ce}]^{-1}\text{day}^{-1}$		$\rho : [\text{Cy}][\text{Ce}]^{-1}\text{day}^{-1}$		$\alpha_R : \text{day}^{-1}$			

We tested six exposure durations D_E (one short s and five prolonged p_1, \dots, p_5) and six graduated levels of exposure intensity \mathcal{N}_E (L_1, \dots, L_6) given in TABLE III.3. Each simple exposure function is denoted by $E_{D_E}^{\mathcal{N}_E}$. We defined a first complete design \mathbf{D}_1 for the simple exposures crossing the six exposure durations D_E , the six exposure intensities and the three virulence levels S_{vir} (FIGURE III.4).

For the combined exposures E_{s+p} , we defined a second complete design \mathbf{D}_2 (FIGURE III.4) : first we crossed two D_{E_p} durations (p_1 and p_5) with three exposure intensities \mathcal{N}_{E_p} (L_1, L_4, L_6); then we combined them with the same three intensities \mathcal{N}_{E_s} for the short exposure; finally we crossed these 18 exposure scenarios with the three virulence levels. Each combined exposure function is denoted by $E_{D_{E_s}+D_{E_p}}^{\mathcal{N}_{E_s}+\mathcal{N}_{E_p}}$. Values of the combined exposure intensity $\mathcal{N}_{E_{s+p}}$ are shown in TABLE III.4. They can be approximated by the highest intensity of the combination : $\mathcal{N}_{E_{s+p}} \simeq \max(\mathcal{N}_{E_s}, \mathcal{N}_{E_p})$.

Illustrations of simple and combined exposure functions are shown in FIGURE III.3.

Table III.3 Exposure parameter values for the simple exposures used in design \mathbf{D}_1 . Parameters, defined in Equation (III.3), are the exposure intensity \mathcal{N}_E , the exposure duration D_E and the shape parameters a and b . a is deduced from the three other parameters and the exposure peak date P_E by : $a = \frac{P_E(b-2)+D_E}{D_E-P_E}$.

		L_1	L_2	L_3	L_4	L_5	L_6
\mathcal{N}_E		$10^{4.3}$	$10^{5.3}$	$10^{6.3}$	$10^{7.3}$	$10^{8.3}$	$10^{9.3}$
D_E	P_E	b					
s	1	0.35	5	5	5	5	5
p_1	10	7	1.4	1.9	2.3	2.7	3.1
p_2	20	7	2.9	4.7	6.6	8.4	10.3
p_3	30	7	4.3	7.6	11	14	17
p_4	40	7	5.7	5.7	5.7	8.1	8.1
p_5	50	7	7.1	7.1	7.1	7.1	7.1
units	$\mathcal{N}_E : \text{TCID}_{50}/\text{ml}$		$D_E, P_E : \text{day}$		$a, b : \text{no unit}$		

Table III.4 Exposure intensity values for the combined exposures used in design \mathbf{D}_2 .

A combined exposure being defined as the sum of a short and a prolonged exposure, its exposure intensity is the sum of the corresponding two simple exposure intensities :

$$\mathcal{N}_{E_{s+p}} = \mathcal{N}_{E_s} + \mathcal{N}_{E_p}.$$

		\mathcal{N}_{E_s}		
+		L_1	L_4	L_6
\mathcal{N}_{E_p}	L_1	$10^{4.6}$	$10^{7.3}$	$10^{9.3}$
	L_4	$10^{7.3}$	$10^{7.6}$	$10^{9.3}$
	L_6	$10^{9.3}$	$10^{9.3}$	$10^{9.6}$
unit	$\mathcal{N}_E : \text{TCID}_{50}/\text{ml}$			

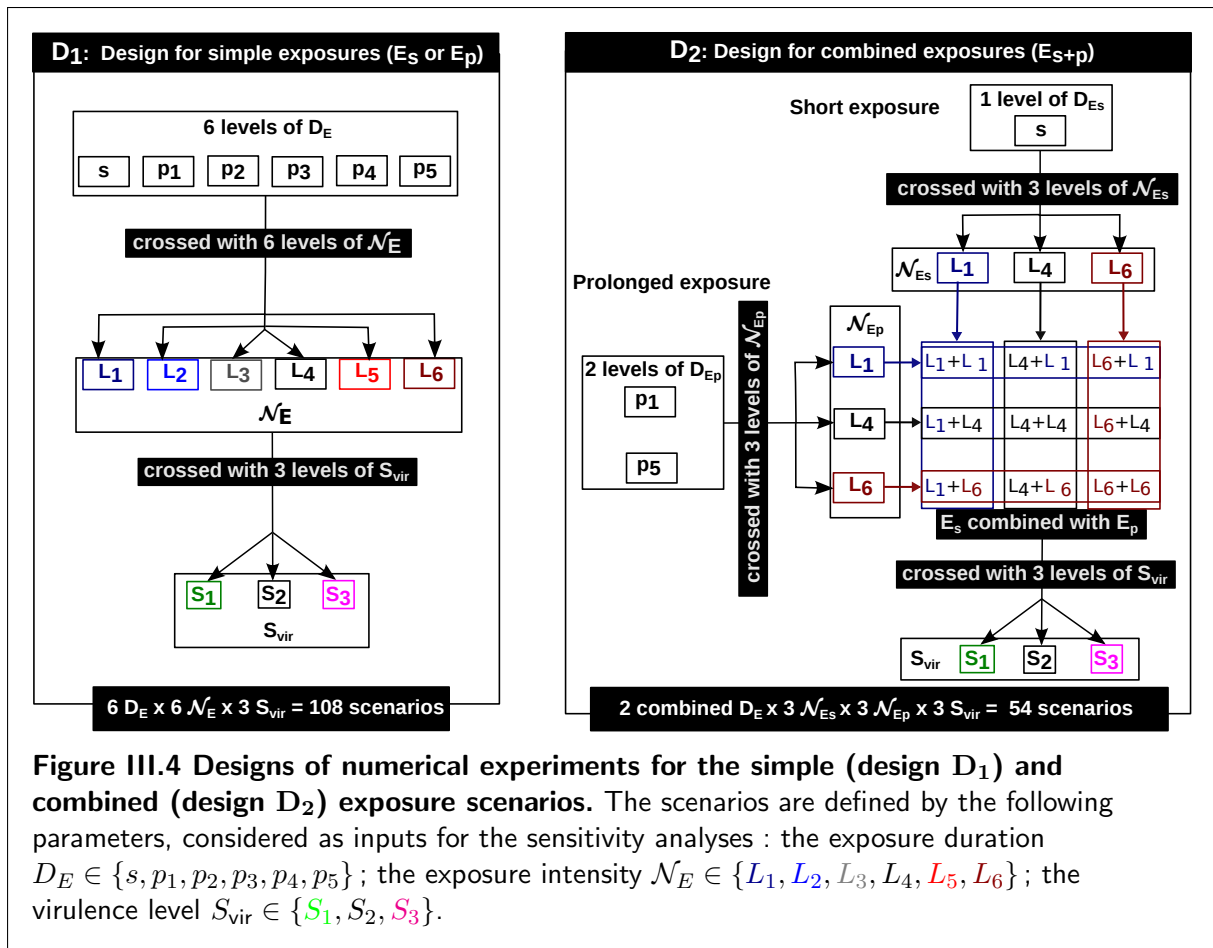
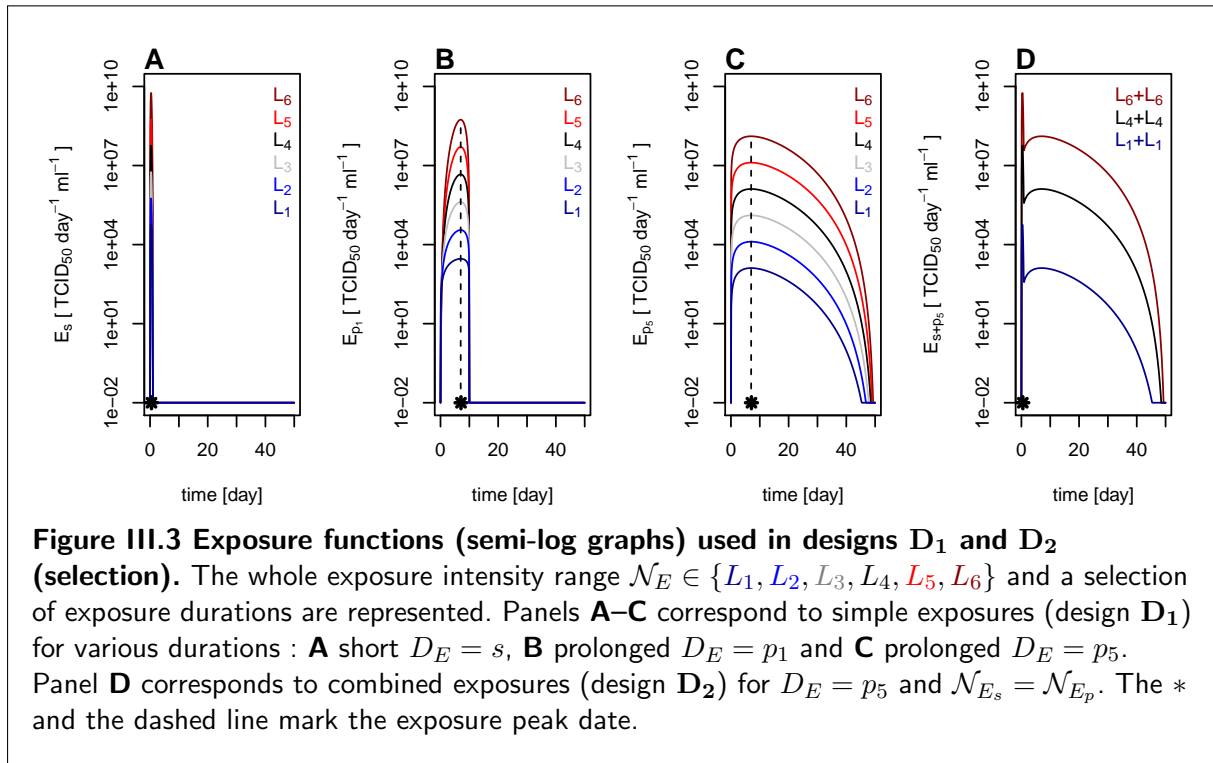

III.2.4 Characteristics of the viral and immune dynamics

To illustrate the within-host dynamics, we looked at the viral titer V and selected seven key immune outputs relevant to PRRSV infection : the infected macrophages M_i , the cellular R_c and humoral R_h effectors, the pro-inflammatory cytokines P_i , the innate antiviral cytokines A_i and two immuno-regulatory cytokines IFN_γ and IL_{10} [6, 30, 32, 33].

To characterise the viral titer curve over time, we considered five scalar descriptors based on [3]. They are listed below and illustrated in FIGURE III.5 :

- Σ_V : the total viral dose, defined as the cumulative number of viral particles over the simulation duration (AUC), an indicator of the infection severity ;
- V_{\max} : the viral peak ;
- T_{\max} : the viral peak date ;
- D_I : the infection duration ; D_I is defined as the time during which the viral titer is higher than 10^{-2} TCID₅₀/ml ;
as we used a continuous time formalism in our model, the variables may tend to zero but cannot reach the zero value in finite time. So we fixed a threshold at 10^{-2} TCID₅₀/ml below which we assumed that the infection was resolved ;
- D_D : the detection duration, defined as the time during which the viral titer is higher than the detection limit set at 10^2 TCID₅₀/ml, as in [3].

The viral peak and infection duration more or less determine the total viral dose and are hence two components of the infection severity.

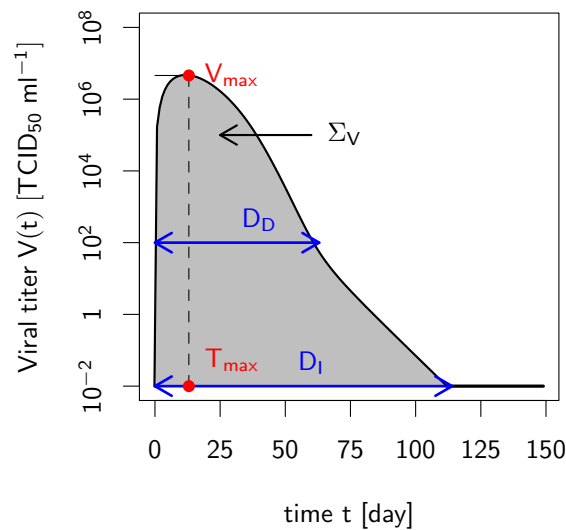

Figure III.5 Shape of the viral titer curve over time (semi-log graph) and its characteristics. The latter consist of the viral peak V_{\max} , the viral peak date T_{\max} , the infection duration D_I , the detection duration D_D and the total viral dose Σ_V (AUC).

To characterise the immune response, we first chose four basic descriptors that can be measured experimentally and are relevant for PRRSV global immune response [6, 30, 32, 33]. They are based on the AUC of cytokines and adaptive effectors :

- Σ_{P_i} : the total pro-inflammatory cytokines (AUC), shown to be a good proxy of the activation level of the immune response [19] and related to the clinical status of the pig ;
- $\%(A_i + \text{IFN}_\gamma) = 100 \frac{\Sigma_{A_i + \text{IFN}_\gamma}}{\Sigma_{A_i + \text{IFN}_\gamma} + \Sigma_{\text{TGF}_\beta} + \Sigma_{\text{IL}_{10}}}$: the percentage of anti-viral cytokines, supposed to play a key role in PRRSv infection resolution ;
- $\%R_c = 100 \frac{\Sigma_{R_c}}{\Sigma_{R_c} + \Sigma_{R_h} + \Sigma_{R_r}}$: the percentage of cellular response, supposed to play a key role in PRRSv infection resolution ;
- $\%R_h = 100 \frac{\Sigma_{R_h}}{\Sigma_{R_c} + \Sigma_{R_h} + \Sigma_{R_r}}$: the percentage of humoral response, supposed to play a key role in PRRSv infection persistence.

We also defined another set of five descriptors related to the viral destruction or replication mechanisms : the phagocytosis, neutralisation and excretion of viral particles, the infection by viral particles and the cytolysis of infected macrophages. For each mechanism, the descriptor is defined as the ratio between the total number (AUC) of viral particles or macrophages involved and the exposure intensity (\mathcal{N}_E). This normalisation allowed us to compare the activation levels of the mechanisms independently from the exposure intensity. For instance, the normalised number of viral particles having infected macrophages is defined from Equation (III.2) as follows :

$$\mathcal{N}_{\text{inf}/E} = \frac{\int_{t=0}^{D_I} u \beta M_s(t) V(t) \kappa^- (A_i(t) + \text{TGF}_\beta(t)) [1 + \kappa^+ (\text{IL}_{10}(t))] dt}{\mathcal{N}_E}.$$

The other descriptors are similarly defined. All five are listed below :

- $\mathcal{N}_{\text{pha}/E}$: the normalised number of viral particles phagocytosed by macrophages ;
- $\mathcal{N}_{\text{inf}/E}$: the normalised number of viral particles having infected macrophages ;
- $\mathcal{N}_{\text{neutr}/E}$: the normalised number of viral particles neutralised by the humoral response ;
- $\mathcal{N}_{\text{cyt}/E}$: the normalised number of cytolysed infected macrophages ;
- $\mathcal{N}_{\text{excr}/E}$: the normalised number of viral particles excreted by infected macrophages.

III.2.5 Analyses

To analyse design **D₁** based on simple exposure scenarios, we performed sensitivity analyses. The first set of analyses aimed at exploring the influence of the scenario parameters (D_E , \mathcal{N}_E and S_{vir}), considered as inputs, on the 14 scalar descriptors of the within-host dynamics defined above, considered as outputs. We identified the main effect of each input and the effects of the two-input interactions. For each scalar output, we used a classical univariate method : for a given design – defining the input combinations tested, or scenarios – sensitivity indices quantify the fraction of variance among simulations explained by each input. An ANOVA is performed to estimate the influence of the main effect of each input and the effects of the multi-input interactions on the output. The sensitivity index associated with each term (main effect or interaction) is defined as the ratio between the sum of squares corresponding to that term and the total sum of squares [34].

We also performed a sensitivity analysis to explore the influence of the scenario parameters on the viral titer curve over time, which is non scalar output. We used a multivariate method based on a decomposition of the output by a principal component analysis (PCA) [35]. As a result of the PCA, an inertia proportion is attributed to each component. It represents the variability among simulations carried by the component. Moreover, each simulation is given a “score” on each component, a scalar which represents the projection of the simulation on the component. Sensitivity indices are computed for each component using these scores as outputs. Finally, a generalised sensitivity index (GSI) is calculated for each term as the sum of the

sensitivity indices corresponding to that term on each PCA component, weighted by the inertia of the component. We used the multisensi R package [36] for these analyses.

We did a focus on an output of particular interest, the infection duration (D_I), which is one component of the infectiousness. In order to quantify the influence of the scenario parameters on the infection duration, for both designs \mathbf{D}_1 and \mathbf{D}_2 , we fitted a linear model defined as follows :

$$D_I = \xi_0 + \xi_{S_{\text{vir}}} + \xi_{\mathcal{N}_E} \log(\mathcal{N}_E) + \xi_{D_E} D_E + \varepsilon$$

with ξ_0 the constant term and ε the residual variance. S_{vir} was considered as a qualitative factor, $\log(\mathcal{N}_E)$ and D_E as quantitative covariables. The parameters that were estimated were the three $\xi_{S_{\text{vir}}}$ for $S_{\text{vir}} \in \{S_1, S_2, S_3\}$, $\xi_{\mathcal{N}_E}$ and ξ_{D_E} .

We used design \mathbf{D}_2 to investigate whether combined exposures could be approximated by simpler exposure functions. For instance, we wanted to assess the error made if we neglected the exposure due to contacts in an experimental infection. We chose two approximation types : (a) we neglected either the short or the prolonged simple exposure of the combination ; and (b) we approximated the combination by a simple scenario with a similar exposure intensity and either a short or the same exposure duration. The exposure intensity of the combined scenario is close to the highest intensity of the combination (see TABLE III.4), so this is the value used for the simple scenario in type (ii) approximations. The relative error for each viral characteristic $C \in \{\Sigma_V, V_{\text{max}}, T_{\text{max}}, D_I\}$ was denoted by :

$$\Delta C_k^{i+j}(E_m^l) = \frac{C(E_{s+k}^{i+j}) - C(E_m^l)}{C(E_{s+k}^{i+j})} \quad \text{with } E_m^l \in \left\{ E_s^i, E_k^j, E_s^{\max(i,j)}, E_k^{\max(i,j)} \right\} \quad (\text{III.4})$$

$$\forall i, j \in \{L_1, L_4, L_6\} \ \& \ \forall k \in \{p_1, p_5\}.$$

Comparisons involved the same S_{vir} level for both scenarios.

For the 18 homogeneous scenarios ($i = j$), simple scenarios used in (a) and (b) approximations were the same ($E_s^i = E_s^{\max(i,j)}$ and $E_k^j = E_k^{\max(i,j)}$), leading to $18 \times 2 = 36$ comparisons. For the 36 heterogeneous scenarios ($i \neq j$), one of the four simple scenarios ($E_s^{\max(i,j)}$ if $\max(i, j) = i$, or $E_k^{\max(i,j)}$ if $\max(i, j) = j$) corresponded to both (a) and (b) approximations, leading to $36 \times 3 = 108$ comparisons. So a total of 144 comparisons was performed. Besides, we used type (c) approximations to designate approximations of both types (a) and (b).

We performed all our analysis using R software, version 3.0.2. [37].

III.3 Results

Overview of the within-host dynamics among all scenarios

The viral titer and the seven key immune outputs for the 162 scenarios of designs \mathbf{D}_1 and \mathbf{D}_2 are represented in FIGURE III.6.

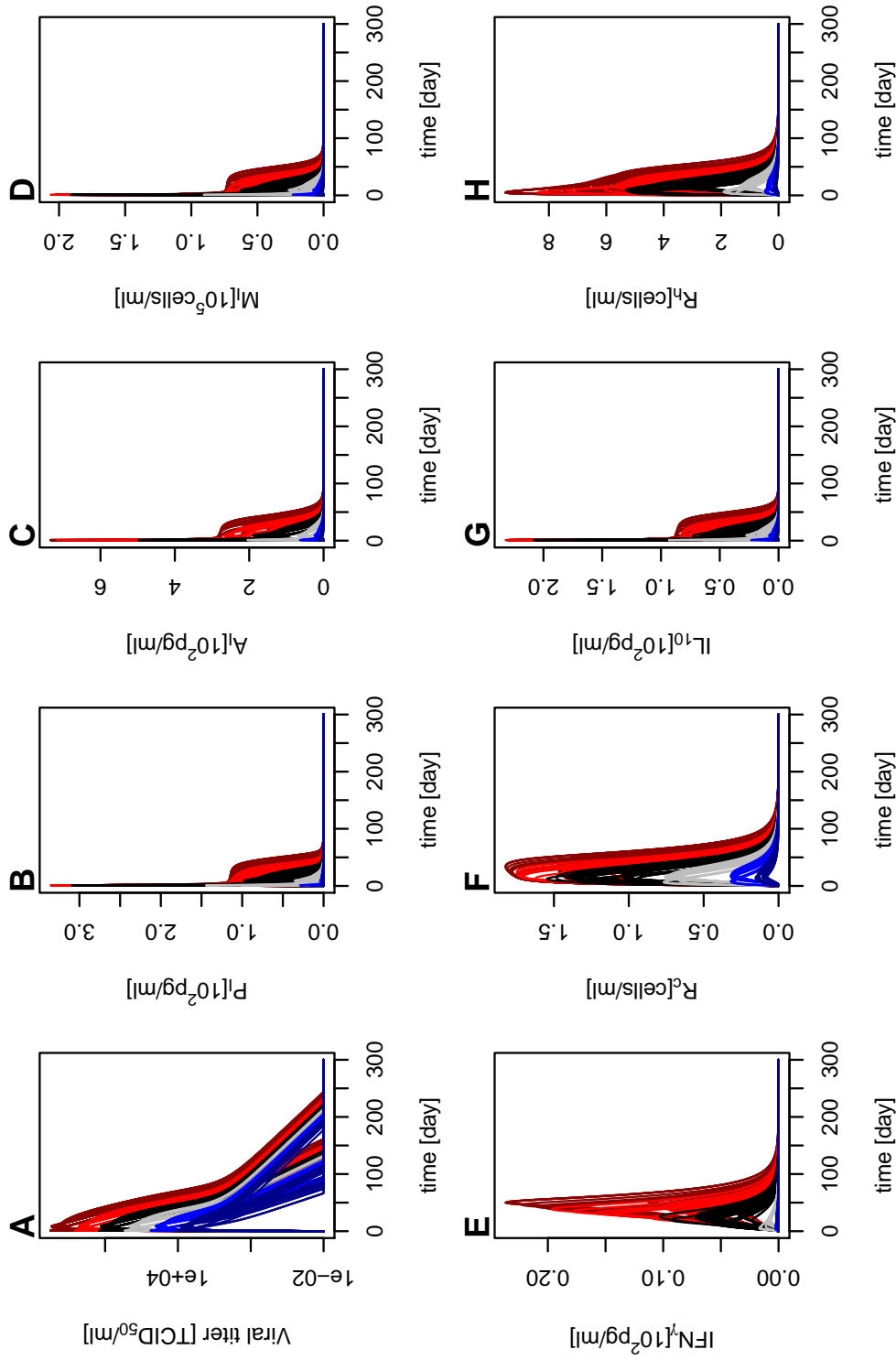

Figure III.6 Dynamics of the viral titer and key immune outputs for all scenarios. **A** : viral titer (semi-log graph) ; **B** : pro-inflammatory cytokines ; **C** : innate antiviral cytokines ; **D** : infected macrophages ; **E** : IFN $_{\gamma}$ cytokine ; **F** : cellular effectors ; **G** : IL $_{10}$ cytokine ; **H** : humoral effectors. The 108 simple (design **D** $_1$) and 54 combined (design **D** $_2$) exposure scenarios are represented. Exposure intensities are highlighted by colours on the graphs : $\mathcal{N}_E \in \{L_1, L_2, L_3, L_4, L_5, L_6\}$. The intensity of combined scenarios is approximated by the highest intensity of the combination (e.g. $L_1 + L_4 \simeq L_4$).

Firstly, we compared our results with the literature (TABLE III.5). Results related to the viral titer dynamics are in good agreement with the literature data. We compared the detection durations D_D with the experimental infection durations reported in the literature, as measurement techniques have a detection threshold *a priori* close to the value we chose (10^2 TCID₅₀/ml). The D_D range (15–94 days) is narrower than the infection durations reported in the literature (*ca* 28–251 days). However, the mean D_D (54 days) is close to the mean infection duration in the lung reported in experimental studies (56 days) [6].

Table III.5 Summary of the viral titer and key immune outputs compared with literature data. Minimal, median, mean and maximal values of : (i) the viral characteristics : infection D_I and detection D_D durations, viral peak V_{\max} and viral peak date T_{\max} ; (ii) the peak concentrations of key cytokines : innate antiviral A_i , pro-inflammatory P_i , IL₁₀ and IFN_γ; (iii) the peak values of the cellular $\%R_c$ and the humoral $\%R_h$ effectors expressed as percentages of the sum of the three adaptive effector peaks. The infected macrophages M_i also belong to the key immune outputs but are not presented here, as the only relevant data found in the literature reported a maximal M_i number of $15 \cdot 10^6$ cells, representing around 40% of the total macrophage concentration in the bronchoalveolar lavage fluids [38]. Our results exhibited a maximal M_i percentage ranging between 0.5% and 99%, with a mean value of 42%.

	D_I	D_D	V_{\max}	T_{\max}	A_i^{peak}	P_i^{peak}	IL ₁₀ ^{peak}	IFN _γ ^{peak}	$\%R_c^{\text{peak}}$	$\%R_h^{\text{peak}}$
min	67	15	$10^{3.5}$	1	5	0.3	0.7	0.03	9	34
median	133	60	$10^{7.2}$	10	176	96	66	4	14	46
mean	151	58	$10^{6.9}$	7	274	165	110	6	18	43
max	244	95	$10^{9.3}$	12	1002	580	580	24	33	50
References from reviews on PRRSv infection [5, 6, 8, 30, 33]										
tendency					low	high	high	low	low(high)	high(low)
mean		$\simeq 37 - 56$								
range		28 – 251	$10^2 - 10^9$	7 – 14	0 – 10^3	0 – 10^3	0 – 10^3	0 – 10^3		
References from PRRSv experimental infections										
[39]		> 24	$10^{2.5} - 10^{4.5}$		60	75				
[14]		> 42	10^7			1600		40		
[31]					0 – 2800		0 – 1350			
[40]						1800	1000			
[41]		43	$10^{4.5}$					80 – 120		
[38, 42]		52			0		$\simeq 139$			
[43]		> 21	$10^3 - 10^{10}$		600	450		100		
[44]		> 14	$10^{4.5} - 10^{5.5}$					0 – 328		
[45]		52	$10^4 - 10^6$							
units	D_I, D_D, T_{\max} : day		V_{\max} : TCID ₅₀ /ml		$A_i^{\text{peak}}, P_i^{\text{peak}}, \text{IL}_{10}^{\text{peak}}, \text{IFN}_{\gamma}^{\text{peak}}$: pg/ml					

The viral titer dynamics is widely informed in the literature, but we found few data on the immune dynamics. So we looked at the qualitative behaviour rather than quantitative values of the immune response. Our results exhibited realistic qualitative behaviours and variation ranges (TABLE III.5). The innate variables ($A_i, P_i, M_i, \text{IL}_{10}$ in FIGURE III.6) peaked in the first infection days, whereas the adaptive variables (IFN_γ, R_c, R_h in FIGURE III.6) peaked later, around two to three weeks, in agreement with the literature [5, 30, 32]. As reported in the literature, our results exhibited lower percentages of cellular response than of humoral response (TABLE III.5).

Secondly, we looked at the impact of exposure on the model outputs. Globally, the higher the exposure intensity ($\log(\mathcal{N}_E)$), the higher the viral titer and the key immune outputs (FIGURE III.6), in agreement with the literature [16–18]. For a given level of exposure intensity, we identified the impact of the other inputs (exposure duration and virulence level). In particular, scenarios with short exposure durations (D_E) resulted in an early peak (for example, the viral titer peaked at 1 day), whereas scenarios with prolonged exposure durations resulted in a delayed peak (for example, the viral titer peaked between 9 and 12 days).

Thirdly, we focused on the infection duration (D_I), an output related to the infectiousness. The impact of exposure on this output was further investigated by fitting linear models. They exhibited a good fit ($R^2 > 0.98$) for the simple and combined exposure scenarios. The effects of exposure intensity ($\log(\mathcal{N}_E)$), exposure duration (D_E) and virulence (S_{vir}) were significant for both designs : D_I showed a linear relation with $\log(\mathcal{N}_E)$ and with D_E for each virulence level S_{vir} (FIGURE III.7). For virulence levels $S_{\text{vir}} \in [S_1, S_3]$ (a realistic range), we found that, after a simple exposure $D_I = [31.67, 140.82] + 9.21 \log(\mathcal{N}_E) + 0.33 D_E$ and after a combined exposure $D_I = [29.62, 141.12] + 9.42 \log(\mathcal{N}_E) + 0.17 D_E$.

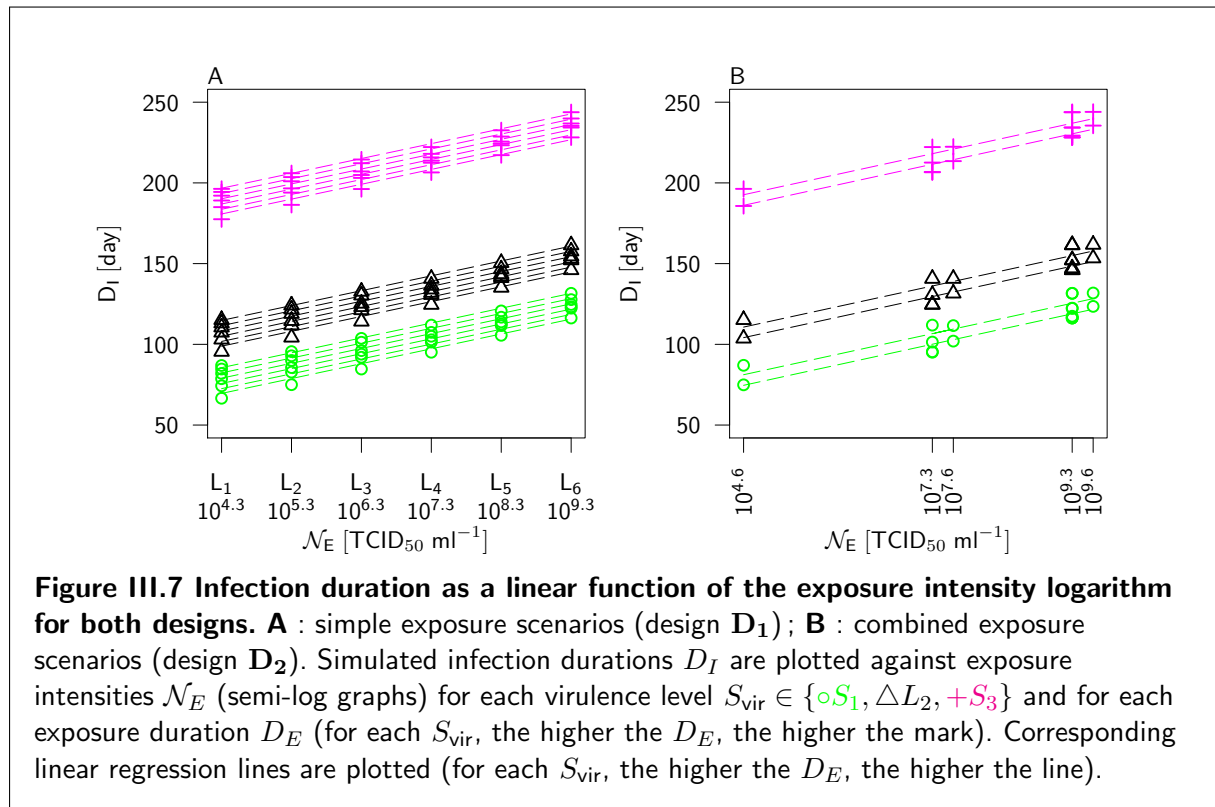

We used the four basic immune descriptors (ΣP_i , $\%(A_i + \text{IFN}_\gamma)$, $\%R_c$ and $\%R_h$) to assess the impact of the immune response on the infection duration among all exposure and virulence scenarios (FIGURE III.8). D_I always decreased as $\%(A_i + \text{IFN}_\gamma)$, the percentage of antiviral cytokines, increased. No such trends were identified for the other descriptors. However, for a given virulence level, increasing levels of the total pro-inflammatory cytokines (ΣP_i) and percentage of humoral response ($\%R_h$) and decreasing levels of the percentage of cellular response ($\%R_c$) tended to increase the infection duration. These results are consistent with the literature [7, 8, 12, 14, 19].

We highlighted two scenarios with similar infection durations, but contrasted immune dynamics : $Sc^- = E_{p_5}^{L_6} \times S_2$ ($D_I = 162$ days) and $Sc^+ = E_s^{L_1} \times S_3$ ($D_I = 176$ days), highlighted on FIGURE III.8. Compared to Sc^- , Sc^+ was associated with a lower Σ_{P_i} , similar $\%(A_i+IFN_\gamma)$, a higher $\%R_c$ and a lower $\%R_h$.

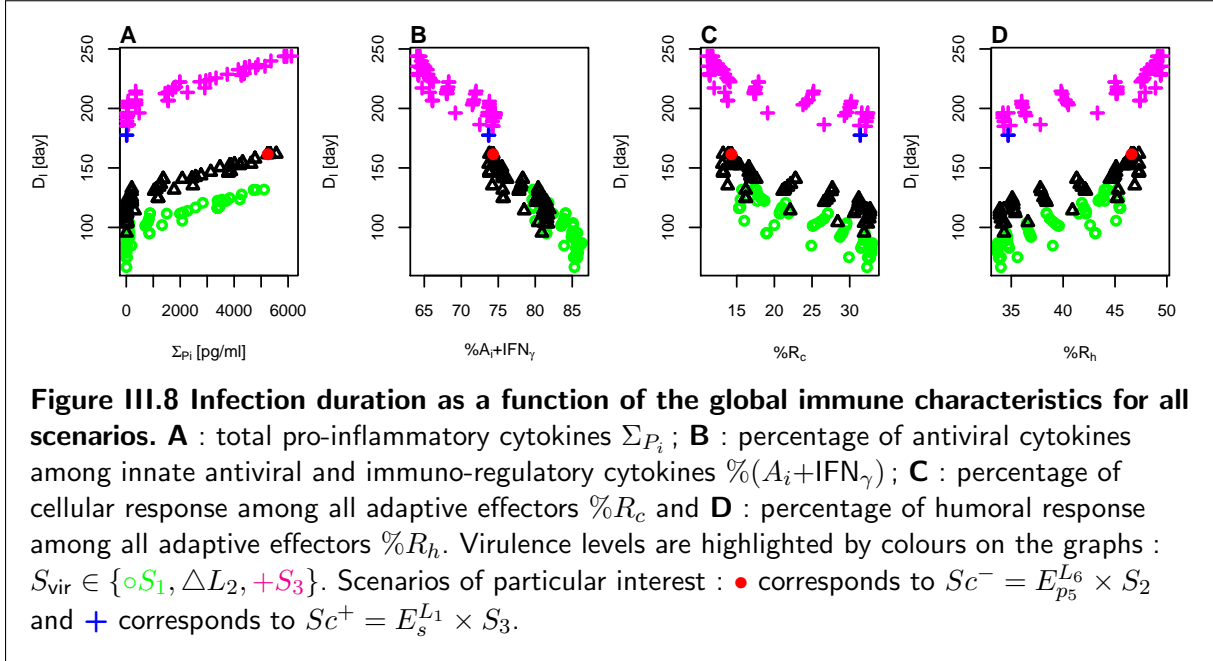

III.3.1 Exploring the influence of simple exposures

Thanks to a multivariate sensitivity analysis, we quantified the influence of the simple scenario parameters (design D_1) on the viral titer dynamics. We showed that more than 90% of the variability was determined, in descending order, by : the virulence level S_{vir} , the exposure intensity \mathcal{N}_E , the interaction between both and the interaction between \mathcal{N}_E and D_E (FIGURE III.9).

To better understand how virulence and exposure influenced the viral titer and the immune response, we performed sensitivity analyses on each viral and immune characteristic (output). The viral titer curve is decomposed into several characteristics (*e.g.* peak) and the immune characteristics summarise different features of the immune response. Results are presented in TABLE III.6 and illustrated in FIGURE III.10. If an output increases (decreases) with a given input, we say that this input has a positive (negative) impact on the output.

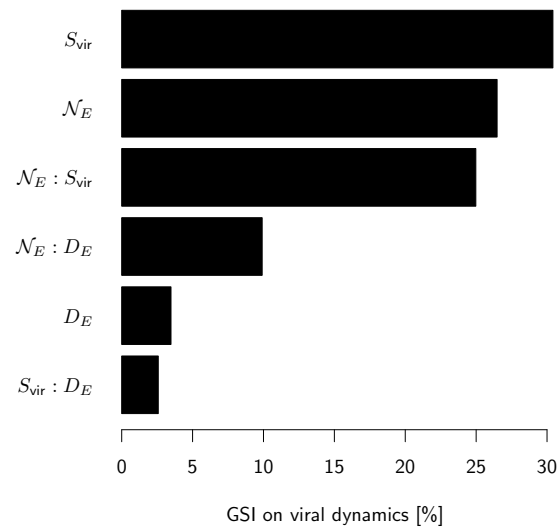

Figure III.9 Multivariate sensitivity analysis for the viral titer dynamics based on simple exposure scenarios (design D_1). Global sensitivity indices (GSI) of the virulence level S_{vir} , exposure intensity \mathcal{N}_E exposure duration D_E and their two-way interactions.

Table III.6 Sensitivity analyses for the within-host characteristics based on simple exposure scenarios (design D₁). Sensitivity indices (in %) of the virulence level S_{vir} , exposure intensity N_E exposure duration D_E and their two-way interactions for (i) the five viral descriptors : total viral dose Σ_V , infection duration D_I , detection duration D_D , viral peak V_{max} and viral peak date T_{max} ; (ii) the four basic immune descriptors : total pro-inflammatory cytokines Σ_{Pi} , percentage of antiviral cytokines $\%(A_i+IFN_\gamma)$, percentage of cellular $\%R_c$ and $\%R_h$ humoral effectors; and (iii) the five descriptors related to immune mechanisms : normalised number of excreted viral particles $N_{exc/E}$, normalised number of viral particles having infected macrophages $N_{inf/E}$, normalised number of cytolysed infected macrophages $N_{cyl/E}$, normalised number of neutralised viral particles $N_{neur/E}$ and normalised number of phagocytosed viral particles $N_{pha/E}$.

	Σ_V	D_I	D_D	V_{max}	T_{max}	Σ_{Pi}	$\%(A_i+IFN_\gamma)$	$\%R_c$	$\%R_h$	$N_{exc/E}$	$N_{inf/E}$	$N_{cyl/E}$	$N_{neur/E}$	$N_{pha/E}$
N_E	100	10	82	80	0	94	19	87	86	64	80	51	97	80
S_{vir}	0	89	8	0	0	2	79	7	9	9	8	22	0	12
D_E	0	1	10	4	99	1	1	3	2	0	0	1	1	1
$N_E \times S_{vir}$	0	0	0	0	0	1	1	2	3	25	11	17	1	5
$S_{vir} \times D_E$	0	0	0	0	0	0	0	0	0	0	0	0	0	0
$N_E \times D_E$	0	0	0	16	0	2	0	1	1	1	0	7	1	1
units	D_I, D_D	T_{max}	day	V_{max}	TCID ₅₀ /ml	Σ_{Pi}	day	pg/ml	$N_{exc/E}$	no unit	except $N_{neur/E}$	cells/TCID ₅₀		

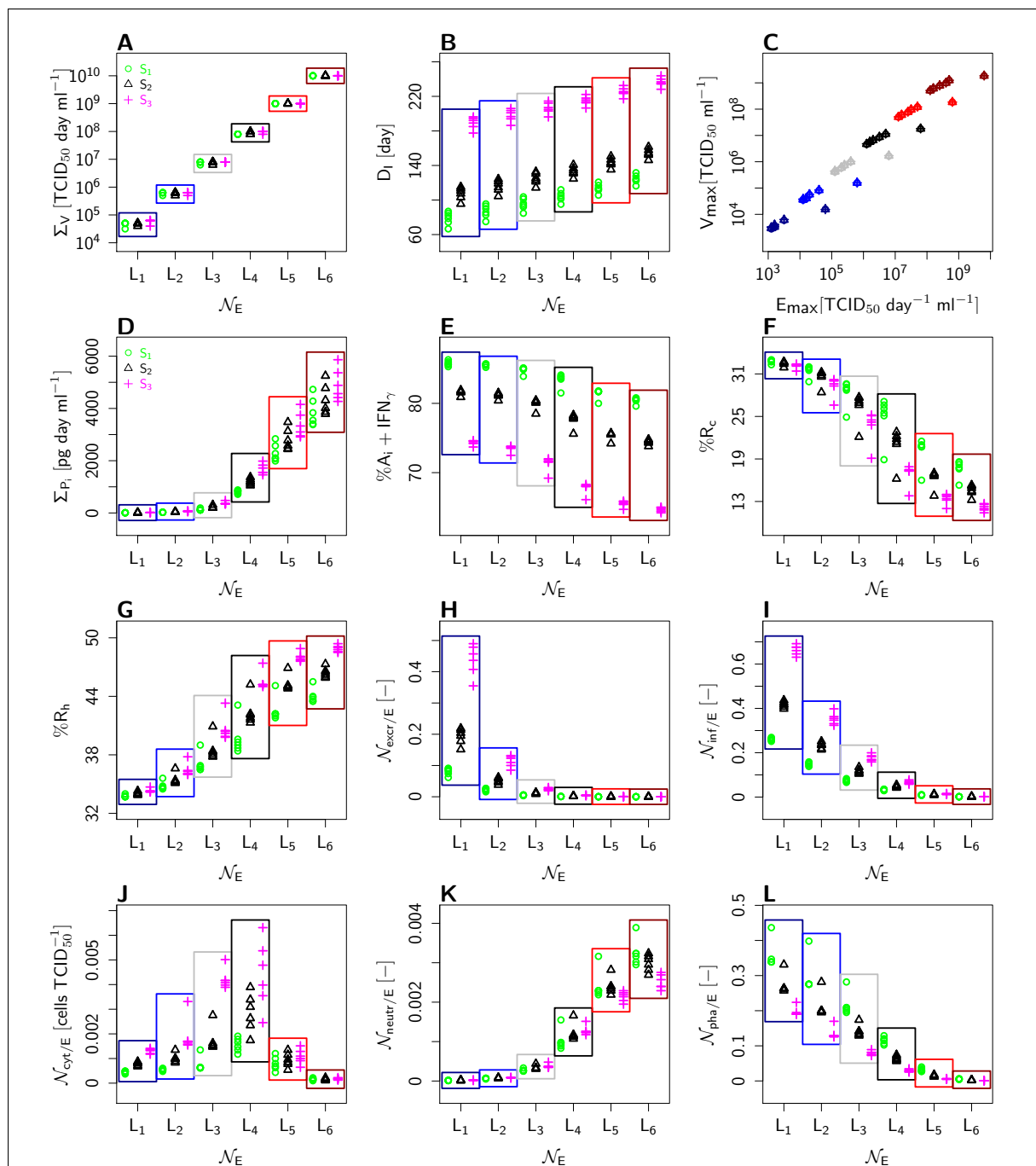
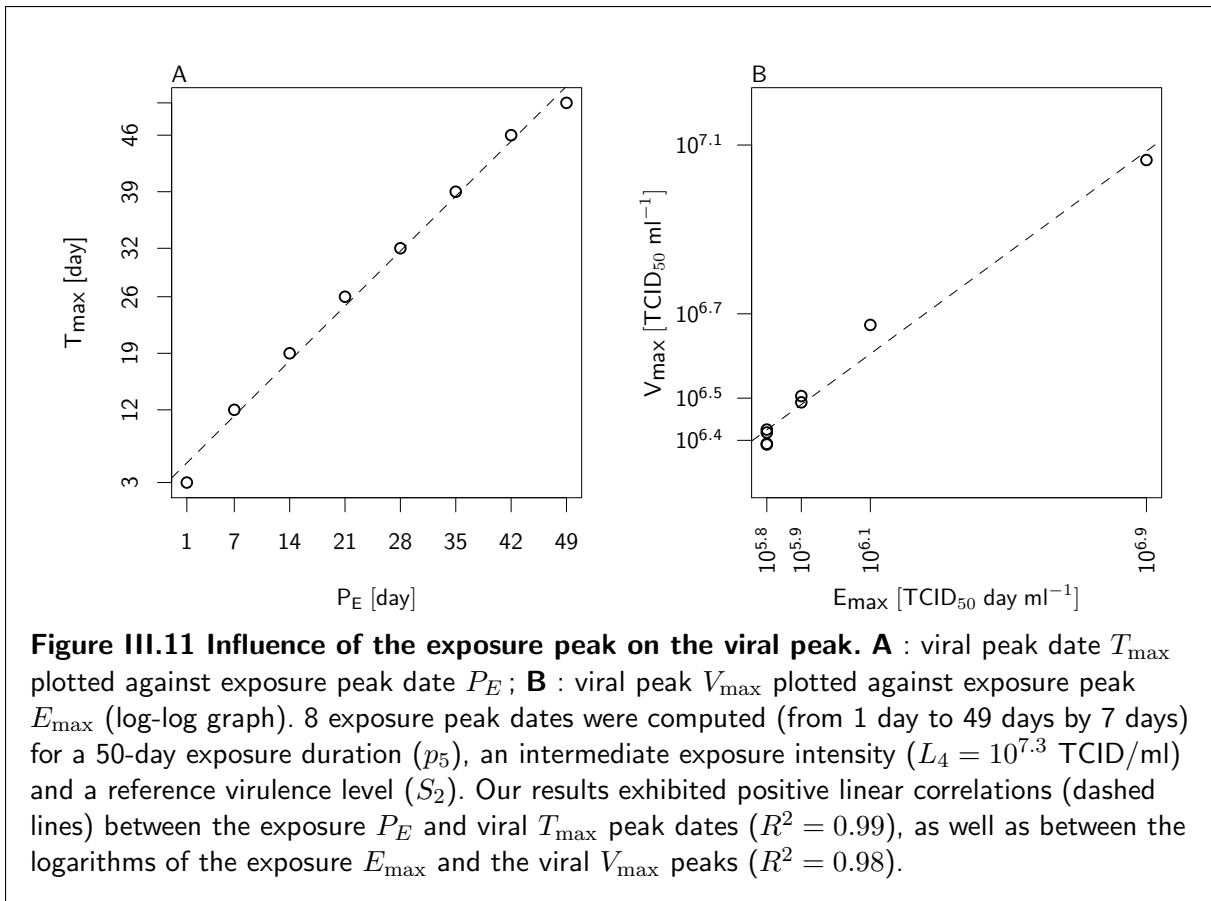

Figure III.10 Impact of scenario parameters on viral and immune characteristics for simple exposures (design D₁). **A** : total viral dose; **B** : infection duration D_I ; **C** : viral peak V_{\max} ; **D** : total pro-inflammatory cytokines Σ_{P_i} ; **E** : percentage of antiviral cytokines $\%(A_i + \text{IFN}_\gamma)$; **F** : percentage of cellular effectors $\%R_c$; **G** : percentage of humoral effectors $\%R_h$; **H** : normalised number of excreted viral particles $\mathcal{N}_{\text{excr}/E}$; **I** : normalised number of viral particles having infected macrophages $\mathcal{N}_{\text{inf}/E}$; **J** : normalised number of cytolysed infected macrophages $\mathcal{N}_{\text{cyt}/E}$; **K** : normalised number of neutralised viral particles $\mathcal{N}_{\text{neutr}/E}$; **L** : normalised number of phagocytosed viral particles $\mathcal{N}_{\text{pha}/E}$. All characteristics but the viral peak (all but **C**) are plotted against the exposure intensity $\mathcal{N}_E \in \{L_1, L_2, L_3, L_4, L_5, L_6\}$, with the virulence level highlighted in colours : $S_{\text{vir}} \in \{oS_1, \Delta S_2, +S_3\}$; replicates (same \mathcal{N}_E and S_{vir}) and correspond to the various exposure durations. The viral peak (**C**) is plotted against the exposure peak E_{\max} , with the exposure intensity highlighted in colours; replicates (same \mathcal{N}_E) correspond to the different virulence levels and exposure durations. [-] = no unit.

The exposure intensity \mathcal{N}_E had a strong and dominant influence (sensitivity indices higher than 50%) on all the within-host characteristics except the viral peak date T_{\max} , the infection duration D_I and the percentage of antiviral cytokines $\%(A_i + \text{IFN}\gamma)$. In particular, \mathcal{N}_E had a positive impact that almost fully explained the variance of the total viral dose Σ_V (FIGURE III.10A), the total pro-inflammatory cytokines Σ_{P_i} (FIGURE III.10D) and the normalised number of viral particles neutralised by the humoral response $\mathcal{N}_{\text{neutr}/E}$ (FIGURE III.10K). As a result, the total viral dose, which is an indicator of the infection severity, increased with the total pro-inflammatory cytokines whatever the virulence level and the exposure dose. This is consistent with PRRSv experimental studies which showed that the levels of pro-inflammatory cytokines were correlated with the severity of pulmonary lesions [39, 46].

There were few significant interactions (*i.e.* $> 10\%$). V_{\max} was influenced by $\mathcal{N}_E \times D_E$. For a given \mathcal{N}_E , the exposure peak E_{\max} was set by D_E , so $\mathcal{N}_E \times D_E$ corresponds in fact to the positive impact of E_{\max} (FIGURE III.10C). $\mathcal{N}_{\text{excr}/E}$ (FIGURE III.10H), $\mathcal{N}_{\text{inf}/E}$ (FIGURE III.10I) and $\mathcal{N}_{\text{cyt}/E}$ (FIGURE III.10J) were influenced by $\mathcal{N}_E \times S_{\text{vir}}$. \mathcal{N}_E had a negative impact on $\mathcal{N}_{\text{excr}/E}$ and $\mathcal{N}_{\text{inf}/E}$, whereas S_{vir} had a positive impact on these outputs which decreased with \mathcal{N}_E . $\mathcal{N}_{\text{cyt}/E}$ increased and then decreased as \mathcal{N}_E increased; the positive impact of S_{vir} was higher for intermediate \mathcal{N}_E values.



Three within-host characteristics were little or not influenced by \mathcal{N}_E . T_{\max} was fully determined by the exposure duration D_E , which had a positive impact. It is linked to the contrasted exposure peak dates between the short ($P_E = 0.35$ and $T_{\max} = 1$) and prolonged exposure ($P_E = 7$ and $9 \leq T_{\max} \leq 12$) functions. T_{\max} was indeed determined by the exposure peak date (FIGURE III.11A). D_I and $\%(A_i + \text{IFN}\gamma)$ were explained by S_{vir} and to a lesser extent by

\mathcal{N}_E . D_I (FIGURE III.10B) was positively impacted by S_{vir} and \mathcal{N}_E , whereas $\%(A_i + \text{IFN}_\gamma)$ (FIGURE III.10E) was negatively impacted by S_{vir} and \mathcal{N}_E . D_D is by definition linked to D_I , but S_{vir} had a very low impact on D_D (TABLE III.5). As D_D is shorter than D_I (FIGURE III.5), this suggests that the exposure effect dominates the virulence effect during the first days and weeks.

Without normalisation, the excretion, infection, cytolysis, neutralisation and phagocytosis increased with \mathcal{N}_E (results not illustrated). With normalisation, all but the neutralisation tended to zero for high values of \mathcal{N}_E , which suggests that these immune mechanisms saturated for high exposure intensities (FIGURE III.10H–L). Furthermore, $\mathcal{N}_{\text{cyt}/E}$ and $\mathcal{N}_{\text{neutr}/E}$ were low, suggesting that cytolysis and neutralisation had a lower impact on the viral titer reduction than phagocytosis by macrophages. This is consistent with experimental PRRSV infection results [7, 8, 12, 14].

III.3.2 Looking at the impact of exposure simplifications

Firstly, we used the results on simple exposure scenarios described above to compare prolonged and short exposures with the same exposure intensity and the same virulence level. Compared to the prolonged exposure scenario, the short exposure scenario had (i) a similar infection severity (marks confounded in FIGURE III.10A for each exposure intensity \mathcal{N}_E); (ii) a shorter infection duration, the corresponding coefficient in the linear regression being positive (illustrated in FIGURE III.7A); and (iii) a higher viral peak and an earlier viral peak date. We deducted (iii) from the exposure definition and the correlations between the exposure and viral characteristics. Indeed, compared to prolonged exposures, the short exposures were defined with a lower exposure peak date ($P_E = 1$ day) and higher exposure peaks (E_{max}). Moreover, P_E and T_{max} were positively correlated, as were E_{max} and V_{max} (FIGURE III.11).

Secondly, we explored the errors made on the viral characteristics when approximating a combined exposure scenario by a simple exposure scenario : (a) by neglecting either the short or the prolonged exposure of the combination ; and (b) by approximating the combined scenario by a simple scenario with a similar exposure intensity and either a short or the same exposure duration. Note that the approximation by the simple scenario of the combination with the highest exposure intensity was both of types (a) and (b) ; it was designated as a type (c) approximation. We showed previously that the total viral dose (Σ_V) of simple scenarios was fully determined by the exposure intensity (\mathcal{N}_E). It was also the case for the combined scenarios (FIGURE III.12A). However, the error made when approximating a combined scenario by a simple scenario ($\Delta\Sigma_V$) was not determined by the exposure intensity of the combined scenario ($\mathcal{N}_{E_{s+p}}$, FIGURE III.12B), but mainly depended on the exposure combination and on the simple scenario used for the approximation ($\mathcal{N}_{E_s} + \mathcal{N}_{E_p}$, FIGURE III.12C). So, we took the combinations into account in our exploration. The results are presented in TABLE III.7.

Good approximations (relative error $\Delta < 0.05$) of all viral characteristics were only obtained for the heterogeneous combined exposures (E_{s+k}^{i+j} with $i \neq j$; type (c) of the last six columns in TABLE III.7), when compared with the simple exposure of the combination that had the highest exposure intensity (E_s^i if $i = \max(i, j)$ or E_k^j if $j = \max(i, j)$; rows (c) in TABLE III.7). Otherwise, approximations generated notable errors.

The viral characteristics of the homogeneous exposure combinations (E_{s+k}^{i+j} with $i = j$; type (c) of the three first columns in TABLE III.7) were approximated as follows : (i) the total viral dose Σ_V was similarly underestimated by short and prolonged exposures ; (ii) the infection duration D_I was well estimated by prolonged exposures and sometimes underestimated by short exposures ; (iii) the viral peak V_{max} was well estimated by short exposures and underestimated

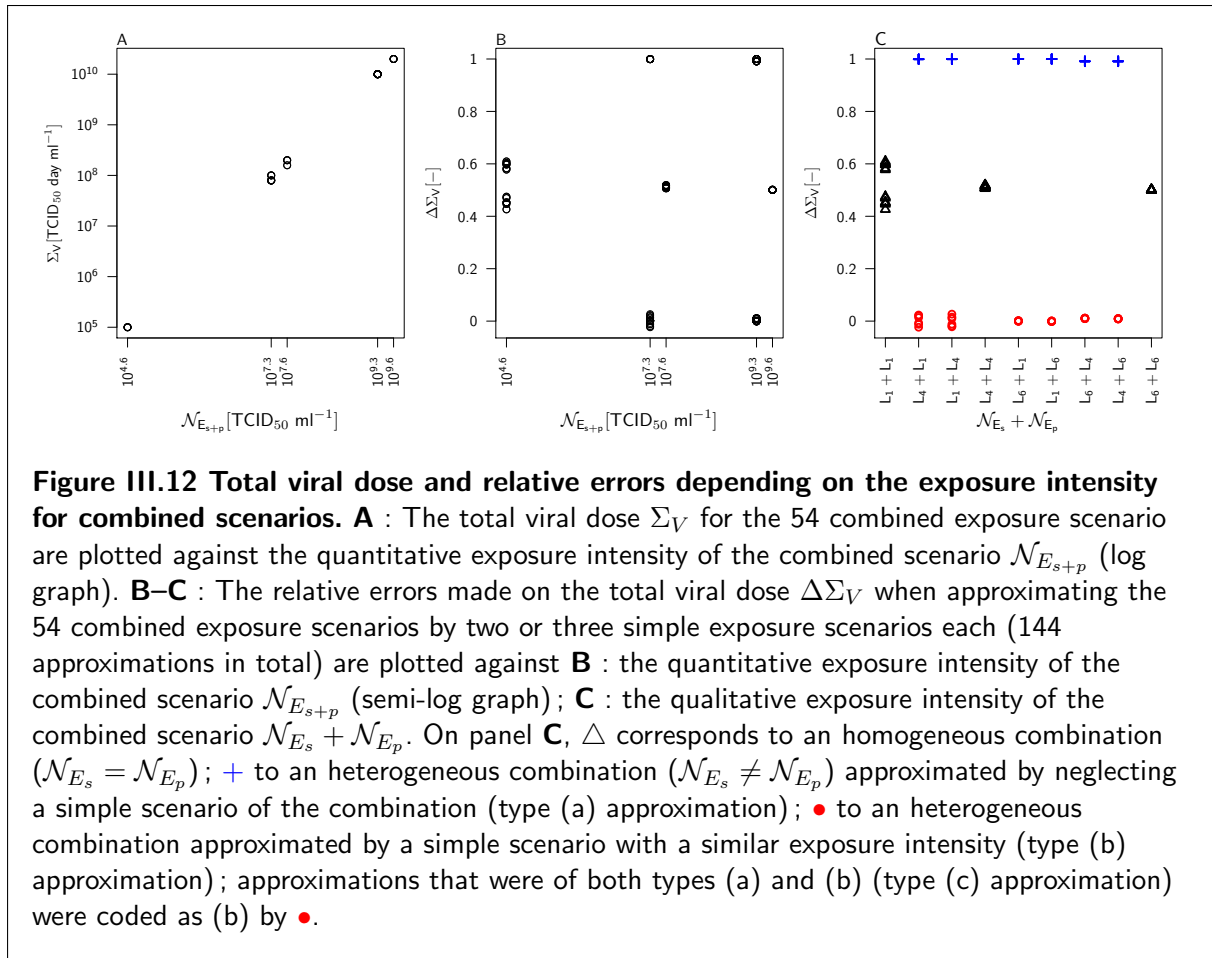

by prolonged exposures ; and (iv) the viral peak date T_{\max} was well estimated by short exposures and highly overestimated by prolonged exposures.

To conclude, the relative errors were globally lower when the approximation had the highest exposure intensity of the combination (type (b) in TABLE III.7). Σ_V was similarly approximated by short (lines E_s^i or E_s^j in TABLE III.7) or prolonged (lines E_k^i or E_k^j in TABLE III.7) simple exposures. D_I was globally better approximated by short exposures. V_{\max} and T_{\max} were globally better approximated by short exposures. All viral characteristics tended to be underestimated, except T_{\max} which tended to be highly overestimated in most cases.

Table III.7 Relative errors on the viral characteristics due to approximations of combined exposures by simple exposures. For each characteristic C among the total viral dose Σ_V , the infection duration D_I , the viral peak V_{\max} and the viral peak date T_{\max} , the relative error ΔC made when approximating a combined scenario E_{s+k}^{i+j} (first row) by a simple scenario E_m^l ($l \in \{i, j\}$ and $m \in \{s, k\}$, first column) with the same virulence level S_{vir} is given by : $\Delta C = [C(E_{s+k}^{i+j} - C(E_m^l))]/C(E_{s+k}^{i+j})$. So positive (respectively negative) errors correspond to underestimations (respectively overestimations) of C by the simple approximated scenarios. Rows (a), (b) and (c) denote the approximation type : (a) approximation obtained by neglecting a simple scenario of the combination ; (b) approximation by a simple scenario with a similar exposure intensity ; (c) approximation by the simple scenario of the combination with the highest exposure intensity, corresponding to both types (a) and (b). When ΔC depends on $k \in \{p_1, p_5\}$ or $S_{\text{vir}} \in \{S_1, S_2, S_3\}$, the value range is presented. The $\mathbf{0}$ value corresponds to an error < 0.05 . 144 approximations were computed for each characteristic.

$E_{s+k}^{i,j}$	$E_{s+k}^{L_1+L_1}$	$E_{s+k}^{L_4+L_4}$	$E_{s+k}^{L_6+L_6}$	$E_{s+k}^{L_4+L_1}$	$E_{s+k}^{L_1+L_4}$	$E_{s+k}^{L_6+L_1}$	$E_{s+k}^{L_1+L_6}$	$E_{s+k}^{L_6+L_4}$	$E_{s+k}^{L_4+L_6}$
Relative errors on the total viral dose $\Delta \Sigma_V$									
$-\frac{E_s^i}{-E_s^{\max(i,j)}} \text{ (a)}$	0.6	0.5	0.5	$\mathbf{0}$	$\frac{1.0}{\mathbf{0}}$	$\mathbf{0}$	$\frac{1.0}{\mathbf{0}}$	$\mathbf{0}$	$\frac{1.0}{\mathbf{0}}$
$-\frac{E_k^j}{-E_k^{\max(i,j)}} \text{ (b)}$									
$-\frac{E_k^j}{-E_k^{\max(i,j)}} \text{ (c)}$	[0.4, 0.5]	0.5	0.5	$\frac{1.0}{\mathbf{0}}$	$\mathbf{0}$	$\frac{1.0}{\mathbf{0}}$	$\mathbf{0}$	$\frac{1.0}{\mathbf{0}}$	$\mathbf{0}$
Relative errors on the infection duration ΔD_I									
$-\frac{E_s^i}{-E_s^{\max(i,j)}} \text{ (a)}$	[0, 0.2]	[0, 0.1]	[0, 0.1]	$\mathbf{0}$	$\frac{[0.2, 0.4]}{[0, 0.2]}$	$\mathbf{0}$	$\frac{[0.2, 0.5]}{[0, 0.1]}$	$\mathbf{0}$	$\frac{[0.1, 0.3]}{[0, 0.1]}$
$-\frac{E_k^j}{-E_k^{\max(i,j)}} \text{ (b)}$									
$-\frac{E_k^j}{-E_k^{\max(i,j)}} \text{ (c)}$	$\mathbf{0}$	$\mathbf{0}$	$\mathbf{0}$	$\frac{[0.1, 0.2]}{[-0.2, \mathbf{0}]}$	$\mathbf{0}$	$\frac{[0.1, 0.4]}{[-0.1, \mathbf{0}]}$	$\mathbf{0}$	$\frac{[0, 0.1]}{[-0.1, \mathbf{0}]}$	$\mathbf{0}$
Relative errors on the viral peak ΔV_{\max}									
$-\frac{E_s^i}{-E_s^{\max(i,j)}} \text{ (a)}$	$\mathbf{0}$	$\mathbf{0}$	$\mathbf{0}$	$\mathbf{0}$	$\frac{1.0}{[-2.9, -0.6]}$	$\mathbf{0}$	$\frac{1.0}{[-2.6, -0.5]}$	$\mathbf{0}$	$\frac{1.0}{[-2.6, -0.5]}$
$-\frac{E_k^j}{-E_k^{\max(i,j)}} \text{ (b)}$									
$-\frac{E_k^j}{-E_k^{\max(i,j)}} \text{ (c)}$	[0.6, 0.8]	[0.4, 0.7]	[0.3, 0.7]	$\frac{1.0}{[0.4, 0.7]}$	$\mathbf{0}$	$\frac{1.0}{[0.3, 0.7]}$	$\mathbf{0}$	$\frac{1.0}{[0.3, 0.7]}$	$\mathbf{0}$
Relative errors on the viral peak date ΔT_{\max}									
$-\frac{E_s^i}{-E_s^{\max(i,j)}} \text{ (a)}$	$\mathbf{0}$	$\mathbf{0}$	$\mathbf{0}$	$\mathbf{0}$	$\frac{0.9}{0.9}$	$\mathbf{0}$	$\frac{0.9}{0.9}$	$\mathbf{0}$	$\frac{0.9}{0.9}$
$-\frac{E_k^j}{-E_k^{\max(i,j)}} \text{ (b)}$									
$-\frac{E_k^j}{-E_k^{\max(i,j)}} \text{ (c)}$	[-11, -8]	[-11, -8]	[-11, -8]	$\frac{[-11, -8]}{[-11, -8]}$	$\mathbf{0}$	$\frac{[-11, -8]}{[-11, -8]}$	$\mathbf{0}$	$\frac{[-11, -8]}{[-11, -8]}$	$\mathbf{0}$

III.4 Discussion

III.4.1 Scope and limits of our approach

We studied the impact of exposure on PRRSv infection and immune dynamics by a modelling approach. Our results show that the exposure characteristics influence the within-host immune dynamics. The within-host immune dynamics determines the viral titer, which in turn determines the infectiousness of the infected pig. The infectiousness contributes to the exposure of susceptible pigs, together with the pig contact structure, and so the loop is closed. Consequently, within-host models need to take the exposure into account to represent the immune and viral dynamics correctly. Between-host models also need to take the exposure of susceptible animals into account to represent the pathogen transmission, which partly depends on the within-host dynamics of infected animals [1].

The simplest way to represent the exposure in a model is by way of a positive initial condition for the pathogen, *i.e.* a punctual exposure dose. Most studies used this approximation in experimental infections [4, 17], in within-host models of various viral infections [3], or in immuno-epidemiological models [1, 47–50]. These theoretical or applied immuno-epidemiological models aim at modelling the pathogen spread while taking into account the host response to the infection. They mainly pertain to the “nested approach”, in which an immunological model is linked to an epidemiological model as follows : the epidemiological model includes a time-since-infection structure for the infected individuals, which corresponds to the time variable of the immunological model ; moreover, some parameters of the epidemiological model depend on the within-host variables (*e.g.* the transmission rate depends on the viral titer). Only few published immuno-epidemiological models represent the exposure as a time-dependent function related to the viral titer of infected individuals in contact [51].

We represented the exposure by bell-shaped functions characterised by their duration and intensity, the latter corresponding to the total viral dose received through exposure. A narrow bell-shaped function is quite an obvious choice to represent an experimental inoculum. Representing repeated contacts with infected individuals by such a smooth function is an approximation that we deemed reasonable, given the high frequency of contacts within a batch. To calibrate our functions, we used reported experimental inoculation doses for the short exposures [13]. It was less obvious for the prolonged exposures. Indeed, directly quantifying PRRSv exposure by contacts in either experimental or natural conditions seems rather difficult. So we assumed that exposure was related to the infectiousness of the contact animals and hence strongly correlated with their viremia. This assumption was based on experimental protocols which followed primary infections occurring by contacts with an inoculated animal, conducted for PRRSv [16].

PRRSv strain virulence has an impact on the within-host dynamics. The gradient of virulence we explored in this study produced realistic results, in the sense that they were consistent with the variation range observed in the literature (details in the Results section). Strain virulence and host susceptibility tend to influence the same immune mechanisms (for instance viral excretion), so our results would still hold for various host susceptibilities : the impact of a more virulent strain would correspond to the response of a more susceptible pig [19].

We simulated the infection of PRRSv-naive pigs at the post-weaning stage. Infection of post-weaners was shown to have a strong impact on PRRSv spread at the herd level [6]. However, if we wanted to take reinfections of older pigs into account, we would need to adapt our model and represent the memory response, which confers a certain protection against reinfection and is determined by the activation and orientation of the adaptive response.

III.4.2 Exposure has an impact on PRRSv spread

Reducing the pig infectiousness should limit PRRSv spread. The infectiousness depends on the infection duration and severity (linked to the total viral dose). Besides, PRRSv most severe infections can result in the death of the pig. So the infection duration and severity are two descriptors of particular interest.

At the within-host scale, our main results involving these descriptors were in agreement with experimental PRRSv infection results : (i) the level of pro-inflammatory cytokines was positively correlated with the infection severity [39, 46] ; (ii) short infection durations were associated with the dominance of the cellular response over the humoral response (for a given strain virulence) [7, 8, 12, 14] ; (iii) the cytolysis and viral neutralisation exhibited a low influence on the infection resolution and were inefficient to reduce PRRSv infection severity [7, 8, 12, 14].

Exploring the impact of exposure characteristics on these descriptors, we exhibited more original results. We found that the infection severity was fully determined by the exposure intensity. The infection duration increased with the strain virulence and, for a given strain virulence, it exhibited a positive linear correlation with the logarithm of the exposure intensity and the exposure duration. Whatever the exposure and strain virulence, the infection duration decreased while the percentage of antiviral cytokines increased. These results are consistent with an experimental study on influenza, which found that the exposure dose influenced the infection dynamics *via* the antiviral cytokines [4]. Consequently, an estimate of the viral dose received through exposure should be enough to infer the infection severity. However, to predict the infection duration, one would also need to know the exposure duration and the strain virulence. The exposure intensity and duration hence affect the pig infectiousness, which is also modulated by the strain virulence.

III.4.3 When and how to take PRRSv exposure into account ?

In PRRSv experimental infection of non-isolated pigs, the exposure due to contacts between inoculated pigs is often considered as negligible. However, there is no study which compares the within-host dynamics of isolated and non-isolated inoculated pigs. We used our model to weigh up this hypothesis. For each virulence level and each inoculum dose, we compared a short exposure scenario, representing the inoculum, with exposure scenarios combining this short exposure with several prolonged exposures, representing contacts. When the exposure intensity due to contacts was lower than the inoculum dose, the infection duration and severity were similar for the short and combined scenarios. When the exposure intensity due to contacts exceeded the inoculum dose, these viral characteristics became notably higher for the combined scenarios. Experimental studies showed that the higher the PRRSv strain virulence, the higher the infectiousness of infected pigs [13, 16]. Moreover, we showed here and in [19] that higher strain virulences induced longer infections. Therefore, an experimental inoculation of non-isolated pigs with a highly virulent strain should result in a high exposure by contacts. The within-host dynamics of pigs inoculated with the same dose of a highly virulent strain, in particular their estimated infection duration and severity, would then be notably higher for non-isolated pigs than for isolated pigs.

In modelling approaches and particularly for immuno-epidemiological models, exposure is a key issue. Most models approximate the exposure by a punctual dose and do not further investigate its impact. We chose to study the impact of exposure by varying the characteristics of a given exposure function (a bell-shaped function). We found that the exposure intensity (the total viral dose received through exposure) and to a lesser extent the exposure duration and

peak had a strong impact on the within-host dynamics, which could vary according to PRRSv strain virulence. Fixing the exposure intensity, we looked at the impact of the exposure duration and peak.

Firstly, from our results on simple exposure scenarios, we deduced that approximating a prolonged exposure by a short exposure with the same exposure intensity would result in (i) a good estimation of the infection severity; (ii) an underestimation of the infection duration; and (iii) an overestimation of the viral peak and an underestimation of the viral peak date. Obviously, when approximating a prolonged exposure by short exposure, the higher the exposure duration of the prolonged exposure, the worse the errors on the within-host dynamics. As our short exposure function is a narrow bell-shaped curve, similar errors would be expected when approximating the exposure by a punctual exposure dose (initial condition).

Secondly, comparing combined exposure scenarios and simple scenarios, we showed that a short exposure was a better approximation for the viral peak and its date, whereas a prolonged exposure was a better approximation for the infection duration. The infection severity was similarly underestimated with both approximations. The approximated exposure duration would then be chosen according to which viral characteristics we would want to estimate best.

To conclude, a good approximation of the exposure should at least preserve the exposure intensity, especially to estimate the infection severity. Besides, representing the exposure due to contacts by a short or even a punctual exposure would tend to underestimate the infection duration. As the infection severity and duration both contribute to the pig infectiousness, a prolonged exposure of the adequate intensity would probably be an adequate choice in an immuno-epidemiological context.

References

- [1] STEINMEYER S.H., WILKE C.O., PEPIN K.M., 2010. Methods of modelling viral disease dynamics across the within-and between-host scales : the impact of virus dose on host population immunity. *Philos T. R. Soc. B* **365**(1548) :1931–1941. doi:10.1098/rstb.2010.0065.
- [2] HELLRIEGEL B., 2001. Immunoepidemiology – bridging the gap between immunology and epidemiology. *Trends Parasitol.* **17**(2) :102–106. doi:10.1016/S1471-4922(00)01767-0.
- [3] LI Y., HANDEL A., 2014. Modeling inoculum dose dependent patterns of acute virus infections. *J. Theor. Biol.* **347** :63–73. doi:10.1016/j.jtbi.2014.01.008.
- [4] MAROIS I., CLOUTIER A., GARNEAU É., RICHTER M.V., 2012. Initial infectious dose dictates the innate, adaptive, and memory responses to influenza in the respiratory tract. *J. Leukocyte Biol.* **92**(1) :107–121. doi:10.1189/jlb.1011490.
- [5] DARWICH L., DÍAZ I., MATEU E., 2010. Certainties, doubts and hypotheses in porcine reproductive and respiratory syndrome virus immunobiology. *Virus Res.* **154**(1-2) :123–132. doi:10.1016/j.virusres.2010.07.017.
- [6] ZIMMERMAN J., BENFIELD D.A., MURTAUGH M.P., OSORIO F., STEVENSON G.W., TORREMORELL M., 2006. Porcine reproductive and respiratory syndrome virus (porcine arterivirus). In *Diseases of swine*, edited by B.E. STRAW, J.J. ZIMMERMAN, S. D'ALLAIRE, D.L. TAYLOR, Blackwell (Oxford, UK), 9th edn., chap. 24, pp. 387–418.
- [7] KIMMAN T.G., CORNELISSEN L.A., MOORMANN R.J., REBEL J.M.J., STOCKHOFER-ZURWIJEDEN N., 2009. Challenges for porcine reproductive and respiratory syndrome virus (PRRSV) vaccinology. *Vaccine* **27**(28) :3704–3718. doi:10.1016/j.vaccine.2009.04.022.
- [8] MURTAUGH M.P., GENZOW M., 2011. Immunological solutions for treatment and prevention of porcine reproductive and respiratory syndrome (PRRS). *Vaccine* **29**(46) :8192–8204. doi:10.1016/j.vaccine.2011.09.013.
- [9] MONDACA-FERNÁNDEZ E., MEYNS T., MUÑOZ-ZANZI C., TRINCADO C., MORRISON R.B., 2007. Experimental quantification of the transmission of Porcine reproductive and respiratory syndrome virus. *Can. J. Vet. Res.* **71**(2) :157.
- [10] NODELIJK G., NIELEN M., DEJONG M.C.M., VERHEIJDEN J.H.M., 2003. A review of porcine reproductive and respiratory syndrome virus in Dutch breeding herds : population dynamics and clinical relevance. *Prev. Vet. Med.* **60** :37–52. doi:10.1016/S0167-5877(03)00081-3.
- [11] HICKSON R.I., ROBERTS M.G., 2014. How population heterogeneity in susceptibility and infectivity influences epidemic dynamics. *J. Theor. Biol.* **350** :70–80. doi:10.1016/j.jtbi.2014.01.014.
- [12] THANAWONGNUWECH R., SURADHAT S., 2010. Taming PRRSV : Revisiting the control strategies and vaccine design. *Virus Res.* **154**(1-2) :133–140. doi:10.1016/j.virusres.2010.09.003.
- [13] JOHNSON W., ROOF M., VAUGHN E., CHRISTOPHER-HENNINGS J., JOHNSON C.R., MURTAUGH M.P., 2004. Pathogenic and humoral immune responses to porcine reproductive and respiratory syndrome virus (PRRSV) are related to viral load in acute infection. *Vet. Immunol. Immunop.* **102**(3) :233–247. doi:10.1016/j.vetimm.2004.09.01.

- [14] LUNNEY J.K., CHEN H., 2010. Genetic control of host resistance to porcine reproductive and respiratory syndrome virus (PRRSV) infection. *Virus Res.* **154**(1–2) :161–169. doi: [10.1016/j.virusres.2010.08.004](https://doi.org/10.1016/j.virusres.2010.08.004).
- [15] REINER G., FRESEN C., BRONNERT S., WILLEMS H., 2009. Porcine reproductive and respiratory syndrome virus (PRRSV) infection in wild boars. *Vet. Microbiol.* **136**(3) :250–258. doi: [10.1016/j.vetmic.2008.11.023](https://doi.org/10.1016/j.vetmic.2008.11.023).
- [16] CHARPIN C., MAHÉ S., KERANFLEC'H A., BELLOC C., CARIOLET R., LE POTIER M.F., ROSE N., 2012. Infectiousness of pigs infected by the porcine reproductive and respiratory syndrome virus (PRRSV) is time-dependent. *Vet. Res.* **43**(1) :69. doi: [10.1186/1297-9716-43-69](https://doi.org/10.1186/1297-9716-43-69).
- [17] HERMANN J.R., MUNOZ-ZANZI C.A., ROOF M.B., BURKHART K., ZIMMERMAN J.J., 2005. Probability of porcine reproductive and respiratory syndrome (PRRS) virus infection as a function of exposure route and dose. *Vet. Microbiol.* **110**(1) :7–16. doi: [10.1016/j.vetmic.2005.06.012](https://doi.org/10.1016/j.vetmic.2005.06.012).
- [18] YOON K.J., ZIMMERMAN J.J., CHANG C.C., CANCEL-TIRADO S., HARMON K.M., MCGINLEY M.J., 1999. Effect of challenge dose and route on porcine reproductive and respiratory syndrome virus (PRRSV) infection in young swine. *Vet. Res.* **30**(6) :629–638.
- [19] GO N., BIDOT C., BELLOC C., TOUZEAU S., 2014. Integrative model of the immune response to a pulmonary macrophage infection : what determines the infection duration ? *PLoS ONE* **9**(9) :e107818. doi: [10.1371/journal.pone.0107818](https://doi.org/10.1371/journal.pone.0107818).
- [20] DOESCHL-WILSON A.B., KYRIAZAKIS I., VINCENT A., ROTHSCHILD M.F., THACKER E., GALINA-PANTOJA L., 2009. Clinical and pathological responses of pigs from two genetically diverse commercial lines to porcine reproductive and respiratory syndrome virus infection. *J. Anim. Sci.* **87** :1638–1647. doi: [10.2527/jas.2008-1447](https://doi.org/10.2527/jas.2008-1447).
- [21] BEAUCHEMIN C., HANDEL A., 2011. A review of mathematical models of influenza A infections within a host or cell culture : lessons learned and challenges ahead. *BMC Public Health* **11**. doi: [10.1186/1471-2458-11-S1-S7](https://doi.org/10.1186/1471-2458-11-S1-S7).
- [22] DOBROVOLNY H.M., REDDY M.B., KAMAL M.A., RAYNER C.R., BEAUCHEMIN C.A.A., 2013. Assessing mathematical models of influenza infections using features of the immune response. *PLoS ONE* **8**(2) :e57088. doi: [10.1371/journal.pone.0057088](https://doi.org/10.1371/journal.pone.0057088).
- [23] SMITH A.M., PERELSON A.S., 2011. Influenza A virus infection kinetics : quantitative data and models. *Wiley Interdiscip. Rev. Syst. Biol. Med.* **3**(4) :429–445. doi: [10.1002/wsbm.129](https://doi.org/10.1002/wsbm.129).
- [24] GAMMACK D., GANGULI S., MARINO S., SEGOVIA-JUAREZ J., KIRSCHNER D., 2005. Understanding the immune response in tuberculosis using different mathematical models and biological scales. *Multiscale Model. Sim.* **3**(2) :312–345. doi: [10.1137/040603127](https://doi.org/10.1137/040603127).
- [25] MARINO S., LINDERMAN J.J., KIRSCHNER D.E., 2011. A multifaceted approach to modeling the immune response in tuberculosis. *Wiley Interdiscip. Rev. Syst. Biol. Med.* **3**(4) :479–489. doi: [10.1002/wsbm.131](https://doi.org/10.1002/wsbm.131).
- [26] MARINO S., MYERS A., FLYNN J.L., KIRSCHNER D.E., 2010. TNF and IL-10 are major factors in modulation of the phagocytic cell environment in lung and lymph node in tuberculosis : A next-generation two-compartmental model. *J. Theor. Biol.* **265**(4) :586–598. doi: [10.1016/j.jtbi.2010.05.012](https://doi.org/10.1016/j.jtbi.2010.05.012).

- [27] WIGGINTON J.E., KIRSCHNER D., 2001. A model to predict cell-mediated immune regulatory mechanisms during human infection with *Mycobacterium tuberculosis*. *J. Immunol.* **166** :1951–1967.
- [28] Scilab. Open source software for numerical computation.
<http://www.scilab.org/>
- [29] MURTAUGH M.P., 2005. PRRSV/host interaction. In *PRRS fatti vs speculazioni*, Università degli Studi di Parma, Dipartimento di Salute Animale (Parma, Italy), pp. 73–80.
http://medvet.unipr.it/cgi-bin/campusnet/documenti.pl/Show?_id=7d0d
- [30] GÓMEZ-LAGUNA J., SALGUERO F.J., PALLARÉS F.J., CARRASCO L., 2013. Immunopathogenesis of porcine reproductive and respiratory syndrome in the respiratory tract of pigs. *Vet. J.* **195**(2) :148–155. doi:10.1016/j.tvjl.2012.11.012.
- [31] GIMENO M., DARWICH L., DÍAZ I., DE LA TORRE E., PUJOLS J., MARTIN M., INUMARU S., CANO E., DOMÍNGO M., MONTOYA M., MATEU E., 2011. Cytokine profiles and phenotype regulation of antigen presenting cells by genotype-I porcine reproductive and respiratory syndrome virus isolates. *Vet. Res.* **42**(9). doi:10.1186/1297-9716-42-9.
- [32] MURTAUGH M.P., 2004. PRRS immunology : what are we missing? In *35th Annual Meeting of the American Association of Swine Veterinarians*, Des Moines, Iowa, USA, pp. 359–367.
- [33] YOO D., SONG C., SUN Y., DU Y., KIM O., LIU H.C., 2010. Modulation of host cell responses and evasion strategies for porcine reproductive and respiratory syndrome virus. *Virus Res.* **154**(1–2) :48–60. doi:10.1016/j.virusres.2010.07.019.
- [34] SALTELLI A., CHAN K., SCOTT E.M. (eds.) 2000. *Sensitivity analysis*. Wiley Series in Probability and Statistics. Wiley (Chichester, UK).
- [35] LAMBONI M., MONOD H., MAKOWSKI D., 2011. Multivariate sensitivity analysis to measure global contribution of input factors in dynamic models. *Reliab. Eng. Syst. Safe.* **96**(4) :450–459. doi:10.1016/j.ress.2010.12.002.
- [36] `multisensi` : Multivariate sensitivity analysis. An R package to perform sensitivity analysis on a model with multivariate outputs.
<http://cran.r-project.org/web/packages/multisensi/index.html>
- [37] The R project for statistical computing.
<http://www.r-project.org>
- [38] LABARQUE G., VAN GUCHT S., NAUWYNCK H., VAN REETH K., PENSART M., 2003. Apoptosis in the lungs of pigs infected with porcine reproductive and respiratory syndrome virus and associations with the production of apoptogenic cytokines. *Vet. Res.* **34** :249–260. doi:10.1051/vetres:2003001.
- [39] GÓMEZ-LAGUNA J., SALGUERO F., PALLARÉS F., FERNÁNDEZ DE MARCO M., BARRANCO I., CERÓN J., MARTÍNEZ-SUBIELA S., VAN REETH K., CARRASCO L., 2010. Acute phase response in porcine reproductive and respiratory syndrome virus infection. *Comp. Immunol. Microb.* **33**(6) :e51–e58. doi:10.1016/j.cimid.2009.11.003.
- [40] AIT-ALI T., WILSON A.D., CARRÉ W., WESTCOTT D.G., FROSSARD J.P., MELLENCAMP M.A., MOUZAKI D., MATIKA O., WADDINGTON D., DREW T.W., BISHOP S.C., ARCHIBALD A.L., 2011. Host inhibits replication of European porcine reproductive and respiratory syndrome virus in macrophages by altering differential regulation of type-I interferon transcriptional responses. *Immunogenetics* **63**(7) :437–448. doi:10.1007/s00251-011-0518-8.

- [41] WESLEY D.R., LAGER K.M., KEHRLI M.E., 2006. Infection with porcine reproductive and respiratory syndrome virus stimulates an early gamma interferon response in the serum of pig. *Can. J. Vet. Res.* **70**(3) :176–182.
- [42] LABARQUE G.G., NAUWYNCK H.J., VAN REETH K., PENSAERT M.B., 2000. Effect of cellular changes and onset of humoral immunity on the replication of porcine reproductive and respiratory syndrome virus in the lungs of pigs. *J. Gen. Virol.* **81**(5) :1327–1334.
- [43] LIU Y., SHI W., ZHOU E., WANG S., HU S., CAI X., RONG F., WU J., XU M., XU M., LI L., 2010. Dynamic changes in inflammatory cytokines in pigs infected with highly pathogenic porcine reproductive and respiratory syndrome virus. *Clin. Vaccine Immunol.* **17**(9) :1439–1445. doi:10.1128/CVI.00517-09.
- [44] PETRY D.B., LUNNEY J., BOYD P., KUCHAR D., BLANKENSHI E., JOHNSON R.K., 2007. Differential immunity in pigs with high and low responses to porcine reproductive and respiratory syndrome virus infection. *J. Anim. Sci.* **85** :2075–2092. doi:10.2527/jas.2006-721.
- [45] ALBINA E., PIROU L., HUTET E., CARIOLET R., L'HOSPITALIER R., 1998. Immune response in pigs infected with porcine reproductive and respiratory syndrome virus (PRRSV). *Vet. Immunol. Immunop.* **61** :49–66. doi:10.1016/S0165-2427(97)00134-7.
- [46] VAN REETH K., NAUWYNCK H., 2000. Proinflammatory cytokines and viral respiratory disease in pigs. *Vet. Res.* **31**(2) :187–213. doi:10.1051/vetres:2000113.
- [47] PEPIN K.M., VOLKOV I., BANAVAR J.R., WILKE C.O., GRENFELL B.T., 2010. Phenotypic differences in viral immune escape explained by linking within-host dynamics to host-population immunity. *J. Theor. Biol.* **265**(4) :501–510. doi:10.1016/j.jtbi.2010.05.036.
- [48] MIDEO N., ALIZON S., DAY T., 2008. Linking within-and between-host dynamics in the evolutionary epidemiology of infectious diseases. *Trends Ecol. Evol.* **23**(9) :511–517. doi:10.1016/j.tree.2008.05.009.
- [49] MARTCHEVA M., 2011. An immuno-epidemiological model of paratuberculosis. *AIP Conf. Proc.* **1404**(1) :176–183. doi:10.1063/1.3659918. In *Application of Mathematics in Technical and Natural Sciences : 3rd International Conference AMiTaNS'11 : Albena, Bulgaria, 20-25 June 2011* ; edited by Todorov M.D. and Christov C.I.
- [50] GANDOLFI A., PUGLIESE A., SINISGALLI C., 2014. Epidemic dynamics and host immune response : a nested approach. *J. Math. Biol.* doi:10.1007/s00285-014-0769-8. Online.
- [51] KOSTOVA T., 2007. Persistence of viral infections on the population level explained by an immunoepidemiological model. *Math. Biosci.* **206**(2) :309–319. doi:10.1016/j.mbs.2005.08.003.

Chapitre IV

Towards an exploration of vaccine efficiency *in silico*

Contents

IV.1 Introduction	129
IV.2 Model description	131
IV.2.1 Overview of the within-host dynamics	131
IV.2.2 Cytokine regulations	137
IV.2.3 Antigen presenting cells	137
IV.2.3.1 Macrophages	138
IV.2.3.2 Dendritic cells	139
IV.2.4 Free viral particles	141
IV.2.5 Helper T cells	141
IV.2.6 Cytotoxic cells	143
IV.2.6.1 Natural killers	143
IV.2.6.2 Cytotoxic T cells	143
IV.2.7 B lymphocytes and antibodies	143
IV.2.7.1 B cells	144
IV.2.7.2 Antibodies	144
IV.2.8 Cytokines	145
IV.2.8.1 Pro-inflammatory cytokines	147
IV.2.8.2 Antiviral cytokines	147
IV.2.8.3 Immuno-regulatory cytokines	148
IV.3 Model validation and numerical exploration	149
IV.3.1 Reference scenario	149
IV.3.1.1 Calibration method	149
IV.3.1.2 Simulations	149
IV.3.1.3 Within-host dynamics	153
IV.3.1.4 On/off immune mechanisms	155
IV.3.2 Exposure and virulence scenarios	156
IV.3.2.1 Scenario definition	156
IV.3.2.2 Results and discussion	158
IV.4 Within-host dynamics of a vaccinated pig after PRRSv exposure	162

IV.4.1	Vaccination strategy	162
IV.4.1.1	Immune protection induced by vaccination	162
IV.4.1.2	Current PRRSv vaccines	162
IV.4.1.3	Vaccination scenarios	163
IV.4.2	Results	165
IV.4.2.1	Viral dynamics	165
IV.4.2.2	Immune response determining the infection resolution	168
IV.5	Discussion	173
IV.5.1	Modelling approach	173
IV.5.2	Vaccine efficiency: preliminary results	174
IV.5.2.1	Immune protection induced by vaccination	174
IV.5.2.2	Within-host dynamics of vaccinated pigs after PRRSv exposure	174
References	177

IV.1 Introduction

Vaccination is the main control strategy used to limit PRRSV infection severity and PRRSV spread [1]. However, no commercial PRRSV vaccine provides a complete protection against PRRSV infection. Vaccines only reduce the infection severity and duration and so PRRSV shedding at the between-host scale [1, 2]. Several recent studies reviewed current knowledge and knowledge gaps that may be relevant for the development of efficient vaccines [1–6]. The main barriers for the development of efficient vaccines include a partial understanding of the immune response to PRRSV, the high diversity of PRRSV strains in field conditions and the high variability of within-host dynamics depending on PRRSV strain and host susceptibility. Consequently, the exploration of vaccine efficiency and the identification of conditions needed for vaccines to have an effect on the immune response are the main challenge for PRRSV control [1, 2, 4, 7].

PRRSV vaccination frequently consists in an inoculation by a more or less modified hypovirulent PRRSV strain to induce an immune response with limited pathogenic effects. During the induced immune response, the adaptive effectors and antibodies partly differentiate into memory components (memory T cells and memory B cells). Memory components have a long lifetime and exhibit no immune functions until they are activated by PRRSV exposure (Section I.1.5). Depending on the memory component titers induced by vaccination, vaccines exhibit variable levels of pig protection against PRRSV infection. Consequently, the immune mechanisms protecting against the viral replication in pigs should be identified and activated by vaccines [6]. Vaccines that can induce strong cross-protective cellular adaptive immunity should have benefits on the reduction of viraemia and PRRSV-induced clinical signs; they should also improve the pig general health condition by reducing secondary complications related to PRRSV-induced immunodeficiency [2].

The immune response induced by PRRSV infection is only partially effective, although the mechanisms responsible for this ineffective response are still unknown. Improving the immune response efficiency remains a challenge [1–6]. Whatever the pathogen, the main immune mechanisms promoting pathogen clearance are (i) a cytokine synthesis orientated more towards antiviral cytokines (including IFN_α , TNF_α and IFN_γ) than immuno-modulatory cytokines (including IL_{10} , TGF_β and IL_4); (ii) a high infected cell destruction by cytotoxic lymphocytes and natural killers; and (iii) a high viral neutralisation by antibodies. PRRSV induces an altered innate response, with (i) a low inflammation, (ii) a cytokine synthesis orientated more towards immuno-modulatory than antiviral cytokines and (iii) a high target cell permissiveness. This impaired innate response could play an important role in the poor, delayed and altered adaptive response and in the prolonged PRRSV infection duration [1–6]. Indeed, the adaptive response is characterised by an orientation towards the humoral response (so low titers of cytotoxic T cells and adaptive antiviral cytokines) associated with high syntheses of immuno-modulatory cytokines but low titers of neutralising antibodies. Given these findings, efficient vaccines would need to induce (i) a better immediate innate response, (ii) higher levels of antiviral cytokines and lower levels of immuno-modulatory cytokines and (iii) higher levels of neutralising antibodies and cytotoxic cells [1–3]. However, experimental studies resulted in controversial conclusions about the influence of these mechanisms on the infection resolution and protection, which are described below.

Antiviral *v.s.* immuno-modulatory cytokines PRRSV infections by virulent or attenuated strains showed no correlation between the IL_{10} levels and the infection duration [1]. The induction of regulatory T cells (the major TGF_β -producing cells) during the early stages of infection is considered as one of the mechanisms that establish prolonged infection durations [1, 3]. However, up to now, no correlation between TGF_β and the viremia has been demonstrated

for PRRSv [8]. Reviews suggest that the suppression of IFN_γ may have little influence on the *in vivo* disease progression [1, 9]. Vaccines promoting the synthesis of antiviral cytokines or minimising IL_{10} production were experimented, but their protective effect was not convincing [1, 2, 7].

Cytotoxic T cells A PRRSv vaccine that induced high cytotoxic T cells protected pigs against viraemia [10]. However, it seems that the cellular response alone cannot curtail the infection. Long-term persistence of the virus in the host associated with a strong cellular response were observed [3]. Under field conditions, cytotoxic T cell titers that developed after vaccination resulted in a partial protection [11]. Moreover, correlations between the strength of the cellular response and PRRSv infection duration were highly variable between hosts and strains [12].

Neutralising antibodies The protection provided by neutralising antibodies is debated [1, 3, 8]. Several papers suggest that clearance of viraemia and high neutralising antibody titers are not necessarily correlated [10, 13], while others [14, 15] suggest that they are [1, 8]. Some studies showed that the pig protection against re-infection increased with the neutralising antibody titer [15]. Most current vaccines result in high levels of neutralising antibodies, but offer only a partial protection upon challenge [1, 3, 8].

In this context, exploring vaccine efficiency by a within-host model that describes the immune mechanisms impacted by vaccination should overcome the current field limitations and lead to new insights.

We developed a lung-based model of PRRSv infection and immune dynamics to PRRSv in the lung [16] (Appendix A). This lung-based model represents the activation of the adaptive response and its orientation towards the cellular, humoral and regulatory responses, but does not detail the adaptive response activation process and the various adaptive components enough to test vaccine strategies. Published immunological models on other pathogens targeting APC were not adapted either (Section I.2). Consequently, we extended our lung-based model to represent PRRSv infection in the main infection sites, *i.e.* lungs and lymph nodes, by adding (i) the dendritic cells, which are the main antigen presenting cells, as well as PRRSv secondary target cells, and (ii) the main components of the three orientations of the adaptive immune response. The main strengths of this within-host model are the integration of :

- the interactions between PRRSv and its target cells, *i.e.* macrophages and dendritic cells ;
- the activation of the adaptive response by the dendritic cells ;
- the orientation of the adaptive response towards the cellular, humoral and regulatory responses, depending on the cytokine environment ;
- key immune functions, including the phagocytosis by macrophages, cytolysis by cytotoxic lymphocytes and natural killers, viral neutralisation by neutralising antibodies, marking of viral particles and infected cells by marker antibodies, cytokine syntheses and regulations.

Our aims are (i) to simulate the immune response induced by current vaccines and the protection they confer ; (ii) to identify which conditions an efficient vaccine would have to fulfil to protect the host from PRRSv infection. The within-host model we propose here can address these issues. However, due to the scarcity and partialness of data, it was not obvious to calibrate the model, especially the impact of current vaccines. So we conducted a more theoretical study to illustrate our model potential, aiming at simulating the within-host dynamics of a vaccinated pig after PRRSv exposure. This study consists of two steps. Firstly, we simulated the immune dynamics induced by an attenuated live virus vaccine, represented in the model as an infection by an hypovirulent and non-pathogenic PRRSv strain. We used this simulation to initialise the

immune state of a vaccinated host, in terms of memory B and T cells, as well as antibodies. Secondly, we exposed the vaccinated host to PRRSv and assessed the vaccine efficiency.

In this chapter, we first describe the mathematical within-host model in some details (Section IV.2). Then we calibrate and validate the model (Section IV.3) by (i) defining a reference scenario and checking its behaviour against the literature and expected dynamic features (Section IV.3.1); and (ii) to explore the model behaviour for various exposure functions (two durations and three intensities) crossed with three levels of strain virulence (Section IV.3.2). Finally, we present our vaccination study (Section IV.4) : firstly the vaccination strategy (Section IV.4.1) and secondly the results obtained when challenging a vaccinated pig with PRRSv (Section IV.4.2). We tested two sets of initial conditions corresponding to two activation levels of the memory response by a given vaccine. We explored the efficiency of these two vaccines crossed with three virulence levels, two PRRSv exposure durations and three PRRSv exposure intensities.

IV.2 Model description

The model represents the within-host infection and immune dynamics induced by a primary PRRSv infection in a PRRSv-naive pig. We assume that the pig is weaned and has no maternal antibodies, so we can neglect passive immunity. Active immunity induced by vaccination is introduced later in Section IV.4, so we do not explicitly represent the memory response in this model.

The model is derived from our lung-based model [16] (Appendix A), which focuses on the macrophage–virus interactions and highly details the innate immune response and cytokine regulations. The adaptive immune response is less detailed in the lung-based model, but it represents the cellular, humoral and regulatory orientations and their main functions. In this within-host dynamic model, we include the adaptive effectors and detail the intermediate steps of the adaptive response orientation, their regulations and their immune functions.

We start our model description by an overview of the within-host dynamics (Section IV.2.1) which is illustrated in FIGURE IV.1 and synthesised in TABLE IV.1. Then we detail the model components. We first present how the cytokine regulations are formalised (Section IV.2.2). Then we describe the dynamics of the state variables : the antigen presenting cells (Section IV.2.3), consisting of macrophages (Section IV.2.3.1) and dendritic cells (Section IV.2.3.2); the free viral particles (Section IV.2.4); the T cells (Section IV.2.5); the cytotoxic cells (Section IV.2.6, consisting of natural killers (Section IV.2.6.1) and cytotoxic T cells (Section IV.2.6.2); the B lymphocytes (Section IV.2.7.1) and antibodies (Section IV.2.7.2); and finally the cytokines (Section IV.2.8) grouped by function, *i.e.* pro-inflammatory (Section IV.2.8.1), antiviral (Section IV.2.8.2) and immuno-regulatory (Section IV.2.8.3) cytokines.

IV.2.1 Overview of the within-host dynamics

The model hypotheses are based on current knowledge on the immune response to respiratory pathogens, reviewed in [17–24], and on PRRSv specificities, reviewed in [1–4, 12, 25, 26].

The model is characterised by 28 state variables, described in TABLE IV.1 :

- the free viral particles (V);
- nine effectors of the innate response, composed of three macrophage states (susceptible M_s , phagocytosing M_p and infected M_i); three states for conventional dendritic cells (susceptible

- D_s^c , mature D_m^c and infected D_i^c); two states for plasmacytoid dendritic cells (susceptible D_s^p and mature D_m^p); and the activated natural killers (NK);
- six effectors of the adaptive response, composed of three T cell states (type 1 helper T_{h1} , type 2 helper T_{h2} and regulatory T_{reg} T cells); the cytotoxic T cells (T_c); and two B lymphocyte states, producing IgM and IgG antibodies (B_{MG}) and producing IgA antibodies (B_A);
 - two functional types of antibodies, consisting of neutralising (A_N) and marker (A_M) antibodies;
 - ten cytokines, consisting of the major pro-inflammatory cytokines (P_i : $IL_{1\beta}$, IL_6 , IL_8); the antiviral cytokines ($\%(A_i+IFN_\gamma)$), composed of innate (A_i : TNF_α , IFN_α and adaptive (IFN_γ) cytokines; the major immuno-regulatory cytokines (IL_{12} , IFN_γ , IL_{10} , IL_4 , TGF_β).

We chose a deterministic continuous time dynamic framework. Our model is hence composed of a set of 28 ordinary differential equations, which represent the evolution over time of the state variables. The main processes that drive their evolution over time and that are integrated in the model are : the macrophage and dendritic cell infection by the virus; the excretion of free viral particles by the infected cells; the phagocytosis of viral particles by the macrophages, resulting in viral destruction; the activation of the adaptive response by dendritic cells and macrophages; the neutralisation of free viral particles by the neutralising antibodies; the marking of free viral particles and infected cells by the marker antibodies; the destruction of infected cells by the cytotoxic lymphocytes and the natural killers; the recruitment, activation and decay/migration of the innate effectors; the activation, proliferation and decay/migration of the adaptive effectors; the cytokine syntheses by the effectors and the cytokine decay; the cytokine regulations. These mechanisms are illustrated in [FIGURE IV.1](#) and synthesised in [TABLE IV.1](#).

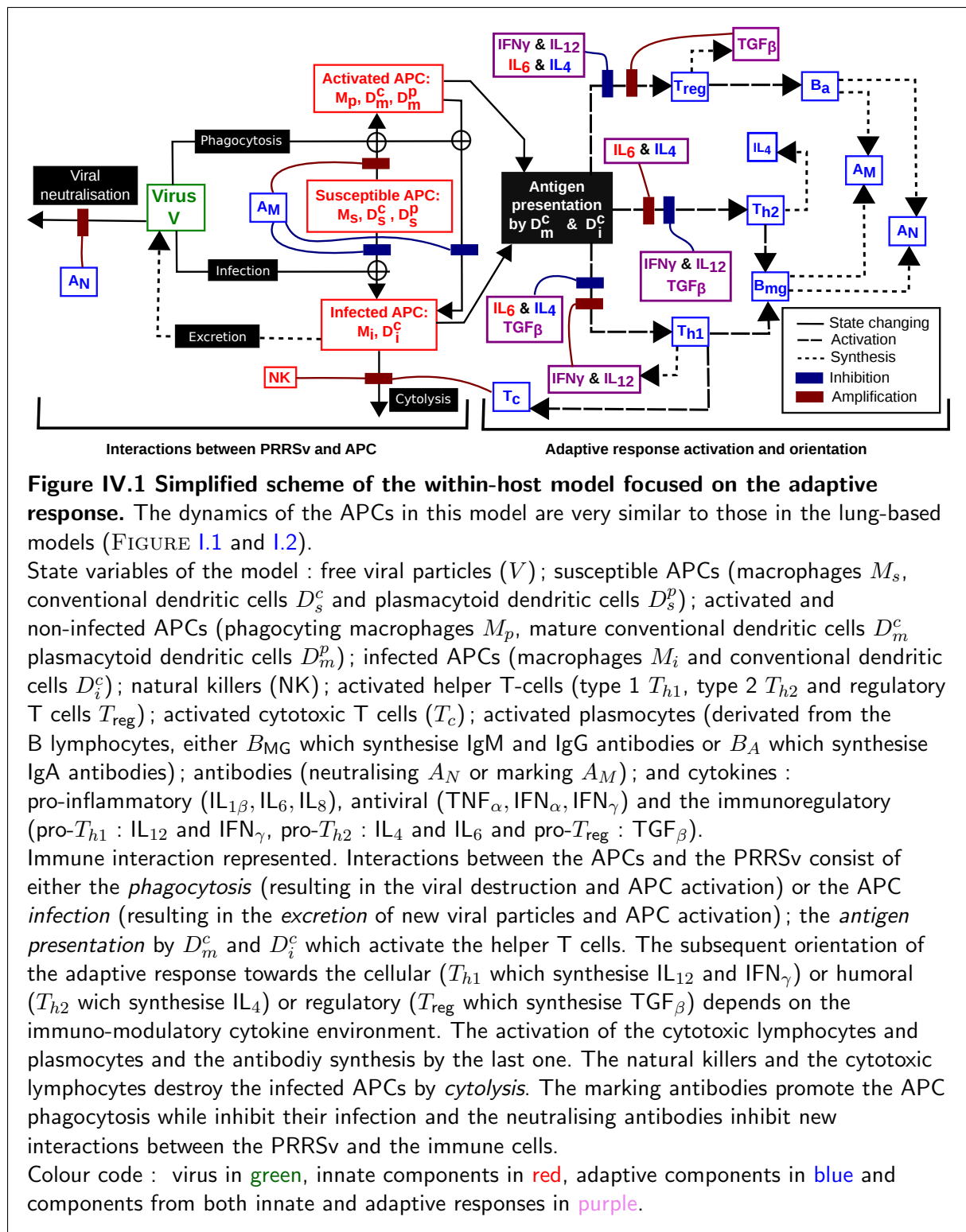

Table IV.1 Overview of PRRSv within-host model.

State variables	Immune functions & dynamics
Virus	
\bar{V} free viral particles	phagocytosed by M_s, M_p, D_s^c, D_m^c and D_s^p (rates η); infection of M_s, M_p, D_s^c, D_m^c (rates β), replication in infected cells (rate e), neutralised by neutralising antibodies A_N (rate μ_V^{ad})
Antigen presenting cells	
\bar{M} Macrophages	Recruitment (rates R) amplified by pro-inflammatory cytokines, natural decay (rates μ^{nat}), apoptosis induced by TNF_α (rates μ^{inf})
\bar{M}_s susceptible	phagocytosis and synthesis of cytokines : pro-inflammatory $\bar{IL}_8, \bar{IL}_{1\beta}, \bar{IL}_6$; innate antiviral TNF_α & IFN_α and immuno-regulatory \bar{IL}_{10} & \bar{IL}_{12} .
M_p phagocytosing	phagocytosis $\bar{M}_s \rightarrow \bar{M}_p$ (rate η_M) or infection $\bar{M}_s \rightarrow \bar{M}_i$ (rate β_M)
M_i infected	phagocytosis (rate η_M), infection $M_p \rightarrow M_i$ (rate β_M), cytokine synthesis (rates ρ^M). Activation loss $M_p \rightarrow M_s$ (rate γ_M)
\bar{D}^c conventional dendritic cells	excretion of viral particles (rate e) & cytokine synthesis (rates ρ^M). Over-mortality induced by infection (factor δ_μ). Cytolysed by natural killers NK and cytotoxic lymphocytes T_c .
\bar{D}_s^c susceptible	adaptive response activation, synthesis of cytokines : pro-inflammatory $\bar{IL}_8, \bar{IL}_{1\beta}, \bar{IL}_6$; innate antiviral TNF_α & IFN_α and immuno-regulatory $\bar{IL}_{12}, IFN_\gamma, \bar{IL}_{10}$ & TGF_β
D_m^c mature	maturation after phagocytosis $\bar{D}_s^c \rightarrow D_m^c$ (rate η_{D^c}) or infection $D_s^c \rightarrow D_i^c$ (rate β_{D^c})
D_i^c infected	adaptive response activation (rates α^m) and cytokine synthesis (rates ρ^{D^c}). Activation loss $D_m^c \rightarrow D_s^c$ (rate γ_{D^c})
\bar{D}^p plasmacytoid dendritic cells	adaptive response activation (rates α^i), excretion of viral particles (rate e), cytokine synthesis (rates ρ^{D^c})
\bar{D}_s^p susceptible	synthesis of innate antiviral cytokines TNF_α & IFN_α
D_m^p mature	maturation after phagocytosis $\bar{D}_s^p \rightarrow D_m^p$ (rate η_{D^p})
T cells	
\bar{T}_{h1} T-helpers one	cytokine synthesis (rates ρ^{D^p}). Activation loss $D_m^p \rightarrow D_s^p$ (rate γ_{D^p})
\bar{T}_{h2} T-helpers two	Activated by D_m^c (rate $\alpha_{T_h}^m$) & D_i^c (rate $\alpha_{T_h}^i$). Proliferation (rate p_{T_h}) amplified by \bar{IL}_{12} and inhibited by TGF_β . Natural decay (rate $\mu_{T_h}^{nat}$) amplified by TNF_α
\bar{T}_{reg} T-regulatory	activate the cytotoxic lymphocytes T_c (rates α_{T_h}) & B-lymphocytes synthesising IgG (rate α_B), synthesise IFN_γ cytokine. Activation induced by IFN_γ & \bar{IL}_{12}
Cytotoxic T cells & Natural killers	activate the B-lymphocytes synthesising Ig_M (rate α_B). Synthesise \bar{IL}_4 & \bar{IL}_{10} . Activation amplified by \bar{IL}_4 & \bar{IL}_6
	activate the B-lymphocytes synthesising Ig_A (rate α_B). Synthesise \bar{TGF}_β & \bar{IL}_{10} . Activation induced by TGF_β & \bar{IL}_6
	Cytolysis of infected cells and synthesis cytokines

Table 1. Overview of the within-host model to PRRSv infection.

State variables	Immune functions & dynamics
T_c cytotoxic lymphocyte	cytolysis of infected cells (rates μ^{ad}) and synthesise IFN_γ & TNF_α (rates ρ^{tc}). Activated by D^c and T_{h1} . Proliferation (rate p_{T_c}) amplified by IL_{12} and inhibited by TGF_β . Natural decay (rate μ_c^{nat}) amplified by TNF_α
NK natural killers	cytolysis of infected cells (rates μ^{inn}) and synthesise IFN_γ . Recruitment induced by pro-inflammatory cytokines and activation induced by IFN_γ & IL_{12} and inhibited by IL_{10} (rate α_{NK}).
B lymphocytes & antibodies (Ig)	
B_{MG} B-plasmocytes	synthesis of antibodies Ig_M or Ig_G (rates ρ_{Ig}). Activation by V and T_{h1} or T_{h2} (rate α_B).
sing Ig_M or Ig_G	Proliferation (rate p_B) inhibited by TGF_β
B_A B-plasmocytes	synthesis of antibodies Ig_A (rates ρ_{Ig}). Activation by V and T_{reg} (rate α_B). Proliferation (rate p_B) inhibited by TGF_β
A_N neutralising Ig	Neutralise the free viral particles V (rate μ_V^{ad}). Synthesised by B_{MG} (rate ρ_{Ig})
A_M marking Ig	Amplify the phagocytosis and the cytolysis. Synthesised by B_{MG} or B_A (rate ρ_{Ig})
Cytokines	
P_i Pro-inflammatory	Amplify the recruitment of innate cells. Synthesised by M_p, M_i, D_m^c & D_i^c
$IL_{1\beta}$ Interleukin 1	Induce the synthesis of IL_6 . Synthesised by M_p, M_i, D_m^c & D_i^c (rate $\rho_{IL_{1\beta}}$), inhibited by IL_{10}
IL_6 Interleukin 6	Amplify the recruitment of M_s, D_s^c & D_s^p and activate the recruitment of NK. Inhibit the differentiation of T-helpers towards T_{h1} & T_{reg} . Synthesised by M_p, M_i, D_m^c & D_i^c (rate ρ_{IL_6}), induced by $IL_{1\beta}$ & TNF_α
IL_8 Interleukin 8	Amplify the recruitment of M_s, D_s^c & D_s^p and activate the recruitment of NK. Synthesised by M_p, M_i, D_m^c & D_i^c (rate ρ_{IL_8})
A_i innate antiviral	Inhibit the cell infection & viral replication and amplify the phagocytosis. Synthesised by M_p, M_i, D_m^c, D_i^c & D_m^p
TNF_α Tumour necrosis factor α	Inhibit the cell infection & viral replication and amplify the phagocytosis. Induce the cell apoptosis & the synthesis of IL_6 . Synthesised by $M_p, M_i, D_m^c, D_i^c, D_m^p$ & T_c (rate ρ_{TNF_α}), inhibited by IL_{10}
IFN_α Interferon α	Inhibit the cell infection & viral replication and amplify the phagocytosis. Synthesised by M_p, M_i, D_m^c, D_i^c & D_m^p (rate ρ_{IFN_α})
I_r Immuno-regulatory	Orientate the adaptive response.
IL_{12} Interleukin 12	Amplify the recruitment of M_s, D_s^c & D_s^p and activate the recruitment of NK. Amplify the proliferation of T-lymphocytes. Induce the differentiation of T-helpers toward T_{h1} . Synthesised by M_p, M_i, D_m^c & D_i^c (rate $\rho_{IL_{12}}$), amplified by IFN_γ & inhibited by IL_{10}

Table 1. Overview of the within-host model to PRRSv infection.

State variables	Immune functions & dynamics
IFN_γ	Inhibit the viral replication and amplify the phagocytosis. Induce the differentiation of T-helpers toward T_{h1} . Synthesised by $D_m^c, D_i^c, T_{h1}, \text{NK} \& T_c$ (rate ρ_{IFN_γ}), auto-amplified and inhibited by IL_{10} & TGF_β
IL_{10}	Inhibit the phagocytosis & the activation loss of innate cells and amplify the cell infection.
IL_4	Inhibit the synthesis of $\text{IL}_{1,\beta}, \text{TNF}_\alpha, \text{IL}_{12}$ & IFN_γ . Synthesised by $M_p, M_i, D_m^c, D_i^c, T_{h2}$ & T_{reg} (rate $\rho_{\text{IL}_{10}}$), amplify or inhibited by TGF_β and auto-amplified
TGF_β	Amplify the differentiation of T-helpers toward T_{h2} . Synthesised by T_{h2} (rate ρ_{IL_4})
Transforming growth factor β	Inhibit the phagocytosis, the activation loss of innate cells, the cell infection, the proliferation of lymphocytes, the synthesis of IFN_γ and amplify or inhibit the synthesis of IL_{10} . Induce the differentiation of T-helpers toward T_{reg} . Synthesised by $D_m^c, D_i^c \& T_{\text{reg}}$ (rate ρ_{TGF_β})

IV.2.2 Cytokine regulations

The processes driving the state variable dynamics are regulated by a complex cytokine feedback system. Some cytokines have opposite effects: for example, the antiviral cytokines up-regulate the phagocytosis and down-regulate the viral infection, whereas IL₁₀ inhibits the phagocytosis and promotes the infection. Cytokines regulate the cellular functions through their recognition by specific receptors, inducing cascaded reactions within the cells. The higher the cytokine concentration, the stronger the effect. However, there is a limited number of cytokine receptors on the cell surface, so the effect saturates above a given cytokine concentration.

We formalised the cytokine regulations (up κ^+ and down κ^-) based on the Michaelis–Menten function of the cytokine concentration (C_i) [27–29] as follows:

$$\kappa^+(C_i) = \frac{v_m C_i}{k_m + C_i}, \quad \kappa^-(C_i) = \frac{k_m}{k_m + C_i},$$

where v_m denotes the saturation factor and k_m the half saturation constant.

A cytokine can have three possible effects on a given basic rate (r):

- activation: $r \kappa^+(C_i)$, the basic rate increases with the cytokine concentration from 0 to $r v_m$;
- amplification: $r [1 + \kappa^+(C_i)]$, the basic rate increases with the cytokine concentration from r to $r (1 + v_m)$;
- inhibition: $r \kappa^-(C_i)$, the basic rate decreases and tends to zero.

Regulations often involve several cytokines (C_i and C_j) which can act

- either independently: $\kappa^\pm(C_i + C_j)$;
- or in synergy:
 - $\kappa^+(C_i C_j) = \frac{v_m C_i C_j}{k_m^2 + C_i C_j}$ for an activation or an amplification,
 - $\kappa^-(C_i C_j) = \frac{k_m^2}{k_m^2 + C_i C_j}$ for an inhibition.

As very few studies estimate the regulation parameters (k and K) in the literature [29], we used the same parameter values for all cytokine regulations.

IV.2.3 Antigen presenting cells

PRRSv replicates in antigen presenting cells (APC), mainly in the pulmonary macrophages and secondarily in the dendritic cells [25]. Both have key immune functions that are hampered by infection. Macrophages are responsible for the phagocytosis of viral particles, cytokine syntheses and to a lesser extent, adaptive response activation. Dendritic cells are responsible for cytokine syntheses, adaptive response activation and to a lesser extent, phagocytosis of viral particles. The APC activation occurs by the binding of a free viral particle either *via* toll-like receptors (TLR), resulting in their simple activation, or *via* the receptors of the viral infection. More details are provided in Section I.1.3.

In the lung-based model, the only APC represented are the macrophages. Indeed, dendritic cells mature during their migration from the infection site to the lymph nodes, where they synthesise cytokines. They influence the infection dynamics through the cytokines they synthesise, which are consequently negligible in the lung. Moreover, dendritic cells and macrophages drive the adaptive response orientation in a similar way. This simplification is appropriate when

dealing with PRRSV, as the virus also infects dendritic cells. Dendritic cells and macrophages hence have very similar dynamics and impacts during PRRSV infection [30, 31].

The present within-host model describes the infection and immune dynamics in the lungs and lymph nodes. So it is more appropriate to explicitly include the dendritic cells. The model takes into account the main immune functions of each APC : the macrophages are responsible for phagocytosis, the dendritic cells are responsible for the adaptive response activation and both synthesise cytokines.

IV.2.3.1 Macrophages

There are three macrophage states in the model : susceptible (M_s), phagocytosing (M_p) and infected (M_i). The model represents the evolution over time of the macrophage concentrations for these three states.

Recruitment Susceptible macrophages are recruited from the bloodstream (rate R_M). Cytokines IL₆ and IL₁₂ co-amplify the macrophage recruitment [32–34] in synergy and IL₈ attracts the macrophages to the infection place [34]. In the absence of virus, the cytokine concentrations are supposed to be negligible and the resulting concentration of susceptible macrophages is constant : $M_s = M_s^0 = \frac{R_M}{\mu_M^{\text{nat}}}$.

Decay All macrophage states are subject to natural decay and/or migration (rate μ_M^{nat}), as well as apoptosis induced by TNF_α (rate μ_M^{ap}) [35]. The natural decay rate is considered higher for infected macrophages than for susceptible and phagocytosing macrophages (multiplicative factor δ_μ). Moreover, infected macrophages can be destroyed by natural killers (rate μ_M^{inn}) and cytotoxic T cells (rate μ_M^{ad}). Marker antibodies amplify the cytolysis of infected cells (Section IV.2.7.2).

State changes When susceptible macrophages encounter free viral particles (V), they can either phagocyte the virus (rate η_M) or become infected (rate β_M). We assumed that phagocytosing macrophages revert to the susceptible state after activation loss (rate γ_M), whereas infected macrophages remain infected (*i.e.* they cannot eliminate the virus). As the phagocytosis of a viral particle lasts between 1 and 4 hours, we neglected this duration. We also assumed that macrophages activated by phagocytosis can be infected. However, once infected, macrophages cannot be infected by other viral particles [36].

Phagocytosis is amplified by the antiviral cytokines (TNF_α, IFN_α, IFN_γ) and inhibited by the immuno-modulatory cytokines (IL₁₀, TGF_β). Activation loss is amplified by the immuno-modulatory cytokine. Macrophage infection is amplified by IL₁₀ and inhibited by innate antiviral cytokines (TNF_α, IFN_α) and TGF_β. Moreover, marker antibodies amplify the phagocytosis of free viral particles. We assumed that cytokine regulations and marking act independently.

Macrophage dynamics It is governed by the recruitment, decay and state changes described above and results in the following equations.

Susceptible macrophages M_s :

$$\begin{aligned}
\dot{M}_s = & + R_M [1 + \kappa^+(\text{IL}_{12} \text{IL}_6 + \text{IL}_8)] && \leftarrow \text{recruitment} \\
& - \eta_M M_s V \kappa^-(\text{IL}_{10} + \text{TGF}_\beta) [1 + \kappa^+(\text{TNF}_\alpha + \text{IFN}_\alpha + \text{IFN}_\gamma)] \left[1 + w_A^V \frac{A_M}{m_A^V + V} \right] && \leftarrow \text{activation} \\
& + \gamma_M M_p [1 + \kappa^+(\text{IL}_{10} + \text{TGF}_\beta)] && \leftarrow \text{activation loss} \\
& - \beta_M M_s V \kappa^-(\text{TNF}_\alpha + \text{IFN}_\alpha + \text{TGF}_\beta) [1 + \kappa^+(\text{IL}_{10})] && \leftarrow \text{infection} \\
& - M_s (\mu_M^{\text{nat}} + \mu_M^{\text{ap}} \kappa^+(\text{TNF}_\alpha)) && \leftarrow \text{decay} \\
& && \text{(IV.1)}
\end{aligned}$$

Phagocytosing (activated) macrophages M_p :

$$\begin{aligned}
\dot{M}_p = & + \eta_M M_s V \kappa^-(\text{IL}_{10} + \text{TGF}_\beta) [1 + \kappa^+(\text{TNF}_\alpha + \text{IFN}_\alpha + \text{IFN}_\gamma)] \left[1 + w_A^V \frac{A_M}{m_A^V + V} \right] && \leftarrow \text{activation} \\
& - \gamma_M M_p [1 + \kappa^+(\text{IL}_{10} + \text{TGF}_\beta)] && \leftarrow \text{activation loss} \\
& - \beta_M M_p V \kappa^-(\text{TNF}_\alpha + \text{IFN}_\alpha + \text{TGF}_\beta) [1 + \kappa^+(\text{IL}_{10})] && \leftarrow \text{infection} \\
& - M_p (\mu_M^{\text{nat}} + \mu_M^{\text{ap}} \kappa^+(\text{TNF}_\alpha)) && \leftarrow \text{decay} \\
& && \text{(IV.2)}
\end{aligned}$$

Infected (activated) macrophages M_i :

$$\begin{aligned}
\dot{M}_i = & + \beta_M (M_p + M_s) V : \kappa^-(\text{TNF}_\alpha + \text{IFN}_\alpha + \text{TGF}_\beta) [1 + \kappa^+(\text{IL}_{10})] && \leftarrow \text{infection} \\
& - M_i \left(\mu_M^{\text{nat}} \delta_\mu + \mu_M^{\text{ap}} \kappa^+(\text{TNF}_\alpha) + (\mu_M^{\text{inn}} \text{NK} + \mu_M^{\text{ad}} T_c) \left[1 + w_A^M \frac{A_M}{m_A^M + M_i} \right] \right) && \leftarrow \text{decay} \\
& && \text{(IV.3)}
\end{aligned}$$

Cytokine syntheses Activated macrophages (either phagocytosing or infected) synthesise innate cytokines : pro-inflammatory (P_i : $\text{IL}_{1\beta}$, IL_6 , IL_8), antiviral (A_i : IFN_α , TNF_α) and immunoregulatory (IL_{12} , IL_{10} , TGF_β) cytokines [17].

IV.2.3.2 Dendritic cells

There are two major sub-types of dendritic cells which are supposed to play a key role in PRRSv infection : the conventional (D^c) and the plasmacytoid (D^p) dendritic cells [37, 38]. We represented both in our model.

Conventional dendritic cells The main immune functions of conventional dendritic cells (D^c) are the antigen presentation to the naive adaptive cells and the synthesis of various cytokines : $\text{IL}_{1\beta}$, IL_6 , IL_8 , IFN_α , TNF_α , IL_{12} , IFN_γ , IL_{10} and TGF_β .

The immune function modulations induced by PRRSv infection are similar for the macrophages and the conventional dendritic cells [3]. The D^c permissiveness to PRRSv is lower than the macrophage permissiveness [39], but all published studies point out a similar PRRSv replication rate in D^c and macrophages once infected [30, 39, 40]. Consequently, we modelled the D^c dynamics on the macrophage dynamics, with parameters that can differ between the two, except for PRRSv replication rate (rate e).

The dynamics of conventional dendritic cells is governed by recruitment, decay and state changes similar to the processes described in Section IV.2.3.1, with maturation replacing phagocytosis. It results in the following equations.

Susceptible conventional dendritic cells D_s^c :

$$\begin{aligned}
\dot{D}_s^c = & + R_{D^c} [1 + \kappa^+(\text{IL}_{12} \text{IL}_6 + \text{IL}_8)] && \leftarrow \text{recruitment} \\
& - \eta_{D^c} D_s^c V \kappa^-(\text{IL}_{10} + \text{TGF}_\beta) [1 + \kappa^+(\text{TNF}_\alpha + \text{IFN}_\alpha + \text{IFN}_\gamma)] \left[1 + w_A^V \frac{A_M}{m_A^V + V} \right] && \leftarrow \text{activation} \\
& + \gamma_{D^c} D_m^c [1 + \kappa^+(\text{IL}_{10} + \text{TGF}_\beta)] && \leftarrow \text{activation loss} \\
& - \beta_{D^c} D_s^c V \kappa^-(\text{TNF}_\alpha + \text{IFN}_\alpha + \text{TGF}_\beta) [1 + \kappa^+(\text{IL}_{10})] && \leftarrow \text{infection} \\
& - D_s^c (\mu_{D^c}^{\text{nat}} + \mu_{D^c}^{\text{ap}} \kappa^+(\text{TNF}_\alpha)) && \leftarrow \text{decay}
\end{aligned} \tag{IV.4}$$

Mature conventional dendritic cells D_m^c :

$$\begin{aligned}
\dot{D}_m^c = & + \eta_{D^c} D_s^c V \kappa^-(\text{IL}_{10} + \text{TGF}_\beta) [1 + \kappa^+(\text{TNF}_\alpha + \text{IFN}_\alpha + \text{IFN}_\gamma)] \left[1 + w_A^V \frac{A_M}{m_A^V + V} \right] && \leftarrow \text{activation} \\
& - \gamma_{D^c} D_m^c [1 + \kappa^+(\text{IL}_{10} + \text{TGF}_\beta)] && \leftarrow \text{activation loss} \\
& - \beta_{D^c} D_m^c V \kappa^-(\text{TNF}_\alpha + \text{IFN}_\alpha + \text{TGF}_\beta) [1 + \kappa^+(\text{IL}_{10})] && \leftarrow \text{infection} \\
& - D_m^c (\mu_{D^c}^{\text{nat}} + \mu_{D^c}^{\text{ap}} \kappa^+(\text{TNF}_\alpha)) && \leftarrow \text{decay}
\end{aligned} \tag{IV.5}$$

Infected conventional dendritic cells D_i^c :

$$\begin{aligned}
\dot{D}_i^c = & + \beta_{D^c} (D_m^c + D_s^c) V \kappa^-(\text{TNF}_\alpha + \text{IFN}_\alpha + \text{TGF}_\beta) [1 + \kappa^+(\text{IL}_{10})] && \leftarrow \text{infection} \\
& - D_i^c \left(\mu_{D^c}^{\text{nat}} \delta_\mu + \mu_{D^c}^{\text{ap}} \kappa^+(\text{TNF}_\alpha) + (\mu_{D^c}^{\text{inn}} \text{NK} + \mu_{D^c}^{\text{ad}} \text{Tc}) \left[1 + w_A^M \frac{A_M}{m_A^M + D_i^c} \right] \right) && \leftarrow \text{decay}
\end{aligned} \tag{IV.6}$$

Plasmocytoide dendritic cells The main immune function of plasmocytoid dendritic cells (D^p) is the synthesis of innate antiviral cytokines IFN_α and TNF_α .

Plasmocytoide dendritic cells do not support PRRSv replication [30, 31, 39, 41], so D^p can either be susceptible (D_s^p) or mature (D_m^p). The dynamics of plasmocytoid dendritic cells is governed by recruitment, decay, activation (maturation) and activation loss, that are supposed to be similar for conventional and plasmocytoid dendritic cells. It results in the following equations.

Susceptible plasmocytoid dendritic cells D_s^p :

$$\begin{aligned}
\dot{D}_s^p = & + R_{D^p} [1 + \kappa^+(\text{IL}_{12} \text{IL}_6 + \text{IL}_8)] && \leftarrow \text{recruitment} \\
& - \eta_{D^p} D_s^p V \kappa^-(\text{IL}_{10} + \text{TGF}_\beta) [1 + \kappa^+(\text{TNF}_\alpha + \text{IFN}_\alpha + \text{IFN}_\gamma)] \left[1 + w_A^V \frac{A_M}{m_A^V + V} \right] && \leftarrow \text{activation} \\
& + \gamma_{D^p} D_m^p [1 + \kappa^+(\text{IL}_{10} + \text{TGF}_\beta)] && \leftarrow \text{activation loss} \\
& - D_s^p (\mu_{D^p}^{\text{nat}} + \mu_{D^p}^{\text{ap}} \kappa^+(\text{TNF}_\alpha)) && \leftarrow \text{decay}
\end{aligned} \tag{IV.7}$$

Mature plasmocytoid dendritic cells D_m^p :

$$\begin{aligned}
\dot{D}_m^p = & + \eta_{D^p} D_s^p V \kappa^- (\text{IL}_{10} + \text{TGF}\beta) [1 + \kappa^+ (\text{TNF}_\alpha + \text{IFN}_\alpha + \text{IFN}_\gamma)] \left[1 + w_A^V \frac{A_M}{m_A^V + V} \right] && \leftarrow \text{activation} \\
& - \gamma_{D^p} D_m^p [1 + \kappa^+ (\text{IL}_{10} + \text{TGF}\beta)] && \leftarrow \text{activation loss} \\
& - D_m^p (\mu_{D^p}^{\text{nat}} + \mu_{D^p}^{\text{ad}} \kappa^+ (\text{TNF}_\alpha)) && \leftarrow \text{decay} \\
& && \text{(IV.8)}
\end{aligned}$$

IV.2.4 Free viral particles

The virus enters the body through the mucosal surfaces of the respiratory tract. The exposure function ($E(t)$) is defined as for the simplified lung-based model (2, Section III.2.2) :

$$E(t) = \begin{cases} \mathcal{N}_E \frac{t^{a-1} (D_E - t)^{b-1}}{\int_0^{D_E} t^{a-1} (D_E - t)^{b-1} dt} & \text{if } 0 < t < D_E \\ 0 & \text{else} \end{cases}$$

with $\left| \begin{array}{ll} 1 < a < b & \text{shape parameters (no unit) for a left-shifted bell-shaped curve,} \\ \mathcal{N}_E & \text{exposure intensity (in TCID}_{50}/\text{ml),} \\ D_E & \text{exposure duration (in days).} \end{array} \right.$

When free viral particles (V) encounter susceptible macrophages or dendritic cells, they can either be phagocytosed (rates η), resulting in viral destruction and cell activation, or they can infect the macrophages and conventional dendritic cells (rates β), resulting in virus replication (Sections IV.2.3.1 and IV.2.3.2). Free viral particles are released by infected cells (rate e). The replication is inhibited by antiviral cytokines. Free viral particles are subject to natural decay and migration (rate μ_V^{nat}). They can also be neutralised by antibodies A_N (rate μ_V^{ad}). The resulting dynamics is described in the following equation.

Free viral particles V :

$$\begin{aligned}
\dot{V} = & + E(t) && \leftarrow \text{exposure} \\
& - u_M^V V (\eta_M (M_s + M_p) + \eta_{D^c} D_s^c + \eta_{D^p} D_s^p) \kappa^- (\text{IL}_{10} + \text{TGF}\beta) \\
& [1 + \kappa^+ (\text{TNF}_\alpha + \text{IFN}_\alpha + \text{IFN}_\gamma)] \left[1 + w_A^V \frac{A_M}{m_A^V + V} \right] && \leftarrow \text{phagocytosis} \\
& - u_M^V V (\beta_M (M_p + M_s) + \beta_{D^c} (D_m^c + D_s^c)) && \text{(IV.9)} \\
& \kappa^- (\text{TNF}_\alpha + \text{IFN}_\alpha + \text{TGF}\beta) [1 + \kappa^+ (\text{IL}_{10})] && \leftarrow \text{infection} \\
& + e (M_i + D_i^c) \kappa^- (\text{TNF}_\alpha + \text{IFN}_\alpha + \text{IFN}_\gamma) && \leftarrow \text{excretion} \\
& - V \left(\mu_V^{\text{nat}} + u_A^V \mu_V^{\text{ad}} \frac{A_N}{n_A^V + V} \right) && \leftarrow \text{decay}
\end{aligned}$$

IV.2.5 Helper T cells

Helper T cells orientate the adaptive response towards the cellular, humoral or regulatory response. The activation, differentiation and proliferation of helper T cells are described in Section I.1.5. Only the broad lines are presented here.

Naive helper T cells are activated by mature dendritic cells *via* a major histocompatibility complex (MHC). As PRRSv replication in dendritic cells down-regulates the expression of MHC [30, 39, 40], we distinguished the activation rates by D_m^c (rate $\alpha_{T_h}^m$) and D_i^c (rate $\alpha_{T_h}^i$). We assumed that the naive helper T cells are not limiting, so we did not represent their dynamics in the model.

Depending on the cytokine environment, activated helper T cells differentiate into three effector sub-types :

- type 2 helper T cells (T_{h2}), the default, amplified by IL₄ and IL₁₀. We neglected the amplification by IL₁₀ as it has an indirect influence (see section I.1.5) which is represented in our model through the regulation of the cytokine synthesis ;
- type 1 helper T cells (T_{h1}) induced by IL₁₂, amplified by IFN_γ and inhibited by IL₆ ;
- regulatory T cells (T_{reg}) induced by TGF_β and inhibited by IL₆.

The proportion π_{T_h} of each effector T_h is hence defined as follows :

$$\left\{ \begin{array}{l} \pi_{T_{h2}} = \frac{1 + \text{IL}_4 + \text{IL}_6}{1 + \text{IL}_{12} + \text{IFN}_\gamma + \text{IL}_4 + \text{IL}_6 + \text{TGF}_\beta} \\ \pi_{T_{h1}} = \frac{\text{IL}_{12} + \text{IFN}_\gamma}{1 + \text{IL}_{12} + \text{IFN}_\gamma + \text{IL}_4 + \text{IL}_6 + \text{TGF}_\beta} \\ \pi_{T_{reg}} = \frac{\text{TGF}_\beta}{1 + \text{IL}_{12} + \text{IFN}_\gamma + \text{IL}_4 + \text{IL}_6 + \text{TGF}_\beta} \end{array} \right.$$

Then activated helper T cells proliferate and this proliferation is amplified by IL₁₂ and inhibited by TGF_β. Finally, these cells are subject to natural decay (rate $\mu_{T_h}^{\text{nat}}$) amplified by TNF_α, which induces their apoptosis. The dynamics of the helper T cells is hence defined by the following equations.

Type 1 helper T cells T_{h1} :

$$\begin{aligned} \dot{T}_{h1} = & + (\alpha_{T_h}^m D_m^c + \alpha_{T_h}^i D_i^c) \frac{\text{IL}_{12} + \text{IFN}_\gamma}{1 + \text{IL}_{12} + \text{IFN}_\gamma + \text{IL}_4 + \text{IL}_6 + \text{TGF}_\beta} && \leftarrow \text{activation} \\ & + p_{T_h} T_{h1} \kappa^- (\text{TGF}_\beta) [1 + \kappa^+ (\text{IL}_{12})] && \leftarrow \text{proliferation} \\ & - T_{h1} \mu_{T_h}^{\text{nat}} [1 + \kappa^+ (\text{TNF}_\alpha)] && \leftarrow \text{decay} \end{aligned} \quad (\text{IV.10})$$

Type 2 helper T cells T_{h2} :

$$\begin{aligned} \dot{T}_{h2} = & + (\alpha_{T_h}^m D_m^c + \alpha_{T_h}^i D_i^c) \frac{1 + \text{IL}_4 + \text{IL}_6}{1 + \text{IL}_{12} + \text{IFN}_\gamma + \text{IL}_4 + \text{IL}_6 + \text{TGF}_\beta} && \leftarrow \text{activation} \\ & + p_{T_h} T_{h2} \kappa^- (\text{TGF}_\beta) [1 + \kappa^+ (\text{IL}_{12})] && \leftarrow \text{proliferation} \\ & - T_{h2} \mu_{T_h}^{\text{nat}} [1 + \kappa^+ (\text{TNF}_\alpha)] && \leftarrow \text{decay} \end{aligned} \quad (\text{IV.11})$$

Regulatory T cells T_{reg} :

$$\begin{aligned} \dot{T}_{reg} = & + (\alpha_{T_h}^m D_m^c + \alpha_{T_h}^i D_i^c) \frac{\text{TGF}_\beta}{1 + \text{IL}_{12} + \text{IFN}_\gamma + \text{IL}_4 + \text{IL}_6 + \text{TGF}_\beta} && \leftarrow \text{activation} \\ & + p_{T_h} T_{reg} \kappa^- (\text{TGF}_\beta) [1 + \kappa^+ (\text{IL}_{12})] && \leftarrow \text{proliferation} \\ & - T_{reg} \mu_{T_h}^{\text{nat}} [1 + \kappa^+ (\text{TNF}_\alpha)] && \leftarrow \text{decay} \end{aligned} \quad (\text{IV.12})$$

T_{h1} , associated with the cellular response, synthesise the antiviral cytokine IFN_γ and induce

the activation of cytotoxic T cells T_c . T_{h2} , associated with the humoral response, synthesise IL_4 and IL_{10} . T_{reg} , associated with the regulatory response, synthesise two immuno-modulatory cytokines, IL_{10} and $TGF\beta$. Moreover, helper T cells induce the synthesis of antibodies by B lymphocytes.

IV.2.6 Cytotoxic cells

Cytotoxic cells destroy infected cells by cytolysis. They include natural killers and cytotoxic T cells.

IV.2.6.1 Natural killers

Natural killers (NK) are effectors of the innate response. Their main immune functions are the destruction of infected cells and IFN_γ synthesis. More details are provided in Section I.1.4.

We represented the dynamics of activated NK (assuming that naive NK are not limiting) and included the regulations by the most influential cytokines. The recruitment of natural killers from the bloodstream (rate α_N) requires pro-inflammatory cytokines : IL_{12} and IL_6 co-activate the recruitment, whereas IL_8 acts independently. Natural killers are then activated by IFN_γ and IL_{12} , whereas IL_{10} inhibits the activation. They are subject to natural death or/and migration (rate μ_R). Their equation follows.

Natural killers NK :

$$\begin{aligned} \dot{NK} = & + \alpha_{NK} \kappa^-(IL_{10}) \kappa^+(IL_{12} IL_6 + IL_8) \kappa^+(IFN_\gamma + IL_{12}) && \leftarrow \text{activation} \\ & - NK \mu_{NK}^{\text{nat}} && \leftarrow \text{decay} \end{aligned} \quad (IV.13)$$

IV.2.6.2 Cytotoxic T cells

Cytotoxic T cells (T_c) are effectors of the adaptive response. They are responsible for the synthesis of two antiviral cytokines IFN_γ and TNF_α and the destruction of infected cells.

We represented the dynamics of activated T_c (assuming that naive T_c are not limiting). The activation of cytotoxic T cells is detailed in Section I.1.5. We did not explicitly represent the licensing step, but the T_c activation (rates α_{T_c}) requires activated conventional dendritic cell (mature D_m^c or infected D_i^c) and T_{h1} . Just as for helper T cells (Section IV.2.5), activation is followed by proliferation (rate p_{T_c}) and natural decay (rate $\mu_{T_c}^{\text{nat}}$). The T_c equation follows.

Cytotoxic T cells T_c :

$$\begin{aligned} \dot{T}_c = & + (\alpha_{T_c}^m D_m^c + \alpha_{T_c}^i D_i^c) T_{h1} && \leftarrow \text{activation} \\ & + p_{T_c} T_c \kappa^-(TGF\beta) [1 + \kappa^+(IL_{12})] && \leftarrow \text{proliferation} \\ & - T_c \mu_{T_c}^{\text{nat}} [1 + \kappa^+(TNF_\alpha)] && \leftarrow \text{decay} \end{aligned} \quad (IV.14)$$

IV.2.7 B lymphocytes and antibodies

B cells produce antibodies, which characterise the adaptive humoral response.

IV.2.7.1 B cells

We represented the dynamics of activated B cells (assuming that naive B cells are not limiting). The activation and differentiation are detailed in Section I.1.5. Only the broad lines are presented here.

To take into account the preliminary steps of naive B-cell activation, we assumed that it requires T_h and free viral particles V (rates α_B), with a limiting effect of T_h when V saturates : for high concentrations of V , B-cell activation only depends on T_h . Activated B cells become plasmocytes, which can produce IgM, IgG and IgA antibodies (IgE antibodies are negligible for PRRSv infection). We assumed that the T_h sub-type determines the plasmocyte differentiation. In the presence of free viral particles, the differentiation towards IgM-producing and IgG-producing plasmocytes (grouped in B_{MG} , as both circulate in blood serum) requires a T_{h1} or a T_{h2} , whereas the differentiation towards IgA-producing plasmocytes (B_A , which are found in the respiratory tract) requires a T_{reg} . The proliferation (rate p_B) is inhibited by TGF_β . B cells undergo natural decay (rate μ_B^{nat}). The equations follow.

IgM- and IgG-producing plasmocytes B_{MG} :

$$\begin{aligned} \dot{B}_{MG} = & + \alpha_B \frac{V}{1+V} (T_{h1} + T_{h2}) && \leftarrow \text{activation} \\ & + p_B B_{MG} \kappa^-(TGF_\beta) && \leftarrow \text{proliferation} \\ & - B_{MG} \mu_B^{nat} && \leftarrow \text{decay} \end{aligned} \quad (IV.15)$$

IgA-producing plasmocytes B_A :

$$\begin{aligned} \dot{B}_A = & + \alpha_B \frac{V}{1+V} T_{reg} && \leftarrow \text{activation} \\ & + p_B B_A : \kappa^-(TGF_\beta) && \leftarrow \text{proliferation} \\ & - B_A \mu_B^{nat} && \leftarrow \text{decay} \end{aligned} \quad (IV.16)$$

IV.2.7.2 Antibodies

IgM, IgG and IgA antibodies can have either a neutralising or a marking function. More details are provided in Section I.1.5. In the model, we did not represent the dynamics of IgM, IgG and IgA, but of the two functional groups of antibodies : neutralising (A_N) and marker (A_M) antibodies. Antibodies are produced by plasmocytes (rate ρ_A). We assumed that a fixed proportion of antibodies (r_N) act as neutralising antibodies. Note that with this simplifying assumption, we could consider a single antibody-producing plasmocyte type ($B = B_{MG} + B_A$). Antibodies undergo natural decay (rate μ_A^{nat}). To derive the antibody dynamics, we need to describe the neutralising and marking functions.

Neutralising antibodies Neutralising antibodies directly block the virus pathogenicity. We assumed that the neutralisation of free viral particles (V) by A_N is limited by A_N when V saturate : for high concentrations of V ($\gg n_A^V$), neutralisation only depends on A_N . The neutralisation rate is μ_V^{ad} for the virus and $u_A^V \mu_V^{ad}$ for the antibodies. Parameter u_A^V accounts for stoichiometry (units of viral particles neutralised by one antibody unit) and units (antibodies and virus concentrations are measured in different units). The dynamics of A_N follows.

Neutralising antibodies A_N :

$$\begin{aligned}
 \dot{A}_N = & + \rho_A r_N (B_{\text{MG}} + B_A) && \longleftarrow \text{activation} \\
 & - \mu_V^{\text{ad}} \frac{A_N V}{n_A^V + V} && \longleftarrow \text{neutralisation} \\
 & - A_N \mu_A^{\text{nat}} && \longleftarrow \text{decay}
 \end{aligned} \tag{IV.17}$$

Marker antibodies Marker antibodies (A_M) can either mark the virus and facilitate phagocytosis, or they can mark infected cells and amplify cytolysis. As for neutralisation, we assumed that marking by A_M of free viral particles (V), respectively infected cells (M_i and D_i^c), is limited by A_M when V , respectively infected cells, saturate : for high concentrations of V ($\gg m_A^V$), respectively infected cells ($\gg m_A^M$), marking only depends on A_M . Parameters w_A^V , respectively w_A^M , account for stoichiometry (units of viral particles, respectively infected cells, marked by one antibody unit) and units. The dynamics of A_M follows.

Marker antibodies A_M :

$$\begin{aligned}
 \dot{A}_M = & + \rho_A (1 - r_N) (B_{\text{MG}} + B_A) && \longleftarrow \text{activation} \\
 & - u_M^V \frac{A_M V}{m_A^V + V} \kappa^- (\text{IL}_{10} + \text{TGF}_\beta) [1 + \kappa^+ (\text{TNF}_\alpha + \text{IFN}_\alpha + \text{IFN}_\gamma)] \\
 & (\eta_M (M_s + M_p) + \eta_{D^c} D_s^c + \eta_{D^p} D_s^p) && \longleftarrow \text{phagocytosis} \\
 & - \frac{A_M D_i^c}{m_A^M + D_i^c} (\mu_{D^c}^{\text{inn}} \text{NK} + \mu_{D^c}^{\text{ad}} Tc) - \frac{A_M M_i}{m_A^M + M_i} (\mu_M^{\text{inn}} \text{NK} + \mu_M^{\text{ad}} Tc) && \longleftarrow \text{cytolysis} \\
 & - A_M \mu_A^{\text{nat}} && \longleftarrow \text{decay}
 \end{aligned} \tag{IV.18}$$

IV.2.8 Cytokines

Cytokines are small proteins that play a key role in cell-signalling. They are produced by activated immune cells and affect the behaviour of other cells, sometimes the releasing cell itself. They act through specific membranous receptors inducing cascaded reactions within the target cell. They have various functions. In particular, cytokines modulate the balance between the humoral and cellular responses. Some cytokines enhance or inhibit the action of other cytokines in complex ways.

In the within-host model, we only integrated the regulations by the ten most influential cytokines. We grouped them into three classes depending on their main function : pro-inflammatory cytokines ($\text{IL}_{1\beta}$, IL_6 , IL_8), antiviral cytokines (TNF_α , IFN_α , IFN_γ) and immuno-regulatory (IFN_γ , IL_{12} , IL_4 , IL_{10} , TGF_β) cytokines. TNF_α is generally considered as a pro-inflammatory cytokine, but we were more interested in its antiviral function.

We assumed that the cytokines are efficient enough to neglect their consumption when they interact with a cell. So the cytokine dynamics results from their synthesis by immune cells (rates ρ_x , where x depends on the cytokine considered) and their natural decay (rate μ_C)

The main cytokine regulations are summarised in TABLE IV.2.

Table IV.2 Cytokine regulations. Main positive (+) and negative (-) regulations included in the model for various immune mechanisms.

	Cytokines									
	pro-inflammatory			antiviral		immuno-regulatory				
	IL _{1β}	IL ₆	IL ₈	TNF _α	IFN _α	IFN _γ	IL ₁₂	IL ₄	IL ₁₀	TGF _β
<i>Innate response</i>										
APC recruitment		+	+				+		+	
NK recruitment & activation		+	+							-
APC apoptosis				+						-
Phagocytosis				+	+	+				-
Macrophage permissiveness				-	-	-				+
Viral replication				-	-	-				-
<i>Adaptive response</i>										
T _{h1} activation		-					+	+		-
T _{h2} activation		+					-	+		-
T _{reg} activation				-			-	-		+
T cell proliferation									+	-
B cell proliferation										-
T cell apoptosis				+						
<i>Cytokine syntheses</i>										
Pro-inflammatory	IL _{1β}									-
	IL ₆ , IL ₈	+		+						-
Innate antiviral	TNF _α						+	+		-
Adaptive antiviral	IFN _γ						+			-
Immuno-regulatory	IL ₁₂						+			-
	IL ₁₀								+	±
Specific references	[33, 34, 42]			[25, 35, 43-47]			[25, 42, 44, 48]	[49]	[30, 33, 39, 50-53]	[4]
Common references	innate cytokines [32, 50]			adaptive cytokines [22-24]						
Global references	[8, 14, 17-21, 54]									

IV.2.8.1 Pro-inflammatory cytokines

Pro-inflammatory cytokines $\text{IL}_{1\beta}$, IL_6 and IL_8 amplify the recruitment of innate immune cells (APC and natural killers). IL_6 blocks the differentiation toward the T_{h1} and T_{reg} . They are synthesised by the activated APC. The synthesis of $\text{IL}_{1\beta}$ is inhibited by IL_{10} , whereas the synthesis of IL_6 and IL_8 is co-activated by $\text{IL}_{1\beta}$ and TNF_α .

$$\begin{aligned} \dot{\text{IL}}_{1\beta} = & + \left(\rho_{\text{IL}_{1\beta}}^M (M_p + M_i) + \rho_{\text{IL}_{1\beta}}^{D^c} (D_m^c + D_i^c) \right) \kappa^- (\text{IL}_{10}) \leftarrow \text{synthesis} \\ & - \text{IL}_{1\beta} \mu_c^{\text{nat}} \leftarrow \text{decay} \end{aligned} \quad (\text{IV.19})$$

$$\begin{aligned} \dot{\text{IL}}_6 = & + \left(\rho_{\text{IL}_6}^M (M_p + M_i) + \rho_{\text{IL}_6}^{D^c} (D_m^c + D_i^c) \right) \kappa^+ (\text{IL}_{1\beta} \text{TNF}_\alpha) \leftarrow \text{synthesis} \\ & - \text{IL}_6 \mu_c^{\text{nat}} \leftarrow \text{decay} \end{aligned} \quad (\text{IV.20})$$

$$\begin{aligned} \dot{\text{IL}}_8 = & + \left(\rho_{\text{IL}_8}^M (M_p + M_i) + \rho_{\text{IL}_8}^{D^c} (D_m^c + D_i^c) \right) \kappa^+ (\text{IL}_{1\beta} \text{TNF}_\alpha) \leftarrow \text{synthesis} \\ & - \text{IL}_8 \mu_c^{\text{nat}} \leftarrow \text{decay} \end{aligned} \quad (\text{IV.21})$$

IV.2.8.2 Antiviral cytokines

Antiviral cytokines promote the phagocytosis and reduce the infection by inhibiting the permissiveness of macrophages and conventional dendritic cells and the viral replication.

Innate antiviral cytokines TNF_α also induces the apoptosis of APC and T cells. It is synthesised by activated APC ($M_p, M_i, D_m^c, D_i^c, D_m^p$) and cytotoxic T cells (T_c). These syntheses are inhibited by IL_{10} .

$$\begin{aligned} \dot{\text{TNF}}_\alpha = & + \left(\rho_{\text{TNF}_\alpha}^M (M_p + M_i) + \rho_{\text{TNF}_\alpha}^{D^c} (D_m^c + D_i^c) + \rho_{\text{TNF}_\alpha}^{D^p} D_m^p + \rho_{\text{TNF}_\alpha}^{T_c} T_c \right) \kappa^- (\text{IL}_{10}) \leftarrow \text{synthesis} \\ & - \text{TNF}_\alpha \mu_c^{\text{nat}} \leftarrow \text{decay} \end{aligned} \quad (\text{IV.22})$$

IFN_α is synthesised by infected cells (M_i, D_i^c) and mature plasmocytoid dendritic cells (D_m^p).

$$\begin{aligned} \dot{\text{IFN}}_\alpha = & + \rho_{\text{IFN}_\alpha}^M M_i + \rho_{\text{IFN}_\alpha}^{D^c} D_i^c + \rho_{\text{IFN}_\alpha}^{D^p} D_m^p \leftarrow \text{synthesis} \\ & - \text{IFN}_\alpha \mu_c^{\text{nat}} \leftarrow \text{decay} \end{aligned} \quad (\text{IV.23})$$

Adaptive antiviral cytokine IFN_γ is synthesised by activated conventional dendritic cells (D_m^c, D_i^c), natural killers (NK), type 1 helper T cells (T_{h1}) and cytotoxic T cells (T_c). These syntheses are auto-amplified and inhibited by TGF_β and IL_{10} .

$$\begin{aligned} \dot{\text{IFN}}_\gamma = & + \left(\rho_{\text{IFN}_\gamma}^{D^c} (D_m^c + D_i^c) + \rho_{\text{IFN}_\gamma}^{\text{NK}} \text{NK} + \rho_{\text{IFN}_\gamma}^{T_{h1}} T_{h1} + \rho_{\text{IFN}_\gamma}^{T_c} T_c \right) \\ & \kappa^- (\text{TGF}_\beta + \text{IL}_{10}) [1 + \kappa^+ (\text{IFN}_\gamma)] \leftarrow \text{synthesis} \\ & - \text{IFN}_\gamma \mu_c^{\text{nat}} \leftarrow \text{decay} \end{aligned} \quad (\text{IV.24})$$

IFN_γ is also an immuno-regulatory cytokine and it orientates the adaptive response towards the cellular response [22–25, 42, 44, 48].

IV.2.8.3 Immuno-regulatory cytokines

Immuno-regulatory cytokines have various functions, in particular the regulation of the adaptive immune response. They also regulate the recruitment of macrophages and natural killers, the phagocytosis and infection, as well as the cytokine syntheses. They are produced by cells of the innate and adaptive response.

IL_{12} co-amplifies the recruitment of innate cells, activates the natural killers, induce the differentiation of T_h towards T_{h1} and amplify the proliferation of T cells. It is synthesised by activated macrophages (M_p, M_i) and conventional dendritic cells (D_m^c, D_i^c), as well as cytotoxic T cells (T_c). Syntheses by APC are inhibited by IL_{10} , the synthesis by dendritic cell is amplified by IFN_γ .

$$\begin{aligned} \dot{\text{IL}}_{12} = & + \left(\rho_{\text{IL}_{12}}^M (M_p + M_i) + \rho_{\text{IL}_{12}}^{D^c} (D_m^c + D_i^c) [1 + \kappa^+(\text{IFN}_\gamma)] \right) \kappa^-(\text{IL}_{10}) + \rho_{\text{IL}_{12}}^{T_c} T_c \quad \leftarrow \text{synthesis} \\ & - \text{IL}_{12} \mu_c^{\text{nat}} \quad \leftarrow \text{decay} \end{aligned} \quad (\text{IV.25})$$

IL_4 amplifies the differentiation of T_h towards type 2 helper T cells (T_{h2}) and is synthesised by T_{h2} .

$$\begin{aligned} \dot{\text{IL}}_4 = & + \rho_{\text{IL}_4}^{T_{h2}} T_{h2} \quad \leftarrow \text{synthesis} \\ & - \text{IL}_4 \mu_c^{\text{nat}} \quad \leftarrow \text{decay} \end{aligned} \quad (\text{IV.26})$$

Immuno-modulatory cytokines IL_{10} and TGF_β are both immuno-modulatory cytokines. IL_{10} inhibits the natural killer activation and the phagocytosis, amplifies the target cell permissiveness and inhibits the synthesis of numerous cytokines. IL_{10} is synthesised by activated target cells (M_p, M_i, D_m^c, D_i^c) and regulatory T cells (T_{reg}), both syntheses being amplified by TGF_β . It is also synthesised by type 2 helper T cells T_{h2} , this synthesis being auto-amplified and inhibited by TGF_β .

$$\begin{aligned} \dot{\text{IL}}_{10} = & + \left(\rho_{\text{IL}_{10}}^M (M_p + M_i) + \rho_{\text{IL}_{10}}^{D^c} (D_m^c + D_i^c) + \rho_{\text{IL}_{10}}^{T_{\text{reg}}} T_{\text{reg}} \right) [1 + \kappa^+(\text{TGF}_\beta)] \\ & + \rho_{\text{IL}_{10}}^{T_{h2}} T_{h2} \kappa^-(\text{TGF}_\beta) [1 + \kappa^+(\text{IL}_{10})] \quad \leftarrow \text{synthesis} \quad (\text{IV.27}) \\ & - \text{IL}_{10} \mu_c^{\text{nat}} \quad \leftarrow \text{decay} \end{aligned}$$

TGF_β inhibits the phagocytosis, the target cell permissiveness, the lymphocyte proliferation as well as the synthesis of IFN_γ and IL_{10} by T_{h2} . It induces the differentiation of T_h toward regulatory T cells (T_{reg}). TGF_β is synthesised by activated conventional dendritic cells and T_{reg} .

$$\begin{aligned} \dot{\text{TGF}}_\beta = & + \rho_{\text{TGF}_\beta}^{D^c} (D_m^c + D_i^c) + \rho_{\text{TGF}_\beta}^{T_{\text{reg}}} T_{\text{reg}} \quad \leftarrow \text{synthesis} \\ & - \text{TGF}_\beta \mu_c^{\text{nat}} \quad \leftarrow \text{decay} \end{aligned} \quad (\text{IV.28})$$

IV.3 Model validation and numerical exploration

First we calibrated the within-host model and defined a reference scenario. We simulated the model and checked its within-host dynamics against the literature and our previous studies. We also checked whether its behaviour was consistent when turning off key immune mechanisms. Then we explored the model behaviour numerically by simulating various exposure functions (two durations and three intensities) crossed with three levels of strain virulence. This exploration is similar to the study conducted in Chapter III, but less thorough. Rather like the on/off study on key immune mechanisms, it aims at validating the model behaviour.

IV.3.1 Reference scenario

The reference scenario of the within-host model ③ was based on the two previous studies (Sections II.2.2 and III.2.1), particularly on the simplified lung-based model ② (Section III.2.1, TABLE III.1).

IV.3.1.1 Calibration method

As for the lung-based models, we had to design an *ad hoc* procedure to estimate the model parameters (discussed in Section II.2.2). First, we turned off all the mechanisms which are not represented in ②. We ran ③ with the reference parameter values of ② and we checked whether ③ and ② simulations were similar. When not, we adjusted the parameter values in order to obtain the expected dynamics. To do so, we focused on one variable/mechanism at-a-time, by turning off the others. For instance, focusing on the interactions between the virus and its target cells, we turned off the dynamics of all other state variables, as well as the cell infection and excretion, to adjust the parameter that rules target cell activation. This procedure provided a base for the reference scenario. We also reviewed similar published models to guide the definition of the parameter values related to the adaptive state variables, such as the synthesis rate of antibodies or the decay rates of adaptive effectors. Finally, we adjusted the parameter values after having checked that the model parameter values are robust (*i.e.* reasonable variations of parameter values still result in realistic model outputs) for the virulence and exposure scenarios we describe in section IV.3.2.

The model parameters and references are presented in TABLE IV.3.

IV.3.1.2 Simulations

We simulated the infection of a PRRSV-naive weaned pig, *i.e.* with no maternal antibodies, during 300 days. The initial conditions were set as follows :

- $M_s(0) = 5 \cdot 10^5$ cells/ml for the susceptible macrophages ,
- $D_s^c(0) = 5 \cdot 10^3$ cells/ml for the susceptible conventional dendritic cells,
- $D_s^p(0) = 5 \cdot 10^2$ cells/ml for the susceptible plasmacytoid dendritic cells,

All remaining variables were set to zero. The pig was exposed to PRRSV during one day with and exposure intensity $\mathcal{N}_E = 10^{6.3}$ TCID₅₀/ml, which corresponds to the reference short exposure of our previous studies (Sections III.2.2 and II.2.2).

The model was implemented in Scilab 5.3.3 [55].

Table IV.3 Parameters of the within-host model.

Parameter	Description	Values from the literature	Reference value	Unit
Antigen presenting cells (APC) : macrophages (M), conventional (D^c) and plasmacytoid (D^p) dendritic cells				
R_M	recruitment rate of M_s	$[0.5 \cdot 10^5; 1.5 \cdot 10^5]$ [28, 56]	$0.5 \cdot 10^5$	[Ce] day ⁻¹
R_{D^c}	recruitment rate of D_s^c	$[0.5 \cdot 10^3; 1.5 \cdot 10^3]$ [57]	$0.5 \cdot 10^3$	[Ce] day ⁻¹
R_{D^p}	recruitment rate of D_s^p	\emptyset	$0.5 \cdot 10^2$	[Ce] day ⁻¹
η_M	activation rate of M_s by phagocytosis & phagocytosis rate by M_p	\emptyset	$1 \cdot 10^{-7}$	[V] ⁻¹ day ⁻¹
η_{D^c}	activation rate of D_s^c by phagocytosis	0.0037 [58]	$4 \cdot 10^{-5}$	[V] ⁻¹ day ⁻¹
η_{D^p}	activation rate of D_s^p by phagocytosis	0.0037 [58]	$1 \cdot 10^{-4}$	[V] ⁻¹ day ⁻¹
γ_M	activation loss rate of M_p	$[0.3; 2]$ [29, 58]	0.5	day ⁻¹
γ_{D^c}	activation loss rate of D_m^c	$[1; 10^2]$ [58, 59]	0.5	day ⁻¹
γ_{D^p}	activation loss rate of D_m^p	1 [58]	0.5	day ⁻¹
β_M	infection rate of M_s	0.7 [59]	$8 \cdot 10^{-7}$	[V] ⁻¹ day ⁻¹
β_{D^c}	infection rate of D_s^c	\emptyset	$3 \cdot 10^{-5}$	[V] ⁻¹ day ⁻¹
μ_M^{nat}	natural decay rate of macrophages	$[0.01; 0.3]$ [29]	0.2	day ⁻¹
$\mu_{D^c}^{\text{nat}}$	natural decay rate of D^c	$[0.02; 0.5]$ [28, 57, 59]	0.2	day ⁻¹
$\mu_{D^p}^{\text{nat}}$	natural decay rate of D^p	\emptyset	0.2	day ⁻¹
δ_μ	over-mortality rate of M_i & D_i^c	\emptyset	1.1	no unit
μ_M^{ap}	apoptosis rate of macrophages by TNF $_\alpha$	$[10^{-7}; 0.8]$ [57, 60]	0.8	day ⁻¹
$\mu_{D^c}^{\text{ap}}$	apoptosis rate of D^c by TNF $_\alpha$	\emptyset	0.05	day ⁻¹
$\mu_{D^p}^{\text{ap}}$	apoptosis rate of D^p by TNF $_\alpha$	\emptyset	0.05	day ⁻¹
μ_M^{inn}	cytolysis rate of M_i by NK	$[10^{-8}; 10^{-3}]$ [57]	10^{-5}	[Ce] ⁻¹ day ⁻¹
$\mu_{D^c}^{\text{inn}}$	cytolysis rate of D_i^c by NK	$[10^{-8}; 10^{-3}]$ [57]	10^{-3}	[Ce] ⁻¹ day ⁻¹
μ_M^{ad}	cytolysis rate of M_i by T_c	$[10^{-3}; 3.4]$ [29, 58]	10^{-5}	[Ce] ⁻¹ day ⁻¹
$\mu_{D^c}^{\text{ad}}$	cytolysis rate of D_i^c by T_c	\emptyset	10^{-3}	[Ce] ⁻¹ day ⁻¹
Free viral particles (V)				
u_M^V	macrophage-virus unit conversion	\emptyset	1	[V] [Ce] ⁻¹
e	excretion rate	$[10^3; 10^4]$ [58]	0.2	[V] [Ce] ⁻¹ day ⁻¹
μ_V^{nat}	natural decay rate	$[0.17; 1]$ [58]	0.2	day ⁻¹
μ_V^{ad}	neutralisation rate by A_N	\emptyset	0.2	day ⁻¹
u_V^A	antibody-virus unit conversion	$[0.1; 1]$ [58]	0.1	[V] [Ig] ⁻¹
No data : \emptyset . Units : cells [Ce] = cells/ml, virus [V] = TCID ₅₀ /ml, cytokines [Cy] = pg/ml, antibodies [Ig] = pg/ml				
Continued on next page...				

TABLE IV.3 – continued from previous page

Parameter	Description	Values from the literature	Reference value	Unit
Helper T cells (T_h)				
$\alpha_{T_h}^m$	activation rate of T_h by D_m^c	$[1 \cdot 10^{-3}; 0.5]$ [29, 60]	1	day ⁻¹
$\alpha_{T_h}^i$	activation rate of T_h by D_i^c	\emptyset	0.1	day ⁻¹
p_{T_h}	proliferation rate of T_h	$[1 \cdot 10^{-4}; 2.8]$ [60]	0.033	day ⁻¹
$\mu_{T_h}^{\text{nat}}$	natural decay rate of T_h	$[0.33; 0.55]$ [28, 29, 57, 60]	0.06	day ⁻¹
Cytotoxic cells : natural killers (NK) and cytotoxic T cells (T_c)				
α_{NK}	activation rate of NK	$[0.1; 10]$ [28]	10^4	[Ce] day ⁻¹
$\alpha_{T_c}^m$	activation rate of T_c by D_m^c	\emptyset	10^{-2}	[Ce] ⁻¹ day ⁻¹
$\alpha_{T_c}^i$	activation rate of T_c by D_i^c	\emptyset	10^{-3}	[Ce] ⁻¹ day ⁻¹
p_{T_c}	proliferation rate of T_c	0.4 [57]	0.03	day ⁻¹
μ_{NK}^{nat}	natural decay rate of NK	\emptyset	0.05	day ⁻¹
$\mu_{T_c}^{\text{nat}}$	natural decay rate of T_c	$[0.02; 0.55]$ [28, 57, 60]	0.05	day ⁻¹
B lymphocytes (B) and antibodies (A)				
α_B	activation rate of B	\emptyset	0.1	[V] ⁻¹ day ⁻¹
p_B	proliferation rate of B	2.6 [59]	0.033	day ⁻¹
ρ_A	synthesis rate of A	$[0.043; 0.06]$ [58, 59]	0.005	[Ig] [Ce] ⁻¹ day ⁻¹
r_N	proportion of neutralising antibodies	\emptyset	0.1	-
μ_B^{nat}	natural decay rate of B	0.9 [59]	0.04	day ⁻¹
μ_A^{nat}	natural decay rate of A	$[0.04]$ [58, 59]	0.03	day ⁻¹
n_A^V	neutralisation saturation constant	\emptyset	1	[V]
m_A^V	marking saturation constant for V	\emptyset	1	[V]
w_A^V	units of V marked by one A_M unit	$[0.1; 1]$ [58]	0.1	[V] [Ig] ⁻¹
m_A^M	marking saturation constant for (M_i, D_i^c)	\emptyset	1	[Ce]
w_A^M	units of (M_i, D_i^c) marked by one A_M unit	\emptyset	$5 \cdot 10^{-4}$	[Ce] [Ig] ⁻¹
Cytokines				
$\rho_{IL_{1\beta}}^M$	IL _{1β} synthesis rate by M_p & M_i	\emptyset	0.01	[Cy] [Ce] ⁻¹ day ⁻¹
$\rho_{IL_{1\beta}}^{D_i^c}$	IL _{1β} synthesis rate by D_m^c & D_i^c	\emptyset	0.1	[Cy] [Ce] ⁻¹ day ⁻¹
$\rho_{IL_6}^M$	IL ₆ synthesis rate by M_p & M_i	\emptyset	$2.5 \cdot 10^{-3}$	[Cy] [Ce] ⁻¹ day ⁻¹
$\rho_{IL_6}^{D_i^c}$	IL ₆ synthesis rate by D_m^c & D_i^c	\emptyset	0.1	[Cy] [Ce] ⁻¹ day ⁻¹
$\rho_{IL_8}^M$	IL ₈ synthesis rate by M_p & M_i	\emptyset	$2.5 \cdot 10^{-3}$	[Cy] [Ce] ⁻¹ day ⁻¹
No data : \emptyset . Units : cells [Ce] = cells/ml, virus [V] = TCID ₅₀ /ml, cytokines [Cy] = pg/ml, antibodies [Ig] = pg/ml				
Continued on next page...				

TABLE IV.3 – continued from previous page

Parameter	Description	Values from the literature	Reference value	Unit
$\rho_{IL_8}^c$	IL ₈ synthesis rate by D_m^c & D_i^c	\emptyset	0.01	[Cy] [Ce] ⁻¹ day ⁻¹
$\rho_{TNF_\alpha}^M$	TNF _α synthesis rate by M_p & M_i	$[5 \cdot 10^{-5}; 2 \cdot 10^{-2}]$ [28, 60]	$6.25 \cdot 10^{-3}$	[Cy] [Ce] ⁻¹ day ⁻¹
$\rho_{TNF_\alpha}^D$	TNF _α synthesis rate by D_m^c & D_i^c	$[2 \cdot 10^{-5}; 8 \cdot 10^{-4}]$ [28]	$6.25 \cdot 10^{-2}$	[Cy] [Ce] ⁻¹ day ⁻¹
$\rho_{TNF_\alpha}^D$	TNF _α synthesis rate by D_m^p	\emptyset	1	[Cy] [Ce] ⁻¹ day ⁻¹
$\rho_{TNF_\alpha}^T$	TNF _α synthesis rate by T_c	$[0.6 \cdot 10^{-4}; 1.1 \cdot 10^{-4}]$ [60]	10^{-5}	[Cy] [Ce] ⁻¹ day ⁻¹
$\rho_{IFN_\alpha}^M$	IFN _α synthesis rate by M_i	\emptyset	$6.25 \cdot 10^{-3}$	[Cy] [Ce] ⁻¹ day ⁻¹
$\rho_{IFN_\alpha}^D$	IFN _α synthesis rate by D_i^c	\emptyset	$6.25 \cdot 10^{-2}$	[Cy] [Ce] ⁻¹ day ⁻¹
$\rho_{IFN_\alpha}^D$	IFN _α synthesis rate by D_m^p	\emptyset	1	[Cy] [Ce] ⁻¹ day ⁻¹
$\rho_{IFN_\alpha}^D$	IFN _α synthesis rate by D_m^c & D_i^c	\emptyset	10^{-3}	[Cy] [Ce] ⁻¹ day ⁻¹
$\rho_{IFN_\gamma}^{Th1}$	IFN _γ synthesis rate by $Th1$	$[0.02; 100]$ [29, 57, 60]	$7 \cdot 10^{-3}$	[Cy] [Ce] ⁻¹ day ⁻¹
$\rho_{IFN_\gamma}^{NK}$	IFN _γ synthesis rate by NK	\emptyset	$3 \cdot 10^{-2}$	[Cy] [Ce] ⁻¹ day ⁻¹
$\rho_{IFN_\gamma}^T$	IFN _γ synthesis rate by T_c	$[1; 100]$ [60]	$2 \cdot 10^{-3}$	[Cy] [Ce] ⁻¹ day ⁻¹
$\rho_{IL_{12}}^M$	IL ₁₂ synthesis rate by M_p & M_i	$[8 \cdot 10^{-6}; 0.1]$ [28, 29, 57, 60]	$8 \cdot 10^{-3}$	[Cy] [Ce] ⁻¹ day ⁻¹
$\rho_{IL_{12}}^D$	IL ₁₂ synthesis rate by D_m^c & D_i^c	$[3.5 \cdot 10^{-3}; 0.23]$ [28, 57]	0.2	[Cy] [Ce] ⁻¹ day ⁻¹
$\rho_{IL_{12}}^T$	IL ₁₂ synthesis rate by T_c	\emptyset	10^{-5}	[Cy] [Ce] ⁻¹ day ⁻¹
$\rho_{IL_4}^{Th2}$	IL ₄ synthesis rate by $Th2$	$[1 \cdot 10^{-3}; 9 \cdot 10^{-2}]$ [29, 60]	1	[Cy] [Ce] ⁻¹ day ⁻¹
$\rho_{IL_{10}}^M$	IL ₁₀ synthesis rate by M_p & M_i	$[0; 0.1]$ [28, 29]	$8 \cdot 10^{-3}$	[Cy] [Ce] ⁻¹ day ⁻¹
$\rho_{IL_{10}}^D$	IL ₁₀ synthesis rate by D_m^c & D_i^c	$[9 \cdot 10^{-4}; 2 \cdot 10^{-3}]$ [28]	0.4	[Cy] [Ce] ⁻¹ day ⁻¹
$\rho_{IL_{10}}^{reg}$	IL ₁₀ synthesis rate by T_{reg}	$[1 \cdot 10^{-4}; 6 \cdot 10^{-2}]$ [29, 57, 60]	10^{-2}	[Cy] [Ce] ⁻¹ day ⁻¹
$\rho_{TGF_\beta}^{reg}$	TGF _β synthesis rate by T_{reg}	\emptyset	10^{-4}	[Cy] [Ce] ⁻¹ day ⁻¹
$\rho_{TGF_\beta}^{reg}$	TGF _β synthesis rate by T_{reg}	\emptyset	10^{-2}	[Cy] [Ce] ⁻¹ day ⁻¹
μ_c^{nat}	natural decay rate of cytokines	$[1; 40]$ [29, 60]	2	[Cy] [Ce] ⁻¹ day ⁻¹
k_m	half saturation constant in κ functions	\emptyset	20	day ⁻¹
v_m	saturation factor in κ functions	\emptyset	30	[Cy]
			1.5	–

No data : \emptyset . Units : cells [Ce] = cells/ml, virus [V] = TCID₅₀/ml, cytokines [Cy] = pg/ml, antibodies [Ig] = pg/ml

IV.3.1.3 Within-host dynamics

We present a synthetic view of the within-host dynamics in FIGURE IV.2 and all state variables in Appendix C. To assess the validity of the within-host model ③, we compare our results with the literature and with results produced by the lung-based model ①.

The reference scenario resulted in a realistic behaviour (Section I.1). PRRSv infection lasted 84 days (FIGURE IV.2A) and was characterised by : more infected APC than activated and non-infected APC (FIGURE IV.2B–C); lower titres of pro-inflammatory cytokines, antiviral cytokines and IL_{12} than of immuno-modulatory cytokines (FIGURE IV.2E–H); a cellular response lower than the humoral and regulatory adaptive responses (FIGURE IV.2I–K); and a low and delayed titre of neutralising antibodies compared to marker antibodies (FIGURE IV.2O–P). Innate components globally peaked in the first days (red lines in FIGURE IV.2), whereas adaptive components globally peaked later (blue lines in FIGURE IV.2). Infected APC peaks correspond to 50% of the total APC concentration, compared to the 40% observed by Labarque *et al.* [56]. Neutralising antibodies peaked 18 weeks post infection, compared to the 10 to 18 weeks reported in the literature [8, 14, 26]. The cytotoxic T cells T_c peaked during the 4th week post infection, compared to the 4 to 7 weeks reported in the literature [8, 14, 26]. During the first month post infection, antibodies mainly consisted of IgM and IgG (more than 50% of B_{MG} plasmocytes among the total plasmocyte titre up to 50 days post infection). Then they switched to IgA antibodies (plasmocytes stabilised around 40% of B_{MG} and 60% of B_A 100 days post infection). Labarque *et al.* [56] reported an IgA peak occurring later than IgG and IgM peaks, after an experimental infection by PRRSv.

Compared to the reference scenario of the lung-based model ① (black lines in FIGURE II.5), our results (FIGURE IV.2) exhibit similar tendencies with few quantitative differences :

- a longer infection duration (① : 72 and ③ : 84 days);
- a higher peak of phagocytosing macrophages (① : $8 \cdot 10^3$ and ③ : $5 \cdot 10^3$ cells/ml) and a higher peak of infected macrophages (① : $7 \cdot 10^4$ and ③ : $1.5 \cdot 10^5$ cells/ml);
- lower peaks of summed pro-inflammatory cytokines $IL_{1\beta} + IL_6 + IL_8$ (① : 80 and ③ : 29 pg/ml) and innate antiviral cytokines $TNF_\alpha + IFN_\alpha$ (① : 300 and ③ : 89 pg/ml);
- a lower peak of IFN_γ (① : 6 and ③ : 0.5 pg/ml), a similar peak of IL_{10} (① : 100 and ③ : 165 pg/ml) and a higher peak of TGF_β (① : 1 and ③ : 103 pg/ml).

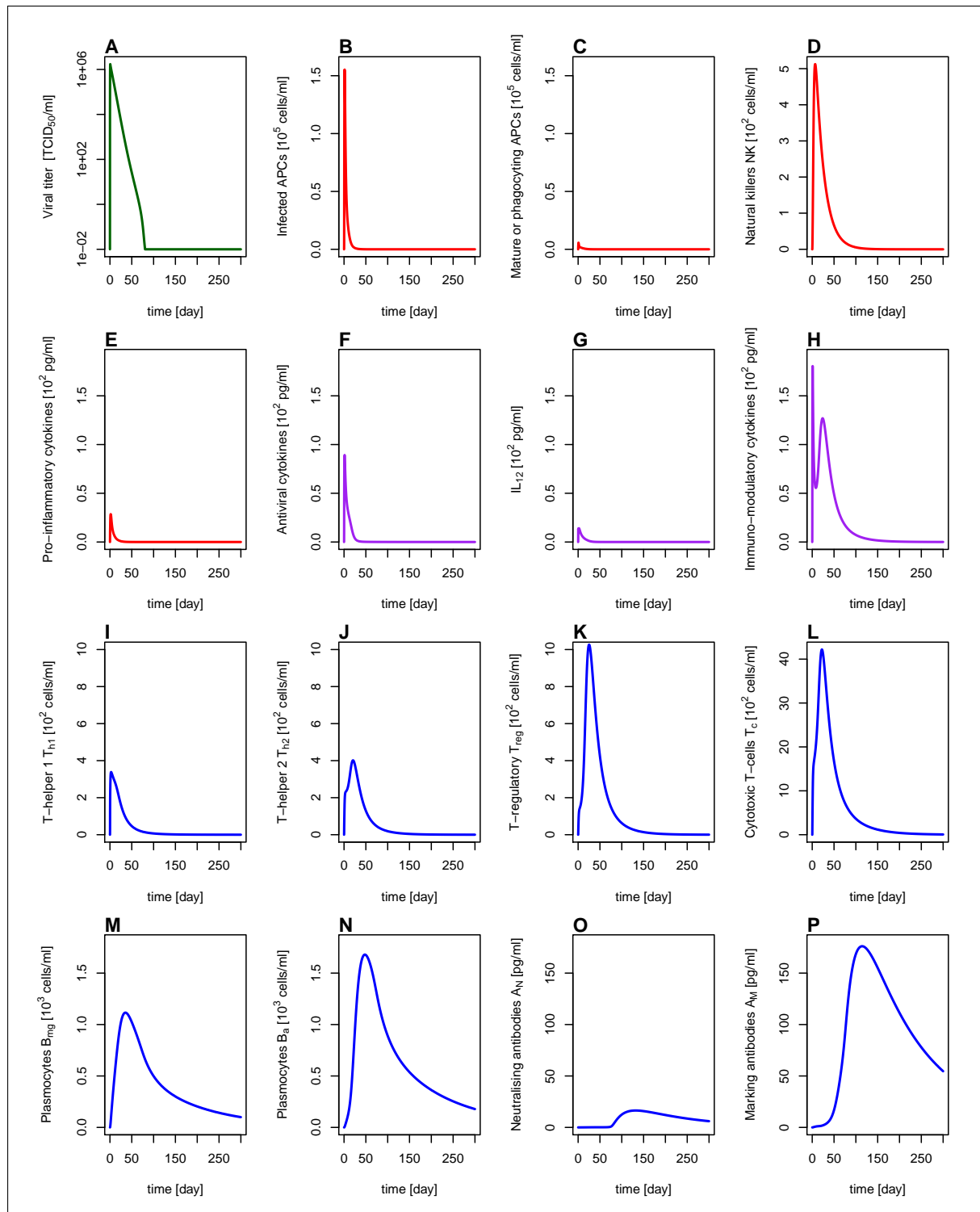

Figure IV.2 Synthesis of the infection and immune dynamics for the reference scenario of the within-host model ③. **A** viral titer (semi-log graph). Effectors : **B** infected antigen presenting cells ($M_i + D_i^c$), **C** phagocytosing or mature antigen presenting cells ($M_p + D_m^c + D_m^p$), **D** natural killers (NK in **D**), **I** type 1 helper T cells (T_{h1}), **J** type 2 helper T cells (T_{h2}), **K** regulatory T cells (T_{reg}), **L** cytotoxic lymphocytes (T_c), **M** plasmocytes producing IgM or IgG antibodies (B_{MG}) and **N** plasmocytes producing IgA antibodies (B_A).

Antibodies : **O** neutralising antibodies (A_N) and **P** marker antibodies (A_M). Cytokines : **E** pro-inflammatory cytokines ($IL_{1\beta} + IL_6 + IL_8$), **F** antiviral cytokines ($IFN_\alpha + TNF_\alpha + IFN_\gamma$), **G** other immuno-regulatory cytokines promoting the cellular response (IL_{12}) and **H** immuno-modulatory cytokines ($IL_{10} + IL_4 + TGF_\beta$).

PRRSv in green, innate components in red, adaptive components in blue and both innate and adaptive components in purple.

IV.3.1.4 On/off immune mechanisms

To further check if our model simulates a realistic behaviour, we turned off one by one the nine immune mechanisms which are thought to determine PRRSv infection resolution (FIGURE IV.3) :

- the synthesis of antiviral cytokines TNF_α , IFN_α and IFN_γ (by setting $\rho_{\text{TNF}_\alpha} = \rho_{\text{IFN}_\alpha} = \rho_{\text{IFN}_\gamma} = 0$ in equations (IV.22,IV.23,IV.24)),
- *vs* the synthesis of immuno-modulatory cytokines IL_{10} and TGF_β (by setting $\rho_{\text{IL}_{10}} = \rho_{\text{TGF}_\beta} = 0$ in equations (IV.27,IV.28)),
- the viral replication (by setting $e = 0$ in equation (IV.9)),
- the target cell infection (by setting $\beta = 0$ in equations (IV.1,IV.3,IV.4,IV.6,IV.9)),
- the cytolysis of infected cells by natural killers NK (by setting $\mu_M^{\text{inn}} = \mu_{D^c}^{\text{inn}} = 0$ in equations (IV.3,IV.6)),
- the cytolysis of infected cells by cytotoxic T cells T_c (by setting $\mu_M^{\text{ad}} = \mu_{D^c}^{\text{ad}} = 0$ in equations (IV.3,IV.6)),
- the target cells apoptosis due to TNF_α (by setting $\mu_M^{\text{ap}} = 0$, $\mu_{D^c}^{\text{ap}} = \mu_{D^p}^{\text{ap}} = 0$ in equations (IV.1–IV.8)),
- the phagocytosis by macrophages M_p (by setting $\eta_M = 0$ in equations (IV.1,IV.2)),
- the viral neutralisation by antibodies (by setting $\mu_V^{\text{ad}} = 0$ in equations (IV.9,IV.17)).

We focused on the resulting viral dynamics and in particular on the infection duration D_I , presented in FIGURE IV.3. As expected, (i) the absence of immuno-modulatory cytokines, viral excretion and target cell infection all resulted in lower infection durations D_I than the reference value $D_I = 83.5$ days; and (ii) the absence of NK cytolysis, M_p phagocytosis, apoptosis due to TNF_α , T_c cytolysis, antiviral cytokines and viral neutralisation all resulted in higher D_I (in ascending order of D_I).

Among the nine mechanisms tested, the absence of immuno-modulatory cytokines resulted in the higher D_I reduction and the absence of viral neutralisation or antiviral cytokines resulted in the higher D_I increase. The strong influence of antiviral and immuno-modulatory cytokines seems consistent with the literature (Section I.1.6).

One other striking result is that the absence of each innate immune mechanism (NK cytolysis, M_p phagocytosis and apoptosis due to TNF_α) induced a clear but feable increase of D_I . However, the literature suggest that these mechanisms should be sufficient to explain prolonged PRRSv infection durations (Section I.1.6). So we tone down our results, which suggest a low influence of the innate mechanisms on the infection resolution. Given (i) the high reduction of D_I induced by the absence of viral excretion or target cell infection and (ii) the strong modulation of the innate mechanisms by the antiviral and immuno-modulatory cytokines, which exhibited a strong influence on the infection duration and which are also impacted by the strain virulence, our results seem robust.

Looking at the shape of the viral titre in the absence of viral neutralisation (brown curve in FIGURE IV.3), it is interesting to note that only this curve is fairly linear, especially ten days before the infection resolution. This suggests that the neutralisation reduces tardily the viral titre. As neutralising antibodies response to PRRSv is weak and delayed (Section I.1.5), this result is logical.

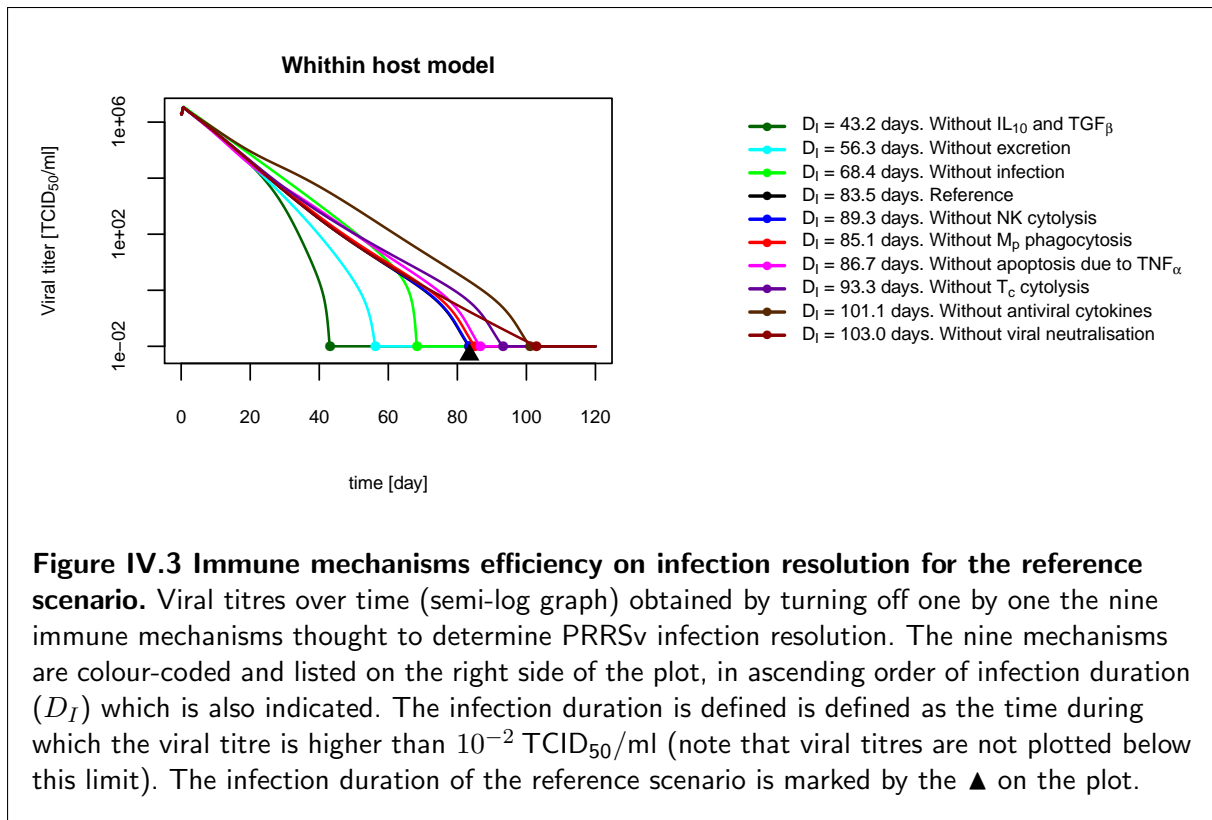

IV.3.2 Exposure and virulence scenarios

We previously showed that variability in terms of viral exposure (intensity and duration) and PRRSV strain virulence (and/or pig susceptibility) need to be considered (sections II.4 and III.4) in order to explore the within-host dynamics after PRRSV infection. So we conducted such a study on the within-host model. It is similar to the study in Chapter III, but less thorough. Rather like the on/off study on key immune mechanisms (Section IV.3.1.4), it aims at validating the model behaviour.

First we define the scenarios and the design of numerical experiments used to explore the impact of exposure and virulence. Then we present results in terms of viral dynamics and immune characteristics.

IV.3.2.1 Scenario definition

Exposure We tested three exposure intensities $\mathcal{N}_E \in \{L_1; L_3; L_5\}$ and two exposure durations D_E : the reference exposure lasting one day (E_s exposure) and a prolonged exposure lasting 20 days (E_{p2} exposure). Crossing the three exposure intensities with the two exposure durations, we tested six exposure scenarios.

Virulence levels We tested three virulence levels: $S_{vir} \in \{S_1; S_2; S_3\}$ where S_2 is the reference scenario, S_1 a lowly virulent PRRSV strain and S_3 a highly virulent strain.

The parameter values of our virulence scenarios are based on the scenarios defined in Section III.2.3. Highly virulent strains are assumed to (i) efficiently infect the cells and replicate,

(ii) promote the host capacity to synthesise immuno-modulatory over antiviral cytokines and (iii) reduce the activation of the adaptive response [1, 4, 47]. We selected the parameters related to these immune functions as parameters modulated by PRRSv strain virulence :

- the activation rates of antigen presenting cells η , found in equations (IV.1, IV.2, IV.4, IV.5, IV.7, IV.8, IV.9) ;
- the infection rates of target cells β , found in equations (IV.1, IV.3, IV.4, IV.6, IV.9) ;
- the viral replication rate e , found in equation (IV.9) ;
- the adaptive effector activation rates by the conventional dendritic cells α_{T_h} and α_{T_c} , found in equations (IV.10–IV.12, IV.14) ;
- the synthesis rates of antiviral cytokines by antigen presenting cells (for TNF_α : $\rho_{\text{TNF}_\alpha}^M$, $\rho_{\text{TNF}_\alpha}^{D^c}$, $\rho_{\text{TNF}_\alpha}^{D^p}$, found in equation (IV.22) ; for IFN_α : $\rho_{\text{IFN}_\alpha}^M$, $\rho_{\text{IFN}_\alpha}^{D^c}$, $\rho_{\text{IFN}_\alpha}^{D^p}$, found in equation (IV.23) ; and for IFN_γ : $\rho_{\text{IFN}_\gamma}^{D^c}$, found in equation (IV.24)) ;
- the synthesis rates of immuno-modulatory cytokines by antigen presenting cells (for IL_{10} : $\rho_{\text{IL}_{10}}^M$, $\rho_{\text{IL}_{10}}^{D^c}$, found in equation (IV.27) ; and for TGF_β : $\rho_{\text{TGF}_\beta}^{D^c}$, found in equation (IV.28)).

We varied their reference values from $\pm 35\%$. The values from the three virulence levels are presented in TABLE IV.4. In the previous study exploring the impact of exposure and strain virulence (Section III.2.3), we also varied the rates of cytokine syntheses by adaptive effectors. Here, we assumed that the strain virulence only impacts the immune functions of the antigen presenting cells.

Table IV.4 Model parameter values for the three virulence levels. The reference value (ref.) corresponds to TABLE IV.3, in which the parameters are defined.

Parameters	Virulence level S_{vir}		
	low S_1	ref. S_2	high S_3
activation rates of antigen presenting cells			
η_M	$1.35 \cdot 10^{-7}$	10^{-7}	$6.5 \cdot 10^{-8}$
η_{D^c}	$5.4 \cdot 10^{-5}$	$4 \cdot 10^{-5}$	$1.6 \cdot 10^{-5}$
η_{D^p}	$1.35 \cdot 10^{-4}$	10^{-4}	$6.5 \cdot 10^{-5}$
infection rates of target cells			
β_M	$5.2 \cdot 10^{-7}$	$8 \cdot 10^{-7}$	$1.08 \cdot 10^{-6}$
β_{D^c}	$1.95 \cdot 10^{-5}$	$3 \cdot 10^{-5}$	$4.05 \cdot 10^{-5}$
viral replication rate			
e	0.13	0.2	0.27
adaptive effector activation rates			
$\alpha_{T_h}^m$	1.35	1	0.65
$\alpha_{T_h}^i$	$1.35 \cdot 10^{-1}$	10^{-1}	$6.5 \cdot 10^{-2}$
$\alpha_{T_c}^m$	$1.35 \cdot 10^{-2}$	10^{-2}	$6.5 \cdot 10^{-3}$
$\alpha_{T_c}^i$	$1.35 \cdot 10^{-3}$	10^{-3}	$6.5 \cdot 10^{-4}$
cytokine synthesis rates by antigen presenting cells			
$\rho_{\text{TNF}_\alpha}^M$	$8.44 \cdot 10^{-3}$	$6.25 \cdot 10^{-3}$	$4.06 \cdot 10^{-3}$
$\rho_{\text{TNF}_\alpha}^{D^c}$	$8.44 \cdot 10^{-2}$	$6.25 \cdot 10^{-2}$	$4.06 \cdot 10^{-2}$
$\rho_{\text{TNF}_\alpha}^{D^p}$	1.35	1	0.65
$\rho_{\text{IFN}_\alpha}^M$	$8.44 \cdot 10^{-3}$	$6.25 \cdot 10^{-3}$	$4.06 \cdot 10^{-3}$
$\rho_{\text{IFN}_\alpha}^{D^c}$	$8.44 \cdot 10^{-2}$	$6.25 \cdot 10^{-2}$	$4.06 \cdot 10^{-2}$
$\rho_{\text{IFN}_\alpha}^{D^p}$	1.35	1	0.65
$\rho_{\text{IFN}_\gamma}^{D^c}$	$1.35 \cdot 10^{-3}$	10^{-3}	$6.5 \cdot 10^{-4}$
$\rho_{\text{IL}_{10}}^M$	$5.2 \cdot 10^{-3}$	$8 \cdot 10^{-3}$	$1.8 \cdot 10^{-2}$
$\rho_{\text{IL}_{10}}^{D^c}$	0.26	0.4	0.54
$\rho_{\text{TGF}_\beta}^{D^c}$	$6.5 \cdot 10^{-3}$	10^{-2}	$1.35 \cdot 10^{-2}$

Design of numerical experiments We crossed all virulence and exposure scenarios, resulting in a complete design of numerical experiments with 18 scenarios.

IV.3.2.2 Results and discussion

The viral titre curves over the infection period for the 18 scenarios are presented in FIGURE IV.4. We also selected twelve scalar descriptors of the viral and immune dynamics, based on Section III.2.4. The results are presented in FIGURE IV.5. To check the realism of the within-host dynamics simulated by model ③, we compared our results with those obtained with the lung-based model ② (Section III.3.1). We found very few quantitative data in the literature on the adaptive component dynamics, so we only discussed the qualitative results.

Within-host characteristics We selected twelve scalar descriptors of the viral and immune dynamics, based on section III.2.4.

- Infection severity (Section III.2.4) :
 - infection duration (D_I);
 - total viral dose (Σ_V);
 - viral peak V_{\max} .

The viral peak and infection duration more or less determine the total viral dose and are hence two components of the infection severity.
- Cytokines :
 - total pro-inflammatory cytokines (Σ_{P_i} , Section III.2.4);
 - total innate antiviral cytokines (Σ_{A_i} , defined as Σ_{P_i});
 - percentage of anti-viral cytokines $\%(A_i + \text{IFN}_\gamma)$ (Section III.2.4).
- Adaptive response orientation :
 - $\%T_{h1}$, a descriptor of the orientation towards the cellular response, defined as follows :

$$100 \frac{\Sigma_{T_{h1}}}{\Sigma_{T_{h1}} + \Sigma_{T_{h2}} + \Sigma_{T_{\text{reg}}}}$$
 - $\%T_{h2}$, a descriptor of the orientation towards the humoral response, defined as follows :

$$100 \frac{\Sigma_{T_{h2}}}{\Sigma_{T_{h1}} + \Sigma_{T_{h2}} + \Sigma_{T_{\text{reg}}}}$$
- Immune mechanisms (Section III.2.4) :
 - the phagocytosis activity, quantified by either $\mathcal{N}_{\text{phag}}$, the total number of viral particles phagocytosed by macrophages, or $\mathcal{N}_{\text{pha}/E}$, the normalised number of viral particles phagocytosed by macrophages;
 - the cell infection activity, quantified by either \mathcal{N}_{inf} , the total number of viral particles having infected a target cell, or $\mathcal{N}_{\text{inf}/E}$, the normalised number of viral particles having infected a target cell;
 - the viral replication activity, quantified by either $\mathcal{N}_{\text{excr}}$, the total number of excreted viral particles by infected cells, or $\mathcal{N}_{\text{excr}/E}$, the normalised number of viral particles excreted by infected cells;
 - the viral neutralisation activity, quantified by either $\mathcal{N}_{\text{neutr}}$, the total number of viral particles neutralised by the antibodies, or $\mathcal{N}_{\text{neutr}/E}$, the normalised number of viral particles neutralised by the antibodies;
 - The cytolysis activity, quantified by either $\mathcal{N}_{\text{cyto}}$, the total number of viral particles destroyed by the infected cell cytolysis, or $\mathcal{N}_{\text{cyt}/E}$, the normalised number of viral particles destroyed by the infected cell cytolysis.

Viral dynamics As expected, the higher the exposure intensity, the exposure duration and the virulence level, the higher the infection duration (FIGURE IV.4). As for ② (FIGURE III.10A and B), the total viral dose was fully determined by the exposure intensity (FIGURE IV.5A); the infection duration was determined first by the virulence level, then by the exposure intensity and finally by the exposure duration (FIGURE IV.5B). Scenarios of low virulence S_1 resulted

in infection durations between 43 and 99 days; scenarios of reference virulence S_2 in infection durations between 62 and 114 days; and scenarios of high virulence S_3 in infection durations between 106 and 157 days (FIGURE IV.5B). If the variation ranges of the infection durations were lower than in Section III.3.1, the total viral doses were the same. As the reference scenarios of both models resulted in slightly different dynamics and the as virulence scenarios were not exactly the same, these infection duration differences are not surprising.

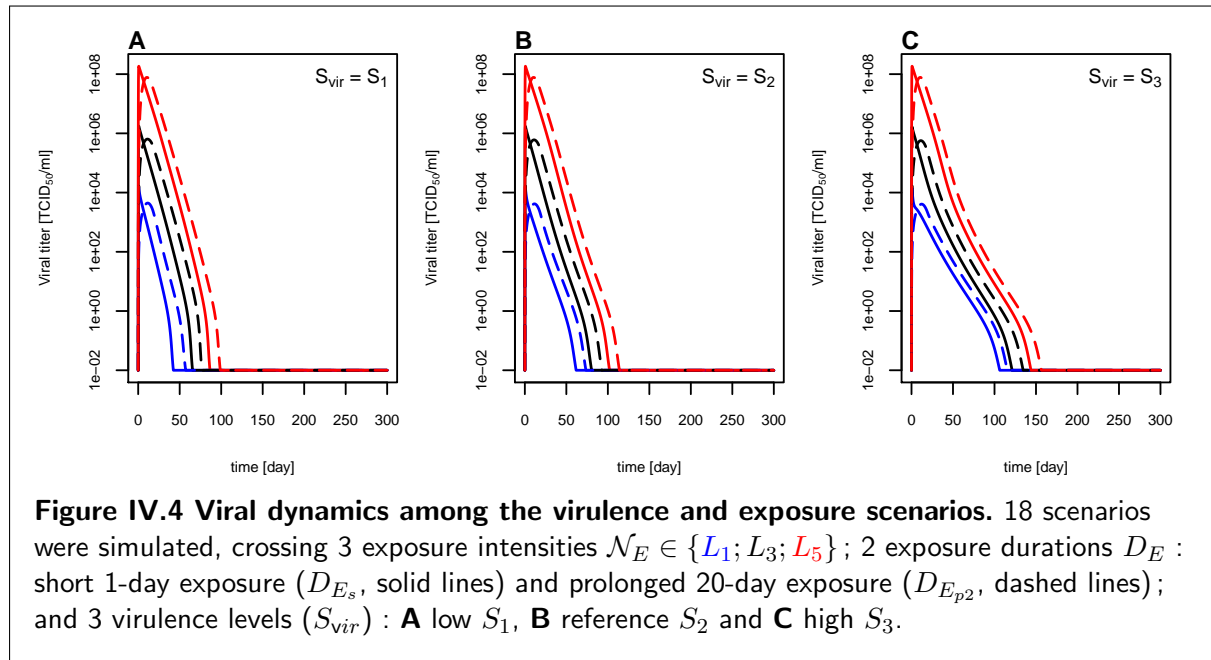

Immune characteristics Pro-inflammatory cytokines. Our results (FIGURE IV.5C) exhibited lower total pro-inflammatory cytokines Σ_{P_i} than in Section III.3.1 (FIGURE III.10D). In both cases, Σ_{P_i} was strongly determined by the exposure intensity \mathcal{N}_E . Previously, we found that for a given \mathcal{N}_E , Σ_{P_i} increased with the virulence level (FIGURE III.10D). In the present case, Σ_{P_i} increased or decreased with the virulence level, depending on the exposure intensity (FIGURE IV.5C).

Antiviral cytokines. The total innate antiviral cytokines Σ_{A_i} increased with the exposure intensity and for a given \mathcal{N}_E , decreased with the increase of the virulence level (FIGURE IV.5D). These results are consistent with the way we defined the virulence levels. $\%(A_i + \text{IFN}_\gamma)$ reached lower values (between 3 and 29%, FIGURE IV.5E) than the previous simulations (Section III.3.1, FIGURE III.10E) and were differently impacted by the exposure intensity and the virulence level. Here (*vs* previously), $\%(A_i + \text{IFN}_\gamma)$ increased (*vs* decreased) with \mathcal{N}_E and for a given \mathcal{N}_E , increased or decreased with S_{vir} (*vs* decreased). As S_{vir} was defined by varying the cytokine synthesis rates by the antigen presenting cells (*vs* by all producing cells), these differences were expected.

Adaptive response orientation. The orientation towards the cellular response is characterised by $\%T_{h1}$ (FIGURE IV.5F) (*vs* $\%R_c$ in FIGURE III.10F) and towards the humoral response by $\%T_{h2}$ (FIGURE IV.5G) (*vs* the R_h in FIGURE III.10G). Whatever the scenario, the $\%T_{h1}$ were lower than 23%, so the adaptive response was orientated towards the humoral or the regulatory responses. This is consistent with the previous results. Here, the orientation of the adaptive response appeared more strongly influenced by the exposure duration and the virulence level

and less strongly by the exposure intensity than previously. There was no clear relation between the exposure intensity and the adaptive response orientation. For a given exposure intensity, $\%T_{h1}$ ($\%T_{h2}$) globally increased (decreased) with the increase of the virulence level. This result contradicts previous results, but could be due to the difference of virulence level definitions.

Immune mechanisms. All normalised immune mechanisms of interest tended to zero for high exposure intensities, suggesting that they saturated. The immune mechanisms in favour of viral replication ($\mathcal{N}_{\text{excr}/E}$ in FIGURE IV.5H *vs* in FIGURE III.10H and $\mathcal{N}_{\text{inf}/E}$ in FIGURE IV.5I *vs* in FIGURE III.10I) decreased with the increase of exposure intensity and increased with the virulence levels. The values reached here were higher than in the previous simulations. The immune mechanisms in favour of viral neutralisation ($\mathcal{N}_{\text{cyt}/E}$ in FIGURE IV.5J *vs* in FIGURE III.10J; $\mathcal{N}_{\text{neutr}/E}$ in FIGURE IV.5K *vs* in FIGURE III.10K and $\mathcal{N}_{\text{pha}/E}$ in FIGURE IV.5L *vs* in FIGURE III.10L) decreased (*vs* increased or decreased) with the increase of the exposure intensity. $\mathcal{N}_{\text{cyt}/E}$ increased with the virulence level whereas $\mathcal{N}_{\text{neutr}/E}$ and $\mathcal{N}_{\text{pha}/E}$ decreased. The values reached by $\mathcal{N}_{\text{cyt}/E}$ here were higher than in the previous simulations, whereas $\mathcal{N}_{\text{neutr}/E}$ and $\mathcal{N}_{\text{pha}/E}$ were lower.

Synthesis. For a given exposure intensity, infection with a lowly (highly) virulent PRRSV strain resulted in short (prolonged) infection durations associated with :

- high (low) total levels of innate antiviral cytokines and phagocytosis activity, with low (high) viral excretion and cell infection ;
- a stronger adaptive response orientation towards the humoral (cellular) compared to the reference scenario ;
- a low (high) cytolysis activity, but a high (low) viral neutralisation activity.

These results are consistent with the hypotheses published to explain prolonged infection durations (Section I.1.6), suggesting that altering the immune functions of the antigen presenting cells could hamper the whole immune response.

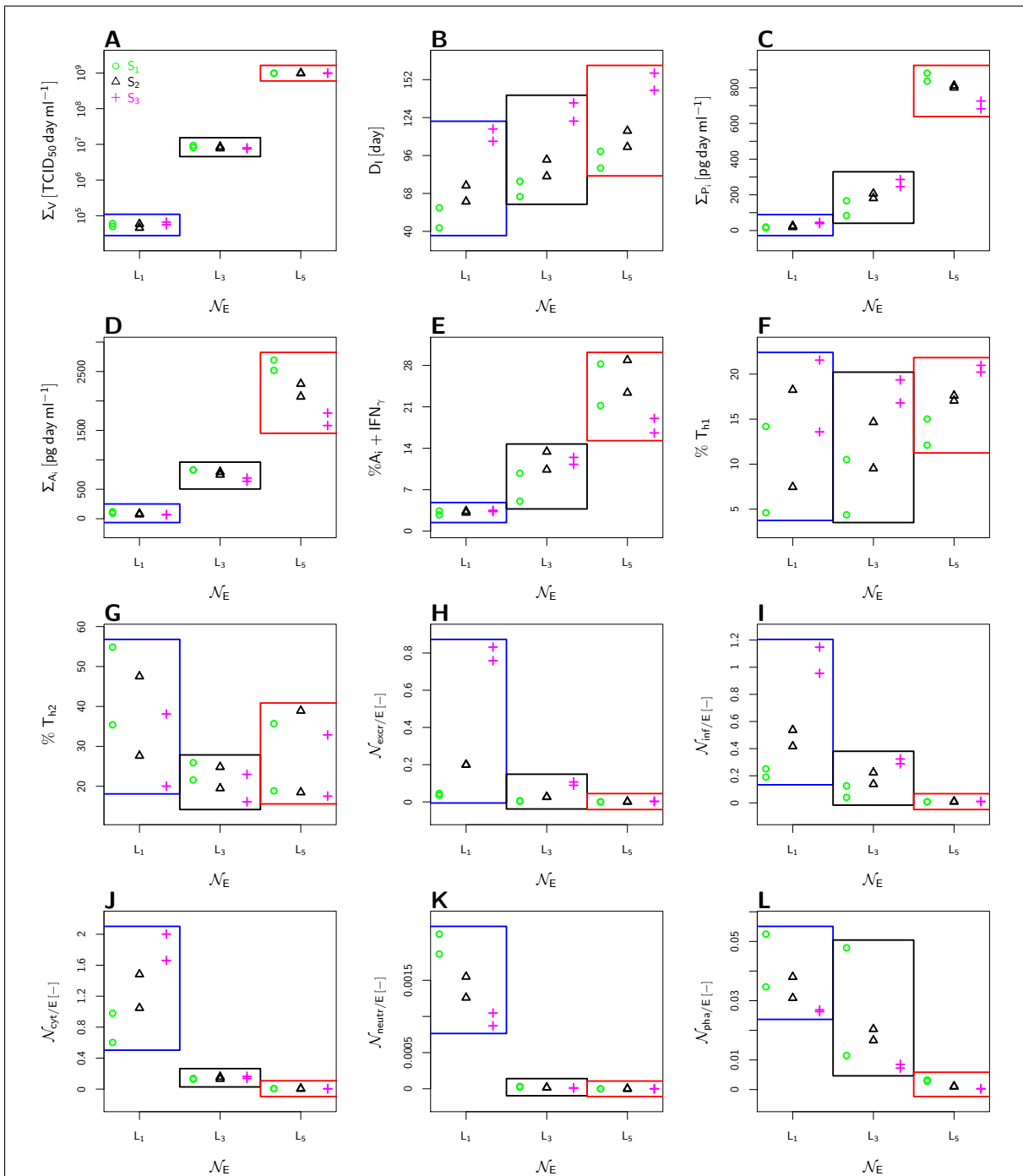

Figure IV.5 Within-host characteristics for the virulence and exposure scenarios. 18 scenarios were simulated, crossing 3 exposure intensities $\mathcal{N}_E \in \{L_1; L_3; L_5\}$; 2 exposure durations D_E : short 1-day exposure (D_{E_s}) and prolonged 20-day exposure ($D_{E_{p2}}$); and 3 virulence levels ($S_{vir} \in \{\bullet S_1, \blacktriangle L_2, + S_3\}$).

IV.4 Within-host dynamics of a vaccinated pig after PRRSv exposure

To simulate the within-host dynamics of a vaccinated pig after PRRSv exposure, we need to define the pig the immune state, in terms of memory B and T cells, as well as antibodies. This information is not readily available, so we had to define a vaccination strategy *in silico* (Section IV.4.1). Then we explored the efficiency of two vaccines crossed with three virulence levels, two PRRSv exposure durations and three PRRSv exposure intensities (Section IV.4.2).

IV.4.1 Vaccination strategy

IV.4.1.1 Immune protection induced by vaccination

If the animal has been exposed to PRRSv previously, by infection or vaccination, the adaptive response has already been activated and memory components have been induced. It can result in a (partial) protection even if no detectable antibodies remain. The cells in the expanded clone are called memory cells [33] and are responsible for the immunological protection conferred by vaccination. The memory response consists in adaptive effectors (helper T cells, cytotoxic lymphocytes and B lymphocytes) and antibodies with prolonged lifetime (several months compared to a few weeks for the non-memory components) [33]. These memory effectors and antibodies appear during the adaptive response activation and consist in a given proportion of the activated adaptive effectors and antibodies. During the primary immune response induced by vaccination or infection, the memory components have no immune function. However, when the animal is re-exposed to the pathogen, the memory components quickly undergo a multi-cycle proliferative expansion and exhibit the same immune functions as the adaptive components from which they were differentiated. Consequently, the animal with memory components starts with adaptive components, while they would appear tardily after a primary exposure to the pathogen. This confers a significant benefit to control the infection.

IV.4.1.2 Current PRRSv vaccines

Vaccination is a strategy currently used to control clinical diseases caused by PRRSv [7]. Many vaccines have been produced to combat PRRSv [1]. There are at least two types of commercialised PRRSv vaccine : modified-live virus vaccines (or attenuated live virus vaccines) and killed virus vaccines (or inactivated virus vaccines) [1–3, 7]. In contrast to live vaccines, the inactivated (or killed) vaccines contain adjuvants [1].

None of the current vaccines is able to prevent respiratory infection, nor pig-to-pig transmission of the virus [3, 61]. Attenuated live vaccines have been widely used and have shown some efficacy in reducing disease occurrence and severity, as well as the duration of viraemia and virus shedding [14, 61]. They induce delayed antibody and cytotoxic lymphocyte responses [7]. Protection provided by attenuated live vaccines is better than by inactivated vaccines [3, 7, 61]. Inactivated vaccines may reduce the levels of viraemia in some pigs, but do not show consistent benefit against infection [14]. They induce poor cytotoxic lymphocyte response and do not induce an antibody response [7].

IV.4.1.3 Vaccination scenarios

In this preliminary exploration of the vaccine efficiency, we focused on the most efficient vaccines : the attenuated live virus vaccines. PRRSV attenuated live vaccines induce infection of lung and lymphoid tissues ; the infection durations are similar to infections by virulent viruses and the vaccinated pigs can transmit the disease to contact pigs ; these vaccines are immunologically protective, *i.e.* they eliminate or reduce the infection and disease qualitatively and quantitatively [1].

In our within-host model, we did not represent the memory component dynamics, but we can define positive initial conditions for the adaptive components which correspond to the memory components induced by vaccination. In the literature, there are very few quantitative data on the adaptive components during PRRSV infection, as well as on the memory component concentrations induced by vaccination. So we had to find an alternative to inform the vaccinated pig initial immune state. We used our model to simulate the within-host dynamics induced by PRRSV vaccination and inform the initial conditions corresponding to a vaccinated pig. To do so, we had to (i) define the parameter values corresponding to a vaccine scenario ; (ii) determine how the adaptive components activated by vaccination translate into memory cells. We then defined the vaccine scenarios and the design of numerical experiments.

Simulation of the within-host dynamics induced by vaccination A vaccination with an attenuated virus can be assimilated to an infection with a PRRSV strain characterised by a significant induction of the immune responses (the more the cytotoxic cells and antibodies are activated, the better the pig protection), but a low severity. Based on this statement, we defined vaccination as follows :

- a low vaccine exposure intensity : $10^{4.3}$ TCID/ml ;
- a hypovirulent vaccine strain : the values of the parameters affected by PRRSV strain virulence (Section IV.3.2) were set to $\pm 50\%$ compared to the reference values (instead of $\pm 35\%$ for the lowly virulent strain S_1).
- no viral replication : the replication rate e was set to zero.

We ran the model with these parameter values and we saved the output dynamics. The within-host dynamics induced by this vaccination exhibited realistic behaviour, illustrated in FIGURE IV.6. The infection duration D_I was around 40 days ; the neutralising antibodies A_N peaked around 100 days post-vaccination and reached 13 pg/ml ; and the cytotoxic lymphocytes T_c peaked between the second and the third week post-vaccination and reached $2 \cdot 10^4$ cells/ml.

Definition of the memory response induced by vaccination From the vaccination simulation, we extracted the cumulated concentrations (denoted by Σ) of the adaptive effectors (T_{h1} , T_{h2} , T_{reg} , T_c , B_{MG} and B_A) and antibodies (A_N and A_M) activated during the simulation duration (300 days, denoted by T) :

$$IC_M^0 = (\Sigma_{T_{h1}}, \Sigma_{T_{h2}}, \Sigma_{T_{reg}}, \Sigma_{T_c}, \Sigma_{B_{MG}}, \Sigma_{B_A}, \Sigma_{A_N}, \Sigma_{A_M})$$

For instance, the cumulated concentration of T_{h1} activated $\Sigma_{T_{h1}}$ is calculated as follows :

$$\Sigma_{T_{h1}} = \int_{t=0}^T (\alpha_{T_h}^m D_m^c(t) + \alpha_{T_h}^i D_i^c(t)) \frac{IL_{12}(t) + IFN_\gamma(t)}{1 + IL_{12}(t) + IFN_\gamma(t) + IL_4(t) + IL_6(t) + TGF_\beta(t)} dt.$$

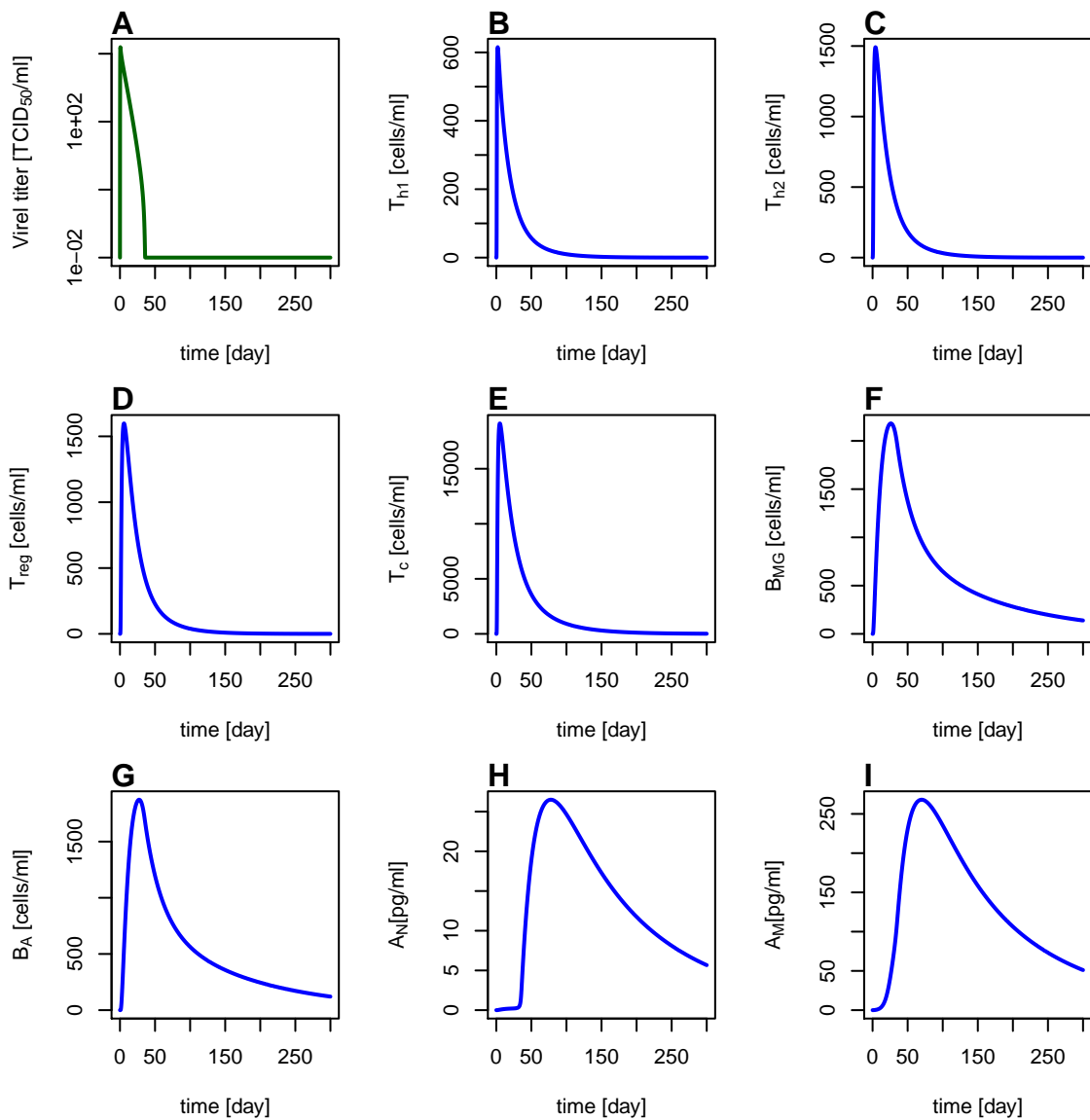

Figure IV.6 Dynamics of infection, adaptive effectors and antibodies induced by vaccination from within-host model $\textcircled{3}$ simulations. **A** viral titer (semi-log graph, in green). Adaptive effectors, in blue : **B** type 1 helper T cells (T_{h1}), **C** type 2 helper T cells (T_{h2}), **D** regulatory T cells (T_{reg}), **E** cytotoxic lymphocytes (T_c), **F** plasmocytes producing IgM or IgG antibodies (B_{MG}) and **G** plasmocytes producing IgA antibodies (B_A). Antibodies, in blue : **H** neutralising antibodies (A_N) and **I** marker antibodies (A_M).

We obtained the following cumulated values of adaptive effectors and antibodies :

$$\text{IC}_M^0 = (\Sigma_{T_{h1}}, \Sigma_{T_{h2}}, \Sigma_{T_{\text{reg}}}, \Sigma_{T_c}, \Sigma_{B_{\text{MG}}}, \Sigma_{B_A}, \Sigma_{A_N}, \Sigma_{A_M})$$

$$= (7 \cdot 10^2, 2 \cdot 10^3, 2 \cdot 10^3, 3 \cdot 10^4, 8 \cdot 10^6, 5 \cdot 10^6, 10, 2 \cdot 10^3)$$

The memory response acquired by the host after vaccination corresponds to a fraction r of the cumulated values in vector IC_M^0 .

Definition of vaccination strategies We found no relevant data in the literature, so we tested two values : $r_1 = 10\%$ and $r_2 = 40\%$. We then defined three vaccination strategies $V_s \in \{\text{No}, V_1, V_2\}$ as follows :

- No corresponds to the reference scenario, without vaccination, defined with zero initial conditions for the adaptive effectors and antibodies involved in the memory response ;
- V_1 is defined by the initial conditions $r_1 \times \text{IC}_M^0$;
- V_2 is defined by the initial conditions $r_2 \times \text{IC}_M^0$.

Design of numerical experiments We defined a complete design of numerical experiment in order to explore the within-host dynamics of a vaccinated pig ($V_s \in \{\text{No}, V_1, V_2\}$) in a variability context in terms of virulence level ($S_{\text{vir}} \in \{S_1, S_2, S_3\}$), exposure intensity ($\mathcal{N}_E \in \{L_1, L_3, L_5\}$) and exposure duration ($D_E \in \{D_{E_s}, D_{E_{p2}}\}$), resulting in 54 scenarios.

IV.4.2 Results

We explored the influence of the three vaccine strategies $V_s \in \{\text{No}, V_1, V_2\}$ among the 18 exposure and virulence scenarios. First, we identified the influence of the vaccine strategies on the viral dynamics. Then, we explored the immune response associated with the viral dynamics in order to identify which immune mechanisms were involved in the vaccine strategy efficiency.

IV.4.2.1 Viral dynamics

Viral titer We present the viral titer for the 54 scenarios in FIGURE IV.7.

Whatever the virulence level and the exposure duration and intensity, the infections were resolved more rapidly for vaccinated pigs (FIGURE IV.7, column two and three) than for naive pigs (FIGURE IV.7, first column). Moreover, the the V_2 vaccine (FIGURE IV.7, third column) was more efficient than the V_1 vaccine (FIGURE IV.7, second column). Comparing the viral titre between the vaccination strategies $V_s \in \{\text{No}, V_1, V_2\}$, it appears that the vaccination reduced the viral titre fairly late in the course of infection. Indeed, looking at the shape of the viral dynamics, we can observe a slope break for vaccinated pigs occurring around 30 days before the infection resolution without vaccination. Moreover, a fairly linear viral titre was observed in the On/Off tests above without neutralisation (FIGURE IV.3). Those two results combined suggest that the quicker infection resolution induced by vaccination could be due to a higher viral neutralisation by antibodies.

Viral characteristics We present the viral characteristics (total viral dose Σ_V , infection duration D_I and viral peak V_{max}) for the 54 scenarios in FIGURE IV.8.

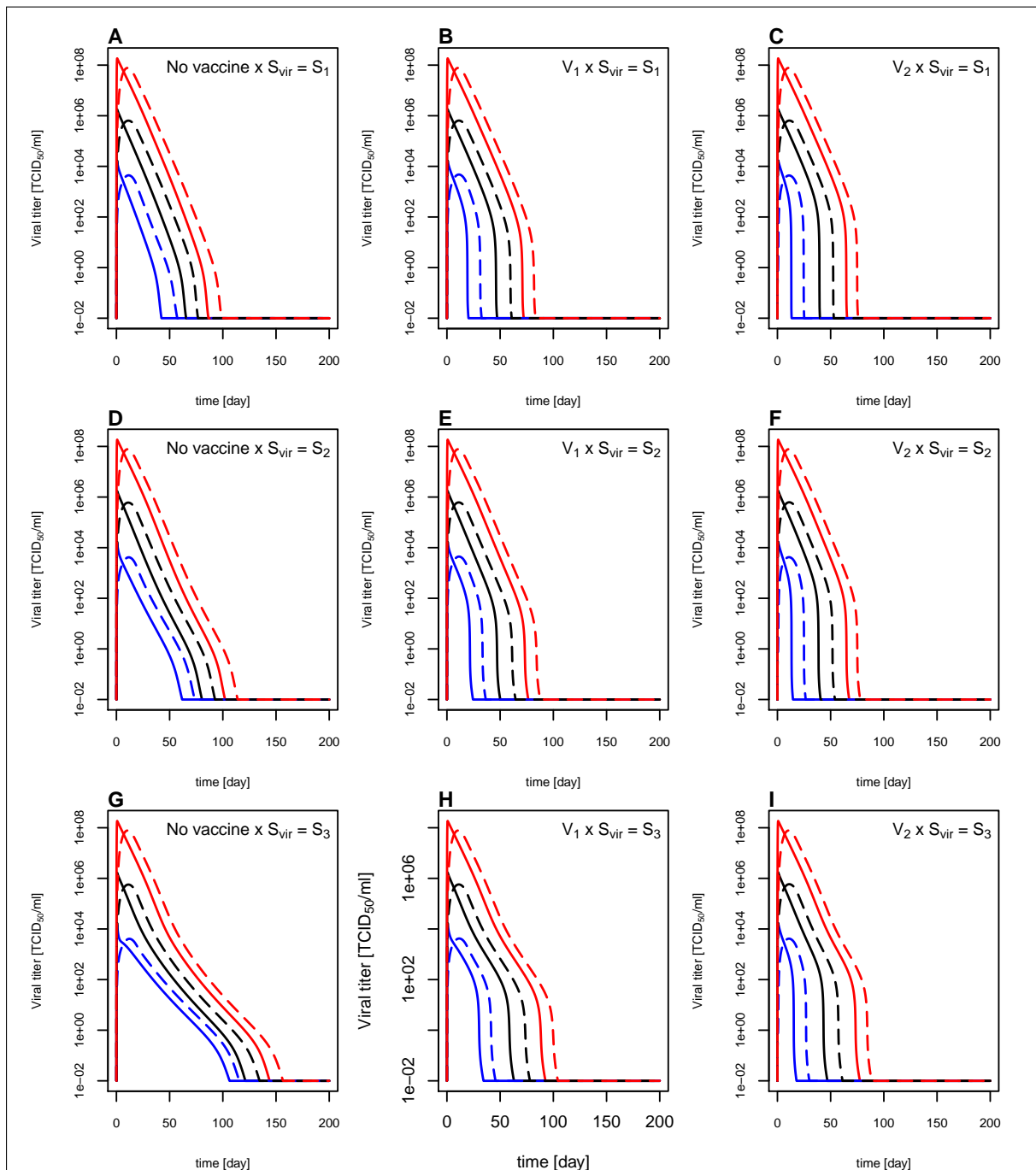

Figure IV.7 Viral titre for the virulence, exposure and vaccine scenarios. 54 scenarios were simulated, crossing 3 exposure intensities $\mathcal{N}_E \in \{L_1; L_3; L_5\}$; 2 exposure durations D_E : short 1-day exposure (D_{E_s} , solid lines) and prolonged 20-day exposure ($D_{E_{p2}}$, dashed lines); and 3 virulence levels (S_{vir}): **A** low S_1 , **B** reference S_2 and **C** high S_3 ; 3 virulence levels (ξ_{vir}): low S_1 (first row), reference S_2 (2nd row) and high S_3 (3rd row); and 3 vaccine scenarios: no vaccine (1st column), vaccine V_1 (2nd column) and vaccine V_2 (3rd column).

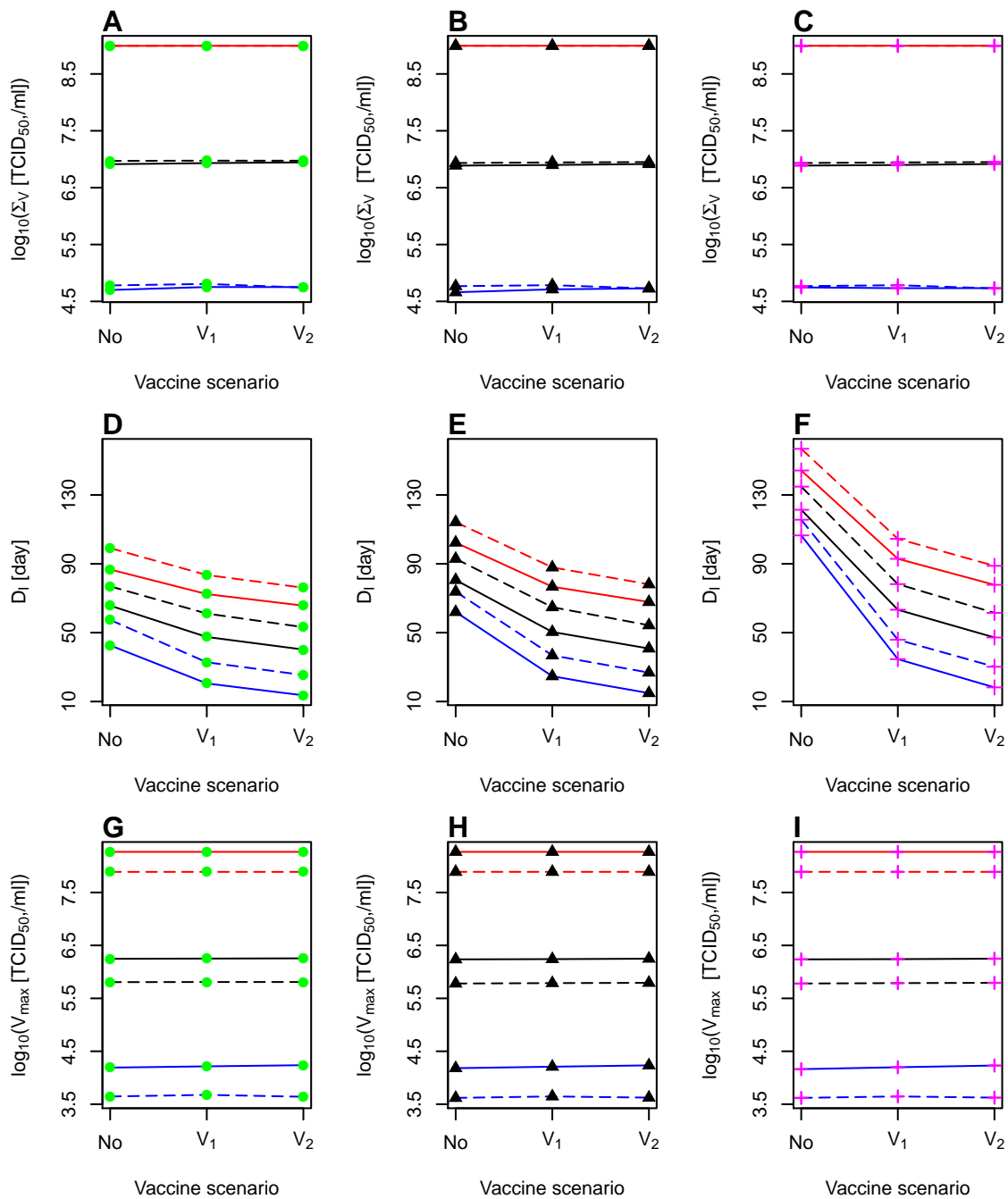

Figure IV.8 Viral characteristics for the virulence, exposure and vaccination scenarios. **A–C** total viral dose Σ_V ; **D–F** infection duration D_I ; **G–I** viral peak V_{\max} . 54 scenarios were simulated, crossing 3 exposure intensities $\mathcal{N}_E \in \{L_1; L_3; L_5\}$; 2 exposure durations D_E : short 1-day exposure (D_{E_s} , solid lines) and prolonged 20-day exposure ($D_{E_{p2}}$, dashed lines); 3 virulence levels $S_{\text{vir}} \in \{S_1, L_2, S_3\}$; and 3 vaccine scenarios: no vaccine, vaccine 1 V_1 and vaccine 2 V_2 .

Whatever the scenario, it appears that vaccination only significantly impacted the infection duration D_I (FIGURE IV.8D–F) and neither the total viral dose Σ_V (FIGURE IV.8A–C), nor the viral peak V_{\max} (G–I).

Without vaccination, the infection lasted on average 96 days (range : 43 to 157 days), 60 days (range : 21 to 105 days) with the V_1 vaccine and 49 days (range : 14 to 89 days) with the V_2 vaccine (FIGURE IV.8D–F). The infection duration was on average 1.7 times lower with the V_1 vaccination strategy and 2.4 times lower with the V_2 vaccination strategy compared to the durations without vaccination. The vaccine efficacy depended on the virulence level and was all the more efficient for more virulent strains :

- among the low virulence S_1 scenarios, the infection duration was 1.5 times lower with V_1 and 1.8 times lower with V_2 , compared with the durations without vaccination ;
- among the reference virulence S_2 scenarios, the infection duration was 1.7 times lower with V_1 and 2.3 times lower with V_2 compared with the durations without vaccination ;
- among the high virulence S_3 scenarios, the infection duration was 2.0 times lower with V_1 and 3.0 times lower with V_2 compared with the durations without vaccination.

Finally, our results exhibited interactions between (i) the vaccine scenario and the exposure intensity on the one hand, (ii) the vaccine scenario and the exposure duration on the other hand. This result can be seen in FIGURE IV.8D–F : (i) on each frame between colours, neither solid, nor dashed lines are parallel ; (ii) on each frame between line types, the blue/black/red lines are not parallel.

IV.4.2.2 Immune response determining the infection resolution

We showed that vaccination only significantly impacts the infection duration. Consequently, we explored which immune mechanisms are involved in the infection duration regulation among the mechanisms generally considered as determining for PRRSv resolution.

Innate response Among the innate mechanisms, we focused on the phagocytosis, the infection and the excretion (Section I.1.4), illustrated in FIGURE IV.9. The innate immune response exhibited globally a low influence on the infection duration.

Phagocytosis It is characterised by $\mathcal{N}_{\text{phag}}$ and illustrated in FIGURE IV.9A–C). Without vaccination, the infection duration was globally positively related to the total number of phagocytosed viral particles (FIGURE IV.9A). This suggested that the phagocytosis activity increased with the infection severity (related to a higher response activation), but it was efficient or at least sufficient to reduce the infection duration. However, for a given exposure intensity, the higher the virulence level, the higher the infection duration and the lower the $\mathcal{N}_{\text{phag}}$ values. This suggests that a higher phagocytosis could participate to the reduction of the infection duration.

Vaccination resulted in a reduction of the infection durations whatever the scenario, but the phagocytosis activity was not notably impacted (FIGURE IV.9A, B & C). This suggests that the D_I decrease with vaccination is probably not due to a higher phagocytosis activity.

Infection and excretion They are characterised by \mathcal{N}_{inf} and $\mathcal{N}_{\text{excr}}$, respectively, and illustrated in FIGURE IV.9D–F and FIGURE IV.9G–I), respectively. Without vaccination, the infection duration was positively related to the total number of viral particles having infected a cell and to the total number of excreted viral particles (FIGURE IV.9D & G). The higher the

exposure intensities and the virulence level, the higher the infection duration, as well as the viral excretion and cell infection. These results suggest that the cell infection and the viral excretion strongly determine the infection severity.

Vaccination resulted in a reduction of the infection durations whatever the scenario, but the cell infection and viral excretion were only reduced for the low exposure intensity. This suggests that vaccination could result in lower cell infection and viral excretion and hence participate in the infection duration reduction for low exposures only.

Adaptive response Among the adaptive mechanisms, we focused on the adaptive response orientation, the infected cell cytolysis and the viral neutralisation (Section 1.1.5), illustrated in FIGURE IV.10.

Adaptive response orientation The adaptive response orientation towards the cellular response is characterised by $\%T_{h1}$ (FIGURE IV.10A–C) and towards the humoral response by $\%T_{h2}$ (FIGURE IV.10D–F). Without vaccination, the infection durations globally increased with the $\%T_{h1}$ (mean=14%) and decreased with $\%T_{h2}$ (mean=29%). This suggests that the reduction of the infection severity was induced by the orientation of the adaptive response towards the humoral and not towards the cellular response.

Vaccination resulted in lower infection durations and globally lower $\%T_{h1}$ and $\%T_{h2}$ (and so higher $\%T_{reg}$) compared infections of non-vaccinated pigs. Indeed, V_1 (V_2) strategy resulted on average in 0.48 (0.53) times lower $\%T_{h1}$, in 0.63 (0.91) times lower $\%T_{h2}$, so in 1.3 (1.1) times higher $\%T_{reg}$. This suggests that stronger orientation towards the regulatory response could reduce the infection severity.

Regarding the interactions between vaccination and virulence, the highest D_I (130 days on average) resulted from the [No vaccination $\times S_3$] scenarios and the smallest D_I (46 days on average) from the [$V_2 \times S_1$] scenarios. D_I in [$V_2 \times S_1$] scenarios was on average 0.27 times lower D_I than in [No vaccination $\times S_3$] scenarios, associated with on average 0.25 times lower $\%T_{h1}$ (from 19 to 5% on average), on average 0.83 times lower $\%T_{h2}$ (from 25 to 22% on average) and on average 1.3 times higher $\%T_{reg}$ (from 57 to 73% on average).

Regarding the interactions between vaccination and exposure intensity, the highest D_I (117 days on average) resulted from [No vaccination $\times L_5$] scenarios and the smallest D_I (22 days on average) from [$V_2 \times L_1$] scenarios. D_I in [$V_2 \times L_1$] scenarios was on average 0.17 times than in [No vaccination $\times L_5$] scenarios, associated with on average 0.53 times lower $\%T_{h1}$ (from 17 to 9% on average), on average 1.3 times higher $\%T_{h2}$ (from 27 to 35% on average) and similar $\%T_{reg}$ (56% on average).

Regarding the interactions between vaccination, exposure intensity and virulence, the highest D_I (151 days on average) resulted from [No vaccination $\times L_5 \times S_3$] scenarios and the smallest D_I (20 days on average) from [$V_2 \times L_1 \times S_1$] scenarios. D_I in [$V_2 \times L_1 \times S_1$] scenarios was on average 0.13 times lower than in [No vaccination $\times L_5 \times S_3$] scenarios, associated with on average 0.34 times lower $\%T_{h1}$ (from 21 to 7% on average), on average 1.3 times higher $\%T_{h2}$ (from 25 to 32% on average) and on average 1.1 times higher $\%T_{reg}$ (from 54 to 61% on average).

These results suggest that the adaptive response orientation could play a significant role in the infection severity, but a reduction of the infection severity could be associated with various adaptive response orientations. Consequently, the adaptive response orientation is not sufficient to conclude on the immune response efficiency regarding the host protection.

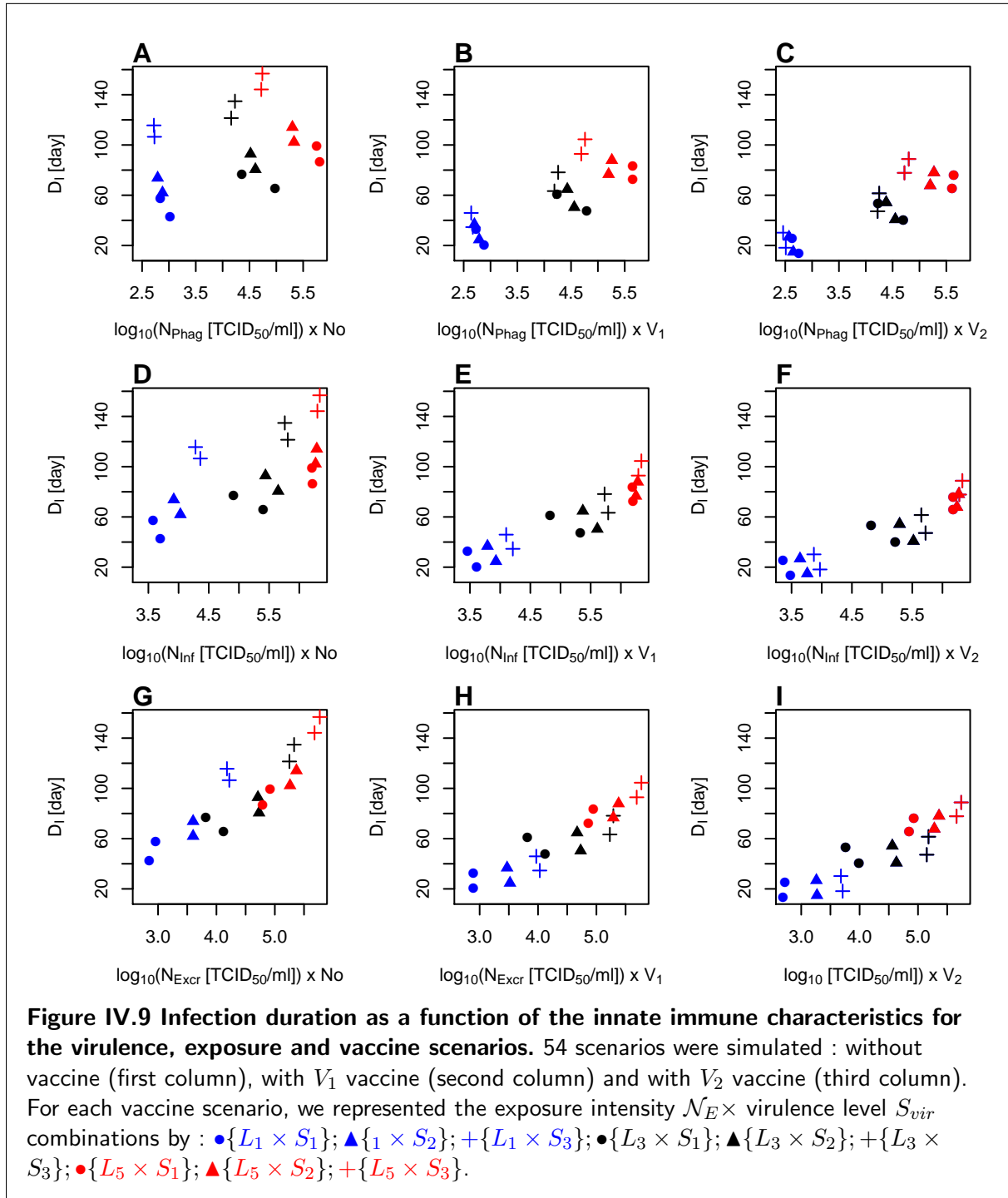

Cytolysis It is characterised by $\mathcal{N}_{\text{cyto}}$ and illustrated in FIGURE IV.10G–I). Without vaccination, our results exhibited a positive relation between infection duration and cytolysis (FIGURE IV.10G). The higher the exposure intensity or the virulence level, the higher the D_I and $\mathcal{N}_{\text{cyto}}$ values. This result suggests that increasing cytolysis activation is not sufficient to reduce the infection severity.

However, scenarios with vaccination tone down this result. On the one hand, V_1 vaccination for a given exposure intensity resulted in an increase of the cytolysis activity (and a stronger reduction of D_I) among the virulence level (FIGURE IV.8G–H). On the other hand, V_2 vaccination resulted in increase of the cytolysis activity for the reference and high exposure intensities, but did not induce stronger D_I reductions (FIGURE IV.8H–I).

Neutralisation It is characterised by $\mathcal{N}_{\text{neutr}}$ and illustrated in FIGURE IV.10J–L). Without vaccination, our results exhibited a low negative relation between infection duration and viral neutralisation (FIGURE IV.10J). The higher the virulence level, the lower the neutralisation activity, but this effect was low. Viral neutralisation was nearly independent from the exposure intensity, despite marked differences for the associated infection durations. These results suggest that increasing the neutralisation activity could be efficient but not sufficient to reduce the infection severity.

The vaccination strategies clearly resulted in an increase of the viral neutralisation, inducing shorter infection durations (FIGURE IV.10K–L). Moreover, the differences in terms of neutralisation were more marked for vaccinated than for non-vaccinated pigs. The lower the exposure intensity, the higher the neutralisation activity; and the higher the virulence level, the higher the neutralisation activity. This last point highlights the fact that neutralisation is not sufficient to explain the infection severity.

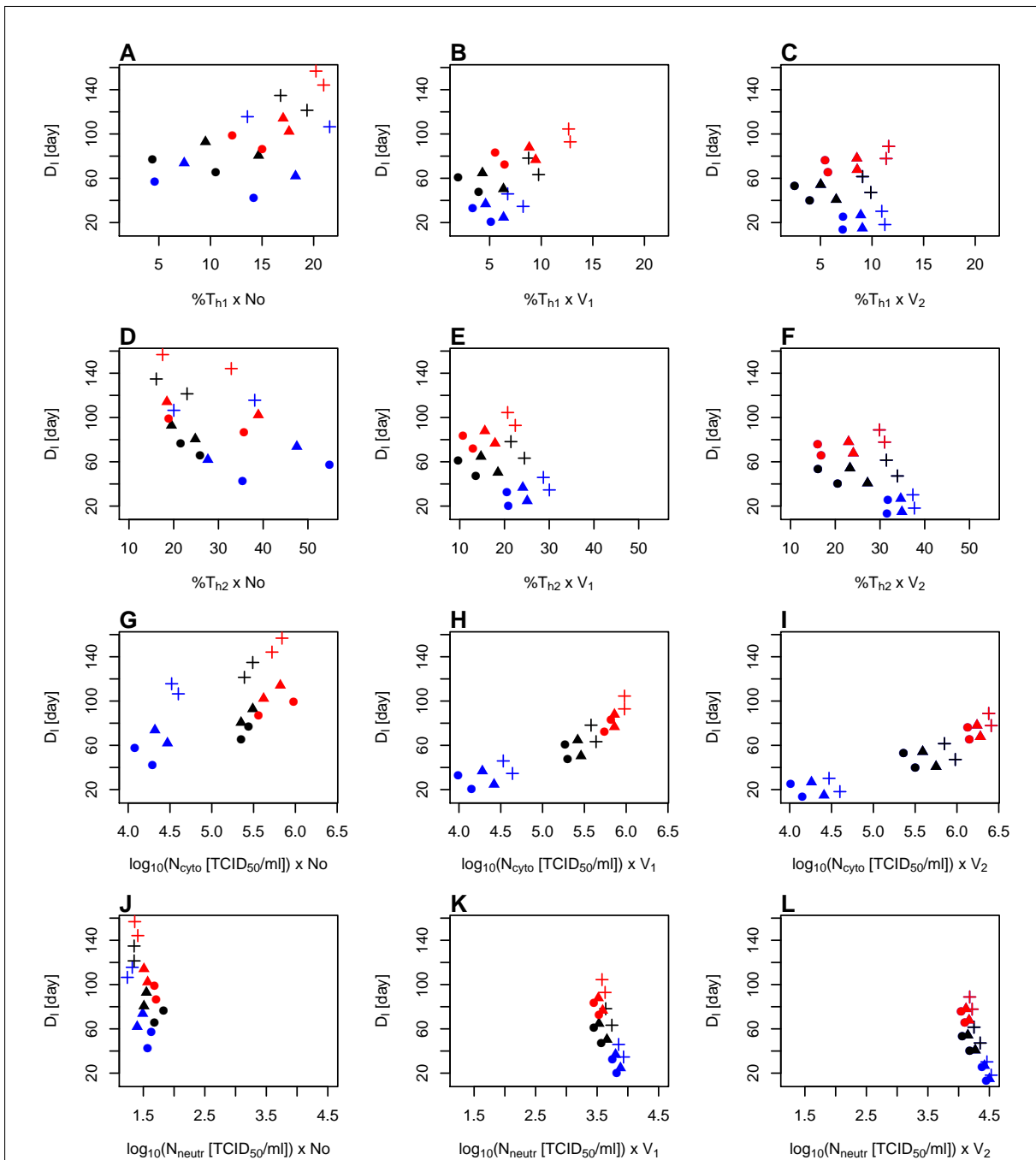

Figure IV.10 Infection duration as a function of the adaptive immune characteristics for the virulence, exposure and vaccination strategy scenarios. 54 scenarios were simulated : without vaccine (first column), with V_1 vaccine (second column) and with V_2 vaccine (third column). For each vaccine scenario, we represented the exposure intensity $\mathcal{N}_E \times$ virulence level combinations by : $\bullet\{L_1 \times S_1\}$; $\blacktriangle\{1 \times S_2\}$; $+\{L_1 \times S_3\}$; $\bullet\{L_3 \times S_1\}$; $\blacktriangle\{L_3 \times S_2\}$; $+\{L_3 \times S_3\}$; $\bullet\{L_5 \times S_1\}$; $\blacktriangle\{L_5 \times S_2\}$; $+\{L_5 \times S_3\}$.

IV.5 Discussion

IV.5.1 Modelling approach

We proposed an original integrative model of the within-host dynamics for a virus targeting antigen presenting cells at the between-cell scale. This model is particularly adapted to simulate the within-host dynamics of a weaned pig infected by PRRSV, as it represents the immune mechanisms assumed to determine PRRSV infection resolution and the mechanisms induced by or regulating these mechanisms. The within-host dynamics is highly variable between hosts and PRRSV strains and the level of details of our model makes it possible to explore various strain virulence and host susceptibility levels. As the immune mechanisms determining PRRSV infection resolution among PRRSV strains and hosts are not fully identified and as we previously showed that several immune mechanisms can result in similar infection durations (Chapter II [16]), this point is crucial. Moreover, we considered various exposure intensities and durations, as we previously showed that exposure impacts the within-host dynamics and interacts in complex ways with the virulence level (Chapter III).

We addressed the issue of vaccine efficiency on the within-host dynamics. As vaccines involve the adaptive response, a detailed representation of the adaptive response activation and orientation was required. As the adaptive response is initiated by the innate response and as both interact in complex ways during the infection duration, we believe that our integrative approach is particularly adapted. The main challenge for PRRSV vaccination is linked to the high variability of PRRSV strains. Consequently, taking this variability into account was a prerequisite. PRRSV being mainly transmitted by contacts, pigs in fields are subject to variable exposures, depending on their contact structure. As the exposure is rarely considered in within-host approaches, our exploration could provide new insights. Finally, assessing vaccine efficiency should be done at both within- and between-host scales. We focused on the within-host scale, but we considered variability factors from the between-host scale, which is rarely done.

Although our model did not explicitly represent the memory response, we were able to derive this response from the adaptive response activation. This allowed us to estimate the initial immune state of a vaccinated pig and hence to compare the within-host dynamics during PRRSV infection for vaccinated *vs* naive pigs. The memory response is currently extracted from the dynamics of the adaptive components, but it would be straightforward to incorporate its dynamics explicitly. It would require only to duplicate the adaptive components which partially differentiate into memory components. Furthermore, our adaptive response representation is well adapted to test heterologous re-infection/vaccination by a PRRSV strain that differs from the primary infection/vaccination, pending some model extensions. Indeed, the variability in PRRSV virulence is due to a variability in the viral epitopes and as the adaptive response is epitope-specific, so simulation of heterologous re-infection and multi-strain infections would require to duplicate the virus and all immune components, except the cytokines, and to consider the potential cross-immunisation, *i.e.* interactions between components specific to one or the other strain. To our knowledge, no published immunological model proposes such an approach to re-infection/vaccination. Preliminary results could be obtained by using the model a first time to simulate the immune response to a given strain and so extract the resulting memory response; and then by using the model a second time to simulate a re-infection with a different strain, after having informed the initial conditions related to the memory response. In some sense, it is what we did when we simulated PRRSV infection for a vaccinated pig : vaccination corresponded to a first infection by an hypovirulent strain, as we considered an attenuated live vaccine, and it was followed by an infection by a more virulent strain.

IV.5.2 Vaccine efficiency : preliminary results

We used the within-host model (i) to simulate the immune protection induced by vaccination in terms of memory response activation and (ii) to explore the within-host dynamics of vaccinated pigs during PRRSv infection, taking into account the variability in strain virulence and exposure. We discuss below the results of this preliminary exploration in terms of realism and inputs for further work.

IV.5.2.1 Immune protection induced by vaccination

Vaccination and PRRSv infection were similarly simulated. Indeed, some current vaccines consist in modified PRRSv strains in order to induce a high and efficient immune response, but with as low as possible clinical symptoms and infection severity. Consequently, we defined the parameter values for the vaccination simulation as for a very low virulent strain that is not able to replicate within the target cells, associated with a low exposure intensity compared to PRRSv inoculation doses used in experimental infections.

As we proposed here more an illustration of the possible model uses and as there are very few literature data about the memory response induced by vaccination alone, we believe that this approach is satisfying. Among current vaccines, we chose to represent a modified-live virus vaccine rather than a killed virus vaccine, as the former is assumed to be more efficient to protect from PRRSv infection. Our results exhibited a realistic behaviour, with an infection duration similar to the durations reported for wild-field strains, as well as a delayed and weak response of neutralising antibodies and cytotoxic T cells.

IV.5.2.2 Within-host dynamics of vaccinated pigs after PRRSv exposure

We tested two vaccination strategies which differed only in the activation level of the memory response. Our results exhibited a significant efficiency of both vaccines to reduce the PRRSv infection duration, but not to reduce the viral peak and the total viral dose. Moreover, we found that the vaccine impact on the infection and immune dynamics depends on both virulence levels and exposure. This result underlines the importance of such variability factors when exploring vaccine efficiency at the within-host scale. We now summarise and discuss the outlines of our results regarding the current vaccination strategies.

Our vaccine strategies did not improve the innate response Tested vaccination strategies resulted in quicker infection resolutions, but did not significantly reduce the total viral dose and the viral peak. This suggests that these vaccination strategies improve the adaptive response but not the innate response. Indeed, tested vaccination strategies did not significantly promote an efficient innate immune response. The phagocytosis activity was similar with and without vaccination. The APC infection and viral excretion activities were reduced only for low exposure intensities. As these activities are modulated by antiviral and immuno-modulatory cytokines, a vaccine capable of promoting the synthesis of antiviral cytokines and/or inhibiting the synthesis of immuno-modulatory cytokines would be more efficient.

Previous reports demonstrated various negative effects of PRRSv on innate immune functions, including direct cytolysis, suppression of phagocytosis and antigen presentation activities and alteration of the cytokine patterns [3, 26, 31]. For example, down-regulation of IFN_{α} is a crucial step in PRRSv pathogenesis [3], as IFN_{α} significantly inhibits PRRSv replication and

is important for the induction of adaptive IFN $_{\gamma}$ -producing cells. Conversely, the up-regulation of IL $_{10}$ explains several immunological phenomena observed in PRRSv infection [2]. Vaccine that can minimise IL $_{10}$ production or enhance IL $_{10}$ blockade and/or promote the synthesis of antiviral cytokines following PRRSv exposure should be explored [2, 7].

Recent interest in improving the immune response to PRRSv vaccines lies in the better use of vaccine adjuvants [7]. Several kinds of vaccine adjuvants have been studied for their ability to potentiate the immune response to PRRSv vaccines, reviewed in Chareerntantanakul [7]. Adjuvants include cytokines, chemical reagents and bacterial products. Some of them possess innate immune stimulatory properties, *i.e.* APC activation and pro-inflammatory cytokine production. To date, commercial PRRSv modified live and killed vaccines have tried these adjuvants. Only some of them, however, enhanced the adaptive immune response or increased the vaccine efficacy [7]. Vaccines promoting the synthesis of IFN $_{\alpha}$ due to the addition of adjuvants were tested but the results were not concluding [7]. At present, there is no information whether conventional PRRSv vaccines can inhibit IL $_{10}$ production in vaccinated pigs after PRRSv exposure. Current modified live vaccines can either enhance or suppress IL $_{10}$ production, depending on the challenge viral strains [2]. Future studies are, therefore, required to seek new vaccine adjuvants that can potentiate immunogenicity and protective efficiency of PRRSv vaccines [7]. Complementing experimental approaches, our model can be used to address this issue.

Most current vaccines are developed to improve the adaptive response, in particular the neutralising antibody and cytotoxic T cell responses [1–3, 7]. However, several studies support the assumption that PRRSv-induced inefficient adaptive response is at least partly determined by the weak and altered innate response [1]. Moreover, there is increasing evidence that the innate response to PRRSv is epitope-dependent and could hence be improved by vaccination. PRRSv nucleocapsid protein (N) could be involved in the up-regulation of IL $_{10}$ synthesis [3, 51, 62] and nsp1 and nsp2 in the down-regulation of IFN $_{\alpha}$ and TNF $_{\alpha}$ syntheses [8, 62]. Although PRRSv nucleocapsid protein can significantly induce IL $_{10}$, it should be noted that previous works on vaccine using nucleocapsid protein or gene alone were discouraging [2]. The nsp2 protein is the most variable part of the virus. So a modified live vaccine developed from a low virulent strain (and so resulting in a lower alteration of the innate cytokine synthesis) should induce a more efficient innate response. Further experimental studies on the link between the viral epitope and the innate response to PRRSv are required and would guide the development of more efficient vaccines.

Vaccine efficiency and regulatory response Whatever the virulence and exposure scenarios, infection of vaccinated pigs resulted in lower infection durations and globally lower percentages of T_{h1} and T_{h2} (and so higher percentages of T_{reg}) compared to the infection of naive pigs. This suggests that a stronger orientation towards the regulatory response could help the infection resolution. This preliminary result should be confirmed by experimental data. We illustrate the kind of interpretations we can make from a such exploration of the vaccine efficiency and the resulting tracks to guide the development of more efficient vaccines.

The regulatory response during PRRSv infection has been poorly explored [1, 2]. It is considered that enhanced T_{reg} activities can exacerbate negative immuno-modulatory effects in PRRSv re-exposure [2]. However, it would be interesting to follow T_{reg} in pigs vaccinated with conventional modified live vaccines (MLV), as they may significantly interfere with the vaccine efficiency, in particular with the activation of PRRSv-specific memory populations [2]. It is well-known that the expression of TGF $_{\beta}$ may either favour or hinder the onset of an efficient host immune regulatory response and that a late regulatory response would be responsible for limiting the inflammation and hence protecting the host against severe PRRSv infection (Section I.1.5.1).

We showed that the higher the memory response activation by vaccination, the higher the vaccine efficiency (V_2 vs V_1 strategies). This suggests that a higher adaptive response activation by vaccination or during a primary infection induces a higher host protection from re-infection. Consequently, an efficient vaccine should induce a strong adaptive immune response but a moderate inflammatory response (as it is responsible for pulmonary damages). Moreover, we showed that the vaccine efficiency did not exhibit a linear relation with the induced memory response level. So efficient vaccines would have to balance the adaptive response activation (and so the protection level) and the inflammatory response activation (and so the infection severity). This should be improved by adding adjuvant or develop a vaccine which also induce a significant regulatory response.

Moreover, TGF_{β} , mainly synthesised by the T_{reg} , is known to induce IgA antibodies, which express significant neutralising functions in the mucosal surfaces. One of the hypotheses to explain prolonged PRRSv infection is the weak and delayed activation of neutralising antibodies. Moreover, PRRSv infection may persist for long periods with low replication rates in the infection sites, including the lungs. Consequently, the regulatory response could significantly help the PRRSv infection resolution in the lung mucosal surfaces.

Vaccine efficiency in relation to strain virulence and exposure intensity The vaccination strategies we tested exhibited a variable efficiency, depending on the strain virulence and the exposure scenarios, and resulted in variable adaptive immune responses. Vaccination strategies were more efficient for highly virulent strains. Highly virulent strains in field generally result in high exposure due to contacts. Considering scenarios of high exposure intensity and virulence level [$L_5 \times S_3$], compared to a naive pig response, vaccination induced (i) lower $\%T_{h1}$ and either higher $\%T_{reg}$ (V_2 strategy) or higher $\%T_{h2}$ (V_1 strategy); (ii) a higher cytolysis activity; and (iii) a higher viral neutralisation activity. Considering scenarios of low exposure intensity and virulence level [$L_1 \times S_1$], compared to a naive pig response, vaccination induced (i) lower $\%T_{h1}$ and $\%T_{h2}$ and higher of $\%T_{reg}$; (ii) a similar cytolysis activity; and (iii) a higher viral neutralisation activity. Considering all these results together, it seems that a vaccine inducing only higher neutralising antibody titres would be less efficient than a vaccine inducing both higher neutralising antibody and cytotoxic lymphocyte titres. This result is consistent with the dominant assumption to explain prolonged PRRSv infections (Section I.1.5.1).

We defined our vaccine as a modified live attenuated virus with a very low virulence. Consequently, the infection of a vaccinated pig by highly virulent PRRSv strain (S_3 scenario) could correspond to a challenge with a different PRRSv strain from the one used for vaccination (heterologous challenge). Diaz *et al.* [10] showed that protection against the development of viraemia was significantly better in pigs with higher levels of cytotoxic T cells subjected to an heterologous challenge, compared to pigs with lower levels of cytotoxic T cells challenged with a PRRSv strain similar to the one used for vaccination. Our results are consistent with these findings, although they must be interpreted cautiously, as our model does only allow to explore an heterologous re-infection with a full cross-protection. Exploring the within-host dynamics following heterologous challenges taking into account cross-protection levels in field condition would require model adaptations such as those presented in Section IV.5.1.

References

- [1] MURTAUGH M.P., GENZOW M., 2011. Immunological solutions for treatment and prevention of porcine reproductive and respiratory syndrome (PRRS). *Vaccine* **29**(46) :8192–8204. doi:10.1016/j.vaccine.2011.09.013.
- [2] THANAWONGNUWECH R., SURADHAT S., 2010. Taming PRRSV : Revisiting the control strategies and vaccine design. *Virus Res.* **154**(1-2) :133–140. doi:10.1016/j.virusres.2010.09.003.
- [3] KIMMAN T.G., CORNELISSEN L.A., MOORMANN R.J., REBEL J.M.J., STOCKHOFE-ZURWIEDEN N., 2009. Challenges for porcine reproductive and respiratory syndrome virus (PRRSV) vaccinology. *Vaccine* **27**(28) :3704–3718. doi:10.1016/j.vaccine.2009.04.022.
- [4] GÓMEZ-LAGUNA J., SALGUERO F.J., PALLARÉS F.J., CARRASCO L., 2013. Immunopathogenesis of porcine reproductive and respiratory syndrome in the respiratory tract of pigs. *Vet. J.* **195**(2) :148–155. doi:10.1016/j.tvjl.2012.11.012.
- [5] BUTLER J.E., LAGER K.M., GOLDE W., FAABERG K.S., SINKORA M., LOVING C., ZHANG Y.I., 2014. Porcine reproductive and respiratory syndrome (PRRS) : an immune dysregulatory pandemic. *Immunologic research* **59**(1-3) :81–108. doi:10.1007/s12026-014-8549-5.
- [6] NAUWYNCK H.J., VAN GORP H., VANHEE M., KARNIYCHUK U., GELDHOF M., CAO A., VERBEECK M., VAN BREEDAM W., 2012. Micro-dissecting the pathogenesis and immune response of PRRSV infection paves the way for more efficient PRRSV vaccines. *Transbound. Emerg. Dis.* **59** :50–54. doi:10.1111/j.1865-1682.2011.01292.x.
- [7] CHARERNTANTANAKUL W., 2009. Adjuvants for porcine reproductive and respiratory syndrome virus vaccines. *Vet. Immunol. Immunop.* **129**(1) :1–13. doi:10.1016/j.vetimm.2008.12.018.
- [8] DARWICH L., DÍAZ I., MATEU E., 2010. Certainties, doubts and hypotheses in porcine reproductive and respiratory syndrome virus immunobiology. *Virus Res.* **154**(1-2) :123–132. doi:10.1016/j.virusres.2010.07.017.
- [9] MOGLER M., 2012. *Evaluation of replicon particle vaccines for porcine reproductive and respiratory syndrome virus*. PhD thesis, Iowa State University. <http://lib.dr.iastate.edu/etd/12841>
- [10] DIAZ I., DARWICH L., PAPPATERRA G., PUJOLS J., MATEU E., 2006. Different European-type vaccines against porcine reproductive and respiratory syndrome virus have different immunological properties and confer different protection to pigs. *Virology* **351**(2) :249–259. doi:10.1016/j.virol.2006.03.046.
- [11] MARTELLI P., GOZIO S., FERRARI L., ROSINA S., DE ANGELIS E., QUINTAVALLA C., BOTTARELLI E., BORGHETTI P., 2009. Efficacy of a modified live porcine reproductive and respiratory syndrome virus (PRRSV) vaccine in pigs naturally exposed to a heterologous European (Italian cluster) field strain : Clinical protection and cell-mediated immunity. *Vaccine* **27**(28) :3788–3799. doi:10.1016/j.vaccine.2009.03.028.
- [12] LUNNEY J.K., CHEN H., 2010. Genetic control of host resistance to porcine reproductive and respiratory syndrome virus (PRRSV) infection. *Virus Res.* **154**(1-2) :161–169. doi:10.1016/j.virusres.2010.08.004.

- [13] XIAO Z., BATISTA L., DEE S., HALBUR P., MURTAUGH M.P., 2004. the level of virus-specific T-cell and macrophage recruitment in porcine reproductive and respiratory syndrome virus infection in pigs is independent of virus load. *J. Virol.* **78** :5923–5933. doi:10.1128/JVI.78.11.5923–5933.2004.
- [14] MURTAUGH M.P., XIAO Z., ZUCKERMANN F., 2002. Immunological responses of swine to porcine reproductive and respiratory syndrome virus infection. *Viral Immunol.* **15**(4) :533–547. doi:10.1089/088282402320914485.
- [15] LOPEZ O.J., OSORIO F.A., 2004. Role of neutralizing antibodies in PRRSV protective immunity. *Vet. Immunol. Immunop.* **102**(3) :155–163. doi:10.1016/j.vetimm.2004.09.005.
- [16] GO N., BIDOT C., BELLOC C., TOUZEAU S., 2014. Integrative model of the immune response to a pulmonary macrophage infection : what determines the infection duration ? *PLoS ONE* **9**(9) :e107818. doi:10.1371/journal.pone.0107818.
- [17] ROUSE B.T., SEHRAWAT S., 2010. Immunity and immunopathology to viruses : what decides the outcome ? *Nat. Rev. Immunol.* **10**(7) :514–526. doi:10.1038/nri2802.
- [18] BRACIALE T.J., SUN J., KIM T.S., 2012. Regulating the adaptive immune response to respiratory virus infection. *Nat. Rev. Immunol.* **12**(4) :295–305. doi:10.1038/nri3166.
- [19] COQUERELLE C., MOSER M., 2010. DC subsets in positive and negative regulation of immunity. *Immunol. Rev.* **234**(1) :317–334. doi:10.1111/j.0105-2896.2009.00887.x.
- [20] BORGHETTI P., 2005. Cell-mediated immunity and viral infection in pig. In *PRRS fatti vs speculazioni*, Università degli Studi di Parma, Dipartimento di Salute Animale (Parma, Italy), pp. 27–46.
http://medvet.unipr.it/cgi-bin/campusnet/documenti.pl/Show?_id=7d0d
- [21] BOSCH A.A.T.M., BIESBROEK G., TRZCINSKI K., SANDERS E.A.M., BOGAERT D., 2013. Viral and bacterial interactions in the upper respiratory tract. *PLoS Pathog.* **9**(1) :e1003057. doi:10.1371/journal.ppat.1003057.
- [22] KIDD P., 2003. Th1/Th2 balance : the hypothesis, its limitations, and implications for health and disease. *Altern. Med. Rev.* **8**(3) :223–246.
- [23] LEROITH T., AHMED S.A., 2012. Regulatory T cells and viral disease. In *Inflammation, Chronic Diseases and Cancer : Cell and Molecular Biology, Immunology and Clinical Bases*, edited by M. KHATAMI, InTech (Rijeka, Croatia), chap. 6, pp. 121–144. doi:10.5772/28502.
- [24] KNOSP C.A., JOHNSTON J.A., 2012. Regulation of CD4+ T-cell polarization by suppressor of cytokine signalling proteins. *Immunology* **135**(2) :101–111. doi:10.1111/j.1365-2567.2011.03520.x.
- [25] ZIMMERMAN J., BENFIELD D.A., MURTAUGH M.P., OSORIO F., STEVENSON G.W., TORREMORELL M., 2006. Porcine reproductive and respiratory syndrome virus (porcine arterivirus). In *Diseases of swine*, edited by B.E. STRAW, J.J. ZIMMERMAN, S. D'ALLAIRE, D.L. TAYLOR, Blackwell (Oxford, UK), 9th edn., chap. 24, pp. 387–418.
- [26] MATEU E., DÍAZ I., 2008. The challenge of PRRS immunology. *Vet. J.* **177** :345–351. doi:10.1016/j.tvjl.2007.05.022.

- [27] GAMMACK D., GANGULI S., MARINO S., SEGOVIA-JUAREZ J., KIRSCHNER D., 2005. Understanding the immune response in tuberculosis using different mathematical models and biological scales. *Multiscale Model. Sim.* **3**(2) :312–345. doi:10.1137/040603127.
- [28] MARINO S., MYERS A., FLYNN J.L., KIRSCHNER D.E., 2010. TNF and IL-10 are major factors in modulation of the phagocytic cell environment in lung and lymph node in tuberculosis : A next-generation two-compartmental model. *J. Theor. Biol.* **265**(4) :586–598. doi:10.1016/j.jtbi.2010.05.012.
- [29] WIGGINTON J.E., KIRSCHNER D., 2001. A model to predict cell-mediated immune regulatory mechanisms during human infection with Mycobacterium tuberculosis. *J. Immunol.* **166** :1951–1967.
- [30] FLORES-MENDOZA L., SILVA-CAMPA E., RESÉNDIZ M., OSORIO F.A., HERNÁNDEZ J., 2008. Porcine reproductive and respiratory syndrome virus infects mature porcine dendritic cells and up-regulates interleukin-10 production. *Clin. Vaccine Immunol.* **15** :720–725. doi:10.1128/CVI.00224-07.
- [31] PARK J.Y., KIM H.S., SEO S.H., 2008. Characterization of interaction between porcine reproductive and respiratory syndrome virus and porcine dendritic cells. *J. Microbiol. Biotechn* **18**(10) :1709–1716.
- [32] VAN REETH K., VAN GUCHT S., PENZAERT M., 2002. In vivo studies on cytokine involvement during acute viral respiratory disease of swine : troublesome but rewarding. *Vet. Immunol. Immunop.* **87**(3-4) :161–168. doi:10.1016/S0165-2427(02)00047-8.
- [33] ROTH A.J., THACKER E.L., 2006. Immune system. In *Diseases of swine*, edited by B.E. STRAW, J.J. ZIMMERMAN, S. D'ALLAIRE, D.L. TAYLOR, Blackwell (Oxford, UK), 9th edn., chap. 2, pp. 15–36.
- [34] TOSI M.F., 2005. Innate immune responses to infection. *J. Allergy Clin. Immun.* **116**(2) :241–249. doi:10.1016/j.jaci.2005.05.036.
- [35] CHOI C., CHAE C., 2002. Expression of tumour necrosis factor alpha is associated with apoptosis in lungs of pigs experimentally infected with porcine reproductive and respiratory syndrome virus. *Res. Vet. Sci.* **72**(1) :45–49. doi:10.1053/rvsc.2001.0519.
- [36] THANAWONGNUWECH R., 1999. Pulmonary intravascular macrophages (PIMs) : What do we know about their role in PRRSV infection in pigs. *Wetchasan Sattawaphaet (The Thai journal of veterinary medicine)* **29**.
- [37] BAUMANN A., MATEU E., MURTAUGH M.P., SUMMERFIELD A., 2013. Impact of genotype 1 and 2 of porcine reproductive and respiratory syndrome viruses on interferon- α responses by plasmacytoid dendritic cells. *Vet. Res.* **44**(1) :33. doi:10.1186/1297-9716-44-33.
- [38] SILVA-CAMPA E., CORDOBA L., FRAILE L., FLORES-MENDOZA L., MONTOYA M., HERNÁNDEZ J., 2010. European genotype of porcine reproductive and respiratory syndrome (PRRSV) infects monocyte-derived dendritic cells but does not induce Treg cells. *Virology* **396**(2) :264–271. doi:10.1016/j.virol.2009.10.024.
- [39] CHANG H.C., PENG Y.T., CHANG H.L., CHAUNG H.C., CHUNG W.B., 2008. Phenotypic and functional modulation of bone marrow-derived dendritic cells by porcine reproductive and respiratory syndrome virus. *Vet. Microbiol.* **129**(3–4) :281–293. doi:10.1016/j.vetmic.2007.12.002.

- [40] WANG X., EATON M., MAYER M., LI H., HE D., NELSON E., CHRISTOPHER-HENNINGS J., 2007. Porcine reproductive and respiratory syndrome virus productively infects monocyte-derived dendritic cells and compromises their antigen-presenting ability. *Arch. Virol.* **152**(2) :289–303. doi:10.1007/s00705-006-0857-1.
- [41] SILVA-CAMPA E., FLORES-MENDOZA L., RESÉNDIZ M., PINELLI-SAAVEDRA A., MATA-HARO V., MWANGI W., HERNÁNDEZ J., 2009. Induction of T helper 3 regulatory cells by dendritic cells infected with porcine reproductive and respiratory syndrome virus. *Virology* **387**(2) :373–379. doi:10.1016/j.virol.2009.02.033.
- [42] LUNNEY J.K., FRITZ E.R., REECY J.M., ANDR ELIZABETH PRUCNAL D.K., MOLINA R., CHRISTOPHER-HENNINGS J., ZIMMERMAN J., ROWLAND R.R.R., 2010. Interleukin-8, interleukin-1 β , and interferon- γ levels are linked to PRRS virus clearance. *Viral Immunol.* **23**(2) :127–134. doi:10.1089/vim.2009.0087.
- [43] ALBINA E., 2000. Le point sur le dernier-né des arterivirus : le virus du syndrome dysgénésique et respiratoire porcin (SDRP). *Virologie* **4**(2) :113–121.
- [44] LOPEZ-FUERTES L., CAMPOS E., DOMENECH N., EZQUERRA A., CASTRO J.M., DOMINGUEZ J., ALONSO F., 1999. Porcine reproductive and respiratory syndrome (PRRS) virus down-modulates TNF- α production in infected macrophages. *Virus Res.* **69**(269) :41–46. doi:10.1016/S0168-1702(00)00172-6.
- [45] MURTAUGH M.P., 2005. PRRSV/host interaction. In *PRRS fatti vs speculazioni*, Università degli Studi di Parma, Dipartimento di Salute Animale (Parma, Italy), pp. 73–80. http://medvet.unipr.it/cgi-bin/campusnet/documenti.pl/Show?_id=7d0d
- [46] MILLER L.C., LAEGREID W.W., BONO J.L., CHITKO-McKOWN C.G., FOX J.M., 2004. Interferon type I response in porcine reproductive and respiratory syndrome virus-infected MARC-145 cells. *Arch. Virol.* **149** :2453–2463. doi:10.1007/s00705-004-0377-9.
- [47] GIMENO M., DARWICH L., DÍAZ I., DE LA TORRE E., PUJOLS J., MARTIN M., INUMARU S., CANO E., DOMÍNGO M., MONTOYA M., MATEU E., 2011. Cytokine profiles and phenotype regulation of antigen presenting cells by genotype-I porcine reproductive and respiratory syndrome virus isolates. *Vet. Res.* **42**(9). doi:10.1186/1297-9716-42-9.
- [48] MOLINA R.M., CHA S.H., CHITTICK W., LAWSON S., MURTAUGH M.P., NELSON E.A., CHRISTOPHER-HENNINGS J., YOON K.J., EVANS R., ROWLAND R.R.R., ZIMMERMAN J.J., 2008. Immune response against porcine reproductive and respiratory syndrome virus during acute and chronic infection. *Vet. Immunol. Immunop.* **126** :283–292. doi:10.1016/j.vetimm.2008.08.002.
- [49] THANAWONGNUWECH R., RUNGSIPIPAT A., DISATIAN S., SAIYASOMBAT R., NPAKANA-PORN S., HALBUR P.G., 2003. Immunohistochemical staining of IFN γ positive cells in porcine reproductive and respiratory syndrome virus-infected lungs. *Vet. Immunol. Immunop.* **91**(1) :73–77. doi:10.1016/S0165-2427(02)00268-4.
- [50] PENG Y.T., CHAUNG H.C., CHANG H.L., CHANG H.C., CHUNG W.B., 2009. Modulations of phenotype and cytokine expression of porcine bone marrow-derived dendritic cells by porcine reproductive and respiratory syndrome virus. *Vet. Microbiol.* **136**(3-4) :359–365. doi:10.1016/j.vetmic.2008.11.013.
- [51] YOO D., SONG C., SUN Y., DU Y., KIM O., LIU H.C., 2010. Modulation of host cell responses and evasion strategies for porcine reproductive and respiratory syndrome virus. *Virus Res.* **154**(1–2) :48–60. doi:10.1016/j.virusres.2010.07.019.

- [52] SURADHAT S., THANAWONGNUWECH R., POOVORAWAN Y., 2003. Upregulation of IL-10 gene expression in porcine peripheral blood mononuclear cells by porcine reproductive and respiratory syndrome. *J. Gen. Virol.* **84** :453–459. doi:10.1099/vir.0.18698-0.
- [53] MOORE K.W., DE WAAL MALEFYT R., COFFMAN R.L., O’GARRA A., 2001. Interleukin-10 and the interleukin-10 receptor. *Annu. Rev. Immunol.* **19**(1) :683–765. doi:10.1146/annurev.immunol.19.1.683.
- [54] GÓMEZ-LAGUNA J., SALGUERO F.J., BARRANCO I., PALLARES F.J., RODRIGUEZ-GOMEZ I.M., BERNABE A., CARRASCO L., 2009. Cytokine expression by macrophages in the lung of pigs infected with the porcine reproductive and respiratory syndrome virus. *J. Comp. Pathol.* **142**(1) :51–60. doi:10.1016/j.jcpa.2009.07.004.
- [55] Scilab. Open source software for numerical computation.
<http://www.scilab.org/>
- [56] LABARQUE G.G., NAUWYNCK H.J., VAN REETH K., PENSART M.B., 2000. Effect of cellular changes and onset of humoral immunity on the replication of porcine reproductive and respiratory syndrome virus in the lungs of pigs. *J. Gen. Virol.* **81**(5) :1327–1334.
- [57] MARINO S., KIRSCHNER D.E., 2004. The human immune response to Mycobacterium tuberculosis in lung and lymph node. *J. Theor. Biol.* **227** :463–486. doi:10.1016/j.jtbi.2003.11.023.
- [58] HANCIOGLU B., SWIGON D., CLERMONT G., 2014. An ensemble model of the human immune response to influenza A virus infection and its application to the evaluation of treatment strategies. Submitted to PNAS.
- [59] LEE H.Y., TOPHAM D.J., PARK S.Y., HOLLENBAUGH J., TREANOR J., MOSMANN T.R., JIN X., WARD B.M., MIAO H., HOLDEN-WILTSE J., PERELSON A.S., ZAND M., WU H., 2009. Simulation and prediction of the adaptive immune response to influenza A virus infection. *J. Virol.* **83**(14) :7151–7165. doi:10.1128/JVI.00098-09.
- [60] SUD D., BIGBEE C., FLYNN J.L., KIRSCHNER D.E., 2006. Contribution of CD8+ T cells to control of Mycobacterium tuberculosis infection. *J. Immunol.* **176**(7) :4296–4314.
- [61] HU J., ZHANG C., 2012. Porcine reproductive and respiratory syndrome virus vaccines : current status and strategies to a universal vaccine. *Transbound. Emerg. Dis.* doi:10.1111/tbed.12016.
- [62] DARWICH L., GIMENO M., SIBILA M., DÍAZ I., DE LA TORRE E., DOTTI S., KUZEMTSEVA L., MARTIN M., PUJOLS J., MATEU E., 2011. Genetic and immunobiological diversities of porcine reproductive and respiratory syndrome genotype I strains. *Vet. Microbiol.* **150**(1–2) :49–62. doi:10.1016/j.vetmic.2011.01.008.

Conclusion

Contents

1	Insights from the within-host approach to better understand and control PRRSv infection	184
1.1	Which immune mechanisms determine PRRSv infection resolution?	185
1.1.1	Regarding isolated pigs	185
1.1.2	Regarding infection in field	186
1.1.3	Synthesis	186
1.2	Efficiency of the current commercial PRRSv vaccines	187
1.3	Common limits of our modelling approaches: model calibration and validation	187
1.3.1	Experimental infection	188
1.3.2	Future work	189
2	Towards a multi-strain approach to guide the development of more efficient vaccines	189
2.1	Experimental approach to guide the development of PRRSv universal vaccines	189
2.2	Modelling approach to guide the development of more efficient vaccines	190
3	Towards an immuno-epidemiological approach	191
3.1	Introduction to immuno-epidemiological models	192
3.2	From the viral exposure to the pig infectiousness	193
3.3	From the immune dynamics to the health status	194
3.4	Vaccination strategies at the herd level	196
4	Synthesis	196
	References	198

Vaccination is the main control strategy used to limit PRRSv infection severity and PRRSv spread [1]. However, PRRSv commercial vaccines do not provide a complete protection against PRRSv infection, but only allow to reduce the infection severity and duration and so PRRSv shedding at the between-host scale [1, 2]. The major reason for vaccines lacking efficiency is that the mechanisms determining PRRSv infection duration are still poorly understood and exhibit a strong variability among PRRSv strains and hosts [1, 3–6]. In this context, we addressed three issues in this thesis :

- First, considering an isolated pig, we explored the immune mechanisms which determine PRRSv infection resolution for various pig susceptibility and strain virulence levels (Chapter II).
- Then, we added a variability factor from the between-host scale considering that pigs in herds can be subject to various exposures (Chapter III).
- Finally, we proposed a preliminary exploration of the efficiency of current commercial vaccines on the within-host dynamics, taking into account the variability in both strain virulence and exposure (Chapter IV).

This work provides new insights to better understand and control PRRSv infection. We showed that apparent inconsistencies among experimental studies and assumptions proposed to explain PRRSv prolonged infection can be explained by the influence of PRRSv strain virulence and host susceptibility on the within-host dynamics. Moreover, the exposure intensity and duration also impact the within-host dynamics and their influences were variable depending on the strain virulence. Consequently, variability in exposure and strain virulence/host susceptibility should not be neglected. Finally, we showed that an immunological model could be helpful to (i) test the efficiency of current vaccines and (ii) identify the needed conditions in term of immune mechanisms induced by a vaccination to reach a given level of protection against PRRSv infection.

We first synthesise here the main results of our within-host approach and their insights and limits regarding the major issues of PRRSv infection control. We then discuss the prospects offered by (i) a model extension for multi-strain system regarding the exploration of vaccine efficiency at the within-host scale and (ii) coupling both within- and between-host dynamics regarding the exploration of PRRSv spread and vaccine efficiency at the herd level.

1 Insights from the within-host approach to better understand and control PRRSv infection

We first considered a PRRSv infection of an isolated pig *i.e.* in controlled experimental conditions. However, as PRRSv is mainly transmitted by contacts, a pig in the field is subject to variable exposures. The impact of variable exposures on the within-host dynamics has not yet been explored for PRRSv infection. We so explored this issue. These allowed us to determine which immune mechanisms are involved in PRRSv resolution and which variability factors impact the within-host dynamics. Then we were able to propose a modelling framework to explore the efficiency of current commercial PRRSv vaccines. Finally, we presented the major common limit of our modelling approaches, the model calibration and hence validation and we present the custom-made experimental infection which has been implemented to unravel this limit.

1.1 Which immune mechanisms determine PRRSV infection resolution ?

Reviews suggest that the concepts proposed to explain prolonged PRRSV infection have not yet been experimentally proved; in particular, the roles of the cytokines and the orientation of the adaptive response need to be more clearly elucidated [1–3, 7]. We addressed this issue considering infection of either isolated pigs or in field conditions and taking into account at least the variability in PRRSV strain virulence.

1.1.1 Regarding isolated pigs

We used our lung-based model to explore the influence strain virulence and host susceptibility, which are linked to : (i) the virus capacity to infect the cell and replicate, (ii) the host capacity to synthesise antiviral *vs* immuno-modulatory cytokines in response to PRRSV infection, and (iii) the activation and orientation of the adaptive response towards the cellular, humoral or regulatory. Recent studies hypothesise that these variations are due to cascaded reactions initiated by the macrophage–virus interactions [3, 4, 8, 9]. Both macrophage permissiveness and viral replication impact the cytokine synthesis, which in turn regulates them. Discriminating their respective influences of macrophage permissiveness and cytokine synthesis is very difficult experimentally. Published experimental studies on PRRSV infection (reviewed in [1–5, 10–13]) are highly heterogeneous and differ on : (i) the monitoring duration, (ii) the measured immune components, (iii) the viral strain, (iv) the pig genotype. Our integrative model allowed go beyond the experimental limitations.

We obtained contrasted dynamics in terms of immune response and infection duration among virulence and susceptibility scenarios, suggesting hypotheses to explain the apparent contradictions between published results. We observed that high levels of antiviral cytokines and a dominant cellular response were associated with either short, the usual assumption, or long infection durations, depending on the immune mechanisms involved (cytokine synthesis capacities or macrophage permissiveness). Indeed, high antiviral (immuno-modulatory) cytokine synthesis rates, corresponding to a low (high) virulence or susceptibility level, resulted in short (prolonged) infection durations associated with high (low) levels of antiviral cytokines and a dominant cellular (humoral and regulatory) response. Conversely, low (high) macrophage permissiveness, corresponding to a low (high) virulence or susceptibility level, resulted in short (prolonged) infection durations associated with low (high) levels of antiviral cytokines and a dominant humoral (cellular) response. We showed that to identify and understand the immune mechanisms responsible for the infection duration, at least (i) the levels of innate antiviral cytokines, (ii) the level of IL₁₀ (a good indicator of the infected macrophage level) and (iii) the relative levels of IL₁₀ and IFN_γ (a good indicator of adaptive response orientation) need to be monitored. These results provide new insights to better construe the experimental results variability. Moreover, they suggest that there is not efficient mechanisms to resolve PRRSV infection whatever the virulence and the susceptibility but rather few mechanisms which are not exclusive and can be involved in various proportions depending on the strains and the hosts. Whatever the strain virulence and host susceptibility, the infection duration was linked to some immune variables : (a) the level of pro-inflammatory cytokines was a good indicator of the infection severity; and (b) a dominant regulatory response was associated with a prolonged infection.

1.1.2 Regarding infection in field

PRRSv is mainly transmitted by close contacts with an infected pig [13]. Some epidemiological studies pointed out that the spread of PRRSv depends on the pig contact network, the pig infectiousness and the pig susceptibility [14, 15]. The infectiousness and susceptibility are influenced by several factors, which probably interact in a complex way [16]: the PRRSv strain virulence [1–3, 17], the pig genetic resistance to PRRSv infection [1, 4, 18], as well as the exposure intensities and inoculation routes [19–21]. Experimental studies found that (i) the infectiousness is a log-normal-like function of the time post-infection [19] and that (ii) PRRSv infection probability is a logistic function of the initial inoculum dose [20]. Studies on other viruses showed that the initial inoculum dose determines the within-host immune dynamics and course of infection [22, 23]. However, no such studies were conducted for PRRSv, neither experimentally, nor through a modelling approach. We used our model to explore the exposure impact on PRRSv within-host dynamics, representing the exposure variability in terms of intensity, duration and peak.

At the within-host scale, our main results were in agreement with results obtained for isolated pigs and experimental PRRSv infection results: (i) the level of pro-inflammatory cytokines was positively correlated with the infection severity [24–26]; (ii) short infection durations were associated with the dominance of the cellular response over the humoral response (for a given strain virulence) [1–4, 26]; (iii) the cytolysis and viral neutralisation exhibited a low influence on the infection resolution and were inefficient to reduce PRRSv infection severity [1–4]. Exploring the impact of exposure characteristics on these descriptors, we exhibited more original results. We found that the infection severity was fully determined by the exposure intensity. The infection duration increased with the strain virulence and, for a given strain virulence, it exhibited a positive linear correlation with the logarithm of the exposure intensity and the exposure duration. Whatever the exposure and strain virulence, the infection duration decreased while the percentage of antiviral cytokines increased. These results are consistent with an experimental study on influenza, which found that the exposure dose influenced the infection dynamics *via* the antiviral cytokines [23]. Consequently, an estimate of the viral dose received through exposure should be enough to infer the infection severity. However, to predict the infection duration, one would also need to know the exposure duration and the strain virulence. The exposure intensity and duration hence affect the pig infectiousness, which is also modulated by the strain virulence.

Given these findings, the PRRSv exposure and the pig susceptibility/strain virulence should not be neglected for exploring either the within or between-host dynamics induced by PRRSv infection.

1.1.3 Synthesis

We showed that depending on the strain virulence/pig susceptibility and the PRRSv exposure, various immune mechanisms are involved in PRRSv infection resolution. Both innate and adaptive mechanisms, involving cytokines regulations, exhibited a strong influence on the within-host dynamics, which is consistent with the assumptions reported in the literature [1, 3–6]. Consequently, the whole immune response and the variability factors from the between-host dynamics (strain virulence, pig susceptibility, viral exposure) have to be considered to understand which immune mechanisms are responsible for PRRSv infection resolution. Given the complexity of the immune response and the high variability between host and strains, our modelling approaches provided a powerful framework.

1.2 Efficiency of the current commercial PRRSv vaccines

Having identified the mechanisms determining for the PRRSv within-host dynamics, we were interested in the exploration of the efficiency of current vaccines. Our aims were (i) to simulate the immune response induced by current vaccines and the protection they confer ; (ii) to identify which conditions an efficient vaccine would have to fulfil to protect the host from PRRSv infection. However, due to the scarcity and partiality of data, it was difficult to calibrate the model, especially the impact of current vaccines. So, we conducted a more theoretical study aiming at simulating the within-host dynamics of a vaccinated pig after PRRSv exposure. This study consisted of two steps. Firstly, we simulated the immune dynamics induced by an attenuated live virus vaccine, represented in the model as an infection by an hypo-virulent and non-pathogenic PRRSv strain. We used this simulation to initialise the immune state of a vaccinated host, in terms of memory B and T cells, as well as antibodies. Secondly, we exposed the vaccinated host to PRRSv and assessed the vaccine efficiency.

We showed that our model is well adapted to (i) estimate the memory response induced by a vaccine and (ii) explore the within-host dynamics after an homologous challenge of vaccinated pigs. The infection resolution of vaccinated pigs did not involve the innate response, but offered a partial protection involving the neutralisation activity by antibodies and/or the infected cell cytolysis by cytotoxic T cells. The protection level varied depending on the PRRSv exposure, the strain virulence and the activation level of the memory response by the vaccine. Our results were consistent with the tendencies reported in experimental studies. We discuss our results to provide a better understanding of the vaccine efficiency variability and to guide the development of more efficient vaccines. Although realistic, this exploration remains a theoretical study. A finer and more applied exploration would require experimental data.

1.3 Common limits of our modelling approaches : model calibration and validation

Whatever our issues, the model calibration and hence validation is the major weak point. Indeed, published PRRSv experimental infection data exhibit a strong heterogeneity (in term of monitoring durations, measured immune components, viral strain and pig genotype). Moreover, among the variables included in our model, only a few were monitored in each experimental study and there were few measures over time. Consequently, based on these data, classical parameter estimation methods were not suitable to calibrate our model and we had to design an *ad hoc* procedure. We so defined a reference scenario as robust as possible, checking that the model results were consistent with the available experimental data and that varying the parameter values around the reference values still resulted in realistic dynamics. For each applied issue, we discussed the validation limits of our approaches and we pointed out that experimental studies would be needed to validate our results and conclusions.

1.3.1 Experimental infection

To address this issue, we designed an experimental infection study in collaboration with the Anses Laboratory in Ploufragan (France), as part of the ANR project MIHMES¹. This experimentation, completed in summer 2014, resulted in successful infections and globally successful laboratory analysis. The main strengths of this experimentation regarding the published experimental PRRSv infections are (i) the infection by either low or high virulent two PRRSv strains in same experimental conditions, (ii) the monitoring of both innate and adaptive immune components, including more components of interest than most of the published experimental data and (iii) the monitoring duration which was higher than the infection duration for most monitored pigs. The experimentation is succinctly described below.

Outlines of the experimental protocol Eighteen 5-weeks old SPF piglets free from PRRSv and without maternal immunity derived from the Anses SPF herd were used. They were housed in air-filtered level-3 bio-security facilities in three isolated batches consisting in either eight pigs inoculated by the European Lena PRRSv strain (a high virulent strain belonging to the sub-genotype 3) or five pigs inoculated by the European Finistere PRRSv strain (a moderate virulent strain belonging to the sub-genotype 1) or five pigs kept as negative controls. Eight pigs instead of five were used for the batch infected by the Lena strain as this PRRSv strain induces a high mortality rate. Indeed, three pigs over eight died before the end of the experiment. Besides clinical signs, the protocol consisted in monitoring the viral titer and the concentration of immune components of interest (including both innate and adaptive components and the major cytokines) in both the broncho-alveolar lavage (BAL) fluids and the blood from 3 to 43 days after PRRSv infection. At the end of the experiment, pigs were euthanised and the immune components of interest were measured in the lymph nodes. The immune components of interest and the sample frequency were selected according the model needs (partly regarding the lacks in published experimental data), the results from the lung-based model exploration and the experimental constraints.

Monitored components Among the immune effectors, we monitored (i) the total concentration of monocytes, macrophages and activated lymphocytes and (ii) the concentration of T lymphocytes, including cytotoxic T cells and natural killers, B cells and phagocytosing cells (in BAL only). Among the cytokines, we monitored the innate antiviral IFN_{α} and TNF_{α} , the pro-inflammatory IL_8 cytokine and the immuno-regulatory IL_{12} , IFN_{γ} (only in BAL as it was undetectable in the blood) and TGF_{β} . Finally, we also monitored the antibody titres as sample/positive (S/P) ratio.

The viral titer was monitored by PCR, the immune cells were monitored by flow cytometry and cytokines and antibodies were monitored by ELISA assays.

Samples As the dynamics in the first days evolve rapidly, we collected four samples within the first week, two samples within the second week and one sample by week for the four last weeks. The viral titer was monitored for each of these samples but all the immune components were not as some of them are known to appear tardily. For instance, we started to monitor the natural killers and the cytotoxic T cells from 15 days post infection.

¹MIHMES : Multi-scale modelling, from animal Intra-Host to Metapopulation, of mechanisms of pathogen spread to Evaluate control Strategies, see <http://www6.inra.fr/mihmes>

1.3.2 Future work

We will use these experimental data to calibrate our models, in particular, the within-host model. This will allow us to validate (or redefine the reference scenario) and to check up our preliminary results from the efficiency exploration of current commercial PRRSv vaccines, presented in chapter IV. This work will be valuated by a publication.

2 Towards a multi-strain approach to guide the development of more efficient vaccines

Our within-host model is adapted to simulate an infection of either a naive pig to a given PRRSv strain or an infection of a vaccinated pig (or a re-infection) for homologous challenges or heterologous challenges assuming a full cross-protection. However, several PRRSv strains can coexist in the same area and in the same time in field conditions and it is well known that the cross-protection involved during heterologous either re-infection or infection after vaccination is only partial [1–3, 27]. Developing vaccine that can provide a broad cross-protection protection against circulating PRRSv strains has become a major challenge for current vaccine development [7].

Considering the protection level induced by a given vaccine against an heterologous challenged, we identified two issues :

- First, the memory response is epitope specific, so a vaccine protecting against various PRRSv strains has to be multi-epitopes (which can be common) among the epitope range of PRRSv strains in order to the memory cells induced by the a such vaccine recognise the various PRRSv strains. This issue, recently discussed by Hu and Zhang [7], require a better characterisation of the antigenic regions of the PRRSv strains in order to identify and use the appropriate combinations of regions for efficient multi-epitope vaccines, named universal vaccines.
- Then, assuming an universal vaccine, the induced memory response should be efficient whatever the PRRSv strain. Indeed, the various PRRSv strains induced various immune responses (titer and relative levels of antibodies, cytotoxic T cells, adaptive response orientation, ...) depending on the viral epitopes and which exhibit various efficiency in PRRSv infection resolution and protection. Consequently, the efficiency of the immune response induced by such vaccines should be explored, and a modelling approach would provide a powerful tool to reach this issue.

We here present these two issues where experimental and modelling approaches provide complementary insights to guide the development of more efficient vaccines. .

2.1 Experimental approach to guide the development of PRRSv universal vaccines

Due to the antigenic heterogeneity of the PRRS virus, current commercial PRRSV vaccines (killed-virus and modified-live vaccines) are of unsatisfactory efficacy, especially against heterologous infection [7]. Continuous efforts have been devoted to develop better PRRSv vaccines. Experimental PRRSv vaccines, including live attenuated vaccines, recombinant vectors expressing PRRSv viral proteins, DNA vaccines and plant-made subunit vaccines, have been developed. However, the genetic and antigenic heterogeneity of the virus limits the value of almost all of

the PRRSv vaccines tested. Developing a universal vaccine that can provide broad protection against circulating PRRSv strains has become a major challenge for current vaccine development [7]. For PRRSv infection, protection is conferred by the humoral immune response, represented by neutralising antibodies and by the cellular immune response, represented by the cytotoxic T cells. Thus, an effective universal PRRSv vaccine must invoke a strong response against diverse field strains from both T cells and B cells [7].

The first strategy would be to develop **multi-strain vaccines** consisting of antigenically distinct strains, as in the case for poliovirus vaccines [7]. Up to now, results from experimental multi-strains PRRSv vaccines did not exhibit a higher efficiency than single-strain vaccines [7, 28]. The second strategy would be the development of **conserved-region vaccines** [7]. Its purpose is to incorporate into vaccines B cell and T cell epitopes from the most conserved regions of the virus. They would thus have high probability of interacting with the circulating viruses. Therefore identifying conserved regions of the viral proteome is the starting point for this strategy. The third strategy would be the development of **poly-epitope vaccines** [7]. It is based on the fact that, despite PRRSv great genetic and antigenic variability, a cross-protection does exist involving a strong T cell and B cell responses, even between genetically distant type 1 and type 2 strains. However, the limited knowledge on T cell and B cell epitopes among the PRRSv strains is still a barrier for the design of a poly-epitope vaccine [7].

2.2 Modelling approach to guide the development of more efficient vaccines

For PRRSv, numerous experimental studies showed that various PRRSv strains (and so various PRRSv vaccines) induced various immune response and resulted in various memory responses and so various protection levels with only partial cross-protections [1–3, 27] against heterologous challenge. Consequently, in addition to the variable level of cross-protection linked to the variable level of viral epitope recognition, there is also a variable level of cross-protection due to the variability of the immune response induced by the various PRRSv strains, which is also epitope dependent. On the one hand, the immune system is designed to rapidly recall pre-existing cross-reactive immune responses from memory immunity and any such responses should therefore provide an advantage over a re-infection comparatively to a primary infection of a naive host. On the other hand, recalled responses may also result in a less efficient immune response over an heterologous re-infection than that seen in naïve individuals. In particular for PRRSv infection, as various PRRSv strains induce variable immune responses, a recalled response from a primary exposure by a given PRRSv strain should be less efficient over an heterologous re-infection than from a primary exposure by the re-challenged PRRSv strain. Consequently, the immune mechanisms protecting against PRRSv infection depending on the PRRSv strains and whatever the PRRSv strain (if they are) should be identified [1, 3].

We showed in this thesis that the apparent inconsistencies between experimental data in term of which immune mechanisms are determining for the PRRSv infection resolution should be explained by considering the immune mechanism variability involved depending on the PRRSv strain (see Chapter II). However, this approach is insufficient to conclude on the immune mechanisms protecting against PRRSv infection depending on the PRRSv strains and whatever the PRRSv strain. Our preliminary exploration of the current vaccine efficiency (see Chapter IV) exhibited that an hypo-virulent PRRSv strain vaccine induce a memory response which would be more protective against a hyper-virulent PRRSv strain than against an hypo-virulent PRRSv strain. This result supports the assumption that the cross-protection level induced by a vaccine dose not only depend on the memory component ability to recognise the PRRSv epitopes, but also on the induced immune response, which is epitope dependent. However, we assumed a full cross-protection, which is not realistic. Consequently, a finer exploration would require

a straightforward model adaptation to consider the partial cross-protection, *i.e.* a multi-strain within-host model, introduced in the Section IV.5.1. The memory response dynamics has first to be incorporated explicitly. It would require only to duplicate the adaptive components which partially differentiate into memory components. Then, model adaptation for heterologous re-infection and multi-strain infections would require to duplicate (for two strains) the virus and all immune components, except the cytokines, and to consider the potential cross-immunisation, *i.e.* interactions between components specific to one or the other strain.

It has been previously pointed out that a careful consideration of the within-host dynamics in such context of re-infection by either homologous or heterologous challenge would help to develop more informative models of pathogen spread at the herd level [29]. Multi-strain within-host models are classically used in immuno-epidemiological models [30–34] and in particular to explore the host-pathogen co-evolution, whereas we found only one published multi-strain immunological model [35]. Such models have to consider how the various immune mechanisms of the both innate and adaptive immune responses interact to resolve the pathogen infection at the within host level [29]. Our within-host model provides then an interesting framework to reach this issue whatever the pathogen. Finally, multi-strain within-host model will provide new insights for the pathogen spread at the within-host scale and for linking within to between-host dynamics in immuno-epidemiological models [29].

3 Towards an immuno-epidemiological approach

The within-host dynamics is impacted by several factors which can vary at the between-host scale and can exhibit a temporal dynamics, such as the host susceptibility, the pathogen strain virulence and the pathogen exposure. The within-host dynamics determines in turn the susceptibility of the pig (and in particular its protection level) and its infectiousness, which are specific to the pathogen strains. The between-host dynamics of a pathogen transmitted by contacts is determined by the contact structure, the host susceptibility and the host infectiousness of individuals in contacts. Consequently, the within and between-host pathogen spread interact in a temporal dynamics way and are linked by the health status of hosts and by the pathogen exposure (from between-host towards within-host dynamics) and the host infectiousness (from the within-host towards the between-host dynamics). In a context of temporal and between-host variability of the within-host dynamics to a pathogen (as for the PRRSv), neglecting either the within-host dynamics at the between-host scale or the between-host dynamics at the within-host scale would be too strong simplifications. As a result, understand, predict and control the spread of such pathogens at the herd level each requires the consideration of the within-host dynamics and its interactions with the between-host dynamics, named immuno-epidemiological approaches.

For PRRSv control, immuno-epidemiological framework would be particularly adapted as :

- the immune dynamics to PRRSv is highly variable depending on the host, the PRRSv strain and the PRRSv exposure. The within-host dynamics variability results in a variability of health status and so in the probability of an infectious pig to infect another pig and of a pig either naive or (partially) protected to be infected ;
- the major PRRSv control measure is the vaccination, which directly involves the within-host dynamics and provides variable protection level depending on the host health status, its interactions with the other pigs and PRRSv strain challenged. None of the current commercial vaccines provides a full protection, exhibits a variable efficiency depending on

the PRRSv strain against an homologous challenge and only a partial (and more often a poor) cross-protection against heterologous challenge ;

- several PRRSv strains coexist in the same area and in the same time in field conditions, so the efficiency of a vaccination strategy at either the within-host or herd level should be considered regarding the dynamical interactions between the two scales.

In this thesis, we showed that understand, predict and control the within-host dynamics to PRRSv infection requires an integrative view of the immune response (including the innate and adaptive dynamics and their interactions involving cytokine regulations). Consequently, our within-host model provides a powerful framework in the prospect of an immuno-epidemiological approach. After an introduction presenting the immuno-epidemiological approaches, we discuss the insights and limits of our within-host approach regarding an immuno-epidemiological approach prospect in term of linking both scale through (i) the exposure/infectiousness and (ii) the health status of hosts. Finally, we discuss the insights of using an immuno-epidemiological model to explore the efficiency of current PRRSv vaccines and to guide the development of more efficient vaccines.

3.1 Introduction to immuno-epidemiological models

Immunological and epidemiological models has historically been considered as separate disciplines. Most immunological models are self-contained and do not incorporate links to the epidemiology of the disease. In particular, these type of models ignore the amount of pathogen transmitted (*i.e.* the infectiousness) and the status of the immune system at infection (*i.e.* the protection and/or susceptibility levels).

Epidemiological models take into account the heterogeneity of within-host dynamics by describing the population through discrete classes depending of the health status of individuals, mainly susceptible, infected and non-infectious (latent), infected and infectious and recovered-immune status. Hosts can be refined by introducing subcategories of infected hosts. Standard epidemiological models assume that each host is infected with the same amount of pathogen and exhibits the same time course of infection. Some epidemiological models (i) include time-since-infection structure to account for variable infectiousness during infection and so implicitly account for the pathogen load of the individuals and/or (ii) are structured by time-since-recovery and so implicitly account for the temporal loss of protection recovery. Yet, most epidemiological models do not take into account the pathogen load of infected individuals and the detailed immune status during infection. However, some infections are characterised by a strong variability in the immune dynamics between-host, which can result in a strong variability in the infectiousness of the infected hosts and the protection level of the susceptible hosts. In these cases, classical epidemiological approaches are insufficient, in particular to explore the vaccine strategy efficiency at the herd level or to guide the development of more efficient vaccine strategies.

Given this context, immuno-epidemiological models, bridging the gap between immunology and epidemiology combining within and between-host approaches, provides new perspectives [32, 36]. They examine how the within-host dynamics differences among hosts affect the between-host dynamics to produce the epidemiological dynamics observed in heterogeneous host populations [36]. Immuno-epidemiological approaches have first been developed for macroparasitic (helminth) infections and malaria [36]. It is a field of increasing interest and numerous models applied to various diseases, such as Influenza [32, 37–40] or HIV [32–34], has been developed and consider assumptions about acquired immunity to study spread of infection [41–44] or host-pathogen co-evolution [45–47]. One type of immuno-epidemiological models is the nested approach, developed in Gilchrist and Sasaki [45], which provides a simple framework for linking immunological and

epidemiological models. The nested modelling approach embeds a mechanistic ODE model of host-pathogen disease dynamics into a time-since-infection epidemiological model of infection by linking epidemiological parameters such as transmission rate or duration of infectiousness [45, 46, 48]. The two models are linked by two mechanisms.

1. Through a structural variable. The epidemic model is structured through time-since-infection, used as an independent variable in the immunological model only for the infected individual class of the epidemiological model.
2. Through parameters. Parameters of the epidemiological model are expressed as functions of the dependent variables of the immunological model. For instance, the transmission rate is proportional to the pathogen titer within the host and the disease-induced virulence depends on both the infection and immune dynamics within the host.

For diseases with recovery, the main disadvantage of this nested approach is that the host immune status upon recovery is not retained, *i.e.* each new infection has to start with the same immune status. Ideally, for diseases that allow repeated infections and/or exhibiting variable levels of protection depending on the time-since-infection, the hosts and the the pathogen strain (such as for PRRSv infections), we would like to retain the immune status, so that upon re-infection the immune system can mount a more efficient response and clear the pathogen faster. For these issues, stochastic discrete-time Agent Based Models (ABM) would be more adapted as proposed by Lukens *et al.* [37], Steinmeyer *et al.* [44]. In ABM, individuals are represented as autonomous agents whose within-host dynamics and in particular infectious status is followed in time. The infection propagates in the population according to disease transmission and duration rules, where between-host variability is represented in the form of statistical distributions.

Whatever the pathogen, a major challenge for the area is how to choose an appropriate abstraction : for a given system, how should we move from the full immune dynamics at the individual host level to reasonable assumptions that can be incorporated into population models [29]. In other word, which is the ideal detail level of the within-host model and which are links between the within-host and the between-host models that may be implemented. We discuss this issues in the two following sections regarding the PRRSv infections : why and how to link (i) the exposure and the infectiousness and (ii) the within-host dynamics and the health status at the herd level.

3.2 From the viral exposure to the pig infectiousness

At the between-host scale, the infection spread, the infectiousness of infected individuals (*i.e.* the amount of pathogen transmitted) and the host contact structure determine the exposure of susceptible individuals, which can trigger new infections. At the within-host scale, the exposure, the individual susceptibility and the pathogen virulence drive the immune dynamics, which dictates the infection duration and severity, as well as the infectiousness of infected individuals. Exposure hence links the between-host to the within-host dynamics, whereas infectiousness links the within-host to the between-host dynamics. Steinmeyer *et al.* [44], which proposed theoretical immuno-epidemiological approaches, showed that between-host models need to take the exposure of susceptible animals into account to represent the pathogen transmission, which partly depends on the within-host dynamics of infected animals. Studies on other viruses than PRRSv showed that the initial inoculum dose determines the within-host immune dynamics and course of infection [22, 23]. On PRRSv, experimental studies found that (i) the infectiousness is a function of the time post-infection [19] and that (ii) PRRSv infection probability is a logistic

function of the initial inoculum dose [20]. However, the impact of exposure on the within-host dynamics, which is regarded as a key issue [22, 23, 44], has not been explored for PRRSv infection.

We showed that the PRRSv exposure has an influence on the viral titer (see chapter III) so on the infectiousness of an infected pig and consequently on the PRRSv spread at the herd level. We found that the exposure intensity (the total viral dose received through exposure) and to a lesser extent the exposure duration and peak had a strong impact on the within-host dynamics, which could vary according to PRRSv strain virulence. The simplest way to represent the exposure in a model is by way of a positive initial condition for the pathogen, *i.e.* either a punctual exposure dose due to a punctual contact or the total viral dose received through exposure. Most studies used this approximation in experimental infections [20, 23], in within-host models of various viral infections [22], or in immuno-epidemiological models [30, 44, 46, 48, 49]. Only few published immuno-epidemiological models represent the exposure as a time-dependent function related to the viral titer of infected individuals in contact [41]. In order to identify the best way to represent the PRRSv exposure in models, we looked at the impact of the exposure duration and peak for a given exposure intensity. We showed that a good approximation of the exposure should at least preserve the exposure intensity, especially to estimate the infection severity. Besides, representing the exposure due to contacts by a short or even a punctual exposure would tend to underestimate the infection duration. As the infection severity and duration both contribute to the pig infectiousness, a prolonged exposure of the adequate intensity would probably be an adequate choice in an immuno-epidemiological context.

3.3 From the immune dynamics to the health status

The health status of individuals determines their probability to be infected by or to infect other individuals. During infection, the temporal variability of health status is generally represented in epidemiological models by discrete classes depending of the health status of individuals. However, for pathogen infection exhibiting a high variability of the within-host dynamics between hosts, the classical representation of health status in epidemiological models is too simple and would result in wrong estimations of the pathogen spread at the population level. Then, immuno-epidemiological models are powerful to unravel this limit. The health status of individuals are directly determined by their within-host dynamics and their probability to infect (or/and be infected by) another individual could be defined as a continuous function of their within-host pathogen titer (or/and their immune response). In the previous subsection, we discussed the link between infectiousness of an infected individual and exposure of a susceptible individual, which involves the pathogen titer of the infected individuals in contact. Here, we discuss the link between the host susceptibility level during the infection time and the health status at the herd level. Susceptibility of host depends on its own characteristics (such as its age, genotype, ...) and its infectious past. Considering a naive host (*i.e.* it has never encountered the pathogen), a successful infection results in the activation of the immune response and the establishment of a memory response which is specific to the pathogen. Then, if this immunised host is re-exposed to the same pathogen after the infection resolution, the immune system is designed to rapidly recall the memory response, which provides either an advantage over a re-infection comparatively to a primary infection of a naive host or in a less efficient immune over an heterologous re-infection than that seen in naive individuals. Considering the memory response is consequently necessary when the hosts which can be challenged several times (depending on the pathogen and/or the time-duration of interest). Moreover, the protection level (and so the host susceptibility) conferred by the memory response exhibits a temporal variability, which can be variable between host. Finally, for some diseases, several pathogen strains can circulate in

the same area and in the same time, and as the memory response is specific to the pathogen strain, the protection level resulting from an exposure to a given strain would vary depending on re-challenged pathogen strain. This last point is related to the **cross-protection**, determined by the host, the pathogen strain and the infectious past of the host. In turn, the duration of infectiousness is affected by the protection level of the host and this will consequently impact the pathogen spread at the herd level. Consequently, a careful consideration of the within-host dynamics in such context of re-infection by either homologous or heterologous challenge would help us to develop more informative models of pathogen spread at the herd level [29].

For PRRSv, numerous experimental studies showed that various PRRSv strains induced various immune response and so variable infection severity and duration resulting in variable infectiousness [17, 19] and resulted in variable memory responses and so variable protection levels with only partial cross-protections [1–3, 27]. As a result, an immuno-epidemiological model is required to simulate the PRRSv spread at the herd level linking the within-host immune dynamics and the health status of hosts and considering the variable protection levels depending on hosts, PRRSv strains and infectious past of host. This implies to follow the dynamics of each host of the herd during the time window of interest thanks an ABM immuno-epidemiological model. Moreover, as several PRRSv strains can co-exist in the same area and in the same time, the immuno-epidemiological model should consider a multi-strain system.

Concerning the within-host scale, our within-host model extended to a multi-strain system would be particularly adapted for PRRSv disease, as presented in the subsection 2.2. Indeed, PRRSv exhibits (i) numerous evasion strategies to the immune system altering both innate and adaptive components; (ii) a high variability in evasion strategies (and consequently of immune dynamics during infection) between-hosts and strains and (iii) a co-existence of several strains in the same area and in the same time. Consequently, simulating the within-host dynamics to such pathogens requires an integrative view of the immune response specific to a given strain including the innate and adaptive components dynamics and their interactions, as proposed in our within-host model.

To make tractable population models of multiple strains, modellers typically make relatively simple assumptions about the nature of partial cross-immunity [29]. For example, a partially immune host can be treated as having a lower probability of becoming infected (reduced susceptibility) and/or a lower probability of transmitting the infection to others (reduced transmissibility). Among the published immuno-epidemiological models, none represented explicitly the link between the multi-strain immune dynamics and the health status of host in the herd including the cross-protection. However, each proposed an interesting framework and combining the various approaches would result in a more adapted immuno-epidemiological model. Luo *et al.* [50] defined a nested two-strain immuno-epidemiological model where all hosts are naive at the beginning of the simulations, hosts can be re-infected with the same strain and each infection increases the immune status of the host. Such framework could be extended to also consider the cross-protection. Similarly, Lythgoe *et al.* [34] proposed a nested multi-strain immuno-epidemiological model where the host infectiousness depends on the strain and the host, but the host protection dynamics is not considered and the within and between-host dynamics are linked only through the infectiousness. Lukens *et al.* [37] defined a mono-strain ABM immuno-epidemiological model where immune characteristics are extracted from the within-host dynamics and used as parameters of the epidemiological model to generate population response variability. This framework is particularly adapted to our heterogeneity level, but should be extended to a multi-strain system.

3.4 Vaccination strategies at the herd level

Vaccination is implemented at the within-host scale, but the vaccination strategy is designed at the herd level. Consequently, exploring the vaccination strategy efficiency at the herd level is required. Whatever the pathogen, this issue has been addressed as a key challenge for disease control by Metcalf *et al.* [51], which pointed out challenges in modelling vaccine preventable diseases at both within and between-host scales in a recent review. One of them is to develop models that can address the vaccine efficiency issue at the within-host scale [51]. Briefly, the success of vaccines at an individual level is determined by the induced immune dynamics and the resulting memory response. Vaccine efficiency can exhibit a temporal variability and can vary depending on host, pathogen strain and infectious past of host. Carefully calibrated immunological models will ultimately touch on a large number of critical immune and vaccine-related questions such as what are the immunodynamics responsible for protecting against infection, against disease, and against onward transmission [51]. We addressed the vaccination issue at the within-host scale in subsection 2.2. Then, in a such context of variability, exploring the vaccination strategy efficiency at the herd level would required immuno-epidemiological approach [51]. However, linking within-host immune processes with population effects such as herd immunity remains an open and important question [51].

The major PRRSv control measure is the vaccination, but none of the current commercial vaccines provides a full protection and the development of more efficient vaccines, in particular to provide a better cross-protection, is still a major challenge for PRRSv control. Given the high variability in vaccine efficiency at the within-host scale depending on the PRRSv strain against an homologous challenge and the only partial (and more often a poor) cross-protection against heterologous challenge, an immuno-epidemiological approach would be particularly helpful for PRRSv infection. We showed that a fine exploration of the vaccine efficiency at the within-host scale required a multi-strain within-host model (see subsection 2.2) and immuno-epidemiological approach applied to PRRSv required an ABM multi-strain immuno-epidemiological model (see subsection 3.3). So such immuno-epidemiological model would be adapted to explore the vaccine strategy efficiency at the herd level.

4 Synthesis

In this thesis, we presented integrative within-host modelling approaches applied to PRRSv infections. This work provides new insights in the understanding of the immune response to PRRSv depending on the host susceptibility, PRRSv strain virulence and PRRSv exposure. We also introduce a framework to explore the efficiency of current PRRSv vaccines at the within-host scale and to guide the development of more efficient vaccines. Our within-host modelling framework is particularly adapted to PRRSv infection, its main strengths regarding the published immunological models are : (i) an explicit and detailed representation of both major innate and adaptive immune mechanisms, (ii) an integrative view of the within-host dynamics representing the interactions between the innate and adaptive responses at the between-cell scale and (iii) the integration of the complex regulation by the major pro-inflammatory, antiviral and immunomodulatory cytokines. Beyond the application to PRRSv, our model could easily be adapted to other respiratory pathogens and so provide a within-host framework for a various pathogens. The major limit of our modelling approach is the model calibration and hence validation, which would required experimental data. To reach this issue, we implemented a custom-made experimental infection. Finally, we conducted this work regarding the prospect of better control PRRSv spread at the herd level using immuno-epidemiological approaches. In particular, our

work provides new insights on the within-host dynamics depending on factors which can vary at the herd level (PRRSv strain virulence, host susceptibility and PRRSv exposure) which were looked at independently and simultaneously. As a result, we showed that :

- our within-host model has the required level of detail in terms of immune mechanisms to be embedded in an PRRSv epidemiological model ;
- a straightforward model extension to multi-strain system would result in a well adapted within-host model for an immuno-epidemiological approach ;
- the within and between-host dynamics to PRRSv should be linked through both the exposure/infectiousness and the immune dynamics/health status.

Looking at the efficiency of vaccination, which is the major control measure to control PRRSv spread at the herd level, our extended model would allow a fine exploration at the within-host scale and provides an interesting framework for the exploration at the herd level thanks an immuno-epidemiological approach.

References

- [1] MURTAUGH M.P., GENZOW M., 2011. Immunological solutions for treatment and prevention of porcine reproductive and respiratory syndrome (PRRS). *Vaccine* **29**(46) :8192–8204. doi:10.1016/j.vaccine.2011.09.013.
- [2] THANAWONGNUWECH R., SURADHAT S., 2010. Taming PRRSV : Revisiting the control strategies and vaccine design. *Virus Res.* **154**(1-2) :133–140. doi:10.1016/j.virusres.2010.09.003.
- [3] KIMMAN T.G., CORNELISSEN L.A., MOORMANN R.J., REBEL J.M.J., STOCKHOFE-ZURWIEDEN N., 2009. Challenges for porcine reproductive and respiratory syndrome virus (PRRSV) vaccinology. *Vaccine* **27**(28) :3704–3718. doi:10.1016/j.vaccine.2009.04.022.
- [4] LUNNEY J.K., CHEN H., 2010. Genetic control of host resistance to porcine reproductive and respiratory syndrome virus (PRRSV) infection. *Virus Res.* **154**(1-2) :161–169. doi:10.1016/j.virusres.2010.08.004.
- [5] DARWICH L., DÍAZ I., MATEU E., 2010. Certainties, doubts and hypotheses in porcine reproductive and respiratory syndrome virus immunobiology. *Virus Res.* **154**(1-2) :123–132. doi:10.1016/j.virusres.2010.07.017.
- [6] BUTLER J.E., LAGER K.M., GOLDE W., FAABERG K.S., SINKORA M., LOVING C., ZHANG Y.I., 2014. Porcine reproductive and respiratory syndrome (PRRS) : an immune dysregulatory pandemic. *Immunologic research* **59**(1-3) :81–108. doi:10.1007/s12026-014-8549-5.
- [7] HU J., ZHANG C., 2012. Porcine reproductive and respiratory syndrome virus vaccines : current status and strategies to a universal vaccine. *Transbound. Emerg. Dis.* doi:10.1111/tbed.12016.
- [8] AIT-ALI T., WILSON A.D., CARRÉ W., WESTCOTT D.G., FROSSARD J.P., MELLENCAMP M.A., MOUZAKI D., MATIKA O., WADDINGTON D., DREW T.W., BISHOP S.C., ARCHIBALD A.L., 2011. Host inhibits replication of European porcine reproductive and respiratory syndrome virus in macrophages by altering differential regulation of type-I interferon transcriptional responses. *Immunogenetics* **63**(7) :437–448. doi:10.1007/s00251-011-0518-8.
- [9] GIMENO M., DARWICH L., DÍAZ I., DE LA TORRE E., PUJOLS J., MARTIN M., INUMARU S., CANO E., DOMÍNGO M., MONTOYA M., MATEU E., 2011. Cytokine profiles and phenotype regulation of antigen presenting cells by genotype-I porcine reproductive and respiratory syndrome virus isolates. *Vet. Res.* **42**(9). doi:10.1186/1297-9716-42-9.
- [10] DARWICH L., GIMENO M., SIBILA M., DÍAZ I., DE LA TORRE E., DOTTI S., KUZEMTSEVA L., MARTIN M., PUJOLS J., MATEU E., 2011. Genetic and immunobiological diversities of porcine reproductive and respiratory syndrome genotype I strains. *Vet. Microbiol.* **150**(1–2) :49–62. doi:10.1016/j.vetmic.2011.01.008.
- [11] MATEU E., DÍAZ I., 2008. The challenge of PRRS immunology. *Vet. J.* **177** :345–351. doi:10.1016/j.tvjl.2007.05.022.
- [12] NAUWYNCK H.J., VAN GORP H., VANHEE M., KARNIYCHUK U., GELDHOF M., CAO A., VERBEECK M., VAN BREEDAM W., 2012. Micro-dissecting the pathogenesis and immune response of PRRSV infection paves the way for more efficient PRRSV vaccines. *Transbound. Emerg. Dis.* **59** :50–54. doi:10.1111/j.1865-1682.2011.01292.x.

- [13] ZIMMERMAN J., BENFIELD D.A., MURTAUGH M.P., OSORIO F., STEVENSON G.W., TORREMORELL M., 2006. Porcine reproductive and respiratory syndrome virus (porcine arterivirus). In *Diseases of swine*, edited by B.E. STRAW, J.J. ZIMMERMAN, S. D'ALLAIRE, D.L. TAYLOR, Blackwell (Oxford, UK), 9th edn., chap. 24, pp. 387–418.
- [14] MONDACA-FERNÁNDEZ E., MEYNS T., MUÑOZ-ZANZI C., TRINCADO C., MORRISON R.B., 2007. Experimental quantification of the transmission of Porcine reproductive and respiratory syndrome virus. *Can. J. Vet. Res.* **71**(2) :157.
- [15] NODELIJK G., NIELEN M., DEJONG M.C.M., VERHEIJDEN J.H.M., 2003. A review of porcine reproductive and respiratory syndrome virus in Dutch breeding herds : population dynamics and clinical relevance. *Prev. Vet. Med.* **60** :37–52. doi:10.1016/S0167-5877(03)00081-3.
- [16] HICKSON R.I., ROBERTS M.G., 2014. How population heterogeneity in susceptibility and infectivity influences epidemic dynamics. *J. Theor. Biol.* **350** :70–80. doi:10.1016/j.jtbi.2014.01.014.
- [17] JOHNSON W., ROOF M., VAUGHN E., CHRISTOPHER-HENNINGS J., JOHNSON C.R., MURTAUGH M.P., 2004. Pathogenic and humoral immune responses to porcine reproductive and respiratory syndrome virus (PRRSV) are related to viral load in acute infection. *Vet. Immunol. Immunop.* **102**(3) :233–247. doi:10.1016/j.vetimm.2004.09.01.
- [18] REINER G., FRESEN C., BRONNERT S., WILLEMS H., 2009. Porcine reproductive and respiratory syndrome virus (PRRSV) infection in wild boars. *Vet. Microbiol.* **136**(3) :250–258. doi:10.1016/j.vetmic.2008.11.023.
- [19] CHARPIN C., MAHÉ S., KERANFLEC'H A., BELLOC C., CARIOLET R., LE POTIER M.F., ROSE N., 2012. Infectiousness of pigs infected by the porcine reproductive and respiratory syndrome virus (PRRSV) is time-dependent. *Vet. Res.* **43**(1) :69. doi:10.1186/1297-9716-43-69.
- [20] HERMANN J.R., MUNOZ-ZANZI C.A., ROOF M.B., BURKHART K., ZIMMERMAN J.J., 2005. Probability of porcine reproductive and respiratory syndrome (PRRS) virus infection as a function of exposure route and dose. *Vet. Microbiol.* **110**(1) :7–16. doi:10.1016/j.vetmic.2005.06.012.
- [21] YOON K.J., ZIMMERMAN J.J., CHANG C.C., CANCEL-TIRADO S., HARMON K.M., MCGINLEY M.J., 1999. Effect of challenge dose and route on porcine reproductive and respiratory syndrome virus (PRRSV) infection in young swine. *Vet. Res.* **30**(6) :629–638.
- [22] LI Y., HANDEL A., 2014. Modeling inoculum dose dependent patterns of acute virus infections. *J. Theor. Biol.* **347** :63–73. doi:10.1016/j.jtbi.2014.01.008.
- [23] MAROIS I., CLOUTIER A., GARNEAU É., RICHTER M.V., 2012. Initial infectious dose dictates the innate, adaptive, and memory responses to influenza in the respiratory tract. *J. Leukocyte Biol.* **92**(1) :107–121. doi:10.1189/jlb.1011490.
- [24] GÓMEZ-LAGUNA J., SALGUERO F., PALLARÉS F., FERNÁNDEZ DE MARCO M., BARRANCO I., CERÓN J., MARTÍNEZ-SUBIELA S., VAN REETH K., CARRASCO L., 2010. Acute phase response in porcine reproductive and respiratory syndrome virus infection. *Comp. Immunol. Microb.* **33**(6) :e51–e58. doi:10.1016/j.cimid.2009.11.003.
- [25] VAN REETH K., NAUWYNCK H., 2000. Proinflammatory cytokines and viral respiratory disease in pigs. *Vet. Res.* **31**(2) :187–213. doi:10.1051/vetres:2000113.

- [26] GO N., BIDOT C., BELLOC C., TOUZEAU S., 2014. Integrative model of the immune response to a pulmonary macrophage infection : what determines the infection duration ? *PLoS ONE* **9**(9) :e107818. doi:10.1371/journal.pone.0107818.
- [27] CHARERNTANTANAKUL W., 2009. Adjuvants for porcine reproductive and respiratory syndrome virus vaccines. *Vet. Immunol. Immunop.* **129**(1) :1–13. doi:10.1016/j.vetimm.2008.12.018.
- [28] MENGELING W.L., LAGER K.M., VORWALD A.C., KOEHLER K.J., 2003. Strain specificity of the immune response of pigs following vaccination with various strains of porcine reproductive and respiratory syndrome virus. *Vet. Microbiol.* **93**(1) :13–24. doi:10.1016/S0378-1135(02)00427-3.
- [29] WIKRAMARATNA P.S., KUCHARSKI A., GUPTA S., ANDREASEN V., MCLEAN A.R., GOG J.R., 2014. Five challenges in modelling interacting strain dynamics. *Epidemics* doi:10.1016/j.epidem.2014.07.005. In press.
- [30] PEPIN K.M., VOLKOV I., BANAVAR J.R., WILKE C.O., GRENFELL B.T., 2010. Phenotypic differences in viral immune escape explained by linking within-host dynamics to host-population immunity. *J. Theor. Biol.* **265**(4) :501–510. doi:10.1016/j.jtbi.2010.05.036.
- [31] VASCO D.A., WEARING H.J., ROHANI P., 2007. Tracking the dynamics of pathogen interactions : modeling ecological and immune-mediated processes in a two-pathogen single-host system. *J. Theor. Biol.* **245**(1) :9–25. doi:10.1016/j.jtbi.2006.08.015.
- [32] DEBROY S., MARTCHEVA M., 2008. Immuno-epidemiology and HIV/AIDS : A modeling prospective. In *Mathematical Biology Research Trends*, edited by L.B. WILSON, Nova Science Publishers (New York, USA), pp. 175–192.
- [33] MARTCHEVA M., LI X.Z., 2013. Linking immunological and epidemiological dynamics of HIV : the case of super-infection. *J. Biol. Dyn.* **7**(1) :161–182. doi:10.1080/17513758.2013.820358.
- [34] LYTHGOE K.A., PELLIS L., FRASER C., 2013. Is HIV short-sighted? Insights from a multistrain nested model. *Evolution* **67**(10) :2769–2782. doi:10.1111/evo.12166.
- [35] DE LEENHEER P., PILYUGIN S.S., 2008. Immune response to a malaria infection : properties of a mathematical model. *J. Biol. Dyn.* **2**(2) :102–120. doi:10.1080/17513750701769865.
- [36] HELLRIEGEL B., 2001. Immunoepidemiology – bridging the gap between immunology and epidemiology. *Trends Parasitol.* **17**(2) :102–106. doi:10.1016/S1471-4922(00)01767-0.
- [37] LUKENS S., DEPASSE J., ROSENFELD R., GHEDIN E., MOCHAN E., BROWN S.T., GRENFENSTETTE J., BURKE D.S., SWIGON D., CLERMONT G., 2014. A large-scale immuno-epidemiological simulation of influenza A epidemics. *BMC Public Health* **14** :1019. doi:10.1186/1471-2458-14-1019.
- [38] HANDEL A., BROWN J., STALLKNECHT D., ROHANI P., 2013. A multi-scale analysis of influenza A virus fitness trade-offs due to temperature-dependent virus persistence. *PLoS Comput. Biol.* **9**(3) :e1002989. doi:10.1371/journal.pcbi.1002989.
- [39] HANDEL A., LEBARBENCHON C., STALLKNECHT D., ROHANI P., 2014. Trade-offs between and within scales : environmental persistence and within-host fitness of avian influenza viruses. *Proc. R. Soc. B* **281**(1787) :20133051. doi:10.1098/rspb.2013.3051.

- [40] MURILLO L.N., MURILLO M.S., PERELSON A.S., 2013. Towards multiscale modeling of influenza infection. *J. Theor. Biol.* **332** :267–290. doi:10.1016/j.jtbi.2013.03.024.
- [41] KOSTOVA T., 2007. Persistence of viral infections on the population level explained by an immunoepidemiological model. *Math. Biosci.* **206**(2) :309–319. doi:10.1016/j.mbs.2005.08.003.
- [42] HEFFERNAN J.M., KEELING M.J., 2009. Implications of vaccination and waning immunity. *Proc. R. Soc. B* **276**(1664) :2071–2080. doi:10.1098/rspb.2009.0057.
- [43] MARTCHEVA M., PILYUGIN S.S., 2006. An epidemic model structured by host immunity. *J Biol. Syst.* **14**(02) :185–203. doi:10.1142/S0218339006001787.
- [44] STEINMEYER S.H., WILKE C.O., PEPIN K.M., 2010. Methods of modelling viral disease dynamics across the within-and between-host scales : the impact of virus dose on host population immunity. *Philos T. R. Soc. B* **365**(1548) :1931–1941. doi:10.1098/rstb.2010.0065.
- [45] GILCHRIST M.A., SASAKI A., 2002. Modeling host-parasite coevolution : a nested approach based on mechanistic models. *J. Theor. Biol.* **218**(3) :289–308. doi:10.1006/jtbi.2002.3076.
- [46] MIDEO N., ALIZON S., DAY T., 2008. Linking within-and between-host dynamics in the evolutionary epidemiology of infectious diseases. *Trends Ecol. Evol.* **23**(9) :511–517. doi:10.1016/j.tree.2008.05.009.
- [47] DAY T., ALIZON S., MIDEO N., 2011. Bridging scales in the evolution of infectious disease life histories : theory. *Evolution* **65**(12) :3448–3461. doi:10.1111/j.1558-5646.2011.01394.x.
- [48] GANDOLFI A., PUGLIESE A., SINISGALLI C., 2014. Epidemic dynamics and host immune response : a nested approach. *J. Math. Biol.* doi:10.1007/s00285-014-0769-8. Online.
- [49] MARTCHEVA M., 2011. An immuno-epidemiological model of paratuberculosis. *AIP Conf. Proc.* **1404**(1) :176–183. doi:10.1063/1.3659918. In *Application of Mathematics in Technical and Natural Sciences : 3rd International Conference AMiTaNS'11 : Albena, Bulgaria, 20-25 June 2011* ; edited by Todorov M.D. and Christov C.I.
- [50] LUO S., REED M., MATTINGLY J.C., KOELLE K., 2012. The impact of host immune status on the within-host and population dynamics of antigenic immune escape. *J. R. Soc. Interface* **9**(75) :2603–2613. doi:10.1098/rsif.2012.0180.
- [51] METCALF C.J.E., ANDREASEN V., BJØRNSTAD O.N., EAMES K., EDMUNDS W.J., FUNK S., HOLLINGSWORTH T.D., LESSLER J., VIBOUD C., GRENFELL B.T., 2014. Seven challenges in modelling vaccine preventable diseases. *Epidemics* doi:10.1016/j.epidem.2014.08.004. In press.

Appendices

Annexe A

Complete description of the lung-based model, used in Chapter II

Contents

A.1 Complete model description	206
A.1.1 Cytokine regulations	207
A.1.2 Macrophage dynamics	207
A.1.3 Viral dynamics	209
A.1.4 Natural killer dynamics	210
A.1.5 Adaptive effector dynamics	210
A.1.6 Cytokine dynamics	212
References	216
A.2 Supplementary figures	220

Supporting Information to Integrative Model of the Immune Response to a Pulmonary Macrophage Infection : What Determines the Infection Duration ?

Natacha Go^{*,†}, Caroline Bidot^{*}, Catherine Belloc[†] and Suzanne Touzeau^{‡,§}

* INRA, UR341 MIA, F-78352 Jouy-en-Josas, France

† LUNAM Université, Oniris, INRA, UMR1300 BioEpAR, F-44307 Nantes, France

‡ INRA, Université Nice Sophia Antipolis, UMR1355 ISA ; CNRS, UMR 7254 ; F-06903 Sophia Antipolis, France

§ Inria, BIOCORE, F-06902 Sophia Antipolis, France

Citation : Go N, Bidot C, Belloc C, Touzeau S (2014) Integrative Model of the Immune Response to a Pulmonary Macrophage Infection : What Determines the Infection Duration ? PLoS ONE 9(9) : e107818. doi :10.1371/journal.pone.0107818

A.1 Complete model description

This model describes the infection and immune dynamics induced by a pathogen targeting pulmonary macrophages in the lung. It focuses on the macrophage–virus interactions and highly details the innate immune response and cytokine regulations. The adaptive immune response is less detailed but includes the cellular, humoral and regulatory orientations and their main functions.

The model is characterised by 18 state variables : the free viral particles ; five effectors of the innate response, consisting of four macrophage states (susceptible, phagocytosing, infected and latent, infected and excreting the virus) and the natural killers ; three effectors of the adaptive response, representing the cellular, humoral and regulatory responses ; nine cytokines composed of the major pro-inflammatory ($IL_{1\beta}$, IL_6 , IL_8), the innate antiviral (TNF_α , IFN_α) and the immuno-regulatory (IFN_γ , IL_{12} , IL_{10} , TGF_β) cytokines.

We chose a deterministic continuous-time dynamic framework. Our model is hence a set of 18 ordinary differential equations, which represent the evolution over time of the state variables. The main processes that drive their evolution over time and that are integrated in the model are : the phagocytosis of the viral particles by the macrophages ; the macrophage infection by the virus ; the excretion of free viral particles by the infected macrophages ; the recruitment and decay/migration of the macrophages ; the activation and decay/migration of the other effectors ; the cytokine productions by the immune cells and their decay ; the cytokine regulations.

The functional diagram of the system appears in FIGURE 1 (main text). FIGURE 2 (main text) gives a schematic representation of the model (without regulations). Parameter descriptions and values are synthesised in TABLE 1 (main text). The cytokine regulations and syntheses represented in our model as well as the related literature references are summarised in TABLE S1 and TABLE S2 respectively.

We first present how the cytokine regulations are formalised in the model and then describe the dynamics of the various state variables : macrophages, free viral particles, natural killers, effectors of the adaptive response and cytokines.

A.1.1 Cytokine regulations

Cytokines regulate the cellular functions through their recognition by specific receptors, inducing cascaded reactions within the cells. The higher the cytokine concentration, the stronger the effect. However,

there is a limited number of cytokine receptors on the cell surface, so the effect saturates above a given cytokine concentration. We formalised the cytokine effects by a Michaelis–Menten function (κ) of the cytokine concentration (C_i) as follows :

$$\kappa(C_i) = \frac{K C_i}{C_i + k},$$

where K represents the saturation factor and k the half-saturation cytokine concentration [1–3].

Considering a flow (R), which can either be an inflow (*e.g.* recruitment) or an outflow (*e.g.* decay), a cytokine can have three possible effects listed below.

- Activation : $R \kappa(C_i)$. The flow is only possible in the presence of the cytokine and it increases with the cytokine concentration.
- Amplification : $R [1 + \kappa(C_i)]$. The flow increases with the cytokine concentration.
- Inhibition : $R/[1 + \kappa(C_i)]$. The flow decreases with the cytokine concentration.

Regulations often involve several cytokines (C_i and C_j), which can act

- either independently :
 - co-activation : $R [\kappa(C_i) + \kappa(C_j)]$,
 - co-amplification : $R [1 + \kappa(C_i)] [1 + \kappa(C_j)]$,
 - co-inhibition : $R/([1 + \kappa(C_i)] [1 + \kappa(C_j)])$;
- or in synergy :
 - co-activation : $R \kappa(C_i, C_j) = R \kappa(C_i) \kappa(C_j)$,
 - co-amplification : $R [1 + \kappa(C_i, C_j)] = R [1 + \kappa(C_i) \kappa(C_j)]$,
 - co-inhibition : $R/[1 + \kappa(C_i, C_j)] = R/[1 + \kappa(C_i) \kappa(C_j)]$.

As very few studies estimate the regulation parameters (k and K) in the literature [3], we used the same parameter values for all cytokine regulations.

A.1.2 Macrophage dynamics

Macrophages phagocyte and destroy the virus, but they are also target cells for the virus. Activated macrophages (either phagocytosing or infected) present the viral antigen and activate the adaptive response. The macrophage activation also induces the synthesis of innate cytokines : pro-inflammatory ($\text{IL}_{1\beta}$, IL_6 , IL_8), antiviral (IFN_α , TNF_α) and immuno-regulatory (IL_{12} , IL_{10} , TGF_β) cytokines [4].

States In the model, macrophages can either be susceptible (M_s), phagocytosing (M_p), or infected; in this latter case, they are either latent (M_l) or excreting the virus (M_e). We represented the evolution over time of the macrophage concentrations for these four states.

Decay All macrophage states are submitted to natural death or/and migration (rate μ_M^{nat}), as well as apoptosis induced by TNF_α (rate μ_M^{ap}) [5]. The natural death rate is considered higher for infected macrophages than for susceptible and phagocytosing macrophages (multiplicative factor

δ_μ). Moreover, infected macrophages can be destroyed by natural killers (rate μ_M^{inn}) and cells from the cellular response (rate μ_M^{ad}).

Recruitment Susceptible macrophages are recruited from the bloodstream (rate A_m). Cytokines IL₆ and IL₁₂ co-amplify the macrophage recruitment [6–8] in synergy and IL₈ attracts the macrophages in the infection place [8]. In the absence of virus, the cytokine concentrations are supposed to be negligible and the resulting concentration of susceptible macrophages in the lung is constant : $M_s = M_s^0 = \frac{A_m}{\mu_M^{\text{nat}}}$.

Phagocytosis and infection When susceptible macrophages encounter free viral particles (V), they can either phagocytose the virus (rate η) or become infected (rate β). We assume that phagocytosing macrophages revert to the susceptible state after viral destruction (rate γ), whereas infected macrophages remain infected (*i.e.* they cannot eliminate the virus). We also assume that the infected and phagocytosing states are exclusive and that once phagocytosing or infected, macrophages cannot phagocytose or be infected by other viral particles [9].

The phagocytosis is amplified by the antiviral cytokines (IFN_α, TNF_α, IFN_γ) and inhibited by the immuno-modulatory cytokines (IL₁₀, TGF_β) – . The phagocytosis ending is amplified by the antiviral cytokines and inhibited by IL₁₀. The macrophage infection is amplified by IL₁₀ and inhibited by innate antiviral cytokines (IFN_α, TNF_α) and TGF_β.

Viral excretion Infected macrophages are first latent (mean duration $1/\lambda$) before they start excreting. The transition between the latent and excreting states (rate λ) is inhibited by the antiviral cytokines. Excretion is supposed to be transitory and excreting macrophages may revert to the latent state in the presence of antiviral cytokines.

$$\begin{aligned}
\dot{M}_s &= A_m [1 + \kappa(\text{IL}_{12}, \text{IL}_6)] [1 + \kappa(\text{IL}_8)] && \leftarrow \text{recruitment} \\
&\quad - \eta M_s V \frac{[1 + \kappa(\text{TNF}_\alpha)] [1 + \kappa(\text{IFN}_\alpha)] [1 + \kappa(\text{IFN}_\gamma)]}{[1 + \kappa(\text{IL}_{10})] [1 + \kappa(\text{TGF}_\beta)]} && \leftarrow \text{phagocytosis} \\
&\quad + \gamma M_p \frac{[1 + \kappa(\text{TNF}_\alpha)] [1 + \kappa(\text{IFN}_\alpha)] [1 + \kappa(\text{IFN}_\gamma)]}{1 + \kappa(\text{IL}_{10})} && \leftarrow \text{phagocytosis ending} \\
&\quad - \beta M_s V \frac{1 + \kappa(\text{IL}_{10})}{[1 + \kappa(\text{TNF}_\alpha)] [1 + \kappa(\text{IFN}_\alpha)] [1 + \kappa(\text{TGF}_\beta)]} && \leftarrow \text{infection} \\
&\quad - M_s (\mu_M^{\text{nat}} + \mu_M^{\text{inf}} \text{TNF}_\alpha) && \leftarrow \text{decay} \\
\dot{M}_p &= \eta M_s V \frac{[1 + \kappa(\text{TNF}_\alpha)] [1 + \kappa(\text{IFN}_\alpha)] [1 + \kappa(\text{IFN}_\gamma)]}{[1 + \kappa(\text{IL}_{10})] [1 + \kappa(\text{TGF}_\beta)]} && \leftarrow \text{phagocytosis} \\
&\quad - \gamma M_p \frac{[1 + \kappa(\text{TNF}_\alpha)] [1 + \kappa(\text{IFN}_\alpha)] [1 + \kappa(\text{IFN}_\gamma)]}{1 + \kappa(\text{IL}_{10})} && \leftarrow \text{phagocytosis ending} \\
&\quad - M_p (\mu_M^{\text{nat}} + \mu_M^{\text{ap}} \text{TNF}_\alpha) && \leftarrow \text{decay} \\
\dot{M}_l &= \beta M_s V \frac{1 + \kappa(\text{IL}_{10})}{[1 + \kappa(\text{TNF}_\alpha)] [1 + \kappa(\text{IFN}_\alpha)] [1 + \kappa(\text{TGF}_\beta)]} && \leftarrow \text{infection} \\
&\quad - \lambda M_l \frac{1}{[1 + \kappa(\text{TNF}_\alpha)] [1 + \kappa(\text{IFN}_\gamma)] [1 + \kappa(\text{IFN}_\alpha)]} && \leftarrow \text{excretion} \\
&\quad + \nu M_e [\kappa(\text{TNF}_\alpha) + \kappa(\text{IFN}_\gamma) + \kappa(\text{IFN}_\alpha)] && \leftarrow \text{excretion ending} \\
&\quad - M_l (\mu_M^{\text{nat}} \delta_\mu + \mu_M^{\text{ap}} \text{TNF}_\alpha + \mu_M^{\text{inn}} \text{NK} + \mu_M^{\text{ad}} R_c) && \leftarrow \text{decay} \\
\dot{M}_e &= \lambda M_l \frac{1}{[1 + \kappa(\text{TNF}_\alpha)] [1 + \kappa(\text{IFN}_\gamma)] [1 + \kappa(\text{IFN}_\alpha)]} && \leftarrow \text{excretion} \\
&\quad - \nu M_e [\kappa(\text{TNF}_\alpha) + \kappa(\text{IFN}_\gamma) + \kappa(\text{IFN}_\alpha)] && \leftarrow \text{excretion ending} \\
&\quad - M_e (\mu_M^{\text{nat}} \delta_\mu + \mu_M^{\text{ap}} \text{TNF}_\alpha + \mu_M^{\text{inn}} \text{NK} + \mu_M^{\text{ad}} R_c) && \leftarrow \text{decay}
\end{aligned}$$

A.1.3 Viral dynamics

The virus enters the body through the mucosal surfaces of the respiratory tract and replicates in the pulmonary macrophages.

We represented the evolution over time of the free viral particles (V). When they encounter susceptible macrophages (M_s), they can either be phagocytosed by the macrophages (rate η), resulting in viral destruction, or they can infect the macrophages (rate β), resulting in virus replication. Free viral particles are released in the lung by excreting macrophages (rate e). They can be neutralised by antibodies represented by the humoral response R_h (rate μ_V^{ad}). They are also submitted to natural death and migration outside the lung (rate μ_V^{nat}).

$$\begin{aligned}
\dot{V} &= e M_e && \longleftarrow \text{replication} \\
&- \eta M_s V \frac{[1 + \kappa(\text{TNF}_\alpha)] [1 + \kappa(\text{IFN}_\alpha)] [1 + \kappa(\text{IFN}_\gamma)]}{[1 + \kappa(\text{IL}_{10})] [1 + \kappa(\text{TGF}_\beta)]} && \longleftarrow \text{phagocytosis} \\
&- \beta M_s V \frac{1 + \kappa(\text{IL}_{10})}{[1 + \kappa(\text{TNF}_\alpha)] [1 + \kappa(\text{IFN}_\alpha)] [1 + \kappa(\text{TGF}_\beta)]} && \longleftarrow \text{infection} \\
&- V (\mu_V^{\text{nat}} + \mu_V^{\text{ad}} R_h) && \longleftarrow \text{decay}
\end{aligned}$$

A.1.4 Natural killer dynamics

Natural killers are effectors of the innate response. Their main immune functions are the destruction of infected cells and IFN_γ synthesis [4, 8, 10, 11]. These cytotoxic cells are recruited on the infection by pro-inflammatory cytokines. Their proliferation and immune functions are activated by several cytokines (IFN_γ , IL_{12} , IL_{15} , IL_{18} , IL_{21} , $\text{IFN}_{\alpha\beta}$), whereas IL_{10} inhibits the natural killer differentiation and their immune functions [10].

We represented the dynamics of activated natural killers (NK) and only included the regulations by the most influential cytokines. The recruitment of natural killers from the bloodstream (rate α_N) requires pro-inflammatory cytokines : IL_{12} and IL_6 co-activate the recruitment, whereas IL_8 acts independently. Natural killers are then activated by IFN_γ and IL_{12} , whereas IL_{10} inhibits the activation. They are submitted to natural death or/and migration (rate μ_R).

$$\begin{aligned}
\dot{\text{NK}} &= \alpha_N \frac{[\kappa(\text{IL}_{12}, \text{IL}_6) + \kappa(\text{IL}_8)] [\kappa(\text{IFN}_\gamma) + \kappa(\text{IL}_{12})]}{[1 + \kappa(\text{IL}_{10})]} && \longleftarrow \text{recruitment \& activation} \\
&- \mu_R \text{NK} && \longleftarrow \text{decay}
\end{aligned}$$

A.1.5 Adaptive effector dynamics

The adaptive response activation begins with the naive CD_4^+ T cell differentiation by antigen presenting cells (dendritic cells or macrophages) within the lymphoid tissues. Depending on the cytokine profiles in the lymph nodes, CD_4^+ T cells differentiate in one of three main CD_4^+ effector types, which each have specific immune functions : type 1 T helpers ($\text{T}_{\text{h}1}$, belonging to the cellular response), type 2 T helpers ($\text{T}_{\text{h}2}$, belonging to the humoral response) and regulatory T lymphocytes (T_{reg} , belonging to the regulatory response) [4, 12–19]. The differentiation towards $\text{T}_{\text{h}1}$ is induced by IL_{12} and amplified by IFN_γ . The differentiation towards $\text{T}_{\text{h}2}$ is induced by IL_6 and amplified by IL_4 . The differentiation towards T_{reg} is induced by TGF_β and amplified by IL_{10} . The cytokines responsible for the differentiation towards a CD_4^+ effector type simultaneously inhibit the differentiation towards the two other types. After the differentiation step, the CD_4^+ effectors express their specific immune functions and proliferate. $\text{T}_{\text{h}1}$ synthesise the IL_2 and IFN_γ cytokines. In addition, they are responsible for the differentiation of the CD_8^+ T cells in cytotoxic lymphocytes (CTL). CTL synthesise IFN_γ and TNF_α and destroy the infected macrophages. $\text{T}_{\text{h}2}$ synthesise IL_4 and IL_{10} . In addition, they are the main activator of the B lymphocytes (through IL_4 and IL_{10}), which produce the neutralising antibodies. T_{reg} synthesise the TGF_β and IL_{10} immuno-modulatory cytokines. In summary :

- The cellular response : (i) includes the T_{h1} and CTL; (ii) is activated by IL_{12} and IFN_γ and inhibited by IL_6 , IL_{10} and TGF_β ; and (iii) is responsible for the synthesis of IL_2 , IFN_γ and TNF_α .
- The humoral response : (i) includes the T_{h2} , B lymphocytes and antibodies; (ii) is activated by IL_6 , IL_4 and IL_{10} and inhibited by IL_{12} , IFN_γ and TGF_β ; and (iii) is responsible for the synthesis of IL_4 and IL_{10} and for the viral particle neutralisation.
- The regulatory response : (i) only includes the T_{reg} ; (ii) is activated by TGF_β and IL_{10} and inhibited by IL_6 , IL_{12} and IFN_γ ; and (iii) is responsible for the immune response inhibition through its synthesis of the TGF_β and IL_{10} immuno-modulatory cytokines.

In our model, we represented the adaptive response by three effectors corresponding to the three main orientations : cellular (R_c), humoral (R_h) and regulatory (R_r) responses. As for the NK cells, we only represented the dynamics of the activated effectors.

Based on the model proposed by Yates *et al.* for the regulation of T helper cell populations [19], we synthesised the dynamics of each adaptive effector by three steps : activation by activated macrophages (rate α_R), proliferation (rate p_R) and decay. We represented the regulations of the activation and proliferation steps by the most influential cytokines : IFN_γ , IL_{12} , IL_{10} and TGF_β .

The decay includes the natural decay (rate μ_R) and the Activation Induced Cell Death (AICD) induced by the interaction with a T_{h1} from the R_c compartment (rate δ_{R_c}) [19].

Cellular response [16–18, 20–23] R_c represents the type 1 T helper cells and the cytotoxic lymphocytes. Activation is amplified by IFN_γ and IL_{12} and inhibited by IL_{10} . Proliferation is activated by IFN_γ and IL_{12} and inhibited by IL_{10} and TGF_β . R_c synthesises IFN_γ and is responsible for the destruction of infected cells.

$$\begin{aligned} \dot{R}_c &= \alpha_R (M_p + M_l + M_e) \frac{[1 + \kappa(IFN_\gamma)] [1 + \kappa(IL_{12})]}{1 + \kappa(IL_{10})} && \leftarrow \text{activation} \\ &+ p_R R_c \frac{[\kappa(IFN_\gamma) + \kappa(IL_{12})]}{[1 + \kappa(IL_{10})] [1 + \kappa(TGF_\beta)]} && \leftarrow \text{proliferation} \\ &- \mu_R R_c - \delta_{R_c} R_c^2 && \leftarrow \text{decay} \end{aligned}$$

Humoral response [16–18, 24] R_h represents the type 2 T helper cells, the B lymphocytes and the antibodies. Activation is amplified by IL_{10} and inhibited by IFN_γ and IL_{12} . Proliferation is activated by IL_{10} and inhibited by IFN_γ , IL_{12} and TGF_β . R_h synthesises IL_{10} and is responsible for the neutralisation of free viral particles through antibodies.

$$\begin{aligned} \dot{R}_h &= \alpha_R (M_p + M_l + M_e) \frac{[1 + \kappa(IL_{10})]}{[1 + \kappa(IFN_\gamma)] [1 + \kappa(IL_{12})]} && \leftarrow \text{activation} \\ &+ p_R R_h \frac{\kappa(IL_{10})}{[1 + \kappa(IFN_\gamma)] [1 + \kappa(IL_{12})] [1 + \kappa(TGF_\beta)]} && \leftarrow \text{proliferation} \\ &- \mu_R R_h - \delta_{R_c} R_c R_h && \leftarrow \text{decay} \end{aligned}$$

Regulatory response [16–18, 25] R_r represents the represents the regulatory T cells. Activation is amplified by IL_{10} and TGF_β and inhibited by IFN_γ and IL_{12} . Proliferation is activated by TGF_β and inhibited by IL_{10} , IFN_γ and IL_{12} . R_r synthesises IL_{10} and TGF_β .

$$\begin{aligned}
\dot{R}_r &= \alpha_R (M_p + M_l + M_e) \frac{[1 + \kappa(\text{IL}_{10})] [1 + \kappa(\text{TGF}_\beta)]}{[1 + \kappa(\text{IFN}_\gamma)] [1 + \kappa(\text{IL}_{12})]} && \longleftarrow \text{activation} \\
&+ p_R R_r \frac{\kappa(\text{TGF}_\beta)}{[1 + \kappa(\text{IL}_{10})] [1 + \kappa(\text{IFN}_\gamma)] [1 + \kappa(\text{IL}_{12})]} && \longleftarrow \text{proliferation} \\
&- \mu_R R_r - \delta_{R_c} R_c R_r && \longleftarrow \text{decay}
\end{aligned}$$

A.1.6 Cytokine dynamics

Cytokines are small proteins that play a key role in cell-signalling. They are produced by activated immune cells and affect the behaviour of other cells, sometimes the releasing cell itself. They act through specific membranous receptors inducing cascaded reactions within the target cell. They have various functions. In particular, cytokines modulate the balance between the humoral and cellular responses. Some cytokines enhance or inhibit the action of other cytokines in complex ways.

In the model, we only integrated the regulations by the nine most influential cytokines. We grouped them into three classes depending on their main function : pro-inflammatory ($\text{IL}_{1\beta}$, IL_6 , IL_8), antiviral (TNF_α , IFN_α , IFN_γ) and immuno-regulatory (IL_{12} , IL_{10} , TGF_β) cytokines. TNF_α is generally considered as a pro-inflammatory cytokine, but we were here more interested in its antiviral function.

We assumed that the cytokines are efficient enough in order to neglect their consumption when they interact with a cell. So the cytokine dynamics results from their synthesis by immune cells (rates ρ_x , where x depends on the cytokine considered) and their natural death (rate μ_C)

The main cytokine regulations are summarised in TABLE A.1 and the cytokine syntheses in TABLE A.2.

Pro-inflammatory cytokines [4, 6–8, 31, 35] Pro-inflammatory cytokines $\text{IL}_{1\beta}$, IL_6 and IL_8 amplify the recruitment of macrophages and activated natural killers. They are synthesised by the activated macrophages. As we had no information on their respective production rate, we used the same synthesis rate (ρ_{P_i}) for the three cytokines. The synthesis of $\text{IL}_{1\beta}$ is inhibited by IL_{10} , whereas the synthesis of IL_6 and IL_8 is co-activated by $\text{IL}_{1\beta}$ and TNF_α .

$$\begin{aligned}
\dot{\text{IL}}_{1\beta} &= \rho_{P_i} (M_p + M_l + M_e) \frac{1}{1 + \kappa(\text{IL}_{10})} && \longleftarrow \text{synthesis} \\
&- \mu_C \text{IL}_{1\beta} && \longleftarrow \text{decay} \\
\dot{\text{IL}}_6 &= \rho_{P_i} (M_p + M_l + M_e) \kappa(\text{IL}_{1\beta}, \text{TNF}_\alpha) && \longleftarrow \text{synthesis} \\
&- \mu_C \text{IL}_6 && \longleftarrow \text{decay} \\
\dot{\text{IL}}_8 &= \rho_{P_i} (M_p + M_l + M_e) \kappa(\text{IL}_{1\beta}, \text{TNF}_\alpha) && \longleftarrow \text{synthesis} \\
&- \mu_C \text{IL}_8 && \longleftarrow \text{decay}
\end{aligned}$$

Antiviral cytokines Antiviral cytokines promote the phagocytosis and reduce the infection by inhibiting the macrophage permissiveness and/or the viral replication.

Table A.1 Cytokine regulations. Main positive (+) and negative (-) regulations included in the model for various immune mechanisms.
 * Pro-inflammatory cytokines $P_i = \text{IL}_{1\beta}, \text{IL}_6, \text{IL}_8$

	Cytokines						
	pro-inf. P_i^*	TNF $_{\alpha}$	innate antiviral IFN $_{\alpha}$	IFN $_{\gamma}$	immuno-regulatory IL $_{12}$	IL $_{10}$	TGF $_{\beta}$
<i>Innate response</i>							
Macrophage recruitment	+				+		
NK recruitment & activation	+			+	+	-	
Macrophage apoptosis		+					
Phagocytosis		+	+			-	
Macrophage permissiveness		-	-			+	-
Viral replication		-	-				
<i>Adaptive response</i>							
Cellular response				+	+	-	-
Humoral response				-	-	+	-
Regulatory response				-	-	\pm	+
<i>Cytokine syntheses</i>							
Pro-inflammatory IL $_{1\beta}$							-
IL $_6, \text{IL}_8$	+	+					
Innate antiviral TNF $_{\alpha}$							-
Adaptive antiviral IFN $_{\gamma}$		+	+		+		
Immuno-regulatory IL $_{12}$							-
IL $_{10}$						+	\pm
Specific references	[7, 8, 23]	[5, 20, 21, 26-29]	[20-23]	[24]	[7, 30-35]	[25]	
Common references		[6, 31]			[16-18]		
Global references				[4, 12-15, 36-38]			

Table A.2 Cytokine syntheses. Production of cytokines included (\checkmark) in the model by innate or adaptive immune cells.

* Pro-inflammatory cytokines $P_i = \text{IL}_{1\beta}, \text{IL}_6, \text{IL}_8$

† Global references : [4, 12–15, 17, 36, 39, 40]

	Cytokines							References
	pro-inf. P_i^*	innate TNF_α	antiviral IFN_α	immuno-regulatory IFN_γ	IL_{12}	IL_{10}	TGF_β	
<i>Innate cells</i>								
Activated macrophages	\checkmark	\checkmark	\checkmark		\checkmark	\checkmark		[8, 41] [†]
Activated natural killers				\checkmark				[8, 11] [†]
<i>Adaptive cells</i>								
Cellular effectors				\checkmark				†
Humoral effectors						\checkmark		†
Regulatory effectors						\checkmark	\checkmark	†

The innate antiviral cytokines TNF_α and IFN_α are synthesised by activated macrophages [5, 6, 20, 21, 26–29, 31]. IL_{10} inhibits the synthesis of TNF_α .

$$\begin{aligned} \dot{\text{TNF}}_\alpha &= \rho_{\text{TNF}_\alpha} (M_p + M_l + M_e) \frac{1}{1 + \kappa(\text{IL}_{10})} && \longleftarrow \text{synthesis} \\ &- \mu_C \text{TNF}_\alpha && \longleftarrow \text{decay} \\ \\ \dot{\text{IFN}}_\alpha &= \rho_{\text{IFN}_\alpha} (M_l + M_e) && \longleftarrow \text{synthesis} \\ &- \mu_C \text{IFN}_\alpha && \longleftarrow \text{decay} \end{aligned}$$

The adaptive antiviral cytokine IFN_γ is synthesised by cells of the cellular response (R_c) and natural killers (NK). This synthesis is auto-amplified. It is also amplified by IFN_α and TNF_α , in synergy with IL_{12} , and inhibited by IL_{10} and TGF_β . IFN_γ is also an immuno-regulatory cytokine and it orients the adaptive response towards the cellular response [16–18, 20–23].

$$\begin{aligned} \dot{\text{IFN}}_\gamma &= \rho_{\text{IFN}_\gamma} (R_c + \text{NK}) \frac{[1 + \kappa(\text{IFN}_\gamma)] [1 + \kappa(\text{IL}_{12}, \text{TNF}_\alpha)] [1 + \kappa(\text{IL}_{12}, \text{IFN}_\alpha)]}{[1 + \kappa(\text{IL}_{10})] [1 + \kappa(\text{TGF}_\beta)]} && \longleftarrow \text{synthesis} \\ &- \mu_C \text{IFN}_\gamma && \longleftarrow \text{decay} \end{aligned}$$

Immuno-regulatory cytokines [12–18] The immuno-regulatory cytokines IL_{12} , IFN_γ (see above), IL_{10} and TGF_β have various functions, in particular the regulation of the adaptive immune response. They also regulate the recruitment of macrophages and natural killers, the phagocytosis and infection, as well as the cytokine syntheses. They are produced by cells of the innate and adaptive response.

IL_{12} co-amplifies the recruitment of macrophages, activates the natural killers and orients the adaptive response towards the cellular response. It is synthesised by activated macrophages. Its synthesis is inhibited by IL_{10} .

$$\begin{aligned} \dot{\text{IL}}_{12} &= \rho_{\text{IL}_{12}} (M_p + M_l + M_e) \frac{1}{1 + \kappa(\text{IL}_{10})} && \longleftarrow \text{synthesis} \\ &- \mu_C \text{IL}_{12} && \longleftarrow \text{decay} \end{aligned}$$

IL_{10} and TGF_β are both immuno-modulatory cytokines. IL_{10} inhibits the natural killer activation and the phagocytosis, it amplifies the macrophage permissiveness and it orients the adaptive response towards the humoral and regulatory responses. IL_{10} is synthesised by activated macrophages and cells of the regulatory (R_r) and humoral (R_h) responses. Its synthesis by macrophages and R_r is amplified by TGF_β , whereas its synthesis by R_h is auto-amplified and inhibited by TGF_β .

$$\begin{aligned} \dot{\text{IL}}_{10} &= \rho_{\text{IL}_{10}} \left((M_p + M_l + M_e + R_r) [1 + \kappa(\text{TGF}_\beta)] + R_h \frac{1 + \kappa(\text{IL}_{10})}{1 + \kappa(\text{TGF}_\beta)} \right) && \longleftarrow \text{synthesis} \\ &- \mu_C \text{IL}_{10} && \longleftarrow \text{decay} \end{aligned}$$

TGF_β inhibits the phagocytosis and macrophage permissiveness and orients the adaptive response towards the regulatory response. In the model, we neglected the synthesis of TGF_β by

activated macrophages, so it is only synthesised by cells of the regulatory response.

$$\begin{aligned} \text{TGF}_\beta &= \rho_{\text{TGF}_\beta} R_r && \longleftarrow \text{synthesis} \\ &- \mu_C \text{TGF}_\beta && \longleftarrow \text{decay} \end{aligned}$$

References

- [1] GAMMACK D., GANGULI S., MARINO S., SEGOVIA-JUAREZ J., KIRSCHNER D., 2005. Understanding the immune response in tuberculosis using different mathematical models and biological scales. *Multiscale Model. Sim.* **3**(2) :312–345. doi:10.1137/040603127.
- [2] MARINO S., MYERS A., FLYNN J.L., KIRSCHNER D.E., 2010. TNF and IL-10 are major factors in modulation of the phagocytic cell environment in lung and lymph node in tuberculosis : A next-generation two-compartmental model. *J. Theor. Biol.* **265**(4) :586–598. doi:10.1016/j.jtbi.2010.05.012.
- [3] WIGGINTON J.E., KIRSCHNER D., 2001. A model to predict cell-mediated immune regulatory mechanisms during human infection with Mycobacterium tuberculosis. *J. Immunol.* **166** :1951–1967.
- [4] ROUSE B.T., SEHRAWAT S., 2010. Immunity and immunopathology to viruses : what decides the outcome? *Nat. Rev. Immunol.* **10**(7) :514–526. doi:10.1038/nri2802.
- [5] CHOI C., CHAE C., 2002. Expression of tumour necrosis factor alpha is associated with apoptosis in lungs of pigs experimentally infected with porcine reproductive and respiratory syndrome virus. *Res. Vet. Sci.* **72**(1) :45–49. doi:10.1053/rvsc.2001.0519.
- [6] VAN REETH K., VAN GUCHT S., PENSART M., 2002. In vivo studies on cytokine involvement during acute viral respiratory disease of swine : troublesome but rewarding. *Vet. Immunol. Immunop.* **87**(3-4) :161–168. doi:10.1016/S0165-2427(02)00047-8.
- [7] ROTH A.J., THACKER E.L., 2006. Immune system. In *Diseases of swine*, edited by B.E. STRAW, J.J. ZIMMERMAN, S. D'ALLAIRE, D.L. TAYLOR, Blackwell (Oxford, UK), 9th edn., chap. 2, pp. 15–36.
- [8] TOSI M.F., 2005. Innate immune responses to infection. *J. Allergy Clin. Immun.* **116**(2) :241–249. doi:10.1016/j.jaci.2005.05.036.
- [9] THANAWONGNUWECH R., 1999. Pulmonary intravascular macrophages (PIMs) : What do we know about their role in PRRSV infection in pigs. *Wetchasan Sattawaphaet (The Thai journal of veterinary medicine)* **29**.
- [10] DEFranco A.L., LOCKSLEY R.M., ROBERTSON M., CUNIN R., 2009. *Immunité : la réponse immunitaire dans les maladies infectieuses et inflammatoires*. DeBoeck (Bruxelles, Belgium). 2nd edn.
- [11] VIDAL S.M., KHAKOO S.I., BIRON C.A., 2011. Natural killer cell responses during viral infections : flexibility and conditioning of innate immunity by experience. *Curr. Opin. Virol.* **1**(6) :497–512. doi:10.1016/j.coviro.2011.10.017.
- [12] BOSCH A.A.T.M., BIESBROEK G., TRZCINSKI K., SANDERS E.A.M., BOGAERT D., 2013. Viral and bacterial interactions in the upper respiratory tract. *PLoS Pathog.* **9**(1) :e1003057. doi:10.1371/journal.ppat.1003057.

- [13] BORGHETTI P., 2005. Cell-mediated immunity and viral infection in pig. In *PRRS fatti vs speculazioni*, Università degli Studi di Parma, Dipartimento di Salute Animale (Parma, Italy), pp. 27–46.
http://medvet.unipr.it/cgi-bin/campusnet/documenti.pl/Show?_id=7d0d
- [14] BRACIALE T.J., SUN J., KIM T.S., 2012. Regulating the adaptive immune response to respiratory virus infection. *Nat. Rev. Immunol.* **12**(4) :295–305. doi:10.1038/nri3166.
- [15] COQUERELLE C., MOSER M., 2010. DC subsets in positive and negative regulation of immunity. *Immunol. Rev.* **234**(1) :317–334. doi:10.1111/j.0105-2896.2009.00887.x.
- [16] KIDD P., 2003. Th1/Th2 balance : the hypothesis, its limitations, and implications for health and disease. *Altern. Med. Rev.* **8**(3) :223–246.
- [17] LEROITH T., AHMED S.A., 2012. Regulatory T cells and viral disease. In *Inflammation, Chronic Diseases and Cancer : Cell and Molecular Biology, Immunology and Clinical Bases*, edited by M. KHATAMI, InTech (Rijeka, Croatia), chap. 6, pp. 121–144. doi:10.5772/28502.
- [18] KNOSP C.A., JOHNSTON J.A., 2012. Regulation of CD4+ T-cell polarization by suppressor of cytokine signalling proteins. *Immunology* **135**(2) :101–111. doi:10.1111/j.1365-2567.2011.03520.x.
- [19] YATES A., BERGMANN C., VAN HEMMEN J.L., STARK J., CALLARD R., 2000. Cytokine-modulated regulation of helper T cell populations. *J. Theor. Biol.* **206**(4) :539–560. doi:10.1006/jtbi.2000.2147.
- [20] LOPEZ-FUERTES L., CAMPOS E., DOMENECH N., EZQUERRA A., CASTRO J.M., DOMINGUEZ J., ALONSO F., 1999. Porcine reproductive and respiratory syndrome (PRRS) virus down-modulates TNF- α production in infected macrophages. *Virus Res.* **69**(269) :41–46. doi:10.1016/S0168-1702(00)00172-6.
- [21] ZIMMERMAN J., BENFIELD D.A., MURTAUGH M.P., OSORIO F., STEVENSON G.W., TORREMORELL M., 2006. Porcine reproductive and respiratory syndrome virus (porcine arterivirus). In *Diseases of swine*, edited by B.E. STRAW, J.J. ZIMMERMAN, S. D'ALLAIRE, D.L. TAYLOR, Blackwell (Oxford, UK), 9th edn., chap. 24, pp. 387–418.
- [22] MOLINA R.M., CHA S.H., CHITTICK W., LAWSON S., MURTAUGH M.P., NELSON E.A., CHRISTOPHER-HENNINGS J., YOON K.J., EVANS R., ROWLAND R.R.R., ZIMMERMAN J.J., 2008. Immune response against porcine reproductive and respiratory syndrome virus during acute and chronic infection. *Vet. Immunol. Immunop.* **126** :283–292. doi:10.1016/j.vetimm.2008.08.002.
- [23] LUNNEY J.K., FRITZ E.R., REECY J.M., ANDR ELIZABETH PRUCNAL D.K., MOLINA R., CHRISTOPHER-HENNINGS J., ZIMMERMAN J., ROWLAND R.R.R., 2010. Interleukin-8, interleukin-1 β , and interferon- γ levels are linked to PRRS virus clearance. *Viral Immunol.* **23**(2) :127–134. doi:10.1089/vim.2009.0087.
- [24] THANAWONGNUWECH R., RUNGSIPIPAT A., DISATIAN S., SAIYASOMBAT R., NPAKANA-PORN S., HALBUR P.G., 2003. Immunohistochemical staining of IFN γ positive cells in porcine reproductive and respiratory syndrome virus-infected lungs. *Vet. Immunol. Immunop.* **91**(1) :73–77. doi:10.1016/S0165-2427(02)00268-4.

- [25] GÓMEZ-LAGUNA J., SALGUERO F.J., PALLARÉS F.J., CARRASCO L., 2013. Immunopathogenesis of porcine reproductive and respiratory syndrome in the respiratory tract of pigs. *Vet. J.* **195**(2) :148–155. doi:10.1016/j.tvj.2012.11.012.
- [26] ALBINA E., 2000. Le point sur le dernier-né des arterivirus : le virus du syndrome dysgénésique et respiratoire porcin (SDRP). *Virologie* **4**(2) :113–121.
- [27] MURTAUGH M.P., 2005. PRRSV/host interaction. In *PRRS fatti vs speculazioni*, Università degli Studi di Parma, Dipartimento di Salute Animale (Parma, Italy), pp. 73–80. http://medvet.unipr.it/cgi-bin/campusnet/documenti.pl/Show?_id=7d0d
- [28] MILLER L.C., LAEGREID W.W., BONO J.L., CHITKO-McKOWN C.G., FOX J.M., 2004. Interferon type I response in porcine reproductive and respiratory syndrome virus-infected MARC-145 cells. *Arch. Virol.* **149** :2453–2463. doi:10.1007/s00705-004-0377-9.
- [29] GIMENO M., DARWICH L., DÍAZ I., DE LA TORRE E., PUJOLS J., MARTIN M., INUMARU S., CANO E., DOMÍNGO M., MONTOYA M., MATEU E., 2011. Cytokine profiles and phenotype regulation of antigen presenting cells by genotype-I porcine reproductive and respiratory syndrome virus isolates. *Vet. Res.* **42**(9). doi:10.1186/1297-9716-42-9.
- [30] CHANG H.C., PENG Y.T., CHANG H.L., CHAUNG H.C., CHUNG W.B., 2008. Phenotypic and functional modulation of bone marrow-derived dendritic cells by porcine reproductive and respiratory syndrome virus. *Vet. Microbiol.* **129**(3–4) :281–293. doi:10.1016/j.vetmic.2007.12.002.
- [31] PENG Y.T., CHAUNG H.C., CHANG H.L., CHANG H.C., CHUNG W.B., 2009. Modulations of phenotype and cytokine expression of porcine bone marrow-derived dendritic cells by porcine reproductive and respiratory syndrome virus. *Vet. Microbiol.* **136**(3-4) :359–365. doi:10.1016/j.vetmic.2008.11.013.
- [32] YOO D., SONG C., SUN Y., DU Y., KIM O., LIU H.C., 2010. Modulation of host cell responses and evasion strategies for porcine reproductive and respiratory syndrome virus. *Virus Res.* **154**(1–2) :48–60. doi:10.1016/j.virusres.2010.07.019.
- [33] FLORES-MENDOZA L., SILVA-CAMPA E., RESÉNDIZ M., OSORIO F.A., HERNÁNDEZ J., 2008. Porcine reproductive and respiratory syndrome virus infects mature porcine dendritic cells and up-regulates interleukin-10 production. *Clin. Vaccine Immunol.* **15** :720–725. doi:10.1128/CVI.00224-07.
- [34] SURADHAT S., THANAWONGNUWECH R., POOVORAWAN Y., 2003. Upregulation of IL-10 gene expression in porcine peripheral blood mononuclear cells by porcine reproductive and respiratory syndrome. *J. Gen. Virol.* **84** :453–459. doi:10.1099/vir.0.18698-0.
- [35] MOORE K.W., DE WAAL MALEFYT R., COFFMAN R.L., O’GARRA A., 2001. Interleukin-10 and the interleukin-10 receptor. *Annu. Rev. Immunol.* **19**(1) :683–765. doi:10.1146/annurev.immunol.19.1.683.
- [36] DARWICH L., DÍAZ I., MATEU E., 2010. Certainties, doubts and hypotheses in porcine reproductive and respiratory syndrome virus immunobiology. *Virus Res.* **154**(1-2) :123–132. doi:10.1016/j.virusres.2010.07.017.
- [37] MURTAUGH M.P., XIAO Z., ZUCKERMANN F., 2002. Immunological responses of swine to porcine reproductive and respiratory syndrome virus infection. *Viral Immunol.* **15**(4) :533–547. doi:10.1089/088282402320914485.

- [38] GÓMEZ-LAGUNA J., SALGUERO F.J., BARRANCO I., PALLARES F.J., RODRIGUEZ-GOMEZ I.M., BERNABE A., CARRASCO L., 2009. Cytokine expression by macrophages in the lung of pigs infected with the porcine reproductive and respiratory syndrome virus. *J. Comp. Pathol.* **142**(1) :51–60. doi:10.1016/j.jcpa.2009.07.004.
- [39] AKIRA S., TAKEDA K., KAISHO T., 2001. Toll-like receptors : critical proteins linking innate and acquired immunity. *Nat. Immunol.* **2**(8) :675–680. doi:10.1038/90609.
- [40] SEN G.C., 2001. Viruses and interferons. *Annu. Rev. Microbiol.* **55** :255–281. doi:10.1146/annurev.micro.55.1.255.
- [41] UNDERHILL D.M., GOODRIDGE H.S., 2012. Information processing during phagocytosis. *Nat. Rev. Immunol.* **12** :492–502. doi:10.1038/nri3244.
- [42] ALBINA E., PIROU L., HUTET E., CARIOLET R., L'HOSPITALIER R., 1998. Immune response in pigs infected with porcine reproductive and respiratory syndrome virus (PRRSV). *Vet. Immunol. Immunop.* **61** :49–66. doi:10.1016/S0165-2427(97)00134-7.
- [43] MURTAUGH M.P., GENZOW M., 2011. Immunological solutions for treatment and prevention of porcine reproductive and respiratory syndrome (PRRS). *Vaccine* **29**(46) :8192–8204. doi:10.1016/j.vaccine.2011.09.013.
- [44] LABARQUE G., VAN GUCHT S., NAUWYNCK H., VAN REETH K., PENSART M., 2003. Apoptosis in the lungs of pigs infected with porcine reproductive and respiratory syndrome virus and associations with the production of apoptogenic cytokines. *Vet. Res.* **34** :249–260. doi:10.1051/vetres:2003001.

A.2 Supplementary figures

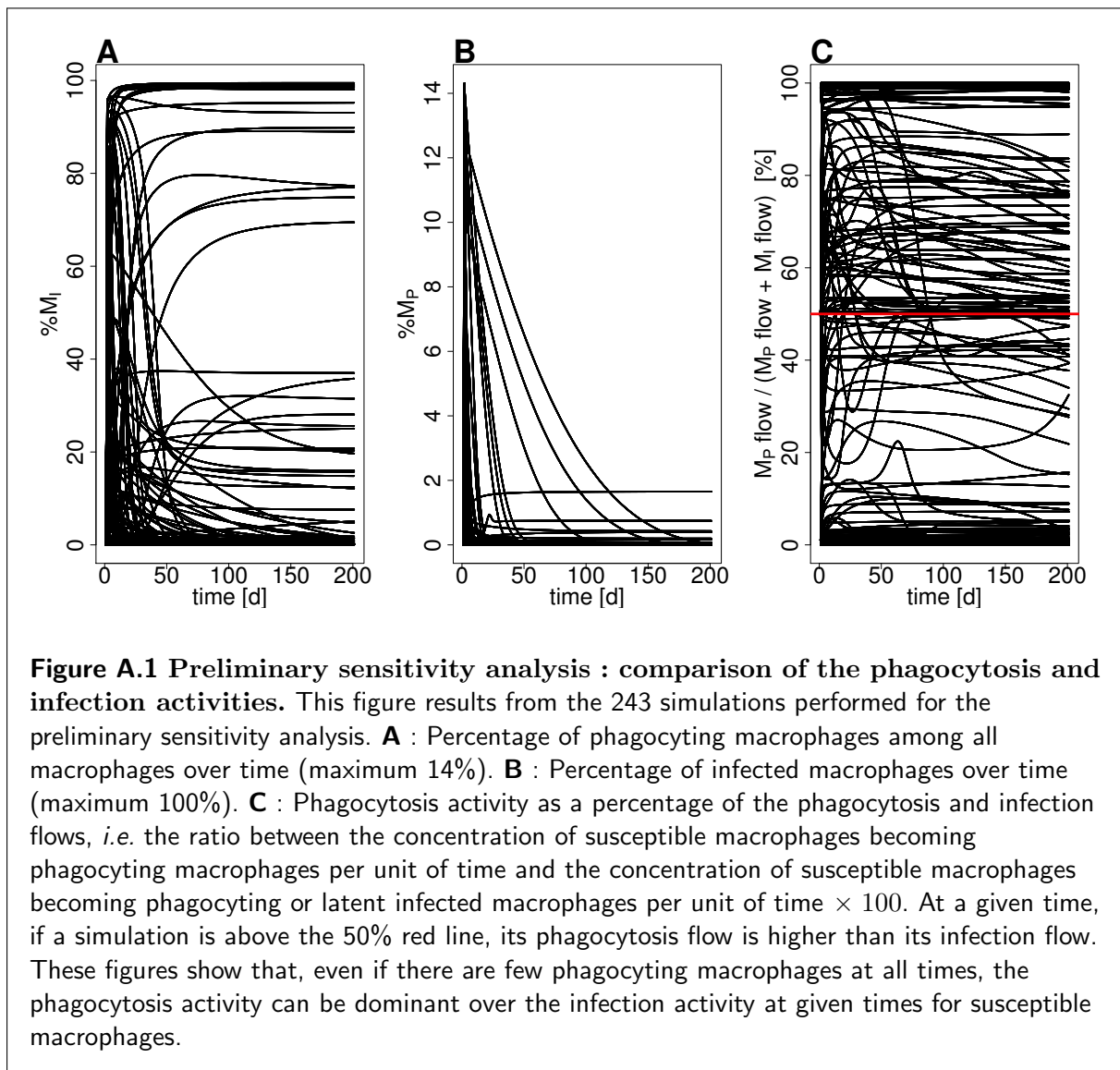

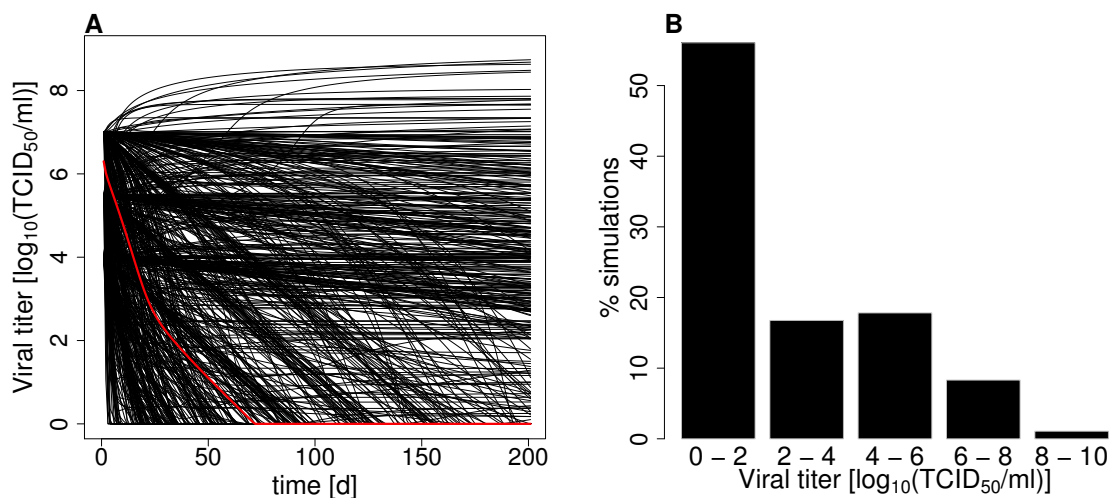
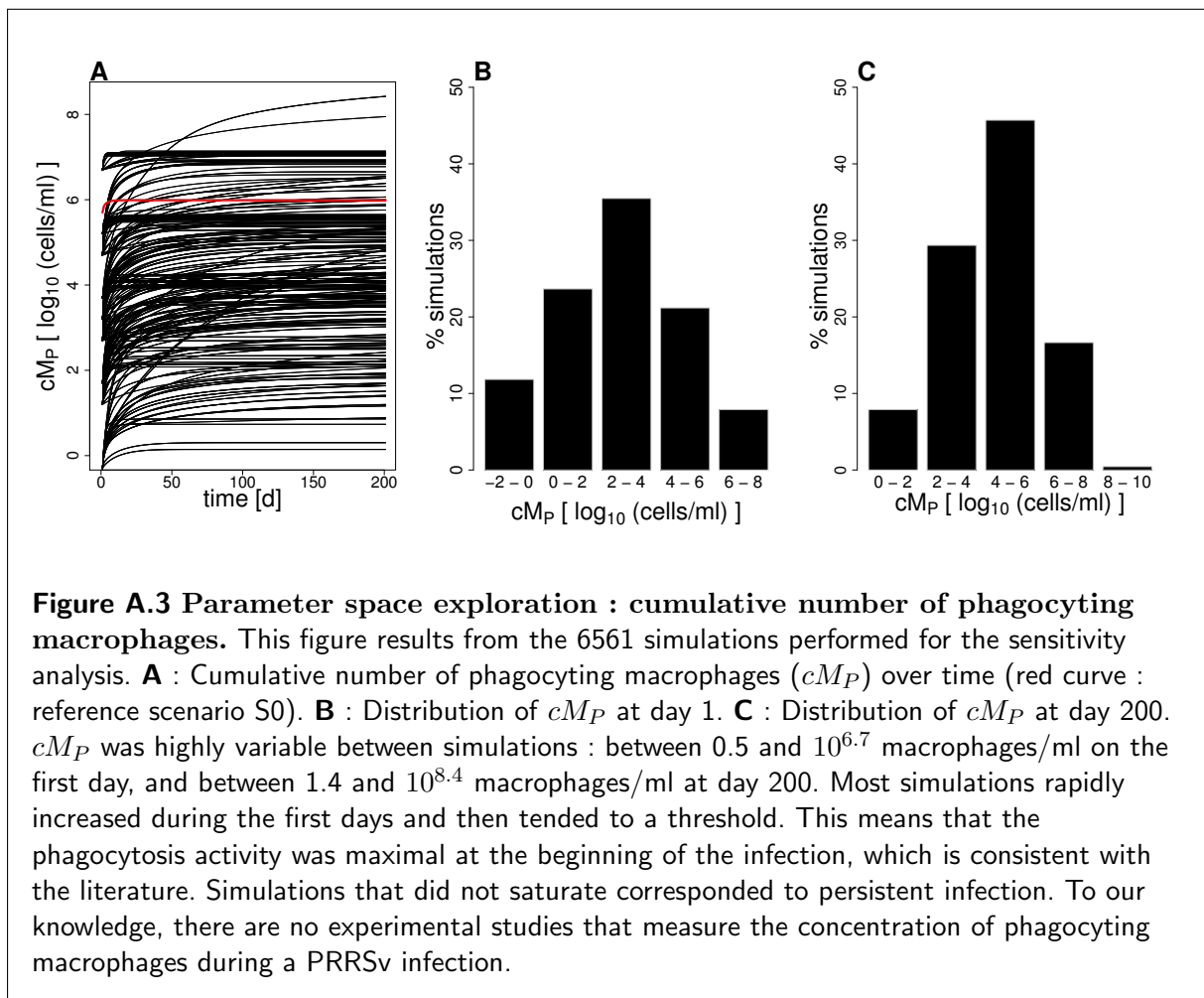
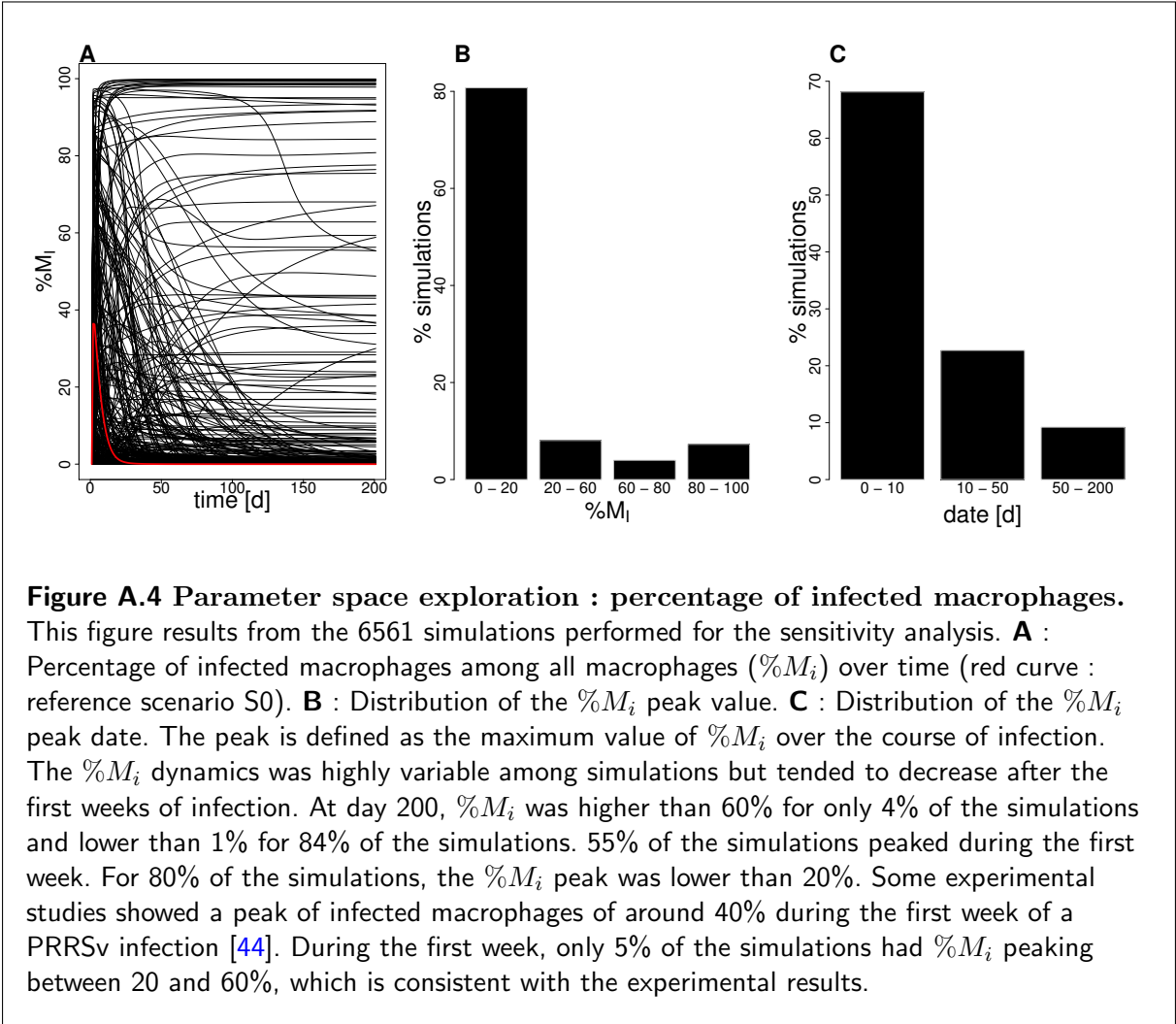

Figure A.2 Parameter space exploration : viral titer. This figure results from the 6561 simulations performed for the sensitivity analysis. **A** : Viral titer over time (red curve : reference scenario S0). **B** : Distribution of the viral titer at day 200. Some simulations resulted in infection persistence, others in infection resolution occurring at various dates. The viral titer at day 200 was heterogeneously distributed : 56% of the simulations had a viral titer lower than $2 \log_{10}(\text{TCID}_{50}/\text{ml})$, which is usually considered as the infection resolution ; the remaining simulations had viral titers ranging between 2 and $8.96 \log_{10}(\text{TCID}_{50}/\text{ml})$. More precisely : (i) 3.7% of the simulations had a viral titer higher than the maximal initial inoculation titer ($7 \log_{10}(\text{TCID}_{50}/\text{ml})$) and (ii) 90% of the simulations had a viral titer lower than its corresponding inoculation titer (4, 5 or $7 \log_{10}(\text{TCID}_{50}/\text{ml})$). In the lung, PRRSv infection lasts 56 days on average [21] and can be longer than 200 days [42, 43].





Annexe B

Complete description of the simplified lung-based model, used in Chapter **III**

Contents

B.1	Model presentation	226
B.2	Cytokine regulations	227
B.3	Macrophage dynamics	228
B.4	Viral dynamics	229
B.5	Natural killer dynamics	230
B.6	Adaptive effector dynamics	230
B.7	Cytokine dynamics	232
	References	235

Supporting Information to

Why, when and how should exposure be considered at the within-host scale ? A modelling contribution to PRRSv infection

Natacha Go^{*,†}, Catherine Belloc[†], Caroline Bidot^{*} and Suzanne Touzeau^{‡,§}

* INRA, UR341 MIA, F-78352 Jouy-en-Josas, France

† LUNAM Université, Oniris, INRA, UMR1300 BioEpAR, F-44307 Nantes, France

‡ INRA, Université Nice Sophia Antipolis, UMR1355 ISA ; CNRS, UMR 7254 ; F-06903 Sophia Antipolis, France

§ Inria, BIOCORE, F-06902 Sophia Antipolis, France

Submitted to *Veterinary Research* in October 2014

The model presented here is a simplified version of a model that we published previously [1]. Changes are highlighted *in italics* in the following description, which includes all equations and details our modelling assumptions. We checked that both models produced similar simulations for the reference scenario (not illustrated).

B.1 Model presentation

The model aims at simulating the infection and immune dynamics induced by PRRSv in the lung. We chose a deterministic continuous-time dynamic framework. Our model is hence a set of 14 ordinary differential equations, which represent the evolution over time of the state variables : the free viral particles (V) ; the susceptible (M_s), phagocytosing (M_p) and infected (M_i) macrophages ; the natural killers (NK) ; the cellular (R_c), humoral (R_h) and regulatory (R_r) adaptive effectors ; the pro-inflammatory (P_i , grouping $IL_{1\beta}$, IL_6 and IL_8), innate antiviral (A_i , grouping IFN_α and TNF_α) and immuno-regulatory cytokines (IL_{12} , adaptive anti-viral : IFN_γ , immuno-modulatory : IL_{10} & TGF_β). The main processes that drive their evolution over time and that are integrated in the model are : the phagocytosis of the viral particles by the macrophages ; the macrophage infection by the virus ; the excretion of free viral particles by the infected macrophages ; the recruitment and decay/migration of the macrophages ; the activation and decay/migration of the other effectors ; the cytokine productions by the immune cells and their decay ; the cytokine regulations.

The functional diagram of the system appears in Chapter III, FIGURE III.1. FIGURE B.1 gives a schematic representation of the model (without regulations). Parameter descriptions and values are synthesised in **Table 1** (main text). The cytokine regulations and syntheses represented in our model, as well as the related literature references are summarised in TABLE B.1 and TABLE B.2 respectively.

We first present how the cytokine regulations are formalised in the model and then describe the dynamics of the various state variables : macrophages, free viral particles, natural killers, effectors of the adaptive response and cytokines.

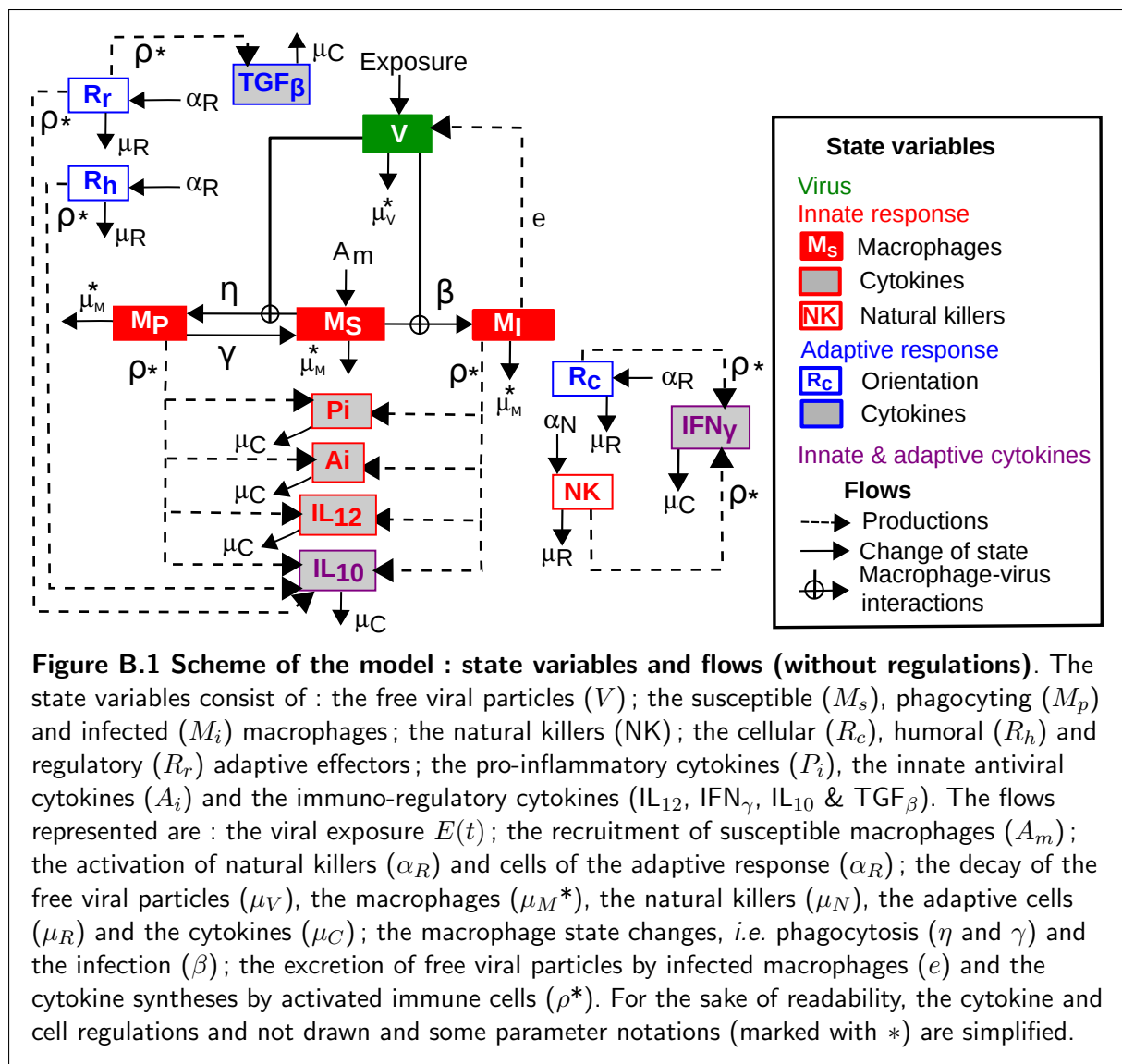

B.2 Cytokine regulations

The processes driving the state variable dynamics are regulated by a complex cytokine feedback system (presented in FIGURE III.1). Some cytokines have opposite effects : for example, the antiviral cytokines up-regulate the phagocytosis and down-regulate the viral infection, whereas IL₁₀ inhibits the phagocytosis and promotes the infection. Cytokines regulate the cellular functions through their recognition by specific receptors, inducing cascaded reactions within the cells. The higher the cytokine concentration, the stronger the effect. However, there is a limited number of cytokine receptors on the cell surface, so the effect saturates above a given cytokine concentration.

We formalised the cytokine regulations (up κ^+ and down κ^-) based on the Michaelis–Menten function of the cytokine concentration (C_i) [2–4] as follows :

$$\kappa^+(C_i) = \frac{v_m C_i}{k_m + C_i}, \quad \kappa^-(C_i) = \frac{k_m}{k_m + C_i},$$

where v_m denotes the saturation factor and k_m the half saturation constant.

Compared to [1], the down-regulation function κ^- is simplified.

A cytokine can have three possible effects on a given basic rate (r) :

- activation : $r \kappa^+(C_i)$, the basic rate increases with the cytokine concentration from 0 to $r v_m$;
- amplification : $r [1 + \kappa^+(C_i)]$, the basic rate increases with the cytokine concentration from r to $r (1 + v_m)$;
- inhibition : $r \kappa^-(C_i)$, the basic rate decreases and tends to zero.

Regulations often involve several cytokines (C_i and C_j) which can act

- either independently : $\kappa^\pm(C_i + C_j)$;
- or in synergy :
 - $\kappa^+(C_i C_j) = \frac{v_m C_i C_j}{k_m^2 + C_i C_j}$ for an activation or an amplification,
 - $\kappa^-(C_i C_j) = \frac{k_m^2}{k_m^2 + C_i C_j}$ for an inhibition.

Compared to [1], effects involving multiple cytokines are simplified.

As very few studies estimate the regulation parameters (k_m and v_m) in the literature [4], we used the same parameter values for all cytokine regulations.

B.3 Macrophage dynamics

Macrophages phagocyte and destroy the virus, but they are also target cells for the virus. Activated macrophages (either phagocytosing or infected) present the viral antigen and activate the adaptive response. The macrophage activation also induces the synthesis of innate cytokines : pro-inflammatory ($IL_{1\beta}$, IL_6 , IL_8), antiviral (IFN_α , TNF_α) and immuno-regulatory (IL_{12} , IL_{10}) cytokines [5].

In the model, macrophages can be susceptible M_s , phagocytosing M_p , or infected and excreting the virus M_i . We represented the evolution over time of the macrophage concentrations for these three states.

Compared to [1], we grouped the latent and excreting macrophage states into a single infected state.

Decay All macrophage states are submitted to natural death or/and migration (rate μ_M^{nat}), as well as apoptosis induced by TNF_α (rate μ_M^{ap}) [6]. The natural death rate is considered higher for infected macrophages than for susceptible and phagocytosing macrophages (multiplicative factor δ_μ). Moreover, infected macrophages can be destroyed by natural killers (rate μ_M^{inn}) and cells from the cellular response (rate μ_M^{ad}).

Recruitment Susceptible macrophages are recruited from the bloodstream (rate A_m). Cytokines IL_6 and IL_{12} co-amplify the macrophage recruitment in synergy [7–9]. IL_8 attracts the macrophages to the infection place [9].

Compared to [1], we grouped the pro-inflammatory cytokines $IL_{1\beta}$, IL_6 and IL_8 and hence simplified their action on the macrophage recruitment.

In the absence of virus, the cytokine concentrations are supposed to be negligible and the resulting concentration of susceptible macrophages in the lung is constant : $M_s = M_s^0 = \frac{A_m}{\mu_M^{\text{nat}}}$.

Phagocytosis and infection When susceptible macrophages encounter free viral particles (V), they can either phagocytose the virus (rate η) or become infected (rate β). We assume that phagocytosing macrophages revert to the susceptible state after viral destruction (rate γ), whereas infected macrophages remain infected (*i.e.* they cannot eliminate the virus). We also assume that the infected and phagocytosing states are exclusive and that once phagocytosing or infected, macrophages cannot phagocytose or be infected by other viral particles [10].

The phagocytosis is amplified by the antiviral cytokines (A_i and IFN_γ) and inhibited by the immuno-modulatory cytokines (IL_{10} , TGF_β). The phagocytosis ending is amplified by the antiviral cytokines and inhibited by IL_{10} . The macrophage infection is amplified by IL_{10} and inhibited by innate antiviral cytokines (A_i) and TGF_β .

Susceptible macrophages :

$$\begin{aligned}
 \dot{M}_s &= A_m [1 + \kappa^+(P_i \text{IL}_{12})] && \longleftarrow \text{recruitment} \\
 &- \eta M_s V \kappa^-(\text{IL}_{10} + \text{TGF}_\beta) [1 + \kappa^+(A_i + \text{IFN}_\gamma)] && \longleftarrow \text{phagocytosis} \\
 &+ \gamma M_p \kappa^-(\text{IL}_{10}) [1 + \kappa^+(A_i + \text{IFN}_\gamma)] && \longleftarrow \text{phagocytosis ending} \\
 &- \beta M_s V \kappa^-(A_i + \text{TGF}_\beta) [1 + \kappa^+(\text{IL}_{10})] && \longleftarrow \text{infection} \\
 &- M_s \left(\mu_M^{\text{nat}} + \mu_M^{\text{inf}} \kappa^+(A_i) \right) && \longleftarrow \text{decay}
 \end{aligned}$$

Phagocytosing macrophages :

$$\begin{aligned}
 \dot{M}_p &= \eta M_s V \kappa^-(\text{IL}_{10} + \text{TGF}_\beta) [1 + \kappa^+(A_i + \text{IFN}_\gamma)] && \longleftarrow \text{phagocytosis} \\
 &- \gamma M_p \kappa^-(\text{IL}_{10}) [1 + \kappa^+(A_i + \text{IFN}_\gamma)] && \longleftarrow \text{phagocytosis ending} \\
 &- M_p \left(\mu_M^{\text{nat}} + \mu_M^{\text{inf}} \kappa^+(A_i) \right) && \longleftarrow \text{decay}
 \end{aligned}$$

Infected macrophages :

$$\begin{aligned}
 \dot{M}_i &= \beta M_s V \kappa^-(A_i + \text{TGF}_\beta) [1 + \kappa^+(\text{IL}_{10})] && \longleftarrow \text{infection} \\
 &- M_i \left(\mu_M^{\text{nat}} \delta_\mu + \mu_M^{\text{inf}} \kappa^+(A_i) + \mu_M^{\text{inn}} \text{NK} + \mu_M^{\text{adap}} R_c \right) && \longleftarrow \text{decay}
 \end{aligned}$$

B.4 Viral dynamics

The virus enters the body through the mucosal surfaces of the respiratory tract and replicates in the pulmonary macrophages.

We represented the evolution over time of the free viral particles (V). The inflow of these free viral particles is given by the time-dependent exposure function ($E(t)$). When they encounter susceptible macrophages (M_s), they can either be phagocytosed by the macrophages (rate $u \eta$), resulting in viral destruction, or they can infect the macrophages (rate $u \beta$), resulting in virus replication. Free viral particles are released in the lung by excreting macrophages (rate e). The

viral replication is inhibited by antiviral cytokines. Free viral particles can be neutralised by antibodies represented by the humoral response R_h (rate μ_V^{ad}). They are also submitted to natural death and migration outside the lung (rate μ_V^{nat}). .

Compared to [1], we considered that the phagocytosis or macrophage infection consume u TCID₅₀ virus per macrophage. As we set $u = 1[\text{TCID}_{50}/\text{cell}]$, this modification finally induced no change. Moreover, the cytokine regulations that applied to the macrophage change of state between the infected latent and excreting states in [1], apply to the viral excretion in this model.

$$\begin{aligned}
 \dot{V} = E(t) & \quad \leftarrow \text{exposure} \\
 - u \eta M_s V \kappa^- (\text{IL}_{10} + \text{TGF}_\beta) [1 + \kappa^+ (A_i + \text{IFN}_\gamma)] & \quad \leftarrow \text{phagocytosis} \\
 - u \beta M_s V \kappa^- (A_i + \text{TGF}_\beta) [1 + \kappa^+ (\text{IL}_{10})] & \quad \leftarrow \text{infection} \\
 + e M_i \kappa^- (A_i + \text{IFN}_\gamma) & \quad \leftarrow \text{excretion} \\
 - V \left(\mu_V^{\text{nat}} + \mu_V^{\text{adap}} R_h \right) & \quad \leftarrow \text{decay / migration}
 \end{aligned}$$

B.5 Natural killer dynamics

Natural killers are effectors of the innate response. Their main immune functions are the destruction of infected cells and IFN_γ synthesis [5, 9, 11, 12]. These cytotoxic cells are recruited on the infection site by pro-inflammatory cytokines. Their proliferation and immune functions are activated by several cytokines ($\text{IFN}_\gamma, \text{IL}_{12}, \text{IL}_{15}, \text{IL}_{18}, \text{IL}_{21}, \text{IFN}_{\alpha\beta}$), whereas IL_{10} inhibits the natural killer differentiation and their immune functions [11].

We represented the dynamics of activated natural killers (NK) and only included the regulations by the most influential cytokines. Their recruitment from the bloodstream (rate α_N) requires pro-inflammatory cytokines P_i and IL_{12} . Natural killers are then activated by IFN_γ and IL_{12} , whereas IL_{10} inhibits the activation. They are submitted to natural death or/and migration (rate μ_R).

Compared to [1], the effects of the pro-inflammatory cytokines on the macrophage recruitment are simplified, as for the susceptible macrophages.

$$\begin{aligned}
 \dot{NK} = \alpha_N \kappa^- (\text{IL}_{10}) \kappa^+ (\text{IL}_{12} P_i) \kappa^+ (\text{IL}_{12} + \text{IFN}_\gamma) & \quad \leftarrow \text{recruitment \& activation} \\
 - \mu_R NK & \quad \leftarrow \text{decay}
 \end{aligned}$$

B.6 Adaptive effector dynamics

The adaptive response activation begins with the naive CD_4^+ T cell differentiation by antigen presenting cells (dendritic cells or macrophages) within the lymphoid tissues. Depending on the cytokine profiles in the lymph nodes, CD_4^+ T cells differentiate into one of three main CD_4^+ effector types, which have specific immune functions : type 1 T helpers ($\text{T}_{\text{h}1}$, belonging to the cellular response), type 2 T helpers ($\text{T}_{\text{h}2}$, belonging to the humoral response) and regulatory T lymphocytes (T_{reg} , belonging to the regulatory response) [5, 13–20]. The differentiation towards $\text{T}_{\text{h}1}$ is induced by IL_{12} and amplified by IFN_γ . The differentiation towards $\text{T}_{\text{h}2}$ is induced by IL_6 and amplified by IL_4 . The differentiation towards T_{reg} is induced by TGF_β and amplified by IL_{10} . The cytokines responsible for the differentiation towards a CD_4^+ effector type simultaneously inhibit the differentiation towards the two other types. After the differentiation step, the CD_4^+

effectors express their specific immune functions and proliferate. T_{h1} synthesise the IL_2 and IFN_γ cytokines. In addition, they are responsible for the differentiation of the CD_8^+ T cells in cytotoxic lymphocytes (CTL). CTL synthesise IFN_γ and TNF_α and destroy the infected macrophages. T_{h2} synthesise IL_4 and IL_{10} . In addition, they are the main activator of the B lymphocytes (through IL_4 and IL_{10}), which produce the neutralising antibodies. T_{reg} synthesise the TGF_β and IL_{10} immuno-modulatory cytokines. In summary :

- The cellular response : (i) includes T_{h1} and CTL; (ii) is activated by IL_{12} and IFN_γ , inhibited by IL_6 , IL_{10} and TGF_β ; and (iii) is responsible for the synthesis of IL_2 , IFN_γ and TNF_α .
- The humoral response : (i) includes T_{h2} , B lymphocytes and antibodies; (ii) is activated by IL_6 , IL_4 and IL_{10} , inhibited by IL_{12} , IFN_γ and TGF_β ; and (iii) is responsible for the synthesis of IL_4 and IL_{10} and for the viral particle neutralisation.
- The regulatory response : (i) only includes T_{reg} ; (ii) is activated by TGF_β and IL_{10} , inhibited by IL_6 , IL_{12} and IFN_γ ; and (iii) is responsible for the immune response inhibition through its synthesis of the TGF_β and IL_{10} immuno-modulatory cytokines.

In our model, we represented the adaptive response by three effectors corresponding to the three main orientations : cellular (R_c), humoral (R_h) and regulatory (R_r) responses. As for the NK cells, we only represented the dynamics of the activated effectors. Based on the model proposed by Yates *et al.* for the regulation of T helper cell populations [20], we synthesised the dynamics of each adaptive effector by three steps : activation by activated macrophages (rate α_R), proliferation (rate p_R) and decay. We represented the regulations of the activation and proliferation steps by the most influential cytokines : IFN_γ , IL_{12} , IL_{10} and TGF_β . The decay includes the natural decay (rate μ_R) and the Activation Induced Cell Death (AICD) induced by the interaction with a T_{h1} from the R_c compartment (rate δ_{R_c}) [20].

Cellular response [17–19, 21–24] R_c represents the type 1 T helper cells and the cytotoxic lymphocytes. Activation is amplified by IFN_γ and IL_{12} and inhibited by IL_{10} . Proliferation is activated by IFN_γ and IL_{12} and inhibited by IL_{10} and TGF_β . R_c synthesises IFN_γ and is responsible for the destruction of infected cells.

$$\begin{aligned} \dot{R}_c &= \alpha_R (M_p + M_i) [1 + \kappa^+(IFN_\gamma + IL_{12})] \kappa^-(IL_{10}) && \longleftarrow \text{activation} \\ &+ p_R R_c \kappa^+(IFN_\gamma + IL_{12}) \kappa^-(IL_{10} + TGF_\beta) && \longleftarrow \text{proliferation} \\ &- \mu_R R_c - \delta_{R_c} R_c^2 && \longleftarrow \text{decay} \end{aligned}$$

Humoral response [17–19, 25] R_h represents the type 2 T helper cells, the B lymphocytes and the antibodies. Activation is amplified by IL_{10} and inhibited by IFN_γ and IL_{12} . Proliferation is activated by IL_{10} and inhibited by IFN_γ , IL_{12} and TGF_β . R_h synthesises IL_{10} and is responsible for the neutralisation of free viral particles through antibodies.

$$\begin{aligned} \dot{R}_h &= \alpha_R (M_p + M_i) [1 + \kappa^+(IL_{10})] \kappa^-(IFN_\gamma + IL_{12}) && \longleftarrow \text{activation} \\ &+ p_R R_h \kappa^+(IL_{10}) \kappa^-(IFN_\gamma + IL_{12} + TGF_\beta) && \longleftarrow \text{proliferation} \\ &- \mu_R R_h - \delta_{R_c} R_c R_h && \longleftarrow \text{decay} \end{aligned}$$

Regulatory response [17–19, 26] R_r represents the represents the regulatory T cells. Activation is amplified by IL_{10} and TGF_β and inhibited by IFN_γ and IL_{12} . Proliferation is activated by TGF_β and inhibited by IL_{10} , IFN_γ and IL_{12} . R_r synthesises IL_{10} and TGF_β .

$$\begin{aligned}
\dot{R}_r &= \alpha_R (M_p + M_i) [1 + \kappa^+(\text{IL}_{10} + \text{TGF}_\beta)] \kappa^-(\text{IFN}_\gamma + \text{IL}_{12}) && \longleftarrow \text{activation} \\
&+ p_R R_r \kappa^+(\text{TGF}_\beta) \kappa^-(\text{IFN}_\gamma + \text{IL}_{12} + \text{IL}_{10}) && \longleftarrow \text{proliferation} \\
&- \mu_R R_r - \delta_{R_c} R_c R_r && \longleftarrow \text{decay}
\end{aligned}$$

B.7 Cytokine dynamics

Cytokines are small proteins that play a key role in cell-signalling. They are produced by activated immune cells and affect the behaviour of other cells, sometimes the releasing cell itself. They act through specific membranous receptors inducing cascaded reactions within the target cell. They have various functions. In particular, cytokines modulate the balance between the humoral, cellular and regulatory responses. Some cytokines enhance or inhibit the action of other cytokines in complex ways.

In the model, we only integrated the regulations by the most influential cytokines. We grouped them into three classes depending on their main function : pro-inflammatory ($P_i = \text{IL}_{1\beta} + \text{IL}_6 + \text{IL}_8$), antiviral (innate $A_i = \text{TNF}_\alpha + \text{IFN}_\alpha$ and adaptive IFN_γ) and immunoregulatory (IL_{12} , IFN_γ , IL_{10} and TGF_β) cytokines. TNF_α is generally considered as a pro-inflammatory cytokine, but we were here more interested in its antiviral function. IFN_γ is an antiviral and immunoregulatory cytokine.

Compared to [1], we represented (i) the pro-inflammatory cytokines $\text{IL}_{1\beta}$, IL_6 and IL_8 by a single variable P_i ; (ii) the innate antiviral cytokines TNF_α and IFN_α by a single variable A_i .

We assumed that the cytokines are efficient enough in order to neglect their consumption when they interact with a cell. So the cytokine dynamics results from their synthesis by immune cells (rates ρ_x^y , where x depends on the cytokine considered and y depends on the producing cells) and their natural death (rate μ_C).

The main cytokine regulations are summarised in TABLE B.1 and the cytokine syntheses in TABLE B.2.

Pro-inflammatory cytokines [5, 7–9, 32, 36] $P_i = \text{IL}_{1\beta} + \text{IL}_6 + \text{IL}_8$ amplify the recruitment of macrophages and natural killers. They are synthesised by activated macrophages. The synthesis of $\text{IL}_{1\beta}$ is inhibited by IL_{10} , whereas the synthesis of IL_6 and IL_8 is co-activated by $\text{IL}_{1\beta}$ and TNF_α .

$$\begin{aligned}
\dot{P}_i &= \rho_{P_i} (M_p + M_i) [\kappa^-(\text{IL}_{10}) + 2 \kappa^+(P_i A_i)] && \longleftarrow \text{synthesis} \\
&- \mu_C P_i && \longleftarrow \text{decay}
\end{aligned}$$

Antiviral cytokines Antiviral cytokines promote the phagocytosis and reduce the infection by inhibiting the macrophage permissiveness and/or the viral replication.

Innate antiviral cytokines are represented by $A_i = \text{TNF}_\alpha + \text{IFN}_\alpha$. TNF_α is synthesised by activated macrophages, IFN_α by infected macrophages [6, 7, 21, 22, 27–30, 32]. IL_{10} inhibits the synthesis of TNF_α .

$$\begin{aligned}
\dot{A}_i &= \rho_{A_i} (M_p + M_i) \kappa^-(\text{IL}_{10}) + \rho_{A_i} M_i && \longleftarrow \text{synthesis} \\
&- \mu_C A_i && \longleftarrow \text{decay}
\end{aligned}$$

Table B.1 Cytokine regulations. Main up (+) and down (-) regulations included in the model for various immune mechanisms.
 * Pro-inflammatory cytokines $P_i = \text{IL}_{1\beta} + \text{IL}_6 + \text{IL}_8$.
 ** Innate antiviral cytokines $A_i = \text{TNF}_\alpha + \text{IFN}_\alpha$.

	Cytokines						
	pro-inf. P_i^*	innate antiviral A_i^{**}	IFN $_\gamma$	IL $_{12}$	IL $_{10}$	TGF $_\beta$	
<i>Innate response</i>							
Macrophage recruitment	+			+			
NK recruitment & activation	+		+	+	-		
Macrophage apoptosis		+					
Phagocytosis		+	+		-		-
Macrophage permissiveness		-	-		+		-
Viral replication		-	-				
<i>Adaptive response</i>							
Cellular response			+	+	-		-
Humoral response			-	-	+		-
Regulatory response			-	-	\pm		+
<i>Cytokine syntheses</i>							
Pro-inflammatory P_i	+				-		
Innate antiviral A_i					-		
Adaptive antiviral IFN $_\gamma$		+	+	+	-		-
Immuno-regulatory IL $_{12}$					-		
IL $_{10}$					+		\pm
Specific references	[8, 9, 24]	[6, 21, 22, 27-30]	[21-24]	[25]	[8, 31-36]	[26]	
Common references		[7, 32]			[17-19]		
Global references					[5, 13-16, 37-39]		

Table B.2 Cytokine syntheses. Production of cytokines included (\checkmark) in the model by innate or adaptive immune cells.* Pro-inflammatory cytokines $P_i = \text{IL}_{1\beta} + \text{IL}_6 + \text{IL}_8$.** Innate antiviral cytokines $A_i = \text{TNF}_\alpha + \text{IFN}_\alpha$.

† Global references : [5, 13–16, 18, 37, 40, 41]

	Cytokines				References	
	pro-inf. P_i^*	innate antiviral A_i^{**}	immuno-regulatory IFN_γ IL_{12} IL_{10} TGF_β			
<i>Innate cells</i>						
Activated macrophages	\checkmark	\checkmark		\checkmark	\checkmark	[9, 42]†
Activated natural killers			\checkmark			[9, 12]†
<i>Adaptive cells</i>						
Cellular effectors			\checkmark			†
Humoral effectors				\checkmark		†
Regulatory effectors				\checkmark	\checkmark	†

The adaptive antiviral cytokine IFN_γ is synthesised by cells of the cellular response (R_c) and natural killers (NK). This synthesis is auto-amplified. It is also amplified by A_i , in synergy with IL_{12} , and inhibited by IL_{10} and TGF_β . IFN_γ is also an immuno-regulatory cytokine and it orientates the adaptive response towards the cellular response [17–19, 21–24].

$$\begin{aligned} \dot{\text{IFN}}_\gamma &= (\rho_{\text{IFN}_\gamma}^{\text{inn}} \text{NK} + \rho_{\text{IFN}_\gamma}^{\text{ad}} R_c) [1 + \kappa^+(\text{IL}_{12} A_i) + \kappa^+(\text{IFN}_\gamma)] \kappa^-(\text{IL}_{10} + \text{TGF}_\beta) && \longleftarrow \text{synthesis} \\ &- \mu_C \text{IFN}_\gamma && \longleftarrow \text{decay} \end{aligned}$$

Immuno-regulatory cytokines [13–19] IL_{12} , IFN_γ (see above), IL_{10} and TGF_β have various functions, in particular the regulation of the adaptive immune response. They also regulate the recruitment of macrophages and natural killers, the phagocytosis and infection, as well as the cytokine syntheses. They are produced by cells of the innate and adaptive response.

IL_{12} co-amplifies the recruitment of macrophages, activates the natural killers and orientates the adaptive response towards the cellular response. It is synthesised by activated macrophages. Its synthesis is inhibited by IL_{10} .

$$\begin{aligned} \dot{\text{IL}}_{12} &= \rho_{\text{IL}_{12}} (M_p + M_i) \kappa^-(\text{IL}_{10}) && \longleftarrow \text{synthesis} \\ &- \mu_C \text{IL}_{12} && \longleftarrow \text{decay} \end{aligned}$$

IL_{10} and TGF_β are both immuno-modulatory cytokines. IL_{10} inhibits the activation of natural killers and the phagocytosis, it amplifies the macrophage permissiveness and it orientates the adaptive response towards the humoral and regulatory responses. IL_{10} is synthesised by activated macrophages and cells of the regulatory (R_r) and humoral (R_h) responses. Its synthesis by macrophages and R_r is amplified by TGF_β , whereas its synthesis by R_h is auto-amplified and inhibited by TGF_β .

$$\begin{aligned} \dot{\text{IL}}_{10} &= \left(\rho_{\text{IL}_{10}}^{\text{inn}} (M_p + M_i) + \rho_{\text{IL}_{10}}^{\text{ad}} R_r \right) [1 + \kappa^+(\text{TGF}_\beta)] \\ &+ \rho_{\text{IL}_{10}}^{\text{ad}} R_h [1 + \kappa^+(\text{IL}_{10})] \kappa^-(\text{TGF}_\beta) && \longleftarrow \text{synthesis} \\ &- \mu_C \text{IL}_{10} && \longleftarrow \text{decay} \end{aligned}$$

TGF $_{\beta}$ inhibits the phagocytosis and macrophage permissiveness and orientates the adaptive response towards the regulatory response. In the model, we neglected the synthesis of TGF $_{\beta}$ by activated macrophages, so it is only synthesised by cells of the regulatory response.

$$\begin{aligned} \dot{\text{TGF}}_{\beta} &= \rho_{\text{TGF}_{\beta}} R_r && \longleftarrow \text{synthesis} \\ &- \mu_C \text{TGF}_{\beta} && \longleftarrow \text{decay} \end{aligned}$$

References

- [1] GO N., BIDOT C., BELLOC C., TOUZEAU S., 2014. Integrative model of the immune response to a pulmonary macrophage infection : what determines the infection duration ? *PLoS ONE* **9**(9) :e107818. doi:10.1371/journal.pone.0107818.
- [2] GAMMACK D., GANGULI S., MARINO S., SEGOVIA-JUAREZ J., KIRSCHNER D., 2005. Understanding the immune response in tuberculosis using different mathematical models and biological scales. *Multiscale Model. Sim.* **3**(2) :312–345. doi:10.1137/040603127.
- [3] MARINO S., MYERS A., FLYNN J.L., KIRSCHNER D.E., 2010. TNF and IL-10 are major factors in modulation of the phagocytic cell environment in lung and lymph node in tuberculosis : A next-generation two-compartmental model. *J. Theor. Biol.* **265**(4) :586–598. doi:10.1016/j.jtbi.2010.05.012.
- [4] WIGGINTON J.E., KIRSCHNER D., 2001. A model to predict cell-mediated immune regulatory mechanisms during human infection with Mycobacterium tuberculosis. *J. Immunol.* **166** :1951–1967.
- [5] ROUSE B.T., SEHRAWAT S., 2010. Immunity and immunopathology to viruses : what decides the outcome ? *Nat. Rev. Immunol.* **10**(7) :514–526. doi:10.1038/nri2802.
- [6] CHOI C., CHAE C., 2002. Expression of tumour necrosis factor alpha is associated with apoptosis in lungs of pigs experimentally infected with porcine reproductive and respiratory syndrome virus. *Res. Vet. Sci.* **72**(1) :45–49. doi:10.1053/rvsc.2001.0519.
- [7] VAN REETH K., VAN GUCHT S., PENZAERT M., 2002. In vivo studies on cytokine involvement during acute viral respiratory disease of swine : troublesome but rewarding. *Vet. Immunol. Immunop.* **87**(3-4) :161–168. doi:10.1016/S0165-2427(02)00047-8.
- [8] ROTH A.J., THACKER E.L., 2006. Immune system. In *Diseases of swine*, edited by B.E. STRAW, J.J. ZIMMERMAN, S. D’ALLAIRE, D.L. TAYLOR, Blackwell (Oxford, UK), 9th edn., chap. 2, pp. 15–36.
- [9] TOSI M.F., 2005. Innate immune responses to infection. *J. Allergy Clin. Immun.* **116**(2) :241–249. doi:10.1016/j.jaci.2005.05.036.
- [10] THANAWONGNUWECH R., 1999. Pulmonary intravascular macrophages (PIMs) : What do we know about their role in PRRSV infection in pigs. *Wetchasan Sattawaphaet (The Thai journal of veterinary medicine)* **29**.
- [11] DEFranco A.L., LOCKSLEY R.M., ROBERTSON M., CUNIN R., 2009. *Immunité : la réponse immunitaire dans les maladies infectieuses et inflammatoires*. DeBoeck (Bruxelles, Belgium). 2nd edn.

- [12] VIDAL S.M., KHAKOO S.I., BIRON C.A., 2011. Natural killer cell responses during viral infections : flexibility and conditioning of innate immunity by experience. *Curr. Opin. Virol.* **1**(6) :497–512. doi:10.1016/j.coviro.2011.10.017.
- [13] BOSCH A.A.T.M., BIESBROEK G., TRZCINSKI K., SANDERS E.A.M., BOGAERT D., 2013. Viral and bacterial interactions in the upper respiratory tract. *PLoS Pathog.* **9**(1) :e1003057. doi:10.1371/journal.ppat.1003057.
- [14] BORGHETTI P., 2005. Cell-mediated immunity and viral infection in pig. In *PRRS fatti vs speculazioni*, Università degli Studi di Parma, Dipartimento di Salute Animale (Parma, Italy), pp. 27–46. http://medvet.unipr.it/cgi-bin/campusnet/documenti.pl/Show?_id=7d0d
- [15] BRACIALE T.J., SUN J., KIM T.S., 2012. Regulating the adaptive immune response to respiratory virus infection. *Nat. Rev. Immunol.* **12**(4) :295–305. doi:10.1038/nri3166.
- [16] COQUERELLE C., MOSER M., 2010. DC subsets in positive and negative regulation of immunity. *Immunol. Rev.* **234**(1) :317–334. doi:10.1111/j.0105-2896.2009.00887.x.
- [17] KIDD P., 2003. Th1/Th2 balance : the hypothesis, its limitations, and implications for health and disease. *Altern. Med. Rev.* **8**(3) :223–246.
- [18] LEROITH T., AHMED S.A., 2012. Regulatory T cells and viral disease. In *Inflammation, Chronic Diseases and Cancer : Cell and Molecular Biology, Immunology and Clinical Bases*, edited by M. KHATAMI, InTech (Rijeka, Croatia), chap. 6, pp. 121–144. doi:10.5772/28502.
- [19] KNOSP C.A., JOHNSTON J.A., 2012. Regulation of CD4+ T-cell polarization by suppressor of cytokine signalling proteins. *Immunology* **135**(2) :101–111. doi:10.1111/j.1365-2567.2011.03520.x.
- [20] YATES A., BERGMANN C., VAN HEMMEN J.L., STARK J., CALLARD R., 2000. Cytokine-modulated regulation of helper T cell populations. *J. Theor. Biol.* **206**(4) :539–560. doi:10.1006/jtbi.2000.2147.
- [21] LOPEZ-FUERTES L., CAMPOS E., DOMENECH N., EZQUERRA A., CASTRO J.M., DOMINGUEZ J., ALONSO F., 1999. Porcine reproductive and respiratory syndrome (PRRS) virus down-modulates TNF- α production in infected macrophages. *Virus Res.* **69**(269) :41–46. doi:10.1016/S0168-1702(00)00172-6.
- [22] ZIMMERMAN J., BENFIELD D.A., MURTAUGH M.P., OSORIO F., STEVENSON G.W., TORREMORELL M., 2006. Porcine reproductive and respiratory syndrome virus (porcine arterivirus). In *Diseases of swine*, edited by B.E. STRAW, J.J. ZIMMERMAN, S. D'ALLAIRE, D.L. TAYLOR, Blackwell (Oxford, UK), 9th edn., chap. 24, pp. 387–418.
- [23] MOLINA R.M., CHA S.H., CHITTICK W., LAWSON S., MURTAUGH M.P., NELSON E.A., CHRISTOPHER-HENNINGS J., YOON K.J., EVANS R., ROWLAND R.R.R., ZIMMERMAN J.J., 2008. Immune response against porcine reproductive and respiratory syndrome virus during acute and chronic infection. *Vet. Immunol. Immunop.* **126** :283–292. doi:10.1016/j.vetimm.2008.08.002.
- [24] LUNNEY J.K., FRITZ E.R., REECY J.M., ANDR ELIZABETH PRUCNAL D.K., MOLINA R., CHRISTOPHER-HENNINGS J., ZIMMERMAN J., ROWLAND R.R.R., 2010. Interleukin-8, interleukin-1 β , and interferon- γ levels are linked to PRRS virus clearance. *Viral Immunol.* **23**(2) :127–134. doi:10.1089/vim.2009.0087.

- [25] THANAWONGNUWECH R., RUNGSIPIPAT A., DISATIAN S., SAIYASOMBAT R., NPAKANA-PORN S., HALBUR P.G., 2003. Immunohistochemical staining of IFN γ positive cells in porcine reproductive and respiratory syndrome virus-infected lungs. *Vet. Immunol. Immunop.* **91**(1) :73–77. doi:10.1016/S0165-2427(02)00268-4.
- [26] GÓMEZ-LAGUNA J., SALGUERO F.J., PALLARÉS F.J., CARRASCO L., 2013. Immunopathogenesis of porcine reproductive and respiratory syndrome in the respiratory tract of pigs. *Vet. J.* **195**(2) :148–155. doi:10.1016/j.tvjl.2012.11.012.
- [27] ALBINA E., 2000. Le point sur le dernier-né des arterivirus : le virus du syndrome dysgénésique et respiratoire porcin (SDRP). *Virologie* **4**(2) :113–121.
- [28] MURTAUGH M.P., 2005. PRRSV/host interaction. In *PRRS fatti vs speculazioni*, Università degli Studi di Parma, Dipartimento di Salute Animale (Parma, Italy), pp. 73–80. http://medvet.unipr.it/cgi-bin/campusnet/documenti.pl/Show?_id=7d0d
- [29] MILLER L.C., LAEGREID W.W., BONO J.L., CHITKO-McKOWN C.G., FOX J.M., 2004. Interferon type I response in porcine reproductive and respiratory syndrome virus-infected MARC-145 cells. *Arch. Virol.* **149** :2453–2463. doi:10.1007/s00705-004-0377-9.
- [30] GIMENO M., DARWICH L., DÍAZ I., DE LA TORRE E., PUJOLS J., MARTIN M., INUMARU S., CANO E., DOMÍNGO M., MONTOYA M., MATEU E., 2011. Cytokine profiles and phenotype regulation of antigen presenting cells by genotype-I porcine reproductive and respiratory syndrome virus isolates. *Vet. Res.* **42**(9). doi:10.1186/1297-9716-42-9.
- [31] CHANG H.C., PENG Y.T., CHANG H.L., CHAUNG H.C., CHUNG W.B., 2008. Phenotypic and functional modulation of bone marrow-derived dendritic cells by porcine reproductive and respiratory syndrome virus. *Vet. Microbiol.* **129**(3–4) :281–293. doi:10.1016/j.vetmic.2007.12.002.
- [32] PENG Y.T., CHAUNG H.C., CHANG H.L., CHANG H.C., CHUNG W.B., 2009. Modulations of phenotype and cytokine expression of porcine bone marrow-derived dendritic cells by porcine reproductive and respiratory syndrome virus. *Vet. Microbiol.* **136**(3-4) :359–365. doi:10.1016/j.vetmic.2008.11.013.
- [33] YOO D., SONG C., SUN Y., DU Y., KIM O., LIU H.C., 2010. Modulation of host cell responses and evasion strategies for porcine reproductive and respiratory syndrome virus. *Virus Res.* **154**(1–2) :48–60. doi:10.1016/j.virusres.2010.07.019.
- [34] FLORES-MENDOZA L., SILVA-CAMPA E., RESÉNDIZ M., OSORIO F.A., HERNÁNDEZ J., 2008. Porcine reproductive and respiratory syndrome virus infects mature porcine dendritic cells and up-regulates interleukin-10 production. *Clin. Vaccine Immunol.* **15** :720–725. doi:10.1128/CVI.00224-07.
- [35] SURADHAT S., THANAWONGNUWECH R., POOVORAWAN Y., 2003. Upregulation of IL-10 gene expression in porcine peripheral blood mononuclear cells by porcine reproductive and respiratory syndrome. *J. Gen. Virol.* **84** :453–459. doi:10.1099/vir.0.18698-0.
- [36] MOORE K.W., DE WAAL MALEFYT R., COFFMAN R.L., O’GARRA A., 2001. Interleukin-10 and the interleukin-10 receptor. *Annu. Rev. Immunol.* **19**(1) :683–765. doi:10.1146/annurev.immunol.19.1.683.
- [37] DARWICH L., DÍAZ I., MATEU E., 2010. Certainties, doubts and hypotheses in porcine reproductive and respiratory syndrome virus immunobiology. *Virus Res.* **154**(1-2) :123–132. doi:10.1016/j.virusres.2010.07.017.

- [38] MURTAUGH M.P., XIAO Z., ZUCKERMANN F., 2002. Immunological responses of swine to porcine reproductive and respiratory syndrome virus infection. *Viral Immunol.* **15**(4) :533–547. doi:10.1089/088282402320914485.
- [39] GÓMEZ-LAGUNA J., SALGUERO F.J., BARRANCO I., PALLARES F.J., RODRIGUEZ-GOMEZ I.M., BERNABE A., CARRASCO L., 2009. Cytokine expression by macrophages in the lung of pigs infected with the porcine reproductive and respiratory syndrome virus. *J. Comp. Pathol.* **142**(1) :51–60. doi:10.1016/j.jcpa.2009.07.004.
- [40] AKIRA S., TAKEDA K., KAISHO T., 2001. Toll-like receptors : critical proteins linking innate and acquired immunity. *Nat. Immunol.* **2**(8) :675–680. doi:10.1038/90609.
- [41] SEN G.C., 2001. Viruses and interferons. *Annu. Rev. Microbiol.* **55** :255–281. doi:10.1146/annurev.micro.55.1.255.
- [42] UNDERHILL D.M., GOODRIDGE H.S., 2012. Information processing during phagocytosis. *Nat. Rev. Immunol.* **12** :492–502. doi:10.1038/nri3244.

Annexe C

Supplementary figures of the within-host model outputs, related to Chapter **IV**

Contents

C.1	Outputs of the reference scenario	240
C.1.1	PRRSv and antigen presenting cells	240
C.1.2	Adaptive effectors, natural killers and antibodies	241
C.1.3	Cytokines	242
C.2	Outputs of the 54 scenarios of exposure, virulence and vaccination strategy	243
C.2.1	PRRSv and antigen presenting cells	243
C.2.2	Adaptive effectors, natural killers and antibodies	244
C.2.3	Cytokines	245

C.1 Outputs of the reference scenario

C.1.1 PRRSv and antigen presenting cells

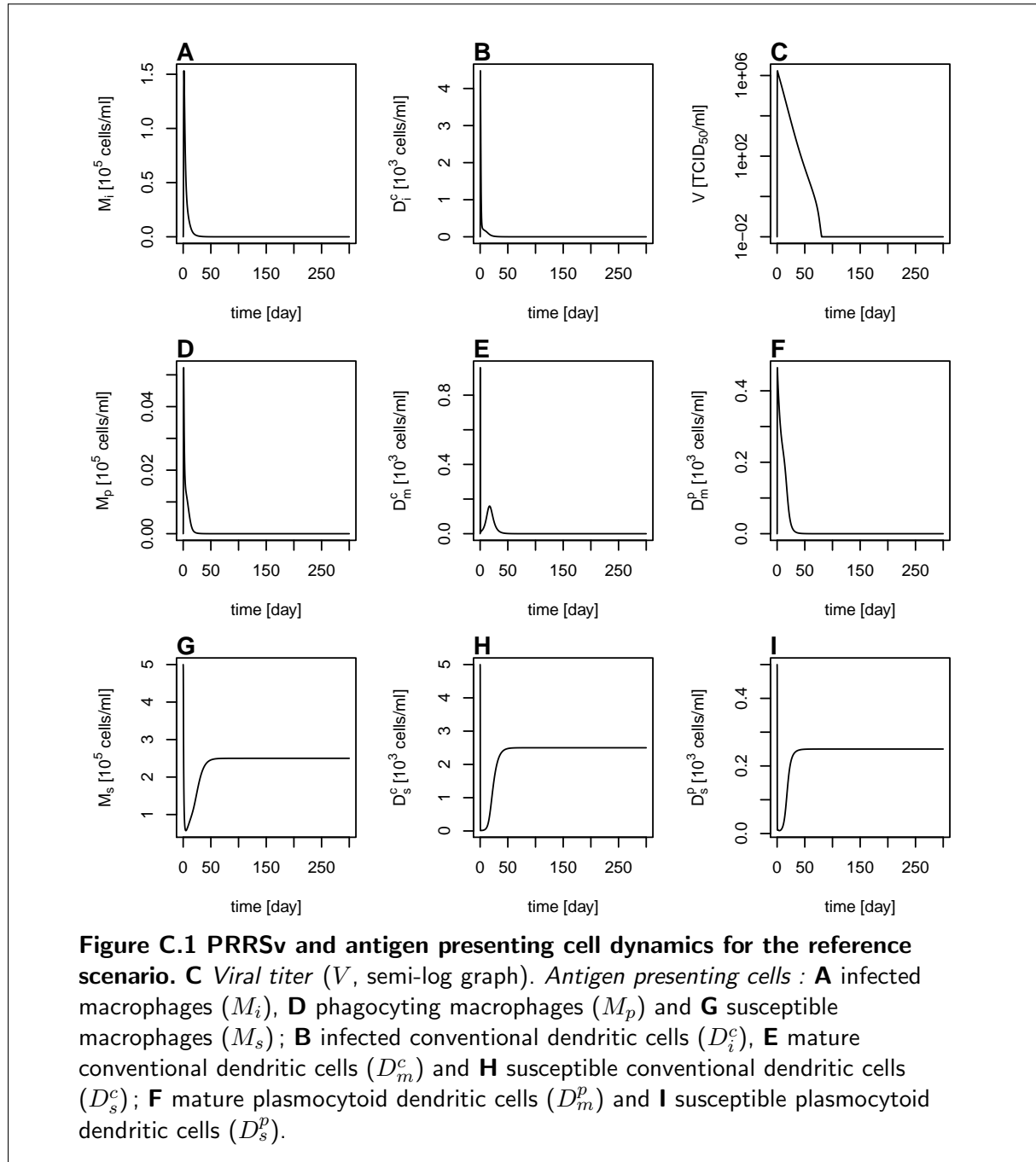

C.1.2 Adaptive effectors, natural killers and antibodies

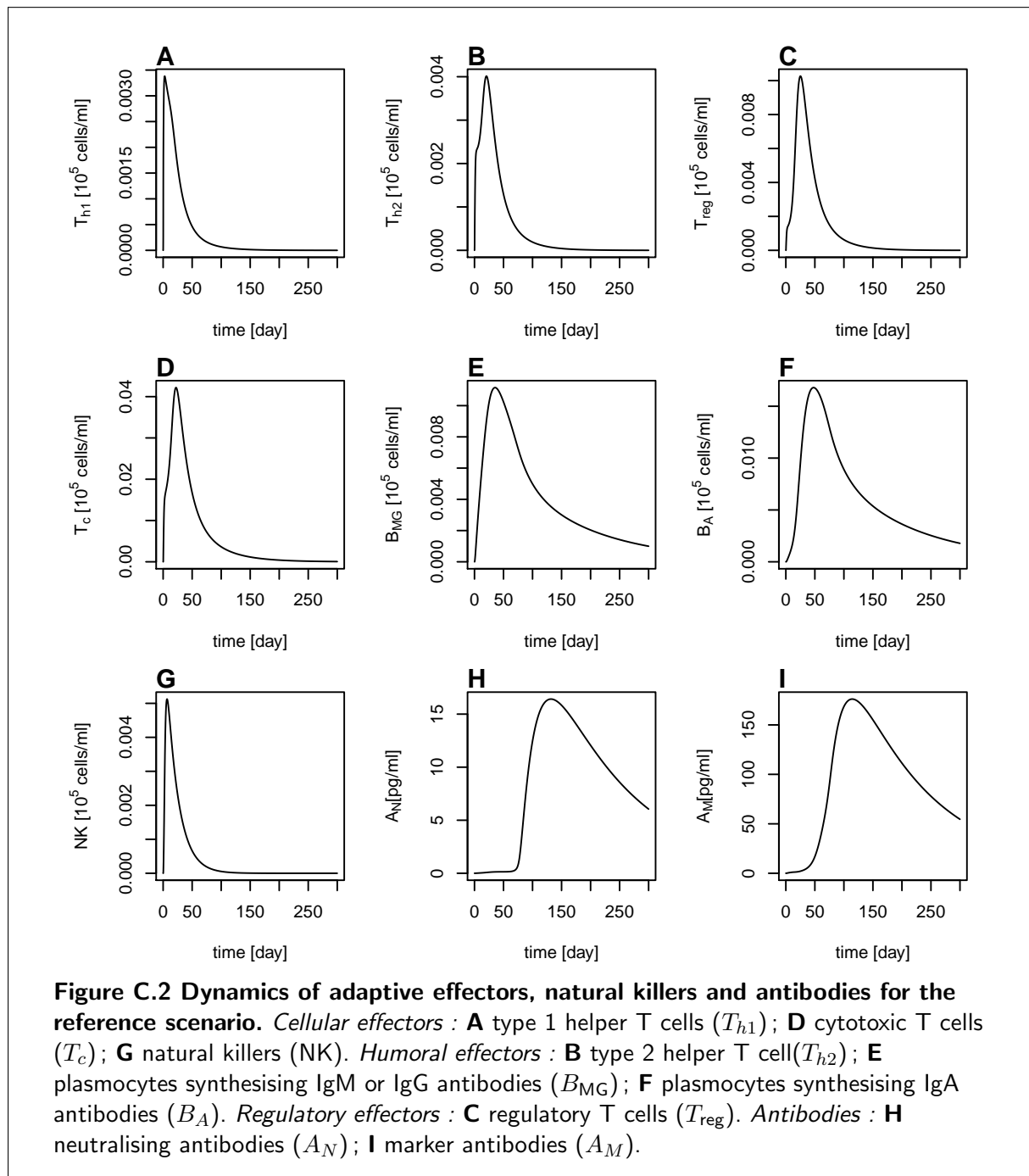

C.1.3 Cytokines

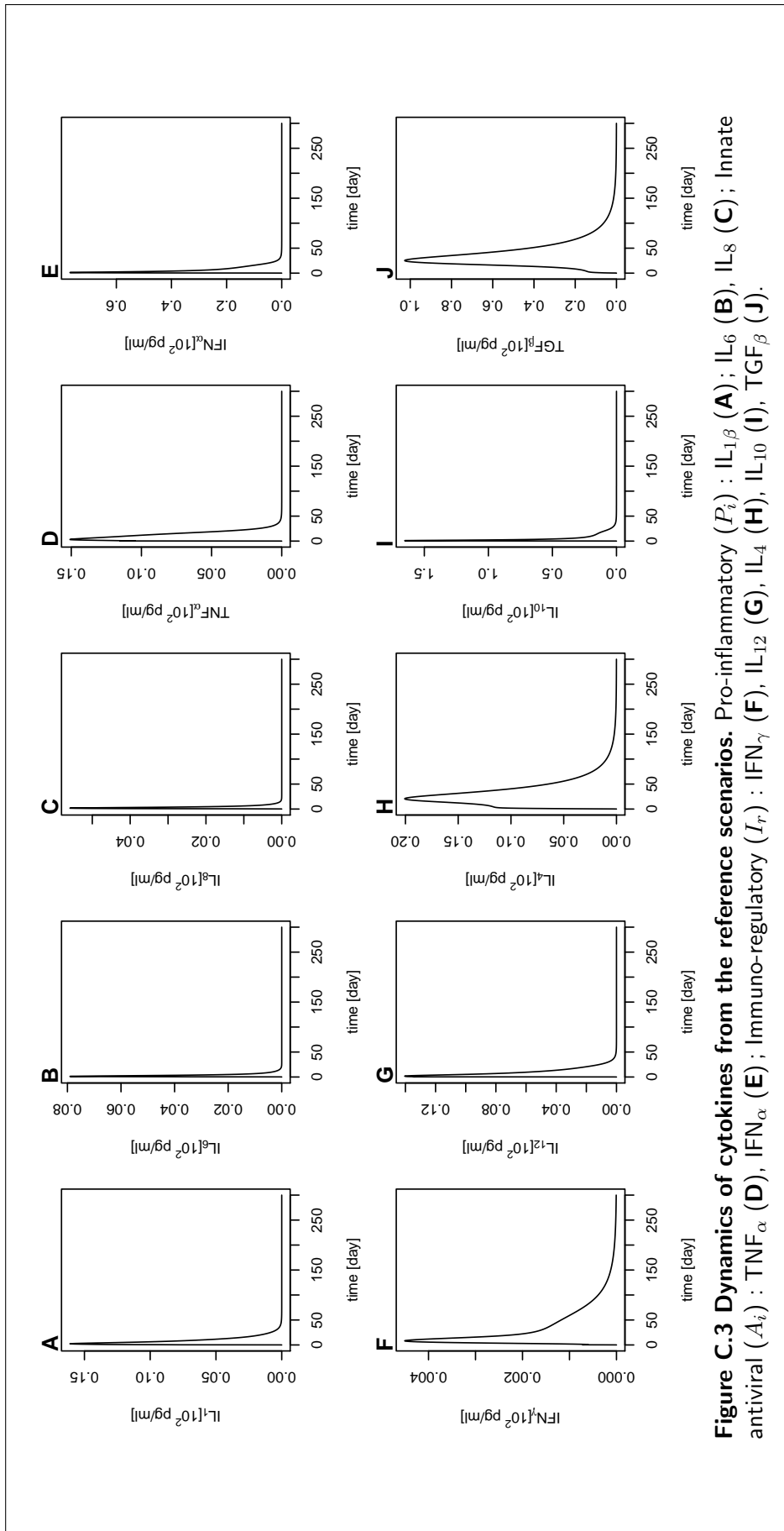

C.2 Outputs of the 54 scenarios of exposure, virulence and vaccination strategy

C.2.1 PRRSv and antigen presenting cells

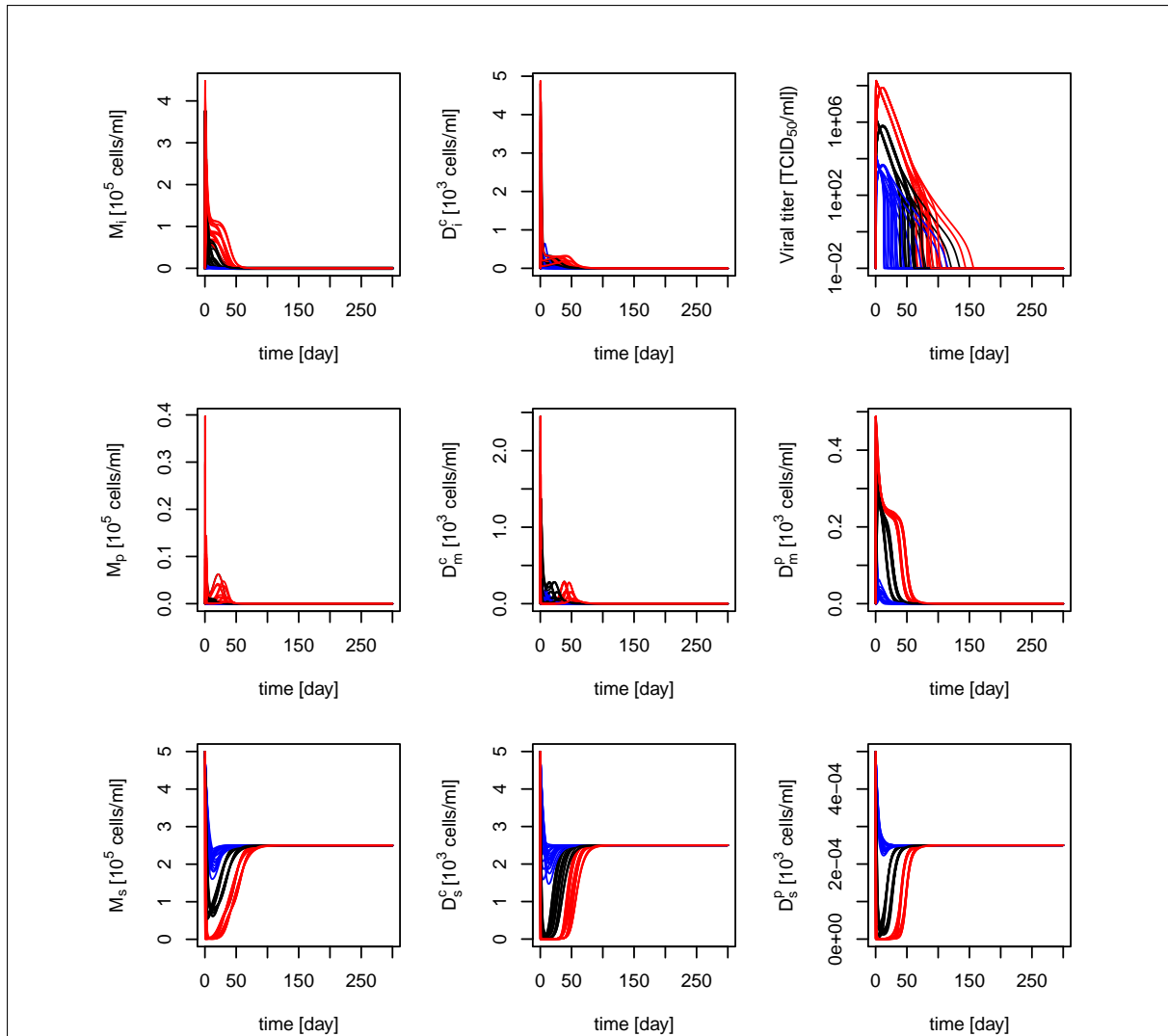
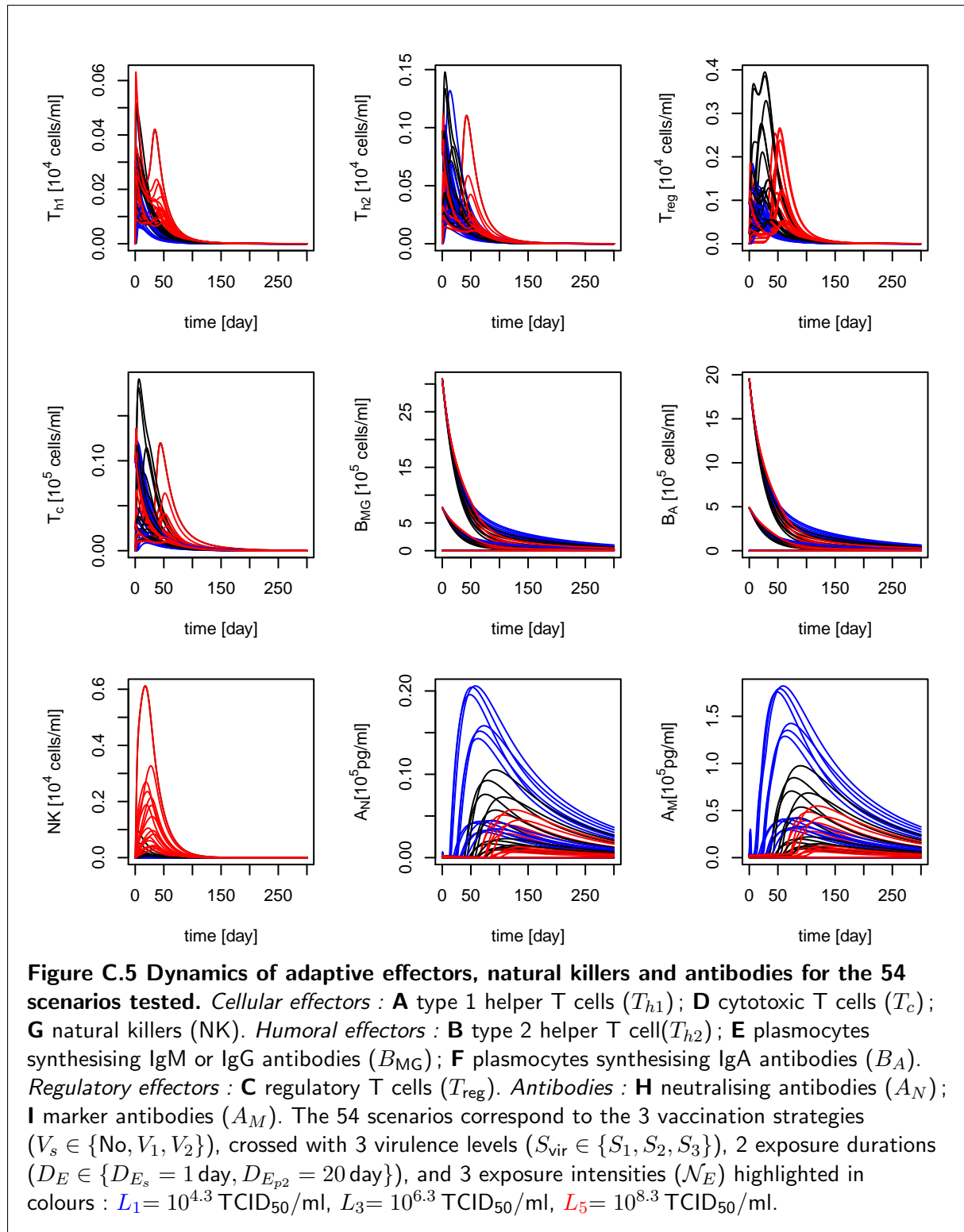
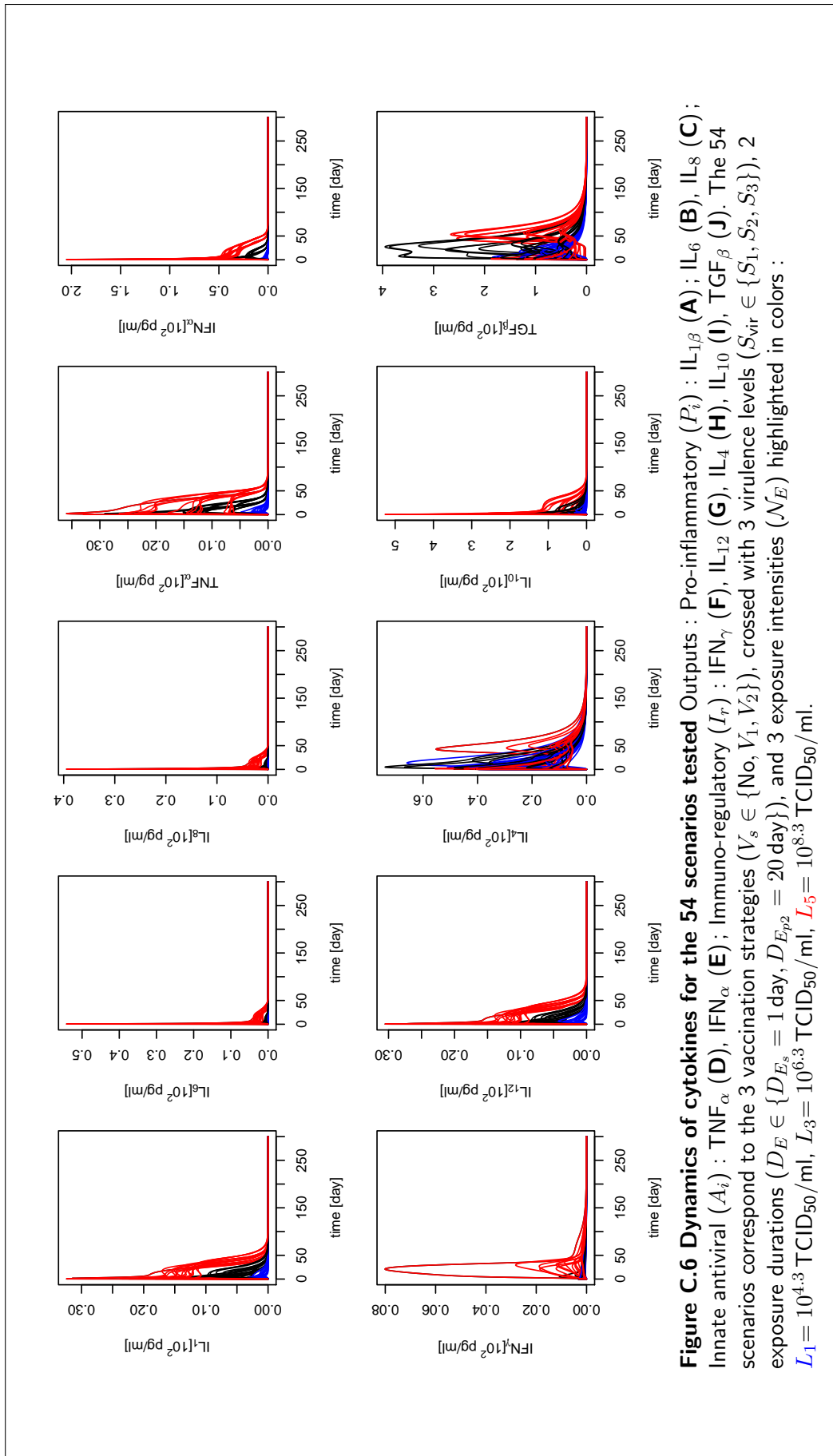

Figure C.4 PRRSv and antigen presenting cells dynamics for the 54 scenarios tested. C Viral titer (V , semi-log graph). **Antigen presenting cells** : **A** infected macrophages (M_i), **D** phagocytosing macrophages (M_p) and **G** susceptible macrophages (M_s); **B** infected conventional dendritic cells (D_i^c), **E** mature conventional dendritic cells (D_m^c) and **H** susceptible conventional dendritic cells (D_s^c); **F** mature plasmacytoid dendritic cells (D_m^p) and **I** susceptible plasmacytoid dendritic cells (D_s^p). The 54 scenarios correspond to the 3 vaccination strategies ($V_s \in \{\text{No}, V_1, V_2\}$), crossed with 3 virulence levels ($S_{\text{vir}} \in \{S_1, S_2, S_3\}$), 2 exposure durations ($D_E \in \{D_{E_s} = 1 \text{ day}, D_{E_{p2}} = 20 \text{ day}\}$), and 3 exposure intensities (\mathcal{N}_E) highlighted in colours : $L_1 = 10^{4.3}$ TCID₅₀/ml, $L_3 = 10^{6.3}$ TCID₅₀/ml, $L_5 = 10^{8.3}$ TCID₅₀/ml.

C.2.2 Adaptive effectors, natural killers and antibodies



C.2.3 Cytokines



Bibliography

AIT-ALI T., WILSON A.D., CARRÉ W., WESTCOTT D.G., FROSSARD J.P., MELLENCAMP M.A., MOUZAKI D., MATIKA O., WADDINGTON D., DREW T.W., BISHOP S.C., ARCHIBALD A.L., 2011. Host inhibits replication of European porcine reproductive and respiratory syndrome virus in macrophages by altering differential regulation of type-I interferon transcriptional responses. *Immunogenetics* **63**(7) :437–448. doi:10.1007/s00251-011-0518-8.

AIT-ALI T., WILSON A.D., WESTCOTT D.G., CLAPPERTON M., WATERFALL M., MELLENCAMP M.A., DREW T.W., BISHOP S.C., ARCHIBALD A.L., 2007. Innate immune responses to replication of porcine reproductive and respiratory syndrome virus in isolated swine alveolar macrophages. *Viral Immunol.* **20**(1) :105–118. doi:10.1089/vim.2006.0078.

AKIRA S., TAKEDA K., KAISHO T., 2001. Toll-like receptors : critical proteins linking innate and acquired immunity. *Nat. Immunol.* **2**(8) :675–680. doi:10.1038/90609.

ALBINA E., 2000. Le point sur le dernier-né des arterivirus : le virus du syndrome dysgénésique et respiratoire porcin (SDRP). *Virologie* **4**(2) :113–121.

ALBINA E., PIROU L., HUTET E., CARIOLET R., L'HOSPITALIER R., 1998. Immune response in pigs infected with porcine reproductive and respiratory syndrome virus (PRRSV). *Vet. Immunol. Immunop.* **61** :49–66. doi:10.1016/S0165-2427(97)00134-7.

ALLENDE R., LAEGREID W.W., KUTISH G.F., GALEOTA J.A., WILLS R.W., OSORIO F.A., 2000. Porcine reproductive and respiratory syndrome virus : description of persistence in individual pigs upon experimental infection. *J. Virol.* **74**(22) :10834–10837. doi:10.1128/JVI.74.22.10834-10837.2000.

ANDREW S.M., BAKER C.T.H., BOCHAROV G.A., 2007. Rival approaches to mathematical modelling in immunology. *J. Comput. Appl. Math.* **205**(2) :669–686. doi:10.1016/j.cam.2006.03.035.

BAUMANN A., MATEU E., MURTAUGH M.P., SUMMERFIELD A., 2013. Impact of genotype 1 and 2 of porcine reproductive and respiratory syndrome viruses on interferon- α responses by plasmacytoid dendritic cells. *Vet. Res.* **44**(1) :33. doi:10.1186/1297-9716-44-33.

BEAUCHEMIN C., HANDEL A., 2011. A review of mathematical models of influenza A infections within a host or cell culture : lessons learned and challenges ahead. *BMC Public Health* **11**. doi:10.1186/1471-2458-11-S1-S7.

BEYER J., FICHTNER D., SCHIRRMER H., POLSTER U., WEILAND E., WEGE H., 2000. Porcine reproductive and respiratory syndrome virus (PRRSV) : kinetics of infection in lymphatic organs and lung. *J. Vet. Med. B Infect. Dis. Vet. Public Health* **47**(1) :9–25. doi:10.1046/j.1439-0450.2000.00305.x.

- BOCHAROV G.A., ROMANYUKHA A.A., 1994. Mathematical model of antiviral immune response. III. Influenza A virus infection. *J. Theor. Biol.* **167**(4) :323–360. doi:10.1006/jtbi.1994.1074.
- BODDICKER N., WAIDE E.H., ROWLAND R.R.R., LUNNEY J.K., GARRICK D.J., REECY J.M., DEKKERS J.C.M., 2012. Evidence for a major QTL associated with host response to porcine reproductive and respiratory syndrome virus challenge. *J. Anim. Sci.* **90**(6) :1733–1746. doi:10.2527/jas.2011-4464.
- BORGHETTI P., 2005. Cell-mediated immunity and viral infection in pig. In *PRRS fatti vs speculazioni*, Università degli Studi di Parma, Dipartimento di Salute Animale (Parma, Italy), pp. 27–46.
http://medvet.unipr.it/cgi-bin/campusnet/documenti.pl/Show?_id=7d0d
- BOSCH A.A.T.M., BIESBROEK G., TRZCINSKI K., SANDERS E.A.M., BOGAERT D., 2013. Viral and bacterial interactions in the upper respiratory tract. *PLoS Pathog.* **9**(1) :e1003057. doi:10.1371/journal.ppat.1003057.
- BRACIALE T.J., SUN J., KIM T.S., 2012. Regulating the adaptive immune response to respiratory virus infection. *Nat. Rev. Immunol.* **12**(4) :295–305. doi:10.1038/nri3166.
- BUTLER J.E., LAGER K.M., GOLDE W., FAABERG K.S., SINKORA M., LOVING C., ZHANG Y.I., 2014. Porcine reproductive and respiratory syndrome (PRRS) : an immune dysregulatory pandemic. *Immunologic research* **59**(1-3) :81–108. doi:10.1007/s12026-014-8549-5.
- CAFRUNY W.A., DUMAN R.G., WONG G.H., SAID S., WARD-DEMO P., ROWLAND R.R., NELSON E.A., 2006. Porcine reproductive and respiratory syndrome virus (PRRSV) infection spreads by cell-to-cell transfer in cultured MARC-145 cells, is dependent on an intact cytoskeleton, and is suppressed by drug-targeting of cell permissiveness to virus infection. *Viol. J.* **3** :90. doi:10.1186/1743-422X-3-90.
- CALZADA-NOVA G., SCHNITZLEIN W., HUSMANN R., ZUCKERMANN F.A., 2010. Characterization of the cytokine and maturation responses of pure populations of porcine plasmacytoid dendritic cells to porcine viruses and toll-like receptor agonists. *Vet. Immunol. Immunop.* **135**(1) :20–33. doi:10.1016/j.vetimm.2009.10.026.
- CHANG H.C., PENG Y.T., CHANG H.L., CHAUNG H.C., CHUNG W.B., 2008. Phenotypic and functional modulation of bone marrow-derived dendritic cells by porcine reproductive and respiratory syndrome virus. *Vet. Microbiol.* **129**(3–4) :281–293. doi:10.1016/j.vetmic.2007.12.002.
- CHARERNTANTANAKUL W., 2009. Adjuvants for porcine reproductive and respiratory syndrome virus vaccines. *Vet. Immunol. Immunop.* **129**(1) :1–13. doi:10.1016/j.vetimm.2008.12.018.
- CHARERNTANTANAKUL W., PLATT R., ROTH J.A., 2006. Effects of porcine reproductive and respiratory syndrome virus-infected antigen-presenting cells on T cell activation and antiviral cytokine production. *Viral Immunol.* **19**(4) :646–661. doi:10.1089/vim.2006.19.646.
- CHARPIN C., MAHÉ S., KERANFLEC'H A., BELLOC C., CARIOLET R., LE POTIER M.F., ROSE N., 2012. Infectiousness of pigs infected by the porcine reproductive and respiratory syndrome virus (PRRSV) is time-dependent. *Vet. Res.* **43**(1) :69. doi:10.1186/1297-9716-43-69.
- CHOI C., CHAE C., 2002. Expression of tumour necrosis factor alpha is associated with apoptosis in lungs of pigs experimentally infected with porcine reproductive and respiratory syndrome virus. *Res. Vet. Sci.* **72**(1) :45–49. doi:10.1053/rvsc.2001.0519.

- COQUERELLE C., MOSER M., 2010. DC subsets in positive and negative regulation of immunity. *Immunol. Rev.* **234**(1) :317–334. doi:10.1111/j.0105-2896.2009.00887.x.
- COSTERS S., DELPUTTE P.L., NAUWYNCK H.J., 2006. Porcine reproductive and respiratory syndrome virus-infected alveolar macrophages contain no detectable levels of viral proteins in their plasma membrane and are protected against antibody-dependent, complement-mediated cell lysis. *J. Gen. Virol.* **87** :2341–2351. doi:10.1099/vir.0.81808-0.
- CRISCI E., MUSSÁ T., FRAILE L., MONTROYA M., 2013. Review : influenza virus in pigs. *Mol. Immunol.* **55**(3) :200–211. doi:10.1016/j.molimm.2013.02.008.
- DARWICH L., DÍAZ I., MATEU E., 2010. Certainties, doubts and hypotheses in porcine reproductive and respiratory syndrome virus immunobiology. *Virus Res.* **154**(1-2) :123–132. doi:10.1016/j.virusres.2010.07.017.
- DARWICH L., GIMENO M., SIBILA M., DÍAZ I., DE LA TORRE E., DOTTI S., KUZEMTSEVA L., MARTIN M., PUJOLS J., MATEU E., 2011. Genetic and immunobiological diversities of porcine reproductive and respiratory syndrome genotype I strains. *Vet. Microbiol.* **150**(1–2) :49–62. doi:10.1016/j.vetmic.2011.01.008.
- DAY J., FRIEDMAN A., SCHLESINGER L.S., 2009. Modeling the immune rheostat of macrophages in the lung in response to infection. *Proc. Natl. Acad. Sci. U.S.A.* **106**(27) :11246–11251. doi:10.1073/pnas.0904846106.
- DAY T., ALIZON S., MIDEO N., 2011. Bridging scales in the evolution of infectious disease life histories : theory. *Evolution* **65**(12) :3448–3461. doi:10.1111/j.1558-5646.2011.01394.x.
- DE LEENHEER P., PILYUGIN S.S., 2008. Immune response to a malaria infection : properties of a mathematical model. *J. Biol. Dyn.* **2**(2) :102–120. doi:10.1080/17513750701769865.
- DEBROY S., MARTCHEVA M., 2008. Immuno-epidemiology and HIV/AIDS : A modeling prospective. In *Mathematical Biology Research Trends*, edited by L.B. WILSON, Nova Science Publishers (New York, USA), pp. 175–192.
- DEFRANCO A.L., LOCKSLEY R.M., ROBERTSON M., CUNIN R., 2009. *Immunité : la réponse immunitaire dans les maladies infectieuses et inflammatoires*. DeBoeck (Bruxelles, Belgium). 2nd edn.
- DELISI C., 1983. Mathematical modeling in immunology. *Annu. Rev. Biophys. Bioeng.* **12**(1) :117–138. doi:10.1146/annurev.bb.12.060183.001001.
- DELPUTTE P.L., MEERTS P., COSTERS S., NAUWYNCK H.J., 2004. Effect of virus-specific antibodies on attachment, internalization and infection of porcine reproductive and respiratory syndrome virus in primary macrophages. *Vet. Immunol. Immunop.* **102**(3) :179–188. doi:10.1016/j.vetimm.2004.09.007.
- DELPUTTE P.L., VANDERHEIJDEN N., NAUWYNCK H.J., PENSART M.B., 2002. Involvement of the matrix protein in attachment of porcine reproductive and respiratory syndrome virus to a heparinlike receptor on porcine alveolar macrophages. *J. Virol.* **76**(9) :4312–4320. doi:10.1128/JVI.76.9.4312-4320.2002.
- DIAZ I., DARWICH L., PAPPATERRA G., PUJOLS J., MATEU E., 2005. Immune responses of pigs after experimental infection with a european strain of porcine reproductive and respiratory syndrome virus. *J. Gen. Virol.* **86**(7) :1943–1951. doi:10.1099/vir.0.80959-0.

- DIAZ I., DARWICH L., PAPPATERRA G., PUJOLS J., MATEU E., 2006. Different European-type vaccines against porcine reproductive and respiratory syndrome virus have different immunological properties and confer different protection to pigs. *Virology* **351**(2) :249–259. doi:10.1016/j.virol.2006.03.046.
- DÍAZ I., GIMENO M., DARWICH L., NAVARRO N., KUZEMTSEVA L., LÓPEZ S., GALINDO I., SEGALÉS J., MARTÍN M., PUJOLS J., MATEU E., 2012. Characterization of homologous and heterologous adaptive immune responses in porcine reproductive and respiratory syndrome virus infection. *Vet. Res.* **43**(1) :30. doi:10.1186/1297-9716-43-30.
- DOBROVOLNY H.M., REDDY M.B., KAMAL M.A., RAYNER C.R., BEAUCHEMIN C.A.A., 2013. Assessing mathematical models of influenza infections using features of the immune response. *PloS ONE* **8**(2) :e57088. doi:10.1371/journal.pone.0057088.
- DOESCHL-WILSON A., GALINA-PANTOJA L., 2010. Using mathematical models to gain insight into host-pathogen interaction in mammals : porcine reproductive and respiratory syndrome. In *Host-pathogen interactions : genetics, immunology and physiology*, edited by A.W. BARTON, Immunology and Immune System Disorders, Nova Science Publishers (New York, USA), chap. 4, p. 109–131.
- DOESCHL-WILSON A.B., 2011. The role of mathematical models of host-pathogen interactions for livestock health and production – a review. *Animal* **5**(6) :895–910. doi:10.1017/S1751731110002557.
- DOESCHL-WILSON A.B., KYRIAZAKIS I., VINCENT A., ROTHSCHILD M.F., THACKER E., GALINA-PANTOJA L., 2009. Clinical and pathological responses of pigs from two genetically diverse commercial lines to porcine reproductive and respiratory syndrome virus infection. *J. Anim. Sci.* **87** :1638–1647. doi:10.2527/jas.2008-1447.
- DUAN F., SIMEONE S., WU R., GRADY J., MANDOIU I., SRIVASTAVA P.K., 2012. Area under the curve as a tool to measure kinetics of tumor growth in experimental animals. *J. Immunol. Methods* **382**(1) :224–228. doi:10.1016/j.jim.2012.06.005.
- DUAN X., NAUWYNCK H.J., PENSAERT M.B., 1997. Virus quantification and identification of cellular targets in the lungs and lymphoid tissues of pigs at different time intervals after inoculation with porcine reproductive and respiratory syndrome virus (PRRSV). *Vet. Microbiol.* **56**(1–2) :9–19. doi:10.1016/S0378-1135(96)01347-8.
- DWIVEDI V., MANICKAM C., BINJAWADAGI B., LINHARES D., MURTAUGH M.P., RENUKARADHYA G.J., 2012. Evaluation of immune responses to porcine reproductive and respiratory syndrome virus in pigs during early stage of infection under farm conditions. *Virol. J.* **9** :45. doi:10.1186/1743-422X-9-45.
- FLORES-MENDOZA L., SILVA-CAMPA E., RESÉNDIZ M., OSORIO F.A., HERNÁNDEZ J., 2008. Porcine reproductive and respiratory syndrome virus infects mature porcine dendritic cells and up-regulates interleukin-10 production. *Clin. Vaccine Immunol.* **15** :720–725. doi:10.1128/CVI.00224-07.
- GAMMACK D., DOERING C.R., KIRSCHNER D.E., 2004. Macrophage response to Mycobacterium tuberculosis infection. *J. Math. Biol.* **48** :218–242. doi:10.1007/s00285-003-0232-8.
- GAMMACK D., GANGULI S., MARINO S., SEGOVIA-JUAREZ J., KIRSCHNER D., 2005. Understanding the immune response in tuberculosis using different mathematical models and biological scales. *Multiscale Model. Sim.* **3**(2) :312–345. doi:10.1137/040603127.

- GANDOLFI A., PUGLIESE A., SINISGALLI C., 2014. Epidemic dynamics and host immune response : a nested approach. *J. Math. Biol.* doi:10.1007/s00285-014-0769-8. Online.
- GAUDREAU N., ROWLAND R., WYATT C., 2009. Factors affecting the permissiveness of porcine alveolar macrophages for porcine reproductive and respiratory syndrome virus. *Arch. Virol.* **154** :133–136. doi:10.1007/s00705-008-0271-y.
- GENINI S., DELPUTTE P.L., MALINVERNI R., CECERE M., STELLA A., NAUWYNCK H.J., GIUFFRÀ E., 2008. Genome-wide transcriptional response of primary alveolar macrophages following infection with porcine reproductive and respiratory syndrome virus. *J. Gen. Virol.* **89**(10) :2550–2564. doi:10.1099/vir.0.2008/003244-0.
- GILCHRIST M.A., SASAKI A., 2002. Modeling host-parasite coevolution : a nested approach based on mechanistic models. *J. Theor. Biol.* **218**(3) :289–308. doi:10.1006/jtbi.2002.3076.
- GIMENO M., DARWICH L., DÍAZ I., DE LA TORRE E., PUJOLS J., MARTIN M., INUMARU S., CANO E., DOMÍNGO M., MONTOYA M., MATEU E., 2011. Cytokine profiles and phenotype regulation of antigen presenting cells by genotype-I porcine reproductive and respiratory syndrome virus isolates. *Vet. Res.* **42**(9). doi:10.1186/1297-9716-42-9.
- GO N., BIDOT C., BELLOC C., TOUZEAU S., 2014. Integrative model of the immune response to a pulmonary macrophage infection : what determines the infection duration? *PLoS ONE* **9**(9) :e107818. doi:10.1371/journal.pone.0107818.
- GÓMEZ-LAGUNA J., RODRÍGUEZ-GOMEZ I.M., BARRANCO I., PALLARÉS F.J., SALGUERO F.J., CARRASCO L., 2012. Enhanced expression of TGF β protein in lymphoid organs and lung, but not in serum, of pigs infected with a European field isolate of porcine reproductive and respiratory syndrome virus. *Vet. Microbiol.* **158**(1) :187–193. doi:10.1016/j.vetmic.2012.02.003.
- GÓMEZ-LAGUNA J., SALGUERO F., PALLARÉS F., FERNÁNDEZ DE MARCO M., BARRANCO I., CERÓN J., MARTÍNEZ-SUBIELA S., VAN REETH K., CARRASCO L., 2010. Acute phase response in porcine reproductive and respiratory syndrome virus infection. *Comp. Immunol. Microb.* **33**(6) :e51–e58. doi:10.1016/j.cimid.2009.11.003.
- GÓMEZ-LAGUNA J., SALGUERO F.J., BARRANCO I., PALLARÉS F.J., RODRÍGUEZ-GOMEZ I.M., BERNABE A., CARRASCO L., 2009. Cytokine expression by macrophages in the lung of pigs infected with the porcine reproductive and respiratory syndrome virus. *J. Comp. Pathol.* **142**(1) :51–60. doi:10.1016/j.jcpa.2009.07.004.
- GÓMEZ-LAGUNA J., SALGUERO F.J., PALLARÉS F.J., CARRASCO L., 2013. Immunopathogenesis of porcine reproductive and respiratory syndrome in the respiratory tract of pigs. *Vet. J.* **195**(2) :148–155. doi:10.1016/j.tvjl.2012.11.012.
- GUZYLACK-PIRIOU L., PIERSMA S., MCCULLOUGH K., SUMMERFIELD A., 2006. Role of natural interferon-producing cells and T lymphocytes in porcine monocyte-derived dendritic cell maturation. *Immunology* **118**(1) :78–87. doi:10.1111/j.1365-2567.2006.02343.x.
- HANCIOGLU B., SWIGON D., CLERMONT G., 2007. A dynamical model of human immune response to influenza A virus infection. *J. Theor. Biol.* **246**(1) :70–86. doi:10.1016/j.jtbi.2006.12.015.
- HANCIOGLU B., SWIGON D., CLERMONT G., 2014. An ensemble model of the human immune response to influenza A virus infection and its application to the evaluation of treatment strategies. Submitted to PNAS.

- HANDEL A., BROWN J., STALLKNECHT D., ROHANI P., 2013. A multi-scale analysis of influenza A virus fitness trade-offs due to temperature-dependent virus persistence. *PLoS Comput. Biol.* **9**(3) :e1002989. doi:{10.1371/journal.pcbi.1002989}.
- HANDEL A., LEBARBENCHON C., STALLKNECHT D., ROHANI P., 2014. Trade-offs between and within scales : environmental persistence and within-host fitness of avian influenza viruses. *Proc. R. Soc. B* **281**(1787) :20133051. doi:10.1098/rspb.2013.3051.
- HANDEL A., LONGINI I.M., ANTIA R., 2010. Towards a quantitative understanding of the within-host dynamics of influenza A infections. *J. R. Soc. Interface* **7**(42) :35–47.
- HEFFERNAN J.M., 2011. Mathematical immunology of infectious diseases. *Math. Popul. Stud.* **18**(2) :47–54. doi:10.1080/08898480.2011.564559.
- HEFFERNAN J.M., KEELING M.J., 2009. Implications of vaccination and waning immunity. *Proc. R. Soc. B* **276**(1664) :2071–2080. doi:10.1098/rspb.2009.0057.
- HELLRIEGEL B., 2001. Immunoepidemiology – bridging the gap between immunology and epidemiology. *Trends Parasitol.* **17**(2) :102–106. doi:10.1016/S1471-4922(00)01767-0.
- HERMANN J.R., MUNOZ-ZANZI C.A., ROOF M.B., BURKHART K., ZIMMERMAN J.J., 2005. Probability of porcine reproductive and respiratory syndrome (PRRS) virus infection as a function of exposure route and dose. *Vet. Microbiol.* **110**(1) :7–16. doi:10.1016/j.vetmic.2005.06.012.
- HICKSON R.I., ROBERTS M.G., 2014. How population heterogeneity in susceptibility and infectivity influences epidemic dynamics. *J. Theor. Biol.* **350** :70–80. doi:10.1016/j.jtbi.2014.01.014.
- HU J., ZHANG C., 2012. Porcine reproductive and respiratory syndrome virus vaccines : current status and strategies to a universal vaccine. *Transbound. Emerg. Dis.* doi:10.1111/tbed.12016.
- JOHNSON W., ROOF M., VAUGHN E., CHRISTOPHER-HENNINGS J., JOHNSON C.R., MURTAUGH M.P., 2004. Pathogenic and humoral immune responses to porcine reproductive and respiratory syndrome virus (PRRSV) are related to viral load in acute infection. *Vet. Immunol. Immunop.* **102**(3) :233–247. doi:10.1016/j.vetimm.2004.09.01.
- KARNIYCHUK U., GELDHOF M., VANHEE M., VAN DOORSSELAERE J., SAVELEVA T., NAUWYNCK H., 2010. Pathogenesis and antigenic characterization of a new East European subtype 3 porcine reproductive and respiratory syndrome virus isolate. *Vet. Res.* **6**(1) :30. doi:10.1186/1746-6148-6-30.
- KIDD P., 2003. Th1/Th2 balance : the hypothesis, its limitations, and implications for health and disease. *Altern. Med. Rev.* **8**(3) :223–246.
- KIMMAN T.G., CORNELISSEN L.A., MOORMANN R.J., REBEL J.M.J., STOCKHOFE-ZURWIEDEN N., 2009. Challenges for porcine reproductive and respiratory syndrome virus (PRRSV) vaccinology. *Vaccine* **27**(28) :3704–3718. doi:10.1016/j.vaccine.2009.04.022.
- KIROS T.G., VAN KESSEL J., BABIUK L.A., GERDTS V., 2011. Induction, regulation and physiological role of IL-17 secreting helper T-cells isolated from PBMC, thymus, and lung lymphocytes of young pigs. *Vet. Immunol. Immunop.* **144**(3) :448–454. doi:10.1016/j.vetimm.2011.08.021.

- KLINGE K.L., VAUGHN E.M., ROOF M.B., BAUTISTA E.M., MURTAUGH M.P., 2009. Age-dependent resistance to porcine reproductive and respiratory syndrome virus replication in swine. *Virol. J.* **6**(1) :177. doi:10.1186/1743-422X-6-177.
- KNOSP C.A., JOHNSTON J.A., 2012. Regulation of CD4+ T-cell polarization by suppressor of cytokine signalling proteins. *Immunology* **135**(2) :101–111. doi:10.1111/j.1365-2567.2011.03520.x.
- KOHLMEIER J.E., WOODLAND D.L., 2009. Immunity to respiratory viruses. *Annu. Rev. Immunol.* **27**(1) :61–82. doi:10.1146/annurev.immunol.021908.132625.
- KORN T., BETTELLI E., OUKKA M., KUCHROO V.K., 2009. IL-17 and Th17 cells. *Annu. Rev. Immunol.* **27** :485–517. doi:10.1146/annurev.immunol.021908.132710.
- KOSTOVA T., 2007. Persistence of viral infections on the population level explained by an immunoepidemiological model. *Math. Biosci.* **206**(2) :309–319. doi:10.1016/j.mbs.2005.08.003.
- LABARQUE G., VAN GUCHT S., NAUWYNCK H., VAN REETH K., PENSAERT M., 2003. Apoptosis in the lungs of pigs infected with porcine reproductive and respiratory syndrome virus and associations with the production of apoptogenic cytokines. *Vet. Res.* **34** :249–260. doi:10.1051/vetres:2003001.
- LABARQUE G.G., NAUWYNCK H.J., VAN REETH K., PENSAERT M.B., 2000. Effect of cellular changes and onset of humoral immunity on the replication of porcine reproductive and respiratory syndrome virus in the lungs of pigs. *J. Gen. Virol.* **81**(5) :1327–1334.
- LAMBONI M., MONOD H., MAKOWSKI D., 2011. Multivariate sensitivity analysis to measure global contribution of input factors in dynamic models. *Reliab. Eng. Syst. Safe.* **96**(4) :450–459. doi:10.1016/j.ress.2010.12.002.
- LEE H.Y., TOPHAM D.J., PARK S.Y., HOLLENBAUGH J., TREANOR J., MOSMANN T.R., JIN X., WARD B.M., MIAO H., HOLDEN-WILTSE J., PERELSON A.S., ZAND M., WU H., 2009. Simulation and prediction of the adaptive immune response to influenza A virus infection. *J. Virol.* **83**(14) :7151–7165. doi:10.1128/JVI.00098-09.
- LEE S.M., SCHOMMER S.K., KLEIBOEKER S.B., 2004. Porcine reproductive and respiratory syndrome virus field isolates differ in in vitro interferon phenotypes. *Vet. Immunol. Immunop.* **102**(3) :217–231. doi:10.1016/j.vetimm.2004.09.009.
- LEROITH T., AHMED S.A., 2012. Regulatory T cells and viral disease. In *Inflammation, Chronic Diseases and Cancer : Cell and Molecular Biology, Immunology and Clinical Bases*, edited by M. KHATAMI, InTech (Rijeka, Croatia), chap. 6, pp. 121–144. doi:10.5772/28502.
- LI Y., HANDEL A., 2014. Modeling inoculum dose dependent patterns of acute virus infections. *J. Theor. Biol.* **347** :63–73. doi:10.1016/j.jtbi.2014.01.008.
- LIU C.H., CHAUNG H.C., CHANG H.I., PENG Y.T., CHUNG W.B., 2009. Expression of Toll-like receptor mRNA and cytokines in pigs infected with porcine reproductive and respiratory syndrome virus. *Vet. Microbiol.* **136**(3) :266–276. doi:10.1016/j.vetmic.2008.11.016.
- LIU Y., SHI W., ZHOU E., WANG S., HU S., CAI X., RONG F., WU J., XU M., XU M., LI L., 2010. Dynamic changes in inflammatory cytokines in pigs infected with highly pathogenic porcine reproductive and respiratory syndrome virus. *Clin. Vaccine Immunol.* **17**(9) :1439–1445. doi:10.1128/CVI.00517-09.

- LOPEZ O.J., OSORIO F.A., 2004. Role of neutralizing antibodies in PRRSV protective immunity. *Vet. Immunol. Immunop.* **102**(3) :155–163. doi:10.1016/j.vetimm.2004.09.005.
- LOPEZ-FUERTE L., CAMPOS E., DOMENECH N., EZQUERRA A., CASTRO J.M., DOMINGUEZ J., ALONSO F., 1999. Porcine reproductive and respiratory syndrome (PRRS) virus down-modulates TNF- α production in infected macrophages. *Virus Res.* **69**(269) :41–46. doi:10.1016/S0168-1702(00)00172-6.
- LOVING C.L., BROCKMEIER S.L., SACCO R.E., 2007. Differential type I interferon activation and susceptibility of dendritic cell populations to porcine arterivirus. *Immunology* **120**(2) :217–229. doi:10.1111/j.1365-2567.2006.02493.x.
- LUKENS S., DEPASSE J., ROSENFELD R., GHEDIN E., MOCHAN E., BROWN S.T., GREFFENSTETTE J., BURKE D.S., SWIGON D., CLERMONT G., 2014. A large-scale immunoepidemiological simulation of influenza A epidemics. *BMC Public Health* **14** :1019. doi:10.1186/1471-2458-14-1019.
- LUNNEY J.K., CHEN H., 2010. Genetic control of host resistance to porcine reproductive and respiratory syndrome virus (PRRSV) infection. *Virus Res.* **154**(1–2) :161–169. doi:10.1016/j.virusres.2010.08.004.
- LUNNEY J.K., FRITZ E.R., REECY J.M., ANDR ELIZABETH PRUCNAL D.K., MOLINA R., CHRISTOPHER-HENNINGS J., ZIMMERMAN J., ROWLAND R.R.R., 2010. Interleukin-8, interleukin-1 β , and interferon- γ levels are linked to PRRS virus clearance. *Viral Immunol.* **23**(2) :127–134. doi:10.1089/vim.2009.0087.
- LUO S., REED M., MATTINGLY J.C., KOELLE K., 2012. The impact of host immune status on the within-host and population dynamics of antigenic immune escape. *J. R. Soc. Interface* **9**(75) :2603–2613. doi:10.1098/rsif.2012.0180.
- LYTHGOE K.A., PELLIS L., FRASER C., 2013. Is HIV short-sighted? Insights from a multistrain nested model. *Evolution* **67**(10) :2769–2782. doi:10.1111/evo.12166.
- MALDONADO-LÓPEZ R., MOSER M., 2001. Dendritic cell subsets and the regulation of Th1/Th2 responses. *Semin. Immunol.* **13**(5) :275–282. doi:10.1006/smim.2001.0323.
- MARINO S., KIRSCHNER D.E., 2004. The human immune response to Mycobacterium tuberculosis in lung and lymph node. *J. Theor. Biol.* **227** :463–486. doi:10.1016/j.jtbi.2003.11.023.
- MARINO S., LINDERMAN J.J., KIRSCHNER D.E., 2011. A multifaceted approach to modeling the immune response in tuberculosis. *Wiley Interdiscip. Rev. Syst. Biol. Med.* **3**(4) :479–489. doi:10.1002/wsbm.131.
- MARINO S., MYERS A., FLYNN J.L., KIRSCHNER D.E., 2010. TNF and IL-10 are major factors in modulation of the phagocytic cell environment in lung and lymph node in tuberculosis : A next-generation two-compartmental model. *J. Theor. Biol.* **265**(4) :586–598. doi:10.1016/j.jtbi.2010.05.012.
- MARINO S., SUD D., PLESSNER H., LIN P.L., CHAN J., FLYNN J.L., KIRSCHNER D.E., 2007. Differences in reactivation of tuberculosis induced from anti-TNF treatments are based on bioavailability in granulomatous tissue. *PLoS Comput. Biol.* **3**(10) :e194. doi:10.1371/journal.pcbi.0030194.

- MAROIS I., CLOUTIER A., GARNEAU É., RICHTER M.V., 2012. Initial infectious dose dictates the innate, adaptive, and memory responses to influenza in the respiratory tract. *J. Leukocyte Biol.* **92**(1) :107–121. doi:10.1189/jlb.1011490.
- MARTCHEVA M., 2011. An immuno-epidemiological model of paratuberculosis. *AIP Conf. Proc.* **1404**(1) :176–183. doi:10.1063/1.3659918. In *Application of Mathematics in Technical and Natural Sciences : 3rd International Conference AMiTaNS'11 : Albena, Bulgaria, 20-25 June 2011* ; edited by Todorov M.D. and Christov C.I.
- MARTCHEVA M., LI X.Z., 2013. Linking immunological and epidemiological dynamics of HIV : the case of super-infection. *J. Biol. Dyn.* **7**(1) :161–182. doi:10.1080/17513758.2013.820358.
- MARTCHEVA M., PILYUGIN S.S., 2006. An epidemic model structured by host immunity. *J Biol. Syst.* **14**(02) :185–203. doi:10.1142/S0218339006001787.
- MARTELLI P., GOZIO S., FERRARI L., ROSINA S., DE ANGELIS E., QUINTAVALLA C., BOTTARELLI E., BORGHETTI P., 2009. Efficacy of a modified live porcine reproductive and respiratory syndrome virus (PRRSV) vaccine in pigs naturally exposed to a heterologous European (Italian cluster) field strain : Clinical protection and cell-mediated immunity. *Vaccine* **27**(28) :3788–3799. doi:10.1016/j.vaccine.2009.03.028.
- MARTÍNEZ-LOBO F.J., DÍEZ-FUERTES F., SEGALÉS J., GARCÍA-ARTIGA C., SIMARRO I., CASTRO J.M., PRIETO C., 2011. Comparative pathogenicity of type 1 and type 2 isolates of porcine reproductive and respiratory syndrome virus (PRRSv) in a young pig infection model. *Vet. Microbiol.* **154**(1) :58–68. doi:10.1016/j.vetmic.2011.06.025.
- MATEU E., DÍAZ I., 2008. The challenge of PRRS immunology. *Vet. J.* **177** :345–351. doi:10.1016/j.tvjl.2007.05.022.
- MENGELING W.L., LAGER K.M., VORWALD A.C., KOEHLER K.J., 2003. Strain specificity of the immune response of pigs following vaccination with various strains of porcine reproductive and respiratory syndrome virus. *Vet. Microbiol.* **93**(1) :13–24. doi:10.1016/S0378-1135(02)00427-3.
- METCALF C.J.E., ANDREASEN V., BJØRNSTAD O.N., EAMES K., EDMUNDS W.J., FUNK S., HOLLINGSWORTH T.D., LESSLER J., VIBOUD C., GRENFELL B.T., 2014. Seven challenges in modelling vaccine preventable diseases. *Epidemics* doi:10.1016/j.epidem.2014.08.004. In press.
- MEULENBERG J., BESTEN A., 1996. Identification and characterization of a sixth structural protein of Lelystad virus : The glycoprotein GP₂ encoded by ORF2 is incorporated in virus particles. *Virology* **225**(1) :44–51. doi:10.1006/viro.1996.0573.
- MIAO H., HOLLENBAUGH J.A., ZAND M.S., HOLDEN-WILTSE J., MOSMANN T.R., PERELSON A.S., WU H., TOPHAM D.J., 2010. Quantifying the early immune response and adaptive immune response kinetics in mice infected with influenza A virus. *J. Virol.* **84**(13) :6687–6698. doi:10.1128/JVI.00266-10.
- MIDEO N., ALIZON S., DAY T., 2008. Linking within-and between-host dynamics in the evolutionary epidemiology of infectious diseases. *Trends Ecol. Evol.* **23**(9) :511–517. doi:10.1016/j.tree.2008.05.009.
- MIGUEL J.C., CHEN J., VAN ALSTINE W.G., JOHNSON R.W., 2010. Expression of inflammatory cytokines and Toll-like receptors in the brain and respiratory tract of pigs infected with porcine reproductive and respiratory syndrome virus. *Vet. Immunol. Immunop.* **135**(3) :314–319. doi:10.1016/j.vetimm.2010.01.002.

- MILLER L.C., FOX J.M., 2004. Apoptosis and porcine reproductive and respiratory syndrome virus. *Vet. Immunol. Immunop.* **102**(3) :131–142. doi:10.1016/j.vetimm.2004.09.004.
- MILLER L.C., LAEGREID W.W., BONO J.L., CHITKO-McKOWN C.G., FOX J.M., 2004. Interferon type I response in porcine reproductive and respiratory syndrome virus-infected MARC-145 cells. *Arch. Virol.* **149** :2453–2463. doi:10.1007/s00705-004-0377-9.
- MOGLER M., 2012. *Evaluation of replicon particle vaccines for porcine reproductive and respiratory syndrome virus*. PhD thesis, Iowa State University.
<http://lib.dr.iastate.edu/etd/12841>
- MOLINA R.M., CHA S.H., CHITTICK W., LAWSON S., MURTAUGH M.P., NELSON E.A., CHRISTOPHER-HENNINGS J., YOON K.J., EVANS R., ROWLAND R.R.R., ZIMMERMAN J.J., 2008. Immune response against porcine reproductive and respiratory syndrome virus during acute and chronic infection. *Vet. Immunol. Immunop.* **126** :283–292. doi:10.1016/j.vetimm.2008.08.002.
- MONDACA-FERNÁNDEZ E., MEYNS T., MUÑOZ-ZANZI C., TRINCADO C., MORRISON R.B., 2007. Experimental quantification of the transmission of Porcine reproductive and respiratory syndrome virus. *Can. J. Vet. Res.* **71**(2) :157.
- MOORE K.W., DE WAAL MALEFYT R., COFFMAN R.L., O’GARRA A., 2001. Interleukin-10 and the interleukin-10 receptor. *Annu. Rev. Immunol.* **19**(1) :683–765. doi:10.1146/annurev.immunol.19.1.683.
- MORGAN S.B., GRAHAM S.P., SALGUERO F.J., SÁNCHEZ CORDÓN P.J., MOKHTAR H., REBEL J.M.J., WEESENDORP E., BODMAN-SMITH K.B., STEINBACH F., FROSSARD J.P., 2013. Increased pathogenicity of European porcine reproductive and respiratory syndrome virus is associated with enhanced adaptive responses and viral clearance. *Vet. Microbiol.* **163**(1) :13–22. doi:10.1016/j.vetmic.2012.09.013.
- multisensi : Multivariate sensitivity analysis. An R package to perform sensitivity analysis on a model with multivariate outputs.
<http://cran.r-project.org/web/packages/multisensi/index.html>
- MULUPURI P., ZIMMERMAN J.J., HERMANN J., JOHNSON C.R., CANO J.P., YU W., DEE S.A., MURTAUGH M.P., 2008. Antigen-specific B-cell responses to porcine reproductive and respiratory syndrome virus infection. *J. Virol.* **82**(1) :358–370. doi:10.1128/JVI.01023-07.
- MURILLO L.N., MURILLO M.S., PERELSON A.S., 2013. Towards multiscale modeling of influenza infection. *J. Theor. Biol.* **332** :267–290. doi:10.1016/j.jtbi.2013.03.024.
- MURTAUGH M.P., 2004. PRRS immunology : what are we missing? In *35th Annual Meeting of the American Association of Swine Veterinarians*, Des Moines, Iowa, USA, pp. 359–367.
- MURTAUGH M.P., 2005. PRRSV/host interaction. In *PRRS fatti vs speculazioni*, Università degli Studi di Parma, Dipartimento di Salute Animale (Parma, Italy), pp. 73–80.
http://medvet.unipr.it/cgi-bin/campusnet/documenti.pl/Show?_id=7d0d
- MURTAUGH M.P., GENZOW M., 2011. Immunological solutions for treatment and prevention of porcine reproductive and respiratory syndrome (PRRS). *Vaccine* **29**(46) :8192–8204. doi:10.1016/j.vaccine.2011.09.013.
- MURTAUGH M.P., XIAO Z., ZUCKERMANN F., 2002. Immunological responses of swine to porcine reproductive and respiratory syndrome virus infection. *Viral Immunol.* **15**(4) :533–547. doi:10.1089/088282402320914485.

NARANG V., DECRAENE J., WONG S.Y., AISWARYA B.S., WASEM A.R., LEONG S.R., GOUAILLARD A., 2012. Systems immunology : a survey of modeling formalisms, applications and simulation tools. *Immunol. Res.* **53**(1-3) :251–265. doi:10.1007/s12026-012-8305-7.

NAUWYNCK H.J., VAN GORP H., VANHEE M., KARNIYCHUK U., GELDHOF M., CAO A., VERBEECK M., VAN BREEDAM W., 2012. Micro-dissecting the pathogenesis and immune response of PRRSV infection paves the way for more efficient PRRSV vaccines. *Transbound. Emerg. Dis.* **59** :50–54. doi:10.1111/j.1865-1682.2011.01292.x.

NODELIJK G., NIELEN M., DEJONG M.C.M., VERHEIJDEN J.H.M., 2003. A review of porcine reproductive and respiratory syndrome virus in Dutch breeding herds : population dynamics and clinical relevance. *Prev. Vet. Med.* **60** :37–52. doi:10.1016/S0167-5877(03)00081-3.

NOWAK M., MAY R.M., 2000. *Virus Dynamics : Mathematical Principles of Immunology and Virology*. Oxford University Press.

Porcine reproductive and respiratory syndrome. OIE. Animal Disease Information Summaries. http://www.oie.int/fileadmin/Home/eng/Media_Center/docs/pdf/Disease_cards/PPRS-EN.pdf

OLEKSIEWICZ M.B., NIELSEN J., 1999. Effect of porcine reproductive and respiratory syndrome virus (PRRSV) on alveolar lung macrophage survival and function. *Vet. Microbiol.* **66**(1) :15–27. doi:10.1016/S0378-1135(98)00309-5.

OSORIO F.A., GALEOTA J.A., NELSON E., BRODERSEN B., DOSTER A., WILLS R., ZUCKERMANN F., LAEGREID W.W., 2002. Passive transfer of virus-specific antibodies confers protection against reproductive failure induced by a virulent strain of porcine reproductive and respiratory syndrome virus and establishes sterilizing immunity. *Virology* **302**(1) :9–20. doi:10.1006/viro.2002.1612.

OSTROWSKI M., GALEOTA J.A., JAR A.M., PLATT K.B., OSORIO F.A., LOPEZ O.J., 2002. Identification of neutralizing and nonneutralizing epitopes in the porcine reproductive and respiratory syndrome virus GP5 ectodomain. *J. Virol.* **76**(9) :4241–4250. doi:10.1128/JVI.76.9.4241-4250.2002.

PARK J.Y., KIM H.S., SEO S.H., 2008. Characterization of interaction between porcine reproductive and respiratory syndrome virus and porcine dendritic cells. *J. Microbiol. Biotechnol.* **18**(10) :1709–1716.

PAWELEK K.A., HUYNH G.T., QUINLIVAN M., CULLINANE A., RONG L., PERELSON A.S., 2012. Modeling within-host dynamics of influenza virus infection including immune responses. *PLoS Comput. Biol.* **8**(6) :e1002588. doi:10.1371/journal.pcbi.1002588.

PENG Y.T., CHAUNG H.C., CHANG H.L., CHANG H.C., CHUNG W.B., 2009. Modulations of phenotype and cytokine expression of porcine bone marrow-derived dendritic cells by porcine reproductive and respiratory syndrome virus. *Vet. Microbiol.* **136**(3-4) :359–365. doi:10.1016/j.vetmic.2008.11.013.

PEPIN K.M., VOLKOV I., BANAVAR J.R., WILKE C.O., GRENFELL B.T., 2010. Phenotypic differences in viral immune escape explained by linking within-host dynamics to host-population immunity. *J. Theor. Biol.* **265**(4) :501–510. doi:10.1016/j.jtbi.2010.05.036.

PERELSON A.S., 2002. Modelling viral and immune system dynamics. *Nat. Rev. Immunol.* **2**(1) :28–36. doi:10.1038/nri700.

PETRY D.B., HOLL J.W., WEBER J.S., DOSTER A.R., OSORIO F.A., JOHNSON R.K., 2005. Biological responses to porcine respiratory and reproductive syndrome virus in pigs of two genetic populations. *J. Anim. Sci.* **83** :1494–1502.

PETRY D.B., LUNNEY J., BOYD P., KUCHAR D., BLANKENSHI E., JOHNSON R.K., 2007. Differential immunity in pigs with high and low responses to porcine reproductive and respiratory syndrome virus infection. *J. Anim. Sci.* **85** :2075–2092. doi:10.2527/jas.2006-721.

The R project for statistical computing.

<http://www.r-project.org>

REINER G., FRESEN C., BRONNERT S., WILLEMS H., 2009. Porcine reproductive and respiratory syndrome virus (PRRSV) infection in wild boars. *Vet. Microbiol.* **136**(3) :250–258. doi:10.1016/j.vetmic.2008.11.023.

REINER G., WILLEMS H., PESCH S., OHLINGER V.F., 2010. Variation in resistance to the porcine reproductive and respiratory syndrome virus (PRRSV) in Pietrain and Miniature pigs. *J. Anim. Breed. Genet.* **127** :100–106. doi:10.1111/j.1439-0388.2009.00818.x.

ROACH J.C., GLUSMAN G., ROWEN L., KAUR A., PURCELL M.K., SMITH K.D., HOOD L.E., ADEREM A., 2005. The evolution of vertebrate Toll-like receptors. *Proc. Natl. Acad. Sci. U.S.A.* **102**(27) :9577–9582. doi:10.1073/pnas.0502272102.

ROTH A.J., THACKER E.L., 2006. Immune system. In *Diseases of swine*, edited by B.E. STRAW, J.J. ZIMMERMAN, S. D'ALLAIRE, D.L. TAYLOR, Blackwell (Oxford, UK), 9th edn., chap. 2, pp. 15–36.

ROUSE B.T., SEHRAWAT S., 2010. Immunity and immunopathology to viruses : what decides the outcome? *Nat. Rev. Immunol.* **10**(7) :514–526. doi:10.1038/nri2802.

ROWLAND R.R.R., LUNNEY J., DEKKERS J., 2012. Control of porcine reproductive and respiratory syndrome (PRRS) through genetic improvements in disease resistance and tolerance. *Front. Genet.* **3** :260. doi:10.3389/fgene.2012.00260.

ROYAEE A.R., HUSMANN R.J., DAWSON H.D., CALZADA-NOVA G., SCHNITZLEIN W.M., ZUCKERMANN F.A., LUNNEY J.K., 2004. Deciphering the involvement of innate immune factors in the development of the host response to PRRSV vaccination. *Vet. Immunol. Immunop.* **102**(3) :199–216. doi:10.1016/j.vetimm.2004.09.018.

SAENZ R.A., QUINLIVAN M., ELTON D., MACRAE S., BLUNDEN A.S., MUMFORD J.A., DALY J.M., DIGARD P., CULLINANE A., GRENFELL B.T., MCCAULEY J.W., WOOD J.L.N., GOG J.R., 2010. Dynamics of influenza virus infection and pathology. *J. Virol.* **84**(8) :3974–3983. doi:10.1128/JVI.02078-09.

SAITO S., NAKASHIMA A., SHIMA T., ITO M., 2010. Th1/Th2/Th17 and regulatory T-cell paradigm in pregnancy. *Am. J. Reprod. Immunol.* **63**(6) :601–610. doi:10.1111/j.1600-0897.2010.00852.x. Review article.

SALTELLI A., CHAN K., SCOTT E.M. (eds.) 2000. *Sensitivity analysis*. Wiley Series in Probability and Statistics. Wiley (Chichester, UK).

Scilab. Open source software for numerical computation.

<http://www.scilab.org/>

SEN G.C., 2001. Viruses and interferons. *Annu. Rev. Microbiol.* **55** :255–281. doi:10.1146/annurev.micro.55.1.255.

- SILVA-CAMPA E., CORDOBA L., FRAILE L., FLORES-MENDOZA L., MONTOYA M., HERNÁNDEZ J., 2010. European genotype of porcine reproductive and respiratory syndrome (PRRSV) infects monocyte-derived dendritic cells but does not induce Treg cells. *Virology* **396**(2) :264–271. doi:10.1016/j.virol.2009.10.024.
- SILVA-CAMPA E., FLORES-MENDOZA L., RESÉNDIZ M., PINELLI-SAAVEDRA A., MATA-HARO V., MWANGI W., HERNÁNDEZ J., 2009. Induction of T helper 3 regulatory cells by dendritic cells infected with porcine reproductive and respiratory syndrome virus. *Virology* **387**(2) :373–379. doi:10.1016/j.virol.2009.02.033.
- SILVA-CAMPA E., MATA-HARO V., MATEU E., HERNANDEZ J., 2012. Porcine reproductive and respiratory syndrome virus induces CD4⁺CD8⁺CD25⁺Foxp3⁺ regulatory T cells (Tregs). *Virology* **430** :73–80. doi:10.1016/j.virol.2012.04.009.
- SMITH A.M., PERELSON A.S., 2011. Influenza A virus infection kinetics : quantitative data and models. *Wiley Interdiscip. Rev. Syst. Biol. Med.* **3**(4) :429–445. doi:10.1002/wsbm.129.
- STEINMEYER S.H., WILKE C.O., PEPIN K.M., 2010. Methods of modelling viral disease dynamics across the within-and between-host scales : the impact of virus dose on host population immunity. *Philos T. R. Soc. B* **365**(1548) :1931–1941. doi:10.1098/rstb.2010.0065.
- SUD D., BIGBEE C., FLYNN J.L., KIRSCHNER D.E., 2006. Contribution of CD8⁺ T cells to control of Mycobacterium tuberculosis infection. *J. Immunol.* **176**(7) :4296–4314.
- SURADHAT S., THANAWONGNUWECH R., POOVORAWAN Y., 2003. Upregulation of IL-10 gene expression in porcine peripheral blood mononuclear cells by porcine reproductive and respiratory syndrome. *J. Gen. Virol.* **84** :453–459. doi:10.1099/vir.0.18698-0.
- TAKEDA K., AKIRA S., 2004. TLR signaling pathways. *Semin. Immunol.* **16**(1) :3–9. doi:10.1016/j.smim.2003.10.003.
- TAKEDA K., KAISHO T., AKIRA S., 2003. Toll-like receptors. *Annu. Rev. Immunol.* **21**(1) :335–376. doi:10.1146/annurev.immunol.21.120601.141126.
- TEIFKE J.P., DAUBER M., FICHTNER D., LENK M., POLSTER U., WEILAND E., BEYER J., 2001. Detection of european porcine reproductive and respiratory syndrome virus in porcine alveolar macrophages by two-colour immunofluorescence and in-situ hybridization-immunohistochemistry double labelling. *J. Comp. Pathol.* **124**(4) :238–245. doi:10.1053/jcpa.2000.0458.
- THANAWONGNUWECH R., 1999. Pulmonary intravascular macrophages (PIMs) : What do we know about their role in PRRSV infection in pigs. *Wetchasan Sattawaphaet (The Thai journal of veterinary medicine)* **29**.
- THANAWONGNUWECH R., RUNGSIPIPAT A., DISATIAN S., SAIYASOMBAT R., NAPAKANAPORN S., HALBUR P.G., 2003. Immunohistochemical staining of IFN γ positive cells in porcine reproductive and respiratory syndrome virus-infected lungs. *Vet. Immunol. Immunop.* **91**(1) :73–77. doi:10.1016/S0165-2427(02)00268-4.
- THANAWONGNUWECH R., SURADHAT S., 2010. Taming PRRSV : Revisiting the control strategies and vaccine design. *Virus Res.* **154**(1-2) :133–140. doi:10.1016/j.virusres.2010.09.003.

- THANAWONGNUWECH R., YOUNG T.F., THACKER B.J., THACKER E.L., 2001. Differential production of proinflammatory cytokines : in vitro PRRSV and *Mycoplasma hyopneumoniae* co-infection model. *Vet. Immunol. Immunop.* **79**(1) :115–127. doi:10.1016/S0165-2427(01)00243-4.
- TOSI M.F., 2005. Innate immune responses to infection. *J. Allergy Clin. Immun.* **116**(2) :241–249. doi:10.1016/j.jaci.2005.05.036.
- TRIDANE A., KUANG Y., 2010. Modeling the interaction of cytotoxic T lymphocytes and influenza virus infected epithelial cells. *Math. Biosci. Eng.* **7**(1) :171–185. doi:10.3934/mbe.2010.7.171.
- UNDERHILL D.M., GOODRIDGE H.S., 2012. Information processing during phagocytosis. *Nat. Rev. Immunol.* **12** :492–502. doi:10.1038/nri3244.
- VAN BREEDAM W., DELPUTTE P.L., VAN GORP H., MISINZO G., VANDERHEIJDEN N., DUAN X., NAUWYNCK H.J., 2010. Porcine reproductive and respiratory syndrome virus entry into the porcine macrophage. *J. Gen. Virol.* **91**(7) :1659–1667. doi:10.1099/vir.0.020503-0.
- VAN REETH K., NAUWYNCK H., 2000. Proinflammatory cytokines and viral respiratory disease in pigs. *Vet. Res.* **31**(2) :187–213. doi:10.1051/vetres:2000113.
- VAN REETH K., VAN GUCHT S., PENSART M., 2002. In vivo studies on cytokine involvement during acute viral respiratory disease of swine : troublesome but rewarding. *Vet. Immunol. Immunop.* **87**(3-4) :161–168. doi:10.1016/S0165-2427(02)00047-8.
- VANHEE M., VAN BREEDAM W., COSTERS S., GELDHOF M., NOPPE Y., NAUWYNCK H., 2011. Characterization of antigenic regions in the porcine reproductive and respiratory syndrome virus by the use of peptide-specific serum antibodies. *Vaccine* **29**(29-30) :4794–4804. doi:10.1016/j.vaccine.2011.04.071.
- VASCO D.A., WEARING H.J., ROHANI P., 2007. Tracking the dynamics of pathogen interactions : modeling ecological and immune-mediated processes in a two-pathogen single-host system. *J. Theor. Biol.* **245**(1) :9–25. doi:10.1016/j.jtbi.2006.08.015.
- VIDAL S.M., KHAKOO S.I., BIRON C.A., 2011. Natural killer cell responses during viral infections : flexibility and conditioning of innate immunity by experience. *Curr. Opin. Virol.* **1**(6) :497–512. doi:10.1016/j.coviro.2011.10.017.
- VINCENT A.L., THACKER B.J., HALBUR P.G., ROTHSCHILD M.F., THACKER E.L., 2005. In vitro susceptibility of macrophages to porcine reproductive and respiratory syndrome virus varies between genetically diverse lines of pigs. *Viral Immunol.* **18**(3) :506–512. doi:10.1089/vim.2005.18.506.
- VINCENT A.L., THACKER B.J., HALBUR P.G., ROTHSCHILD M.F., THACKER E.L., 2006. An investigation of susceptibility to porcine reproductive and respiratory syndrome virus between two genetically diverse commercial lines of pigs. *J. Anim. Sci.* **84**(1) :49–57.
- WANG X., EATON M., MAYER M., LI H., HE D., NELSON E., CHRISTOPHER-HENNINGS J., 2007. Porcine reproductive and respiratory syndrome virus productively infects monocyte-derived dendritic cells and compromises their antigen-presenting ability. *Arch. Virol.* **152**(2) :289–303. doi:10.1007/s00705-006-0857-1.

- WEESENDORP E., MORGAN S., STOCKHOFE-ZURWIEDEN N., GRAAF D.J., GRAHAM S.P., REBEL J.M.J., 2013. Comparative analysis of immune responses following experimental infection of pigs with european porcine reproductive and respiratory syndrome virus strains of differing virulence. *Vet. Microbiol.* **163** :1–12. doi:10.1016/j.vetmic.2012.09.013.
- WENSVOORT G., DE KLUYVER E.P., LUIJTZE E.A., DEN BESTEN A., HARRIS L., COLLINS J.E., CHRISTIANSON W.T., CHLADEK D., 1992. Antigenic comparison of lelystad virus and swine infertility and respiratory syndrome (SIRS) virus. *J. Vet. Diagn. Invest.* **4**(2) :134–138. doi:10.1177/104063879200400203.
- WESLEY D.R., LAGER K.M., KEHRLI M.E., 2006. Infection with porcine reproductive and respiratory syndrome virus stimulates an early gamma interferon response in the serum of pig. *Can. J. Vet. Res.* **70**(3) :176–182.
- WIGGINTON J.E., KIRSCHNER D., 2001. A model to predict cell-mediated immune regulatory mechanisms during human infection with *Mycobacterium tuberculosis*. *J. Immunol.* **166** :1951–1967.
- WIKRAMARATNA P.S., KUCHARSKI A., GUPTA S., ANDREASEN V., MCLEAN A.R., GOG J.R., 2014. Five challenges in modelling interacting strain dynamics. *Epidemics* doi:10.1016/j.epidem.2014.07.005. In press.
- WILLS R.W., DOSTER A.R., GALEOTA J.A., SUR J.H., OSORIO F.A., 2003. Duration of infection and proportion of pigs persistently infected with porcine reproductive and respiratory syndrome virus. *J. Clin. Microbiol.* **41**(1) :58–62. doi:10.1128/JCM.41.1.58-62.2003.
- WONGYANIN P., BURANAPRADITKUN S., CHOKESHAI-USAHA K., THANAWONGUWECH R., SURADHAT S., 2010. Induction of inducible CD4+CD25+Foxp3+ regulatory T lymphocytes by porcine reproductive and respiratory syndrome virus (PRRSV). *Vet. Immunol. Immunop.* **133**(2-4) :170–182. doi:10.1016/j.vetimm.2009.07.012.
- XIAO Z., BATISTA L., DEE S., HALBUR P., MURTAUGH M.P., 2004. The level of virus-specific T-cell and macrophage recruitment in porcine reproductive and respiratory syndrome virus infection in pigs is independent of virus load. *J. Virol.* **78** :5923–5933. doi:10.1128/JVI.78.11.5923-5933.2004.
- YATES A., BERGMANN C., VAN HEMMEN J.L., STARK J., CALLARD R., 2000. Cytokine-modulated regulation of helper T cell populations. *J. Theor. Biol.* **206**(4) :539–560. doi:10.1006/jtbi.2000.2147.
- YATES A., CHAN C.C.W., CALLARD R.E., GEORGE A.J.T., STARK J., 2001. An approach to modelling in immunology. *Brief. Bioinform.* **2**(3) :245–257. doi:10.1093/bib/2.3.245.
- YOO D., SONG C., SUN Y., DU Y., KIM O., LIU H.C., 2010. Modulation of host cell responses and evasion strategies for porcine reproductive and respiratory syndrome virus. *Virus Res.* **154**(1–2) :48–60. doi:10.1016/j.virusres.2010.07.019.
- YOON K.J., WU L.L., ZIMMERMAN J.J., PLATT K.B., 1997. Field isolates of porcine reproductive and respiratory syndrome virus (PRRSV) vary in their susceptibility to antibody dependent enhancement (ADE) of infection. *Vet. Microbiol.* **55**(1) :277–287. doi:10.1016/S0378-1135(96)01338-7.
- YOON K.J., ZIMMERMAN J.J., CHANG C.C., CANCEL-TIRADO S., HARMON K.M., MCGINLEY M.J., 1999. Effect of challenge dose and route on porcine reproductive and respiratory syndrome virus (PRRSV) infection in young swine. *Vet. Res.* **30**(6) :629–638.

ZIMMERMAN J., 2003. Epidemiology and ecology. In *2003 PRRS Compendium : A Comprehensive Reference on Porcine Reproductive and Respiratory Syndrome for Pork Producers, Veterinary Practitioners, and Researchers*, edited by J. ZIMMERMAN, K.J. YOON, National Pork Board (Des Moines, Iowa, USA), 2nd edn., chap. 4, pp. 25–34.

ZIMMERMAN J., BENFIELD D.A., MURTAUGH M.P., OSORIO F., STEVENSON G.W., TORRE-MORELL M., 2006. Porcine reproductive and respiratory syndrome virus (porcine arterivirus). In *Diseases of swine*, edited by B.E. STRAW, J.J. ZIMMERMAN, S. D'ALLAIRE, D.L. TAYLOR, Blackwell (Oxford, UK), 9th edn., chap. 24, pp. 387–418.

Publication list

1 Journal publications

1. GO N., BELLOC C., BIDOT C., TOUZEAU S., 2014. Why, when and how should exposure be considered at the within-host scale? A modelling contribution to PRRSv infection. Submitted to *Epidemics*, December 2014.

ABSTRACT – Understanding the impact of exposure on the within-host dynamics and its outcome in terms of infectiousness is a key issue to better understand and control the infection spread. It has not been fully explored yet, neither in experimental infections, nor in modelling studies, which mostly represent exposure by a punctual dose. We tackled this issue by a modelling approach focused on the Porcine Reproductive and Respiratory Syndrome virus (PRRSv), a major concern for the swine industry. PRRSv immune response is partially understood and highly variable depending on viral strains and host susceptibilities.

We used a mathematical model representing PRRSv immune and infection dynamics in the lung; we built designs of numerical experiments to explore the impact of exposure intensity, duration and peak, as well as strain virulence, on characteristics of the viral and immune dynamics; we then quantified their impact by sensitivity analyses and descriptive statistics.

We found that the infection severity was fully determined by the exposure intensity. The infection duration increased with the strain virulence and, for a given strain, exhibited a positive linear correlation with the exposure intensity logarithm and the exposure duration.

Exposure simplifications should hence at least preserve the exposure intensity. Besides, representing the exposure due to contacts by short or even punctual exposures would tend to underestimate the infection duration. As the infection severity and duration both contribute to the pig infectiousness, a prolonged exposure of the adequate intensity would be recommended in an immunological context.

2. GO N., BIDOT C., BELLOC C., TOUZEAU S., 2014. Integrative model of the immune response to a pulmonary macrophage infection : what determines the infection duration? *PLoS ONE* **9**(9) :e107818. doi : [10.1371/journal.pone.0107818](https://doi.org/10.1371/journal.pone.0107818).

ABSTRACT – The immune mechanisms which determine the infection duration induced by pathogens targeting pulmonary macrophages are poorly known. To explore the impact of such pathogens, it is indispensable to integrate the various immune mechanisms and to take into account the variability in pathogen virulence and host susceptibility. In this context, mathematical models complement experimentation and are powerful tools to represent and explore the complex mechanisms involved in the infection and immune dynamics. We developed an

original mathematical model in which we detailed the interactions between the macrophages and the pathogen, the orientation of the adaptive response and the cytokine regulations. We applied our model to the Porcine Respiratory and Reproductive Syndrome virus (PRRSv), a major concern for the swine industry. We extracted value ranges for the model parameters from modelling and experimental studies on respiratory pathogens. We identified the most influential parameters through a sensitivity analysis. We defined a parameter set, the reference scenario, resulting in a realistic and representative immune response to PRRSv infection. We then defined scenarios corresponding to graduated levels of strain virulence and host susceptibility around the reference scenario. We observed that high levels of antiviral cytokines and a dominant cellular response were associated with either short, the usual assumption, or long infection durations. We showed that, to identify and understand the immune mechanisms responsible for the infection duration, we need at least (i) the levels of innate antiviral cytokines, (ii) the level of IL₁₀ (a good indicator of the infected macrophage level), and (iii) the relative level of IL₁₀ and IFN_γ (good indicators of the adaptive response orientation). Available PRRSv vaccines lack efficiency. By integrating the main interactions between the complex immune mechanisms, this modelling framework could be used to help designing more efficient vaccination strategies.

2 Oral presentations in conferences

1. GO N., BELLOC C., BIDOT C., TOUZEAU S., 2014. Modelling the infection and immune dynamics induced by a pathogen targeting pulmonary macrophages : influence of strain virulence and host exposure. In *9th European Conference on Mathematical and Theoretical Biology (ECMTB 2014)* , Göteborg (Sweden), June 2014. <http://ecmtb2014.org/>

ABSTRACT – The immune mechanisms which determine the infection severity and duration induced by pathogens targeting pulmonary macrophages are poorly known. To explore the impact of such pathogens, it is indispensable to integrate the various immune mechanisms and to take into account the variability in pathogen virulence, host susceptibility, and host exposure to the pathogen. In this context, we developed an original ODE model representing the infection and immune dynamics induced by a pathogen targeting pulmonary macrophages in the lung. Compared to previous modelling studies, we detailed the macrophage-pathogen interactions, the innate immune response, and the cytokine regulations. The adaptive immune response included the cellular, humoral, and regulatory orientations, and their main functions.

The model obtained has 14 state variables : the free viral particles ; four effectors of the innate response, consisting of three macrophage states (susceptible, phagocytosing, and infected) and the natural killers ; three effectors of the adaptive response, representing the cellular, humoral and regulatory responses ; seven cytokine groups consisting of the major pro-inflammatory, the innate antiviral and the immuno-regulatory (IFN_γ, IL₁₂, IL₁₀, TGF_β) cytokines. The main processes integrated in the model are : the phagocytosis of the viral particles by the macrophages ; the macrophage infection by the virus ; the excretion of free viral particles by the infected macrophages ; the recruitment and decay/migration of the macrophages ; the activation and decay/migration of the other effectors ; the cytokine productions by the immune cells and their decay ; the cytokine regulations.

We calibrated our model for the Porcine Respiratory and Reproductive Syndrome virus (PRRSv), a major concern for the swine industry. We extracted value ranges for the model parameters from modelling and experimental studies on respiratory pathogens. We identified the most influential parameters through a sensitivity analysis.

We first used our model to explore the influence of strain virulence and host susceptibility on the infection duration and immune dynamics. We obtained contrasted dynamics, suggesting hypotheses to explain the apparent contradictions between published results : high levels of antiviral cytokines and a dominant cellular response were associated with either short, the usual assumption, or long infection durations. In addition, we extracted some synthetic and original elements from our work to characterise immune mechanisms and their impact on the infection duration.

We then used our model to explore the impact of host exposure on the infection duration and severity for various levels of strain virulence. We tested several functions to account for experimental inoculations or natural infections (by contact). We performed multivariate sensitivity analysis to identify the influences of strain virulence, dose and duration exposure on the viral and immune dynamics. We found that the maximal inoculation dose, the exposure duration and the virulence levels highly influenced the viral and immune dynamics. In particular, (i) short and high exposures induced high viral peaks associated with a cellular and antiviral responses and (ii) high virulence, high or/and prolonged exposure induced prolonged infection associated with a strong immune response activation and a dominante humoral response.

2. GO N., BIDOT C., BELLOC C., TOUZEAU S., 2013. Modelling of immune response to a respiratory virus targeting pulmonary macrophages : exploration of the host susceptibility and viral virulence. In *Systems Biology Approach to Infectious Processes (SBIP 2013)*, Lyon (France), May 2013. <http://sbip2013.sciencesconf.org/>

ABSTRACT – Respiratory viruses are responsible for tissue damages and local inflammation. The best strategy to control their severity is to limit the infection while maintaining an efficient immune response. Given this context, the case when the macrophage is the target cell of infection is of interest. Indeed, pulmonary macrophages (i) are responsible for inflammation and viral destruction by phagocytosis and (ii) participate in the induction and orientation of the adaptive immune response. Consequently, macrophage infection hampers the whole immune response. The interaction between macrophages and virus during the first steps of infection has not been thoroughly investigated in experimental studies and is not detailed in models of immune response. Consequently, the influence of macrophage–virus interactions on the infection resolution is unknown. Here, we propose an original model of the immune response centred on the macrophage – virus interactions. We represent all macrophage infectious statuses, their immune functions, and the interactions between innate and adaptive responses taking into account the cytokines regulations. We use the model to study the relative influence of macrophage – virus interactions on the infection resolution by a multivariate sensitivity analysis. Then, we explore the influence of macrophage immune functions by considering two levels of host susceptibility and viral virulence. We conclude that both replication rate of the virus and host capacity to synthesize anti-viral cytokines are key for infection resolution.

3. GO N., BIDOT C., BELLOC C., TOUZEAU S., 2013. Modelling the interactions between the PRRSV and its target cells : conditions for virus clearance. In *9^{ème} colloque du réseau français d'Immunologie des Animaux Domestiques (IAD)*, Paris (France), January 2013. <https://colloque6.inra.fr/iad/Programme>

ABSTRACT – Efficient vaccines are lacking for the control of Porcine Respiratory and Reproductive Syndrome Virus (PRRSV) infection, a major concern for swine industry. The interactions between the virus and the immune system are only partially understood. The first steps of the innate immune response seem crucial for the infection outcome. The PRRS virus replicates mainly in the pulmonary macrophages which play a key role in the innate immunity mechanisms. They are responsible for inflammation and viral destruction by phagocytosis and they participate in the induction and orientation of the adaptive immune response. During a PRRS infection, macrophages also act as target cells for the virus, which can hamper the immune response. To explore these complex mechanisms and test biological hypothesis, we propose an original model centred on macrophage - virus interactions in the lung. Comparatively to previous modelling studies we highly detail the temporal dynamics of the innate immune response to better understand the influences of the macrophage-virus interactions on the viral clearance. We use a system of eighteen state variables : the viral particles, the four macrophage states (healthy, phagocytosing, infected non excreting and infected excreting), the nine major cytokines involved in the macrophage dynamics ($IL_{1\beta}$, IL_6 , IL_8 , IL_{10} , IL_{12} , TNF_{α} , IFN_{α} , IFN_{γ} , TGF_{β}) and four other immune cells (natural killers, cells involved in the humoral and cellular adaptive immune responses and regulatory cells). Cytokine productions by the immune cells are represented. The macrophages interactions with the viral particles are regulated by the cytokines. Activation/inhibition effects of the cytokines are included. These numerous interactions result in a complex non-linear model. To calibrate our model, we combined data from experimental and modelling studies on the PRRS virus and similar pathogens. To explore the relative influence of the immune mechanisms on the virus clearance we conducted a multivariate sensitivity analysis using the R package multisensi. We showed that the first steps of macrophage-virus interactions are crucial for the outcome of the PRRS virus infection. As expected, the promoting of the cellular response favoured the viral clearance. In further studies we will use the model in order to test control measures to resolve the infection. Moreover, our model can be easily adapted and applied to other pathogens infecting macrophages.

4. GO N., BIDOT C., BELLOC C., TOUZEAU S., 2012. Modelling the interactions between virus and pulmonary macrophages as target cells in a respiratory infection : conditions for virus clearance. In *11th International Conference on Artificial Immune System (ICARIS)*, Taormina (Italy), August 2012. <http://www.artificial-immune-systems.org/icaris/2012/>

ABSTRACT – Respiratory infections are a major issue for both human and animal health. To control their severity, the best strategy is to limit the inflammation while maintaining an efficient immune response. Macrophages play a key role in the innate immunity mechanisms. They are responsible for inflammation and viral destruction by phagocytosis and they participate in the induction and orientation of the adaptive immune response. However, when macrophages also act as target cells for the infection, the immune response is hampered. Some recent

studies suggest that the innate immune mechanisms could play a key role in the virus clearance. Our goal is to further explore the influence of these mechanisms. We chose a modelling approach to combine data from several studies in order to represent the immune response dynamics. We have developed an original model centred on macrophage - virus interactions in the lung. We use a system of eighteen state variables : the viral particles, the four macrophage states (healthy, phagocytosing, infected non excreting and infected excreting), the nine major cytokines involved in the macrophage dynamics ($IL_{1\beta}$, IL_6 , IL_8 , IL_{10} , IL_{12} , TNF_α , IFN_α , IFN_γ , TGF_β) and the main other immune cells (natural killers, cells involved in the humoral and cellular adaptive immune response and regulatory cells). The temporal dynamics of the innate immune response is highly detailed compared to previous modelling studies. Cytokine productions by macrophages and other immune cells are represented. The macrophages interactions with the viral particles are regulated by the cytokines. Activation/inhibition effects of the cytokines are included. These numerous interactions result in a complex non-linear model. The model was calibrated for the porcine reproductive and respiratory syndrome virus, a major respiratory pathogen in swine production. We used the model to explore the influence of the innate immune mechanisms on the virus clearance. Our results could suggest new orientations in vaccine development. Moreover, our model can easily be adapted and applied to other pathogens infecting pulmonary macrophages.

3 Posters in conferences

1. GO N., BIDOT C., BELLOC C., TOUZEAU S., 2013. Identification of key immune mechanisms for Porcine Respiratory and Reproductive Syndrome Virus resolution of infection by a modelling approach. In *4th International Conference on Infectious Disease Dynamics (EPIDEMICS 4)*, Amsterdam (The Netherlands), November 2013. <http://www.epidemics.elsevier.com/previous-conferences.html>

ABSTRACT – The Porcine Respiratory and Reproductive Syndrome (PRRS) is a major concern for the swine industry. The host response presents a high temporal and between-host variability in particular the host infectiousness. Therefore, to predict and control the infection spread, one first needs to better understand the within-host dynamics. However, the immune mechanisms are still poorly understood. To explore their impact on the infection resolution, we chose a modelling approach.

We first developed an original model of the infection and immune dynamics in the lung. We represented the interactions between target cells (macrophages) and viral particles (phagocytosis and infection), the innate immune response, the adaptive response orientation (regulatory, humoral and cellular responses) and the cytokine regulations. We calibrated the model to literature data. We performed a multivariate sensitivity analysis to identify the model key parameters for the infection resolution. We then explored the influence of host susceptibility and viral virulence.

Our first results show that the parameters involved in the macrophage-virus interactions have a strong impact on the viral titer. Compared to a reference scenario with intermediate conditions of virulence and susceptibility (black plain line), conditions in favour of infection (red dashed line) highly increased the infection

duration, while lower conditions (blue dotted line). Moreover, the infection severity is positively correlated to the proportion of infected macrophages, the concentration of immuno-modulatory cytokines and the orientation towards the regulatory adaptive response.

We are currently integrating a better representation of the immune dynamics outside the lung and a more detailed adaptive response. Our results suggest that the macrophage-virus interactions can determine the infection outcome, while they have been neglected in previous studies. As a consequence strategies promoting innate immunity, such as selection of less susceptible pigs, could improve the control of PRRS if associated with vaccines.

2. GO N., BIDOT C., BELLOC C., TOUZEAU S., 2013. Exploration of the macrophage – virus interactions during a Porcine Respiratory and Reproductive Syndrome Virus (PRRSV) infection by a modelling approach. In *64th Annual Meeting of the European federation of animal science (EAAP 2013)*, Nantes (France), August 2013. <http://www.eaap2013.org/>

ABSTRACT – Porcine Respiratory and Reproductive Syndrome Virus (PRRSV) infection is a major concern for swine industry. Our partial understanding of the interactions between the virus and the immune system is the major reason for the lack of efficient control measures. The PRRS virus replicates mainly in the pulmonary macrophages which (i) are responsible for inflammation and viral destruction by phagocytosis and (ii) participate in the induction and orientation of the adaptive immune response. Consequently, macrophage infection hampers the whole immune response. The interactions between macrophages and virus during the first steps of infection have not been thoroughly investigated and their influence on the infection resolution is unknown. Here, we propose an original model simulating immune and infection dynamics to explore these complex mechanisms and test biological hypotheses. We highly detail the immune functions and infectious statuses of macrophages and take into account interactions between innate and adaptive responses and cytokines regulations. We use the model to study the relative influence of macrophage–virus interactions on the infection resolution comparatively to adaptive mechanisms .

3. GO N., BIDOT C., BELLOC C., TOUZEAU S., 2013. Exploration of the immune response to the PRRSV by a modelling approach. In *5th European Symposium of Porcine Health Management (ESPHM 2013)*, Edinburgh (UK), May 2013. <http://www.esphm2013.org/>

ABSTRACT – PRRSV replicates mainly in the pulmonary macrophages which (i) are responsible for inflammation and viral destruction by phagocytosis and (ii) participate in the induction and orientation of the adaptive immune response. Experimental studies have shown that PRRSV is able to inhibit innate immunity, to reduce the gamma interferon synthesis and to limit the efficiency of neutralizing antibodies. Moreover the virulence and the resulting interaction with the host immune system are variable between viral strains. Our limited understanding of the interaction between the virus and the immune system is the main obstacle in the evaluation of control measures and the development of more efficient vaccines. To explore these complex mechanisms and test biological hypotheses, we propose an original model of the immune response centred on macrophage - virus interactions in the lung. Comparatively to previous modelling studies we highly detailed the temporal dynamics of the innate immune response to better understand the effect of the macrophage-virus interactions on the viral clearance. To explore the relative influence of the immune mechanisms

on the infection outcome we conducted a multivariate sensitivity analysis using the R package *multisensi*. We showed that the first steps of macrophage-virus interactions are crucial. We used the model to explore the immune response to strains of variable virulence and to determine the required conditions for viral clearance.

PhD defense



PHD THESIS, INRA - DOCTORAL SCHOOL ABIES - AGROPARISTECH

Monday 8th December 2014

MODELLING THE IMMUNE RESPONSE TO THE PORCINE RESPIRATORY AND REPRODUCTIVE SYNDROME VIRUS (PRRSv)

Natacha Go

UR341 MIA, INRA, Jouy-en-Josas, France & UMR1300 BioEpAR, Oniris & INRA, Nantes, France

Supervisors:

Suzanne TOUZEAU, UMR1355 ISA, INRA & BIOCORE, Inria, Sophia Antipolis, France

Catherine BELLOC, UMR1300 BioEpAR, Oniris & INRA, Nantes, France



What is PRRS?

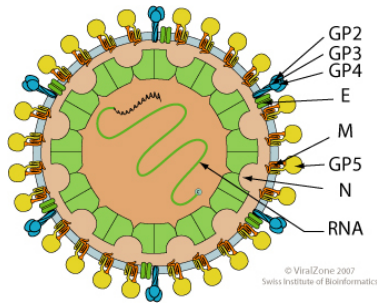

Arterivirus, small enveloped
RNA (nucleocapsid core)

A major concern for the swine industry:

- Present in most pig-producing areas throughout the world
- Responsible for significant production losses
- Numerous commercial **vaccines**, but
 - not efficient enough to eradicate the infection
 - conferring only a partial protection
- allow to reduce the disease spread and the symptom severity

Need to improve the vaccine efficiency at the host level!

2

PRRSv spread

- Transmission: direct contacts
- **Spread** [Nodeljik *et al.*, 2003]:
 - contact structure
 - prevalence
 - **susceptibility**: genotype (breed...), age & infectious past [Lunney *et al.*, 2010]
 - **infectiousness**: viral titer (immune dynamics) [Charpin *et al.*, 2012]
- **Protection** (~ immune status): memory response

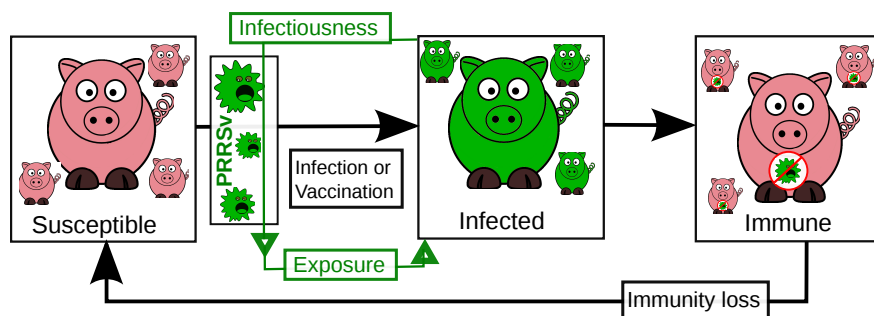

3

PRRSv within-host dynamics

PRRSv targets antigen presenting cells → infection & immune response

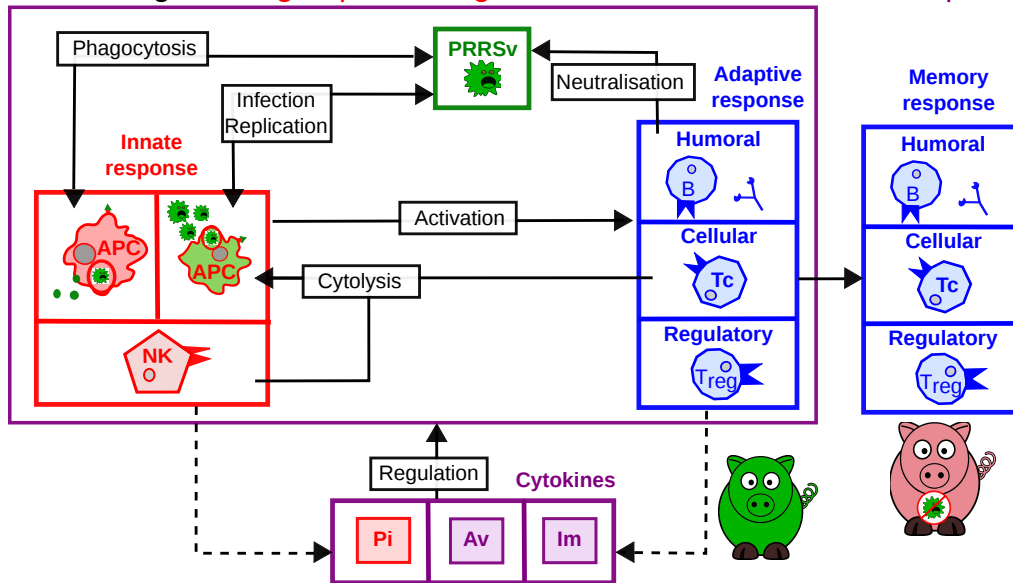

PRRSv specificities

PRRSv hampers the whole immune response

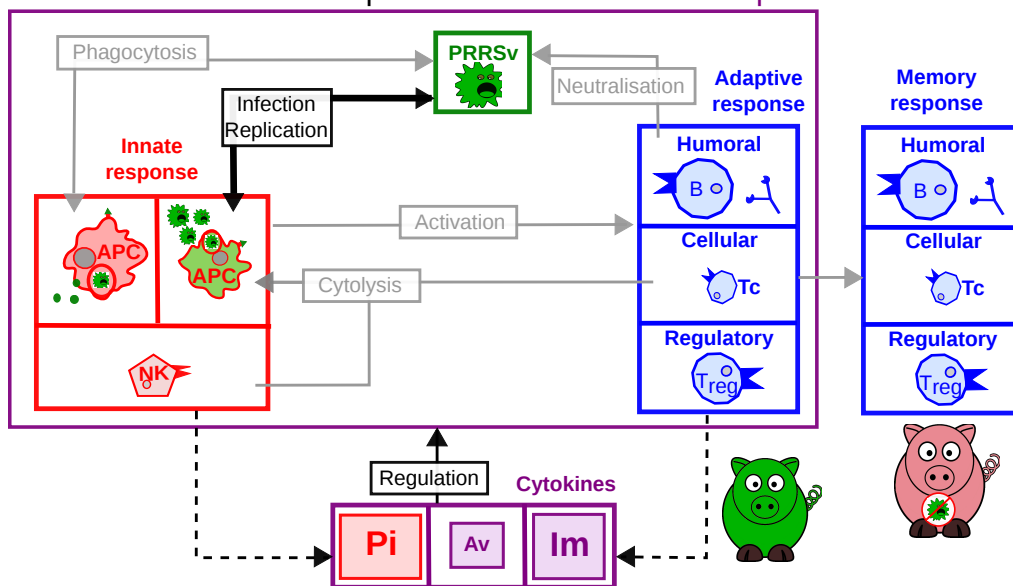

→ Prolonged and severe infection; weak memory response

[Zimmerman *et al.*, 2006; Mateu & Diaz, 2008; Darwich *et al.*, 2010; Murtaugh & Genzow, 2011; Gomez-Laguna *et al.*, 2013; Buttler, 2014]

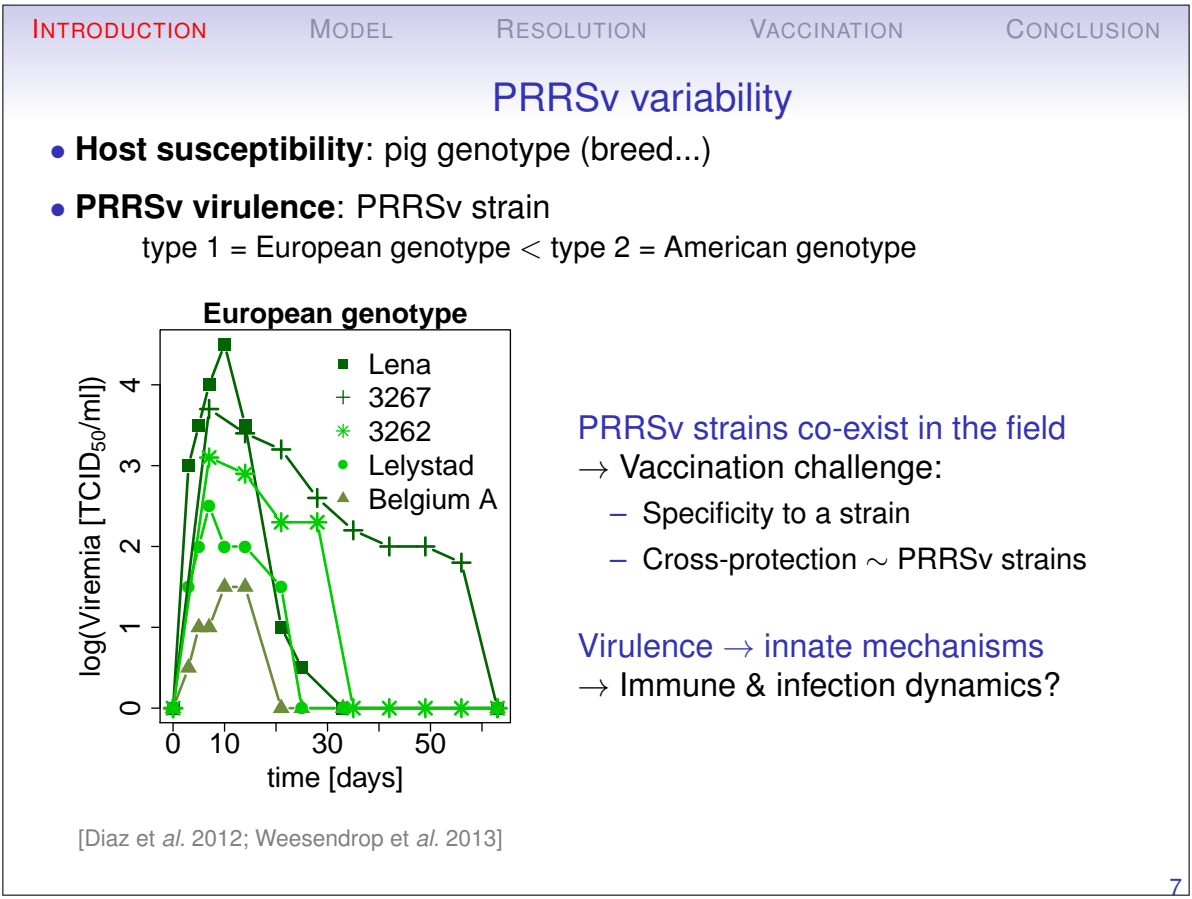
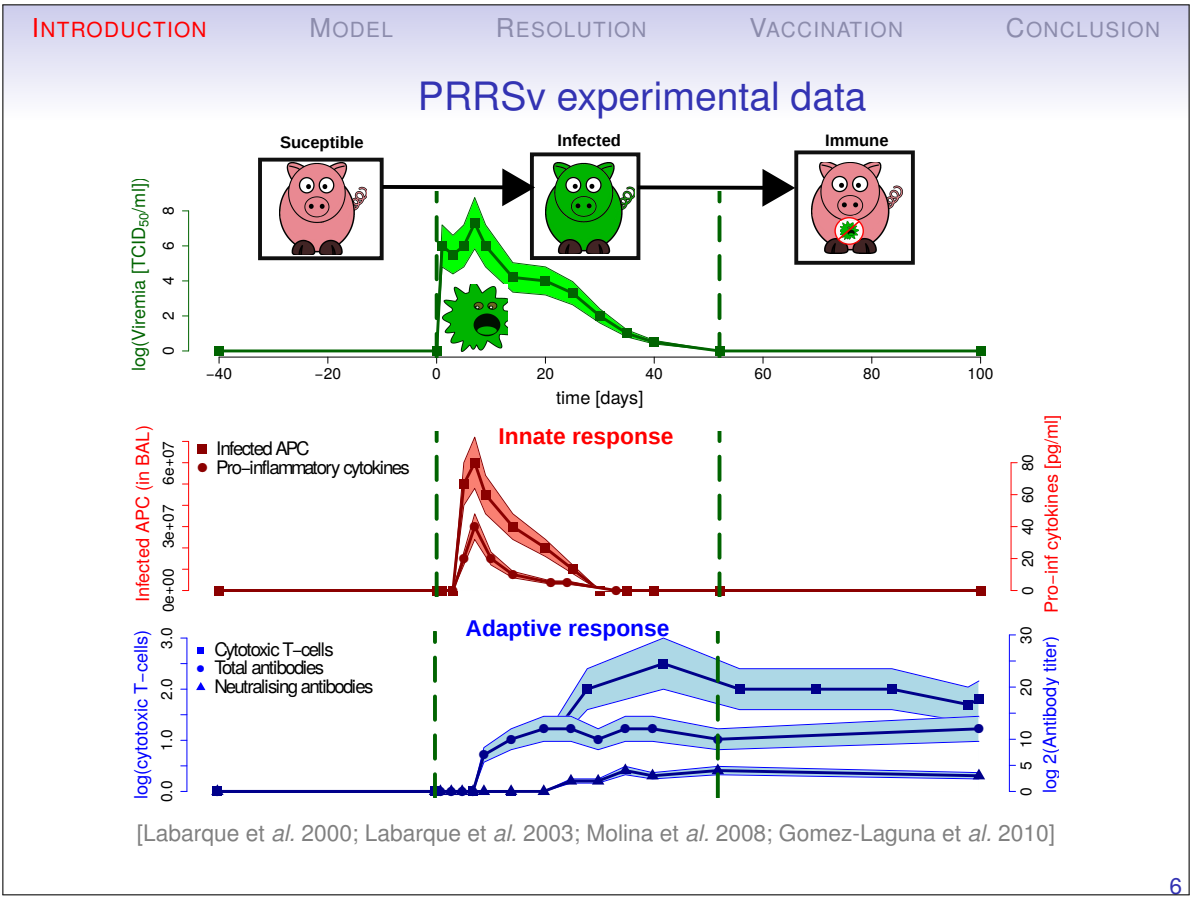

PRRSv variability

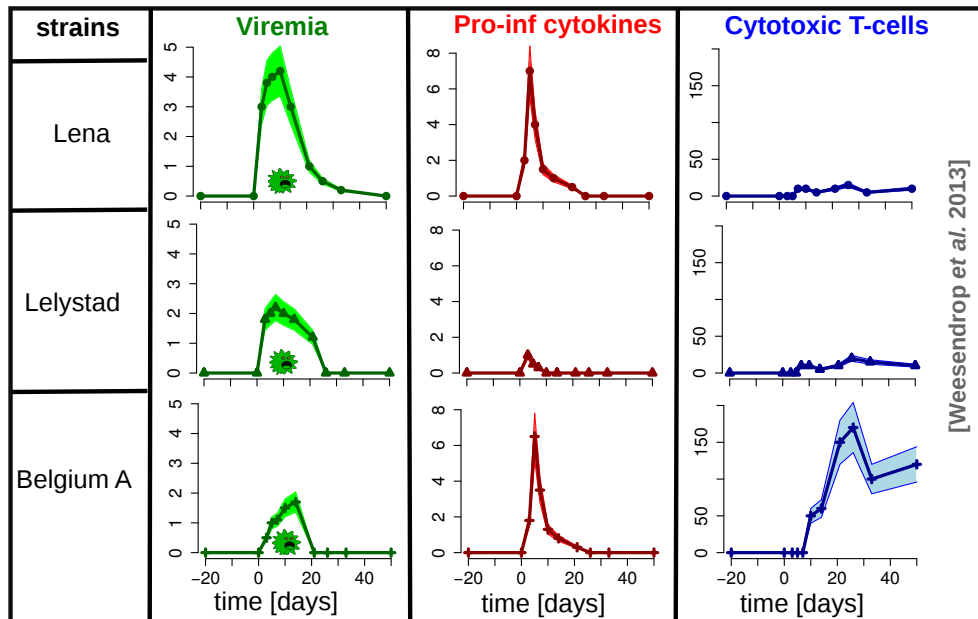

Link: viral dynamics ↔ innate & adaptive mechanisms?
 Variable adaptive response → variable protection levels

8

Thesis issues

1. Which **immune mechanisms** determine the **infection resolution**?

A- Naive & isolated pig: [Go et al., 2014]
 depending on **virulence**

B- Naive pig in the field: [Go et al., 2014 (submitted)]
 depending on virulence & **exposure** (infectiousness of contact pigs)

2. Which **immune mechanisms** determine the **protection**?

Vaccinated pig in the field:
 depending on virulence, exposure & **memory response**

→ **Modelling approach:**

- linking immune mechanisms & viral titer
 → difficult with experimental approaches (scale, technical constraints)
- strain virulence & host susceptibility variability
 → costly with experimentation

9

Outline

1. Introduction
2. **Modelling approach**
 - Model scheme
 - Model equations
 - Model overview
 - Calibration
3. Which immune mechanisms determine the infection resolution?
4. Exploration of vaccine efficiency
5. General conclusion

10

Modelling approach

Scale: integrative view at the between-cell scale

- PRRSv infection hampers and is regulated by the innate & adaptive immune mechanisms
- PRRSv variability affects immune mechanisms

Formalism: deterministic dynamic system (ODE)

evolution over time of PRRSv and immune component concentrations

Literature review:

- immune mechanisms involved during PRRSv infection
- published models (applied to PRRSv or other pathogens targeting APC)
Either [*detailed but partial*] or [*global but with few explicit mechanisms*]

→ **ORIGINAL MODEL** of PRRSv within-host dynamics

11

Model scheme – Within-host dynamics

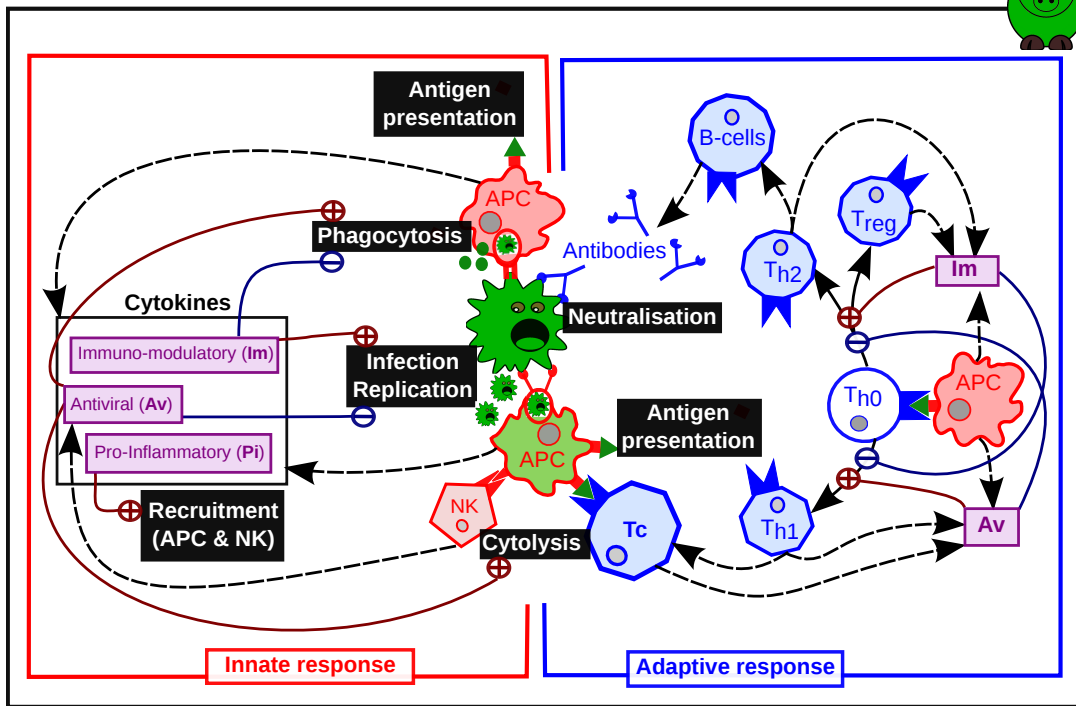
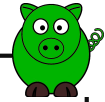

Model equations (1/2)

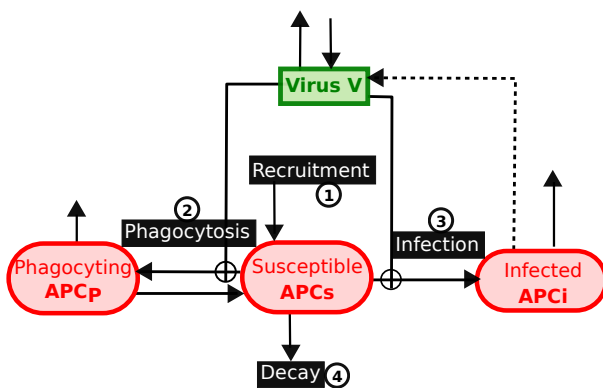

$$\begin{aligned}
 \dot{APC}_s = & \\
 & + A_m \quad \text{①} \\
 & - \eta APC_s V \quad \text{②} \\
 & + \gamma APC_p \quad \text{②} \\
 & - \beta APC_s V \quad \text{③} \\
 & - APC_s \mu_M^{nat} \quad \text{④}
 \end{aligned}$$

Model equations (2/2)

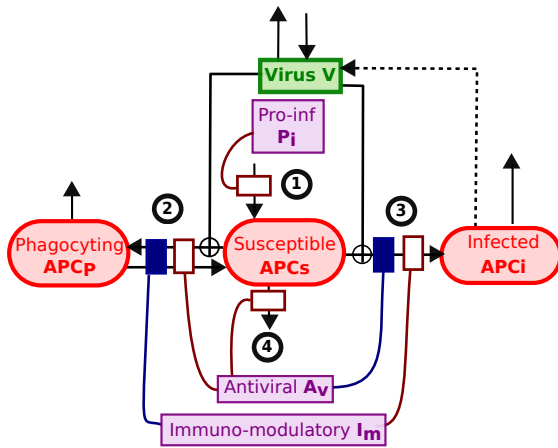

$$\begin{aligned}
 \dot{APC}_S = & \\
 & + A_m [1 + \kappa^+(P_i)] \textcircled{1} \\
 & - \eta APC_S V \kappa^-(I_m) [1 + \kappa^+(A_v)] \textcircled{2} \\
 & + \gamma APC_P \kappa^-(I_m) [1 + \kappa^+(A_v)] \textcircled{2} \\
 & - \beta APC_S V \kappa^-(A_v) [1 + \kappa^+(I_m)] \textcircled{3} \\
 & - APC_S [\mu_M^{\text{nat}} + \mu_M^{\text{inf}} \kappa^+(A_v)] \textcircled{4}
 \end{aligned}$$

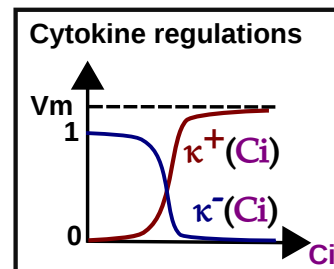

14

Model overview

State variables [28]

- PRRSv [1]
- **Innate response**: APC [8], NK [1]
- **Adaptive response**: Cellular [2], Humoral [5], Regulatory [1]
- **Cytokines** [10]: Pro-inf [3], Antiviral [4], Immuno-mod [3]

Parameters:

MECHANISMS:	PARAMETERS [76]
- APC-virus interactions	[9]
- Adaptive response activation	[2]
- Adaptive response orientation	[8]
- Cytotoxic cell functions	[4]
- Antibody functions	[6]
- Cytokine synthesis	[27]
- Cytokine functions	[2]
- Other (recruitment, decay, ...)	[19]

→ **Next step: model calibration**

15

Calibration

Few experimental data, high variability and uncertainty → *ad hoc* method

1. Exploration

- (a) Data collection from models on similar pathogens
- (b) Definition of large parameter ranges → exploration

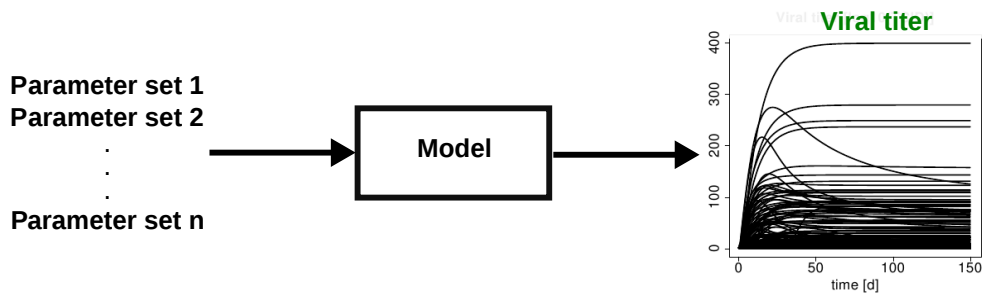

16

Calibration

Few experimental data, high variability and uncertainty → *ad hoc* method

1. Exploration

- (a) Data collection from models on similar pathogens
- (b) Definition of large parameter ranges → exploration

2. Selection

- (a) Definition of quantitative criteria for realistic dynamics (viral titer mainly)
- (b) Identification of realistic parameter sets → reference scenario

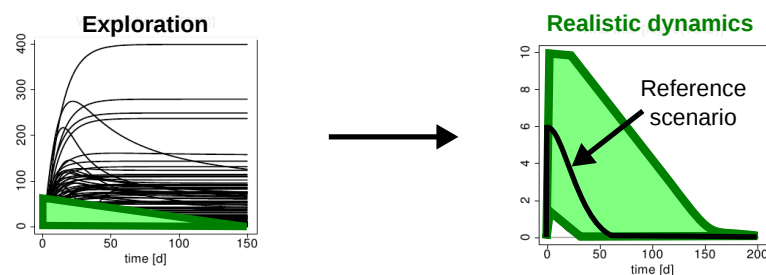

16

Calibration

Few experimental data, high variability and uncertainty → *ad hoc* method

1. Exploration

- (a) Data collection from models on similar pathogens
- (b) Definition of large parameter ranges → exploration

2. Selection

- (a) Definition of quantitative criteria for realistic dynamics (viral titer mainly)
- (b) Identification of realistic parameter sets → reference scenario

3. Sensitivity analysis

- (a) Robustness: varying the parameter values → realistic dynamics
- (b) Identification of most influential parameters

16

Outline

1. Introduction

2. Modelling approach

3. Which immune mechanisms determine the infection resolution?

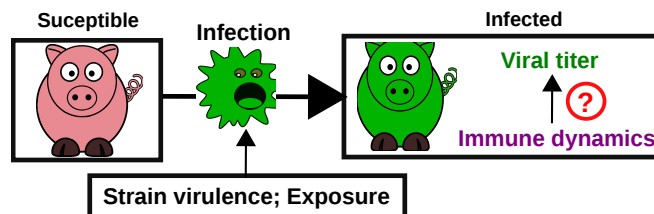

- Method
- Main results

4. Exploration of vaccine efficiency

5. General conclusion

17

Method

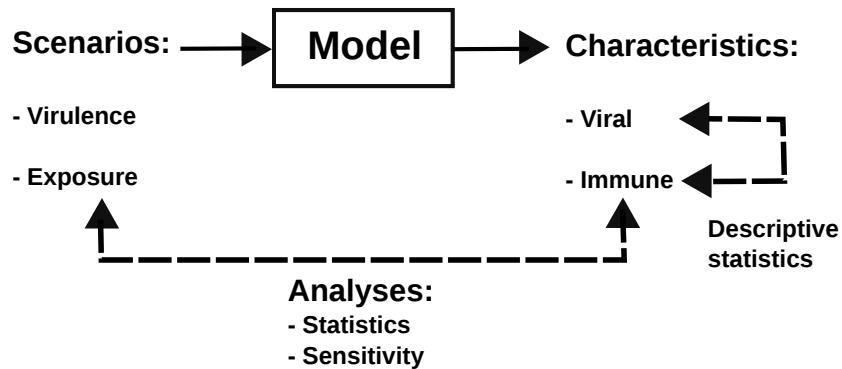

18

Method – Virulence scenarios

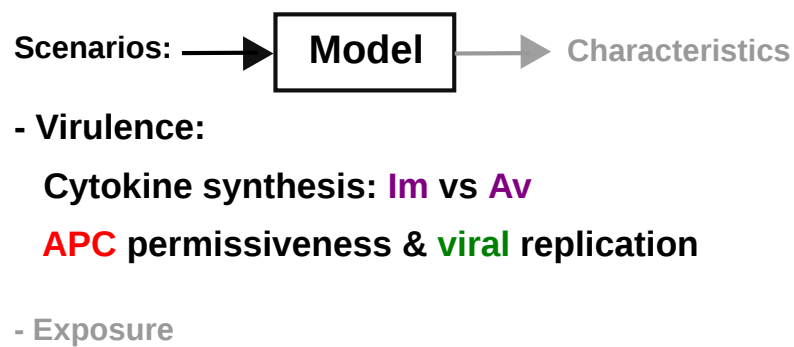

18

Method – Exposure scenarios



- Virulence

- Exposure:

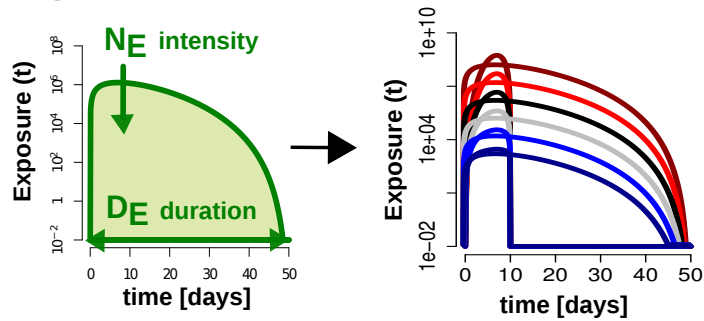

18

Method – Viral characteristics



- Viral:

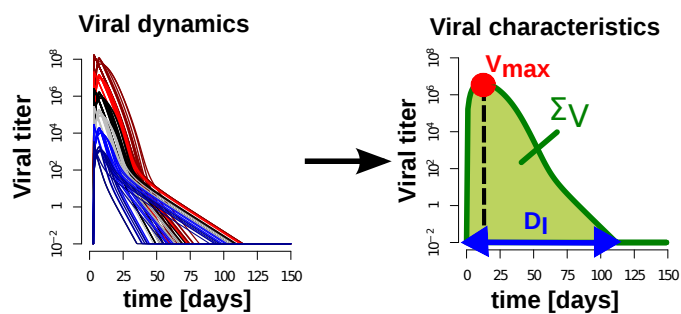

- Immune

18

Method – Immune characteristics

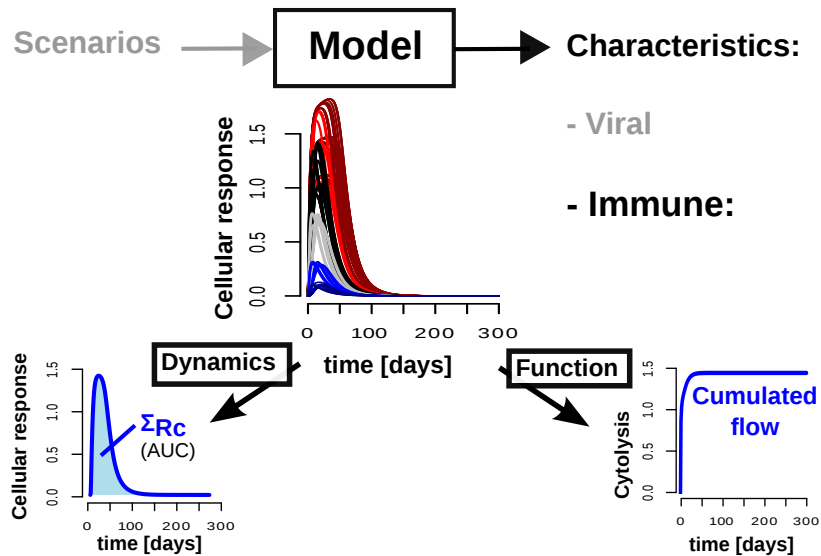

18

Which mechanisms determine the resolution?

Virulence:

low A_v & high I_m	→ high humoral	→ prolonged duration
high permissiveness	→ high cellular	

→ could explain apparent inconsistencies between experimental results

Exposure:

infection duration = virulence + exposure intensity + exposure duration

→ Insights for modelling:

- **Explicit mechanisms** of virulence & host susceptibility
- Exposure intensity + **duration**
- **Key parameters** linked to APC-PRRSv interactions

→ Insights for experimentations:

- **Measurable indicators:**
 - Pro-inflammatory cytokines → infection severity
 - IL_{10} (immuno-modulatory cytokine) → infected APC
 - Relative titers of A_v & I_m cytokines → adaptive response orientation

19

Outline

1. Introduction
2. Modelling approach
3. Which immune mechanisms determine the infection resolution?
4. **Exploration of vaccine efficiency**

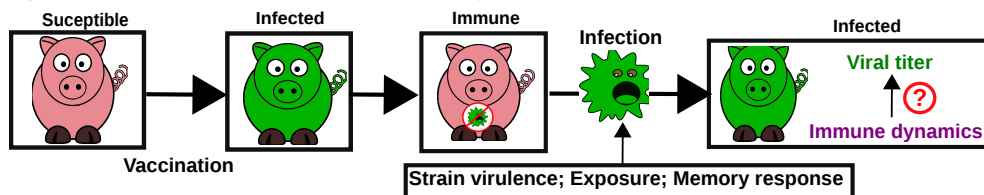

- Vaccination implementation
- Results
- Conclusion

5. General conclusion

20

Vaccination implementation

Modified-live PRRSv vaccine

1st step: Vaccination?

~ *Infection by an hypo-virulent PRRSv strain*

→ Simulation with adapted parameters (naive pig & hypo-virulent strain)

2nd step: Memory response?

~ *% of adaptive effectors with prolonged lifetime*

→ Cumulated number of activated cells (T_h , T_c , B) & antibodies from **1st step**

→ Two memory activation levels: $V_1 \equiv 10\%$ & $V_2 \equiv 40\%$

3rd step: Vaccinated pig?

~ *With memory response*

→ Initial conditions for the adaptive response: V_1 or V_2

Numerical design ~ 54 scenarios:

3 vaccination strategies (No, V_1 , V_2)

x 3 virulence levels

x 3 exposure intensities x 2 exposure durations

21

Results – Viral titer

- No impact on the total viral dose & viral peak,
- Clear impact on the **infection duration**

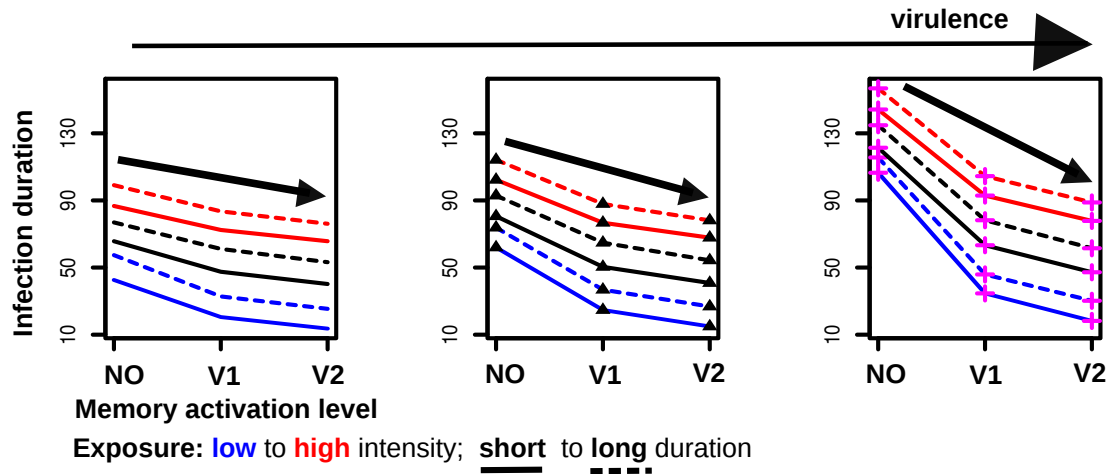

- The higher the **memory activation**, the higher the **vaccine efficiency**
- The higher the **virulence**, the higher the **vaccine efficiency**

22

Results – Viral titer

- No impact on the total viral dose & viral peak,
- Clear impact on the **infection duration**

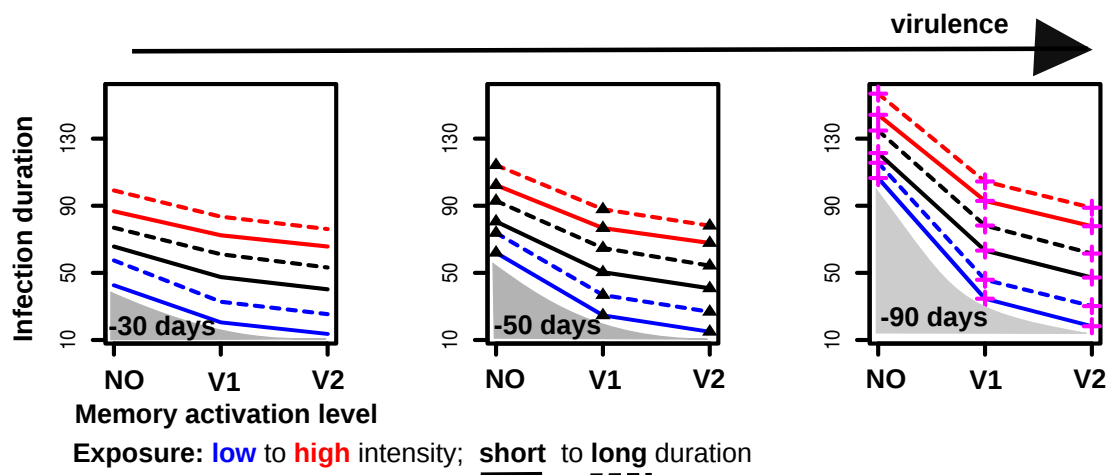

- The higher the **memory activation**, the higher the **vaccine efficiency**
- The higher the **virulence**, the higher the **vaccine efficiency**

22

Results – Infection duration & immune response

Innate mechanisms (phagocytosis, infection, excretion): \emptyset

Adaptive response orientation: no clear pattern, globally towards **regulatory**

Adaptive mechanisms: ↗ [neutralisation, cytolysis] → infection duration ↘

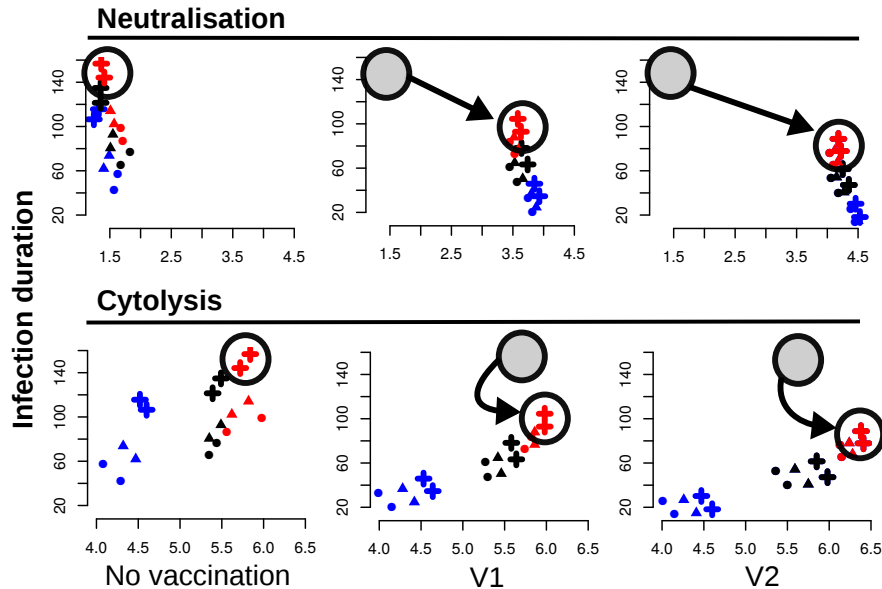

23

Conclusion

Results → towards more efficient vaccines

Assumptions:

- Live-modified vaccine (hypo-virulent strain)
- Full cross-protection
- No adjuvant

Prospects:

- Role of the regulatory response?
- Vaccines with adjuvant to improve the innate response?
- Multiple strains → cross-protection?

24

Outline

1. Introduction
2. Modelling approach
3. Which immune mechanisms determine the infection resolution?
4. Exploration of vaccine efficiency
5. **General conclusion**
 - Thesis insights
 - Main limits
 - Towards an immuno-epidemiological approach

25

Thesis insights

A powerful tool...

- Original within-host between-cell dynamic **model**
(*innate response, adaptive response orientation, cytokine regulations*)
- *Ad hoc* **calibration** method
(*parameter space exploration & constraints on observed outputs*)

... to:

- Better understand the interactions between immune mechanisms
- Guide further experiments
- Test & help the design of more efficient control strategies at the host level

26

Main limits

Model calibration & validation

- Implementation of an experimental infection:
2 PRRSV strains, monitoring key immune components

Full cross-protection

- Towards a multi-strain model with explicit memory dynamics

27

Towards an immuno-epidemiological approach

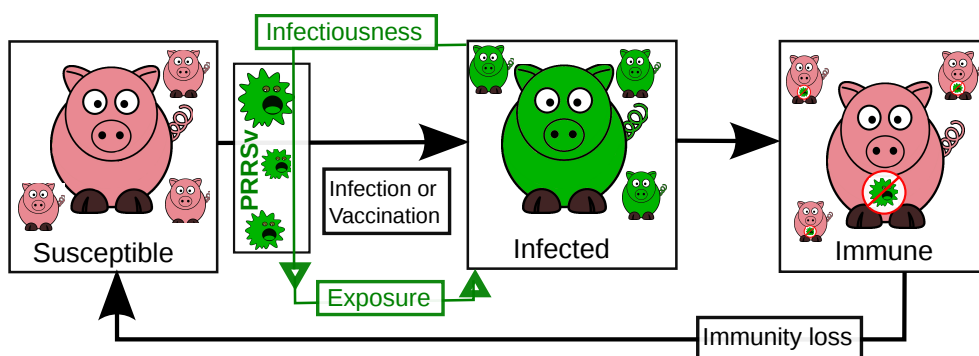

- + Between-host variability (variable susceptibility parameters)
- + Multiple strains (model with cross-protection)
- + Model reduction → at least:
[APC, functional cytokines, cellular effectors, neutralising antibodies]

28

Towards an immuno-epidemiological approach

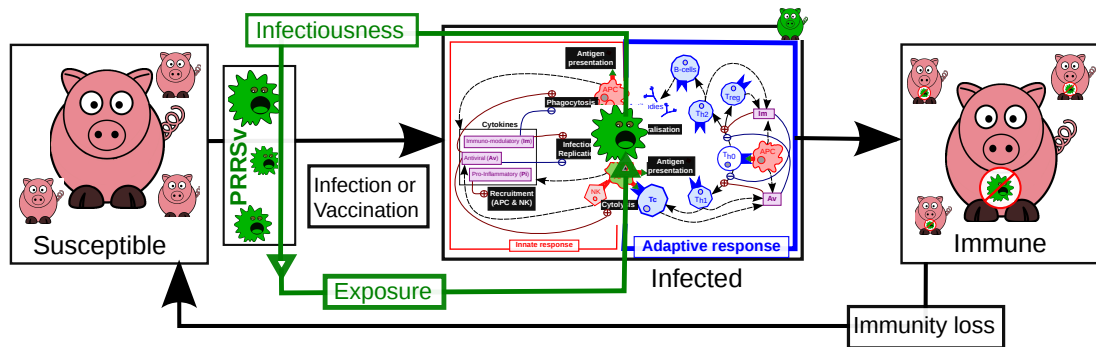

- + Between-host variability (variable susceptibility parameters)
- + Multiple strains (model with cross-protection)
- + Model reduction → at least:
[APC, functional cytokines, cellular effectors, neutralising antibodies]

Towards an immuno-epidemiological approach

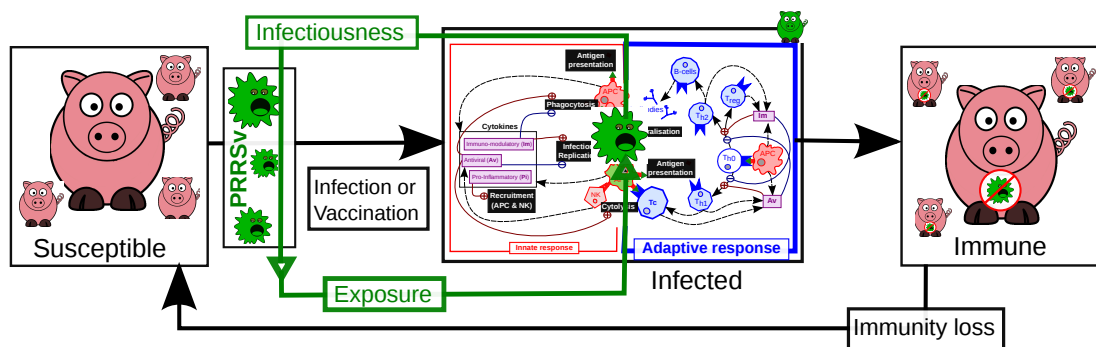

- + Between-host variability (variable susceptibility parameters)
- + Multiple strains (model with cross-protection)
- + Model reduction → at least:
[APC, functional cytokines, cellular effectors, neutralising antibodies]

RÉSUMÉ

Modélisation de la réponse immunitaire au virus du Syndrome Dysgénésique et Respiratoire Porcin (SDRPv)

Le SDRPv est responsable de pertes économiques mondiales et son contrôle est un enjeu majeur pour la production porcine. La vaccination, principale mesure de contrôle, ne permet pas d'éradiquer l'infection et confère seulement une protection partielle de l'hôte. Ce manque d'efficacité est principalement due à grande variabilité de virulence des souches de SDRPV, induisant des dynamiques intra-hôte très variables. L'objectif de cette thèse est de mieux comprendre les interactions entre le virus et la réponse immunitaire dans l'optique d'améliorer le contrôle de cette maladie. Pour cela, une approche de modélisation (déterministe et dynamique) a été choisie. Le modèle immunitaire développé est original et particulièrement adapté au SDRP. Il consiste en une représentation intégrative des interactions entre le SDRPv et le système immunitaire, décrivant les mécanismes à l'échelle inter-cellulaire. Premièrement, nos résultats montrent que des durées d'infection similaires associées à des dynamiques immunitaires contrastées s'expliquent par la prise en compte des mécanismes immunitaires impactés par la virulence. Cela apporte de nouvelles pistes pour expliquer les incohérences apparentes entre résultats expérimentaux. Ensuite, nous avons mis en évidence un impact du niveau et de la durée d'exposition sur la dynamique intra-hôte (encore non explorés pour le SDRP) et cet impact était variable en fonction de la virulence. Finalement, nous avons exploré la dynamique intra-hôte induite par l'infection (en condition naturelle) d'animaux vaccinés, ouvrant des pistes pour améliorer l'efficacité des vaccins. Cette thèse apporte également de nouvelles pistes pour guider les approches futures, aussi bien expérimentales que par modélisation, ainsi que des perspectives prometteuses pour le contrôle du SDRP à l'échelle du troupeau.

Mots-clés : SDRP, pathogène respiratoire, modèle mathématique, dynamique intra-hôte, échelle inter-cellulaire, réponse immunitaire (innée et adaptative), virulence de la souche, exposition, vaccination

ABSTRACT

Modelling the immune response to the Porcine Respiratory and Reproductive Syndrome virus (PRRSv)

PRRSv is responsible for significant worldwide production loses and its control is a major challenge for the swine industry. The vaccination, which is the main control measure, did not allow to eradicate the infection and confers only a partial protection of the host. This efficiency lack is mainly due to the strong variability in PRRSv strain virulence, which induces highly variable within-host dynamics. This thesis aims to better understand the interactions between the virus and the immune response in order to improve the PRRS control. To tackle this issue, a modelling approach (deterministic and dynamic) has been choose. We developed an original immunological model, particularly adapted to PRRS. It consists of an integrative view of the interactions between the PRRSv and the immune system, representing the mechanisms at the between-cell scale. First, our results show that similar infection durations associated with contrasted immune dynamics are explained by the consideration of the immune mechanisms involved by the strain virulence. This provides new insights to explain apparent inconsistencies between experimental data. Then, an impact of both exposure intensity and duration on the within-host dynamics (which have not yet been explored for PRRS) has been shown and this impact varied depending on the strain virulence. Finally, the within-host dynamics induced by vaccinated pig infection in the field has been explored, providing new insights to improve the vaccine efficiency. This thesis also provides new insights to guide further experimental and modelling approaches and promising prospects for the PRRS control at the herd level.

Keywords: PRRSv, respiratory pathogen, mathematical model, within-host dynamics, between-cell scale, immune response (innate and adaptive), strain virulence, exposure, vaccination
