

École doctorale n° 432 : Science des Métiers de l'ingénieur

**Doctorat ParisTech**

**T H È S E**

pour obtenir le grade de docteur délivré par

**l'École Nationale Supérieure d'Arts et Métiers**

**Spécialité “ Génie Mécanique et Industriel ”**

*présentée et soutenue publiquement par*

**Mehrdad MOHAMMADI**

le 10 décembre 2015

**A multi-objective optimization framework for an inspection planning  
problem under uncertainty and breakdown**

Directeur de thèse : **Jean-Yves DANTAN**

Co-encadrement de la thèse : **Ali SIADAT, Reza TAVAKKOLI-MOGHADDAM**

**Jury**

**M. Yannick FREIN**, Professeur, G-SCOP, Grenoble INP, Grenoble

**M. Bernard GRABOT**, Professeur, LGP-ENIT, Ecole Nationale d'Ingénieurs de Tarbes, Tarbes

**M. Stéphane DAUZERE-PERES**, Professeur, CMP, Ecole des Mines de Saint-Etienne, Gardanne

**M. Jean-Yves DANTAN**, Professeur, LCFC, Arts et Métiers ParisTech, Metz

**M. Ali SIADAT**, HDR, LCFC, Arts et Métiers ParisTech, Metz

**M. Aymen MILI**, PhD, Process Control Engineer, ST Microelectronics, Lyon

Président

Rapporteur

Rapporteur

Examineur

Examineur

Invité

**T  
H  
È  
S  
E**



## **Acknowledgement**

I would like to express my special appreciation and thanks to my advisors Prof. Jean-Yves DANTAN, Prof. Reza TAVAKKOLI-MOGHADDAM and Dr. Ali SIADAT. You have been a tremendous mentor for me. I would like to thank you for encouraging my research and for allowing me to grow as a research scientist. Your advice on both research as well as on my career have been priceless. I would also like to thank my jury members, Prof. Bernard GRABOT, Prof. Stéphane DAUZERE-PERES, Prof. Yannick FREIN, and Dr. Aymen MILI for serving as my jury members even at hardship. I also want to thank you for letting my defense be an enjoyable moment, and for your brilliant comments and suggestions, thanks to you.

A special thanks to my family. Words cannot express how grateful I am to my mother and my father for all of the sacrifices that you've made on my behalf. Your prayer for me was what sustained me thus far. I would also like to specially thank my best friend who campaigns and supports me in the whole life that incited me to strive towards my goal.





# Content

---

<b>Acknowledgement</b>	ii
------------------------	----

## **Chapter I: General Introduction**

1.2. Chapter purpose and outline	2
1.2. Introduction	2
1.2. Problem statement	4
1.2. Scope and objectives	6
1.2. Research methodology	8
1.2. Thesis contribution	8
1.2. Organization of the thesis	

## **Chapter II: Literature Review**

2.0. Chapter purpose and outline	11
2.1. Introduction	11
2.1.1. Production system characteristics	12
2.1.2. Methodology	14
2.2. Separate optimization	19
2.3. Simultaneous optimization	22
2.4. Conclusion and gap analysis	27

## **Chapter III: Mathematical Formulations & Solution Approaches**

3.0. Chapter purpose and outline	40
3.1. Problem statement	40
3.2. Main Problem ( <i>MP</i> )	43
3.2.1. Assumption	43
3.2.2. Notations	44
3.2.3. Mathematical formulation	46
3.2.3.1. Formulation of MI-or-CI strategy	46
3.2.3.2. Formulation of MI-and-CI strategy	50
3.2.4. Robust Optimization	51
3.3. Extended Problem ( <i>EP</i> )	58
3.3.1. Bi-objective model	58
3.3.1.1. Notations	58
3.3.1.2. Mathematical formulation	59
3.3.1.3. Robust Optimization	60
3.3.2. Multi-objective model	60
3.3.2.1. Assumptions	60

3.3.2.2.	Notations	61
3.3.2.3.	Mathematical formulation	64
3.3.2.4.	Robust Optimization	70
3.4.	Solution algorithms: Meta-heuristics	71
3.4.1.	Solution representation: <i>Main Problem</i>	71
3.5.	Discussion and Summary	73

## Chapter VI: Experimental Results

4.0.	Chapter purpose and outline	77
4.1.	Experiments	77
4.1.1.	Case study	77
4.1.2.	Experimental setup	79
4.2.	Computational results: <i>Main Problem</i>	79
4.2.1.	<i>Main Problem</i> results	79
4.3.	Computational results: <i>Extended Problem</i>	86
4.3.1.	BMILP_EP model	86
4.3.2.	TMINLP_EP model	89
4.3.3.	Sensitivity analysis	92
4.3.4.	Computational time complexity	98
4.3.5.	Model uncertainty	99
4.4.	Summary	

## Chapter V: Hub Location Problem

5.0.	Chapter purpose and outline	103
5.1.	Introduction	103
5.2.	Literature review	105
5.3.	The reliability hub location problem	108
5.3.1.	Partial disruptions in hubs and links	108
5.3.2.	Uncertainty of transportation time due to stochastic degradation	110
5.3.3.	Stochastic disruption of hubs' service rates	111
5.4.	Mathematical formulation	111
5.5.	Linearization of the model: A piecewise function	116
5.6.	Approximated BOCRHL (AMIP)	118
5.7.	Multi-objective lower bound approach (MOLB)	119
5.8.	Multi-objective meta-heuristic algorithm	121
5.8.1.	Solution representation scheme	121
5.8.1.1.	Hub location (Phase 1)	121
5.8.1.2.	Hub capacity level (Phase 2)	122
5.8.1.3.	Spoke allocation (Phase 3)	122

5.8.1.4. Transportation mode (Phase 4)	123
5.8.2. The Proposed algorithm	123
5.8.2.1. Self-adaptive NSGA-II	124
5.8.2.2. SGV-II algorithm's framework	124
5.8.2.3. Intensification using VNS	125
5.8.2.4. Termination criteria	126
5.9. Experiments	127
5.9.1. Test problems	127
5.9.2. Experimental setup	128
5.9.3. Performance metrics	128
5.10. Results and discussion	128
5.11. Case study	135
5.11.1. Sensitivity analysis	138
5.12. Summery	146

## Chapter VI: Conclusion & Future Research

6.0. Chapter purpose and outline	149
6.1. Concluding comments	149
6.3.1. General conclusion	149
6.3.2. Inspection planning problem	151
6.3.3. Hub Location problem	155
6.2. Future research directions	

## Appendix 1

A1.0. Appendix purpose and outline	160
A1.1. Literature Review: Simultaneous optimization	160

## Appendix 2

A2.0. Appendix purpose and outline	166
A2.1. Errors Type I & II	166

## Appendix 3

A3.0. Appendix purpose and outline	169
A3.1. Introduction	169
A3.2. Genetic Algorithm (GA)	169
A3.3. Genetic operators	172
A3.3.1. Initialization	172
A3.3.2. Selection operator	172
A3.3.3. Crossover operator	172

A3.3.4. Mutation operator .....	172
A3.4. Multi-objective optimization algorithm .....	174
A3.5. Differential evolution algorithm .....	175
A3.6. DE operators .....	175
A3.6.1. Initialization .....	176
A3.6.2. Mutation .....	176
A3.6.3. Crossover .....	177
A3.6.4. Selection .....	177
<b>References</b> .....	180

## List of Figures

Figure 1.1. Inspection planning problem in a MPS .....	5
Figure 2.1. Criteria of production system characteristics .....	17
Figure 2.2. Criteria of methodology .....	18
Figure 2.3. Papers in category of production system characteristics .....	36
Figure 2.4. Papers in category of methodology .....	37
Figure 3.1. Inspection of quality characteristics in a serial MPS .....	42
Figure 3.2. Effect of misadjustment on failure rate .....	52
Figure 3.3. Uncertainty in dispersion .....	52
Figure 3.4. Deterministic trade-off cost diagram .....	53
Figure 3.5. Trade-off cost diagram with lower uncertainty .....	54
Figure 3.6. Trade-off cost diagram with higher uncertainty .....	54
Figure 3.7. Flowchart of the T1 method .....	57
Figure 3.8. Flowchart of the T2 method .....	58
Figure 3.9. Manufacturing time at a stage .....	66
Figure 3.10. <i>Which-What</i> decision .....	72
Figure 3.11. <i>When</i> decision .....	72
Figure 3.12. <i>Which-What, inspection tool selection and allocation</i> decisions .....	73
Figure 3.13. <i>Machine selection and allocation</i> decision .....	73
Figure 4.1. Solid frame of the industrial part .....	78
Figure 4.2. Labeled operations of the industrial part .....	78
Figures 4.3. Robust inspection plan of <i>Main Problem</i> for MI-or-CI strategy .....	81
Figures 4.4. Robust inspection plan of <i>Main Problem</i> for MI-and-CI strategy .....	81
Figure 4.5. Warranty cost vs. different source of uncertainty .....	82
Figure 4.6. Internal cost vs. different source of uncertainty .....	83
Figure 4.7. Total cost increase vs. different source of uncertainty .....	83
Figure 4.8. Price increase per part vs. different source of uncertainty .....	84
Figure 4.9. Cost of robustness vs. increase in $\rho_{e-I}$ and $\rho_{e-II}$ .....	85
Figure 4.10. Cost of robustness vs. increase in the production time .....	85
Figure 4.11. Cost of robustness vs. increase in the misadjustment .....	86
Figure 4.12. Cost of robustness vs. increase in the dispersion .....	86
Figure 4.13. Pareto frontiers for deterministic and uncertain models .....	87
Figure 4.14. Inspection plans of the Pareto solutions for the robust BMILP_EP .....	88
Figure 4.15. Effect of uncertain parameters on the objective functions .....	89
Figure 4.16. Inspection plan for Pareto solution number 5 .....	91
Figure 4.17. Objective function increase vs. increase in misadjustment .....	92
Figure 4.18. Objective function increase vs. increase in dispersion .....	93
Figure 4.19. Objective function increase vs. increase in capacity .....	93
Figure 4.20. Objective function increase vs. increase in production time .....	94

Figure 4.21. Objective function decrease vs. increase in production rate .....	95
Figure 4.22. Objective function decrease vs. increase in inspection rate .....	96
Figure 4.23. Third objective increase vs. increase in breakdown rate .....	96
Figure 4.24. Third objective increase vs. increase in retrieve time .....	96
Figure 4.25. Third objective increase vs. simultaneous increase in breakdown rate and retrieve time .....	97
Figure 4.26. General sensitivity analysis .....	97
Figure 4.27. Model uncertainty & objective sensitivity vs. parameters uncertainty	99
Figure 4.28. Cost terms effectiveness in the model .....	101
Figure 5.1. Hub location representation .....	122
Figure 5.2. Hub capacity level .....	122
Figure 5.3. Spoke allocation .....	123
Figure 5.4. Transportation mode allocation .....	123
Figure 5.5. Pseudo code of SNSGA-II's initialization phase .....	125
Figure 5.6. Flowchart of the proposed SGV-II .....	126
Figure 5.7. Main steps of VNS in the SGV-II algorithm .....	126
Figure 5.8. Performance of the proposed local searches .....	127
Figure 5.9. Optimal PF by GAMS and NF by MOLB .....	131
Figure 5.10. CPU time of different algorithms for different problems .....	132
Figure 5.11. NFs of different meta-heuristics fro problem number 5 .....	134
Figure 5.12. NFs of different meta-heuristics fro problem number 30 .....	135
Figure 5.13. France cities .....	136
Figure 5.14. Results of $\mathbb{P}_1$ .....	139
Figure 5.15. Results of $\mathbb{P}_2$ .....	140
Figure 5.16. Results of $\mathbb{P}_3$ .....	141
Figure 5.17. Results of $\mathbb{P}_4$ .....	142
Figure 5.18. Current transportation network in France .....	144
Figure 5.19. Current network vs. non-dominated Pareto fronts .....	144
Figure 5.20. Increase in $\mathbb{Z}_2$ vs. Increase in parameters .....	144
Figure 5.21. Increase in $\mathbb{Z}_1$ vs. Increase in parameters .....	145
Figure 5.22. Increase of $\Gamma$ , $\xi$ and $\mu$ vs. decrease in $\mathbb{Z}_1$ and $\mathbb{Z}_2$ .....	145
Figure 5.23. Increase in parameters vs. Increase in $\mathbb{Z}_1$ and $\mathbb{Z}_2$ .....	146
Figure A3.1. Genetic algorithm flowchart .....	170
Figure A3.2. Crossover operators .....	172
Figure A3.3. Mutation operators .....	173
Figure A3.4. GA's Pseudo code .....	173
Figure A3.5. Genetic algorithm flowchart .....	178

## List of Tables

Table 1.1. Details of <i>Main Problem</i> and <i>Extended Problem</i> .....	7
Table 2.1. Classification of literature based on the production system characteristics	28
Table 2.2. Classification of literature based on the methodology .....	32
Table 3.1. Variation intervals of the uncertain parameters .....	56
Table 3.2. Similarities between inspection problem and HLP .....	75
Table 4.1. Information of the industrial case .....	78
Table 4.2. Parameter settings used in the proposed GA and DE .....	79
Table 4.3. Costs for different sources of uncertainty: <i>Main Model</i> .....	80
Table 4.4. Pareto solutions of BMILP_EP model .....	87
Table 4.5. Pareto solutions of TMINLP_EP model .....	90
Table 4.6. Machines and inspection tools selection .....	91
Table 4.7. Cubic model summary and parameter estimates .....	98
Table 4.8. Cost terms identification .....	100
Table 5.1. Sources of random data generation .....	127
Table 5.3. Results of small size instances .....	129
Table 5.4. Results of medium size instances .....	129
Table 5.5. Results of large size instances .....	130
Table 5.6. Detailed statistics of paired <i>t</i> test .....	130
Table 5.7. Results of small size instances .....	132
Table 5.8. Results of medium size instances .....	133
Table 5.9. Results of large size instances .....	133
Table 5.10. Paired <i>t</i> test for comparison between MOLB and meta-heuristics .....	134
Table 5.11. Paired <i>t</i> test for comparison between SGV-II and meta-heuristics .....	135
Table 5.12. Parameters for each capacity level .....	138
Table 5.13. Second objective function changes vs. changes in parameters .....	143
Table 5.14. First objective function changes vs. Changes in parameters .....	143
Table A2.1. Errors type I and II .....	167





## **UN CADRE D'OPTIMISATION MULTI-OBJECTIF POUR LES PROBLEMES DE PLANIFICATION DES INSPECTIONS AVEC PRISE EN COMPTE DES INCERTITUDES ET DEFFAILLANCES**

**RESUME :** Dans les systèmes manufacturiers de plus en plus complexes, les variations du processus de fabrication et de ses paramètres opératoires ainsi que leurs effets sur l'ensemble du système doivent être maîtrisés, mesurés et contrôlés. Cette thèse propose un cadre d'optimisation pour l'élaboration d'un plan d'inspection optimal qui permet une prise de décision opérationnelle afin d'assurer la satisfaction des objectifs stratégiques (réduction des coûts, amélioration de la qualité, augmentation de la productivité, ...). La prise de décision se divise en trois questions : Quoi contrôler ? Comment contrôler ? Quand contrôler ? Le manque d'informations fiables sur les processus de production et plusieurs facteurs environnementaux est devenu un problème important qui impose la prise en compte de certaines incertitudes lors de la planification des inspections. Cette thèse propose plusieurs formulations du problème d'optimisation de la planification du processus d'inspection, dans lesquelles, les paramètres sont incertains et les machines de production sont sujettes aux défaillances. Ce problème est formulé par des modèles de programmation mathématique avec les objectifs : minimiser le coût total de fabrication, maximiser la satisfaction du client, et minimiser le temps de la production totale. En outre, les méthodes Taguchi et Monte Carlo sont appliquées pour faire face aux incertitudes. En raison de la complexité des modèles proposés, les algorithmes de méta-heuristiques sont utilisés pour trouver les solutions optimales.

**Mots clés :** Systèmes de Production Multi-échelle, Problème de Planification des Inspections, Optimisation Multi Objectif, Modèles de Programmation Mathématique, Incertitude, Défaillance, méta-heuristiques.

## **1. Introduction**

*Ce résumé étendu en français ne reprend pas l'ensemble des items détaillés dans le manuscrit principal en anglais. Seuls les aspects qualitatifs et les résultats sont abordés dans le résumé. Les modèles mathématiques et les détails d'implémentation ne sont pas détaillés dans le résumé étendu en français. Cette thèse a été réalisée en cotutelle entre l'Université de Téhéran et l'Ecole Nationale Supérieure d'Arts et Métiers.*

Dans les systèmes manufacturiers de plus en plus complexes, les variations du processus de fabrication et de ses paramètres opératoires ainsi que leurs effets sur l'ensemble du système doivent être maîtrisés. Au regard de la conception du produit, la « vérification » est ce qui permet de confirmer (ou non) le maintien du processus de fabrication dans un état stable et le respect des spécifications et exigences du produit. La tendance de ce jour à l'automatisation dans les industries demande une vérification plus stricte et une meilleure organisation de celle-ci.

La « vérification » est ce qui permet de confirmer (ou non) le maintien du processus de fabrication dans un état stable et le respect des spécifications et exigences du produit. La tendance de ce jour à l'automatisation dans les industries demande une vérification plus stricte et une meilleure organisation de celle-ci.

La version 2008 de la certification ISO 9001 indique aussi la nécessité d'inspection et d'organisation de celle-ci, la définition du plan d'inspection : « L'organisme doit déterminer les activités de surveillance et de mesure à entreprendre et les dispositifs de surveillance et de mesure nécessaires pour apporter la preuve de la conformité du produit aux exigences déterminées ... L'organisme doit établir des processus pour assurer que les activités de surveillance et de mesure peuvent être effectuées de manière cohérente par rapport aux exigences de surveillance et de mesure ». En résumé, ce qui nous incite à mener des activités de vérification est donc la « variation » au sens large. L'inspection comprend la vérification de l'aptitude du processus et le suivi du « résultat » de processus sur le produit ou le service, « qualité ». Pour suivre l'effet de ces variations sur le produit et ces exigences, le meilleur moyen reste

l'inspection par le biais des mesures, « un mal nécessaire que l'on doit réduire le plus possible » (Pillet et al. 2007).

La conformité du produit est assurée grâce à la fonctionnalité et le comportement de tous ces composants. Leur conformité par rapport aux exigences est vérifiée (pour être acceptée ou rejetée) par le contrôle de la qualité du produit. D'autre part la non-conformité pour le client peut être due à une dérive du procédé de fabrication. C'est pourquoi la surveillance préventive est parfois nécessaire pour maîtriser un système de production. Une politique de maintenance préventive peut assurer l'efficacité des moyens de production et peut réduire également le coût d'intervention lié à la dégradation ou la défaillance des moyens de production. Réduire le nombre de ces interventions que ce soit le contrôle de conformité ou le suivi de fabrication, augmente également la productivité du système. Réduction des coûts et augmentation de la productivité ont toujours été les principaux intérêts des industriels.

La génération d'un plan d'inspection se fait en règle générale à la suite de la conception du produit et de son processus de fabrication. Le développement des systèmes de « Computer Aided Inspection Planning (CAIP) » est donc la suite logique des travaux de recherche en Computer Aided Tolerancing (CAT) et Computer Aided Process Planning (CAPP).

Les objectifs (ou contraintes) fondamentaux sont : réduction des coûts, diminution des risques, amélioration de la qualité, de la productivité, et de la satisfaction de client ... Afin d'accroître l'efficacité des plans d'inspection, il est nécessaire d'exploiter l'interdépendance des caractéristiques (l'ensemble des tolérances, des spécifications des composants, et des exigences fonctionnelles ou non-fonctionnelles du produit, ainsi que les paramètres opératoires de processus de fabrication) et leurs variations.

## **2. Cadre d'une méthodologie pour la génération d'un plan d'inspection**

D'après (Peters 1977), le besoin de la métrologie précise et exacte a émergé dans le monde industriel initialement dans le but de réduire les activités d'assemblage et de garantir l'interchangeabilité des composants. La métrologie passive, la vérification de satisfaction des exigences après

les opérations de fabrication n'a pas été souvent défendable d'un point de vue économique. L'apparition de la métrologie active a déclenché une tendance à la réalisation des mesures plus proche des opérations de fabrication tout au long du processus afin de pouvoir intervenir le plus rapidement possible dans le cas d'une dérive au niveau du processus. Les pratiques de la maîtrise de qualité dont l'inspection ont également évolué, comme évoqué par (Pillet 1993), de l'artisanal à l'industriel dans un premier temps et ensuite d'une vision purement orientée produit, à une vision orientée vers l'ensemble produit, processus, ressource.

La métrologie productive (Kunzmann et al., 2005) assure non seulement la satisfaction du client final mais également se fonde sur des arguments économiques, en fournissant de la connaissance pour une meilleure prise de décision tout au long de la conception du produit, son processus de fabrication et le plan d'inspection. Ce dernier comprend les activités de la maîtrise du processus (vérification intermédiaire) et celles de la vérification finale de la conformité du produit.

Pour la planification d'inspection, les entreprises sont aussi contraintes par la disponibilité des moyens de production et ceux de l'inspection ainsi que leurs critères de performances (le coût de la métrologie, l'incertitude de l'inspection ou de la pertinence des mesures liée à la précision et à l'exactitude, la capacité de production etc.) pour garantir la qualité. De multiples critères et objectifs sont soulignés ci-dessus qui doivent être intégrés lors de la prise de décision pour la génération du plan d'inspection. Selon (Pfeifer 2002) lorsqu'on planifie les activités d'inspection, d'une manière générale certaines questions doivent être posées :

- What to test ?
- When to test ?
- How to test ?
- How much to test ?

Nous avons résumé la problématique par trois grandes questions :

- Quoi contrôler ?
- Comment contrôler ?
- Quand contrôler ?

qui pilotent le cadre de la prise de décision.

Ainsi un cadre méthodologique est proposé qui se décompose en quatre sous-activités ([Figure 1](#)) : (A00) identifier les critères de la prise de décision, (A01) identifier les caractéristiques clés liées au produit/processus à contrôler/suivre, (A02) identifier le moyen d'inspection, et (A03) identifier les points d'insertion des activités d'inspection.

Les objectifs opérationnels de ces activités sont la co-conception du plan de contrôle de conformité du produit et des pièces, et le suivi du processus de fabrication. C'est-à-dire qu'une activité d'inspection peut être destinée à :

- la surveillance des paramètres opératoires du processus de fabrication, par l'application des mesures au niveau du processus même, ou par l'application des mesures sur des spécifications au niveau de la pièce fabriquée par le processus (mais toujours dans le but de maintenir le processus sous surveillance),
- le contrôle de conformité des spécifications des composants au regard de leur conception et de leurs limites de tolérance, et
- le contrôle de conformité des fonctionnalités ou exigences attendues du produit selon le cahier des charges.

### **3. Modèle de coût**

Dans la planification des inspections, le but est non seulement l'allocation des activités d'inspection, mais aussi une évaluation de la performance, notamment l'évaluation conjointe du coût et de la qualité (qualité pondérée par le coût) ([Etienne, 2007](#)), assurés par la détection ou la prévention de la défaillance survenue au niveau du produit ou du processus.

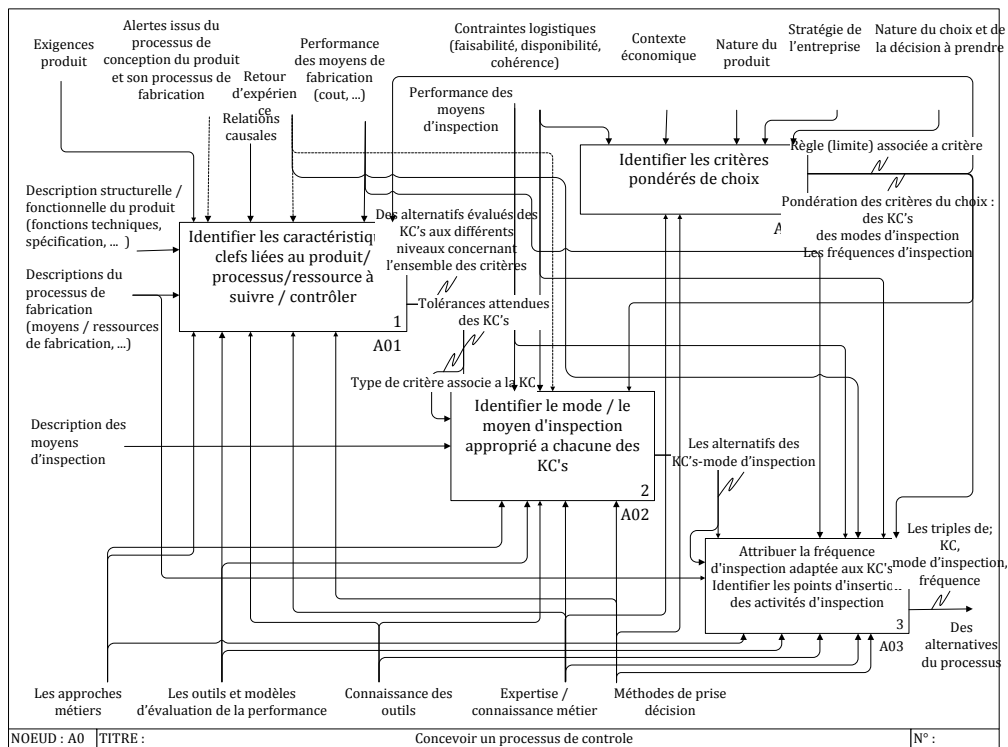

Figure 1. Les sous-activités de la prise de décision sous le formalisme IDEF0 (Mirdamadi, 2014)

La dimension économique devient un critère de la génération des processus ou gamme d'inspection.

Malgré la réputation non productive de la métrologie dans les industries, Kunzmann et al. (2005) approuvent le rôle de cette dernière comme un générateur de valeur aux yeux de chacun : l'ingénieur de production et le métrologue industriel. La métrologie productive assure non seulement la satisfaction du client final mais également se fonde sur des arguments économiques, en fournissant de la connaissance pour une meilleure prise de décision tout au long de la conception du produit, son processus de fabrication et le plan d'inspection. Ce dernier comprend les activités de la maîtrise du processus (vérification intermédiaire) et celles de la vérification finale de la conformité du produit. D'un point de vue économique, Kunzmann et al. (2005) démontre l'évolution du coût de la prévention de la défaillance, l'objectif de la surveillance du processus, et celui de la détection et de l'élimination de la défaillance, ainsi que l'objectif de contrôle de conformité des produits, tout au long du cycle de vie du

produit. Que ce soit par la détection ou la prévention de la défaillance, la génération d'un plan d'inspection a pour but d'assurer la conformité du produit au client (qualité perçue en externe) pour un moindre coût d'inspection (objectif en interne).

La dimension économique grandissante de la qualité fournie, a ouvert la voie aux travaux d'estimation et d'optimisation du bénéfice attendu d'un processus de qualité, le contrôle de conformité ou le suivi de fabrication. Le choix d'inspection ne garantit pas uniquement le niveau de la qualité mais peut optimiser à la fois le bénéfice. Les travaux de recherche ont contribué à une meilleure formulation (plus proche de la pratique) de ce problème d'optimisation (Hunter and Kartha, 1977 ; Bisgaard et al., 1984). Ils ont également démontré l'impact des erreurs (le rejet dû à l'erreur d'inspection) ou la précision d'inspection (maximale lorsque l'erreur tend vers zéro) sur le bénéfice (Carlsson, 1989). Lorsque le contrôle d'un processus de fabrication est nécessaire, l'outil commun est souvent la maîtrise statistique des procédés (MSP). La conception de cartes de contrôle se réfère à la spécification de la taille de l'échantillon, la fréquence d'échantillonnage et des limites de contrôle de la carte. Dans le passé, toutefois, les facteurs économiques ont été exploités après la mise en place des cartes de contrôle. Lall et al. (1991) propose d'intégrer la dimension économique dans le modèle de calcul des limites de contrôle.

Mesurant l'intérêt de la dimension économique dans la génération ou sélection des processus d'inspection, la section suivante explique le modèle du coût prenant en compte les spécificités des activités d'inspection (contrôle de conformité et suivi de fabrication). La Section 3.1 détaille les travaux existants sur les modèles de coût et plus particulièrement sur les modèles de coût orienté « qualité ».

Duret et Pillet (2011) décomposent le coût de la non-qualité en coût de gestion de la qualité et en coût de la défaillance. Les coûts sont donc décomposés de manière suivante :

- Coût de gestion de la qualité :
  - Coût de la prévention : Le coût des actions visant à éviter la non – qualité, le suivi de fabrication, la maintenance préventive, ...

- Coût de la détection : Le coût des activités de vérification de la qualité, la mesure et l'observation des résultats par inspections et tests...
- Coût de la défaillance :
  - Coût de la défaillance interne : Le coût engendré par des activités telles que la reproduction des produits défectueux, le maintien des produits défectueux dans la chaîne de production jusqu'à la détection, la réduction de productivité...
  - Coût de la défaillance externe : Le coût engendré par la perte de parts de marché, la maintenance de produit externe, la réclamation du client, ...

Parmi les catégories de méthodes d'estimation de coût, cet état de l'art se focalise donc sur les méthodes analytiques et paramétriques. Afin de comprendre les forces et les faiblesses de ces catégories, [Etienne \(2007\)](#) propose une comparaison de leur aptitude dans le contexte particulier de la maîtrise des variations :

### **3.1. Méthodes paramétriques**

Méthodes paramétriques : Cette catégorie comprend les méthodes d'évaluation des coûts en utilisant des relations mathématiques reliant l'indicateur de coût à d'autres paramètres quantifiables, tels que le volume de produit, le temps, etc., rassemblés comme des méthodes paramétriques. Parmi les nombreuses références disponibles dans la littérature, trois étapes majeures pour cette catégorie sont identifiées ;

- La première étape, consiste à identifier et collecter tous les paramètres et données considérés comme ayant une influence sur l'indicateur de coût. Cette activité de sélection de paramètres peut être effectuée subjectivement (expérience ou savoir-faire) ou objectivement (analyse des composants principaux).
- L'étape suivante essaie de trouver à partir de plusieurs modèles mathématiques celui qui démontre le mieux la relation existante liant l'indicateur de performance, et le coût, aux paramètres sélectionnés par l'étape précédente.



- La dernière étape consiste à valider le modèle mathématique en faisant face à plusieurs cas connus.

En conclusion, la méthode paramétrique est en soi rapide et facile à utiliser une fois les valeurs paramétriques recueillies. Mais contrairement aux méthodes analytiques, elle est difficilement déployée dans un environnement industriel où les paramètres d'entrée sont à la fois contextuels et les liens entre eux complexes. À savoir que les paramètres dépendent souvent des ressources disponibles et sont propres à chaque entreprise et à chaque problème. En effet, le choix des paramètres et le modèle de relation mathématique ont une validité limitée puisqu'ils dépendent de plusieurs caractéristiques (la localisation de l'entreprise, le matériel, les machines, les conditions de coupe, ...). En outre, l'évaluation de ces paramètres est coûteuse en termes de temps et en ressources.

### **3.2. Méthodes analytiques**

Méthodes analytiques : Les approches analytiques ont pour but également d'évaluer le coût d'une solution en analysant les tâches et activités nécessaires au cours de l'ensemble de son cycle de vie (conception, fabrication, recyclage ...). Les activités principales sont responsables de coûts directs ou indirects et de variations. Parmi les différentes solutions analytiques disponibles, tel que la méthode des form features (Feng et al., 1996) et l'entité coût, ce document se concentre uniquement sur la méthode Activity Based Costing (ABC). La méthode ABC a été principalement développée dans les années 1980 (Johnson and Kaplan, 1987). Elle consiste à effectuer un « Break down » des activités engagées à la réalisation des objectifs d'une façon directe (productive) ou indirecte (non-productive). La méthode ABC identifie les liens de la consommation et de la causalité entre les produits, les activités, et les ressources. Ces liens sont quantifiés et font émerger le coût avec trois inducteurs :

- Inducteur de ressource qui est utilisé pour allouer les ressources entre les activités. Cet inducteur facilite l'évaluation des coûts.
- Inducteur de coût décrivant le niveau de performance de l'activité et sa consommation de ressources.

- Inducteur d'activité qui est égal à l'unité de travail. Cet inducteur permet de répartir les coûts des activités entre les objets de coûts.

Cette méthode évalue, d'une façon relativement précise et simple à la fois (contrairement aux méthodes paramétriques souvent associées aux modèles mathématiques complexes), le coût du produit réel car il prend en compte les coûts indirects. Néanmoins, la méthode ABC, qui semble être une approche assez puissante et générique, doit faire face à des enjeux majeurs. En effet, la difficulté d'identifier et d'évaluer les inducteurs reste le principal inconvénient de cette méthode...

### 3.3. Modèles de cout orienté « qualité »

[Etienne \(2007\)](#) a établi un modèle d'estimation où l'efficacité de l'ensemble d'une allocation de tolérance et de son processus de fabrication est mesurée par « le coût pondéré qualité » (Éq. I). Il met en avant la flexibilité de ce modèle et la possibilité d'enrichissement de ce dernier par d'autres coûts (logistiques, environnementaux, ...) et d'autres facteurs d'efficacité.

$$Cout = \frac{C_{production}}{P(OK)} + C_{retraitement} \cdot P(Nonconforme) + C_{réassortiment} \cdot P(NonMontable) + \dots \quad (I)$$

Le modèle se décompose en trois parties :

- Le coût de production des produits satisfaisant l'ensemble des contraintes, spécifications, ou exigences. Il est considéré que le coût de production est pondéré par l'efficacité du processus employé,
- Le coût de retraitement des pièces ou produits non-conformes,
- Le coût de réassortiment des produits dû à une inadéquation entre les spécifications et les exigences fonctionnelles ou d'assemblage.

[Moroni et al. \(2011\)](#) présentent une méthodologie pour l'estimation du coût d'inspection des tolérances géométriques dès les étapes préliminaires de la conception. Il considère le coût d'inspection comme la somme des coûts de mesures et d'incertitudes. Le coût de mesure dépend en soi de la stratégie de mesure, la mise en place du poste de mesure, et le

temps de mesure (qui varie selon les instruments de mesure discrète ou les instruments de mesure continue) qui sont généralement fixes et estimables d'une manière ponctuelle. L'estimation du coût lié aux incertitudes de mesure est ensuite proposée par une approche probabiliste. L'objectif est l'optimisation du coût d'inspection (en fonction des limites de spécification) étant donné les facteurs qui pourraient entraîner des effets opposés sur les deux parties du coût total ou même entre eux comme la taille de l'échantillon qui diminue l'incertitude de mesure et donc son coût relatif et qui augmente le coût de mesure.

Savio (2012) propose une estimation du coût d'inspection associée par un seul modèle au coût de processus de fabrication pour l'évaluation d'impact économique de la métrologie sur l'ensemble des décisions relatives au processus de fabrication et à l'inspection. Il met en avant un « cost-benefit model », bien que la nature des bénéfices, tels que l'amélioration de la fiabilité du produit et la réduction relative des coûts de garantie, rende difficile leurs quantifications. Par ce modèle, il propose avant tout l'évaluation économique d'investissement par le coût initial de l'investissement, le taux d'intérêt, .... Ensuite se décompose le bénéfice d'inspection en :

- L'économie de la réduction de la fabrication inefficace en raison des activités à valeur ajoutée sur les pièces défectueuses,
- L'économie de la réduction des coûts de garantie des produits défectueux entrés sur le marché,
- L'économie rendue possible par l'augmentation du savoir-faire, par exemple, une meilleure compréhension de la fonctionnalité des produits, élargissement de la zone de tolérance, meilleure connaissance des processus de fabrication,
- ....

L'estimation de tous ces coûts s'ajoute aux coûts directs du processus d'inspection comme celui engendré par l'erreur d'inspection, calculé en fonction de la capacité du processus et des limites de tolérance.

Les deux dernières méthodologies [Moroni et al. \(2011\)](#) et [Savio \(2012\)](#), peuvent être complémentaires puisqu'elles partagent la même vision en ce qui concerne la décomposition des coûts.

L'ensemble des modèles d'estimation de coût proposés par la littérature tendent non seulement à estimer le coût, mais aussi à étudier l'efficacité des solutions, que ce soit sur l'allocation des tolérances, le processus ou le plan d'inspection, et les origines de la non-efficacité. Indépendamment du stade de la conception et du niveau de précision de l'information, il est nécessaire d'évaluer la pertinence des alternatives de la conception. Puisqu'il est insuffisant de traiter uniquement la dimension financière de leur performance, ces modèles proposent un point de vue multicritères, la satisfaction du client et le coût. Une analyse multi-niveaux se présente également par le biais des facteurs intervenant : taux de non-conformité de produit, fréquence de maintenance préventive inhérente au processus, taux de non-détection des moyens d'inspection, ... Il existe également dans la littérature, des travaux visant l'estimation de coût des risques ([Mirdamadi et al., 2013, 2014](#) ; [Hassan, 2010](#)).

#### **4. Formalisation Mathématique du problème de planification des activités d'inspection**

Cette section explique le problème fondamental de cette thèse. Dans la [section 4.1](#), une introduction générale détaille la planification de l'inspection dans le système de production. Dans la [section 4.2](#), le problème est détaillé avec les décisions correspondantes. Les contraintes et les objectifs sont expliqués dans la [section 4.3](#).

##### **4.1. Planification de l'inspection dans un système de production**

Pour la quasi-totalité des systèmes de production, les matières premières passent sous une série d'étapes de traitement distinctes et sont transformés en produits finals. Dans de tels systèmes, la sortie de chaque étage de traitement (pas la dernière) est l'entrée pour l'étape suivante. En raison de conditions de production non idéales et la nature stochastique des processus de production, à chaque étape, des écarts par rapport aux spécifications de conception se produisent qui conduisent à des produits de moindre qualité.

L'inspection de qualité dans les systèmes de production multi-étapes (MPSs) est devenue une question difficile étant donné que le MPS présente différentes possibilités pour l'inspection. Dans de tels systèmes, l'inspection de la qualité correspond généralement à identifier les éléments non conformes qui sont réparables et à supprimer les éléments irréparables. Ces activités augmentent le coût de production puisque certaines ou la totalité des étapes de fabrication doivent être dupliquées. D'autre part, le passage des éléments non conformes détectés à des étapes ultérieures de la fabrication augmente les coûts de production en augmentant le nombre d'étapes de reprise nécessaires pour restaurer une qualité à travers de multiples étapes de fabrication.

Il peut y avoir deux stratégies différentes, premièrement, la localisation d'une station d'inspection après chaque étape de fabrication et de détecter les objets non conformes immédiatement après l'opération correspondante de cette phase. Cela permettrait de réduire la probabilité de propagation des articles défectueux dans la suite du processus de production. Cependant, le coût de l'inspection après chaque étape de fabrication dans le processus de production pourrait être plus que les économies obtenues par la détection précoce d'éléments non conformes. Deuxièmement, l'inspection pourrait être déployée après l'étape de production finale et à aucun autre emplacement. Bien que cette stratégie diminue le coût des activités d'inspection, mais si une non-conformité dans le produit final correspond à la première étape, il pourrait être nécessaire de répéter toutes les étapes de fabrication, qui conduisent à l'augmentation du coût de la production totale. Afin de minimiser le coût de fabrication, en termes de production, d'inspection, et d'ajustement, il est essentiel de faire un bilan des différents coûts et de trouver une stratégie d'inspection optimale.

Le problème de trouver le meilleur plan d'inspection est un «problème de planification des inspections». Un problème typique de planification des inspections dans MPS est d' (i) identifier les positions et les caractéristiques de qualité qui doivent être inspectés et, simultanément, de (ii) déterminer le meilleur type et la stratégie pour chaque inspection, afin de minimiser le coût total de fabrication.

Le type d'inspection se compose de deux principaux : «conformité» et "Surveillance". L'inspection de la conformité (CI) est un terme

générique utilisé pour un certain nombre d'activités (par exemple, les tests, l'inspection et la certification) qui analyse si le produit satisfait les spécifications. L'inspection de surveillance (MI) est souvent utilisée afin de détecter si un processus de fabrication est exécuté dans des conditions normales. Dans MI, les paramètres de processus sont surveillés. Si l'un de ces paramètres s'écartent de sa tendance normale, un arrêt du système de production est opéré et les paramètres sont re-réglés. En plus des types d'inspection, la stratégie d'inspection peut comprendre « pas d'inspection programmée », une inspection complète, ou une inspection d'échantillonnage.

En plus des préoccupations énumérées des fabricants concernant la planification de l'inspection, le manque d'information sur les processus de production et sur plusieurs facteurs environnementaux sont devenus d'importants défis. Ces situations ont imposé un degré d'incertitude sur les paramètres de planification, qui affectent directement les autres décisions du processus d'inspection. Bien que, dans toutes les industries, la qualité des produits est diminuée en raison des variations de fabrication, tels que la dégradation de la performance, non-conformité aux spécifications, le coût élevé des ajustements, les méthodes classiques considèrent les conditions déterministes lors de la planification d'un processus d'inspection, tandis que la fabrication processus sont naturellement stochastique. Par conséquent, un pour cent du produit manufacturé ne sont pas conformes aux spécifications de conception et leurs processus est sensible aux variations de fabrication. Traditionnellement, les tolérances serrées ou de mauvaises capacités des processus de fabrication sont sources de rebus et des coûts énormes de fabrication. Par conséquent, les fabricants sont intéressés par des procédés de fabrication moins sensibles. Ces procédés de fabrication sont des processus robustes, qui sont relativement insensibles à la modification des paramètres incertains.

D'une manière générale, plus d'inspections strictes feront évidemment augmenter la qualité du produit en termes de satisfaction des spécifications de conception de produits et empêchant les produits non conformes d'être livré aux clients, mais aussi conduisent à des coûts plus élevés de l'inspection et d'ajustement. De plus, l'incertitude dans les processus de production pourrait affecter les décisions finales concernant

les plans d'inspection. La modélisation de ce problème et donc d'étudier les moyens de trouver un plan d'inspection optimale et insensible à la modification des paramètres incertains est au cœur de cette recherche.

## 4.2. Détails du problème

Comme énumérés à la [section 4.1](#), les décisions simultanées dans un problème de planification des inspections sont triples: (i) quelles caractéristiques de qualité doivent être inspectés, (ii) quel type d'inspection doit être effectuée pour les caractéristiques de qualité sélectionnés, et (iii) où ces inspections devraient être effectuées. Il y a aussi une autre décision comme "comment inspecter?". La décision de comment correspond à la sélection de l'outil d'inspection.

En conséquence, la procédure de prise de décision dans un problème de planification des inspections, constitué d'une caractéristique de qualité,  $i$  type d'inspection et  $n$  étapes de fabrication a été schématisé à la [Figure I](#). Initialement, on vérifie que si l'inspection est nécessaire pour chaque caractéristique de la qualité. Le produit peut être transféré à l'étape suivante ou au client final si une caractéristique de qualité n'a pas besoin d'une opération d'inspection. Ensuite, le produit est inspecté et déclaré conforme ou non conforme aux spécifications de conception. Le produit est envoyé à l'étape suivante en cas de conformité avec les spécifications de conception, mais en cas de produit non conforme, différentes décisions peuvent être prises : (a) il peut être retraité et repassé au contrôle, (b) il peut être transféré à l'étape suivante en tant que produit dégradé; ou (c) qui peuvent être enlevé.

Bien que la planification d'un processus d'inspection constitue un coût supplémentaire, mais il permet d'augmenter la satisfaction du client. Dans de tels cas, le coût associé de l'inspection est couvert par les bénéfices réalisés par la détection des produits non conformes.

Il faut noter que, l'inspection après chaque étape de fabrication va augmenter les coûts des déchets, retraitement et d'ajustement, et va éviter les produits non conformes d'arriver chez les clients. Mais d'autre part, les inspections inutiles constituent un énorme coût d'équipement, de personnel, de temps et d'espace. Par conséquent, si les inspections sont effectuées inutilement, le coût total est considérablement augmenté.

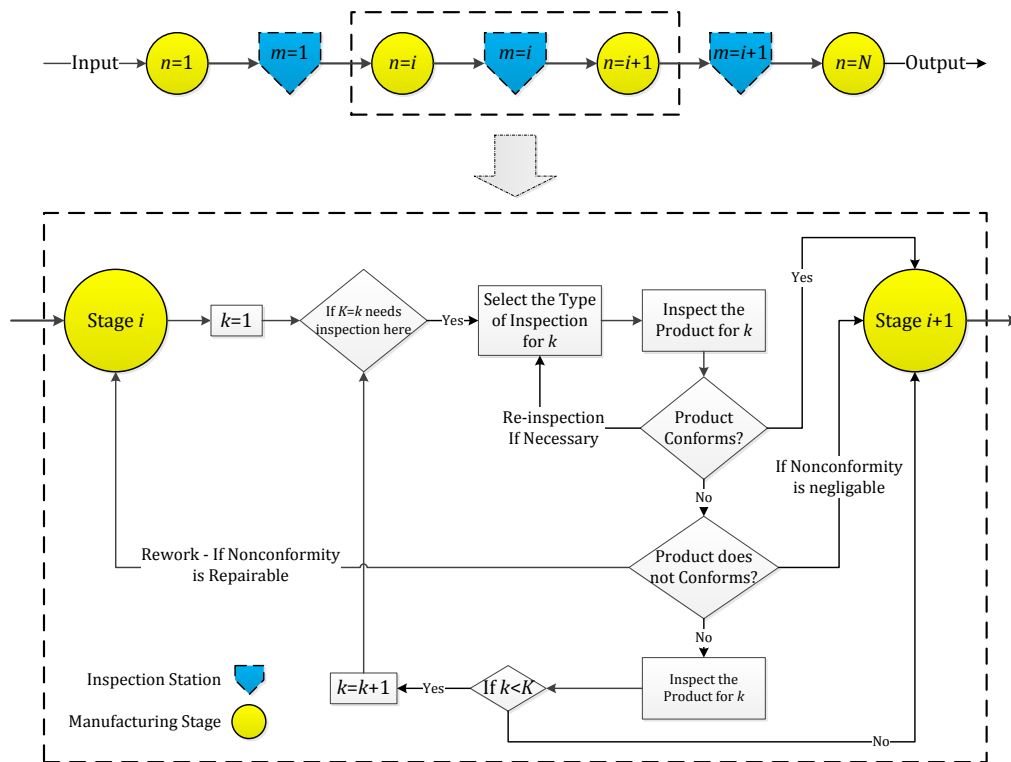

Figure 2. Inspection planning problem in a MPS

Le problème de planification des inspections peut être généralisé en un problème plus complexe et plus réaliste en tant que multi-produits MPS avec l'allocation de la machine et de l'outil d'inspection (PSMIA). Dans PSMIA, d'autres objectifs importants sont considérés en plus du coût de fabrication telle que la satisfaction du client et le temps de fabrication.

Il faut noter que le coût minimum de fabrication est idéal pour le fabricant, alors que le maximum de satisfaction des clients et le temps minimum de fabrication sont souhaités pour les clients. Bien que les fabricants souhaitent diminuer les coûts, mais aussi ils souhaitent atteindre un niveau acceptable de qualité et de production des articles en un temps minimal. Par conséquent, ces objectifs sont en conflit : une augmentation de la satisfaction de la clientèle génère une augmentation du coût de fabrication; une diminution du temps de fabrication génère une augmentation du coût de fabrication; et une diminution du coût de fabrication conduit à une baisse de la qualité.



Tableau I. Détails du problème principal et problème étendu

Détail	Problème	
	<i>problème principal</i>	<i>problème étendu</i>
Caractéristiques	<ul style="list-style-type: none"> <li>• Mono-produit</li> <li>• Mono-objectif</li> <li>• inspection complète</li> <li>• inspection complète</li> <li>• complète d'inspection</li> </ul>	<ul style="list-style-type: none"> <li>• Multi-produits</li> <li>• Multi- objectifs</li> <li>• inspection complète</li> <li>• L'inspection d'échantillons</li> <li>• Deux types d'inspection</li> <li>• Allocation de la machine</li> <li>• Allocation de l'outil d'inspection</li> <li>• Capacité de production</li> <li>• La capacité d'inspection</li> </ul>
Décisions	<ul style="list-style-type: none"> <li>• Lesquels les caractéristiques de qualité</li> <li>• Quels types d'inspection</li> <li>• Où effectuer une inspection</li> </ul>	<ul style="list-style-type: none"> <li>• Lesquels les caractéristiques de qualité</li> <li>• Quels types d'inspection</li> <li>• Où effectuer des inspections</li> <li>• Quelles machines pour faire fonctionner</li> <li>• Quels outils pour inspecter</li> </ul>
Des objectifs	<ul style="list-style-type: none"> <li>• Minimiser les coûts de fabrication</li> </ul>	<ul style="list-style-type: none"> <li>• Minimiser les coûts de fabrication</li> <li>• Maximiser la satisfaction du client</li> <li>• Minimiser le temps de fabrication</li> </ul>

En résumé, cette thèse propose un modèle de planification des activités d'inspection mono-objectif pour déterminer quelles caractéristiques de qualité ont besoin de quel type d'inspection et où ces inspections devraient être effectuées dans le processus de fabrication. Ensuite, il est proposé une généralisation de ce problème en PSMIA : optimisation multi objectif. Pour une meilleure compréhension, le détail de ces problèmes a été fourni au [tableau I](#), et son expression est détaillée dans la section suivante.

Le cadre considéré a les propriétés suivantes : fabrication de produits multiples ; chaque étape correspond à une opération et chaque opération porte sur un ensemble de caractéristiques de qualité. Le coût de fabrication considéré se compose du coût de production, des coûts fixes et variables de l'inspection, et des coûts de garantie quand un élément non conforme est chez le client. Bien que la satisfaction du client est un facteur naturellement qualitatif, mais dans cette thèse, en minimisant le nombre d'éléments non détectés qui sont expédiés aux clients est considéré comme un facteur quantitatif à minimiser. Enfin, le temps de fabrication comprend le temps de production, le temps d'inspection, et le temps que les éléments en cours de fabrication, doivent attendre de recevoir des opérations (opérations de fabrication ou d'inspection). Dans le système considéré tous les éléments non conformes sont supposés non réparables et ils seront mis au rebut une fois qu'ils sont détectés. En d'autres termes, les procédures de reprise ne sont pas considérées dans cette thèse. L'opération d'inspection de chaque caractéristique de qualité peut être effectuée seulement après les étapes spécifiques à travers l'ensemble du processus de production. Par exemple, le processus ne peut être arrêté ou l'accessibilité à cette caractéristique est impossible.

### **4.3. Cadre de l'optimisation**

Considérons un système de production en série avec  $N$  étapes dans lesquelles in-process les pièces passent successivement depuis l'étape 1 vers l'étape  $N$  et les inspections des unités sont effectuées aux  $m$  locations ( $m \leq N$ ). Il faut noter que chaque étape est une opération et un ensemble d'opérations peut être effectuée sur la même machine. A chaque étape, une pièce (sortie de l'étape immédiatement précédente) rentre dans l'étape de production où une opération de fabrication est effectuée sur elle. La

production de cette opération est transférée vers un poste d'inspection ou de l'étape suivante de production.

Supposons qu'une pièce ait des caractéristiques qui permettent de qualifier chaque étape de production. Toutes les caractéristiques de la pièce d'une même étape sont traitées simultanément. Si un CI est effectuée entre la  $i$  et  $(i + 1)$  ième opérations de production, les pièces non conformes provenant de l'opération  $i$  ou des opérations précédentes sont détectées et supprimées et aucun reprise est considérée. En outre, si un MI est effectuée entre la  $i$ -ième et  $(i + 1)$  ième opération de production, les caractéristiques de traitement sont suivis par échantillonnage, cette opération de MI permet de détecter un dérèglement et ne contrôle pas la conformité du produit, elle impactera les capacités de nos process. Les opérations d'inspection sont sujettes à des erreurs de type I et II.

L'idée portée par la conception robuste est de concevoir un produit ou un processus moins sensible aux incertitudes plutôt que de supprimer les causes de ces variations. C'est-à-dire que les incertitudes sont acceptées tant que leurs effets sont maîtrisés. Plusieurs définitions de la conception robuste ont été proposées dans la littérature. Dans une revue bibliographique sur la conception robuste, (Park et al., 2006) définit la conception robuste comme une conception insensible aux variations des paramètres intervenant dans le cycle de vie du produit. Il est possible de traduire la robustesse du processus d'inspection grâce à l'écriture d'une fonction objectif modélisant les coûts associés au processus. La robustesse consiste alors à évaluer l'écart du coût réel par rapport au coût nominal. La formulation de la fonction objectif dans le cas l'optimisation robuste porte sur deux variables : la moyenne et l'écart-type de la fonction objectif du modèle déterministe. Nous cherchons à minimiser le cout et sa variabilité. La nouvelle formulation de la fonction objectif robuste est basée sur une pondération linéaire entre la minimisation de la moyenne de la fonction objectif  $\mu f$  et son écart-type  $\sigma f$ . Nous considérons nos incertitudes comme des variables aléatoires et nous évaluons les moyennes et écart type par simulation de Monte Carlo.

Les modèles mathématiques et leurs résolutions sont détaillés dans le manuscrit en anglais. Nous ne détaillerons dans le résumé étendu en français que le cas d'étude et les résultats obtenus.

## 5. Illustration

Pour illustrer la validité des modèles mathématiques proposés et l'efficacité des approches robustes et de solutions proposées, un cas industriel est considéré comme de la société CERTA Renault correspondant à une pompe hydraulique illustrée en [Figure 3](#) avec 15 caractéristiques de qualité est étudié dans cette thèse.

La raison du choix des cas d'étude est principalement la disponibilité des données industrielles. La définition géométrique de ces produits ainsi que leurs gammes de fabrication sont connues. Ils font l'objet de la génération d'un plan d'inspection conformément au positionnement du travail de recherche présenté dans ce mémoire de thèse. Dans ce travail de recherche nous avons limité l'étude à des spécifications géométriques, mais la démarche est évidemment valable pour d'autres contextes.

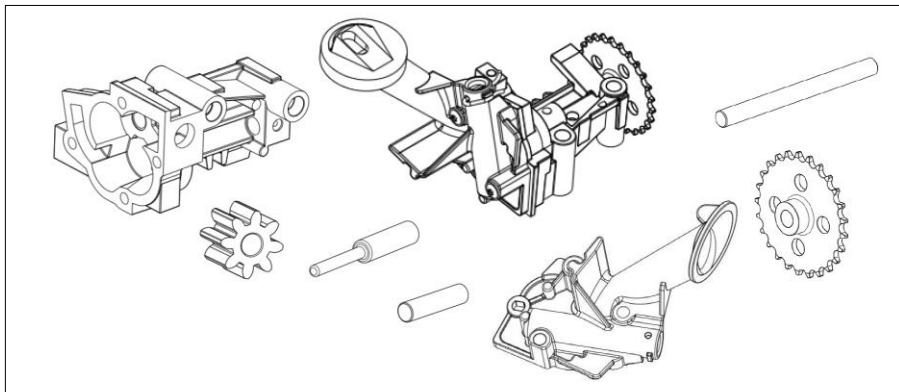

[Figure 3](#). La pompe

Notre étude se focalise sur le carter principal de la pompe dont le processus de production comporte 15 opérations qui sont décrites dans le [Tableau 2](#) Chaque opération est caractérisée par ces capabilités et la fenêtre d'insertion des activités d'inspection relatives aux caractéristiques de cette opération.

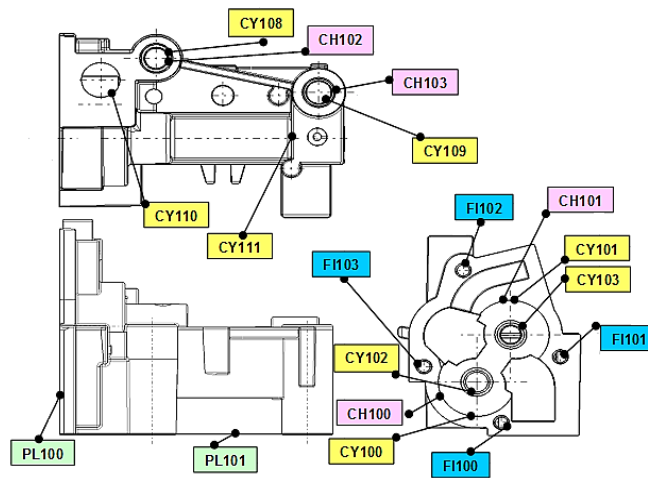

Figure 4. Le Carter CPHC

Tableau 2. Descriptif du processus de fabrication du carter.

Operation Number	Operation Name	Details			
		$PT$	$C_p$	$P_p$	$AP$
1	Rough milling PL100	0.148	2	1.50	1→13
2	Rough milling PL100	0.166	2	1.50	2→14
3	Rough milling PL101	0.133	2	1.66	3→15
4	Boring CY110	0.154	1.60	1.33	4→10
5	Rough drilling CY108 & CY109	0.09	2	1.66	5→10
6	Chamfering CY108 & CY109	0.25	2	1.66	6→6
7	Chamfering CY100 & CY101	0.257	1.50	1.20	7→15
8	Boring CY100	0.257	1.50	1.20	8→15
9	Boring CY101	0.122	1.66	1.30	9→12
10	Rough drilling CY102 & CY103	0.109	1.66	1.40	10→12
11	Rough drilling CY111	0.134	1.66	1.40	11→15
12	Boring CY108 & CY109	0.122	1.30	1.10	12→15
13	Boring CY102 & CY103	0.122	1.30	1	13→15
14	Boring CY111	0.117	1.66	1.33	14→15
15	Finish milling PL100	0.129	1.66	1.33	15→15

La Figure 5 synthétise l'ensemble des résultats de cette étude de cas. La première solution correspond à la solution du modèle déterministe sans considération des incertitudes et donc sans considération des décentrages et dérèglages possibles. Cette première solution ne comporte que des activités de surveillance et aucune activité de contrôle de conformité. Les solutions suivantes correspondent à des solutions de l'optimisation robuste qui pour les premières se focalisent uniquement sur un paramètre incertain et pour la dernière l'ensemble des paramètres incertains. Cette étude de cas montre que le principal paramètre incertain

qui impacte la solution est le décentrage ou dérèglement du système de production, que les erreurs de type I et II n'impactent pas la solution avec des amplitudes de variations de 20% de leur valeur (cette variation correspond à une probabilité d'avoir une pièce mauvaise qui soit déclarée bonne de l'ordre de  $10^{-7}$ ). La présence de ces incertitudes génère des contrôles de conformité qui sont principalement placés à la fin du processus de production. Les solutions optimales identifiées sont proches des solutions pratiquées dans le secteur de l'automobile suite à des préséries.

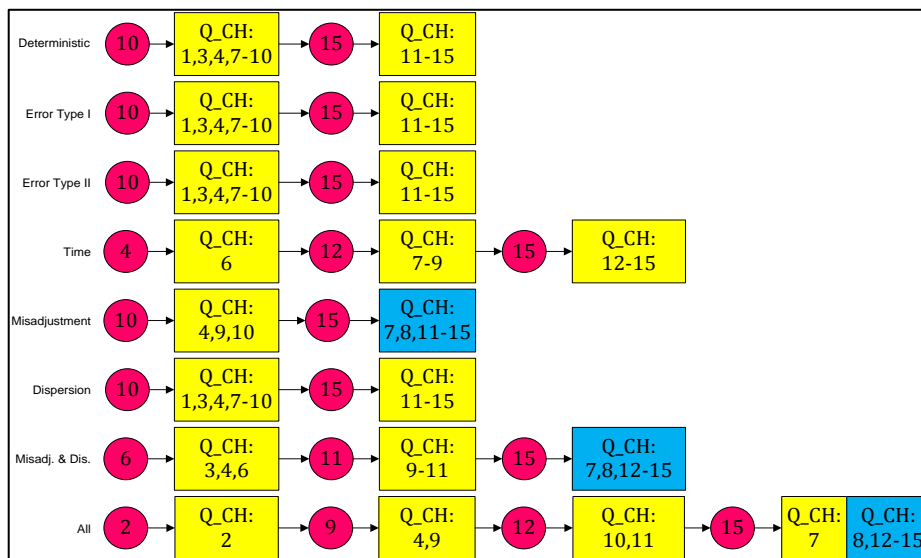

Figure 5. Les processus d'inspection obtenus

Le modèle précédent était relatif à une ligne de production. Une extension de celui-ci a été proposée afin de pouvoir traiter la planification des opérations d'inspection dans le cas d'un système de production flexible par ilots. Le modèle inclut les trois objectifs cités dans la section 4 et 4 postes de contrôle flexibles avec des files d'attente ; la Figure 6 illustre les résultats obtenus dans ce cas. Cette solution permet un équilibrage des charges entre les 4 postes.

Les solutions robustes sont analysées en procédant à une analyse de sensibilité locale des principaux paramètres sur les valeurs prises par les fonctions objectifs, les coûts et les changements de solution. La figure 7 synthétise les résultats de cette analyse de sensibilité locale. Ces résultats

nécessitent une interprétation supplémentaire en calculant les ratios de variations : le plus grand ratio est celui du décentrage (36,8%) et le plus faible celui de l'erreur de type II (0,1%). Ce constat sur cette étude de cas ne permet de conclure sur des tendances génériques.

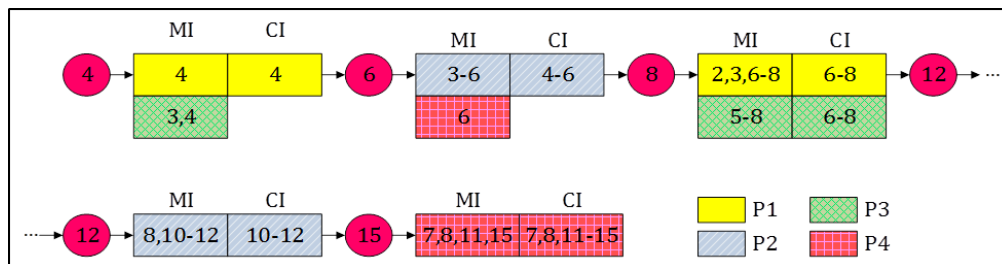

Figure 6. Les processus d'inspection avec 4 postes de métrologie

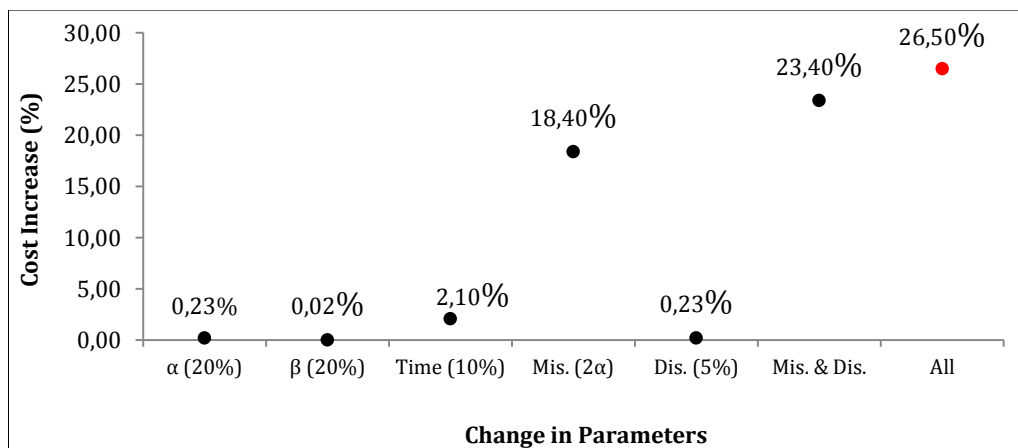

Figure 7. Sensibilité locale du cout au regard des variations des paramètres principaux.

La robustesse du processus d'inspection a un cout. Afin de compléter l'analyse de sensibilité, une analyse de l'augmentation du cout inhérent aux modifications du processus d'inspection a été faite, elle est synthétisée dans la figure 8. Cette analyse prend comme référence le cout du processus d'inspection identifié pour le problème déterministe. La conclusion est identique qu'avec l'analyse de sensibilité, le dérèglement est le paramètre incertain qui coûte le plus cher.

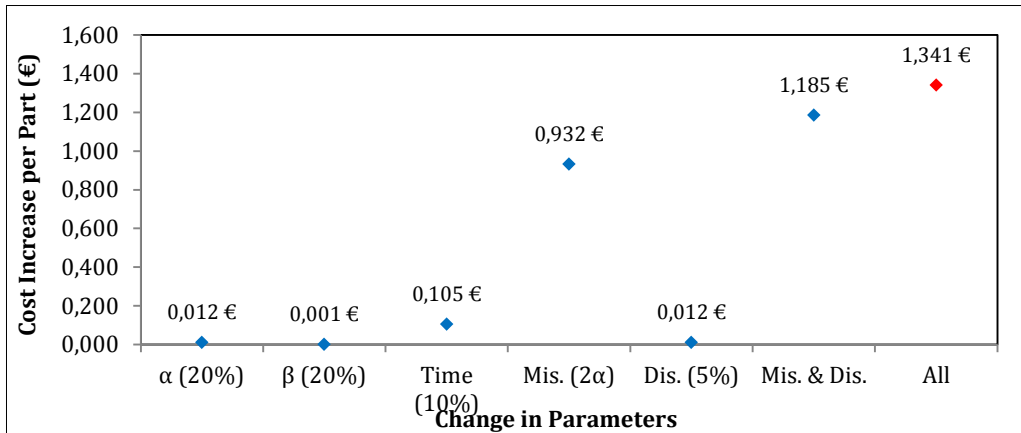

Figure 8. Cout des modifications inhérentes à la prise en compte de certaines incertitudes

Les études précédentes ont montré que le dérèglement était le paramètre incertain le plus impactant. Une analyse de sensibilité sur plusieurs points (plusieurs valeurs de dérèglement) a été réalisée. Cette analyse montre que la sensibilité n'est pas linéaire mais quadratique (Figure 9).

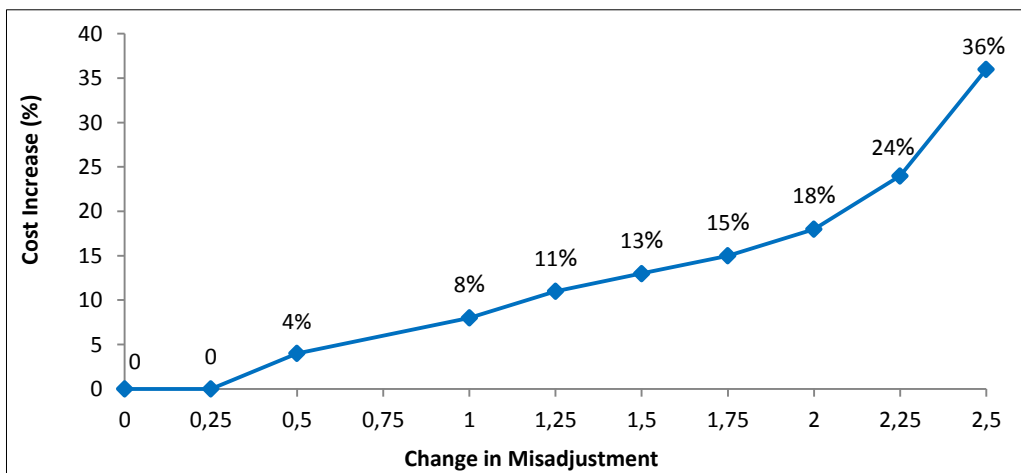

Figure 9. Analyse de sensibilité du dérèglement



## 6. Conclusion

Au terme de ce travail, nous nous proposons de rappeler la problématique, les objectifs, et la méthodologie de recherche suivie. Un bilan de ce qui a été réalisé et apporté en réponse aux attentes, est ensuite établi.

A ce stade la problématique peut être reformulée ainsi :

« Comment générer un plan d'inspection optimal par une prise de décision multicritères, via la co-planification robuste des activités de contrôle de conformité du produit et de suivi de fabrication du processus ? »

A l'issue des premières sections, le contexte global a été introduit notamment par la définition des concepts relatifs à ces travaux. Cela nous a permis de justifier le rôle de l'inspection des caractéristiques pour garantir la qualité. Le concept d'inspection se décline en deux facettes perçues par les industriels : le contrôle de conformité du produit et le suivi de fabrication du processus.

Pour optimiser ces plans d'inspection nous nous sommes intéressés à leurs objectifs stratégiques en particulier le cout afin de formuler un modèle mathématique.

Une expérimentation à dimension industrielle nous a permis de valider l'applicabilité, de comparer différentes stratégies et de comparer différents algorithmes d'optimisation.

Les perspectives principales sont déclinées comme suit, selon leurs rôles et les limites tirées du bilan qui doivent être dégagées :

- Extension du modèle pour la prise en compte d'autres aspects du monde industriel,
- La prise en compte de la précision des connaissances des experts et l'évaluation de la robustesse des solutions au regard de ces méconnaissances,
- La planification de l'ensemble des activités de qualité (inspection, plan d'expérience, AMDEC, ...).

## **Chapter I**

# **General Introduction**

### 1.0. Chapter purpose and outline

This Chapter provides a general view of under study problem and there is no intention to provide in-depth details on the models and approaches discussed, but rather to introduce some of the underlying assumptions and novelties used throughout this thesis, and to position the thesis subject in its research domain. Accordingly, [Section 1.1](#) provides an informative introduction on the problem and the necessity of this research. [Section 1.2](#) describes the problem and represents the underlying assumptions and the main decisions that should be made in the problem. The scope of this problem and main objectives are outlined in [Section 1.3](#) following by solution methodology to solve the problem and achieve the objectives in [Section 1.4](#). [Section 1.5](#) explains the contributions and novelties of this study and the organization of the thesis will be presented in [Section 1.6](#).

### 1.1. Introduction

In recent decades, the egregious importance of total quality management has been completely clarified to all industries. In order to maintain profitable and stay in a competitive edge, reaching to high quality level of products, processes and services has been nowadays a vital issue in many organizations, while they cannot survive without providing high quality products. For this aim, manufacturers are applying a variety of tools to improve quality throughout the production process such as Six Sigma, statistical process control (SPC), process improvement, inspection, robust design, etc.

Through technologically incapable production processes, manufacturers encounter different external factors resulting in quality problem such as inefficient design of products, incapable production techniques, defective equipment and inferior raw materials. Accordingly, production managers are attempting to provide a quality control system to achieve high-quality products in the presence of such pesky external factors. The achievement of quality involves many different aspects, yielding different fields of study: designing quality, manufacturing quality, servicing quality and managing quality. In this thesis, focus is on a specific tool for achieving high manufacturing quality: quality inspections.

Inspection can be defined as “an organized examination or formal evaluation exercise. Inspection involves examination, measurement, testing, gauging, and comparison of materials or items. An inspection determines if the material or item is in proper quantity and condition, and if it conforms to the applicable or specified requirements” ([Winchell, 1996](#)).

Inspecting the quality of products to remove nonconforming items before delivering to the customers is comprehensively performed in every production

system, in which the quality characteristics of a product are evaluated possibly at several phases in its production process. If a nonconforming item is found, it can either be reworked or scrapped. The domain of quality inspection of production processes studies the costs and benefits related to these efforts for obtaining manufacturing or service quality.

In almost all production systems, raw materials undergo a series of distinct processing stages and are transformed into the finish products. In such systems, the output of each processing stage (not the last) is the input for the next stage. Due to non-ideal production conditions and stochastic nature of the production processes at each stage, deviations from design specifications occur that lead to lower quality of products.

Quality inspection in multistage production systems (MPSs) has become a challenging issue and this is because the MPS presents various possibilities for inspection. In such systems, quality inspection is generally corresponds to rework for nonconforming items which are repairable and to scrap the unrepairable items. These activities increase the cost of production since some or all of the processing stages must be duplicated. On the other hand, passing the undetected nonconforming items through subsequent manufacturing stages increases production costs by increasing the number of rework stages needed to restore a unit back through multiple manufacturing stages.

There might be two different strategies, first, locating an inspection station after each manufacturing stage and detect nonconforming items immediately after corresponding operation of that stage. This would reduce the likelihood of shipping defective items across the production process. However, the cost of inspecting after each manufacturing stage in the production process might be more than the savings obtained by the early detection of nonconforming items. Second, inspection could be used after the final processing stage and at no other location. Although this strategy would decrease the cost of the inspection activities, but if there would be a nonconformance in the finish product corresponding to stage one, it might be necessary to repeat all manufacturing stages, that lead to increase in total production cost. In order to minimize the manufacturing cost, in terms of production, inspection, scrap and rework, it is vital to make a balance in different costs and find an optimal inspection strategy.

The problem of finding the best inspection plan is an “inspection planning problem”. A typical inspection planning problem in a MPS is to (i) identify the locations where the quality characteristics should be inspected and simultaneously (ii) determine the best type and strategy for each inspection, in order to minimize total manufacturing cost. Inspection type consists of two main “Conformity” and “Monitoring” inspections. Conformity inspection (CI) is a collective term used for a number of activities (e.g., testing, inspection and certification) to specify whether a product has met the designed characteristics. Monitoring inspection (MI) is often employed in order to detect whether a manufacturing process is running under normal conditions. In MI, the process parameters are watched over by the plant

operators. If one of these parameters deviates from its normal trend, a faulty condition is alarmed and the parameters are adjusted. In addition to inspection types, inspection strategy includes no inspection, full inspection, or sampling inspection (see [Chapter 2](#) for more information).

In addition to enumerated concerns of manufacturers regarding to inspection planning, lack of information about production processes and several environmental factors have become important challenges. These situations have imposed a degree of uncertainty to the planning parameters, which directly affect other decisions of inspection process. Although, in all industries, quality of products is decreased due to manufacturing variations such as performance degradation, non-conformance to specifications, high cost of redesign or scrap and failure, classical methods consider deterministic conditions during the planning of an inspection process, while manufacturing processes are stochastic in nature. Consequently, a percent of the manufactured product do not conform design specifications and their processes is sensitive to manufacturing variations. Traditionally, tight tolerance or a higher precision manufacturing process was applied to solve this issue, which leads to huge manufacturing cost. Hence, manufacturers are interested in less sensitive manufacturing processes. These manufacturing processes are robust processes, which are relatively insensitive to alteration of uncertain parameters.

Broadly speaking, more and strict inspections will obviously increase the product quality in terms of reaching product design specifications and preventing nonconforming items from reaching the customers, but will also leads to higher costs of inspection, scrap and rework. Furthermore, uncertainty in production processes might affect final decisions regarding to inspection plans. Modeling this trade-off and thus investigating ways of finding an optimal inspection plan that is insensitive to alteration of uncertain parameters is at the heart of this research.

### 1.2. Problem statement

As enumerated at [Section 1.1](#), the main simultaneous decisions in an inspection planning problem in a MPS are threefold: (i) *which* quality characteristics need to be inspected, (ii) *what* type of inspection should be performed for selected quality characteristics, and (iii) *where* these inspections should be performed. There would be also another decision like *how* to inspect. The *how* decision usually corresponds to selection of the inspection tool. Accordingly, the procedure of making decisions in an inspection planning problem in a MPS, consisting of  $k$  quality characteristic,  $i$  type of inspection and  $n$  processing stages has been shown schematically in [Figure 1.1](#). Initially, it is checked that whether inspection is needed for quality characteristic  $k$ . The product may be transferred to the next stage or to the final customer unless at least one quality characteristic needs inspection. Next, the product is inspected and it may conform or not to the design specifications. The product will be sent to the next stage in case of conformance with design specification, but in case of nonconforming product, different decisions may be made including: (a) they may be reworked and undergo the inspection again, (b) they may

be transferred to the next stage as downgraded products; or (c) they may be scrapped.

Although planning an inspection process in a MPS constitutes an additional cost, but in imperfect manufacturing systems, specific level of inspection will decrease total cost of manufacturing as well as increase the customer satisfaction. In such cases, the associated cost of inspection will be covered by the benefits realized through the detection of nonconforming products.

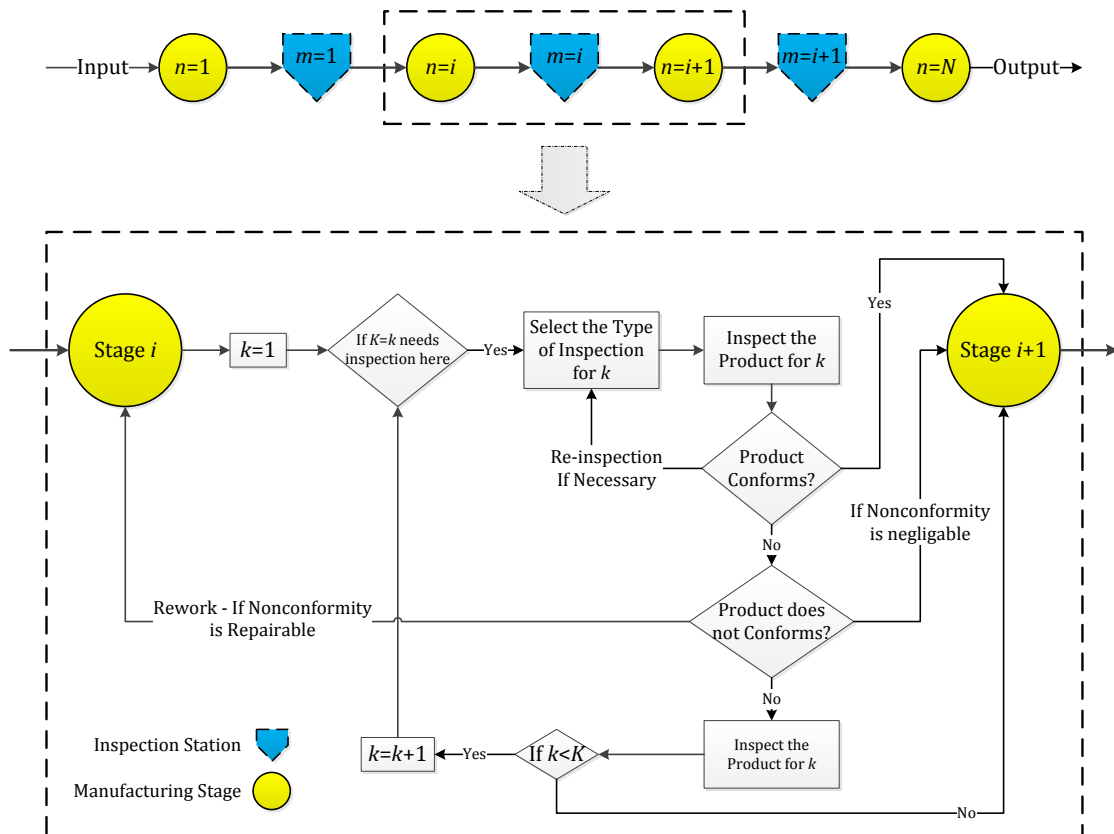

**Figure 1.1.** Inspection planning problem in a MPS

It must be noted that although considering inspection after every manufacturing stage will decrease the scrap, reworking, and downgrading costs and prevent nonconforming products from reaching the customers, but on the other hand, unnecessary and often too inspections constitute huge cost of equipment, staff, time, and space as well as interrupt the overall process that might lead to extra work in-progress (WIP) and flow. Accordingly, if inspections are performed unnecessarily, then greater total costs will incur.

In a MPS as [Figure 1.1](#), as the problem size increases, the number of inspection planning possibilities increases exponentially. For example, in a typical MPS consisting of 20 manufacturing stages where each stage corresponds to one quality characteristic and one type of inspections, if we are allowed only to inspect each characteristic only at its corresponding manufacturing stage, there are  $2^{20}=1,048,576$

possible plans for inspecting the product, when the complete enumeration method becomes impractical.

The problem therefore is to determine which quality characteristics need what kind of inspection and where these inspections should be performed throughout the manufacturing process (i.e., main decisions) to make a balance between minimizing the total cost, by preventing nonconforming products from reaching the customer and maintaining the required level of quality. This inspection planning is the main problem this thesis tries to model and solve. But this typical problem is generalized as follow.

The under study inspection planning problem can be generalized into more complex and more realistic multi-product MPS with machine and inspection tool allocation (PSMIA). In PSMIA, other important objectives raise beside to manufacturing cost including customer satisfaction and manufacturing time. It is noteworthy that minimum manufacturing cost is ideal for manufacturer, while maximum customer satisfaction and minimum manufacturing time are desired for customers. Although manufacturers eager to cost less, but reaching acceptable quality level as well as producing items in lower time to satisfy the customers forces manufacturers to cost more. Accordingly, these objectives are in conflict where higher customer satisfaction needs higher manufacturing cost; lower manufacturing time needs higher manufacturing cost; and lower manufacturing cost may lead to lower quality (i.e., lower manufacturing time may need to ignore time-consuming inspection activities and this event leads to lower quality and consequently lower customer satisfaction).

Summarized, this thesis first proposes and solves a single-objective inspection planning model to determine which quality characteristics need what kind of inspection and where these inspections should be performed throughout the manufacturing process. Hereafter, the first part is named the *Main Problem*. Next, it is tried to generalize the *Main Problem* into PSMIA, namely *Extended Problem*. For better understanding, the detail of these problems has been provided as [Table 1.1](#).

### 1.3. Scope and objectives

The purpose of this thesis is to develop a framework that addresses the inspection planning problem (see [Table 1.1](#)) to mainly determine which quality characteristics need what kind of inspection and where these inspections should be performed throughout the manufacturing process as well as to allocate machines to process the products and assign tools for inspections in a MPS in order to minimize manufacturing cost, maximize customer satisfaction, and minimize manufacturing time. In addition and due to the stochastic nature of production systems, the framework is considered under uncertainty and finally a framework is developed that is insensitive to the variability of the production system. Accordingly, an optimization framework is developed to achieve the objectives.

**Table 1.1.** Details of *Main Problem* and *Extended Problem*

Detail	Problem	
	<i>Main Problem</i>	<i>Extended Problem</i>
Features	<ul style="list-style-type: none"><li>• Single-product</li><li>• Single-objective</li><li>• Full inspection</li><li>• Two inspection types</li></ul>	<ul style="list-style-type: none"><li>• Multi-product</li><li>• Multi-objective</li><li>• Full inspection</li><li>• Sampling inspection</li><li>• Two inspection types</li><li>• Machine allocation</li><li>• Inspection tool allocation</li><li>• Production capacity</li><li>• Inspection capacity</li></ul>
Decisions	<ul style="list-style-type: none"><li>• Which quality characteristics</li><li>• What types of inspection</li><li>• Where to perform inspection</li></ul>	<ul style="list-style-type: none"><li>• Which quality characteristics</li><li>• What types of inspection</li><li>• Where to perform inspections</li><li>• Which machines to operate</li><li>• Which tools to inspect</li></ul>
Objectives	<ul style="list-style-type: none"><li>• Minimizing manufacturing cost</li></ul>	<ul style="list-style-type: none"><li>• Minimizing manufacturing cost</li><li>• Maximizing customer satisfaction</li><li>• Minimizing manufacturing time</li></ul>

The scope under consideration is a MPS processing multiple products, where each stage corresponds to one operation and each operation deals with a set of quality characteristics. The considered manufacturing cost consists of the cost of production, fixed and variable costs of inspection, and warranty costs when a nonconforming item reach customers. Although customer satisfaction is a qualitative factor in nature, but in this thesis, minimizing the number of undetected items that are shipped to the customers is considered to maximize the customer satisfaction. Finally, manufacturing time includes production time, inspection time, and the time that in-process items must wait to receive services (i.e., operation or inspection services). In the system considered all nonconforming items are assumed to be no repairable and they will be scrapped once they are detected. In other words, rework procedures are not considered in this thesis. The inspection operation of each quality characteristic can be performed only after specific stages across the overall production process. For example, the process cannot be stopped or accessibility to that characteristic is impossible unless some furthers specific stages.

#### **1.4. Research methodology**

According to [Section 1.3](#), this thesis proposes an optimization framework that addresses the inspection planning problem to mainly determine which quality characteristics need what kind of inspection and where these inspections should be performed throughout the manufacturing process as well as to allocate machines to



process the products and assign tools for inspections in a MPS processing multiple products. The aim is to minimize manufacturing cost, maximize customer satisfaction, and minimize manufacturing time.

The above research is realized through a methodology with following steps:

- **Step 1:** Specification of needs, specification of problem scope, specification of computation requirements, extensive bibliographic analysis of the scientific approaches and problem definition.
- **Step 2:** Problem formulation and development of models, approaches and concepts. Qualitative comparisons with the existing approaches and concepts.
- **Step 3:** Solving the models and implementing various approaches.
- **Step 4:** Efficiency assessment, approaches comparison and conclusions.

### 1.5. Thesis contribution

There are several researches that have studied quality inspection problem in MPS, namely *Inspection allocation problem*. In these problems, the goal is determining the location of inspection stations throughout the production system as well as determining the inspection strategy in order to minimize total manufacturing cost (Chakravarty and Shtub, 1987; Yum and McDowell, 1987; Emmons and Rabinowitz, 2002; Shiau, 2002, 2003a, 2003b; Hanne and Nickel, 2005; Shiau et al., 2007; Agrawal, 2007; Azadeh et al., 2012). These studies have developed a cost model including production, inspection, rework and penalty costs, and tried to solve the model with different methods consisting of heuristics, meta-heuristics and mixed-integer linear programming approaches.

This research has been defined under a joint program between “School of industrial engineering” from University of Tehran (Iran) and LCFC<sup>1</sup> laboratory from Ecole Nationale Supérieure d'Arts et Métiers-ENSAM (France). This work is the continuation of previous works done by Etienne (2007), Hassan (2010) and Mirdamadi (2014) in the LCFC laboratory.

The contributions that differentiate this research from those of previously published in the literature, are as follows:

- Making simultaneous decision regarding to the quality characteristics that needs inspection, the location of inspection of each quality characteristic and the type of inspections,
- Considering different locations to perform the inspection of each quality characteristic throughout the manufacturing system,
- Developing mixed-integer linear and non-linear programming models to optimally solve the inspection planning problem,
- Designing a multi-objective mathematical model in order to minimize total manufacturing cost, maximizing customer satisfaction, and minimizing manufacturing time.

---

<sup>1</sup> Laboratoire de Conception, Fabrication Commande

- Considering different machines for processing each quality characteristic, where different machines have different features such as failure rate, production time, production cost, capacity, etc.
- Considering different tools for performing inspection of each quality characteristic, where different tools have different features such as detection rate, inspection time, inspection cost, capacity, etc.,
- Taking capacity constraint for both machines and inspection tools into account,
- Analyzing and considering the waiting time of machines and inspection tools and its effect of time objective function,
- Utilizing queuing theory to model the waiting time of machines and inspection tools,
- Assuming that machines and inspection tools are subject to disruption and may stochastically fail for a period of time,
- Developing tailored meta-heuristic algorithms for both single and multi-objective mathematical models.

### 1.6. Organization of the thesis

Following the general introduction in [Chapter 1](#), the literature on the earlier researches done in the area of inspection planning problem is comprehensively reviewed in [Chapter 2](#). [Chapter 3](#) presents the proposed mathematical models for *Main Problem* and *Extended Problem* as well as the solution approach and developed meta-heuristic algorithms. [Chapter 4](#) first explains the case study following by experiments and computational results. In addition, a comprehensive sensitivity analysis is done in [Chapter 4](#). In order to generalize mathematical model and solution approaches in other domains, a part of our findings are applied in transportation network design problem. This extension is provided in [Chapter 5](#) by proposing mathematical models and solution approaches. [Chapter 6](#) shows the results in transportation network design problem. Finally, concluding remarks are presented in [Chapter 7](#) as well as future research directions and limitations of this study.

## **Chapter II**

# **Literature Review**

### 2.0. Chapter purpose and outline

In the [Chapter 1](#), the general framework of the inspection planning problem including the main assumption, main decisions, and new ideas were outlined. This Chapter reviews the literature on the proposed models and solution approaches, applied in quality inspection perspective, to determine optimal inspection plans in MPSs. After an introduction in [Section 2.1](#) and providing a comprehensive terminology of inspection planning problems, different studies are reviewed whether their models have made decisions regarding the location, type and time of inspections separately or simultaneously, in [Sections 2.2](#) and [2.3](#), respectively. Finally, [Section 2.4](#) provides a gap analysis based on the papers reviewed in [Sections 2.2](#) and [2.3](#).

### 2.1. Introduction

In any manufacturing system, reducing variations is one of the most effective ways to meet design specifications and reach a high level of product quality. This reduction is investigated among different paths through the manufacturing system from design to sale phases. The implementation of an optimal inspection plan is one of these paths. Effective inspection plans guaranty the product quality while minimizing total inspection cost. Obviously, more and tighter inspections lead to higher product quality but also induce higher costs of inspection, scrap and rework. An optimal inspection plan will balance these aspects.

In a single-stage production system, inspection plan deals with determining the number of inspections as well as the inspection strategy (i.e., no inspection, full inspection, sampling inspection). Therefore, the inspection planning problem separately investigates an optimal combination of these inspection parameters for each stage that minimizes total inspection cost ([Van Volssem, 2006](#)). Contrary, in MPSs, there are different decisions that must be made for all stages at the same time including the number and location of inspection operations throughout the production system as well as inspection strategies.

Accordingly, in typical MPSs the following main decisions are made:

- The number of inspection operations,
- The location of inspection stations,
- The inspection strategies.

Developing the optimal inspection plans in MPSs deals with determining these main decisions at the same time. In some cases, the decision regarding to the inspection tool selection and the question of how to inspect can be made through the

inspection plan. This issue makes the problem more complex and leads to a simultaneous optimization problem. Although separate optimization has been widely studied and well implemented in the literature, the simultaneous optimization has not been subject to intense research.

Before reviewing relevant papers based on separate and simultaneous optimizations, some criteria are defined in the subsequent sections to better classify the papers. [Subsection 2.1.1](#) discusses the characteristics of the production system such as production structure, production flow, inspection type, inspection strategy, inspection errors, failure type and rate, and nonconforming strategy. In [subsection 2.1.2](#), we discuss the methodologies to model the inspection planning problem strategy as well as the associated solution methods.

### 2.1.1. Production system characteristics

In any industry, a production system can be categorized from the following seven major points of view: 1) production structure; 2) production/inspection flow; 3) inspection type; 4) inspection strategy; 5) inspection errors; 6) failure type and rate; and 7) nonconforming strategy. Each of these major categories is described and will be divided into sub-categories as well. These categories have been also illustrated in detail in [Figure 2.1](#).

#### ***Production structure***

According to the reviewed papers and the research of [Mandroli et al. \(2006\)](#), most of papers have studied multistage production systems (MPSs) with different structures. Accordingly, there are three major production structures based on the item flow passing through the MPSs:

- i. *Serial structure*: in a serial structure, all items pass through the same successive stages sequentially.
- ii. *Convergent structure*: in a convergent structure, each item passes through a specific set of successive stages sequentially. In this structure, different paths may be converged in a specific stage. On the other hand, each manufacturing stage has at most one successor but many predecessor stages. Assembly process is an example of this structure.
- iii. *Nonserial structure*: in a nonserial structure, each item passes through different stages sequentially. In this structure, each manufacturing stage may have several successors and predecessor stages.

#### ***Production/inspection flow***

According to [Mandroli et al. \(2006\)](#), either a single type of product or multiple types of products from the same product family can be produced in a production line. On the other hand, inspections of a production line can be performed per item or per batch (or a lot). Therefore, four possibilities are provided as:

- i. *Single production/single inspection*,
- ii. *Single production/batch inspection*,

- iii. *Mixed production/single inspection,*
- iv. *Mixed production/batch inspection.*

### ***Inspection type***

Through inspection planning problem, two different kinds of inspection, namely conformity (CI) and monitoring (MI) inspections, are integrated with production processes.

- i. *Conformity inspection:* CI is the collective term used for a number of activities (e.g., testing, inspection and certification) to specify whether a product has met the designed characteristics. In other words, CI determines that a product has been correctly manufactured based on the process plan and is in compliance with the design requirements. In CI, no deviations from the design specifications are allowed where non-conformed items may have to be reproduced or reworked in order to bring them into conformance. Therefore, the main aim of CI in production is to minimize the risk of manufacturing products that have to be rejected instead of being sold (Hinrichs, 2011). In CI, the production process is interrupted and the products are checked whether the most important characteristics can meet standard specifications.
- ii. *Monitoring inspection:* since stopping the production process may not be cost-effective, MI can be taken into account as a process status indicator where corresponding features of the process (e.g., feed speed of a drilling machine, force and temperature) are checked, not to deviate from their set value. Manufacturing process monitoring attracted a considerable amount of attention over the years (Liang et al., 2004; Abellan-Nebot and Subirón, 2010). The reason for this is that when machining is done within the right tolerances, the required quality of the produced part is achieved and hence the monitoring of the machining process contributes greatly to the manufacturing quality assurance. MI is needed to obtain not only higher productivity and better product quality, but also to identify the risks of severe damage to workpieces or machine-tool components. This is because the operator reaction time has become insufficient during an emergency, and the use of high speeds can cause serious damages (Ritou et al., 2014).

### ***Inspection strategy***

As enumerated in Section 1, different inspection strategies have been adopted by the researchers as:

- i. *No inspection:* In this strategy, some quality characteristics are not inspected.
- ii. *Full inspection:* In this strategy, if we decide to inspect a quality characteristic, all items are inspected.
- iii. *Sampling inspection:* In this strategy, if we decide to inspect a quality characteristic, a sample of items is inspected.

### **Inspection errors**

An inspection operation may involve errors of two types:

- i. *Error type I*: misclassification of a conforming component as non-conforming
- ii. *Error type II*: and nonconforming one as conforming (type II error).

### **Failure rate and type**

Failure rate is the proportion of defective items among all items produced by a manufacturing stage (Mandroli et al., 2006). In the literature, a known constant failure rate for all operations has been considered by some authors, whereas others have considered either a possible range of failure rates or random failure following certain distribution. From another aspect, two single and multiple failure types have been assumed by researchers. In single type failure, there is only one failure rate corresponding to the failure type, while in multiple types, a vector of failure rates are associated with each type of failure (Mandroli et al., 2006). Therefore, four potential combinations are as follows:

- i. *Constant rate/single type*,
- ii. *Random rate/single type*,
- iii. *Constant rate/multiple type*,
- iv. *Random rate/multiple type*.

### **Nonconforming strategy**

Once a nonconforming item is detected during inspection, this item is repaired, replaced, or scrapped. The proper action depends not only on the cost associated with that subsequent action but also on knowledge of whether the nonconformance is reparable since certain types of nonconformance must be scrapped.

Accordingly, researchers have assumed a level of scrapping for nonconforming parts (Mandroli et al., 2006). This level can be either deterministic or probabilistic. A deterministic level means that for a given type of nonconformance, the scrapping level is given and involves three different possibilities as all, none, or some of the nonconforming items are scrapped. On the other hand, others have considered a probabilistic level for scrapping. This strategy assumes that a nonconforming item is scrapped with a given probability. It means that some of items may have a chance to be repaired. Based on these explanations, nonconforming strategy is divided into for subcategories as follows:

- i. *Scrapping all* (deterministic),
- ii. *Scrapping some* (deterministic),
- iii. *No scrap* (deterministic),
- iv. *Probabilistic*.

### **2.1.2. Methodology**

According to the vast literature on inspection planning problems, most of researchers have solved the problem through an optimization formulation. Almost all

objective functions have been to minimize the total cost including the costs of inspection, scrap, rework, warranty, and so on. In this section, different components of the cost objective function are discussed first; next, the three fundamental parts of an optimization formulation as (i) objective function; (ii) constraint; and (iii) solution approach, are discussed. The category of methodology has been illustrated in detail in [Figure 2.2](#).

### **Cost components**

In almost all researches, the authors have considered specific components for the cost objective function including production, inspection, and failure costs. The failure cost itself contains internal and external cost. An internal failure cost is incurred when nonconforming items are detected before reaching the customers. This cost specially reflects the costs associated with reworking, replacing, or scrapping a nonconforming item. External failure costs are all costs that manufacturer faces with when a nonconforming product is sold and delivered to the customers. These costs may be a certain penalty or compensation, as well as the lost sales and costs for restoring the reputation of the product. The external failure costs have not been taken into account in every research.

On the other hand, the inspection cost involves two fixed and variables costs. The fixed inspection cost corresponds to fixed amount of capital for providing inspection tools and the variable cost directly depends on the frequency and number of inspected items. The variable inspection cost has been often considered as a linear function, in which, the total variable inspection cost is the number of items inspected multiplied by the variable inspection cost per item. Some other researchers have treated this cost as a quasi-concave function ([Britney, 1972](#)).

### **Objective functions**

The most common form of objective functions in the literature is minimizing total expected cost to optimize the inspection plans. Another common treatment is expected unit cost, instead of the total expected cost. However there are different ways to determine the units. Some papers have computed the expected unit cost as total cost divided by the number of input items; i.e.,  $(total\ cost)/(input\ items)$ . Another version is dividing total cost by number of output; i.e.,  $(total\ cost)/(output\ items)$ . Another idea for the second form is dividing total cost by the number of conforming outputs;  $(total\ cost)/(conforming\ output\ items)$ .

There are only a few authors considering maximization formulations in their studies. The maximization objectives have mainly proposed in inspection scheduling problems besides to classical inspection planning problem. To the best of our knowledge, there is no study that has considered minimizing total manufacturing time as well as maximizing customer satisfaction.



### ***Constraints***

The constraints in typical inspection planning problem are mostly related to the type of production structure, the type of nonconformance, the type of inspection. The authors have derived other constraints such as: (i) an upper bound for inspection time; (ii) limited number of inspection stations; (iii) limited number of rework and the times that an inspection can be repeated; (iv) limited budget for manufacturing and inspection actions; (v) a limited places that an inspection can be performed, and (vi) a lower bound requirement on throughput or production capacity (Mandroli et al., 2006). It is noteworthy that constraints (i) and (ii) can be categorized as a special form of constraints (vi) and (iv), respectively.

Other constraints in inspection plans could be the dependency between different quality characteristics that need to be inspected. For example, two quality characteristics must be inspected at the same time or vice versa. Besides to quality characteristics dependency, operations that realize the characteristics might be dependent and there is no possibility to stop a specific operation to inspect a characteristic and we have to wait once the second operation is terminated. For more information regarding to operation dependency, interested readers are referred to the work done by Mirdamadi (2014). There may be other constraints applicable in domain of inspection planning problems that have not gained lot of attention such as limited capacity of operating machines and inspection tools to treat the items.

### ***Solution approaches***

The authors have proposed a wide variety of approaches for solving small and large size instances. In small size instances, approaches such as dynamic programming (DP), integer programming (IP) and nonlinear programming (NLP) have been utilized. Among these, DP has gained more popularity due to multistage structure of production systems following by NLP and IP methods in lower popularity.

An important limitation of these approaches is their incapability of solving medium and large size problems due to requirement of high computational time and memory. This limitation led to arise of heuristic and metaheuristics algorithms in this domain such as Simulated Annealing (SA) and Genetic Algorithms (GAs), while they provide near optimal solutions in considerable low computational time. Another optimization approach includes using simulation to solve the problem.

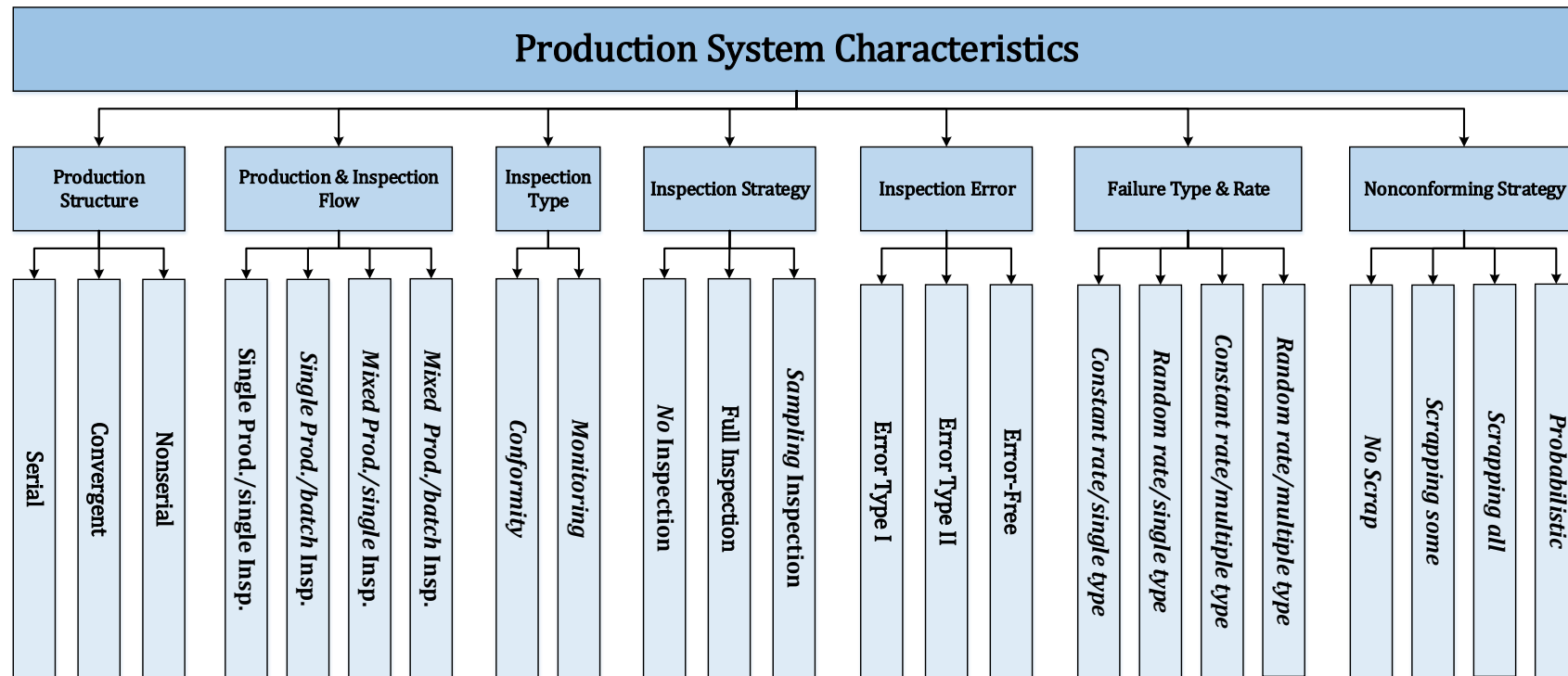

Figure 2.1. Criteria of production system characteristics

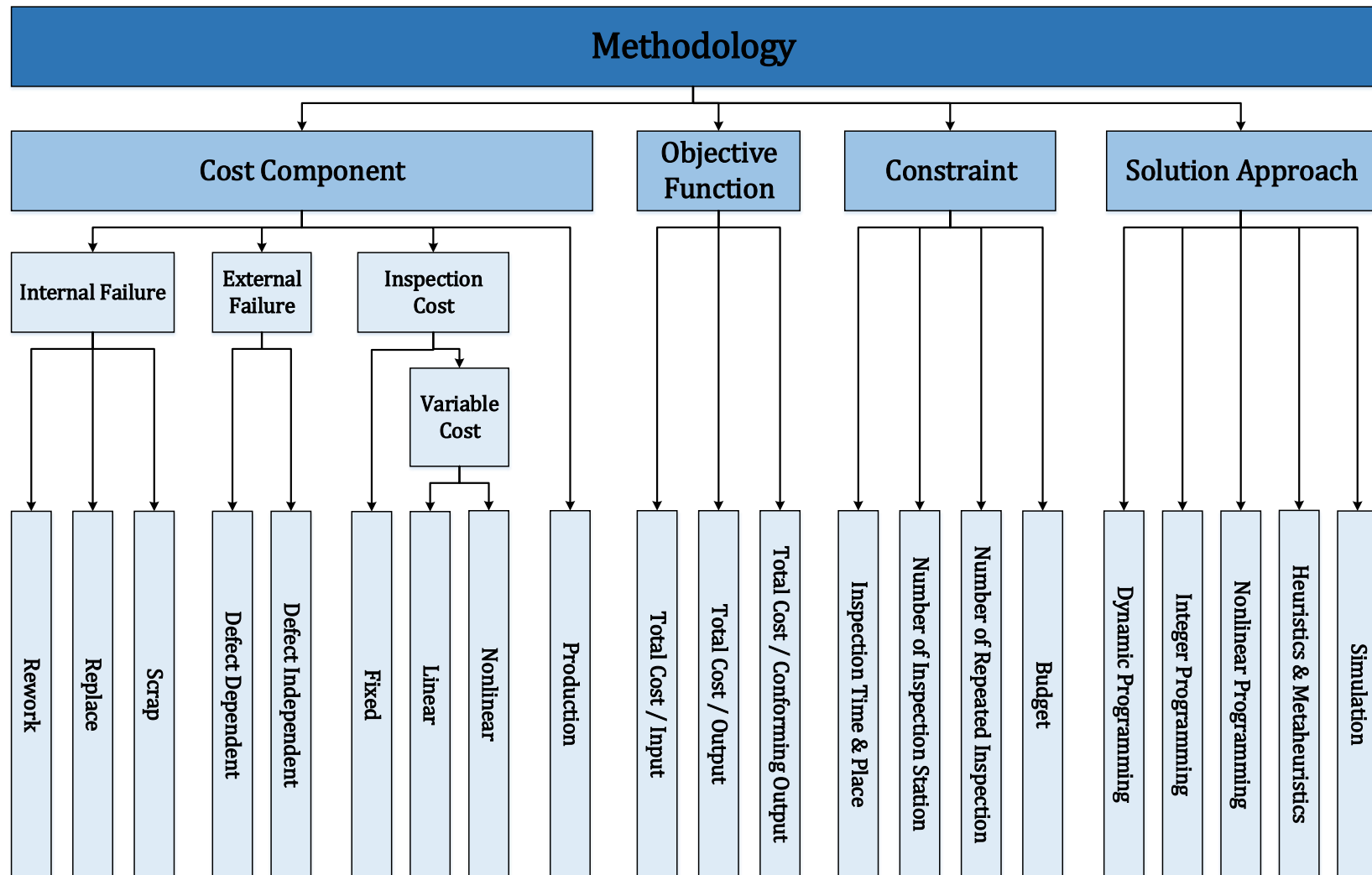

Figure 2.2. Criteria of methodology

In the following, the literature is first reviewed based on two main categories described in [Section 2.1](#) as separate and simultaneous optimizations; next, the surveyed papers are analyzed to drag the gaps.

### 2.2. Separate optimization

Inspection planning problems have been studied by many researchers since the 1960s. As the first attempt, [Lindsay and Bishop \(1964\)](#) proposed a basic conceptual model and considered perfect inspection accuracy for workstations of attribute data (WAD), in which all nonconforming items were scrapped. They also assumed that the inspection station could only check the outcome of the immediately preceding workstation. They tried to determine optimal inspection allocation along a serial multistage and constant rate production system and perfect inspection. They applied dynamic programming approach to solve the model and concluded that this solution approach produces expected results. Their important finding is that the total cost will only be minimized by an extreme-point solution, such that, at each production stage, the cost of optimal inspection level is either 0 (no inspection) or 1 (full inspection).

The extension of their study was proposed by [White \(1966\)](#) where the nonconforming items are replaced with conforming ones. By adopting the finding of [Lindsay and Bishop \(1964\)](#), [White \(1966\)](#) proposed shortest route models to determine the optimal inspection allocation in order to minimize the costs of inspection, replacement and non-detected defective items (i.e., external failure cost). [Britney \(1972\)](#) also extended the work of [Lindsay and Bishop \(1964\)](#) for an  $n$ -stage nonserial production process. [Britney \(1972\)](#) proposed the optimal level of screening at every potential inspection station to minimize total expected cost of inspection, repair cost and cost of undetected items. The author reported that for the proposed quasi-concave cost structure (i.e., nonlinear inspection cost function), the optimal screening program employed either zero or 100% effective screening throughout. Finally, a standard branch and bound “backtrack” strategy was developed identify optimal screening programs for the proposed unconstrained  $(0, 1)$  nonlinear integer programming problem.

[Hurst \(1973\)](#) and [Eppen and Hurst \(1974\)](#) first planned an inspection process by investigating the effect of type I and type II inspection errors on the optimal inspection allocation decisions. [Eppen and Hurst \(1974\)](#) modeled an inspection allocation problem with full inspection strategy by assuming that the inspection error probabilities are known at each stage and the probability of detecting a defective item is independent of the type of error or the stage where the defect was produced. They concluded that their cost objective function is concave and piecewise linear. Finally, a dynamic programming based approach was developed to solve the model and provide inspection policies for the production system.

[Peters and Williams \(1984\)](#) investigated the performance of five heuristic algorithms to aid in the location of quality inspection stations within a production

line. Their research tried to identify the relations between various cost and process characteristics and the operative condition of the heuristics. The five heuristics are based on five rules of thumb including: 1) allocating the inspections before to all manufacturing stages, 2) allocating the inspections before those high cost manufacturing stages, 3) allocating the inspections before those manufacturing stages that may make the later detection of defective items more difficult and costly, 4) allocating inspection after those manufacturing stages with higher probability of producing defective items, and 5) allocating inspections at the end of production line. The authors examined the performance of the heuristics on an example with 13 manufacturing stages and concluded that the cost of processing had no significant effect of the performance of heuristics, while the production constraints on the operating conditions significantly affected the performance of the four heuristics.

[Chakravarty and Shtub \(1987\)](#) investigated the effect of setup and inventory carrying costs on the inspection strategy (i.e., "all or none" versus partial inspection). They suggested a shortest path heuristic to determine the strategic location of inspection activities and the production lot sizes. [Verduzco et al. \(2001\)](#) presented a real-time inspection allocation that is based on the information gained by inspecting one additional component. They modeled the selection of which components to be inspected as an information maximization problem.

[Saxena et al. \(1990\)](#) evaluated the performance of four inspection station allocation heuristics on the basis of job completion time in serial production systems under different operating conditions. The main goal of this paper was to find parameters that significantly affect both the performance of the heuristics and cost function. The core decision of these heuristics can be stated as 1) performing inspections before the manufacturing stages with the longest processing time and performing an inspection at the end of the production line, 2) informing inspections after manufacturing stages that were more likely to product nonconforming items and performing an inspection at the end of the production line, 3) performing inspections after each manufacturing stages, and 4) performing an inspection at the end of the production line. The authors applied simulation methods to simulate the production system and adopted full inspection strategy (i.e., 100% inspection). They finally reported the time as the most significant parameter affecting the performance of the heuristics. They suggested inspections after each manufacturing stage, when the inspection time is high comparing to processing time. On the other hand, inspections are recommended after the manufacturing stage that are most likely to produce nonconforming items, when the inspection time is low comparing to the processing time.

In addition to decisions regarding the location of inspections, determining the optimal sample size and sampling frequency of inspections has been extensively studied in terms of Statistical Process Control (SPC) and its applications. Recent studies in this field have been oriented towards the investigation of economic benefits of adaptive versus control charting as well as towards adaptive sample size

and sampling frequency. Other contributors in this field are [Montgomery et al. \(1994\)](#), [Keats et al. \(1997\)](#), and [Del Castillo and Hurwitz \(1997\)](#).

[Taneja and Viswanadham \(1994\)](#) concerned with the problem of location of inspection station in a MPS. They developed a cost function that included inspection, manufacturing and scrapping cost at each stage of the production process as well as penalty cost when a defective item reaches customers. The authors developed a genetic algorithm based approach to determine the location of inspection station resulting in a minimum expected total cost. Finally, a set of test problems were solved using this algorithm. This problem with the same assumptions was solved using simulated annealing algorithm in another work by [Taneja et al. \(1994\)](#).

In a similar work to [Taneja and Viswanadham \(1994\)](#), [Viswanadham et al. \(1996\)](#) were concerned with the problem of location of inspection stations in a MPS. The authors present two stochastic search algorithms for solving this problem, one based on simulated annealing and the other on genetic algorithms. These algorithms are developed to determine the location of inspection stations resulting in a minimum expected total cost in a multistage manufacturing system. The total cost includes inspection, processing and scrapping cost at each stage of the production process. A penalty cost is also included in it to account for a defective item which is not detected by the inspection scheme. A set of test examples are solved using these algorithms. The authors also compare performance of these two algorithms.

[Narahari and Khan \(1995\)](#) considered re-entrant manufacturing systems (such as semiconductor fabrication facilities) with inspections at various stages of processing. The authors considered three policies respecting to inspected items, namely accept, reject, or rework at some previous stage. The authors proposed re-entrant lines with probabilistic routing as models for such systems and presented an efficient analytical technique based on mean value analysis (MVA) to predict mean cycle times and throughput rates. They evaluated the performance of the method using several numerical experiments and simulation. They finally concluded that performing small number of strategically allocated inspection stations perform better than large number of poorly located inspection stations.

[Rabinowitz and Emmons \(1997\)](#) considered a single inspection facility that can be quickly switched among multiple inspection tasks. They introduced their study to be used (for example) for detecting malfunction (or down state) production stages in a MPS. They assumed that a properly working (or up state) production stage moved to a down state in any period with fixed probability. Then, stage stood down until it was inspected and immediately restored back to an up state. The authors purposed a model to schedule inspections among the different production stages so as to maximize the fraction of good items produced. They provided optimal inspection schedule for a two stage production system and developed four heuristics for the general case of more than two stages. They finally concluded that the proposed dynamic schedule was easy to derive, always feasible, and outperformed the static schedules.

Accordingly, [Tagaras \(1996, 1998\)](#) developed a dynamic programming model for the optimization of statistical process control for finite production runs, while a dynamic chart allows all three parameters, namely the sampling interval; sample size and control limit location. The major conclusion of this research was that significant cost savings may be realized through the application of dynamic control charts and even greater benefits may be obtained by investing in process understanding and improvements.

[Van Volsem and Van Landeghem \(2003\)](#) investigated the effect of various cost parameters on selection of an optimal inspection policy (i.e., no inspection, full inspection, sampling inspection) in a MPS with constant production and inspection rates, error-free inspection and perfect rework. Their developed cost function included inspection, rework and penalty costs. They used simulation to solve the cost function and considered two different problems. The first problem included fixed inspection cost but variable rework and penalty costs and the second problem consisted of fixed inspection and penalty costs with variable rework cost.

### 2.3. Simultaneous optimization

The studies discussed in the [Section 2.2](#) are all limited to single-issue optimization. In order to make the main inspection decisions at the same time along a MPS, simultaneous or combined optimization approaches are necessary. Since this section reviews the most related papers, interested readers are invited to read the review of other papers in [Appendix 1](#).

[Bai and Yun \(1986\)](#) studied an economic design of inspection allocation plan for a serial MPS, in which, a product consists of many identical components, only a limited number of inspection stations are available, and the rate of production is restricted by the rate of inspection. They proposed a cost model and a method of finding optimal locations of inspection stations and inspection level (i.e., sampling inspection). They also proposed a solution procedure based on dynamic programming for solving small size problems and for large size instances a heuristic allocation algorithm was presented. The authors concluded that the developed method obtains optimal or near optimal solutions in less computational time even for large enough instances.

[Tang \(1991\)](#) presented an inspection-production model for planning an inspection process in an  $N$ -stage production system, where each stage performs manufacturing operations that are followed by a potential inspection location. The proposed model attempts to simultaneously find the inspection location, the number of testers at each inspection location and the number of machines at each production stage. The model can be used for budget planning, while it makes a trade-off analysis between the initial investment and total operating cost.

[Raz and Kapsi \(1991\)](#) presented an integrated approach to the problem of allocation of inspection stations in MPSs. This research addressed multiple inspection operations, different disposition policies and inspection (i.e., no



inspection, full inspection, sampling inspection), production and repair errors. The authors developed quality and cost transfer functions to model production operations and different types of inspection operations in a unified manner and to facilitate the recursive computations required to evaluate alternative system configurations. They formulated the combined inspection location and sequencing problem as a nonlinear mathematical programming problem and solved it with a branch and bound technique, using a heuristic to generate a feasible solution and upper bound. Finally, the authors conducted the developed model on a numerical example and showed the performance of the proposed algorithm.

[Veatch \(2000\)](#) studied the problem of inspection allocation to find inspection strategies in a MPS with time varying quality. This research formulated an economic cost of quality model with multiple inspection locations and sampling. The model was applied to a thermal printer for digital photographs to determine when inspection of incoming material should be performed. The authors concluded that inspection is cost effective only for parts that were produced with low quality or a very high unit cost. In addition, it was reported that sampling inspection was costly efficient when there was a significant variation in the defect rate between lots. They finally recommended their model to wide range of assembly processes.

[Verduzco et al. \(2001\)](#) presented inspection allocation that is based on the real-time Automated Visual Inspection (AVI) in the electronics assembly industry. The problem in this research was determining which components to be inspected at each one of the AVI stations such that the available inspection time was used in an optimal way. Accordingly, this paper presented a real-time inspection allocation that was based on the information gained by inspecting one additional component. The authors modeled this problem as an information maximization problem. Besides, a modified knapsack greedy heuristic method was used to find near-optimal solutions to this optimization problem within the required time constraints.

The study of [Emmons and Rabinowitz \(2002\)](#) dealt with the layout and operation of an inspection system used for detecting malfunctioning processors in a MPS. Their problem involved three inter-related decisions including: (i) the overall inspection capacity; (ii) the assignment of inspection tasks to inspectors; and (iii) the scheduling of the inspector's tasks. Their study ensured a trade-off between the cost of inspectors and the loss associated with non-conforming products. In order to support these three related decisions, a hierarchical heuristic solution procedure was proposed. They reported the performance of the proposed heuristic by comparing the results with a lower bound. They finally declared that their results might be applicable to any organization, which inspects and maintains a variety of characteristics of its branches or activities.

[Kogan and Raz \(2002\)](#) studied the problem of simultaneously managing the intensity, sequence and timing of inspection processes in an  $N$ -stage production system with  $M$  inspection activities possible at each stage. They proposed a cost function to be minimized constituting of the sum of the inspection costs and the



penalties caused by undetected defects. By means of the maximum principle, they proved several properties of the optimal solution that lead to reduction of the continuous-time inspection effort allocation problem to a combinatorial one.

Zhou and Zhao (2002) concerned a problem that involved the selection of quality tools and assignment of the tools and quality operations to machine centers or inspection stations. They used mathematical modelling approach to minimize the total cost respecting customer demands and resource constraints. The authors developed five heuristic algorithms based on a tripartite graph representation of the original problem, namely random search algorithm, cubic greedy algorithm, edge greedy algorithm, single matching algorithm, and double matching algorithm. Based on experimental results, the authors showed that the proposed algorithms were effective and efficient in terms of computational performance.

Shiau (2002) studied inspection resource assignment in a multi-stage manufacturing system that considering inspection errors. They considered a limited number of inspection stations of each inspection station class to solve the inspection allocation problem when inspection errors happened due to rapid changes of tolerances to satisfy customer requirements. Since determining the optimal inspection allocation plan seemed impractical as the problem size became quite large, the author developed two heuristic methods by considering the defective rate to solve the model, namely earliest stage assignment method and hybrid weighting assignment method. Shiau (2002) measured the performance of each method in comparison with the enumeration method that generates the optimal solution. The higher performance of the hybrid weighting assignment method was reported comparing to the earliest stage assignment method in terms of computation.

As an extension of the work by Shiau (2002), Shiau (2003a) studied the problem of allocating inspection stations throughout a MPS with inspection errors and limited inspection resources. The author took manufacturing and inspection capabilities and tolerances into account in the cost model. In order to solve the model, two heuristic methods were developed based on two criteria as sequence order of workstations and tolerance interval. Shiau (2003a) measured the performance of each method in comparison with the enumeration method that generates the optimal solution. The author reported the higher performance of the heuristic method based on time efficiency sequence order in comparison with tolerance interval method.

Similarly, Shiau (2003b) studied inspection-allocation planning (IAP) for a multiple quality characteristic manufacturing system, in which the production recourses are restricted and the limited number of inspection stations, of each inspection station class, is considered for solving IAP. This paper solved IAP using a unit cost model, in which the manufacturing capability, inspection capability, and tolerance specified are simultaneously considered as well as situation of the unbalanced tolerance design.

Hanne and Nickel (2005) developed a multi-objective inspection planning model to find the optimal allocation of inspection station throughout the MPS within a software development (SD) project. The authors considered three objectives as (a) the quality of the product measured by the eventual overall number of defects of the documents produced during a project, (b) the makespan of the project (its duration), and (c) the costs or total effort of the project. The developed model of SD processes included different phases as coding, inspection, test, and rework and comprised the assignment of operations to persons and the generation of a project schedule. For solving the proposed multi-objective model, the authors designed an evolutionary algorithm combined with some additional scheduling heuristics. The application of the algorithm to test instances of the problem showed significant improvements in most cases with respect to all of the objectives compared to a first-come first-serve solution implicitly used within the original simulation model.

Feng and Kapur (2006) investigated the economic and statistical effects of inspection error on the design of specifications due to imperfect measurement systems. In this study, three different models were developed under 100% inspection assumption (i.e., full inspection strategy) including: 1) assuming error-free inspections 2) assuming error for inspections but constant inspection cost, and 3) assuming error for inspections and variable inspection cost. The objective of all three models was to minimize sum of inspection, scrap and quality loss costs. The authors proposed a genetic algorithm to optimally solve the models. Finally, numerical examples were given to illustrate the applicability of the presented models for the disposition of the output of any process for quality improvement.

Van Volsem et al. (2007) studied the problem of inspection planning for a given MPS in order to minimize the total inspection cost, while still assuring a required output quality. The problem was modelled as a simultaneous optimization to determine the inspection location, type and inspection strategies (i.e., no inspection, full inspection, sampling inspection) in order to minimize the sum of inspection, rework and penalty costs. The authors suggested a fusion between a discrete event simulation to model the multi-stage process subject to inspection and to calculate the resulting inspection costs, and an Evolutionary Algorithm (EA) to optimize the inspection strategies. The experimental results showed the effectiveness and efficiency of the proposed EA algorithm in optimizing the inspection planning problem.

As a remarkable example of simultaneous optimization, Shiau et al. (2007) integrated production process and inspection planning problems while higher performance of a production industry can be realized if process planning and inspection planning become integrated to cope with the limited manufacturing resources. On the other hand, since the product variety in batch production or job-shop production are increased for satisfying the changing requirements of various customers, the specified tolerance of each quality characteristic vary from time to time. Accordingly, except for finite manufacturing resource constraints, the authors

considered the manufacturing capability, inspection capability, and tolerance specified by customer requirement for a customized manufacturing system. Due to complexity of the proposed model, a genetic algorithm was applied with the realistic unit cost embedded to solve the model. The performance of genetic algorithm was measured in comparison with the enumeration method. The authors concluded that a near-optimal manufacturing resource allocation plan could be determined efficiently for meeting the changing requirement of customers as the problem size became quite large.

In a similar work, [Penn and Raviv \(2008\)](#) again studied unreliable serial production lines with known failure probabilities for each operation. The aim of this research was to simultaneously decide where and if to allocate inspection stations throughout the production system and to determine the production rate, so as to maximize the steady state expected net profit per time unit from the system. They did not consider a specific distribution for arrival rate of jobs and considered holding costs equal to zero. Similarly, they proposed two  $O(N^2)$  and  $O(N^2)$  time dynamic programming algorithms to solve cost minimization and profit maximization models. The authors recommended the branch-and-bound algorithm when the holding costs are high. They finally reported the high efficiency of their algorithms.

[Rau and Cho \(2009\)](#) studied the inspection allocation problem in a reentrant production system, in which, it is difficult to inspect some defects after they are covered by the next layer. They proposed a genetic algorithm (GA) for solving the inspection allocation problem. Based on the declaration of the authors, this algorithm was very suitable for solving such problem and led to near optimal solutions comparing to complete enumeration, because the codes used in the chromosome of the GA approach were exactly the same as the representation of the inspection allocation policy for workstations in the production system.

In a new work, [Ferreira et al. \(2009\)](#) studied the problem of determining the inspection interval of condition monitoring in a MPS. In their problem, the decision variable was represented by the time of next inspection of condition monitoring. The authors tried to optimize the model from different points of view by proposing a decision model, which could simultaneously determine inspection intervals for condition monitoring regarding the failure behavior of equipment to be inspected, features of maintainability and decision maker preferences about cost and downtime. The proposed model was based on delay time analysis assumptions and a multi-criteria framework. The authors applied their model in an electric power distribution company. By this application, they highlighted the suitability and practicality of the model.

[Van Volsem \(2010\)](#) studied the allocation of inspection stations in a MPS as a joint optimization problem by making decision regarding to all inspection parameters such as inspection location, inspection type, inspection limits and sampling characteristics, in order to obtain an efficient inspection strategy that resulted in the lowest total inspection cost. The authors proposed a metaheuristic

solution approach, namely an evolutionary algorithm (EA) to solve the model. They also used simulation to calculate the inspection costs for every candidate solution.

Korytkowski (2011) considered a multiproduct MPS in case of allocating inspection stations throughout the production system. In the proposed model, part types competed with each other for common production resources. In such environment, it is important to consider factors such as throughput time variability and to include the corresponding queuing aspects into the model. The author modeled each workstation as a GI/G/c queue. Finally, the optimal allocation was determined by using a genetic algorithm with tournament selection, one-point crossover and uniform mutation.

In a different work, Mousavi et al. (2015) studied the problem of selecting important quality characteristics to be inspected in order to minimize inspection cost while assuring a high level of quality for the final products. The authors considered uncertainty in their selection model by modifying the classical methods. To cope with uncertainty of the input parameters, this research introduced a distance-based decision model for the multi-attributes analysis by considering the concepts of intuitionistic fuzzy sets (IFSs), grey relations and compromise ratio approaches. The authors first developed a weighting method for the attributes based on a generalized version of the entropy and IFSs along with experts' judgments. Then, a new grey relational analysis was introduced to analyze the extent of connections between two potential scenarios by an intuitionistic fuzzy distance measurement. Finally, an intuitionistic fuzzy compromise ratio index to prioritize the scenarios was proposed by considering the weight of the strategy for the maximum group utility in intuitionistic fuzzy grey environment. Finally, the authors illustrated the feasibility and practicability of the proposed selection method by implementing it in a real case study to the inspection planning for the oil pump housing from Renault automobile manufacturing.

### 2.4. Conclusion and gap analysis

According to the elaborated criteria in Section 2.1, the reviewed papers in Sections 2.2 and 2.3 are classified into different categories associated with each of the criterion. Tables 2.1 and 2.2 represent a summary of the classifications respecting to the criteria proposed in subsections 2.1.1 and 2.1.2; i.e., production system characteristics and methodology, respectively. Furthermore, Figures 2.3 and shows the number of different papers studying each production system characteristic. Similarly, Figure 2.4 depicts the number of papers in each sub-category of methodology in the inspection planning problem. Regarding to the comprehensive survey in domain of inspection planning problems, the following gaps were investigated and each of these gaps can be a research direction for future studied.

Table 2.1. Classification of literature based on the production system characteristics

Author	Year	Prod. structure			Prod./Insp. flow					Insp. type	Insp. strategy			Insp. errors			Failure type and rate					Nonconforming strategy		
		Serial	Convergent	Nonserial	Single Prod./single Insp.	Single Prod./batch Insp.	Mixed Prod./single Insp.	Mixed Prod./batch Insp.	Monitoring		Conformity	No Insp.	Full Insp.	Sampling Insp.	type I	type II	Error free	Constant rate/single type	Random rate/single type	Constant rate/multiple type	Random rate/multiple type	No Scrap	Scraping some	Scraping all
Beightler and Mitten	1964	✓			✓				✓			✓			✓		✓			✓				
Lindsay and Bishop	1964	✓			✓				✓			✓			✓	✓						✓		
White	1965	✓			✓				✓			✓			✓	✓				✓				
Pruzan and Jackson	1967	✓			✓				✓			✓			✓			✓					✓	
Brown	1968	✓			✓				✓			✓			✓	✓				✓				
White	1969	✓			✓				✓			✓			✓			✓				✓		
Ercan	1972	✓			✓				✓			✓			✓	✓				✓				
Garey	1972	✓			✓				✓		✓				✓	✓							✓	
Woo and Metcalfe	1972	✓			✓				✓		✓				✓			✓					✓	
Britney	1972			✓	✓				✓		✓				✓			✓				✓		
Hurst	1973	✓			✓				✓			✓	✓	✓		✓							✓	
Dietrich and Sanders	1974	✓			✓				✓		✓				✓		✓						✓	
Eppen	1974	✓			✓				✓			✓	✓	✓		✓							✓	
Ercan et al.	1974	✓			✓				✓			✓			✓	✓				✓				
Trippi	1974	✓			✓				✓			✓			✓			✓				✓		
Enrick	1975	✓			✓				✓			✓	✓	✓		✓						✓		
Trippi	1975	✓			✓				✓			✓			✓			✓			✓			
Yum and McDowell	1981			✓	✓				✓		✓		✓	✓		✓				✓				
Ballou and Pazer	1982	✓			✓				✓			✓	✓	✓		✓							✓	
Hsu	1984	✓			✓				✓			✓			✓	✓				✓				
Peters and Williams	1984	✓			✓				✓			✓			✓	✓						✓		

Table 2.1. Classification of literature based on the production system characteristics (continue)

Author	Year	Prod. structure			Prod./Insp. flow				Insp. type		Insp. strategy			Insp. errors			Failure type and rate					Nonconforming strategy		
		Serial	Convergent	Nonserial	Single Prod./single Insp.	Single Prod./batch Insp.	Mixed Prod./single Insp.	Mixed Prod./batch Insp.	Monitoring	Conformity	No Insp.	Full Insp.	Sampling Insp.	type I	type II	Error free	Constant rate/single type	Random rate/multiple type	Constant rate/multiple type	Random rate/multiple type	No Scrap	Scrapping some	Scrapping all	Probabilistic
Garcia-Diaz et al.	1984		√		√				√		√		√	√		√				√				
Ballou and Pazer	1985	√				√			√			√	√	√		√						√		
Gunter and Swanson	1985		√		√				√		√				√	√						√		
Bai and Yun	1986	√					√		√		√	√	√					√				√		
Chakravarty and Shtub	1987	√					√		√			√			√			√						√
Lee and Rosenblatt	1987	√			√				√		√		√					√		√				
Peters and Williams	1987	√				√			√			√	√					√				√		
Yum and McDowell	1987	√				√			√			√	√	√		√					√			
Tayi and Ballou	1988	√				√			√			√			√	√				√				
Saxena et al.	1990	√			√				√		√				√	√						√		
Barad	1990	√				√			√			√	√	√				√						√
Foster et al.	1990	√			√				√		√	√	√		√	√						√		
Kang et al.	1990	√				√			√		√		√	√		√					√			
Raz and Kaspi	1991	√			√				√		√		√	√		√								√
Tang	1991	√			√				√		√				√	√						√		
Villalobos and Foster	1991	√			√				√		√		√	√		√						√		
Villalobos et al.	1993	√			√				√		√		√	√		√						√		
Taneja & Viswanadham	1994	√		√	√				√		√		√	√		√						√		
Jewkes	1995	√			√				√		√				√	√				√				
Rebello et al.	1995	√			√				√		√		√					√			√			
Shin	1995	√			√				√		√		√		√	√				√				

Table 2.1. Classification of literature based on the production system characteristics (continue)

Author	Year	Prod. structure			Prod./Insp. flow				Insp. type		Insp. strategy			Insp. errors			Failure type and rate					Nonconforming strategy		
		Serial	Convergent	Nonserial	Single Prod./single Insp.	Single Prod./batch Insp.	Mixed Prod./single Insp.	Mixed Prod./batch Insp.	Monitoring	Conformity	No Insp.	Full Insp.	Sampling Insp.	type I	type II	Error free	Constant rate/single type	Random rate/single type	Constant rate/multiple type	Random rate/multiple type	No Scrap	Scrapping some	Scrapping all	Probabilistic
Deliman and Feldman	1996	√			√				√		√			√		√							√	
Gurnani et al.	1996	√				√			√			√			√	√				√				
Viswandham et al.	1996	√	√			√			√		√		√	√		√						√		
Narahari and Khan	1996			√	√				√		√				√	√							√	
Chevalier and Wein	1997	√			√				√		√		√	√					√	√				
Rabinowitz and Emmons	1997			√	√				√		√				√	√						√		
Chen et al.	1998	√				√			√		√				√		√			√				
Lee and Unnikrishnan	1998	√						√	√			√	√	√				√			√			
Yao and Zheng	1999a	√				√			√		√				√		√			√				
Yao and Zheng	1999b	√				√			√		√				√			√	√	√				
Chen and Thornton	1999			√				√	√		√				√			√			√			
Hassan and Pham	2000	√			√				√		√		√	√		√							√	
Veatch	2000	√			√	√			√		√			√			√			√			√	
Zheng	2000		√			√			√		√				√			√	√	√				
Verduzco et al.	2001		√					√	√			√	√	√				√				√		
Zhou and Zhao	2002	√			√				√		√				√	√						√		
Shiau	2002	√				√			√			√	√	√			√				√			
Emmons and Rabinowitz	2002			√				√	√			√			√	√						√		
Avinadav and Raz	2003	√				√			√		√		√	√			√					√		
Oppermann et al.	2003	√			√				√		√		√	√				√				√	√	
Van Volsem & Van Landeghem	2003	√			√				√		√				√	√					√			

Table 2.1. Classification of literature based on the production system characteristics (continue)

Author	Year	Prod. structure			Prod./Insp. flow					Insp. type		Insp. strategy			Insp. errors			Failure type and rate					Nonconforming strategy		
		Serial	Convergent	Nonserial	Single Prod./single Insp.	Single Prod./batch Insp.	Mixed Prod./single Insp.	Mixed Prod./batch Insp.	Conformity	Monitoring	No Insp.	Full Insp.	Sampling Insp.	type I	type II	Error free	Constant rate/single type	Random rate/single type	Constant rate/multiple type	Random rate/multiple type	No Scrap	Scrapping some	Scrapping all	Probabilistic	
Shiau	2003a	√				√				√			√	√			√					√			
Shiau	2003b	√				√				√			√	√			√					√			
Kakade et al.	2004	√			√						√				√			√				√			
Valenzuela et al.	2004	√			√						√				√			√				√			
Rau and Chu	2005	√			√						√				√			√				√			
Hanne and Nickel	2005	√			√						√				√	√						√			
Feng and Kapur	2006	√			√					√			√	√		√							√		
Shiau et al.	2007	√				√					√		√	√		√							√		
Penn and Raviv	2007	√			√						√				√			√					√		
Van Volsem et al.	2007	√				√					√				√	√						√			
Penn and Raviv	2008	√					√				√				√	√							√		
Vaghefi and Sarhangian	2009	√			√							√	√	√		√						√			
Ferreira et al.	2009	√			√							√			√	√							√		
Rau and Cho	2009	√			√						√				√	√						√			
Azadeh and Sangari	2010	√			√						√				√	√							√		
Van Volsem	2010	√			√						√		√	√			√					√			
Korytkowski	2011	√				√					√				√	√							√		
Rau and Cho	2011	√			√						√				√	√							√		
Azadeh et al.	2012	√			√							√			√	√						√			
Azadeh et al.	2014	√			√							√	√	√		√						√			
Mousavi et al.	2015	√			√					√		√	√	√		√							√		



Table 2.2. Classification of literature based on the methodology

Author	Year	Cost component								Objective Function			Constraint				Solution Approach								
		Internal Failure			External Failure		Insp. Cost			Production Cost	Total/input	Total/output	Total/Conf. output	Insp. time	No. of Insp. Station	Insp.	No. of repeated	Budget	Dynamic Prog.	Integer Prog.	Nonlinear Prog.	Metahuristics	Heuristics & Metahuristics	Simulation	
		Rework	Replace	Scrap	Defect Dep.	Defect Ind.	Fixed	Variable																	
								Linear	Non linear																
Beightler and Mitten	1964					√		√	√									√							
Lindsay and Bishop	1964			√				√										√							
White	1965		√			√		√										√							
Pruzan and Jackson	1967					√		√		√								√							
Brown	1968			√		√		√		√								√							
White	1969	√	√	√		√		√		√				√				√							
Britney	1972	√				√			√										√						
Ercan	1972	√		√		√		√		√									√		√				
Garey	1972							√		√								√							
Woo and Metcalfe	1972			√		√		√				√						√							
Hurst	1973			√				√		√															
Dietrich and Sanders	1974					√		√		√													√		
Eppen	1974			√		√		√		√								√							
Ercan et al.	1974	√	√	√		√		√		√															
Trippi	1974	√		√	√		√	√		√				√							√				
Enrick	1975	√		√		√		√		√								√							
Trippi	1975		√		√		√	√		√									√						
Yum and McDowell	1981	√	√			√		√		√									√						
Ballou and Pazer	1982			√		√		√				√										√			
Garcia-Diaz et al.	1984	√				√		√		√								√							
Hsu	1984			√		√		√		√								√							

Table 2.2. Classification of literature based on the methodology (continue)

Author	Year	Cost component								Objective Function			Constraint				Solution Approach						
		Internal Failure			External Failure		Insp. Cost			Production Cost	Total/input	Total/output	Total/Conf. output	Insp. time	No. of Insp. Station	No. of repeated Insp.	Budget	Dynamic Prog.	Integer Prog.	Nonlinear Prog.	Metaheuristics	Heuristics & Metaheuristics	Simulation
		Rework	Replace	Scrap	Defect Dep.	Defect Ind.	Fixed	Variable															
								Linear	Non linear														
Peters and Williams	1984	√		√	√		√	√		√									√				
Ballou and Pazer	1985					√			√	√									√				
Gunter and Swanson	1985			√		√	√				√						√						
Bai and Yun	1986			√		√	√			√				√			√						
Chakravarty and Shtub	1987	√		√	√		√	√		√	√						√		√				
Lee and Rosenblatt	1987					√	√		√		√								√				
Peters and Williams	1987			√		√	√		√			√					√						
Yum and McDowell	1987	√	√	√		√		√		√								√					
Tayi and Ballou	1988	√		√		√		√		√	√								√				
Saxena et al.	1990			√				√		√	√										√		
Barad	1990	√	√	√		√		√		√	√										√		
Foster et al.	1990			√		√		√			√			√							√		
Kang et al.	1990	√		√		√	√	√		√	√											√	
Raz and Kaspi	1991	√		√		√		√		√		√						√					
Tang	1991			√		√	√	√		√	√					√	√						
Villalobos and Foster	1991			√		√		√			√						√						
Villalobos et al.	1993			√		√		√			√			√			√						
Taneja & Viswanadham	1994			√			√	√		√	√				√	√					√		
Jewkes	1995	√				√		√		√	√								√				
Rebello et al.	1995	√		√	√			√		√			√				√					√	
Shin	1995	√						√			√												

Table 2.2. Classification of literature based on the methodology (continue)

Author	Year	Cost component								Objective Function			Constraint			Solution Approach								
		Internal Failure			External Failure		Insp. Cost			Production Cost	Total/ Input	Total/ output	Total/ Conf. output	Insp. time	No. of Insp. Station	Insp.	No. of repeated Insp.	Budget	Dynamic Prog.	Integer Prog.	Nonlinear Prog.	Metaheuristics	Heuristics & Metaheuristics	Simulation
		Rework	Replace	Scrap	Defect Dep.	Defect Ind.	Fixed	Variable																
								Linear	Non linear															
Deliman and Feldman	1996	√		√		√			√	√										√				
Gurnani et al.	1996	√							√									√						
Narahari and Khan	1996	√	√							√										√				
Viswandham et al.	1996	√		√		√			√	√				√								√		
Chevalier and Wein	1997	√				√			√	√										√				
Rabinowitz and Emmons	1997								√										√					
Chen et al.	1998	√				√			√	√								√						
Lee and Unnikrishnan	1998	√			√				√	√				√						√				
Chen and Thornton	1999			√			√		√	√												√		
Yao and Zheng	1999a	√				√			√	√									√					
Yao and Zheng	1999b	√			√				√	√									√					
Hassan and Pham	2000	√		√		√			√		√											√		
Veatch	2000			√	√				√		√											√		
Zheng	2000	√			√				√		√								√					
Zhou and Zhao	2002			√	√				√			√					√					√		
Emmons and Rabinowitz	2002								√	√												√		
Shiau	2002	√	√	√		√			√	√				√								√		
Oppermann et al.	2003	√		√		√			√	√									√					
Avinadav and Raz	2003				√		√	√			√											√		
Van Volsem & Van Landeghem	2003	√				√	√	√		√													√	
Shiau	2003a	√	√	√		√		√		√				√								√		

Table 2.2. Classification of literature based on the methodology (continue)

Author	Year	Cost component								Objective Function			Constraint				Solution Approach						
		Internal Failure			External Failure		Insp. Cost			Production Cost	Total/input	Total/output	Total/Conf. output	Insp. time	No. of Insp. Station	No. of repeated Insp.	Budget	Dynamic Prog.	Integer Prog.	Nonlinear Prog.	Metahuristics	Heuristics & Metahuristics	Simulation
		Rework	Replace	Scrap	Defect Dep.	Defect Ind.	Fixed	Variable															
								Linear	Nonlinear														
Shiau	2003b	√	√	√		√		√					√							√			
Kakade et al.	2004	√			√			√				√								√			
Valenzuela et al.	2004					√						√								√			
Rau and Chu	2005	√		√	√		√	√	√	√										√			
Hanne and Nickel	2005	√		√			√	√	√	√										√			
Feng and Kapur	2006			√			√	√	√	√													
Shiau et al.	2007	√		√			√	√		√				√						√			
Penn and Raviv	2007						√	√	√	√							√						
Van Volsem et al.	2007	√			√		√	√		√										√			
Penn and Raviv	2008			√			√	√			√									√			
Vaghefi and Sarhangian	2009	√		√		√	√	√	√	√												√	
Ferreira et al.	2009	√		√		√	√	√		√										√			
Rau and Cho	2009	√	√	√				√	√	√										√			
Azadeh and Sangari	2010						√	√		√										√			
Van Volsem	2010	√		√		√	√	√		√										√		√	
Korytkowski	2011						√	√		√				√						√			
Rau and Cho	2011	√		√			√	√		√										√			
Azadeh et al.	2012	√		√		√	√	√		√										√			
Azadeh et al.	2014	√		√		√	√	√		√										√		√	
Mousavi et al.	2015			√		√		√	√	√										√			

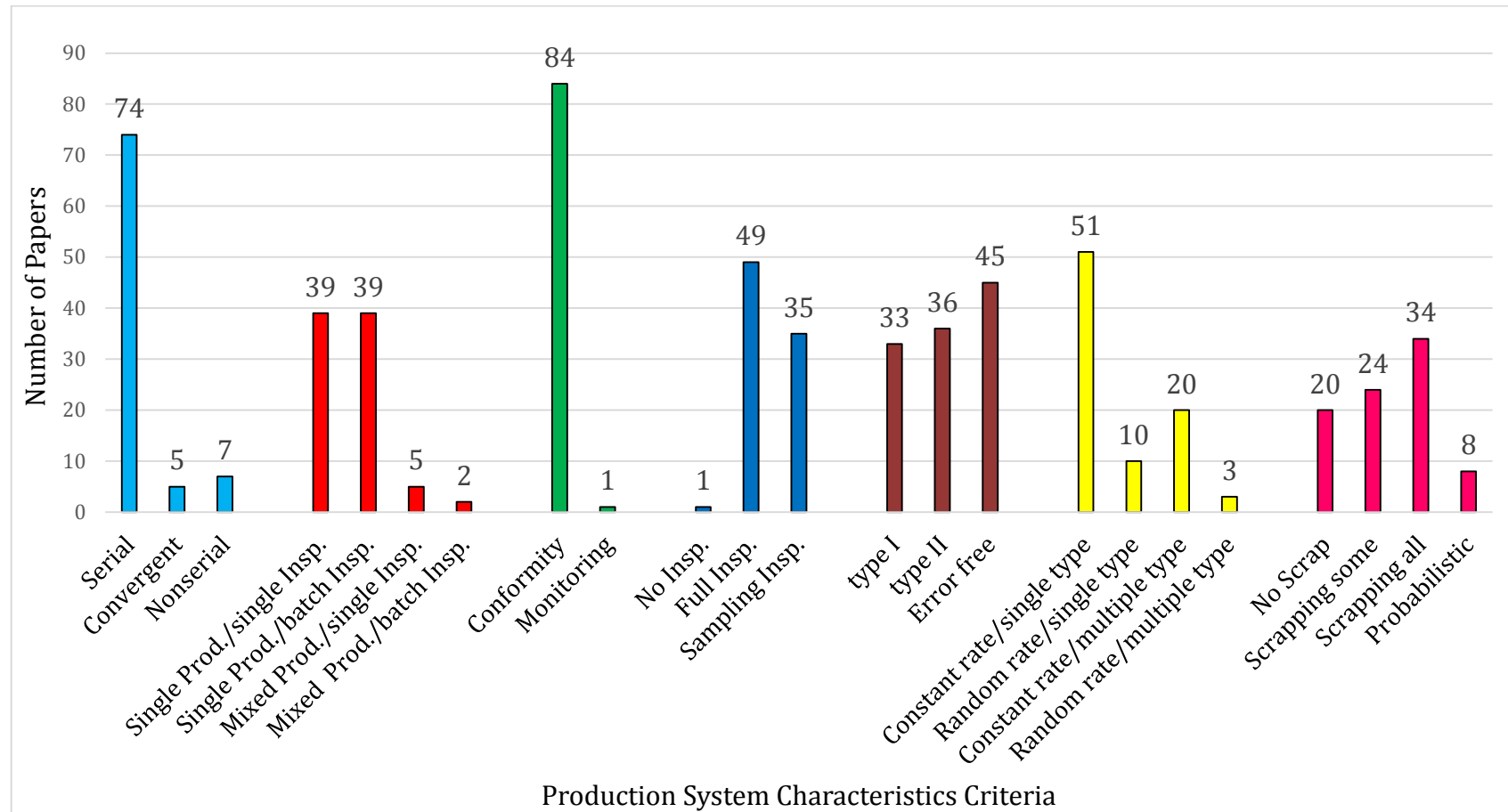

Figure 2.3. Papers in category of production system characteristics

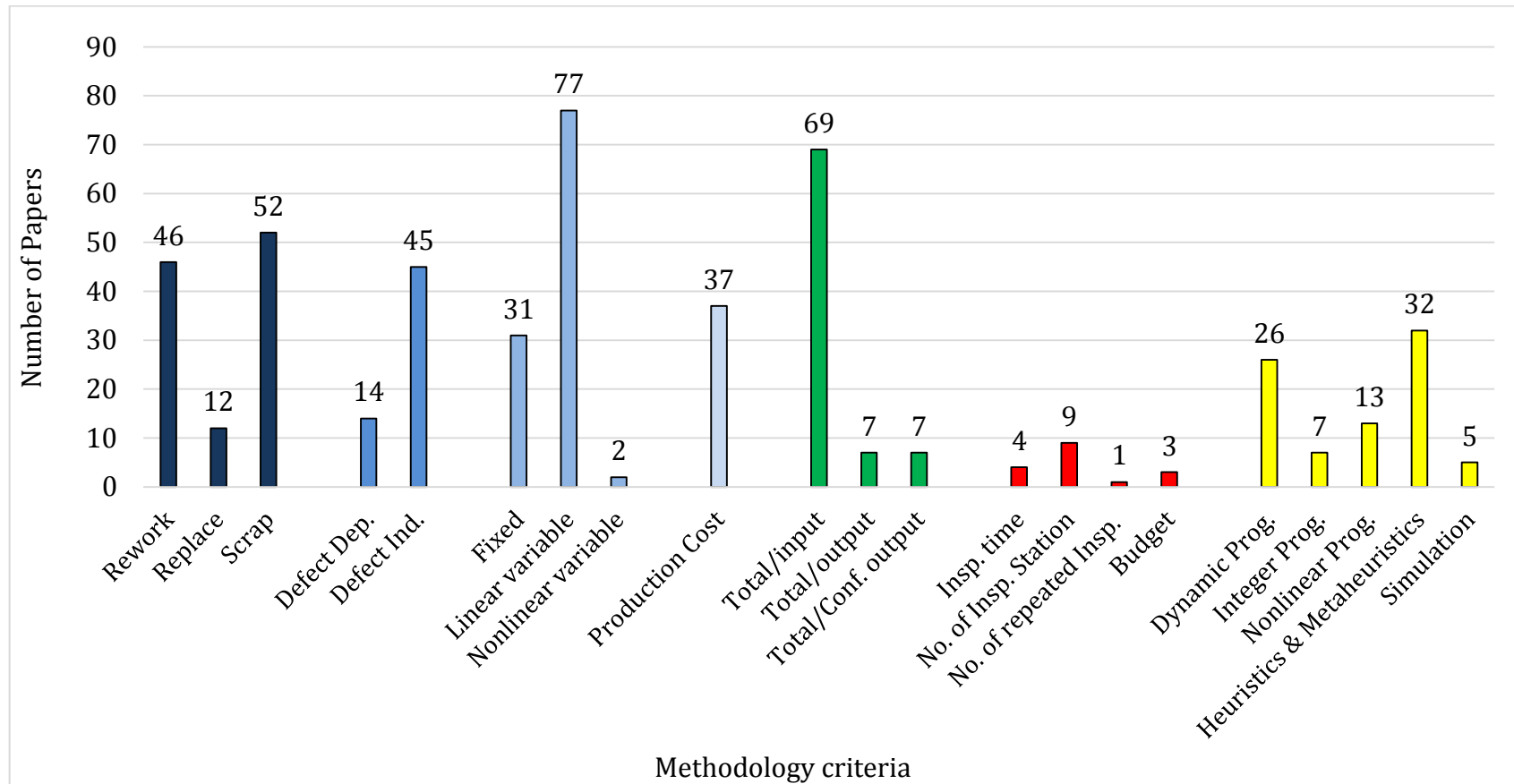

Figure 2.4. Papers in category of methodology

- A few of papers have considered multi-product manufacturing system with different quality characteristics.
- Only three of papers have considered inspection tool selection, while this assumption makes the model more real and provides more flexible inspection plan. By this assumption, manufacturer can purchase inspection tools with higher precision and reduce non-detected items that reach customers and consequently increase customer satisfaction.
- To the best of our knowledge, there is no paper in the literature considering machine selection. By considering machine selection assumption, manufacturer can purchase machine with high capability to obtain high quality level for important design characteristics.
- No paper has design a multi-objective inspection planning model by considering other criteria to be optimized. Other objectives can be maximizing customer satisfaction as well as minimizing total manufacturing time.
- By considering time as an objective, one important issue that comes up is waiting time of items through the production system. Different items must wait before each machinery or inspection station to receive services. These waiting times should be analyzed and taken into account in the final decisions.
- To the best of our knowledge, no paper has considered the reliability of production system. Since production systems are stochastic in nature and are affected by different unpredictable environmental factors, machines and inspection tools are subjected to disruption. Any breakdown in the production system not only increases the manufacturing cost, but also significantly affects the quality of final products. Therefore, considering reliability issue of production system and investigate the effect of unreliable machines and inspection tools on the final inspection planning could be an interesting research direction.
- Almost all of the authors have ignored manufacturing constraint in their studies. Some of these constraints could be capacity of machines and inspection tools, an upper bound for total production time, low capital for initial investment and limited places for performing inspections and so on. Considering these constraints provides more real and applicable inspection plans.
- Developing more efficient metaheuristic algorithms for solving inspection planning models could be also another gap in the literature.

## **Chapter III**

# **Mathematical Formulations & Solution Approaches**



### 3.0. Chapter purpose and outline

In the [Chapter 2](#), a comprehensive survey was done on the domain of inspection planning problem and literature gaps were extracted. This Chapter provides a comprehensive optimization framework to model the studied inspection planning problem and propose an efficient solution approach to solve the model. The proposed framework attempts to fill the gaps elaborated in [Section 2.4](#). [Section 3.1](#) describes the general characteristics of the under-study inspection planning problem in detail. [Sections 3.2](#) and [3.3](#) will proposed the mathematical models for the *Main Problem* and *Extended Problem*, respectively (see [Table 1.1](#)). Each of [Sections 3.2](#) and [3.3](#) contains the main assumptions, notations, mathematical formulation and robust approach for their corresponding models. After providing the optimization framework for both Main and Extended Problems, two meta-heuristic algorithms are proposed in [Section 3.4](#) to solve the models. Finally, [Section 3.5](#) provides a summary of the chapter.

### 3.1. Problem statement

As discussed in the previous chapters, the problem considered in this research is mainly to determine an optimal inspection plan so as to minimize total manufacturing cost for a given serial multistage production system (MPS) to obtain a desired quality level of final products. Through an inspection plan, considering a part with an initial set of quality characteristics, three main simultaneous decisions should be made including: (i) *which* quality characteristics should be inspected, (ii) *what* type of inspection should be performed for the selected quality characteristics, and (iii) *where* these inspections should be performed. There would be also another decision like *how* to inspect that usually corresponds to selection of the inspection tool. Although there is a vast number of characteristics belongs to a part, but only a few of them are key characteristics that represent the quality level of the part. Accordingly, there is no need to potentially consider all the characteristics, while some of them can be filtered. So, the initial set is better to contain the most important characteristics. There are different techniques in the literature to select the key characteristics but the most recent work by [Mirdamadi \(2014\)](#) can be applied to provide the initial set of quality characteristics. Therefore, the results of the work of [Mirdamadi \(2014\)](#) could be an input for the problem that is addressed by this thesis.

The specific features of the production system include the number of different quality characteristic, the number of manufacturing stages, the failure rate of each stage in producing nonconforming items, inspection errors for each quality characteristic, the inspection strategy (i.e., no inspection, full inspection, sampling inspection) and the costs associated with manufacturing and inspection activities.

As an example for such production systems, consider a MPS as [Figure 3.1](#) with  $k$  quality characteristic,  $i$  type of inspection and  $n$  processing stages. Initially, it is checked that whether inspection is needed for quality characteristic  $k$ . The part may be transferred to the next stage or to the final customer unless at least one quality characteristic needs inspection. Next, at least one type of inspection (i.e., CI and MI) is performed. Not important what type of inspection is performed, in-process parts must wait until the inspection is finished. After inspection, items are sent to the next stage in the case of no nonconformance in terms of items or processing features. In presence of any nonconformity in the items, different decisions may be made including: (a) they may be reworked and undergo the inspection again, (b) they may be repaired and be transferred to the next stage as downgraded products; or (c) they may be scrapped.

In this thesis, the operation of a conformity inspection may involve errors of two types: misclassification of a conforming item as non-conforming (error type I) and nonconforming one as conforming (error type II). For more information about these errors, please read the [Appendix 2](#).

Although planning an inspection process in a MPS constitutes an additional cost, but in imperfect manufacturing systems, specific level of inspection will decrease total cost of manufacturing as well as increase the customer satisfaction. In such cases, the associated cost of inspection will be covered by the benefits realized through the detection of nonconforming products.

It must be noted that although considering inspection after every manufacturing stage will decrease the scrap, reworking, and downgrading costs and prevent nonconforming products from reaching the customers, but on the other hand, unnecessary and often too inspections constitute huge cost of equipment, staff, time, and space as well as interrupt the overall process that might lead to extra work in-progress (WIP) and flow. Accordingly, if inspections are performed unnecessarily, then greater total costs will incur.

In a MPS as [Figure 3.1](#), after the processing stage  $i$ , there is a possibility to inspect the quality characteristics that have been realized by previous stages and have not been inspected before. It is noteworthy that inspection of each quality characteristic can be performed only in some specific allowed stages.

The above-mentioned problem is solved to obtain the optimal inspection plan with the objective of minimizing the total manufacturing cost. This cost includes production cost, fixed and variable costs of inspection, scrap cost, and penalty cost of nondetected nonconforming products that reach the customers. The difference between this problem and those of in the literature is that not only almost all of the papers have considered the inspection as a general term and have not specified different quality characteristics, but also they have not considered the possibility of inspecting the quality characteristics in different stages.

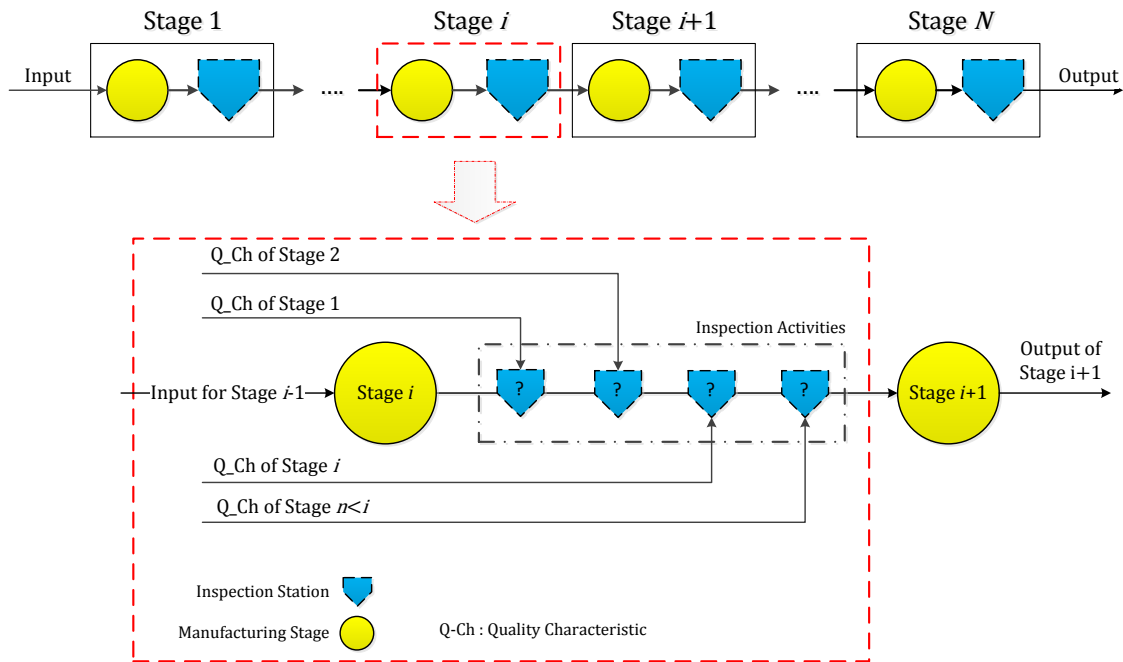

Figure 3.1. Inspection of quality characteristics in a serial MPS

This thesis also tries to generalize the classic inspection planning into more complex and more realistic multi-product MPS with machine and inspection tool allocation (PSMIA). In PSMIA, other important objectives raise beside to manufacturing cost including customer satisfaction and manufacturing time. It is noteworthy that minimum manufacturing cost is ideal for manufacturer, while maximum customer satisfaction and minimum manufacturing time are desired for customers. Although manufacturers eager to cost less, but reaching acceptable quality level as well as producing items in lower time to satisfy the customers forces manufacturers to cost more. Accordingly, these objectives are in conflict where higher customer satisfaction needs higher manufacturing cost; lower manufacturing time needs higher manufacturing cost; and lower manufacturing cost may lead to lower quality (i.e., lower manufacturing time may need to ignore time-consuming inspection activities and this event leads to lower quality and consequently lower customer satisfaction).

As enumerated in Section 3.1, due to uncertainty in environmental production parameters, a percent of the manufactured products do not conform design specifications and their processes are sensitive to manufacturing variations. Accordingly, manufacturers are interested in robust processes, which are relatively insensitive to alteration of uncertain parameters.

Summarized, this chapter first proposes a single-objective inspection planning model for the *Main Problem*. Next, the *Extended Problem* is modeled. In addition, the robustness of both *Main* and *Extended* problems are investigated.

### 3.2. Main Problem (MP)

Consider a serial MPS with  $N$  stages, in which in-process parts pass sequentially from stage 1 to stage  $N$  and inspections of units are performed at  $m$  ( $m \leq N$ ) locations. It should be noted that each stage can be an operation and a set of operations can be performed on the same machine. At each stage, a part (output of the immediately preceding stage) enters the processing stage where a manufacturing operation is performed on it. Output of this operation is transferred to an inspection station or to the next processing stage. Suppose that a unit consists of  $K$  quality characteristics and all characteristics of the part are simultaneously operated throughout the production system. If a CI is performed between the  $i$ th and  $(i+1)$ th processing stations, nonconforming parts originated at the  $i$ th operation or at some of the earlier operations are detected and scrapped and no rework is considered. Besides, If an MI is performed between the  $i$ th and  $(i+1)$ th processing stations, the processing features are monitored after a specific number of parts. Inspection operations subjects to both errors type I and II.

This model of *Main Problem* attempts to plan an inspection process under a twofold decision as 1) which quality characteristics need what kind of inspection (i.e., *which-what* decision) and 2) when the inspection of these characteristics should be performed (i.e., *when* decision). For *which-what* decision, although characteristics that have more impact on product functionality and significantly affect customer satisfaction should be chosen; however, all the characteristics cannot be inspected while inspection cost is highly increased. The *when* decision regarding the location of inspection is also challenging, in which inspection of a characteristic can be done only at specific stages across the overall process. For example, the process cannot be stopped or accessibility to that characteristic is impossible unless some furthers specific stages. In addition, finding and removing nonconforming parts at initial stages is desired, in which nonconforming produced parts do not pass through next stages and the cost of production is consequently decreased. Although it is desire to detect nonconforming parts exactly after their operation and before the next operation starts, but the number of inspection stations and interruptions in the overall process as well as the total cost of inspection are increased. For better understanding, consider a situation that each characteristic is inspected exactly after its operation. Since each inspection activity includes three steps as: 1) removing the part from the machine, 2) inspecting and 3) setting up the part for the next operation; hence, these steps are repeated for each characteristic. On the opposite site when a set of characteristics is inspected at a same allowable stage, the removing and set up steps are needed once. Therefore, making *which-what* and *when* decisions are challenging issues and this paper attempts to address (Mohammadi et al., 2015).

#### 3.2.1. Assumption

This section provides the assumptions for the *Main Problem* as follows:

- The system has  $N$  manufacturing stages arranged serially and processes one part type with  $K$  different quality characteristics.

- Different quality characteristics may be processed in a same manufacturing stage.
- Nonconformities are generated only at the manufacturing processes and other activities such as movement, setup and inspection activities do not make nonconformity.
- Each manufacturing stage has a failure rate of producing nonconforming items.
- Two types of conformity (CI) and monitoring (MI) inspections are considered, while considering MI for a manufacturing stage decreases the failure rate of that stage.
- CI subjects to both errors type I and II.
- Two inspection strategies may be taken at each manufacturing stage as no inspection and full inspection.
- The frequency of MI is fixed.
- MI affects the mean value of process capability statistics such as  $P_{pk}$ .
- We estimate the scrap rate without misadjustment in the deterministic model.
- Detected nonconforming items from CI are directly scrapped and no rework or repair operation is considered.
- A unit scrap cost is imposed to the system in case of detecting a nonconforming item. The scrap cost depends on both the number of manufacturing stage and the quality characteristics.
- The production system reaches a steady state and system breakdown is not assumed.
- Input parameters of the problem are considered under uncertainty.
- In the robust model, we consider misadjustment that affects  $C_{pk}$  and  $P_{pk}$  as well as failure and scrap rates.

#### 3.2.2. Notations

Before the mathematical model is presented, necessary notations are first provided in this section.

##### **Sets:**

- $p, p' \in \{1, 2, \dots, P + 1\}$       Set of manufacturing operations  
 $k \in \{1, 2, \dots, K\}$       Set of different quality characteristics

##### **Parameters:**

- $fr_{pk}^1$       Failure rate of operation  $p$  for characteristic  $k$  with monitoring inspection.  
 $fr_{pk}^2$       Failure rate of operation  $p$  for characteristic  $k$  without monitoring inspection.  
 $d_{pk}$       Detection rate of conformity inspection assigned to operation  $p$  for characteristic  $k$ .  
 $\alpha_{pk}$       Type I error of conformity inspection assigned to operation  $p$  for characteristic  $k$ .

### Chapter III: Mathematical Formulation & Solution Approaches

---

$\beta_{pk}$	Type II error of conformity inspection assigned to operation $p$ for characteristic $k$ ( $\beta_{pk} = 1 - d_{pk}$ ).
$n_T$	Total number of parts fed to the production process.
$pc_p$	Unit production cost per time for operation $p$ .
$pt_p$	Production time of operation $p$ .
$sc_p$	Scrap cost of parts after operation $p$ .
$nc_k$	Cost of nonconforming part in the market due to characteristic $k$ .
$fm_{pk}$	Fixed cost of an MI station after operation $p$ for characteristic $k$ .
$fc_{pk}$	Fixed cost of a CI station after operation $p$ for characteristic $k$ .
$vm_{pk}$	Unit variable cost of MI per time stationed after operation $p$ for characteristic $k$ .
$vc_{pk}$	Unit variable cost of CI per time stationed after operation $p$ for characteristic $k$ .
$mt_{pk}$	Time of MI stationed after operation $p$ for characteristic $k$ .
$ct_{pk}$	Time of CI stationed after operation $p$ for characteristic $k$ .
$fs_p$	Fixed independent space cost per part of establishing any inspection station (i.e., CI or MI) after operation $p$ .
$\zeta_{p'p}$	Is 1 if two operations $p'$ and $p$ are dependent; and 0, otherwise.
$\psi_{pk}$	Is 1 if characteristic $k$ belongs to operation $p$ ; and 0, otherwise.
$mf_k$	Monitoring frequency for characteristic $k$ .
$cf_k$	Conformity frequency for characteristic $k$ .
$M$	A big number.

#### **Decision Variables:**

$NP_{pk}$	Number of nonconforming parts due to characteristic $k$ from operation $p$ .
$YC_{pk}$	1 if operation $p$ needs CI for characteristic $k$ ; and 0, otherwise.
$YM_{pk}$	1 if operation $p$ needs MI for characteristic $k$ ; and 0, otherwise.
$XC_{p'p}^k$	1 if CI of operation $p'$ for characteristic $k$ is performed after operation $p$ ( $p' \leq p$ ); and 0, otherwise.
$XM_{p'p}^k$	1 if MI of operation $p'$ for characteristic $k$ is performed after operation $p$ ( $p' \leq p$ ); and 0, otherwise.
$N_p$	Number of parts entering operation $p$ .
$NM_{pk}$	Number of MIs performed between operations $p$ and $p+1$ for characteristic $k$ .
$NC_{pk}$	Number of CIs performed between operations $p$ and $p+1$ for characteristic $k$ .
$NS_p$	Is 1 if there is an inspection station between operations $p$ and $p+1$ .
$S_{pk}$	Number of the scrapped part between operations $p$ and $p+1$ due to characteristic $k$ .
$S_p$	Total number of the scrapped parts between operations $p$ and $p+1$ .

$OFV^{D\_MP}$  Deterministic objective function value of the *Main Problem*.

### 3.2.3. Mathematical formulation

This section proposes a single-objective mixed-integer mathematical formulation for the *Main Problem*. [Mirdamadi et al. \(2013\)](#) have proposed different cost components in a manufacturing industry. Accordingly, the objective of this model is to minimize the total cost of manufacturing which can be separated into the sum of total costs of production ( $TCP$ ), scrap ( $TCS$ ), inspection (i.e., fixed ( $TCIF$ ) and variable costs ( $TCIV$ )) ( $TCI=TCIF+TCIV$ ), and warranty ( $TCW$ ) when a nonconforming product is sold. Through a full inspection strategy, two different approaches are adopted. First approach considers that all quality characteristics need inspection and only one kind of MI or CI should be performed. In the second approach, it is considered that none, one and both of MI and CI can be performed for each quality characteristic. Hereafter, the first and second inspection approaches are called MI-or-CI and MI-and-CI strategies, respectively.

#### 3.2.3.1. Formulation of MI-or-CI strategy

##### ♣ Objective Function (OFV)

The objective function of this *Main* model consists of total cost of production ( $TCP$ ), total cost of scrap ( $TCS$ ), total cost of inspection that itself includes total fixed cost of inspection ( $TCIF$ ) and total variable cost of inspection ( $TCIV$ ), and total cost of warranty ( $TCW$ ). Hereafter, the sum  $TCP + TCS + TCIF + TCIV$  is called as total internal cost. Accordingly, total manufacturing cost is calculated as [Equation 3.1](#).

$$OFV^{D\_MP} = \min\{TCP + TCS + TCI (TCIF + TCIV) + TCW\} \quad (3.1)$$

where,

$$TCP = \sum_{p=1}^P pc_p pt_p N_p \quad (3.2)$$

$$TCS = \sum_{p=1}^P sc_p S_p \quad (3.3)$$

$$TCIF = \sum_{p=1}^P \sum_{k=1}^K fc_{pk} NC_{pk} + \sum_{p=1}^P \sum_{k=1}^K fm_{pk} NM_{pk} + \sum_{p=1}^P fs_p NS_p N_p \quad (3.4)$$

$$TCIV = \sum_{p=1}^P \sum_{k=1}^K cf_k ct_{pk} vc_{pk} N_p XC_{p'p}^k + \sum_{p=1}^P \sum_{k=1}^K mf_k mt_{pk} vm_{pk} N_p XM_{p'p}^k \quad (3.5)$$

$$TCW = \sum_{p=1}^P \sum_{k=1}^K nc_k (NP_{pk} YC_{pk} \beta_{pk} + NP_{pk} \times YM_{pk}) \quad (3.6)$$

♣ Constraints

The constraints of the *Main* model have been provided as Constraints (3.7) to (3.17).

$$\sum_{p=p'}^P \zeta_{p'p} X C_{p'p}^k = \psi_{p'k} Y C_{p'k} \quad \forall p', k; p' \leq P \quad (3.7)$$

$$\sum_{p=p'}^P \zeta_{p'p} X M_{p'p}^k = \psi_{p'k} Y M_{p'k} \quad \forall p', k; p' \leq P \quad (3.8)$$

$$Y C_{p'k} + Y M_{p'k} = \psi_{p'k} \quad \forall p', k \quad (3.9)$$

$$N P_{pk} = N_p \times Y M_{pk} f r_{pk}^1 + N_p \times Y C_{pk} f r_{pk}^2 \quad \forall p, k; p \leq P \quad (3.10)$$

$$\begin{aligned} S_{pk} \geq & \left[ X C_{p'p}^k \times N P_{p'k} \times d_{pk} \right] \\ & + \left[ X C_{p'p}^k \times N_p \times \alpha_{pk} - X C_{p'p}^k \times N P_{p'k} \right. \\ & \left. \times \alpha_{pk} \right] - \left[ X C_{p'p}^k \times N P_{p'k} \times \beta_{pk} \right] \quad \forall p, p', k; p, p' \leq P \end{aligned} \quad (3.11)$$

$$S_p \geq S_{pk} \quad \forall p, k; p \leq P \quad (3.12)$$

$$N_p = N_{p-1} - S_{p-1} \quad \forall p; p \leq P + 1 \quad (3.13)$$

$$N_0 = n_T \quad (3.14)$$

$$N M_{pk} \geq \sum_{p'=1}^P X M_{p'p}^k \quad \forall p, k; p \leq P \quad (3.15)$$

$$N C_{pk} \geq \sum_{p'=1}^P X C_{p'p}^k \quad \forall p, k; p \leq P \quad (3.16)$$

$$M \times N S_p \geq \sum_{p'=1}^P \sum_{k=1}^K (X C_{p'p}^k + X M_{p'p}^k) \quad \forall p, p', k; p, p' \leq P \quad (3.17)$$

Equations (3.7) and (3.8) ensure that CI and MI of a quality characteristic should be done for all part only in one stage, respectively. Equation (3.9) forces that one kind of inspection is needed for each quality characteristic. This equation is directly related to the MI-or-CI strategy. Equation (3.10) calculates the number of nonconforming parts based on the decision whether the MI is considered for that characteristic or not. Constraints (3.11) and (3.12) calculate the number of scraps after each inspection stage based on errors type I and type II. Constraints (3.13) and (3.14) determine the in-process part after each operation, where the number of parts is decreased in presence of any inspection due to scrap detection and removal. Equations (3.15) and (3.16) calculate total number of MIs and CIs throughout the whole production system. Constraint (3.17) calculates different inspection stage among the whole process.



♣ **Linearization**

As it can be seen, the objective function and some of the constraints include nonlinear terms and this issue may make the model harder to solve. For this aim, a linearization technique is applied to linearize the nonlinear terms. In this technique, the product of each pair of variables is replaced by a new auxiliary variable and three extra constraints are added to the model for each pair. It must be noted that this technique is used when at least one of the variables is binary variable. For example, consider a binary variable  $X$  and a real variable  $Y$ . The problem is to linearize the product of these two variables (i.e.,  $X \times Y$ ). Therefore, a new real auxiliary variable  $Z$  is considered. Next, the term  $X \times Y$  is replaced by  $Z$  in the whole model. Finally, the following three constraints are added to the model to make relationship between the variables.

$$\begin{aligned} Z &\leq M \times X, \\ Z &\leq Y, \\ Z &\geq Y - M(1 - X). \end{aligned}$$

Before linearizing the model, necessary auxiliary variables are provided.

**Auxiliary variables:**

$\mathbb{A}_{p'p}^k$	Linear form of $XC_{p'p}^k \times N_{p'}$ .
$\mathbb{B}_{p'p}^k$	Linear form of $XM_{p'p}^k \times N_{p'}$ .
$\mathbb{D}_{p'p}^k$	Linear form of $XC_{p'p}^k \times NP_{p'k}$ .
$\mathbb{E}_{pk}$	Linear form of $NP_{pk} \times YC_{pk}$ .
$\mathbb{F}_{pk}$	Linear form of $NP_{pk} \times YM_{pk}$ .
$\mathbb{L}_p$	Linear form of $NS_p \times N_p$ .
$\mathbb{U}_{pk}$	Linear form of $N_p \times YC_{pk}$ .
$\mathbb{V}_{pk}$	Linear form of $N_p \times YM_{pk}$ .

After adding the linearization constraints (i.e., [Constraints \(3.21\)](#) to [\(3.44\)](#)) to the model, the final single-objective mixed-integer linear programming model for the main problem (SMILP\_MP) under *MI-or-CI* strategy is proposed as follows:

SMILP\_MP (MI-or-CI):

$$\begin{aligned}
 \min OFV^{D\_MP} = & \sum_{p=1}^P pc_p pt_p N_p + \sum_{p=1}^P sc_p S_p + \sum_{p=1}^P \sum_{k=1}^K fc_{pk} NC_{pk} \\
 & + \sum_{p=1}^P \sum_{k=1}^K cf_k ct_{pk} vc_{pk} A_p + \sum_{p=1}^P \sum_{k=1}^K fm_{pk} NM_{pk} \\
 & + \sum_{p=1}^P \sum_{k=1}^K mf_k mt_{pk} vm_{pk} B_p + \sum_{p=1}^P fs_p L_p \\
 & + \sum_{p=1}^P \sum_{k=1}^K nc_k (\mathbb{E}_{pk} \beta_{pk} + \mathbb{F}_{pk})
 \end{aligned} \tag{3.18}$$

s.t.

$$\sum_{p=p'}^P \zeta_{p'p} XC_{p'p}^k = \psi_{p'k} YC_{p'k} \quad \forall p', k; p' \leq P \tag{3.7}$$

$$\sum_{p=p'}^P \zeta_{p'p} XM_{p'p}^k = \psi_{p'k} YM_{p'k} \quad \forall p', k; p' \leq P \tag{3.8}$$

$$YC_{p'k} + YM_{p'k} = \psi_{p'k} \quad \forall p', k \tag{3.9}$$

$$S_p \geq \mathcal{S}_{pk} \quad \forall p, k; p \leq P \tag{3.12}$$

$$N_p = N_{p-1} - S_{p-1} \quad \forall p; p \leq P + 1 \tag{3.13}$$

$$N_0 = n_T \tag{3.14}$$

$$NM_{pk} \geq \sum_{p'=1}^P XM_{p'p}^k \quad \forall p, k; p \leq P \tag{3.15}$$

$$NC_{pk} \geq \sum_{p'=1}^P XC_{p'p}^k \quad \forall p, k; p \leq P \tag{3.16}$$

$$M \times NS_p \geq \sum_{p'=1}^P \sum_{k=1}^K (XC_{p'p}^k + XM_{p'p}^k) \quad \forall p, p', k; p, p' \leq P \tag{3.17}$$

$$NP_{pk} = \mathbb{V}_{pk} fr_{pk}^1 + \mathbb{U}_{pk} fr_{pk}^2 \quad \forall p, k; p \leq P \tag{3.19}$$

$$\mathcal{S}_{pk} \geq \left[ \mathbb{D}_{p'p}^k \times d_{pk} \right] + \left[ \mathbb{A}_{p'p}^k \times \alpha_{pk} - \mathbb{D}_{p'p}^k \times \alpha_{pk} \right] - \left[ \mathbb{D}_{p'p}^k \times \beta_{pk} \right] \quad \forall p, p', k; p, p' \leq P \tag{3.20}$$

$$\mathbb{A}_{p'p}^k \leq M \times XC_{p'p}^k \quad \forall p, p', k; p, p' \leq P \tag{3.21}$$

$$\mathbb{A}_{p'p}^k \leq N_{p'} \quad \forall p, p', k; p, p' \leq P \tag{3.22}$$

$$\mathbb{A}_{p'p}^k \geq N_{p'} - M \left( 1 - XC_{p'p}^k \right) \quad \forall p, p', k; p, p' \leq P \tag{3.23}$$

$$\mathbb{B}_{p'p}^k \leq M \times XM_{p'p}^k \quad \forall p, p', k; p, p' \leq P \tag{3.24}$$

$$\mathbb{B}_{p'p}^k \leq N_{p'} \quad \forall p, p', k; p, p' \leq P \tag{3.25}$$

$$\mathbb{B}_{p'p}^k \geq N_{p'} - M(1 - XM_{p'p}^k) \quad \forall p, p', k; p, p' \leq P \quad (3.26)$$

$$\mathbb{V}_{p'k} \leq M \times YM_{p'k} \quad \forall p, p', k; p, p' \leq P \quad (3.27)$$

$$\mathbb{V}_{p'k} \leq N_{p'} \quad \forall p, p', k; p, p' \leq P \quad (3.28)$$

$$\mathbb{V}_{p'k} \geq N_{p'} - M(1 - YM_{p'k}) \quad \forall p, p', k; p, p' \leq P \quad (3.29)$$

$$\mathbb{U}_{p'k} \leq M \times YC_{p'k} \quad \forall p, p', k; p, p' \leq P \quad (3.30)$$

$$\mathbb{U}_{p'k} \leq N_{p'} \quad \forall p, p', k; p, p' \leq P \quad (3.31)$$

$$\mathbb{U}_{p'k} \geq N_{p'} - M(1 - YC_{p'k}) \quad \forall p, p', k; p, p' \leq P \quad (3.32)$$

$$\mathbb{D}_{p'p}^k \leq M \times XC_{p'p}^k \quad \forall p, p', k; p, p' \leq P \quad (3.33)$$

$$\mathbb{D}_{p'p}^k \leq NP_{p'k} \quad \forall p, p', k; p, p' \leq P \quad (3.34)$$

$$\mathbb{D}_{p'p}^k \geq NP_{p'k} - M(1 - XC_{p'p}^k) \quad \forall p, p', k; p, p' \leq P \quad (3.35)$$

$$\mathbb{E}_{p'k} \leq M \times YC_{p'k} \quad \forall p', k; p' \leq P \quad (3.36)$$

$$\mathbb{E}_{p'k} \leq NP_{p'k} \quad \forall p', k; p' \leq P \quad (3.37)$$

$$\mathbb{E}_{p'k} \geq NP_{p'k} - M(1 - YC_{p'k}) \quad \forall p', k; p' \leq P \quad (3.38)$$

$$\mathbb{F}_{p'k} \leq M \times YM_{p'k} \quad \forall p', k; p' \leq P \quad (3.39)$$

$$\mathbb{F}_{p'k} \leq NP_{p'k} \quad \forall p', k; p' \leq P \quad (3.40)$$

$$\mathbb{F}_{p'k} \geq NP_{p'k} - M(1 - YM_{p'k}) \quad \forall p', k; p' \leq P \quad (3.41)$$

$$\mathbb{L}_p \leq M \times NS_p \quad \forall p; p \leq P \quad (3.42)$$

$$\mathbb{L}_p \leq N_p \quad \forall p; p \leq P \quad (3.43)$$

$$\mathbb{L}_p \geq N_p - M(1 - NS_p) \quad \forall p; p \leq P \quad (3.44)$$

$$XC_{p'p}^k, XM_{p'p}^k, NS_p, Y_p, YC_{p'k}, YM_{p'k} \in \{0,1\} \quad \forall p, p'; p, p' \leq P \quad (3.45)$$

$$\begin{aligned} \mathcal{S}_{pk}, \mathcal{S}_p, \mathbb{D}_{p'p}^k, NM_{pk}, NC_{pk}, \mathbb{A}_{p'p}^k, \mathbb{B}_{p'p}^k, NP_{pk}, \mathbb{E}_{p'k}, \mathbb{E}_{p'k}, \mathbb{L}_p, N_p \quad \forall p', p, k; p', p \\ \geq 0 \quad \leq P \end{aligned} \quad (3.46)$$

where, [Constraints \(3.45\)](#) and [\(3.46\)](#) are domain constraint.

### 3.2.3.2. Formulation of MI-and-CI strategy

This section develops a SMILP\_MP for the *MI-and-CI* strategy. The notations and most of the constraints are same as *MI-or-CI* with only difference in one constraint. Accordingly, the final SMILP\_MP under *MI-and-CI* is proposed as follows:

**SMILP\_MP (MI-and-CI):**

$$\begin{aligned}
 \min OFV^{D-MP} = & \sum_{p=1}^P p c_p p t_p N_p + \sum_{p=1}^P s c_p S_p + \sum_{p=1}^P \sum_{k=1}^K f c_{pk} N C_{pk} \\
 & + \sum_{p=1}^P \sum_{k=1}^K c f_k c t_{pk} v c_{pk} A_p + \sum_{p=1}^P \sum_{k=1}^K f m_{pk} N M_{pk} \\
 & + \sum_{p=1}^P \sum_{k=1}^K m f_k m t_{pk} v m_{pk} B_p + \sum_{p=1}^P f s_p L_p \\
 & + \sum_{p=1}^P \sum_{k=1}^K n c_k (\mathbb{E}_{pk} \beta_{pk} + \mathbb{F}_{pk})
 \end{aligned} \tag{3.18}$$

s.t.

Constraints (3.7), (3.8), (3.12)-(3.17), (3-19)-(3-46).

$$Y C_{p'k} + Y M_{p'k} \leq 2 \psi_{p'k} \quad \forall p', k \tag{3.47}$$

**3.2.4. Robust Optimization**

As mentioned in Section 3.1, lack of information about production processes and several environmental factors have imposed a degree of uncertainty to the design parameters which directly affect other decisions of production.

One of the most important effects of production variations and uncertainty in any industry is increasing the number and cost of scraps. Scrap cost is a manufacturing reality affecting organizations across all industries and product lines. No matter why scrap occurs, its impacts on an organization are always wasted time and money, while no organization wants to admit it, these expenses add up quickly and negatively impact the bottom line. Although it is near-impossible to eliminate scrap completely, managers can reduce the amount of scrap in their organization by optimizing the way they produce the products. Therefore, manufacturers can reduce the scraps by carefully and consistently monitoring the parameters of the process to know how products are made. As a consequence of this monitoring, parameters with higher variation are being controlled and consequently the number of scraps is decreased.

Two of the main resources of variation in the production processes are misadjustment and dispersion of an operation. Figures 3.2 and 3.3 show how misadjustment and dispersion of an operation directly affect the failure rate and the amount of scraps. In fact, the higher the values of misadjustment and dispersion are, the higher the value of failure rate and the amount of scraps are. Besides, the failure rate of each operation is one of the most significant parameters that affect the quality of the products.

There are other parameters besides to misadjustment and dispersion in the proposed SMILP\_MP that are affected by environmental factors and may fluctuate over the time. These parameters are production and inspection times, errors type I and type II of the CI, costs of manufacturing, inspection as well as warranty. Uncertainty in type I and type II errors directly affect the number and cost of scraps

and may influence the warranty cost. In this section, the variation of misadjustment and dispersion is considered first.

Manufacturers are interested in less sensitive manufacturing processes by taking into account the effect of manufacturing variations on the products during the design phase. These manufacturing processes are robust processes which are relatively insensitive to alteration of uncertain parameters. It is noteworthy that in the robust manufacturing processes, the effect of uncertainty in the system is minimized without eliminating the sources of uncertainty.

In the following, it will be shown that how failure rate variations indirectly affect the objective function of the proposed model. The objective of the proposed mathematical model is to minimize the total cost which is the sum of the manufacturing (i.e.,  $TCP + TCS + TCI (TCIF + TCIV)$ ) and the warranty costs ( $TCW$ ). It can easily be proved that these two parts of the objective function are in conflict in terms of the number of conformity inspections ( $NC$ ), where having higher  $NC$  increases the manufacturing cost and at the same time decreases the warranty cost. This directly relates to the amount of scraps; where considering CIs in the process increases the cost of inspections (i.e.,  $TCS + TCIF$ ) but decreases the warranty cost. Hence, uncertainty in the failure rate, which directly affects the amount of scraps, makes tangible changes in the objective function.

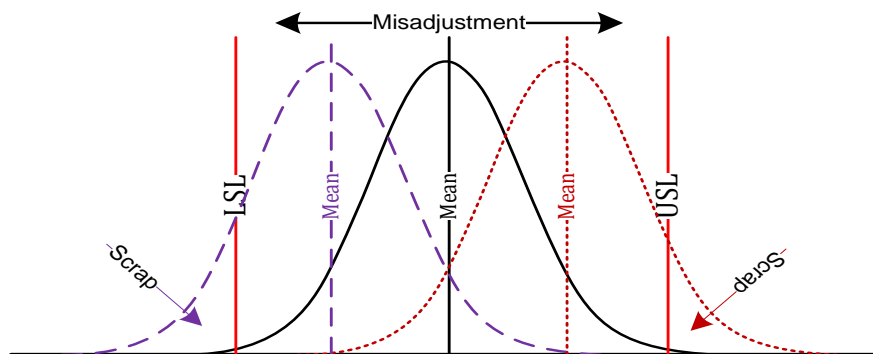

**Figure 3.2.** Effect of misadjustment on failure rate

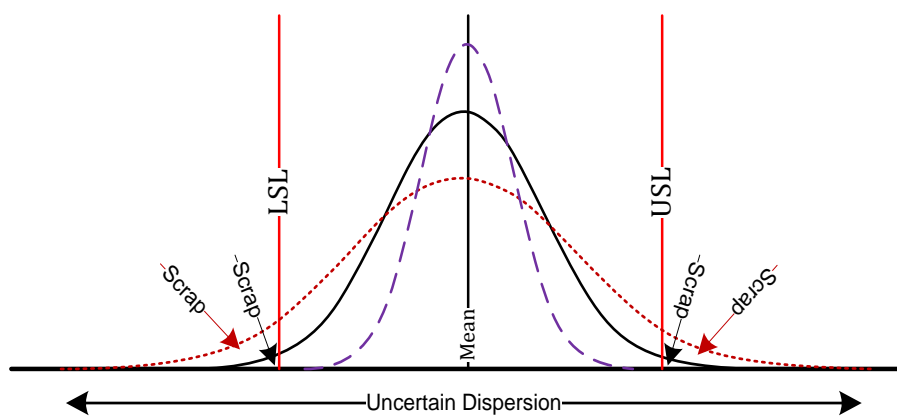

**Figure 3.3.** Uncertainty in dispersion

In order to investigate the effect of failure rate in the result of the proposed model, the pseudo tradeoff diagram of manufacturing and warranty costs are illustrated in Figures 3.4 to 3.6. Vertical and horizontal axes show cost and  $NC$ , respectively. Figure 3.4 demonstrates the tradeoff diagram for deterministic problem, in which no alteration in the parameters has been considered. Since, in the deterministic problem, the increase rate of the manufacturing cost is more than the decrease rate of the warranty cost; therefore, the minimum total cost belongs to a solution with no conformity inspection (i.e.,  $NC = 0$ ). It is obvious that alteration in failure rate significantly affects the amount of scraps as well as the value of warranty cost. Figure 3.5 depicts the tradeoff cost diagram for a problem with little increase in misadjustment which consequently increases the failure rate. As it can be seen, the decrease rate of warranty cost is initially more than the increase rate of the manufacturing cost for  $NC \leq N_2^*$  and vice versa for  $> N_2^*$ . Therefore, the minimum total cost occurs for a solution with  $= N_2^*$ . Similarly, Figure 3.6 illustrates the tradeoff cost diagram for a problem with higher increases in misadjustment compared to the problem in Figure 3.5. The optimal  $NC$  in the problem with higher uncertainty in misadjustment is equal to  $N_3^*$ .

It can also be inferred from Figures 3.5 and 3.6 that the higher the uncertainty in the misadjustment, the higher the  $NC$  is (i.e.,  $N_3^* > N_2^*$ ). It should be noted that Figures 3.4 to 3.6 have been conceptually illustrated based on the proposed mathematical model, however, the curve of manufacturing and warranty cost is not so simple in the industries, while the general results and trends are similar. For better supporting the effect of failure rate's uncertainty, several experiments have been done in Chapter 4.

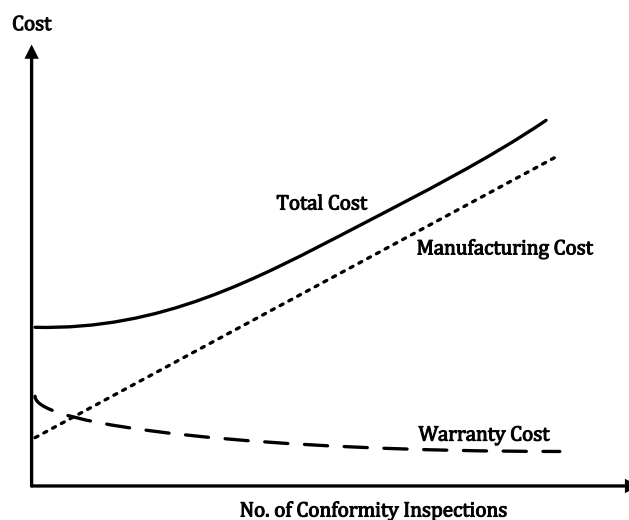

Figure 3.4. Deterministic trade-off cost diagram

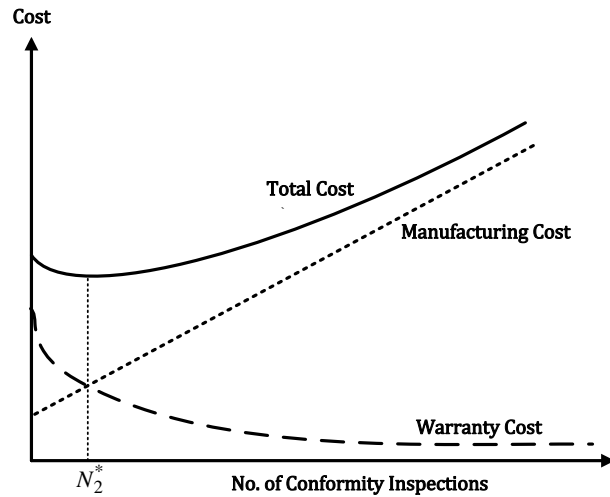

Figure 3.5. Trade-off cost diagram with lower uncertainty

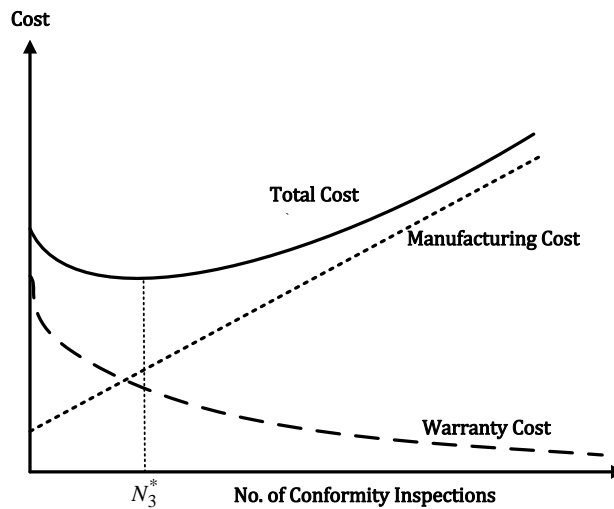

Figure 3.6. Trade-off cost diagram with higher uncertainty

Several methods have been proposed to take manufacturing variations and uncertainty in input parameter into account in order to design a robust manufacturing process (Arvidsson and Gremyr, 2008; Hans-Georg and Sendho, 2007; Wei et al., 2007; Xiaoping and Chen 2000; Torben et al., 2009; Beiqing and Du, 2006; Gyung-Jin and Hee-Lee, 2002; Michael, 2013). In this paper, we apply a special case of Taguchi’s method (Jin and Sendhoff, 2003) to cope with the uncertainty of the misadjustment and in order to design a robust inspection process plan. Robustness of an optimal solution can usually be discussed from the following two perspectives:

- The optimal solution is insensitive to any variations of the design variables.
- The optimal solution is insensitive to any variations of the environmental parameters.

In order to increase the robustness of the solutions, two methods have been mostly used as follows (Das, 2000; Beyer et al., 2002):

- Optimization of the expected value of the objective functions under different alteration in the uncertain input parameters.
- Minimization of the objective function variance under different alteration in the uncertain input parameters.

It has been mentioned that although the expectation based measure does not sufficiently take care of variations of the objective function while these variations are symmetric around the average value; on the other hand a purely variance based measure also does not take the absolute value of the solution into account. Hence, we formulate a single objective optimization problem which minimizes both expected value and variance of the objective function to search for robust optimal solutions. For this purpose, two different combinations of expected and variance values, namely Taguchi methods 1 and 2 (i.e., T1 and T2) are considered as [Equations \(3.48\)](#) and [\(3.49\)](#) that must be minimized ([Gyung-Jin et al., 2006](#)). First, necessary notations are provided as bellow.

**Parameters:**

- MCR* Number of Monte Carlo sample iterations.  
*ω* Weight factor of standard deviation in the Taguchi method.  
*CP<sub>p</sub>* Process Capability. A simple and straightforward indicator of process capability.  
*CPk<sub>p</sub>* Process Capability Index. Adjustment of *CP* for the effect of a non-centered distribution.  
*ρ<sub>MI</sub>* Uncertainty factor of the process misadjustment under MI.  
*ρ<sub>CI</sub>* Uncertainty factor of process misadjustment under CI.  
*ρ<sub>σ</sub>* Uncertainty factor of process dispersion.  
*ρ<sub>TP</sub>* Uncertainty factor of production time.  
*ρ<sub>TMI</sub>* Uncertainty factor of MI time.  
*ρ<sub>TCl</sub>* Uncertainty factor of CI time.  
*ρ<sub>e-I</sub>* Uncertainty factor of type I error.  
*ρ<sub>e-II</sub>* Uncertainty factor of type II error.

**Variables:**

- μ<sub>OFV</sub>* Expected value of the objective function.  
*σ<sub>OFV</sub>* Standard deviation of the objective function.  
*OFV<sub>T1</sub><sup>R</sup>* Objective function value of Taguchi method 1.  
*OFV<sub>T2</sub><sup>R</sup>* Objective function value of Taguchi method 2.

$$OFV_{T1}^R = \mu_{Cost} + k\sigma_{Cost} \tag{3.48}$$

$$OFV_{T2}^R = (\mu_{Cost} - OFV^{D.MP})^2 + \pi\sigma_{Cost}^2 \tag{3.49}$$



The purpose of the objective function (3.48) is merely to minimize variation through expected value and standard deviation; while the objective function (3.49) not only tries to reduce variation through expected value and standard deviation, but also attempts to shift the mean value to a target value (i.e., deterministic value).

Now, we first need to vary the misadjustment in its variation interval; next, calculate the expected and standard deviation values through different variations. This procedure is repeated for each solution. Finally, a solution with the minimum value of objective functions (3.48) or (3.49) would be the most robust one.

**Table 3.1.** Variation intervals of the uncertain parameters

Parameters	Uniform Fluctuation Interval
misadjustment	$FR_{pk}^{MI}$ $\left[ \left[ 1 - P\{z \leq 3 \times CP_p\} + P\{z \leq -3 \times CP_p\} \right], \left[ 1 - P\{z \leq 3 \times CP_p - \rho_{MI}\} + P\{z \leq -3 \times CP_p - \rho_{MI}\} \right] \right]$
	$FR_{pk}^{CI}$ $\left[ \left[ 1 - P\{z \leq 3 \times CPK_p\} + P\{z \leq -3 \times CPK_p\} \right], \left[ 1 - P\{z \leq 3 \times CPK_p - \rho_{CI}\} + P\{z \leq -3 \times CPK_p - \rho_{CI}\} \right] \right]$
dispersion	$FR_{pk}^{MI}$ $\left[ \left[ 1 - P\left\{z \leq 3 \times \frac{CP_p}{1 - \rho_\sigma}\right\} + P\left\{z \leq -3 \times \frac{CP_p}{1 - \rho_\sigma}\right\} \right], \left[ 1 - P\left\{z \leq 3 \times \frac{CP_p}{1 + \rho_\sigma}\right\} + P\left\{z \leq -3 \times \frac{CP_p}{1 + \rho_\sigma}\right\} \right] \right]$
	$FR_{pk}^{CI}$ $\left[ \left[ 1 - P\left\{z \leq 3 \times \frac{CPK_p}{1 - \rho_\sigma}\right\} + P\left\{z \leq -3 \times \frac{CPK_p}{1 - \rho_\sigma}\right\} \right], \left[ 1 - P\left\{z \leq 3 \times \frac{CPK_p}{1 + \rho_\sigma}\right\} + P\left\{z \leq -3 \times \frac{CPK_p}{1 + \rho_\sigma}\right\} \right] \right]$
$TP_p$	$[TP_p(1 - \rho_{TP}), TP_p(1 + \rho_{TP})]$
$TMI_{pk}$	$[TMI_{pk}(1 - \rho_{TMI}), TMI_{pk}(1 + \rho_{TMI})]$
$TCI_{pk}$	$[TCI_{pk}(1 - \rho_{TCI}), TCI_{pk}(1 + \rho_{TCI})]$
$\alpha_{pk}$	$[\alpha_{pk}(1 - \rho_{e-I}), \alpha_{pk}(1 + \rho_{e-I})]$
$\beta_{pk}$	$[\beta_{pk}(1 - \rho_{e-II}), \beta_{pk}(1 + \rho_{e-II})]$
Uncertainty in misadjustment & dispersion	$FR_{pk}^{MI}$ $\left[ \left[ 1 - P\left\{z \leq 3 \times \frac{CP_p}{1 - \rho_\sigma}\right\} + P\left\{z \leq -3 \times \frac{CP_p}{1 - \rho_\sigma}\right\} \right], \left[ 1 - P\left\{z \leq 3 \times \frac{CP_p}{1 + \rho_\sigma} - r_{MI}\right\} + P\left\{z \leq -3 \times \frac{CP_p}{1 + \rho_\sigma} - r_{MI}\right\} \right] \right]$
	$FR_{pk}^{CI}$ $\left[ \left[ 1 - P\left\{z \leq 3 \times \frac{CPK_p}{1 - \rho_\sigma}\right\} + P\left\{z \leq -3 \times \frac{CPK_p}{1 - \rho_\sigma}\right\} \right], \left[ 1 - P\left\{z \leq 3 \times \frac{CPK_p}{1 + \rho_\sigma} - r_{CI}\right\} + P\left\{z \leq -3 \times \frac{CPK_p}{1 + \rho_\sigma} - r_{CI}\right\} \right] \right]$

To generate different values for uncertain parameters, a Monte Carlo simulation technique is utilized. In a special case, in order to generate random values of misadjustment, it must be regarded that the quality characteristic  $k$  of operation  $p$  needs monitoring or conformity inspection. Based on the type of inspection, the

failure rate in presence of monitoring ( $FR_{pk}^{MI}$ ) and conformity ( $FR_{pk}^{CI}$ ) inspections are calculated differently (Kane, 1986).

The variation intervals of the input parameters under uncertainty have been tabulated in Table 3.1, in which the value of the parameters is generated uniformly over the intervals (Kane, 1986) and  $P\{z \leq Z\}$  stands for the cumulative probability of standard normal distribution. It is noteworthy that Table 3.1 shows the distinct variation intervals; however, in case of simultaneous uncertainty in misadjustment and dispersion, the value of failure rate is calculated as two last row of Table 3.1.

As an example when the failure rate is uncertain, the flowcharts of T1 and T2 robust methods have been provided as Figures 3.7 and 3.8, respectively. For more explanation, consider a sample production system with  $p$  operations and one quality characteristic corresponding to each operation. For each operation, the value of failure rate depends on the decision that is whether the related characteristic needs MI (while we have assumed that MI affects the mean value of  $C_{pk}$  and  $P_{pk}$ ). After calculating the failure rate based on Table 3.1, the objective function of the sample solution is calculated and archived. The following calculations are repeated for the all MCR iterations. Finally, Equations (3.48) and (3.49) are calculated based on the archived values of the objective function.

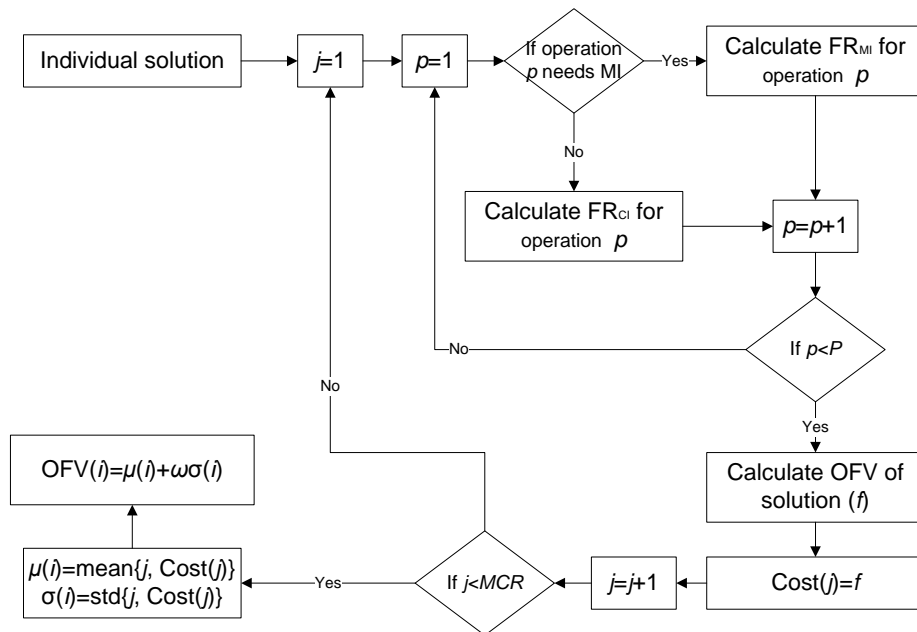

Figure 3.7. Flowchart of the T1 method

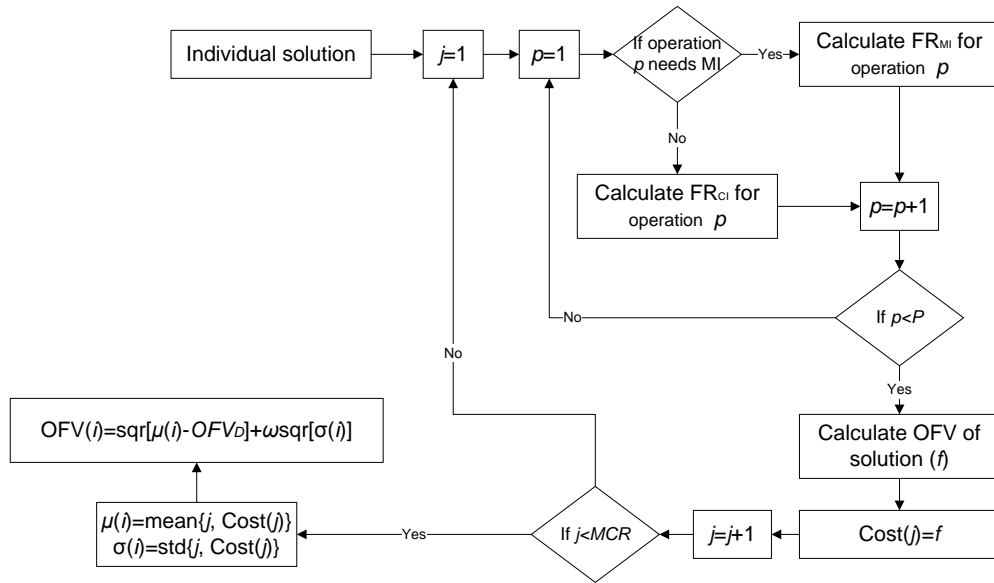

Figure 3.8. Flowchart of the T2 method

### 3.3. Extended Problem (EP)

This section developed the *Extended Problem* by considering new assumption, new objective functions, and new constraints. The *Extended Problem* includes two main parts. At the first part, a bi-objective version of the proposed SMILP\_MP is developed with the same assumptions, same constraint, and same robust approach. Second, a multi-objective inspection planning model is proposed with the assumptions as of Table 1.1.

#### 3.3.1. Bi-objective model

As studied in Section 3.2, the proposed SMILP\_MP model tries to minimize the sum of manufacturing and warranty costs, while, through Figures 3.4 to 3.6, it was conceptually demonstrated that these costs are naturally in conflict. Accordingly, this section proposes a bi-objective mixed-integer linear programming (BMILP\_EP) model. The first objective function is to minimize manufacturing cost and second objective tries to minimize warranty costs. It can be declared that the second objective indirectly relates to the customer satisfaction, while minimizing the number of nonconforming products through the second objective function will increase the customer satisfaction.

Since the assumptions of the BMILP\_EP are the same as of SMILP\_MP, the section of assumption is ignored. In the following, necessary notations and mathematical formulations are proposed.

##### 3.3.1.1. Notations

There is only one parameter besides to those of Section 3.2.2, that is the importance of each quality characteristic for the customers to be conforming. By other word, nonconformity in different quality characteristics has different effects on the customers. Accordingly, we have:

**Parameters:**

$G_k$  Relative importance of quality characteristic  $k$ .

**Variables:**

$OFV_{\tau}^{D-EP}$  Deterministic value of  $\tau$ th objective function for the *Extended Problem* ( $\tau = 1,2$ ).

**3.3.1.2. Mathematical formulation**

This section proposes a bi-objective mixed-integer mathematical formulation for the *Extended Problem*. The objectives are to minimize the sum of total production cost ( $TCP$ ), total scrap cost ( $TCS$ ), total inspection cost (i.e., fixed ( $TCIF$ ) and variable costs ( $TCIV$ )) ( $TCI=TCIF+TCIV$ ), and to minimize total warranty cost ( $TCW$ ). Despite of the *Main Problem*, only the MI-and-CI approach is adopted.

♣ **Objective Functions (OFVs)**

First and second objective functions are proposed as [Equations \(3.50\)](#) and [\(3.51\)](#).

$$OFV_1^{D-EP} = \min\{TCP + TCS + TCIF + TCIV\} \quad (3.50)$$

$$OFV_2^{D-EP} = \min\{Gravity \times TCW\} \quad (3.51)$$

♣ **Constraints**

The constraints of the BMILP\_EP are the same as those of [Section 3.2.3.2](#).

After developing new objective functions, the final BMILP\_EP under *MI-and-CI* strategy is proposed as follows:

**BMILP\_EP (MI-and-CI):**

$$\begin{aligned} \min OFV_1^{D-EP} = & \sum_{p=1}^P pc_p pt_p N_p + \sum_{p=1}^P sc_p S_p + \sum_{p=1}^P \sum_{k=1}^K fc_{pk} NC_{pk} \\ & + \sum_{p=1}^P \sum_{k=1}^K cf_k ct_{pk} vc_{pk} A_p + \sum_{p=1}^P \sum_{k=1}^K fm_{pk} NM_{pk} \\ & + \sum_{p=1}^P \sum_{k=1}^K mf_k mt_{pk} vm_{pk} B_p + \sum_{p=1}^P fs_p L_p \end{aligned} \quad (3.52)$$

$$\min OFV_2^{D-EP} = \sum_{p=1}^P \sum_{k=1}^K G_k n c_k (\mathbb{E}_{pk} \beta_{pk} + \mathbb{F}_{pk}) \quad (3.53)$$

s.t.

[Constraints \(3.7\)](#), [\(3.8\)](#), [\(3.12\)-\(3.17\)](#), [\(3.19\)-\(3.47\)](#).

### 3.3.1.3. Robust Optimization

The procedure of the robust optimization approach for the BMILP\_EP is the same as SMILP\_MP with difference in the number of robust objectives. In addition, only Taguchi method 1 (T1) is applied. Accordingly, the following two robust objective functions (3.56) and (3.57) are developed to be minimized. Necessary notations are first provided.

**Variables:**

$\mu_{\tau}^{OFV}$  Expected value of the  $\tau$ th objective function.

$\sigma_{\tau}^{OFV}$  Standard deviation of the  $\tau$ th objective function.

$OFV_{\tau}^R$  Value of  $\tau$ th robust objective function.

$$OFV_1^R = \mu_1^{OFV} + k\sigma_1^{OFV} \quad (3.56)$$

$$OFV_2^R = \mu_2^{OFV} + k\sigma_2^{OFV} \quad (3.57)$$

### 3.3.2. Multi-objective model

This section extends the proposed BMILP\_EP model by considering a MPS with different products, different quality characteristics, and different machine and inspection tools with a new objective to minimize the total manufacturing time for each product. In this model and besides to *which-what* and *where* decisions, machines to operate and tools to inspect the items need to be determined. There are different machines with specific features such as production cost, production time and process capability. It is obvious that decision regarding equipment (i.e., machines and inspection tools) selection directly affect other decisions as well as final quality of products. For example, consider a manufacturer who has targeted high quality products to increase the customer satisfaction; therefore, the company needs to cost more to purchase/utilize machines with high capability and inspection tools with lowest errors. An obstacle in this way is the limited budget of companies. Accordingly, the manufacturer must simultaneously make *which-what* and *where* decisions and decide to utilize which equipment not to exceed the budget constraint but reach a good level of customer satisfaction and produce each product in a reasonable time. Decisions in such a complex manufacturing environment are what this section tries to address.

The main assumptions are first provided following by necessary notations and mathematical formulation.

#### 3.3.2.1. Assumptions

This section provides the assumptions for the *Extended Problem* as follows:

- The system has  $N$  manufacturing stages arranged serially and processes  $P$  types of products with  $K$  different quality characteristics.
- Different quality characteristics may be processed in a same manufacturing stage.
- Nonconformities are generated only at the manufacturing processes and other activities such as movement, setup and inspection activities do not make nonconformity.

- Each manufacturing stage has a failure rate of producing nonconforming items.
- Two types of conformity (CI) and monitoring (MI) inspections are considered, while considering MI for a manufacturing stage decreases the failure rate of that stage.
- CI subjects to both errors type I and II.
- Two inspection strategies may be taken at each manufacturing stage as no inspection and full inspection.
- The frequency of MI is fixed.
- Detected nonconforming items are directly scrapped and no rework or repair operation is considered.
- A unit scrap cost is imposed to the system in case of detecting a nonconforming item. The scrap cost depends on both the number of manufacturing stage and the quality characteristics.
- Different machines with specific features (i.e., time, cost, capability, etc.) exist to operate the items and machine can operate a set of quality characteristics.
- Only one machine is allocated for operating each quality characteristics.
- Different inspection tools with specific features (i.e., errors, detection rate, time, cost, etc.) exist to inspect the items and these tools can inspect a set of quality characteristics.
- Only one inspection tool is allocated for inspecting each quality characteristic.
- In-process items must wait in a queue to receive services (i.e., machinery or inspection). Therefore, Machines and Inspection tools are modeled as a M/M/1 queuing system.
- The production system reaches a steady state but machines and inspection tools are subject to disruption and breakdown.
- In case of disruption, the processing and inspection rates are degraded to 0.
- Machines and inspection tools are disrupted with a random rate and are retrieved again with a random rate.
- A capacity constraint is assumed for both machines and inspection tools.

#### 3.3.2.2. Notations

Before the mathematical model is presented, necessary notations are first provided in this section.

**Sets:**

$o, o' \in \{1, 2, \dots, O + 1\}$	Set of operations
$p \in \{1, 2, \dots, P\}$	Set of products
$m \in \{1, 2, \dots, M\}$	Set of Machines
$i \in \{1, 2, \dots, I\}$	Set of inspection tools
$k \in \{1, 2, \dots, K\}$	Set of quality characteristics

**Parameters:**

$fr_{okpm}^1$	Failure rate of operation $o$ for quality characteristic $k$ for product $p$ on machine $m$ with monitoring inspection.
$fr_{okpm}^2$	Failure rate of operation $o$ for quality characteristic $k$ for product $p$ on machine $m$ without monitoring inspection.
$d_{ok}^{pi}$	Detection rate of conformity inspection assigned to operation $o$ for quality characteristic $k$ in product $p$ using inspection tool $i$ .
$\alpha_{ok}^{pi}$	Type I error of conformity inspection assigned to operation $o$ for quality characteristic $k$ in product $p$ using inspection tool $i$ .
$\beta_{ok}^{pi}$	Type II error of conformity inspection assigned to operation $o$ for quality characteristic $k$ in product $p$ using inspection tool $i$ ( $\beta_{ok}^{pi} = 1 - d_{ok}^{pi}$ ).
$G_k^P$	Relative importance of quality characteristic $k$ in product $p$ .
$n_T^p$	Total number of raw parts of product $p$ fed to the production process.
$pc_{op}^m$	Unit production cost per time for operation $o$ in product $p$ on machine $m$ .
$pt_{op}^m$	Unit production time of operation $o$ in product $p$ on machine $m$ .
$sc_o^p$	Scrap cost of nonconforming items detected between operations $o$ and $o+1$ in product $p$ .
$nc_k^p$	Cost of nonconforming items in the market due to quality characteristic $k$ in product $p$ .
$fm_{ok}^{pmi}$	Fixed cost of an MI between operations $o$ and $o+1$ for quality characteristic $k$ in product $p$ on machine $m$ using inspection tool $i$ .
$fc_{ok}^{pmi}$	Fixed cost of an CI between operations $o$ and $o+1$ for characteristic $k$ in product $p$ on machine $m$ using inspection tool $i$ .
$fp_m$	Fixed cost of utilizing machine $m$ .
$fa_{op}^m$	Fixed cost of performing operation $o$ in product $p$ using machine $m$ .
$cp_i$	Fixed cost of utilizing inspection tool $i$ .
$ca_{ok}^{pi}$	Fixed cost of conformity inspection of quality characteristic $k$ in operation $o$ in product $p$ using inspection tool $i$ .
$vm_{ok}^{pmi}$	Unit variable cost of MI per time between operations $o$ and $o+1$ for quality characteristic $k$ in product $p$ on machine $m$ using inspection tool $i$ .
$vc_{ok}^{pmi}$	Unit variable cost of CI per time between operations $o$ and $o+1$ for quality characteristic $k$ in product $p$ on machine $m$ using inspection tool $i$ .
$mt_{ok}^{pi}$	Unit time of MI between operations $o$ and $o+1$ for quality characteristic $k$ in product $p$ on machine $m$ using inspection tool $i$ .
$ct_{ok}^{pi}$	Unit time of CI between operations $o$ and $o+1$ for quality characteristic $k$ in product $p$ on machine $m$ using inspection tool $i$ .
$\mu p_{op}^m$	Production rate of machine $m$ for performing operation $o$ in product $p$ ( $\mu p_{op}^m = 1/pt_{op}^m$ ).
$\mu c_{ok}^{pi}$	CI rate (part/time) of inspection tool $i$ for quality characteristic $k$ of operation $o$ in product $p$ ( $\mu c_{ok}^{pi} = 1/ct_{ok}^{pi}$ ).
$\mu m_{ok}^{pi}$	MI rate (part/time) of inspection tool $i$ for quality characteristic $k$ of operation $o$ in product $p$ ( $\mu m_{ok}^{pi} = 1/mt_{ok}^{pi}$ ).

$fp_{op}^m$	Breakdowns rate of machine $m$ for performing operation $o$ in product $p$ .
$rp_{op}^m$	Retrieve time rate of machine $m$ for performing operation $o$ in product $p$ .
$fc_{ok}^{pi}$	Breakdowns rate of inspection tool $i$ for performing CI of quality characteristic $k$ of operation $o$ in product $p$ .
$rc_{ok}^{pi}$	Retrieve time rate of inspection tool $i$ for performing CI of quality characteristic $k$ of operation $o$ in product $p$ .
$fm_{ok}^{pi}$	Breakdowns rate of inspection tool $i$ for performing MI of quality characteristic $k$ of operation $o$ in product $p$ .
$rm_{ok}^{pi}$	Retrieve time rate of inspection tool $i$ for performing MI of quality characteristic $k$ of operation $o$ in product $p$ .
$fs_o^p$	Fixed space cost per part of performing inspection between operations $o$ and $o+1$ in product $p$ .
$\zeta_{o'o}^p$	Is 1 if two operations $o'$ and $o$ are dependent in product $p$ and 0 otherwise.
$\psi_{ok}^p$	Is 1 if quality characteristic $k$ belongs to operation $o$ in product $p$ and 0 otherwise.
$mf_k^p$	Monitoring frequency for quality characteristic $k$ of operation $o$ in product $p$ .
$cf_k^p$	Conformity frequency for quality characteristic $k$ of operation $o$ in product $p$ .
$\mathcal{M}$	A big number.

**Decision Variables:**

$NP_{ok}^p$	Number of nonconforming items due to characteristic $k$ from operation $o$ in product $p$ .
$YC_{ok}^p$	1 if operation $o$ in product $p$ needs CI for characteristic $k$ ; and 0, otherwise.
$YM_{ok}^p$	1 if operation $o$ in product $p$ needs MI for characteristic $k$ ; and 0, otherwise.
$XC_{o'o}^{kpi}$	1 if CI of operation $o'$ for characteristic $k$ in product $p$ is performed between operations $o$ and $o+1$ using inspection tool $i$ ( $o' \leq o$ ); and 0, otherwise.
$XM_{o'o}^{kpi}$	1 if MI of operation $o'$ for characteristic $k$ in product $p$ is performed between operations $o$ and $o+1$ using inspection tool $i$ ( $o' \leq o$ ); and 0, otherwise.
$N_o^p$	Number of in-process parts entering operation $o$ in product $p$ .
$NM_{ok}^{pi}$	Number of MIs performed using inspection tool $i$ between operations $o$ and $o+1$ for quality characteristic $k$ in product $p$ .
$NC_{ok}^{pi}$	Number of CIs performed using inspection tool $i$ between operations $o$ and $o+1$ for quality characteristic $k$ in product $p$ .
$NS_o^p$	Is 1 if there is an inspection station between operations $o$ and $o+1$ in product $p$ .
$S_{ok}^p$	Number of scrapped part between operations $o$ and $o+1$ due to quality



	characteristic $k$ in product $p$ .
$S_o^p$	Total number of scrapped parts between operations $o$ and $o+1$ for product $p$ .
$Z_m$	Number of machine $m$ that must be purchased/utilized.
$Z_i$	Number of inspection tool $i$ that must be purchased/utilized.
$U_{op}^m$	Is 1 if operation $o$ in product $p$ is performed on machine $m$ .
$WP_{op}^m$	Waiting time of parts for performing operation $o$ of product $p$ on machine $m$ .
$WC_{ok}^{pi}$	Waiting time during a CI of quality characteristic $k$ of operation $o$ in product $p$ using inspection tool $i$ .
$WM_{ok}^{pi}$	Waiting time during a MI of quality characteristic $k$ of operation $o$ in product $p$ using inspection tool $i$ .
$OFV_{\tau}^{D-EP}$	Deterministic value of the $\tau$ th objective function for the <i>Extended Problem</i> ( $\tau = 1,2,3$ ).

**Auxiliary variables:**

$A_{o'o}^{kpi}$	Linear form of $XC_{o'o}^{kpi} \times N_{o'}^p$ .
$B_{o'o}^{kpi}$	Linear form of $XM_{o'o}^{kpi} \times N_{o'}^p$ .
$D_{o'o}^{kpi}$	Linear form of $XC_{o'o}^{kpi} \times NP_{o'k}^p$ .
$E_{o'k}^p$	Linear form of $NP_{o'k}^p \times YC_{o'k}^p$ .
$F_{o'k}^p$	Linear form of $NP_{o'k}^p \times YM_{o'k}^p$ .
$L_o^p$	Linear form of $N_o^p \times NS_o^p$ .
$U_{o'k}^p$	Linear form of $N_{o'}^p \times YC_{o'k}^p$ .
$V_{o'k}^p$	Linear form of $N_{o'}^p \times YM_{o'k}^p$ .

**3.3.2.3. Mathematical formulation**

This section proposes a three-objective mixed-integer nonlinear programming model for the *Extended Problem* (TMINLP\_EP). The objectives are to minimize the sum of total production cost ( $TCP$ ), total scrap cost ( $TCS$ ), total inspection cost (i.e., fixed ( $TCIF$ ) and variable costs ( $TCIV$ )) ( $TCI=TCIF+TCIV$ ), total machine purchasing/utilizing cost ( $TCM$ ), to minimize total warranty cost ( $TCW$ ), and to minimize the maximum manufacturing time for each product ( $TMT_p$ ). Like BMILP\_EP, only the MI-and-CI approach is adopted.

**♣ Objective Functions (OFVs)**

First, second and third objective functions are proposed as [Equations \(3.58\) to \(3.60\)](#).

$$OFV_1^{D-EP} = \min\{TCP + TCS + TCIF + TCIV + TCM\} \tag{3.58}$$

$$OFV_2^{D-EP} = \min\{TCW\} \tag{3.59}$$

$$OFV_3^{D-EP} = \min \left\{ \max_p \{TMT_p\} \right\} \quad (3.60)$$

The value of  $TCP$ ,  $TCS$ ,  $TCIF$ ,  $TCIV$ ,  $TCM$ , and  $TCW$  are calculated as Equations (3.61) to (3.66). Calculating the value of  $TMT_p$  is described next.

$$TCP = \sum_{p=1}^P \sum_{o=1}^O \sum_{m=1}^M pc_{op}^m pt_{op}^m N_o^p U_{op}^m + \sum_{p=1}^P \sum_{o=1}^O \sum_{m=1}^M fa_{op}^m U_{op}^m \quad (3.61)$$

$$TCS = \sum_{p=1}^P \sum_{o=1}^O sc_o^p S_o^p \quad (3.62)$$

$$TCIF = \sum_{p=1}^P \sum_{o=1}^O \sum_{m=1}^M \sum_{i=1}^I \sum_{k=1}^K (fc_{ok}^{pmi} NC_{ok}^{pi} + fm_{ok}^{pmi} NM_{ok}^{pi}) + \sum_{p=1}^P \sum_{o=1}^O fs_o^p \mathbb{L}_o^p + \sum_{i=1}^I cp_i Z_i \quad (3.63)$$

$$TCIV = \sum_{p=1}^P \sum_{o=1}^O \sum_{o'=1}^O \sum_{m=1}^M \sum_{i=1}^I \sum_{k=1}^K (cf_k^p ct_{ok}^{pi} vc_{ok}^{pmi} A_{o'}^{kpi} + mf_k^p mt_{ok}^{pi} vm_{ok}^{pmi} B_{o'}^{kpi}) U_{op}^m \quad (3.64)$$

$$TCM = \sum_{m=1}^M fp_m Z_m \quad (3.65)$$

$$TCW = \sum_{p=1}^P \sum_{o=1}^O \sum_{i=1}^I \sum_{k=1}^K G_k^p nc_k^p (\mathbb{E}_{ok}^p \beta_{ok}^{pi} + \mathbb{F}_{ok}^p) \quad (3.66)$$

The rest of this section is dedicated to the explanations to propose third objective function.

Due to limited capacity of manufacturing equipment, all parts entering a machine to undergo their corresponding operations cannot be processed at the same time and need to wait for their turn to be processed. This issue is the same for inspection operations and parts must wait to be inspected. Therefore, the total manufacturing time for final products is the sum of actual production and inspection times and the time spent at the machines and inspection stations. The recourse limitation and limited capacity of machines and inspection tools cause part delays if the average arrival rate gets closer to the service rate. These delays are increased as more and more parts are fed to the system or machines and inspection tools with lower capacity are purchased/utilized to decrease total cost of manufacturing. As these delays significantly affect the manufacturing time requirement, spent time at the machines and inspection stations should be calculated and taken into account.

Several studies have been conducted in the field of modeling manufacturing systems during last decade including scheduling and production planning problems. In most of these problems, it is assumed that all parameters concerning the manufacturing equipment have constant and known values in advance. However, manufacturing systems in the real world are subject to many sources of variability or randomness caused by human or workplace events, such as unexpected machine

breakdowns, changes in due dates, releases of unexpected jobs, imprecise processing times, out of stock conditions, and operator unavailability (Elyasi and Salmasi, 2013). These variability and randomness lead to uncertainty in the part flow between operations. In order to design and control manufacturing systems that operate effectively in this environment, analytical models that capture the effects of randomness are necessary (Cruz et al., 2010; Hulett and Damodaran, 2011; Li et al., 2009; Wu, 2005; Asmundsson et al., 2009). In such systems, queuing approach is an efficient method to take uncertainty into account (Hulett and Damodaran, 2011; Yang et al., 2007; Omar and Kumar, 2008; Connors et al., 1996; Park et al., 2000; Narahari and Khan, 1996; Saboo et al., 1989; Pradhan et al., 2008; Pradhan and Damodaran, 2009). Figure 3.9 illustrates the manufacturing time at each stage in presence of inspection.

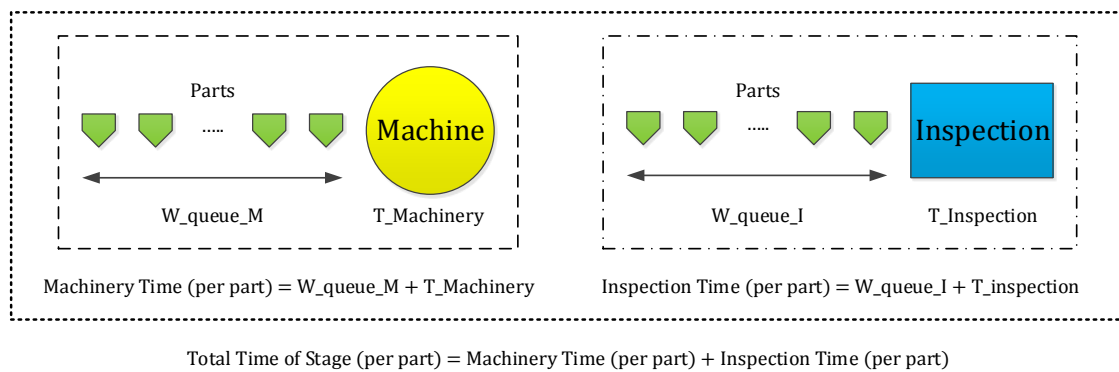

**Figure 3.9.** Manufacturing time at a stage

Accordingly in this thesis, a queuing system is considered to analyze the waiting time of parts at the machines and inspection stations. In this way, accounting for uncertain amount of parts and calculation of waiting times through queue theory, makes the proposed model more attractive in practice. For this aim, a Poisson distribution is considered for modeling the waiting times of entering parts to the machines and inspection stations. This allows us to model the queue formed by part as an M/M/1 queuing system. Due to non-ideal internal and external condition and unpredictable events, consider that the queue systems at machines and inspection stations are stochastically disrupted and again retrieved with specific rates. In the case of M/M/c queue system, service times are assumed to be independent and identically distributed exponentials with rate  $\mu$ . During disruptions, the number of operational servers decreases from  $c$  to  $c'$  and the service rates of all servers drop from  $\mu$  to  $\mu' \geq 0$ . As soon as the hub is retrieved, the number of working servers and their service rates are restored to  $c$  and  $\mu$ , respectively. We assume that breakdowns arrive according to a Poisson process with rate  $f$ , and the retrieve times are i.i.d. exponentials with rate  $r$ . The parts arrivals are in accordance with a homogeneous Poisson process with intensity  $\lambda$ .

In this thesis, a M/M/1 queue system is considered for all machines and inspection stations, in which the mean waiting time,  $W$ , at machines and inspection

stations, when  $\mu' = 0$ , can be derived from the generating function (3.67) as equation (3.68) (Baykal-Gursoy et al., 2009).

$$G(z) = \frac{(r\mu - (r+f)\lambda)(-\lambda z + \lambda + r + f)}{(r+f)(\lambda^2 z^2 - \lambda(\lambda + r + f + \mu)z + \mu(\lambda + r))} \quad (3.67)$$

$$W = \frac{\left[ \frac{dG(z)}{dz} \right]_{z=1}}{\lambda} = \frac{(r+f)^2 + \mu f}{(r+f)(r(\mu - \lambda) - \lambda f)} \quad (3.68)$$

According to equation (3.68), the waiting time of parts entering the machines ( $WP_{op}^m$ ) and the waiting time of parts that undergo conformity ( $WC_{ok}^{pi}$ ) and monitoring ( $WM_{ok}^{pi}$ ) inspections are calculated as Equations (3.69) to (3.71), respectively.

$$WP_{op}^m = \frac{(rp_{op}^m + fp_{op}^m)^2 + \mu p_{op}^m f p_{op}^m Z_m}{(rp_{op}^m + fp_{op}^m)[rp_{op}^m(\mu p_{op}^m Z_m - \lambda) - \lambda f p_{op}^m]} \quad (3.69)$$

$$WC_{ok}^{pi} = \frac{(rc_{ok}^{pi} + fc_{ok}^{pi})^2 + \mu c_{ok}^{pi} f c_{ok}^{pi} Z_i}{(rc_{ok}^{pi} + fc_{ok}^{pi})[rc_{ok}^{pi}\{\mu c_{ok}^{pi} Z_i - \lambda\} - \lambda f c_{ok}^{pi}]} \quad (3.70)$$

$$WM_{ok}^{pi} = \frac{(rm_{ok}^{pi} + fm_{ok}^{pi})^2 + \mu m_{ok}^{pi} f m_{ok}^{pi} Z_i}{(rm_{ok}^{pi} + fm_{ok}^{pi})[rm_{ok}^{pi}\{\mu m_{ok}^{pi} Z_i - \lambda\} - \lambda f m_{ok}^{pi}]} \quad (3.71)$$

where the value of  $\lambda$  is calculated as Equation (3.72). In this equation, it is considered that arrival rate of the parts through the production system is equal to the minimum service rate among manufacturing and inspection stages. Accordingly, the stage with minimum service rate is called as bottleneck stage.

$$\lambda = \left\{ \min_{o,p} \left( \sum_m \mu p_{op}^m U_{op}^m \right), \min_{\substack{o'' < o \\ o,k,p}} \left\{ \left( \sum_{o' \leq o''} \sum_i X M_{o',o-1}^{kpi} \mu m_{ok}^{pi} \right) Y M_{ok}^p + \mathcal{M}(1 - Y M_{ok}^p) \right\}, \min_{o,k,p} \left\{ \left( \sum_{o' \leq o''} \sum_i X C_{o',o-1}^{kpi} \mu m_{ok}^{pi} \right) Y C_{ok}^p + \mathcal{M}(1 - Y C_{ok}^p) \right\} \right\} \quad (3.72)$$

According to Equations (3.60) and (3.69) to (3.71), the value of  $TMT_p$  is provided as Equation (3.73).

$$TMT_p = \sum_{o=1}^O \sum_{m=1}^M (pt_{op}^m + WP_{op}^m) U_{op}^m + \sum_{o=1}^O \sum_{k=1}^K \sum_{i=1}^I (ct_{ok}^{pi} + WC_{ok}^{pi}) Y C_{ok}^{pi} + \sum_{o=1}^O \sum_{k=1}^K \sum_{i=1}^I (mt_{ok}^{pi} + WM_{ok}^{pi}) Y M_{ok}^{pi} \quad (3.73)$$

♣ Constraints

Although the most constraints of the TMINLP\_EP are the same as those of Section 3.2.3.2, but all the constraints with new notations are presented as follows.

$$\sum_{o=o'}^0 \sum_{i=1}^I \zeta_{o'o}^p X C_{o'o}^{kpi} = \psi_{o'k}^p Y C_{o'k}^p \quad \forall o', k; o' \leq O; p \quad (3.74)$$

$$\sum_{o=o'}^0 \sum_{i=1}^I \zeta_{o'o}^p X M_{o'o}^{kpi} = \psi_{o'k}^p Y M_{o'k}^p \quad \forall o', k; o' \leq O, p \quad (3.75)$$

$$Y C_{o'k}^p + Y M_{o'k}^p \leq 2\psi_{o'k}^p \quad \forall o', k, p \quad (3.76)$$

$$N P_{ok}^p = \mathbb{V}_{pk} \sum_{m=1}^M (f r_{okpm}^1 U_{op}^m) + \mathbb{U}_{pk} \sum_{m=1}^M (f r_{okpm}^2 U_{op}^m) \quad \begin{matrix} \forall o, k; o \\ \leq O, p \end{matrix} \quad (3.77)$$

$$S_{ok}^p \geq \left[ \mathbb{D}_{p'p}^k \times d_{ok}^{pi} \right] + \left[ \mathbb{A}_{p'p}^k \times \alpha_{ok}^{pi} - \mathbb{D}_{p'p}^k \times \alpha_{ok}^{pi} \right] - \left[ \mathbb{D}_{p'p}^k \times \beta_{ok}^{pi} \right] \quad \begin{matrix} \forall o, o', k; o, o' \\ \leq O, p \end{matrix} \quad (3.78)$$

$$S_o^p \geq S_{ok}^p \quad \forall o, k; o \leq O, p \quad (3.79)$$

$$N_o^p = N_{o-1}^p - S_{o-1}^p \quad \forall o; o \leq O + 1, p \quad (3.80)$$

$$N_0^p = n_T^p \quad \forall o \quad (3.81)$$

$$N M_{ok}^{pi} \geq \sum_{o'=1}^o X M_{o'o}^{kpi} \quad \forall p, i, k, o; o \leq O \quad (3.82)$$

$$N C_{ok}^{pi} \geq \sum_{o'=1}^o X C_{o'o}^{kpi} \quad \forall p, i, k, o; o \leq O \quad (3.83)$$

$$\mathcal{M} \times N S_o^p \geq \sum_{o'=1}^o \sum_{k=1}^K \sum_{i=1}^I (X C_{o'o}^{kpi} + X M_{o'o}^{kpi}) \quad \forall o, o'; o, o' \leq O, p \quad (3.84)$$

$$\sum_{m=1}^M U_{op}^m = 1 \quad \forall o; o \leq O, p \quad (3.85)$$

$$\sum_{p=1}^P \sum_{o'=1}^o \sum_{o=1}^o (c f_k^p c t_{ok}^{pi} \mathbb{A}_{o'o}^{kpi} U_{op}^m + m f_k^p m t_{ok}^{pi} \mathbb{B}_{o'o}^{kpi} U_{op}^m) \leq \Gamma_k^i Z_i \quad \forall k, i \quad (3.86)$$

$$\sum_{o=1}^o \sum_{p=1}^P p t_{op}^m N_o^p U_{op}^m \leq \mathbb{Q}_m Z_m \quad \forall m \quad (3.87)$$

$$N M_{ok}^{pi} \leq \mathcal{M} Z_i \quad \forall o, k; o \leq O, p, i \quad (3.88)$$

$$N C_{ok}^{pi} \leq \mathcal{M} Z_i \quad \forall o, k; o \leq O, p, i \quad (3.89)$$

$$\mathbb{A}_{o'o}^{kpi} \leq \mathcal{M} \times X C_{o'o}^{kpi} \quad \forall o, o', k; o, o' \leq O, p, i \quad (3.90)$$

$$\mathbb{A}_{o'o}^{kpi} \leq N_o^p \quad \forall o, o', k; o, o' \leq O, p, i \quad (3.91)$$

$$\mathbb{A}_{o'o}^{kpi} \geq N_o^p - \mathcal{M} (1 - X C_{o'o}^{kpi}) \quad \forall o, o', k; o, o' \leq O, p, i \quad (3.92)$$

$$\mathbb{B}_{o'o}^{kpi} \leq \mathcal{M} \times X M_{o'o}^{kpi} \quad \forall o, o', k; o, o' \leq O, p, i \quad (3.93)$$

$$\mathbb{B}_{o'o}^{kpi} \leq N_{o'}^p, \quad \forall o, o', k; o, o' \leq O, p, i \quad (3.94)$$

$$\mathbb{B}_{o'o}^{kpi} \geq N_{o'}^p - \mathcal{M}(1 - XM_{o'o}^{kpi}) \quad \forall o, o', k; o, o' \leq O, p, i \quad (3.95)$$

$$\mathbb{V}_{o'k}^p \leq M \times YM_{o'k}^p \quad \forall o', k; o' \leq O, p \quad (3.96)$$

$$\mathbb{V}_{o'k}^p \leq N_{o'}^p, \quad \forall o', k; o' \leq O, p \quad (3.97)$$

$$\mathbb{V}_{o'k}^p \geq N_{o'}^p - \mathcal{M}(1 - YM_{o'k}^p) \quad \forall o', k; o' \leq O, p \quad (3.98)$$

$$\mathbb{U}_{o'k}^p \leq \mathcal{M} \times YC_{o'k}^p \quad \forall o', k; o' \leq O, p \quad (3.99)$$

$$\mathbb{U}_{o'k}^p \leq N_{o'}^p, \quad \forall o', k; o' \leq O, p \quad (3.100)$$

$$\mathbb{U}_{o'k}^p \geq N_{o'}^p - \mathcal{M}(1 - YC_{o'k}^p) \quad \forall o', k; o' \leq O, p \quad (3.101)$$

$$\mathbb{D}_{o'o}^{kpi} \leq \mathcal{M} \times XC_{o'o}^{kpi} \quad \forall o, o', k; o, o' \leq O, p, i \quad (3.102)$$

$$\mathbb{D}_{o'o}^{kpi} \leq NP_{o'k}^p \quad \forall o, o', k; o, o' \leq O, p, i \quad (3.103)$$

$$\mathbb{D}_{o'o}^{kpi} \geq NP_{o'k}^p - \mathcal{M}(1 - XC_{o'o}^{kpi}) \quad \forall o, o', k; o, o' \leq O, p, i \quad (3.104)$$

$$\mathbb{E}_{o'k}^p \leq \mathcal{M} \times YC_{o'k}^p \quad \forall o', k; o' \leq O, p \quad (3.105)$$

$$\mathbb{E}_{o'k}^p \leq NP_{o'k}^p \quad \forall o', k; o' \leq O, p \quad (3.106)$$

$$\mathbb{E}_{o'k}^p \geq NP_{o'k}^p - \mathcal{M}(1 - YC_{o'k}^p) \quad \forall o', k; o' \leq O, p \quad (3.107)$$

$$\mathbb{F}_{o'k}^p \leq \mathcal{M} \times YM_{o'k}^p \quad \forall o', k; o' \leq O, p \quad (3.108)$$

$$\mathbb{F}_{o'k}^p \leq NP_{o'k}^p \quad \forall o', k; o' \leq O, p \quad (3.109)$$

$$\mathbb{F}_{o'k}^p \geq NP_{o'k}^p - \mathcal{M}(1 - YM_{o'k}^p) \quad \forall o', k; o' \leq O, p \quad (3.110)$$

$$\mathbb{L}_o^p \leq \mathcal{M} \times NS_o^p \quad \forall o; o \leq O, p \quad (3.111)$$

$$\mathbb{L}_o^p \leq N_o^p \quad \forall o; o \leq O, p \quad (3.112)$$

$$\mathbb{L}_o^p \geq N_o^p - \mathcal{M}(1 - NS_o^p) \quad \forall o; o \leq O, p \quad (3.113)$$

$$XC_{o'o}^{kpi}, XM_{o'o}^{kpi}, NS_o^p, YC_{o'k}^p, YM_{o'k}^p, U_{op}^m \in \{0,1\} \quad \forall o, o', k; o, o' \leq O, p, i \quad (3.114)$$

$$S_{ok}^p, S_o^p, \mathbb{D}_{o'o}^{kpi}, NM_{ok}^{pi}, NC_{ok}^{pi}, \mathbb{A}_{o'o}^{kpi}, \mathbb{B}_{o'o}^{kpi}, NP_{o'k}^p \quad \forall o, o', k; o, o' \leq O, p, i \quad (3.115)$$

$$\mathbb{E}_{o'k}^p, \mathbb{F}_{o'k}^p, \mathbb{L}_o^p, N_o^p \geq 0 \quad \leq O, p, i$$

$$Z_i, Z_m \geq 0, \text{ Integer} \quad \forall i, m \quad (3.116)$$

Equations (3.74) and (3.75) ensure that CI and MI of a quality characteristic should be done for all part just in one inspection stage, respectively. Equation (3.76) forces that one kind of inspection is needed for each quality characteristic. This equation is directly related to the MI-and-CI strategy.

Equation (3.77) relates that the failure rate of an operation to the decision whether the MI is considered for that characteristic or not. Constraints (3.78) and (3.79) calculate the number of scraps after each inspection stage based on type I and type II errors. Constraints (3.80) and (3.81) determine the in-process part after each operation, where the number of parts is decreased in presence of any inspection due to scrap detection and removal. Equations (3.82) and (3.83) calculate total number of MIs and CIs after operation. Constraint (3.84) calculates different inspection stage among the whole process. Equation (3.85) imposes that each operation of each product can be performed only on one machine. Constraints (3.86) and (3.87)

indicate the capacity limitations of inspection tools and machines, respectively. [Constraint \(3.88\)](#) provides the maximum manufacturing time among different products. [Constraint \(3.88\)](#) and [\(3.89\)](#) enforce that inspections can be performed if and only if there is a tools for that. [Constraints \(3.90\)](#) to [\(3.113\)](#) are provided to linearize the product of some variables. [Constraints \(3.114\)](#) to [\(3.116\)](#) are domain constraints.

Finally, the proposed TMINLP\_EP is as follow:

**TMINLP\_EP (MI-and-CI):**

$$\begin{aligned} \min OFV_1^{D-EP} = & \sum_{p=1}^P \sum_{o=1}^O \sum_{m=1}^M pc_{op}^m pt_{op}^m N_o^p U_{op}^m + \sum_{p=1}^P \sum_{o=1}^O \sum_{m=1}^M fa_{op}^m U_{op}^m \\ & + \sum_{p=1}^P \sum_{o=1}^O sc_o^p S_o^p \\ & + \sum_{p=1}^P \sum_{o=1}^O \sum_{m=1}^M \sum_{i=1}^I \sum_{k=1}^K (fc_{ok}^{pmi} NC_{ok}^{pi} + fm_{ok}^{pmi} NM_{ok}^{pi}) \end{aligned} \quad (3.117)$$

$$\begin{aligned} & + \sum_{p=1}^P \sum_{o=1}^O fs_o^p \mathbb{L}_o^p + \sum_{i=1}^I cp_i Z_i \\ & + \sum_{p=1}^P \sum_{o=1}^O \sum_{o'=1}^O \sum_{m=1}^M \sum_{i=1}^I \sum_{k=1}^K (cf_k^p ct_{ok}^{pi} vc_{ok}^{pmi} \mathbb{A}_{o'o}^{kpi} \\ & + mf_k^p mt_{ok}^{pi} vm_{ok}^{pmi} \mathbb{B}_{o'o}^{kpi}) U_{op}^m + \sum_{m=1}^M fp_m Z_m \\ \min OFV_2^{D-EP} = & \sum_{p=1}^P \sum_{o=1}^O \sum_{i=1}^I \sum_{k=1}^K G_k^p nc_k^p (\mathbb{F}_{ok}^p \beta_{ok}^{pi} + \mathbb{F}_{ok}^p) \end{aligned} \quad (3.118)$$

$$\min OFV_3^{D-EP} = \Phi \quad (3.119)$$

s.t.

$$\begin{aligned} \sum_{o=1}^O \sum_{m=1}^M (pt_{op}^m + WP_{op}^m) U_{op}^m + \sum_{o=1}^O \sum_{k=1}^K \sum_{i=1}^I (ct_{ok}^{pi} + WC_{ok}^{pi}) YC_{ok}^{pi} \\ + \sum_{o=1}^O \sum_{k=1}^K \sum_{i=1}^I (mt_{ok}^{pi} + WM_{ok}^{pi}) YM_{ok}^{pi} \leq \Phi \end{aligned} \quad \forall p \quad (3.120)$$

[Constraints \(3.74\)](#) to [\(3.116\)](#).

### 3.3.2.4. Robust Optimization

The robust optimization approach for the proposed TMINLP\_EP is similar to those of [Section 3.3.1.3](#) with three objectives. Therefore, explanations are neglected in this section.



### 3.4. Solution algorithms: Meta-heuristics

The main goal of this chapter is to develop two tailored solution methods to solve the mathematical models proposed through the [Sections 3.2](#) and [3.3](#). These solution methods are based on genetic algorithm (GA) and differential evolution (DE) algorithm to solve the *Main Problem* and the *Extended Problem*, respectively.

In order to solve the proposed inspection models with stochastic complexity, the solution algorithm must be capable of obtaining the optimal or near optimal solution within the reasonable time. There are several methods in the literature such as simplex and dynamic programming based optimization algorithms for providing an optimal solution for small size problems ([Taha 2006](#); [Shukla et al., 2013](#)). However, most of the real world problems have large sizes and solving them by mathematical programming approaches takes considerable computational time. Therefore, to cope with this challenging issue, well-known evolutionary algorithms, namely genetic algorithm (GA) and differential evolution (DE) algorithm are proposed in this chapter to solve the *Main Problem* and *Extended Problem*, respectively. It has been shown that evolutionary algorithms such as genetic algorithms ([Holland, 1975](#)) or evolution strategies ([Back et al., 1991](#)) are efficient and robust approaches to solve a wide range of optimization problems. Application of these algorithms in the area of inspection planning and allocation can be found in [Hanne and Nickel \(2005\)](#), [Shiau \(2003b\)](#), [Alam et al. \(2033\)](#) and [Shiau et al. \(2007\)](#).

In order to avoid explanation of general concepts, this section only deals with new solution representations for both Main and Extended Problems in [Sections 3.4.1](#) and [3.4.2](#), respectively. Interested readers are invited to study [Appendix 3](#) for more information regarding to the GA and the use of DE to solve multi-objective problems.

#### 3.4.1. Solution representation: *Main Problem*

The solution representation at each genetic algorithm should be as compact as possible but with complete expression of a solution to the problem. A compact representation contains only the information needed to represent a solution to the problem. A complete representation contains enough information to represent any solution to the problem. If a representation contains more information than is needed to uniquely identify solutions to the problem, the search space will be larger than necessary.

One important issue to be noted is that, if possible, the representation should not represent infeasible solutions. If a chromosome is able to represent an infeasible solution, a penalty value must be considered in the objective function to remove infeasible solutions from reproduction procedures. Generally, it is much netter to propose a mechanism that can only represent feasible solutions within the objective function measures only optimality, not feasibility. Otherwise, representing the infeasible solutions leads to bigger size of the search space, wherein the searching becomes more difficult.

Hereafter, a minimal representation for solving the *Main Problem* is proposed that does not represent infeasible solutions. Each chromosome of the proposed GA to



solve the *Main Problem* must contain information about *which-what* and *when* decisions. For this aim, a new solution representation is developed which includes two different parts representing 1) *which-what* and 2) *when* decisions. For example, consider a problem with 6 quality characteristics with *which-what* and *when* decisions as shown in Figures 3.10 and 3.11, respectively.

In Figure 3.10, each column represents a quality characteristic. Moreover, at each column, value 1 at the first row means that the related quality characteristic needs monitoring inspection and value 1 in the second row indicates the need for conformity inspection. Accordingly, in Figure 3.10, quality characteristics number 1, 2 and 4 need CI, quality, characteristic number 3 needs both MI and CI and quality characteristic number 5 and 6 need MI. In Figure 3.11, the columns explain the operations and the rows signify the quality characteristics. Therefore, value 1 at each array indicates that the inspection of related characteristic (i.e., the row number of an array) is performed after the determined process (i.e., the column number of an array). For instance, MI for characteristic numbers 3, 5 and 6 is carried out after operation number 3, 6 and 6, respectively. Besides, CI of characteristic number 1, 2, 3 and 4 are carried out after operation number 3, 6, 6 and 6, respectively.

		Quality Characteristics					
		1	2	3	4	5	6
Monitoring		0	0	1	0	1	1
Conformity		1	1	1	1	0	0

Figure 3.10. Which-What decision

		Operations					
		1	2	3	4	5	6
Quality Characteristic	1	0	0	1	0	0	0
	2	0	0	0	0	0	1
	3	0	0	1	0	0	1
	4	0	0	0	0	0	1
	5	0	0	0	0	0	1
	6	0	0	0	0	0	1

Figure 3.11. When decision

**3.4.2. Solution representation: Extended Problem**

Each chromosome of the proposed DE to solve the *Extended Problem* must contain information about all decisions consisting of: *which-what*, *when*, *machine selection* and *allocation* (see  $Z_m$  and  $U_{op}^m$  in Section 3.3.2.2), *inspection tool selection* and *allocation* (see  $Z_i$ ,  $XC_{o'o}^{kpi}$ , and  $XM_{o'o}^{kpi}$  in Section 3.3.2.2). Solution representation for *which-what* decisions is similar to Section 3.4.1 with a modification as Figure 3.12. Figure 3.12 contains a  $(2P \times K)$  matrix wherein each pair of consecutive rows belongs to a product. Accordingly in Figure 4.6, there is a production system with two products, six quality characteristics and three inspection tools. It can be easily shown that in product number 1, e.g., quality characteristic number 5 needs both MI and CI using inspection tools number 2 and 1, respectively. In addition, quality characteristic number 3 in product number 2 needs only CI using inspection tool

number 1. It is also obvious that all three inspection tools have been selected. Representation of the *when* decision is similar to Figure 3.11, but this part is repeated for each product.

		Quality Characteristics					
		1	2	3	4	5	6
Product 1	Monitoring	0	0	1	0	2	1
	Conformity	2	2	1	2	1	0
Product 2	Monitoring	0	3	0	2	0	1
	Conformity	0	1	1	0	0	1

Figure 3.12. Which-What, inspection tool selection and allocation decisions

The decisions regarding *machine selection* and *allocation* have been integrated in a  $(O \times P)$  matrix wherein each array represent the machine that has been used for performing the corresponding operation from the corresponding product. Figure 3.13 represents a *machine selection* and *allocation* decision with four operations, three products and three machines. According to Figure 3.13, operations number 1 to 4 in product number 1 are performed by machines number 1, 3, 1 and 3, respectively. The value zero in the matrix means that the corresponding product does not need that operation. It can be also concluded that only machines number 1 and 3 have been selected.

		Products		
		1	2	3
Operations	1	1	3	3
	2	3	3	3
	3	1	0	1
	4	3	0	1

Figure 3.13. Machine selection and allocation decision

### 3.5. Discussion and Summary

The optimization framework for designing an inspection plan as well as solution algorithms were described in this chapter. Through the optimization framework, two problem called *Main Problem* and *Extended Problem* were studied in detail. In the *Main Problem*, the purpose is to design a robust single-objective mathematical model that is less sensitive to production variations and makes decisions regarding to which quality characteristics needs what kind of inspection and where the inspections should be performed. In order to extend the *Main Problem* to a more real and applicable model, we attempted to develop a new variant of inspection planning problem with machine and inspection tool allocation as well as capacity constraints for both machines and inspection tools (i.e., *Extended Problem*). In addition, a multi-product serial MPS was considered the *Extended Problem*. The problem was modeled through a mixed-integer nonlinear programming model with multiple objectives such as minimizing total manufacturing cost, maximizing customer satisfaction, and minimizing the maximum manufacturing time through different products. In the third objective function and besides to actual production

time, the waiting time of in-process items to receive machinery or inspection services was also taken into account. Machines and inspection tools were modeled as a M/M/c queuing system, while they are subject to disruption and breakdowns may happen during their activities. These breakdowns affect the waiting time and should be computed in the third objective function.

For the robust approach, Taguchi and Monte Carlo techniques were applied to propose models that are less sensitive to manufacturing and environmental variations.

Next chapter will propose experimental designs as well as computational experiments in order to validate the proposed mathematical models in this chapter.

After formulating the proposed problems, the main focus of this chapter has been on developing two tailored meta-heuristic algorithms, namely genetic and differential evolution algorithms, to solve problems in order to find near optimal solutions. The proposed GA is to solve the single-objective *Main Problem*, while the DE algorithm has been developed to solve bi-objective and three-objective *Extended Problems*.

The next chapter will provide comprehensive experiments and computational results. The following paragraphs try to explain an important issue regarding to the proposed mathematical models and solution approaches. This issue relates to the applicability and the possibility of implementation of the proposed mathematical models and solution approaches in other domains.

The studied inspection planning problem in this thesis is categorized into domain of supply chain management (SCM) and especially the problems related to the production party. The production party is involved into all problems regarding to the production. Another party in the supply chain that significantly affects the performance of the whole supply chain is distribution party. The main problems in distribution centers are inventory and transportation related problem.

The domain of transportation problems have been selected to apply the proposed models and solution approaches. Among different transportation related problems, Hub Location Problem (HLP) has been selected to be studied.

HLPs have been involved in network design planning in transportation, telecommunication, and computer systems, where hub-and-spoke topologies are applied to efficiently route shipments between many origin and destination (O-D) nodes through intermediate nodes, called hubs. Hub nodes are consolidation, switching, or transshipment facilities to connect a large number of O-D pairs by using a small number of links. Fewer links not only simplify the network structure but also transfer large amounts of flow on interhub links, enabling economies of scale and reducing set-up and operational costs. Hub location models typically try to determine where to locate the hubs among a set of candidate sites and how to allocate spokes to the hubs, so that the total cost can be minimized or the total profit can be maximized (e.g., [Alumur and Kara, 2008](#); [Campbell et al., 2012](#); [Zanjirani Farahani et al., 2013](#); [Mohammadi et al., 2014a](#)).

One of the most studied models in the HLP area is the so-called capacitated hub location problem (CHLP). In the CHLP, we are given a set of O-D nodes (i.e., spokes) with mutual flows, a set of candidate locations, the cost of opening a hub at each location, the cost of routing the flow through the network, and capacity of each candidate location in processing flows (i.e., consolidation, switching and transferring) as well as capacity of the connection links. The objective is to open a set of hub nodes from the candidate locations and assign each spoke to an open hub so as to minimize the total hub opening and flow routing costs by respecting the capacity of hubs and connection links.

In order to justify the application of the findings of this thesis in HLPs, some of the similarities between the proposed inspection problem and transportation problems are elaborated as [Table 3.2](#). The hub location problem is modeled using these similarities in [Chapter 5](#).

**Table 3.2.** Similarities between inspection problem and HLP

Feature	Inspection Problem	Hub Location Problem
Objectives	<ul style="list-style-type: none"> <li>⇒ Minimizing total cost of manufacturing</li> <li>⇒ Minimizing the maximum production time among different products</li> <li>⇒ Maximizing customer satisfaction</li> </ul>	<ul style="list-style-type: none"> <li>⇒ Minimizing total cost of transportation</li> <li>⇒ Minimizing the maximum transportation time among different flows</li> <li>⇒ Maximizing customer services</li> </ul>
Constraints	<ul style="list-style-type: none"> <li>⇒ Machine capacity</li> <li>⇒ Inspection tool capacity</li> </ul>	<ul style="list-style-type: none"> <li>⇒ Hub capacity</li> <li>⇒ Vehicle capacity</li> </ul>
Location	<ul style="list-style-type: none"> <li>⇒ Determining the location of inspection stations (i.e., after which manufacturing stage, the inspections should be performed)</li> </ul>	<ul style="list-style-type: none"> <li>⇒ Determining the location of hubs</li> </ul>
Allocation	<ul style="list-style-type: none"> <li>⇒ Allocating the inspection of the parts to the located inspection stations</li> </ul>	<ul style="list-style-type: none"> <li>⇒ Allocating the spokes to the located hubs</li> </ul>
Mode selection	<ul style="list-style-type: none"> <li>⇒ Which kind of inspections should be selected (i.e., MI and/or CI)</li> </ul>	<ul style="list-style-type: none"> <li>⇒ Which transportation mode should be selected</li> </ul>
Disruption	<ul style="list-style-type: none"> <li>⇒ Machines and inspection tools are subject to disruption</li> </ul>	<ul style="list-style-type: none"> <li>⇒ Hubs and connection links are subject to disruption</li> </ul>
Congestion	<ul style="list-style-type: none"> <li>⇒ Machines and inspection tools may become overloaded</li> </ul>	<ul style="list-style-type: none"> <li>⇒ Hubs and connection links may be overloaded</li> </ul>
Queuing	<ul style="list-style-type: none"> <li>⇒ Machines and inspection tools are modeled as queuing systems</li> <li>⇒ Queuing systems are subject to disruption</li> </ul>	<ul style="list-style-type: none"> <li>⇒ Hubs are modeled as queuing systems</li> <li>⇒ Queuing systems are subject to disruption</li> </ul>
Uncertainty	<ul style="list-style-type: none"> <li>⇒ Most of the production related parameters are uncertain</li> </ul>	<ul style="list-style-type: none"> <li>⇒ Most of the transportation related parameters are uncertain</li> </ul>
Robustness	<ul style="list-style-type: none"> <li>⇒ Production related parameters are stochastic with no specific distribution function</li> <li>⇒ A robust inspection plan is desired</li> </ul>	<ul style="list-style-type: none"> <li>⇒ Transportation related parameters are stochastic with no specific distribution function</li> <li>⇒ A robust transportation network is desired</li> </ul>
Solution algorithm	<ul style="list-style-type: none"> <li>⇒ Metaheuristic algorithms are being used to solve large scale problems</li> </ul>	<ul style="list-style-type: none"> <li>⇒ Metaheuristic algorithms are being used to solve large scale problems</li> </ul>

## **Chapter IV**

# **Experimental Results**

### 4.0. Chapter purpose and outline

The main goal of this chapter is to solve the proposed mathematical models in [Chapter 3](#) using developed metaheuristic algorithms in [Section 3.4](#). In order to validate the proposed models and solutions approaches, computational experiments are conducted on a real industrial case and valuable sensitivity analyses are drawn. Accordingly, [Section 4.1](#) explains the real industrial case and provides the experimental design of the metaheuristic algorithm. Computational experiments including sensitivity analyses for *Main* and *Extended Problems* are presented in [Sections 4.2](#) and [4.3](#), respectively. Finally, [Section 4.4](#) provides a short summary of the whole chapter.

### 4.1. Experiments

#### 4.1.1. Case study

To illustrate the validity of the proposed mathematical models (i.e., *Main Problem* and *Extended Problem*) and the effectiveness of the proposed robust and solution approaches, an industrial case is considered from the CERTA Renault company related to a part with 15 quality characteristics is studied in this thesis. This real case contains a special part of a car manufacturer with 15 different quality characteristics. [Figures 4.1](#) and [4.2](#), respectively, show the solid frame of the part and labeled quality characteristics. Accordingly, some required deterministic information of the industrial case has been tabulated in [Table 4.1](#), in which the first to sixth columns explain name of the operations, production time, process capabilities  $C_p$  and  $P_p$  and failure rates with and without monitoring inspection, respectively. Besides, the allowable places (AP) that inspections (i.e., CI and MI) of each quality characteristic can be stationed have been listed in the last column. For example, for characteristic number 4 which belongs to operation number 4, MI or CI can be performed at any place after operations number 4 to 10 and not anywhere else.

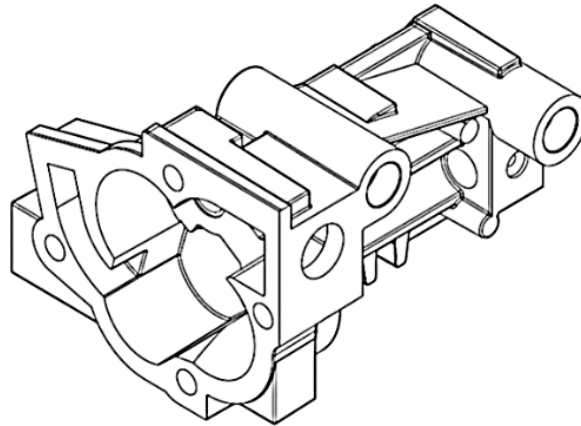

Figure 4.1. Solid frame of the industrial part

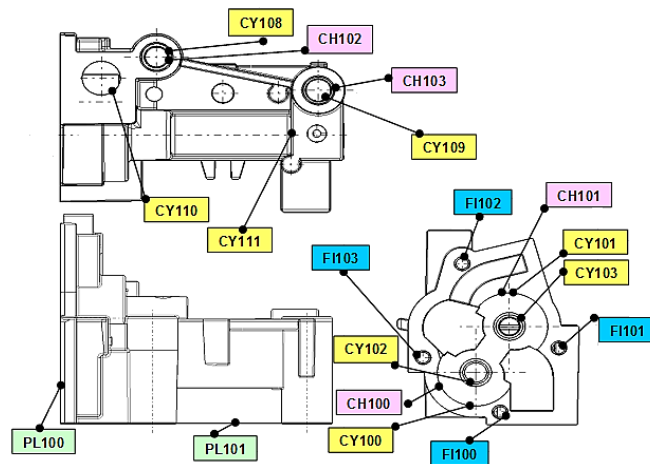

Figure 4.2. Labeled operations of the industrial part

Table 4.1. Information of the industrial case

Operation Number	Operation Name	Details					
		$PT$	$C_p$	$P_p$	$FR^1$	$FR^2$	$AP$
1	Rough milling PL100	0.148	2	1.50	1.97e-9	6.79e-6	1→13
2	Rough milling PL100	0.166	2	1.50	1.97e-9	6.79e-6	2→14
3	Rough milling PL101	0.133	2	1.66	1.97e-9	6.35e-7	3→15
4	Boring CY110	0.154	1.60	1.33	1.58e-6	6.60e-5	4→10
5	Rough drilling CY108 & CY109	0.09	2	1.66	1.97e-9	6.35e-7	5→10
6	Chamfering CY108 & CY109	0.25	2	1.66	1.97e-9	6.35e-7	6→6
7	Chamfering CY100 & CY101	0.257	1.50	1.20	6.79e-6	3.18e-4	7→15
8	Boring CY100	0.257	1.50	1.20	6.79e-6	3.18e-4	8→15
9	Boring CY101	0.122	1.66	1.30	6.35e-7	9.61e-5	9→12
10	Rough drilling CY102 & CY103	0.109	1.66	1.40	6.35e-7	2.66e-5	10→12
11	Rough drilling CY111	0.134	1.66	1.40	6.35e-7	2.66e-5	11→15
12	Boring CY108 & CY109	0.122	1.30	1.10	9.61e-5	9.66e-4	12→15
13	Boring CY102 & CY103	0.122	1.30	1	9.61e-5	2.69e-3	13→15
14	Boring CY111	0.117	1.66	1.33	6.35e-7	6.60e-5	14→15
15	Finish milling PL100	0.129	1.66	1.33	6.35e-7	6.60e-5	15→15

**4.1.2. Experimental setup**

The performance of the proposed GA and DE algorithms strongly depend on the level of their parameters. The parameter settings used in the proposed GA and DE algorithm have been summarized in [Table 4.2](#). All algorithms are compiled in MATLAB software and are executed on a Pentium 4 CPU with 3.4 GHz processor and 4 GB of memory and 10 times for each problem.

[Table 4.2](#). Parameter settings used in the proposed GA and DE

Parameter	GA	DE
Population size	120	80
Number of iteration	200	150
Selection operator	Binary tournament	Binary tournament
Crossover operator	see <a href="#">Figure A3.2*</a>	see <a href="#">Equation (A3.10)*</a>
Mutation operator	see <a href="#">Figure A3.3*</a>	see <a href="#">Equation (A3.2)*</a>
Crossover rate	0.8	-
Mutation rate	0.2	-

\*A3 stands for [Appendix 3](#).

**4.2. Computational results: Main Problem**

In this section, the *Main Problem* is solved using the proposed genetic algorithm (see [Appendix 3](#)) with specific experiments setting as [Table 4.2](#). This section also provides comprehensive analyses for each problem.

**4.2.1. Main Problem results**

This section provides the results of implementing the mathematical model of the *Main Problem* on the real industrial case. First, the effect of uncertainty of the parameters in *which-what* and *when* decisions in the *Main Problem* is investigated for both MI-or-CI and MI-and-CI strategies. In addition, since the failure rate is affected by both misadjustment and dispersion, the effect of uncertainty in both of these parameters is also examined on the inspection decisions. Finally, a global robust inspection plan is obtained by considering all parameters under the uncertainty. The results have been tabulated in [Table 4.3](#), in which the first to fourth columns, respectively, show different sources of uncertainty, uncertainty factor, inspection strategy, and total cost (per part) of manufacturing. The fifth to eleventh columns explain the details of different costs of the objective function as a percent of the total cost.

The robust inspection plan for each row of [Table 4.3](#) has been illustrated in [Figures 4.3](#) and [4.4](#) for MI-or-CI and MI-and-CI strategies, respectively. For example, in [Figure 4.3](#) and when misadjustment and dispersion are simultaneously uncertain, quality characteristics number 1-3, 5 and 6 need MI after operation number 6; quality characteristics number 9 and 10 need MI after operation number 10; and quality characteristics number 4, 7, 8 and 11-15 need CI after operation number 15. On the other hand, in [Figure 4.4](#) and when misadjustment and dispersion are simultaneously uncertain, quality characteristics number 3, 4 and 6 need MI after



## Chapter IV: Experimental Results

operation number 6; quality characteristics number 9-11 need MI after operation number 11; and quality characteristics number 7, 8 and 12-15 need CI after operation number 15. In this plan, quality characteristics number 1, 2 and 5 do not need any kind of inspection.

According to Figures 4.3 and 4.4, uncertainty in type I and type II errors and dispersion have no effect on the final inspection plan. This issue points out that at the current level of uncertainty factors of type I and type II errors and dispersion, the final decisions are not changed meaning that the company does not need to determine a precise value for these parameters, while estimating precise values for these parameters or decreasing their variations is not cost-efficient.

Table 4.3. Costs for different sources of uncertainty: *Main Model*

Source of Uncertainty	Uncertainty Factor	Strategy	Cost							
			Total (€ Per Part)	Detail Costs (% of Total Cost)						
				Production	Scrap	Fixed CI	Fixed MI	Variable CI	Variable MI	Warranty
Deterministic	0.0	MI-or-CI	5.16	93	0	0	0.20	0	6	0.8
Type I error	0.2		5.16	93	0	0	0.20	0	6	0.8
Type II error	0.2		5.16	93	0	0	0.20	0	6	0.8
Time	0.1		5.37	90	0	0	0.16	0	9.34	0.5
Misadjustment	*		6.08	79	0.04	0.06	0.09	17	3.50	0.31
Dispersion	0.05		5.16	93	0	0	0.17	0	6.00	0.83
Misadj. & Dis.*	-		6.40	75	0.04	0.04	0.10	16	8.00	0.82
All parameters	-		6.50	75	0.04	0.05	0.08	15	9.50	0.33
Deterministic	0.0	MI-and-CI	5.07	94	0	0	0.14	0	4.00	1.86
Type I error	0.2		5.08	94	0	0	0.12	0	4.00	1.88
Type II error	0.2		5.07	94	0	0	0.13	0	4.00	1.87
Time	0.1		5.17	93	0	0	0.09	0	6.00	0.91
Misadjustment	*		6.00	80	0.04	0.07	0.03	17	1.50	1.36
Dispersion	0.05		5.08	94	0	0	0.11	0	4.00	1.89
Misadj. & Dis.*	-		6.25	76	0.04	0.05	0.06	17	5.00	1.85
All parameters	-		6.41	75	0.04	0.05	0.06	16	8.00	0.85

\* $\rho_{MI} \in [0,1]$ ,  $\rho_{CI} \in [0,2]$ , Misadj. & Dis.: Misadjustment & Dispersion.

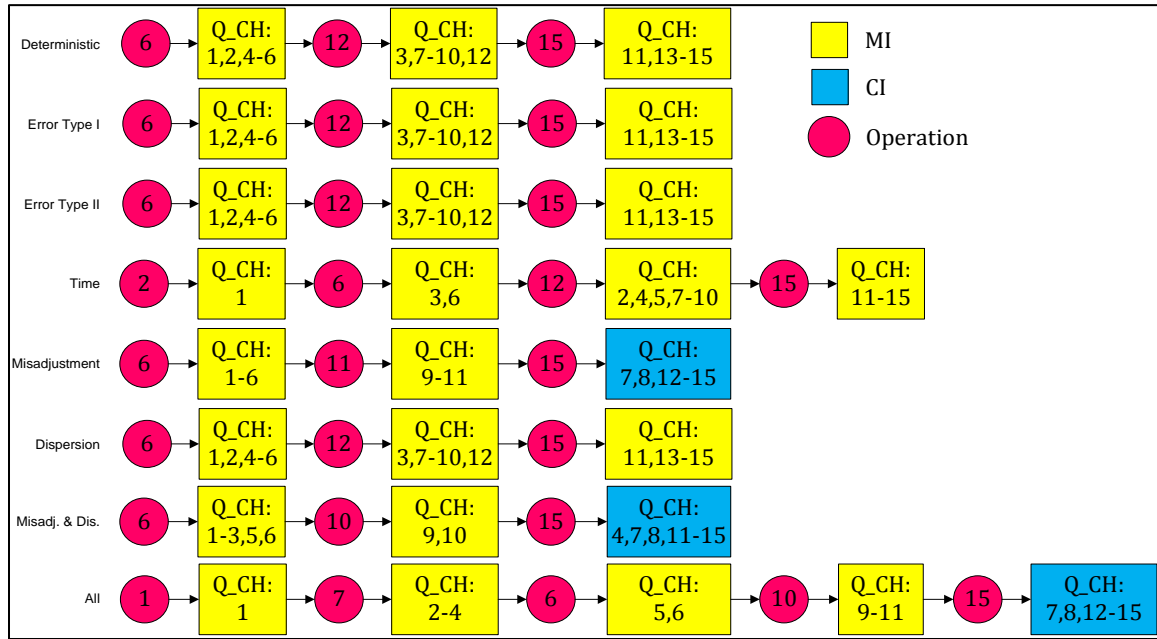

Figures 4.3. Robust inspection plan of *Main Problem* for MI-or-CI strategy

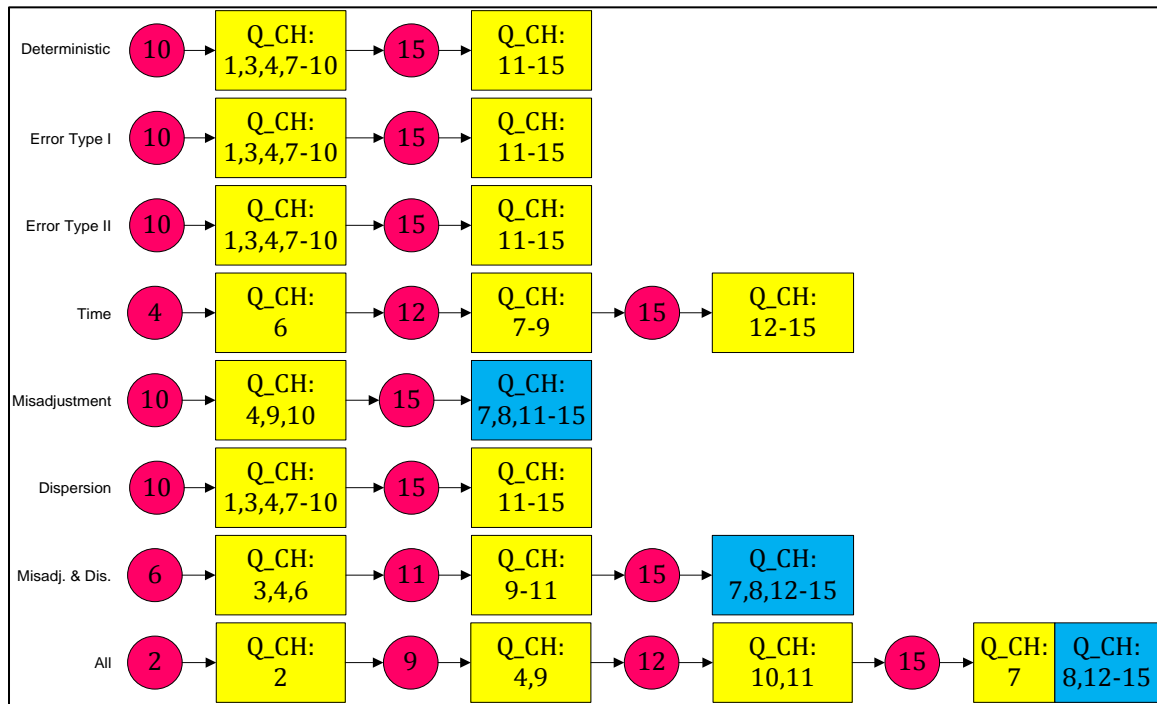

Figures 4.4. Robust inspection plan of *Main Problem* for MI-and-CI strategy

There are some characteristics which impose more variation to the objective function, and it can be proved that performing CI for them will reduce the variation. Regarding this proof, it can be easily conceived that  $FR_{pk}^{MI}$  and  $FR_{pk}^{CI}$  have an inverse relationship with process capabilities (i.e.,  $P_{pk}$ ,  $CPK_p$ ). Therefore, lowering the values of  $CPk_p$  and  $CP_p$  may increase the values of  $FR_{pk}^{MI}$  and  $FR_{pk}^{CI}$ , respectively. According to what was mentioned in Section 3.2.4, more numbers of inspections are needed once the failure rate of operations is increased. Since in the in-hand industrial case,

the cost of the conformity inspection for all the operations is the same, an operation with the lowest value of  $CP$  is selected and goes under conformity inspection, then this selection is continued for the next lowest values of  $CP$ s until the total cost reaches its global minimum. Since the ascending order of  $CP$  for the operations of the industrial case is like  $CP_{12} = CP_{13} < CP_7 = CP_8 < CP_4 = CP_9 = CP_{10} = CP_{11} = CP_{14} = CP_{15} < CP_1 = CP_2 = CP_3 = CP_5 = CP_6$ , the results under MI-or-CI strategy, when both misadjustment and dispersion are uncertain, contain six conformity inspections for operations number 7, 8 and 12 to 15. As a result, since operations number 7, 8, 12 to 15 have the lowest process capability, they are selected for performing CI in any case of uncertainty.

In the following, Figures 4.5 and 4.6 illustrate the warranty and total internal costs (see Section 3.2.3.1) for different sources of uncertainty and both inspection strategies. It is noteworthy that lower values of the total internal and warranty costs correspond to higher efficiency and responsiveness of the production system. Efficiency and responsiveness are defined based and the desire of the manufacturers and customers. By the other words, although manufacturers are interested in more efficient production systems (i.e., lower total cost), customers are likely to contact with more responsive production systems (i.e., lower warranty cost). It can be seen from Figures 4.5 and 4.6 that the MI-or-CI strategy is more responsive; however, the MI-and-CI strategy is more efficient. In the MI-or-CI strategy, the worst cases in terms of responsiveness and efficiency belong to situations with no uncertainty and uncertainty in all parameters, respectively. On the other hand, in the MI-and-CI strategy, the worst cases in terms of responsiveness and efficiency belong to situations with uncertainty in both misadjustment and dispersion and uncertainty in all parameters, respectively. Hence, parameter variations and specially misadjustment has significant effect on the inspection plan and needs to be precisely determined and their variation should be decreased as much as possible.

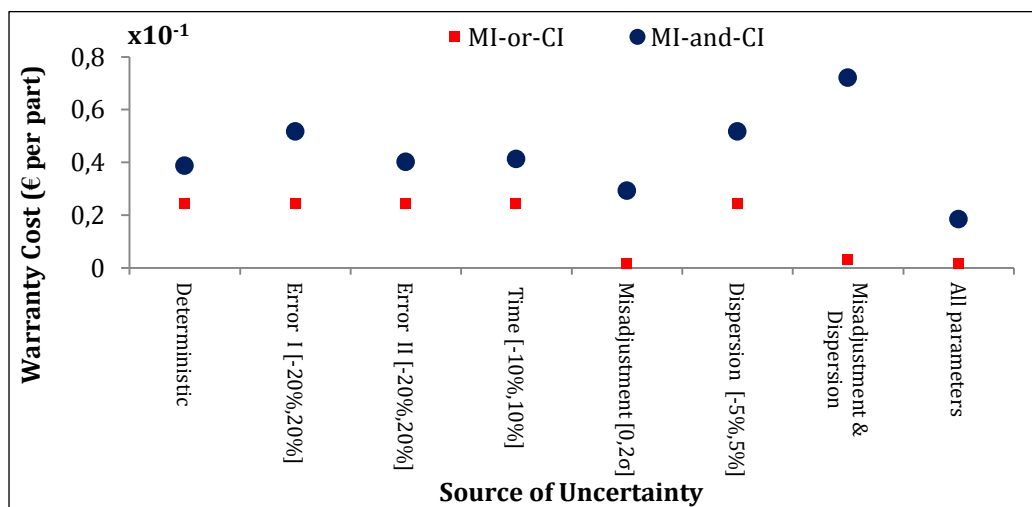

Figure 4.5. Warranty cost vs. different source of uncertainty

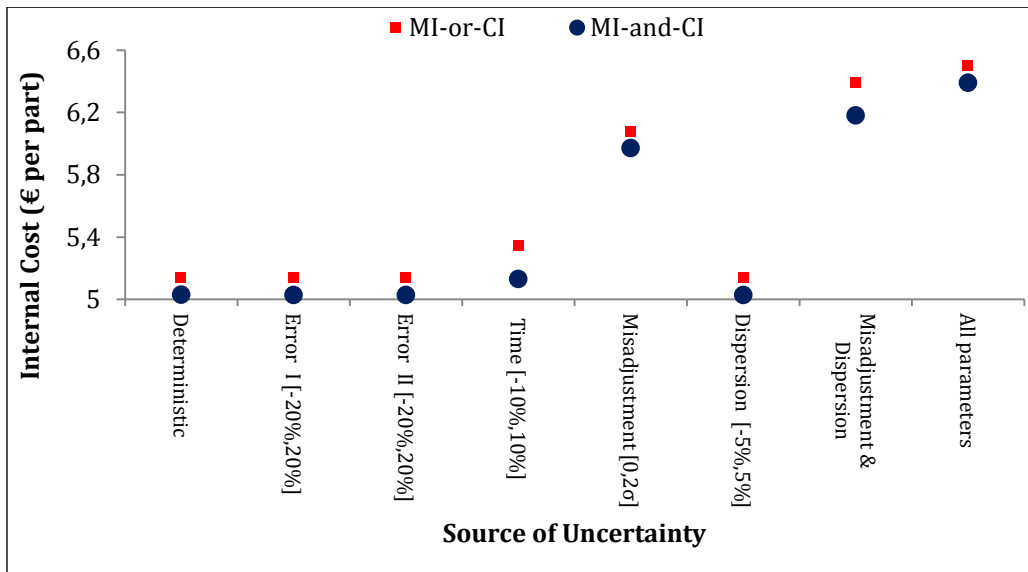

Figure 4.6. Internal cost vs. different source of uncertainty

In another analysis, the impact of each source of uncertainty (in %) has been illustrated in Figure 4.7, for both strategies. The maximum increase percentage belongs to a situation when all parameters are uncertain with increase around up to 24% for both strategies. In addition errors type I and II and dispersion, separately, have no impact on the total cost in their current values of uncertainty factor in MI-or-CI strategy. It can be also seen that impact of uncertain factors on the total cost for the MI-and-CI strategy is more than the MI-or-CI strategy in almost all cases. Besides, Figure 4.8 illustrates the same results as Figure 4.7 but shows the monetary values of uncertainty. For instance, when all parameters are uncertain and we try to design a robust inspection plan, we need to spend extra 1.340€ and 1.341€ costs for the final price of each product at MI-or-CI and MI-and-CI strategies, respectively.

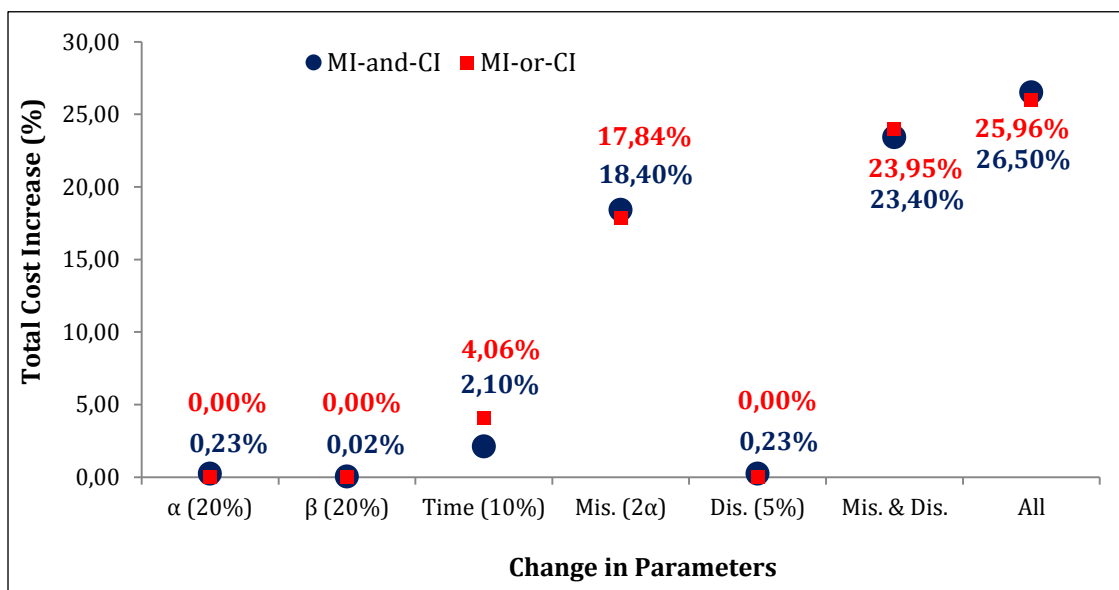

Figure 4.7. Total cost increase vs. different source of uncertainty

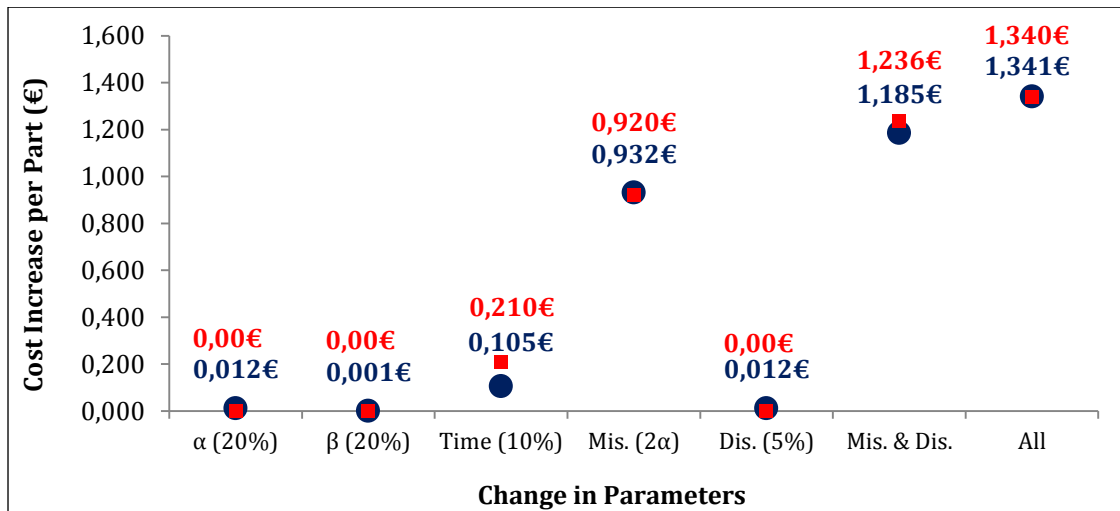

Figure 4.8. Price increase per part vs. different source of uncertainty

Additionally, the sensitivity of robustness cost versus alteration in uncertain parameters are investigated for the MI-or-CI strategy as shown in Figure 4.9 to 4.12. It should be noted that in Figures 4.9 to 4.12, the lower bound of the uncertainty intervals for all parameters are considered equal to their current real value and only the upper bound is changed.

Figure 4.9 illustrates the effect of alteration in errors type I and type II in the cost of robustness. The vertical axis shows the price of robustness per part. The vertical axis determines the increase in the errors type I and II. For instance, the value 7 in the vertical axis means that the errors become 7 times greater than their mean values. As it can be seen, type I error has no effect on the robustness cost once  $\rho_{e-I} \geq 5$ , e.g., for  $\rho_{e-I} = 9$ , the robustness cost is equal to 0.25€ per part. Despite of error type I, error type II has no effect even for  $\rho_{e-II} \cong 15$ . Therefore, it can be resulted that the manufacturer should pay more attention to error type I rather than error type II. Since  $\rho_{e-I}$  is equal to 0.2 in the industrial case, it can be increased even to 5 with no increase in the total cost. On the other words, by increasing error type I, the inspection plan remains robust. On the other hand, the inspection plan remains robust when error type II becomes even 15 times greater.

Figure 4.10 depicts the alteration in robustness cost versus increase in the production time's uncertainty factor. The vertical axis shows the percent increase in the production time. It is noteworthy that by increasing the uncertainty factor of time ( $\rho_{TP}$ ) from 0 to 0.4, the *which-what* decision does not change and all quality characteristics need MI; while for values bigger than 0.4, the *which-what* decision is changed and some quality characteristics need CI. It can be stated that for values higher than 0.4, the costs of production and inspection are highly increased and the model decides to decrease the amount of parts through the process. Consequently, the costs of production and inspection are decreased and the only way to decrease the amount of parts is to perform CI through the process. Therefore, for values higher than 0.4, the model decides to station CI for some of quality characteristics. Figure 4.11 shows the effect of alteration in misadjustment on the robustness cost, so that

## Chapter IV: Experimental Results

by increasing the misadjustment, the cost of creating a robust plan is extremely increased. It is noteworthy that the value of misadjustment can be increased up to  $0.25\sigma$  with no increase in robustness cost. Finally, Figure 4.12 illustrates the impact of increase in dispersion on the cost of robustness. As it is obvious, for values of  $\rho_\sigma$  lower than 0.1, the robust plan is not changed. Since decreasing dispersion in manufacturing processes is too expensive, hence, in the real industrial case, a manufacturer can let dispersion to be increased to 0.1.

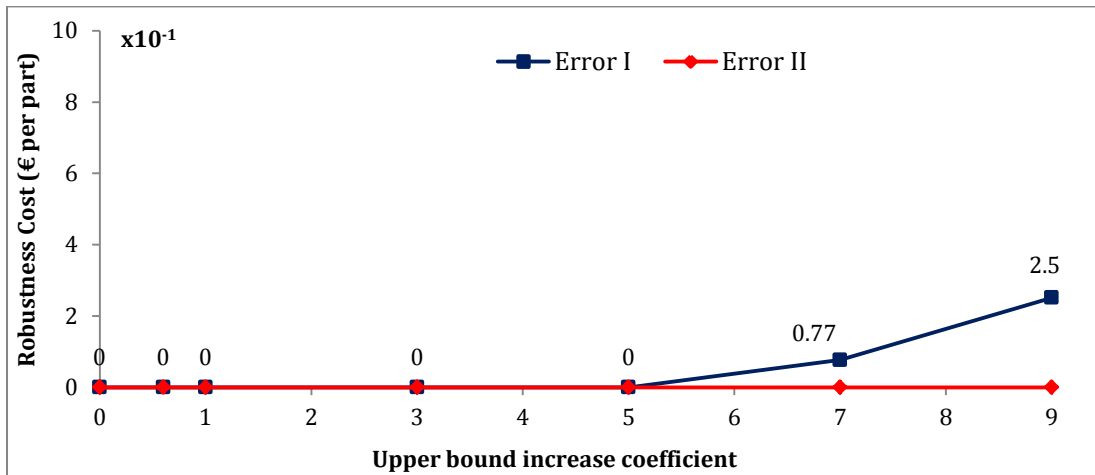

Figure 4.9. Cost of robustness vs. increase in  $\rho_{e-I}$  and  $\rho_{e-II}$

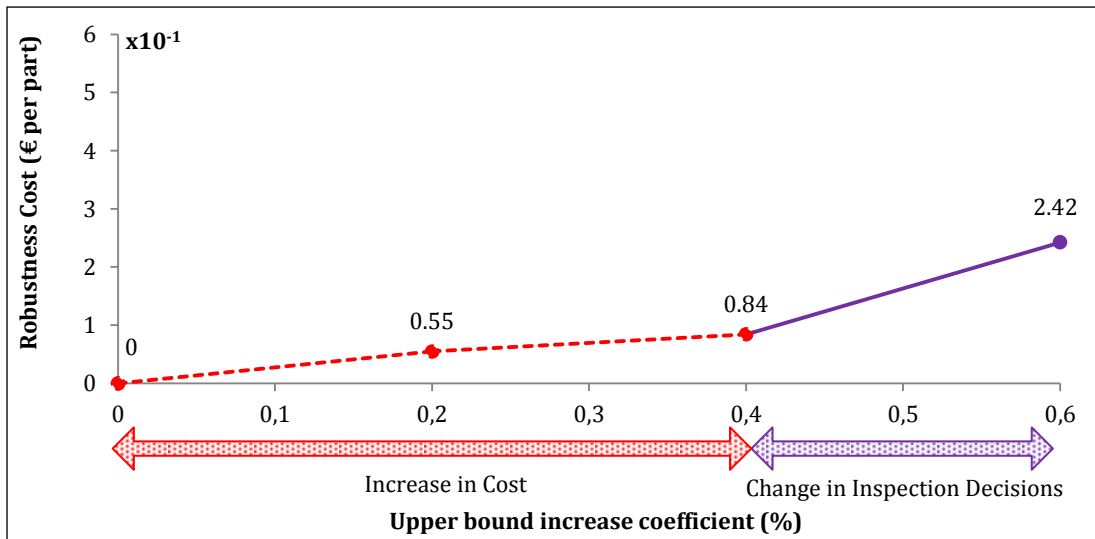

Figure 4.10. Cost of robustness vs. increase in the production time

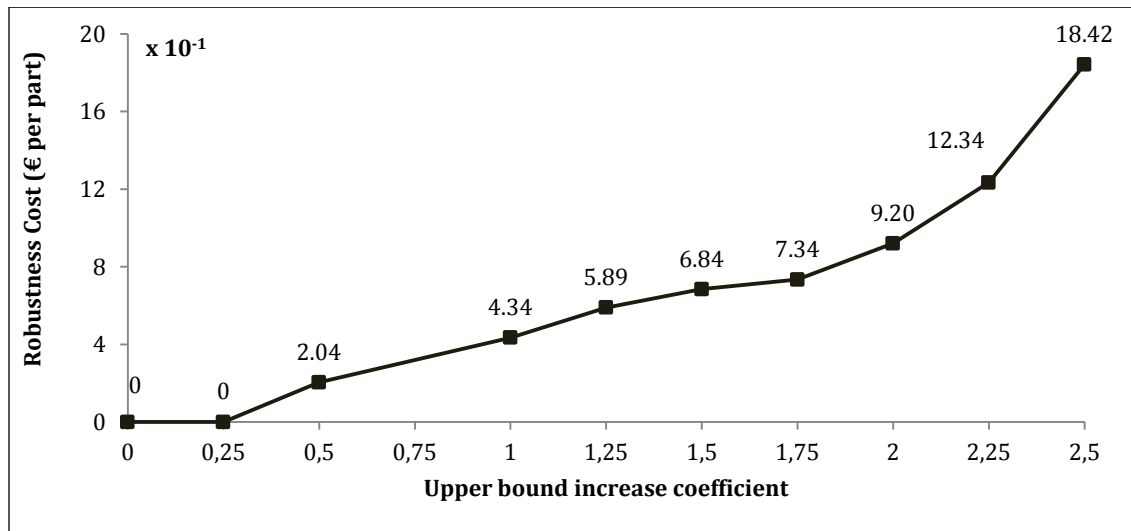

Figure 4.11. Cost of robustness vs. increase in the misadjustment

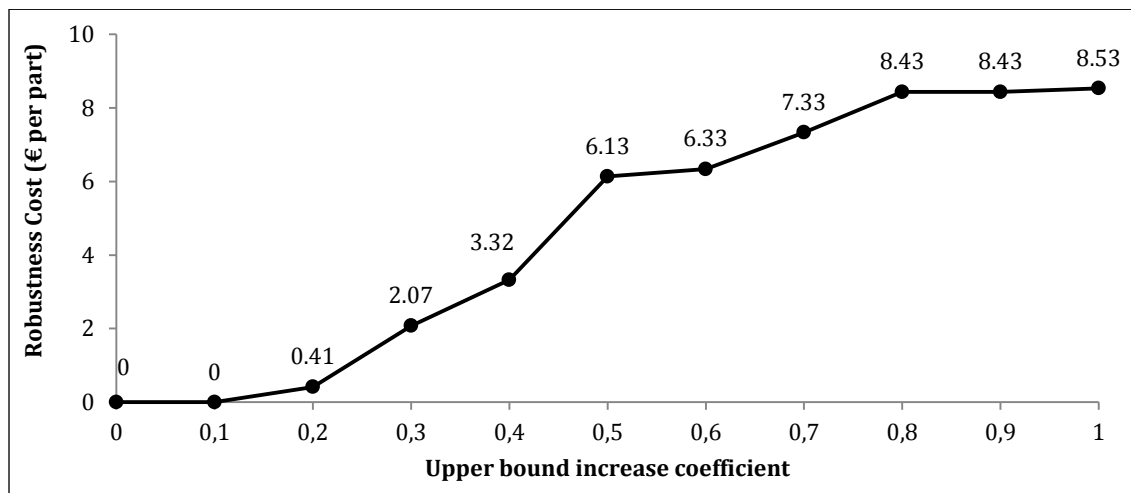

Figure 4.12. Cost of robustness vs. increase in the dispersion

### 4.3. Computational results: *Extended Problem*

This section provides the results of implementing the mathematical models of the *Extended Problem* (see Sections 3.3.1 and 3.3.2) on the real industrial case and solving them by the proposed multi-objective differential algorithm (MODE) in Section A3.5. The results of the proposed BMILP\_EP and TMINLP\_EP models are provided in the following Sections 4.3.1 and 4.3.2, respectively.

#### 4.3.1. BMILP\_EP model

This section provides the results of the proposed BMILP\_EP model. First, the Pareto frontier of the BMILP\_EP model is extracted only for MI-and-CI strategy. The real industrial case was solved using the proposed MODE algorithm and the objective function values for the Pareto solutions have been listed in Table 4.4 for both deterministic and uncertain models. In the uncertain model, it is considered that all parameters are uncertain. In Table 4.4, first column shows the number of Pareto solution. Second and third columns represent the values of the first and second

## Chapter IV: Experimental Results

objective functions for deterministic model. Similarly, fourth and fifth columns show the values of the first and second objective functions for uncertain model. Accordingly, twenty one and six Pareto solutions were obtained for deterministic and uncertain parameters, respectively.

**Table 4.4.** Pareto solutions of BMILP\_EP model

Pareto solution	Deterministic model		Uncertain model (Robust)	
	$OFV_1$	$OFV_2$	$OFV_1$	$OFV_2$
1	6077043	20900	6288260	44440
2	6076760	30800	5342750	322410
3	6076160	32340	5219250	1649230
4	6075560	55220	5130050	2328370
5	5970993	142670	5029200	5473050
6	5240900	165440	5014600	6467010
7	5240300	166980	-	-
8	5185450	170060	-	-
9	5164850	171600	-	-
10	5154250	179300	-	-
11	5143650	190740	-	-
12	5143050	213620	-	-
13	5138450	302500	-	-
14	5097000	412830	-	-
15	5066400	546150	-	-
16	5055800	877470	-	-
17	5054200	1357290	-	-
18	5039600	2351250	-	-
19	4964950	3630610	-	-
20	4929750	5561930	-	-
21	4910150	6555890	-	-

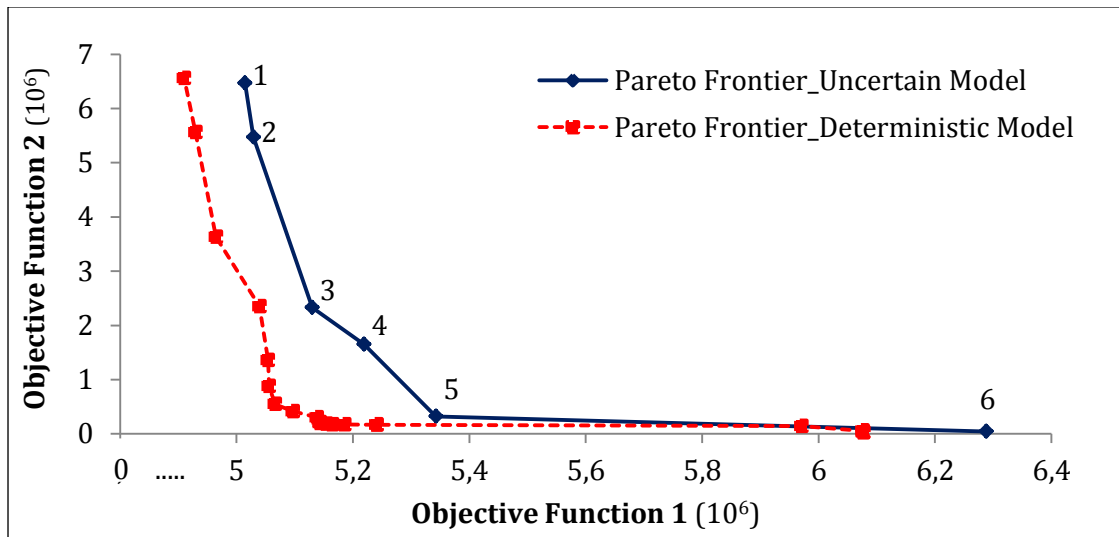

**Figure 4.13.** Pareto frontiers for deterministic and uncertain models

The results of [Table 4.4](#) have been illustrated in [Figure 4.13](#) wherein dash and solid lines represent the Pareto frontier of deterministic and uncertain models, respectively.



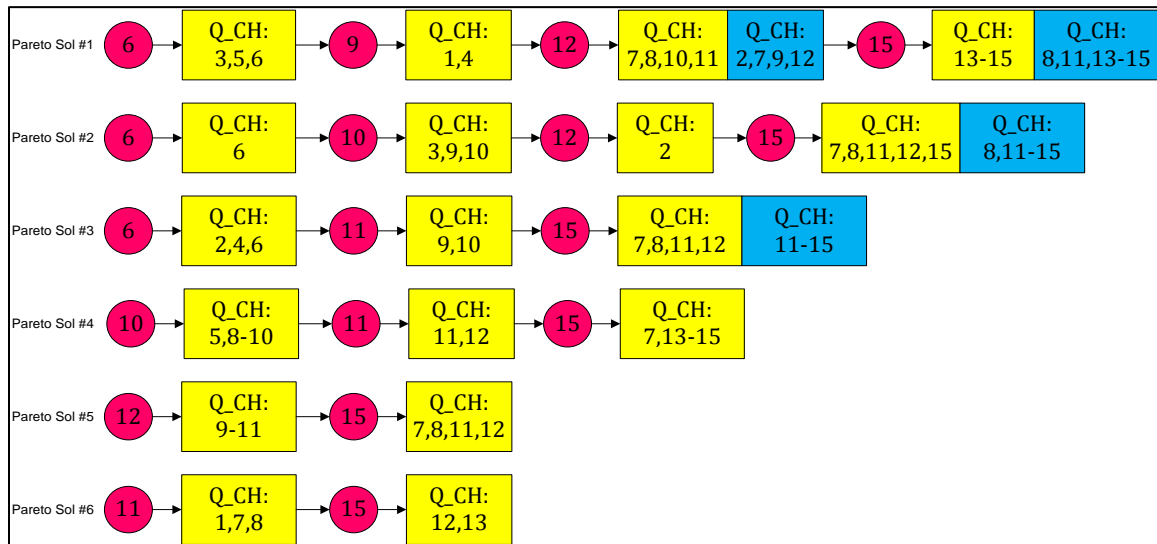

Figure 4.14. Inspection plans of the Pareto solutions for the robust BMILP\_EP

The inspection plans for different six Pareto solutions of the uncertain model have been depicted in Figure 4.14. As it can be seen, solutions with lower value of the total internal cost, e.g., solutions number 1 and 2, include inspection plans with less number of MI and CI inspections. This is because of that the total internal cost is decreased by decreasing the cost of inspections, while lower inspection cost deals with less numbers of inspections. On the other hand, solutions with lower values of the warranty cost relate to those inspection plans wherein the minimum nonconforming items reach the customers. Accordingly, more numbers of inspections are performed in these plans. These different plans show the conflict of the total internal and warranty costs and highlight the applicability and validity of the proposed BMILP\_EP.

The contribution of each uncertain parameter in the increase of objective functions has been depicted as Figure 4.15. As it can be seen, misadjustment and dispersion have the highest effect on the both objective functions. In addition, misadjustment has higher effect on objective function 1 rather than objective function 2 and vice versa for dispersion. Therefore, companies who eager to minimize manufacturing cost should determine exact value for misadjustment and try to omit variation in it as much as possible. On the other hand, companies who attempt to keep their customers satisfied should control both misadjustment and dispersion and determine exact value for them in their plans.

Respecting the validation of our results, Adragna et al. (2010) and Thornton (2004) have also proved the significant impact of misadjustment and dispersion in calculating inertial tolerancing and process capability index.

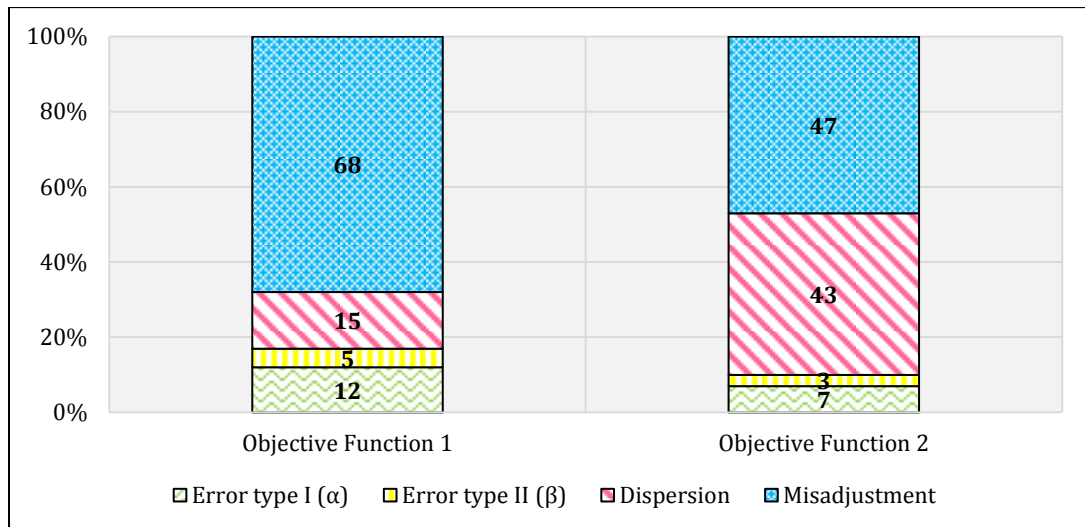

Figure 4.15. Effect of uncertain parameters on the objective functions

#### 4.3.2. TMINLP\_EP model

This section provides the results of the proposed TMINLP\_EP model. In order to apply the proposed TMINLP\_EP model on the real industrial case, there are other parameters besides to those in the BMILP\_EP model that need to be provided. Due to limited access to the industrial party, the new parameters are randomly generated based on expert's idea and near to real settings. In this section, the same multistage production system as the real industrial case (see Section 4.1.1) is studied with four products (i.e., P1 to P4), three choices for machines at each stage, and three choices for inspection tools for inspecting each quality characteristic. There are 10, 12, 8, and 15 quality characteristics to be inspected for P1 to P4, respectively. The characteristics utilize the same machine and inspection tools. In generating the data, following logical rules are respected:

- Machines with higher cost have higher process capability and consequently have lower failure rate.
- Machines with higher fixed cost have lower unit production time as well as lower unit production cost.
- Machines with higher cost have lower breakdown rate, lower retrieve time, and higher production rate.
- Machines with higher cost have higher fixed and variable monitoring inspection (i.e., MI) cost.
- Machines with higher cost have higher production capacities.
- Inspection tools with higher cost have higher failure detection and consequently have lower values of error type I and II for CI.
- Inspection tools with higher fixed cost have lower unit inspection time as well as lower unit inspection cost for both MI and CI.
- Inspection tools with higher cost have lower breakdown rate, lower retrieve time, and higher inspection rate for both MI and CI.

## Chapter IV: Experimental Results

- Inspection tools with higher cost have higher inspection capacities for both MI and CI.

After generating new data for the real industrial case, the proposed TMINLP\_EP model is solved using the proposed MODE algorithm. It should be noted that all parameters are considered under uncertainty and the same robust approach as BMILP\_EP model is utilized. After solving the model, fifteen and ten Pareto solutions have been obtained for deterministic and uncertain models, respectively, as Table 4.5. The first column shows the number of Pareto solutions. The second and third columns show the first, second and third objective function values for the deterministic problem. Besides, fourth and fifth columns represent the first, second and third objective function values for the uncertain problem.

Table 4.5. Pareto solutions of TMINLP\_EP model

Pareto solution	Deterministic model			Uncertain model (Robust)		
	$OFV_1(10^6\text{€})$	$OFV_2(10^5\text{€})$	$OFV_3(s)$	$OFV_1(10^6\text{€})$	$OFV_2(10^5\text{€})$	$OFV_3(s)$
1	44.245	1.256	6364	48.581	1.445	7009
2	43.015	1.686	6024	47.239	2.343	6537
3	41.842	2.128	6226	46.235	4.932	6639
4	40.486	4.326	5912	45.208	7.457	6045
5	39.278	6.325	5521	43.402	13.601	4235
6	38.602	9.586	5837	42.647	16.773	5420
7	38.206	12.264	5348	38.388	25.876	5140
8	37.708	16.333	4853	37.388	32.776	4242
9	37.198	20.268	4631	36.677	42.866	4409
10	36.548	21.671	4428	35.138	58.452	3681
11	35.319	23.985	4712	-	-	-
12	34.914	27.334	4381	-	-	-
13	34.342	33.419	3831	-	-	-
14	33.849	40.843	3003	-	-	-
15	33.658	50.128	3305	-	-	-

It is obvious that the objective function values are increased by proposing the robust solutions. The mean increases are 8%, 12%, and 8% for the first, second, and third objective functions, respectively. These values show that the second objective function is more sensitive to the uncertainty of the parameters.

The inspection plan for the Pareto solution number 5 of the uncertain model has been depicted in Figure 4.16. For example in product number 4 (i.e., P4), quality characteristic number 6 needs MI after operation number 6. In addition, quality characteristics number 7, 8, 11 and 15 need MI after operation number 15. Besides, quality characteristics number 7, 8, and 11 to 15 need CI after operation number 15.

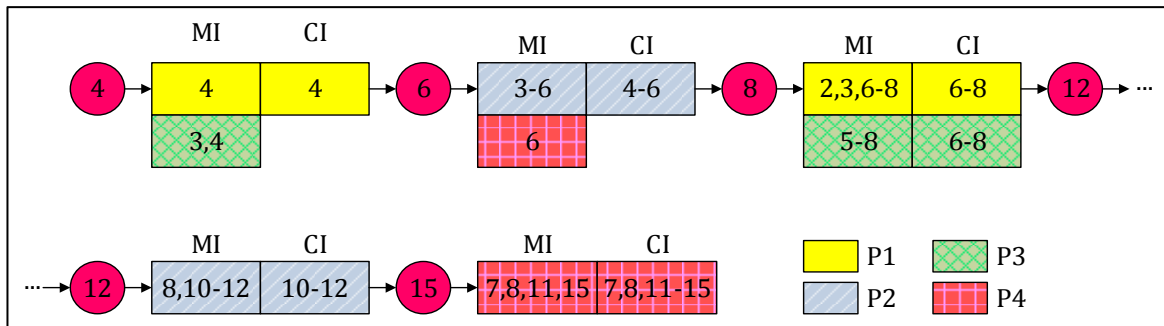

Figure 4.16. Inspection plan for Pareto solution number 5

The information regarding to the machines and inspection tools selection has been presented in Table 4.6. It can be seen that all three types of machines and inspection tools have been utilized through manufacturing these four products. For instance, the operation number 1 is performed by the machine number 2 for P1, P2, and P2, and the same operation is performed by machine number 3 in P4. In addition, the MI for quality characteristic number 8 is performed by inspection tools number 1, 1, 3, and 3, for P1, P2, P3, and P4, respectively. Furthermore, the CI for quality characteristic number 8 is performed by inspection tools number 3, 1, and 1, for P1, P3, and P4, respectively. It is noteworthy that the inspections of those quality characteristics that their corresponding operations are performed on the machines with lower capability are performed by inspection tools with higher capability as well as lower errors type I and II. For instance, the CI of the quality characteristic number 8 in P1 is performed by inspection tool number 3 that has higher capability. This issue is due to that the corresponding operation which realizes the quality characteristic number 8 in P1, is performed on machine number 1 that has lower capability regarding to the machines with higher numbering index.

Table 4.6. Machines and inspection tools selection

Product	Selection	Quality Characteristics & Operations														
		1	2	3	4	5	6	7	8	9	10	11	12	13	14	15
P1	Machines	2	1	1	1	2	1	1	1	2	1	2	1	2	2	2
P2		2	3	1	1	1	1	2	2	2	1	1	1	2	2	2
P3		2	3	1	1	1	1	1	1	2	1	2	1	2	2	2
P4		3	3	2	3	2	1	1	1	2	1	1	1	1	1	1
P1	Inspection Tools (MI)		1	1	2		2	2	1							
P2				1	1	2	1		1		1	1	1			
P3				2	2	1	1	3	3							
P4							2	3	3			2				1
P1	Inspection Tools (CI)				3		3	3	3							
P2					2	2	2				3	3	3			
P3							1	1	1							
P4								1	1			3	3	2	2	2

In the production system, the usage percentages of machines number 1, 2, and 3 are 53%, 38% and 5%, respectively. On the another hand, the usage percentages of the monitoring inspection tools number 1, 2, and 3 are 52%, 32% and 16%,

respectively. These percentages are 25%, 30% and 45% for the conformity inspection tools number 1, 2, and 3, respectively.

Among P1 to P4, the maximum manufacturing time (i.e.,  $OFV_3^{R-EP}$ ) is equal to 5132 seconds and this value belongs to P4 with 15 quality characteristics. From this value, 3747 seconds (73%) is spent for production and the rest 1385 seconds (27%) is spent for the waiting time of the items to be processed or be inspected.

**4.3.3. Sensitivity analysis**

This section investigates the sensitivity of the objective functions in the TMINLP\_EP model regarding to the input parameters such as misadjustment, dispersion, capacity of machines and inspection tools, production time, production and inspection rates as well as breakdown rate and retrieve time. In all of the following analyses, the sensitivity of the objective functions has been calculated based on the based deterministic scenario.

Figure 4.17 represents the sensitivity of the objective functions to the increase in misadjustment value. As it can be seen, although all the objective functions increase once the misadjustment increases, but the second objective function is more sensitive to the misadjustment variation. In addition, the third objective function is less sensitive to the misadjustment variation. Figure 4.17 highlights this issue that manufacturers, who are customer satisfaction oriented, need to control the variation of the misadjustment.

Figure 5.18 illustrates the sensitivity of the objective functions to the increase in dispersion of the production processes. Similar to the results of Figure 5.17, all the objective functions are increased once the dispersion is increased, wherein the highest and lowest sensitivities belong to the second and the third objective functions. These results also impose more attention to the uncertainty of the dispersion and the need to control this variation.

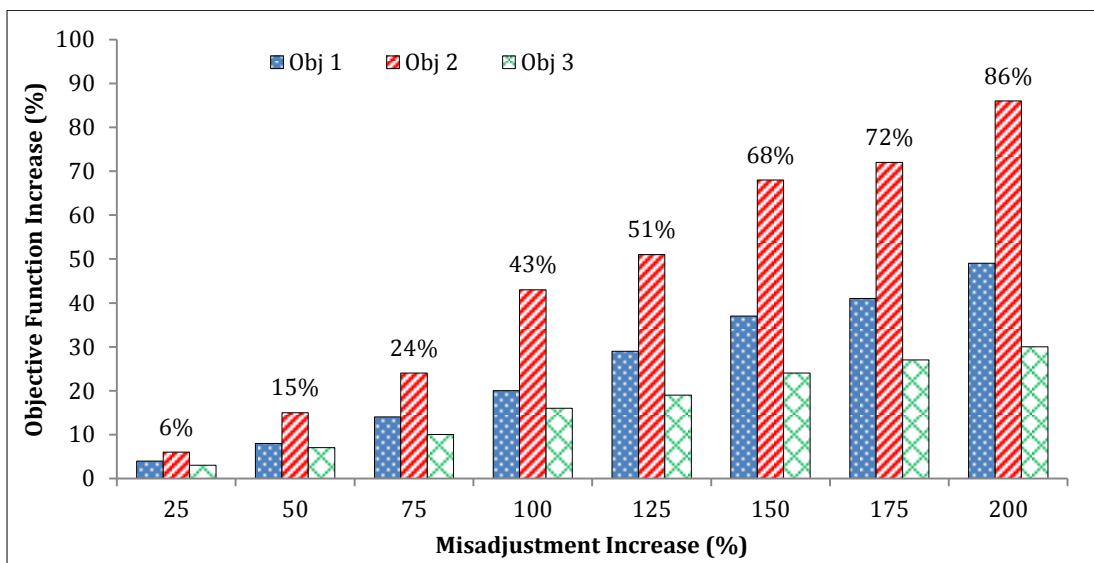

Figure 4.17. Objective function increase vs. increase in misadjustment

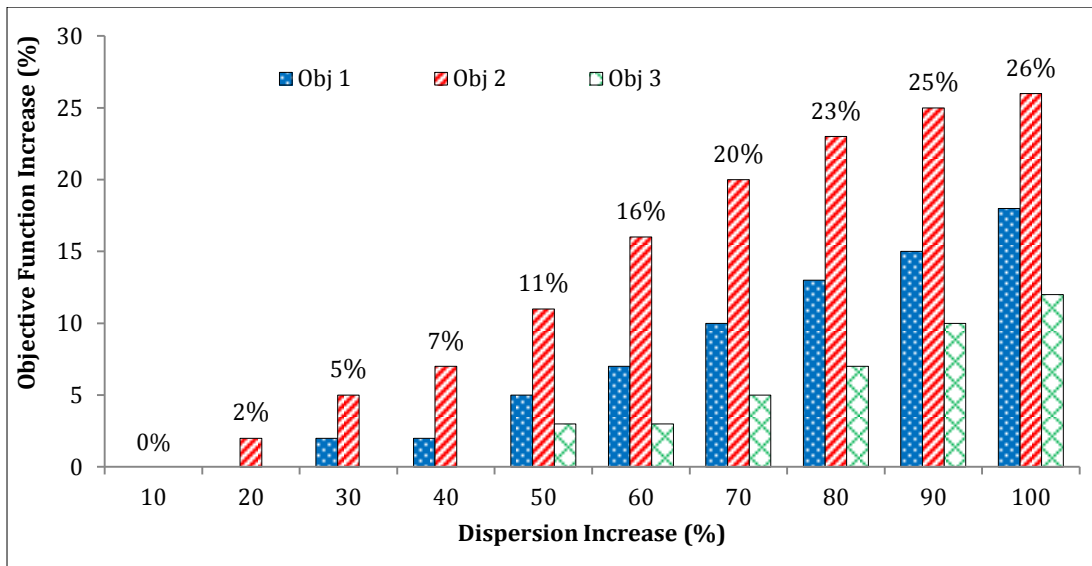

Figure 4.18. Objective function increase vs. increase in dispersion

Figure 4.19 investigates the effect of increasing the capacity of machines and inspection tools on the objective function values. As it was previously assumed in Section 4.3.2 (i.e., logical rules), machines and inspection tools with higher capacity have also have higher service rate as well as lower failure rate. Accordingly, increasing the capacity increases the first objective function, while decreases the second and the third objectives. It is obvious that the third objective function is more sensitive to capacity of machines and inspection tools. This sensitivity can be considered as the effect of the waiting time on the total manufacturing time. By the other words, increasing the capacity as well as increasing the service rate of machines and inspection tools will definitively lead to lower waiting time and lower total manufacturing time.

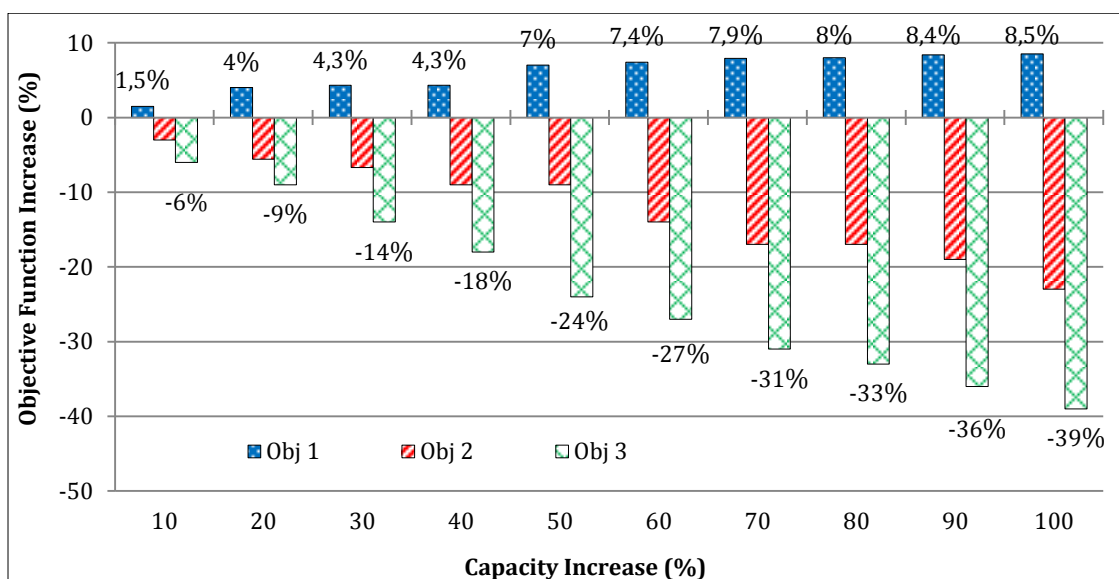
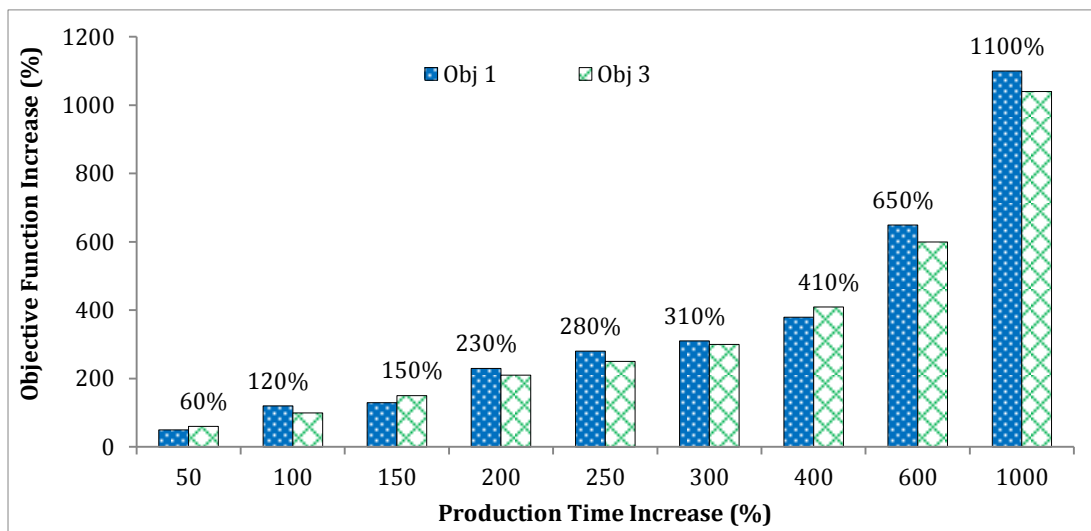

Figure 4.19. Objective function increase vs. increase in capacity

To demonstrate this declaration, another analysis was done by increasing the capacity without increasing the service rate and decreasing the failure rate and it was observed that only the first objective function is increased without any sensitivity on the second and the third objectives.

Following the sensitivity analyses, [Figure 4.20](#) depicts the sensitivity of the objective functions versus increase in the production time without any change in the service rates. It can be shown that increase in the production time only increases the value of the first and the third objective functions. In [Figure 4.20](#), a constant increase in the objectives is seen by increasing the production time, since the first and the third objectives are linear functions of the production time.



[Figure 4.20](#). Objective function increase vs. increase in production time

Regarding to the effect of service rate of the machines and the inspection tools, [Figures 4.21](#) and [4.22](#) illustrate the sensitivity of the objective function by increasing the value of the production rate and inspection rate, respectively. In these analyses, the purchase cost of the machines and the inspection tools are considered to be independent to the value of the service rates. After the experiment, it was obtained that the first and the third objectives are the only objectives that are sensitive to the variation of the service rates. Although the values of the both first and third objectives are decreased by increasing the value of the service rates, but the third objective is more sensitive to this variation.

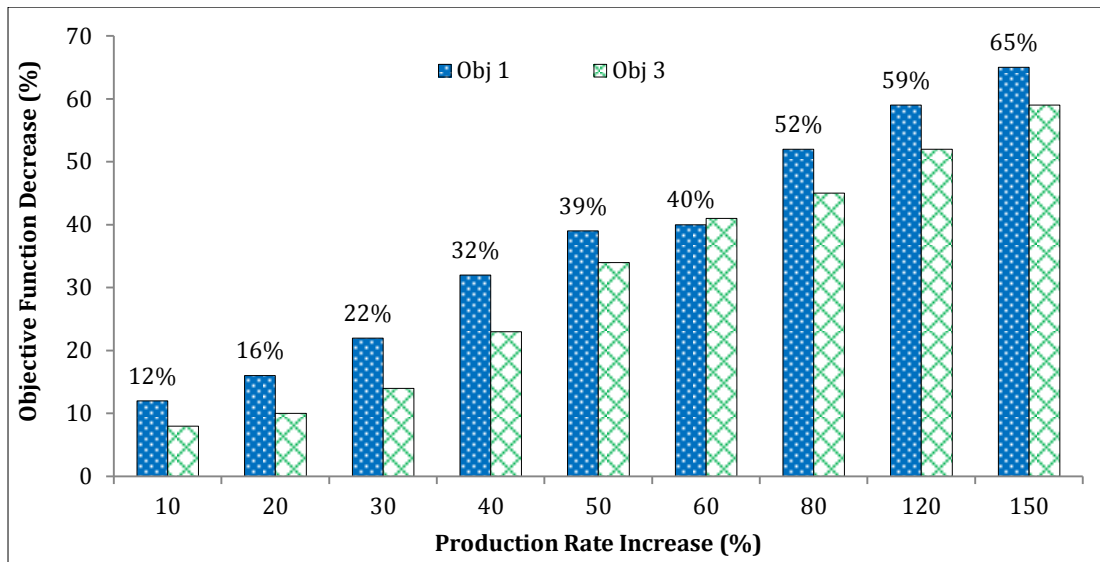

Figure 4.21. Objective function decrease vs. increase in production rate

As it can be seen in Figure 4.21, increase in production service rate leads to higher decrease in the first objective rather than the third objective. This decrease is due to the higher contribution of the production cost in the first objective function comparing to the contribution of the production time in the third objective. This result is inversed for the analysis based on the increase in the inspection rate. According to Figure 4.22, increase in the inspection rate leads to higher decrease in the third objective comparing to the first objective, while increase in the inspection rate not only decreases the total inspection time, but also decreases the total waiting time of the products. Therefore, the variation of the inspection rate mainly affects the third objective.

Figures 4.23 and 4.24 illustrate the effect of the breakdown rate and retrieve time on the third objective value. It has been shown in Figure 4.23 that once the breakdown rate is increased (retrieve rate is fixed), the total manufacturing time (i.e., third objective function) is also increased. It is noteworthy that increase in breakdown rate directly increases the waiting time of the products. Similar to Figure 4.23, Figure 4.24 shows the same trend for the total manufacturing time once the retrieve time is also increased.



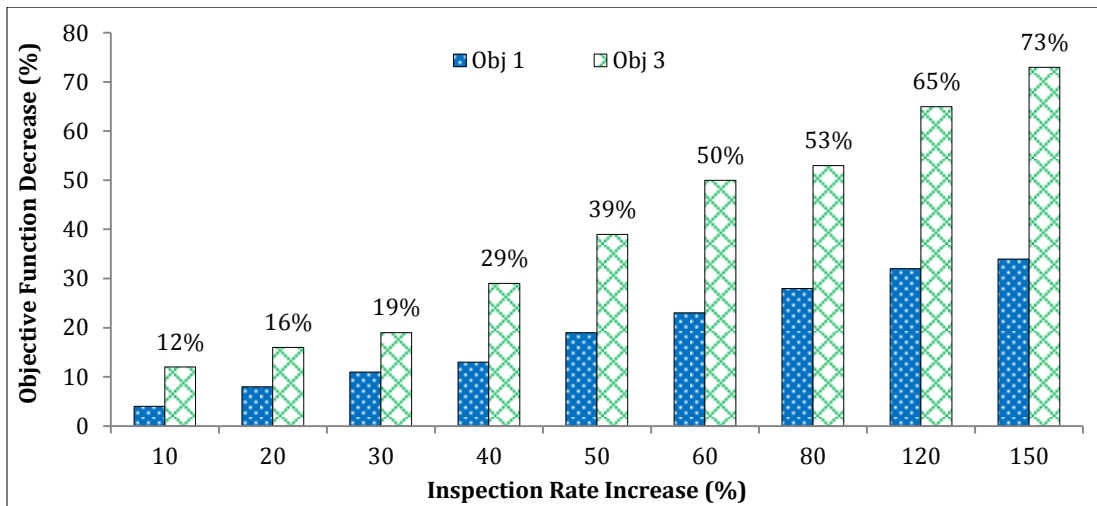

Figure 4.22. Objective function decrease vs. increase in inspection rate

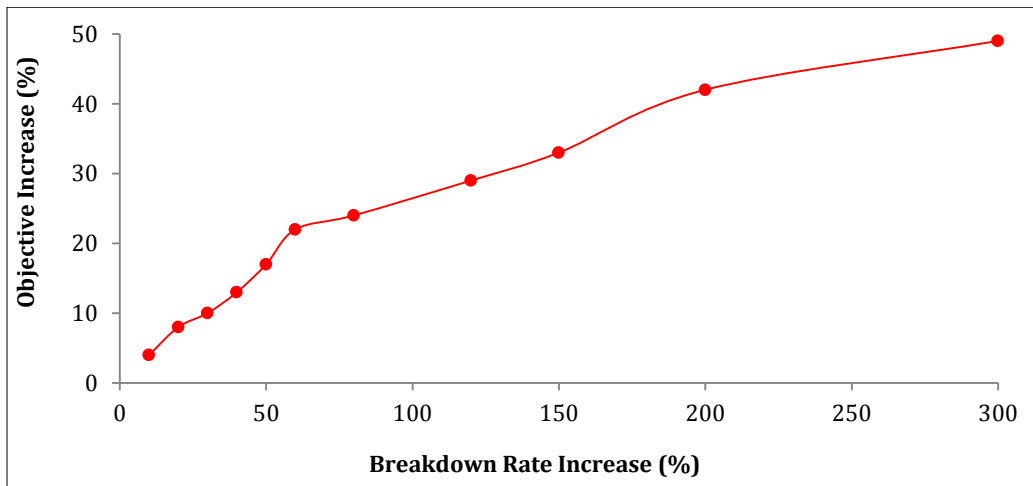

Figure 4.23. Third objective increase vs. increase in breakdown rate

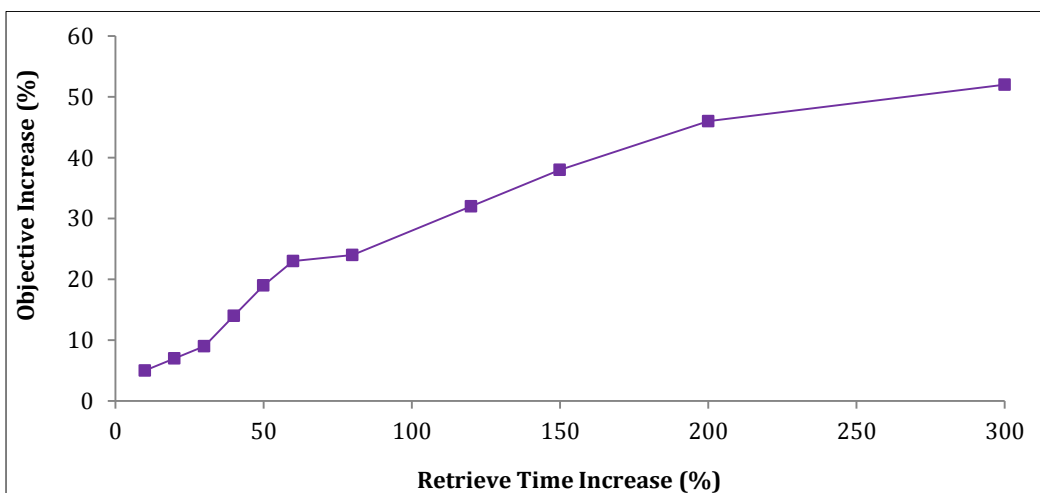

Figure 4.24. Third objective increase vs. increase in retrieve time

A sensitivity analysis is done for a situation that both breakdown rate and retrieve time are increased simultaneously. As it can be seen from Figure 4.25, when

## Chapter IV: Experimental Results

both breakdown rate and retrieve time are getting worse, the total manufacturing time is increased exponentially. Therefore, the manufacturer needs to control these parameters and decreases them as much as possible. Among both, the retrieve time is more likely to be decreased while the breakdown rate is somehow impossible to be predicted due to the influence of several external and internal environmental factors.

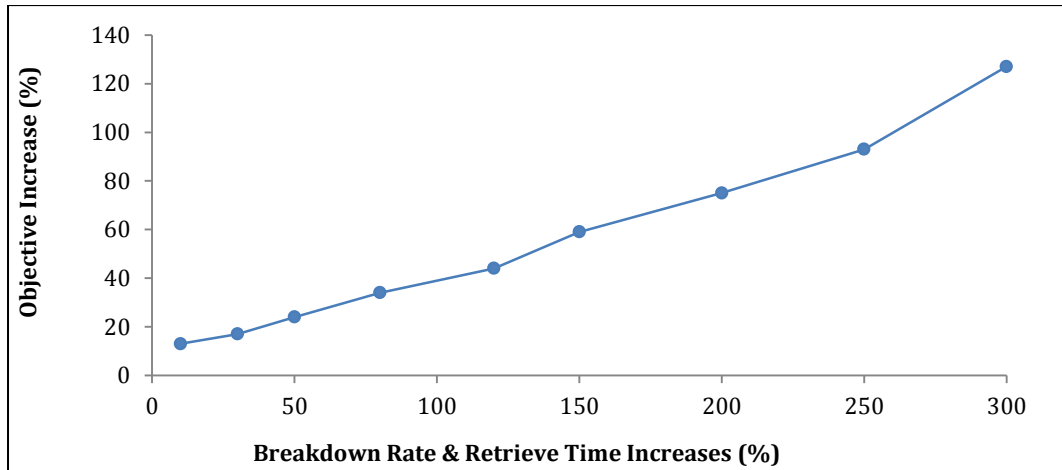

Figure 4.25. Third objective increase vs. simultaneous increase in breakdown rate and retrieve time

In Figures 4.17 to 4.25, the sensitivity of the objectives was investigated based on the uncertainty of the input parameters separately. Accordingly, Figure 4.26 provides a global sensitivity analysis when all the input parameters are uncertain and vary simultaneously and shows the contribution of each parameter in the increase of each objective function, while the sum of the contribution percentages is equal to 100%. In Figure 4.26, the terms *MA*, *Dis*, *EI*, *EII*, *Ca*, *PT*, *PR*, *IR*, *BR*, and *RT* stand for misadjustment, dispersion, error type I, error type II, capacity, production time, production rate, inspection rate, breakdown rate, and retrieve time, respectively.

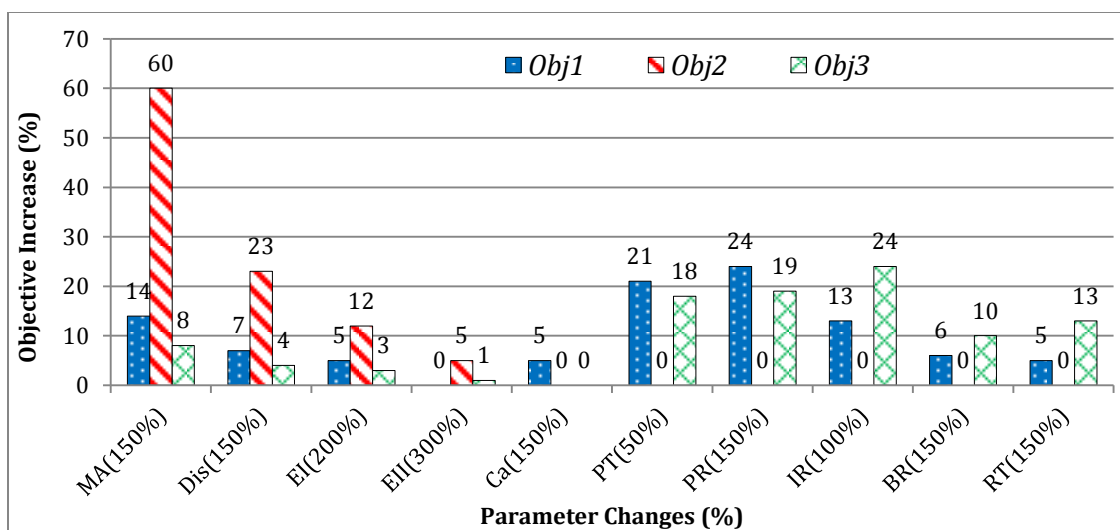

Figure 4.26. General sensitivity analysis

As it can be seen from [Figure 4.26](#), the first objective function is affected by the uncertainty in almost all parameters except error type II, wherein the most effective parameters are misadjustment, production time and production rate. Besides, the second objective function is affected by the uncertainty in only misadjustment, dispersion and errors type I and II, in which, the most effective parameters are misadjustment and dispersion. Similar to the first objective function, the third objective function is affected by the uncertainty in almost all parameters except capacity wherein the most effective parameters are inspection rate, production rate and retrieve time. Remarkably, the effective parameters need to be controlled in order to decrease the value of the objective functions due to the uncertainty.

**4.3.4. Computational time complexity**

In the rest of this section, the mathematical relation between Problem Size (i.e., number of products, number of manufacturing stages, number of quality characteristics, number of machines and inspection tools) and required CPU-time is found using a fitting (linear regression) algorithm by the SPSS software. So, you can see the rate of increase of CPU-time regarding to the increase of the size of the problem. The models summary and parameter estimates can be seen in [Table 4.7](#). It should be noted that among different fitting models (i.e., Linear, Logarithmic, Quadratic, Cubic, Compound, Growth, and Exponential), the Cubic model better fits for all the parameters. The estimated Cubic function with its parameters is as [Equation \(4.1\)](#). [Equation \(4.1\)](#) can be rewritten by replacing the value of coefficients  $\beta$  with those obtained coefficients of SPSS software as [Equations \(4.2\) to \(4.6\)](#).

**Table 4.7.** Cubic model summary and parameter estimates

Parameter*	Model summary					Parameter estimates			
	R square	F	df <sub>1</sub>	df <sub>2</sub>	Sig.	Constant	b <sub>1</sub>	b <sub>2</sub>	b <sub>3</sub>
<i>PN</i>	.992	156.88	3	4	.000	-.363	.126	.002	-1.8E-5
<i>SN</i>	.992	161.10	3	4	.000	.037	.250	-.002	6.9E-6
<i>QN</i>	.998	613.78	3	4	.000	1.074	.120	-1.5E-4	1.8E-7
<i>MN</i>	.999	1075.6	3	4	.000	-1.789	.595	-.015	1.3E-4
<i>IN</i>	.997	479.79	3	4	.000	.009	.375	-.004	1.6E-5

\**PN*: Product No., *SN*: Stage No., *QN*: Quality Characteristic No., *MN*: Machine No., *IN*: Inspection Tool No.

$$y_i = \beta_0 + \beta_1 x_i^1 + \beta_2 x_i^2 + \beta_3 x_i^3 \tag{4.1}$$

$$CPU\_Time_{PN} = -.363 + .126(PN)^1 + .002(PN)^2 - .000018(PN)^3 \tag{4.2}$$

$$CPU\_Time_{SN} = -.037 + .250(SN)^1 - .002(SN)^2 + .0000069(SN)^3 \tag{4.3}$$

$$CPU\_Time_{QN} = 1.074 + .120(QN)^1 - .00015(QN)^2 + .00000018(QN)^3 \tag{4.4}$$

$$CPU\_Time_{MN} = -1.789 + .595(MN)^1 - .015(MN)^2 - .00013(MN)^3 \tag{4.5}$$

$$CPU\_Time_{IN} = -.009 + .375(IN)^1 - .004(IN)^2 - .000016(IN)^3 \tag{4.6}$$

4.3.5. Model uncertainty

All of the previous analyses were to investigate the effect of uncertainty in the parameters on the objective function. However, another important analysis is going to be done to investigate the effect of uncertainty in the parameters on the solutions. This kind of uncertainty is called as *model uncertainty*. It is noteworthy that uncertainty in some parameters only affects the value of the objective function(s) and do not impact the structure of the solution. In almost all industries, manufacturers try to discover those parameters that affect the production plans as well as the structures of the production systems.

Accordingly, the effect of the input parameters (i.e., misadjustment, dispersion, errors type I and II, capacity of machines and inspection tools, production time, production and inspection rates as well as breakdown rate and retrieve time).

Figure 4.27 shows both the model uncertainty and objective sensitivity regarding to the uncertainty of the input parameters. The model uncertainty is calculated by the number of modifications that occur in the solutions representations (see Chapter 3) once the input parameters are changed through a given variation interval.

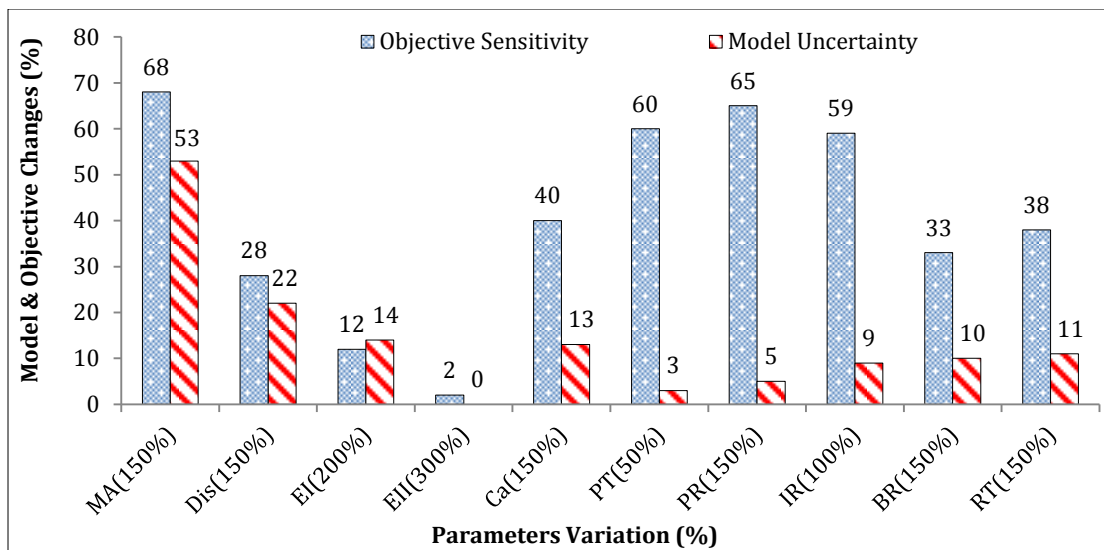

Figure 4.27. Model uncertainty & objective sensitivity vs. parameters uncertainty

In Figure 4.27, those parameters that significantly affect the objective function value are misadjustment, production time and rate, inspection rate, capacity and dispersion. But among these parameters, the only parameters that affect the structure of the solutions as well as inspection plans are misadjustment, dispersion, error type I, capacity, breakdown rate, and retrieve time. For example, by increasing the production time or production rate up to 50% and 150%, the objective function value is only increased with no changes in the solution structure or final inspection plan. This analysis discovers that objective function sensitivity analysis may lead to incorrect results regarding to the important parameters, while model uncertainty analysis provides more reliable results.

At the end of this section, another important analysis is done in order to validate different cost terms in the first objective function. As explained in Section 3.3.2.3, the first objective function includes different parts as  $TCP$ ,  $TCS$ ,  $TCIF$ ,  $TCIV$  and  $TCM$  and different cost term in each part. This analysis is to investigate the necessity of each cost term and to explore the possibility of omitting a term from the objective function. Accordingly, the proposed TMINLP\_EP is solved and at each run, one cost term of the objective function is omitted and the problem is solved again. During this procedure, the model uncertainty and the number of modifications in the solution's structure are the metrics to show the effectiveness of each cost term. Figure 4.28 illustrates the effectiveness percentage of each cost term in the proposed TMINLP\_EP model wherein the higher percentage relates to the higher effectiveness of the corresponding cost term. First, different cost terms are identified as Table 4.8.

Table 4.8. Cost terms identification

ID	Cost Term	Explanation
PC	$\sum_{p=1}^P \sum_{o=1}^O \sum_{m=1}^M p c_{op}^m p t_{op}^m N_o^p U_{op}^m$	Variable production cost
FA	$\sum_{p=1}^P \sum_{o=1}^O \sum_{m=1}^M f a_{op}^m U_{op}^m$	Fixed production cost
SC	$\sum_{p=1}^P \sum_{o=1}^O s c_o^p S_o^p$	Scrap cost
FC	$\sum_{p=1}^P \sum_{o=1}^O \sum_{m=1}^M \sum_{i=1}^I \sum_{k=1}^K f c_{ok}^{pmi} N C_{ok}^{pi}$	Fixed conformity cost
FM	$\sum_{p=1}^P \sum_{o=1}^O \sum_{m=1}^M \sum_{i=1}^I \sum_{k=1}^K f m_{ok}^{pmi} N M_{ok}^{pi}$	Fixed monitoring cost
FS	$\sum_{p=1}^P \sum_{o=1}^O f s_o^p \mathbb{I}_o^p$	Fixed inspection cost
CP	$\sum_{i=1}^I c p_i Z_i$	Fixed inspection tool utilizing cost
CF	$\sum_{p=1}^P \sum_{o=1}^O \sum_{o'=1}^O \sum_{m=1}^M \sum_{i=1}^I \sum_{k=1}^K c f_k^p c t_{ok}^{pi} v c_{ok}^{pmi} A_{o'o}^{kpi} U_{op}^m$	Variable conformity cost
MF	$\sum_{p=1}^P \sum_{o=1}^O \sum_{o'=1}^O \sum_{m=1}^M \sum_{i=1}^I \sum_{k=1}^K m f_k^p m t_{ok}^{pi} v m_{ok}^{pmi} \mathbb{B}_{o'o}^{kpi} U_{op}^m$	Variable monitoring cost
FP	$\sum_{m=1}^M f p_m Z_m$	Fixed machine utilizing cost

As it can be seen from Figure 5.28, all the cost terms in the objective function of the proposed TMINLP\_EP model are effective. Therefore, the cost objective function is justified and the necessity of its corresponding terms is clarified. The highest effectiveness percentages belong to the variable production cost, scrap cost, variable conformity cost, and variable monitoring cost.

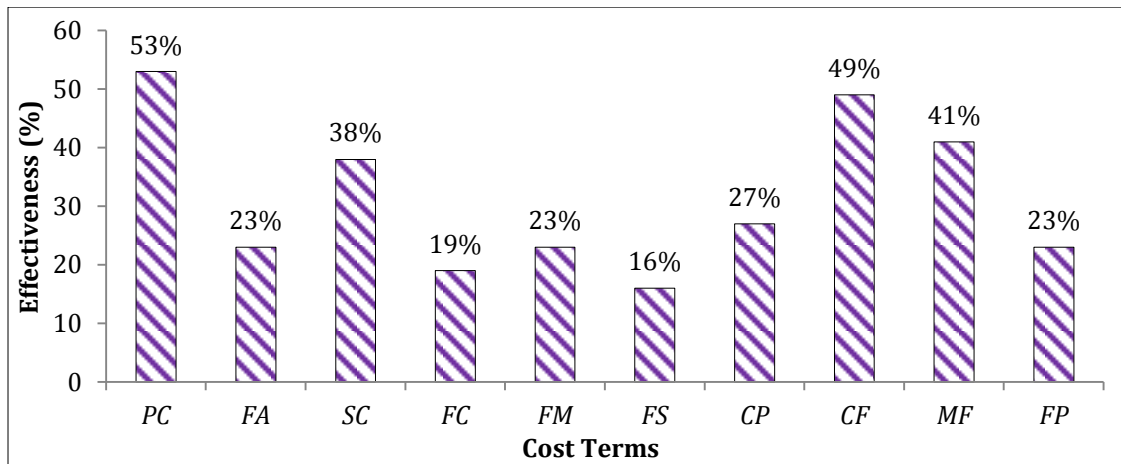

Figure 4.28. Cost terms effectiveness in the model

#### 4.4. Summary

In this chapter, the inspection planning models (i.e., *Main* and *Extended Problems*) proposed in Chapter 3 were solved by two tailored metaheuristic algorithms developed in Appendix 3. In order to validate the correctness of the proposed models and solution approaches, a real industrial case vase solved to obtain near optimal solutions.

To solve the Main Problem, the industrial case represents a multistage serial manufacturing system including 15 different quality characteristics and one manufacturing stage for each quality characteristic wherein inspection and production related parameters are uncertain. For solving the problem, two inspection strategies as MI-or-CI and MI-and-CI were considered. Under each inspection strategy and each source of uncertainty, the model was solved by the proposed genetic algorithm and near optimal solutions was obtained. It was resulted that these strategies are different in terms of effectiveness and responsiveness and lead to different manufacturing and warranty costs. Through a comprehensive experiment, the sensitivity of the objective function was also investigated regarding to the input parameters.

The second part of this chapter has been dedicated to solve the Extended Problem that involves the two proposed bi-objective and three-objective models. Each model was solved by the proposed multi-objective differential evolution algorithm and the experiments were conducted on the extended industrial case. For both models, Pareto solutions were obtained and comprehensive sensitivity analyses were done on the input parameters. Next, the complexity of the proposed models in terms of computational time was investigated and the relation between the size of problem and the required computational time was obtained. Finally, in order to investigate the effect of different parameters on the structure of the solutions (i.e., inspection plan) and to justify the importance of different cost terms in the cost objective function, several experiments were done and important parameters and cost terms were reported.

## **Chapter V**

# **Hub Location Problem**

### 5.0. Chapter purpose and outline

As mentioned in [Chapter 4](#), the studied inspection planning problem in this thesis is categorized into domain of supply chain management (SCM) and especially the problems related to the production party. Another party across the supply chain that significantly affects the performance of the whole supply chain is distribution party. The main problems in distribution centers are inventory and transportation related problem.

The domain of transportation problems have been selected to apply the proposed models and solution approaches. Among different transportation related problems, Hub Location Problem (HLP) has been selected to be studied.

The similarities between inspection planning problem and HLP have been elaborated in [Table 4.1](#). This chapter attempts to model a HLP based on these similarities. Accordingly, [Section 5.1](#) introduces the hub location problem with specific assumptions in [Table 4.1](#). [Section 5.2](#) reviews the related works in domain of HLPs considering uncertainty and disruption. [Section 5.3](#) describes the reliability and uncertainty in HLPs and tries to model these uncertainties. Bi-objective non-linear mathematical formulation is proposed in [Section 5.4](#) following by a linearization technique to linearize the model in [Section 5.5](#). [Sections 5.6](#) to [5.8](#) present novel solution approaches to solve the proposed model. Experiments and computational results are presented in [Sections 5.9](#) and [5.10](#), respectively. Furthermore, in order to validate the proposed model and solution approaches, a real case is studied based in [Section 5.11](#). Finally, [Section 5.12](#) provides conclusion and future research directions.

### 5.1. Introduction

Hub location problems (HLPs) have been part of network design planning in transportation, telecommunication, and computer systems, where hub-and-spoke topologies are applied to efficiently route shipments between many origins and destinations (O-D) nodes through intermediate nodes, called hubs. Hub nodes are consolidation, switching, or transshipment facilities to connect a large number of O-D pairs by using a small number of links. Fewer links not only simplify the network structure but also transfer large amounts of flow on inter-hub links, enabling time and cost discount factors and reducing setup and operational costs. Hub location models typically try to determine where to locate the hubs among a set of candidate sites and how to assign spokes to the hubs, so that the total cost can be minimized or the total profit can be maximized (e.g., [Alumur and Kara, 2008](#); [Campbell et al., 2012](#); [Zanjirani Farahani et al., 2013](#); [Mohammadi et al., 2014a](#); [Martins de Sá et al., 2015](#); [Mohammadi et al., 2010, 2011b](#)). Most models in the literature have treated the



components of the hub-and-spoke network as if they would never fail; in other words, they are completely reliable. We will relax this assumption in this chapter.

One of the most studied models in this area is the so-called capacitated hub location problem (CHLP). In the CHLP, we are given a set of O-D nodes (i.e., spokes) with mutual flows, a set of candidate sites, the cost of locating a hub at each site, the cost of routing the flow through the network, and capacity of each candidate site in processing flows (i.e., consolidation, switching and transferring). The objective is to locate a set of hub nodes from the candidate sites and allocate each spoke to a located hub to minimize the total hub location and routing costs while considering the capacity of hubs.

The CHLP and its generalizations are NP-hard problems and there are no polynomial-time algorithms to find an optimal solution. There is a large number of papers studying these NP-hard HLPs, and many solution approaches (e.g., mathematical programming, heuristic and meta-heuristics algorithms, approximation algorithms, etc.) have been suggested in the last two decades. One common underlying assumption in these papers is that the input parameters of the problems (flows, costs, times, hub capacities, etc.) are deterministic. However, such assumptions may not be valid in many realistic applications because many input parameters in the model are uncertain due to unavoidable environmental variations.

The uncertainties in HLPs can be generally categorized into hub-side uncertainty, spoke-side uncertainty, and connection-link uncertainty. Hereafter, these uncertainties are called hub, spoke and link uncertainties. The hub uncertainty may be represented as the randomness in hub capacity and the reliability of hubs, etc.; the spoke uncertainty captures the randomness in flows; and the link uncertainty can be the random travel time, random transportation cost, unreliable routes, etc. Most papers studying HLPs under uncertainty focus on a limited number of spoke and link uncertainties such as uncertain flows, transportation costs and times (see [Zanjirani Farahani et al., 2013](#) and the references therein). In hub and link uncertainties, it is commonly assumed that the topology of the hub-and-spoke network is not changed once the hubs are located and spokes are assigned to the hubs. However, this is not a valid assumption anymore if the located hubs and established transportation links are subject to disruption. On the other hand, disruptions at hubs and connection links are twofold: complete or partial disruptions.

When a hub node is completely disrupted, that hub becomes unavailable and spokes originally allocated to it have to be re-allocated to other (operational) hub nodes that usually require higher connection costs (i.e., re-allocation cost). Similarly, if a link is subject to complete disruption, an alternative link or an alternative transportation mode is utilized. In partial disruption case, although the hub node may still be available, the service rate or the capacity of the hub is degraded to a lower level. In case of service rate degradation, hubs become congested and incoming flow must spend more time and wait to be processed. In case of capacity degradation, flows are being limited to enter the hub (i.e., capacity of the hub is decreased).

Similarly, any disruption at connection links directly affects the designed capacity of the link, hence the capacity of the link is reduced to a lower level. In this situation, the flows exceed the capacity of the link and the congestion at links consequently increases the transportation time of flows. Therefore, disruptions at hub network can strongly affect the performance of the network.

The importance of the link uncertainty is more highlighted when the hub-and-spoke network acts as a shipment delivery system. Nowadays in all shipment delivery systems, most of customers are looking for companies which offer fast and reliable delivery service as well as guarantee that when deliveries will be made. A delivery hub-and-spoke network consolidates shipments from origin spokes, transports sorted shipments between hub nodes and finally distributes shipments to the destination spokes. The configuration of the hub-and-spoke network will determine the company's ability to meet or exceed service requirements.

In this chapter, we address both complete and partial disruptions of hubs, and partial disruptions of links. Also, the effect of these uncertainties on the hub-and-spoke topology and ability of the network to meet delivery requirements of the shipments are investigated. The uncertainties are modeled by an individual and independent failure probability inherent in each hub and link. Although each spoke needs to be served by one operational hub only, in case of complete disruption, the spoke should be allocated to a group of hubs that are ordered by levels: in the event of the lowest-level hub becomes unavailable, the spoke can then be served by the next level hub that is available; and so on until it is served by a non-failable hub. The objectives are thus: a) to minimize the total cost including transportation cost and expected failure cost, and b) to minimize the maximum transportation time between each pair of O-D nodes. This problem will be referred to as the bi-objective capacitated reliable hub location problem (BOCRHLP).

The BOCRHLP is clearly NP-hard because it generalizes the CHLP. We propose an efficient approximation approach to provide lower bound for the optimal Pareto-frontier of the model. We also develop a hybrid meta-heuristic algorithm to solve the bi-objective model and obtain near optimal Pareto-frontier, while its performance is benchmarked by developed approximation approach. Designing approximation and meta-heuristic algorithms for the CHLP and its variations has recently received considerable attention from the research community. However, to the best of our knowledge, this thesis presents the first approximation algorithm for the bi-objective capacitated reliable hub location problem with hub and link uncertainties.

### 5.2. Literature review

Studying impact of uncertainty in decision making has been done in a number of researchers to address hub location models (e.g., [Alumur and Kara, 2008](#); [Campbell et al., 2002](#); [Zanjirani Farahani et al., 2013](#)). However, as we pointed out in the [Section 6.1](#), the most of the recently published papers have mainly considered uncertainty in the spoke and link related parameters such as demand, time, etc. This

includes [Contreras et al. \(2011\)](#), [Alumur et al. \(2012\)](#), and [Mohammadi et al., 2014a](#), among others.

In this section, the most related literature of papers which have considered disruption in their model is reviewed. Most of the previous paper studying disruption in the network takes its roots in the classical  $p$ -median ([Tansel et al., 1983](#)) and the uncapacitated fixed-charge location problems ([Nemhauser and Wolsey, 1988](#)). Both these problems locate facilities and allocate customers to located facilities to minimize the total transportation cost while all facilities are assumed to be totally available and reliable. The first model of reliability facility location was proposed by [Snyder and Daskin \(2005\)](#), where the authors assume that some facilities are perfectly available while others are subject to failure and become unavailable with the same probability. In their model, each customer is allocated to a primary facility and a number of backup facilities, in which at least one facility must be available. If the current facility fails, the customer is served by the next available backup facility. They proposed a linear integer programming model to formulate their problem and developed a Lagrangian relaxation solution method. No approximation algorithm has been proposed in [Snyder and Daskin \(2005\)](#).

A recent paper by [Cui et al. \(2010\)](#) relaxes the uniform failure probability assumption in [Snyder and Daskin \(2005\)](#) and allows the failure probabilities to be facility-specific. The authors proposed a compact mixed integer program formulation and a continuum approximation model to solve the model that seeks to minimize initial setup costs and expected transportation costs in normal and failure scenarios. The continuum approximation model predicts the total system cost without details about facility locations and customer assignments, and it provides a fast heuristic to find near-optimum solutions. Their computational results show that for large-scale problems, the continuum approximation method is very effective algorithm, and it avoids prohibitively long running times.

[Cui et al. \(2010\)](#) presented two related models as reliable  $p$ -median problem and reliable uncapacitated fixed-charge location problem. Both models consider heterogeneous facility failure probabilities, one layer of supplier backup, and facility fortification within a finite budget. The authors formulated both model as nonlinear integer programming models and proved to be NP-hard. They also developed Lagrangian relaxation-based solution algorithms and demonstrate their computational efficiency. Similar to [Cui et al. \(2010\)](#), [Aboolian et al. \(2012\)](#) considered reliable facility location models in which facilities are subject to unexpected failures, and customers may be reassigned to facilities other than their regular facilities. Their main effort was to derive Lower bounds for reliable uncapacitated fixed-charge location problem (RUFLP) and introduce a class of efficient algorithms for solving the RUFLP problem.

[Peng et al. \(2011\)](#) introduced the  $p$ -robustness criterion so that the designed network performs well in both disrupted and normal conditions. The authors presented a mixed-integer programming model which tries to minimize the nominal cost (i.e., the cost when no disruptions occur) while reducing the disruption risk

using the  $p$ -robustness criterion that bounds the cost in disruption scenarios. They proposed a hybrid meta-heuristic algorithm that is based on genetic algorithms, local improvement, and the shortest augmenting path method. They also proved the superiority of their heuristic algorithm comparing to CPLEX in terms of solution speed, while still delivering excellent solution quality. [Shen et al. \(2011\)](#) studied a reliable facility location problem wherein some facilities are subject to failure from time to time. If a facility fails, customers originally allocated to it have to be re-allocated to other (operational) facilities. They formulated this problem as a two-stage stochastic program and then as a nonlinear integer program. Several heuristics that can produce near-optimal solutions were proposed for this NP-hard problem. For the special case where the probability of facility failure is constant (independent of the facility), they provided an approximation algorithm with a worst-case bound of 4. [Li et al. \(2013\)](#) presented two related models (i.e., reliable  $p$ -median and reliable uncapacitated fixed-charge location) for the design of reliable distribution networks. Both models are formulated as nonlinear integer programming and considered heterogeneous facility failure probabilities, one layer of supplier backup, and facility fortification within a finite budget. The NP-hardness of the models was also proved.

To the best of our knowledge, there are just two studies dealing with the hub network design problem and taking hub disruptions into account. [Parvaresh et al. \(2012\)](#) formulated a bi-level multiple allocation  $p$ -hub median problem under intentional disruptions by a bi-level model with bi-objective functions at an upper level and a single objective at a lower level. In their model, the leader aims at identifying the location of hubs so that normal and worst-case transportation costs are minimized while normal and failure conditions are taken into account. Finally, the worst-case scenario is modeled in a lower level, where the follower's objective is to identify the hubs the loss of which would most diminish service efficiency. Additionally, they developed two multi-objective meta-heuristics based on simulated annealing and tabu search to solve their proposed model. In a similar work, [Parvaresh et al. \(2013\)](#) developed a multiple allocation  $p$ -hub median problem under intentional disruptions using different definitions of a failure probability of the hub in comparison to their previous work. All of reviewed papers have considered complete disruption for facilities.

Regarding to studies dealing with spoke uncertainty, [Mohammadi et al. \(2011a, 2015\)](#) and [Sedehzadeh et al. \(2014, 2015\)](#) studied a HLP with uncertain demand as a Poisson distribution, where limited number of flows can enter a hub. They presented a M/M/c queuing system to handle the uncertainty of demands between each pair of O-D nodes. Similarly, [Contreras et al. \(2011\)](#) studied stochastic uncapacitated HLPs in which uncertainty is associated to demands and transportation costs. They showed that the stochastic problems with uncertain demands or dependent transportation costs are equivalent to their associated deterministic expected value problem, in which random variables are replaced by their expectations.

Finally, to the best of our knowledge, this research is the first that has considered all hub, link and spoke uncertainties in designing a reliable hub-and-spoke network. We depart from common assumptions in the literature by considering complete and partial disruptions in the hubs, and partial disruptions in connection links.

### 5.3. The reliability hub location problem

In this section we discuss a hub location model that simultaneously a) minimizes the sum of operating cost (the transportation cost when all hubs are operational) and the expected failure cost (the expected transportation cost, taking into account random hub failures), and b) minimizes the expected maximum travel time between each pair of O-D nodes when hubs and links are subject to disruption. In this section, all uncertainties including hub, link and spoke uncertainties are independently taken into account. In hub uncertainty, each hub is disrupted in three ways as follows: 1) hub is completely disrupted and no spoke can be served, 2) capacity of hub is partially disrupted and the capacity is degraded to a lower level, and 3) service rate of the hub is stochastically disrupted and subsequently retrieved with specific rates. Each hub is disrupted with a given probability, and multiple hubs may be disrupted (i.e., completely or partially) simultaneously. Certain hubs may be designated as “non-failable.” The non-failable hubs represent those locations in favorable environmental conditions, and deemed to have a negligible probability of failure.

In spoke uncertainty, flow between each pair of O-D nodes is considered to be uncertain. Finally in link uncertainty, connection links are subject to partial disruption where 1) capacity of each link is stochastically degraded, and 2) transportation time over some partially disrupted links may be increased due to stochastic degradation.

Uncertainties in HLP are first formulated in the following [subsections 3.1 to 3.3](#) as “*Partial disruptions in hubs and links*”, “*Uncertainty of transportation time due to stochastic degradation*”, and “*Stochastic disruption of hub’s service rate*”. We first introduce the main assumptions that will be considered throughout the paper.

- The number of hubs that must be located is given,
- Each spoke can be allocated to exactly one hub at each level,
- Graph of hubs is a complete graph,
- A limited volume of flows can enter a hub (i.e., hub capacity limitation),
- A limited volume of flows can be transferred through a link (i.e., link capacity limitation)
- Flows entering a hub need specific operations before being transferred (i.e., unloading, sorting, loading, etc.),
- All types of disruptions (i.e., complete and partial) happen independently with a given probability.

### 5.3.1. Partial disruptions in hubs and links

As mentioned previously, capacity of hubs and connection links become partially disrupted and degrade to a lower level, in which, the flows entering the hub or traversing a link will exceed the realized capacity of the hub or the link by certain probability. It is desirable to ensure that the probability of such an occurrence to be lower than a specified or satisfactory level. This section introduces the hub and link capacity reliability as the probability of the flows entering a hub or traversing a link exceeds the capacity of the hub or the link, referred to as the capacity exceedance probability  $(1 - \eta)$  and  $(1 - \vartheta)$ , respectively, in which  $\eta$  and  $\vartheta$  are partially disruption probability in hubs and links. It is obvious that higher probability of disruption leads to lower probability of respecting the capacity. The hub capacity reliability can be mathematically written by:

$$P\{\Gamma \leq EF\} \leq (1 - \eta) \quad (5.1)$$

where  $EF$  and  $\Gamma$  are flows entered the hub and the designed capacity of the hub, respectively. It should be noted that the hub capacity reliability requirement can be different for different hubs. In (5.1),  $\Gamma$  is a random variable specified by a particular probability density function (PDF). The left-hand side (LHS) of inequality (5.1) can be considered as a cumulative distribution function (CDF) of  $\Gamma$ , written by:

$$F_{\Gamma}(EF) = P\{\Gamma \leq EF\} \quad (5.2)$$

Using equation (5.2), equation (5.1) can be rewritten by:

$$F_{\Gamma}(EF) \leq (1 - \eta) \quad (5.3)$$

Since the CDF are monotonic one-to-one functions, one can take the inverse of inequality (5.3) and write the following inequality (5.4).

$$EF \leq F_{\Gamma}^{-1}(1 - \eta) \quad (5.4)$$

By specifying the CDF of the hub capacity  $\Gamma$  and the acceptable capacity exceedance probability  $(1 - \eta)$ , inequality (5.4) becomes a deterministic constraint. For simplicity, in this section, we assume that the hub capacity follows a uniform distribution defined by an upper bound (i.e., design capacity) and a lower bound (i.e., worst-degraded capacity). Generalizing the consideration to other probability distributions (e.g., Gamma and truncated Gamma) can be accomplished with the Mellin Transform technique as discussed in the work by Lo et al. (2006). Noteworthy, several papers (Chen et al., 2002; Lo and Tung, 2003; Luo, 2004 ; Lo et al., 2006) have



considered uniform distribution that is more applicable in transportation domain affected by disruption.

It should be mentioned that other distribution functions (e.g., Gamma and truncated Gamma) model the capacity degradation. Furthermore, we consider the lower bound to be a fraction  $\theta$  of the design capacity. For a uniform distribution, the inverse CDF of  $\Gamma$  can be written as:

$$F_{\Gamma}^{-1}(\eta) = \theta\bar{\Gamma} + (1 - \eta)\bar{\Gamma}(1 - \theta) = \bar{\Gamma}[\theta + (1 - \eta)(1 - \theta)] \quad (5.5)$$

where  $\bar{\Gamma}$  is the design capacity of the hub that has a deterministic value. Applying equation (5.5) to inequality (5.4), we obtain the following hub capacity reliability:

$$EF \leq \bar{\Gamma}[\theta + (1 - \eta)(1 - \theta)] \quad (5.6)$$

Similar to hub capacity disruption, the link capacity disruption is presented as inequality (5.7).

$$LF \leq \bar{\xi}[\vartheta + (1 - \vartheta)(1 - \delta)] \quad (5.7)$$

where  $LF$ ,  $\bar{\xi}$  and  $\vartheta$  are flows traversing the link, designed link capacity, probability of partial disruption in the link. Besides, in case of disruption, capacity of the link ( $\bar{\xi}$ ) degrades to a lower level with fraction  $\delta$ .

### 5.3.2. Uncertainty of transportation time due to stochastic degradation

As mentioned before, transportation time over some links may be increased due to stochastic degradation. In this section, the Bureau roads link performance function (Lo and Tung, 2003) is presented as equation (5.8) to cope with the stochastic alteration of transportation time.

$$T(LF, \xi) = t \left[ 1 + \beta \left( \frac{LF}{\xi} \right)^{\zeta} \right] \quad (5.8)$$

where  $t$  and  $T$  are link free-flow travel time and variable transportation time of the link with flow  $LF$ , respectively;  $\beta$  and  $\zeta$  are constant parameters. Besides,  $\xi$  is a random capacity variable of the link specified by a particular PDF. According to equation (5.8), the mean and variance of  $T$  are calculated as equations (5.9) and (5.10):

$$E(T) = t + \beta t E \left[ \left( \frac{LF}{\xi} \right)^{\zeta} \right] \quad (5.9)$$

$$V(T) = \beta^2 t^2 V \left[ \left( \frac{LF}{\xi} \right)^{\zeta} \right] \quad (5.10)$$

By assuming  $t$  as deterministic parameter and  $\xi$  as independent random variable from amount of flow  $LF$ ,  $E(t) = t$  and  $V(t) = 0$  and the mean and variance of  $1/\xi$  are derived as follows by assuming the uniform distribution for the link capacity.

$$E\left(\frac{1}{\xi^\zeta}\right) = \int_{\delta\bar{\xi}}^{\bar{\xi}} \frac{1}{\xi^\zeta} \frac{1}{(\bar{\xi} - \delta\bar{\xi})} d\xi = \frac{1 - \delta^{1-\zeta}}{\bar{\xi}^\zeta(1 - \delta)(1 - \zeta)} \quad (5.11)$$

$$E\left(\frac{1}{\xi^{2\zeta}}\right) = \int_{\delta\bar{\xi}}^{\bar{\xi}} \frac{1}{\xi^{2\zeta}} \frac{1}{(\bar{\xi} - \delta\bar{\xi})} d\xi = \frac{1 - \delta^{1-2\zeta}}{\bar{\xi}^{2\zeta}(1 - \delta)(1 - 2\zeta)} \quad (5.12)$$

$$V\left(\frac{1}{\xi^\zeta}\right) = E\left(\frac{1}{\xi^{2\zeta}}\right) - \left(E\left(\frac{1}{\xi^\zeta}\right)\right)^2 = \frac{1 - \delta^{1-2\zeta}}{\bar{\xi}^{2\zeta}(1 - \delta)(1 - 2\zeta)} - \left(\frac{1 - \delta^{1-\zeta}}{\bar{\xi}^\zeta(1 - \delta)(1 - \zeta)}\right)^2 \quad (5.13)$$

where  $1/(\bar{\xi} - \delta\bar{\xi})$  is probability density function (PDF) of the uniform distribution with upper bound  $\bar{\xi}$  and lower bound  $\delta\bar{\xi}$ . Using (5.11) to (5.13), the mean and variance of  $T$  are, respectively:

$$E(T) = t + \beta t L F^\zeta \frac{1 - \delta^{1-\zeta}}{\bar{\xi}^\zeta(1 - \delta)(1 - \zeta)} \quad (5.14)$$

$$V(T) = \beta^2 t^2 L F^{2\zeta} \left[ \frac{1 - \delta^{1-2\zeta}}{\bar{\xi}^{2\zeta}(1 - \delta)(1 - 2\zeta)} - \left(\frac{1 - \delta^{1-\zeta}}{\bar{\xi}^\zeta(1 - \delta)(1 - \zeta)}\right)^2 \right] \quad (5.15)$$

Equations (5.14) and (5.15) state that for a specific designed capacity  $\bar{\xi}$ , both mean and variance of transportation time are increased by flow  $LF$  traversing the link. Therefore, the variability of travel time in heavy traffic is higher than that in the light traffic. On the contrary, variance is equal to zero when there is no flow.

### 5.3.3. Stochastic disruption of hubs' service rates

In this section, we assume flows entering a hub undergo a set of operations such as loading, sorting, unloading, etc. Due to resource limitations at the hub(s), all flows cannot be processed at the same time and need to wait for their turn to be processed. Therefore, the total travel time between each pair of O-D nodes is the sum of transportation time on the links and the time spent at the hub(s). The resource limitation at the hub(s) causes significant delays if the average arrival rate gets closer to the service rate at these operations. These delays are increased as more and more flows are attracted to the hub to take advantage of the economies of scale. As these delays significantly affect the delivery time requirement, time spent at the hubs should be calculated and taken into account.

Since the flow between each pair of O-D nodes has been considered as uncertain parameter (i.e., spoke uncertainty), a queuing approach is an efficient method to analyze the waiting time at the hubs. In this way, accounting for uncertain amount of flows and calculation of waiting times through queue theory, makes the proposed model more attractive in practice.



Hereafter, the queuing model proposed in [Section 3.3.2.3](#) is applied to model the waiting time of flows entering a hub. Similar to [Section 3.3.2.3](#), hubs act as machines and inspection tools wherein flows in the transportation network look like products in the production system.

### 5.4. Mathematical formulation

This section tries to mathematically model the BOCRHLP considering uncertainty formulations of [subsections 5.3.1](#) to [5.3.3](#). In the BOCRHLP, we are to locate  $P$  hubs in the network and allocate spokes to the located  $P$  hubs. Each spoke is assigned to up to  $R \geq 1$  hubs ( $R \leq P$ ) and can be serviced by these and only these hubs, in which spokes are served by next backup hub once a hub is disrupted at the lowest level. In addition, spokes are allocated to different hubs level by level once they are served by a non-failable hub at a certain level.

Except for few authors (see, e.g., [Correia et al, 2010](#); [Elhedhli and Wu, 2010](#); [Contreras et al, 2012](#)), hub capacity in the literature is considered exogenous. Hub capacities can have a determining impact on hub-and-spoke related decisions, and thus on the overall transportation cost. Therefore, capacity selection should ideally be considered as part of the decision process. Consequently, in order to develop a more realistic and flexible hub-and-spoke network, multiple hub capacity levels is considered where one and only one capacity level at each hub is allowed. The higher the level of capacity at hubs, the higher the amount of flow they can process. Another important aspect in designing hub networks which has been traditionally overlooked is the choice of transportation mode. It is often assumed that there is only one type of transportation mode in most of the hub location models presented in the literature. However, there are usually alternative choices among air, road and rail transportation modes. Since different transportation modes are subject to different disruptions with different probabilities, designing multimodal hub-and-spoke network allows companies to choose specific transportation modes with lower probability of disruption to transfer the flows.

Before proposing the BOCRHLP with multiple capacity levels, necessary notations are provided as follows.

#### **Sets:**

$i, j \in \{1, 2, \dots, N\}$	Set of nodes (hereafter, non-hub nodes are called as spokes).
$k, l \in H; H \in N$	Set of hubs.
$m \in \{1, 2, \dots, M\}$	Set of transportation modes; $m = 1$ is road mode.
$s \in \{1, 2, \dots, S\}$	Set of hub capacity levels.
$r, v \in \{1, 2, \dots, R\}$	Set of allocation levels.

#### **Parameters:**

$w_{ij}$	Flow between spokes $i$ and $j$ .
$c_{ij}^m$	Transportation cost of a unit of flow between spokes $i$ and $j$ using transportation mode $m$ .
$oc_k^{ms}$	Unit operational cost at hub $k$ with capacity level $s$ using transportation mode $m$ .
$FH_k^{ms}$	Fixed cost of locating a hub at node $k$ with capacity level $s$ using transportation mode $m$ .
$FL_{kl}^m$	Fixed cost of link between hubs $k$ and $l$ using transportation mode $m$ .
$\alpha_{ij}^m$	Cost discount factor between hubs $k$ and $l$ using transportation mode $m$ .

## Chapter V: Hub Location Problem

$\alpha t_{ij}^m$	Time discount factor between hubs $k$ and $l$ using transportation mode $m$ .
$\bar{f}_k^{sm}$	Designed capacity of hub $k$ with capacity level $s$ using transportation mode $m$ .
$\bar{\xi}_{kl}^m$	Designed capacity of the link between hubs $k$ and $l$ using transportation mode $m$ .
$q_k$	Failure probability of complete disruption of hub $k$ .
$P$	Number of hubs to be located.
$O_i = \sum_j w_{ij}$	Total flow originating from spoke $i$ .
$D_i = \sum_j w_{ji}$	Total flow with destination of spoke $i$ .
$\mu_k^{ms}$	Service rate of hub $k$ with capacity level $s$ using transportation mode $m$ .
$f_k^{ms}$	Disruption rate of hub $k$ with capacity level $s$ using transportation mode $m$ .
$r_k^{ms}$	Retrieval time rate of hub $k$ with capacity level $s$ using transportation mode $m$ .
$\eta_k^{ms}$	Disruption probability at hub $k$ with capacity level $s$ using transportation mode $m$ .
$\theta_k^{ms}$	Capacity disruption factor at hub $k$ with capacity level $s$ using transportation mode $m$ .
$\vartheta_{kl}^m$	Disruption probability at link between hubs $k$ and $l$ using transportation mode $m$ .
$\delta_{kl}^m$	Capacity disruption factor at link between $k$ and $l$ using transportation mode $m$ .
$t_{ij}^m$	Free-flow travel time between nodes $i$ and $j$ (spokes/hubs) using transportation mode $m$ ( $t_{ij}^m$ is a deterministic parameter).

### Variables:

$X_{ik}^r$	1 if spoke $i$ is allocated to hub $k$ at level $r$ ; 0 otherwise.
$Z_k^{ms}$	1 if a hub is established at node $k$ with capacity level $s$ using transportation mode $m$ ; 0 otherwise.
$Y_{iklj}^m$	1 if the flow originated at spoke $i$ destined to spoke $j$ uses the hub link $\{k,l\}$ from hub $k$ to hub $l$ with transportation mode $m$ ; 0 otherwise.
$L_{kl}^m$	1 if there is a link between hubs $k$ and $l$ with transportation mode $m$ ; 0 otherwise.
$U_k$	1 if a hub is located at node $i$ .
$P_{ik}^r$	Probability that hub $k$ serves spoke $i$ at level $r$ .
$PX_{ik}^r$	Linear form of $P_{ik}^r \times X_{ik}^r$ .
$PY_{ilkj}^{mr}$	Linear form of $Y_{ilkj}^m \times P_{jk}^r$ .
$EF_k^m = \lambda_k^m = \sum_i \sum_{\substack{j \\ j \neq i}} \sum_{l \neq k} w_{ij} Y_{ilkj}^m$	Flow entering the hub $k$ using transportation mode $m$ .
$LF_{kl}^m = \sum_i \sum_j w_{ij} Y_{iklj}^m$	Flow passing the link between hubs $k$ to $l$ using transportation mode $m$ .
$E(W_k^{ms})$	Mean expected value of the stochastic operational time (waiting time + processing time) at hub $k$ with capacity level $s$ for transportation mode $m$ .
$V(W_k^{ms})$	Variance value of the stochastic operational time (waiting time + processing time) at hub $k$ with capacity level $s$ for transportation mode $m$ .
$W_k^{ms}$	Operational time (waiting time + processing time) at hub $k$ with capacity level $s$ for transportation mode $m$ ( $W_k^{ms} \sim (E(W_k^{ms}), V(W_k^{ms}))$ ).
$E(T_{ij}^m)$	Mean expected value of the stochastic travel time between nodes $i$ and $j$ using transportation mode $m$ .
$V(T_{ij}^m)$	Variance value of the stochastic travel time between nodes $i$ and $j$ using transportation mode $m$ .
$T_{ij}^m$	Transportation time between nodes $i$ and $j$ using transportation mode $m$ ( $T_{ij}^m \sim (E(t_{ij}^m), V(t_{ij}^m))$ ).

The proposed BOCRHLP model is as follow:

$$\begin{aligned} \min Z_1 = & \sum_{k=1}^N \sum_{m=1}^M \sum_{s=1}^L FH_k^{ms} Z_k^{ms} + \sum_{k=1}^{N+1} \sum_{m=1}^M \sum_{\substack{l=1 \\ l>k}}^{N+1} FL_{kl}^m L_{kl}^m \\ & + \sum_{s=1}^L \sum_{i=1}^N \sum_{\substack{j=1 \\ j \neq i}}^N w_{ij} \left[ \sum_{\substack{k=1 \\ k \neq i}}^{N+1} \sum_{r=1}^R c_{ik}^1 P X_{ik}^r \right. \\ & \left. + \sum_{m=1}^M \sum_{k=1}^{N+1} \sum_{\substack{l=1 \\ l \neq k}}^{N+1} \sum_{r=1}^R \sum_{r'=1}^R (oc_k^{ms} + ac_{kl}^m c_{kl}^m + oc_l^{ms}) P_{ik}^r P_{jl}^{r'} Y_{iklj}^m + \sum_{\substack{k=1 \\ k \neq j}}^{N+1} \sum_{r=1}^R c_{kj}^1 P X_{jk}^r \right] \end{aligned} \quad (5.16)$$

$$\text{Min } Z_2 = \Psi \quad (5.17)$$

$$\text{s.t.} \quad \sum_{k=1}^H X_{ik}^r + \sum_{v=1}^r X_{i(H+1)}^v + U_i = 1 \quad \forall i, r \quad (5.18)$$

$$\sum_{r=1}^R X_{i(H+1)}^r + U_i = 1 \quad \forall i \quad (5.19)$$

$$X_{ik}^r \leq U_k \quad \forall i, k \quad (5.20)$$

$$\sum_s Z_k^{ms} \leq U_k \quad \forall k, m \quad (5.21)$$

$$\sum_s Z_k^{ms} = 1 \quad \forall k, m \quad (5.22)$$

$$\sum_k U_k = P \quad (5.23)$$

$$L_{kl}^m \leq \sum_s Z_k^{ms} \quad \forall k, l: k < l, m \in M \setminus \{1\} \quad (5.24)$$

$$L_{kl}^m \leq \sum_s Z_l^{ms} \quad \forall k, l: k < l, m \in M \setminus \{1\} \quad (5.25)$$

$$L_{kl}^1 \leq \sum_m \sum_s Z_k^{ms} \quad \forall k, l: k < l \quad (5.26)$$

$$L_{kl}^1 \leq \sum_m \sum_s Z_l^{ms} \quad \forall k, l: k < l \quad (5.27)$$

$$\sum_l Y_{iklj}^m \geq X_{ik}^r + X_{jl}^v - 1 \quad \forall i, j, k, l: i \neq j; k \neq l; r, v \quad (5.28)$$

$$Y_{iklj}^m + Y_{ilkj}^m \leq L_{kl}^m \quad \forall i, j, k, l \in N: i \neq j \quad (5.29)$$

$$P\{(T_{ik}^1 + W_k^{ms} + at_{kl}^m T_{kl}^m + W_l^{ms} + T_{ij}^1) Y_{iklj}^m \leq \Psi\} \geq \gamma \quad \forall i, j, k, l, m, s: i \neq j \quad (5.30)$$

$$\sum_i \sum_l \sum_j \sum_r w_{ij} P Y_{ilkj}^{mr} \leq \sum_s \bar{r}_k^{ms} [\theta_k^{sm} + (1 - \eta_k^{ms})(1 - \theta_k^{sm})] Z_k^{ms} \quad \forall k, m \quad (5.31)$$

$$\sum_i \sum_j \sum_r \sum_v w_{ij} Y_{iklj}^m P_{ik}^r P_{jl}^v \leq \bar{\xi}_{kl}^m [\delta_{kl}^m + (1 - \vartheta_{kl}^m)(1 - \delta_{kl}^m)] L_{kl}^m \quad \forall k, l, m \quad (5.32)$$

$$P_{ik}^1 = 1 - q_k \quad \forall i, k \in \{1, \dots, H+1\} \quad (5.33)$$

$$P_{il}^r = (1 - q_l) \sum_{k=1}^H \frac{q_k}{1 - q_k} P X_{ik}^{r-1} \quad \forall i, l \in \{1, \dots, H+1\}, r \in \{2, \dots, R\} \quad (5.35)$$

$$P X_{ik}^r \leq P_{ik}^r \quad \forall i; k \in \{1, \dots, H+1\}; r \quad (5.35)$$

$$P X_{ik}^r \leq X_{ik}^r \quad \forall i; k \in \{1, \dots, H+1\}; r \quad (5.36)$$

$$X_{ik}^r + P_{ik}^r - P X_{ik}^r \leq 1 \quad \forall i; k \in \{1, \dots, H+1\}; r \quad (5.37)$$

$$P Y_{ilkj}^{mr} \leq P_{jk}^r \quad \forall i, j, k, l, m, r \quad (5.38)$$

$$P Y_{ilkj}^{mr} \leq Y_{ilkj}^m \quad \forall i, j, k, l, m, r \quad (5.39)$$

$$Y_{ilkj}^m + P_{jk}^r - P Y_{ilkj}^{mr} \leq 1 \quad \forall i, j, k, l, m, r \quad (5.40)$$

$$X_{ik}^r, Z_k^{ms}, L_{kl}^m, U_k, Y_{ilkj}^m \in \{0, 1\} \quad \forall i, j, k, l, m, s, r \quad (5.41)$$

$$P X_{ik}^r, W_k^{ms}, T_{kl}^m, \Psi \geq 0 \quad \forall i, k, l, m, s, r \quad (5.42)$$

Objective function (5.16) minimizes total expected transportation and operation cost in the hub network. Objective function (5.17) and chance constraint

(5.30) minimize the maximum transportation time between each pair of O-D nodes. Equation (5.18) enforces that for each spoke  $i$  and each level  $r$ , either  $i$  is allocated to a regular hub at level  $r$  or is allocated to the non-failable hub  $H + 1$  at certain level  $v \leq r$  (taking  $\sum_{v=1}^r X_{i,H+1}^v = 0$  if  $r = 1$ ). Constraint (5.19) requires each spoke to be allocated to the non-failable hub at a certain level. Constraint (5.20) ensures that a spoke must be allocated to a valid hub. Constraints (5.21) and (5.22) guarantee that just one capacity level is allowed for each located hub. Constraint (5.23) ensures the number of hubs should be equal to a pre-defined value  $P$ . Constraints (5.24) and (5.25) show that specific capacity levels in both hubs  $k$  and  $l$  for mode  $m$  must be established if there is a link between them with mode  $m$ . Constraints (5.26) and (5.27) explain that any hub constructed for mode  $m \geq 2$  can be utilized also for mode  $m$  equal to 1. In this model, mode equal to 1 is considered as road transportation. Constraints (5.28) and (5.29) create valid route between each pair of O-D nodes. Constraints (5.31) and (5.32) are the hub and the link capacity constraints, respectively. Constraints (5.33) and (5.34) are the “transitional probability” equations.  $P_{ik}^r$ , the probability that hub  $k$  serves spoke  $i$  at level  $r$ , is just the probability that  $k$  remains open if  $r = 1$ . For  $2 \leq r \leq R$ ,  $P_{ik}^r$  is equal to  $(q_l(1 - q_k)/(1 - q_l))P_{il}^{r-1}$  given that hub  $l$  serves spoke  $i$  at level  $r$ . Constraints (5.35) to (5.37) and (5.38) to (5.40) make the terms of  $X_{ik}^r \times P_{ik}^r$  and  $Y_{ilkj}^m \times P_{jk}^r$  linear. Finally, constraints (5.41) and (5.42) are domain constraints.

In order to transform chance constraint (5.30) to a standard form, consider:

$$\mathcal{K} = T_{ik}^1 + W_k^{ms} + \alpha t_{kl}^m t_{kl}^m + W_l^{ms} + T_{lj}^1$$

Mean expected and variance values of  $\mathcal{K}$  can be stated as (5.43) and (5.44), respectively. It should be noted that transportation time between spoke nodes to the hubs (i.e.,  $T_{ik}^1$  and  $T_{kj}^1$ ) are considered as deterministic parameters.

$$E(\mathcal{K}) = t_{ik}^1 + E(W_k^{ms}) + \alpha t_{kl}^m E(T_{kl}^m) + E(W_l^{ms}) + t_{lj}^1 \quad (5.43)$$

$$V(\mathcal{K}) = V(W_k^{ms}) + \alpha t_{kl}^{m2} V(t_{kl}^m) + V(W_l^{ms}) \quad (5.44)$$

Therefore, we can express the chance constraint (5.30) for path  $i \rightarrow k \rightarrow l \rightarrow j$  with mode  $m$  as below (Mohammadi et al., 2013):

$$\Psi \geq \left[ E(\mathcal{K}) + z_\gamma \sqrt{V(\mathcal{K})} \right] Y_{iklj}^m,$$

where  $z_\gamma$  is the  $z$ -value corresponding to the 100  $\gamma$ -th percentile from the standard normal distribution. (With the service-level parameter  $\gamma$  reasonably assumed to be at least 0.5,  $z_\gamma$  is non-negative.) It follows that constraint (5.30) can be rewritten as constraint (5.45):

$$\Psi \geq \left[ t_{ik}^1 + E(W_k^{ms}) + \alpha t_{kl}^m E(t_{kl}^m) + E(W_l^{ms}) + \right. \quad \left. \forall i, j, k, l, m, s: i \neq j \right] \quad (5.45)$$

$$z_{\gamma} \sqrt{V(W_k^{ms}) + \alpha t_{kl}^2 V(t_{kl}^m) + V(W_l^{ms}) + t_{lj}^1} Y_{iklj}^m$$

According to Section 3.3.2.3,  $E(W_k^{ms})$ ,  $V(W_k^{ms})$ ,  $E(T_{kl}^m)$ , and  $V(T_{kl}^m)$  are calculated as equations (5.46) to (5.49).

$$E(W_k^{ms}) = \frac{(r_k^{ms} + f_k^{ms})^2 + \mu_k^{ms} f_k^{ms}}{(r_k^{ms} + f_k^{ms})(r_k^{ms}(\mu_k^{ms} - \lambda_k^m) - \lambda_k^m f_k^{ms})} \quad (5.46)$$

$$V(W_k^{ms}) = \frac{2\lambda_k^m(\lambda_k^m(f_k^{ms} + r_k^{ms}) - \mu_k^{ms} r_k^{ms})}{(\mu_k^{ms}(\lambda_k^m + r_k^{ms}) + \lambda_k^{m^2} - \lambda_k^m(f_k^{ms} + r_k^{ms} + \lambda_k^m + \mu_k^{ms}))^2} - \frac{\lambda_k^m(2\lambda_k^m - (f_k^{ms} + r_k^{ms} + \lambda_k^m + \mu_k^{ms}))^2(2\lambda_k^m(f_k^{ms} + r_k^{ms}) - 2\mu_k^{ms} r_k^{ms})}{(\mu_k^{ms}(\lambda_k^m + r_k^{ms}) + \lambda_k^{m^2} - \lambda_k^m(f_k^{ms} + r_k^{ms} + \lambda_k^m + \mu_k^{ms}))^3} - \frac{2(2\lambda_k^{m^2} - \lambda_k^m(f_k^{ms} + r_k^{ms} + \lambda_k^m + \mu_k^{ms}))(\lambda_k^m(f_k^{ms} + r_k^{ms}) - \mu_k^{ms} r_k^{ms})}{(r_k^{ms} + f_k^{ms})(\mu_k^{ms}(\lambda_k^m + r_k^{ms}) + \lambda_k^{m^2} - \lambda_k^m(f_k^{ms} + r_k^{ms} + \lambda_k^m + \mu_k^{ms}))^2} - \left( \frac{(r_k^{ms} + f_k^{ms})^2 + \mu_k^{ms} f_k^{ms}}{(r_k^{ms} + f_k^{ms})(r_k^{ms}(\mu_k^{ms} - \lambda_k^m) - \lambda_k^m f_k^{ms})} \right)^2 \quad (5.47)$$

$$E(T_{kl}^m) = t_{kl}^m + \beta t_{kl}^m L F_{kl}^{m\zeta} \frac{1 - \delta_{kl}^{m1-\zeta}}{\xi^{\zeta}(1 - \delta_{kl}^m)(1 - \zeta)} \quad (5.48)$$

$$V(T_{kl}^m) = \beta^2 t^2 L F_{kl}^{2\zeta} \left[ \frac{1 - \delta_{kl}^{m1-2\zeta}}{\xi^{2\zeta}(1 - \delta_{kl}^m)(1 - 2\zeta)} - \left( \frac{1 - \delta_{kl}^{m1-\zeta}}{\xi^{\zeta}(1 - \delta_{kl}^m)(1 - \zeta)} \right)^2 \right] \quad (5.49)$$

### 5.5. Linearization of the model: A piecewise function

Since the proposed BORCHLP model is a non-linear model because of constraint (48) and due to its high complexity, finding an optimal solution, even for some small-size instances of this problem, is not possible. In this section, we develop a piecewise function to approximately linearize the constraint (48). Recently, many approaches have been developed in terms of mixed integer linear programming (MILP) models in order to solve non-linear problems by using efficient techniques to linearize non-linear functions of one or more variables. One of these efficient approaches is the piecewise linear approximation of such functions (D'Ambrosio et al., 2010).

Let  $f(\omega)$  be the piecewise linear approximation of a single variable function by considering a number  $\Pi$  of sampling coordinates  $\omega_1, \dots, \omega_{\Pi}$  on the  $\omega$  axis (*breakpoints*) on which the function is evaluated. The function is then approximated by the linear term  $[(\omega_{\pi}, f(\omega_{\pi})), (\omega_{\pi+1}, f(\omega_{\pi+1}))]$  ( $\pi = 1, \dots, \Pi - 1$ ). Therefore, for any given  $\omega$  value, where  $\omega_{\pi} \leq \bar{\omega} \leq \omega_{\pi+1}$ , the function value  $f^{\approx}(\bar{\omega})$  is approximated as equation (5.50) and (5.51).

$$\bar{\omega} = \partial \omega_{\pi} + (1 - \partial) \omega_{\pi+1} \quad (5.50)$$

$$f^{\approx}(\bar{\omega}) = \partial f(\omega_{\pi}) + (1 - \partial) f(\omega_{\pi+1}) \quad (5.51)$$

where  $\partial$  is a (unique) value in  $[0, 1]$ .

In order to use the above technique in the proposed model, it is necessary to include in the model variables and constraints that force any  $\omega$  value to be associated with the proper pair of consecutive breakpoints. Since four terms of  $E(W_k^{ms})$ ,  $V(W_k^{ms})$ ,  $E(T_{kl}^m)$  and  $V(T_{kl}^m)$  are nonlinear, four piecewise linear approximations are needed. Let  $\Upsilon_\pi$  be a continuous variable for each breakpoint  $\pi$ , such that  $\Upsilon_\pi \in [0,1]$ ; ( $\pi = 1, \dots, \Pi$ ). In addition,  $\phi_\pi$  is a binary variable associated with the  $\pi$ th interval  $[\omega_\pi, \omega_{\pi+1}]$  ( $\pi = 1, \dots, \Pi - 1$ ), where  $\phi_0 = \phi_\Pi = 1$  at the extremes. Finally, the approximate value  $f^\approx$  can then be obtained by imposing the following constraints by introducing special  $\Upsilon_\pi$  and  $\xi_\pi$  corresponding to each nonlinear term. Hence, following notations are first presented, then additional constraints are presented to linearize the non-linear terms of [constraint \(5.45\)](#).

**Parameters:**

$\omega_\pi^{H,km}$	$\pi$ th breakpoint of arrival flow to the hub $k$ by transportation mode $m$ .
$\omega_\pi^{L,klm}$	$\pi$ th breakpoint of hub link flow $k$ to $l$ by transportation mode $m$ .
$f^{EW}(\omega_\pi^{H,km})$	Expected waiting time value of flow $\omega_\pi^{H,km}$ .
$f^{VW}(\omega_\pi^{H,km})$	Waiting time variance value of flow $\omega_\pi^{H,km}$ .
$f^{ET}(\omega_\pi^{L,klm})$	Expected waiting time value of flow $\omega_\pi^{L,klm}$ .
$f^{ET}(\omega_\pi^{L,klm})$	Waiting time variance value of flow $\omega_\pi^{L,klm}$ .
$G$	An arbitrary large number.

**Variables:**

$\Upsilon_\pi^{W,kms}$	Continuous variable for breakpoint $\pi$ associated with $E(W_k^{ms})$ .
$\Upsilon_\pi^{T,klm}$	Continuous variable for breakpoint $\pi$ associated with $E(T_{kl}^m)$ .
$\phi_\pi^{W,kms}$	Binary variable for breakpoint $\pi$ associated with $E(W_k^{ms})$ .
$\phi_\pi^{T,klm}$	Binary variable for breakpoint $\pi$ associated with $E(T_{kl}^m)$ .

$$\sum_{\pi=1}^{\Pi-1} \phi_\pi^{W,kms} = 1 \quad \forall k, m, s \quad (5.52)$$

$$\Upsilon_\pi^{W,kms} \leq \phi_{\pi-1}^{W,kms} + \phi_\pi^{W,kms} \quad \forall k, m, s, \pi \in \Pi \quad (5.53)$$

$$\sum_{\pi=1}^{\Pi} \Upsilon_\pi^{W,kms} = 1 \quad \forall k, m, s \quad (5.54)$$

$$\sum_i \sum_{\substack{j \\ j \neq i}} \sum_l \sum_{\substack{r \\ l \neq k}} w_{ij} P Y_{ilkj}^{mr} = \sum_{\pi=1}^{\Pi} \Upsilon_\pi^{W,kms} \omega_\pi^{H,km} \quad \forall k, m, s \quad (5.55)$$

$$E(W_k^{ms}) = \sum_{\pi=1}^{\Pi} \Upsilon_\pi^{W,kms} f^{EW}(\omega_\pi^{H,km}) \quad \forall k, m, s \quad (5.56)$$

$$V(W_k^{ms}) = \sum_{\pi=1}^{\Pi} \Upsilon_\pi^{W,kms} f^{VW}(\omega_\pi^{H,km}) \quad \forall k, m, s \quad (5.57)$$

$$E(W_k^{ms}) \leq G Z_k^{ms} \quad \forall k, m, s \quad (5.58)$$

$$V(W_k^{ms}) \leq G Z_k^{ms} \quad \forall k, m, s \quad (5.59)$$

$$\sum_{\pi=1}^{\Pi-1} \phi_\pi^{T,klm} = 1 \quad \forall k, l, m \quad (5.60)$$

$$\Upsilon_\pi^{T,klm} \leq \phi_{\pi-1}^{T,klm} + \phi_\pi^{T,klm} \quad \forall k, l, m, \pi \in \Pi \quad (5.61)$$

$$\sum_{\pi=1}^{\Pi} \gamma_{\pi}^{T,klm} = 1 \quad \forall k, l, m \quad (5.62)$$

$$\sum_i \sum_j \sum_r \sum_v w_{ij} Y_{iklj}^m P_{ik}^r P_{jl}^v = \sum_{\pi=1}^{\Pi} \gamma_{\pi}^{T,klm} \omega_{\pi}^{L,klm} \quad \forall k, l, m \quad (5.63)$$

$$E(T_{kl}^m) = \sum_{\pi=1}^{\Pi} \gamma_{\pi}^{T,klm} f^{ET}(\omega_{\pi}^{L,klm}) \quad \forall k, l, m \quad (5.64)$$

$$V(T_{kl}^m) = \sum_{\pi=1}^{\Pi} \gamma_{\pi}^{T,klm} f^{VT}(\omega_{\pi}^{L,klm}) \quad \forall k, l, m \quad (5.65)$$

$$\gamma_{\pi}^{W,kms}, \gamma_{\pi}^{T,klm} \in [0,1] \quad \forall k, l, m, \pi \in \Pi \quad (5.66)$$

$$\phi_{\pi}^{W,kms}, \phi_{\pi}^{T,klm} \in \{0,1\} \quad \forall k, l, m, \pi \in \Pi \quad (5.67)$$

where  $f^{EW}(\omega_{\pi}^{H,km})$  and  $f^{VW}(\omega_{\pi}^{H,km})$  are calculated by substituting the value  $\omega_{\pi}^{H,km}$  in equations (5.46) and (5.47), respectively. A similar approach is carried out for obtaining  $f^{ET}(\omega_{\pi}^{L,klm})$  and  $f^{VT}(\omega_{\pi}^{L,klm})$  by substituting the value  $\omega_{\pi}^{L,klm}$  in equations (5.48) and (5.49), respectively. Although the non-linearity of the model is significantly decreased, there still remains the non-linear term of product of two continuous variables in the objective function (5.16), constraint (5.32) and equation (5.63). This issue is handled during solution algorithm (see Section 5.6). Finally, the BORCHLP model is presented as follow:

$$\begin{aligned} \min \mathbb{Z}_1 = & \sum_{k=1}^N \sum_{m=1}^M \sum_{s=1}^L FH_k^{ms} Z_k^{ms} + \sum_{k=1}^{N+1} \sum_{m=1}^M \sum_{\substack{l=1 \\ l>k}}^{N+1} FL_{kl}^m L_{kl}^m \\ & + \sum_{s=1}^L \sum_{i=1}^N \sum_{\substack{j=1 \\ j \neq i}}^N w_{ij} \left[ \sum_{k=1}^{N+1} \sum_{\substack{r=1 \\ k \neq i}}^R c_{ik}^1 P X_{ik}^r \right. \\ & + \sum_{m=1}^M \sum_{k=1}^{N+1} \sum_{\substack{l=1 \\ l \neq k}}^{N+1} \sum_{r=1}^R \sum_{v=1}^R (oc_k^{ms} + \alpha c_{kl}^m c_{kl}^m + oc_l^{ms}) P_{ik}^r P_{jl}^v Y_{iklj}^m \\ & \left. + \sum_{k=1}^{N+1} \sum_{\substack{r=1 \\ k \neq j}}^R c_{kj}^1 P X_{jk}^r \right] \end{aligned} \quad (5.16)$$

$$\text{Min } \mathbb{Z}_2 = \Psi \quad (5.17)$$

s.t: (5.18)-(5.29), (5.31)-(5.42), (5.45)-(5.49), (5.52)-(5.67).

In this following sections, a novel solution approach is developed to solve the proposed BORCHLP. This approach includes: 1) exact approximation of the proposed BORCHLP, 2) multi-objective lower bound procedure, and 3) multi-objective meta-heuristic algorithm. In Section 4.1, we develop an approximated mixed-integer program (AMIP), in which the non-linear term  $P_{ik}^r \times P_{jl}^v$  is substituted with a given value (Aboolian et al., 2012). In Section 4.2, we present an efficient multi-objective lower bound (MOLB) approach to find a tight Pareto lower bound frontier of the AMIP. The proposed MOLB provides near optimal lower bound for the optimal Pareto-frontier of BORCHLP, while finding bounds for a multi-objective problem is

desirable. On the other hand, finding feasible and near optimal feasible solutions are obtained by developing an efficient multi-objective meta-heuristic algorithm (see Section 4.3), while its efficiency will be demonstrated in comparison with MOLB.

### 5.6. Approximated BOCRHL P (AMIP)

As shown in the proposed model, spokes are re-allocated to other hubs in higher levels when any lower-level hub fails to provide services. In the case of failing all of hubs for a spoke, there is a non-failable hub, denoted by  $H + 1$ , that has no fixed cost with failure probability  $q_{H+1} = 0$  and a transportation cost  $c_{i,H+1}^1 = \phi_i$  for spoke  $i$ .

Let  $q_{[1]} \leq q_{[2]} \leq \dots \leq q_{[h-1]} \leq q_{[h]}$  be an ordering of failure probabilities in  $H$ . An optimistic version of  $P_{ik}^r$  can be provided as  $\mathcal{L}_{kr}$  that is calculated as following equations (5.68) and needs to be proved that  $\mathcal{L}_{kr}$  is a lower bound for  $P_{ik}^r$ , which has been demonstrated by [Aboolian et al. \(2012\)](#). Therefore, since  $\mathcal{L}_{kr} \leq P_{ik}^r$ , AMIP provides lower bound for the main problem BORCHLP.

$$\mathcal{L}_{kr} = \begin{cases} \left( \prod_{h=1}^r q_{[h]} \right) (1 - q_k) & k \in H, \\ \prod_{h=1}^{r-1} q_{[h]} & k = H + 1. \end{cases} \quad (5.68)$$

According to equations (5.68), the AMIP can be presented as follow.

$$\begin{aligned} \min \mathbb{Z}_1 = & \sum_{k=1}^N \sum_{m=1}^M \sum_{s=1}^L FH_k^{ms} Z_k^{ms} + \sum_{k=1}^{N+1} \sum_{m=1}^M \sum_{\substack{l=1 \\ l>k}}^{N+1} FL_{kl}^m L_{kl}^m \\ & + \sum_{s=1}^L \sum_{i=1}^N \sum_{\substack{j=1 \\ j \neq i}}^N w_{ij} \left[ \sum_{\substack{k=1 \\ k \neq i}}^{N+1} \sum_{r=1}^R c_{ik}^1 \mathcal{L}_{kr} X_{ik}^r \right. \\ & + \sum_{m=1}^M \sum_{k=1}^{N+1} \sum_{\substack{l=1 \\ l \neq k}}^{N+1} \sum_{r=1}^R \sum_{v=1}^R (oc_k^{ms} + \alpha c_{kl}^m c_{kl}^m + oc_l^{ms}) \mathcal{L}_{kr} \mathcal{L}_{lv} Y_{iklj}^m \\ & \left. + \sum_{\substack{k=1 \\ k \neq j}}^{N+1} \sum_{r=1}^R c_{kj}^1 \mathcal{L}_{kr} X_{ik}^r \right] \end{aligned} \quad (5.69)$$

$$\text{Min } \mathbb{Z}_2 = \Psi \quad (5.17)$$

s.t: (5.18)-(5.29), (5.41), (5.42), (5.45)-(5.49), (5.52)-(5.54), (5.56)-(5.62), (5.64), (5.67).

$$\sum_i \sum_l \sum_j \sum_r w_{ij} \mathcal{L}_{kr} Y_{ilkj}^m \leq \sum_s \bar{\Gamma}_k^{ms} [\theta_k^{sm} + (1 - \eta_k^{ms})(1 - \theta_k^{sm})] Z_k^{ms} \quad \forall k, m \quad (5.70)$$

$$\sum_i \sum_j \sum_r \sum_v w_{ij} Y_{iklj}^m \mathcal{L}_{kr} \mathcal{L}_{lv} \leq \bar{\xi}_{kl}^m [\delta_{kl}^m + (1 - \vartheta_{kl}^m)(1 - \delta_{kl}^m)] \quad \forall k, l, m \quad (5.71)$$



$$\sum_i \sum_{\substack{j \\ j \neq i}} \sum_{\substack{l \\ l \neq k}} \sum_r w_{ij} \mathcal{L}_{kr} Y_{ilkj}^m = \sum_{\pi=1}^{\Pi} \gamma_{\pi}^{W,kms} \omega_{\pi}^{H,km} \quad \forall k, m, s \quad (5.72)$$

$$\sum_i \sum_j \sum_r \sum_v w_{ij} Y_{iklj}^m \mathcal{L}_{kr} \mathcal{L}_{lv} = \sum_{\pi=1}^{\Pi} \gamma_{\pi}^{T,klm} \omega_{\pi}^{L,klm} \quad \forall k, l, m \quad (5.73)$$

### 5.7. Multi-objective lower bound approach (MOLB)

In this section, a solution algorithm is proposed based on augmented  $\epsilon$ -constraint method (Mavrotas, 2009; Mavrotas and Florios, 2013) and lower bound approach proposed by Mohammadi et al. (2014a) to provide Pareto lower bound frontier for the proposed AMIP. Before presenting the augmented  $\epsilon$ -constraint, a brief review of the traditional one is presented; next, the proposed method by Mohammadi et al. (2014a) and Vahdani and Mohammadi (2015) is modified to be adapted in the proposed AMIP.

Consider the following multi-objective problem with minimized objectives:

$$\begin{aligned} & \min f_p(x) \\ & \text{s.t.} \\ & \quad f_1(x) \leq e_1 \\ & \quad f_2(x) \leq e_2 \\ & \quad \dots \\ & \quad f_{p-1}(x) \leq e_{p-1} \\ & \quad x \in R \end{aligned} \quad (5.74)$$

where  $e = (e_1, e_2, \dots, e_{p-1})$  is the vector of satisfaction levels which stipulates the maximum allowance on the constrained objectives. Solutions can be obtained by parametrical variations of satisfaction levels of vector  $e$  in the right side of constraints. The interested readers are referred to Deb (2001) and Ehrgott (2005) for more information on this method. Since solving these series of models with optimization software with obtained solutions are usually not efficient (Mavrotas, 2009). In order to guarantee the efficiency of the obtained solutions, the proposed AUGMECON method by Mavrotas (2009) is revised to be used in model (5.74).

The revised method transforms inequality constraints of model (5.74) into equality constraints by introducing non-negative slack variables or surplus variables and then reduces the objective function with the weighted sum of these slack or surplus variables. Accordingly, the model (5.74) is rewritten as follow:

$$\begin{aligned} & \min f_p(x) + \varphi(s_1/\zeta_1 + s_2/\zeta_2 + \dots + s_{p-1}/\zeta_{p-1}) \\ & \text{s.t.} \\ & \quad f_1(x) + s_1 = e_1 \\ & \quad f_2(x) + s_2 = e_2 \\ & \quad \dots \\ & \quad f_{p-1}(x) + s_{p-1} = e_{p-1} \\ & \quad x \in R \text{ and } s_i \in Z^+, i \in [1, \dots, p-1] \end{aligned} \quad (5.75)$$

where  $\varphi$  is an adequately small number usually between  $10^{-3}$  and  $10^{-6}$  and  $\zeta_i$ ,  $i \in [1, \dots, p-1]$ , is the range of  $i$ th objective function. Applying model (5.75), the

proposed bi-objective AMIP reduces to a single-objective AMIP (SAMIP), in which by altering the vector  $e$ , the Pareto-frontier of the AMIP model is obtained.

Mohammadi et al. (2014a) and Zahiri et al. (2014) presented a lower bound procedure for a single objective sustainable hub location problem (SHLP) and an organ transplant network, respectively, while we develop the multi-objective variant of their approach by adding some modification and integrating their lower bound approach by the proposed augmented  $e$ -constraint method to find Pareto lower bound frontier for the AMIP. For this aim, at each variation of vector  $e$  to find Pareto solutions, the lower bound approach is utilized with this exception that visited nodes are removed from the solution space in order to reduce the computational time.

In the MOLB, once the vector  $e$  varies, a lower bound value is found using partial relaxation of a sub-problem of the original SAMIP model. It should be noted that any sub-problem of the original problem  $P_{SAMIP}$  can be created by dividing the set of hubs distinctly. It means that any two sets of hub locations,  $U_\phi$  and  $U_\tau$ , are distinct if there is at least one hub  $k \in U_\phi$  and  $k \notin U_\tau$ . Hence, for each vector  $e$  of the SAMIP model, there will be  $C_p^{|H|} = H!/((H - P)!P!)$  number of distinct hub sets in a network. For each selected set of hubs in SAMIP, corresponding location decision variables  $U_\phi$  are fixed at 1, and the original problem is then reduced to a mixed integer sub-problem ( $SP_{SAMIP}^\phi$ ) over the binary decision variables  $X_{ik}^r, Z_k^{ms}, L_{kl}^m, Y_{ilkj}^m, \xi_\pi^{W,kms}, \xi_\pi^{T,klm}$ . Now let  $PR(SP_{SAMIP}^\phi)$  be the partial relaxation of  $SP_{SAMIP}^\phi$  that relaxes the integrality of some binary variables, i.e., we assume that:  $0 \leq X_{ik}^r, Y_{ilkj}^m, \xi_\pi^{W,kms}, \xi_\pi^{T,klm} \leq 1$ . Besides, let  $Z_{PR(SP_{SAMIP}^\phi)}$  be the objective function value for this partial relaxation. This values can be stated as a lower bound for the optimal value of  $SP_{SAMIP}$ . Now, we can obtain different  $C_p^{|H|}$  solutions among the possible hub sets. It should be noted that may only some sets of hubs are feasible through all  $C_p^{|H|}$  possible hub sets. Afterward, the minimum value between the values among the feasible hub sets determines a lower bound for the optimal value of the original problem  $P_{SAMIP}$  where  $Z_{LB(P_{SAMIP})} = \min_\phi Z_{PR(SP_{SAMIP}^\phi)}$ . This solution also can be stated as one of the solutions of Pareto lower bound frontier of the AMIP model. Accordingly, the vector  $e$  varies and another solution from the Pareto lower bound frontier of the AMIP model is obtained. Finally, it can be easily stated that the proposed MOLB approach provides the Pareto lower bound frontier for the main BORCHLP model.

### 5.8. Multi-objective meta-heuristic algorithm

In this section, we proposed a hybrid meta-heuristic algorithm based on new self-adaptive non-dominated genetic algorithm II (SNSGA-II) and variable neighborhood search (VNS) algorithm, namely SGV-II, in order to find non-dominated front (NF) near to optimal Pareto frontier (PF) of the proposed BORCHLP.

For this purpose, a new solution representation scheme in a matrix form and special solution procedures are proposed.

### 5.8.1. Solution representation scheme

One important decision in designing a meta-heuristic algorithm is to decide how to represent the solution in an efficient way to the search space. In this section, we use continuous representation instead of discrete points. The proposed solution scheme includes the following phases:

#### 5.8.1.1. Hub location (Phase 1)

The first matrix corresponds to the location decision presented by a  $(\mathbf{1} \times \mathbf{H} + \mathbf{1})$  matrix, in which  $\mathbf{H}$  denotes the number of potential hubs. This matrix is filled with random numbers belong to  $[0,1]$ . In this matrix, the first maximum  $P$  numbers are considered as located hubs. For example, consider a network with six potential hubs nodes and  $P = 3$ . The matrix of hub location is a  $(\mathbf{1} \times \mathbf{7})$  matrix as [Figure 5.1](#), in which, three of six potential hub nodes must be located. Therefore, first, fourth and sixth nodes in the hub set are located as hubs. It should be noted that the last array of the matrix that corresponds to the non-failable hub must be equal to 1.

#### 5.8.1.2. Hub capacity level (Phase 2)

This part of solution represents the capacity level considered for each located hub. Similar to *Phase 1*, a  $(\mathbf{1} \times \mathbf{H})$  matrix is generated with random numbers belong to  $[0,1]$ . Next, the matrix is multiplied by the number of capacity levels ( $S$ ) and rounded up. [Figure 5.2](#) shows that located hubs in *Phase 1* have first, third and second levels of capacity.

#### 5.8.1.3. Spoke allocation (Phase 3)

This section represents the allocation of the spokes to the located hubs. Spokes are allocated to failable hubs level by level once they are allocated to the non-failable hub at a certain level. This part of solution contains a  $(\mathbf{N} \times \mathbf{H} + \mathbf{1})$  matrix that is filled by random numbers belongs to  $[0,1]$ . First of all, each row of the matrix is multiplied by the location matrix (*Phase 1*). Next, each spoke is allocated to its biggest corresponding non-zero column as a first level of allocation and this value is replaced by 1. Moreover, the spoke is allocated to the next big value for the next level of allocation and this value is replaced by 2.

This procedure continues  $R$  times (i.e., maximum number of allocation levels) once the spoke is allocated to the non-failable hub at the last column. In a situation that the spoke has not been allocated to the non-failable hub at  $(R - 1)$ th level, that spoke is intentionally allocated to the non-failable hub at level  $R$ . For this aim, the last column of that spoke is replaced by  $R$ . [Figure 5.3](#) shows the spoke allocation for previous example with  $R = 3$ .

Potential Hub Nodes						Non-failable hub
1	2	3	4	5	6	
0.94	0.45	0.02	0.67	0.11	0.59	0.41
$P=3$						
1	0	0	1	0	1	1

Figure 5.1. Hub location representation

Potential Hub Nodes					
1	2	3	4	5	6
0.14	0.65	0.72	0.84	0.01	0.59
$[ \times S = 3 ]$					
1	2	3	3	1	2

Figure 5.2. Hub capacity level

		Potential Hub Nodes						Non-failable hub
		1	2	3	4	5	6	
Location of Hubs		1	0	0	1	0	1	1
Hub	1	0.51	0	0	0.79	0	0.60	0.67
Spoke	2	0.40	0	0	0.85	0	0.03	0.75
Spoke	3	0.72	0	0	0.15	0	0.27	0.74
Hub	4	0.91	0	0	0.03	0	0.04	0.39
Spoke	5	0.63	0	0	0.84	0	0.99	0.65
Hub	6	0.09	0	0	0.93	0	0.12	0.17
Hub	1	-	-	-	-	-	-	-
Spoke	2	-	-	-	1	-	-	2
Spoke	3	-	-	-	-	-	-	1
Hub	4	-	-	-	-	-	-	-
Spoke	5	-	-	-	2	-	1	3
Hub	6	-	-	-	-	-	-	-

Figure 5.3. Spoke allocation

In Figure 5.3, for instance, spoke number 2 has been allocated to failable hub number 4 at the first level and allocated to the non-failable hub at second level. Furthermore, spoke number 3, has been only allocated to the non-failable hub at level one. Besides, spoke number 5, has been allocated to failable hubs number 6 and 4 and the non-failable hub for first, second and third levels of allocation, respectively.

5.8.1.4. Transportation mode (Phase 4)

This part of solution representation contains a  $(H + 1 \times H + 1)$  matrix that illustrates transportation mode assignment between hub nodes. This matrix also is first filled by random numbers belongs to  $[0,1]$ , then is multiplied by number of transportation modes ( $M$ ) and is rounded up. In Figure 5.4, for example, modes number 3, 2 and 1 have been assigned to the links between hub pairs 1 to 4, 1 to 6 and 1 to non-failable hub.

		Potential Hubs						Non-failable hub
		1	2	3	4	5	6	
Potential Hubs	1	0.81	0.27	0.95	0.79	0.67	0.41	0.81
	2	0.90	0.54	0.48	0.95	0.75	0.03	0.90
	3	0.12	0.95	0.80	0.65	0.74	0.27	0.12
	4	0.91	0.96	0.14	0.03	0.39	0.24	0.11

	5	0.63	0.15	0.42	0.84	0.65	0.09	0.63
	6	<b>0.65</b>	0.09	0.98	<b>0.19</b>	0.88	0.54	<b>0.35</b>
	Non-failable hub	<b>0.43</b>	0.29	0.86	<b>0.59</b>	0.72	<b>0.19</b>	0.48
		[× M = 3]						
		⇩						
Potential Hubs	1	-	-	-	<b>3</b>	-	<b>2</b>	<b>3</b>
	2	-	-	-	-	-	-	-
	3	-	-	-	-	-	-	-
	4	<b>3</b>	-	-	-	-	<b>1</b>	<b>1</b>
	5	-	-	-	-	-	-	-
	6	<b>2</b>	-	-	<b>1</b>	-	-	<b>3</b>
	Non-failable hub	<b>2</b>	-	-	<b>2</b>	-	<b>1</b>	-

Figure 5.4. Transportation mode allocation

### 5.8.2. The Proposed algorithm

This section presents a detailed description of the proposed SGV-II algorithm, including the whole algorithmic flow and various features borrowed from NSGA-II and VNS algorithms.

#### 5.8.2.1. Self-adaptive NSGA-II

In this section, a new variant of NSGA-II, namely self-adaptive NSGA-II (SNSGA-II), is proposed to obtain near optimal Pareto solutions of the proposed approximated AMIP in comparison with pure NSGA-II. In the SNSGA-II, a self-adaptive version of crossover and mutation operators is applied. In the literature, several crossover (e.g., one point, two points, three points, uniform, cycle crossover and etc.) and mutation (e.g., Swap, insertion, reversion and etc.) operators have been introduced while using all of them simultaneously in an algorithm extremely increases the computational time. Therefore, many researches have just used a few of them to search the solution space. In the proposed SNSGA-II, several crossover and mutation operators are simultaneously applied without increasing the computational time. Accordingly, the SNSGA-II includes an initialization phase where each crossover and mutation operator obtains a score rather than other operators if it could be able to find better solution at each iteration. At the end of the initialization phase which is limited by a predefined number of iterations, a selection probability (*SP*) metric is calculated for each crossover and mutation operator by dividing the obtained score by number of iterations, in which sum of all selection probabilities is equal to 1. When the initialization phase is finished, the main phase of SNSGA-II is started including searching the solution space using self-adapted crossover and mutation operators and VNS algorithm. The crossover operators applied in this thesis consist of one point, two points, three points, uniform and three parent crossover operators and mutation operators include swap, insertion and reversion operators (Sivanandam and Deepa, 2008). The Pseudo code of the initialization phase of the proposed SNSGA-II has been shown as Figure 5.5.

#### 5.8.2.2. SGV-II algorithm's framework

The flowchart of the proposed SGV-II is depicted as Figure 5.6. The optimization process begins with initializing the SNSGA-II based on Figure 5.5. The

initial population of the proposed SGV-II is randomly generated. After population initialization, each individual is evaluated by the value of objective functions and is ranked based on non-dominated sorting procedure. Afterward, Pareto solutions are archived. A set of genetic operators, including binary tournament selection, self-adapted crossover, and self-adapted mutation, is then performed on the evaluated and ranked population. Next, the Pareto archive is updated. Thereafter, the Pareto solutions are considered for VNS initialization. The local search procedure of VNS (to be detailed in Section 5.8.2.3) is then applied to each individual in the Pareto frontier. Finally, the results from both SNSGA-II and VNS are combined and the final Pareto frontier is extracted. The evolution process is repeated until the stopping criterion is met.

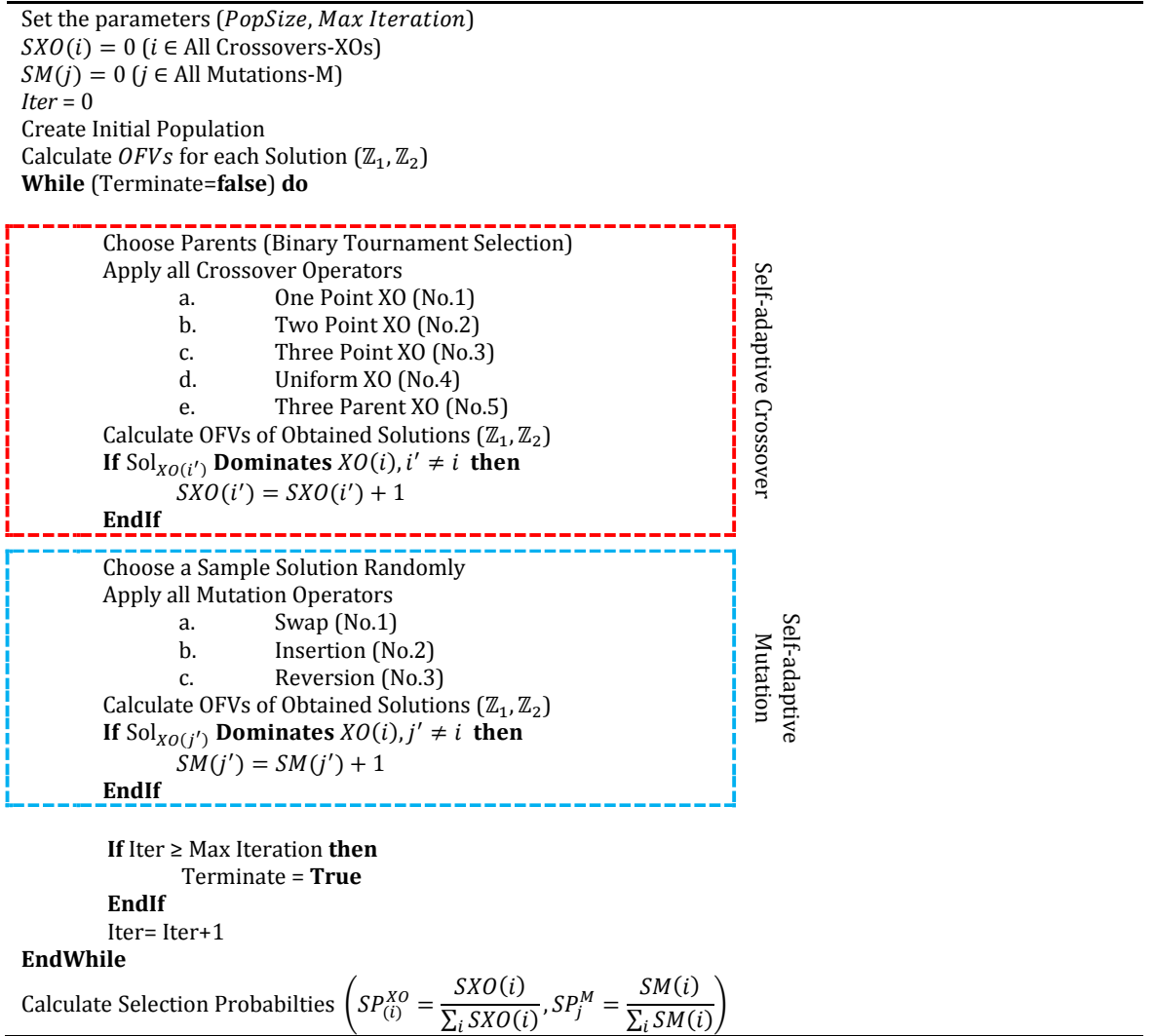

**Figure 5.5.** Pseudo code of SNSGA-II's initialization phase

### 5.8.2.3. Intensification using VNS

It has been proven that genetic algorithms are generally very good at diversifying the solution space but fail to intensify the search in local regions. However, hybridization with local search methods may cope with this weakness and lead to powerful search algorithm. Hence, VNS is hybridized by the proposed SNSGA-

II to balance global exploration and local exploitation during the evolutionary process (Wen et al., 2011). The main steps of the proposed VNS are described in Figure 5.7.

In order to locally search the Pareto solutions in the proposed VNS, three types of move have been proposed, namely *HubChange*, *AssignmentChange*, and *ModeChange*. Using a *HubChange* move, the locations of a hub and a spoke are alternatively substituted. Using the *AssignmentChange* move, the assignments of some spokes are randomly changed. The move *ModeChange* is used whenever the mode type between a pair of hubs is changed. The performance of these moves has been illustrated in Figure 5.8.

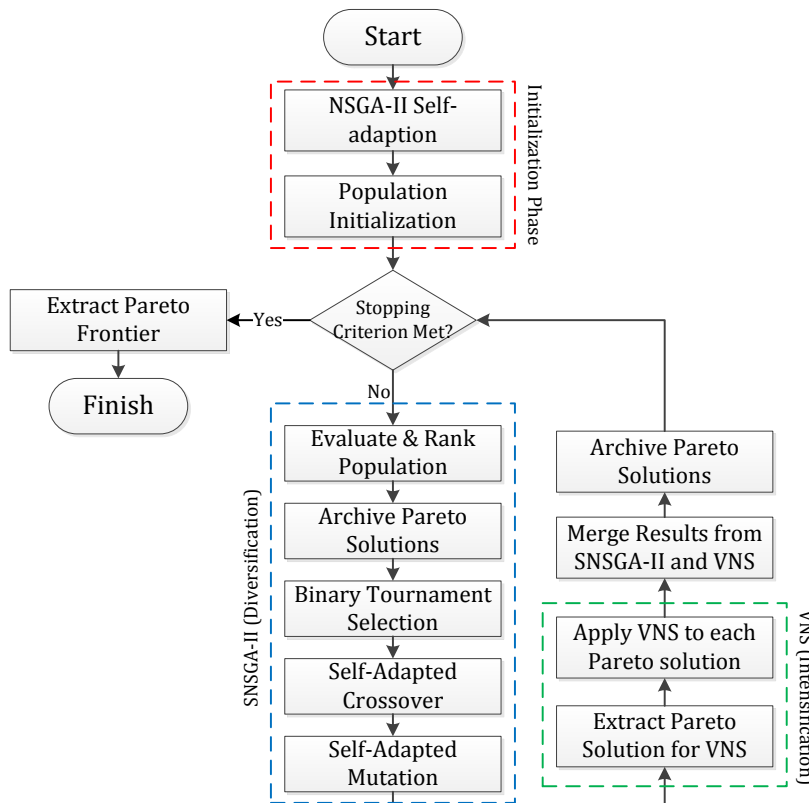

Figure 5.6. Flowchart of the proposed SGV-II

Extract the set of the Pareto solutions (SPS) obtained by SNSGA-II

Select the set of neighborhood structures  $\mathbb{N}_h$  ( $h = 1, 2, \dots, h_{max}$ )

**For** each individual  $x$  in the SPS **Do**

$h = 1$

**While** (Terminate = false) **do**

*Sub-optimality avoidance*: Randomly generate a solution  $x'$  from the  $h$ th neighborhood of  $x$

*Local search*: Search  $x'$  locally to obtain possible better local optimum solution  $\leftarrow x''$

**If**  $x''$  is better than  $x$  **Then**

Substitute  $x$  by  $x''$  ( $x \leftarrow x''$ )

$h = 1$

**Else**

$h = h + 1$

**Endif**

**If**  $h \geq h_{max}$  **Then**

Terminate = True

**Endif**

**EndWhile**

**EndFor**

Figure 5.7. Main steps of VNS in the SGV-II algorithm

5.8.2.4. Termination criteria

Dual termination criteria are used in the SGV-II algorithm. The first criterion limits the number of iterations in both SNSGA-II and VNS algorithm. This criterion is set to 30 for the local search in the proposed VNS, while its value for SNSGA-II depends on the size of the problem and varies from 100 to 500. The second criterion is considered only for the proposed VNS algorithm that sets the maximum number of iterations without improvement to 5.

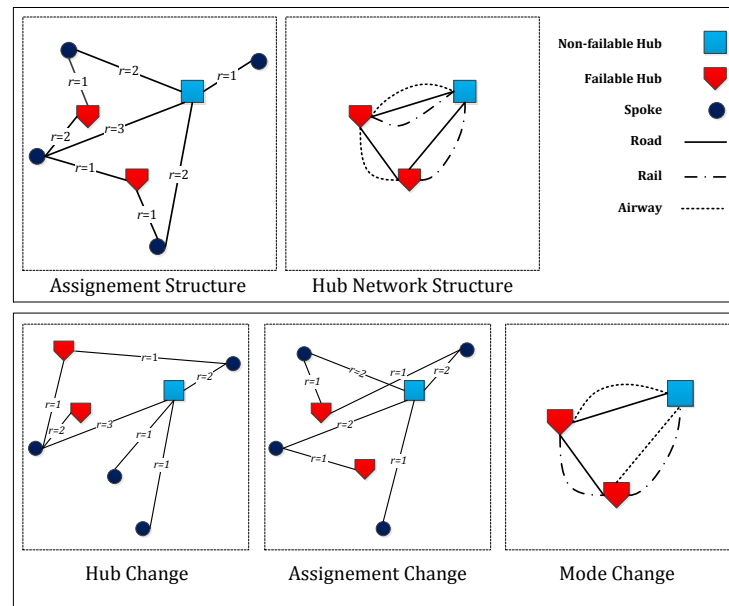

Figure 5.8. Performance of the proposed local searches

Table 5.1. Sources of random data generation

Parameters	Problem size		
	Small	Medium	Large
$N$	$5 \leq I \leq 15$	$20 \leq I \leq 40$	$50 \leq I \leq 70$
$H$	$1 \leq H \leq 3$	$2 \leq H \leq 5$	$4 \leq H \leq 6$
$M$	$1 \leq M \leq 2$	$1 \leq M \leq 3$	$1 \leq M \leq 3$
$P$	$2 \leq M \leq 5$	$4 \leq M \leq 8$	$6 \leq M \leq 16$
$R$	$2 \leq R \leq P$	$3 \leq R \leq P$	$4 \leq R \leq P$
$S$	$1 \leq S \leq 3$	$1 \leq S \leq 3$	$1 \leq S \leq 3$
$w_{ij}$	$Poisson(150)$	$Poisson(300)$	$Poisson(500)$
$c_{ij}^m$	$U \sim (40,60)$	$U \sim (100,300)$	$U \sim (400,1000)$
$oc_k^{ms}$	$U \sim (5,10)$	$U \sim (10,25)$	$U \sim (15,30)$
$FH_k^{ms}$	$U \sim (1000,2500)$	$U \sim (2000,4000)$	$U \sim (5000,15000)$
$FL_{kl}^m$	$U \sim (200,500)$	$U \sim (400,1000)$	$U \sim (500,1500)$
$t_{ij}^m$	$U \sim (20,50)$	$U \sim (40,100)$	$U \sim (50,150)$
$\alpha_{ij}^m$	0.95	0.90	0.85
$\alpha_{ij}^m$	0.90	0.85	0.80
$\bar{l}_k^{sm}$	$U \sim (1000,2000)$	$U \sim (5000,8000)$	$U \sim (10000,15000)$
$\bar{\xi}_{kl}^m$	$U \sim (300,800)$	$U \sim (1000,2000)$	$U \sim (3000,6000)$
$q_k$	$U \sim (0.01,0.05)$	$U \sim (0.05,0.1)$	$U \sim (0.05,0.2)$
$\mu_k^{ms}$	$Poisson(600)$	$Poisson(1200)$	$Poisson(2000)$
$f_k^{ms}$	$Poisson(150)$	$Poisson(300)$	$Poisson(500)$
$r_k^{ms}$	$Exp(10)$	$Exp(30)$	$Exp(50)$
$\eta_k^{ms}$	$U \sim (0.01,0.05)$	$U \sim (0.05,0.1)$	$U \sim (0.05,0.2)$
$\theta_k^{ms}$	$U \sim (0.80,0.95)$	$U \sim (0.70,0.90)$	$U \sim (0.70,0.80)$



$\vartheta_{kl}^m$	$U\sim(0.01,0.05)$	$U\sim(0.05,0.1)$	$U\sim(0.05,0.2)$
$\delta_{kl}^m$	$U\sim(0.80,0.95)$	$U\sim(0.70,0.90)$	$U\sim(0.70,0.80)$

## 5.9. Experiments

### 5.9.1. Test problems

To illustrate the validity of the proposed BORCHLP model and the effectiveness of the proposed solution approaches, several numerical experiments in small, medium and large sizes are carried out and the related results are reported in this section. The details of parameters and the size of test instances are listed in [Table 5.1](#).

### 5.9.2. Experimental setup

The performance of the proposed SGV-II algorithm is compared with those of the other three state-of-art multi-objective algorithms, including MOICA ([Mohammadi et al., 2013; Mohammadi et al., 2014b](#)), MOIWO ([Niakan et al., 2015](#)), and NSGA-II ([Mohammadi et al., 2013](#)). The parameter settings used in the proposed SGV-II and other algorithms in comparison are summarized in [Table 5.2](#). Unless otherwise specified, the following values are used in our comparative evaluation. All algorithms are compiled in MATLAB software and are executed on a Pentium 4 CPU with 3.4 GHz processor and 4 GB of memory and 10 times for each problem.

**Table 5.2.** Parameter settings used in the proposed SGV-II

Parameter	SGV-II	MOICA	MOIWO	NSGA-II
Population size	80 <sup>S</sup> , 150 <sup>M</sup> , 200 <sup>L</sup> *	80 <sup>S</sup> , 150 <sup>M</sup> , 200 <sup>L</sup>	80 <sup>S</sup> , 150 <sup>M</sup> , 200 <sup>L</sup>	80 <sup>S</sup> , 150 <sup>M</sup> , 200 <sup>L</sup>
Number of iteration	150 <sup>S</sup> , 250 <sup>M</sup> , 500 <sup>L</sup>	150 <sup>S</sup> , 250 <sup>M</sup> , 500 <sup>L</sup>	150 <sup>S</sup> , 250 <sup>M</sup> , 500 <sup>L</sup>	150 <sup>S</sup> , 250 <sup>M</sup> , 500 <sup>L</sup>
Selection operator	Binary tournament	Power-based selection	Power-based selection	Binary tournament
Crossover operator	See <a href="#">Figure 5.8</a>	Assimilation	Random local search	Random one-point
Mutation operator	See <a href="#">Figure 5.8</a>	Revolution	-	Random mutation
Crossover rate	0.8	0.8	-	0.8
Mutation rate	0.2	0.2	-	0.2

\*S: Small size; M: Medium size; L: Large size.

### 5.9.3. Performance metrics

To validate the proposed SGV-II, we used the methodology normally adopted in the evolutionary multi-objective optimization literature. The five common metrics used to compare SGV-II with other multi-objective evolutionary algorithms (MOEAs) are (1) quality metric (QM), (2) convergence metric (CM), (3) divergence metric (DM), (4) spacing metric (SM), and (5) mean ideal distance (MID) metric. They represent both quantitative and qualitative comparisons with MOEAs. For these metrics we need to know the true Pareto front. For more detail, the readers are referred to [Deb et al. \(2001\)](#).

## 5.10. Results and discussion

We coded the proposed BOCRHL model and MOLB approach at the GAMS software utilizing Cplex solver. We compared our MOLB approach with optimal value in small and some medium size instances in terms of performance metrics (see [Section 5.9.3](#)) to show the tightness of MOLB, while for larger size of the problem, the

optimal solution cannot be obtained due to NP-hard nature of the problem and limited memory of the GAMS software. It is obvious that the value of QM for MOLB is equal to 1 because NF obtained by MOLB absolutely dominates the optimal PF. Therefore, we neglect QM in the comparison between optimal solutions and those obtained by MOLB. Hereafter, the optimal solutions are called solutions obtained by “Cplex” and those of obtained by MOLB are called “MOLB”. It should be mentioned that the results of Cplex have been obtained by solving the main BOCRHLP without any relaxation and approximation. The results have been tabulated in Table 5.3 to 5.5, respectively, for small, medium and large size instances.

Considering Tables 5.3 and 5.4, the computational time of optimal PF is significantly increased from 88 to 16894 seconds with the increase of problem size. While the CPU time for the proposed MOLB remains below 3580 seconds for the largest corresponding instances. In Table 5.4, the last optimal PF was obtained for problem number 14 with CPU time close to 5 hours (16894 seconds). For larger medium-size instances, the GAMS solver cannot find a solution due to high required memory. According to CM metric for the first 14 problems, it can be concluded that the mean tightness of the proposed MOLB is equal to 1.05%. It means that the gap between the NF of MOLB and optimal PF is equal to 1.05%. Over small and medium size instances, the effectiveness (quality of solution) of the proposed MOLB approach can be shown in terms of low gap (closeness to optimal solution), and its efficiency can be demonstrated by low CPU time. Finally, in Table 5.5, NF of MOLB is obtained for the largest problem with computational time up to approximately 3.4 hour (12345 seconds). Since Tables 5.3 to 5.5 shows the quantitative results, finally, Figures 5.9a to 5.9d illustrate qualitative results by illustrating the obtained NFs and optimal PFs for four samples of problems.

**Table 5.3.** Results of small size instances

Problem No	Cplex				MOLB				
	DM	SM	MID	CPU (s)	CM	DM	SM	MID	CPU (s)
1	0.721	0.549	0.851	88	0.587	0.875	0.315	0.774	52
2	0.612	0.681	0.769	157	0.892	1.058	0.441	0.621	99
3	0.481	0.429	0.821	324	0.792	1.117	0.286	0.553	157
4	0.395	0.514	0.763	459	0.991	0.984	0.416	0.671	220
5	0.510	0.629	0.660	894	0.769	1.159	0.333	0.452	301
6	0.518	0.549	0.696	1227	0.681	1.146	0.417	0.513	456
7	0.346	0.661	0.719	1767	0.885	1.261	0.353	0.447	568
8	0.298	0.842	0.749	2960	1.174	0.976	0.413	0.542	974
9	0.379	0.749	0.806	4016	1.188	0.917	0.331	0.468	1288
10	0.519	0.798	0.942	5663	1.246	1.224	0.601	0.468	1641

**Table 5.4.** Results of medium size instances

Problem No	Cplex				MOLB				
	DM	SM	MID	CPU (s)	CM	DM	SM	MID	CPU (s)
11	0.557	0.842	0.914	7649	1.423	1.103	0.341	0.587	2138
12	0.496	0.691	0.865	9792	1.372	0.886	0.271	0.601	2645
13	0.671	0.713	0.911	12578	1.219	1.076	0.457	0.628	3164
14	0.659	0.000	0.879	16894	1.483	1.137	0.149	0.419	3580
15	-	-	-	-	-	1.425	0.553	0.497	4103
16	-	-	-	-	-	1.022	0.379	0.446	4723
17	-	-	-	-	-	1.341	0.289	0.557	5249

## Chapter V: Hub Location Problem

18	-	-	-	-	-	1.108	0.401	0.671	5968
19	-	-	-	-	-	0.994	0.314	0.492	6398
20	-	-	-	-	-	0.948	0.370	0.409	6851

A paired  $t$  test was conducted to see whether the significant difference exists between NF obtained by the proposed MOLB and the optimal PF by GAMS or not considering CM, DM, SM and MID comparison metrics. Let  $D_i$  equals to difference between the calculated values of two approaches for test problem  $i$ . So the statistics are:

$$t = \frac{\sqrt{n} \times \bar{D}}{S_D} \quad \text{where} \quad \bar{D} = \frac{\sum \bar{D}}{n} \quad \text{and} \quad S_D = \sqrt{\frac{\sum (D_i - \bar{D})^2}{n - 1}} \quad (5.76)$$

**Table 5.5.** Results of large size instances

Problem No	Cplex				MOLB				
	DM	SM	MID	CPU (s)	CM	DM	SM	MID	CPU (s)
21	-	-	-	-	-	1.234	0.298	0.416	7298
22	-	-	-	-	-	1.247	0.168	0.351	7652
23	-	-	-	-	-	0.983	0.332	0.419	8197
24	-	-	-	-	-	0.893	0.265	0.335	8987
25	-	-	-	-	-	1.354	0.331	0.438	9391
26	-	-	-	-	-	1.541	0.316	0.339	9779
27	-	-	-	-	-	1.319	0.451	0.518	10592
28	-	-	-	-	-	0.996	0.213	0.571	11012
29	-	-	-	-	-	0.946	0.441	0.349	11786
30	-	-	-	-	-	1.112	0.238	0.437	12345

We conducted the paired  $t$  test by 14 test problems in the SPSS software. By referencing to  $t$  table, for 13degrees of freedom the significances (2-tailed) are closed to 0.000. The detailed statistics are shown in Table 5.6. These tests show that there are not statistical significant differences between solutions obtained by MOLB and those of the Cplex in terms of SM, DM, and MID metrics while MOLB obtains solutions in considerably lower CPU time.

**Table 5.6.** Detailed statistics of paired  $t$  test

Metric	Paired Differences						$t$	$df$	Sig. (2-tailed)
	Mean	Std. Deviation	Std. Error Mean	95% Confidence Interval of the Difference					
				Lower	Upper				
DM	-0.554	0.179	0.048	-0.658	-0.451	-11.56	13	0.00	
SM	0.252	0.168	0.045	0.154	0.349	5.593	13	0.00	
MID	0.257	0.119	0.032	0.189	0.326	8.118	13	0.00	

Hereafter, we perform an additional experiment to validate the performance and the efficiency of the proposed SGV-II algorithm comparing to MOLB approach, MOICA, MOIWO, and NSGA-II in terms of CM, DM, SM and MID comparison metrics. The experiment is designed to determine whether the proposed SGV-II algorithm really provides high-quality NF. The results for small, medium and large instances are shown in Tables 5.7 to 5.9, respectively. It should be noted that the value of CM,

## Chapter V: Hub Location Problem

DM, SM and MID metrics for meta-heuristics has been obtained comparing to MOLB approach.

The results from Tables 5.7 to 5.9 show the higher performance of the proposed SGV-II comparing to the well-known meta-heuristic algorithms considering obtained lower values for CM, DM, and MID metrics and higher value of DM metric. In addition, the efficiency of the proposed SGV-II can be shown by lower computational time to obtain non-dominated solutions. The high performance of the proposed SGV-II is demonstrated according to QM metric where the NF by SGV-II completely dominates NFs of other algorithms in almost all problem instances. Considering CM metric, the mean gap between the proposed SGV-II and MOLB is equal to 2.03%. By a simple calculation, it can be concluded that the mean gap between the NF of SGV-II and optimal PF is equal to 0.98% (i.e., 2.03-1.05). This value is equal to 3.5%, 3.92%, and 3.65% for MOICA, MOIWO, and NSGA-II, respectively. The CPU time for the meta-heuristic algorithms is increased from 15 to 2543 seconds, 17 to 2843 seconds, and 13 to 2610 for MOICA, MOIWO, and NSGA-II, respectively, while this time for the proposed SGV-II is 12 seconds for the smallest size instance and is increased modestly to 1319 seconds for the largest instance.

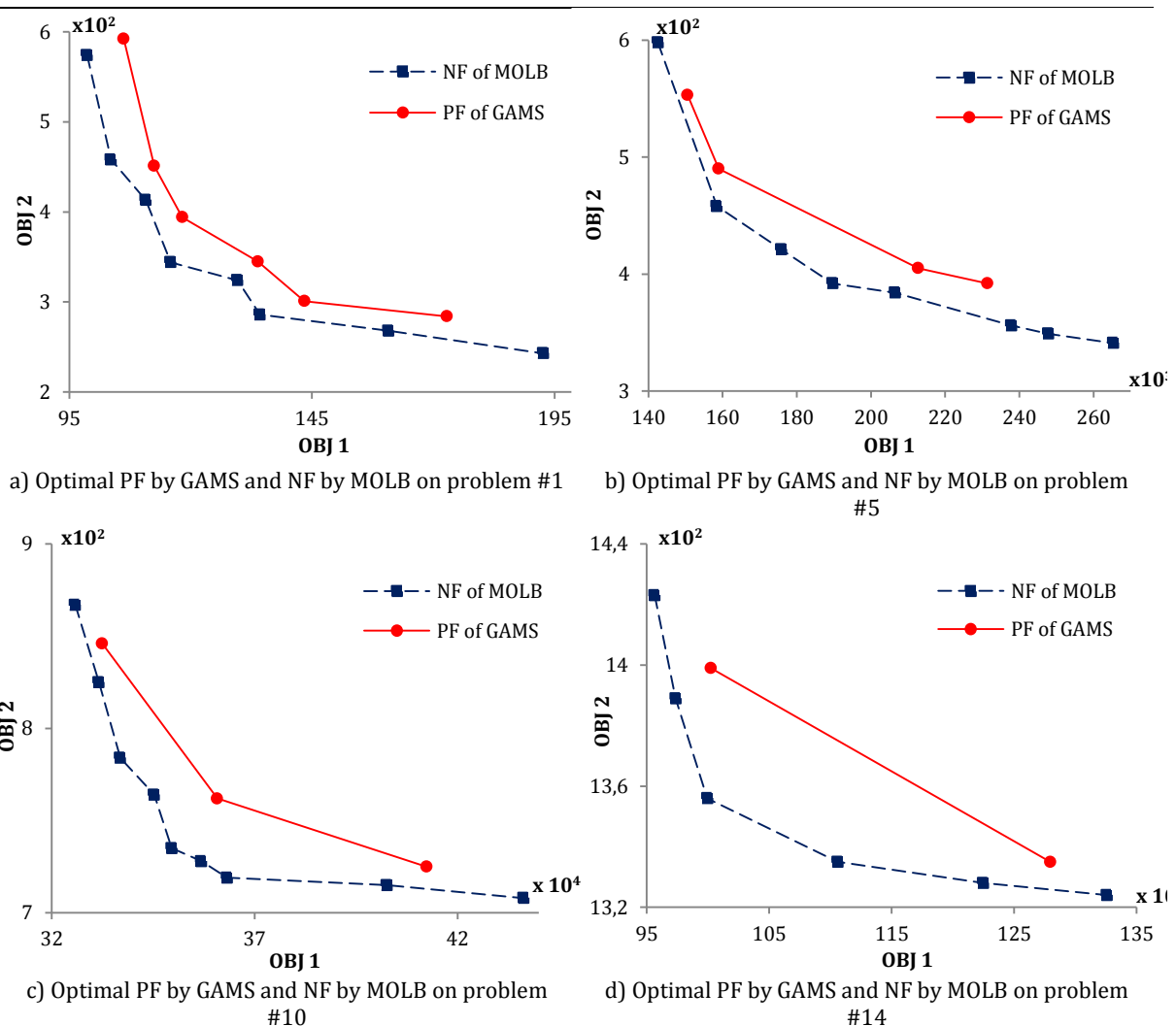

Figure 5.9. Optimal PF by GAMS and NF by MOLB

Table 5.7. Results of small size instances

Problem No	SGV-II						MOICA					
	QM	CM	DM	SM	MID	CPU (s)	QM	CM	DM	SM	MID	CPU (s)
1	0.50	0.649	0.994	0.221	0.558	12	0.30	0.967	0.813	0.349	0.689	15
2	0.70	0.942	1.124	0.319	0.486	19	0.10	1.177	0.876	0.485	0.667	24
3	1	0.894	1.276	0.318	0.437	27	0	1.135	0.816	0.476	0.746	32
4	0.85	1.113	1.234	0.284	0.437	36	0.05	1.258	1.008	0.389	0.619	49
5	0.80	0.812	1.286	0.296	0.529	45	0.10	1.082	1.104	0.512	0.712	65
6	1	0.773	1.319	0.331	0.412	56	0	1.082	0.943	0.498	0.557	89
7	1	1.187	1.186	0.419	0.378	68	0	1.291	0.974	0.678	0.539	113
8	1	1.498	1.343	0.289	0.443	74	0	1.867	0.873	0.389	0.694	148
9	0.90	1.749	1.221	0.297	0.311	88	0.10	1.301	1.017	0.446	0.584	181
10	1	1.489	1.471	0.476	0.402	102	0	1.985	1.110	0.647	0.671	218
	MOIWO						NSGA-II					
	QM	CM	DM	SM	MID	CPU (s)	QM	CM	DM	SM	MID	CPU (s)
1	0	1.258	0.776	0.296	0.713	17	0.20	1.009	0.740	0.298	0.614	13
2	0	1.368	1.029	0.398	0.558	26	0	1.288	0.558	0.469	0.735	22
3	0.10	1.590	1.213	0.467	0.648	39	0.10	1.412	0.889	0.429	0.665	28
4	0	1.636	0.819	0.459	0.571	53	0.10	1.158	1.114	0.578	0.710	41
5	0	1.279	1.537	0.572	0.843	74	0.10	1.566	0.935	0.619	0.706	60
6	0	1.613	0.971	0.519	0.643	102	0	1.489	1.005	0.458	0.623	92
7	0	2.404	0.729	0.643	0.573	143	0	2.261	0.976	0.713	0.571	121
8	0	2.867	0.833	0.571	0.737	188	0	2.436	1.022	0.513	0.713	158
9	0	2.598	0.910	0.519	0.648	236	0	2.431	1.078	0.648	0.632	215
10	0	2.486	1.102	0.446	0.715	281	0	2.371	0.941	0.571	0.741	234

Figure 5.10 schematically shows the CPU time of different algorithms is increased by increasing the size of the problem. The higher efficiency of the proposed SGV-II algorithm can be followed in Figure 5.10 where the CPU time stays low even for larger size instances comparing to other state-of-art algorithms.

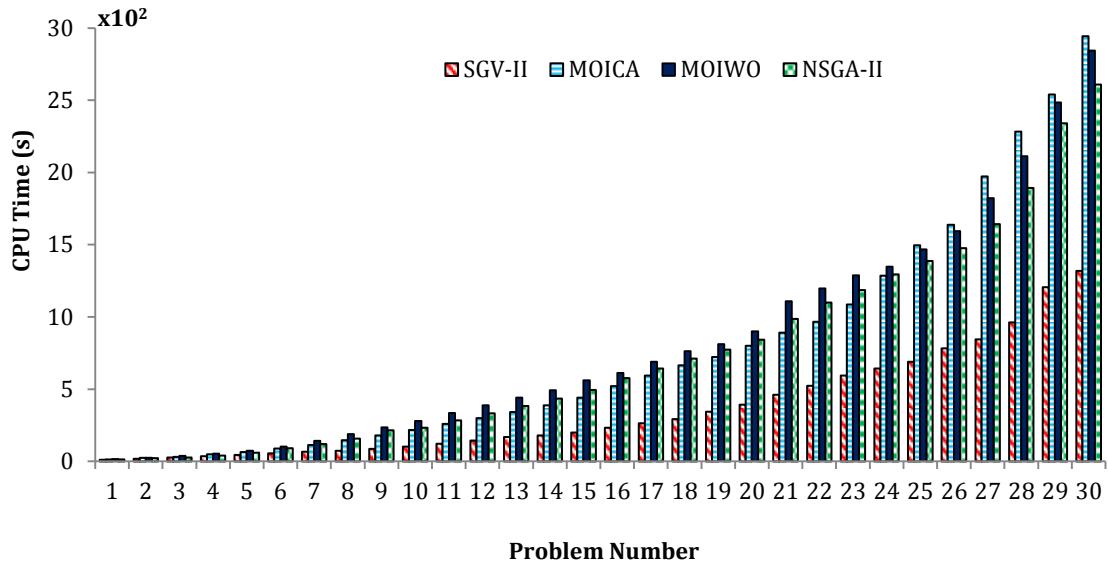

Figure 5.10. CPU time of different algorithms for different problems

Table 5.8. Results of medium size instances

Problem No	SGV-II						MOICA					
	QM	CM	DM	SM	MID	CPU (s)	QM	CM	DM	SM	MID	CPU (s)
11	1	1.865	1.123	0.221	0.558	123	0	2.592	0.691	0.349	0.689	259
12	1	1.942	1.101	0.319	0.486	144	0	2.951	0.770	0.485	0.667	299
13	1	1.768	1.186	0.318	0.437	169	0	2.192	0.873	0.476	0.746	341
14	1	1.668	1.024	0.284	0.437	181	0	2.618	0.927	0.389	0.619	389
15	1	1.852	1.285	0.296	0.529	201	0	2.944	1.104	0.512	0.712	442
16	1	1.789	1.131	0.331	0.412	234	0	2.808	1.007	0.498	0.557	521
17	1	2.013	1.261	0.419	0.378	264	0	3.199	1.032	0.678	0.539	594
18	1	1.896	1.437	0.289	0.443	294	0	2.844	0.838	0.389	0.694	665
19	1	1.889	1.233	0.297	0.311	344	0	2.569	1.159	0.446	0.584	723
20	1	2.011	1.547	0.476	0.402	394	0	2.995	1.254	0.647	0.671	801
	MOIWO						NSGA-II					
	QM	CM	DM	SM	MID	CPU (s)	QM	CM	DM	SM	MID	CPU (s)
11	0	2.443	0.892	0.713	0.855	336	0	2.545	0.784	0.542	0.736	285
12	0	3.210	1.234	0.521	0.591	389	0	3.185	0.513	0.636	0.815	332
13	0	2.239	0.913	0.429	0.817	441	0	2.058	0.791	0.559	0.778	384
14	0	2.552	0.819	0.585	0.759	492	0	2.568	0.980	0.606	0.972	435
15	0	3.307	0.927	0.474	1.087	561	0	2.815	1.428	0.843	0.994	494
16	0	2.582	1.097	0.560	0.861	613	0	2.419	0.834	0.608	0.865	576
17	0	3.640	0.707	0.765	0.722	689	0	2.997	0.907	0.770	0.631	643
18	0	2.749	0.741	0.788	0.928	764	0	3.090	0.858	0.523	0.912	711
19	0	3.550	1.019	0.608	0.753	812	0	3.285	0.971	0.748	0.821	774
20	0	3.584	1.143	0.698	0.765	901	0	3.432	0.922	0.631	0.878	842

Table 5.9. Results of large size instances

Problem No	SGV-II						MOICA					
	QM	CM	DM	SM	MID	CPU (s)	QM	CM	DM	SM	MID	CPU (s)
21	1	2.514	1.381	0.493	0.502	461	0	5.455	0.739	0.328	0.751	892
22	1	2.471	0.946	0.447	0.505	523	0	4.892	0.831	0.611	0.873	968
23	1	2.615	1.352	0.594	0.610	594	0	4.759	1.030	0.637	1.074	1087
24	1	2.715	0.860	0.323	0.667	643	0	6.245	1.084	0.525	0.903	1286
25	1	2.915	1.323	0.446	0.549	689	0	6.179	1.115	0.578	0.875	1496

## Chapter V: Hub Location Problem

26	1	3.165	1.549	0.413	0.457	783	0	6.219	0.976	0.468	0.785	1638
27	1	3.421	1.664	0.698	0.727	846	0	6.328	1.022	0.935	0.716	1974
28	1	3.619	1.696	0.367	0.531	962	0	7.762	0.888	0.385	0.923	2284
29	1	3.762	1.501	0.486	0.576	1207	1	7.911	1.193	0.611	0.889	2541
30	1	3.894	1.201	0.566	0.714	1319	0	8.060	1.254	0.808	0.852	2943
MOIWO							NSGA-II					
	QM	CM	DM	SM	MID	CPU (s)	QM	CM	DM	SM	MID	CPU (s)
21	0	4.034	1.061	0.777	1.068	1108	0	4.133	0.838	0.651	0.839	986
22	0	4.741	1.034	0.693	0.750	1197	0	4.353	0.548	0.664	0.623	1099
23	0	5.388	0.922	0.549	0.866	1289	0	5.227	0.759	0.709	0.811	1186
24	0	6.354	0.859	0.926	0.796	1348	0	6.197	1.058	0.696	0.710	1294
25	0	6.598	0.927	0.678	1.173	1467	0	6.034	1.499	0.918	1.083	1387
26	0	7.680	0.986	0.737	1.076	1593	0	6.779	0.775	0.832	1.063	1476
27	0	7.753	0.763	0.848	0.895	1822	0	6.883	1.015	1.008	0.744	1642
28	0	8.432	0.766	0.929	1.030	2112	0	7.545	0.823	0.753	0.921	1894
29	0	8.271	0.869	0.814	0.963	2486	0	8.089	0.903	0.927	0.919	2341
30	0	9.562	1.188	0.974	0.940	2843	0	8.559	1.014	0.731	1.274	2610

In order to schematically show the high performance of the proposed SGV-II in obtaining quality solutions, the NFs of different algorithms are illustrated in Figures 5.11 and 5.12 for instances number 5 and 30, respectively.

In order to study whether there is a significant difference between NF obtained by MOLB and NFs obtained by meta-heuristic algorithms, a paired  $t$  test is conducted considering CM, DM, SM and MID comparison metrics as shown in Table 5.10. Similar analysis is conducted to compare the performance of the proposed SGV-II approach and other meta-heuristic algorithms, as listed in Table 5.11. The results of Table 5.10 shows that there is no significant difference between the proposed SGV-II and MOLB approach, while significant difference exists between other meta-heuristic algorithms and MOLB. This means that the proposed SGV-II leads to near optimal solutions. On the other hand, Table 5.11 demonstrates that the proposed SGV-II obtains high quality non-dominated solutions compare to other meta-heuristic algorithms.

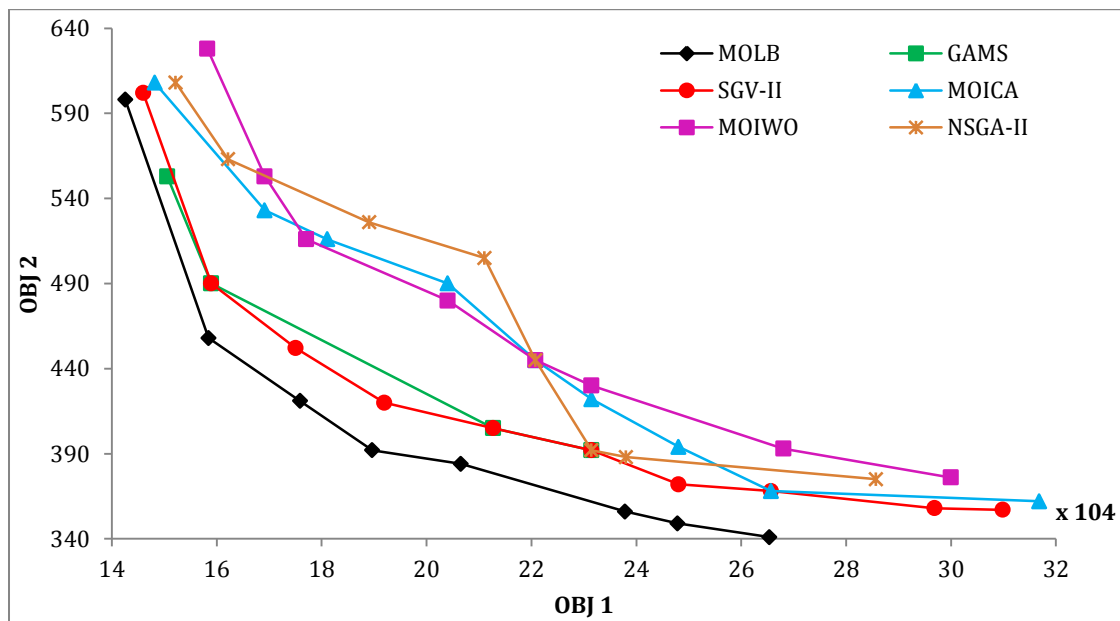

Figure 5.11. NFs of different meta-heuristics fro problem number 5

Table 5.10. Paired *t* test for comparison between MOLB and meta-heuristics

Metric	Pair	Paired Differences					<i>t</i>	<i>df</i>	Sig.
		Mean	Std.	Std. Error Mean	95% Confidence Interval				
					Lower	Upper			
CM	SGV-II	0.122	0.188	0.034	0.051	0.191	3.54	.001	
DM		0.162	0.225	0.041	0.078	0.246	3.96	.003	
SM		0.028	0.148	0.027	-0.027	0.083	1.05	.002	
MID		-0.012	0.159	0.029	-0.072	0.047	-0.42	.009	
CM	MOICA	1.581	1.322	0.241	1.087	2.074	6.54	.512	
DM		-0.135	0.221	0.040	-0.218	-0.053	-3.35	.018	
SM		0.171	0.160	0.029	0.111	0.231	5.86	.673	
MID		0.220	0.195	0.036	0.147	0.293	6.17	.205	
CM	MOIWO	2.017	1.487	0.271	1.462	2.572	7.43	.698	
DM		-0.153	0.256	0.047	-0.249	-0.057	-3.27	.003	
SM		0.282	0.229	0.042	0.197	0.368	6.76	.025	
MID		0.312	0.229	0.042	0.226	0.397	7.46	.000	
CM	NSGA-II	1.745	1.270	0.232	1.271	2.220	7.52	.610	
DM		-0.1968	0.230	0.042	-0.283	-0.111	-4.68	.002	
SM		0.305	0.185	0.034	0.237	0.375	9.04	.093	
MID		0.304	0.220	0.040	0.221	0.386	7.55	.012	

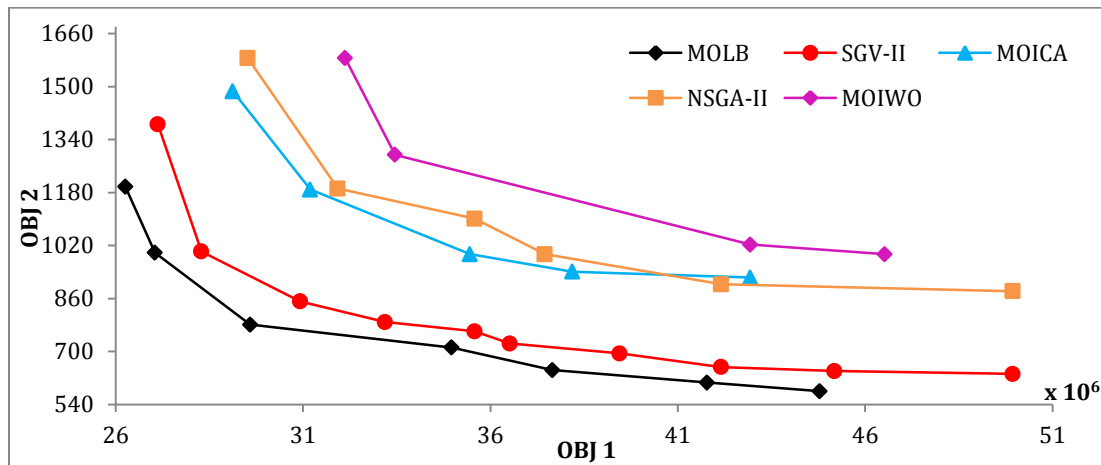

Figure 5.12. NFs of different meta-heuristics from problem number 30

Table 5.11. Paired *t* test for comparison between SGV-II and meta-heuristics

Metric	Pair	Paired Differences					<i>t</i>	<i>df</i>	Sig.
		Mean	Std.	Std. Error Mean	95% Confidence Interval				
					Lower	Upper			
CM	MOICA	-1.459	1.407	0.257	-1.984	-0.934	-5.67	.429	
DM		0.298	0.218	0.039	0.216	0.379	7.48	.120	
SM		-0.143	0.083	0.015	-0.174	-0.112	-9.43	.319	
MID		-0.232	0.096	0.018	-0.268	-0.196	-13.19	.338	
CM	SGV-II	-1.895	1.559	0.285	-2.478	-1.314	-6.66	.643	
DM		0.316	0.281	0.051	0.211	0.421	6.14	.312	
SM		-0.254	0.153	0.028	-0.311	-0.197	-9.07	.313	
MID		-0.324	0.154	0.028	-0.381	-0.266	-11.55	.419	
CM	NSGA-II	-1.624	1.341	0.245	-2.125	-1.123	-6.63	.519	
DM		0.359	0.266	0.048	0.260	0.458	7.40	.187	
SM		-0.277	0.124	0.023	-0.324	-0.231	-12.24	.418	
MID		-0.316	0.160	0.029	-0.376	-0.256	-10.80	.504	

### 5.11. Case study



With an efficient SGV-II algorithm at hand, we are now able to solve the problem on the original French transportation network (FTN) to validate the performance of the proposed model and the solution approaches. Transportation in France relies on one of the densest networks in the world with 146 km of road and 6.2 km of rail lines per 100 km<sup>2</sup>. The transportation sector includes such dynamic companies as the National Society of French Railways-SNCF, the state-owned railways operator, and Air France, the national airline. Closely allied are manufacturers of transport equipment and the civil engineering concerns responsible for constructing new infrastructure. Generally, France benefits from a dense and diversified transport network, limited only by its still excessive focus upon the capital city ([Encyclopedia Britannica Online, 2015](#)). FTN utilizes different modes of transportation including road, rail, air and waterways (i.e., inland and marine) modes. There are 1,000,960 km of roads in France, accounting for 85% of passenger travel. There is also a total of 64,900 kilometers of railway in France. However, the railway system is a small portion of total travel, accounting for less than 10% of passenger travel. The French natural and man-made waterways network is the largest in Europe extending to over 8,500 kilometers. Waterway transportation in France includes two main inland and marine modes of transportation. Inland mode has made up of 3,800 kilometers of canals and 2,900 kilometers of navigable rivers often to transport goods and cargos. On the other hand, France operates over 1,400 ships. Each year, 305 million tons of goods and 15 million passengers are transported by sea. Besides, marine transport is responsible for 72% of France's imports and exports ([EU transport in figures, 2014](#)). In addition, transportation in France has had turnover totally equal to 103 billion € at 2010, in which the contribution of road, rail, air and waterway modes of transportation is equal to 56 (i.e., 54.4%), 19 (i.e., 18.5%), 18 (i.e., 17.5%), and 10 (i.e., 9.6%) billion €, respectively ([EU transport in figures, 2014](#)). We use a special instance on cargo and passenger transportation network in France between 48 cities (see [Figure 5.13](#)). In this case, three rail, roads and air transportation modes have been considered.

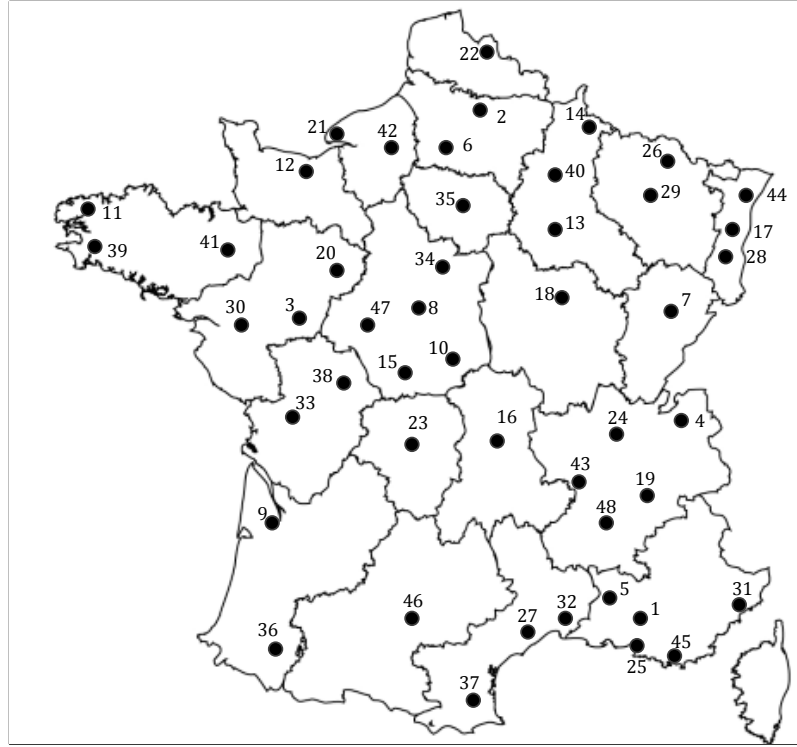

1	Aix	13	Champagne-Ardenne	25	Marseille	37	Perpignan
2	Amiens	14	Charleville-Mézières	26	Metz	38	Poitiers
3	Angers	15	Châteauroux	27	Montpellier	39	Quimper
4	Annecy	16	Clermont-Ferrand	28	Mulhouse	40	Reims
5	Avignon	17	Colmar	29	Nancy	41	Rennes
6	Beauvais	18	Dijon	30	Nantes	42	Rouen
7	Brégançon	19	Grenoble	31	Nice	43	ST. Etienne
8	Blois	20	La Mans	32	Nimes	44	Strasbourg
9	Bordeaux	21	Le Havre	33	Niort	45	Toulon
10	Bourges	22	Lille	34	Orléans	46	Toulouse
11	Brest	23	Limoges	35	Paris	47	Tours
12	Caen	24	Lyon	36	Pau	48	Valence

Figure 5.13. France cities

The unit transportation cost ( $c_{ij}^m$ ), fixed cost of connection links ( $FL_{kl}^m$ ) and travel time ( $t_{ij}^m$ ) for both road and air modes can be calculated based on the distance between cities. We also considered  $\alpha c_{ij}^m$  and  $\alpha t_{ij}^m$  equal to 0.8 and 0.75, respectively. We extended the FTN dataset by defining three levels for designed capacity of the hub nodes ( $\bar{F}_k^{sm}$ ) as: small ( $s = 1$ ), medium ( $s = 2$ ), and large ( $s = 3$ ). Two cases have been also considered for the designed capacities, namely tight capacity and excess capacity. The designed capacity of hubs ( $\bar{F}_k^{sm}$ ) for each level, designed capacity of connection links ( $\bar{\xi}_{kl}^m$ ), fixed cost of locating hubs ( $FH_k^{ms}$ ), unit operational cost at hubs ( $oc_k^{ms}$ ), and service rate at hubs ( $\mu_k^{ms}$ ) for tight and excess levels are as Table 5.12, where  $\bar{W} = \sum_{i,j>i} w_{ij}$ ,  $\bar{FH}_k$  and  $\bar{oc}_k$  are the data obtained from FTN, and  $m = 1, 2$  and 3 are for road, rail and air transportation modes.

The parameters are set to lead to different system characteristics with two levels (i.e., tight and excess levels) and two values of  $P$ . Consequently, 4 real cases are investigated, namely  $\mathbb{P}_1$ : (Tight capacity,  $P = 5$ ),  $\mathbb{P}_2$ : (Tight capacity,  $P = 6$ ),  $\mathbb{P}_3$ : (Excess capacity,  $P = 3$ ), and  $\mathbb{P}_4$ : (Excess capacity,  $P = 4$ ). After implementing the

proposed model and solution approaches on the FTN data set, the results obtained by SGV-II algorithm have been illustrated in Figures 5.14 to 5.17 for  $\mathbb{P}_1$  to  $\mathbb{P}_4$ , respectively. Part *a* of Figures 5.14 to 5.17 illustrates the NF of the corresponding real case. Part *b* shows the hubs' structure of the extreme Pareto solution with minimum value of  $\mathbb{Z}_1$  and maximum value of  $\mathbb{Z}_2$ , part *c* depict the hubs' structure of a Pareto solution in the middle of PF, and part *d* shows the hubs' structure of the extreme Pareto solution with minimum value of  $\mathbb{Z}_2$  and maximum value of  $\mathbb{Z}_1$ .

In addition, the modes of transportation utilized in each problem have been also provided in Figures 5.14 to 5.17 for different Pareto solutions. As shown, in solutions with minimum value of  $\mathbb{Z}_1$  (i.e., efficient solutions), road transportation mode is more used than other modes due to lower utilization cost, while air mode of transportation is highly utilized in solutions with lower value of  $\mathbb{Z}_2$  (i.e., responsive solutions) due to it lower transportation time and lower congestion. In addition, in lower cost solutions, hubs with lower capacity levels (i.e., lower costs) are located that leads to higher congestion as well as higher value of  $\mathbb{Z}_2$ . Besides, in higher cost solutions, hubs with higher capacity levels (i.e., higher costs) are located that leads to lower congestion as well as lower value of  $\mathbb{Z}_1$ .

On the other hand, there are other solutions in the middle of the NF that are more desired for decision makers. In these solutions, rail mode of transportation is utilized more than other modes, while rail mode benefits from lower transportation time and lower congestion with medium transportation cost comparing to road and air modes. It can also be calculated that for efficient solutions, approximately 52%, 41% and 7% of connection links utilize road, rail and air modes of transportation, respectively. Contrarily, in responsive solutions, approximately 3%, 52% and 45% of connection links utilize road, rail and air modes of transportation, respectively. Finally, in the middle solutions, approximately 16%, 60% and 14% of connection links utilize road, rail and air modes of transportation, respectively. It can be totally included that 24%, 51% and 22% of connection links in FTN database utilize road, rail and air modes of transportation, respectively. The higher percentage of rail modes refers to the efficiency of high-speed trains, called TGV in France, as well as its high responsiveness.

Table 5.12. Parameters for each capacity level

Parameter	Tight capacity			Excess capacity		
	Small ( $s = 1$ )	Medium ( $s = 2$ )	Large ( $s = 3$ )	Small ( $s = 1$ )	Medium ( $s = 2$ )	Large ( $s = 3$ )
$\bar{f}_k^{sm}$	$\frac{1}{P \times m} \bar{W}$	$\frac{P-1}{P \times m} \bar{W}$	$\frac{P+1}{P \times m} \bar{W}$	$\frac{1}{m} \bar{W}$	$\frac{2}{m} \bar{W}$	$\frac{3}{m} \bar{W}$
$\bar{\xi}_{kl}^m$	$\frac{m \times (P-1)}{P} \bar{W}$	$\frac{m \times (P-1)}{P} \bar{W}$	$\frac{m \times (P-1)}{P} \bar{W}$	$2m \bar{W}$	$2m \bar{W}$	$2m \bar{W}$
$FH_k^{ms}$	$m \bar{F} \bar{H}_k$	$m \sqrt{P-2} \times \bar{F} \bar{H}_k$	$m \sqrt{P} \times \bar{F} \bar{H}_k$	$m \sqrt{P} \times \bar{F} \bar{H}_k$	$m \sqrt{2P} \times \bar{F} \bar{H}_k$	$m \sqrt{3P} \times \bar{F} \bar{H}_k$
$oc_k^{ms}$	$m \bar{o} \bar{c}_k$	$m \sqrt{P-2} \times \bar{o} \bar{c}_k$	$m \sqrt{P} \times \bar{o} \bar{c}_k$	$m \sqrt{P} \times \bar{o} \bar{c}_k$	$m \sqrt{2P} \times \bar{o} \bar{c}_k$	$m \sqrt{3P} \times \bar{o} \bar{c}_k$
$\mu_k^{ms}$	$\left(1 + \frac{P-1}{2m}\right) \frac{\bar{W}}{P}$	$\left(1 + \frac{P}{2m}\right) \frac{\bar{W}}{P}$	$\left(1 + \frac{P+1}{2m}\right) \frac{\bar{W}}{P}$	$\left(1 + \frac{P-1}{m}\right) \frac{\bar{W}}{P}$	$\left(1 + \frac{P}{m}\right) \frac{\bar{W}}{P}$	$\left(1 + \frac{P+1}{m}\right) \frac{\bar{W}}{P}$
$q_k$	[0,0.20]	[0,0.20]	[0,0.20]	[0.20,0.5]	[0.20,0.5]	[0.20,0.5]
$\eta_k^{ms}$	[0,0.15]	[0.10,0.20]	[0.20,0.30]	[0,0.15]	[0.10,0.20]	[0.20,0.30]
$\vartheta_{kl}^m$	[0,0.20]	[0.15,0.25]	[0.25,0.35]	[0,0.20]	[0.15,0.25]	[0.25,0.35]
$P$	5,6	5,6	5,6	3,4	3,4	3,4

$R$	4	4	4	3	3	3
$f_k^{ms} (1/h)$	[0.40,0.60]	[0.50,0.80]	[0.70,1]	[0.80,1.20]	[1.00,1.60]	[1.60,2.00]
$r_k^{ms} (1/h)$	[4,6]	[5,8]	[7,10]	[8,12]	[10,16]	[16,20]
$\theta_k^{ms}$	0.90	0.80	0.70	0.80	0.70	0.60
$\delta_{kl}^m$	0.80	0.70	0.60	0.70	0.60	0.50

In order to show the performance of the proposed mathematical model, the current structure of the transportation network in France is analyzed respecting to  $\mathbb{Z}_1$  and  $\mathbb{Z}_2$  and congestion in the hubs. Figure 18 shows the current transportation network in France with 3 hubs at Paris, Lyon and Rennes, total cost (i.e.,  $\mathbb{Z}_1$ ) equal to 61.4 Billion \$, maximum transportation time between each pair of OD nodes (i.e.,  $\mathbb{Z}_2$ ) equal to 25 hours, and mean congestion at equal to 5.5, 4.8 and 3.9 hours at Paris, Lyon and Rennes, respectively. It is noteworthy that the congestion at hubs is considered equal to mean time that flows must spend to be processed, where the higher the congestion in hubs, the higher the waiting time that must be spent. According to Figure 19, the proposed mathematical model not only provides solutions with lower values for both objective functions, but also provides better balance for congestion at hubs with mean waiting times up to 3.5 hours in the most congested hubs.

### 5.11.1. Sensitivity analysis

To do the sensitivity analysis, firstly, the sensitivity of second objective function with changes of flow ( $w$ ), designed capacity of hubs ( $\Gamma$ ), designed capacity of connection links ( $\xi$ ), service rate of hubs ( $\mu$ ), and disruption related parameters including failure probability of complete disruption at hubs ( $q$ ), disruption rate at hubs ( $f$ ), retrieval time rate at hubs ( $r$ ), disruption probability at hubs ( $\eta$ ), capacity disruption factor at hub ( $\theta$ ), disruption probability at connection links ( $\vartheta$ ), and capacity disruption factor at connection links ( $\delta$ ) is investigated. Next, the sensitivity of the first objective function is investigated with changes of parameters including  $w$ ,  $\Gamma$ ,  $\xi$ ,  $q$ ,  $\eta$ ,  $\theta$ ,  $\vartheta$ , and  $\delta$ . The results of the current network are presented in Tables 5.13 and 5.14, respectively for second and first objective functions, in which the results are shown based on changes according to the base scenario. In Tables 5.13 and 5.14, negative values relate to decrease in the value of objective function. It should be noted that the best values of objective functions in  $\mathbb{P}_2$  is considered as the base scenario with the values equal to 45.84 (Billion €) and 8.58 (h) for  $\mathbb{Z}_1$  and  $\mathbb{Z}_2$ , respectively.

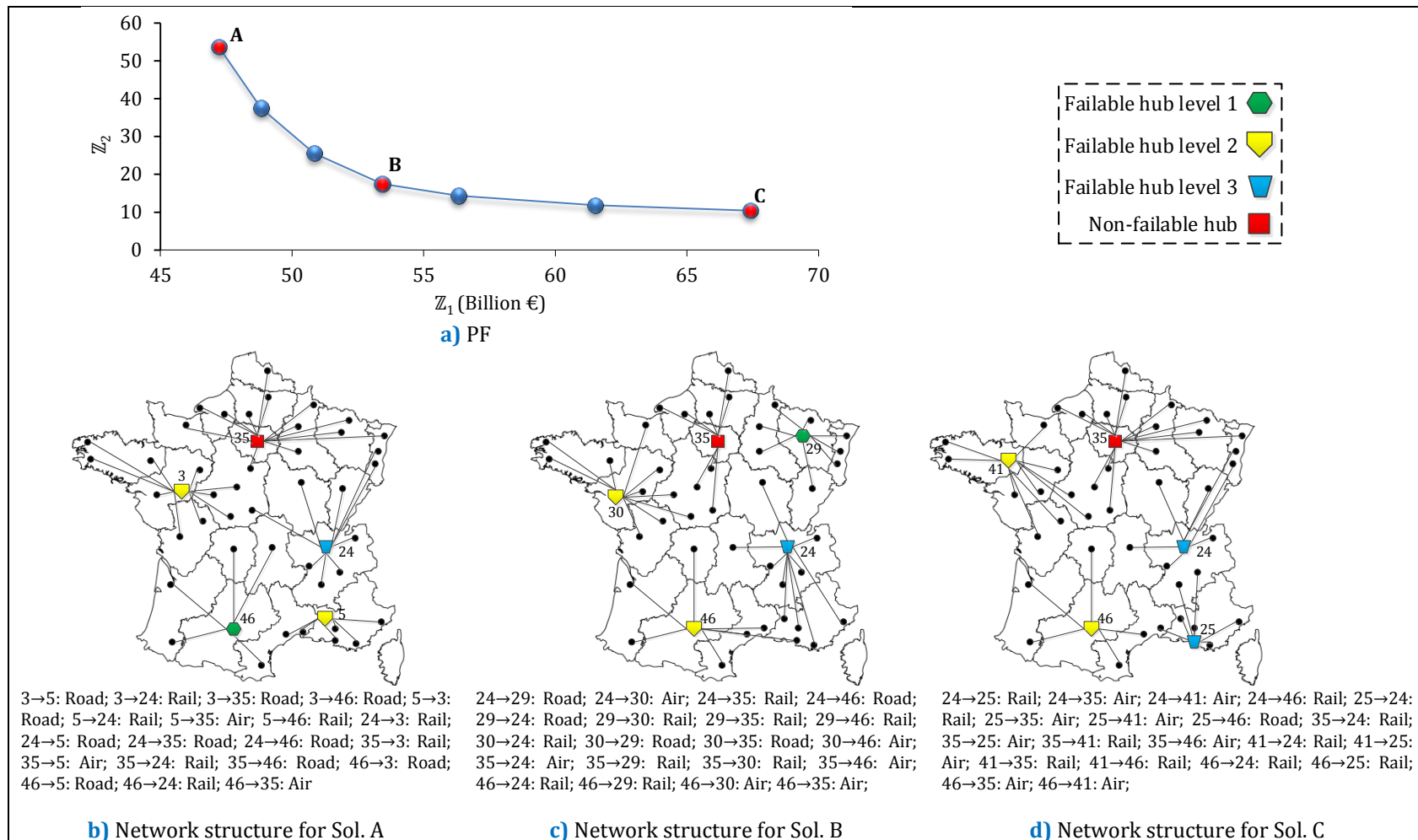

3→5: Road; 3→24: Rail; 3→35: Road; 3→46: Road; 5→3: Road; 5→24: Rail; 5→35: Air; 5→46: Rail; 24→3: Rail; 24→5: Road; 24→35: Road; 24→46: Road; 35→3: Rail; 35→5: Air; 35→24: Rail; 35→46: Road; 46→3: Road; 46→5: Road; 46→24: Rail; 46→35: Air

24→29: Road; 24→30: Air; 24→35: Rail; 24→46: Road; 29→24: Road; 29→30: Rail; 29→35: Rail; 29→46: Rail; 30→24: Rail; 30→29: Road; 30→35: Road; 30→46: Air; 35→24: Air; 35→29: Rail; 35→30: Rail; 35→46: Air; 46→24: Rail; 46→29: Rail; 46→30: Air; 46→35: Air;

24→25: Rail; 24→35: Air; 24→41: Air; 24→46: Rail; 25→24: Rail; 25→35: Air; 25→41: Air; 25→46: Road; 35→24: Rail; 35→25: Air; 35→41: Rail; 35→46: Air; 41→24: Rail; 41→25: Air; 41→35: Rail; 41→46: Rail; 46→24: Rail; 46→25: Rail; 46→35: Air; 46→41: Air;

Figure 5.14. Results of  $\mathbb{P}_1$

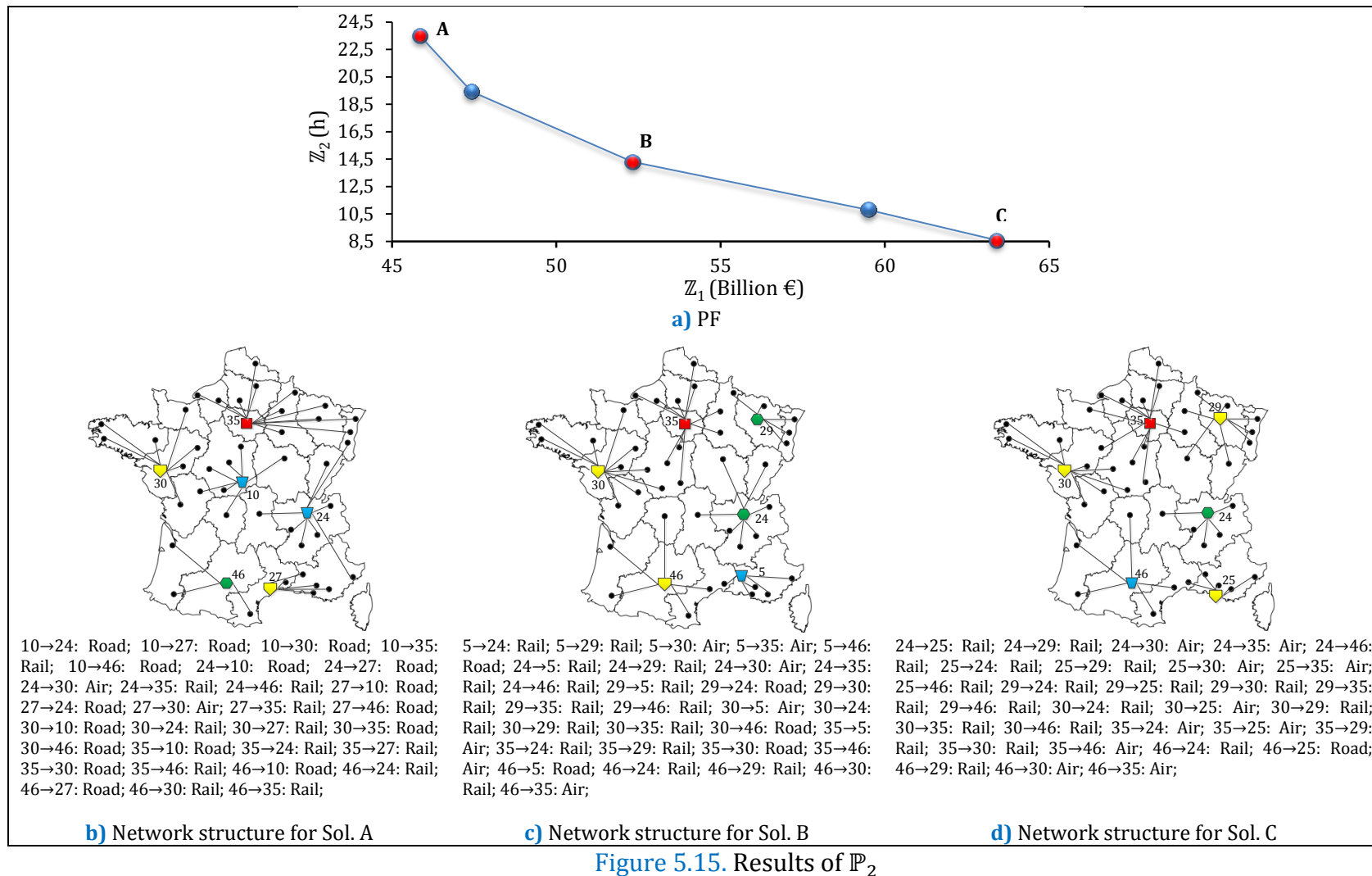

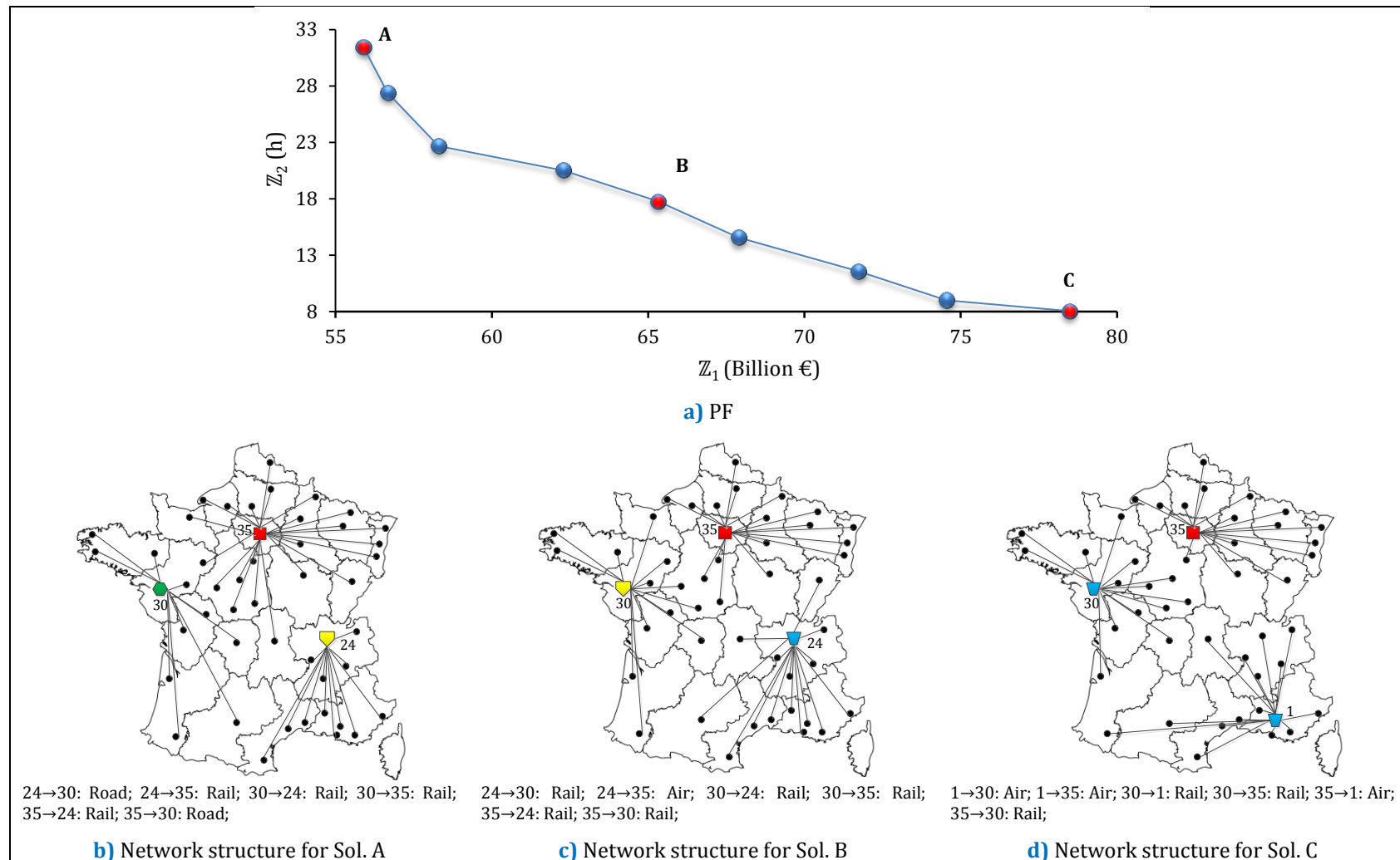

Figure 5.16. Results of  $\mathbb{P}_3$

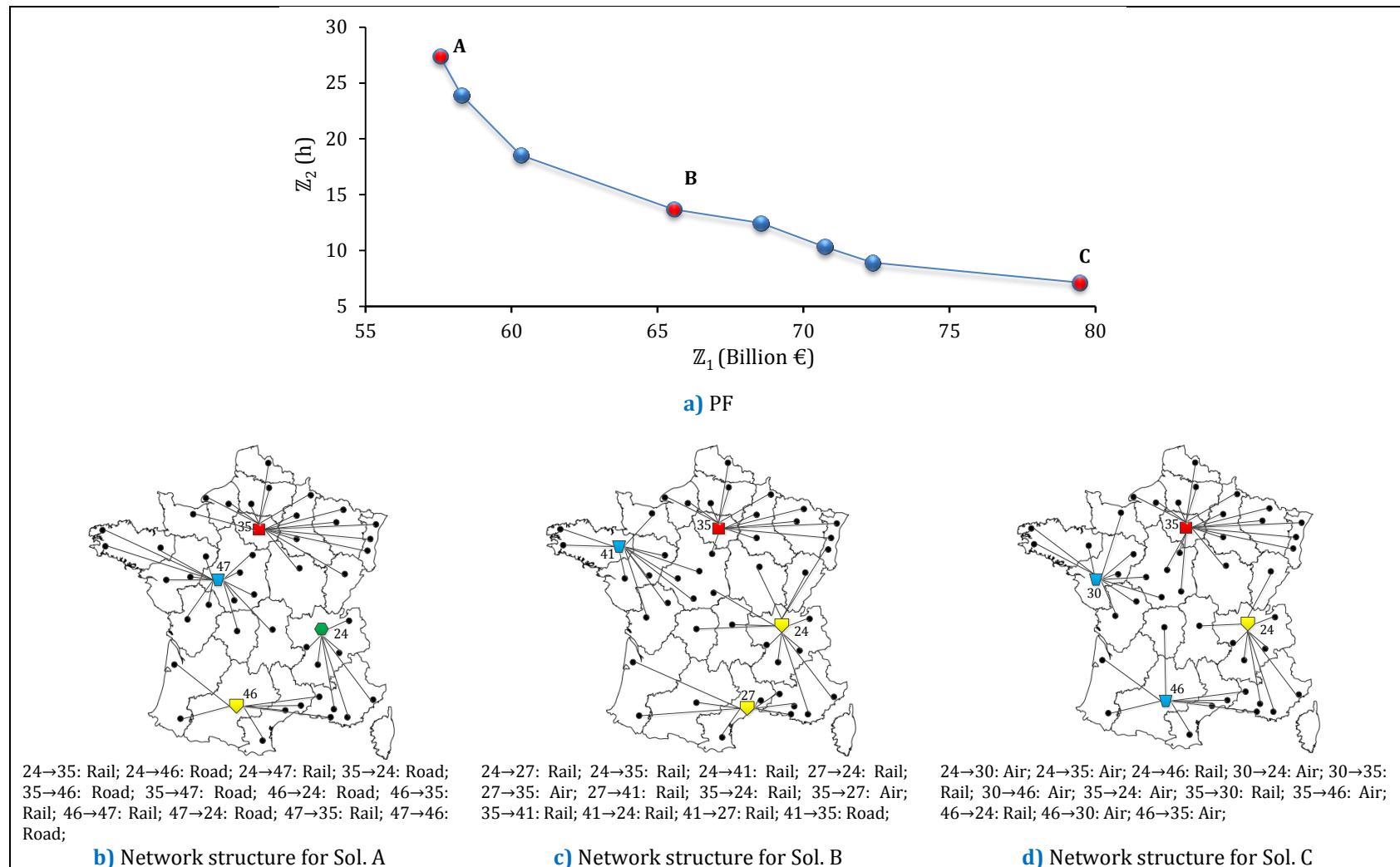

Figure 5.17. Results of  $\mathbb{P}_4$



Table 5.13. Second objective function changes vs. changes in parameters

Parameter Increase (%)	Objective function value changes (%)										
	$w$	$\Gamma$	$\xi$	$\mu$	$q$	$f$	$r$	$\eta$	$\theta$	$\vartheta$	$\delta$
10	12	-5	-3	-6	4	8	6	5	9	3	6
15	18	-8	-5	-10	9	13	10	9	12	6	8
20	25	-16	-11	-18	14	18	15	14	21	11	16
25	31	-20	-16	-28	17	23	19	19	30	15	19
30	40	-28	-19	-34	21	28	23	25	41	19	19
35	48	-30	-19	-42	25	36	30	32	41	24	28
40	53	-30	-23	-45	34	41	35	32	41	27	34
45	65	-30	-25	-49	39	49	39	39	53	27	38
50	78	-30	-25	-53	46	58	45	42	58	35	43
55	90	-30	-25	-57	52	64	52	42	69	35	49
60	105	-30	-25	-60	56	72	60	50	76	42	54

Table 5.14. First objective function changes vs. Changes in parameters

Parameter Increase (%)	Objective function value changes (%)								
	$w$	$\Gamma$	$\xi$	$q$	$\eta$	$\theta$	$\vartheta$	$\delta$	
10	12	-5	-3	4	5	9	3	6	
15	18	-8	-5	9	9	12	6	8	
20	25	-16	-11	14	14	21	11	16	
25	31	-20	-16	17	19	30	15	19	
30	40	-28	-19	21	25	41	19	19	
35	48	-30	-19	25	32	41	24	28	
40	53	-30	-23	34	32	41	27	34	
45	65	-30	-25	39	39	53	27	38	
50	78	-30	-25	46	42	58	35	43	
55	90	-30	-25	52	42	69	35	49	
60	105	-30	-25	56	50	76	42	54	

Figure 20 illustrates the results of Table 13, while increase in flow ( $w$ ) and increase in disruption probability at connection links ( $\vartheta$ ) have the highest and the lowest effect on increase of the second objective function, respectively; and increase in service rate of hubs ( $\mu$ ) and increase in designed capacity of connection links ( $\xi$ ) have the highest and the lowest effect on decrease in the second objective function.

Figure 21 illustrates the results of Table 14, while increase in failure probability of complete disruption at hubs ( $q$ ) and increase in disruption probability at connection links ( $\vartheta$ ) have the highest and the lowest effect on increase of the first objective function, respectively; and increase in designed capacity of hubs ( $\Gamma$ ) and increase in designed capacity of connection links ( $\xi$ ) have the highest and the lowest effect on decrease in the second objective function.

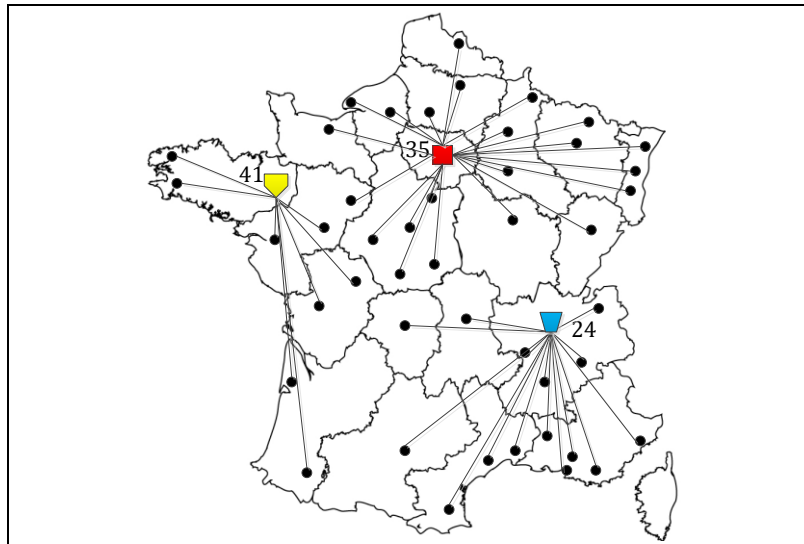

Figure 5.18. Current transportation network in France

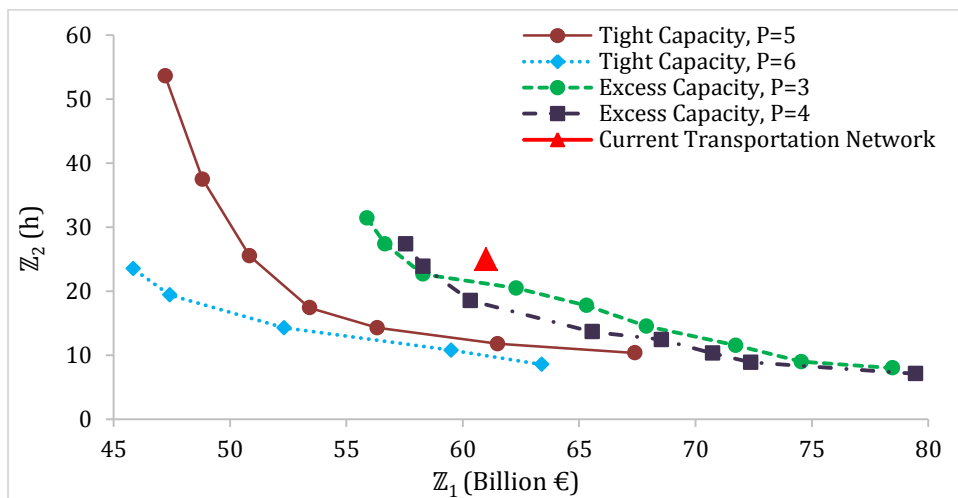

Figure 5.19. Current network vs. non-dominated Pareto fronts

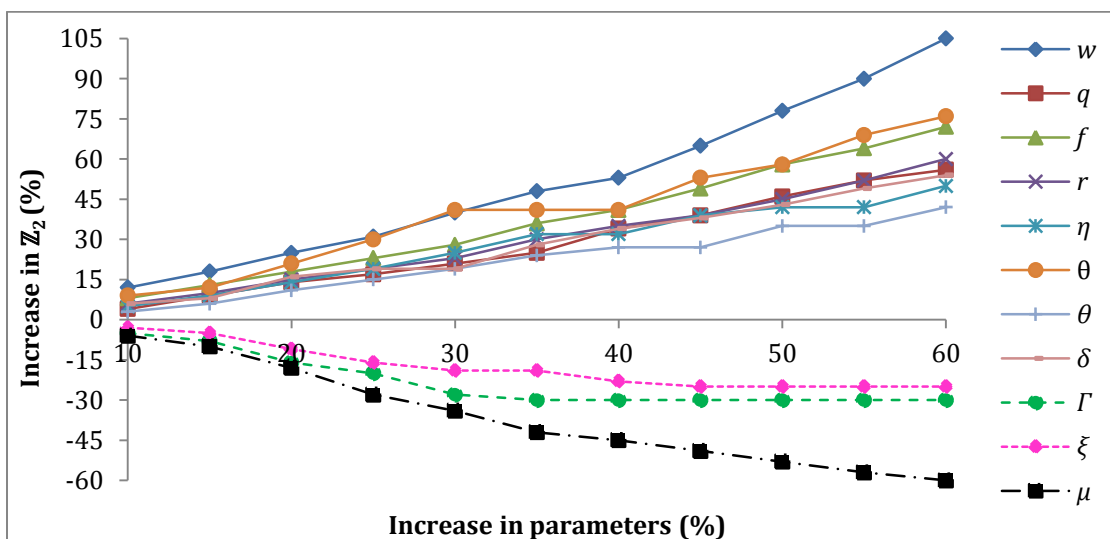

Figure 5.20. Increase in  $Z_2$  vs. Increase in parameters

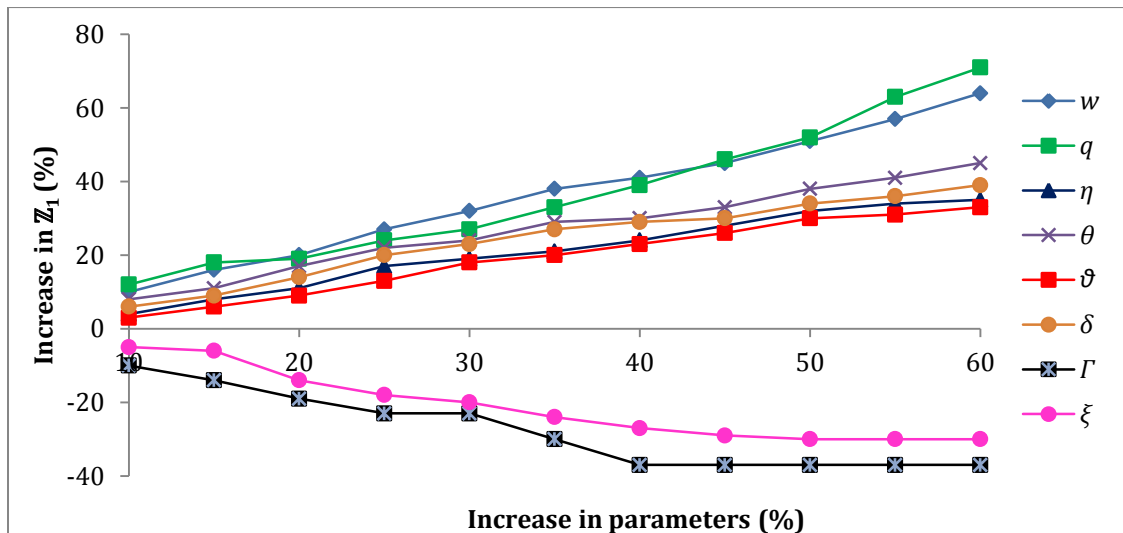

Figure 5.21. Increase in  $Z_1$  vs. Increase in parameters

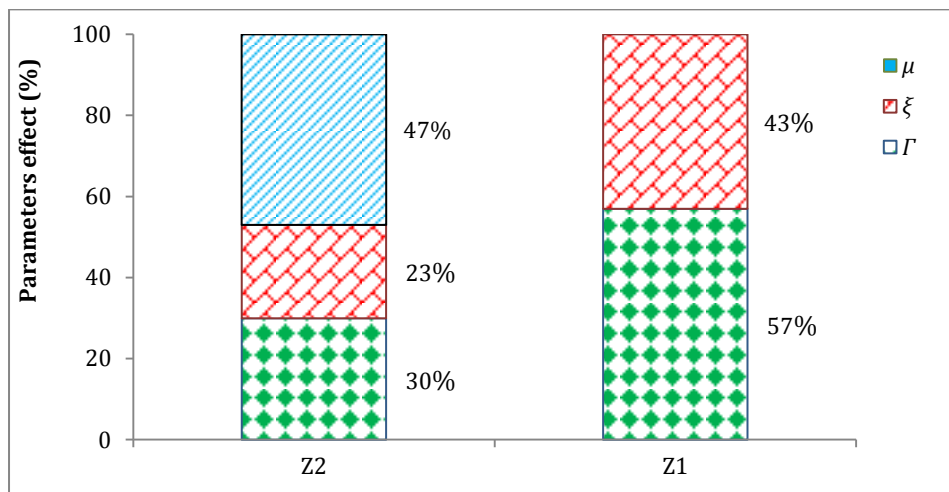

Figure 5.22. Increase of  $\Gamma$ ,  $\xi$  and  $\mu$  vs. decrease in  $Z_1$  and  $Z_2$

In Figure 5.20, since  $w$ ,  $\theta$ ,  $f$ ,  $r$ , and  $\mu$  have the highest effect on the second objective function, it can be easily demonstrated that congestion in hubs strongly affects the travel time between each pair of O-D nodes. This result highlights the importance of analyzing congestion in HLP. On the other hand and based on Figure 5.21, since  $q$ ,  $\theta$ , and  $\Gamma$  have the highest effect on the first objective function, the high importance of complete and partial disruption can be easily shown. Remarkably, analyzing congestion and considering complete and partial disruptions in the hub network are important issues that this thesis tried to address.

Figure 5.22 shows the general sensitivity analysis and illustrates the effect of increase in  $\Gamma$ ,  $\xi$  and  $\mu$  on decrease of objective functions. Accordingly, in the first objective function, increase in  $\Gamma$  has the highest effect, while in the second objective function,  $\mu$  plays this role. Regarding to those parameters that their increase will increase the value of objective function, Figure 5.23 depicts the general sensitivity of objective functions respecting to parameters  $w$ ,  $q$ ,  $f$ ,  $r$ ,  $\eta$ ,  $\theta$ ,  $\vartheta$ , and  $\delta$ . In Figure 5.23, it can be easily shown that flow ( $w$ ) and disruption factors ( $q$  and  $\theta$ ) have the highest

effect on both objective functions. Figures 5.22 and 5.23 again demonstrate the importance of studying disruption and congestion in HLPs.

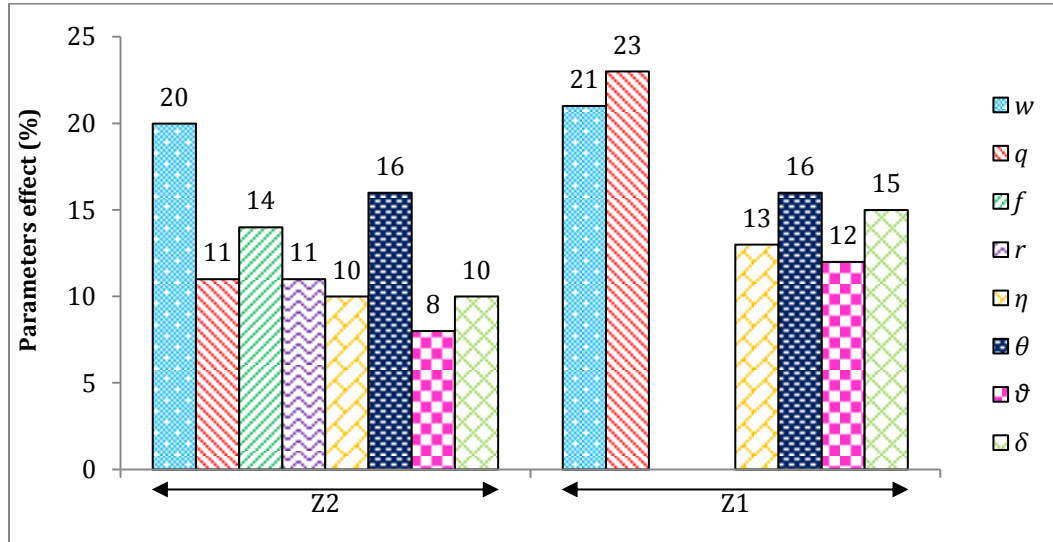

Figure 5.23. Increase in parameters vs. Increase in  $Z_1$  and  $Z_2$

### 5.12. Summary

As mentioned before, the studied inspection planning problem in this thesis is categorized into domain of supply chain management (SCM) and especially the problems related to the production party. Another party across the supply chain that significantly affects the performance of the whole supply chain is distribution party. The main problems in distribution centers are inventory and transportation related problem.

The domain of transportation problems were selected in this chapter to apply the proposed models and solution approaches. Among different transportation related problems, Hub Location Problem (HLP) was considered to be studied.

According to this chapter, hub transportation networks are greatly vulnerable to uncertainties caused by natural disasters, terrorist attacks, or man-made deficiencies. In this chapter, we focused on the reliability issues of hub uncertainties (complete and partial disruptions) and link uncertainties (partial disruptions). We investigated the effect of these uncertainties on the hub-and-spoke topology and ability of the network to meet delivery requirements of the shipments through a new bi-objective mathematical model where the hub-side and link uncertainties were modeled independently. The proposed model was clearly NP-hard and consequently we proposed an efficient approximation approach to provide lower bound for the optimal Pareto-frontier of the model. We also developed a hybrid self-adaptive multi-objective meta-heuristic algorithm based on GA and VNS algorithm, namely SGV-II.

The computational results generally demonstrated the importance of studying and considering hub-side uncertainty and link uncertainty in designing hub location networks as well as the high performance of the proposed approximated solution approach and meta-heuristic algorithm. Through benchmarking with the approximated non-dominated lower bound, the proposed SGV-II strongly

outperforms the other well-known NSGA-II, MOIWO and MOICA algorithms considering QM, CM, SM, DM, and MID comparison metrics. In addition, a real transportation case in France was studied to demonstrate the high performance of the proposed model and solution approaches in handling large and real size instances. Finally, a numerous sensitivity analyses were done to investigate the effect of important parameters on the objective functions and valuable managerial insights were extracted.

## **Chapter IV**

# **Conclusion & Future Research**

### 6.0. Chapter purpose and outline

In this Chapter, [Section 6.1](#) presents a summary of the research conducted in this thesis. First, a general conclusion is provided based on the similarities between both inspection planning and hub location problems in [Section 6.1.1](#). After the general conclusion, several concluding comments are also explained based on the proposed models and experimental results for both inspection planning and hub location problems in [Sections 6.1.2](#) and [6.1.3](#), respectively. Finally, future research directions are provided in [Section 6.2](#).

### 6.1. Concluding comments

#### 6.1.1. General conclusion

In this thesis, the main goal has been to provide an optimization framework dealing with two main parties in every supply chain, called production and distribution parties. It should be mentioned that this thesis is not to integrate the production and distribution parties in the supply chain, but it is to study the basic problems in each party by finding similarities between the problems and using the same tools and approaches to solve them.

Accordingly, two inspection planning problem and hub location problem were considered from production and distribution parties, respectively. These two problems remarkably affects the performance of the whole supply chain as well as the customer satisfaction. That is, inspection planning directly deals with the quality of the products which might be the most important factor for the customers; and hub location problem relates to transportation activities and delivery service requirements which are also important factors for both the customers and companies.

As mentioned before in [Section 3.5](#) (see [Table 3.2](#)), there are several similarities between the inspection planning and the hub location problems corresponding to the formulation techniques as well as similar uncertainties and solution approaches. In the both problems, we considered the same objective functions for minimizing total cost and maximizing customer satisfaction. Regarding to the formulations, we made location, allocation and selection decisions. In the inspection planning problem, we located the inspection stations, allocate the quality characteristics to the located stations and select the machines and inspection tools to perform the production and inspection tasks. On the other hand and in hub location problem, we made decision regarding to the locating the hub nodes, allocating the spokes to the located hubs and select the transportation modes in the network.

In both problems, we considered the capacity on the components of the problem such as production machines and inspection tools as well as hub facilities and connection links. Disruption and congestion were taken into account in both problems and similar queuing systems were applied to model the congestion. In order to provide more applicable models, the effect of uncertainty of the parameters on the models and solutions was investigated in the both problems and we tried to provide robust models and solutions. Finally, similar solution approaches such as meta-heuristic algorithms were employed to solve the large-sized problems.

In the following, some of the main concluding remarks are presented for both the inspection planning and hub location problems.

- Fixed and variable costs should be considered in the cost objective functions while the sum of them provide better estimation of the total cost of the problem.
- Total manufacturing and transportation costs are in conflict with customer satisfaction, wherein minimum total cost increases the efficiency of the solution but decreases the effectiveness. By other words, minimum total cost leads to lower quality in the inspection problem as well as longer delivery time in the transportation network.
- In the both problems, it was concluded that by only a little increase in the cost, a huge improvement is obtained in the customer satisfaction.
- Regarding to the location decision, it was concluded that by locating higher numbers of inspection station or hub facilities, customer satisfaction is increased. For instance, higher numbers of inspections lead to higher quality and higher numbers of hubs lead to lower delivery time.
- Decisions regarding to how to inspect or how to transport significantly affect the customer satisfaction. These decisions not only affect the congestion, but also impact the quality of the products or the delivery service requirements.
- It was concluded that the capacity of the inspection tools or hub facilities remarkably impact the solution structure as well as objective function values. Where, higher capacity increases the total cost but decreases the congestion of the flows of the products or shipments in the inspection planning and the hub location problems, respectively. These results highlight the importance of capacity planning problems in the supply chain, wherein, the decision makers should determine an efficient level of capacity in order to make a trade-off between cost and customer satisfaction.
- One important result was the effect of uncertainty on the solutions and the objective functions. Generally, uncertainty increases the objective functions and impact the structure of the solutions. As an important result, the uncertainty of those parameters that directly affects the performance of the solution (e.g., misadjustment in inspection planning and disruption factors in hub location problem) have more impact on the solutions. On the other hand,



- some parameters like cost and time usually increase the objective functions values and not the structure of the solutions, while the parameters like misadjustment and disruptions factor not only affect the objective function (Objective uncertainty) but also impact the solution structure (Model uncertainty). Therefore, we can conclude that parameters can be divided into two category as performance parameters and objective parameters. Performance parameters (e.g., misadjustment and disruptions factor) leads to both objective and model uncertainties, while objective parameters (e.g., cost and time) only lead to objective uncertainty.
- In the both inspection planning and hub location problems, disruptions significantly affect both objective function values and solution structures. In the both problems, higher customer satisfaction is achieved by more reliable solutions. Reliable solution in inspection planning is the solution that has considered the inspection tools and machine with lower disruption factor as well as lower retrieve time. In the hub location problem, spokes are more likely to be assigned by hubs with lower probability of disruption to provide more reliable solution.

In the next two [Sections 6.1.2](#) and [6.1.3](#), the detail conclusions are provided for inspection planning problem and hub location problem, respectively.

### **6.1.2. Inspection planning problem**

Recently, the egregious importance of total quality management has been completely clarified to all industries. In order to maintain profitable and stay in a competitive edge, reaching to high quality level of products, processes and services has been nowadays a vital issue in many organizations, while they cannot survive without providing high quality products. For this aim, manufacturers are applying a variety of tools to improve the quality throughout the production process such as Six Sigma, statistical process control (SPC), process improvement, inspection, robust design, etc.

In this thesis, we focused on a specific tool for achieving high manufacturing quality as quality inspections and providing effective inspection planning. Inspection the quality of products to remove nonconforming items before delivering to the customers is comprehensively performed in every production system, in which the quality characteristics of a product are evaluated possibly at several stages in its production process.

Through this research, three main simultaneous decisions in an inspection planning problem in a multi-stage production system (MPS) were: (i) which quality characteristics need to be inspected, (ii) what type of inspection should be considered for the selected quality characteristics, and (iii) where these inspections should be performed. These decisions are made to reach different objectives such as minimum manufacturing cost, maximum customer satisfaction as well as minimum manufacturing time.

For this aim, this thesis modeled the inspection planning problem through a main and an extended problems. The *Main Problem* was a single-objective inspection planning model to determine which quality characteristics need what kind of inspection and where these inspections should be performed throughout the manufacturing process in order to minimize total cost of manufacturing.

On the other hand, the *Extended Problem* is a generalized version of the *Main Problem* and was proposed as a multi-objective inspection planning model to determine which quality characteristics need what kind of inspection and where these inspections should be performed through a multi-product multi-stage production system. In such system, the products has their own quality characteristics and manufacturing stages. In the *Extended Problem*, other decisions regarding the machine and inspection tools selection are also taken into account. The objectives of the *Extended Problem* were minimizing total manufacturing cost, minimizing total warranty cost as well as minimizing the maximum manufacturing time of each product. It was also considered that the manufacturing time of each product is the sum of production time and waiting time. The waiting time is the time that products must spend to receive services at the machines and inspection tools.

In addition, it was assumed that the machines and inspection tools are unreliable and are subject to breakdown. These breakdowns occur stochastically and a retrieve time is required to return the machines and inspection tools to their functioning situations. These factors affect total manufacturing time of each product.

Besides to inspection planning decisions, it was considered that input parameters such as misadjustment and dispersion of the processes, production time, inspection time, errors type I and II, capacity, breakdown rate and retrieve time are uncertain and the effect of uncertainty on the inspection plans were investigated in this thesis. For this goal, a robust optimization technique was applied to find the less sensitive plan to the variations. Finally, to solve the proposed *Main* and *Extended* models, to well-known genetic and differential evolution algorithms were developed.

After solving the *Main* and the *Extended Problems*, the following concluding remarks were elaborated:



***Main Problem:***

- Under any inspection strategy (i.e., MI-or-CI and MI-and-CI), operations with lower process capability (i.e., *CP*) as well as higher failure rate are more likely to go under conformity inspection.
- Under any inspection strategy (i.e., MI-or-CI and MI-and-CI), operations with higher process capability (i.e., *CP*) as well as lower failure rate are more likely to go under no or at most monitoring inspection.
- MI-or-CI strategy is more responsive; however, the MI-and-CI strategy is more efficient.
- Under the MI-or-CI strategy, the worst cases in terms of responsiveness and efficiency belong to situations with no uncertainty and uncertainty in all parameters, respectively.

- Under the MI-and-CI strategy, the worst cases in terms of responsiveness and efficiency belong to situations with uncertainty in both misadjustment and dispersion and uncertainty in all parameters, respectively.
- As a general conclusion, providing robust inspection plan needs to spend more cost. This cost would be the robustness cost. Cost of robustness is around 24% of the total cost for both inspection strategies.
- Among different parameters, misadjustment has significant effect on the inspection plan and needs to be precisely determined and its variation should be decreased and controlled as much as possible.
- Despite of misadjustment, separate variation in errors type I and II and dispersion have a little impact on the total cost. However, variation in error type I has higher effect on the total cost as well as final inspection plan.
- The MI-and-CI strategy is more sensitive to parameters' variation comparing to the MI-or-CI strategy. Therefore, it could be concluded that MI-or-CI is more robust.
- Extra 1.340€ and 1.341€ (per part) are needed to be spent under MI-or-CI and MI-and-CI strategies, respectively, when all parameters are uncertain and we try to design a robust inspection plan.
- The value of misadjustment can be increased up to  $0.25\sigma$  with no increase in robustness cost. In addition, dispersion can be increased up to 0.1 with no increase in the total cost.



### ***Extended Problem:***

- Customer satisfaction can be increased indirectly by decreasing the warranty cost.
- Manufacturing cost and warranty costs are in conflict in terms of the total inspection cost.
- Solutions with lower values of the manufacturing cost (or higher values of warranty cost) correspond to those plans with lower number of inspections as well as higher number of nonconforming products that reach the customers. These inspection plans are more efficient from the manufacturer's point of view.
- Solutions with lower values of the warranty cost (or higher values of manufacturing cost) correspond to those plans with higher number of inspections as well as lower number of nonconforming products that reach the customers. These inspection plans are more responsive from the customer's point of view.
- Variation of misadjustment and dispersion have the highest effect on the both objective functions, wherein misadjustment has higher effect on the objective function 1 (i.e., total manufacturing cost) rather than objective function 2 (i.e., total warranty cost) and vice versa for dispersion.

- Companies who eager to minimize manufacturing cost should determine exact value for misadjustment and try to omit variation in it as much as possible.
- Companies who attempt to keep their customers satisfied should control both misadjustment and dispersion and determine exact value for them in their plans.
- The objective function values are increased by proposing the robust solutions and making the inspection plans robust.
- After providing the robust inspection plans, the first, second, and third objective functions are increased by 8%, 12%, and 8%, respectively. These values show that the second objective function is more sensitive to the uncertainty of the parameters.
- Machines and inspection tools allocation significantly affect the total cost as well as final inspection plans.
- Inspections of those quality characteristics that their corresponding operations are performed on the machines with lower capability are performed by inspection tools with higher capability and lower values of errors type I and II.
- Breakdown rate and retrieve time of the machines and the inspection tools significantly affect the third objective function (i.e., maximum manufacturing time of the products).
- Although all the objective functions are increased once the misadjustment is increased, but the second objective function is more sensitive to the misadjustment variation, while the third objective function is less sensitive to the misadjustment variation.
- All the objective functions are increased once the dispersion is increased, wherein the highest and lowest sensitivities belong to the second and the third objective functions. These results also impose more attention to the uncertainty of the dispersion and the need to control this variation.
- Increasing the capacity of machines and inspection tools increases the first objective function, while decreases the second and the third objectives.
- The third objective function is more sensitive to the capacity of the machines and the inspection tools. This sensitivity is due to the effect of the waiting time on the total manufacturing time. By the other words, increasing the capacity as well as increasing the service rate of machines and inspection tools will definitively lead to lower waiting time and lower total manufacturing time.
- Increase in the production time only increases the value of the first and the third objective functions.
- By considering the direct dependency between the purchase cost of the machines and the inspection tools and the value of the service rates (i.e., higher service rate leads to higher purchasing cost), the first and the third objectives are the only objectives that are sensitive to the variation of the service rates, wherein the third objective is more sensitive to this variation.

- Increase in the inspection rate leads to decrease in the third objective comparing to the first objective, while increase in the inspection rate not only decreases the total inspection time, but also decreases the total waiting time of the products. Therefore, the variation of the inspection rate mainly affects the third objective.
- Once the breakdown rate is increased (retrieve time is fixed), the total manufacturing time (i.e., third objective function) is increased. It is noteworthy that increase in breakdown rate directly increases the waiting time of the products.
- The first objective function is affected by the uncertainty in almost all parameters except error type II, wherein the most effective parameters are misadjustment, production time and production rate.
- The second objective function is affected by the uncertainty in only misadjustment, dispersion and errors type I and II, in which, the most effective parameters are misadjustment and dispersion.
- Similar to the first objective function, the third objective function is affected by the uncertainty in almost all parameters except capacity wherein the most effective parameters are inspection rate, production rate and retrieve time.
- As an important result, parameters that affect the value of the objective functions may have no effect on the structure of the inspection plans. Therefore, variation in these parameters could be neglected.
- Those parameters that significantly affect the objective functions value are misadjustment, production time and rate, inspection rate, capacity and dispersion. But among these parameters, the only parameters that affect the structure of the solutions as well as inspection plans are misadjustment, dispersion, error type I, capacity, breakdown rate, and retrieve time.

### 6.1.3. Hub Location problem

The studied inspection planning problem in this thesis is categorized into domain of supply chain management (SCM) and especially the problems related to the production party. The production party is involved into all problems regarding to the production. Another party in the supply chain that significantly affects the performance of the whole supply chain is distribution party. The main problems in distribution centers are inventory and transportation related problem.

The domain of transportation problems was selected to apply the the same assumptions and considerations like inspection planning problem. Among different transportation related problems, Hub Location Problem (HLP) has been selected to be studied.

HLPs have been involved in network design planning in transportation, telecommunication, and computer systems, where hub-and-spoke topologies are applied to efficiently route shipments between many origin and destination (O-D) nodes through intermediate nodes, called hubs. Hub nodes are consolidation,

switching, or transshipment facilities to connect a large number of O-D pairs by using a small number of links. Fewer links not only simplify the network structure but also transfer large amounts of flow on interhub links, enabling economies of scale and reducing set-up and operational costs. Hub location models typically try to determine where to locate the hubs among a set of candidate sites and how to allocate spokes to the hubs, so that the total cost can be minimized or the total profit can be maximized.

In this thesis, the underlying concern was that hub transportation networks are greatly vulnerable to uncertainties caused by natural disasters, terrorist attacks, or man-made deficiencies. In this thesis, we focused on the reliability issues of hubs and links uncertainties. We investigated the effect of these uncertainties on the hub-and-spoke topology and ability of the network to meet delivery requirements of the shipments through a new bi-objective mathematical model where the hub-side and link uncertainties were modeled independently. The proposed model was clearly NP-hard and consequently we proposed an efficient approximation approach to provide lower bound for the optimal Pareto-frontier of the model. We also developed a hybrid self-adaptive multi-objective meta-heuristic algorithm based on GA and VNS algorithm, namely SGV-II.

The computational results generally demonstrated the importance of studying and considering hub-side uncertainty and link uncertainty in designing hub location networks as well as the high performance of the proposed approximated solution approach and meta-heuristic algorithm. Through benchmarking with the approximated non-dominated lower bound, the proposed SGV-II strongly outperforms the other well-known NSGA-II, MOIWO and MOICA algorithms considering QM, CM, SM, DM, and MID comparison metrics. In addition, a real transportation case in France was studied to demonstrate the high performance of the proposed model and solution approaches in handling large and real size instances. Finally, a numerous sensitivity analyses were done to investigate the effect of important parameters on the objective functions and valuable managerial insights were extracted.

To the best of our knowledge, our effort is the first to present bi-objective reliable capacitated HLP with hub and link uncertainties as well as approximation algorithm and lower bound approach for a bi-objective mathematical model. It is our hope that this study could inspire additional in-depth research and discussions on this topic.

Finally, our results lead us to these conclusions:

- In the cases of dominant transportation costs, total costs decrease as the number of hubs increases. This is because adding another hub provides more flow routing options. It is also observed that adding one hub reduces total costs because an extra open hub reduces the overall congestion. However, in the case of dominant fixed costs, the total cost increases as the number of hub increases. It seems that the reduction in transportation and congestion costs achieved by adding an extra hub is less than its fixed cost. In this research, due

- to dominant congestion and transportation cost, adding an extra hub to the network is recommended.
- The amount of flow plays a significant role in network performance. Increase in flow will highly increase total costs as well as congestion at hubs and connection links. Congestion at the network significantly affects delivery requirement of the companies. Accordingly, the amount of flows should be accurately determined or estimated.
  - Considering a major part of travel time is due to waiting time at hubs, disruptions at hubs has higher effect on the travel time than disruptions at connection links. On the other hand, locating hubs with higher service rates significantly decreases travel time and congestion at the network. Accordingly, locating extra hubs is recommended to significantly decrease the travel time.
  - When a hub node is completely disrupted, that hub becomes unavailable and spokes originally allocated to it have to be re-allocated to other (operational) hub nodes that usually require higher re-allocation cost. Accordingly, complete disruption at hubs contributes to a major part of total cost in case of dominate re-allocation cost. In the studied France transportation network, it was shown that re-allocation costs dominate other costs. Therefore, locating hubs at nodes with lower probability of disruption is recommended for the France transportation network.
  - In the studied France transportation network, the rail mode has been widely used through the network and railways have been mostly allocated to hub nodes with lower disruption probability. This issue is due to high cost of re-allocation.
  - In case of lower costs for higher capacity levels, the capacity of hubs plays an important role in delivery service requirements. By selecting higher capacity hubs, total delivery times are significantly decreased, due to reduction in congestion. In the studied France transportation network, due to high cost of higher capacity, locating hubs with low and medium capacity is recommended.
  - If a hub is more likely to be disrupted, fewer spokes should be allocated to this hub. If a hub is disrupted too often, then it will be closed frequently, and the spokes originally served by the hub will be re-allocated to other open hubs, hence, increasing the cost.
  - If retrieval process of a hub is slow, fewer spokes should be allocated to this hub. Therefore, hubs are more likely to be located at sites with quick retrieval, and spokes are more likely to be served by hubs with lower retrieval time.
  - Significant cost savings may be realized if disruptions are considered during the hub network design phase, especially if the hubs or connection links are often unavailable.

### **6.2. Future research directions**

In this section, some directions for the future research of the inspection planning problem is provided as follows:

- Integrating inspection planning problem with production and capacity planning problems in order to provide more comprehensive model.
- Considering rework and repair activities for the nonconforming parts.
- Considering priority for the parts in both machining and inspection tasks and using multi-priority queuing systems to analyze the congestion and to calculate the waiting time of different parts.
- Employing other evolutionary algorithms to solve the model.



## **Appendix 1**

# **Literature Review**

### A1.0. Appendix purpose and outline

This appendix reviews more paper in the category of simultaneous optimization in Chapter 2. More papers have been reviewed in [Section A1.1](#).

### A1.1. Literature Review: Simultaneous optimization

[Tannock \(1995, 1997\)](#) proposed a simulation approach to the investigation of control chart economics in a single-stage production system to provide guidance on chart design issues such as sample size, sampling interval and the use of alternative chart alarm rules. These studies compared the cost of different inspection strategies (i.e., no inspection, full inspection, sampling inspection) based on simulated quality data for different values of production capabilities,  $C_p$  and  $C_{pk}$ . They emphasized the importance of process capability in the choice of quality control strategy and demonstrated the economic advantages of control charting where special or assignable causes exist.

[Lee and Unnikrishnan \(1998\)](#) developed a mathematical model for solving the inspection allocation and assignment problems in a multistage manufacturing system, in which part types are processed with distinctive machine visitation sequences and inspections can be performed on one of the several inspection stations with possible inspection errors. The authors take into account different costs to be minimized including manufacturing, inspection, internal and external failure costs. In order to solve large size instances, they developed three heuristic solution methods, namely sequential plan selection method (SPS), time constraint solution method (TCS), and manufacturing cost and nonconforming probability selection method (CNS). These algorithms were effective in obtaining near optimal solutions with considerable savings in computational effort when compared with the optimization method based on complete enumeration. They finally compared the heuristics using simulated data for a production system with six manufacturing stages, three inspection stations and four part types. The TCS method completely outperformed SPS and CNS in terms of near optimality of the solutions as well as required computational time.

[Chen \(1999\)](#) applied two approaches to analyze the optimal inspection plan for a multistage assembly process. This thesis mainly focused on how to choose an inspection plan to remove the most variation at the lowest cost, in which the optimal inspection plan balances the cost of inspection and rework against the cost of increased quality. This thesis describes an empirical analysis and prototype software that employs Monte Carlo simulation and simulated annealing to identify the optimal inspection plan. The authors used Monte Carlo technique to predict the expected inspection plan cost and applied simulated annealing to simultaneously find the

optimal allocation of inspection stations, inspection limits and whether the products need rework or should be scrapped. An aircraft wing case was studied to test the performance of the proposed model. [Chen \(1999\)](#) finally reported that a quantitative inspection plan can be successfully developed by applying the proposed approach.

[Hassan and Pham \(2000\)](#) employed the simulated annealing algorithm to solve the problem of inspection planning in MPSs. The authors proposed a cost function based on the work of [Raz and Kapsi \(1991\)](#) and used simulated annealing algorithm to solve it. They also described the representation of the solutions in a binary form, the re-configuration mechanism, and the evaluation of the objective functions based on empirically found cooling schedule. Finally the results of optimization experiments were presented and compared to those obtained by Branch and Bound technique found earlier in the literature. They concluded that the cooling schedule was the most significant factor affecting the quality of the solutions.

[Rabinowitz and Yahalom \(2001\)](#) studied the problem of determining the inspection capacity, frequency of inspecting each attribute and inspection schedule in a production system. Based on a tradeoff between the cost of inspectors and the loss associated with reaching of nonconforming items to the customers, the authors introduced, analyzed and solved three models. In the first model, they assumed that inspection and restoration are perfect, product attribute is up (down) when the system attribute is up (down), and restoration is immediate. The assumptions of perfect inspection and restoration and the assumption of immediate restoration were relaxed in the second and third models, respectively. The authors provided an efficient heuristic method to solve these models and analyzed the sensitivity of the solution to system parameters. Based on several numerical experiments, they concluded that process imperfection had the most effect on the inspection plan. The negative effect of inspection duration on inspection plan was also reported when this duration contributed the major portion of manufacturing duration.

[Opperman et al. \(2003\)](#) attempted to propose an inspection process for a surface mount technology (SMT) production line with the objective of minimizing quality cost in the production system. They described quality cost models to compare the quality behaviors of different technological processes and of different inspection strategies (no inspection, full inspection, and statistical process control (SPC)). The quality costs in their models are the costs of "measurement system" to compare the different inspection strategies with each other, in which the costs are calculated by the use of mathematical models. Finally, the authors suggested dynamic programming as a possible solution approach.

Given a fixed sequence of unreliable inspection operations with known costs and type I and type II inspection errors probabilities, [Avinadav and Raz \(2003\)](#) developed a model for selecting the set of inspections in order to minimize expected total sum of inspection and penalty costs. For optimally solve the model, the authors presented a branch and bound algorithm combined by two greedy heuristics to obtain good solutions at a  $O(n^2)$  computational complexity.

[Kakade et al. \(2004\)](#) proposed an optimization model for allocating inspection efforts at each stage in a serial multistage assembly line producing printed circuit board (PCBs) using surface mount technology. Their model explicitly considered the economic tradeoff between product yield and inspection accuracy. The proposed cost function included costs of inspection, rework and penalty cost. This research also showed that the use of simulated annealing algorithm combined by branch-and-bound was effective and efficient for solving the inspection allocation model. In order to evaluate the performance of the proposed heuristic, problem instances were developed using real production and visual inspection data provided by a local high-volume electronics manufacturer. They finally reported that the proposed heuristic significantly outperformed simple simulated annealing algorithm, while the proposed heuristic was able to obtain near optimal solutions for small and medium size instances.

[Rau and Chu \(2005\)](#) considered inspection allocation problems for an MPS with two types of workstations, workstation of attribute data (WAD) and workstation of variable data (WVD). The authors also considered three possibilities for the treatment of detected nonconforming items as repair, rework and scrap. Assuming these considerations, a profit model, involving processing, inspection, rework, repair, scrap, and penalty costs, was developed for optimally allocating inspection stations. In order to solve the model, a heuristic solution method was developed based on those of [Peters and Williams \(1984\)](#) and it was proved to have much less computation time, compared with an optimization method based on complete enumeration, especially as the number of workstations increases.

As an extension of the work previously done by [Rau and Chu \(2005\)](#), [Rau et al. \(2005\)](#) developed a mathematical model considering layered fabrication to find the optimal solution for allocating inspections in re-entrant production systems, in which, workstations of variables data is only considered. In addition, this research assumed three repair, rework and scrap possibilities for the treatment of detected non-conforming items. Moreover, a heuristic algorithm was proposed based on those of [Peters and Williams \(1984\)](#) in order to improve the optimization method comparing to complete enumeration method, which suffers from a large amount of computation time, especially as the number of workstations increases. The authors concluded that the proposed mathematical model was highly extensible and applicable, so it could serve as a production-planning tool to solve the inspection allocation problem in re-entrant production systems.

[Penn and Raviv \(2007\)](#) studied unreliable serial production lines with known failure probabilities for each operation. The aim was to decide on the allocation of the quality control stations (QCSs) within the assembly line, so as to maximize the expected profit of the system. The authors tried to determine the QCS configuration and the production rate simultaneously. For this aim, the authors developed a cost minimization model under specific assumptions and included the holding costs in the objective function by assuming exponentially distributed processing times, Poisson arrival process of jobs into the system. The novel feature of their model was to

incorporate holding costs in the model. In order to solve the cost minimization problem, the authors developed an  $O(N^2)$  time dynamic programming algorithm by considering exponential and Poisson distributions for processing time and jobs arrival, respectively, where  $N$  stands for the number of operations. On the other hand and under the same assumption, an  $O(N^4)$  time branch-and-bound algorithm was developed for the profit maximization model. The performance of the developed algorithms was tested on the several numerical experiments. Finally, the efficiency and applicability of these algorithms in wide range of manufacturing environment were reported.

Vaghefi and Sarhangian (2009) developed a new mathematical model to optimize inspection plans by minimizing total inspection cost for a MPS with possible misclassification errors. Due to the complexity of the proposed mathematical model, the authors proposed a simulation algorithm to model the MPS subject to inspection and to estimate the resulting inspection costs. They used the popular Arena simulation software to implement the simulation algorithm and then they utilized OptQuest, Arena's builtin optimization package, to find the optimal inspection plan.

Rau and Cho (2011) used the particle swarm optimization (PSO) method for solving the inspection allocation problem in reentrant production systems. The authors added new features to the original PSO to escape from local optimums. For this aim, they considered the mutation scheme borrowed from the genetic algorithm (GA) method for searching the position of optimal fitness function value from each particle. A comparison between the original PSO and PSO with mutation was made in terms of solution performance. In addition, the authors compared the proposed method with the GA method discussed in the literature for the inspection allocation problem in reentrant production systems. The authors finally concluded that the proposed PSO method almost could find the optimal solution, and its execution time was less than that of the GA method.

Azadeh and Sangari (2010) studied optimization of inspection strategies in a serial multistage process. The authors developed a solution algorithm using a metaheuristic method, i.e., simulated annealing, to find the optimal inspection strategy for a serial multistage process by making decisions regarding the allocation of inspection stations, the acceptance limits and the extent of inspection. The objective of the model was minimizing the total inspection cost. They illustrated the practicality of the proposed solution algorithm through a numerical example.

In a similar work to Azadeh and Sangari (2010), Azadeh et al. (2012) proposed a particle swarm optimization (PSO) algorithm to determine the optimal inspection policy in serial MPS. The policy consisted of three decision parameters to be optimized; i.e. the stages in which inspection occurs, tolerance of inspection, and size of sample to inspect. The authors considered total inspection cost as the performance measure of the algorithm. A numerical example was investigated in two phases, i.e. fixed sample size and sample size as a decision parameter, to ensure the practicality and validity of the proposed PSO algorithm. It was shown that PSO gives better results in comparison with two other algorithms proposed by earlier works.

## **Appendix 1: Literature Review**

---

As an extension of [Azadeh et al. \(2012\)](#), [Azadeh et al. \(2014\)](#) addressed the problem of finding optimal inspection policies in serial MPS to minimize total inspection cost where the cost components were described by the use of fuzzy numbers. The authors made decision on the type of inspection in each stage, the acceptance limits, and the size of sample to be inspected. They assumed that inspectors are not error-free. In order to optimally solve the model, a solution algorithm was proposed based on particle swarm optimization, and simulation. The authors reported the applicability and efficiency of the proposed approach by several numerical experiments.

## **Appendix 2**

# **Errors Type I & II**

### A2.0. Appendix purpose and outline

This appendix provides general and comprehensive explanations regarding to errors type I and II.

### A2.1. Errors Type I & II

During a hypothesis test, two types of errors are possibly occurred as errors type I and type II. The level of significance and the power for the test determine the errors, while these errors are inversely related. These errors are unavoidable since a hypothesis test is not 100% certain, when the test is based on probabilities and there is always a possibility for incorrect conclusions (Sarkar and Saren, 2016; Duffuaa and El-Gaaly, 2015; Lin et al., 2011). Table A2.1 shows the situations that errors type I and II occur.

#### ⇒ **Type I error**

When the null hypothesis is true and we reject it, we make a type I error. More generally, a Type I error occurs when a significance test results in the rejection of a true null hypothesis. The probability of making a type I error is  $\alpha$ , which is the level of significance you set for your hypothesis test. For example, an  $\alpha$  equal to 0.05 indicates that there is a 5% chance to wrongly reject the null hypothesis. The lower the value for  $\alpha$ , the lower the value of this risk. On the other hand, setting lower values for  $\alpha$  means that we will be less likely to detect a true difference if one really exists.

Here, we provide more precise definition for value of  $\alpha$ . The above definition might be incorrect and it is more valid to say that  $\alpha$  is the probability of a type I error given that the null hypothesis is true. If the null hypothesis is false, then it is impossible to make a type I error.

#### ⇒ **Type II error**

Despite of error type I, error type II corresponds to a situation when the null hypothesis is false and we fail to reject it. The probability of making a type II error is  $\beta$  that depends on the power of the test. Ensuring that the test has enough power will decrease the risk of making a type II error. The power of a test is increased by ensuring that the sample size is large enough to detect a practical difference when one truly exists. The power of a test is shown as  $1-\beta$  that is the probability of rejecting the null hypothesis when it is false.



## Appendix 2: Errors Type I & II

---

---

Table A2.1. Errors type I and II

Decision	Null Hypothesis	
	True	False
Accept	Correct Decision (probability = $1-\alpha$ )	<b>Type II Error</b> - fail to reject the null when it is false (probability = $\beta$ )
Reject	<b>Type I Error</b> - rejecting the null when it is true (probability = $\alpha$ )	Correct Decision (probability = $1-\beta$ )

## **Appendix 3**

# **GA & DE**

### A3.0. Appendix purpose and outline

The main goal of this Appendix is to explain the solution methods that are based on genetic algorithm (GA) and differential evolution (DE) algorithm to solve the *Main Problem* and the *Extended Problem*, respectively. After a general introduction in [Section A3.1](#), proposed genetic algorithm is described in detail through [Sections A3.2](#) and [A3.3](#) including basic concepts of GA and Ga's operators. [Section A3.4](#) provides explanations about multi-objective optimization and Pareto optimality. Furthermore, [Sections A3.5](#) to [A3.7](#) explain DE algorithm, solution representation for Extended Problem, and DE's operators.

### A3.1. Introduction

In order to solve the proposed inspection models with stochastic complexity, the solution algorithm must be capable of obtaining the optimal or near optimal solution within the reasonable time. There are several methods in the literature such as simplex and dynamic programming based optimization algorithms for providing an optimal solution for small size problems ([Taha 2006](#); [Shukla et al., 2013](#)). However, most of the real world problems have large sizes and solving them by mathematical programming approaches takes considerable computational time. Therefore, to cope with this challenging issue, well-known evolutionary algorithms, namely genetic algorithm (GA) and differential evolution (DE) algorithm are proposed in this chapter to solve the *Main Problem* and *Extended Problem*, respectively. It has been shown that evolutionary algorithms such as genetic algorithms ([Holland, 1975](#)) or evolution strategies ([Back et al., 1991](#)) are efficient and robust approaches to solve a wide range of optimization problems. Application of these algorithms in the area of inspection planning and allocation can be found in [Hanne and Nickel \(2005\)](#), [Shiau \(2003b\)](#), [Alam et al. \(2033\)](#) and [Shiau et al. \(2007\)](#).

### A3.2. Genetic Algorithm (GA)

The principles of genetic algorithm are well known. GA is an adaptive heuristic search method based on population genetics and Darwin's theory of natural selection. [Holland \(1975\)](#) first proposed the basic concepts and [De Jong \(1975\)](#) and [Goldberg \(1989\)](#) first applied these concepts for solving complex optimization problems. The first step in any GA is representing solutions or population members. Typically, this representation is done in a form of a string or chromosome (see [Section 4.1.1](#)). Each bit of this string is referred to a gene. Both binary and non-binary representations have been favored by many GA researchers ([Bean, 1994](#)).

The implementation of a GA starts with initializing a population (i.e., the first generation) of chromosomes, which is described in [Section A3.3](#). The number of

individuals in the population is referred to an integer value as *Pop\_Size*. Next, the fitness value of the individuals of the initial population is determined. After that, the population undergoes specific operators to reproduce new individuals wherein more chances are given to find better solutions regarding the fitness function value. Next generation is formed by three operators, namely elitism, crossover and mutation operators. In elitism operator, a number of best individuals (i.e., *Elit\_P*) in terms of fitness function value are transferred directly to the next generation. By this method, individuals with relatively good fitness levels are more likely to survive and reproduce, with the expectation that fitness levels throughout the population will improve as it evolves.

A number of the next generation individuals is reproduced by crossover operator (i.e., *Cross\_P*), in which, a pair of individuals (parents) are selected to create two new (child) individuals. Subsequently, the mutation operator is applied to the genotypes of some of the current individuals or the newly reproduced children (i.e., *Mutate\_P*). After computing the fitness of each child individual, if the children are better than their corresponding parents in the population, the parents in the population are replaced by the new reproduced children. Doing so, we obtain the next generation to which we again apply the elitism, crossover and mutation operators. This process is repeated for a pre-specified number of generations (or iteration) which is denoted as *Max\_Itr*. This process is illustrated in [Figure A3.1](#).

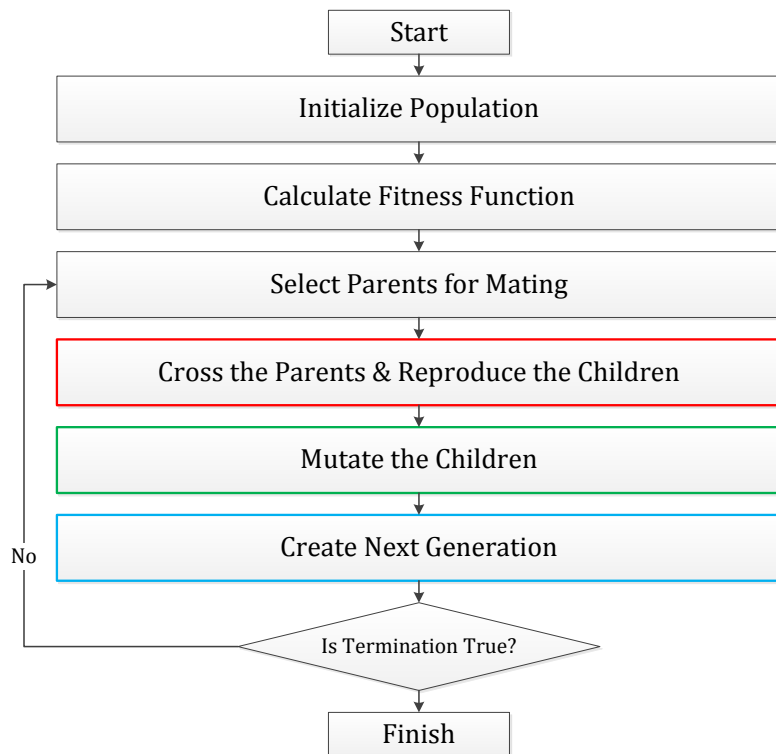

**Figure A3.1.** Genetic algorithm flowchart

Generally, the implementation of the genetic algorithms is independent of the problems to which they are applied. Although the genetic operators are heuristics and

they are commonly expected to operate in the space defined by the problem itself, but genetic operators typically operate in the space defined by the actual representation of a solution (i.e., solution representation). In addition, other operators of any genetic algorithm are heuristic including an operator to select the parents that will mate (selection operator), and an operator to determine which individuals will survive to the next generation (replacement operator). The GAs' operators are some representation-dependent and some are representation neutral. For instance, the initialization, crossover, and mutation are representation-dependent operators. On the other hand, selection, replacement, and termination are all representation-independent operators. In the context of the proposed inspection planning problems in this thesis, the solution representation is a tailored representation, but in most of the papers in the literature, a general representation has been used with many different variations of the inspection problem.

One critical decision in each genetic algorithm that significantly affects the performance of the algorithm is how to represent the solutions and tailoring of genetic operators. Although the selection and replacement operators are representation-independent, but the representation and genetic operators determine how the selection and replacement actions will be performed. An important performance criterion for each genetic algorithm is the robustness of the algorithm. The robustness of genetic algorithm strongly depends on the hardness of the problem while some genetic algorithms appear to be more robust than what they actually are only because they are used to relatively easy problems. These genetic algorithms when are used for large-scale problems wherein especially the ratio of the number of feasible solutions to the number of infeasible solutions is low, the algorithm may get caught in local optima and consequently the robustness is decreased. Accordingly, it must be noted to properly represent the solutions and define the operators, otherwise the genetic algorithm will perform no better than a random search. Therefore, proper design of genetic algorithm will make balance between exploration and exploitation and consequently the algorithm will be able not only in avoiding local optima in global search, but also find small improvements in local search ([Gruninger, 1996](#)).

In each genetic algorithm, one important issue in making balance between exploration and exploitation is developing an operator to measure similarity between solutions in order to maintain clusters of similar solutions. This operator helps to keep the population divers. By this operator, the algorithm has a higher chance to explore the search space and to prevent from premature convergence that is a common problem in genetic algorithms. The premature convergence happens when all of the individuals reach the same representation. In this situation, the algorithm cannot find better solutions and if the optimal solution has not been found, then the convergence is, by definition, premature ([Wall, 1996](#)).

**A3.3. Genetic operators**

Applying each GA needs developing an initialization, selection, crossover, and mutation operators specific to the solution representation. These operators are explained as follows.

**A3.3.1. Initialization**

Lots of researchers have done several experiments with randomly generated initial population, with an initial population of structured solutions, and with an initial population with both random and structured solutions (Baker and Ayechev, 2003). They resulted that an initial population of structured solutions leads to high-quality solutions in a relatively small number of generations of the GA. However, the initial population in this thesis is generated randomly.

**A3.3.2. Selection operator**

A binary tournament selection procedure has been applied for selecting solutions for both the crossover and mutation operators. For applying this procedure, first, two solutions from the population are selected, and then the best solution in terms of the objective function value is selected. This procedure is repeated until the required number of solutions is reached.

**A3.3.3. Crossover operator**

In this step, individuals (parents) are sharing their information by using crossover operator to create better offspring (child). Individuals with better fitness function value have more chance than others for sharing their information under a binary tournament selection. For applying crossover on the solutions, three different kinds of crossover are separately adopted on both *which-what* and *when* representations, including: (i) one-point crossover, (ii) two-points crossover, and (iii) three-point crossover. Figure A3.2 illustrates the crossover operators for a sample *which-what* representation.

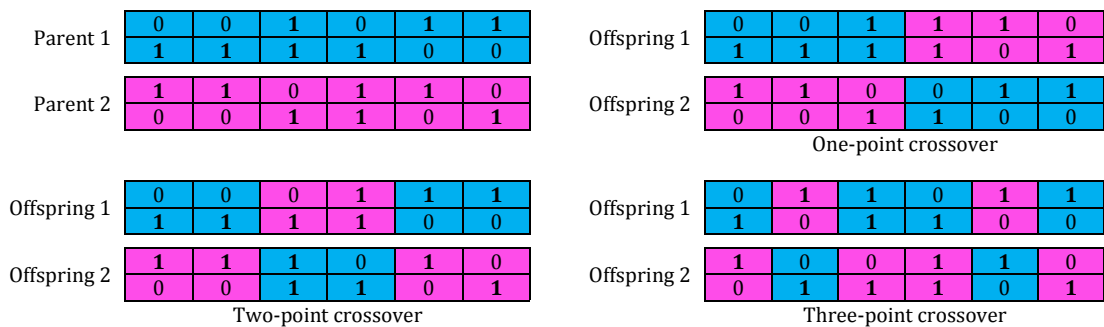

Figure A3.2. Crossover operators

**A3.3.4. Mutation operator**

In order to release from local minima, some random selected individuals undergo the mutation operator. For applying this operator on both parts (i.e., *which-what* and *what* parts) of each solution, three different procedures are utilized

### Appendix 3: GA & DE

including: (i) swap, (ii) reversion and (iii) insertion operators as they have been shown in Figure A3.3. In the swap operator, a random part of a solution is selected and its permutation is reversed. In the reversion operator, places of two random selected bits are exchanged. Finally, in the insertion operator, two bits are selected and the second one is inserted next to the first bit. Finally, the Pseudo code of the proposed GA is illustrated as Figure A3.4.

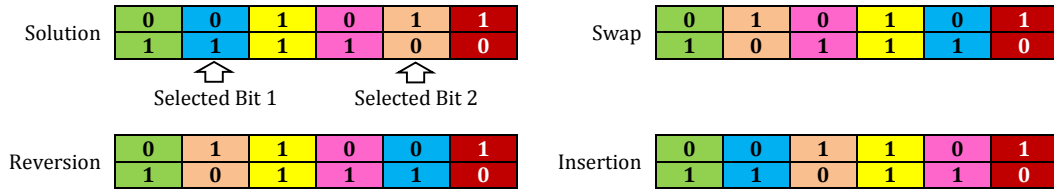

Figure A3.3. Mutation operators

Set the parameters ( $Pop\_Size, Max\_Itr, Elit\_P, Cross\_P, Mutate\_P$ )  
 $Iter = 0$

Create Initial Population ( $Pop1$ )  $\leftarrow Pop\_Size$

Calculate the fitness of each Solution ( $OFV$ )

Transform the Best Individuals to Next Generation ( $Pop2$ )  $\leftarrow Elit\_P$

**While** (Terminate=**false**) **do**

**For**  $i=1:round(Cross\_P \times Pop\_Size)$

Choose Parents (Binary Tournament Selection)

Apply One Crossover Operator Randomly

- a. One Point XO
- b. Two Point XO
- c. Three Point XO

Calculate  $OFV$  of Created Offspring

Archive New Offspring ( $Pop3$ )

**EndFor**

Crossover Operator

**For**  $j=1:round(Cross\_P \times Pop\_Size)$

Choose a Sample Solution Randomly

Apply One Mutation Operator Randomly

- a. Swap
- b. Insertion
- c. Reversion

Calculate  $OFV$  of Mutated Solution

Archive New Solution ( $Pop4$ )

**EndFor**

Mutation Operator

Merge  $Pop1, Pop3$  and  $Pop4$

Sort the Merged Population Based On  $OFVs$

Select the first  $(Pop\_Size - Elit\_P)$ s Solutions ( $Pop5$ )

Create Next Generation by Merging  $Pop2$  and  $Pop5$

Next Generation

**If**  $Iter \geq Max\_Itr$  **then**

Terminate = **True**

**EndIf**

Termination Criterion

$Iter = Iter + 1$

**EndWhile**

Figure A3.4. GA's Pseudo code

In the following sections, a well-known evolutionary algorithm is developed, namely differential evolution (DE), in order to solve the *Extended Problem*. It has been demonstrated that evolutionary algorithms (e.g., DE (Storn and Price, 1997)) or evolution strategies (Back et al., 1991) are capable and robust approaches to solve a wide range of optimization problems.

Since the *Extended Problem* is in the form of a multi-objective optimization model, we will obtain a set of solutions (i.e., Pareto solutions) instead of a single one. In Section 4.5, we will explain the concepts of multi-objective optimization and Pareto optimality.

#### **A3.4. Multi-objective optimization algorithm**

The main difference between single and multi-objective optimization problems is the number of obtained optimal solutions. In a single-objective optimization algorithm, decision maker (DM) is looking for one and only one optimal solution, while in multi-objective optimization problems, a set of solutions depending on non-dominance criterion are found that is named the Pareto sense. In this section, a summary of some basic definitions is presented to better understand the multi-objective optimization problem. A multi-objective problem (MOP) can be described as follows.

$$\begin{aligned} \min_x & [f_1(x), f_2(x), \dots, f_k(x)]^T \\ \text{s.t.} & \\ & x \in S, \end{aligned}$$

where  $k$  is the number of objectives,  $f_i(x)$  is the  $i$ th objective function ( $i = 1, 2, \dots, k$ ) and  $S$  is the feasible region.

⇒ **Definition 1:**

Let  $z^1 = (f_1(x^1), f_2(x^1), \dots, f_k(x^1))$  and  $z^2 = (f_1(x^2), f_2(x^2), \dots, f_k(x^2)) \in R^k$  be two objective vectors. Then,  $z^1$  dominated  $z^2$  if and only if  $z^1 \leq z^2$  and  $z^1 \neq z^2$  (i.e.,  $f_i(x^1) \leq f_i(x^2)$  for all  $i$  and  $f_i(x^1) \neq f_i(x^2)$  for at least one  $i$ ).

⇒ **Definition 2:**

A feasible solution  $x^e$  of the MOP is called to be locally optimal in the Pareto sense if there exist a real  $\varepsilon > 0$  such that there is no solution  $x^l$  that dominates the solution  $x^e$  with  $x^l \in R^k \cap B(x^e, \varepsilon)$ , where  $B(x^e, \varepsilon)$  shows a bowl with center of  $x^e$  and of radius  $\varepsilon$ .

⇒ **Definition 3:**

A solution  $x^e$  is globally optimal in the Pareto sense if there does not exist any vector  $x^l$  such that  $x^l$  dominates the vector  $x^e$ . The main difference between this



definition and the definition of local optimality lies in the fact that we do not have a restriction on the set  $R^k$  anymore.

As it is obvious, the solutions within the Pareto frontier do not dominate each other. Accordingly, in order to compare the solutions in a same frontier, crowding distance metric is used (Mohammadi et al., 2013). The crowding distance is a measure of the density of solutions. Value of the crowding distance presents an estimation of density of solutions surrounding a particular solution. This metric is calculated as Equation (A3.1). The solutions having a higher value of the crowding distance are preferred over solutions with a lower value of the crowding distance.

$$CD_i = \sum_{j=1}^k \frac{f_{j,i+1}^P - f_{j,i-1}^P}{f_{j,total}^{P,max} - f_{j,total}^{P,min}} \quad (A3.1)$$

where  $k$  is the number of objective functions,  $f_{j,i+1}^P$  is the  $j$ th objective function of the  $(i+1)$ th solution and  $f_{j,i-1}^P$  is the  $j$ th objective function of  $(i-1)$ th solution after sorting the population according to crowding distance of the  $j$ th objective function. Also,  $f_{j,total}^{P,max}$  and  $f_{j,total}^{P,min}$  are the maximum and minimum value of objective function  $j$ , respectively.

#### A3.5. Differential evolution algorithm

Like other evolutionary computational algorithms, DE involves the evolution of a population of solution vectors with a size of *Pop\_Size* using specific operators (Calegari et al., 1999). Unlike GA, in which chromosomes are combined to create child individuals, DE uses the "differences" between chromosomes to reproduce a child. Therefore, as the population converges to the global minimum and the differences between individuals decrease, the search space in which children are reproduced decreases simultaneously. In addition, the DE algorithm does not use probability functions to control evolutionary operations like mutation and selection; while the population of individuals is evolved using given arithmetic operators. By this, finding the optimal combination of parameters used to control the operation of DE algorithm becomes easier and so DE can be easily applied to optimize a variety of problems therein GAs are more complex to be implemented and controlled.

In DE algorithm, the initial population is often randomly generated over the variables domain and the child solutions are created from parent solutions using two main arithmetic operators. These operators are: a) recombination (which is similar to the crossover operator used by GAs) and b) mutation. In the following sections, the steps of the proposed DE algorithm are elaborated.

#### A3.6. DE operators

Applying each DE needs developing an initialization, mutation, crossover, and selection operators specific to the solution representation. These operators are explained as follows.

### A3.6.1. Initialization

Like GA, the first step of the DE algorithm is initializing the population of the individual solution vectors. Typically, the matrixes of the solution representation are filled with random values belong to  $[0,1]$  interval.

### A3.6.2. Mutation

The DE algorithm precedes utilizing three basic operators including: mutation, crossover and selection. After the population is initialized, these operators create the population of the next generation  $P_{G+1}$  by using the current population  $P_G$ . During the algorithm, each solution vector in the population has to be selected once as the target vector so that totally  $Pop\_Size$  competitions take place in one generation. A new solution vector is generated by DE's mutation operator, in which, the weighted difference between two solution vectors is added to the third vector. Hence, this algorithm is named as differential evolution. Note that these three vectors are randomly selected and must be different from the target vector; therefore,  $Pop\_Size$  must be at least 4. Let  $e_i, i = 1, \dots, Pop\_Size$ , be the target vector, a mutated vector is generated according to the following equation.

$$\mu_i = e_{v_1} + F(e_{v_2} - e_{v_3}) \quad (A3.2)$$

where  $v_1, v_2$ , and  $v_3$  are mutually different random indices taking from  $\{1, 2, \dots, Pop\_Size\}$ , and are not equal to  $i$ .  $F$  in Equation (A3.2) is a constant real value  $\in [0, 2]$ , which controls the amplification of the differential variation between the second and third randomly chosen population vectors (i.e.,  $e_{v_2} - e_{v_3}$ ).

There are several strategies that can be employed for mutating the solution vectors as Equations (A3.3) to (A3.9) (Storn, 1996). One may choose another strategy instead of that proposed in Equation (A3.2).

$$\mu_i = e_{best} + F(e_{v_2} - e_{v_3}) \quad (A3.3)$$

$$\mu_i = e_{v_1} + \rho(e_{best} - e_{v_3}) + F(e_{v_2} - e_{v_3}) \quad (A3.4)$$

$$\mu_i = e_{best} + F(e_{v_1} + e_{v_2} - e_{v_3} - e_{v_4}) \quad (A3.5)$$

$$\mu_i = e_{v_5} + F(e_{v_1} + e_{v_2} - e_{v_3} - e_{v_4}) \quad (A3.6)$$

$$\mu_i = e_{best} + F(e_{best} - e_{v_1}) \quad (A3.7)$$

$$\mu_i = e_{best} + F(e_{best} - e_{v_1} - e_{v_2} - e_{v_3}) \quad (A3.8)$$

$$\mu_i = e_{best} + \rho(e_{best} - e_{v_1}) + F(e_{v_1} - e_{v_2}) \quad (A3.9)$$

where  $e_{best}$  is the best vector of the current generation (i.e., a Pareto solution with the highest crowding distance).

### A3.6.3. Crossover

In this step, each mutated vector shares its information with a target vector using the crossover operation in order to create new solution  $\tau_i = \{\tau_{i1}, \dots, \tau_{ij}, \dots, \tau_{iD}\}$  as follows.

$$\tau_{ij} = \begin{cases} \mu_{ij} & \text{if } rand(j) \leq CR \text{ and } j = rnbr(i) \\ e_{ij} & \text{if } rand(j) > CR \text{ and } j \neq rnbr(i) \end{cases} \quad (\text{A3.10})$$

where  $rand(j)$  is the  $j$ -th component of a  $D$ -dimensional uniform random number  $\in [0, 1]$  and  $rnbr(i)$  is a randomly chosen index  $\in \{1, \dots, D\}$  to ensure that at least one mutated dimensional value is used in the new created solution.

### A3.6.4. Selection

After creating the new solution vectors, the selection operator is applied to choose the individuals that are going to compose the population in the next generation. In the selection operator, if the new created solution vector dominates the target vector, then the new solution is replaced by the target vector in the next generation. If not, the solution with higher crowding distance between new created solution and target vector remains in the population. Otherwise, the current solution vector is transferred directly to the next generation. Finally, the algorithm can be terminated with a pre-specified maximum number of generations and/or a pre-specified maximum number of function evaluations. The DE procedure has been illustrated in [Figure A3.5](#).

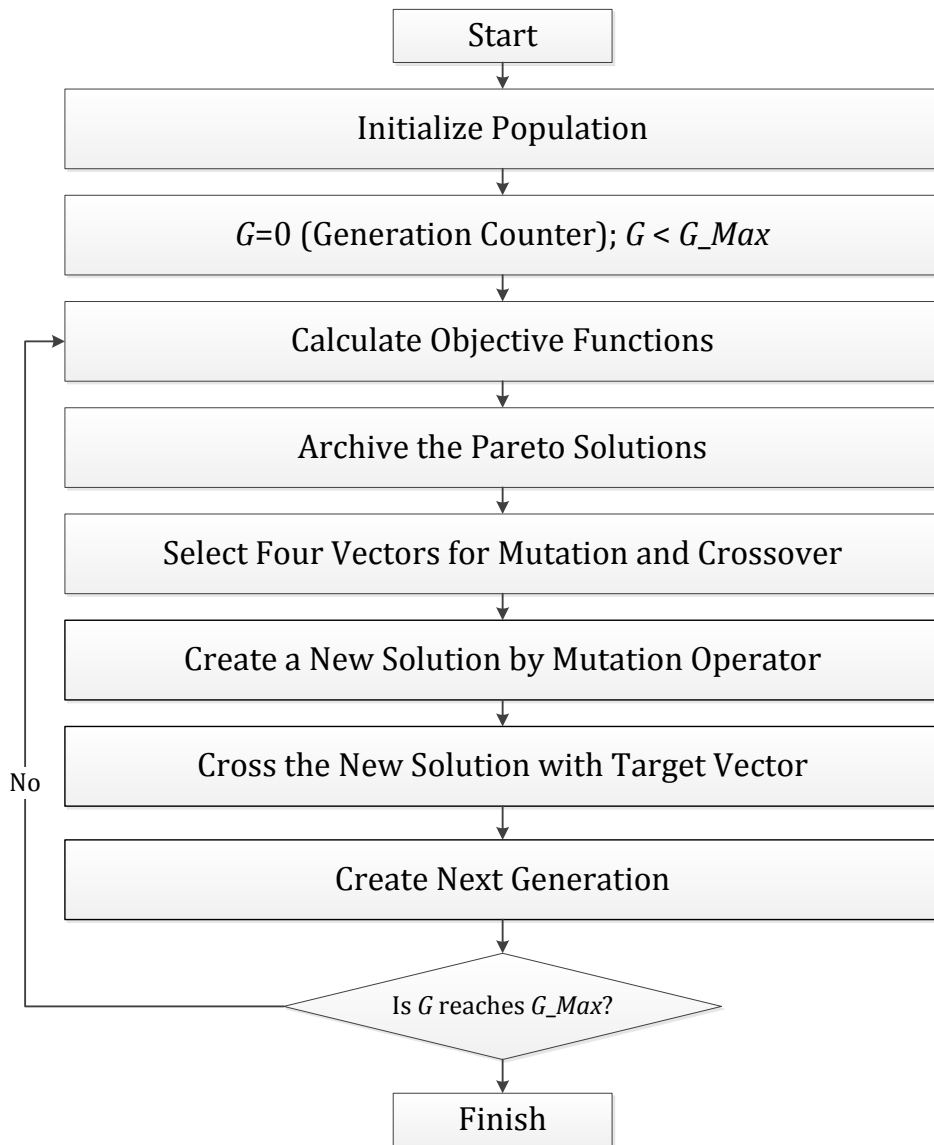

Figure A3.5. Genetic algorithm flowchart

# References

## References

---

- Abellan-Nebot, J.V., Subirón, F.R., 2010. A review of machining monitoring systems based on artificial intelligence process models, *Int. J. Adv. Manuf. Technol*, 47 (1–4): 237–257.
- Aboolian, R., Cui, T., Max Shen, Z.J., 2012. An Efficient Approach for Solving Reliable Facility Location Models. *INFORMS Journal on Computing* 25 (4): 720-729.
- Adragna, P., Samper, S. et Pillet, M., 2010. A proposition of 3D inertial tolerancing to consider the statistical combination of the location and orientation deviations. *International Journal of Product Development*, 10 (1): 26–45.
- Agrawal, A.K., 2007. A dynamic programming approach for economic optimization of inspection strategies in a multi-stage manufacturing system. Master's thesis, Concordia University.
- Alam, M.R., Lee, K.S., Rahman, M., Zhang, Y.F., 2003. Process planning optimization for the manufacture of injection molds using a genetic algorithm. *International Journal of Computer Integrated Manufacturing*, 16(3): 181–191.
- Alumur, S., Kara, B.Y., 2008. Network hub location problems: the state of the art. *European Journal of Operational Research* 190 (1): 1–21.
- Alumur, S.A., Nickel, S., Saldanha-da-Gama, F., 2012. Hub location under uncertainty. *Transportation Research Part B* 46: 529–543.
- Arvidsson, M., Gremyr, I., 2008. Principles of Robust Design Methodology. *Quality and Reliability Engineering International*, 24(1): 23-35.
- Asmundsson, J., Rardin, R.L., Turkseven, C.H., Uzsoy, R., 2009. Production planning with resources subject to congestion. *Nav. Res. Logist.* 56: 142–157.
- Avinadav, T., Raz, T., 2003. Economic optimization in a fixed sequence of unreliable inspections. *Journal of the Operational Research Society*, 54(6): 605-613.
- Azadeh, A., Sangari, M.S., 2010. A metaheuristic method for optimising inspection strategies in serial multistage processes. *International Journal of Productivity and Quality Management*, 6(3): 289-303.
- Azadeh, A., Sangari, M.S., Amiri, A.S., 2012. A particle swarm algorithm for inspection optimization in serial multi-stage processes. *Applied Mathematical Modelling*, 36(4), 1455-1464.
- Azadeh, A., Sangari, M.S., Sangari, E., Fatehi, S., 2014. A particle swarm algorithm for optimising inspection policies in serial multistage production processes with uncertain inspection costs. *International Journal of Computer Integrated Manufacturing*, (ahead-of-print): 1-15.
- Azadeh, A., Sangari, M.S., Shamekhi Amiri, A., 2012. A particle swarm algorithm for inspection optimization in serial multi-stage processes. *Applied Mathematical Modelling*, 36: 1455–1464.

## References

---

- Back, T., Hoffmeister, F., Schwefel, H.-P., 1991. A survey of evolution strategies. In: Belew, R.K., Booker, L.B. (Eds.), Genetic Algorithms. Proceedings of the Fourth International Conference. Morgan Kaufmann, San Mateo: 2–9.
- Bai, D., Yun, H., 1987. Optimal allocation of inspection effort in a serial multi-stage production system. *Computers and Industrial Engineering*, 30: 387-396.
- Baker, B. M., Ayechev, M.A., 2003. A genetic algorithm for the vehicle routing problem. *Computers & Operations Research*, 30(5): 787-800.
- Ballou, D.P. and Pazer, H.L., 1982. The impact of inspector fallibility on the inspection policy in serial production systems. *Management Science*, 28: 387–399.
- Ballou, D.P., Pazer, H.L., 1985. Process improvement versus enhanced inspection in optimized systems. *International Journal of Production Research*, 23: 1233–1245.
- Barad, M., 1990. A break-even quality level approach to location of inspection stations in a multi-stage production process. *International Journal of Production Research*, 28: 29–45.
- Baykal-Gursoy, M., Xiao, W., Ozbay, K., 2009. Modeling traffic flow interrupted by incidents. *European Journal of Operational Research*, 195: 127–138.
- Bean, J.C., 1994. Genetic algorithms and random keys for sequencing and optimization. *ORSA journal on computing*, 6(2): 154-160.
- Beightler, C.S. and Mitten, L.G., 1964. Design of an optimal sequence of interrelated sampling plans. *Journal of the American Statistical Association*, 59: 96–104.
- Beiqing, H., Du, X., 2006. A Robust Design Method Using Variable Transformation and Gauss-Hermite Integration. *International Journal for Numerical Methods in Engineering*, 66(12): 1841-1858.
- Beyer H.G., Olhofer, M., Sendhoff, B., 2002. On the behavior of  $(\mu/\mu_i, \lambda)$ -es optimizing functions disturbed by generalized noises. In *Foundations of Genetic Algorithms*.
- Bisgaard, S., Hunter, W.G., Pallesen, L., 1984. Economic Selection of Quality Manufactured Product. *Technometrics*, 26(1): 9–18.
- Britney, R.R., 1972. Optimal screening plans for nonserial production systems. *Management Science*, 18 (9): 550-559.
- Brown, E.D., 1968. Some mathematical models of inspection along a production line (No. TR-36). Massachusetts Inst of Tech Cambridge Operations Research Center.
- Calégari, P., Coray, G., Hertz, A., Kobler, D., Kuonen, P., 1999. A taxonomy of evolutionary algorithms in combinatorial optimization. *Journal of Heuristics*, 5(2): 145-158.
- Campbell J.F., O’Kelly, M.E., 2012. Twenty-Five Years of Hub Location Research. *Transportation Science*. 46 (2): 153–169.
- Carlsson, O., 1989. Economic selection of a process level under acceptance sampling by variables. *Engineering Costs and Production Economics*, 16(1): 69–78.
- Chakravarty, A.K., Shtub, A., 1987. Strategic allocation of inspection effort in a serial, multi-product production system, *IIE Transactions*, 19(1): 13-22.

## References

---

- Chakravarty, A.K., Shtub, A., 1987. Strategic allocation of inspection effort in a serial, multi-product production system, *IIE Transactions*, 19(1): 13-22.
- Chen, A., Yang, H., Lo, H., Tang, W.H., 2002. Capacity reliability of a road network: an assessment methodology and numerical results. *Transportation Research Part B*, 36 (3): 225-252.
- Chen, J., Yao, D.D. and Zheng, S. (1998) Quality control for products supplied with warranty. *Operations Research*, 46, 107–115.
- Chen, T. J. (1999). Quantitative selection of inspection plans for variation risk management (Doctoral dissertation, Massachusetts Institute of Technology).
- Chen, T.J. and Thornton, A.C. (1999) Quantitative selection of inspection plans. In *Proceedings of the 1999 ASME Design Engineering Technical Conferences*, American Society of Mechanical Engineers, New York, NY
- Chevalier, P.B. and Wein, L.W. (1997) Inspection for circuit board assembly, *Management Science*, 43, 1198–1213.
- Connors, D., Feigin, G., Yao, D., 1996. A queueing network model for semiconductor manufacturing. *IEEE Transactions on Semiconductor Manufacturing* 9 (3).
- Contreras, I., Cordeau, J.F., Laporte, G., 2011. Stochastic uncapacitated hub location. *European Journal of Operational Research* 212: 518–528.
- Contreras, I., Cordeau, J.F., Laporte, G., 2012. Exact Solution of Large-Scale Hub Location Problems with Multiple Capacity Levels. *Transportation Science*, 46 (4): 439–459.
- Correia, I., S. Nickel, F. Saldanha-da-Gama. 2010. Single assignment hub location problems with multiple capacity levels. *Transportation Research Part B*, 44 (8–9): 1047–1066.
- Cruz, F.R.B., Van Woensel, T., Smith, J.M., 2010. Buffer and throughput trade-offs in M/G/1/K queueing networks: a bi-criteria approach. *International Journal of Production Economics* 125, 224–234.
- Cui, T., Y. Ouyang, Z. J. Shen. 2010. Reliable facility location design under the risk of disruptions. *Operation Research*, 58 (4, Part 1): 998–1011.
- D'Ambrosio, C., Lodi, A., Martello, S., 2010. Piecewise linear approximation of functions of two variables in MILP models. *Operations Research Letters* 38: 39-46.
- Das, I., 2000. Robustness optimization for constrained nonlinear programming problems. *Engineering Optimization*, 32(5): 585–618.
- De Jong, K. A., 1975. An analysis of the behavior of a class of genetic adaptive systems. Ph.D. thesis, University of Michigan Press.
- Deb, K., 2001. Multi-objective optimization using evolutionary algorithms. New York: John Wiley & Sons, LTD.
- Del Castillo, E., Hurwitz, A.M., 1997. Run-to-run process control: Literature Review and extensions. *Journal of Quality Technology*, 29 (2): 184-195.
- Deliman, N.C. and Feldman, R.M. (1996) Optimization of process improvement and inspection location for serial manufacturing. *International Journal of Production Research*, 34, 395–405.



## References

---

- Dietrich, D.L. and Sanders, J.L. (1974) A Bayesian quality assurance model for a multi-stage production process, in ASQC Technical Conference Transactions, American Society for Quality Control, Milwaukee, WI, pp. 338–348.
- Duffuaa, S.O., El-Gaaly, A., 2015. Impact of inspection errors on the formulation of a multi-objective optimization process targeting model under inspection sampling plan. *Computers & Industrial Engineering*, 80: 254-260.
- Duret, D., Pillet, M., 2011. *Qualité en production: de l'ISO 9000 à Six Sigma*. Editions Eyrolles.
- Ehrgott, M., 2005. *Multicriteria optimization* (2nd ed.). Berlin: Springer.
- Elhedhli, S., Wu, H., 2010. A Lagrangean heuristic for hub-and-spoke system design with capacity selection and congestion. *INFORMS Journal of Computing*, 22 (2): 282–296.
- Elyasi, A., Salmasi, N., 2013. Stochastic scheduling with minimizing the number of tardy jobs using chance constrained programming. *Mathematical and Computer Modelling*, 57: 1154–1164.
- Emmons, H., Rabinowitz, G., 2002. Inspection allocation for multistage deteriorating production systems. *IIE Transactions*, 34: 1031–1041.
- Emmons, H., Rabinowitz, G., 2002. Inspection allocation for multistage deteriorating production systems. *IIE Transactions*, 34: 1031–1041.
- Enrick, N.L. (1975) Towards optimization of inspection allocation Part I and II. *Industrial Management*, 17, 7–11.
- Eppen, G.D., Hurst, Jr.E.G., 1974. Optimal location of inspection stations in a multistage production process. *Management Science*, 20 (8): 1194-1200.
- Ercan, S.S. (1972) Systems approach to the multistage manufacturing connected-unit situation. *Naval Research Logistics Quarterly*, 19, 493–500.
- Ercan, S.S., Hassan, M.Z. and Taulananda, A. (1974) Cost minimizing single sampling plans with AIQL and AOQL constraints. *Management Science*, 20, 1112–1121.
- Etienne, A. (2007). *Intégration Produit/Process par les concepts d'activités et de caractéristiques clés-Application à l'optimisation de l'allocation des tolérances géométriques* (Doctoral dissertation, Université de Metz).
- Etienne, A., 2007. *Intégration Produit / Process par les concepts d'activités et de caractéristiques clés - Application à l'optimisation de l'allocation des tolérances géométriques*. Thèse de doctorat à l'Université Paul Verlaine - Metz.
- EU transport in figures, 2014. *Statistical Pocketbook 2014*, from [http://ec.europa.eu/transport/facts-fundings/statistics/pocketbook-2014\\_en.htm](http://ec.europa.eu/transport/facts-fundings/statistics/pocketbook-2014_en.htm).
- Feng, C.X., Kusiak, A., Huang, C.C., 1996. Cost evaluation in design with form features. *Computer-Aided Design*, 28(11): 879–885.
- Feng, Q., & Kapur, K. C. (2006). Economic design of specifications for 100% inspection with imperfect measurement systems. *Quality Technology & Quantitative Management*, 3, 127-144.

## References

---

- Ferreira, R.J.P., Almeida, A.T., Cavalcante, C. 2009. A multi-criteria decision model to determine inspection intervals of condition monitoring based on delay time analysis. *Reliability Engineering and System Safety*, 94: 905–912.
- Foster, J.W., Malave, C.O. and Villalobos, J.R. (1990) Flexible inspection within an aggregated information environment. *Computers & Industrial Engineering*, 19, 224–228.
- France. 2015. *Encyclopædia Britannica Online*. Retrieved 31 mars, 2015, from <http://www.britannica.com/EBchecked/topic/215768/France/41146/Transportation-and-telecommunications>
- Garcia-Diaz, A., Foster, J.W. and Bonyuet, M. (1984) Dynamic programming analysis of special multi-stage inspection systems. *IIE Transactions*, 16, 115–125.
- Garey, M.R. (1972) Optimal test point selection for sequential manufacturing processes. *The Bell System Technical Journal*, 51, 291–300.
- Goldberg, D., (1989). *Genetic algorithms in search, optimization, and machine learning*. Addition Wesley, NY.
- Gruninger, M. (1996, August). Designing and evaluating generic ontologies. In *Proceedings of the 12th European Conference of Artificial Intelligence (Vol. 1, pp. 53-64)*.
- Gunter, S.I. and Swanson, L.A. (1985) Inspector location in convergent production line. *International Journal of Production Research*, 23, 1153–1169.
- Gurnani, H., Drezner, Z. and Akella, R. (1996) Capacity planning under different inspection strategies. *European Journal of Operations Research*, 89, 302–312.
- Gyung-Jin, P., Lee, K.H., 2002. Robust Optimization in Discrete Design Space for Constrained Problems. *AIAA Journal*, 40(4): 774–780.
- Hanne, T., & Nickel, S. (2005). A multiobjective evolutionary algorithm for scheduling and inspection planning in software development projects. *European Journal of Operational Research*, 167(3), 663-678.
- Hanne, T., Nickel, S., 2005. A multi-objective evolutionary algorithm for scheduling and inspection planning in software development projects. *European Journal of Operational Research*, 167: 663–678.
- Hans-Georg, B., Sendho, Bernhard, 2007. Robust optimization - A comprehensive survey. *Computer Methods in Applied Mechanics and Engineering*, 196(33-34): 3190–3218.
- Hassan, A. (2010). Proposition et développement d'une approche pour la maîtrise conjointe qualité/coût lors de la conception et de l'industrialisation du produit (Doctoral dissertation, Arts et Métiers ParisTech).
- Hassan, A., & Pham, D. T. (2000). OPTIMISATION OF INSPECTION STATIONS BY USING SIMULATED ANNEALING. *International Journal for Manufacturing Science and Technology*, 2, 59-65.
- Hassan, A., 2010. Proposition et développement d'une approche pour la maîtrise conjointe qualité/coût lors de la conception et de l'industrialisation du produit. Thèse soutenue à l'ENSAM.

## References

---

- Hinrichs, W. (2011). Product-specific adaption of conformity assessment criteria and their financial consequences. *Production Engineering*, 5(5), 549-556.
- Holland, J.H., 1975. *Adaption in natural and artificial systems*. Ann Arbor, MI: University of Michigan Press.
- Hsu, J.I.S. (1984) A hybrid inspection system for the multistage production process. *International Journal of Production Research*, 22, 63–69.
- Hulett, M., Damodaran, P., 2011. Analytical approximations to predict performance measures of markovian type manufacturing systems with job failures and parallel processing. *European Journal of Operational Research*, 212: 89–99.
- Hunter, W.G., Kartha, C.P., 1977. Determining the Most Profitable Target Value for a Production Process. *Journal of Quality Technology*, 9(4): 176–181.
- Hurst, E., 1973. Imperfect inspection in a in a multi-workstation production process. *Management Science*, 20: 378–384.
- ISO 9001, 2008. « Systèmes de management de la qualité – Exigences ».
- Jewkes, E.M. (1995) Optimal inspection effort and scheduling for a manufacturing process with repair. *European Journal of Operational Research*, 85, 340–351.
- Jin, Y., Sendhoff, B., 2003. Trade-Off between Performance and Robustness: An Evolutionary Multiobjective Approach. *Lecture note in computer science*, 2632: 237–251.
- Johnson, H.T., Kaplan, R.S., 1987. *Relevance Lost: The Rise and Fall of Management Accounting*. Boston: Harvard Business School Press.
- Kakade, V., Valenzuela, J. F., & Smith, J. S. (2004). An optimization model for selective inspection in serial manufacturing systems. *International journal of production research*, 42(18), 3891-3909.
- Kane, V.E., 1986. Process Capability Indices. *Journal of Quality Technology*, 18 (1): 41-52.
- Kang, K., Ebeling, K.A., and La, S. (1990) The optimal location of inspection stations using a rule-based methodology. *Computers & Industrial Engineering*, 19, 272–275.
- Keats, J.B., Del Castillo, E., Von Collani, E., Saniga, E.M., 1997. Economic modeling for statistical process control. *Journal of Quality Technology*, 29 (2): 144-147.
- Kogan, K., Raz, T., 2002. Optimal allocation of inspection effort over a finite planning horizon. *IIE Transactions*, 34: 515–527.
- Korytkowski, P. (2011). A genetic algorithm with tournament selection for optimising inspection allocation in multiproduct multistage production systems. *International Journal of Simulation and Process Modelling*, 6(3), 238-244.
- Kunzmann, H., Pfeifer, T., Schmitt, R., Schwenke, H. and Weckenmann, A., 2005. Productive metrology-Adding value to manufacture. *CIRP Annals-Manufacturing Technology*, 54(2): 155-168.
- Lall, V., Stylianides, C., Stanislaio, J., 1991. Integrating economics into quality control charts”. *Computers & Industrial Engineering*, 21(1), pp.135–139.

## References

---

- Lee, H.L. and Rosenblatt, M.J. (1987) Simultaneous determination of production cycle and inspection schedules in a production system. *Management Science*, 33, 1125–1136.
- Lee, J., Unnikrishnan, S., 1998. Planning quality inspection operations in multistage manufacturing systems with inspection errors. *International Journal of Production Research*, 36(1): 141–155.
- Li, J., Blumenfeld, D.E., Huang, N., Alden, J.M., 2009. Throughput analysis of production systems: recent advances and future topics. *International Journal of Production Research* 47, 3823–3851.
- Li, Q., Zeng, B., Savachkin, A., 2013. Reliable facility location design under disruptions. *Computers & Operations Research*, 40: 901–909.
- Liang, S.Y., Hecker, R.L., Landers, R.G., 2004. Machining process monitoring and control: the state-of-the-art, *J. Manuf. Sci. Eng.*, 126 (2): 297–310.
- Lin, Y.H., Chen, J.M., Chen, Y.C., 2011. The impact of inspection errors, imperfect maintenance and minimal repairs on an imperfect production system. *Mathematical and Computer Modelling*, 53(9): 1680-1691.
- Lindsay, G.F., Bishop, A.B., 1964. Allocation of screening inspection effort – dynamic programming approach. *Management Science*, 10(2): 343–352.
- Lo, H., Luo, X.W., Siu, W.Y., 2006. Degradable transport network: Travel time budget of travelers with heterogeneous risk aversion. *Transportation Research Part B*, 40: 792-806.
- Lo, H., Tung, Y.K., 2003. Network with degradable links: capacity analysis and design. *Transportation Research Part B*, 37 (4): 345-363.
- Lo, H.K., Tung, Y.K., 2003. Network with degradable links: capacity analysis and design. *Transportation Research Part B* 37: 345–363.
- Luo, X.W., 2004. Degradable transport networks. MPhil. Thesis, Department of Civil Engineering, Hong Kong University of Science and Technology, Hong Kong.
- Mandroli, S. S., Shrivastava, A. K., & Ding, Y. (2006). A survey of inspection strategy and sensor distribution studies in discrete-part manufacturing processes. *IIE Transactions*, 38(4), 309-328.
- Martins de Sá, E., Contreras, I., Cordeau, J. F., Saraiva de Camargo, R., & de Miranda, G., 2015. The hub line location problem. *Transportation Science*. Accepted manuscript. DOI: 10.1287/trsc.2014.0576.
- Mavrotas, G., & Florios, K., 2013. An improved version of the augmented -constraint method (AUGMECON2) for finding the exact Pareto set in multiobjective integer programming problems. *Applied Mathematics and Computation*, 219 (18): 9652–9669.
- Mavrotas, G., 2009. Effective implementation of the -constraint method in multiobjective mathematical programming problems. *Applied Mathematics and Computation*, 213 (2): 455–465.
- Michael, W.T., 2013. Taguchi and Robust Optimization: 1–10.

## References

---

- Mirdamadi, S., 2014. Système d'aide à la décision pour la génération des processus d'inspection par la fédération des expertises métier. Thèse soutenue à l'ENSAM en septembre 2014.
- Mirdamadi, S., 2014. Système d'aide à la décision pour la génération des processus d'inspection par la fédération des expertises métier (Doctoral dissertation, Institut d'Optique Graduate School).
- Mirdamadi, S., Etienne, A., Hassan, A., Dantan, J. Y., & Siadat, A., 2013. Cost estimation method for variation management. *Procedia CIRP*, 10: 44-53.
- Mirdamadi, S., Etienne, A., Hassan, A., Dantan, J-Y., Siadat, A., 2013. Cost Estimation Method for Variation Management. In *Procedia CIRP* : 44–53.
- Mohammadi, M., Dehbari, S., Vahdani, B., 2014b. Design of a bi-objective reliable healthcare network with finite capacity queue under service covering uncertainty. *Transportation Research Part E*, 72: 15–41.
- Mohammadi, M., Jolai, F., Rostami, H., 2011a. An M/M/c queue model for hub covering location problem. *Mathematical and Computer Modelling* 54: 2623–2638.
- Mohammadi, M., Jolai, F., Tavakkoli-Moghaddam, R., 2013. Solving a new stochastic multi-mode p-hub covering location problem considering risk by a novel multi-objective algorithm, *Applied Mathematical Modelling*, 37, 10053–10073.
- Mohammadi, M., Siadat, A., Dantan, J. Y., & Tavakkoli-Moghaddam, R., 2015. Mathematical modelling of a robust inspection process plan: Taguchi and Monte Carlo methods. *International Journal of Production Research*, 53(7): 2202-2224.
- Mohammadi, M., Tavakkoli-Moghaddam, R., & Rostami, R., 2011b. A multi-objective imperialist competitive algorithm for a capacitated hub covering location problem. *International Journal of Industrial Engineering Computations*, 2(3): 671-688.
- Mohammadi, M., Tavakkoli-Moghaddam, R., 2015. Design of a fuzzy bi-objective reliable p-hub center problem. *Journal of Intelligent & Fuzzy Systems*, (Preprint), 1-18. DOI: 10.3233/IFS-151846.
- Mohammadi, M., Tavakkoli-Moghaddam, R., Tolouei, H., Yousefi, M., 2010. Solving a hub covering location problem under capacity constraints by a hybrid algorithm. *Journal of Applied Operational Research*, 2(2): 109-116.
- Mohammadi, M., Torabi, S.A., Tavakkoli-Moghaddam, R., 2014a. Sustainable hub location under mixed uncertainty. *Transportation Research Part E* 62: 89–115.
- Montgomery, D.C., Keats, J., Runger, G.C., Messina, W.S., 1994. Integrating statistical process control and engineering process control. *Journal of Quality Technology*, 26 (2): 79-87.
- Moroni, G., Petrò, S., Tolio, T., 2011. Early cost estimation for tolerance verification. *CIRP Annals - Manufacturing Technology*, 60(1): 195–198.
- Mousavi, S. M., Mirdamadi, S., Siadat, A., Dantan, J., & Tavakkoli-Moghaddam, R. (2015). An intuitionistic fuzzy grey model for selection problems with an application to the inspection planning in manufacturing firms. *Engineering Applications of Artificial Intelligence*, 39, 157-167.

## References

---

- Narahari, Y. and Khan, L.M. (1996) Modeling reentrant manufacturing systems with inspection stations. *Journal of Manufacturing Systems*, 15, 367–378.
- Narahari, Y., & Khan, L. M. (1995, May). Modeling re-entrant manufacturing systems with inspections. In *Robotics and Automation, 1995. Proceedings., 1995 IEEE International Conference on* (Vol. 2, pp. 1738-1743). IEEE.
- Narahari, Y., Khan, L.M., 1996. Modeling reentrant manufacturing systems with inspection stations. *Journal of Manufacturing Systems* 15 (6), 367–378.
- Nemhauser, G.L., Wolsey, L.A., 1988. *Integer and combinatorial optimization*. Wiley-Interscience; 1988.
- Niakan, F., Vahdani, B., Mohammadi, M., 2015. A multi-objective optimization model for hub network design under uncertainty: An inexact rough-interval fuzzy approach. *Engineering Optimization*. DOI: 10.1080/0305215X.2014.992891.
- Omar, M.K., Kumar, S., 2008. Performance analysis in a probabilistic re-entrant for an environmental stress testing operation. *Computers & Industrial Engineering* 54, 932–944.
- Oppermann, M., Sauer, W., Wohlrabe, H., & Zerna, T. (2003). New quality cost models to optimize inspection strategies. *Electronics Packaging Manufacturing, IEEE Transactions on*, 26(4), 328-337.
- Park, Y., Kim, S., Jun, C.H., 2000. Performance analysis of re-entrant flow shop with single-job and batch machines using mean value analysis. *Production Planning & Control* 11 (6), 537–546.
- Parvaresh, F., Hashemi Golpayegany, S.A., Moattar Hussein, S.M., Karimi, B., 2013. Solving the p-hub Median Problem Under Intentional Disruptions Using Simulated Annealing. *Network & Spatial Economics*, DOI 10.1007/s11067-013-9189-3.
- Parvaresh, F., Moattar Hussein, S.M., Hashemi Golpayegany, S.A., Karimi, B., 2012. Hub network design problem in the presence of disruptions. *Journal of Intelligent Manufacturing*. DOI 10.1007/s10845-012-0717-7.
- Peng, P., Snyder, L.V., Liu, Z., Lim, A., 2011. Design of reliable logistics networks with facility disruptions. *Transportation Research Part B: Methodological* 45: 1190–1211.
- Penn, M., & Raviv, T. (2007). Optimizing the quality control station configuration. *Naval Research Logistics (NRL)*, 54(3), 301-314.
- Penn, M., & Raviv, T. (2008). A polynomial time algorithm for solving a quality control station configuration problem. *Discrete Applied Mathematics*, 156(4), 412-419.
- Peters, J., 1977. Metrology in design and manufacturing: facts and trends. *CIRP Annals-Manufacturing Technology* 2: 415-421.
- Peters, M. H., & Williams, W. W. (1984). Location of quality inspection stations: an experimental assessment of five normative heuristics. *Decision Sciences*, 15(3), 389-408.
- Peters, M.H. and Williams, W.W. (1987) Economic design of quality monitoring efforts for multi-stage production systems. *IIE Transactions*, 19, 81–87.

## References

---

- Peterson, M., Bertsimas, D., Odoni, A., 1995. Models and algorithms for transient queuing congestion at airports. *Management Science*, 41 (8): 1279–1295.
- Pfeifer, T., 2002. *Production metrology*. Oldenbourg Verlag.
- Pillet, M., 1993. *Contribution à la maîtrise statistique des procédés. Cas particulier des petites séries* (Doctoral dissertation).
- Pillet, M., Ozouf, V., Sergent, A., & Duret, D., 2007. La matrice d'impact pour construire un plan de surveillance avec les contraintes de l'ingénierie simultanée. In *5th International Seminar Integrated Design and Production* (p. NC).
- Pradhan, S., Damodaran, P., 2009. Performance characterization of complex manufacturing systems with general distributions and job failures. *European Journal of Operational Research* 197, 588–598.
- Pradhan, S., Damodaran, P., Srihari, K., 2008. Predicting performance measures for markovian type of manufacturing systems with product failures. *European Journal of Operational Research* 184, 725–744.
- Pruzan, P. M., & Jackson, J. R. (1967). A dynamic programming application in production line inspection. *Technometrics*, 9(1), 73-81.
- Rabinowitz, G., & Emmons, H. (1997). Optimal and heuristic inspection schedules for multistage production systems. *IIE transactions*, 29(12), 1063-1071.
- Rabinowitz, G., & Yahalom, O. (2001). Imperfect inspection of a multi-attribute deteriorating production system—a continuous time model. *Quality and Reliability Engineering International*, 17(6), 407-418.
- Rau, H., & Cho, K. H. (2009). Genetic algorithm modeling for the inspection allocation in reentrant production systems. *Expert Systems with Applications*, 36(8), 11287-11295.
- Rau, H., & Cho, K. H. (2011). Particle swarm optimization with mutation for the inspection allocation in reentrant production systems. In *Machine Learning and Cybernetics (ICMLC), 2011 International Conference on* (Vol. 3, pp. 1025-1030). IEEE.
- Rau, H., Chu, Y. H., & Cho, K. H. (2005). Layer modelling for the inspection allocation problem in re-entrant production systems. *International journal of production research*, 43(17), 3633-3655.
- Rau, H., Chu, Y.H., 2005. Inspection allocation planning with two types of workstation: WVD and WAD. *International Journal of Advanced Manufacturing Technology*, 25: 947–953.
- Raz, T. and Kaspi, M. (1991) Location and sequencing of imperfect inspection operations in serial multi-stage production systems. *International Journal of Production Research*, 29, 1645–1659.
- Raz, T., & Kaspi, M. (1991). Location and sequencing of imperfect inspection operations in serial multi-stage production systems. *International Journal of Production Research*, 29(8), 1645-1659.
- Rebello, R., Agnetis, A. and Mirchandani, P.B. (1995) Specialized inspection problems in serial production systems. *European Journal of Operations Research*, 80, 277–296.

## References

---

- Ritou, M., Garnier, S., Furet, B., Hascoet, J.Y., 2014. Angular approach combined to mechanical model for tool breakage detection by eddy current sensors, *Mech. Syst. Signal Process*, 44 (1-2): 211-220.
- Saboo, S., Wang, L., Wihelm, W.E., 1989. Recursion models for describing and managing the transient flow of materials in generalized flowlines. *Management Science* 35 (6), 722-742.
- Sarkar, B., Saren, S., 2016. Product inspection policy for an imperfect production system with inspection errors and warranty cost. *European Journal of Operational Research*, 248(1): 263-271.
- Savio, E., 2012. A methodology for the quantification of value-adding by manufacturing metrology. *CIRP Annals - Manufacturing Technology*, 61(1): 503-506.
- Saxena, S., Chang, C. M., Chow, H. B., & Lee, J. (1990, December). Evaluation of heuristics for inspection station allocation in serial production systems. In *Proceedings of the 22nd conference on Winter simulation* (pp. 919-922). IEEE Press.
- Sedehzadeh, S., Tavakkoli-Moghaddam, R., Baboli, A., Mohammadi, M., 2015. Optimization of a multi-modal tree hub location network with transportation energy consumption: A fuzzy approach. *Journal of Intelligent & Fuzzy Systems*, (Preprint), 1-18. DOI: 10.3233/IFS-151709.
- Sedehzadeh, S., Tavakkoli-Moghaddam, R., Mohammadi, M., Jolai, F., 2014. Solving a new priority m/m/c queue model for a multi-mode hub covering location problem by multi-objective parallel simulated annealing. *Economic Computation And Economic Cybernetics Studies and Research*, 48(4), 299-318.
- Shen, Z.J.M., Zhan, R.L., Zhang, J., 2011. The Reliable Facility Location Problem: Formulations, Heuristics, and Approximation Algorithms. *INFORMS Journal on Computing*, 23 (3): 470-482.
- Shiau, Y.R., 2002. Inspection resource assignment in a multistage manufacturing system with inspection error model. *International Journal of Production Research*, 40(8): 1787-1806.
- Shiau, Y.R., 2003a. Inspection allocation planning for a multiple quality characteristic advanced manufacturing system. *International Journal of Advanced Manufacturing Technology*, 21: 494-500.
- Shiau, Y.R., 2003b. Quick decision-making support for inspection allocation planning with rapidly changing customer requirements. *International Journal of Advanced Manufacturing Technology*, 22(9-10): 633-640.
- Shiau, Y.R., Lin, M.H., Chuang, W.C., 2007. Concurrent process/inspection planning for a customized manufacturing system based on genetic algorithm. *International Journal of Advanced Manufacturing Technology*, 33: 746-755.
- Shin, W.S., Hart, S.M. and Lee, H.F. (1995) Strategic allocation of inspection stations for a flow assembly line: a hybrid procedure. *IIE Transactions*, 27, 707-715.



## References

---

- Shukla, N., Tiwari, M.K., Ceglarek, D., 2013. Genetic-algorithms-based algorithm portfolio for inventory routing problem with stochastic demand. *International Journal of Production Research* 51 (1): 118–137.
- Sim, T., Lowe, T.J., Thomas, B.W., 2009. The stochastic p-hub center problem with service-level constraints. *Computers and Operations Research*, 36 (12): 3166-3177.
- Sivanandam, S., Deepa, S., 2008. *Introduction to genetic algorithms*. Springer Publishing Company, Incorporated.
- Snyder, L.V., Daskin, M.S., 2005. Reliability models for facility location: the expected failure cost case. *Transportation Science* 39: 400–416.
- Storn, R. (1996, June). On the usage of differential evolution for function optimization. In *Fuzzy Information Processing Society, 1996. NAFIPS., 1996 Biennial Conference of the North American* (pp. 519-523). IEEE.
- Storn, R., & Price, K. (1997). Differential evolution—a simple and efficient heuristic for global optimization over continuous spaces. *Journal of global optimization*, 11(4), 341-359.
- Tagaras, G., 1996. Dynamic control charts for finite production runs. *European Journal of Operational Research*, 91: 38-55.
- Tagaras, G., 1998. A survey of recent development in the design of adaptive control charts. *Journal of Quality Technology*, 30 (3): 212-231.
- Taha, H.A., 2006. *Operations research: an introduction*. Englewood Cliffs, NJ: Prentice-Hall.
- Taneja, M., & Viswanadham, N. (1994, May). Inspection allocation in manufacturing systems: A genetic algorithm approach. In *Robotics and Automation, 1994. Proceedings., 1994 IEEE International Conference on* (pp. 3537-3542). IEEE.
- Taneja, M., Sharma, S. M., & Viswanadham, N. (1994). Location of quality-control stations in manufacturing systems: a simulated annealing approach. *Systems practice*, 7(4), 367-380.
- Tang, C.S., 1991. Designing an optimal production system with inspection. *European Journal of Operational Research*, 52(1): 45-54.
- Tannock, J. D. (1995). Choice of inspection strategy using quality simulation. *International Journal of Quality & Reliability Management*, 12(5), 75-84.
- Tannock, J. D. (1997). An economic comparison of inspection and control charting using simulation. *International Journal of Quality & Reliability Management*, 14(7), 687-699.
- Tansel, B.C., Francis, R.L., Lowe, T.J., 1983. Location on networks: a survey. Part I: the P-center and P-median problems. *Management Science* 29: 482–497.
- Tayi, G.K. and Ballou, D.P. (1988) An integrated production-inventory model with reprocessing and inspection. *International Journal of Production Research*, 26, 1299–1315.
- Thornton A. C., 2004. *Variation risk management*. Ed. John Wiley. New Jersey: Hoboken
- Torben, H., Arvidsson, M., Gremyr, I., 2009. A Review of Practices for Robust Design Methodology. *Journal of Engineering Design*, 20(6): 645-657.

## References

---

- Trippi, R.R. (1974) An on-line computational model for inspection resource allocation. *Journal of Quality Technology*, 6, 167–174.
- Trippi, R.R. (1975) The warehouse location formulation as a special type of inspection problem. *Management Science*, 21, 986–988.
- Vaghefi, A., & Sarhangian, V. (2009). Contribution of simulation to the optimization of inspection plans for multi-stage manufacturing systems. *Computers & Industrial Engineering*, 57(4), 1226-1234.
- Vahdani, B., & Mohammadi, M., 2015. A bi-objective interval-stochastic robust optimization model for designing closed loop supply chain network with multi-priority queuing system. *International Journal of Production Economics*, 170, 67-87.
- Valenzuela J.F., Smith J.S. and Evans J.L. (2004) Allocating solder-paste printing inspection in high volume electronics manufacturing. *IIE Transactions*, 36, 1171–1181.
- Van Volsem, S., & Van Landeghem, H. (2003). Optimizing Inspection Strategies for Multi-Stage Processes: an Exploratory Modeling Framework and Simulation. *Qualité et Sûreté de Fonctionnement*, 2-9.
- Van Volsem, S., (2010). Joint optimisation of all inspection parameters for multistage processes: evolutionary algorithm and simulation. *International Journal of Innovative Computing and Applications*, 2(3), 170-177.
- Van Volsem, S., 2006. A method for determining cost-efficient inspection strategies in multistage production systems. *Universiteit Gent, Faculteit Ingenieurswetenschappen, Gent*.
- Van Volsem, S., Dullaert, W., & Van Landeghem, H. (2007). An Evolutionary Algorithm and discrete event simulation for optimizing inspection strategies for multi-stage processes. *European Journal of Operational Research*, 179(3), 621-633.
- van Woensel, T., Cruz, F.R.B., 2009. A stochastic approach to traffic congestion costs. *Computers & Operations Research* 36, 1731-1739.
- van Woensel, T., Vandaele, N., 2006. Empirical validation of a queueing approach to uninterrupted traffic flows. *4OR* 4 (1), 59-72.
- van Woensel, T., Wuyts, B., Vandaele, N., 2006. Validating state-dependent queueing models for uninterrupted traffic flows using simulation. *4OR*, 4(2), 159-174.
- Veatch, M. H. (2000). Inspection strategies for multistage production systems with time-varying quality. *International Journal of Production Research*, 38(4), 837-853.
- Verduzco, A., Villalobos, J. R., & Vega, B. (2001). Information-based inspection allocation for real-time inspection systems. *Journal of Manufacturing Systems*, 20(1), 13-22.
- Villalobos, J.R. and Foster, J.W. (1991) Some results from model of dynamic inspection allocation. *Computers and Industrial Engineering*, 21, 355–358.
- Villalobos, J.R., Foster, J.W. and Disney, R.L. (1993) Flexible inspection systems for serial multi-stage production systems. *IIE Transactions*, 25, 16–26.

## References

---

- Viswanadham, N., Sharma, S. and Taneja, M. (1996) Inspection allocation in manufacturing systems using stochastic search techniques. *IEEE Transactions on Systems, Man and Cybernetics, Part A (Systems & Humans)*, 26, 222–230.
- Viswanadham, N., Sharma, S.M., Taneja, M., 1996. Inspection allocation in manufacturing systems using stochastic search technique. *IEEE Transactions on Systems, Man, and Cybernetics - Part A: Systems and Humans*, 26 (2): 222-230.
- Wall, M. (1996). GAlib: A C++ library of genetic algorithm components. Mechanical Engineering Department, Massachusetts Institute of Technology, 87, 54.
- Wei, C., Allen, J.K., Tsui, K.L., Mistree, F., 2007. A Procedure for Robust Design: Minimizing Variations Caused by Noise Factors and Control Factors. *Journal of Mechanical Design*, 1-8.
- Wen, Y., Xu, H., Yang, J., 2011. A heuristic-based hybrid genetic-variable neighborhood search algorithm for task scheduling in heterogeneous multiprocessor system. *Information Sciences* 181: 567–581.
- White, L.S., 1966. The analysis of a simple class of multistage inspection plans. *Management Science*, 12(7): 685–693.
- Winchell, W. (1996). *Inspection and measurement in manufacturing: keys to process planning and improvement*. Society of Manufacturing Engineers.
- Woo, W.K. and Metcalfe, J.E. (1972) Optimal allocation of inspection effort in multistage manufacturing processes. *Western Electric Engineer*, 16, 3–16.
- Wu, K., 2005. An examination of variability and its basic properties for a factory. *IEEE Transactions on Semiconductor Manufacturing* 18, 214–221.
- Xiaoping, D., Chen, W., 2000. Methodology for Managing the Effect of Uncertainty in Simulation-Based Design. *AIAA Journal*, 38(8): 1471-1478.
- Yang, F., Ankenman, B., Nelson, B., 2007. Efficient generation of cycle time throughput curves through simulation and meta-modeling. *Naval Research Logistics* 54, 78–93.
- Yang, K., Liu, Y., Yang, G., 2013. Solving fuzzy p-hub center problem by genetic algorithm incorporating local search, *Applied Soft Computing*, 13: 2624–2632.
- Yao, D.D., Zheng, S., 1999a. Sequential inspection under capacity constraints. *Operations Research*, 47: 410–422.
- Yao, D.D., Zheng, S., 1999b. Coordinated quality control in a two-stage system. *IEEE Transactions on Automatic Control*, 44: 1166–1179.
- Yum, B.J. and McDowell, E.D., 1981. The optimal allocation of inspection effort in a class of nonserial production systems. *IIE Transactions*, 13, 285–293.
- Yum, B.J. and McDowell, E.D., 1987. Optimal inspection policies in a serial production system including scrap rework and repair: an MILP approach. *International Journal of Production Research*, 25: 1451–1464.
- Yum, B.J., McDowell, E.D., 1987. Optimal inspection policies in a serial production system including scrap rework and repair: An MILP approach. *International Journal of Production Research*, 25(8): 1451–1464.

## References

---

- Zahiri, B., Tavakkoli-Moghaddam, R., Mohammadi, M., Jula, P., 2014. Multi-objective design of an organ transplant network under uncertainty. *Transportation Research Part E*, 72: 101-124
- Zanjirani Farahani, R., Hekmatfar, M., Boloori Arabani, A., Nikbakhsh, E., 2013. Hub Location Problems: A Review of Models, Classification, Techniques and Application. *Computers & Industrial Engineering*, 64 (4): 1096-1109.
- Zheng, S., 2000. Dynamic quality control in assembly systems. *IIE Transactions*, 32, 797-806.
- Zhou, M., Zhao, C., 2002. An optimization model and multiple matching heuristics for quality planning in manufacturing systems. *Computers & industrial engineering*, 42(1), 91-101.

## UN CADRE D'OPTIMISATION MULTI-OBJECTIF POUR LES PROBLEMES DE PLANIFICATION DES INSPECTIONS AVEC PRISE EN COMPTE DES INCERTITUDES ET DEFFAILLANCES

**RESUME :** Dans les systèmes manufacturiers de plus en plus complexes, les variations du processus de fabrication et de ses paramètres opératoires ainsi que leurs effets sur l'ensemble du système doivent être maîtrisés, mesurés et contrôlés. Cette thèse propose un cadre d'optimisation pour l'élaboration d'un plan d'inspection optimal qui permet une prise de décision opérationnelle afin d'assurer la satisfaction des objectifs stratégiques (réduction des coûts, amélioration de la qualité, augmentation de la productivité, ...). La prise de décision se divise en trois questions : Quoi contrôler ? Comment contrôler ? Quand contrôler ? Le manque d'informations fiables sur les processus de production et plusieurs facteurs environnementaux est devenu un problème important qui impose la prise en compte de certaines incertitudes lors de la planification des inspections. Cette thèse propose plusieurs formulations du problème d'optimisation de la planification du processus d'inspection, dans lesquelles, les paramètres sont incertains et les machines de production sont sujettes aux défaillances. Ce problème est formulé par des modèles de programmation mathématique avec les objectifs : minimiser le coût total de fabrication, maximiser la satisfaction du client, et minimiser le temps de la production totale. En outre, les méthodes Taguchi et Monte Carlo sont appliquées pour faire face aux incertitudes. En raison de la complexité des modèles proposés, les algorithmes de méta-heuristiques sont utilisés pour trouver les solutions optimales.

**Mots clés :** Systèmes de Production Multi-échelle, Problème de Planification des Inspections, Optimisation Multi Objectif, Modèles de Programmation Mathématique, Incertitude, Défaillance, méta-heuristiques.

### A MULTI-OBJECTIVE OPTIMIZATION FRAMEWORK FOR AN INSPECTION PLANNING PROBLEM UNDER UNCERTAINTY AND BREAKDOWN

**ABSTRACT:** Quality inspection in multistage production systems (MPSs) has become an issue and this is because the MPS presents various possibilities for inspection. The problem of finding the best inspection plan is an "inspection planning problem". The main simultaneous decisions in an inspection planning problem in a MPS are: 1) *which* quality characteristics need to be inspected, 2) *what* type of inspection should be performed for the selected quality characteristics, 3) *where* these inspections should be performed, and 4) *how* the inspections should be performed. In addition, lack of information about production processes and several environmental factors has become an important issue that imposes a degree of uncertainty to the inspection planning problem. This research provides an optimization framework to plan an inspection process in a MPS, wherein, input parameters are uncertain and inspection tools and production machines are subject to breakdown. This problem is formulated through several mixed-integer mathematical programming models with the objectives of minimizing total manufacturing cost, maximizing customer satisfaction, and minimizing total production time. Furthermore, Taguchi and Monte Carlo methods are applied to cope with the uncertainties. Due to the complexity of the proposed models, meta-heuristic algorithms are employed to find optimal or near-optimal solutions. Finally, this research implements the findings and methods of the inspection planning problem in another application as hub location problem. General and detail concluding remarks are provided for both inspection and hub location problems.

**Keywords :** Inspection Planning, Multistage Production System, Optimization Framework, Robust Optimization, Uncertainty, Breakdown, Mathematical Programming.